



RF TEST REPORT

Applicant Huawei Technologies Co., Ltd
FCC ID QISHIKEY960
Product Hikey960
Brand Hikey
Model Hikey960
Report No. R1809A0407-R2
Issue Date September 21, 2018

TA Technology (Shanghai) Co., Ltd. tested the above equipment in accordance with the requirements in **FCC CFR47 Part 15E (2018)**. The test results show that the equipment tested is capable of demonstrating compliance with the requirements as documented in this report.

Performed by: Peng Tao

Approved by: Kai Xu

TA Technology (Shanghai) Co., Ltd.

No.145, Jintang Rd, Tangzhen Industry Park, Pudong Shanghai, China

TEL: +86-021-50791141/2/3

FAX: +86-021-50791141/2/3-8000



TABLE OF CONTENT

1. Test Laboratory	4
1.1. Notes of the test report.....	4
1.2. Test facility	4
1.3. Testing Location.....	5
2. General Description of Equipment under Test.....	6
3. Applied Standards	7
4. Test Configuration	8
5. Test Case Results	10
5.1. Unwanted Emission	10
5.2. Conducted Emission	51
6. Main Test Instruments.....	54

Summary of measurement results

Number	Summary of measurements of results	Clause in FCC rules	Verdict
1	Average conducted output power	15.407(a)	Refer to Report No.: FR4O0971D and FR4O0971E
2	Occupied bandwidth	15.407(e)	Refer to Report No.: FR4O0971D and FR4O0971E
3	Frequency stability	15.407(g)	Refer to Report No.: FR4O0971D and FR4O0971E
4	Maximum power spectral density	15.407(a)	Refer to Report No.: FR4O0971D and FR4O0971E
5	Unwanted Emissions	15.407(b)	PASS
6	Conducted Emissions	15.207	PASS
Date of Testing: September 7, 2018 ~ September 13, 2018			

Only Unwanted Emission and Conducted Emission are tested for Hikey960 in this report. Other test items refer to the WiFi and Bluetooth Module report (Report No.: FR4O0971D and FR4O0971E).



1. Test Laboratory

1.1. Notes of the test report

This report shall not be reproduced in full or partial, without the written approval of **TA technology (shanghai) co., Ltd.** The results documented in this report apply only to the tested sample, under the conditions and modes of operation as described herein. Measurement Uncertainties were not taken into account and are published for informational purposes only. This report is written to support regulatory compliance of the applicable standards stated above.

1.2. Test facility

CNAS (accreditation number: L2264)

TA Technology (Shanghai) Co., Ltd. has obtained the accreditation of China National Accreditation Service for Conformity Assessment (CNAS).

FCC (Designation number: CN1179, Test Firm Registration Number: 446626)

TA Technology (Shanghai) Co., Ltd. has been listed on the US Federal Communications Commission list of test facilities recognized to perform electromagnetic emissions measurements.

IC (recognition number is 8510A)

TA Technology (Shanghai) Co., Ltd. has been listed by industry Canada to perform electromagnetic emission measurement.

VCCI (recognition number is C-4595, T-2154, R-4113, G-10766)

TA Technology (Shanghai) Co., Ltd. has been listed by industry Japan to perform electromagnetic emission measurement.

A2LA (Certificate Number: 3857.01)

TA Technology (Shanghai) Co., Ltd. has been listed by American Association for Laboratory Accreditation to perform electromagnetic emission measurement.



1.3. Testing Location

Company: TA Technology (Shanghai) Co., Ltd.
Address: No.145, Jintang Rd, Tangzhen Industry Park, Pudong
City: Shanghai
Post code: 201201
Country: P. R. China
Contact: Xu Kai
Telephone: +86-021-50791141/2/3
Fax: +86-021-50791141/2/3-8000
Website: <http://www.ta-shanghai.com>
E-mail: xukai@ta-shanghai.com

2. General Description of Equipment under Test

Client Information

Applicant	Huawei Technologies Co., Ltd
Applicant address	Administration Building, Headquarters of Huawei Technologies Co., Ltd., Bantian, Longgang District, Shenzhen, China
Manufacturer	HiSilicon Technologies Co., Ltd
Manufacturer address	D3, Huawei Base, Bantian, Longgang District, Shenzhen, China

General information

EUT Description	
Model	Hikey960
IMEI	/
Hardware Version	Hikey960_VB
Software Version	android Q
Power Supply	External Power Supply
Antenna Type	Chip Antenna
Antenna Gain	Antenna 1: 4.5 dBi Antenna 2: 4.5 dBi
additional beamforming gain	NA
Test Mode(s)	U-NII-1(5150MHz-5250MHz) U-NII-3(5725MHz-5850MHz)
Modulation Type	802.11a/n (HT20/HT40) : OFDM
Operating Frequency Range(s)	U-NII-1: 5150-5250MHz U-NII-3: 5725-5850MHz
Operating temperature range:	0 ° C to 70° C
Operating voltage range:	8 V to 18 V
State AC voltage:	12V
Note: The information of the EUT is declared by the manufacturer.	



3. Applied Standards

According to the specifications of the manufacturer, it must comply with the requirements of the following standards:

FCC CFR47 Part 15E (2018) Unlicensed National Information Infrastructure Devices

ANSI C63.10 (2013)

KDB 789033 D02 General UNII Test Procedures New Rules v02r01

KDB 662911 D01 Multiple Transmitter Output v02r01

4. Test Configuration

Test Mode

The EUT has been associated with peripherals and configuration operated in a manner tended to maximize its emission characteristics in a typical application.

The radiated emission was measured in the following position: EUT stand-up position (Z axis), lie-down position (X, Y axis). The worst emission was found in lie-down position (X axis) and the worst case was recorded.

In order to find the worst case condition, Pre-tests are needed at the presence of different data rate. Preliminary tests have been done on all the configuration for confirming worst case. Data rate below means worst-case rate of each test item.

Worst-case data rates are shown as following table.

Band	Data Rate	
	Antenna 1	Antenna 2
802.11a	6 Mbps	6 Mbps
802.11n HT20	MCS0	MCS0
802.11n HT40	MCS0	MCS0

The worst case Antenna mode for each of the following tests for Wi-Fi:

Test Cases	Antenna 1	Antenna 2
Unwanted Emissions	802.11a	802.11a
	802.11n HT20/40	802.11n HT20/40
Conducted Emissions	802.11a	802.11a
	802.11n HT20/40	802.11n HT20/40
Note: "O": test all bands		

After the pretest, Antenna 1 was selected as the worst antenna, Only the worst case will be recorded in this report.

**Wireless Technology and Frequency Range**

Wireless Technology		Bandwidth	Channel	Frequency
Wi-Fi	U-NII-1	20 MHz	36	5180MHz
			40	5200MHz
			44	5220MHz
			48	5240MHz
		40 MHz	38	5190MHz
			46	5230MHz
			110	5550MHz
			118	5590MHz
	U-NII-3	20 MHz	134	5670MHz
			142	5710MHz
			149	5745MHz
		40 MHz	153	5765MHz
			157	5785MHz
			161	5805MHz
		165	5825MHz	
		151	5755MHz	
		159	5795MHz	
Does this device support TPC Function? <input type="checkbox"/> Yes <input checked="" type="checkbox"/> No				
Does this device support TDWR Band? <input type="checkbox"/> Yes <input checked="" type="checkbox"/> No				

5. Test Case Results

5.1. Unwanted Emission

Ambient condition

Temperature	Relative humidity	Pressure
23°C ~25°C	45%~50%	101.5kPa

Method of Measurement

The test set-up was made in accordance to the general provisions of ANSI C63.10-2013. The Equipment Under Test (EUT) was set up on a non-conductive table in the semi-anechoic chamber. The test was performed at the distance of 3 m between the EUT and the receiving antenna. The radiated emissions measurements were made in a typical installation configuration. Sweep the whole frequency band range from 9kHz to the 10th harmonic of the carrier, and the emissions less than 20 dB below the permissible value are reported.

During the test, the height of receive antenna shall be moved from 1 to 4 meters, and the antenna shall be performed under horizontal and vertical polarization. The turntable shall be rotated from 0 to 360 degrees for detecting the maximum of radiated spurious signal level. The measurements shall be repeated with orthogonal polarization of the test antenna. The data of cable loss and antenna factor has been calibrated in full testing frequency range before the testing.

Set the spectrum analyzer in the following:

Below 1GHz (detector: Peak and Quasi-Peak)

RBW=100kHz / VBW=300kHz / Sweep=AUTO

Above 1GHz (detector: Peak):

I) Peak emission levels are measured by setting the instrument as follows:

1) RBW = 1 MHz.

2) VBW \geq [3 × RBW]

3) Detector = peak.

4) Sweep time = auto.

5) Trace mode = max hold.

6) Allow sweeps to continue until the trace stabilizes. Note that if the transmission is not continuous, then the time required for the trace to stabilize will increase by a factor of approximately 1 / D, where D is the duty cycle.

II) Average emission levels are measured by setting the instrument as follows:

a) RBW = 1 MHz.

b) VBW \geq [3 × RBW].

c) Detector = RMS (power averaging), if [span / (# of points in sweep)] \leq RBW / 2. Satisfying this condition can require increasing the number of points in the sweep or reducing the span. If the condition is not satisfied, then the detector mode shall be set to peak.

d) Averaging type = power (i.e., rms) (As an alternative, the detector and averaging type may be set



for linear voltage averaging. Some instruments require linear display mode to use linear voltage averaging. Log or dB averaging shall not be used.)

e) Sweep time = auto.

f) Perform a trace average of at least 100 traces if the transmission is continuous. If the transmission is not continuous, then the number of traces shall be increased by a factor of $1 / D$, where D is the duty cycle. For example, with 50% duty cycle, at least 200 traces shall be averaged. (If a specific emission is demonstrated to be continuous—i.e., 100% duty cycle—then rather than turning ON and OFF with the transmit cycle, at least 100 traces shall be averaged.)

g) If tests are performed with the EUT transmitting at a duty cycle less than 98%, then a correction factor shall be added to the measurement results prior to comparing with the emission limit, to compute the emission level that would have been measured had the test been performed at 100% duty cycle. The correction factor is computed as follows:

1) If power averaging (rms) mode was used in the preceding step e), then the correction factor is $[10 \log (1 / D)]$, where D is the duty cycle. For example, if the transmit duty cycle was 50%, then 3 dB shall be added to the measured emission levels.

2) If linear voltage averaging mode was used in the preceding step e), then the correction factor is $[20 \log (1 / D)]$, where D is the duty cycle. For example, if the transmit duty cycle was 50%, then 6 dB shall be added to the measured emission levels.

3) If a specific emission is demonstrated to be continuous (100% duty cycle) rather than turning ON and OFF with the transmit cycle, then no duty cycle correction is required for that emission.

The field strength of spurious emission was measured in the following position: EUT stand-up position (Z axis), lie-down position (X, Y axis). The worst emission was found in stand-up position (Z axis) and the antenna is vertical.

The test is in transmitting mode.

9KHz~~~30MHz

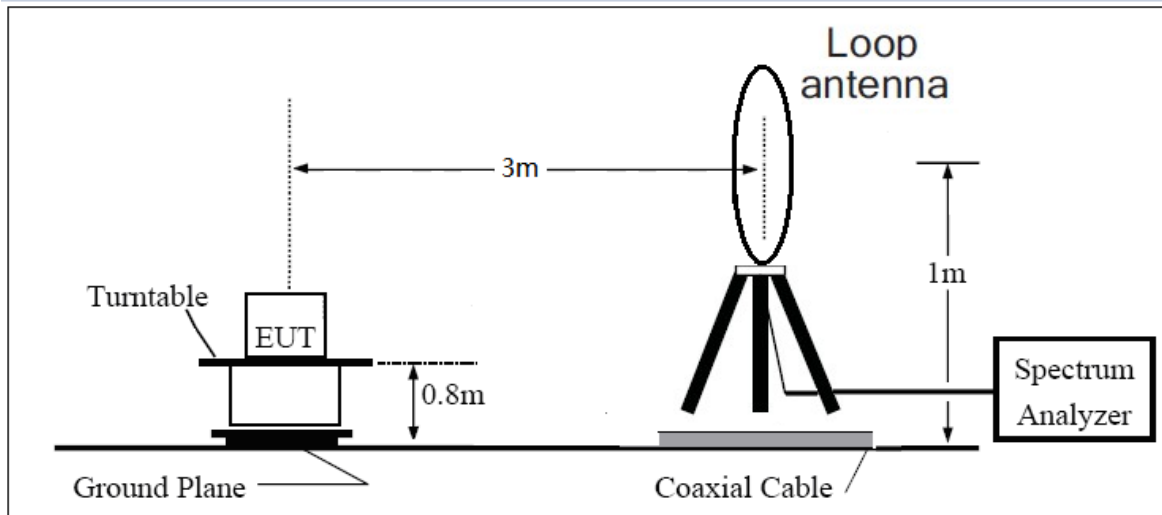

30MHz~~~ 1GHz

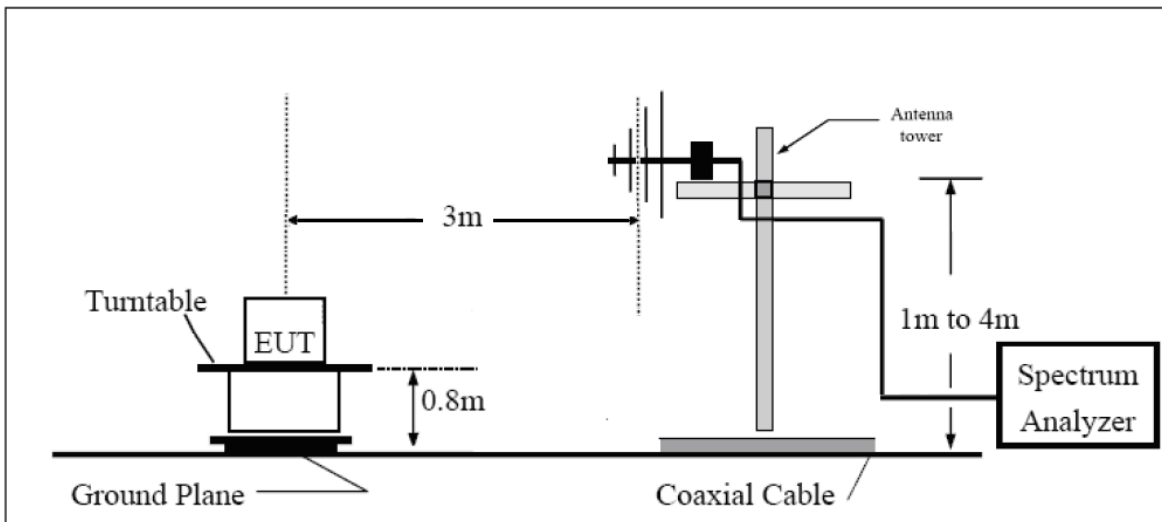

Above 1GHz

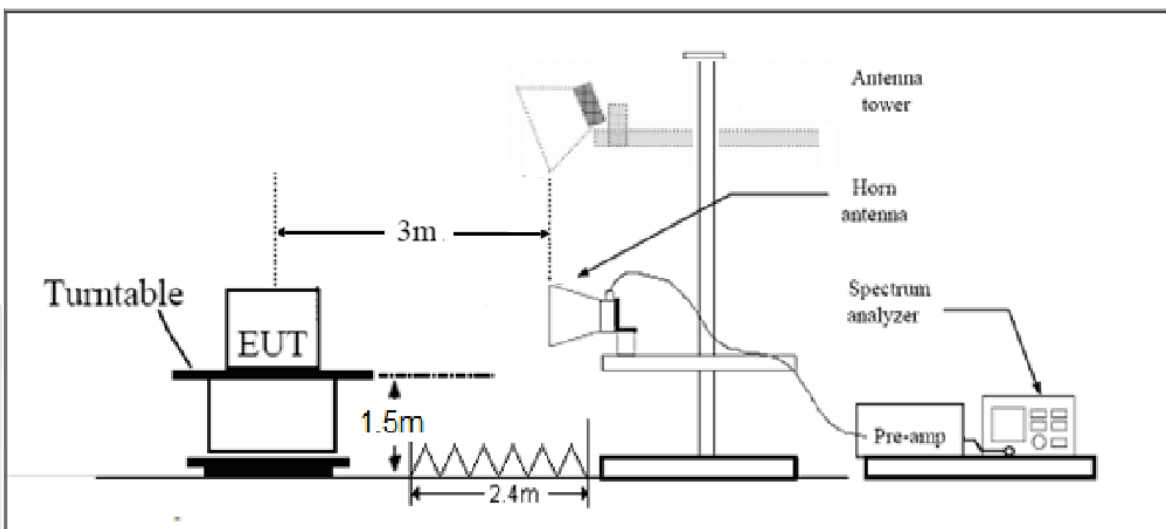

Note: Area side:2.4mX3.6m

Limits

- (1) For transmitters operating in the 5725-5850 MHz band: All emissions shall be limited to a level of -27 dBm/MHz at 75 MHz or more above or below the band edge increasing linearly to 10 dBm/MHz at 25 MHz above or below the band edge, and from 25 MHz above or below the band edge increasing linearly to a level of 15.6 dBm/MHz at 5 MHz above or below the band edge, and from 5 MHz above or below the band edge increasing linearly to a level of 27 dBm/MHz at the band edge.
- (2) For transmitters operating in the 5.15-5.25 GHz band: All emissions outside of the 5.15-5.35 GHz band shall not exceed an e.i.r.p. of -27 dBm/MHz(68.2dBμV/m).
- (3) For transmitters operating in the 5.25-5.35 GHz band: All emissions outside of the 5.15-5.35 GHz band shall not exceed an e.i.r.p. of -27 dBm/MHz(68.2dBμV/m).
- (4) For transmitters operating in the 5.47-5.725 GHz band: All emissions outside of the 5.47-5.725 GHz band shall not exceed an e.i.r.p. of -27 dBm/MHz(68.2dBμV/m).

Note: the following formula is used to convert the EIRP to field strength

§1、 $E[\text{dB}\mu\text{V}/\text{m}] = \text{EIRP}[\text{dBm}] - 20 \log(d[\text{meters}]) + 104.77$, where E = field strength and

d = distance at which field strength limit is specified in the rules;

§2、 $E[\text{dB}\mu\text{V}/\text{m}] = \text{EIRP}[\text{dBm}] + 95.2$, for d = 3 meters

- (5) Unwanted spurious emissions fallen in restricted bands per FCC Part15.205 shall comply with the general field strength limits set forth in § 15.209 as below table.

Frequency of emission (MHz)	Field strength(uV/m)	Field strength(dBuV/m)
0.009–0.490	2400/F(kHz)	/
0.490–1.705	24000/F(kHz)	/
1.705–30.0	30	/
30-88	100	40
88-216	150	43.5
216-960	200	46
Above960	500	54

MHz	MHz	MHz	GHz
0.090 - 0.110	16.42 - 16.423	399.9 - 410	4.5 - 5.15
0.495 - 0.505	16.69475 - 16.69525	608 - 614	5.35 - 5.46
2.1735 - 2.1905	16.80425 - 16.80475	960 - 1240	7.25 - 7.75
4.125 - 4.128	25.5 - 25.67	1300 - 1427	8.025 - 8.5
4.17725 - 4.17775	37.5 - 38.25	1435 - 1626.5	9.0 - 9.2
4.20725 - 4.20775	73 - 74.6	1645.5 - 1646.5	9.3 - 9.5
6.215 - 6.218	74.8 - 75.2	1660 - 1710	10.6 - 12.7
6.26775 - 6.26825	108 - 121.94	1718.8 - 1722.2	13.25 - 13.4
6.31175 - 6.31225	123 - 138	2200 - 2300	14.47 - 14.5
8.291 - 8.294	149.9 - 150.05	2310 - 2390	15.35 - 16.2
8.362 - 8.366	156.52475 - 156.52525	2483.5 - 2500	17.7 - 21.4
8.37625 - 8.38675	156.7 - 156.9	2690 - 2900	22.01 - 23.12
8.41425 - 8.41475	162.0125 - 167.17	3260 - 3267	23.6 - 24.0
12.29 - 12.293	167.72 - 173.2	3332 - 3339	31.2 - 31.8
12.51975 - 12.52025	240 - 285	3345.8 - 3358	36.43 - 36.5
12.57675 - 12.57725	322 - 335.4	3600 - 4400	(²)
13.36 - 13.41			

Measurement Uncertainty

The assessed measurement uncertainty to ensure 95% confidence level for the normal distribution is with the coverage factor $k = 1.96$.

Frequency	Uncertainty
9KHz-30MHz	3.55 dB
30MHz-200MHz	4.19 dB
200MHz-1GHz	3.63 dB
1GHz-26.5G	3.68 dB
26.5G-40GHz	4.76dB



Test Results:

The signal beyond the limit is carrier.

After the pretest, Antenna 1 was selected as the worst antenna, Only the worst case will be recorded in this report.

Antenna 1

U-NII-1

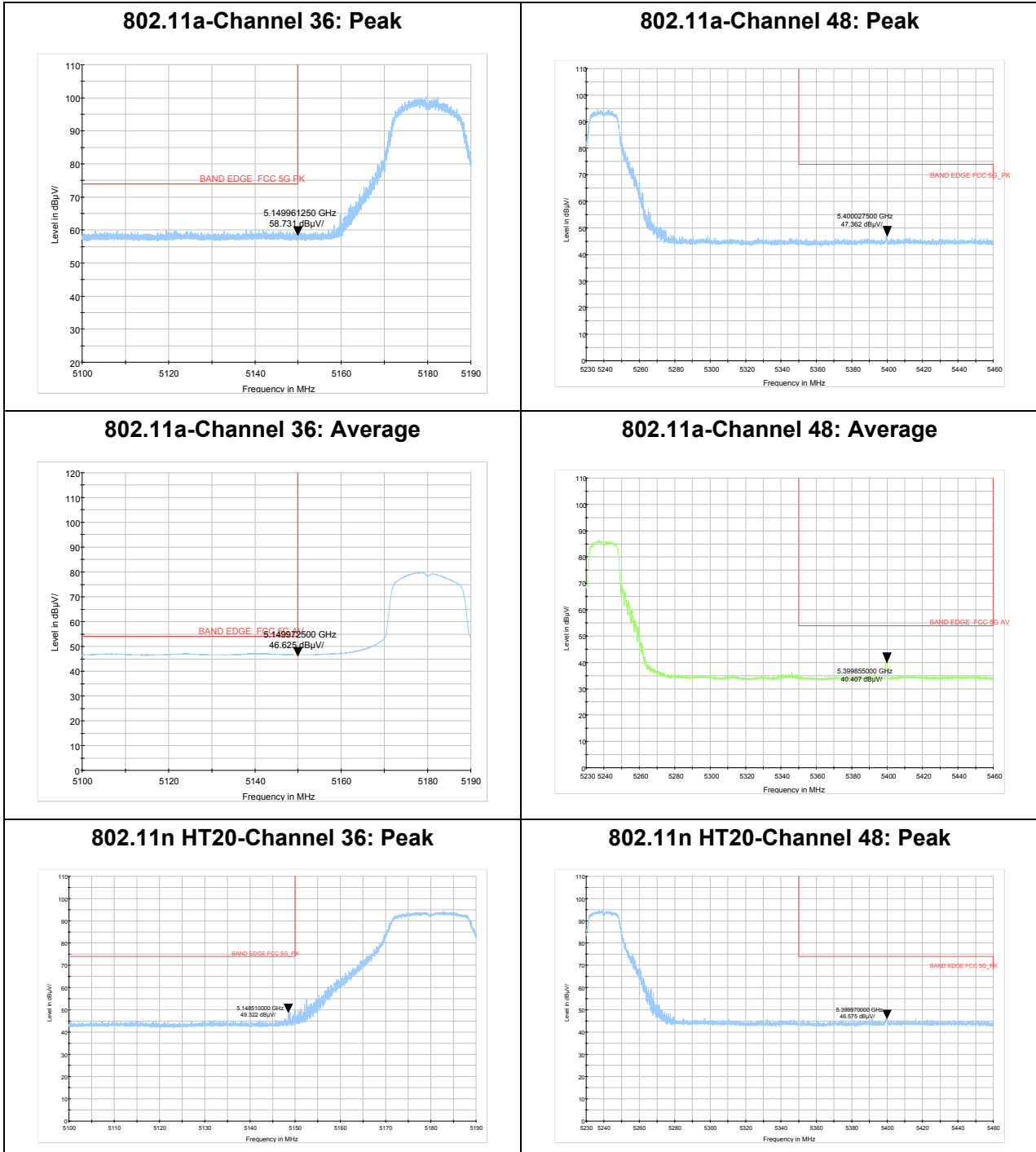



802.11n HT20-Channel 36: Average

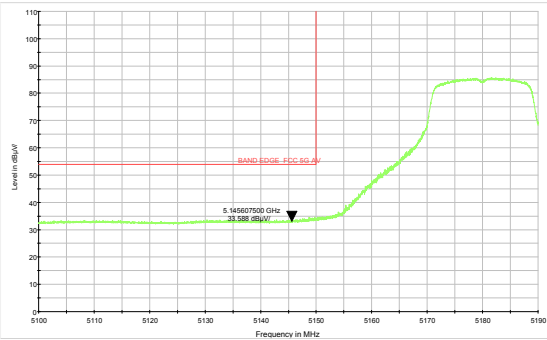

802.11n HT20-Channel 48: Average

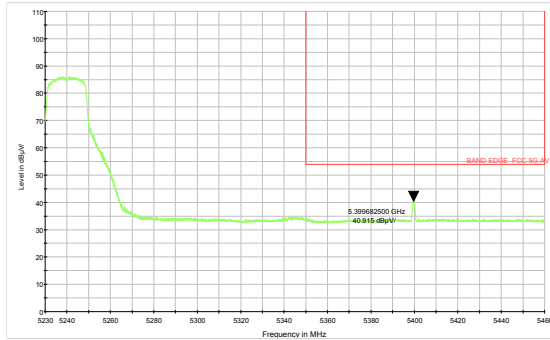

802.11n HT40-Channel 38: Peak

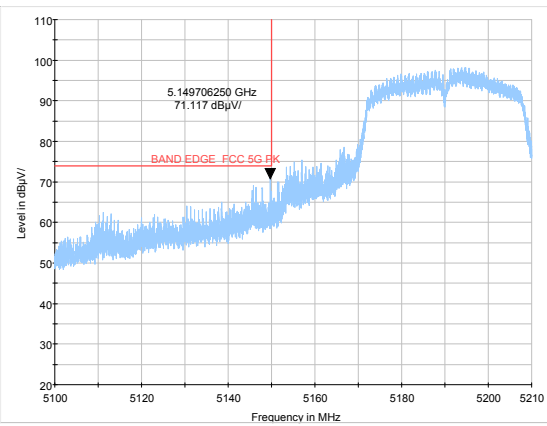

802.11n HT40-Channel 46: Peak

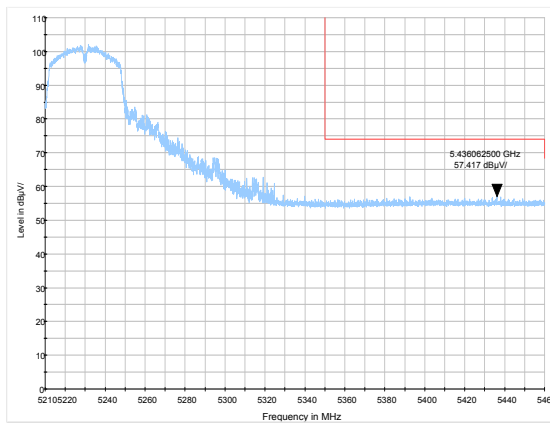

802.11n HT40-Channel 38: Average

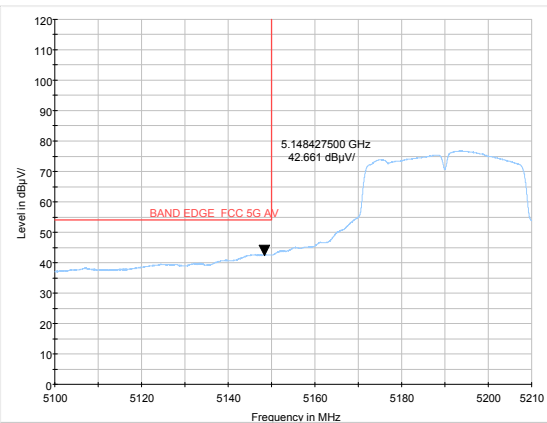

802.11n HT40-Channel 46: Average

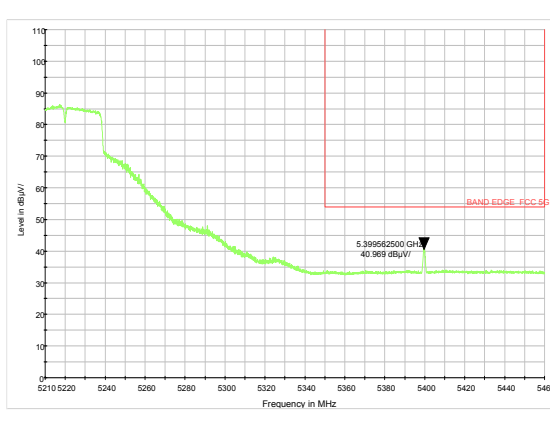



U-NII-3

802.11a-Channel 149: Peak

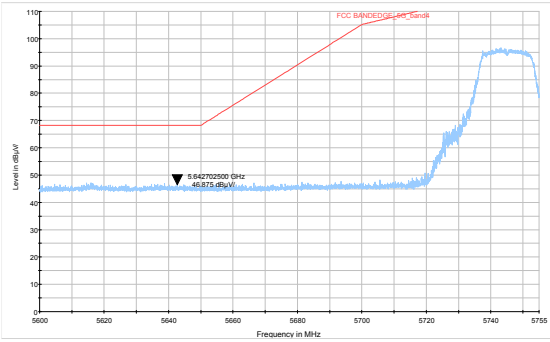

802.11a-Channel 165: Peak

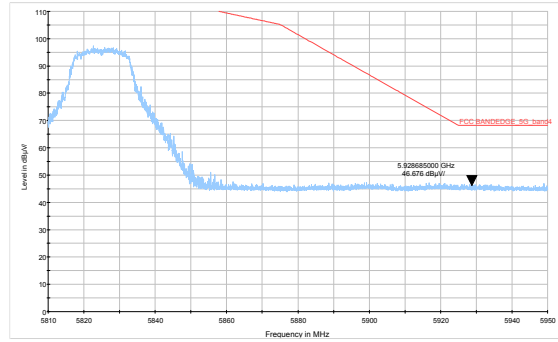

802.11n HT20-Channel 149: Peak

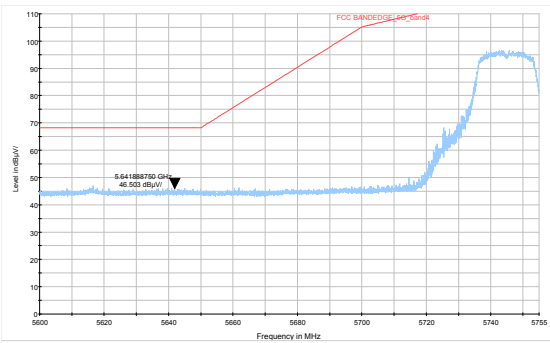

802.11n HT20-Channel 165: Peak

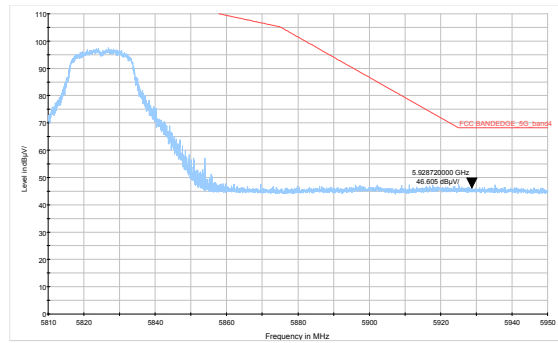

802.11n HT40-Channel 151: Peak

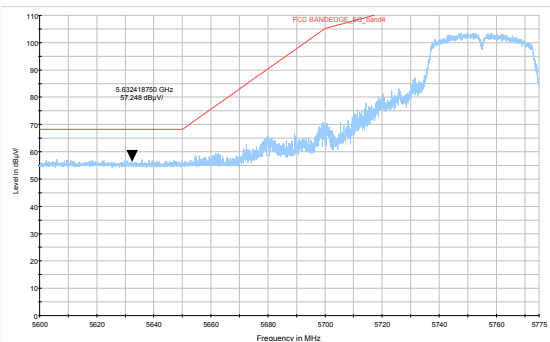

802.11n HT40-Channel 159: Peak

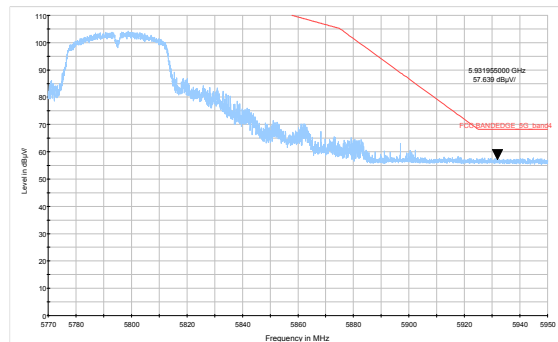

Result of RE

Test result

Sweep the whole frequency band through the range from 9kHz to the 10th harmonic of the carrier, the Emissions in the frequency band 9kHz-30MHz and 18GHz-40GHz are more than 20dB below the limit are not reported.

After the pretest, Antenna 1 was selected as the worst antenna, Only the worst case will be recorded in this report.

During the test, the Radiates Emission from 30MHz to 1GHz was performed in all modes with all channels, 802.11a, Channel 36 are selected as the worst condition. The test data of the worst-case condition was recorded in this report.

Continuous TX mode:

RE 0.03-1GHz QP Class B

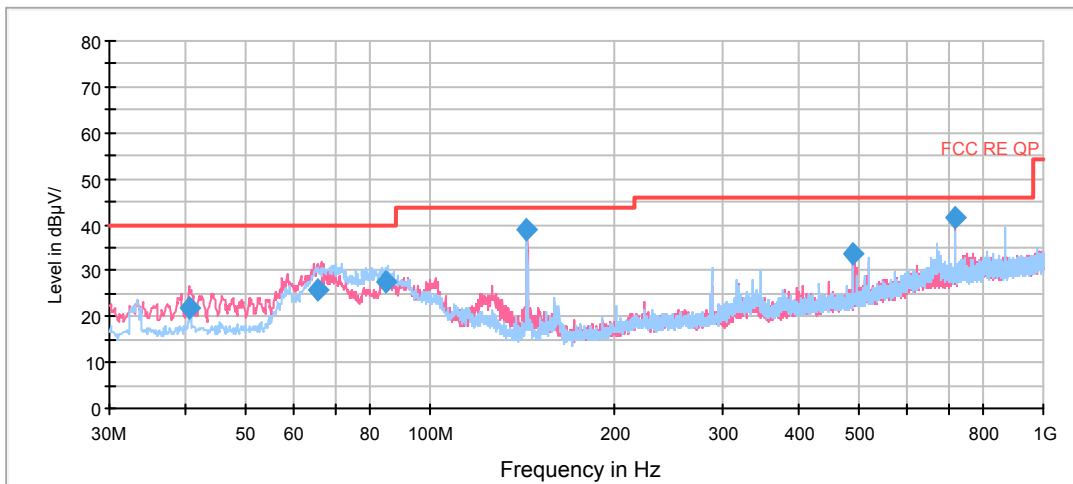

Radiates Emission from 30MHz to 1GHz

Frequency (MHz)	Quasi-Peak (dBuV/m)	Reading value (dBuV/m)	Height (cm)	Polarization	Azimuth (deg)	Correct Factor (dB)	Margin (dB)	Limit (dBuV/m)
40.667500	22.0	8.7	100.0	V	249.0	13.3	18.0	40.0
65.775000	25.9	15.7	100.0	V	96.0	10.2	14.1	40.0
84.850000	27.4	17.2	200.0	H	349.0	10.2	12.6	40.0
144.015000	38.8	29.7	100.0	V	190.0	9.1	4.7	43.5
489.577500	33.5	13.2	100.0	V	119.0	20.3	12.5	46.0
719.993750	41.7	17.5	100.0	V	346.0	24.2	4.3	46.0

- Remark: 1. Quasi-Peak = Reading value + Correction factor
- 2. Correction Factor = Antenna factor+ Insertion loss(cable loss+amplifier gain)
- 3. Margin = Limit – Quasi-Peak



Antenna 1
802.11a CH36

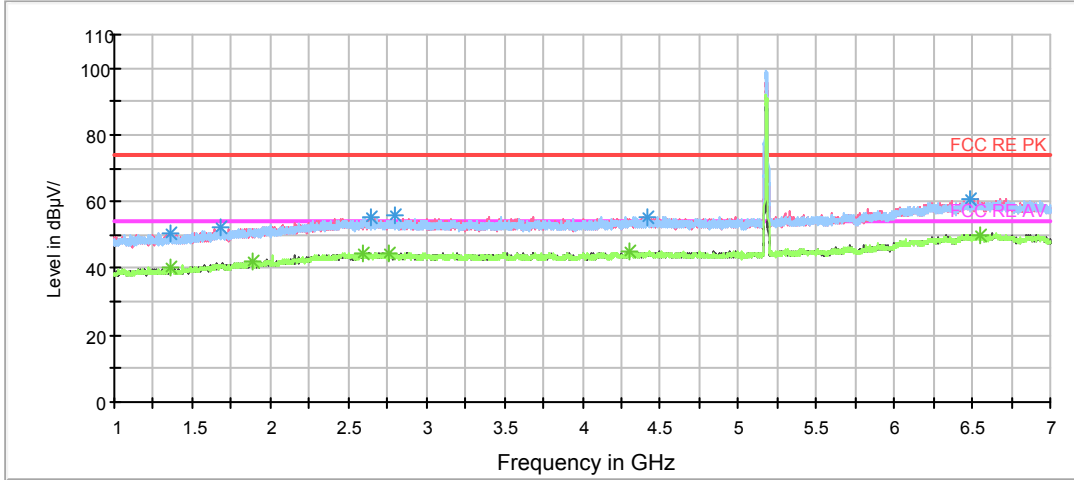

Note: The signal beyond the limit is carrier.
Radiates Emission from 1GHz to 7GHz

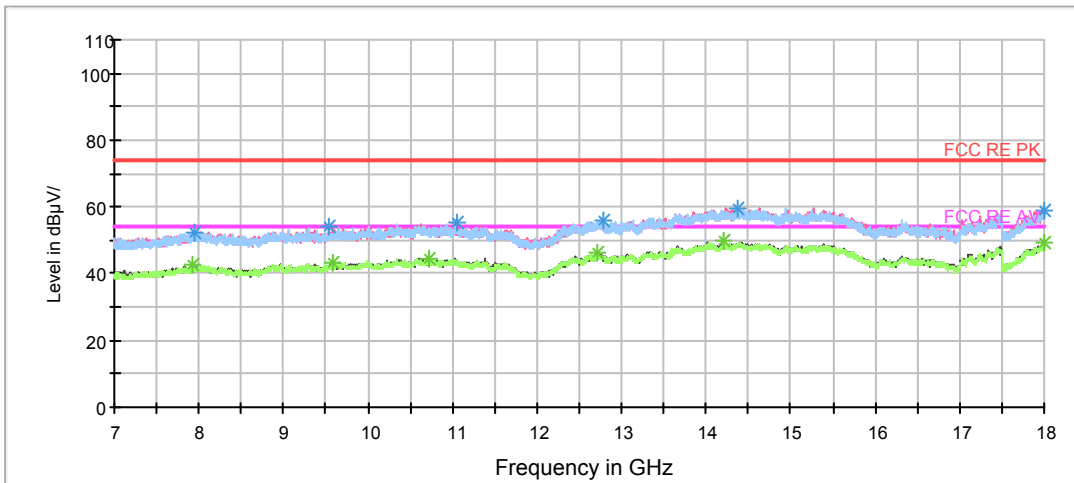

Radiates Emission from 7GHz to 18GHz



Frequency (MHz)	Peak (dBuV/m)	Height (cm)	Polarization	Azimuth (deg)	Reading value (dBuV/m)	Correct Factor (dB)	Margin (dB)	Limit (dBuV/m)
1363.000000	50.5	200.0	V	171.0	50.8	-0.3	23.5	74
1681.000000	52.1	200.0	H	307.0	50.9	1.2	21.9	74
2641.000000	55.1	200.0	H	357.0	49.7	5.4	18.9	74
2803.750000	55.7	200.0	H	352.0	49.9	5.8	18.3	74
4422.250000	55.5	100.0	V	359.0	47.7	7.8	18.5	74
6481.000000	61.0	100.0	H	279.0	47.4	13.6	13.0	74

Remark: 1. Correction Factor = Antenna factor+ Insertion loss (cable loss + amplifier gain)

Frequency (MHz)	Average (dBuV/m)	Height (cm)	Polarization	Azimuth (deg)	Reading value (dBuV/m)	Correct Factor (dB)	Margin (dB)	Limit (dBuV/m)
1357.000000	40.2	100.0	H	0.0	40.6	-0.4	13.8	54
1880.500000	42.0	100.0	V	356.0	39.5	2.5	12.0	54
2587.750000	44.7	100.0	V	303.0	39.2	5.5	9.3	54
2755.750000	44.6	200.0	H	0.0	39.1	5.5	9.4	54
4303.750000	45.0	100.0	V	204.0	37.6	7.4	9.0	54
6545.500000	50.1	200.0	V	60.0	35.9	14.2	3.9	54

Remark: 1. Correction Factor = Antenna factor+ Insertion loss (cable loss + amplifier gain)

802.11a CH40

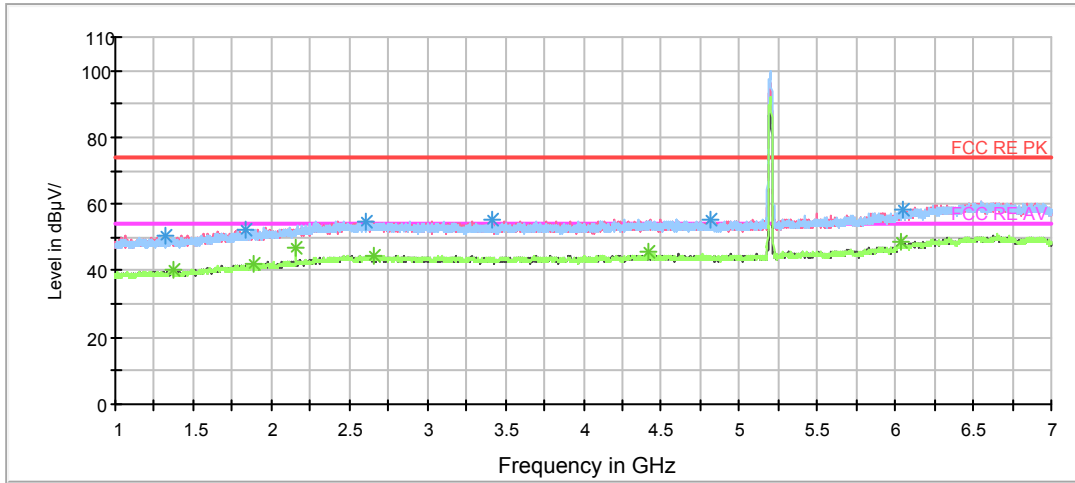

Note: The signal beyond the limit is carrier.
Radiates Emission from 1GHz to 7GHz

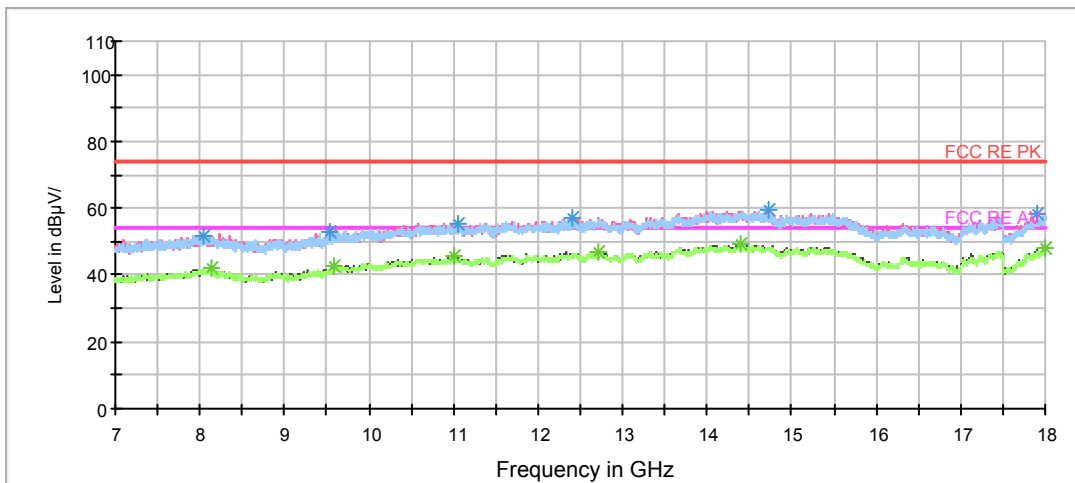

Radiates Emission from 7GHz to 18GHz



Frequency (MHz)	Peak (dBuV/m)	Height (cm)	Polarization	Azimuth (deg)	Reading value (dBuV/m)	Correct Factor (dB)	Margin (dB)	Limit (dBuV/m)
1326.250000	50.4	100.0	H	137.0	51.4	-1.0	23.6	74
1841.500000	52.6	200.0	V	14.0	50.8	1.8	21.4	74
2611.000000	55.0	100.0	V	324.0	49.6	5.4	19.0	74
3412.000000	55.6	200.0	V	182.0	49.7	5.9	18.4	74
4813.750000	55.5	200.0	V	182.0	47.7	7.8	18.5	74
6049.000000	58.6	200.0	V	47.0	46.8	11.8	15.4	74

Remark: 1. Correction Factor = Antenna factor+ Insertion loss (cable loss + amplifier gain)

Frequency (MHz)	Average (dBuV/m)	Height (cm)	Polarization	Azimuth (deg)	Reading value (dBuV/m)	Correct Factor (dB)	Margin (dB)	Limit (dBuV/m)
1372.000000	40.0	100.0	V	358.0	40.3	-0.3	14.0	54
1881.250000	42.0	200.0	V	120.0	39.5	2.5	12.0	54
2159.500000	46.7	100.0	H	87.0	43.1	3.6	7.3	54
2654.500000	44.5	200.0	H	108.0	39.1	5.4	9.5	54
4423.750000	45.7	100.0	H	0.0	38.0	7.7	8.3	54
6033.250000	48.4	100.0	H	50.0	36.7	11.7	5.6	54

Remark: 1. Correction Factor = Antenna factor+ Insertion loss (cable loss + amplifier gain)

802.11a CH48

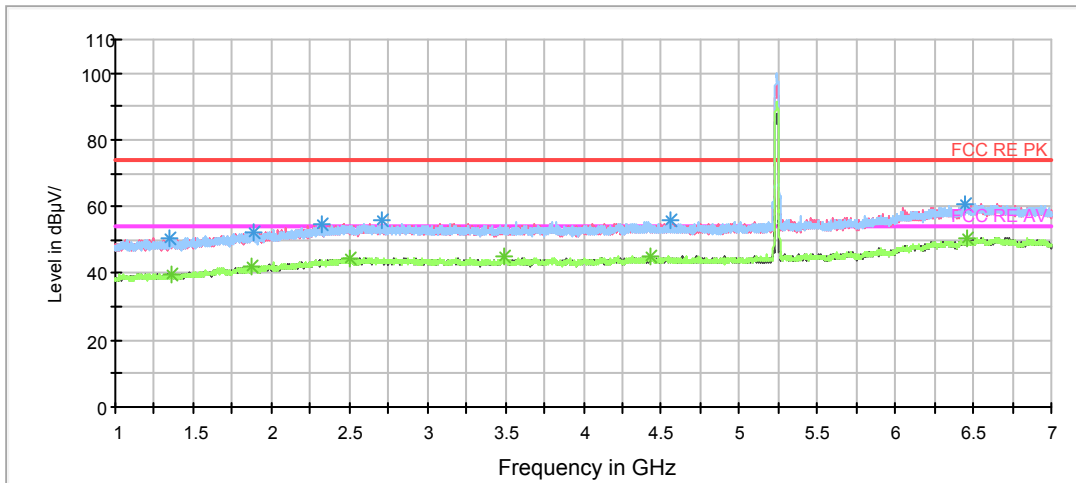

Note: The signal beyond the limit is carrier.
Radiates Emission from 1GHz to 7GHz

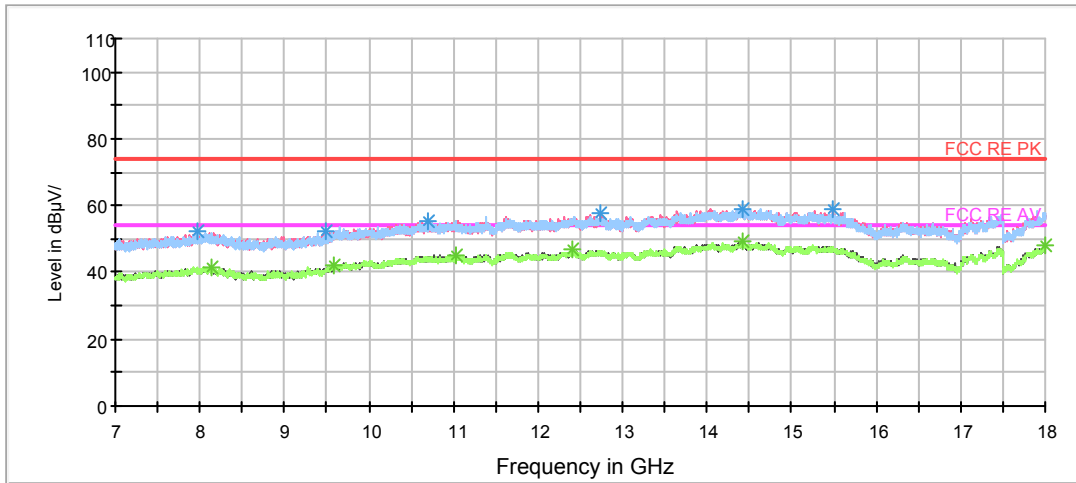

Radiates Emission from 7GHz to 18GHz



Frequency (MHz)	Peak (dBuV/m)	Height (cm)	Polarization	Azimuth (deg)	Reading value (dBuV/m)	Correct Factor (dB)	Margin (dB)	Limit (dBuV/m)
1345.000000	50.6	200.0	H	357.0	51.2	-0.6	23.4	74
1892.500000	52.4	100.0	H	292.0	50.1	2.3	21.6	74
2321.500000	54.9	100.0	V	81.0	50.3	4.6	19.1	74
2713.000000	55.9	200.0	V	7.0	50.4	5.5	18.1	74
4560.250000	55.7	100.0	H	357.0	48.2	7.5	18.3	74
6451.750000	60.6	100.0	V	0.0	46.7	13.9	13.4	74

Remark: 1. Correction Factor = Antenna factor+ Insertion loss (cable loss + amplifier gain)

Frequency (MHz)	Average (dBuV/m)	Height (cm)	Polarization	Azimuth (deg)	Reading value (dBuV/m)	Correct Factor (dB)	Margin (dB)	Limit (dBuV/m)
1360.750000	39.9	200.0	H	248.0	40.3	-0.4	14.1	54
1876.750000	42.2	200.0	V	15.0	39.7	2.5	11.8	54
2500.000000	44.6	200.0	V	15.0	39.3	5.3	9.4	54
3492.250000	44.8	100.0	H	0.0	38.6	6.2	9.2	54
4425.250000	45.3	200.0	H	284.0	37.6	7.7	8.7	54
6463.750000	50.4	100.0	V	330.0	36.6	13.8	3.6	54

Remark: 1. Correction Factor = Antenna factor+ Insertion loss (cable loss + amplifier gain)

802.11a CH149

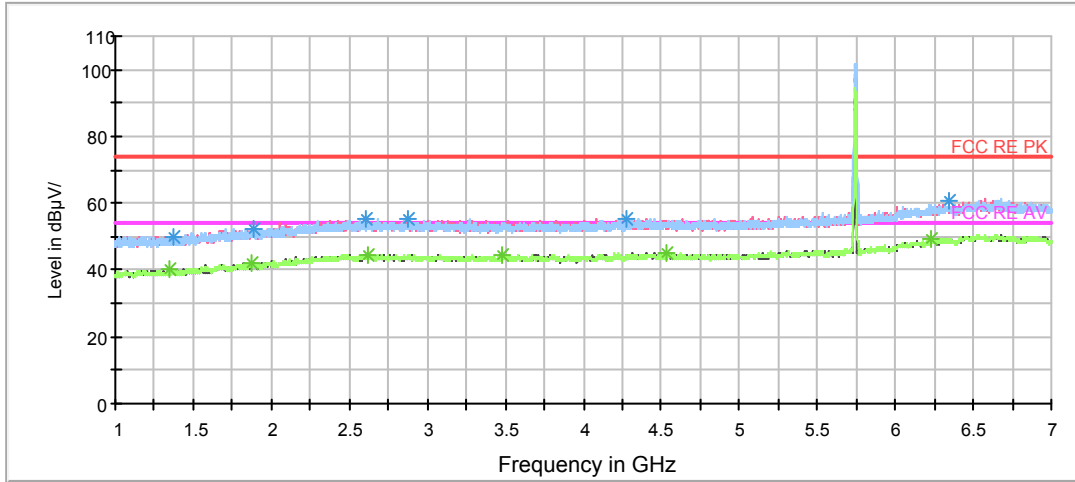

Note: The signal beyond the limit is carrier.
Radiates Emission from 1GHz to 7GHz

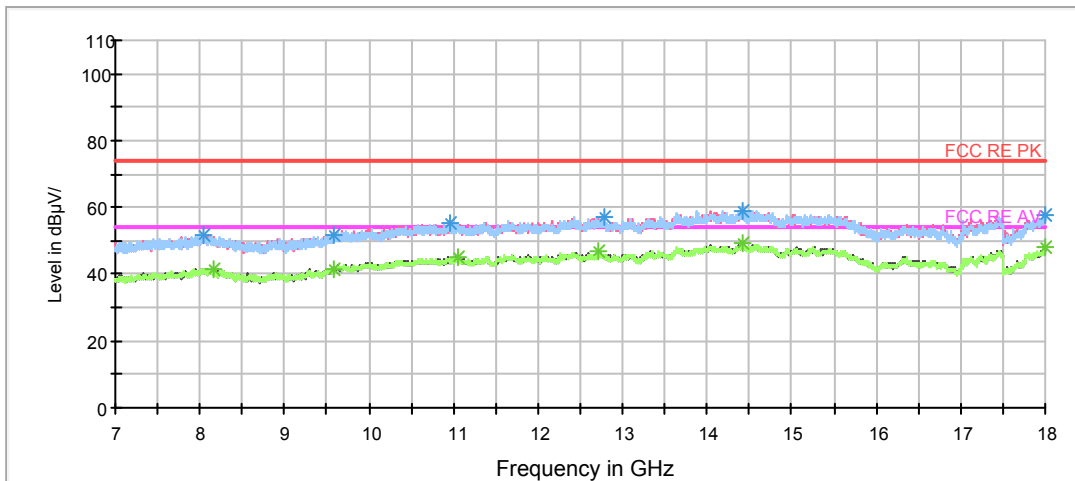

Radiates Emission from 7GHz to 18GHz



Frequency (MHz)	Peak (dBuV/m)	Height (cm)	Polarization	Azimuth (deg)	Reading value (dBuV/m)	Correct Factor (dB)	Margin (dB)	Limit (dBuV/m)
1369.000000	50.2	100.0	H	3.0	50.5	-0.3	23.8	74
1891.000000	52.3	100.0	H	136.0	50.0	2.3	21.7	74
2608.000000	55.0	200.0	V	8.0	49.6	5.4	19.0	74
2875.750000	55.4	100.0	H	2.0	49.7	5.7	18.6	74
4273.750000	55.5	100.0	V	173.0	48.4	7.1	18.5	74
6339.250000	60.7	100.0	V	356.0	47.3	13.4	13.3	74

Remark: 1. Correction Factor = Antenna factor+ Insertion loss (cable loss + amplifier gain)

Frequency (MHz)	Average (dBuV/m)	Height (cm)	Polarization	Azimuth (deg)	Reading value (dBuV/m)	Correct Factor (dB)	Margin (dB)	Limit (dBuV/m)
1343.500000	40.0	100.0	H	61.0	40.6	-0.6	14.0	54
1873.000000	42.3	200.0	H	264.0	39.9	2.4	11.7	54
2619.250000	44.6	100.0	V	0.0	39.1	5.5	9.4	54
3481.000000	44.6	100.0	H	86.0	38.5	6.1	9.4	54
4530.250000	45.2	200.0	V	0.0	37.5	7.7	8.8	54
6223.750000	49.3	100.0	V	354.0	36.2	13.1	4.7	54

Remark: 1. Correction Factor = Antenna factor+ Insertion loss (cable loss + amplifier gain)

802.11a CH157

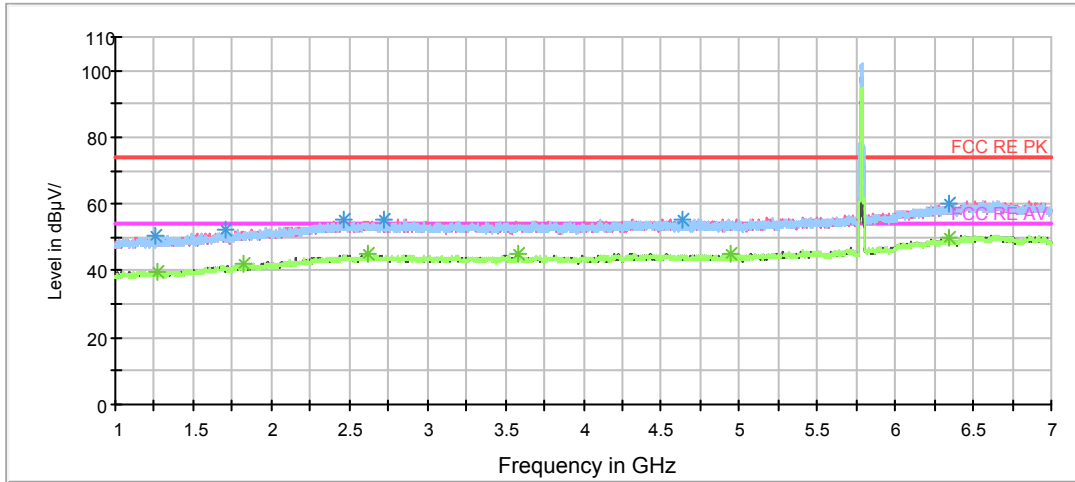

Note: The signal beyond the limit is carrier.
Radiates Emission from 1GHz to 7GHz

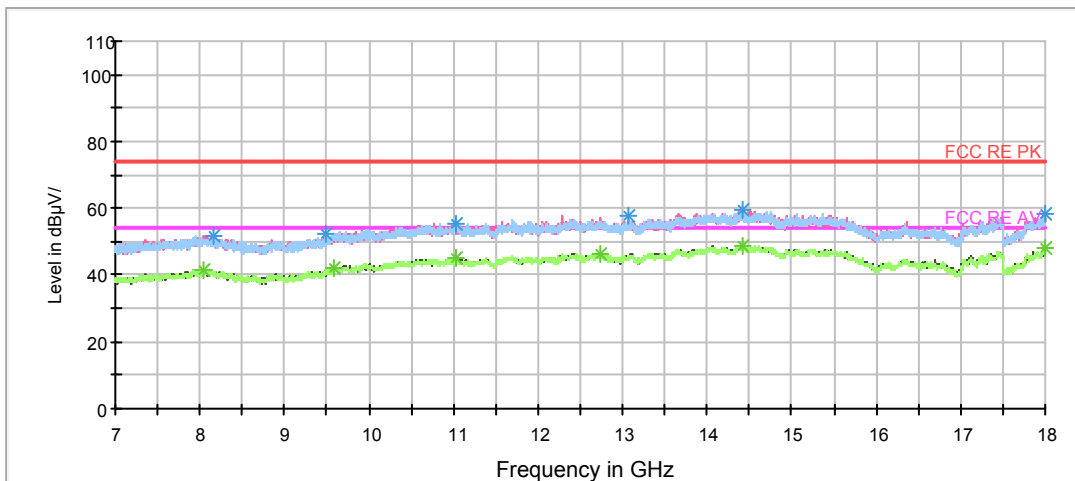

Radiates Emission from 7GHz to 18GHz



Frequency (MHz)	Peak (dBuV/m)	Height (cm)	Polarization	Azimuth (deg)	Reading value (dBuV/m)	Correct Factor (dB)	Margin (dB)	Limit (dBuV/m)
1258.000000	50.6	100.0	H	0.0	51.6	-1.0	23.4	74
1702.000000	52.6	100.0	H	2.0	51.4	1.2	21.4	74
2467.750000	55.5	100.0	V	358.0	50.2	5.3	18.5	74
2716.750000	55.3	100.0	H	212.0	49.8	5.5	18.7	74
4631.500000	55.4	200.0	V	278.0	47.7	7.7	18.6	74
6347.500000	60.0	200.0	V	4.0	46.7	13.3	14.0	74

Remark: 1. Correction Factor = Antenna factor+ Insertion loss (cable loss + amplifier gain)

Frequency (MHz)	Average (dBuV/m)	Height (cm)	Polarization	Azimuth (deg)	Reading value (dBuV/m)	Correct Factor (dB)	Margin (dB)	Limit (dBuV/m)
1276.000000	40.0	200.0	V	195.0	40.8	-0.8	14.0	54
1816.000000	42.1	200.0	H	321.0	40.5	1.6	11.9	54
2617.000000	44.9	200.0	V	2.0	39.4	5.5	9.1	54
3586.000000	44.8	100.0	H	4.0	38.4	6.4	9.2	54
4948.000000	45.2	200.0	H	357.0	37.2	8.0	8.8	54
6343.750000	49.6	100.0	V	198.0	36.2	13.4	4.4	54

Remark: 1. Correction Factor = Antenna factor+ Insertion loss (cable loss + amplifier gain)

802.11a CH165

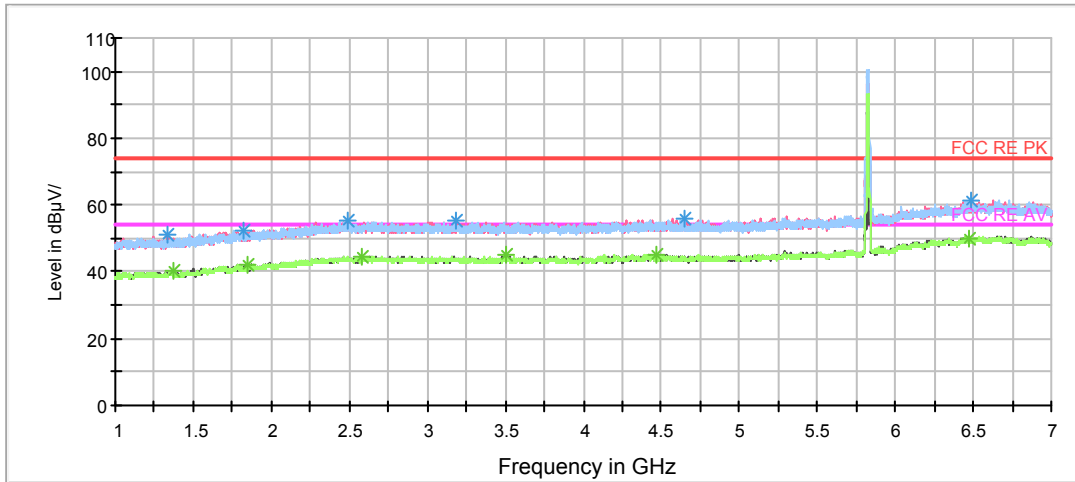

Note: The signal beyond the limit is carrier.
Radiates Emission from 1GHz to 7GHz

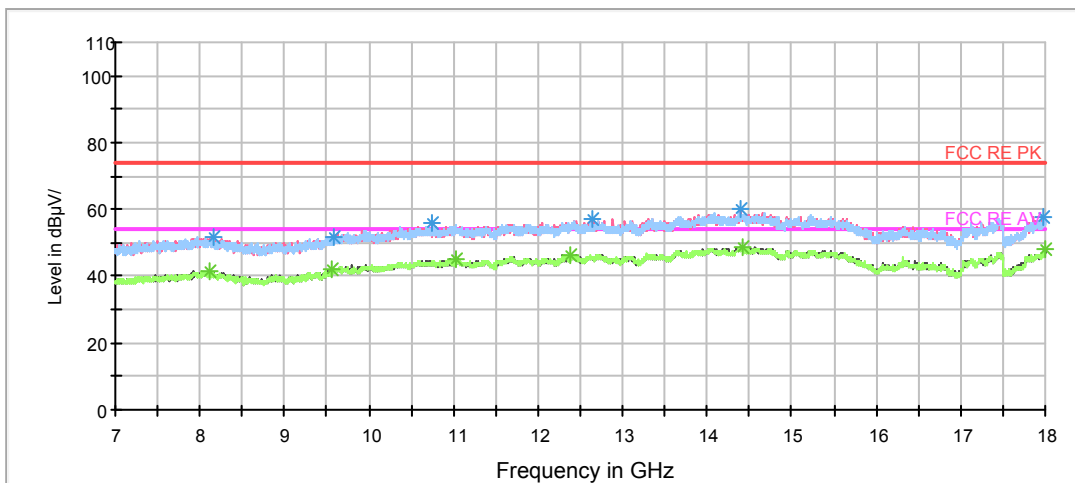

Radiates Emission from 7GHz to 18GHz



Frequency (MHz)	Peak (dBuV/m)	Height (cm)	Polarization	Azimuth (deg)	Reading value (dBuV/m)	Correct Factor (dB)	Margin (dB)	Limit (dBuV/m)
1329.250000	51.0	200.0	V	99.0	51.9	-0.9	23.0	74
1828.000000	52.5	200.0	H	0.0	50.9	1.6	21.5	74
2488.750000	55.3	200.0	V	15.0	50.0	5.3	18.7	74
3180.250000	55.5	200.0	H	199.0	49.6	5.9	18.5	74
4651.750000	56.1	100.0	V	93.0	48.5	7.6	17.9	74
6484.750000	61.3	200.0	V	136.0	47.8	13.5	12.7	74

Remark: 1. Correction Factor = Antenna factor+ Insertion loss (cable loss + amplifier gain)

Frequency (MHz)	Average (dBuV/m)	Height (cm)	Polarization	Azimuth (deg)	Reading value (dBuV/m)	Correct Factor (dB)	Margin (dB)	Limit (dBuV/m)
1369.750000	40.0	200.0	V	199.0	40.3	-0.3	14.0	54
1849.750000	42.3	100.0	H	6.0	40.4	1.9	11.7	54
2584.000000	44.6	100.0	H	4.0	39.2	5.4	9.4	54
3511.000000	44.8	100.0	V	358.0	38.7	6.1	9.2	54
4465.750000	45.2	200.0	V	124.0	37.8	7.4	8.8	54
6473.500000	50.1	200.0	V	0.0	36.4	13.7	3.9	54

Remark: 1. Correction Factor = Antenna factor+ Insertion loss (cable loss + amplifier gain)

802.11n (HT20) CH36

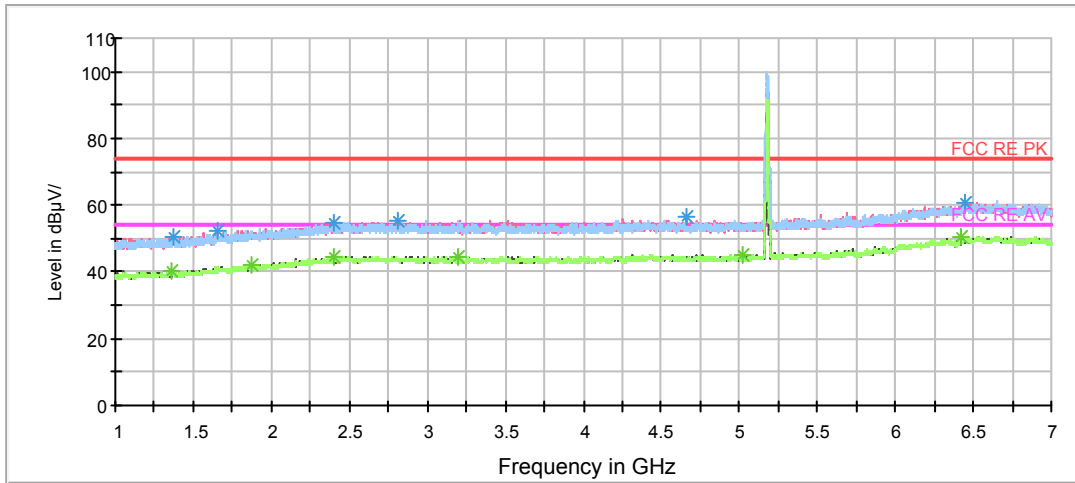

Note: The signal beyond the limit is carrier.
Radiates Emission from 1GHz to 7GHz

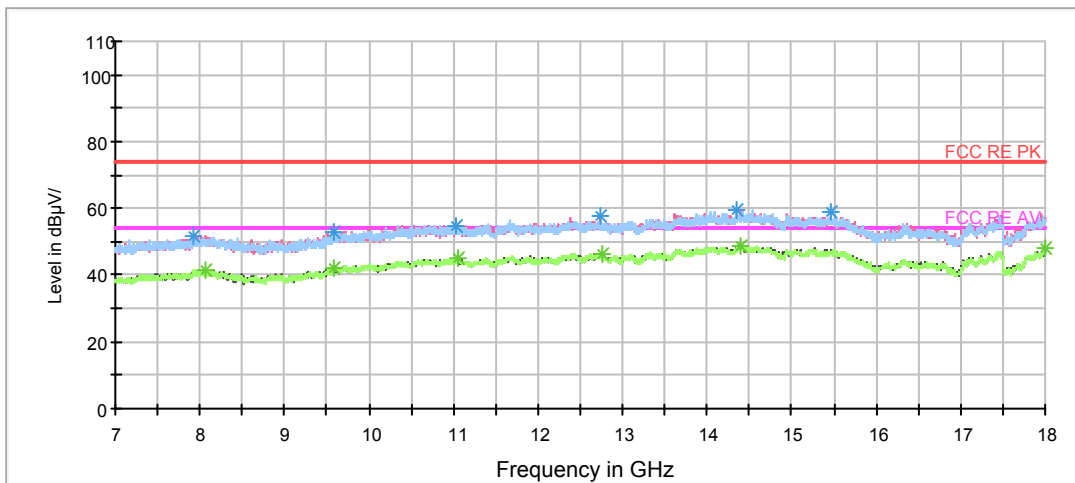

Radiates Emission from 7GHz to 18GHz



Frequency (MHz)	Peak (dBuV/m)	Height (cm)	Polarization	Azimuth (deg)	Reading value (dBuV/m)	Correct Factor (dB)	Margin (dB)	Limit (dBuV/m)
1368.250000	50.5	200.0	V	3.0	50.8	-0.3	23.5	74
1652.500000	52.4	100.0	V	289.0	51.4	1.0	21.6	74
2398.750000	54.9	200.0	H	235.0	50.0	4.9	19.1	74
2805.250000	55.4	100.0	V	289.0	49.6	5.8	18.6	74
4657.000000	56.3	200.0	V	63.0	48.7	7.6	17.7	74
6442.750000	60.5	200.0	H	235.0	46.7	13.8	13.5	74

Remark: 1. Correction Factor = Antenna factor+ Insertion loss (cable loss + amplifier gain)

Frequency (MHz)	Average (dBuV/m)	Height (cm)	Polarization	Azimuth (deg)	Reading value (dBuV/m)	Correct Factor (dB)	Margin (dB)	Limit (dBuV/m)
1357.750000	40.2	200.0	V	3.0	40.6	-0.4	13.8	54
1877.500000	41.9	100.0	V	289.0	39.4	2.5	12.1	54
2395.000000	44.6	200.0	V	238.0	39.7	4.9	9.4	54
3202.000000	44.7	200.0	H	0.0	38.8	5.9	9.3	54
5022.250000	45.1	200.0	H	359.0	37.0	8.1	8.9	54
6426.250000	50.3	100.0	V	333.0	36.7	13.6	3.7	54

Remark: 1. Correction Factor = Antenna factor+ Insertion loss (cable loss + amplifier gain)

802.11n (HT20) CH40

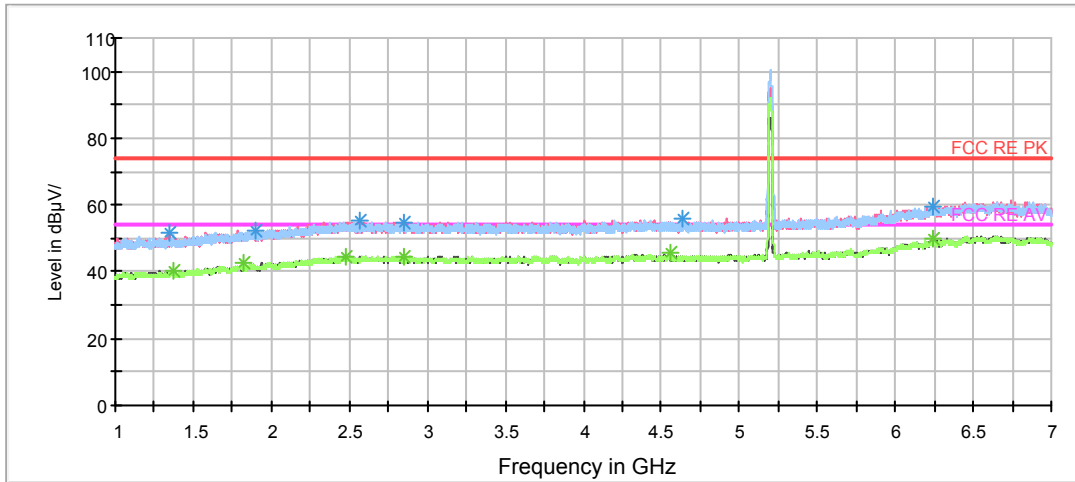

Note: The signal beyond the limit is carrier.
Radiates Emission from 1GHz to 7GHz

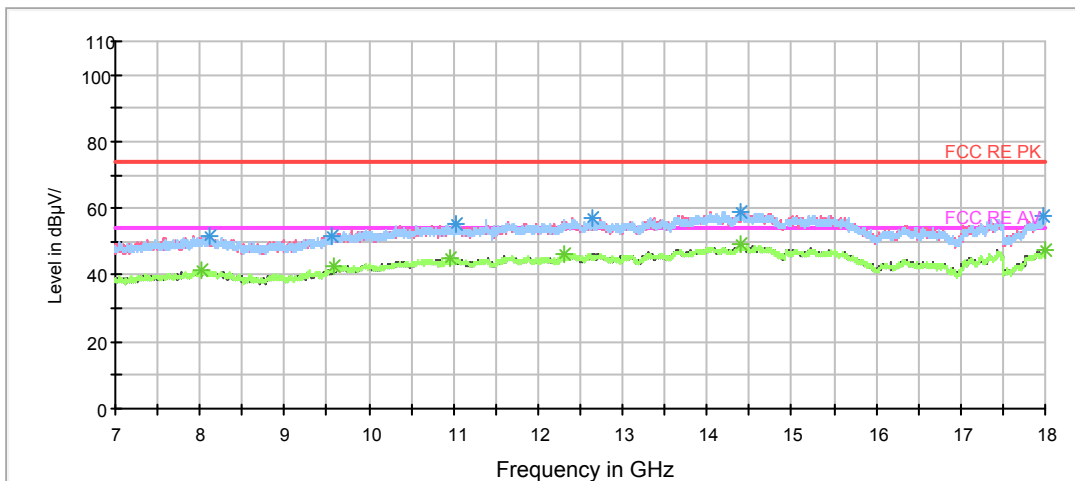

Radiates Emission from 7GHz to 18GHz



Frequency (MHz)	Peak (dBuV/m)	Height (cm)	Polarization	Azimuth (deg)	Reading value (dBuV/m)	Correct Factor (dB)	Margin (dB)	Limit (dBuV/m)
1346.500000	52.0	200.0	V	186.0	52.6	-0.6	22.0	74
1902.250000	52.3	200.0	H	342.0	50.1	2.2	21.7	74
2573.500000	55.2	200.0	V	0.0	49.8	5.4	18.8	74
2855.500000	55.0	100.0	V	350.0	49.3	5.7	19.0	74
4637.500000	55.9	100.0	H	3.0	48.2	7.7	18.1	74
6247.750000	59.3	200.0	V	161.0	46.2	13.1	14.7	74

Remark: 1. Correction Factor = Antenna factor+ Insertion loss (cable loss + amplifier gain)

Frequency (MHz)	Average (dBuV/m)	Height (cm)	Polarization	Azimuth (deg)	Reading value (dBuV/m)	Correct Factor (dB)	Margin (dB)	Limit (dBuV/m)
1369.000000	40.0	100.0	V	330.0	40.3	-0.3	14.0	54
1819.000000	42.4	100.0	H	98.0	40.8	1.6	11.6	54
2474.500000	44.7	100.0	H	264.0	39.4	5.3	9.3	54
2851.000000	44.7	100.0	H	48.0	39.0	5.7	9.3	54
4554.250000	45.4	100.0	H	61.0	37.8	7.6	8.6	54
6237.250000	49.6	200.0	H	101.0	36.3	13.3	4.4	54

Remark: 1. Correction Factor = Antenna factor+ Insertion loss (cable loss + amplifier gain)

802.11n (HT20) CH48

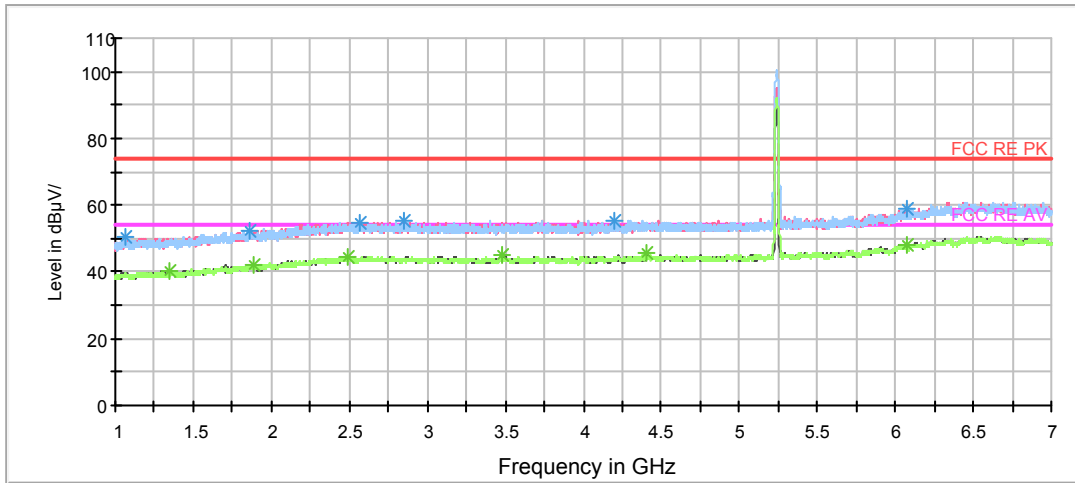

Note: The signal beyond the limit is carrier.
Radiates Emission from 1GHz to 7GHz

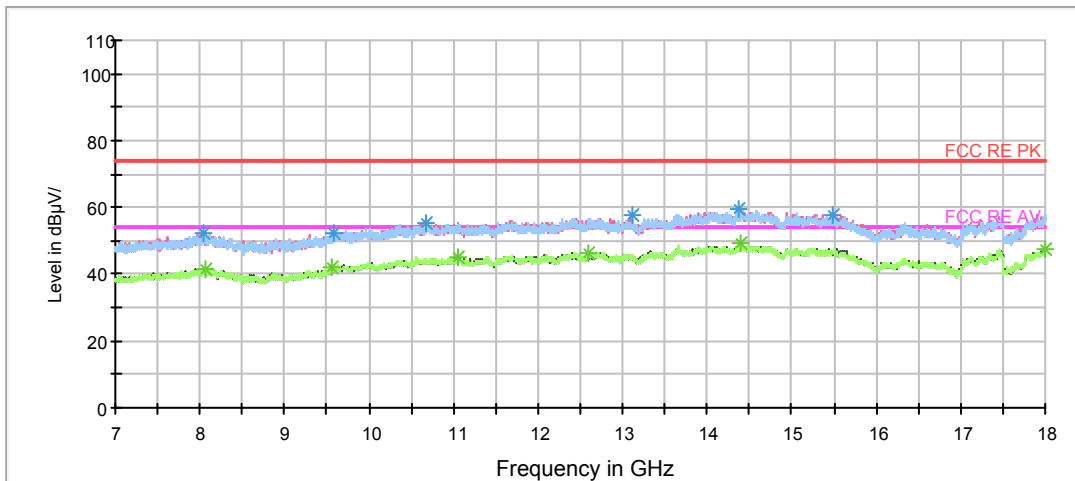

Radiates Emission from 7GHz to 18GHz



Frequency (MHz)	Peak (dBuV/m)	Height (cm)	Polarization	Azimuth (deg)	Reading value (dBuV/m)	Correct Factor (dB)	Margin (dB)	Limit (dBuV/m)
1062.250000	50.3	100.0	H	0.0	51.9	-1.6	23.7	74
1863.250000	52.5	200.0	H	322.0	50.5	2.0	21.5	74
2562.250000	54.9	200.0	H	0.0	49.6	5.3	19.1	74
2850.250000	55.3	100.0	V	210.0	49.6	5.7	18.7	74
4204.000000	55.4	200.0	H	148.0	48.2	7.2	18.6	74
6072.250000	58.9	100.0	V	357.0	47.3	11.6	15.1	74

Remark: 1. Correction Factor = Antenna factor+ Insertion loss (cable loss + amplifier gain)

Frequency (MHz)	Average (dBuV/m)	Height (cm)	Polarization	Azimuth (deg)	Reading value (dBuV/m)	Correct Factor (dB)	Margin (dB)	Limit (dBuV/m)
1348.750000	40.2	100.0	V	358.0	40.8	-0.6	13.8	54
1885.000000	42.1	100.0	V	172.0	39.6	2.5	11.9	54
2490.250000	44.8	200.0	V	0.0	39.5	5.3	9.2	54
3485.500000	44.8	100.0	V	0.0	38.7	6.1	9.2	54
4409.500000	45.4	100.0	V	185.0	37.8	7.6	8.6	54
6076.000000	48.1	100.0	V	50.0	36.5	11.6	5.9	54

Remark: 1. Correction Factor = Antenna factor+ Insertion loss (cable loss + amplifier gain)

802.11n (HT20) CH149

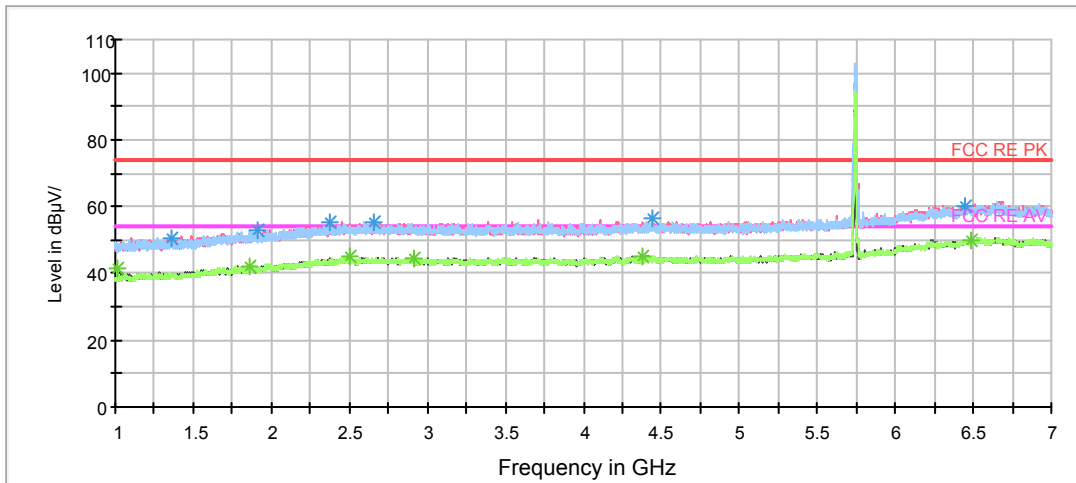

Note: The signal beyond the limit is carrier.
Radiates Emission from 1GHz to 7GHz

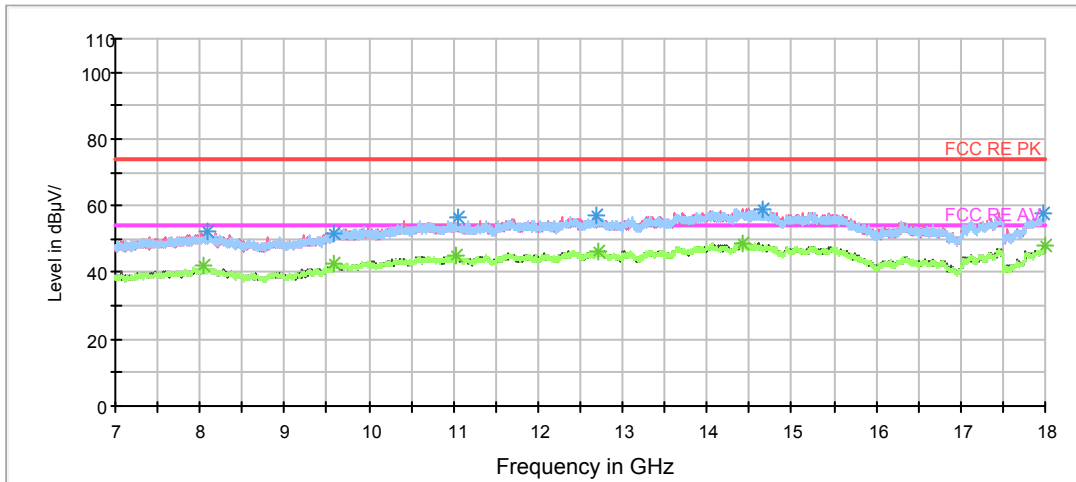

Radiates Emission from 7GHz to 18GHz



Frequency (MHz)	Peak (dBuV/m)	Height (cm)	Polarization	Azimuth (deg)	Reading value (dBuV/m)	Correct Factor (dB)	Margin (dB)	Limit (dBuV/m)
1354.000000	50.6	200.0	V	186.0	51.1	-0.5	23.4	74
1910.500000	53.0	200.0	H	291.0	50.8	2.2	21.0	74
2370.250000	55.5	100.0	V	255.0	50.7	4.8	18.5	74
2652.250000	55.5	100.0	H	98.0	50.1	5.4	18.5	74
4439.500000	56.4	200.0	H	149.0	48.8	7.6	17.6	74
6442.750000	60.2	100.0	V	335.0	46.4	13.8	13.8	74

Remark: 1. Correction Factor = Antenna factor+ Insertion loss (cable loss + amplifier gain)

Frequency (MHz)	Average (dBuV/m)	Height (cm)	Polarization	Azimuth (deg)	Reading value (dBuV/m)	Correct Factor (dB)	Margin (dB)	Limit (dBuV/m)
1007.500000	41.7	100.0	H	73.0	43.8	-2.1	12.3	54
1861.000000	42.3	200.0	H	342.0	40.3	2.0	11.7	54
2499.250000	45.0	100.0	V	0.0	39.7	5.3	9.0	54
2908.750000	44.7	200.0	H	205.0	39.1	5.6	9.3	54
4373.500000	45.1	200.0	H	335.0	38.0	7.1	8.9	54
6480.250000	50.1	200.0	V	306.0	36.5	13.6	3.9	54

Remark: 1. Correction Factor = Antenna factor+ Insertion loss (cable loss + amplifier gain)

802.11n (HT20) CH157

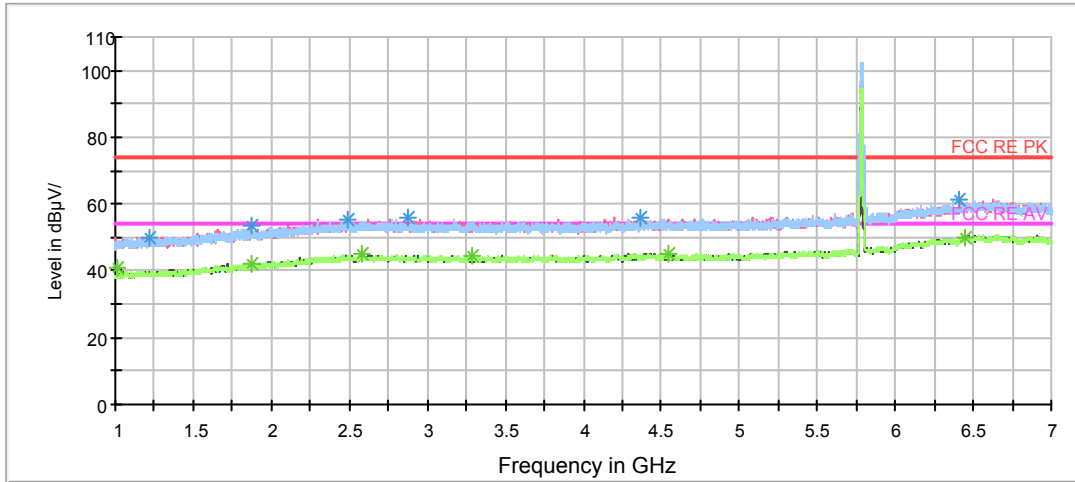

Note: The signal beyond the limit is carrier.
Radiates Emission from 1GHz to 7GHz

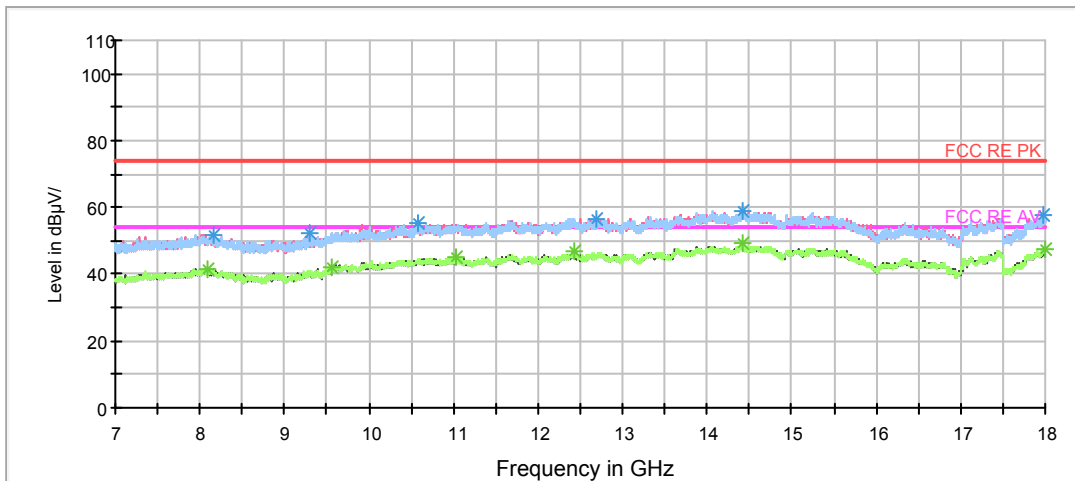

Radiates Emission from 7GHz to 18GHz



Frequency (MHz)	Peak (dBuV/m)	Height (cm)	Polarization	Azimuth (deg)	Reading value (dBuV/m)	Correct Factor (dB)	Margin (dB)	Limit (dBuV/m)
1216.000000	50.2	200.0	V	0.0	51.4	-1.2	23.8	74
1876.000000	53.7	200.0	V	6.0	51.2	2.5	20.3	74
2495.500000	55.2	100.0	H	25.0	49.9	5.3	18.8	74
2870.500000	55.8	200.0	V	20.0	50.1	5.7	18.2	74
4371.250000	56.0	100.0	H	0.0	48.9	7.1	18.0	74
6414.250000	61.2	200.0	V	38.0	47.8	13.4	12.8	74

Remark: 1. Correction Factor = Antenna factor+ Insertion loss (cable loss + amplifier gain)

Frequency (MHz)	Average (dBuV/m)	Height (cm)	Polarization	Azimuth (deg)	Reading value (dBuV/m)	Correct Factor (dB)	Margin (dB)	Limit (dBuV/m)
1007.500000	41.1	100.0	H	80.0	43.2	-2.1	12.9	54
1871.500000	42.2	200.0	H	297.0	39.9	2.3	11.8	54
2584.750000	44.9	200.0	H	23.0	39.5	5.4	9.1	54
3284.500000	44.6	100.0	H	12.0	38.6	6.0	9.4	54
4543.750000	45.2	200.0	V	28.0	37.6	7.6	8.8	54
6441.250000	50.1	200.0	V	1.0	36.3	13.8	3.9	54

Remark: 1. Correction Factor = Antenna factor+ Insertion loss (cable loss + amplifier gain)



802.11n (HT20) CH165

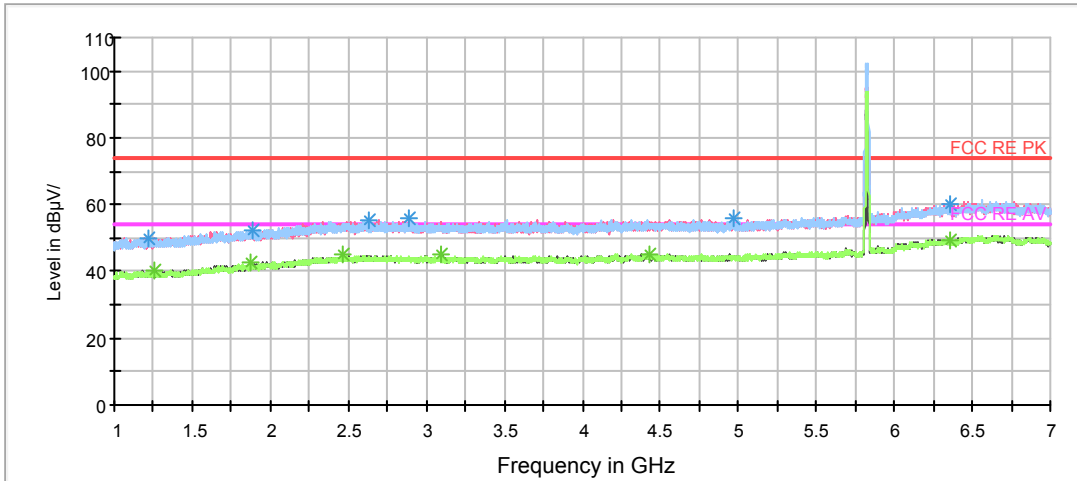

Note: The signal beyond the limit is carrier.
Radiates Emission from 1GHz to 7GHz

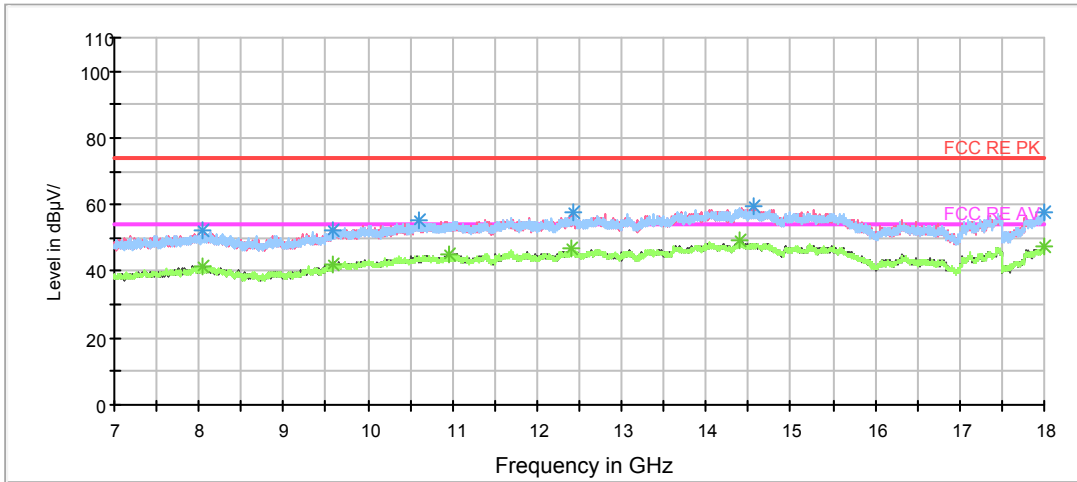

Radiates Emission from 7GHz to 18GHz



Frequency (MHz)	Peak (dBuV/m)	Height (cm)	Polarization	Azimuth (deg)	Reading value (dBuV/m)	Correct Factor (dB)	Margin (dB)	Limit (dBuV/m)
1213.000000	50.1	200.0	H	350.0	51.4	-1.3	23.9	74
1882.000000	52.5	100.0	V	357.0	50.0	2.5	21.5	74
2637.250000	55.2	200.0	H	55.0	49.8	5.4	18.8	74
2890.000000	55.7	100.0	V	0.0	49.9	5.8	18.3	74
4964.500000	55.7	200.0	H	321.0	47.7	8.0	18.3	74
6359.500000	60.3	100.0	V	338.0	47.0	13.3	13.7	74

Remark: 1. Correction Factor = Antenna factor+ Insertion loss (cable loss + amplifier gain)

Frequency (MHz)	Average (dBuV/m)	Height (cm)	Polarization	Azimuth (deg)	Reading value (dBuV/m)	Correct Factor (dB)	Margin (dB)	Limit (dBuV/m)
1258.750000	40.1	200.0	H	0.0	41.1	-1.0	13.9	54
1878.250000	42.4	200.0	V	148.0	39.9	2.5	11.6	54
2458.750000	44.9	200.0	V	0.0	39.8	5.1	9.1	54
3098.500000	44.8	100.0	V	321.0	39.0	5.8	9.2	54
4426.750000	45.3	100.0	V	0.0	37.6	7.7	8.7	54
6361.750000	49.5	200.0	V	0.0	36.2	13.3	4.5	54

Remark: 1. Correction Factor = Antenna factor+ Insertion loss (cable loss + amplifier gain)



802.11n (HT40) CH38

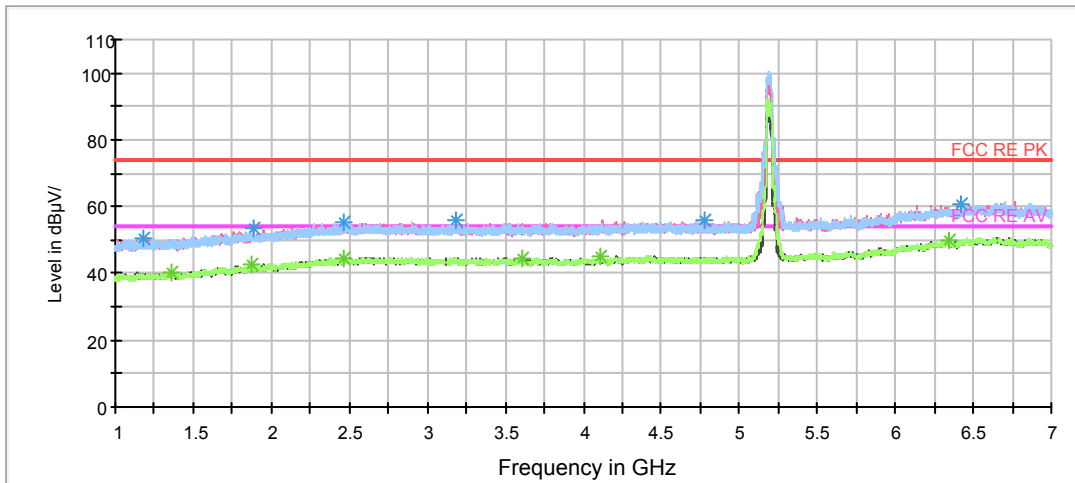

Note: The signal beyond the limit is carrier.
Radiates Emission from 1GHz to 7GHz

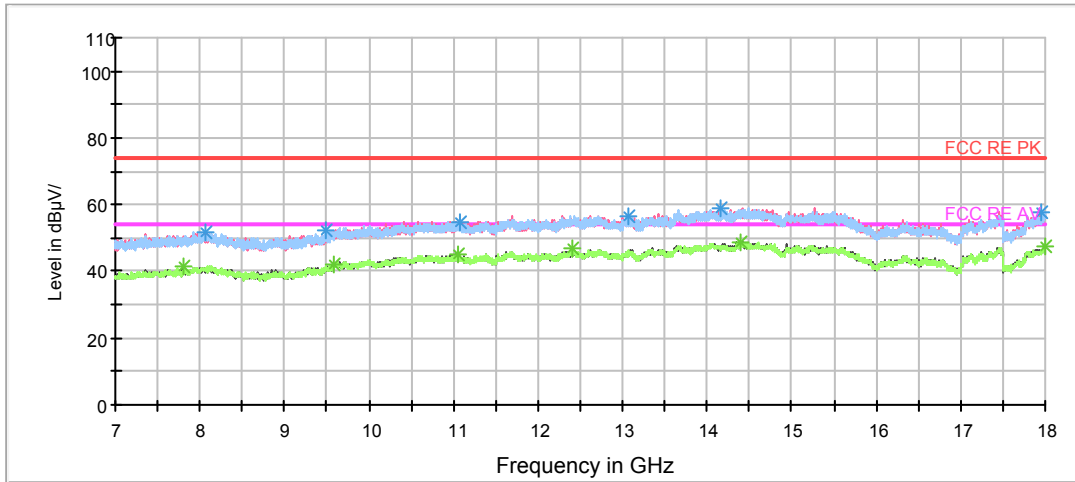

Radiates Emission from 7GHz to 18GHz



Frequency (MHz)	Peak (dBuV/m)	Height (cm)	Polarization	Azimuth (deg)	Reading value (dBuV/m)	Correct Factor (dB)	Margin (dB)	Limit (dBuV/m)
1177.000000	50.6	200.0	V	34.0	51.9	-1.3	23.4	74
1880.500000	53.4	100.0	H	0.0	50.9	2.5	20.6	74
2467.000000	55.3	200.0	V	155.0	50.0	5.3	18.7	74
3184.000000	56.1	200.0	V	180.0	50.2	5.9	17.9	74
4774.000000	55.8	100.0	H	198.0	48.1	7.7	18.2	74
6427.750000	60.7	200.0	V	0.0	47.0	13.7	13.3	74

Remark: 1. Correction Factor = Antenna factor+ Insertion loss (cable loss + amplifier gain)

Frequency (MHz)	Average (dBuV/m)	Height (cm)	Polarization	Azimuth (deg)	Reading value (dBuV/m)	Correct Factor (dB)	Margin (dB)	Limit (dBuV/m)
1366.000000	40.1	100.0	V	202.0	40.4	-0.3	13.9	54
1879.750000	42.9	200.0	H	345.0	40.4	2.5	11.1	54
2467.000000	44.7	200.0	V	155.0	39.4	5.3	9.3	54
3605.500000	44.7	200.0	H	148.0	38.5	6.2	9.3	54
4111.750000	45.2	200.0	V	130.0	38.2	7.0	8.8	54
6340.000000	49.7	100.0	V	286.0	36.3	13.4	4.3	54

Remark: 1. Correction Factor = Antenna factor+ Insertion loss (cable loss + amplifier gain)

802.11n (HT40) CH46

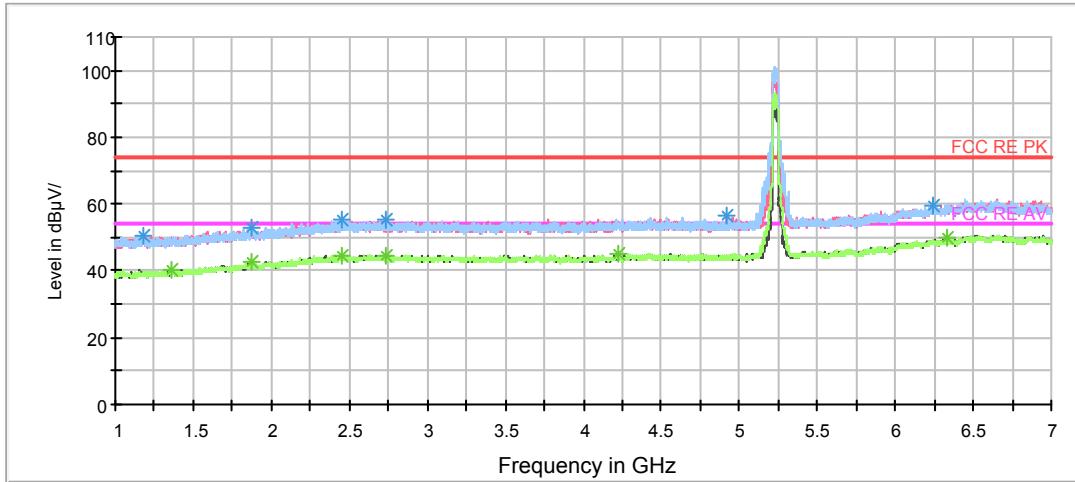

Note: The signal beyond the limit is carrier.
Radiates Emission from 1GHz to 7GHz

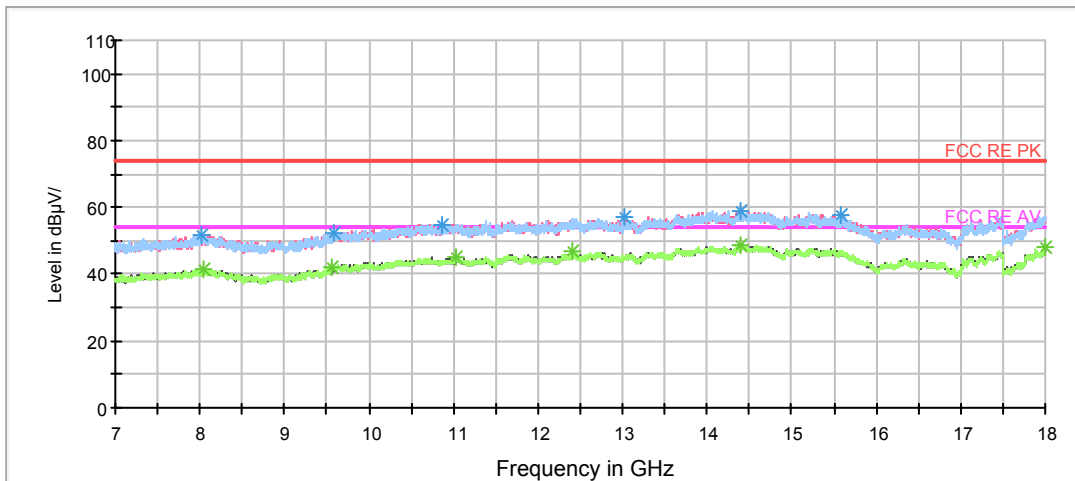

Radiates Emission from 7GHz to 18GHz



Frequency (MHz)	Peak (dBuV/m)	Height (cm)	Polarization	Azimuth (deg)	Reading value (dBuV/m)	Correct Factor (dB)	Margin (dB)	Limit (dBuV/m)
1181.500000	50.3	100.0	V	331.0	51.6	-1.3	23.7	74
1872.250000	52.9	200.0	H	262.0	50.6	2.3	21.1	74
2451.250000	55.0	200.0	H	353.0	50.0	5.0	19.0	74
2734.000000	55.2	100.0	H	3.0	49.8	5.4	18.8	74
4923.250000	56.5	200.0	V	279.0	48.6	7.9	17.5	74
6235.750000	59.4	200.0	H	353.0	46.1	13.3	14.6	74

Remark: 1. Correction Factor = Antenna factor+ Insertion loss (cable loss + amplifier gain)

Frequency (MHz)	Average (dBuV/m)	Height (cm)	Polarization	Azimuth (deg)	Reading value (dBuV/m)	Correct Factor (dB)	Margin (dB)	Limit (dBuV/m)
1354.000000	40.4	100.0	H	21.0	40.9	-0.5	13.6	54
1877.500000	42.4	200.0	H	123.0	39.9	2.5	11.6	54
2454.250000	44.6	200.0	H	322.0	39.6	5.0	9.4	54
2740.750000	44.6	200.0	H	356.0	39.2	5.4	9.4	54
4220.500000	45.1	100.0	V	353.0	37.8	7.3	8.9	54
6337.000000	49.8	100.0	V	345.0	36.4	13.4	4.2	54

Remark: 1. Correction Factor = Antenna factor+ Insertion loss (cable loss + amplifier gain)

802.11n (HT40) CH151

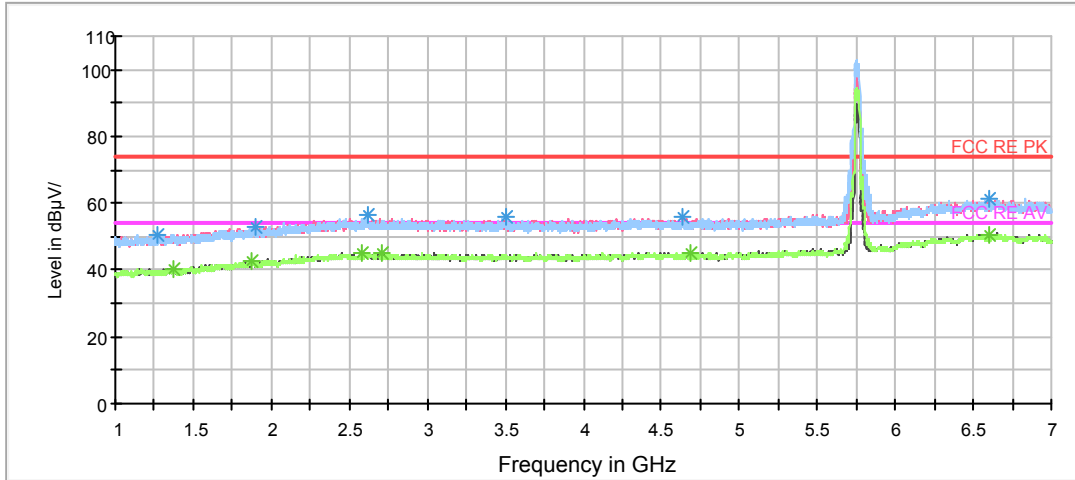

Note: The signal beyond the limit is carrier.
Radiates Emission from 1GHz to 7GHz

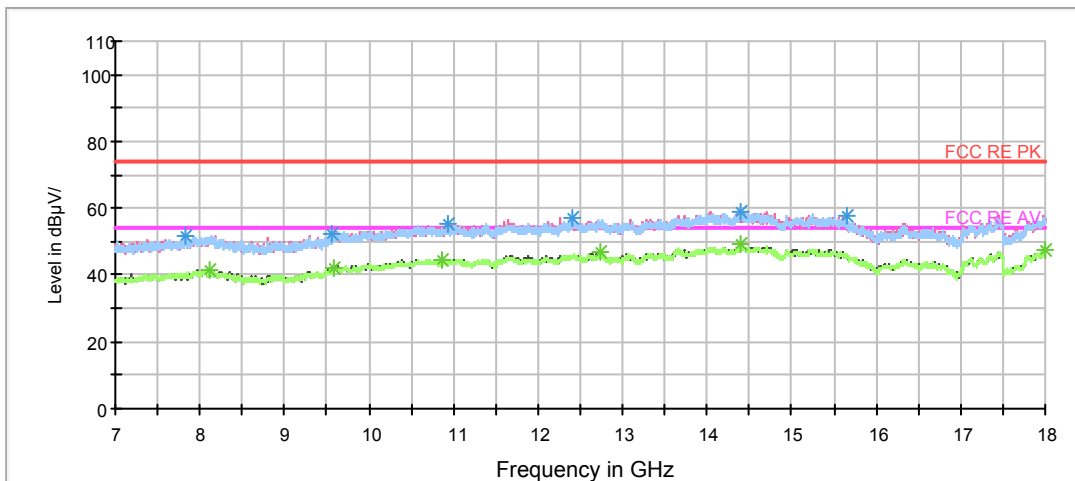

Radiates Emission from 7GHz to 18GHz



Frequency (MHz)	Peak (dBuV/m)	Height (cm)	Polarization	Azimuth (deg)	Reading value (dBuV/m)	Correct Factor (dB)	Margin (dB)	Limit (dBuV/m)
1264.000000	50.7	100.0	V	0.0	51.6	-0.9	23.3	74
1893.250000	53.2	200.0	V	122.0	50.9	2.3	20.8	74
2614.750000	56.2	100.0	H	236.0	50.8	5.4	17.8	74
3511.750000	55.7	200.0	H	173.0	49.6	6.1	18.3	74
4642.000000	55.7	200.0	V	3.0	48.0	7.7	18.3	74
6601.000000	61.5	100.0	V	275.0	47.7	13.8	12.5	74

Remark: 1. Correction Factor = Antenna factor+ Insertion loss (cable loss + amplifier gain)

Frequency (MHz)	Average (dBuV/m)	Height (cm)	Polarization	Azimuth (deg)	Reading value (dBuV/m)	Correct Factor (dB)	Margin (dB)	Limit (dBuV/m)
1372.750000	40.4	100.0	H	0.0	40.7	-0.3	13.6	54
1879.750000	42.7	100.0	H	73.0	40.2	2.5	11.3	54
2578.000000	45.0	200.0	V	2.0	39.7	5.3	9.0	54
2702.500000	45.0	200.0	H	310.0	39.5	5.5	9.0	54
4690.000000	45.3	100.0	V	208.0	37.7	7.6	8.7	54
6598.750000	50.2	100.0	V	286.0	36.5	13.7	3.8	54

Remark: 1. Correction Factor = Antenna factor+ Insertion loss (cable loss + amplifier gain)

802.11n (HT40) CH159

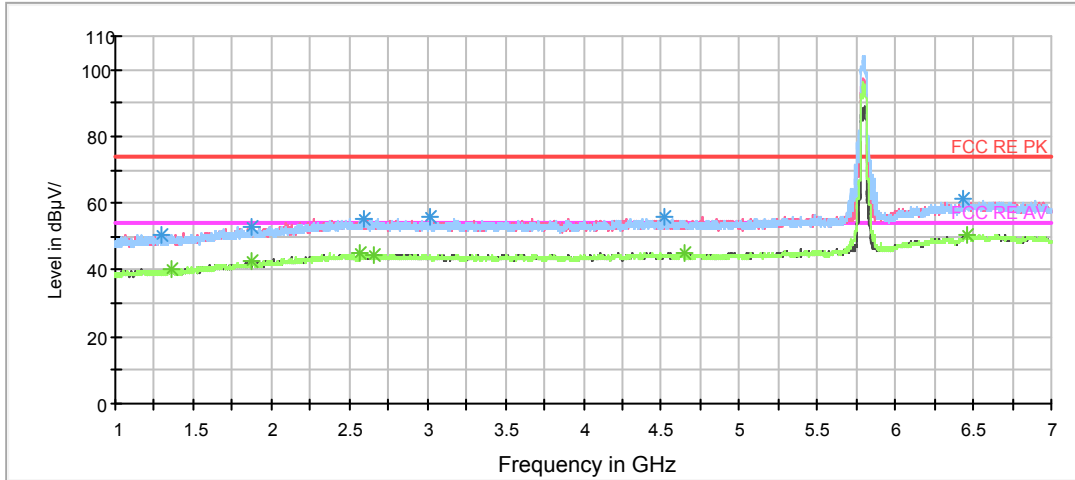

Note: The signal beyond the limit is carrier.
Radiates Emission from 1GHz to 7GHz

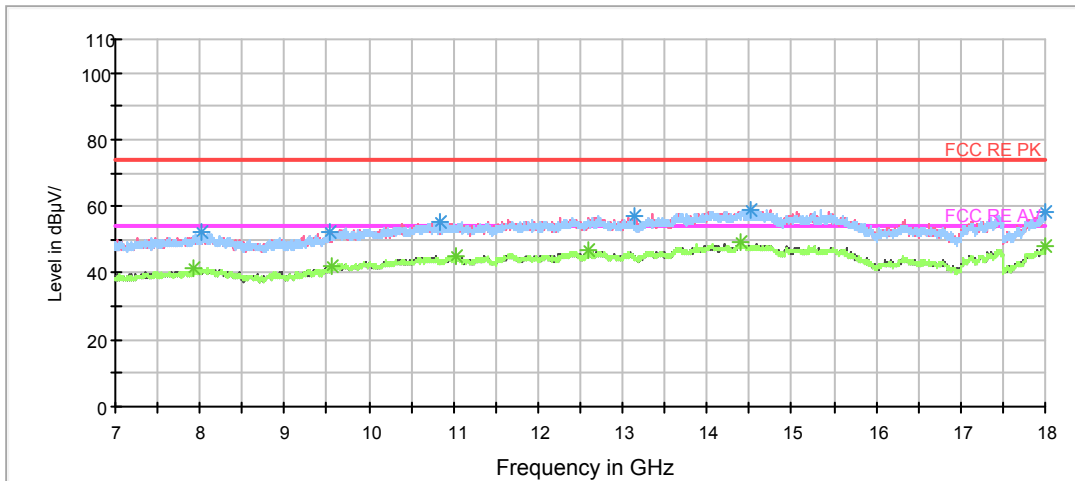

Radiates Emission from 7GHz to 18GHz



Frequency (MHz)	Peak (dBuV/m)	Height (cm)	Polarization	Azimuth (deg)	Reading value (dBuV/m)	Correct Factor (dB)	Margin (dB)	Limit (dBuV/m)
1293.250000	50.8	200.0	V	1.0	51.8	-1.0	23.2	74
1876.750000	52.6	100.0	H	136.0	50.1	2.5	21.4	74
2594.500000	55.4	200.0	V	48.0	49.9	5.5	18.6	74
3019.000000	55.6	100.0	H	0.0	50.0	5.6	18.4	74
4520.500000	56.2	200.0	H	200.0	48.5	7.7	17.8	74
6434.500000	61.2	100.0	V	212.0	47.5	13.7	12.8	74

Remark: 1. Correction Factor = Antenna factor+ Insertion loss (cable loss + amplifier gain)

Frequency (MHz)	Average (dBuV/m)	Height (cm)	Polarization	Azimuth (deg)	Reading value (dBuV/m)	Correct Factor (dB)	Margin (dB)	Limit (dBuV/m)
1364.500000	40.5	200.0	V	4.0	40.8	-0.3	13.5	54
1876.000000	42.4	200.0	V	7.0	39.9	2.5	11.6	54
2571.250000	45.1	200.0	V	211.0	39.7	5.4	8.9	54
2662.000000	44.8	200.0	H	0.0	39.3	5.5	9.2	54
4647.250000	45.1	100.0	H	161.0	37.4	7.7	8.9	54
6456.250000	50.4	200.0	V	1.0	36.5	13.9	3.6	54

Remark: 1. Correction Factor = Antenna factor+ Insertion loss (cable loss + amplifier gain)

5.2. Conducted Emission

Ambient condition

Temperature	Relative humidity	Pressure
23°C ~25°C	45%~50%	101.5kPa

Methods of Measurement

The EUT IS placed on a non-metallic table of 80cm height above the horizontal metal reference ground plane. During the test, the EUT was operating in its typical mode. The test method is according to ANSI C63.10-2013. Connect the AC power line of the EUT to the LISN Use EMI receiver to detect the average and Quasi-peak value. RBW is set to 9kHz, VBW is set to 30kHz The measurement result should include both L line and N line.

The test is in transmitting mode.

Test Setup

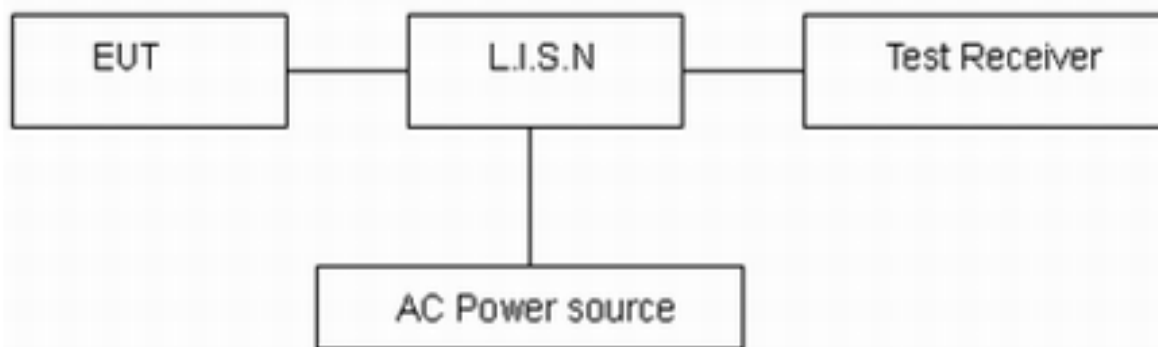

Note: AC Power source is used to change the voltage 110V/60Hz.

Limits

Frequency (MHz)	Conducted Limits(dBμV)	
	Quasi-peak	Average
0.15 - 0.5	66 to 56 *	56 to 46*
0.5 - 5	56	46
5 - 30	60	50

*: Decreases with the logarithm of the frequency.

Measurement Uncertainty

The assessed measurement uncertainty to ensure 95% confidence level for the normal distribution is with the coverage factor $k = 1.96$, $U = 2.69$ dB.

Test Results:

Following plots, Blue trace uses the peak detection and Green trace uses the average detection. During the test, the Conducted Emission was performed in all modes with all channels, 802.11a, Channel 36 are selected as the worst condition. The test data of the worst-case condition was recorded in this report.

Full Spectrum

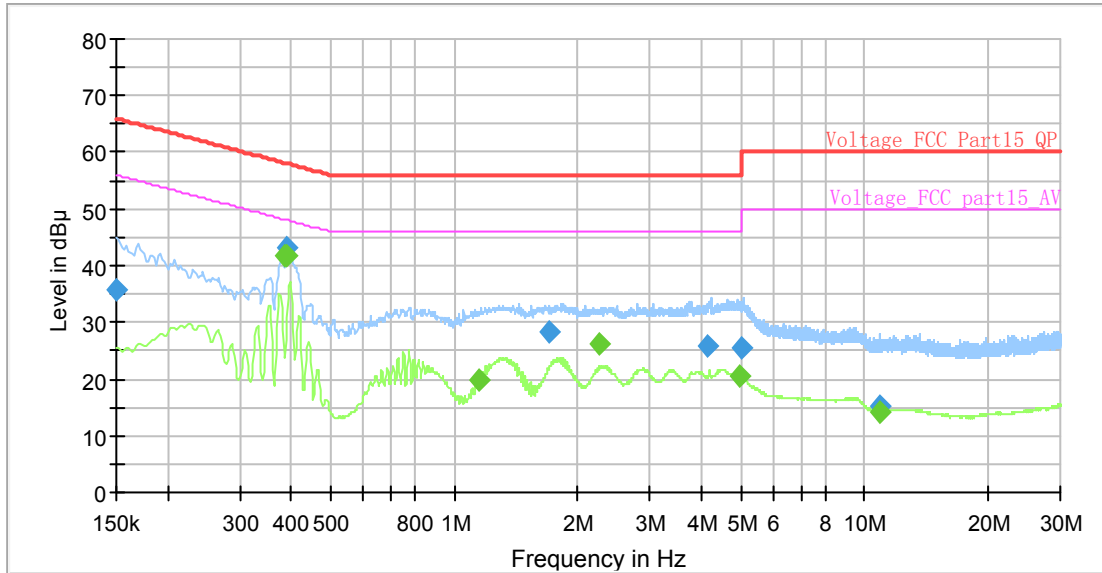

Final Result

Frequency (MHz)	QuasiPeak (dB μV)	Average (dB μV)	Limit (dB μV)	Margin (dB)	Meas. Time (ms)	Bandwidth (kHz)	Line	Filter	Corr. (dB)
0.150000	35.60	---	66.00	30.40	1000.0	9.000	L1	ON	19.1
0.386250	---	41.60	48.14	6.54	1000.0	9.000	L1	ON	19.2
0.388500	---	41.88	48.10	6.22	1000.0	9.000	L1	ON	19.2
0.388500	43.01	---	58.10	15.08	1000.0	9.000	L1	ON	19.2
1.144500	---	19.97	46.00	26.03	1000.0	9.000	L1	ON	19.2
1.695750	28.44	---	56.00	27.56	1000.0	9.000	L1	ON	19.2
2.262750	---	26.16	46.00	19.84	1000.0	9.000	L1	ON	19.1
4.125750	25.93	---	56.00	30.07	1000.0	9.000	L1	ON	19.1
4.958250	---	20.70	46.00	25.30	1000.0	9.000	L1	ON	19.1
5.034750	25.39	---	60.00	34.61	1000.0	9.000	L1	ON	19.1
10.898250	15.22	---	60.00	44.78	1000.0	9.000	L1	ON	19.4
10.936500	---	14.26	50.00	35.74	1000.0	9.000	L1	ON	19.4

L line

Conducted Emission from 150 KHz to 30 MHz

Full Spectrum

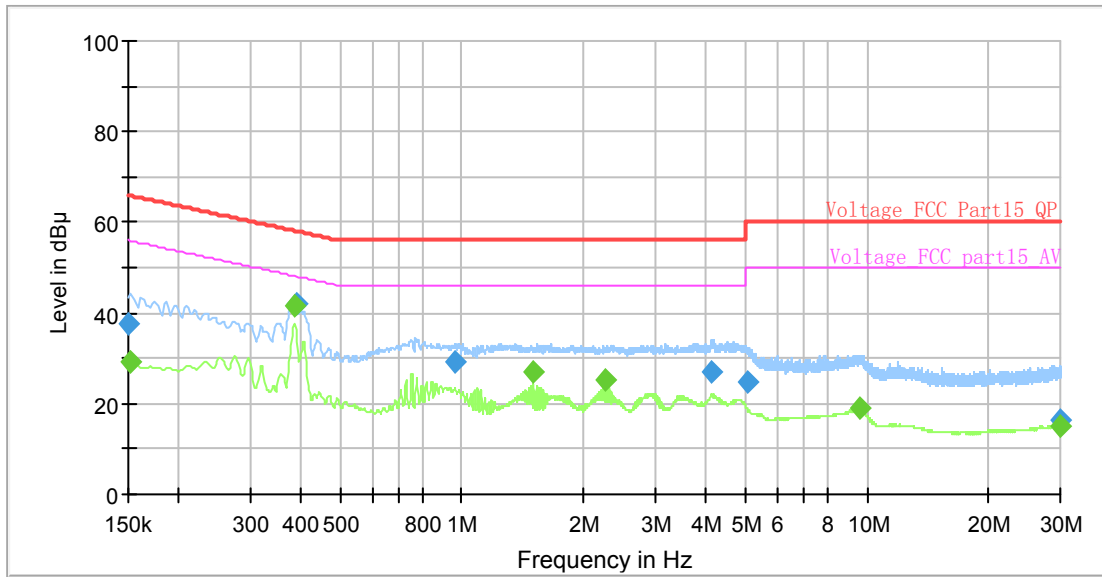

Final Result

Frequency (MHz)	QuasiPeak (dB μ V)	Average (dB μ V)	Limit (dB μ V)	Margin (dB)	Meas. Time (ms)	Bandwidth (kHz)	Line	Filter	Corr. (dB)
0.150000	37.43	---	66.00	28.57	1000.0	9.000	N	ON	19.1
0.152250	---	29.29	55.88	26.58	1000.0	9.000	N	ON	19.1
0.386250	---	41.55	48.14	6.59	1000.0	9.000	N	ON	19.2
0.388500	42.21	---	58.10	15.89	1000.0	9.000	N	ON	19.2
0.955500	29.16	---	56.00	26.84	1000.0	9.000	N	ON	19.2
1.504500	---	26.83	46.00	19.17	1000.0	9.000	N	ON	19.2
2.258244	---	25.27	46.00	20.73	1000.0	9.000	N	ON	19.1
4.127986	26.78	---	56.00	29.22	1000.0	9.000	N	ON	19.1
5.045994	24.73	---	60.00	35.27	1000.0	9.000	N	ON	19.1
9.644976	---	18.82	50.00	31.18	1000.0	9.000	N	ON	19.4
29.876755	---	15.14	50.00	34.86	1000.0	9.000	N	ON	19.7
29.993576	16.27	---	60.00	43.73	1000.0	9.000	N	ON	19.7

N line

Conducted Emission from 150 KHz to 30 MHz



6. Main Test Instruments

Name	Manufacturer	Type	Serial Number	Calibration Date	Expiration Date
Spectrum Analyzer	R&S	FSV40	15195-01-00	2018-05-20	2019-05-19
EMI Test Receiver	R&S	ESCI	100948	2018-05-20	2019-05-19
Loop Antenna	SCHWARZBECK	FMZB1519	1519-047	2017-09-26	2019-09-25
TRILOG Broadband Antenna	SCHWARZBECK	VULB 9163	9163-201	2017-11-18	2019-11-17
Double Ridged Waveguide Horn Antenna	R&S	HF907	100126	2018-07-07	2020-07-06
Standard Gain Horn	ETS-Lindgren	3160-09	00102643	2018-06-20	2020-06-19
Standard Gain Horn	STEATITE	QSH-SL-26-40-K-15	16779	2017-07-20	2019-07-19
Broadband Horn Antenna	SCHWARZBECK	BBHA 9120D	430	2018-07-07	2020-07-06
EMI Test Receiver	R&S	ESR	101667	2018-05-20	2019-05-19
LISN	R&S	ENV216	101171	2016-12-16	2019-12-15
Spectrum Analyzer	KEYSIGHT	N9020A	MY54420163	2017-12-17	2018-12-16
RF Cable	Agilent	SMA 15cm	0001	/	/
TEMPERATURE CHAMBER	WEISS	VT4002	58226119450010	2017-12-17	2018-12-16
AV Power Meter	R&S	NRP	104306	2018-05-20	2019-05-19
Power Probe	R&S	NRP-Z21	104799	2018-05-20	2019-05-19
DC Power Supply	GWINSTEK	GPS-3030D	GEP882653	2018-05-20	2020-05-19
Software	R&S	EMC32	9.26.0	/	/

*****END OF REPORT *****