

# FCC SAR Test Report

APPLICANT : Huawei Technologies Co., Ltd.  
EQUIPMENT : Huawei Mediapad M5 wp  
BRAND NAME : HUAWEI  
MODEL NAME : d-02K  
FCC ID : QISHDL-L0J  
STANDARD : FCC 47 CFR Part 2 (2.1093)  
ANSI/IEEE C95.1-1992  
IEEE 1528-2013

We, Sporton International (Shenzhen) Inc., would like to declare that the tested sample has been evaluated in accordance with the procedures and had been in compliance with the applicable technical standards.

The test results in this report apply exclusively to the tested model / sample. Without written approval of Sporton International (Shenzhen) Inc., the test report shall not be reproduced except in full.



Approved by: Mark Qu / Manager



**Sporton International (Shenzhen) Inc.**

**1/F, 2/F, Bldg 5, Shiling Industrial Zone, Xinwei Village, Xili, Nanshan Shenzhen City  
Guangdong Province 518055 China**



Table of Contents

1. Statement of Compliance ..... 4
2. Administration Data ..... 5
3. Guidance Applied..... 5
4. Equipment Under Test (EUT) Information ..... 6
4.1 General Information ..... 6
4.2 General LTE SAR Test and Reporting Considerations ..... 7
5. Proximity Sensor Triggering Test..... 8
5.1 Proximity sensor clarification ..... 8
5.2 Proximity sensor triggering distances(Per KDB616217§6.2) ..... 9
5.3 Proximity Sensor Triggering Coverage (KDB 616217 D04 section 6.3): .....12
5.4 Tilt angle influences to proximity sensor triggering(Per KDB616217 §6.4).....13
6. Country Code Detection Mechanism.....14
7. RF Exposure Limits.....17
7.1 Uncontrolled Environment.....17
7.2 Controlled Environment.....17
8. Specific Absorption Rate (SAR).....18
8.1 Introduction .....18
8.2 SAR Definition.....18
9. System Description and Setup .....19
9.1 E-Field Probe .....20
9.2 Data Acquisition Electronics (DAE) .....20
9.3 Phantom.....21
9.4 Device Holder.....22
10. Measurement Procedures .....23
10.1 Spatial Peak SAR Evaluation .....23
10.2 Power Reference Measurement.....24
10.3 Area Scan .....24
10.4 Zoom Scan.....25
10.5 Volume Scan Procedures.....25
10.6 Power Drift Monitoring.....25
11. Test Equipment List.....26
12. System Verification .....27
12.1 Tissue Simulating Liquids.....27
12.2 Tissue Verification .....28
12.3 System Performance Check Results.....29
13. RF Exposure Positions .....30
13.1 SAR Testing for Tablet.....30
14. Conducted RF Output Power (Unit: dBm).....31
15. Antenna Location .....45
16. SAR Test Results .....46
16.1 Body SAR .....48
17. Simultaneous Transmission Analysis.....50
17.1 Body Exposure Conditions .....51
18. Uncertainty Assessment .....52
19. References.....53
Appendix A. Plots of System Performance Check
Appendix B. Plots of High SAR Measurement
Appendix C. DASY Calibration Certificate
Appendix D. Test Setup Photos





### 1. Statement of Compliance

The maximum results of Specific Absorption Rate (SAR) found during testing for **Huawei Technologies Co., Ltd., Huawei Mediapad M5 wp, d-02K**, are as follows.

Highest Standalone 1g SAR Summary				
Equipment Class	Frequency Band		Body	Highest Simultaneous Transmission 1g SAR (W/kg)
			1g SAR (W/kg)	
Licensed	WCDMA	Band V	<b>0.65</b>	1.13
	LTE	Band 5	0.55	
DTS	WLAN	2.4GHz WLAN	0.55	1.13
NII		5GHz WLAN	0.16	0.68
Date of Testing:		2018/4/11~2018/4/17		

This device is in compliance with Specific Absorption Rate (SAR) for general population/uncontrolled exposure limits (1.6 W/kg) specified in FCC 47 CFR part 2 (2.1093) and ANSI/IEEE C95.1-1992, and had been tested in accordance with the measurement methods and procedures specified in IEEE 1528-2013 and FCC KDB publications.

## 2. Administration Data

Testing Laboratory	
Test Site	Sporton International (Shenzhen) Inc.
Test Site Location	1/F, 2/F, Bldg 5, Shiling Industrial Zone, Xinwei Village, Xili, Nanshan Shenzhen City Guangdong Province 518055 China TEL: +86-755-8637-9589 FAX: +86-755-8637-9595

Applicant	
Company Name	Huawei Technologies Co., Ltd.
Address	Administration Building, Headquarters of Huawei Technologies Co., Ltd., Bantian, Longgang District, Shenzhen, 518129, P.R.C

Manufacturer	
Company Name	Huawei Technologies Co., Ltd.
Address	Administration Building, Headquarters of Huawei Technologies Co., Ltd., Bantian, Longgang District, Shenzhen, 518129, P.R.C

## 3. Guidance Applied

The Specific Absorption Rate (SAR) testing specification, method, and procedure for this device is in accordance with the following standards:

- FCC 47 CFR Part 2 (2.1093)
- ANSI/IEEE C95.1-1992
- IEEE 1528-2013
- FCC KDB 865664 D01 SAR Measurement 100 MHz to 6 GHz v01r04
- FCC KDB 865664 D02 SAR Reporting v01r02
- FCC KDB 447498 D01 General RF Exposure Guidance v06
- FCC KDB 248227 D01 802.11 Wi-Fi SAR v02r02
- FCC KDB 616217 D04 SAR for laptop and tablets v01r0
- FCC KDB 941225 D01 3G SAR Procedures v03r01
- FCC KDB 941225 D05 SAR for LTE Devices v02r05



4. Equipment Under Test (EUT) Information

4.1 General Information

Product Feature & Specification	
Equipment Name	Huawei Mediapad M5 wp
Brand Name	HUAWEI
Model Name	d-02K
FCC ID	QISHDL-L0J
IMEI Code	Sample 1: 867555030005594 Sample 2: 867555030008747
Wireless Technology and Frequency Range	WCDMA Band V: 826.4 MHz ~ 846.6 MHz LTE Band 5: 824.7 MHz ~ 848.3 MHz WLAN 2.4GHz Band: 2412 MHz ~ 2462 MHz WLAN 5.2GHz Band: 5180 MHz ~ 5240 MHz WLAN 5.3GHz Band: 5260 MHz ~ 5320 MHz WLAN 5.5GHz Band: 5500 MHz ~ 5720MHz WLAN 5.8GHz Band: 5745 MHz ~ 5825 MHz Bluetooth: 2402 MHz ~ 2480 MHz
Mode	RMC 12.2Kbps HSDPA HSUPA LTE: QPSK, 16QAM WLAN 2.4GHz : 802.11b/g/n HT20/HT40 WLAN 5GHz : 802.11a/n/ac HT20/HT40/VHT20/VHT40/VHT80 Bluetooth BR/EDR/LE/HS
HW Version	SH1HDLAL09M
SW Version	18032602
<b>Remark:</b>	
<ol style="list-style-type: none"> <li>This device has no voice function.</li> <li>This device implanted proximity sensor function at back face and bottom edge, power reduction will be implemented immediately at all WWAN bands.</li> <li>There are two samples of EUT, they are only with different suppliers of LCD panel. We only chose sample 1 to do full SAR testing, sample 2 verified the worst case of sample 1.</li> </ol>	

**4.2 General LTE SAR Test and Reporting Considerations**

Summarized necessary items addressed in KDB 941225 D05 v02r05																																																															
FCC ID	QISHDL-L0J																																																														
Equipment Name	Huawei Mediapad M5 wp																																																														
Operating Frequency Range of each LTE transmission band	LTE Band 5: 824.7 MHz ~ 848.3 MHz																																																														
Channel Bandwidth	LTE Band 5: 1.4MHz, 3MHz, 5MHz, 10MHz																																																														
uplink modulations used	QPSK / 16QAM																																																														
LTE Voice / Data requirements	Data only																																																														
LTE Release	R10, Cat4																																																														
LTE MPR permanently built-in by design	<p align="center"><b>Table 6.2.3-1: Maximum Power Reduction (MPR) for Power Class 1, 2 and 3</b></p> <table border="1"> <thead> <tr> <th rowspan="2">Modulation</th> <th colspan="6">Channel bandwidth / Transmission bandwidth (N<sub>RB</sub>)</th> <th rowspan="2">MPR (dB)</th> </tr> <tr> <th>1.4 MHz</th> <th>3.0 MHz</th> <th>5 MHz</th> <th>10 MHz</th> <th>15 MHz</th> <th>20 MHz</th> </tr> </thead> <tbody> <tr> <td>QPSK</td> <td>&gt; 5</td> <td>&gt; 4</td> <td>&gt; 8</td> <td>&gt; 12</td> <td>&gt; 16</td> <td>&gt; 18</td> <td>≤ 1</td> </tr> <tr> <td>16 QAM</td> <td>≤ 5</td> <td>≤ 4</td> <td>≤ 8</td> <td>≤ 12</td> <td>≤ 16</td> <td>≤ 18</td> <td>≤ 1</td> </tr> <tr> <td>16 QAM</td> <td>&gt; 5</td> <td>&gt; 4</td> <td>&gt; 8</td> <td>&gt; 12</td> <td>&gt; 16</td> <td>&gt; 18</td> <td>≤ 2</td> </tr> <tr> <td>64 QAM</td> <td>≤ 5</td> <td>≤ 4</td> <td>≤ 8</td> <td>≤ 12</td> <td>≤ 16</td> <td>≤ 18</td> <td>≤ 2</td> </tr> <tr> <td>64 QAM</td> <td>&gt; 5</td> <td>&gt; 4</td> <td>&gt; 8</td> <td>&gt; 12</td> <td>&gt; 16</td> <td>&gt; 18</td> <td>≤ 3</td> </tr> <tr> <td>256 QAM</td> <td colspan="6" style="text-align: center;">≥ 1</td> <td>≤ 5</td> </tr> </tbody> </table>	Modulation	Channel bandwidth / Transmission bandwidth (N <sub>RB</sub> )						MPR (dB)	1.4 MHz	3.0 MHz	5 MHz	10 MHz	15 MHz	20 MHz	QPSK	> 5	> 4	> 8	> 12	> 16	> 18	≤ 1	16 QAM	≤ 5	≤ 4	≤ 8	≤ 12	≤ 16	≤ 18	≤ 1	16 QAM	> 5	> 4	> 8	> 12	> 16	> 18	≤ 2	64 QAM	≤ 5	≤ 4	≤ 8	≤ 12	≤ 16	≤ 18	≤ 2	64 QAM	> 5	> 4	> 8	> 12	> 16	> 18	≤ 3	256 QAM	≥ 1						≤ 5
	Modulation		Channel bandwidth / Transmission bandwidth (N <sub>RB</sub> )							MPR (dB)																																																					
		1.4 MHz	3.0 MHz	5 MHz	10 MHz	15 MHz	20 MHz																																																								
	QPSK	> 5	> 4	> 8	> 12	> 16	> 18	≤ 1																																																							
	16 QAM	≤ 5	≤ 4	≤ 8	≤ 12	≤ 16	≤ 18	≤ 1																																																							
	16 QAM	> 5	> 4	> 8	> 12	> 16	> 18	≤ 2																																																							
	64 QAM	≤ 5	≤ 4	≤ 8	≤ 12	≤ 16	≤ 18	≤ 2																																																							
64 QAM	> 5	> 4	> 8	> 12	> 16	> 18	≤ 3																																																								
256 QAM	≥ 1						≤ 5																																																								
LTE A-MPR	In the base station simulator configuration, Network Setting value is set to NS_01 to disable A-MPR during SAR testing and the LTE SAR tests was transmitting on all TTI frames (Maximum TTI)																																																														
Spectrum plots for RB configuration	A properly configured base station simulator was used for the SAR and power measurement; therefore, spectrum plots for each RB allocation and offset configuration are not included in the SAR report.																																																														
CA support	Not Supported																																																														
Power reduction applied to satisfy SAR compliance	<ol style="list-style-type: none"> <li>Yes, Proximity Sensor.</li> <li>Power reduction will be active at all WWAN bands.</li> </ol>																																																														

LTE Band 5								
	Bandwidth 1.4 MHz		Bandwidth 3 MHz		Bandwidth 5 MHz		Bandwidth 10 MHz	
	Ch. #	Freq. (MHz)	Ch. #	Freq. (MHz)	Ch. #	Freq. (MHz)	Ch. #	Freq. (MHz)
L	20407	824.7	20415	825.5	20425	826.5	20450	829
M	20525	836.5	20525	836.5	20525	836.5	20525	836.5
H	20643	848.3	20635	847.5	20625	846.5	20600	844

## 5. Proximity Sensor Triggering Test

This device uses a proximity sensor that share the same metallic electrode as the transmitting antenna to facilitate triggering in typical user interactivity with the device.

Due to the operating configurations and exposure conditions required by the device, the proximity sensor is used to indicate when the tablet is held close to a user's body exposure condition. It utilizes the proximity sensor to reduce the output power in specific wireless and operating modes to ensure SAR compliance for the following scenarios: To reduce the output power of main antennas during body operating configurations.

### 5.1 Proximity sensor clarification

The proximity sensor location and clarification please refers to Appendix D for Fig.5.1 and Fig.5.2.

#### Power Reduction operation table

Main antenna		
Band	Sensor Trigger Distance	Power reduction (dB)
LTE Band 5	Back Face: 17mm Bottom Edge : 22mm	9.5
WCDMA Band V	Back Face: 17mm Bottom Edge: 22mm	8

Main antenna			
Band	Sensor Trigger Distance	Power level (dBm)	Power reduction (dB)
LTE Band 5	Distance <17mm	14.5	9.5
	17mm < Distance	24	0
WCDMA Band V	Distance <17mm	16	8
	17mm < Distance	24	0

Note:

1) Since the capacitive proximity sensor triggering distance for the back face/bottom edge is 17 mm, a conservative distance of 17-1=16mm was required for additional SAR test at maximum power level with sensor off.

2) SAR tests with proximity sensor power reduction are only required for the sides of frequency bands in the table above. For the other sides or other frequency bands of the device, SAR is still tested at the maximum power level with sensor off.



**5.2 Proximity sensor triggering distances(Per KDB616217§6.2)**

The device was tested by the test lab to determine the proximity sensor triggering distances for the front side, back side and bottom side of the device. To ensure all production units are compliant, the smallest separation distance determined by the sensor triggering minus 1 mm, must be used as the test separation distance for SAR testing.

In the preliminary triggering distance testing, the tissue-equivalent medium for different frequency bands were used for verification; no other frequency bands tissue-equivalent medium was found to result in shortest triggering distance than that for 850MHz, and the tissue-equivalent medium for 850MHz was used for formal proximity sensor triggering testing.



Picture: Proximity sensor triggering distances assessment  
Bottom Edge



Picture: Proximity sensor triggering distances assessment  
Back Face

**Table: Summary of Trigger Distances**

Band(MHz)	Trigger distance-Back Face		Trigger distance-Bottom Edge	
	Moving toward phantom	Moving away from phantom	Moving toward phantom	Moving away from phantom
LTE Band 5	17mm	21mm	22mm	25mm
WCDMA Band V	17mm	21mm	22mm	25mm

The detailed conducted power measurement data to determine the triggering distances is as below:

**<Sensor Trigger Distance and Measured Power>**

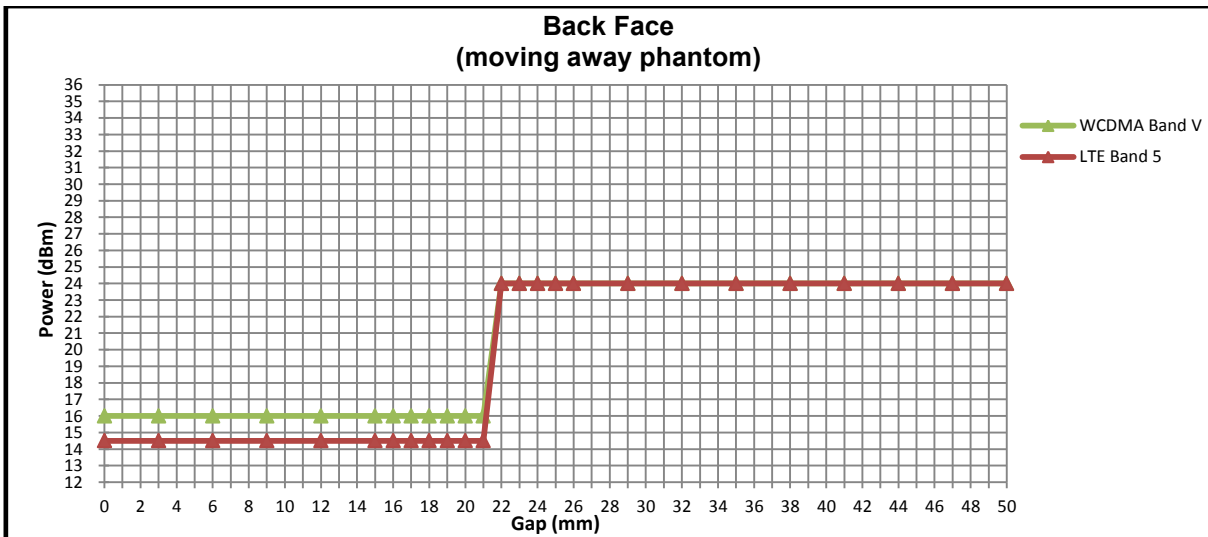
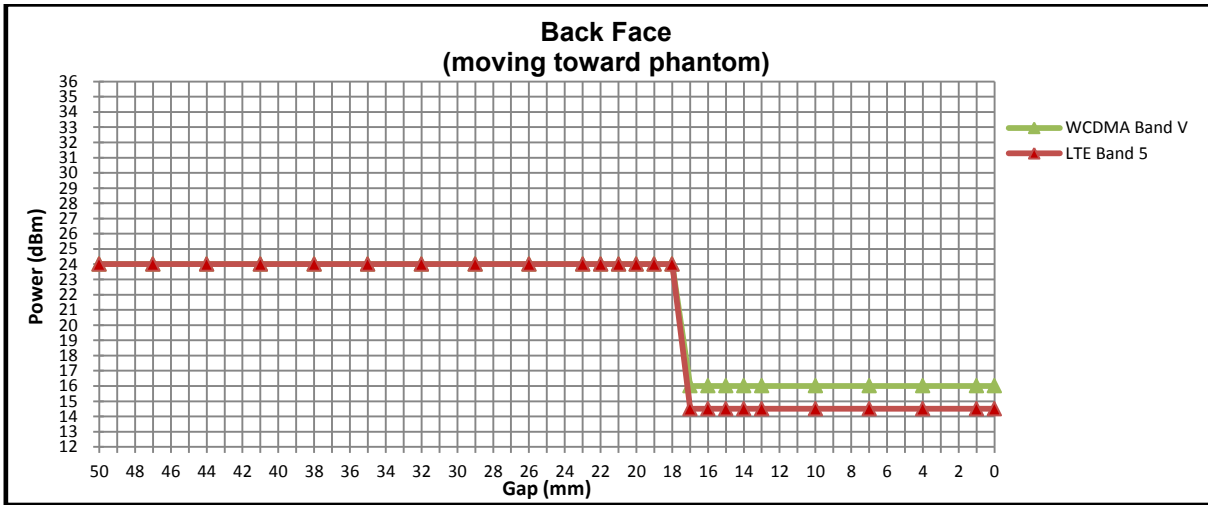

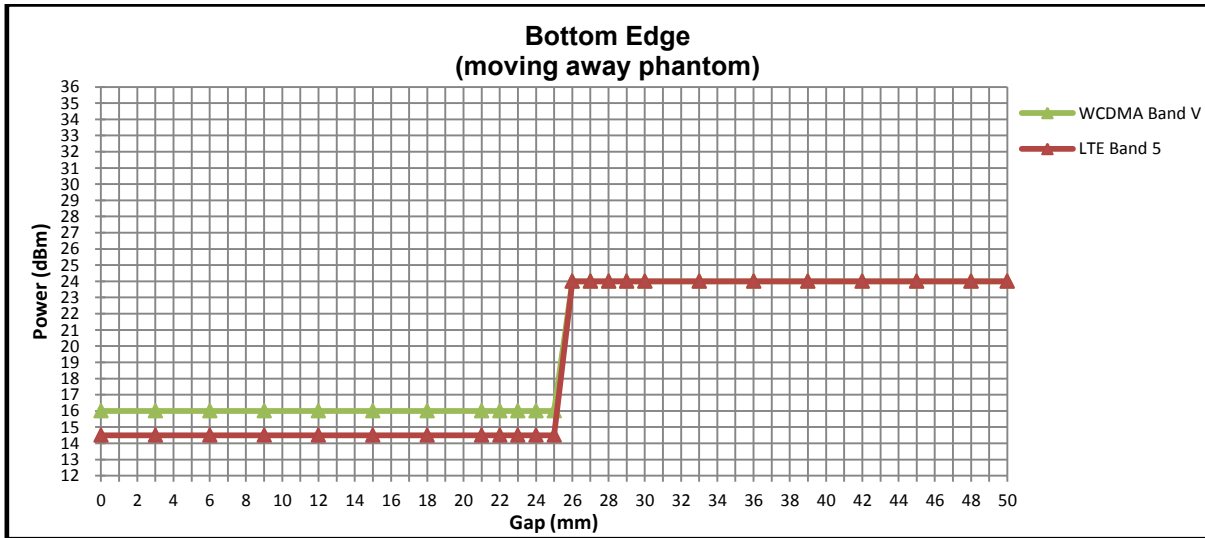
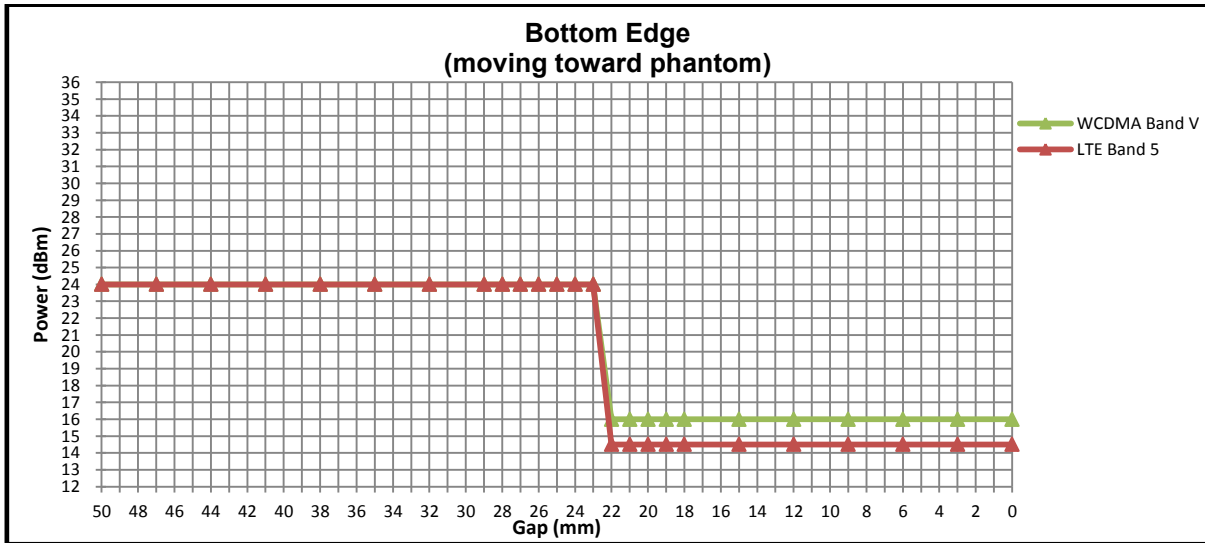

**5.3 Proximity Sensor Triggering Coverage (KDB 616217 D04 section 6.3):**

If a sensor is spatially offset from the antenna(s), it is necessary to verify sensor triggering for conditions where the antenna is next to the user but the sensor is laterally further away to ensure sensor coverage is sufficient for reducing the power to maintain compliance. For p-sensor coverage testing, the device is moved and "along the direction of maximum antenna and sensor offset".

Illustrated in the internal photo exhibit, although the sensor is spatially offset, there is no trigger condition where the antenna is next to the user but the sensor is laterally further away, therefore proximity sensor coverage testing is not required.

This procedure is not required because antenna and sensor are collocated and the peak SAR location is overlapping with the sensor.

**5.4 Tilt angle influences to proximity sensor triggering(Per KDB616217 §6.4)**

The DUT was positioned directly below the flat phantom at the minimum measured trigger distance with Bottom side parallel to the base of the flat phantom for each band.  
 The EUT was rotated about Bottom side for angles up to +/- 45°. If the output power increased during the rotation the DUT was moved 1mm toward the phantom and the rotation repeated. This procedure was repeated until the power remained reduced for all angles up to +/- 45°. The proximity sensor triggering tilt angle measurement methods are as below:

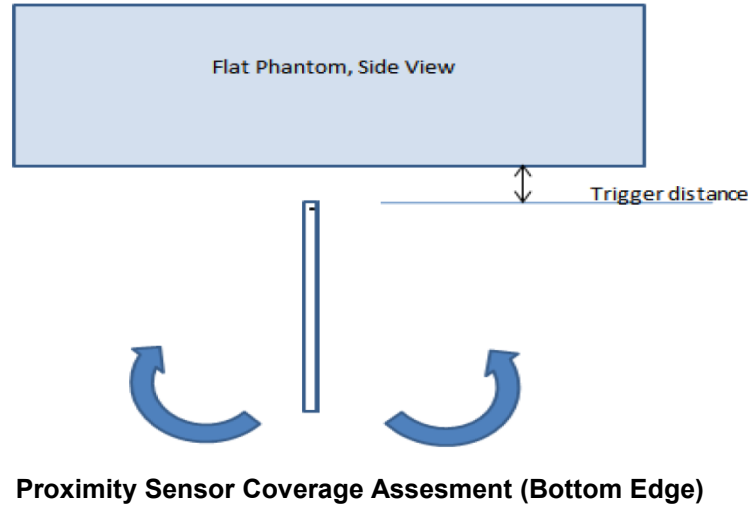

**Table: Summary of Tablet Tilt Angle Influence to Proximity Sensor Triggering (Bottom Edge)**

Main ant Band(MHz)	Minimum trigger distance at which power reduction was maintained over ±45°	Power Reduction Status											
		-45°	-35°	-25°	-15°	-5°	0°	5°	15°	25°	35°	45°	
LTE Band 5	22mm	on	on	on	on	on	on	on	on	on	on	on	on
WCDMA Band V	22mm	on	on	on	on	on	on	on	on	on	on	on	on

**Conclusion:** As is shown from the validation data, it can be ensured that the proximity sensor can be valid triggered for the DUT tilt coverage exposure condition.

**Summary SAR test Plan for Proximity sensor power reduction:**

The proximity sensor is used to indicate when the device is held close to a user’s body exposure condition. SAR tests with proximity sensor power reduction are required for back face and bottom edge of WCDMA Band V and LTE Band 5 with Main Antenna. For the other sides or other frequency bands of the device, SAR is still tested at the maximum power level with sensor off.

Moreover:

- Since the capacitive proximity sensor triggering distance for back face is 17mm, a conservative distance of 16mm<sup>[Note 1]</sup> was required for additional SAR test at maximum power level with sensor off.
- Since the capacitive proximity sensor triggering distance for bottom edge is 22mm, a conservative distance of 16mm<sup>[Note 1]</sup> was required for additional SAR test at maximum power level with sensor off.

**Note 1:**

Per KDB 616217 D04v01r02 footnote 26 at page 13:

Depending on the antenna and sensor offset, if a test separation distance smaller than that determined by the triggering distance procedures can extend the coverage area to include the peak SAR location, a smaller test separation distance may be considered to avoid additional SAR tests.

## 6. Country Code Detection Mechanism

**General description:**

This device supports the countries detection mechanism. The main purpose is to distinguish CE countries and FCC countries and apply the relevant power levels accordingly. The main purpose is to provide enhanced user experience while meeting the SAR compliance for different countries.

This device uses the mobile country code (MCC) to indicate whether the users in CE countries or FCC countries. The selection between CE countries and FCC countries power levels is based on the country code detection mechanism. It can determine the countries where users are and set the relevant power level for WiFi antennas accordingly.

**Table 1: Summary of country code detection mechanism**

Antenna	MCC OF CE COUNTRY (CE standard)	MCC OF FCC COUNTRY (FCC standard)
WiFi 2.4G Ant	Power Level A1	Power Level B1
WiFi 5G Ant	Power Level A2	Power Level B2

**Table 2: The device model and frequency Bands**

Model	d-02K
SIM Card	Single
CE bands	WiFi 2.4G/5G/BT
FCC bands	WiFi 2.4G/5G/BT
Bands supporting country code detection mechanism	WiFi 2.4G WiFi 5G

The software of the device has information of CE and FCC countries so that to detect where the users are. If the users are in CE countries, the power level A is applied. If the users are in FCC countries, the power level B is applied.

**Note:**

- 1) The power level A and B can be set to the same or different.
- 2) The device distinguishes different countries by MCC information. If we are close to a country border and the phone switches to a neighboring network the power reduction will follow the newest registered MCC information.
- 3) The default status when the device doesn't know the MCC information will be set to the Lower Power Level between A and B.
- 4) For WiFi bands, the router also has MCC information so the device can distinguish different countries.
- 5) The following power table is used for MCC of CE countries for WiFi 2.4G/5G.
- 6) About FCC countries, MCC of FCC countries, the power level for WiFi 2.4G/5G are listed on page 40.
- 7) For this device, WiFi 2.4G 12CH and 13 CH can not be used in FCC countries.

**Conducted Power of WiFi 2.4G for CE (MCC of CE countries, full power level)**

Mode	Channel	Frequency (MHz)	Tune-up	Average Power (dBm)
			Max.	1Mbps
802.11b	1	2412	18.0	17.49
	7	2442	18.0	17.48
	13	2472	18.0	17.07
Mode	Channel	Frequency (MHz)	Tune-up	Average Power (dBm)
802.11g	1	2412	19.0	18.24
	7	2442	19.0	18.52
	13	2472	19.0	18.20
Mode	Channel	Frequency (MHz)	Tune-up	Average Power (dBm)
802.11n HT20	1	2412	18.0	17.66
	7	2442	18.0	17.91
	13	2472	18.0	17.80

Mode	Channel	Frequency (MHz)	Tune-up	Average Power (dBm)
			Max.	MCS0
802.11n HT40	3	2422	18.0	17.63
	7	2442	18.0	17.96
	11	2462	18.0	17.89

**Conducted Power of WiFi 5G for CE (MCC of CE countries, full power level)**

Mode	Channel	Frequency (MHz)	Tune-up	Average Power (dBm)
			Max.	6M
802.11a	CH 36	5180	17.0	15.39
	CH 52	5260	17.0	15.67
	CH 64	5320	17.0	15.78
	CH 100	5500	17.0	16.28
	CH 120	5600	17.0	16.15
	CH 140	5700	17.0	15.10
Mode	Channel	Frequency (MHz)	Tune-up	Average Power (dBm)
802.11n HT20	CH 36	5180	17.0	15.57
	CH 52	5260	17.0	15.80
	CH 64	5320	17.0	15.72
	CH 100	5500	17.0	16.22
	CH 120	5600	17.0	16.10
	CH 140	5700	17.0	15.40
Mode	Channel	Frequency (MHz)	Tune-up	Average Power (dBm)
802.11n HT40	CH 38	5190	17.0	15.44
	CH 54	5270	17.0	15.76
	CH 62	5310	17.0	15.56
	CH 102	5510	17.0	16.01
	CH 118	5590	17.0	16.00
	CH 134	5670	17.0	15.50
Mode	Channel	Frequency (MHz)	Tune-up	Average Power (dBm)
802.11ac HT20	CH 36	5180	17.0	15.30
	CH 52	5260	17.0	15.51
	CH 64	5320	17.0	15.66
	CH 100	5500	17.0	16.00
	CH 120	5600	17.0	15.91
	CH 140	5700	17.0	15.22
Mode	Channel	Frequency (MHz)	Tune-up	Average Power (dBm)
802.11ac HT40	CH 38	5190	17.0	15.22
	CH 54	5270	17.0	15.50
	CH 62	5310	17.0	15.72
	CH 102	5510	17.0	16.01
	CH 118	5590	17.0	15.90
	CH 134	5670	17.0	15.38



Mode	Channel	Frequency (MHz)	Tune-up	Average Power (dBm)
			Max.	MCS0
802.11ac HT80	CH 42	5210	17.0	14.53
	CH 58	5290	17.0	14.66
	CH 106	5530	17.0	14.58
	CH 122	5610	17.0	14.87

Summary SAR test Plan

Antenna	MCC OF CE COUNTRY (CE standard)	MCC OF FCC COUNTRY (FCC standard)
WiFi 2.4G	Power Level A1	Power Level B1
WiFi 5G	Power Level A2	Power Level B2

Based on the summary table of countries detection mechanism above, we plan to perform the SAR test as below:
For conducted power test, both the full power level and reduced power level will be tested by setting different MCC to validate that the country code detection mechanism works.

For FCC SAR test,

- 1) Standalone FCC SAR of Wifi 2.4G is evaluated at power level B1;(FCC mobile country code)
2) Standalone FCC SAR of Wifi 5G is evaluated at power level B2;(FCC mobile country code)

For CE SAR test,

- 3) Standalone CE SAR of Wifi 2.4G is evaluated at power level A1;(CE mobile country code)
4) Standalone CE SAR of Wifi 5G is evaluated at power level A2;(CE mobile country code)



## **7. RF Exposure Limits**

### **7.1 Uncontrolled Environment**

Uncontrolled Environments are defined as locations where there is the exposure of individuals who have no knowledge or control of their exposure. The general population/uncontrolled exposure limits are applicable to situations in which the general public may be exposed or in which persons who are exposed as a consequence of their employment may not be made fully aware of the potential for exposure or cannot exercise control over their exposure. Members of the general public would come under this category when exposure is not employment-related; for example, in the case of a wireless transmitter that exposes persons in its vicinity.

### **7.2 Controlled Environment**

Controlled Environments are defined as locations where there is exposure that may be incurred by persons who are aware of the potential for exposure, (i.e. as a result of employment or occupation). In general, occupational/controlled exposure limits are applicable to situations in which persons are exposed as a consequence of their employment, who have been made fully aware of the potential for exposure and can exercise control over their exposure. The exposure category is also applicable when the exposure is of a transient nature due to incidental passage through a location where the exposure levels may be higher than the general population/uncontrolled limits, but the exposed person is fully aware of the potential for exposure and can exercise control over his or her exposure by leaving the area or by some other appropriate means.

**Limits for Occupational/Controlled Exposure (W/kg)**

Whole-Body	Partial-Body	Hands, Wrists, Feet and Ankles
0.4	8.0	20.0

**Limits for General Population/Uncontrolled Exposure (W/kg)**

Whole-Body	Partial-Body	Hands, Wrists, Feet and Ankles
0.08	1.6	4.0

Whole-Body SAR is averaged over the entire body, partial-body SAR is averaged over any 1gram of tissue defined as a tissue volume in the shape of a cube. SAR for hands, wrists, feet and ankles is averaged over any 10 grams of tissue defined as a tissue volume in the shape of a cube.

## **8. Specific Absorption Rate (SAR)**

### **8.1 Introduction**

SAR is related to the rate at which energy is absorbed per unit mass in an object exposed to a radio field. The SAR distribution in a biological body is complicated and is usually carried out by experimental techniques or numerical modeling. The standard recommends limits for two tiers of groups, occupational/controlled and general population/uncontrolled, based on a person's awareness and ability to exercise control over his or her exposure. In general, occupational/controlled exposure limits are higher than the limits for general population/uncontrolled.

### **8.2 SAR Definition**

The SAR definition is the time derivative (rate) of the incremental energy (dW) absorbed by (dissipated in) an incremental mass (dm) contained in a volume element (dv) of a given density ( $\rho$ ). The equation description is as below:

$$SAR = \frac{d}{dt} \left( \frac{dW}{dm} \right) = \frac{d}{dt} \left( \frac{dW}{\rho dv} \right)$$

SAR is expressed in units of Watts per kilogram (W/kg)

$$SAR = \frac{\sigma |E|^2}{\rho}$$

Where:  $\sigma$  is the conductivity of the tissue,  $\rho$  is the mass density of the tissue and E is the RMS electrical field strength.

## 9. System Description and Setup

The DASY system used for performing compliance tests consists of the following items:

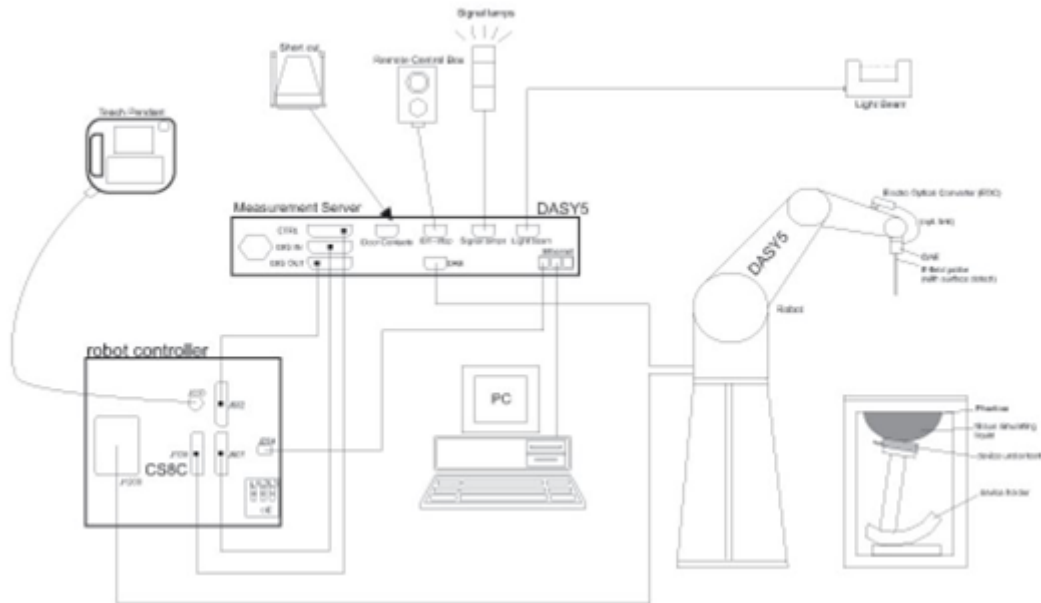

- A standard high precision 6-axis robot with controller, teach pendant and software. An arm extension for accommodating the data acquisition electronics (DAE).
- An isotropic Field probe optimized and calibrated for the targeted measurement.
- A data acquisition electronics (DAE) which performs the signal amplification, signal multiplexing, AD-conversion, offset measurements, mechanical surface detection, collision detection, etc. The unit is battery powered with standard or rechargeable batteries. The signal is optically transmitted to the EOC.
- The Electro-optical converter (EOC) performs the conversion from optical to electrical signals for the digital communication to the DAE. To use optical surface detection, a special version of the EOC is required. The EOC signal is transmitted to the measurement server.
- The function of the measurement server is to perform the time critical tasks such as signal filtering, control of the robot operation and fast movement interrupts.
- The Light Beam used is for probe alignment. This improves the (absolute) accuracy of the probe positioning.
- A computer running WinXP or Win7 and the DASY5 software.
- Remote control and teach pendant as well as additional circuitry for robot safety such as warning lamps, etc.
- The phantom, the device holder and other accessories according to the targeted measurement.

**9.1 E-Field Probe**

The SAR measurement is conducted with the dosimetric probe (manufactured by SPEAG).The probe is specially designed and calibrated for use in liquid with high permittivity. The dosimetric probe has special calibration in liquid at different frequency. This probe has a built in optical surface detection system to prevent from collision with phantom.

**<EX3DV4 Probe>**

<b>Construction</b>	Symmetric design with triangular core Built-in shielding against static charges PEEK enclosure material (resistant to organic solvents, e.g., DGBE)	
<b>Frequency</b>	10 MHz – >6 GHz Linearity: ±0.2 dB (30 MHz – 6 GHz)	
<b>Directivity</b>	±0.3 dB in TSL (rotation around probe axis) ±0.5 dB in TSL (rotation normal to probe axis)	
<b>Dynamic Range</b>	10 µW/g – >100 mW/g Linearity: ±0.2 dB (noise: typically <1 µW/g)	
<b>Dimensions</b>	Overall length: 337 mm (tip: 20 mm) Tip diameter: 2.5 mm (body: 12 mm) Typical distance from probe tip to dipole centers: 1 mm	

**9.2 Data Acquisition Electronics (DAE)**

The data acquisition electronics (DAE) consists of a highly sensitive electrometer-grade preamplifier with auto-zeroing, a channel and gain-switching multiplexer, a fast 16 bit AD-converter and a command decoder and control logic unit. Transmission to the measurement server is accomplished through an optical downlink for data and status information as well as an optical uplink for commands and the clock.

The input impedance of the DAE is 200 MOhm; the inputs are symmetrical and floating. Common mode rejection is above 80 dB.



**Photo of DAE**

**9.3 Phantom**

**<SAM Twin Phantom>**

<b>Shell Thickness</b>	2 ± 0.2 mm; Center ear point: 6 ± 0.2 mm
<b>Filling Volume</b>	Approx. 25 liters
<b>Dimensions</b>	Length: 1000 mm; Width: 500 mm; Height: adjustable feet
<b>Measurement Areas</b>	Left Hand, Right Hand, Flat Phantom



The bottom plate contains three pair of bolts for locking the device holder. The device holder positions are adjusted to the standard measurement positions in the three sections. A white cover is provided to tap the phantom during off-periods to prevent water evaporation and changes in the liquid parameters. On the phantom top, three reference markers are provided to identify the phantom position with respect to the robot.

**<ELI Phantom>**

<b>Shell Thickness</b>	2 ± 0.2 mm (sagging: <1%)
<b>Filling Volume</b>	Approx. 30 liters
<b>Dimensions</b>	Major ellipse axis: 600 mm Minor axis: 400 mm

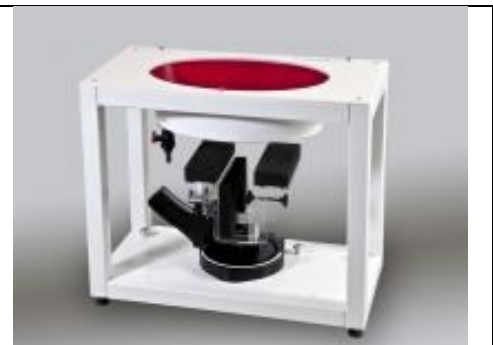

The ELI phantom is intended for compliance testing of handheld and body-mounted wireless devices in the frequency range of 30 MHz to 6 GHz. ELI4 is fully compatible with standard and all known tissue simulating liquids.

## 9.4 Device Holder

### <Mounting Device for Hand-Held Transmitter>

In combination with the Twin SAM V5.0/V5.0c or ELI phantoms, the Mounting Device for Hand-Held Transmitters enables rotation of the mounted transmitter device to specified spherical coordinates. At the heads, the rotation axis is at the ear opening. Transmitter devices can be easily and accurately positioned according to IEC 62209-1, IEEE 1528, FCC, or other specifications. The device holder can be locked for positioning at different phantom sections (left head, right head, flat). And upgrade kit to Mounting Device to enable easy mounting of wider devices like big smart-phones, e-books, small tablets, etc. It holds devices with width up to 140 mm.



Mounting Device for Hand-Held Transmitters

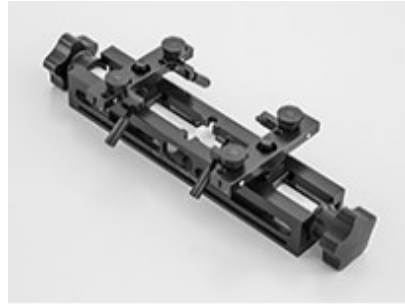

Mounting Device Adaptor for Wide-Phones

### <Mounting Device for Laptops and other Body-Worn Transmitters>

The extension is lightweight and made of POM, acrylic glass and foam. It fits easily on the upper part of the mounting device in place of the phone positioned. The extension is fully compatible with the SAM Twin and ELI phantoms.



Mounting Device for Laptops

## **10. Measurement Procedures**

The measurement procedures are as follows:

### <Conducted power measurement>

- (a) For WWAN power measurement, use base station simulator to configure EUT WWAN transmission in conducted connection with RF cable, at maximum power in each supported wireless interface and frequency band.
- (b) Read the WWAN RF power level from the base station simulator.
- (c) For WLAN/BT power measurement, use engineering software to configure EUT WLAN/BT continuously transmission, at maximum RF power in each supported wireless interface and frequency band
- (d) Connect EUT RF port through RF cable to the power meter, and measure WLAN/BT output power

### <SAR measurement>

- (a) Use base station simulator to configure EUT WWAN transmission in radiated connection, and engineering software to configure EUT WLAN/BT continuously transmission, at maximum RF power, in the highest power channel.
- (b) Place the EUT in the positions as Appendix D demonstrates.
- (c) Set scan area, grid size and other setting on the DASY software.
- (d) Measure SAR results for the highest power channel on each testing position.
- (e) Find out the largest SAR result on these testing positions of each band
- (f) Measure SAR results for other channels in worst SAR testing position if the reported SAR of highest power channel is larger than 0.8 W/kg

According to the test standard, the recommended procedure for assessing the peak spatial-average SAR value consists of the following steps:

- (a) Power reference measurement
- (b) Area scan
- (c) Zoom scan
- (d) Power drift measurement

### **10.1 Spatial Peak SAR Evaluation**

The procedure for spatial peak SAR evaluation has been implemented according to the test standard. It can be conducted for 1g and 10g, as well as for user-specific masses. The DASY software includes all numerical procedures necessary to evaluate the spatial peak SAR value.

The base for the evaluation is a "cube" measurement. The measured volume must include the 1g and 10g cubes with the highest averaged SAR values. For that purpose, the center of the measured volume is aligned to the interpolated peak SAR value of a previously performed area scan.

The entire evaluation of the spatial peak values is performed within the post-processing engine (SEMCAD). The system always gives the maximum values for the 1g and 10g cubes. The algorithm to find the cube with highest averaged SAR is divided into the following stages:

- (a) Extraction of the measured data (grid and values) from the Zoom Scan
- (b) Calculation of the SAR value at every measurement point based on all stored data (A/D values and measurement parameters)
- (c) Generation of a high-resolution mesh within the measured volume
- (d) Interpolation of all measured values from the measurement grid to the high-resolution grid
- (e) Extrapolation of the entire 3-D field distribution to the phantom surface over the distance from sensor to surface
- (f) Calculation of the averaged SAR within masses of 1g and 10g

**10.2 Power Reference Measurement**

The Power Reference Measurement and Power Drift Measurements are for monitoring the power drift of the device under test in the batch process. The minimum distance of probe sensors to surface determines the closest measurement point to phantom surface. This distance cannot be smaller than the distance of sensor calibration points to probe tip as defined in the probe properties.

**10.3 Area Scan**

The area scan is used as a fast scan in two dimensions to find the area of high field values, before doing a fine measurement around the hot spot. The sophisticated interpolation routines implemented in DASY software can find the maximum found in the scanned area, within a range of the global maximum. The range (in dB0 is specified in the standards for compliance testing. For example, a 2 dB range is required in IEEE standard 1528 and IEC 62209 standards, whereby 3 dB is a requirement when compliance is assessed in accordance with the ARIB standard (Japan), if only one zoom scan follows the area scan, then only the absolute maximum will be taken as reference. For cases where multiple maximums are detected, the number of zoom scans has to be increased accordingly.

Area scan parameters extracted from FCC KDB 865664 D01v01r04 SAR measurement 100 MHz to 6 GHz.

	≤ 3 GHz	> 3 GHz
Maximum distance from closest measurement point (geometric center of probe sensors) to phantom surface	5 ± 1 mm	$\frac{1}{2} \cdot \delta \cdot \ln(2) \pm 0.5$ mm
Maximum probe angle from probe axis to phantom surface normal at the measurement location	30° ± 1°	20° ± 1°
Maximum area scan spatial resolution: $\Delta x_{Area}, \Delta y_{Area}$	≤ 2 GHz: ≤ 15 mm 2 – 3 GHz: ≤ 12 mm	3 – 4 GHz: ≤ 12 mm 4 – 6 GHz: ≤ 10 mm
	When the x or y dimension of the test device, in the measurement plane orientation, is smaller than the above, the measurement resolution must be ≤ the corresponding x or y dimension of the test device with at least one measurement point on the test device.	



### 10.4 Zoom Scan

Zoom scans are used assess the peak spatial SAR values within a cubic averaging volume containing 1 gram and 10 gram of simulated tissue. The zoom scan measures points (refer to table below) within a cube shoes base faces are centered on the maxima found in a preceding area scan job within the same procedure. When the measurement is done, the zoom scan evaluates the averaged SAR for 1 gram and 10 gram and displays these values next to the job's label.

Zoom scan parameters extracted from FCC KDB 865664 D01v01r04 SAR measurement 100 MHz to 6 GHz.

		≤ 3 GHz	> 3 GHz	
Maximum zoom scan spatial resolution: $\Delta x_{Zoom}, \Delta y_{Zoom}$		$\leq 2$ GHz: $\leq 8$ mm 2 – 3 GHz: $\leq 5$ mm*	3 – 4 GHz: $\leq 5$ mm* 4 – 6 GHz: $\leq 4$ mm*	
Maximum zoom scan spatial resolution, normal to phantom surface	uniform grid: $\Delta z_{Zoom}(n)$	$\leq 5$ mm	3 – 4 GHz: $\leq 4$ mm 4 – 5 GHz: $\leq 3$ mm 5 – 6 GHz: $\leq 2$ mm	
	graded grid	$\Delta z_{Zoom}(1)$ : between 1 <sup>st</sup> two points closest to phantom surface	$\leq 4$ mm	3 – 4 GHz: $\leq 3$ mm 4 – 5 GHz: $\leq 2.5$ mm 5 – 6 GHz: $\leq 2$ mm
		$\Delta z_{Zoom}(n>1)$ : between subsequent points	$\leq 1.5 \cdot \Delta z_{Zoom}(n-1)$	
Minimum zoom scan volume	x, y, z	$\geq 30$ mm	3 – 4 GHz: $\geq 28$ mm 4 – 5 GHz: $\geq 25$ mm 5 – 6 GHz: $\geq 22$ mm	
Note: $\delta$ is the penetration depth of a plane-wave at normal incidence to the tissue medium; see draft standard IEEE P1528-2011 for details. * When zoom scan is required and the <i>reported</i> SAR from the <i>area scan based 1-g SAR estimation</i> procedures of KDB 447498 is $\leq 1.4$ W/kg, $\leq 8$ mm, $\leq 7$ mm and $\leq 5$ mm zoom scan resolution may be applied, respectively, for 2 GHz to 3 GHz, 3 GHz to 4 GHz and 4 GHz to 6 GHz.				

### 10.5 Volume Scan Procedures

The volume scan is used for assess overlapping SAR distributions for antennas transmitting in different frequency bands. It is equivalent to an oversized zoom scan used in standalone measurements. The measurement volume will be used to enclose all the simultaneous transmitting antennas. For antennas transmitting simultaneously in different frequency bands, the volume scan is measured separately in each frequency band. In order to sum correctly to compute the 1g aggregate SAR, the EUT remain in the same test position for all measurements and all volume scan use the same spatial resolution and grid spacing. When all volume scan were completed, the software, SEMCAD postprocessor can combine and subsequently superpose these measurement data to calculating the multiband SAR.

### 10.6 Power Drift Monitoring

All SAR testing is under the EUT install full charged battery and transmit maximum output power. In DASy measurement software, the power reference measurement and power drift measurement procedures are used for monitoring the power drift of EUT during SAR test. Both these procedures measure the field at a specified reference position before and after the SAR testing. The software will calculate the field difference in dB. If the power drifts more than 5%, the SAR will be retested.



### 11. Test Equipment List

Manufacturer	Name of Equipment	Type/Model	Serial Number	Calibration	
				Last Cal.	Due Date
SPEAG	835MHz System Validation Kit	D835V2	4d162	Dec. 05, 2017	Dec. 04, 2018
SPEAG	2450MHz System Validation Kit	D2450V2	924	Mar. 22, 2018	Mar. 21, 2019
SPEAG	5000MHz System Validation Kit	D5GHzV2	1167	Jul. 26, 2017	Jul. 25, 2018
SPEAG	Data Acquisition Electronics	DAE4	1437	Sep. 15, 2017	Sep. 14, 2018
SPEAG	Dosimetric E-Field Probe	EX3DV4	3819	Jan. 31, 2018	Jan. 30, 2019
SPEAG	SAM Twin Phantom	QDOVA002AA	TP-1149	NCR	NCR
SPEAG	Phone Positioner	N/A	N/A	NCR	NCR
Anritsu	Radio communication analyzer	MT8820C	6201300653	Jul. 19, 2017	Jul. 18, 2018
Agilent	Wireless Communication Test Set	E5515C	MY50267224	Sep. 12, 2017	Sep. 11, 2018
Agilent	Network Analyzer	E5071C	MY46523671	Oct. 18, 2017	Oct. 17, 2018
Speag	Dielectric Assessment KIT	DAK-3.5	1071	Nov. 28, 2017	Nov. 27, 2018
Agilent	Signal Generator	N5181A	MY50145381	Dec. 26, 2017	Dec. 25, 2018
Anritsu	Power Meter	ML2495A	1349001	Jul. 19, 2017	Jul. 18, 2018
Anritsu	Power Sensor	MA2411B	1306099	Aug. 21, 2017	Aug. 20, 2018
Anritsu	Power Meter	ML2495A	1218006	Oct. 06, 2017	Oct. 05, 2018
Anritsu	Power Sensor	MA2411B	1207363	Oct. 06, 2017	Oct. 05, 2018
LKM electronic	Hygrometer	DTM3000	3241	Jul. 21, 2017	Jul. 20, 2018
Anymetre	Thermo-Hygrometer	JR593	2015030903	Jan. 01, 2018	Dec. 31, 2018
R&S	Spectrum Analyzer	FSP7	100818	Jul. 19, 2017	Jul. 18, 2018
ARRA	Power Divider	A3200-2	N/A	Note	
MCL	Attenuation1	BW-S10W5	N/A	Note	
Weinschel	Attenuation2	3M-20	N/A	Note	
Zhongjilianhe	Attenuation3	MVE2214-03	N/A	Note	
mini-circuits	Amplifier	ZHL-42W+	QA1341002	Note	
mini-circuits	Amplifier	ZVE-3W-83+	599201528	Note	
PASTERNAK	Dual Directional Coupler	PE2214-10	N/A	Note	
Agilent	Dual Directional Coupler	778D	50422	Note	

**Note:** Prior to system verification and validation, the path loss from the signal generator to the system check source and the power meter, which includes the amplifier, cable, attenuator and directional coupler, was measured by the network analyzer. The reading of the power meter was offset by the path loss difference between the path to the power meter and the path to the system check source to monitor the actual power level fed to the system check source.

## **12. System Verification**

### **12.1 Tissue Simulating Liquids**

For the measurement of the field distribution inside the SAM phantom with DASY, the phantom must be filled with around 25 liters of homogeneous body tissue simulating liquid. For body SAR testing, the liquid height from the center of the flat phantom to the liquid top surface is larger than 15 cm, which is shown in Fig. 11.1.



**Fig 11.1 Photo of Liquid Height for Body SAR**

**12.2 Tissue Verification**

The following tissue formulations are provided for reference only as some of the parameters have not been thoroughly verified. The composition of ingredients may be modified accordingly to achieve the desired target tissue parameters required for routine SAR evaluation.

Frequency (MHz)	Water (%)	Sugar (%)	Cellulose (%)	Salt (%)	Preventol (%)	DGBE (%)	Conductivity (σ)	Permittivity (ε <sub>r</sub> )
For Body								
835	50.8	48.2	0	0.9	0.1	0	0.97	55.2
2450	68.6	0	0	0	0	31.4	1.95	52.7

**Simulating Liquid for 5GHz, Manufactured by SPEAG**

Ingredients	(% by weight)
Water	64~78%
Mineral oil	11~18%
Emulsifiers	9~15%
Additives and Salt	2~3%

**<Tissue Dielectric Parameter Check Results>**

Frequency (MHz)	Tissue Type	Liquid Temp. (°C)	Conductivity (σ)	Permittivity (ε <sub>r</sub> )	Conductivity Target (σ)	Permittivity Target (ε <sub>r</sub> )	Delta (σ) (%)	Delta (ε <sub>r</sub> ) (%)	Limit (%)	Date
835	Body	22.5	0.977	54.466	0.97	55.20	0.72	-1.33	±5	2018/4/11
2450	Body	22.9	1.992	52.291	1.95	52.70	2.15	-0.78	±5	2018/4/17
5250	Body	22.6	5.298	50.997	5.36	48.90	-1.16	4.29	±5	2018/4/17
5600	Body	22.7	5.906	50.367	5.77	48.50	2.36	3.85	±5	2018/4/17
5750	Body	22.8	6.142	50.003	5.94	48.30	3.40	3.53	±5	2018/4/17

**12.3 System Performance Check Results**

Comparing to the original SAR value provided by SPEAG, the verification data should be within its specification of 10 %. Below table shows the target SAR and measured SAR after normalized to 1W input power. The table below indicates the system performance check can meet the variation criterion and the plots can be referred to Appendix A of this report.

Date	Frequency (MHz)	Tissue Type	Input Power (mW)	Dipole S/N	Probe S/N	DAE S/N	Measured 1g SAR (W/kg)	Targeted 1g SAR (W/kg)	Normalized 1g SAR (W/kg)	Deviation (%)
2018/4/11	835	Body	250	4d162	3819	1437	2.24	9.56	8.96	-6.28
2018/4/17	2450	Body	250	924	3819	1437	12.20	50.70	48.80	-3.75
2018/4/17	5250	Body	100	1167	3819	1437	7.62	76.90	76.20	-0.91
2018/4/17	5600	Body	100	1167	3819	1437	8.47	80.00	84.70	5.88
2018/4/17	5750	Body	100	1167	3819	1437	8.30	77.50	83.00	7.10

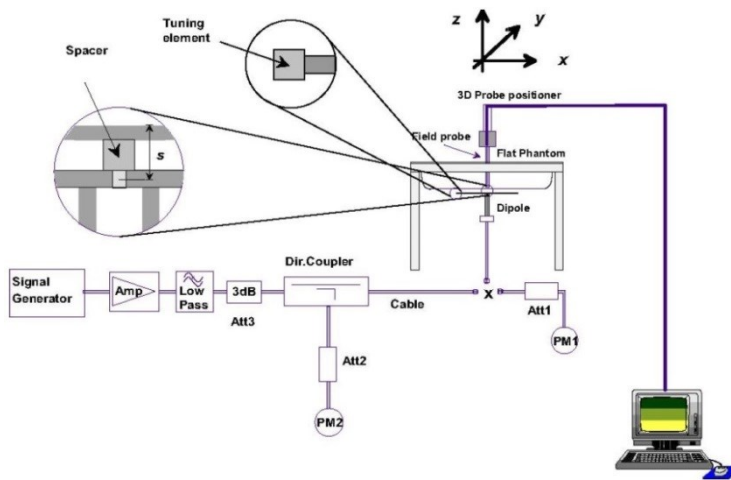

**Fig 11.3.1 System Performance Check Setup**



**Fig 11.3.2 Setup Photo**



## **13. RF Exposure Positions**

### **13.1 SAR Testing for Tablet**

This device can be used also in full sized tablet exposure conditions, due to its size. Per FCC KDB 616217, the back surface and edges of the tablet should be tested for SAR compliance with the tablet touching the phantom. The SAR exclusion threshold in KDB 447498 D01v06 can be applied to determine SAR test exclusion for adjacent edge configurations. The closest distance from the antenna to an adjacent tablet edge is used to determine if SAR testing is required for the adjacent edges, with the adjacent edge positioned against the phantom and the edge containing the antenna positioned perpendicular to the phantom.

#### **<EUT Setup Photos>**

Please refer to Appendix D for the test setup photos.

## 14. Conducted RF Output Power (Unit: dBm)

### <WCDMA Conducted Power>

1. The following tests were conducted according to the test requirements outlines in 3GPP TS 34.121 specification.
2. The procedures in KDB 941225 D01v03r01 are applied for 3GPP Rel. 6 HSPA to configure the device in the required sub-test mode(s) to determine SAR test exclusion.
3. For HSPA+ devices supporting 16 QAM in the uplink, power measurements procedure is according to the configurations in Table C.11.1.4 of 3GPP TS 34.121-1.

A summary of these settings are illustrated below:

### HSDPA Setup Configuration:

- a. The EUT was connected to Base Station Agilent E5515C referred to the Setup Configuration.
- b. The RF path losses were compensated into the measurements.
- c. A call was established between EUT and Base Station with following setting:
  - i. Set Gain Factors ( $\beta_c$  and  $\beta_d$ ) and parameters were set according to each
  - ii. Specific sub-test in the following table, C10.1.4, quoted from the TS 34.121
  - iii. Set RMC 12.2Kbps + HSDPA mode.
  - iv. Set Cell Power = -86 dBm
  - v. Set HS-DSCH Configuration Type to FRC (H-set 1, QPSK)
  - vi. Select HSDPA Uplink Parameters
  - vii. Set Delta ACK, Delta NACK and Delta CQI = 8
  - viii. Set Ack-Nack Repetition Factor to 3
  - ix. Set CQI Feedback Cycle (k) to 4 ms
  - x. Set CQI Repetition Factor to 2
  - xi. Power Ctrl Mode = All Up bits
- d. The transmitted maximum output power was recorded.

**Table C.10.1.4:  $\beta$  values for transmitter characteristics tests with HS-DPCCH**

Sub-test	$\beta_c$	$\beta_d$	$\beta_d$ (SF)	$\beta_c/\beta_d$	$\beta_{hs}$ (Note 1, Note 2)	CM (dB) (Note 3)	MPR (dB) (Note 3)
1	2/15	15/15	64	2/15	4/15	0.0	0.0
2	12/15 (Note 4)	15/15 (Note 4)	64	12/15 (Note 4)	24/15	1.0	0.0
3	15/15	8/15	64	15/8	30/15	1.5	0.5
4	15/15	4/15	64	15/4	30/15	1.5	0.5

Note 1:  $\Delta_{ACK}$ ,  $\Delta_{NACK}$  and  $\Delta_{CQI} = 30/15$  with  $\beta_{hs} = 30/15 * \beta_c$ .

Note 2: For the HS-DPCCH power mask requirement test in clause 5.2C, 5.7A, and the Error Vector Magnitude (EVM) with HS-DPCCH test in clause 5.13.1A, and HSDPA EVM with phase discontinuity in clause 5.13.1AA,  $\Delta_{ACK}$  and  $\Delta_{NACK} = 30/15$  with  $\beta_{hs} = 30/15 * \beta_c$ , and  $\Delta_{CQI} = 24/15$  with  $\beta_{hs} = 24/15 * \beta_c$ .

Note 3: CM = 1 for  $\beta_c/\beta_d = 12/15$ ,  $\beta_{hs}/\beta_c = 24/15$ . For all other combinations of DPCCH, DPDCCH and HS-DPCCH the MPR is based on the relative CM difference. This is applicable for only UEs that support HSDPA in release 6 and later releases.

Note 4: For subtest 2 the  $\beta_c/\beta_d$  ratio of 12/15 for the TFC during the measurement period (TF1, TF0) is achieved by setting the signalled gain factors for the reference TFC (TF1, TF1) to  $\beta_c = 11/15$  and  $\beta_d = 15/15$ .

### Setup Configuration

**HSUPA Setup Configuration:**

- a. The EUT was connected to Base Station Agilent E5515C referred to the Setup Configuration.
- b. The RF path losses were compensated into the measurements.
- c. A call was established between EUT and Base Station with following setting \* :
  - i. Call Configs = 5.2B, 5.9B, 5.10B, and 5.13.2B with QPSK
  - ii. Set the Gain Factors ( $\beta_c$  and  $\beta_d$ ) and parameters (AG Index) were set according to each specific sub-test in the following table, C11.1.3, quoted from the TS 34.121
  - iii. Set Cell Power = -86 dBm
  - iv. Set Channel Type = 12.2k + HSPA
  - v. Set UE Target Power
  - vi. Power Ctrl Mode= Alternating bits
  - vii. Set and observe the E-TFCl
  - viii. Confirm that E-TFCl is equal to the target E-TFCl of 75 for sub-test 1, and other subtest's E-TFCl
- d. The transmitted maximum output power was recorded.

**Table C.11.1.3:  $\beta$  values for transmitter characteristics tests with HS-DPCCH and E-DCH**

Sub-test	$\beta_c$	$\beta_d$	$\beta_d$ (SF)	$\beta_c/\beta_d$	$\beta_{HS}$ (Note1)	$\beta_{ec}$	$\beta_{ed}$ (Note 4) (Note 5)	$\beta_{ed}$ (SF)	$\beta_{ed}$ (Codes)	CM (dB) (Note 2)	MPR (dB) (Note 2) (Note 6)	AG Index (Note 5)	E-TFCl
1	11/15 (Note 3)	15/15 (Note 3)	64	11/15 (Note 3)	22/15	209/25	1309/225	4	1	1.0	0.0	20	75
2	6/15	15/15	64	6/15	12/15	12/15	94/75	4	1	3.0	2.0	12	67
3	15/15	9/15	64	15/9	30/15	30/15	$\beta_{ed1}: 47/15$ $\beta_{ed2}: 47/15$	4	2	2.0	1.0	15	92
4	2/15	15/15	64	2/15	4/15	2/15	56/75	4	1	3.0	2.0	17	71
5	15/15	0	-	-	5/15	5/15	47/15	4	1	1.0	0.0	12	67

Note 1: For sub-test 1 to 4,  $\Delta_{ACK}$ ,  $\Delta_{NACK}$  and  $\Delta_{CQI} = 30/15$  with  $\beta_{hs} = 30/15 * \beta_c$ . For sub-test 5,  $\Delta_{ACK}$ ,  $\Delta_{NACK}$  and  $\Delta_{CQI} = 5/15$  with  $\beta_{hs} = 5/15 * \beta_c$ .

Note 2: CM = 1 for  $\beta_c/\beta_d = 12/15$ ,  $\beta_{hs}/\beta_c = 24/15$ . For all other combinations of DPDCH, DPCCH, HS-DPCCH, E-DPDCH and E-DPCCH the MPR is based on the relative CM difference.

Note 3: For subtest 1 the  $\beta_c/\beta_d$  ratio of 11/15 for the TFC during the measurement period (TF1, TF0) is achieved by setting the signalled gain factors for the reference TFC (TF1, TF1) to  $\beta_c = 10/15$  and  $\beta_d = 15/15$ .

Note 4: In case of testing by UE using E-DPDCH Physical Layer category 1, Sub-test 3 is omitted according to TS25.306 Table 5.1g.

Note 5:  $\beta_{ed}$  can not be set directly; it is set by Absolute Grant Value.

Note 6: For subtests 2, 3 and 4, UE may perform E-DPDCH power scaling at max power which could results in slightly smaller MPR values.

**Setup Configuration**





**<WCDMA Conducted Power>**

**General Note:**

1. Per KDB 941225 D01v03r01, for SAR testing is measured using a 12.2 kbps RMC with TPC bits configured to all "1's".
2. Per KDB 941225 D01v03r01, RMC 12.2kbps setting is used to evaluate SAR. The maximum output power and tune-up tolerance specified for production units in HSDPA / HSUPA is  $\leq \frac{1}{4}$  dB higher than RMC 12.2Kbps or when the highest reported SAR of the RMC12.2Kbps is scaled by the ratio of specified maximum output power and tune-up tolerance of HSDPA / HSUPA to RMC12.2Kbps and the adjusted SAR is  $\leq 1.2$  W/kg, SAR measurement is not required for HSDPA / HSUPA, and according to the following RF output power, the output power results of the secondary modes (HSUPA, HSDPA) are less than  $\frac{1}{4}$  dB higher than the primary modes; therefore, SAR measurement is not required for HSDPA / HSUPA.

**<Maximum Average RF Power (Proximity Sensor Inactive)>**

Band		WCDMA Band V			Tune-up Limit (dBm)
Tx Channel		4132	4182	4233	
Rx Channel		4357	4407	4458	
Frequency (MHz)		826.4	836.4	846.6	
3GPP Rel 99	RMC 12.2Kbps	23.01	23.06	23.02	24.00
3GPP Rel 6	HSDPA Subtest-1	22.93	23.01	22.96	24.00
3GPP Rel 6	HSDPA Subtest-2	22.99	23.04	23.01	24.00
3GPP Rel 6	HSDPA Subtest-3	22.40	22.45	22.36	23.50
3GPP Rel 6	HSDPA Subtest-4	22.40	22.45	22.38	23.50
3GPP Rel 6	HSUPA Subtest-1	22.27	22.60	22.62	23.50
3GPP Rel 6	HSUPA Subtest-2	19.75	20.09	20.07	21.00
3GPP Rel 6	HSUPA Subtest-3	21.37	20.75	20.73	22.00
3GPP Rel 6	HSUPA Subtest-4	20.52	19.90	19.87	21.00
3GPP Rel 6	HSUPA Subtest-5	23.00	23.04	23.00	23.50

**<Maximum Average RF Power (Proximity Sensor Active)>**

Band		WCDMA Band V			Tune-up Limit (dBm)
Tx Channel		4132	4182	4233	
Rx Channel		4357	4407	4458	
Frequency (MHz)		826.4	836.4	846.6	
3GPP Rel 99	RMC 12.2Kbps	14.29	14.70	14.76	16.00
3GPP Rel 6	HSDPA Subtest-1	14.41	14.73	14.71	16.00
3GPP Rel 6	HSDPA Subtest-2	14.33	14.74	14.63	16.00
3GPP Rel 6	HSDPA Subtest-3	13.74	14.17	14.06	15.50
3GPP Rel 6	HSDPA Subtest-4	13.75	14.19	14.06	15.50
3GPP Rel 6	HSUPA Subtest-1	14.35	14.38	14.32	15.50
3GPP Rel 6	HSUPA Subtest-2	11.73	11.86	11.35	13.00
3GPP Rel 6	HSUPA Subtest-3	13.78	13.62	13.74	14.00
3GPP Rel 6	HSUPA Subtest-4	12.46	12.67	12.52	13.00
3GPP Rel 6	HSUPA Subtest-5	14.63	14.69	14.64	15.50



**<LTE Conducted Power>**

**General Note:**

1. Anritsu MT8820C base station simulator was used to setup the connection with EUT; the frequency band, channel bandwidth, RB allocation configuration, modulation type are set in the base station simulator to configure EUT transmitting at maximum power and at different configurations which are requested to be reported to FCC, for conducted power measurement and SAR testing.
2. Per KDB 941225 D05v02r05, when a properly configured base station simulator is used for the SAR and power measurements, spectrum plots for each RB allocation and offset configuration is not required.
3. Per KDB 941225 D05v02r05, start with the largest channel bandwidth and measure SAR for QPSK with 1 RB allocation, using the RB offset and required test channel combination with the highest maximum output power for RB offsets at the upper edge, middle and lower edge of each required test channel.
4. Per KDB 941225 D05v02r05, 50% RB allocation for QPSK SAR testing follows 1RB QPSK allocation procedure.
5. Per KDB 941225 D05v02r05, for QPSK with 100% RB allocation, SAR is not required when the highest maximum output power for 100 % RB allocation is less than the highest maximum output power in 50% and 1 RB allocations and the highest reported SAR for 1 RB and 50% RB allocation are  $\leq 0.8$  W/kg. Otherwise, SAR is measured for the highest output power channel; and if the reported SAR is  $> 1.45$  W/kg, the remaining required test channels must also be tested.
6. Per KDB 941225 D05v02r05, 16QAM output power for each RB allocation configuration is  $>$  not  $\frac{1}{2}$  dB higher than the same configuration in QPSK and the reported SAR for the QPSK configuration is  $\leq 1.45$  W/kg; Per KDB 941225 D05v02r05, 16QAM SAR testing is not required.
7. Per KDB 941225 D05v02r05, smaller bandwidth output power for each RB allocation configuration is  $>$  not  $\frac{1}{2}$  dB higher than the same configuration in the largest supported bandwidth, and the reported SAR for the largest supported bandwidth is  $\leq 1.45$  W/kg; Per KDB 941225 D05v02r05, smaller bandwidth SAR testing is not required.
8. For LTE B5 the maximum bandwidth does not support three non-overlapping channels, per KDB 941225 D05v02r05, when a device supports overlapping channel assignment in a channel bandwidth configuration, the middle channel of the group of overlapping channels should be selected for testing.



<Maximum Average RF Power (Proximity Sensor Inactive)>

<LTE Band 5>

BW [MHz]	Modulation	RB Size	RB Offset	Power Low Ch. / Freq.	Power Middle Ch. / Freq.	Power High Ch. / Freq.	Tune-up limit (dBm)	MPR (dB)
Channel				20450	20525	20600		
Frequency (MHz)				829	836.5	844		
10	QPSK	1	0	22.06	22.69	22.07	24	0
10	QPSK	1	25	23.09	22.71	23.11		
10	QPSK	1	49	22.47	22.04	22.30		
10	QPSK	25	0	21.75	21.53	21.78	23	1
10	QPSK	25	12	22.14	22.06	22.15		
10	QPSK	25	25	22.11	21.50	22.14		
10	QPSK	50	0	21.94	21.81	22.00	23	1
10	16QAM	1	0	21.35	22.03	21.41		
10	16QAM	1	25	22.39	22.14	22.32		
10	16QAM	1	49	21.77	21.39	21.65	22	2
10	16QAM	25	0	20.69	20.99	20.83		
10	16QAM	25	12	21.10	20.99	21.21		
10	16QAM	25	25	21.05	20.57	21.21	22	2
10	16QAM	25	25	21.05	20.57	21.21		
10	16QAM	50	0	20.88	20.81	21.05		
Channel				20425	20525	20625		
Frequency (MHz)				826.5	836.5	846.5		
5	QPSK	1	0	22.07	22.28	22.41	24	0
5	QPSK	1	12	22.44	22.41	22.93		
5	QPSK	1	24	22.13	22.09	22.04		
5	QPSK	12	0	21.14	21.55	21.97	23	1
5	QPSK	12	7	21.49	21.50	22.13		
5	QPSK	12	13	21.45	21.21	21.80		
5	QPSK	25	0	21.30	21.43	21.86	23	1
5	16QAM	1	0	21.52	21.63	21.81		
5	16QAM	1	12	21.79	21.78	22.45		
5	16QAM	1	24	21.50	21.44	21.48	22	2
5	16QAM	12	0	20.10	20.50	21.02		
5	16QAM	12	7	20.46	20.45	21.21		
5	16QAM	12	13	20.46	20.19	20.90	22	2
5	16QAM	12	13	20.46	20.19	20.90		
5	16QAM	25	0	20.26	20.38	20.94		



Channel				20415	20525	20635	Tune-up limit (dBm)	MPR (dB)
Frequency (MHz)				825.5	836.5	847.5		
3	QPSK	1	0	22.02	22.29	22.81	24	0
3	QPSK	1	8	22.06	22.34	22.75		
3	QPSK	1	14	22.07	22.04	22.16		
3	QPSK	8	0	21.07	21.53	22.07	23	1
3	QPSK	8	4	21.28	21.49	22.00		
3	QPSK	8	7	21.31	21.33	21.78		
3	QPSK	15	0	21.18	21.42	21.91	23	1
3	16QAM	1	0	21.03	21.58	22.14		
3	16QAM	1	8	21.45	21.71	22.17		
3	16QAM	1	14	21.35	21.29	21.47	22	2
3	16QAM	8	0	20.04	20.55	21.14		
3	16QAM	8	4	20.24	20.52	21.09		
3	16QAM	8	7	20.28	20.34	20.91	22	2
3	16QAM	15	0	20.12	20.40	20.98		
Channel				20407	20525	20643	Tune-up limit (dBm)	MPR (dB)
Frequency (MHz)				824.7	836.5	848.3		
1.4	QPSK	1	0	22.02	22.41	22.72	24	0
1.4	QPSK	1	3	22.09	22.35	22.54		
1.4	QPSK	1	5	22.01	22.09	22.27		
1.4	QPSK	3	0	22.01	22.49	22.88		
1.4	QPSK	3	1	22.12	22.52	22.81		
1.4	QPSK	3	3	22.08	22.35	22.61	23	1
1.4	QPSK	6	0	21.12	21.51	21.80		
1.4	16QAM	1	0	21.21	21.71	22.09	23	1
1.4	16QAM	1	3	21.42	21.71	21.87		
1.4	16QAM	1	5	21.29	21.44	21.60		
1.4	16QAM	3	0	21.04	21.61	21.98		
1.4	16QAM	3	1	21.20	21.66	21.93		
1.4	16QAM	3	3	21.21	21.47	21.75	22	2
1.4	16QAM	6	0	20.12	20.50	20.94		



<Maximum Average RF Power (Proximity Sensor Active)>

<LTE Band 5>

BW [MHz]	Modulation	RB Size	RB Offset	Power Low Ch. / Freq.	Power Middle Ch. / Freq.	Power High Ch. / Freq.	Tune-up limit (dBm)	MPR (dB)
Channel				20450	20525	20600		
Frequency (MHz)				829	836.5	844		
10	QPSK	1	0	12.86	13.48	12.90	14.5	0
10	QPSK	1	25	13.72	13.59	13.88		
10	QPSK	1	49	13.32	12.81	13.41		
10	QPSK	25	0	12.26	12.59	12.35	13.5	1
10	QPSK	25	12	12.68	12.64	12.72		
10	QPSK	25	25	12.66	12.16	12.64		
10	QPSK	50	0	12.48	12.46	12.56	13.5	1
10	16QAM	1	0	12.18	12.77	12.23		
10	16QAM	1	25	12.98	12.85	13.03		
10	16QAM	1	49	12.64	12.12	12.70	12.5	2
10	16QAM	25	0	11.24	11.58	11.33		
10	16QAM	25	12	11.63	11.51	11.62		
10	16QAM	25	25	11.63	11.12	11.69	12.5	2
10	16QAM	25	25	11.63	11.12	11.69		
10	16QAM	50	0	11.42	11.37	11.53		
Channel				20425	20525	20625	Tune-up limit (dBm)	MPR (dB)
Frequency (MHz)				826.5	836.5	846.5		
5	QPSK	1	0	12.60	13.07	13.10	14.5	0
5	QPSK	1	12	13.39	13.51	13.77		
5	QPSK	1	24	13.07	12.95	13.34		
5	QPSK	12	0	11.95	12.20	12.48	13.5	1
5	QPSK	12	7	12.08	12.13	12.71		
5	QPSK	12	13	12.03	11.84	12.51		
5	QPSK	25	0	11.88	12.07	12.46	13.5	1
5	16QAM	1	0	11.82	12.32	12.34		
5	16QAM	1	12	12.39	12.50	12.80		
5	16QAM	1	24	12.18	12.14	12.37	12.5	2
5	16QAM	12	0	10.70	11.22	11.45		
5	16QAM	12	7	11.09	11.15	11.69		
5	16QAM	12	13	11.03	10.83	11.50	12.5	2
5	16QAM	12	13	11.03	10.83	11.50		
5	16QAM	25	0	10.80	11.03	11.44		



Channel				20415	20525	20635	Tune-up limit (dBm)	MPR (dB)
Frequency (MHz)				825.5	836.5	847.5		
3	QPSK	1	0	12.59	13.12	13.61	14.5	0
3	QPSK	1	8	12.80	13.08	13.64		
3	QPSK	1	14	12.77	12.72	13.21		
3	QPSK	8	0	11.65	12.21	12.72	13.5	1
3	QPSK	8	4	11.84	12.14	12.70		
3	QPSK	8	7	11.90	11.99	12.56		
3	QPSK	15	0	11.79	12.09	12.64	13.5	1
3	16QAM	1	0	12.04	12.36	12.82		
3	16QAM	1	8	12.09	12.33	12.88		
3	16QAM	1	14	12.06	11.95	12.53	12.5	2
3	16QAM	8	0	10.64	11.21	11.71		
3	16QAM	8	4	10.81	11.18	11.70		
3	16QAM	8	7	10.83	10.98	11.54	12.5	2
3	16QAM	15	0	10.73	11.10	11.61		
Channel				20407	20525	20643	Tune-up limit (dBm)	MPR (dB)
Frequency (MHz)				824.7	836.5	848.3		
1.4	QPSK	1	0	12.75	13.16	13.69	14.5	0
1.4	QPSK	1	3	12.90	13.15	13.64		
1.4	QPSK	1	5	12.81	12.92	13.50		
1.4	QPSK	3	0	12.64	13.14	13.72		
1.4	QPSK	3	1	12.83	13.17	13.68		
1.4	QPSK	3	3	12.68	13.02	13.59	13.5	1
1.4	QPSK	6	0	11.85	12.47	12.59		
1.4	16QAM	1	0	11.90	12.38	12.90	13.5	1
1.4	16QAM	1	3	11.92	12.34	12.81		
1.4	16QAM	1	5	11.83	12.11	12.63		
1.4	16QAM	3	0	11.73	12.18	12.69		
1.4	16QAM	3	1	11.93	12.21	12.63		
1.4	16QAM	3	3	11.85	12.07	12.54	12.5	2
1.4	16QAM	6	0	10.68	11.23	11.64		

**<WLAN Conducted Power>****General Note:**

1. Per KDB 248227 D01v02r02, SAR test reduction is determined according to 802.11 transmission mode configurations and certain exposure conditions with multiple test positions. In the 2.4 GHz band, separate SAR procedures are applied to DSSS and OFDM configurations to simplify DSSS test requirements. For OFDM, in both 2.4 and 5 GHz bands, an initial test configuration must be determined for each standalone and aggregated frequency band, according to the transmission mode configuration with the highest maximum output power specified for production units to perform SAR measurements. If the same highest maximum output power applies to different combinations of channel bandwidths, modulations and data rates, additional procedures are applied to determine which test configurations require SAR measurement. When applicable, an initial test position may be applied to reduce the number of SAR measurements required for next to the ear, UMPC mini-tablet or hotspot mode configurations with multiple test positions.
2. For 2.4 GHz 802.11b DSSS, either the initial test position procedure for multiple exposure test positions or the DSSS procedure for fixed exposure position is applied; these are mutually exclusive. For 2.4 GHz and 5 GHz OFDM configurations, the initial test configuration is applied to measure SAR using either the initial test position procedure for multiple exposure test position configurations or the initial test configuration procedures for fixed exposure test conditions. Based on the reported SAR of the measured configurations and maximum output power of the transmission mode configurations that are not included in the initial test configuration, the subsequent test configuration and initial test position procedures are applied to determine if SAR measurements are required for the remaining OFDM transmission configurations. In general, the number of test channels that require SAR measurement is minimized based on maximum output power measured for the test sample(s).
3. For OFDM transmission configurations in the 2.4 GHz and 5 GHz bands, When the same maximum power is specified for multiple transmission modes in a frequency band, the largest channel bandwidth, lowest order modulation, lowest data rate and lowest order 802.11a/g/n/ac mode is used for SAR measurement, on the highest measured output power channel for each frequency band.
4. DSSS and OFDM configurations are considered separately according to the required SAR procedures. SAR is measured in the initial test position using the 802.11 transmission mode configuration required by the DSSS procedure or initial test configuration and subsequent test configuration(s) according to the OFDM procedures.18 The initial test position procedure is described in the following:
  - a. When the reported SAR of the initial test position is  $\leq 0.4$  W/kg, further SAR measurement is not required for the other test positions in that exposure configuration and 802.11 transmission mode combinations within the frequency band or aggregated band.
  - b. When the reported SAR of the test position is  $> 0.4$  W/kg, SAR is repeated for the 802.11 transmission mode configuration tested in the initial test position to measure the subsequent next closet/smallest test separation distance and maximum coupling test position on the highest maximum output power channel, until the report SAR is  $\leq 0.8$  W/kg or all required test position are tested.
  - c. For all positions/configurations, when the reported SAR is  $> 0.8$  W/kg, SAR is measured for these test positions/configurations on the subsequent next highest measured output power channel(s) until the reported SAR is  $\leq 1.2$  W/kg or all required channels are tested.

**<2.4GHz WLAN>(MCC of FCC countries, full power level)**

	Mode	Channel	Frequency (MHz)	Average power (dBm)	Tune-Up Limit	Duty Cycle %
2.4GHz WLAN	802.11b 1Mbps	1	2412	12.31	13.00	100.00
		6	2437	12.44	13.00	
		11	2462	12.09	13.00	
	802.11g 6Mbps	1	2412	12.17	13.00	97.95
		6	2437	12.28	13.00	
		11	2462	12.30	13.00	
	802.11n-HT20 MCS0	1	2412	12.43	13.00	97.00
		6	2437	12.55	13.00	
		11	2462	12.18	13.00	
	802.11n-HT40 MCS0	3	2422	9.62	10.00	95.29
		6	2437	9.73	10.00	
		9	2452	9.56	10.00	





<5GHz WLAN>(MCC of FCC countries, full power level)

	Mode	Channel	Frequency (MHz)	Average power (dBm)	Tune-Up Limit	Duty Cycle %
5.2GHz WLAN	802.11a 6Mbps	36	5180	9.38	10.00	97.74
		40	5200	9.57	10.00	
		44	5220	9.46	10.00	
		48	5240	9.51	10.00	
	802.11n-HT20 MCS0	36	5180	9.01	10.00	97.58
		40	5200	9.29	10.00	
		44	5220	9.16	10.00	
		48	5240	9.23	10.00	
	802.11n-HT40 MCS0	38	5190	9.32	10.00	95.33
		46	5230	9.35	10.00	
	802.11ac-VHT20 MCS0	36	5180	9.03	10.00	97.50
		40	5200	9.32	10.00	
		44	5220	9.19	10.00	
		48	5240	9.26	10.00	
	802.11ac-VHT40 MCS0	38	5190	9.33	10.00	96.04
		46	5230	9.36	10.00	
802.11ac-VHT80 MCS0	42	5210	9.28	10.00	95.74	



	Mode	Channel	Frequency (MHz)	Average power (dBm)	Tune-Up Limit	Duty Cycle %
5.3GHz WLAN	802.11a 6Mbps	52	5260	9.56	10.00	97.74
		56	5280	9.49	10.00	
		60	5300	9.63	10.00	
		64	5320	9.45	10.00	
	802.11n-HT20 MCS0	52	5260	9.26	10.00	97.58
		56	5280	9.19	10.00	
		60	5300	9.37	10.00	
		64	5320	9.25	10.00	
	802.11n-HT40 MCS0	54	5270	9.40	10.00	95.33
		62	5310	9.45	10.00	
	802.11ac-VHT20 MCS0	52	5260	9.32	10.00	97.50
		56	5280	9.22	10.00	
		60	5300	9.39	10.00	
		64	5320	9.26	10.00	
	802.11ac-VHT40 MCS0	54	5270	9.41	10.00	96.04
		62	5310	9.46	10.00	
802.11ac-VHT80 MCS0	58	5290	9.30	10.00	95.74	



	Mode	Channel	Frequency (MHz)	Average power (dBm)	Tune-Up Limit	Duty Cycle %
5.5GHz WLAN	802.11a 6Mbps	100	5500	9.07	10.00	97.74
		116	5580	9.29	10.00	
		124	5620	9.35	10.00	
		132	5660	9.42	10.00	
		140	5700	9.69	10.00	
		144	5720	9.82	10.00	
	802.11n-HT20 MCS0	100	5500	8.83	10.00	97.58
		116	5580	9.06	10.00	
		124	5620	9.13	10.00	
		132	5660	9.17	10.00	
		140	5700	9.45	10.00	
		144	5720	9.57	10.00	
	802.11n-HT40 MCS0	102	5510	9.08	10.00	95.33
		110	5550	8.65	10.00	
		126	5630	8.96	10.00	
		134	5670	9.39	10.00	
		142	5710	9.62	10.00	
	802.11ac-VHT20 MCS0	100	5500	8.87	10.00	97.50
		116	5580	9.08	10.00	
		124	5620	9.14	10.00	
		132	5660	9.19	10.00	
		140	5700	9.47	10.00	
		144	5720	9.59	10.00	
	802.11ac-VHT40 MCS0	102	5510	9.09	10.00	96.04
110		5550	8.66	10.00		
126		5630	8.99	10.00		
134		5670	9.40	10.00		
142		5710	9.63	10.00		
802.11ac-VHT80 MCS0	106	5530	8.69	10.00	95.74	
	122	5610	8.88	10.00		
	138	5690	9.08	10.00		



5.8GHz WLAN	Mode	Channel	Frequency (MHz)	Average power (dBm)	Tune-Up Limit	Duty Cycle %
	802.11a MCS0	149	5745	9.83	10.00	97.74
		157	5785	9.74	10.00	
		165	5825	9.22	10.00	
	802.11n-HT20 MCS0	149	5745	9.60	10.00	97.58
		157	5785	9.50	10.00	
		165	5825	9.00	10.00	
	802.11n-HT40 MCS0	151	5755	9.69	10.00	95.33
		159	5795	9.45	10.00	
	802.11ac-VHT20 MCS0	149	5745	9.62	10.00	97.50
157		5785	9.51	10.00		
165		5825	9.02	10.00		
802.11ac-VHT40 MCS0	151	5755	9.70	10.00	96.04	
	159	5795	9.46	10.00		
802.11ac-VHT80 MCS0	155	5775	9.38	10.00	95.74	

<Bluetooth>

Mode Band	Average power (dBm)	
	BR/EDR	BLE
2.4GHz Bluetooth	9.7	9.7



## **15. Antenna Location**

Please refer to Appendix D for Fig.15.1.



## **16. SAR Test Results**

### **General Note:**

1. Per KDB 447498 D01v06, the reported SAR is the measured SAR value adjusted for maximum tune-up tolerance.
  - a. Tune-up scaling Factor = tune-up limit power (mW) / EUT RF power (mW), where tune-up limit is the maximum rated power among all production units.
  - b. For SAR testing of WLAN signal with non-100% duty cycle, the measured SAR is scaled-up by the duty cycle scaling factor which is equal to "1/(duty cycle)"
  - c. For WWAN: Reported SAR(W/kg)= Measured SAR(W/kg)\*Tune-up Scaling Factor
  - d. For WLAN: Reported SAR(W/kg)= Measured SAR(W/kg)\* Duty Cycle scaling factor \* Tune-up scaling factor
2. Per KDB 447498 D01v06, for each exposure position, testing of other required channels within the operating mode of a frequency band is not required when the *reported* 1-g or 10-g SAR for the mid-band or highest output power channel is:
  - $\leq 0.8$  W/kg or 2.0 W/kg, for 1-g or 10-g respectively, when the transmission band is  $\leq 100$  MHz
  - $\leq 0.6$  W/kg or 1.5 W/kg, for 1-g or 10-g respectively, when the transmission band is between 100 MHz and 200 MHz
  - $\leq 0.4$  W/kg or 1.0 W/kg, for 1-g or 10-g respectively, when the transmission band is  $\geq 200$  MHz
3. Per KDB 865664 D01v01r04, for each frequency band, repeated SAR measurement is not required only when the measured SAR is  $\leq 0.8$ W/kg.
4. This device implanted proximity sensor function at back face and bottom edge , power reduction will be implemented immediately at all WWAN bands.

### **Tablet Note:**

1. For the exposure positions that proximity sensor power reduction is applied for SAR compliance, additional SAR testing with EUT transmitting full power in normal mode was performed; 16mm for back face / bottom edge for WWAN frequency bands.
2. Considering the curvature transition from bottom face to the edge, SAR testing at the curvature was performed. The SAR test setup is included in test setup photo exhibit, and the details of the curvature are included in operation description exhibit.
3. For SAR testing of the curved region of the device, the device was placed directly against the phantom at the point where the distance between the antenna and device exterior is a minimum.
4. When the minimum distance between antenna and device edge along the curve is less than bottom face and surface edge, the curved SAR is necessary, more detail information which can be referred to setup photo.
5. For SAR testing of the curved region of the device, the device was placed directly against the phantom at the point where the distance between the antenna and device exterior is a minimum.

### **WCDMA Note:**

1. Per KDB 941225 D01v03r01, for SAR testing is measured using a 12.2 kbps RMC with TPC bits configured to all "1's".
2. Per KDB 941225 D01v03r01, RMC 12.2kbps setting is used to evaluate SAR. The maximum output power and tune-up tolerance specified for production units in HSDPA / HSUPA is  $\leq 1/4$  dB higher than RMC 12.2Kbps or when the highest reported SAR of the RMC12.2Kbps is scaled by the ratio of specified maximum output power and tune-up tolerance of HSDPA / HSUPA to RMC12.2Kbps and the adjusted SAR is  $\leq 1.2$  W/kg, SAR measurement is not required for HSDPA / HSUPA, and according to the following RF output power, the output power results of the secondary modes (HSUPA, HSDPA) are less than  $1/4$  dB higher than the primary modes; therefore, SAR measurement is not required for HSDPA / HSUPA.



**LTE Note:**

1. Per KDB 941225 D05v02r05, start with the largest channel bandwidth and measure SAR for QPSK with 1 RB allocation, using the RB offset and required test channel combination with the highest maximum output power for RB offsets at the upper edge, middle and lower edge of each required test channel.
2. Per KDB 941225 D05v02r05, 50% RB allocation for QPSK SAR testing follows 1RB QPSK allocation procedure.
3. Per KDB 941225 D05v02r05, for QPSK with 100% RB allocation, SAR is not required when the highest maximum output power for 100 % RB allocation is less than the highest maximum output power in 50% and 1 RB allocations and the highest reported SAR for 1 RB and 50% RB allocation are  $\leq 0.8$  W/kg. Otherwise, SAR is measured for the highest output power channel; and if the reported SAR is  $> 1.45$  W/kg, the remaining required test channels must also be tested.
4. Per KDB 941225 D05v02r05, 16QAM output power for each RB allocation configuration is  $>$  not  $\frac{1}{2}$  dB higher than the same configuration in QPSK and the reported SAR for the QPSK configuration is  $\leq 1.45$  W/kg; Per KDB 941225 D05v02r05, 16QAM SAR testing is not required.
5. Per KDB 941225 D05v02r05, smaller bandwidth output power for each RB allocation configuration is  $>$  not  $\frac{1}{2}$  dB higher than the same configuration in the largest supported bandwidth, and the reported SAR for the largest supported bandwidth is  $\leq 1.45$  W/kg; Per KDB 941225 D05v02r05, smaller bandwidth SAR testing is not required.
6. For LTE B5 the maximum bandwidth does not support three non-overlapping channels, per KDB 941225 D05v02r05, when a device supports overlapping channel assignment in a channel bandwidth configuration, the middle channel of the group of overlapping channels should be selected for testing.

**WLAN Note:**

1. Per KDB 248227 D01v02r02, for 2.4GHz 802.11g/n SAR testing is not required when the highest reported SAR for DSSS is adjusted by the ratio of OFDM to DSSS specified maximum output power and the adjusted SAR is  $\leq 1.2$  W/kg.
2. Per KDB 248227 D01v02r02, U-NII-1 SAR testing is not required when the U-NII-2A band highest reported SAR for a test configuration is  $\leq 1.2$  W/kg, SAR is not required for U-NII-1 band.
3. When the reported SAR of the test position is  $> 0.4$  W/kg, SAR is repeated for the 802.11 transmission mode configuration tested in the initial test position to measure the subsequent next closet/smallest test separation distance and maximum coupling test position on the highest maximum output power channel, until the report SAR is  $\leq 0.8$  W/kg or all required test position are tested.
4. For all positions / configurations, when the reported SAR is  $> 0.8$  W/kg, SAR is measured for these test positions / configurations on the subsequent next highest measured output power channel(s) until the reported SAR is  $\leq 1.2$  W/kg or all required channels are tested.
5. During SAR testing the WLAN transmission was verified using a spectrum analyzer.



16.1 Body SAR

<WCDMA SAR>

Plot No.	Sample	Band	Mode	Test Position	Gap (mm)	Power Reduction	Ch.	Freq. (MHz)	Average Power (dBm)	Tune-Up Limit (dBm)	Tune-up Scaling Factor	Power Drift (dB)	Measured 1g SAR (W/kg)	Reported 1g SAR (W/kg)
	1	WCDMA Band V	RMC 12.2Kbps	Back Face	0	On	4233	846.6	14.76	16.00	1.330	-0.02	0.349	0.464
	1	WCDMA Band V	RMC 12.2Kbps	Bottom Edge	0	On	4233	846.6	14.76	16.00	1.330	0.04	0.128	0.170
	1	WCDMA Band V	RMC 12.2Kbps	Curved Surface of Bottom Edge	0	On	4233	846.6	14.76	16.00	1.330	0.09	0.190	0.253
	1	WCDMA Band V	RMC 12.2Kbps	Back Face	16	Off	4182	836.4	23.06	24.00	1.242	0.01	0.187	0.232
	1	WCDMA Band V	RMC 12.2Kbps	Bottom Edge	16	Off	4182	836.4	23.06	24.00	1.242	-0.07	0.141	0.175
	1	WCDMA Band V	RMC 12.2Kbps	Right Edge	0	Off	4182	836.4	23.06	24.00	1.242	0.04	0.483	0.600
#01	2	WCDMA Band V	RMC 12.2Kbps	Right Edge	0	Off	4182	836.4	23.06	24.00	1.242	-0.15	0.526	0.653

<LTE SAR>

Plot No.	Sample	Band	BW (MHz)	Modulation	RB Size	RB Offset	Test Position	Gap (mm)	Power Reduction	Ch.	Freq. (MHz)	Average Power (dBm)	Tune-Up Limit (dBm)	Tune-up Scaling Factor	Power Drift (dB)	Measured 1g SAR (W/kg)	Reported 1g SAR (W/kg)
	1	LTE Band 5	10M	QPSK	1	25	Back Face	0	On	20525	836.5	13.59	14.50	1.233	-0.08	0.256	0.316
	1	LTE Band 5	10M	QPSK	25	12	Back Face	0	On	20525	836.5	12.64	13.50	1.219	0.09	0.199	0.243
	1	LTE Band 5	10M	QPSK	1	25	Bottom Edge	0	On	20525	836.5	13.59	14.50	1.233	0.11	0.153	0.189
	1	LTE Band 5	10M	QPSK	25	12	Bottom Edge	0	On	20525	836.5	12.64	13.50	1.219	0.01	0.123	0.150
	1	LTE Band 5	10M	QPSK	1	25	Curved Surface of Bottom Edge	0	On	20525	836.5	13.59	14.50	1.233	0.01	0.184	0.227
	1	LTE Band 5	10M	QPSK	25	12	Curved Surface of Bottom Edge	0	On	20525	836.5	12.64	13.50	1.219	0.13	0.144	0.176
	1	LTE Band 5	10M	QPSK	1	25	Back Face	16	Off	20525	836.5	22.71	24.00	1.346	0.09	0.160	0.215
	1	LTE Band 5	10M	QPSK	25	12	Back Face	16	Off	20525	836.5	22.06	23.00	1.242	-0.04	0.130	0.161
	1	LTE Band 5	10M	QPSK	1	25	Bottom Edge	16	Off	20525	836.5	22.71	24.00	1.346	-0.04	0.122	0.164
	1	LTE Band 5	10M	QPSK	25	12	Bottom Edge	16	Off	20525	836.5	22.06	23.00	1.242	-0.07	0.099	0.123
	1	LTE Band 5	10M	QPSK	1	25	Right Edge	0	Off	20525	836.5	22.71	24.00	1.346	0.03	0.393	0.529
#02	2	LTE Band 5	10M	QPSK	1	25	Right Edge	0	Off	20525	836.5	22.71	24.00	1.346	-0.02	0.412	0.554
	1	LTE Band 5	10M	QPSK	25	12	Right Edge	0	Off	20525	836.5	22.06	23.00	1.242	0.06	0.326	0.405





<WLAN SAR>

Plot No.	Sample	Band	Mode	Test Position	Gap (mm)	Ch.	Freq. (MHz)	Average Power (dBm)	Tune-Up Limit (dBm)	Tune-up Scaling Factor	Duty Cycle %	Duty Cycle Scaling Factor	Power Drift (dB)	Measured 1g SAR (W/kg)	Reported 1g SAR (W/kg)
#03	1	WLAN2.4GHz	802.11b 1Mbps	Back Face	0	6	2437	12.44	13.00	1.138	100	1.000	-0.04	0.487	0.554
	2	WLAN2.4GHz	802.11b 1Mbps	Back Face	0	6	2437	12.44	13.00	1.138	100	1.000	0.06	0.372	0.423
	1	WLAN2.4GHz	802.11b 1Mbps	Top Edge	0	6	2437	12.44	13.00	1.138	100	1.000	0.13	0.232	0.264
	1	WLAN2.4GHz	802.11b 1Mbps	Right Edge	0	6	2437	12.44	13.00	1.138	100	1.000	-0.05	0.416	0.473
	1	WLAN 5.3GHz	802.11ac-VHT80 MCS0	Back Face	0	58	5290	9.30	10.00	1.175	95.74	1.044	0.02	0.040	0.049
	1	WLAN 5.3GHz	802.11ac-VHT80 MCS0	Top Edge	0	58	5290	9.30	10.00	1.175	95.74	1.044	0.01	0.078	0.095
#04	2	WLAN 5.3GHz	802.11ac-VHT80 MCS0	Top Edge	0	58	5290	9.30	10.00	1.175	95.74	1.044	-0.03	0.083	0.102
	1	WLAN 5.3GHz	802.11ac-VHT80 MCS0	Right Edge	0	58	5290	9.30	10.00	1.175	95.74	1.044	0.04	0.018	0.021
	1	WLAN 5.5GHz	802.11ac-VHT80 MCS0	Back Face	0	138	5690	9.08	10.00	1.236	95.74	1.044	0.07	0.026	0.033
#05	1	WLAN 5.5GHz	802.11ac-VHT80 MCS0	Top Edge	0	138	5690	9.08	10.00	1.236	95.74	1.044	-0.06	0.114	0.147
	2	WLAN 5.5GHz	802.11ac-VHT80 MCS0	Top Edge	0	138	5690	9.08	10.00	1.236	95.74	1.044	0.05	0.093	0.119
	1	WLAN 5.5GHz	802.11ac-VHT80 MCS0	Right Edge	0	138	5690	9.08	10.00	1.236	95.74	1.044	0.02	0.017	0.022
	1	WLAN 5.8GHz	802.11ac-VHT80 MCS0	Back Face	0	155	5775	9.38	10.00	1.153	95.74	1.044	0.01	0.015	0.018
	1	WLAN 5.8GHz	802.11ac-VHT80 MCS0	Top Edge	0	155	5775	9.38	10.00	1.153	95.74	1.025	0.05	0.112	0.132
#06	2	WLAN 5.8GHz	802.11ac-VHT80 MCS0	Top Edge	0	155	5775	9.38	10.00	1.153	95.74	1.044	-0.09	0.131	0.158
	1	WLAN 5.8GHz	802.11ac-VHT80 MCS0	Right Edge	0	155	5775	9.38	10.00	1.153	95.74	1.044	0.01	0.020	0.024

### 17. Simultaneous Transmission Analysis

No.	Simultaneous Transmission Configurations	Body
1.	WCDMA(Data) + WLAN2.4GHz (data)	Yes
2.	WCDMA(Data) + WLAN5 GHz (data)	Yes
3.	WCDMA(Data) + Bluetooth (data)	Yes
4.	LTE (Data) + WLAN2.4GHz (data)	Yes
5.	LTE (Data) + WLAN5 GHz (data)	Yes
6.	LTE (Data) + Bluetooth (data)	Yes

**General Note:**

1. EUT will choose either WCDMA or LTE according to the network signal condition; therefore, they will not operate simultaneously at any moment.
2. EUT will choose either WLAN 2.4GHz or WLAN 5GHz according to the network signal condition; therefore, 2.4GHz WLAN and 5GHz WLAN will not operate simultaneously at any moment.
3. WLAN and Bluetooth share the same antenna, and cannot transmit simultaneously.
4. For simultaneous transmission analysis for exposure position of bottom face 16mm, WLAN 2.4GHz/5GHz SAR tested at 0mm separation is worse and the test data is used for conservative SAR summation.
5. All licensed modes share the same antenna part and cannot transmit simultaneously.
6. The worst case 5 GHz WLAN reported SAR for each configuration was used for SAR summation.
7. The reported SAR summation is calculated based on the same configuration and test position.
8. Per KDB 447498 D01v06, simultaneous transmission SAR is compliant if,
  - i) Scalar SAR summation < 1.6W/kg.
  - ii)  $SPLSR = (SAR1 + SAR2)^{1.5} / (\text{min. separation distance, mm})$ , and the peak separation distance is determined from the square root of  $[(x1-x2)^2 + (y1-y2)^2 + (z1-z2)^2]$ , where (x1, y1, z1) and (x2, y2, z2) are the coordinates of the extrapolated peak SAR locations in the zoom scan.
  - iii) If  $SPLSR \leq 0.04$ , simultaneously transmission SAR measurement is not necessary.
  - iv) Simultaneously transmission SAR measurement, and the reported multi-band SAR < 1.6W/kg.
9. For simultaneous transmission analysis, Bluetooth SAR is estimated per KDB 447498 D01v06 based on the formula below.
  - i)  $(\text{max. power of channel, including tune-up tolerance, mW}) / (\text{min. test separation distance, mm}) \cdot [\sqrt{f(\text{GHz})} / x] \text{ W/kg}$  for test separation distances  $\leq 50 \text{ mm}$ ; where  $x = 7.5$  for 1-g SAR, and  $x = 18.75$  for 10-g SAR.
  - ii) When the minimum separation distance is < 5mm, the distance is used 5mm to determine SAR test exclusion.
  - iii) 0.4 W/kg for 1-g SAR and 1.0 W/kg for 10-g SAR, when the test separation distances is > 50 mm.
  - iv) Bluetooth estimated SAR is conservatively determined by 5mm separation, for all applicable exposure positions.

Bluetooth Max Power	Exposure Position	All Positions
9.70 dBm	Estimated 1g SAR (W/kg)	0.392 W/kg



**17.1 Body Exposure Conditions**

WWAN Band		Exposure Position	1	2	3	4	1+2 Summed 1g SAR (W/kg)	1+3 Summed 1g SAR (W/kg)	1+4 Summed 1g SAR (W/kg)
			WWAN	2.4GHz WLAN	5GHz WLAN	Bluetooth			
			1g SAR (W/kg)	1g SAR (W/kg)	1g SAR (W/kg)	Estimated 1g SAR (W/kg)			
WCDMA	Band V	Back Face at 16mm	0.232	0.554	0.049	0.392	0.79	0.28	0.62
		Bottom Edge at 16mm	0.175				0.18	0.18	0.18
		Back Face at 0mm	0.464	0.554	0.049	0.392	1.02	0.51	0.86
		Bottom Edge at 0mm	0.170				0.17	0.17	0.17
		Curved Surface of Bottom Edge at 0mm	0.253				0.25	0.25	0.25
		Top Edge at 0mm		0.264	0.158	0.392	0.26	0.16	0.39
		Right Edge at 0mm	0.653	0.473	0.024	0.392	<b>1.13</b>	<b>0.68</b>	1.05
LTE	Band 5	Back Face at 16mm	0.215	0.554	0.049	0.392	0.77	0.26	0.61
		Bottom Edge at 16mm	0.164				0.16	0.16	0.16
		Back Face at 0mm	0.316	0.554	0.049	0.392	0.87	0.37	0.71
		Bottom Edge at 0mm	0.189				0.19	0.19	0.19
		Curved Surface of Bottom Edge at 0mm	0.227				0.23	0.23	0.23
		Top Edge at 0mm		0.264	0.158	0.392	0.26	0.16	0.39
		Right Edge at 0mm	0.554	0.473	0.024	0.392	1.03	0.58	0.95

Test Engineer : Johnny Chen



## **18. Uncertainty Assessment**

Per KDB 865664 D01 SAR measurement 100MHz to 6GHz, when the highest measured 1-g SAR within a frequency band is  $< 1.5$  W/kg. The expanded SAR measurement uncertainty must be  $\leq 30\%$ , for a confidence interval of  $k = 2$ . If these conditions are met, extensive SAR measurement uncertainty analysis described in IEEE Std 1528-2013 is not required in SAR reports submitted for equipment approval. For this device, the highest measured 1-g SAR is less 1.5W/kg. Therefore, the measurement uncertainty table is not required in this report.

## **19. References**

- [1] FCC 47 CFR Part 2 “Frequency Allocations and Radio Treaty Matters; General Rules and Regulations”
- [2] ANSI/IEEE Std. C95.1-1992, “IEEE Standard for Safety Levels with Respect to Human Exposure to Radio Frequency Electromagnetic Fields, 3 kHz to 300 GHz”, September 1992
- [3] IEEE Std. 1528-2013, “IEEE Recommended Practice for Determining the Peak Spatial-Average Specific Absorption Rate (SAR) in the Human Head from Wireless Communications Devices: Measurement Techniques”, Sep 2013
- [4] SPEAG DASY System Handbook
- [5] FCC KDB 865664 D01 v01r04, "SAR Measurement Requirements for 100 MHz to 6 GHz", Aug 2015.
- [6] FCC KDB 865664 D02 v01r02, “RF Exposure Compliance Reporting and Documentation Considerations” Oct 2015.
- [7] FCC KDB 447498 D01 v06, “Mobile and Portable Device RF Exposure Procedures and Equipment Authorization Policies”, Oct 2015
- [8] FCC KDB 248227 D01 v02r02, “SAR Guidance for IEEE 802.11 (WiFi) Transmitters”, Oct 2015.
- [9] FCC KDB 616217 D04 v01r02, “SAR Evaluation Considerations for Laptop, Notebook, Netbook and Tablet Computers”, Oct 2015
- [10] FCC KDB 941225 D01 v03r01, “3G SAR MEAUREMENT PROCEDURES”, Oct 2015
- [11] FCC KDB 941225 D05 v02r05, “SAR Evaluation Considerations for LTE Devices”, Dec 2015



## **Appendix A. Plots of System Performance Check**

The plots are shown as follows.

## System Check\_Body\_835MHz\_180411

### DUT: D835V2-SN:4d162

Communication System: UID 0, CW; Frequency: 835 MHz; Duty Cycle: 1:1  
Medium: MSL\_835\_180411 Medium parameters used:  $f = 835$  MHz;  $\sigma = 0.977$  S/m;  $\epsilon_r = 54.466$ ;  $\rho = 1000$  kg/m<sup>3</sup>  
Ambient Temperature : 23.4 °C; Liquid Temperature : 22.5 °C

#### DASY5 Configuration:

- Probe: EX3DV4 - SN3819; ConvF(9.49, 9.49, 9.49); Calibrated: 2018.01.31;
- Sensor-Surface: 2mm (Mechanical Surface Detection)
- Electronics: DAE4 Sn1437; Calibrated: 2017.09.15
- Phantom: SAM3; Type: QDOVA002AA; Serial: TP:1149
- Measurement SW: DASY52, Version 52.8 (8); SEMCAD X Version 14.6.10 (7331)

**Pin=250mW/Area Scan (61x61x1):** Interpolated grid: dx=15mm, dy=15mm  
Maximum value of SAR (interpolated) = 2.84 W/kg

**Pin=250mW/Zoom Scan (5x5x7)/Cube 0:** Measurement grid: dx=8mm, dy=8mm, dz=5mm  
Reference Value = 49.80 V/m; Power Drift = -0.12 dB  
Peak SAR (extrapolated) = 3.18 W/kg  
**SAR(1 g) = 2.24 W/kg; SAR(10 g) = 1.48 W/kg**  
Maximum value of SAR (measured) = 2.79 W/kg

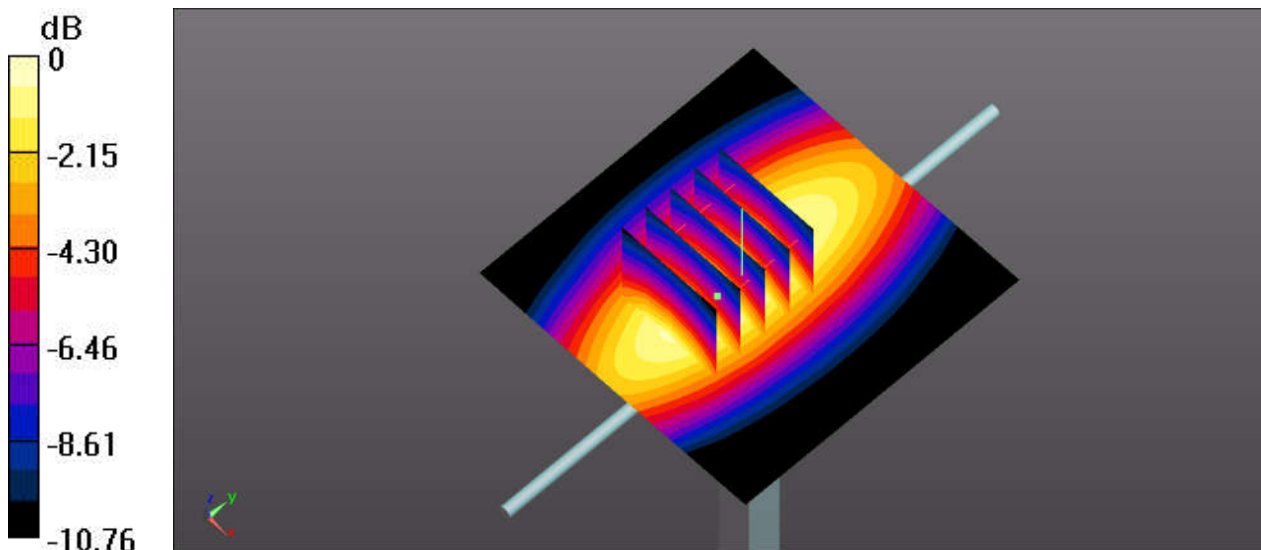

0 dB = 2.84 W/kg

## System Check\_Body\_2450MHz\_180417

**DUT: D2450V2-SN:924**

Communication System: UID 0, CW; Frequency: 2450 MHz; Duty Cycle: 1:1

Medium: MSL\_2450\_180417 Medium parameters used:  $f = 2450$  MHz;  $\sigma = 1.992$  S/m;  $\epsilon_r = 52.291$ ;  
 $\rho = 1000$  kg/m<sup>3</sup>

Ambient Temperature : 23.4 °C; Liquid Temperature : 22.9 °C

DASY5 Configuration:

- Probe: EX3DV4 - SN3819; ConvF(7.46, 7.46, 7.46); Calibrated: 2018.01.31;
- Sensor-Surface: 2mm (Mechanical Surface Detection)
- Electronics: DAE4 Sn1437; Calibrated: 2017.09.15
- Phantom: SAM3; Type: QDOVA002AA; Serial: TP:1149
- Measurement SW: DASY52, Version 52.8 (8); SEMCAD X Version 14.6.10 (7331)

**Pin=250mW/Area Scan (81x81x1):** Interpolated grid: dx=12mm, dy=12mm

Maximum value of SAR (interpolated) = 18.0 W/kg

**Pin=250mW/Zoom Scan (7x7x7)/Cube 0:** Measurement grid: dx=5mm, dy=5mm, dz=5mm

Reference Value = 75.91 V/m; Power Drift = -0.02 dB

Peak SAR (extrapolated) = 23.4 W/kg

**SAR(1 g) = 12.2 W/kg; SAR(10 g) = 5.87 W/kg**

Maximum value of SAR (measured) = 18.1 W/kg

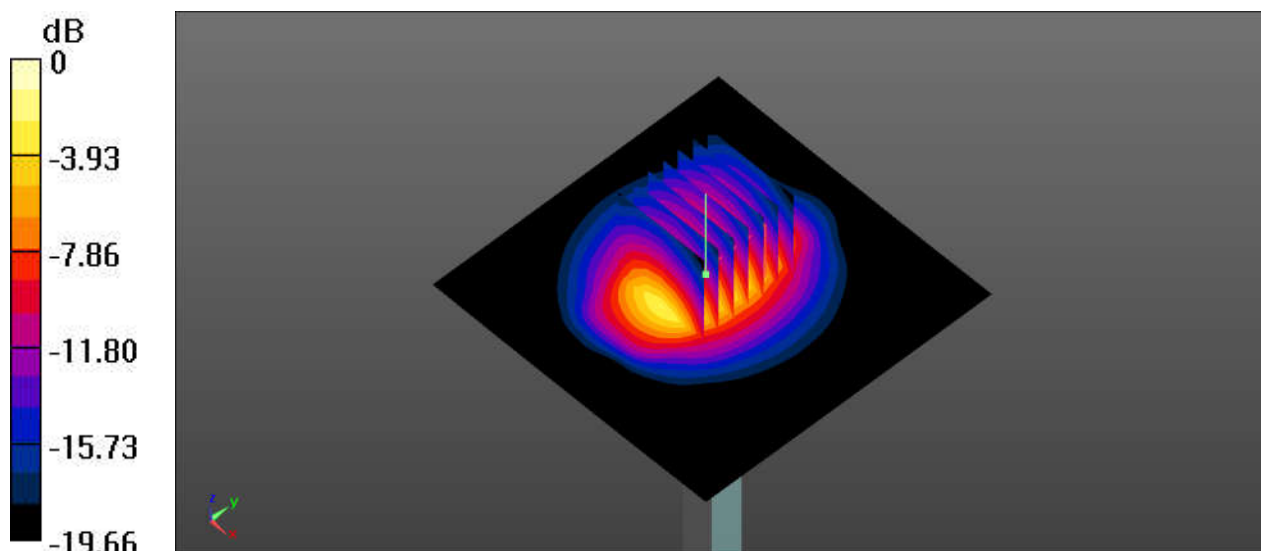

0 dB = 18.0 W/kg



## System Check\_Body\_5250MHz\_180417

### DUT: D5GHzV2-SN:1167

Communication System: UID 0, CW (0); Frequency: 5250 MHz; Duty Cycle: 1:1  
Medium: MSL\_5250\_180417 Medium parameters used:  $f = 5250$  MHz;  $\sigma = 5.298$  S/m;  $\epsilon_r = 50.997$ ;  
 $\rho = 1000$  kg/m<sup>3</sup>  
Ambient Temperature : 23.4 °C; Liquid Temperature : 22.6 °C

### DASY5 Configuration:

- Probe: EX3DV4 - SN3819; ConvF(4.7, 4.7, 4.7); Calibrated: 2018.01.31;
- Sensor-Surface: 1.4mm (Mechanical Surface Detection)
- Electronics: DAE4 Sn1437; Calibrated: 2017.09.15
- Phantom: SAM3; Type: QDOVA002AA; Serial: TP:1149
- Measurement SW: DASY52, Version 52.8 (8); SEMCAD X Version 14.6.10 (7331)

**Pin=100mW/Area Scan (71x71x1):** Interpolated grid: dx=10mm, dy=10mm  
Maximum value of SAR (interpolated) = 17.7 W/kg

**Pin=100mW/Zoom Scan (7x7x7)/Cube 0:** Measurement grid: dx=4mm, dy=4mm, dz=1.4mm  
Reference Value = 48.79 V/m; Power Drift = -0.11 dB  
Peak SAR (extrapolated) = 29.9 W/kg  
**SAR(1 g) = 7.62 W/kg; SAR(10 g) = 2.08 W/kg**  
Maximum value of SAR (measured) = 18.5 W/kg

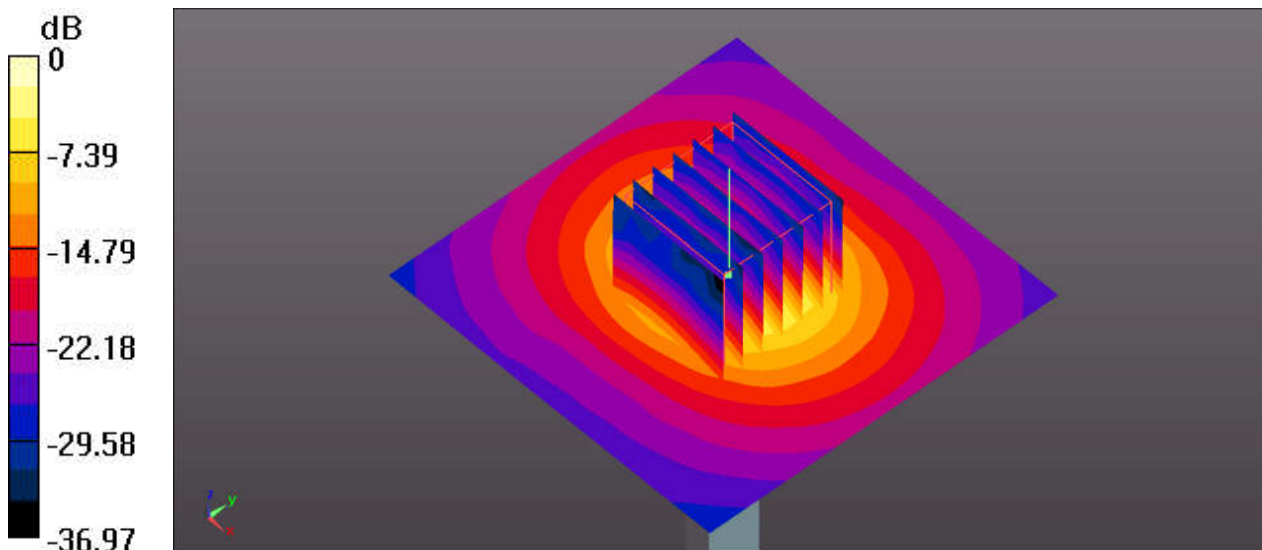

0 dB = 17.7 W/kg

## System Check\_Body\_5600MHz\_180417

**DUT: D5GHzV2-SN:1167**

Communication System: UID 0, CW (0); Frequency: 5600 MHz; Duty Cycle: 1:1  
Medium: MSL\_5600\_180417 Medium parameters used:  $f = 5600$  MHz;  $\sigma = 5.906$  S/m;  $\epsilon_r = 50.367$ ;  
 $\rho = 1000$  kg/m<sup>3</sup>  
Ambient Temperature : 23.4 °C; Liquid Temperature : 22.7 °C

DASY5 Configuration:

- Probe: EX3DV4 - SN3819; ConvF(4.18, 4.18, 4.18); Calibrated: 2018.01.31;
- Sensor-Surface: 1.4mm (Mechanical Surface Detection)
- Electronics: DAE4 Sn1437; Calibrated: 2017.09.15
- Phantom: SAM3; Type: QDOVA002AA; Serial: TP:1149
- Measurement SW: DASY52, Version 52.8 (8); SEMCAD X Version 14.6.10 (7331)

**Pin=100mW/Area Scan (71x71x1):** Interpolated grid: dx=10mm, dy=10mm  
Maximum value of SAR (interpolated) = 20.5 W/kg

**Pin=100mW/Zoom Scan (7x7x7)/Cube 0:** Measurement grid: dx=4mm, dy=4mm, dz=1.4mm  
Reference Value = 48.96 V/m; Power Drift = 0.06 dB  
Peak SAR (extrapolated) = 34.7 W/kg  
**SAR(1 g) = 8.47 W/kg; SAR(10 g) = 2.32 W/kg**  
Maximum value of SAR (measured) = 22.3 W/kg

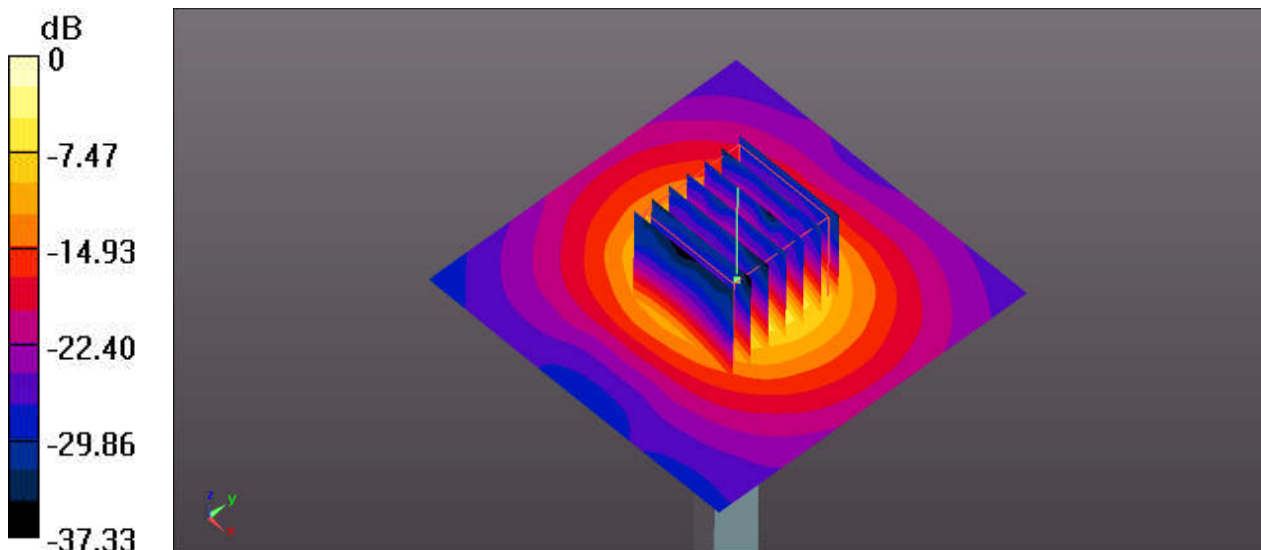

0 dB = 20.5 W/kg

### System Check\_Body\_5750MHz\_180417

**DUT: D5GHzV2-SN:1167**

Communication System: UID 0, CW (0); Frequency: 5750 MHz; Duty Cycle: 1:1  
Medium: MSL\_5750\_180417. Medium parameters used:  $f = 5750$  MHz;  $\sigma = 6.142$  S/m;  $\epsilon_r = 50.003$ ;  
 $\rho = 1000$  kg/m<sup>3</sup>  
Ambient Temperature : 23.4 °C; Liquid Temperature : 22.8 °C

DASY5 Configuration:

- Probe: EX3DV4 - SN3819; ConvF(4.32, 4.32, 4.32); Calibrated: 2018.01.31;
- Sensor-Surface: 1.4mm (Mechanical Surface Detection)
- Electronics: DAE4 Sn1437; Calibrated: 2017.09.15
- Phantom: SAM3; Type: QDOVA002AA; Serial: TP:1149
- Measurement SW: DASY52, Version 52.8 (8); SEMCAD X Version 14.6.10 (7331)

**Pin=100mW/Area Scan (71x71x1):** Interpolated grid: dx=10mm, dy=10mm  
Maximum value of SAR (interpolated) = 20.2 W/kg

**Pin=100mW/Zoom Scan (7x7x7)/Cube 0:** Measurement grid: dx=4mm, dy=4mm, dz=1.4mm  
Reference Value = 46.36 V/m; Power Drift = 0.05 dB  
Peak SAR (extrapolated) = 35.6 W/kg  
**SAR(1 g) = 8.30 W/kg; SAR(10 g) = 2.27 W/kg**  
Maximum value of SAR (measured) = 21.4 W/kg

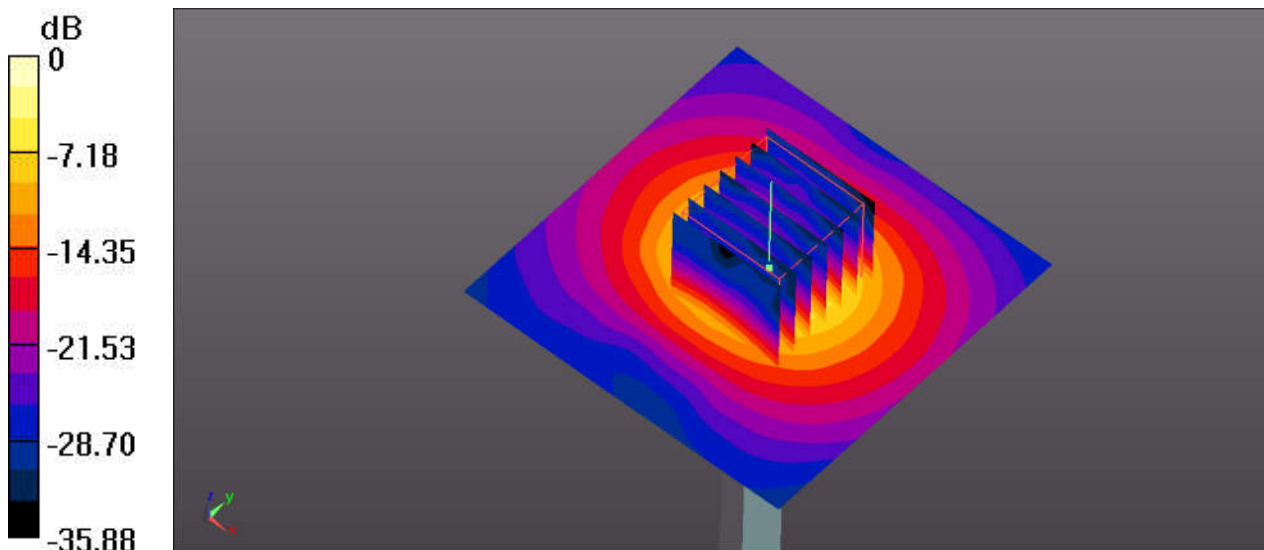

0 dB = 20.2 W/kg



## **Appendix B. Plots of High SAR Measurement**

The plots are shown as follows.

## #01\_WCDMA Band V\_RMC 12.2Kbps\_Right Edge\_0mm\_Ch4182

Communication System: UID 0, UMTS (0); Frequency: 836.4 MHz; Duty Cycle: 1:1  
 Medium: MSL\_835\_180411 Medium parameters used:  $f = 836.4$  MHz;  $\sigma = 0.979$  S/m;  $\epsilon_r = 54.452$ ;  
 $\rho = 1000$  kg/m<sup>3</sup>  
 Ambient Temperature : 23.4 °C ; Liquid Temperature : 22.5 °C

### DASY5 Configuration:

- Probe: EX3DV4 - SN3819; ConvF(9.49, 9.49, 9.49); Calibrated: 2018.01.31;
- Sensor-Surface: 2mm (Mechanical Surface Detection)
- Electronics: DAE4 Sn1437; Calibrated: 2017.09.15
- Phantom: SAM3; Type: QDOVA002AA; Serial: TP:1149
- Measurement SW: DASY52, Version 52.8 (8); SEMCAD X Version 14.6.10 (7331)

**Ch4182/Area Scan (41x161x1):** Interpolated grid: dx=15mm, dy=15mm  
 Maximum value of SAR (interpolated) = 0.711 W/kg

**Ch4182/Zoom Scan (5x5x7)/Cube 0:** Measurement grid: dx=8mm, dy=8mm, dz=5mm  
 Reference Value = 3.842 V/m; Power Drift = -0.15 dB  
 Peak SAR (extrapolated) = 0.920 W/kg  
**SAR(1 g) = 0.526 W/kg; SAR(10 g) = 0.309 W/kg**  
 Maximum value of SAR (measured) = 0.740 W/kg

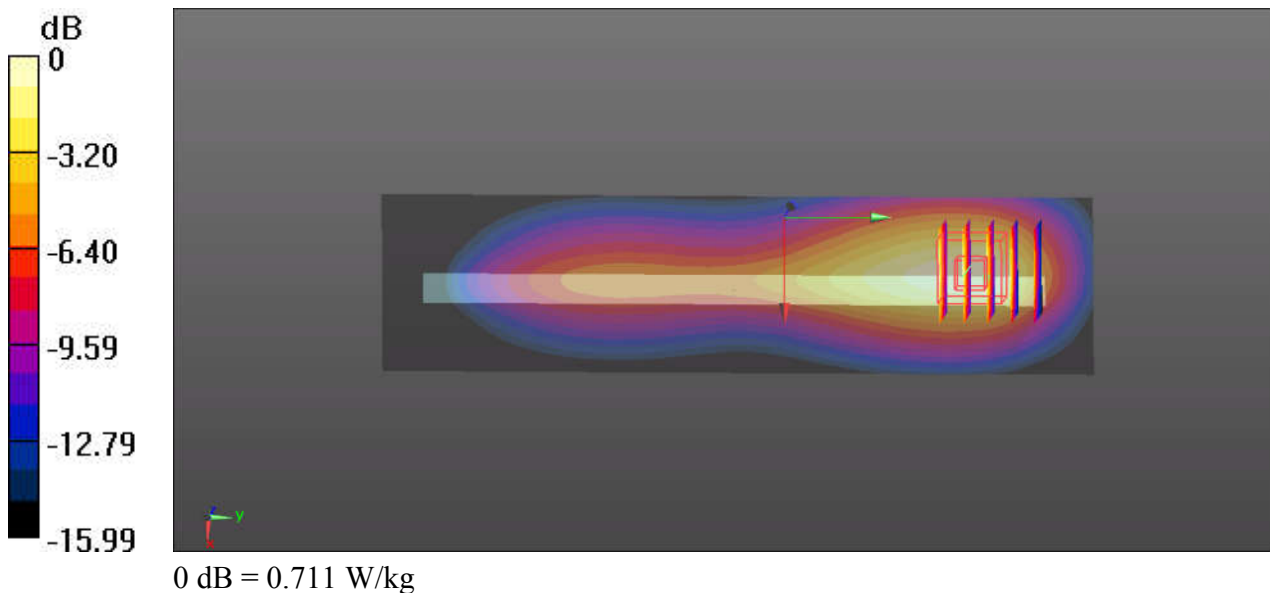

## #02\_LTE Band 5\_10M\_QPSK\_1RB\_25Offset\_Right Edge\_0mm\_Ch20525

Communication System: UID 0, LTE (0); Frequency: 836.5 MHz; Duty Cycle: 1:1  
Medium: MSL\_835\_180411 Medium parameters used:  $f = 836.5$  MHz;  $\sigma = 0.979$  S/m;  $\epsilon_r = 54.452$ ;  
 $\rho = 1000$  kg/m<sup>3</sup>  
Ambient Temperature : 23.4 °C; Liquid Temperature : 22.5 °C

### DASY5 Configuration:

- Probe: EX3DV4 - SN3819; ConvF(9.49, 9.49, 9.49); Calibrated: 2018.01.31;
- Sensor-Surface: 2mm (Mechanical Surface Detection)
- Electronics: DAE4 Sn1437; Calibrated: 2017.09.15
- Phantom: SAM3; Type: QDOVA002AA; Serial: TP:1149
- Measurement SW: DASY52, Version 52.8 (8); SEMCAD X Version 14.6.10 (7331)

**Ch20525/Area Scan (41x161x1):** Interpolated grid: dx=15mm, dy=15mm  
Maximum value of SAR (interpolated) = 0.556 W/kg

**Ch20525/Zoom Scan (5x5x7)/Cube 0:** Measurement grid: dx=8mm, dy=8mm, dz=5mm  
Reference Value = 3.489 V/m; Power Drift = -0.02 dB  
Peak SAR (extrapolated) = 0.719 W/kg  
**SAR(1 g) = 0.412 W/kg; SAR(10 g) = 0.242 W/kg**  
Maximum value of SAR (measured) = 0.578 W/kg

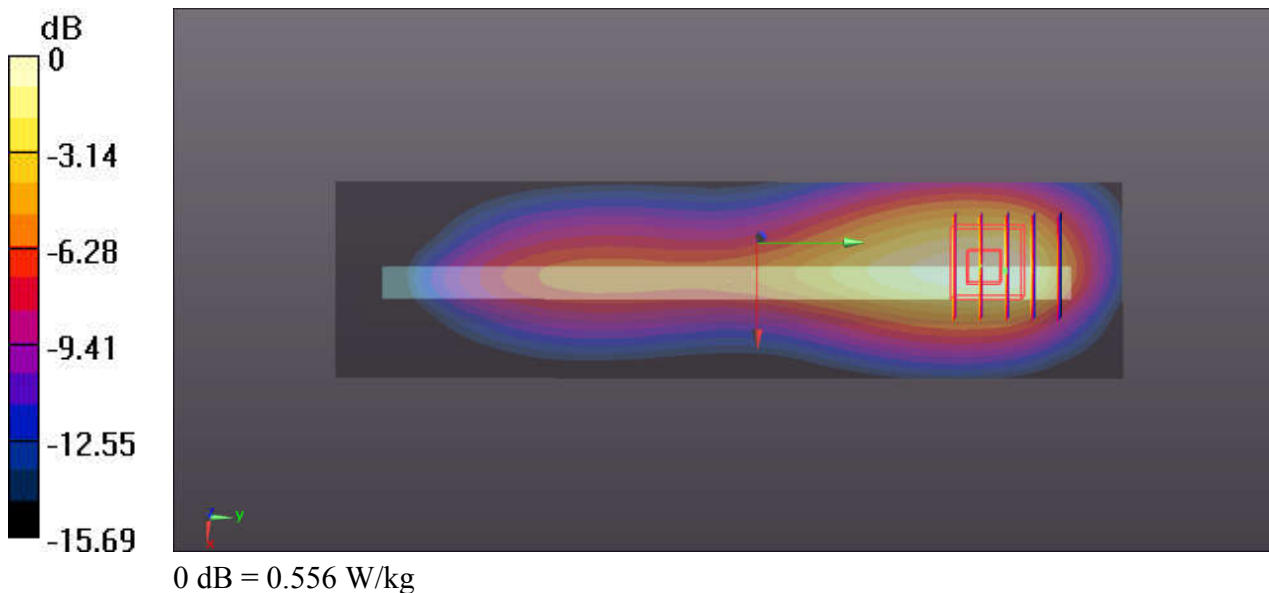

### #03\_WLAN2.4GHz\_802.11b 1Mbps\_Back Face\_0mm\_Ch6

Communication System: UID 0, WIFI (0); Frequency: 2437 MHz; Duty Cycle: 1:1  
Medium: MSL\_2450\_180417 Medium parameters used:  $f = 2437$  MHz;  $\sigma = 1.974$  S/m;  $\epsilon_r = 52.376$ ;  
 $\rho = 1000$  kg/m<sup>3</sup>  
Ambient Temperature : 23.4 °C ; Liquid Temperature : 22.9 °C

#### DASY5 Configuration:

- Probe: EX3DV4 - SN3819; ConvF(7.46, 7.46, 7.46); Calibrated: 2018.01.31;
- Sensor-Surface: 2mm (Mechanical Surface Detection)
- Electronics: DAE4 Sn1437; Calibrated: 2017.09.15
- Phantom: SAM3; Type: QDOVA002AA; Serial: TP:1149
- Measurement SW: DASY52, Version 52.8 (8); SEMCAD X Version 14.6.10 (7331)

#### Ch6/Area Scan (121x101x1): Interpolated grid: dx=12mm, dy=12mm

Maximum value of SAR (interpolated) = 0.677 W/kg

#### Ch6/Zoom Scan (7x7x7)/Cube 0: Measurement grid: dx=5mm, dy=5mm, dz=5mm

Reference Value = 1.852 V/m; Power Drift = -0.04 dB

Peak SAR (extrapolated) = 1.15 W/kg

**SAR(1 g) = 0.487 W/kg; SAR(10 g) = 0.214 W/kg**

Maximum value of SAR (measured) = 0.815 W/kg

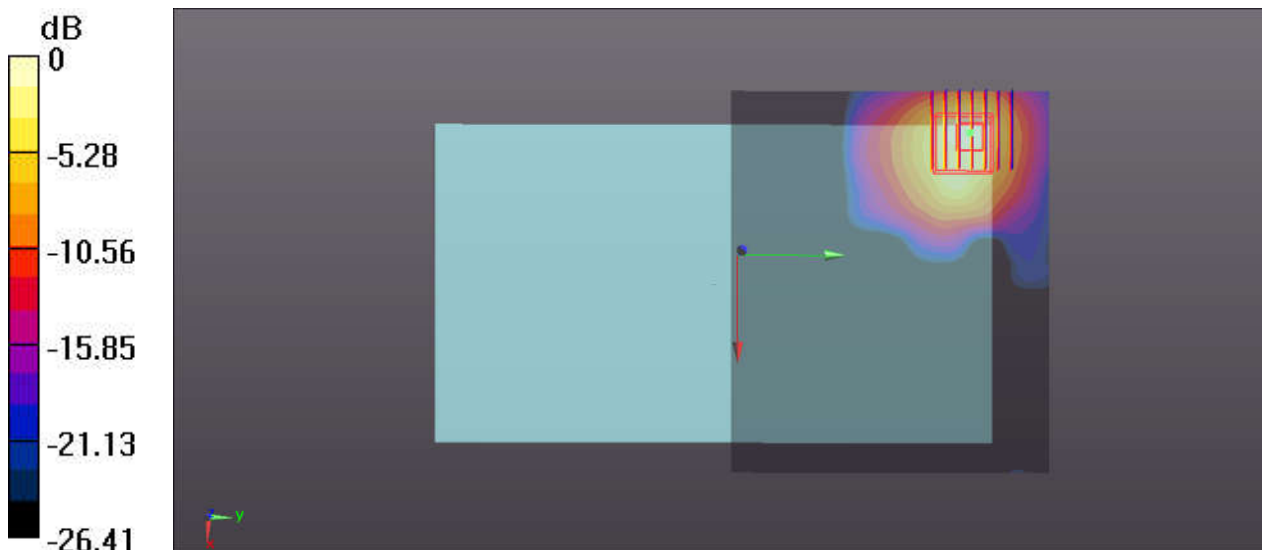

0 dB = 0.677 W/kg

### #04\_WLAN 5.3GHz\_802.11ac-VHT80 MCS0\_Top Edge\_0mm\_Ch58

Communication System: UID 0, WIFI (0); Frequency: 5290 MHz; Duty Cycle: 1:1.044  
Medium: MSL\_5250\_180417 Medium parameters used:  $f = 5290$  MHz;  $\sigma = 5.363$  S/m;  $\epsilon_r = 50.965$ ;  
 $\rho = 1000$  kg/m<sup>3</sup>  
Ambient Temperature : 23.4 °C; Liquid Temperature : 22.6 °C

#### DASY5 Configuration:

- Probe: EX3DV4 - SN3819; ConvF(4.7, 4.7, 4.7); Calibrated: 2018.01.31;
- Sensor-Surface: 1.4mm (Mechanical Surface Detection)
- Electronics: DAE4 Sn1437; Calibrated: 2017.09.15
- Phantom: SAM3; Type: QDOVA002AA; Serial: TP:1149
- Measurement SW: DASY52, Version 52.8 (8); SEMCAD X Version 14.6.10 (7331)

#### Ch58/Area Scan (41x141x1): Interpolated grid: dx=10mm, dy=10mm

Maximum value of SAR (interpolated) = 0.224 W/kg

#### Ch58/Zoom Scan (7x7x7)/Cube 0: Measurement grid: dx=4mm, dy=4mm, dz=1.4mm

Reference Value = 1.121 V/m; Power Drift = -0.03 dB

Peak SAR (extrapolated) = 0.455 W/kg

**SAR(1 g) = 0.083 W/kg; SAR(10 g) = 0.020 W/kg**

Maximum value of SAR (measured) = 0.272 W/kg

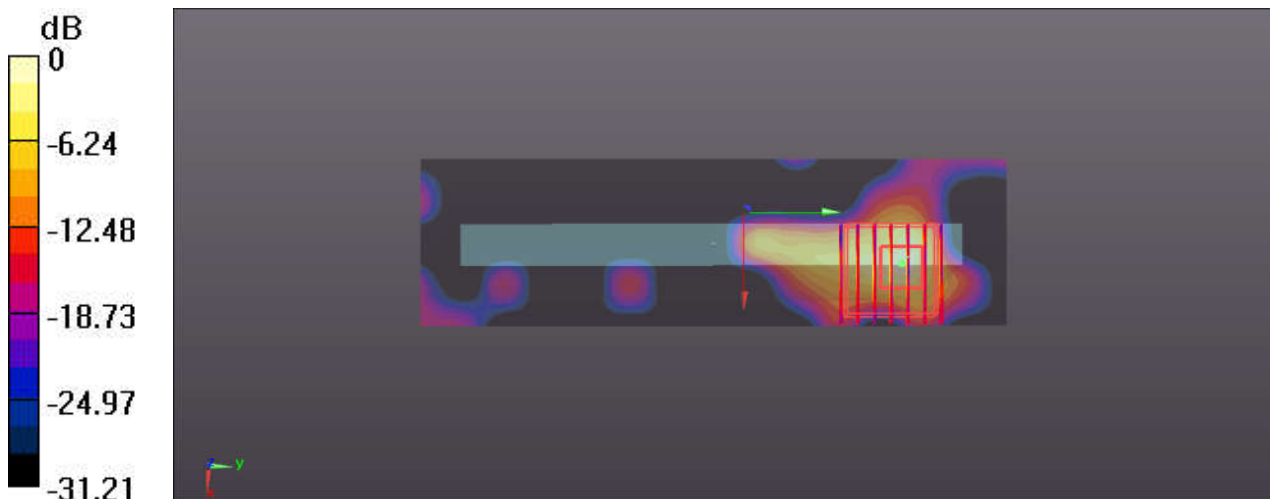

0 dB = 0.272 W/kg



### #05\_WLAN5.5GHz\_802.11ac-VHT80 MCS0\_Top Edge\_0mm\_Ch138

Communication System: UID 0, WIFI (0); Frequency: 5690 MHz; Duty Cycle: 1:1.044  
Medium: MSL\_5600\_180417 Medium parameters used:  $f = 5690$  MHz;  $\sigma = 6.047$  S/m;  $\epsilon_r = 50.13$ ;  
 $\rho = 1000$  kg/m<sup>3</sup>  
Ambient Temperature : 23.4 °C; Liquid Temperature : 22.7 °C

#### DASY5 Configuration:

- Probe: EX3DV4 - SN3819; ConvF(4.18, 4.18, 4.18); Calibrated: 2018.01.31;
- Sensor-Surface: 1.4mm (Mechanical Surface Detection)
- Electronics: DAE4 Sn1437; Calibrated: 2017.09.15
- Phantom: SAM3; Type: QDOVA002AA; Serial: TP:1149
- Measurement SW: DASY52, Version 52.8 (8); SEMCAD X Version 14.6.10 (7331)

**Ch138/Area Scan (41x141x1):** Interpolated grid: dx=10mm, dy=10mm  
Maximum value of SAR (interpolated) = 0.314 W/kg

**Ch138/Zoom Scan (7x7x7)/Cube 0:** Measurement grid: dx=4mm, dy=4mm, dz=1.4mm  
Reference Value = 1.142 V/m; Power Drift = -0.06 dB  
Peak SAR (extrapolated) = 0.739 W/kg  
**SAR(1 g) = 0.114 W/kg; SAR(10 g) = 0.025 W/kg**  
Maximum value of SAR (measured) = 0.350 W/kg

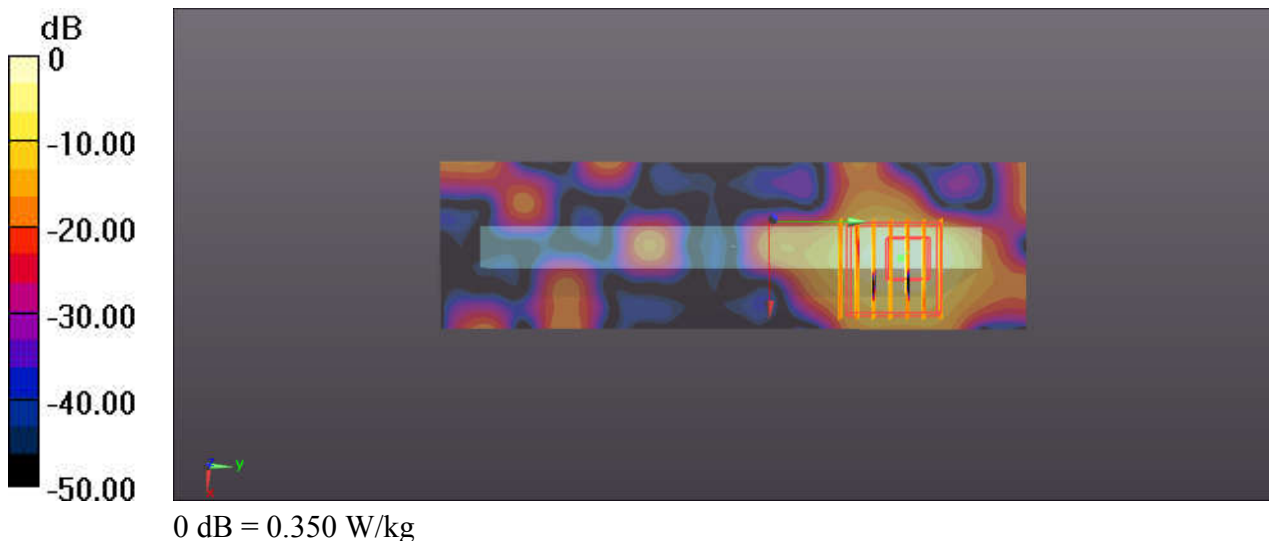

## #06\_WLAN5.8GHz\_802.11ac-VHT80 MCS0\_Top Edge\_0mm\_Ch155

Communication System: UID 0, WIFI (0); Frequency: 5775 MHz; Duty Cycle: 1:1.044  
 Medium: MSL\_5750\_180417 Medium parameters used:  $f = 5775$  MHz;  $\sigma = 6.176$  S/m;  $\epsilon_r = 49.937$ ;  
 $\rho = 1000$  kg/m<sup>3</sup>  
 Ambient Temperature : 23.4 °C; Liquid Temperature : 22.8 °C

### DASY5 Configuration:

- Probe: EX3DV4 - SN3819; ConvF(4.32, 4.32, 4.32); Calibrated: 2018.01.31;
- Sensor-Surface: 1.4mm (Mechanical Surface Detection)
- Electronics: DAE4 Sn1437; Calibrated: 2017.09.15
- Phantom: SAM3; Type: QDOVA002AA; Serial: TP:1149
- Measurement SW: DASY52, Version 52.8 (8); SEMCAD X Version 14.6.10 (7331)

**Ch155/Area Scan (41x141x1):** Interpolated grid: dx=10mm, dy=10mm  
 Maximum value of SAR (interpolated) = 0.451 W/kg

**Ch155/Zoom Scan (7x7x7)/Cube 0:** Measurement grid: dx=4mm, dy=4mm, dz=1.4mm  
 Reference Value = 1.099 V/m; Power Drift = -0.09 dB  
 Peak SAR (extrapolated) = 0.753 W/kg  
**SAR(1 g) = 0.131 W/kg; SAR(10 g) = 0.031 W/kg**  
 Maximum value of SAR (measured) = 0.445 W/kg

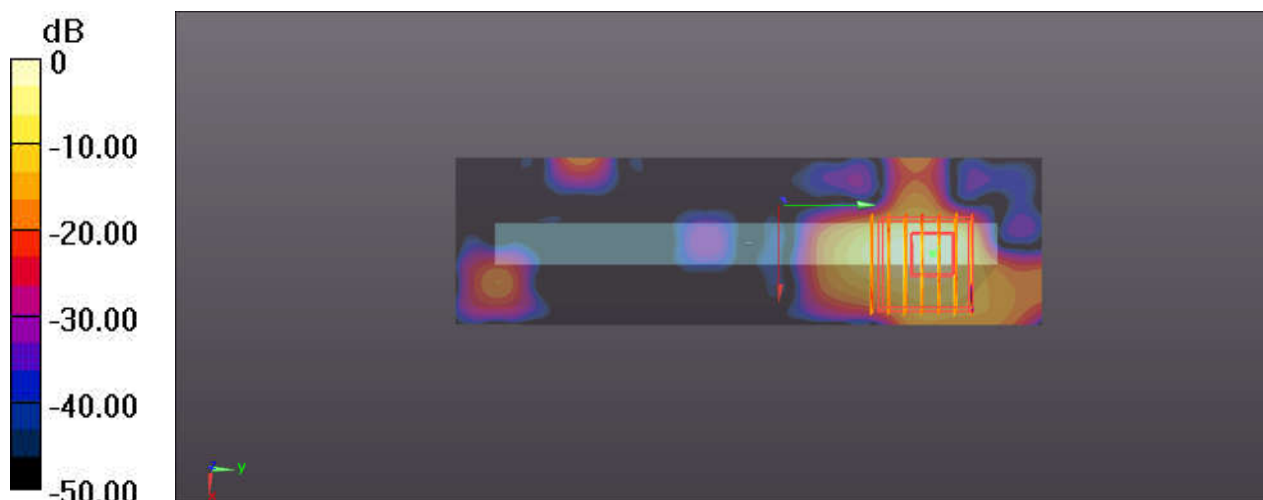

0 dB = 0.445 W/kg



## **Appendix C. DASYS Calibration Certificate**

The DASYS calibration certificates are shown as follows.



Add: No.51 Xueyuan Road, Haidian District, Beijing, 100191, China  
Tel: +86-10-62304633-2079 Fax: +86-10-62304633-2504  
E-mail: cttl@chinattl.com http://www.chinattl.cn

Client Sporton

Certificate No: **Z17-97247**

## CALIBRATION CERTIFICATE

Object **D835V2 - SN: 4d162**

Calibration Procedure(s) **FF-Z11-003-01  
Calibration Procedures for dipole validation kits**

Calibration date: **December 5, 2017**

This calibration Certificate documents the traceability to national standards, which realize the physical units of measurements(SI). The measurements and the uncertainties with confidence probability are given on the following pages and are part of the certificate.

All calibrations have been conducted in the closed laboratory facility: environment temperature(22±3)°C and humidity<70%.

Calibration Equipment used (M&TE critical for calibration)

Primary Standards	ID #	Cal Date(Calibrated by, Certificate No.)	Scheduled Calibration
Power Meter NRVD	102196	02-Mar-17 (CTTL, No.J17X01254)	Mar-18
Power sensor NRV-Z5	100596	02-Mar-17 (CTTL, No.J17X01254)	Mar-18
Reference Probe EX3DV4	SN 3617	23-Jan-17(SPEAG,No.EX3-3617_Jan17)	Jan-18
DAE3	SN 536	09-Oct-17(CTTL-SPEAG,No.Z17-97198)	Oct-18
Secondary Standards	ID #	Cal Date(Calibrated by, Certificate No.)	Scheduled Calibration
Signal Generator E4438C	MY49071430	13-Jan-17 (CTTL, No.J17X00286)	Jan-18
Network Analyzer E5071C	MY46110673	13-Jan-17 (CTTL, No.J17X00285)	Jan-18

	Name	Function	Signature
Calibrated by:	Zhao Jing	SAR Test Engineer	
Reviewed by:	Lin Hao	SAR Test Engineer	
Approved by:	Qi Dianyuan	SAR Project Leader	

Issued: December 9, 2017

This calibration certificate shall not be reproduced except in full without written approval of the laboratory.



Add: No.51 Xueyuan Road, Haidian District, Beijing, 100191, China  
Tel: +86-10-62304633-2079 Fax: +86-10-62304633-2504  
E-mail: cttl@chinattl.com http://www.chinattl.cn

**Glossary:**

TSL	tissue simulating liquid
ConvF	sensitivity in TSL / NORM <sub>x,y,z</sub>
N/A	not applicable or not measured

**Calibration is Performed According to the Following Standards:**

- IEEE Std 1528-2013, "IEEE Recommended Practice for Determining the Peak Spatial-Averaged Specific Absorption Rate (SAR) in the Human Head from Wireless Communications Devices: Measurement Techniques", June 2013
- IEC 62209-1, "Measurement procedure for assessment of specific absorption rate of human exposure to radio frequency fields from hand-held and body-mounted wireless communication devices- Part 1: Device used next to the ear (Frequency range of 300MHz to 6GHz)", July 2016
- IEC 62209-2, "Procedure to measure the Specific Absorption Rate (SAR) For wireless communication devices used in close proximity to the human body (frequency range of 30MHz to 6GHz)", March 2010
- KDB865664, SAR Measurement Requirements for 100 MHz to 6 GHz

**Additional Documentation:**

- DASY4/5 System Handbook

**Methods Applied and Interpretation of Parameters:**

- Measurement Conditions:** Further details are available from the Validation Report at the end of the certificate. All figures stated in the certificate are valid at the frequency indicated.
- Antenna Parameters with TSL:** The dipole is mounted with the spacer to position its feed point exactly below the center marking of the flat phantom section, with the arms oriented parallel to the body axis.
- Feed Point Impedance and Return Loss:** These parameters are measured with the dipole positioned under the liquid filled phantom. The impedance stated is transformed from the measurement at the SMA connector to the feed point. The Return Loss ensures low reflected power. No uncertainty required.
- Electrical Delay:** One-way delay between the SMA connector and the antenna feed point. No uncertainty required.
- SAR measured:** SAR measured at the stated antenna input power.
- SAR normalized:** SAR as measured, normalized to an input power of 1 W at the antenna connector.
- SAR for nominal TSL parameters:** The measured TSL parameters are used to calculate the nominal SAR result.

The reported uncertainty of measurement is stated as the standard uncertainty of Measurement multiplied by the coverage factor  $k=2$ , which for a normal distribution Corresponds to a coverage probability of approximately 95%.



Add: No.51 Xueyuan Road, Haidian District, Beijing, 100191, China  
 Tel: +86-10-62304633-2079 Fax: +86-10-62304633-2504  
 E-mail: cttl@chinattl.com http://www.chinattl.cn

### Measurement Conditions

DASY system configuration, as far as not given on page 1.

DASY Version	DASY52	52.10.0.1446
Extrapolation	Advanced Extrapolation	
Phantom	Triple Flat Phantom 5.1C	
Distance Dipole Center - TSL	15 mm	with Spacer
Zoom Scan Resolution	dx, dy, dz = 5 mm	
Frequency	835 MHz ± 1 MHz	

### Head TSL parameters

The following parameters and calculations were applied.

	Temperature	Permittivity	Conductivity
Nominal Head TSL parameters	22.0 °C	41.5	0.90 mho/m
Measured Head TSL parameters	(22.0 ± 0.2) °C	41.7 ± 6 %	0.88 mho/m ± 6 %
Head TSL temperature change during test	<1.0 °C	----	----

### SAR result with Head TSL

SAR averaged over 1 cm <sup>3</sup> (1 g) of Head TSL	Condition	
SAR measured	250 mW input power	2.34 mW / g
SAR for nominal Head TSL parameters	normalized to 1W	9.56 mW / g ± 18.8 % (k=2)
SAR averaged over 10 cm <sup>3</sup> (10 g) of Head TSL	Condition	
SAR measured	250 mW input power	1.54 mW / g
SAR for nominal Head TSL parameters	normalized to 1W	6.26 mW / g ± 18.7 % (k=2)

### Body TSL parameters

The following parameters and calculations were applied.

	Temperature	Permittivity	Conductivity
Nominal Body TSL parameters	22.0 °C	55.2	0.97 mho/m
Measured Body TSL parameters	(22.0 ± 0.2) °C	54.7 ± 6 %	0.96 mho/m ± 6 %
Body TSL temperature change during test	<1.0 °C	----	----

### SAR result with Body TSL

SAR averaged over 1 cm <sup>3</sup> (1 g) of Body TSL	Condition	
SAR measured	250 mW input power	2.38 mW / g
SAR for nominal Body TSL parameters	normalized to 1W	9.56 mW / g ± 18.8 % (k=2)
SAR averaged over 10 cm <sup>3</sup> (10 g) of Body TSL	Condition	
SAR measured	250 mW input power	1.58 mW / g
SAR for nominal Body TSL parameters	normalized to 1W	6.34 mW / g ± 18.7 % (k=2)



Add: No.51 Xueyuan Road, Haidian District, Beijing, 100191, China  
Tel: +86-10-62304633-2079 Fax: +86-10-62304633-2504  
E-mail: cttl@chinattl.com http://www.chinattl.cn

## Appendix (Additional assessments outside the scope of CNAS L0570)

### Antenna Parameters with Head TSL

Impedance, transformed to feed point	50.3 $\Omega$ - 2.96j $\Omega$
Return Loss	- 30.5dB

### Antenna Parameters with Body TSL

Impedance, transformed to feed point	47.6 $\Omega$ - 3.92j $\Omega$
Return Loss	- 26.6dB

### General Antenna Parameters and Design

Electrical Delay (one direction)	1.264 ns
----------------------------------	----------

After long term use with 100W radiated power, only a slight warming of the dipole near the feedpoint can be measured.

The dipole is made of standard semirigid coaxial cable. The center conductor of the feeding line is directly connected to the second arm of the dipole. The antenna is therefore short-circuited for DC-signals. On some of the dipoles, small end caps are added to the dipole arms in order to improve matching when loaded according to the position as explained in the "Measurement Conditions" paragraph. The SAR data are not affected by this change. The overall dipole length is still according to the Standard.

No excessive force must be applied to the dipole arms, because they might bend or the soldered connections near the feedpoint may be damaged.

### Additional EUT Data

Manufactured by	SPEAG
-----------------	-------



Add: No.51 Xueyuan Road, Haidian District, Beijing, 100191, China  
 Tel: +86-10-62304633-2079 Fax: +86-10-62304633-2504  
 E-mail: cttl@chinattl.com http://www.chinattl.cn

**DASY5 Validation Report for Head TSL**

Date: 12.04.2017

Test Laboratory: CTTL, Beijing, China

**DUT: Dipole 835 MHz; Type: D835V2; Serial: D835V2 - SN: 4d162**

Communication System: UID 0, CW; Frequency: 835 MHz; Duty Cycle: 1:1

Medium parameters used:  $f = 835 \text{ MHz}$ ;  $\sigma = 0.876 \text{ S/m}$ ;  $\epsilon_r = 41.67$ ;  $\rho = 1000 \text{ kg/m}^3$

Phantom section: Center Section

Measurement Standard: DASY5 (IEEE/IEC/ANSI C63.19-2007)

**DASY5 Configuration:**

- Probe: EX3DV4 - SN3617; ConvF(9.73, 9.73, 9.73); Calibrated: 1/23/2017;
- Sensor-Surface: 1.4mm (Mechanical Surface Detection)
- Electronics: DAE3 Sn536; Calibrated: 10/9/2017
- Phantom: Triple Flat Phantom 5.1C; Type: QD 000 P51 CA; Serial: 1161/1
- Measurement SW: DASY52, Version 52.10 (0); SEMCAD X Version 14.6.10 (7417)

**Dipole Calibration/Zoom Scan (7x7x7) (7x7x7)/Cube 0:** Measurement grid:  $dx=5\text{mm}$ ,  $dy=5\text{mm}$ ,  $dz=5\text{mm}$

Reference Value = 58.70V/m; Power Drift = 0.00 dB

Peak SAR (extrapolated) = 3.53 W/kg

**SAR(1 g) = 2.34 W/kg; SAR(10 g) = 1.54 W/kg**

Maximum value of SAR (measured) = 3.13 W/kg

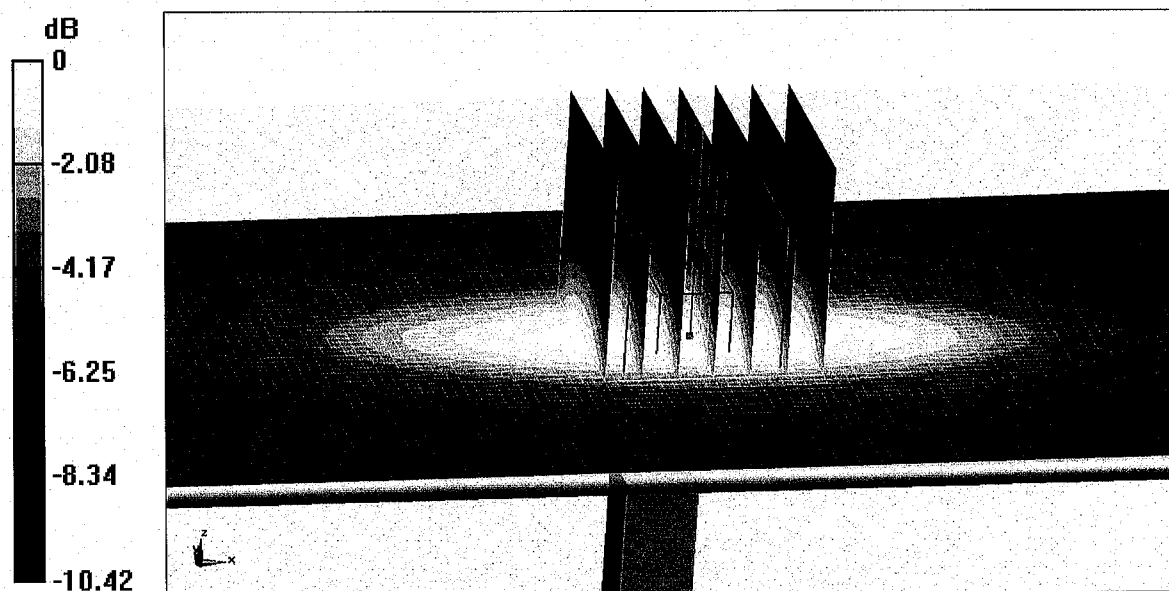

**0 dB = 3.13 W/kg = 4.96 dBW/kg**





Add: No.51 Xueyuan Road, Haidian District, Beijing, 100191, China  
Tel: +86-10-62304633-2079 Fax: +86-10-62304633-2504  
E-mail: cttl@chinattl.com http://www.chinattl.cn

### Impedance Measurement Plot for Head TSL

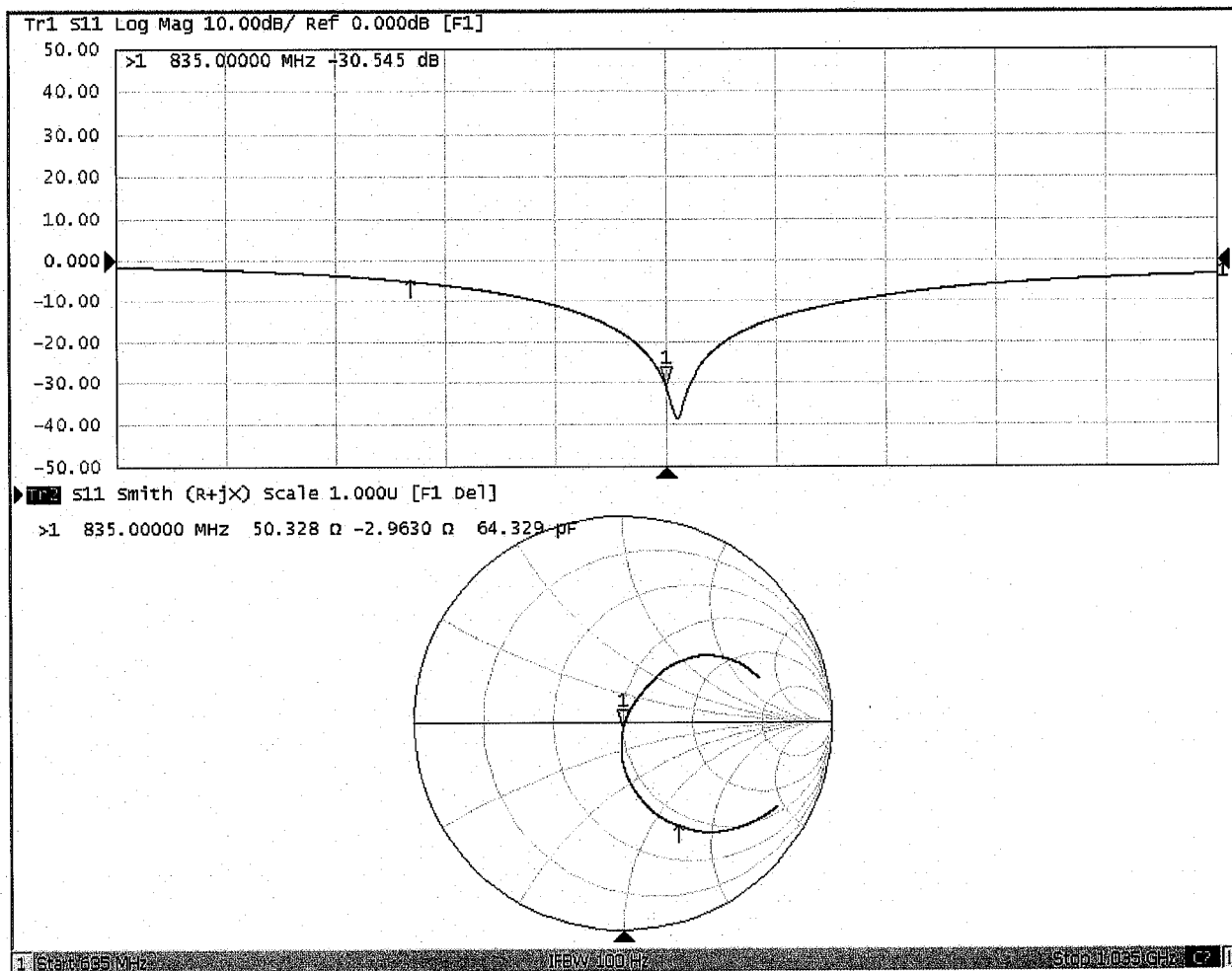



Add: No.51 Xueyuan Road, Haidian District, Beijing, 100191, China  
Tel: +86-10-62304633-2079 Fax: +86-10-62304633-2504  
E-mail: cttl@chinattl.com http://www.chinattl.cn

### DASY5 Validation Report for Body TSL

Date: 12.05.2017

Test Laboratory: CTTL, Beijing, China

**DUT: Dipole 835 MHz; Type: D835V2; Serial: D835V2 - SN: 4d162**

Communication System: UID 0, CW; Frequency: 835 MHz; Duty Cycle: 1:1

Medium parameters used:  $f = 835 \text{ MHz}$ ;  $\sigma = 0.962 \text{ S/m}$ ;  $\epsilon_r = 54.65$ ;  $\rho = 1000 \text{ kg/m}^3$

Phantom section: Left Section

Measurement Standard: DASY5 (IEEE/IEC/ANSI C63.19-2007)

DASY5 Configuration:

- Probe: EX3DV4 - SN3617; ConvF(9.64, 9.64, 9.64); Calibrated: 1/23/2017;
- Sensor-Surface: 1.4mm (Mechanical Surface Detection)
- Electronics: DAE3 Sn536; Calibrated: 10/9/2017
- Phantom: Triple Flat Phantom 5.1C; Type: QD 000 P51 CA; Serial: 1161/1
- Measurement SW: DASY52, Version 52.10 (0); SEMCAD X Version 14.6.10 (7417)

**Dipole Calibration/Zoom Scan (7x7x7) (7x7x7)/Cube 0:** Measurement grid:  $dx=5\text{mm}$ ,  $dy=5\text{mm}$ ,  $dz=5\text{mm}$

Reference Value = 55.91 V/m; Power Drift = -0.03 dB

Peak SAR (extrapolated) = 3.53 W/kg

**SAR(1 g) = 2.38 W/kg; SAR(10 g) = 1.58 W/kg**

Maximum value of SAR (measured) = 3.15 W/kg

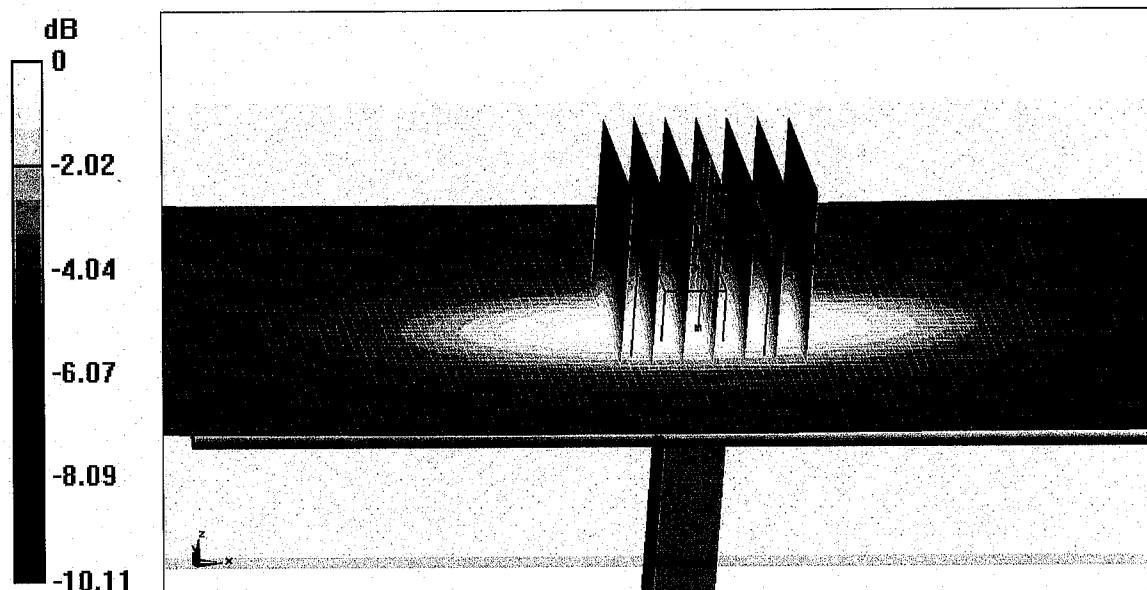

**0 dB = 3.15 W/kg = 4.98 dBW/kg**



Add: No.51 Xueyuan Road, Haidian District, Beijing, 100191, China  
Tel: +86-10-62304633-2079 Fax: +86-10-62304633-2504  
E-mail: cttl@chinattl.com http://www.chinattl.cn

### Impedance Measurement Plot for Body TSL

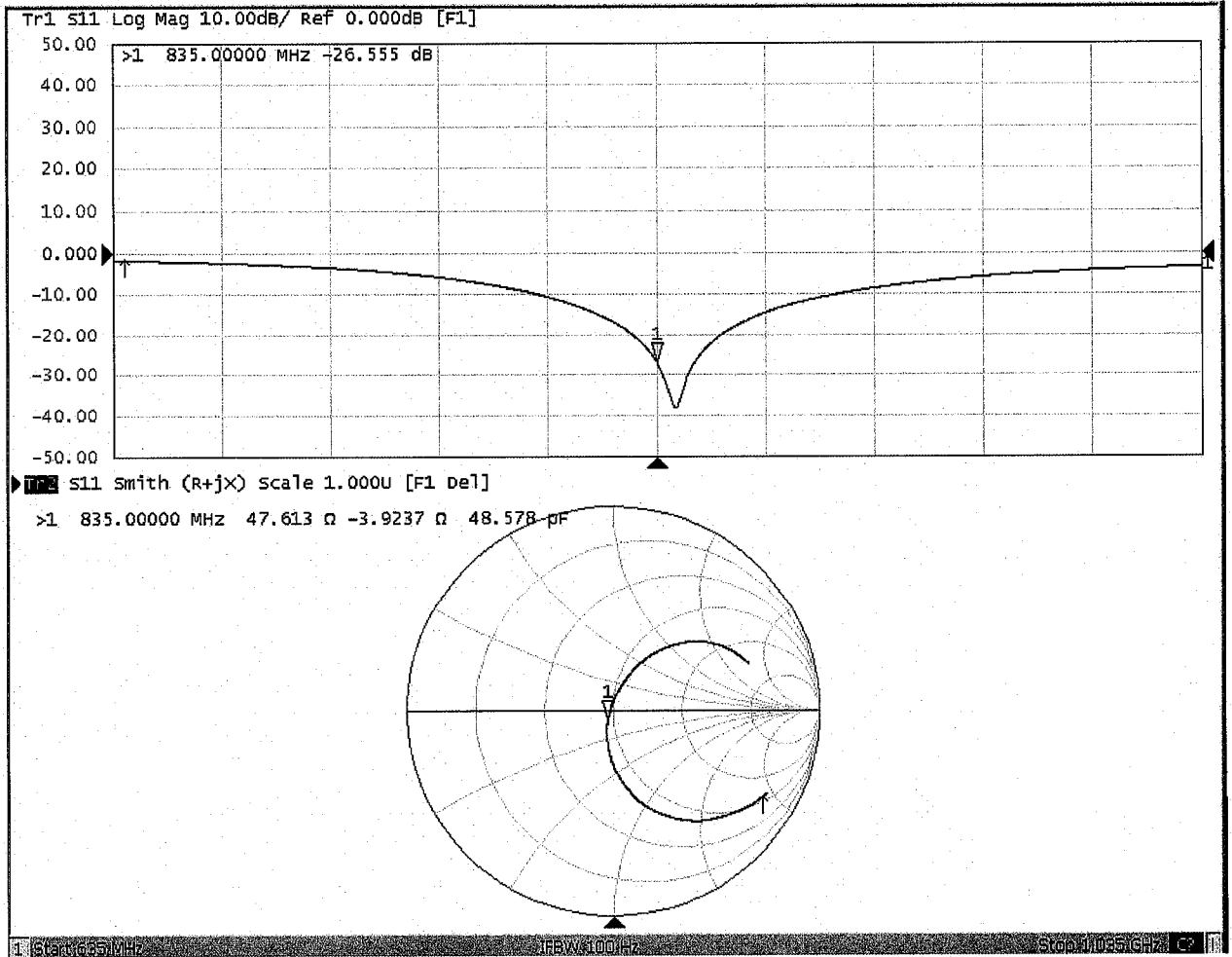



In Collaboration with  
**s p e a g**  
 CALIBRATION LABORATORY



中国认可  
 国际互认  
 校准  
 CALIBRATION  
 CNAS L0570

Add: No.51 Xueyuan Road, Haidian District, Beijing, 100191, China  
 Tel: +86-10-62304633-2079 Fax: +86-10-62304633-2504  
 E-mail: cttl@chinattl.com http://www.chinattl.cn

Client **Sporton**

Certificate No: **Z18-60051**

## CALIBRATION CERTIFICATE

Object **D2450V2 - SN: 924**

Calibration Procedure(s) **FF-Z11-003-01**  
**Calibration Procedures for dipole validation kits**

Calibration date: **March 22, 2018**

This calibration Certificate documents the traceability to national standards, which realize the physical units of measurements(SI). The measurements and the uncertainties with confidence probability are given on the following pages and are part of the certificate.

All calibrations have been conducted in the closed laboratory facility: environment temperature(22±3)°C and humidity<70%.

Calibration Equipment used (M&TE critical for calibration)

Primary Standards	ID #	Cal Date(Calibrated by, Certificate No.)	Scheduled Calibration
Power Meter NRVD	102083	01-Nov-17 (CTTL, No.J17X08756)	Oct-18
Power sensor NRV-Z5	100542	01-Nov-17 (CTTL, No.J17X08756)	Oct-18
Reference Probe EX3DV4	SN 7464	12-Sep-17(SPEAG,No.EX3-7464_Sep17)	Sep-18
DAE4	SN 1525	02-Oct-17(SPEAG,No.DAE4-1525_Oct17)	Oct-18
Secondary Standards	ID #	Cal Date(Calibrated by, Certificate No.)	Scheduled Calibration
Signal Generator E4438C	MY49071430	23-Jan-18 (CTTL, No.J18X00560)	Jan-19
NetworkAnalyzer E5239A	MY55491241	29-Jun-17 (CTTL, No.J18X00561)	Jun-18

	Name	Function	Signature
Calibrated by:	Zhao Jing	SAR Test Engineer	
Reviewed by:	Lin Hao	SAR Test Engineer	
Approved by:	Qi Dianyuan	SAR Project Leader	

Issued: March 25, 2018

This calibration certificate shall not be reproduced except in full without written approval of the laboratory.



In Collaboration with

**s p e a g**

**CALIBRATION LABORATORY**

Add: No.51 Xueyuan Road, Haidian District, Beijing, 100191, China  
Tel: +86-10-62304633-2079 Fax: +86-10-62304633-2504  
E-mail: cttl@chinattl.com http://www.chinattl.cn

### Glossary:

TSL	tissue simulating liquid
ConvF	sensitivity in TSL / NORM <sub>x,y,z</sub>
N/A	not applicable or not measured

### Calibration is Performed According to the Following Standards:

- IEEE Std 1528-2013, "IEEE Recommended Practice for Determining the Peak Spatial-Averaged Specific Absorption Rate (SAR) in the Human Head from Wireless Communications Devices: Measurement Techniques", June 2013
- IEC 62209-1, "Measurement procedure for assessment of specific absorption rate of human exposure to radio frequency fields from hand-held and body-mounted wireless communication devices- Part 1: Device used next to the ear (Frequency range of 300MHz to 6GHz)", July 2016
- IEC 62209-2, "Procedure to measure the Specific Absorption Rate (SAR) For wireless communication devices used in close proximity to the human body (frequency range of 30MHz to 6GHz)", March 2010
- KDB865664, SAR Measurement Requirements for 100 MHz to 6 GHz

### Additional Documentation:

- DASY4/5 System Handbook

### Methods Applied and Interpretation of Parameters:

- Measurement Conditions:** Further details are available from the Validation Report at the end of the certificate. All figures stated in the certificate are valid at the frequency indicated.
- Antenna Parameters with TSL:** The dipole is mounted with the spacer to position its feed point exactly below the center marking of the flat phantom section, with the arms oriented parallel to the body axis.
- Feed Point Impedance and Return Loss:** These parameters are measured with the dipole positioned under the liquid filled phantom. The impedance stated is transformed from the measurement at the SMA connector to the feed point. The Return Loss ensures low reflected power. No uncertainty required.
- Electrical Delay:** One-way delay between the SMA connector and the antenna feed point. No uncertainty required.
- SAR measured:** SAR measured at the stated antenna input power.
- SAR normalized:** SAR as measured, normalized to an input power of 1 W at the antenna connector.
- SAR for nominal TSL parameters:** The measured TSL parameters are used to calculate the nominal SAR result.

The reported uncertainty of measurement is stated as the standard uncertainty of Measurement multiplied by the coverage factor  $k=2$ , which for a normal distribution Corresponds to a coverage probability of approximately 95%.



Add: No.51 Xueyuan Road, Haidian District, Beijing, 100191, China  
 Tel: +86-10-62304633-2079 Fax: +86-10-62304633-2504  
 E-mail: cttl@chinattl.com http://www.chinattl.cn

### Measurement Conditions

DASY system configuration, as far as not given on page 1.

DASY Version	DASY52	52.10.0.1446
Extrapolation	Advanced Extrapolation	
Phantom	Triple Flat Phantom 5.1C	
Distance Dipole Center - TSL	10 mm	with Spacer
Zoom Scan Resolution	dx, dy, dz = 5 mm	
Frequency	2450 MHz ± 1 MHz	

### Head TSL parameters

The following parameters and calculations were applied.

	Temperature	Permittivity	Conductivity
Nominal Head TSL parameters	22.0 °C	39.2	1.80 mho/m
Measured Head TSL parameters	(22.0 ± 0.2) °C	40.3 ± 6 %	1.84 mho/m ± 6 %
Head TSL temperature change during test	<1.0 °C	----	----

### SAR result with Head TSL

SAR averaged over 1 cm <sup>3</sup> (1 g) of Head TSL	Condition	
SAR measured	250 mW input power	13.0 mW / g
SAR for nominal Head TSL parameters	normalized to 1W	<b>51.8 mW / g ± 18.8 % (k=2)</b>
SAR averaged over 10 cm <sup>3</sup> (10 g) of Head TSL	Condition	
SAR measured	250 mW input power	5.98 mW / g
SAR for nominal Head TSL parameters	normalized to 1W	<b>23.9 mW / g ± 18.7 % (k=2)</b>

### Body TSL parameters

The following parameters and calculations were applied.

	Temperature	Permittivity	Conductivity
Nominal Body TSL parameters	22.0 °C	52.7	1.95 mho/m
Measured Body TSL parameters	(22.0 ± 0.2) °C	51.3 ± 6 %	2.00 mho/m ± 6 %
Body TSL temperature change during test	<1.0 °C	----	----

### SAR result with Body TSL

SAR averaged over 1 cm <sup>3</sup> (1 g) of Body TSL	Condition	
SAR measured	250 mW input power	12.9 mW / g
SAR for nominal Body TSL parameters	normalized to 1W	<b>50.7 mW / g ± 18.8 % (k=2)</b>
SAR averaged over 10 cm <sup>3</sup> (10 g) of Body TSL	Condition	
SAR measured	250 mW input power	5.88 mW / g
SAR for nominal Body TSL parameters	normalized to 1W	<b>23.3 mW / g ± 18.7 % (k=2)</b>



Add: No.51 Xueyuan Road, Haidian District, Beijing, 100191, China  
Tel: +86-10-62304633-2079 Fax: +86-10-62304633-2504  
E-mail: cttl@chinattl.com http://www.chinattl.cn

## Appendix (Additional assessments outside the scope of CNAS L0570)

### Antenna Parameters with Head TSL

Impedance, transformed to feed point	50.9Ω+ 4.08jΩ
Return Loss	- 27.7dB

### Antenna Parameters with Body TSL

Impedance, transformed to feed point	50.8Ω+ 4.69jΩ
Return Loss	- 26.5dB

### General Antenna Parameters and Design

Electrical Delay (one direction)	1.060 ns
----------------------------------	----------

After long term use with 100W radiated power, only a slight warming of the dipole near the feedpoint can be measured.

The dipole is made of standard semirigid coaxial cable. The center conductor of the feeding line is directly connected to the second arm of the dipole. The antenna is therefore short-circuited for DC-signals. On some of the dipoles, small end caps are added to the dipole arms in order to improve matching when loaded according to the position as explained in the "Measurement Conditions" paragraph. The SAR data are not affected by this change. The overall dipole length is still according to the Standard.

No excessive force must be applied to the dipole arms, because they might bend or the soldered connections near the feedpoint may be damaged.

### Additional EUT Data

Manufactured by	SPEAG
-----------------	-------



Add: No.51 Xueyuan Road, Haidian District, Beijing, 100191, China  
 Tel: +86-10-62304633-2079 Fax: +86-10-62304633-2504  
 E-mail: cttl@chinattl.com http://www.chinattl.cn

**DASY5 Validation Report for Head TSL**

Date: 03.22.2018

Test Laboratory: CTTL, Beijing, China

**DUT: Dipole 2450 MHz; Type: D2450V2; Serial: D2450V2 - SN: 924**

Communication System: UID 0, CW; Frequency: 2450 MHz; Duty Cycle: 1:1

Medium parameters used:  $f = 2450$  MHz;  $\sigma = 1.841$  S/m;  $\epsilon_r = 40.32$ ;  $\rho = 1000$  kg/m<sup>3</sup>

Phantom section: Center Section

Measurement Standard: DASY5 (IEEE/IEC/ANSI C63.19-2007)

**DASY5 Configuration:**

- Probe: EX3DV4 - SN7464; ConvF(7.89, 7.89, 7.89); Calibrated: 9/12/2017;
- Sensor-Surface: 1.4mm (Mechanical Surface Detection)
- Electronics: DAE4 Sn1525; Calibrated: 10/2/2017
- Phantom: Triple Flat Phantom 5.1C; Type: QD 000 P51 CA; Serial: 1161/1
- Measurement SW: DASY52, Version 52.10 (0); SEMCAD X Version 14.6.10 (7417)

**Dipole Calibration/Zoom Scan (7x7x7) (7x7x7)/Cube 0: Measurement grid: dx=5mm, dy=5mm, dz=5mm**

Reference Value = 101.2 V/m; Power Drift = -0.01 dB

Peak SAR (extrapolated) = 27.2 W/kg

**SAR(1 g) = 13 W/kg; SAR(10 g) = 5.98 W/kg**

Maximum value of SAR (measured) = 22.0 W/kg

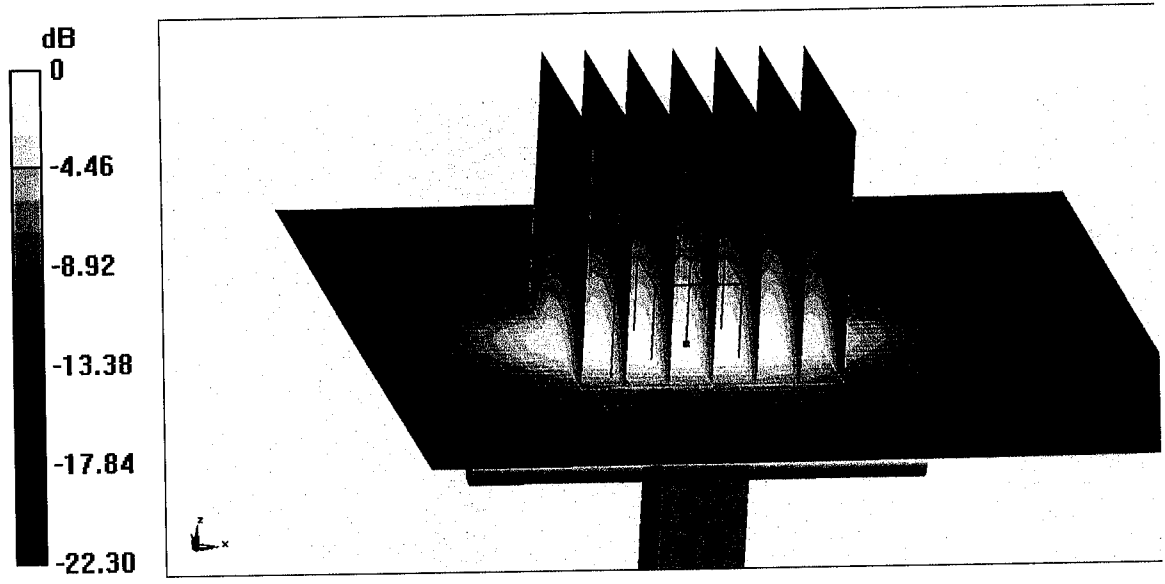

**0 dB = 22.0 W/kg = 13.42 dBW/kg**





Add: No.51 Xueyuan Road, Haidian District, Beijing, 100191, China  
Tel: +86-10-62304633-2079 Fax: +86-10-62304633-2504  
E-mail: cttl@chinattl.com http://www.chinattl.cn

### Impedance Measurement Plot for Head TSL

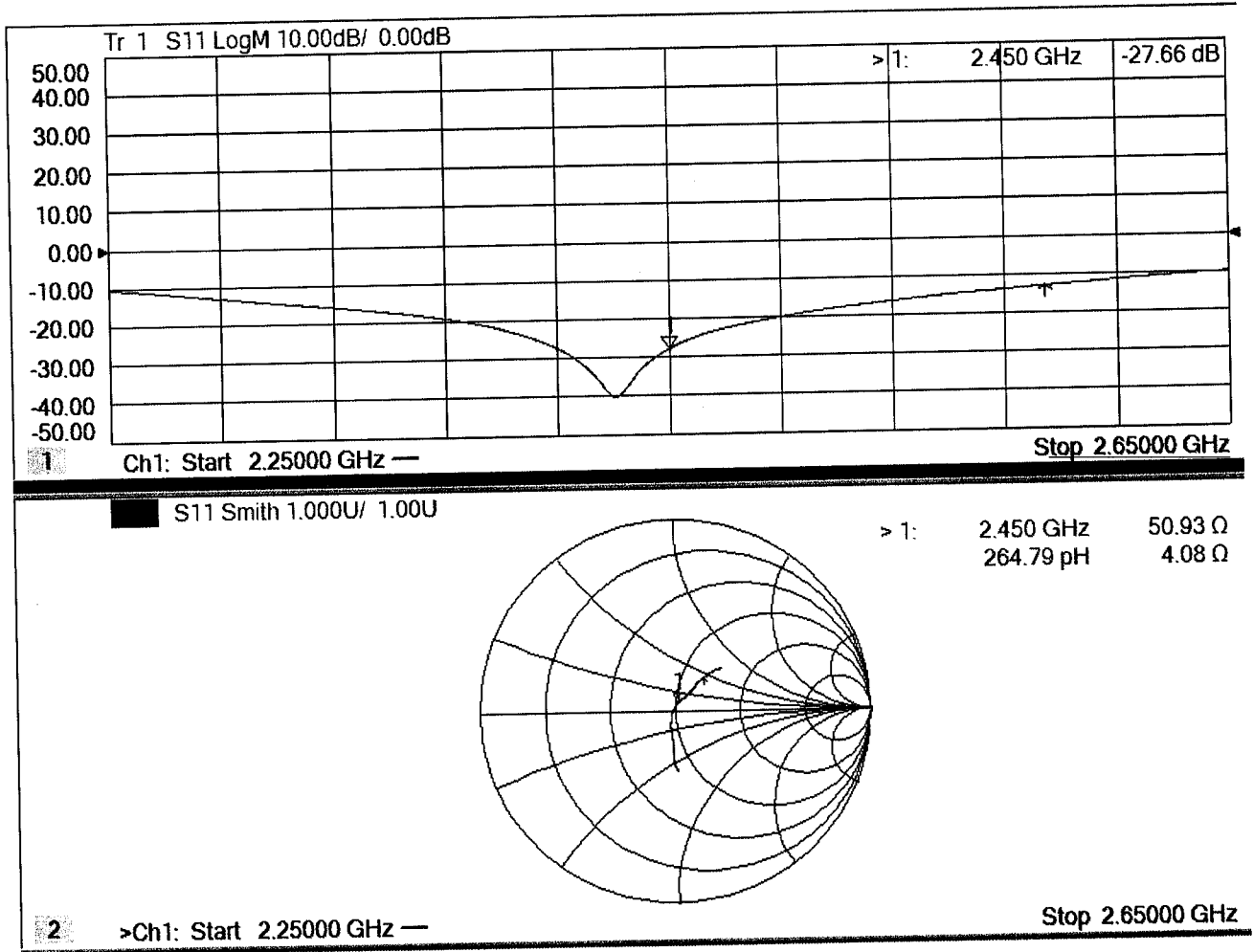



Add: No.51 Xueyuan Road, Haidian District, Beijing, 100191, China  
 Tel: +86-10-62304633-2079 Fax: +86-10-62304633-2504  
 E-mail: cttl@chinattl.com http://www.chinattl.cn

Date: 03.22.2018

**DASY5 Validation Report for Body TSL**

Test Laboratory: CTTL, Beijing, China

**DUT: Dipole 2450 MHz; Type: D2450V2; Serial: D2450V2 - SN: 924**

Communication System: UID 0, CW; Frequency: 2450 MHz; Duty Cycle: 1:1

Medium parameters used:  $f = 2450$  MHz;  $\sigma = 1.998$  S/m;  $\epsilon_r = 51.28$ ;  $\rho = 1000$  kg/m<sup>3</sup>

Phantom section: Left Section

Measurement Standard: DASY5 (IEEE/IEC/ANSI C63.19-2007)

**DASY5 Configuration:**

- Probe: EX3DV4 - SN7464; ConvF(8.09, 8.09, 8.09); Calibrated: 9/12/2017;
- Sensor-Surface: 1.4mm (Mechanical Surface Detection)
- Electronics: DAE4 Sn1525; Calibrated: 10/2/2017
- Phantom: Triple Flat Phantom 5.1C; Type: QD 000 P51 CA; Serial: 1161/1
- Measurement SW: DASY52, Version 52.10 (0); SEMCAD X Version 14.6.10 (7417)

**Dipole Calibration/Zoom Scan (7x7x7) (7x7x7)/Cube 0: Measurement grid: dx=5mm, dy=5mm, dz=5mm**

Reference Value = 98.09 V/m; Power Drift = 0.00 dB

Peak SAR (extrapolated) = 27.1 W/kg

**SAR(1 g) = 12.9 W/kg; SAR(10 g) = 5.88 W/kg**

Maximum value of SAR (measured) = 21.5 W/kg

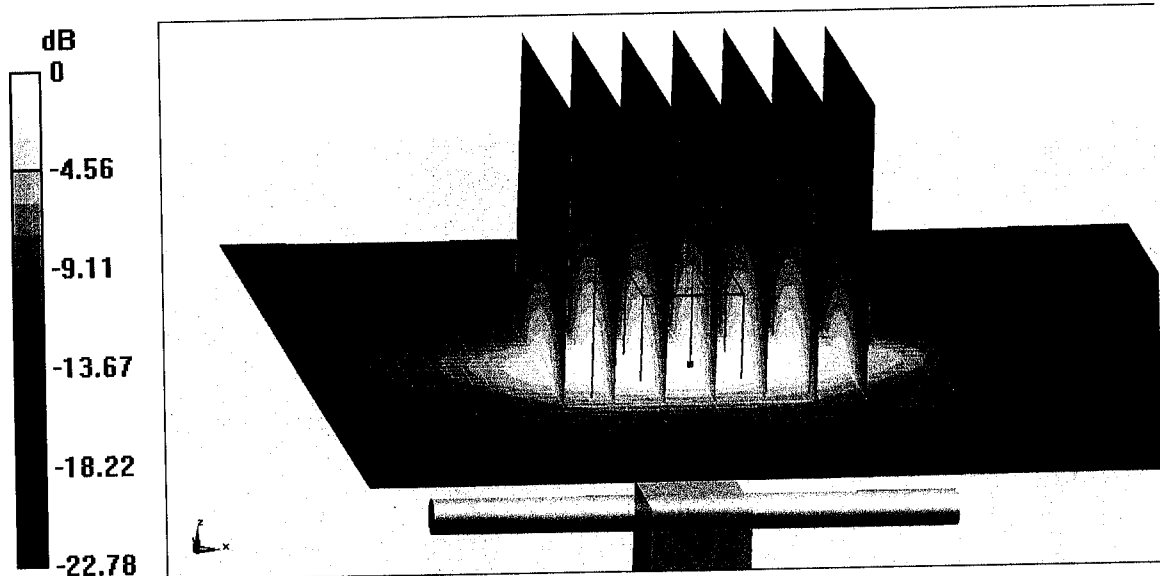

**0 dB = 21.5 W/kg = 13.32 dBW/kg**



Add: No.51 Xueyuan Road, Haidian District, Beijing, 100191, China  
Tel: +86-10-62304633-2079 Fax: +86-10-62304633-2504  
E-mail: cttl@chinattl.com http://www.chinattl.cn

### Impedance Measurement Plot for Body TSL

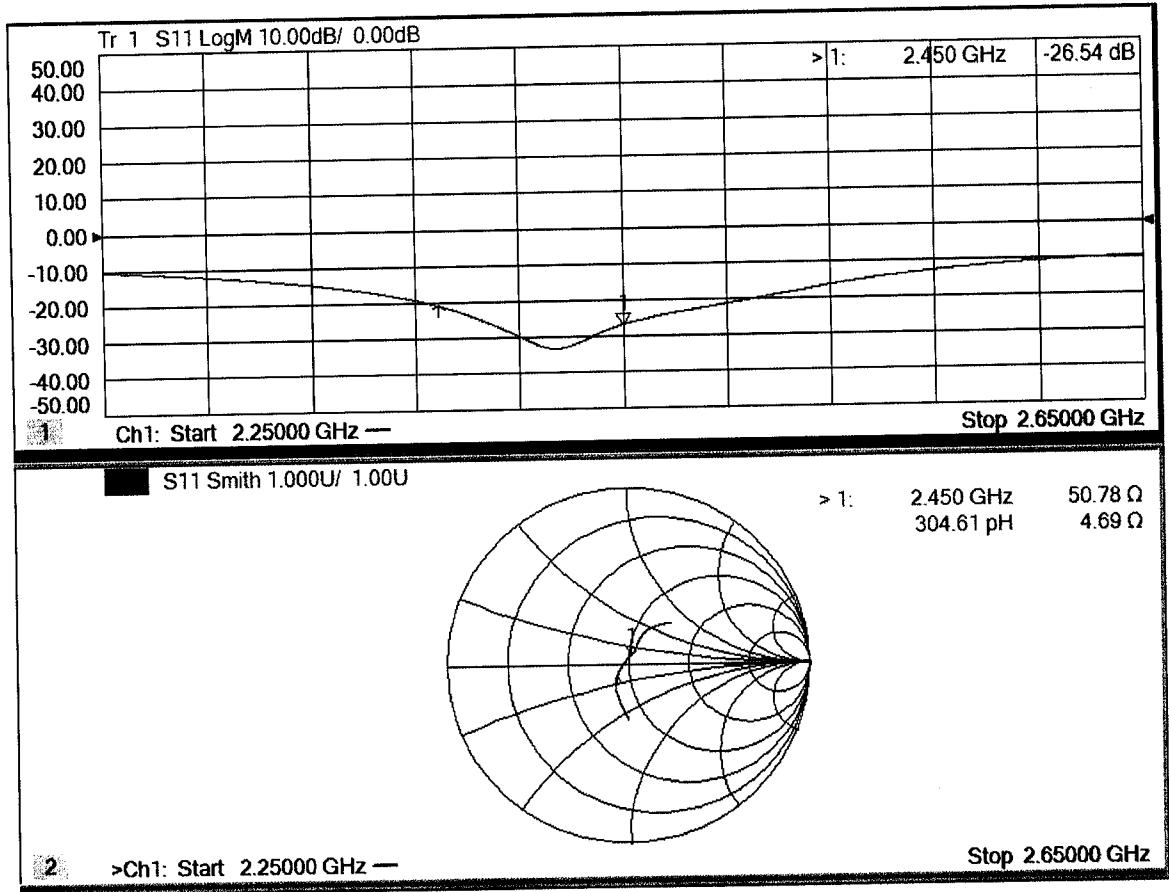



Accredited by the Swiss Accreditation Service (SAS)  
The Swiss Accreditation Service is one of the signatories to the EA  
Multilateral Agreement for the recognition of calibration certificates

Accreditation No.: **SCS 0108**

Client **Sporton (Auden)**

Certificate No: **D5GHzV2-1167\_Jul17**

## CALIBRATION CERTIFICATE

Object **D5GHzV2 - SN:1167**

Calibration procedure(s) **QA CAL-22.v2  
Calibration procedure for dipole validation kits between 3-6 GHz**

Calibration date: **July 26, 2017**

This calibration certificate documents the traceability to national standards, which realize the physical units of measurements (SI).  
The measurements and the uncertainties with confidence probability are given on the following pages and are part of the certificate.

All calibrations have been conducted in the closed laboratory facility: environment temperature ( $22 \pm 3$ )°C and humidity < 70%.

Calibration Equipment used (M&TE critical for calibration)

Primary Standards	ID #	Cal Date (Certificate No.)	Scheduled Calibration
Power meter NRP	SN: 104778	04-Apr-17 (No. 217-02521/02522)	Apr-18
Power sensor NRP-Z91	SN: 103244	04-Apr-17 (No. 217-02521)	Apr-18
Power sensor NRP-Z91	SN: 103245	04-Apr-17 (No. 217-02522)	Apr-18
Reference 20 dB Attenuator	SN: 5058 (20k)	07-Apr-17 (No. 217-02528)	Apr-18
Type-N mismatch combination	SN: 5047.2 / 06327	07-Apr-17 (No. 217-02529)	Apr-18
Reference Probe EX3DV4	SN: 3503	31-Dec-16 (No. EX3-3503_Dec16)	Dec-17
DAE4	SN: 601	28-Mar-17 (No. DAE4-601_Mar17)	Mar-18

Secondary Standards	ID #	Check Date (in house)	Scheduled Check
Power meter EPM-442A	SN: GB37480704	07-Oct-15 (in house check Oct-16)	In house check: Oct-18
Power sensor HP 8481A	SN: US37292783	07-Oct-15 (in house check Oct-16)	In house check: Oct-18
Power sensor HP 8481A	SN: MY41092317	07-Oct-15 (in house check Oct-16)	In house check: Oct-18
RIF generator R&S SMT-06	SN: 100972	15-Jun-15 (in house check Oct-16)	In house check: Oct-18
Network Analyzer HP 8753E	SN: US37390585	18-Oct-01 (in house check Oct-16)	In house check: Oct-17

	<b>Name</b>	<b>Function</b>	<b>Signature</b>
Calibrated by:	Johannes Kurikka	Laboratory Technician	

	<b>Name</b>	<b>Function</b>	<b>Signature</b>
Approved by:	Katja Pokovic	Technical Manager	

Issued: July 27, 2017

This calibration certificate shall not be reproduced except in full without written approval of the laboratory.





Accredited by the Swiss Accreditation Service (SAS)  
The Swiss Accreditation Service is one of the signatories to the EA  
Multilateral Agreement for the recognition of calibration certificates

Accreditation No.: SCS 0108

### Glossary:

TSL	tissue simulating liquid
ConvF	sensitivity in TSL / NORM x,y,z
N/A	not applicable or not measured

### Calibration is Performed According to the Following Standards:

- IEEE Std 1528-2013, "IEEE Recommended Practice for Determining the Peak Spatial-Averaged Specific Absorption Rate (SAR) in the Human Head from Wireless Communications Devices: Measurement Techniques", June 2013
- IEC 62209-1, "Measurement procedure for the assessment of Specific Absorption Rate (SAR) from hand-held and body-mounted devices used next to the ear (frequency range of 300 MHz to 6 GHz)", July 2016
- IEC 62209-2, "Procedure to determine the Specific Absorption Rate (SAR) for wireless communication devices used in close proximity to the human body (frequency range of 30 MHz to 6 GHz)", March 2010
- KDB 865664, "SAR Measurement Requirements for 100 MHz to 6 GHz"

### Additional Documentation:

- DASY4/5 System Handbook

### Methods Applied and Interpretation of Parameters:

- Measurement Conditions:** Further details are available from the Validation Report at the end of the certificate. All figures stated in the certificate are valid at the frequency indicated.
- Antenna Parameters with TSL:** The dipole is mounted with the spacer to position its feed point exactly below the center marking of the flat phantom section, with the arms oriented parallel to the body axis.
- Feed Point Impedance and Return Loss:** These parameters are measured with the dipole positioned under the liquid filled phantom. The impedance stated is transformed from the measurement at the SMA connector to the feed point. The Return Loss ensures low reflected power. No uncertainty required.
- Electrical Delay:** One-way delay between the SMA connector and the antenna feed point. No uncertainty required.
- SAR measured:** SAR measured at the stated antenna input power.
- SAR normalized:** SAR as measured, normalized to an input power of 1 W at the antenna connector.
- SAR for nominal TSL parameters:** The measured TSL parameters are used to calculate the nominal SAR result.

The reported uncertainty of measurement is stated as the standard uncertainty of measurement multiplied by the coverage factor  $k=2$ , which for a normal distribution corresponds to a coverage probability of approximately 95%.