

FCC RF Test Report

Product Name: LTE/UMTS Smart Phone; HUAWEI Ascend G6, HUAWEI Ascend P7 mini

Product Model: HUAWEI G6-L11, G6-L11, P7 mini

Report Number: SYBH(Z-RF)012012014-2004

FCC ID: QISG6-L11

Reliability Laboratory of Huawei Technologies Co., Ltd.

Administration Building, Headquarters of Huawei Technologies Co., Ltd., Bantian, Longgang District,
Shenzhen, 518129, P.R.C

Tel: +86 755 28780808

Fax: +86 755 89652518



Notice

1. The laboratory has Passed the accreditation by China National Accreditation Service for Conformity Assessment (CNAS). The accreditation number is L0310.
2. The laboratory has Passed the accreditation by The American Association for Laboratory Accreditation (A2LA). The accreditation number is 2174.01.
3. The laboratory has been listed by the US Federal Communications Commission to perform electromagnetic emission measurements. The site recognition number is 97456.
4. The laboratory has been listed by Industry Canada to perform electromagnetic emission measurements. The recognition numbers of test site are 6369A-2.
5. The test report is invalid if not marked with the signatures of the persons responsible for preparing and approving the test report.
6. The test report is invalid if there is any evidence of erasure and/or falsification.
7. The test report is only valid for the test samples.
8. Content of the test report, in part or in full, cannot be used for publicity and/or promotional purposes without prior written approval from the laboratory.



Applicant: Huawei Technologies Co., Ltd.
Address: Administration Building, Headquarters of Huawei Technologies Co., Ltd.,
Bantian, Longgang District, Shenzhen, 518129, P.R.C

Date of Receipt Sample: 2014-01-28
Start Date of Test: 2014-02-05
End Date of Test: 2014-02-15

Test Result: Pass

Approved by Senior Engineer:	2014-02-24	Dai Linjun	
	Date	Name	Signature

Prepared by:	2014-02-24	Ling Kaiyun	
	Date	Name	Signature



Modification Record

No.	Last Report No.	Modification Description
1		First report.



CONTENT

1	General Information.....	6
1.1	Applied Standard.....	6
1.2	Test Location	6
1.3	Test Environment Condition.....	6
2	Test Summary	7
3	Description of the Equipment under Test (EUT).....	8
3.1	General Description	8
3.2	EUT Identity	8
3.3	Technical Description.....	9
4	General Test Conditions / Configurations.....	10
4.1	EUT Configurations.....	10
4.2	Test Environments	11
4.3	Test Setups.....	12
4.4	Test Conditions	15
5	Main Test Instruments	16



1 General Information

1.1 Applied Standard

Applied Rules: 47 CFR FCC Part 2, Subpart J 2012
47 CFR FCC Part 15, Subpart C 2012

Test Method: FCC KDB 558074 D01 DTS Meas Guidance v03r01
ANSI C63.10-2009, American National Standard for Testing Unlicensed
Wireless Devices.

1.2 Test Location

Test Location 1: Reliability Laboratory of Huawei Technologies Co., Ltd.
Address: Administration Building, Headquarters of Huawei Technologies Co., Ltd.,
Bantian, Longgang District, Shenzhen, 518129, P.R.C

1.3 Test Environment Condition

Ambient Temperature: 19.5to 25 °C
Ambient Relative Humidity: 40 to 55 %
Atmospheric Pressure: Not applicable

2 Test Summary

Test Item	FCC Part No.	Requirements	Test Result	Verdict
DTS (6 dB) Bandwidth	15.247(a)(2)	≥ 500 kHz.	Appendix A	Pass
Maximum Peak Conducted Output Power	15.247(b)(3)	For directional gain: < 30 dBm – (G[dBi] – 6 [dB]), peak; Otherwise: < 30 dBm, peak.	Appendix B	Pass
Average Power	---	None; for reporting purposes only	Appendix C	---
Maximum Power Spectral Density Level	15.247(e)	For directional gain: < 8 dBm/3 kHz – (G[dBi] – 6 [dB]), peak. Otherwise: < 8 dBm/3 kHz, peak.	Appendix D	Pass
Band Edges Compliance	15.247(d)	< -20 dBm/100 kHz if total peak power ≤ power limit.	Appendix E	Pass
Unwanted Emissions into Non-Restricted Frequency Bands			Appendix F	Pass
Unwanted Emissions into Restricted Frequency Bands (Radiated)	15.247(d) 15.209 (NOTE 1)	FCC Part 15.209 field strength limit;	Appendix G	Pass
AC Power Line Conducted Emissions	15.207	FCC Part 15.207 conducted limit;	Appendix H	Pass
NOTE 1: According to KDB 558074, antenna-port conducted measurements are acceptable as an alternative to radiated measurements for demonstrating compliance to the limits in the restricted frequency bands. If conducted measurements are performed, then proper impedance matching must be ensured and an additional radiated test for cabinet/case emissions will also be required.				



3 Description of the Equipment under Test (EUT)

3.1 General Description

HUAWEI G6-L11, G6-L11, P7 mini is subscriber equipment in the LTE/WCDMA/GSM system. The HSPA/UMTS frequency band is Band I and Band VIII. The LTE frequency band is B3 and B7 and B20. The GSM/GPRS/EDGE frequency band includes GSM850 and GSM900 and DCS1800 and PCS1900. The Mobile Phone implements such functions as RF signal receiving/transmitting, LTE/HSPA/UMTS and GSM/GPRS/EDGE protocol processing, voice, video MMS service, GPS, AGPS, NFC and WIFI etc. Externally it provides micro SD card interface, earphone port (to provide voice service) and USIM card interface. It also provides Bluetooth module to synchronize data between a PC and the phone, or to use the built-in modem of the phone to access the Internet with a PC, or to exchange data with other Bluetooth devices.

3.2 EUT Identity

NOTE: Unless otherwise noted in the report, the functional boards installed in the units shall be selected from the below list, but not means all the functional boards listed below shall be installed in one unit.

3.2.1 Board

Board		
Software Version	Hardware Version	Description
G6-L11V100R001C00B105	HL1G6L22M	Main Board

3.2.2 Sub-Assembly

AC/DCAdapter Model	HW-050100U2W
Manufacturer	Huawei Technologies Co., Ltd.
Input Voltage	~100-240V 50/60Hz 0.2A
Output Voltage	5V  1A
Rated Power	5W



AC/DCAdapter Model	HW-050100E2W
Manufacturer	Huawei Technologies Co., Ltd.
Input Voltage	~100-240V 50/60Hz 0.2A
Output Voltage	5V  1A
Rated Power	5W

AC/DCAdapter Model	HW-050100B2W
Manufacturer	Huawei Technologies Co., Ltd.
Input Voltage	~100-240V 50/60Hz 0.2A



Output Voltage	5V  1A
Rated Power	5W

AC/DCAdapter Model	HW-050100A2W
Manufacturer	Huawei Technologies Co., Ltd.
Input Voltage	~100-240V 50/60Hz 0.2A
Output Voltage	5V  1A
Rated Power	5W

Name	Manufacture	Description
Rechargeable Li-ion	Huawei Technologies Co., Ltd.	Battery Model: HB3742A0EBC Rated capacity: 2000mAh Nominal Voltage:  +3.8V Charging Voltage:  +4.35V

3.3 Technical Description

Characteristics	Description	
TX/RX Operating Range	2400-2483.5 MHz band	$f_c = 2402 \text{ MHz} + N * 2 \text{ MHz}$, where: - f_c = "Operating Frequency" in MHz, - N = "Channel Number" with the range from 0 to 39.
Modulation Type	Digital	GFSK,
Emission Designator	GFSK for BT 4.0: 699KGXD	
Bluetooth Power Class	Class 1	



4 General Test Conditions / Configurations

4.1 EUT Configurations

4.1.1 General Configurations

Configuration	Description
Test Antenna Ports	Until otherwise specified, <ul style="list-style-type: none">- All TX tests are performed at all TX antenna ports of the EUT, and- All RX tests are performed at all RX antenna ports of the EUT.
Multiple RF Sources	Other than the tested RF source of the EUT, other RF source(s) are disabled or shutdown during measurements.

4.1.2 Customized Configurations

# EUT Conf.	Signal Description	Operating Frequency
TM1_DH5_Ch0	GFSK for BT 4.0 modulation, package type DH5, hopping off.	Ch No. 0 / 2402 MHz
TM1_DH5_Ch19	GFSK for BT 4.0 modulation, package type DH5, hopping off.	Ch No. 19 / 2440 MHz
TM1_DH5_Ch39	GFSK for BT 4.0 modulation, package type DH5, hopping off.	Ch No. 39 / 2480 MHz



4.2 Test Environments

NOTE: The values used in the test report may be stringent than the declared.

Environment Parameter	Selected Values During Tests		
	Temperature	Voltage	Relative Humidity
NTNV	Ambient	3.8 VDC	Ambient

4.3 Test Setups

4.3.1 Test Setup 1

The Bluetooth component's antenna ports(s) of the EUT are connected to the measurement instrument per an appropriate attenuator. The EUT is controlled by Bluetooth System Simulator and/or PC/software to emit the specified signals for the purpose of measurements.

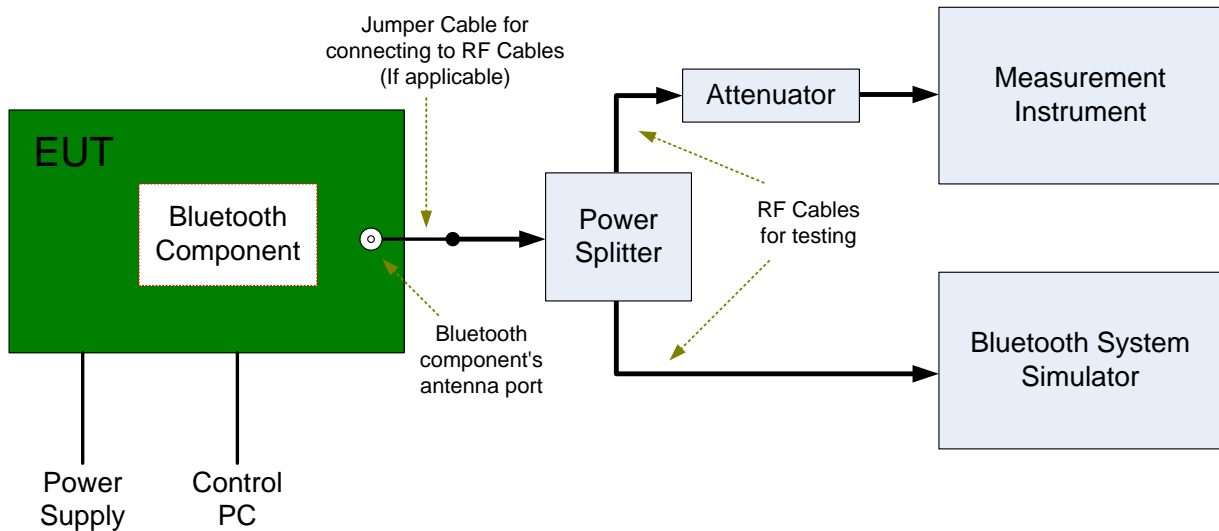

4.3.2 Test Setup 2

The test site semi-anechoic chamber has met the requirement of NSA tolerance 4 dB according to the standards: ANSI C63.4. The test distance is 3m. The setup is according to ANSI C63.4 and CAN/CSA-CEI/IEC CISPR 22.

The maximal emission value is acquired by adjusting the antenna height, polarisation and turntable azimuth. Normally, the height range of antenna is 1 m to 4 m, the azimuth range of turntable is 0° to 360°, and the receive antenna has two polarizations Vertical (V) and Horizontal (H).

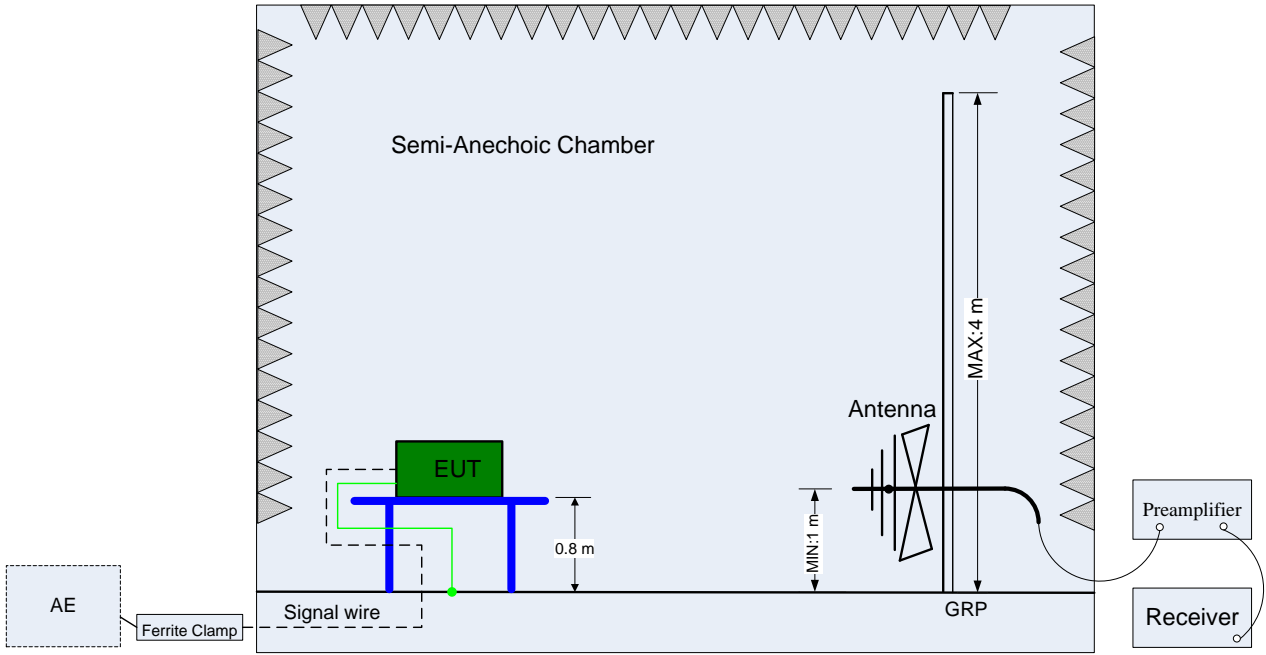

(Below 1 GHz)

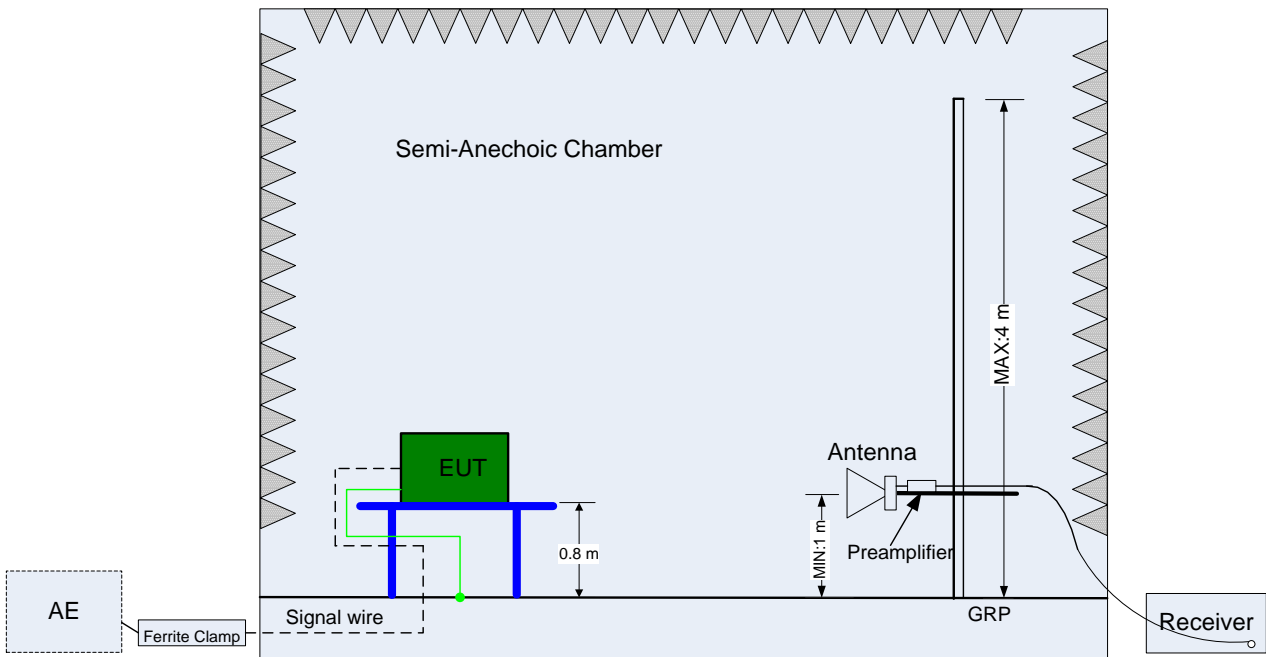

(Above 1 GHz)

4.3.3 Test Setup 3

The mains cable of the EUT (maybe per AC/DC Adapter) must be connected to LISN. The LISN shall be placed 0.8 m from the boundary of EUT and bonded to a ground reference plane for LISN mounted on top of the ground reference plane. This distance is between the closest points of the LISN and the EUT. All other units of the EUT and associated equipment shall be at least 0.8 m from the LISN.

Ground connections, where required for safety purposes, shall be connected to the reference ground point of the LISN and, where not otherwise provided or specified by the manufacturer, shall be of same length as the mains cable and run parallel to the mains connection at a separation distance of not more than 0.1 m.

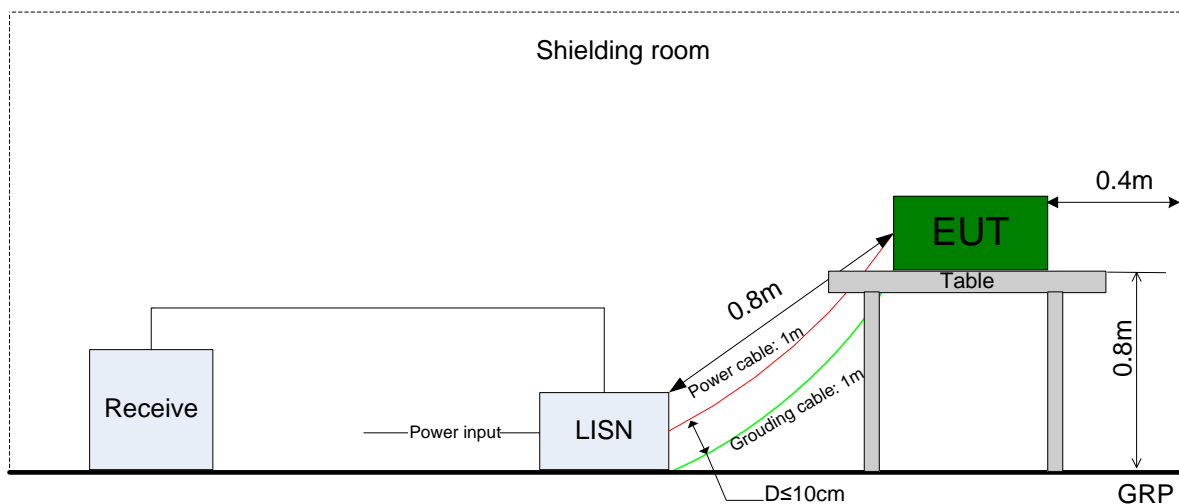



4.4 Test Conditions

Test Case	Test Conditions			
	Configuration	Description		
6dB Emission Bandwidth (EBW)	Meas. Method	FCC KDB 558074 §8.2 Option 2.		
	Test Env.	NTNV		
	Test Setup	Test Setup 1		
	EUT Conf.	TM1_DH5_Ch0, TM1_DH5_Ch19, TM1_DH5_Ch39.		
Maximum Peak Conducted Output Power	Meas. Method	FCC KDB 558074 §9.1 .1 (RBW ≥ DTS bandwidth).		
	Test Env.	NTNV		
	Test Setup	Test Setup 1		
	EUT Conf.	TM1_DH5_Ch0, TM1_DH5_Ch19, TM1_DH5_Ch39.		
Maximum Power Spectral Density Level	Meas. Method	FCC KDB 558074 §10.2 (peak PSD).		
	Test Env.	NTNV		
	Test Setup	Test Setup 1		
	EUT Conf.	TM1_DH5_Ch0, TM1_DH5_Ch19, TM1_DH5_Ch39.		
Band edge spurious emission	Meas. Method	FCC KDB 558074 §13.0.		
	Test Env.	NTNV		
	Test Setup	Test Setup 1		
	EUT Conf.	TM1_DH5_Ch0, TM1_DH5_Ch39.		
Unwanted Emissions into Non-Restricted Frequency Bands	Meas. Method	FCC KDB 558074 §11.0		
	Test Env.	NTNV		
	Test Setup	Test Setup 1		
	EUT Conf.	TM1_DH5_Ch0, TM1_DH5_Ch19, TM1_DH5_Ch39.		
Unwanted Emissions into Restricted Frequency Bands (Radiated)	Meas. Method	ANSI C63.10; FCC KDB 558074 §12.1, Radiated		
	Test Env.	NTNV		
	Test Setup	Test Setup 2		
	EUT Conf.	30 MHz -1 GHz	TM1_DH5_Ch0 (Worst Conf.).	
		1-3 GHz	TM1_DH5_Ch0, TM1_DH5_Ch19, TM1_DH5_Ch39.	
3-18 GHz		TM1_DH5_Ch19 (Worse Conf.),		
18-26.5 GHz		TM1_DH5_Ch0 (Worst Conf.).		
AC Power Line Conducted Emissions	Meas. Method	AC mains conducted. Pre: RBW = 10 kHz; Det. = Peak. Final: RBW = 9 kHz; Det. = CISPR Quasi-Peak & Average.		
	Test Env.	NTNV		
	Test Setup	Test Setup 3		
	EUT Conf.	TM1_DH5_Ch39.		



5 Main Test Instruments

NOTE: Unless otherwise specified, the calibration intervals for test instruments were Annual (per year). The other intervals, if applicable, are marked with (##y), which denotes ## years calibration interval.

Equipment Name	Manufacturer	Model	Serial Number	Cal Date	Cal- Due
Power supply	KEITHLEY	2303	1288003	2012-11-19	2014-11-18
Wireless Communication Test set	Agilent	N4010A	MY49081592	2013-10-29	2014-10-28
Universal Radio Communication Tester	R&S	CMU200	113164	2013-07-18	2014-07-17
Universal Radio Communication Tester	R & S	CMW500	126855	2013-08-08	2015-08-09
Spectrum Analyzer	Agilent	E4440A	MY48250119	2013-08-09	2014-08-08
Signal Analyzer	R&S	FSQ31	200021	2013-10-29	2014-10-28
Spectrum Analyzer	Agilent	N9030A	MY49431698	2013-10-29	2014-10-28
Temperature Chamber	ESPEC	MW3030	06114003	2013-05-14	2014-05-13
Signal generator	Agilent	E8257D	MY51500314	2013-04-15	2014-04-14
Vector Signal Generator	R&S	SMU200A	104162	2013-10-29	2014-10-28
Test receiver	R&S	ESU26	100150	2013-05-15	2014-05-14
Spectrum analyzer	R&S	FSU3	200474	2013-12-24	2014-12-23
Spectrum analyzer	R&S	FSU43	100144	2013-12-24	2014-12-23
Double-Ridged Waveguide Horn Antenna (1G~18GHz)	R&S	HF907	100304	2013-02-02	2015-02-01
Trilog Broadband Antenna (30M~3GHz)	SCHWARZBECK	VULB 9163	9163-490	2013-02-02	2015-02-01
LOOP Antennas(9kHz-30MHz)	R&S	HFH2-Z2	100262	2013-03-23	2015-03-22
Pyramidal Horn Antenna(18GHz-26-5GHz)	ETS-LINDGREN	3160-09	5140299	2013-03-05	2015-03-04
Artificial Mains Network	R&S	ENV4200	100134	2013-12-24	2014-12-23
Artificial Mains Network	R&S	ENV216	100382	2013-12-24	2014-12-23

END