



FCC

RF Test Report

Product Name: LTE/UMTS Smart Phone;HUAWEI Ascend G6

Model Number: HUAWEI G6-L22, G6-L22

Report No: SYBH(Z-RF)008022014-2002

FCC ID: QISG6-L22

Reliability Laboratory of Huawei Technologies Co., Ltd.

Administration Building, Headquarters of Huawei Technologies Co., Ltd., Bantian, Longgang District,
Shenzhen, 518129, P.R.C

Tel: +86 755 28780808

Fax: +86 755 89652518



Notice

1. The laboratory has Passed the accreditation by China National Accreditation Service for Conformity Assessment (CNAS). The accreditation number is L0310.
2. The laboratory has Passed the accreditation by The American Association for Laboratory Accreditation (A2LA). The accreditation number is 2174.01.
3. The laboratory has been listed by the US Federal Communications Commission to perform electromagnetic emission measurements. The site recognition number is 97456.
4. The laboratory has been listed by Industry Canada to perform electromagnetic emission measurements. The recognition numbers of test site are 6369A-2.
5. The test report is invalid if not marked with the signatures of the persons responsible for preparing and approving the test report.
6. The test report is invalid if there is any evidence of erasure and/or falsification.
7. The test report is only valid for the test samples.
8. Content of the test report, in part or in full, cannot be used for publicity and/or promotional purposes without prior written approval from the laboratory.



Applicant: Huawei Technologies Co., Ltd.
Address: Administration Building, Headquarters of Huawei Technologies Co., Ltd.,
Bantian, Longgang District, Shenzhen, 518129, P.R.C

Date of Receipt Sample: 2014-02-05
Start Date of Test: 2014-02-14
End Date of Test: 2014-02-22

Test Result: Pass

Approved by Senior Engineer:	2014-02-25	Dai Linjun	
	Date	Name	Signature

Prepared by:	2014-02-25	Hexiaolin	
	Date	Name	Signature



Modification Record

No.	Last Report No.	Modification Description



CONTENT

1 General Information.....6
1.1 Applied Standard.....6
1.2 Test Location6
1.3 Test Environment Condition.....6
2 Test Summary7
3 Description of the Equipment under Test (EUT)8
3.1 General Description8
3.2 EUT Identity9
3.3 Technical Description..... 11
4 General Test Conditions / Configurations 12
4.1 EUT Configurations..... 12
4.2 Test Environments 13
4.3 Antenna requirements..... 13
4.4 Description of tests..... 14
4.5 Test Setups..... 17
4.6 Test Conditions20
5 Main Test Instruments 22



1 General Information

1.1 Applied Standard

Applied Rules: 47 CFR FCC Part 2, Subpart J 2012
47 CFR FCC Part 15, Subpart C 2012

Test Method: FCC PUBLIC NOTICE DA 00-705 Filing and Measurement Guidelines for Frequency Hopping Spread Spectrum Systems (Released March 30, 2000)

ANSI C63.4-2003/-2009, American National Standard for Methods of Measurement of Radio-Noise Emissions from Low-Voltage Electrical and Electronic Equipment in the Range of 9 kHz to 40 GHz.

ANSI C63.10-2009, American National Standard for Testing Unlicensed Wireless Devices.

1.2 Test Location

Test Location 1: Reliability Laboratory of Huawei Technologies Co., Ltd.
Address: Administration Building, Headquarters of Huawei Technologies Co., Ltd., Bantian, Longgang District, Shenzhen, 518129, P.R.C

1.3 Test Environment Condition

Ambient Temperature: 19.5 to 25 °C
Ambient Relative Humidity: 45 to 55 %
Atmospheric Pressure: Not applicable



2 Test Summary

Test Item	FCC Part No.	Requirements	Test Result	Verdict (NOTE)
20dB Emission Bandwidth (EBW)	15.247(a)(1)	No limit.	Appendix A	SYBH(Z-RF) 012012014-2 003
Carrier Frequency Separation	15.247(a)(1)	\geq MAX {25kHz, IIF{output power \leq 125mW, 2/3*20dB EBW, 20dB EBW }}.	Appendix B	SYBH(Z-RF) 012012014-2 003
Number of Hopping Channel	15.247(a)(1)(iii)	\geq 15 channels.	Appendix C	SYBH(Z-RF) 012012014-2 003
Time of Occupancy (Dwell Time)	15.247(a)(1)(iii)	< 0.4s within a period of (0.4s*hopping number).	Appendix D	SYBH(Z-RF) 012012014-2 003
Maximum Peak Conducted Output Power	15.247(b)(1)	< 1 W if using \geq 75 non-overlapping channels.	Appendix E	SYBH(Z-RF) 012012014-2 003
Band edge spurious emission	15.247(d)	< -20 dBm/100 kHz if total peak power \leq power limit.	Appendix F	SYBH(Z-RF) 012012014-2 003
Conducted RF Spurious Emission			Appendix G	SYBH(Z-RF) 012012014-2 003
Radiated Emissions in the Restricted Bands	15.247(d) 15.209	FCC Part 15.209 field strength limit;	Appendix H	SYBH(Z-RF) 012012014-2 003
AC Power Line Conducted Emissions	15.207	FCC Part 15.207 conducted limit;	Appendix I	SYBH(Z-RF) 012012014-2 003
NOTE: For the verdict, the "N/A" denotes "not applicable", the "N/T" denotes "not tested".				

3 Description of the Equipment under Test (EUT)

3.1 General Description

HUAWEI G6-L22, G6-L22 is subscriber equipment in the LTE/WCDMA/GSM system. The HSPA/UMTS frequency band is Band I and Band V and Band VIII. The LTE frequency band is B3 and B7 and B1. The GSM/GPRS/EDGE frequency band includes GSM850 and GSM900 and DCS1800 and PCS1900. The Mobile Phone implements such functions as RF signal receiving/transmitting, LTE/HSPA/UMTS and GSM/GPRS/EDGE protocol processing, voice, video MMS service, GPS, AGPS, NFC and WIFI etc. Externally it provides micro SD card interface, earphone port (to provide voice service) and USIM card interface. It also provides Bluetooth module to synchronize data between a PC and the phone, or to use the built-in modem of the phone to access the Internet with a PC, or to exchange data with other Bluetooth devices.

The mobile phone G6-L11, G6-L22, and G6-L33 are LTE/UMTS mobile phone with Bluetooth. The differences among G6-L11, G6-L22, and G6-L33 are showed in the following table. Other parts of the mobile phone are the same, including the appearance, the antenna, Chipset, Bluetooth mode, Wifi mode, Adapter, Battery, Mainboard and so on.

	G6-L11	G6-L22	G6-L33
GSM four bands	the same	the same	the same
WCDMA bands	B1/B8	B1/B5/B8	B1/B2/B4/B5
LTE bands	B3/B7/B20	B1/B3/B7	B2/B4/B7
FCC bands	GSM850/1900 LTE B7	GSM850/1900 W850 LTE B7	GSM850/1900 W1900/AWS/W850 LTE B2 B4 B7
FLASH	the same	the same	the same
Mainboard	the same	the same	the same
PCB layout	the same	the same	the same
Appearance	the same	the same	the same
NFC	the same	the same	the same
Bluetooth mode	the same	the same	the same
WLAN mode	the same	the same	the same
BT/ WLAN antenna	the same	the same	the same



GSM/ WCDMA/LTE antenna	the same	the same	the same
External camera	800M	the same	the same
internal camera	100M	the same	the same
Adapter	the same	the same	the same
Battery	the same	the same	the same
Chipset	the same	the same	the same
Memory	the same	the same	the same
RF Parameter	The same RF Parameter in the same band	The same RF Parameter in the same band	The same RF Parameter in the same band
Dimension	the same	the same	the same
Main Frequency NV	The same NV in the same band	The same NV in the same band	The same NV in the same band

So, The BT test cases refer to NO:SYBH(Z-RF)012012014-2003 of G6-L11.

3.2 EUT Identity

NOTE: Unless otherwise noted in the report, the functional boards installed in the units shall be selected from the below list, but not means all the functional boards listed below shall be installed in one unit.

3.2.1 Board

Board		
Software Version	Hardware Version	Description
G6-L22V100R001C00B105	HL1G6L22M	Main Board

3.2.2 Sub-Assembly



AC/DCAdapter Model	HW-050100U2W
Manufacturer	Huawei Technologies Co., Ltd.
Input Voltage	~100-240V 50/60Hz 0.2A
Output Voltage	5V  1A
Rated Power	5W



AC/DCAdapter Model	HW-050100E2W
Manufacturer	Huawei Technologies Co., Ltd.
Input Voltage	~100-240V 50/60Hz 0.2A
Output Voltage	5V  1A
Rated Power	5W

AC/DCAdapter Model	HW-050100B2W
Manufacturer	Huawei Technologies Co., Ltd.
Input Voltage	~100-240V 50/60Hz 0.2A
Output Voltage	5V  1A
Rated Power	5W

AC/DCAdapter Model	HW-050100A2W
Manufacturer	Huawei Technologies Co., Ltd.
Input Voltage	~100-240V 50/60Hz 0.2A
Output Voltage	5V  1A
Rated Power	5W

Name	Manufacture	Description
Rechargeable Li-ion	Huawei Technologies Co., Ltd.	Battery Model: HB3742A0EBC Rated capacity: 2000mAh Nominal Voltage:  +3.8V Charging Voltage:  +4.35V



3.3 Technical Description

Characteristics	Description	
TX/RX Operating Range	2400-2483.5 MHz band	$f_c = 2402 \text{ MHz} + N * 1 \text{ MHz}$, where: - f_c = "Operating Frequency" in MHz, - N = "Channel Number" with the range from 0 to 78.
	Carrier	Frequency Hopping Spread Spectrum (FHSS)
Modulation Type	Digital	GFSK, $\pi/4$ -DQPSK, 8DPSK
	Emission Designator	GFSK:947KGXD $\pi/4$ -DQPSK: 1M29GXD 8DPSK: 1M28GXD
Bluetooth Power Class	Class 1	



4 General Test Conditions / Configurations

4.1 EUT Configurations

4.1.1 General Configurations

Configuration	Description
Test Antenna Ports	Until otherwise specified, <ul style="list-style-type: none">- All TX tests are performed at all TX antenna ports of the EUT, and- All RX tests are performed at all RX antenna ports of the EUT.
Multiple RF Sources	Other than the tested RF source of the EUT, other RF source(s) are disabled or shutdown during measurements.

4.1.2 Customized Configurations

# EUT Conf.	Signal Description	Operating Frequency
TM1_DH5_Hop	GFSK modulation, package type DH5, hopping on.	---
TM1_DH5_Ch0	GFSK modulation, package type DH5, hopping off.	Ch No. 0 / 2402 MHz
TM1_DH5_Ch39	GFSK modulation, package type DH5, hopping off.	Ch No. 39 / 2441 MHz
TM1_DH5_Ch78	GFSK modulation, package type DH5, hopping off.	Ch No. 78 / 2480 MHz
TM2_2DH5_Hop	$\pi/4$ -DQPSK modulation, package type 2DH5, hopping on.	---
TM2_2DH5_Ch0	$\pi/4$ -DQPSK modulation, package type 2DH5, hopping off.	Ch No. 0 / 2402 MHz
TM2_2DH5_Ch39	$\pi/4$ -DQPSK modulation, package type 2DH5, hopping off.	Ch No. 39 / 2441 MHz
TM2_2DH5_Ch78	$\pi/4$ -DQPSK modulation, package type 2DH5, hopping off.	Ch No. 78 / 2480 MHz
TM3_3DH5_Hop	8DPSK modulation, package type 3DH5, hopping on.	---
TM3_3DH5_Ch0	8DPSK modulation, package type 3DH5, hopping off.	Ch No. 0 / 2402 MHz
TM3_3DH5_Ch39	8DPSK modulation, package type 3DH5, hopping off.	Ch No. 39 / 2441 MHz
TM3_3DH5_Ch78	8DPSK modulation, package type 3DH5, hopping off.	Ch No. 78 / 2480 MHz



4.2 Test Environments

NOTE: The values used in the test report may be stringent than the declared.

Environment Parameter	Selected Values During Tests		
	Temperature	Voltage	Relative Humidity
NTNV	Ambient	3.8 VDC	Ambient

4.3 Antenna requirements

Excerpt from §15.203 of the FCC Rules/Regulations:

“An intentional radiator antenna shall be designed to ensure that no antenna other than that furnished by the responsible party can be used with the device. The use of a permanently attached antenna or of an antenna that uses a unique coupling to the intentional radiator shall be considered sufficient to comply with the provisions of this section.”

The antennas of the HUAWEI G6-L22, are **permanently attached**.

There are no provisions for connection to an external antenna.

Conclusion:

The HUAWEI G6-L22, **FCC ID: QISG6-L22** unit complies with the requirement of §15.203.

Ch. Frequency (MHz)

Ch.	Frequency (MHz)
00	2402
.	.
.	.
39	2441
.	.
.	.
78	2480

Frequency/ Channel Operations



4.4 Description of tests

4.4.1 Bandwidth measurement

- (a) Connect EUT test port to universal communication tester.
- (b) Set the EUT to transmit maximum output power at 2.4GHz and switch off frequency hopping function, then set the measuring frequency number, finally test the bandwidth with universal communication tester.

4.4.2 Carrier frequency separation measurement

- (a) Connect EUT test port to spectrum analyzer and universal communication tester.
- (b) Set the EUT to transmit maximum output power at 2.4GHz and switch off frequency hopping function, then set the measured frequency number to two adjacent channels separately and test the carrier frequency separation with spectrum analyzer.

4.4.3 Number of hopping channel

- (a) Connect EUT test port to spectrum analyzer and universal communication tester.
- (b) Set the EUT to transmit maximum output power at 2.4GHz and switch on frequency hopping function, then set enough count time (larger than 5000 times) to get all the hopping frequency channel displayed on the screen of spectrum analyzer.
- (c) Count the quantity of peaks to get the number of hopping channels.

4.4.4 Time of occupancy

- (a) Connect test port of EUT to spectrum analyzer and universal communication tester.
- (b) Set the EUT to transmit maximum output power at 2.4GHz and switch on frequency hopping function.
- (c) Set the span of spectrum analyzer to 0 Hz, and set the resolution bandwidth to 1 MHz and the video bandwidth to 1 MHz, then get the time domain measured diagram. and set sweep time to 2 times of one burst occupancy time, and measure the time of occupancy of one burst.
- (d) Set the resolution bandwidth to 1 MHz and the video bandwidth to 3 MHz, and set the sweep time to a period (0.4 seconds multiplied by the number of hopping channels employed), and count the number of the bursts.
- (e) Calculate the time of occupancy in a period with time occupancy of a burst and quantity of bursts

4.4.5 Peak output power

- (a) Connect EUT test port to spectrum analyzer and universal communication tester.
- (b) Set the EUT to transmit maximum output power at 2.4GHz and switch off frequency hopping function.
- (c) Then set the EUT to transmit at high, middle and low frequency and measure the conducted output power separately.

4.4.6 Average power

- (a) Connect EUT test port to spectrum analyzer and universal communication tester.

(b) Set the EUT to transmit maximum output power at 2.4GHz and switch off frequency hopping function.

(c) Then set the EUT to transmit at high, middle and low frequency and measure the average power separately.

4.4.7 Band edge spurious emission

(a) Connect EUT test port to spectrum analyzer and universal communication tester

(b) Set the EUT to transmit maximum output power at 2.4GHz and switch off frequency hopping function.

(c) Then set the EUT to transmit at high, low frequency and measure the conducted band edge spurious separately.

(d) Switch on the frequency hopping function, and repeat above measurement.

4.4.8 Conducted RF Spurious

(a) Connect EUT test port to spectrum analyzer and universal communication tester

(b) Set the EUT to transmit maximum output power at 2.4GHz and switch off frequency hopping function.

(c) Then set the EUT to transmit at high, middle and low frequency and measure the conducted spurious separately.

(d) Switch on the frequency hopping function, and repeat the above measurement.

4.4.9 Radiated spurious emission & spurious in restricted band

The test site semi-anechoic chamber has met the requirement of NSA tolerance 4dB according to the standards: ANSI C63.10 (2009). The EUT was set-up on insulator 80cm above the Ground Plane. The set-up and test methods were according to ANSI C63.10:2009. The Radiated Disturbance measurements were made using a Rohde and Schwarz Test Receiver and control software.

A preliminary scan and a final scan of the emissions were made by using test script of software; the emissions were measured using a Quasi-Peak Detector below 1GHz, Peak Detector and AV detector above 1GHz. The maximal emission value was acquired by adjusting the antenna height, polarisation and turntable azimuth in accordance with the software setup. Normally, the height range of antenna was 1m to 4m, and the azimuth range of turntable was 0° to 360°. The receive antenna has two polarizations V and H.

A portable or small unlicensed wireless device shall be placed on a non-metallic test fixture or other nonmetallic support during testing. The supporting fixture shall permit orientation of the EUT in each of three orthogonal (x, y, z) axis positions such that emissions from the EUT are maximized.

The EUT communicates with the BTS simulator through Air interface. The EUT transmits maximum output power at 2.4GHz and switch off frequency hopping function.

Measurement bandwidth: 30 MHz - 1000 MHz: 120 kHz

Measurement bandwidth: 1000 MHz - 10th Carrier Frequency: 1 MHz



4.4.10 Conducted Emission at Power Port

The Table-top EUT was placed upon a non-metallic table 0.8 m above the horizontal metal reference ground plane. EUT was connected to LISN and LISN was connected to reference Ground Plane. EUT was 80cm from LISN. The set-up and test methods were according to ANSI C63.10: 2009.

Conducted Disturbance at AC Port measurements were undertaken on the L and N Lines. The emissions were measured using a Quasi-Peak Detector and Average Detector.

The EUT communicates with the BTS simulator through Air interface, the BTS simulator controls the EUT to transmitter the maximum power which defined in specification of product. The EUT operated on the typical channel.

Measurement bandwidth (RBW) for 150kHz to 30 MHz: 9 kHz;

4.5 Test Setups

4.5.1 Test Setup 1

The Bluetooth component's antenna ports(s) of the EUT are connected to the measurement instrument per an appropriate attenuator. The EUT is controlled by Bluetooth System Simulator and/or PC/software to emit the specified signals for the purpose of measurements.

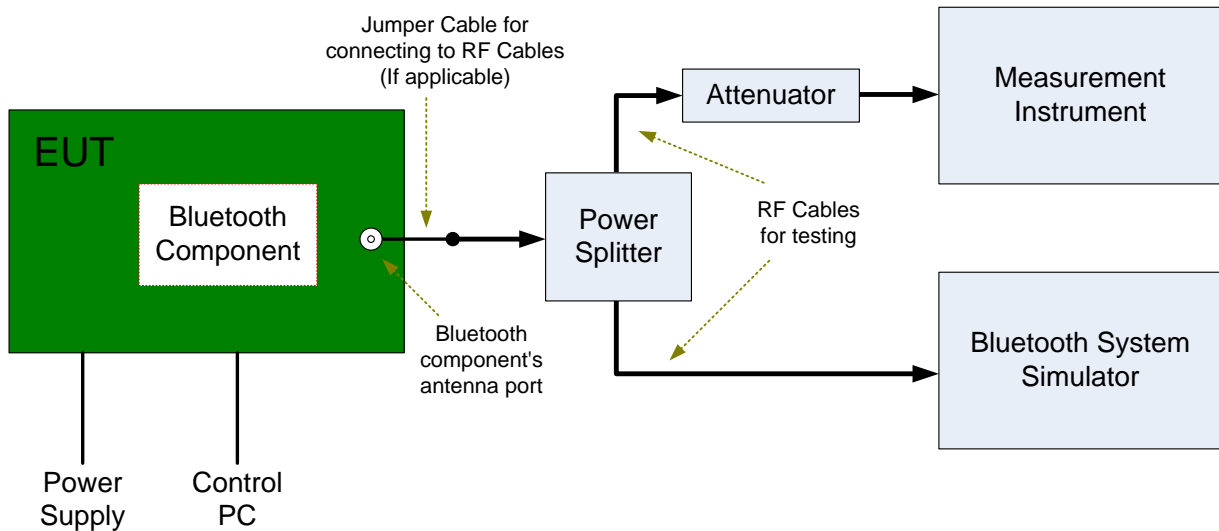

4.5.2 Test Setup 2

The test site semi-anechoic chamber has met the requirement of NSA tolerance 4 dB according to the standards: ANSI C63.4. The test distance is 3m. The setup is according to ANSI C63.4 and CAN/CSA-CEI/IEC CISPR 22.

The maximal emission value is acquired by adjusting the antenna height, polarisation and turntable azimuth. Normally, the height range of antenna is 1 m to 4 m, the azimuth range of turntable is 0° to 360°, and the receive antenna has two polarizations Vertical (V) and Horizontal (H).

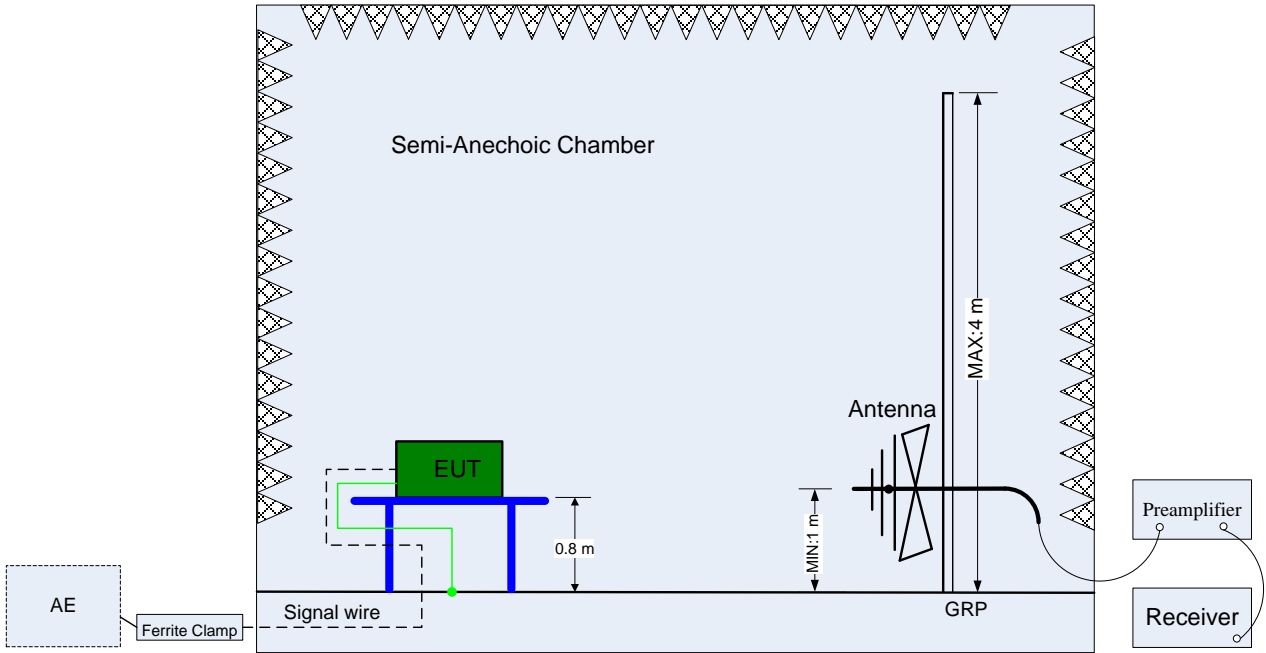

(Below 1 GHz)

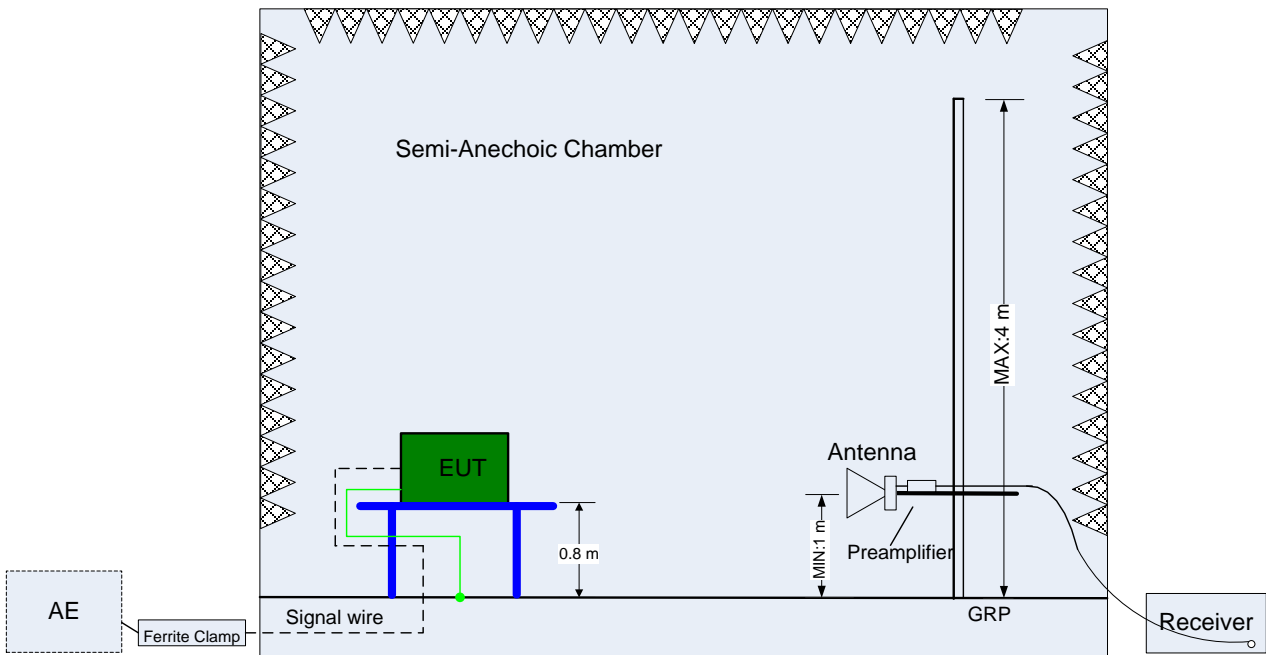

(Above 1 GHz)

4.5.3 Test Setup 3

The mains cable of the EUT (maybe per AC/DC Adapter) must be connected to LISN. The LISN shall be placed 0.8 m from the boundary of EUT and bonded to a ground reference plane for LISN mounted on top of the ground reference plane. This distance is between the closest points of the LISN and the EUT. All other units of the EUT and associated equipment shall be at least 0.8 m from the LISN.

Ground connections, where required for safety purposes, shall be connected to the reference ground point of the LISN and, where not otherwise provided or specified by the manufacturer, shall be of same length as the mains cable and run parallel to the mains connection at a separation distance of not more than 0.1 m.

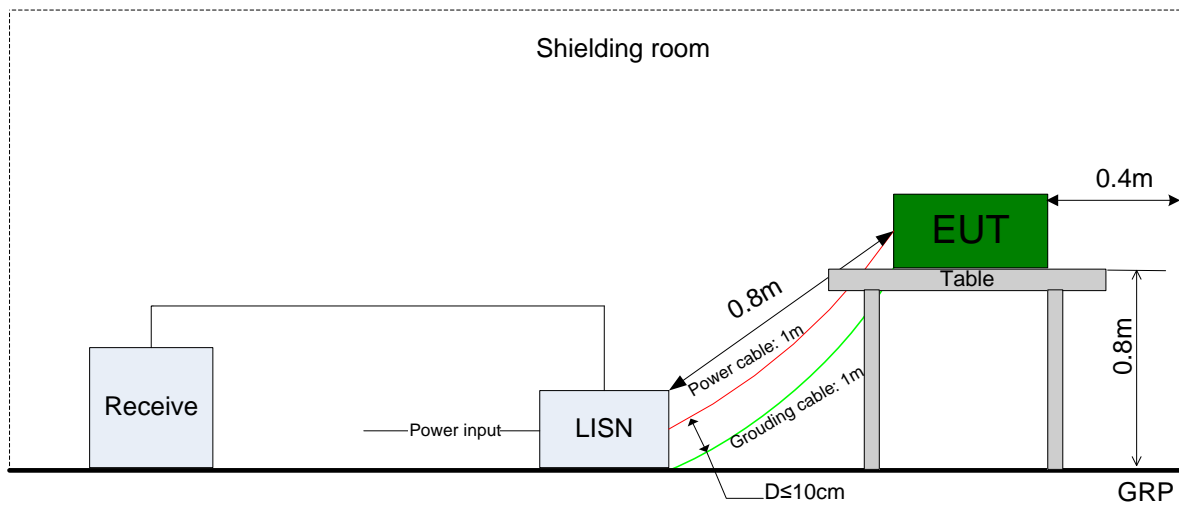

4.6 Test Conditions

Test Case	Test Conditions	
	Configuration	Description
20dB Emission Bandwidth (EBW)	Meas. Method	DA 00-705
	Test Env.	NTNV
	Test Setup	Test Setup 1
	EUT Conf.	TM1_DH5_Ch0, TM1_DH5_Ch39, TM1_DH5_Ch78, TM2_2DH5_Ch0, TM2_2DH5_Ch39, TM2_2DH5_Ch78, TM3_3DH5_Ch0, TM3_3DH5_Ch39, TM3_3DH5_Ch78.
Carrier Frequency Separation	Meas. Method	DA 00-705
	Test Env.	NTNV
	Test Setup	Test Setup 1
	EUT Conf.	TM1_DH5_Hop, TM2_2DH5_Hop, TM3_3DH5_Hop.
Number of Hopping Channel	Meas. Method	DA 00-705
	Test Env.	NTNV
	Test Setup	Test Setup 1
	EUT Conf.	TM1_DH5_Hop, TM2_2DH5_Hop, TM3_3DH5_Hop.
Time of Occupancy (Dwell Time)	Meas. Method	DA 00-705
	Test Env.	NTNV
	Test Setup	Test Setup 1
	EUT Conf.	TM1_DH5_Ch39, TM2_2DH5_Ch39, TM3_3DH5_Ch39.
Maximum Peak Conducted Output Power	Meas. Method	DA 00-705
	Test Env.	NTNV
	Test Setup	Test Setup 1
	EUT Conf.	TM1_DH5_Ch0, TM1_DH5_Ch39, TM1_DH5_Ch78, TM2_2DH5_Ch0, TM2_2DH5_Ch39, TM2_2DH5_Ch78, TM3_3DH5_Ch0, TM3_3DH5_Ch39, TM3_3DH5_Ch78.
Band edge spurious emission	Meas. Method	DA 00-705
	Test Env.	NTNV
	Test Setup	Test Setup 1
	EUT Conf.	TM1_DH5_Ch0, TM1_DH5_Ch78, TM2_2DH5_Ch0, TM2_2DH5_Ch78, TM3_3DH5_Ch0, TM3_3DH5_Ch78.
Conducted RF Spurious Emission	Meas. Method	DA 00-705
	Test Env.	NTNV



Test Case	Test Conditions		
	Configuration	Description	
	Test Setup	Test Setup 1	
	EUT Conf.	TM1_DH5_Ch0, TM1_DH5_Ch39, TM1_DH5_Ch78, TM2_2DH5_Ch0, TM2_2DH5_Ch39, TM2_2DH5_Ch78, TM3_3DH5_Ch0, TM3_3DH5_Ch39, TM3_3DH5_Ch78.	
Radiated Emissions in the Restricted Bands	Meas. Method	DA 00-705, C63.4, C63.10. (1) 30 MHz to 1 GHz: Pre: RBW = 100 kHz; VBW = 300 kHz; Det. = Peak. Final: RBW = 120 kHz; Det. = CISPR Quasi-Peak. (2) 1 GHz to 26.5 GHz: Average: RBW = 1 MHz; VBW = 10 Hz; Det. = Peak; Sweep-time = Auto; Trace = Single. Peak: RBW = 1 MHz; VBW = 3 MHz; Det. = Peak; Sweep-time = Auto; Trace ≥ Max Hold * 100.	
	Test Env.	NTNV	
	Test Setup	Test Setup 2	
	EUT Conf.	30 MHz -1 GHz	TM1_DH5_Ch0 (Worst Conf.).
		1-3 GHz	TM1_DH5_Ch0, TM1_DH5_Ch39, TM1_DH5_Ch78, TM2_2DH5_Ch0, TM2_2DH5_Ch39, TM2_2DH5_Ch78, TM3_3DH5_Ch0, TM3_3DH5_Ch39, TM3_3DH5_Ch78.
		3-18 GHz	TM1_DH5_Ch0 (Worse Conf.), TM1_DH5_Ch39 (Worse Conf.), TM1_DH5_Ch78 (Worse Conf.).
18-26.5 GHz		TM1_DH5_Ch0 (Worst Conf.).	
AC Power Line Conducted Emissions	Meas. Method	AC mains conducted. Pre: RBW = 10 kHz; Det. = Peak. Final: RBW = 9 kHz; Det. = CISPR Quasi-Peak & Average.	
	Test Env.	NTNV	
	Test Setup	Test Setup 3	
	EUT Conf.	TM1_DH5_Ch39.	

**5 Main Test Instruments**

Equipment Name	Manufacturer	Model	Serial Number	Cal Date	Cal- Due
Power supply	KEITHLEY	2303	1288003	2012-11-19	2014-11-18
Wireless Communication Test set	Agilent	N4010A	MY49081592	2013-10-29	2014-10-28
Universal Radio Communication Tester	R&S	CMU200	113164	2013-07-18	2014-07-17
Universal Radio Communication Tester	R & S	CMW500	126855	2013-08-08	2015-08-09
Spectrum Analyzer	Agilent	E4440A	MY48250119	2013-08-09	2014-08-08
Signal Analyzer	R&S	FSQ31	200021	2013-10-29	2014-10-28
Spectrum Analyzer	Agilent	N9030A	MY49431698	2013-10-29	2014-10-28
Temperature Chamber	ESPEC	MW3030	06114003	2013-05-14	2014-05-13
Signal generator	Agilent	E8257D	MY51500314	2013-04-15	2014-04-14
Vector Signal Generator	R&S	SMU200A	104162	2013-10-29	2014-10-28
Test receiver	R&S	ESU26	100150	2013-05-15	2014-05-14
Spectrum analyzer	R&S	FSU3	200474	2013-12-24	2014-12-23
Spectrum analyzer	R&S	FSU43	100144	2013-12-24	2014-12-23
Double-Ridged Waveguide Horn Antenna (1G~18GHz)	R&S	HF907	100304	2013-02-02	2015-02-01
Trilog Broadband Antenna (30M~3GHz)	SCHWARZ BECK	VULB 9163	9163-490	2013-02-02	2015-02-01
LOOP Antennas(9kHz-30MHz)	R&S	HFH2-Z2	100262	2013-03-23	2015-03-22
Pyramidal Horn Antenna(18GHz-26.5 GHz)	ETS-LIND GREN	3160-09	5140299	2013-03-05	2015-03-04
Artificial Mains Network	R&S	ENV4200	100134	2013-12-24	2014-12-23
Artificial Mains Network	R&S	ENV216	100382	2013-12-24	2014-12-23

END