



# FCC

# RF Test Report

**Product Name: LTE/UMTS Smart Phone; HUAWEI Ascend G6**

**Model Number: HUAWEI G6-L22, G6-L22**

**Report No: SYBH(Z-RF)008022014-2001**

**FCC ID: QISG6-L22**

**Reliability Laboratory of Huawei Technologies Co., Ltd.**

Administration Building, Headquarters of Huawei Technologies Co., Ltd., Bantian, Longgang District,  
Shenzhen, 518129, P.R.C

Tel: +86 755 28780808

Fax: +86 755 89652518



## Notice

1. The laboratory has Passed the accreditation by China National Accreditation Service for Conformity Assessment (CNAS). The accreditation number is L0310.
2. The laboratory has Passed the accreditation by The American Association for Laboratory Accreditation (A2LA). The accreditation number is 2174.01.
3. The laboratory has been listed by the US Federal Communications Commission to perform electromagnetic emission measurements. The site recognition number is 97456.
4. The laboratory has been listed by Industry Canada to perform electromagnetic emission measurements. The recognition numbers of test site are 6369A-2.
5. The test report is invalid if not marked with the signatures of the persons responsible for preparing and approving the test report.
6. The test report is invalid if there is any evidence of erasure and/or falsification.
7. The test report is only valid for the test samples.
8. Content of the test report, in part or in full, cannot be used for publicity and/or promotional purposes without prior written approval from the laboratory.



**Applicant:** Huawei Technologies Co., Ltd.  
**Address:** Administration Building, Headquarters of Huawei Technologies Co., Ltd.,  
Bantian, Longgang District, Shenzhen, 518129, P.R.C

**Date of Receipt Sample:** 2014-02-05  
**Start Date of Test:** 2014-02-14  
**End Date of Test:** 2014-02-22

**Test Result:** Pass

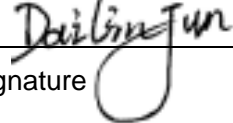
<b>Approved by Senior Engineer:</b>	2014-02-24	Dai Linjun	
	Date	Name	

<b>Prepared by:</b>	2014-02-24	Hexiaolin	
	Date	Name	



### Modification Record

No.	Last Report No.	Modification Description
1		First report.



**CONTENT**

1 General Information.....6

1.1 Applied Standard.....6

1.2 Test Location .....6

1.3 Test Environment Condition.....6

2 Test Summary .....7

2.1 Cellular Band (824-849 MHz paired with 869-894 MHz) .....7

2.2 PCS Band (1850-1915 MHz paired with 1930-1995 MHz).....8

3 Description of the Equipment under Test (EUT)..... 11

3.1 General Description ..... 11

The differences among G6-L11, G6-L22, and G6-L33 are showed in the following table. Other parts of the mobile phone are the same, including the appearance, the antenna, Chipset, Bluetooth mode, Wifi mode, Adapter, Battery, Mainboard and so on. .... 11

3.2 EUT Identity ..... 12

3.3 Technical Specification ..... 14

4 General Test Conditions / Configurations..... 15

4.1 Test Modes ..... 15

4.2 Test Environment..... 15

4.3 Test Frequency..... 16

4.4 DESCRIPTION OF TESTS..... 18

4.5 Test Setups.....21

4.6 Test Conditions .....23

5 Main Test Instruments .....25

6 Measurement Uncertainty.....26





## 2 Test Summary

### 2.1 Cellular Band (824-849 MHz paired with 869-894 MHz)(GSM)

Test Item	FCC Rule No.	Requirements	Test Result	Verdict
Effective (Isotropic) Radiated Power Output Data	§2.1046, §22.913	FCC: ERP ≤ 7 W.	Appendix A	SYBH(Z-RF)01201 2014-200 1
Modulation Characteristics	§2.1047	Digital modulation	Appendix C	SYBH(Z-RF)01201 2014-200 1
Bandwidth	§2.1049	OBW: No limit. EBW: No limit.	Appendix D	SYBH(Z-RF)01201 2014-200 1
Band Edges Compliance	§2.1051, §22.917	≤ -13 dBm/1%*EBW, in 1 MHz bands immediately outside and adjacent to the frequency block.	Appendix E	SYBH(Z-RF)01201 2014-200 1
Spurious Emission at Antenna Terminals	§2.1051, §22.917	FCC: ≤ -13 dBm/100 kHz, from 9 kHz to 10 <sup>th</sup> harmonics but outside authorized operating frequency ranges.	Appendix F	SYBH(Z-RF)01201 2014-200 1
Field Strength of Spurious Radiation	§2.1053, §22.917	FCC: ≤ -13 dBm/100 kHz.	Appendix G	SYBH(Z-RF)01201 2014-200 1
Frequency Stability	§2.1055, §22.355	≤ ±2.5ppm.	Appendix H	SYBH(Z-RF)01201 2014-200 1
NOTE 1: For the verdict, the "N/A" denotes "not applicable", the "N/T" denotes "not tested".				

## 2.2 Cellular Band (824-849 MHz paired with 869-894 MHz)(WCDMA)

Test Item	FCC Rule No.	Requirements	Test Result	Verdict
Effective (Isotropic) Radiated Power Output Data	§2.1046, §22.913	ERP ≤ 7 W.	Appendix A	SYBH(Z-RF)00902 2014-200 1
Modulation Characteristics	§2.1047	Digital modulation	Appendix C	SYBH(Z-RF)00902 2014-200 1
Bandwidth	§2.1049	OBW: No limit. EBW: No limit.	Appendix D	SYBH(Z-RF)00902 2014-200 1
Band Edges Compliance	§2.1051, §22.917	≤ -13 dBm/1%*EBW, in 1 MHz bands immediately outside and adjacent to the frequency block.	Appendix E	SYBH(Z-RF)00902 2014-200 1
Spurious Emission at Antenna Terminals	§2.1051, §22.917	≤ -13 dBm/100 kHz, from 9 kHz to 10 <sup>th</sup> harmonics but outside authorized operating frequency ranges.	Appendix F	SYBH(Z-RF)00902 2014-200 1
Field Strength of Spurious Radiation	§2.1053, §22.917	≤ -13 dBm/100 kHz.	Appendix G	SYBH(Z-RF)00902 2014-200 1
Frequency Stability	§2.1055, §22.355	≤ ±2.5ppm.	Appendix H	SYBH(Z-RF)00902 2014-200 1

## 2.3 PCS Band (1850-1915 MHz paired with 1930-1995 MHz)

Test Item	FCC Rule No.	Requirements	Test Result	Verdict
Effective (Isotropic) Radiated Power Output Data	§2.1046, §24.232	EIRP ≤ 2 W	Appendix A	SYBH(Z-RF)01201 2014-200 1
Peak-Average Ratio	§2.1046, §24.232	FCC: Limit ≤ 13 dB	Appendix B	SYBH(Z-RF)01201 2014-200





Test Item	FCC Rule No.	Requirements	Test Result	Verdict
				1
Modulation Characteristics	§2.1047	Digital modulation	Appendix C	SYBH(Z-RF)01201 2014-200 1
Bandwidth	§2.1049	OBW: No limit. EBW: No limit.	Appendix D	SYBH(Z-RF)01201 2014-200 1
Band Edges Compliance	§2.1051, §24.238	≤ -13 dBm/1%*EBW, in 1 MHz bands immediately outside and adjacent to the frequency block.	Appendix E	SYBH(Z-RF)01201 2014-200 1
Spurious Emission at Antenna Terminals	§2.1051, §24.238	≤ -13 dBm/1 MHz, from 9 kHz to 10 <sup>th</sup> harmonics but outside authorized operating frequency ranges.	Appendix F	SYBH(Z-RF)01201 2014-200 1
Field Strength of Spurious Radiation	§2.1053, §24.238	≤ -13 dBm/1 MHz.	Appendix G	SYBH(Z-RF)01201 2014-200 1
Frequency Stability	§2.1055, §24.235	FCC: within authorized frequency block.	Appendix H	SYBH(Z-RF)01201 2014-200 1
NOTE 1: For the verdict, the "N/A" denotes "not applicable", the "N/T" denotes "not tested".				

#### 2.4 BRS&EBS Band (2500-2570 MHz paired with 2620-2690 MHz)

Test Item	FCC Rule No.	Requirements	Test Result	Verdict (NOTE 2)
Effective (Isotropic) Radiated Power Output Data	§2.1046, §27.50(h)	EIRP ≤ 2W	Appendix A	SYBH(Z-RF)0120 12014-20 01
Modulation Characteristics	§2.1047	Digital modulation	Appendix C	SYBH(Z-RF)0120 12014-20 01
Bandwidth	§2.1049	OBW: No limit. EBW: No limit.	Appendix D	SYBH(Z-RF)0120 12014-20

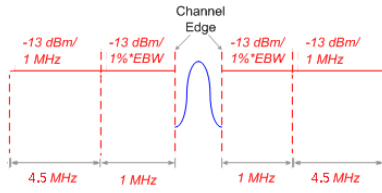
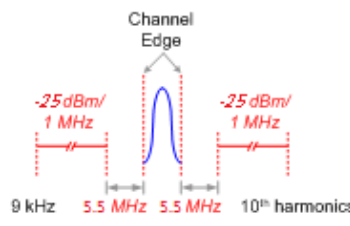
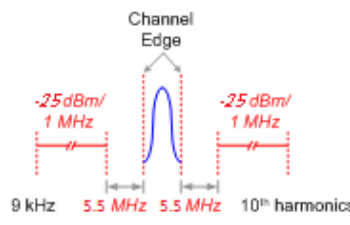
Test Item	FCC Rule No.	Requirements	Test Result	Verdict (NOTE 2)
				01
Band Edges Compliance	§2.1051, §27.53(m)	FCC: 	Appendix E	SYBH(Z-RF)0120 12014-20 01
Spurious Emission at Antenna Terminals	§2.1051, §27.53(m)		Appendix F	SYBH(Z-RF)0120 12014-20 01
Field Strength of Spurious Radiation	§2.1053, §27.53(m)		Appendix G	SYBH(Z-RF)0120 12014-20 01
Frequency Stability	§2.1055, §27.54	Within authorized bands of operation/frequency block.	Appendix H	SYBH(Z-RF)0120 12014-20 01

NOTE 2: For the verdict, the "N/A" denotes "not applicable", the "N/T" denotes "not tested".



### 3 Description of the Equipment under Test (EUT)

#### 3.1 General Description

HUAWEI G6-L22, G6-L22 is subscriber equipment in the LTE/WCDMA/GSM system. The HSPA/UMTS frequency band is Band I and Band V and Band VIII. The LTE frequency band is B3 and B7 and B1. The GSM/GPRS/EDGE frequency band includes GSM850 and GSM900 and DCS1800 and PCS1900, but only GSM850 and GSM1900MHz and WCDMA850 and LTE B7 bands test data included in this report. The Mobile Phone implements such functions as RF signal receiving/transmitting, LTE/HSPA/UMTS and GSM/GPRS/EDGE protocol processing, voice, video MMS service, GPS, AGPS, NFC and WIFI etc. Externally it provides micro SD card interface, earphone port (to provide voice service) and USIM card interface. It also provides Bluetooth module to synchronize data between a PC and the phone, or to use the built-in modem of the phone to access the Internet with a PC, or to exchange data with other Bluetooth devices.

The mobile phone G6-L11, G6-L22, and G6-L33 are LTE/UMTS mobile phone with Bluetooth. The differences among G6-L11, G6-L22, and G6-L33 are showed in the following table. Other parts of the mobile phone are the same, including the appearance, the antenna, Chipset, Bluetooth mode, Wifi mode, Adapter, Battery, Mainboard and so on.

	G6-L11	G6-L22	G6-L33
GSM four bands	the same	the same	the same
WCDMA bands	B1/B8	B1/B5/B8	B1/B2/B4/B5
LTE bands	B3/B7/B20	B1/B3/B7	B2/B4/B7
FCC bands	GSM850/1900 LTE B7	GSM850/1900 W850 LTE B7	GSM850/1900 W1900/AWS/W850 LTE B2 B4 B7
FLASH	the same	the same	the same
Mainboard	the same	the same	the same
PCB layout	the same	the same	the same
Appearance	the same	the same	the same
NFC	the same	the same	the same
Bluetooth mode	the same	the same	the same
WLAN mode	the same	the same	the same
BT/ WLAN antenna	the same	the same	the same
GSM/ WCDMA/LTE	the same	the same	the same



antenna			
External camera	800M	the same	the same
internal camera	100M	the same	the same
Adapter	the same	the same	the same
Battery	the same	the same	the same
Chipset	the same	the same	the same
Memory	the same	the same	the same
RF Parameter	The same RF Parameter in the same band	The same RF Parameter in the same band	The same RF Parameter in the same band
Dimension	the same	the same	the same
Main Frequency NV	The same NV in the same band	The same NV in the same band	The same NV in the same band

So the GSM850/1900 and LTE Band 7 test cases refer to No SYBH(Z-RF)012012014-2001 of G6-L11.the WCDMA 850 test cases refer to No SYBH(Z-RF)009022014-2001 of G6-L33.

### 3.2 EUT Identity

NOTE: Unless otherwise noted in the report, the functional boards installed in the units shall be selected from the below list, but not means all the functional boards listed below shall be installed in one unit.

#### 3.2.1 Board

Board		
Software Version	Hardware Version	Description
G6-L22V100R001C00B105	HL1G6L22M	Main Board

#### 3.2.2 Sub-Assembly



AC/DCAdapter Model	HW-050100U2W
Manufacturer	Huawei Technologies Co., Ltd.
Input Voltage	~100-240V 50/60Hz 0.2A
Output Voltage	5V  1A
Rated Power	5W



AC/DCAdapter Model	HW-050100E2W
Manufacturer	Huawei Technologies Co., Ltd.
Input Voltage	~100-240V 50/60Hz 0.2A
Output Voltage	5V  1A
Rated Power	5W

AC/DCAdapter Model	HW-050100B2W
Manufacturer	Huawei Technologies Co., Ltd.
Input Voltage	~100-240V 50/60Hz 0.2A
Output Voltage	5V  1A
Rated Power	5W

AC/DCAdapter Model	HW-050100A2W
Manufacturer	Huawei Technologies Co., Ltd.
Input Voltage	~100-240V 50/60Hz 0.2A
Output Voltage	5V  1A
Rated Power	5W

Name	Manufacture	Description
Rechargeable Li-ion	Huawei Technologies Co., Ltd.	Battery Model: HB3742A0EBC Rated capacity: 2000mAh Nominal Voltage:  +3.8V Charging Voltage:  +4.35V



### 3.3 Technical Specification

Characteristics	Description	
Radio System Type	<input checked="" type="checkbox"/> GSM <input checked="" type="checkbox"/> UMTS <input checked="" type="checkbox"/> LTE	
Supported Frequency Range	GSM850/ WCDMA850	Transmission (TX): 824 to 849 MHz
		Receiving (RX): 869 to 894 MHz
	GSM1900	Transmission (TX): 1850 to 1910 MHz
		Receiving (RX): 1930 to 1990 MHz
	LTE BAND7	Transmission (TX): 2500 to 2570 MHz
		Receiving (RX): 2620 to 2690 MHz
TX and RX Antenna Ports	TX & RX port:	1
	TX-only port:	0
	RX-only port:	1
Target TX Output Power	GSM850: 32.5 dBm GSM1900: 29.5 dBm UMTS850 23.5dBm LTE: 23 dBm	
Supported Channel Bandwidth	GSM system:	<input checked="" type="checkbox"/> 200 kHz
	UMTS system:	<input checked="" type="checkbox"/> 5 MHz
	LTE band 7	<input checked="" type="checkbox"/> 5 MHz, <input checked="" type="checkbox"/> 10 MHz, <input checked="" type="checkbox"/> 15 MHz, <input checked="" type="checkbox"/> 20 MHz
Designation of Emissions (Note: the necessary bandwidth of which is the worst value from the measured occupied bandwidths for each type of channel bandwidth configuration.)	GSM850:	248KGXW, 246KG7W
	GSM1900:	247KGXW, 251KG7W
	UMTS850:	4M17F9W
	LTE BAND7:	4M51G7D (5 MHz QPSK modulation), 4M50W7D (5 MHz 16QAM modulation) 8M98G7D (10 MHz QPSK modulation), 8M97W7D (10 MHz 16QAM modulation) 13M5G7D (15 MHz QPSK modulation), 13M5W7D (15 MHz 16QAM modulation) 18M0G7D (20 MHz QPSK modulation), 18M0W7D (20 MHz 16QAM modulation)



## 4 General Test Conditions / Configurations

### 4.1 Test Modes

NOTE: The test mode(s) are selected according to relevant radio technology specifications.

Test Mode	Test Modes Description
GSM/TM1	GSM system, GSM/GPRS, GMSK modulation
GSM/TM2	GSM system, EDGE, 8PSK modulation
UMTS/TM1	WCDMA system, QPSK modulation
UMTS/TM2	HSDPA system, QPSK modulation
UMTS/TM3	HSUPA system, QPSK modulation
LTE/TM1	LTE system, QPSK modulation
LTE/TM2	LTE system, 16QAM modulation

### 4.2 Test Environment

Environment Parameter	Selected Values During Tests	
Relative Humidity	Ambient	
Temperature	TN	Ambient
Voltage	VL	3.6V
	VN	3.8V
	VH	4.35V

NOTE: VL= lower extreme test voltage  
VN= nominal voltage  
VH= upper extreme test voltage  
TN= normal temperature

**4.3 Test Frequency**

Test Mode	TX / RX	RF Channel		
		Low (L)	Middle (M)	High (H)
GSM850	TX	Channel 128	Channel 190	Channel 251
		824.2MHz	836.6MHz	848.8MHz
	RX	Channel 128	Channel 190	Channel 251
		869.2MHz	881.6MHz	893.8MHz
Test Mode	TX / RX	RF Channel		
		Low (L)	Middle (M)	High (H)
WCDMA850	TX	Channel 4132	Channel 4182	Channel 4233
		826.4MHz	836.4MHz	846.6MHz
	RX	Channel 4357	Channel 4407	Channel 4458
		871.4MHz	881.4MHz	891.6MHz
Test Mode	TX / RX	RF Channel		
		Low (L)	Middle (M)	High (H)
GSM1900	TX	Channel 512	Channel 661	Channel 810
		1850.2MHz	1880.0MHz	1909.8MHz
	RX	Channel 512	Channel 661	Channel 810
		1930.2 MHz	1960.0 MHz	1989.8 MHz

Test Mode	TX / RX	RF Channel		
		Low (L)	Middle (M)	High (H)
LTE Band 7	TX (5M)	Channel 20775	Channel 21100	Channel 21425
		2502.5 MHz	2535 MHz	2567.5 MHz
	TX (10M)	Channel 20800	Channel 21100	Channel 21400





Test Mode	TX / RX	RF Channel		
		Low (L)	Middle (M)	High (H)
		2505 MHz	2535 MHz	2565 MHz
	TX (15M)	Channel 20825	Channel 21100	Channel 21375
		2507.5 MHz	2535 MHz	2562.5 MHz
	TX (20M)	Channel 20850	Channel 21100	Channel 21350
		2510 MHz	2535 MHz	2560 MHz
	RX (5M)	Channel 2775	Channel 3100	Channel 3425
		2622.5 MHz	2655 MHz	2687.5 MHz
	RX (10M)	Channel 2800	Channel 3100	Channel 3400
		2625 MHz	2655 MHz	2685 MHz
	RX (15M)	Channel 2825	Channel 3100	Channel 3375
		2627.5 MHz	2655 MHz	2682.5 MHz
	RX (20M)	Channel 2850	Channel 3100	Channel 3350
		2630 MHz	2655 MHz	2680 MHz

## 4.4 DESCRIPTION OF TESTS

### 4.4.1 Radiated Power and Radiated Spurious Emissions

Radiated spurious emissions are investigated indoors in a semi-anechoic chamber to determine the frequencies producing the worst case emissions. Final measurements for radiated power and radiated spurious emissions are performed on the 3 meter OATS per the guidelines of ANSI/TIA-603-C-2004. The equipment under test was transmitting while connected to its integral antenna and is placed on a wooden turntable 80cm above the ground plane and 3 meters from the receive antenna. The spectrum is scanned from the lowest frequency generated in the equipment up to a frequency including its 10th harmonic. The receive antenna height is adjusted between 1 and 4 meter height, the turntable is rotated through 360 degrees, and the EUT is manipulated through all orthogonal planes representative of its typical use to achieve the highest reading on the receive spectrum analyzer. Emissions are also investigated with the receive antenna horizontally and vertically polarized.

A portable or small unlicensed wireless device shall be placed on a non-metallic test fixture or other non-metallic support during testing. The supporting fixture shall permit orientation of the EUT in each of three orthogonal (x, y, z) axis positions such that emissions from the EUT are maximized. Measure the EUT maximum RF power and record the result.

A half-wave dipole is then substituted in place of the EUT. For emissions above 1GHz, a horn antenna is substituted in place of the EUT. The substitute antenna is driven by a signal generator with the level of the signal generator being adjusted to obtain the same receive spectrum analyzer level previously recorded from the spurious emission from the EUT. The power of the emission is calculated using the following formula:

$$P_d \text{ [dBm]} = P_g \text{ [dBm]} - \text{cable loss [dB]} + \text{antenna gain [dBd/dBi]}$$

Where,  $P_d$  is the dipole equivalent power,  $P_g$  is the generator output into the substitution antenna, and the antenna gain is the gain of the substitute antenna used relative to either a half-wave dipole (dBd) or an isotropic source (dBi). The substitute level is equal to  $P_g \text{ [dBm]} - \text{cable loss [dB]}$ .

The calculated  $P_d$  levels are then compared to the absolute spurious emission limit of -13dBm which is equivalent to the required minimum attenuation of  $43 + 10\log_{10}(\text{Power [Watts]})$ .

Note: Reference test setup 3

#### 4.4.2 Occupied Bandwidth

The occupied bandwidth, that is the frequency bandwidth such that, below its lower and above its upper frequency limits, the mean powers radiated are each equal to 0.5 percent of the total mean power radiated by a given emission shall be measured. The span of the analyzer shall be set to capture all products of the modulation process, including the emission skirts. The resolution bandwidth shall be set to as close to 1 percent of the selected span as is possible without being below 1 percent. The video bandwidth shall be set to 3 times the resolution bandwidth. Video averaging is not permitted. Where practical, a sampling detector shall be used since a peak or, peak hold, may produce a wider bandwidth than actual. The trace data points are recovered and are directly summed in linear terms. The recovered amplitude data points, beginning at the lowest frequency, are placed in a running sum until 0.5 percent of the total is reached and that frequency recorded. The process is repeated for the highest frequency data points. This frequency is recorded. The span between the two recorded frequencies is the occupied bandwidth.

Note: Reference test setup 1.

#### 4.4.3 Spurious and Harmonic Emissions at Antenna Terminal

The level of the carrier and the various conducted spurious and harmonic frequencies is measured by means of a calibrated spectrum analyzer. The spectrum is scanned from the lowest frequency generated in the equipment up to a frequency including its 10<sup>th</sup> harmonic. On any frequency outside a licensee's frequency block, the power of any emission shall be attenuated below the transmitter power (P) by at least  $43 + 10 \log(P)$  dB. Compliance with these provisions is based on the use of measurement instrumentation employing a resolution bandwidth of 1 MHz or greater. However, in the 1 MHz bands immediately outside and adjacent to the frequency block a resolution bandwidth of at least one percent of the emission bandwidth of the fundamental emission of the transmitter may be employed. The emission bandwidth is defined as the width of the signal between two points, one below the carrier center frequency and one above the carrier center frequency, outside of which all emission are attenuated at least 26 dB below the transmitter power.

Note: Reference test setup 1.

#### 4.4.4 Peak-Average Ratio

A peak to average ratio measurement is performed at the conducted port of the EUT. For WCDMA signals, the spectrum analyzers Complementary Cumulative Distribution Function (CCDF) measurement profile is used to determine the largest deviation between the average and the peak power of the EUT in a given bandwidth. The CCDF curve shows how much time the peak waveform spends at or above a given average power level. The percent of time the signal spends at or above the level defines the probability for that particular power level. For GSM signals, an average and a peak trace are used on a spectrum analyzer to determine the largest deviation between the average and the peak power of the EUT in a bandwidth greater than the emission bandwidth. The traces are generated with the spectrum analyzer set to zero span mode.

Note: Reference test setup 1.



#### 4.4.5 Frequency Stability / Temperature Variation

Frequency stability testing is performed in accordance with the guidelines of ANSI/TIA-603-C-2004. The frequency stability of the transmitter is measured by:

- a.) **Temperature:** The temperature is varied from -30°C to +50°C in 10°C increments using an environmental chamber.
- b.) **Primary Supply Voltage:** The primary supply voltage is varied from 85% to 115% of the nominal value for non hand-carried battery and AC powered equipment. For hand-carried, battery-powered equipment, primary supply voltage is reduced to the battery operating end point which shall be specified by the manufacturer.

Specification – The frequency stability shall be sufficient to ensure that the fundamental emission stays within the authorized frequency block. The frequency stability of the transmitter shall be maintained within  $\pm 0.00025\%$  ( $\pm 2.5$  ppm ) of the center frequency.

**Time Period and Procedure:**

1. The carrier frequency of the transmitter is measured at room temperature (20°C to provide a reference).
2. The equipment is turned on in a “standby” condition for fifteen minutes before applying power to the transmitter. Measurement of the carrier frequency of the transmitter is made within one minute after applying power to the transmitter.
3. Frequency measurements are made at 10°C intervals ranging from -30°C to +50°C. A period of at least one half-hour is provided to allow stabilization of the equipment at each temperature level.

Note: Reference test setup 2.

## 4.5 Test Setups

### 4.5.1 Test Setup 1

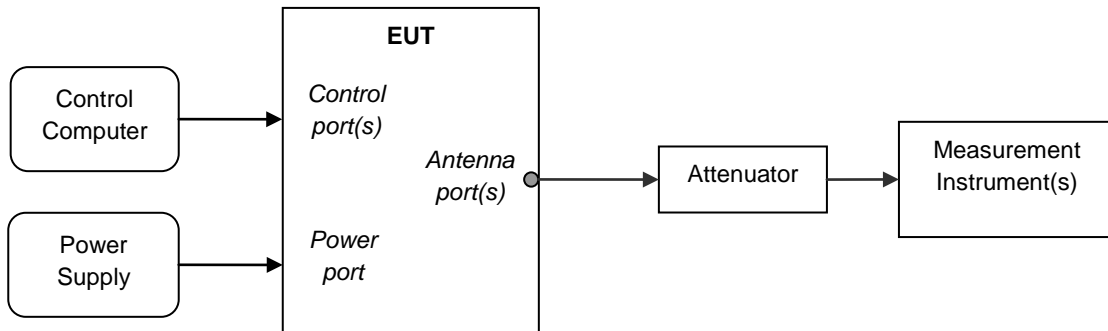

### 4.5.2 Test Setup 2

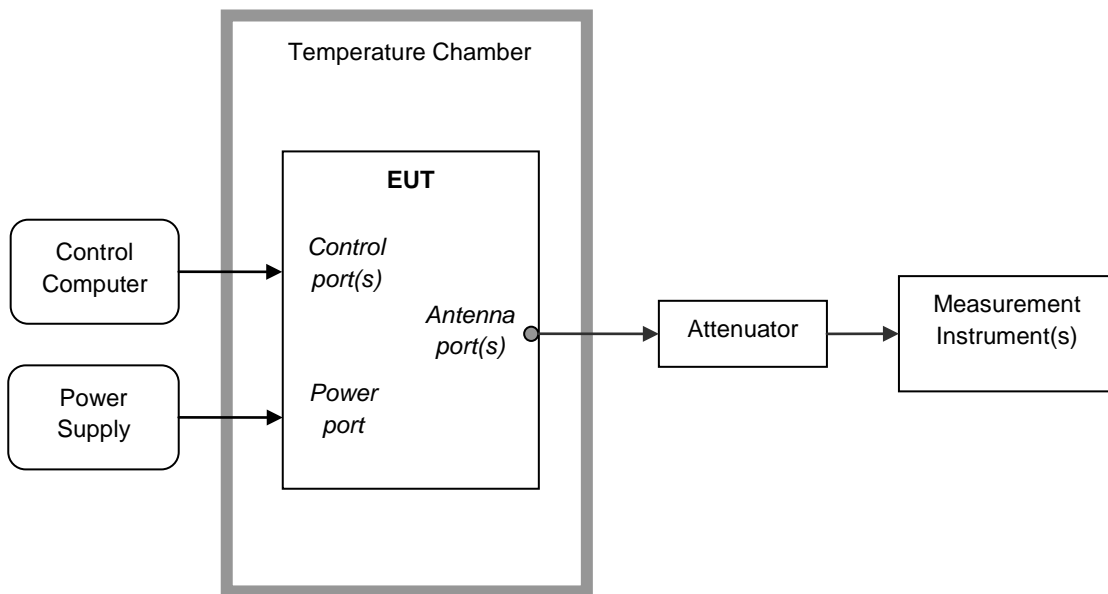

### 4.5.3 Test Setup 3

NOTE: Effective radiated power (ERP) refers to the radiation power output of the EUT, assuming all emissions are radiated from half-wave dipole antennas.

#### 4.5.3.1 Step 1: Pre-test

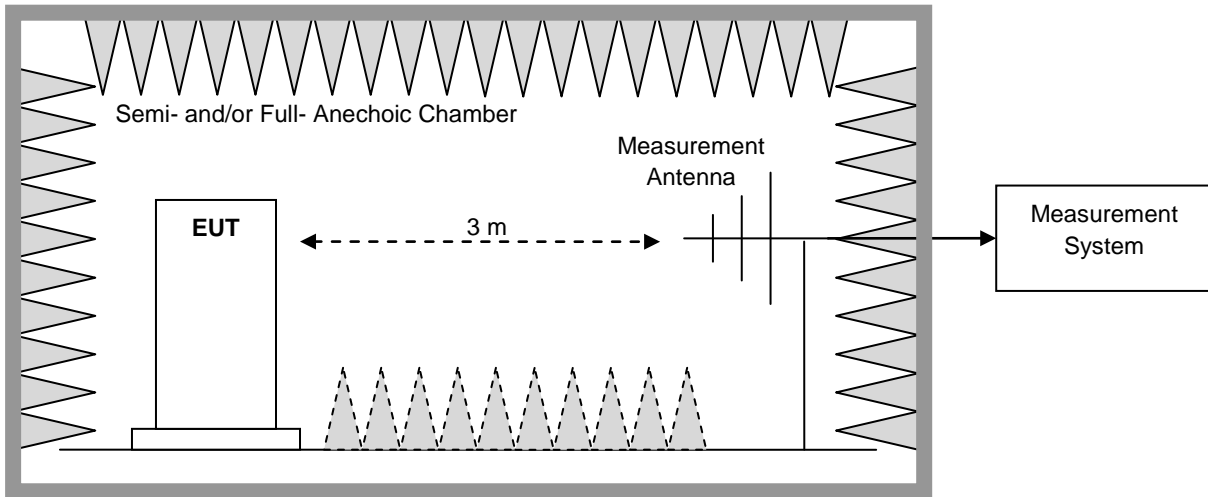

#### 4.5.3.2 Step 2: Substitution method to verify the maximum ERP

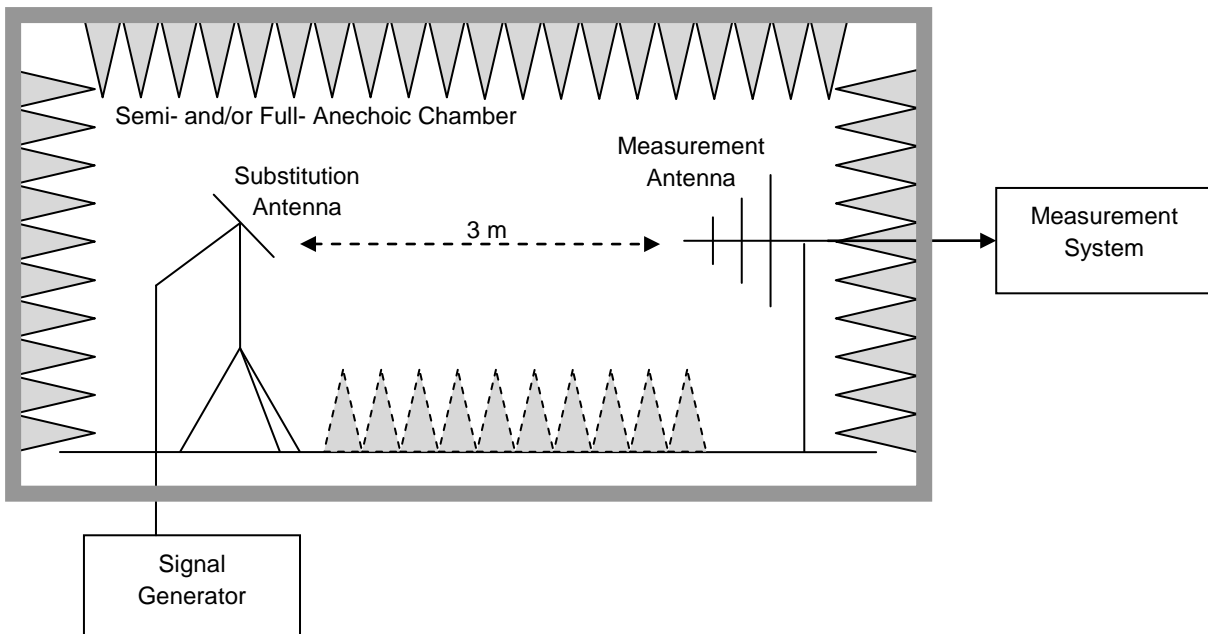

### 4.6 Test Conditions

Test Case		Test Conditions	
Transmit Output Power Data	Average Power, Total	Test Env.	Ambient Climate & Rated Voltage
		Test Setup	Test Seup 1
		RF Channels (TX)	L, M, H (L= low channel, M= middle channel, H= high channel )
		Test Mode	GSM/TM1,GSM/TM2, UMTS/TM1,LTE/TM1,LTE/TM2
	Average Power, Spectral Density (if required)	Test Env.	Ambient Climate & Rated Voltage
		Test Setup	Test Seup 1
		RF Channels (TX)	L, M, H (L= low channel, M= middle channel, H= high channel )
		Test Mode	GSM/TM1,GSM/TM2, UMTS/TM1,LTE/TM1,LTE/TM2
Peak-to-Average Ratio (if required)		Test Env.	Ambient Climate & Rated Voltage
		Test Setup	Test Seup 1
		RF Channels (TX)	L, M, H (L= low channel, M= middle channel, H= high channel )
		Test Mode	GSM/TM1,GSM/TM2, UMTS/TM1,LTE/TM1,LTE/TM2
Modulation Characteristics		Test Env.	Ambient Climate & Rated Voltage
		Test Setup	Test Seup 1
		RF Channels (TX)	M (L= low channel, M= middle channel, H= high channel )
		Test Mode	GSM/TM1,GSM/TM2, UMTS/TM1,LTE/TM1,LTE/TM2
Bandwidth	Occupied Bandwidth	Test Env.	Ambient Climate & Rated Voltage
		Test Setup	Test Seup 1
		RF Channels (TX)	L, M, H (L= low channel, M= middle channel, H= high channel )
		Test Mode	GSM/TM1,GSM/TM2, UMTS/TM1,LTE/TM1,LTE/TM2
	Emission Bandwidth (if required)	Test Env.	Ambient Climate & Rated Voltage
		Test Setup	Test Seup 1
		RF Channels (TX)	L, M, H (L= low channel, M= middle channel, H= high channel )
		Test Mode	GSM/TM1,GSM/TM2,UMTS/TM1
Band Edges Compliance		Test Env.	Ambient Climate & Rated Voltage
		Test Setup	Test Seup 1
		RF Channels (TX)	L, H (L= low channel, M= middle channel, H= high channel )
		Test Mode	GSM/TM1,GSM/TM2, UMTS/TM1,LTE/TM1,LTE/TM2
Spurious Emission at Antenna Terminals		Test Env.	Ambient Climate & Rated Voltage
		Test Setup	Test Seup 1
		RF Channels (TX)	L, M, H (L= low channel, M= middle channel, H= high channel )



Test Case	Test Conditions	
	Test Mode	GSM/TM1,GSM/TM2, UMTS/TM1,LTE/TM1,LTE/TM2
Field Strength of Spurious Radiation	Test Env.	Ambient Climate & Rated Voltage
	Test Setup	Test Seup 3
	Test Mode	GSM/TM1,GSM/TM2 UMTS/TM1,,LTE/TM1,LTE/TM2
	RF Channels (TX)	L, M, H (L= low channel, M= middle channel, H= high channel )
Frequency Stability	Test Env.	(1) -30 °C to +50 °C with step 10 °C at Rated Voltage; (2) VL, VN and VH of Rated Voltage at Ambient Climate.
	Test Setup	Test Seup 2
	RF Channels (TX)	L, M, H (L= low channel, M= middle channel, H= high channel )
	Test Mode	GSM/TM1,GSM/TM2 ,UMTS/TM1,LTE/TM1,LTE/TM2





## 5 Main Test Instruments

Equipment Name	Manufacturer	Model	Serial Number	Cal Date	Cal- Due
Power supply	KEITHLEY	2303	1288003	2012-11-19	2014-11-18
Wireless Communication Test set	Agilent	N4010A	MY49081592	2013-10-29	2014-10-28
Universal Radio Communication Tester	R&S	CMU200	113164	2013-07-18	2014-07-17
Universal Radio Communication Tester	R & S	CMW500	126855	2013-08-08	2015-08-09
Spectrum Analyzer	Agilent	E4440A	MY48250119	2013-08-09	2014-08-08
Signal Analyzer	R&S	FSQ31	200021	2013-10-29	2014-10-28
Spectrum Analyzer	Agilent	N9030A	MY49431698	2013-10-29	2014-10-28
Temperature Chamber	ESPEC	MW3030	06114003	2013-05-14	2014-05-13
Signal generator	Agilent	E8257D	MY51500314	2013-04-15	2014-04-14
Vector Signal Generator	R&S	SMU200A	104162	2013-10-29	2014-10-28
Test receiver	R&S	ESU26	100150	2013-05-15	2014-05-14
Spectrum analyzer	R&S	FSU3	200474	2013-12-24	2014-12-23
Spectrum analyzer	R&S	FSU43	100144	2013-12-24	2014-12-23
Double-Ridged Waveguide Horn Antenna (1G~18GHz)	R&S	HF907	100304	2013-02-02	2015-02-01
Trilog Broadband Antenna (30M~3GHz)	SCHWARZBECK	VULB 9163	9163-490	2013-02-02	2015-02-01
LOOP Antennas(9kHz-30MHz)	R&S	HFH2-Z2	100262	2013-03-23	2015-03-22
Pyramidal Horn Antenna(18GHz-26-5GHz)	ETS-LINDGREN	3160-09	5140299	2013-03-05	2015-03-04
Artificial Mains Network	R&S	ENV4200	100134	2013-12-24	2014-12-23
Artificial Mains Network	R&S	ENV216	100382	2013-12-24	2014-12-23



## 6 Measurement Uncertainty

For a 95% confidence level ( $k = 2$ ), the measurement expanded uncertainties for defined systems, in accordance with the recommendations of ISO 17025 as following:

Test Item		Extended Uncertainty
Transmit Output Power Data	Power [dBm]	U = 0.39 dB
Bandwidth	Magnitude [%]	U = 0.2%
Band Edge Compliance	Disturbance Power [dBm]	U = 2.0 dB
Spurious Emissions, Conducted	Disturbance Power [dBm]	U = 2.0 dB
Field Strength of Spurious Radiation	ERP [dBm]	For 3 m Chamber: U = 4.6 dB (30 MHz to 1GHz) U = 3.0 dB (above 1 GHz) For 10 m Chamber: U = 4.6 dB (30 MHz to 1GHz) U = 3.0 dB (above 1 GHz)
Frequency Stability	Frequency Accuracy [ppm]	U = 0.21 ppm

END