



中国认可  
国际互认  
检测  
TESTING  
CNAS L0310



## FCC SAR Compliance Test Report

**Product Name:** Smart Phone

**Model:** FRD-L24

**Report No.:** SYBH(Z-SAR)20171223016001-2

**FCC ID:** QISFRD-L24

	APPROVED (Lab Manager)	PREPARED (Test Engineer)
BY	<i>Wei Huanbin</i>	<i>Deng Zhao</i>
DATE	2018-03-06	2018-03-06

**Reliability Laboratory of Huawei Technologies Co., Ltd.**

**(Global Compliance and Testing Center of Huawei Technologies Co., Ltd)**

Administration Building, Headquarters of Huawei Technologies Co., Ltd., Bantian, Longgang District,  
Shenzhen, 518129, P.R.C

Tel: +86 755 28780808 Fax: +86 755 89652518

※ ※ **Notice** ※ ※

1. The laboratory has passed the accreditation by China National Accreditation Service for Conformity Assessment (CNAS). The accreditation number is L0310.
2. The laboratory has passed the accreditation by The American Association for Laboratory Accreditation (A2LA). The accreditation number is 2174.01 & 2174.02 & 2174.03
3. The laboratory (Reliability Lab of Huawei Technologies Co., Ltd) is also named “Global Compliance and Testing Center of Huawei Technologies Co., Ltd”, the both names have coexisted since 2009.
4. The test report is invalid if not marked with the signatures of the persons responsible for preparing and approving the test report.
5. The test report is invalid if there is any evidence of erasure and/or falsification.
6. The test report is only valid for the test samples.
7. Content of the test report, in part or in full, cannot be used for publicity and/or promotional purposes without prior written approval from the laboratory.

## Table of Contents

1	General Information.....	6
1.1	Statement of Compliance .....	6
1.2	RF exposure limits .....	7
1.3	EUT Description.....	8
1.3.1	General Description .....	10
1.3.2	Power reduction specification .....	12
1.3.3	Downlink LTE CA specification .....	12
1.4	Test specification(s) .....	16
1.5	Testing laboratory .....	16
1.6	Applicant and Manufacturer .....	16
1.7	Application details .....	16
1.8	Ambient Condition.....	16
2	SAR Measurement System .....	17
2.1	SAR Measurement Set-up.....	17
2.2	Test environment .....	18
2.3	Data Acquisition Electronics description.....	18
2.4	Probe description .....	19
2.5	Phantom description .....	20
2.6	Device holder description .....	21
2.7	Test Equipment List .....	22
3	SAR Measurement Procedure .....	23
3.1	Scanning procedure.....	23
3.2	Spatial Peak SAR Evaluation .....	24
3.3	Data Storage and Evaluation.....	25
4	System Verification Procedure .....	27
4.1	Tissue Verification.....	27
4.2	System Check.....	30
4.3	System check Procedure .....	31
5	SAR measurement variability and uncertainty .....	32
5.1	SAR measurement variability .....	32
5.2	SAR measurement uncertainty .....	32
6	SAR Test Configuration.....	33
6.1	Test Positions Configuration .....	33
6.1.1	General considerations .....	33
6.1.2	Head Exposure Condition .....	33
6.1.3	Body-worn Exposure Condition .....	34
6.1.4	Hotspot Exposure Condition .....	34
6.2	3G SAR Test Reduction Procedure.....	35
6.3	GSM Test Configuration .....	35
6.4	UMTS Test Configuration .....	35
6.5	LTE Test Configuration .....	41
6.6	WiFi Test Configuration .....	43
6.6.1	Initial Test Position Procedure .....	43
6.6.2	Initial Test Configuration Procedure .....	43
6.6.3	Sub Test Configuration Procedure .....	43
6.6.4	WiFi 2.4G SAR Test Procedures .....	44
6.6.5	WiFi 5G SAR Test Procedures .....	45
7	SAR Measurement Results .....	47
7.1	Conducted power measurements.....	47
7.1.1	Conducted power measurements of GSM850 (Main Antenna).....	48
7.1.2	Conducted power measurements of GSM1900 (Main Antenna).....	49
7.1.3	Conducted power measurements of UMTS Band 2 (Main Antenna) .....	50
7.1.4	Conducted power measurements of UMTS Band 4 (Main Antenna) .....	52
7.1.5	Conducted power measurements of UMTS Band 5 (Main Antenna) .....	54
7.1.6	Conducted power measurements of LTE Band 2 (Main Antenna) .....	55
7.1.7	Conducted power measurements of LTE Band 4 (Main Antenna).....	64
7.1.8	Conducted power measurements of LTE Band 5 (Main Antenna).....	73
7.1.9	Conducted power measurements of LTE Band 7 (Main Antenna).....	75
7.1.10	Conducted power measurements of LTE Band 12 (Main Antenna).....	79

---

7.1.11	Conducted power measurements of LTE Band 17 (Main Antenna)	81
7.1.12	Conducted power measurements of Downlink LTE CA	82
7.1.13	Conducted power measurements of WiFi 2.4G	84
7.1.14	Conducted power measurements of WiFi 5G	85
7.1.15	Conducted power measurements of BT	93
7.2	SAR measurement Results	94
7.2.1	SAR measurement Result of GSM850 (Main Antenna)	96
7.2.2	SAR measurement Result of GSM1900 (Main Antenna)	98
7.2.3	SAR measurement Result of UMTS Band 2 (Main Antenna)	100
7.2.4	SAR measurement Result of UMTS Band 4 (Main Antenna)	102
7.2.5	SAR measurement Result of UMTS Band 5 (Main Antenna)	104
7.2.6	SAR measurement Result of LTE Band 2 (Main Antenna)	106
7.2.7	SAR measurement Result of LTE Band 4 (Main Antenna)	110
7.2.8	SAR measurement Result of LTE Band 5 (Main Antenna)	113
7.2.9	SAR measurement Result of LTE Band 7 (Main Antenna)	116
7.2.10	SAR measurement Result of LTE Band 12 (Main Antenna)	119
7.2.11	SAR measurement Result of LTE Band 17 (Main Antenna)	122
7.2.12	SAR measurement Result of WiFi 2.4G	125
7.2.13	SAR measurement Result of WiFi 5G	128
7.3	Multiple Transmitter Evaluation	133
7.3.1	Stand-alone SAR test exclusion	134
7.3.2	Simultaneous Transmission Possibilities	135
7.3.3	SAR Summation Scenario	136
7.3.4	SPLSR Evaluation Analysis	137
7.3.5	Simultaneous Transmission Conclusion	139
	Appendix A. System Check Plots	140
	Appendix B. SAR Measurement Plots	140
	Appendix C. Calibration Certificate	140
	Appendix D. Photo documentation	140

※ ※ **Modified History** ※ ※

REV.	DESCRIPTION	ISSUED DATE	REMARK
Rev.1.0	Initial Test Report Release	2018-02-27	Deng Zhao
Rev.1.1	Update the difference description between FRD-L04 and FRD-L24	2018-03-06	Deng Zhao

# 1 General Information

## 1.1 Statement of Compliance

The maximum results of Specific Absorption Rate (SAR) found during testing for FRD-L24 are as below Table 1.

Band	Max Reported SAR(W/kg)		
	1-g Head	1-g Body-worn (15mm) *	1-g Hotspot (10mm)
<b>GSM850</b>	0.37	0.47	0.55
<b>GSM1900</b>	0.21	0.57	<b>1.38</b>
<b>UMTS Band 2</b>	0.51	1.12	1.12
<b>UMTS Band 4</b>	0.51	1.06	1.32
<b>UMTS Band 5</b>	0.42	0.46	0.64
<b>LTE Band 2</b>	0.68	<b>1.19</b>	1.35
<b>LTE Band 4</b>	0.50	0.52	1.07
<b>LTE Band 5</b>	0.39	0.41	0.52
<b>LTE Band 7</b>	0.11	0.45	0.83
<b>LTE Band 12</b>	0.26	0.38	0.53
<b>LTE Band 17</b>	0.30	0.41	0.45
<b>WiFi 2.4G</b>	1.02	0.12	0.27
<b>WiFi 5G</b>	<b>1.07</b>	0.28	0.17
<b>The highest SAR for head, body-worn, hotspot and simultaneous transmission exposure conditions are 1.07W/kg, 1.19W/kg, 1.38W/kg and 1.58W/kg. per KDB690783 D01.</b>			

Table 1: Summary of test result

Note:

For body worn operation, this device has been tested and meets FCC RF exposure guidelines when used with any accessory that contains no metal and that positions the handset a minimum of 15mm from the body. Use of other accessories may not ensure compliance with FCC RF exposure guidelines.

The device is in compliance with Specific Absorption Rate (SAR) for general population/uncontrolled exposure limits according to the FCC rule §2.1093, the ANSI C95.1:1992/IEEE C95.1:1991, the NCRP Report Number 86 for uncontrolled environment, according to the Industry Canada Radio Standards Specification RSS-102 for General Population/Uncontrolled exposure, and had been tested in accordance with the measurement methods and procedures specified in IEEE Std 1528-2013.

## 1.2 RF exposure limits

Human Exposure	Uncontrolled Environment General Population	Controlled Environment Occupational
<b>Spatial Peak SAR*</b> (Brain/Body/Arms/Legs)	<b>1.60 W/kg</b>	8.00 W/kg
<b>Spatial Average SAR**</b> (Whole Body)	0.08 W/kg	0.40 W/kg
<b>Spatial Peak SAR***</b> (Hands/Feet/Ankle/Wrist)	4.00 W/kg	20.00 W/kg

Table 2: RF exposure limits

The limit applied in this test report is shown in **bold** letters

Notes:

- \* The Spatial Peak value of the SAR averaged over any 1 gram of tissue (defined as a tissue volume in the shape of a cube) and over the appropriate averaging time.
- \*\* The Spatial Average value of the SAR averaged over the whole body.
- \*\*\* The Spatial Peak value of the SAR averaged over any 10 grams of tissue (defined as a tissue volume in the shape of a cube) and over the appropriate averaging time.

**Uncontrolled Environments** are defined as locations where there is the exposure of individuals who have no knowledge or control of their exposure.

**Controlled Environments** are defined as locations where there is exposure that may be incurred by persons who are aware of the potential for exposure, (i.e. as a result of employment or occupation).

### 1.3 EUT Description

Device Information:			
Product Name:	Smart Phone		
Model:	FRD-L24		
FCC ID :	QISFRD-L24		
IMEI:	1#:868352030001214 2#:868352030000281 3#:868352030001974		
Device Type :	Portable device		
Device Phase:	Identical Prototype		
Exposure Category:	Uncontrolled environment / general population		
Hardware Version :	HL1FRDL04M		
Software Version :	FRD-L24C567B100		
Antenna Type :	Internal antenna		
Others Accessories	Headset		
Device Operating Configurations:			
Supporting Mode(s)	GSM850/1900, UMTS Band 2/4/5, LTE Band 2/4/5/7/12/17, WiFi 2.4G/5G,BT		
Test Modulation	GSM(GMSK/8PSK),UMTS(QPSK), LTE(QPSK/16QAM), WiFi(DSSS/OFDM),BT(GFSK)		
Device Class	B		
Operating Frequency Range(s)	Band	Tx (MHz)	Rx (MHz)
	GSM850	824-849	869-894
	GSM1900	1850-1910	1930-1990
	UMTS Band 2	1850-1910	1930-1990
	UMTS Band 4	1710-1755	2110-2155
	UMTS Band 5	824-849	869-894
	LTE Band 2	1850-1910	1930-1990
	LTE Band 4	1710-1755	2110-2155
	LTE Band 5	824-849	869-894
	LTE Band 7	2500-2570	2620-2690
	LTE Band 12	699-716	729-746
	LTE Band 17	704-716	734-746
	WiFi 5G	5150-5250 5250-5350 5470-5725 5725-5850	
	WiFi 2.4G	2412-2462	
BT	2402-2480		
GPRS Multislot Class(10)	Max Number of Timeslots in Uplink:	2	
	Max Number of Timeslots in Downlink:	4	
	Max Total Timeslot:	5	
EGPRS Multislot Class(10)	Max Number of Timeslots in Uplink:	2	
	Max Number of Timeslots in Downlink:	4	
	Max Total Timeslot:	5	
HSDPA UE Category	14		
HSUPA UE Category	6		
DC-HSDPA UE Category	24		
Power Class:	4, tested with power level 5(GSM850)		
	1, tested with power level 0(GSM1900)		
	3, tested with power control "all 1"(UMTS Band 2)		





	3, tested with power control "all 1"(UMTS Band 4)
	3, tested with power control "all 1"(UMTS Band 5)
	3, tested with power control all Max.(LTE Band 2)
	3, tested with power control all Max.(LTE Band 4)
	3, tested with power control all Max.(LTE Band 5)
	3, tested with power control all Max.(LTE Band 7)
	3, tested with power control all Max.(LTE Band 12)
	3, tested with power control all Max.(LTE Band 17)
Test Channels (low-mid-high):	128-190-251(GSM850)
	512-661-810(GSM1900)
	9262-9400-9538(UMTS Band 2)
	1312-1413-1513(UMTS Band 4)
	4132-4182-4233(UMTS Band 5)
	18607-18900-19193(LTE Band 2 BW=1.4MHz)
	18615-18900-19185(LTE Band 2 BW=3MHz)
	18625-18900-19175(LTE Band 2 BW=5MHz)
	18650-18900-19150(LTE Band 2 BW=10MHz)
	18675-18900-19125(LTE Band 2 BW=15MHz)
	18700-18900-19100(LTE Band 2 BW=20MHz)
	19957-20175-20393(LTE Band 4 BW=1.4MHz)
	19965-20175-20385(LTE Band 4 BW=3MHz)
	19975-20175-20375(LTE Band 4 BW=5MHz)
	20000-20175-20350(LTE Band 4 BW=10MHz)
	20025-20175-20325(LTE Band 4 BW=15MHz)
	20050-20175-20300(LTE Band 4 BW=20MHz)
	20407-20525-19193(LTE Band 5 BW=1.4MHz)
	20415-20525-19185(LTE Band 5 BW=3MHz)
	20425-20525-19175(LTE Band 5 BW=5MHz)
	20450-20525-19150(LTE Band 5 BW=10MHz)
	20755-21100-21425(LTE Band 7 BW=5MHz)
	20800-21100-21400(LTE Band 7 BW=10MHz)
	20825-21100-21375(LTE Band 7 BW=15MHz)
	20850-21100-21350(LTE Band 7 BW=20MHz)
	23017-23095-23173(LTE Band 12 BW=1.4MHz)
	23025-23095-23165(LTE Band 12 BW=3MHz)
	23035-23095-23155(LTE Band 12 BW=5MHz)
	23060-23095-23130(LTE Band 12 BW=10MHz)
	23755-23790-23825(LTE Band 17 BW=5MHz)
	23780-23790-23800(LTE Band 17 BW=10MHz)
	802.11a/n/ac 20M: 36-40-44-48-52-56-60-64-100-104-108-112-116-120-124-128-132-136-140-149-153-157-161-165
	802.11 n/ac 40M: 38-46-54-62-102-110-118-126-134-151-159
802.11ac 80M: 42-58-106-122-138-155(WiFi 5G)	
802.11b/g/n 20M:1-6-11	

Table 3: Device information and operating configuration

### 1.3.1 General Description

FRD-L24 is subscriber equipment in the GSM/WCDMA/LTE/CDMA system. The GSM frequency band is GSM850 and GSM900 and DCS1800 and PCS1900. The UMTS frequency band is B1 and B2 and B4 and B5 and B8. The LTE frequency band is B2 and B4 and B5 and B7 and B12 and B17. But only GSM850 and GSM1900, UMTS frequency B2 and B4 and B5, LTE frequency B2 and B4 and B5 and B7 and B12 and B17 bands test data included in this report. The Mobile Phone implements such functions as RF signal receiving/transmitting, LTE/HSPA/UMTS and GSM/GPRS/EDGE protocol processing, voice, video MMS service, GPS, AGPS and WIFI etc. Externally it provides one micro SD card (it can also used as SIM card interface), earphone port (to provide voice service) and one SIM card interface. FRD-L24 is single SIM smart phone. It also provides Bluetooth module to synchronize data between a PC and the phone, or to use the built-in modem of the phone to access the Internet with a PC, or to exchange data with other Bluetooth devices.

#### Battery information:

Name	Manufacture	Serials number	Description
Rechargeable Li-ion	Desay	NA	Battery Model: HB366481ECW Rated capacity: 2900mAh Nominal Voltage:  +3.82V Charging Voltage:  +4.40V

#### Difference descripton:

The mobile FRD-L24 are LTE/UMTS/GSM Single SIM mobile phone. The differences between FRD-L24 and FRD-L04 are showed in the following table. Other parts of the mobile phone are the same, including the appearance, Chipset, Bluetooth mode, Wifi mode, Adapter, Battery, and so on.

	FRD-L04	FRD-L24
GSM four bands	B2/B3/B5/B8	B2/B3/B5/B8
WCDMA bands	B1 /B2/B4/B5/B8	B1 /B2/B4/B5/B8
LTE bands	B1/B2/B3/B4/B5/B7/B8/B12/B17/B20	B2/B4/B5/B7/B12/B17
FCC bands	850/1900 B2/B4/B5 B2/B4/B5/B7/B12/B17	850/1900 B2/B4/B5 B2/B4/B5/B7/B12/B17
SIM card	One	One
NFC	Support	Not support
FM	The same	The same
External camera	the same	the same
internal camera	the same	the same
FLASH	the same	the same
Mainboard	with NFC	Without NFC,

	ROM:32GB No B40, B38 function, but keep the circuit	ROM:64GB No B40, B38 function and circuit Board ID : Make a change
PCB layout	the same	the same
Appearance	the same	the same
Bluetooth mode	the same	the same
WLAN mode	the same	the same
BT/ WLAN antenna	the same	the same
GSM/ WCDMA /LTE antenna	the antenna structure and shape is the same	the antenna structure and shape is the same
Adapter	the same	the same
Battery	the same	the same
Chipset	the same	the same
Memory	32GB	64GB
RF Parameter	The same	The same
Dimension	the same	the same
Main Frequency NV	The same NV in the same band	The same NV in the same band
Power reduction in SAR	<b>WiFi antenna:</b> 1)WiFi 2.4G antenna + Main antenna (wifi station): <b>0db</b> 2)WiFi 2.4G + Mian antenna (wifi hotspot): <b>-1db</b> 3)WiFi 5G antenna + Main antenna (wifi station): <b>0db</b> <b>Main antenna:</b> The same <b>Second antenna:</b> Support	<b>WiFi antenna:</b> 1)WiFi 2.4G antenna + Main antenna (wifi station): <b>-4db</b> 2)WiFi 2.4G + Mian antenna (wifi hotspot): <b>-4db</b> 3)WiFi 5G antenna + Main antenna (wifi station): <b>-4db</b> <b>Main antenna:</b> The same <b>Second antenna:</b> no support second antenna
Switching antenna	Can switch to the upper antenna	It is not able to switch to the upper antenna and does not support the upper antenna.

According to the difference description above,

- 1) For main antenna, FRD-L24 is tested at worst case of FRD-L04 main antenna from the FCC report (report NO.: SYBH(Z-SAR)007052016-2) for each frequency band.
- 2) For WiFi antenna, update the conducted power and FRD-L24 SAR is tested at worst case of FRD-L04 from the FCC report (report NO.: SYBH(Z-SAR)007052016-2)

### 1.3.2 Power reduction specification

This device uses a single fixed level of power reduction through static table look-up for SAR compliance. The PAG requirements can be excluded per KDB 388624D02.

1) A fixed level power reduction is applied for some frequency bands when hotspot mode becomes active. When the hotspot is disabled, the power value will be recovered.

2) A fixed level power reduction is applied for some frequency bands when simultaneously transmitting with the other antennas in certain simultaneous transmission conditions. The standalone SAR compliance still uses the standalone SAR results tested at the maximum output power level without any power reduction.

The following tables summarize the key power reduction information. The detailed full power and reduced tune-up specifications and conducted power measurement results are provided in Section 7 of this report.

2G&3G&4G Main antenna + WiFi antenna simultaneous transmission		
Band	Power Reduction Amount(dB)	
	Main Antenna + WiFi station	Main Antenna + WiFi Hotspot
GSM1900	/	2.0
UMTS Band 2	1.0	5.0
UMTS Band 4	1.0	4.5
LTE Band 2	1.5	4.5
LTE Band 4	1.0	3.5
LTE Band 7	/	1.0
WIFI 2.4G	4.0	4.0
WIFI 5G	4.0	4.0

### 1.3.3 Downlink LTE CA specification

The device supports downlink Release 10 LTE Carrier Aggregation (CA) only. It supports a maximum of 2 carriers in the downlink. Other Release 10 features are not supported, including Uplink Carrier Aggregation, Enhanced SC-FDMA and Uplink MIMO or other antenna diversity configurations etc. All uplink communications are identical to the Release 8 Specifications.

The possible downlink LTE CA combinations supported by this device are as below tables per 3GPP TS 36.101 V12.8.0. The conducted power measurement results of downlink LTE CA are provided in Section 7 of this report per 3GPP TS 36.521-1 V12.6.0. According to KDB 941225 D05A, the downlink LTE CA SAR test is not required and PAG requirements can be excluded.

## intra-band contiguous CA (per 3GPP TS 36.101 V12.8.0 Table 5.6A.1-1)

E-UTRA CA configuration / Bandwidth combination set							
E-UTRA CA configuration	Uplink CA configurations (NOTE 3)	Component carriers in order of increasing carrier frequency				Maximum aggregated bandwidth [MHz]	Bandwidth combination set
		Channel bandwidths for carrier [MHz]	Channel bandwidths for carrier [MHz]	Channel bandwidths for carrier [MHz]	Channel bandwidths for carrier [MHz]		
CA_2C		5	20			40	
		0	15, 20				
		15	10, 15, 20				
		20	5, 10, 15, 20				

Table: Test frequencies for CA\_7C

Range	CC-Combo / N <sub>RB_agg</sub> [RB]	CC1 Note1					CC2 Note1				
		BW [RB]	N <sub>UL</sub>	f <sub>UL</sub> [MHz]	N <sub>DL</sub>	f <sub>DL</sub> [MHz]	BW [RB]	N <sub>UL</sub>	f <sub>UL</sub> [MHz]	N <sub>DL</sub>	f <sub>DL</sub> [MHz]
Low	25+100	25	18633	1853.3	633	1933.3	100	18750	1865	750	1945
		100	18700	1860	700	1940	25	18817	1871.7	817	1951.7
	50+75	50	18653	1855.3	653	1935.3	75	18773	1867.3	773	1947.3
		75	18675	1857.5	675	1937.5	50	18795	1869.5	795	1949.5
	50+100	50	18655	1855.5	655	1935.5	100	18799	1869.9	799	1949.9
		100	18700	1860	700	1940	50	18844	1874.4	844	1954.4
	75+75	75	18675	1857.5	675	1937.5	75	18825	1872.5	825	1952.5
	75+100	75	18678	1857.8	678	1937.8	100	18849	1874.9	849	1954.9
		100	18700	1860	700	1940	75	18871	1877.1	871	1957.1
	100+100	100	18700	1860	700	1940	100	18898	1879.8	898	1959.8
Mid	25+100	25	18808	1870.8	808	1950.8	100	18925	1882.5	925	1962.5
		100	18875	1877.5	875	1957.5	25	18992	1889.2	992	1969.2
	50+75	50	18829	1872.9	829	1952.9	75	18949	1884.9	949	1964.9
		75	18851	1875.1	851	1955.1	50	18971	1887.1	971	1967.1
	50+100	50	18806	1870.6	806	1950.6	100	18950	1885	950	1965
		100	18851	1875.1	851	1955.1	50	18995	1889.5	995	1969.5
	75+75	75	18825	1872.5	825	1952.5	75	18975	1887.5	975	1967.5
	75+100	75	18803	1870.3	803	1950.3	100	18974	1887.4	974	1967.4
		100	18826	1872.6	826	1952.6	75	18997	1889.7	997	1969.7
	100+100	100	18801	1870.1	801	1950.1	100	18999	1889.9	999	1969.9
High	25+100	25	18983	1888.3	983	1968.3	100	19100	1900	1100	1980
		100	19050	1895	1050	1975	25	19167	1906.7	1167	1986.7
	50+75	50	19005	1890.5	1005	1970.5	75	19125	1902.5	1125	1982.5
		75	19027	1892.7	1027	1972.7	50	19147	1904.7	1147	1984.7
	50+100	50	18956	1885.6	956	1965.6	100	19100	1900	1100	1980
		100	19001	1890.1	1001	1970.1	50	19145	1904.5	1145	1984.5
	75+75	75	18975	1887.5	975	1967.5	75	19125	1902.5	1125	1982.5
	75+100	75	18929	1882.9	929	1962.9	100	19100	1900	1100	1980
		100	18951	1885.1	951	1965.1	75	19122	1902.2	1122	1982.2
	100+100	100	18902	1880.2	902	1960.2	100	19100	1900	1100	1980

Note 1: Carriers in increasing frequency order.

inter-band CA (per 3GPP TS 36.101 V12.8.0 Table 5.6A.1-2)

E-UTRA CA Configuration	E-UTRA Bands	1.4 MHz	3 MHz	5 MHz	10 MHz	15 MHz	20 MHz	Maximum aggregated bandwidth [MHz]	Bandwidth combination set
CA_2A-4A	2	Yes	Yes	Yes	Yes	Yes	Yes	40	0
	4			Yes	Yes	Yes	Yes		
	2			Yes	Yes			20	1
	4			Yes	Yes				
	2			Yes	Yes	Yes	Yes	40	2
4			Yes	Yes	Yes	Yes			
CA_2A-5A	2			Yes	Yes	Yes	Yes	30	0
	5			Yes	Yes				
CA_2A-12A	2			Yes	Yes	Yes	Yes	30	0
	12			Yes	Yes				
	2			Yes	Yes	Yes	Yes	30	1
	12		Yes	Yes	Yes				
CA_2A-17A	2			Yes	Yes			20	0
	17			Yes	Yes				
CA_4A-5A	4			Yes	Yes			20	0
	5			Yes	Yes				
	4			Yes	Yes	Yes	Yes	30	1
	5			Yes	Yes				
CA_4A-12A	4	Yes	Yes	Yes	Yes			20	0
	12			Yes	Yes				
	4	Yes	Yes	Yes	Yes	Yes	Yes	30	1
	12			Yes	Yes				
	4			Yes	Yes	Yes	Yes	30	2
	12		Yes	Yes	Yes				
	4			Yes	Yes			20	3
	12			Yes	Yes				
	4			Yes	Yes	Yes	Yes	30	4
12			Yes	Yes					
CA_4A-17A	4			Yes	Yes			20	0
	17			Yes	Yes				

Note:

- 1) For the inter-band CA combinations, Except CA\_4A-12A\ CA\_4A-17A, B12 and B17 can not be PCC, other the listed bands above can be used as PCC or SCC.
- 2) The channel spacing and aggregated channel bandwidth for CA are identical to the associated specification in 3GPP TS 36.101 V12.8.0.
- 3) The reference test frequencies for CA refers to 3GPP TS 36.508 V12.5.0.

#### 1.4 Test specification(s)

ANSI C95.1:1992 /IEEE C95.1:1991	Safety Levels with Respect to Human Exposure to Radio Frequency Electromagnetic Fields, 3 kHz – 300 GHz.( IEEE Std C95.1-1991)
IEEE Std 1528-2013	Recommended Practice for Determining the Peak Spatial-Average Specific Absorption Rate (SAR) in the Human Head from Wireless Communications Devices: Measurement Techniques
KDB941225 D01	3G SAR Procedures v03r01
KDB941225 D05	SAR for LTE Devices v02r05
KDB941225 D05A	LTE Rel.10 KDB Inquiry Sheet v01r02
KDB941225 D06	Hotspot SAR v02r01
KDB447498 D01	General RF Exposure Guidance v06
KDB648474 D04	Handsets SAR v01r03
KDB248227 D01	SAR Guidance for IEEE 802.11 Wi-Fi SAR v02r02
KDB865664 D01	SAR measurement 100 MHz to 6 GHz v01r04
KDB865664 D02	SAR Reporting v01r02
KDB690783 D01	SAR Listings on Grants v01r03

#### 1.5 Testing laboratory

Test Site	The Reliability Laboratory of Huawei Technologies Co., Ltd.
Test Location	Section G1, Huawei Base Bantian, Longgang District, Shenzhen 518129, P.R. China
Telephone	+86 755 28780808
Fax	+86 755 89652518
State of accreditation	The Test laboratory (area of testing) is accredited according to ISO/IEC 17025. CNAS Registration number: L0310 A2LA TESTING CERT 2174.01 & 2174.02 & 2174.03

#### 1.6 Applicant and Manufacturer

Company Name	HUAWEI TECHNOLOGIES CO., LTD
Address	Administration Building, Headquarters of Huawei Technologies Co., Ltd., Bantian, Longgang District, Shenzhen, 518129, P.R.C

#### 1.7 Application details

Start Date of test	2018-02-05
End Date of test	2018-02-08

#### 1.8 Ambient Condition

Ambient temperature	18°C – 25°C
Relative Humidity	30% – 70%



## 2 SAR Measurement System

### 2.1 SAR Measurement Set-up

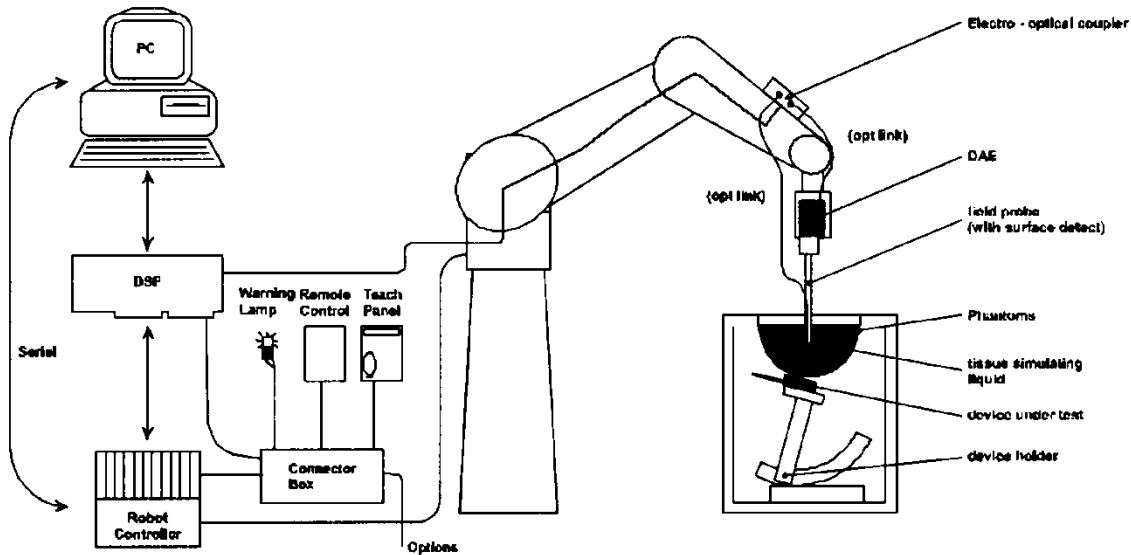

The DASY5/6 system for performing compliance tests consists of the following items:

- A standard high precision 6-axis robot (Stäubli RX family) with controller and software. An arm extension for accommodating the data acquisition electronics (DAE).
- A dosimetric probe, i.e. an isotropic E-field probe optimized and calibrated for usage in tissue simulating liquid. The probe is equipped with an optical surface detector system.
- A data acquisition electronic (DAE) which performs the signal amplification, signal multiplexing, AD-conversion, offset measurements, mechanical surface detection, collision detection, etc. The unit is battery powered with standard or rechargeable batteries. The signal is optically transmitted to the EOC.
- A unit to operate the optical surface detector which is connected to the EOC.
- The Electro-Optical Coupler (EOC) performs the conversion from the optical into a digital electric signal of the DAE. The EOC is connected to the DASY5/6 measurement server.
- The DASY5/6 measurement server, which performs all real-time data evaluation for field measurements and surface detection, controls robot movements and handles safety operation. A computer operating Windows 7.
- DASY5/6 software and SEMCAD data evaluation software.
- Remote control with teach panel and additional circuitry for robot safety such as warning lamps, etc.
- The generic twin phantom enabling the testing of left-hand and right-hand usage.
- The device holder for handheld mobile phones.
- Tissue simulating liquid mixed according to the given recipes.
- System check dipoles allowing to validate the proper functioning of the system.

## 2.2 Test environment

The DASY5/6 measurement system is placed at the head end of a room with dimensions: 5 x 2.5 x 3 m<sup>3</sup>, the SAM phantom is placed in a distance of 75 cm from the side walls and 1.1m from the rear wall. Above the test system a 1.5 x 1.5 m<sup>2</sup> array of pyramid absorbers is installed to reduce reflections from the ceiling.

Picture 1 of the photo documentation shows a complete view of the test environment.

The system allows the measurement of SAR values larger than 0.005 mW/g.

## 2.3 Data Acquisition Electronics description

The data acquisition electronics (DAE) consist of a highly sensitive electrometer-grade preamplifier with auto-zeroing, a channel and gain-switching multiplexer, a fast 16 bit AD-converte and a command decoder with a control logic unit. Transmission to the measurement server is accomplished through an optical downlink for data and status information, as well as an optical uplink for commands and the clock.

The mechanical probe mounting device includes two different sensor systems for frontal and sideways probe contacts. They are used for mechanical surface detection and probe collision detection.

### DAE4

Input Impedance	200MOhm	
The Inputs	symmetrical and floating	
Common mode rejection	above 80 dB	

## 2.4 Probe description

These probes are specially designed and calibrated for use in liquids with high permittivities. They should not be used in air, since the spherical isotropy in air is poor ( $\pm 2$  dB). The dosimetric probes have special calibrations in various liquids at different frequencies.

### Isotropic E-Field Probe ES3DV3 for Dosimetric Measurements

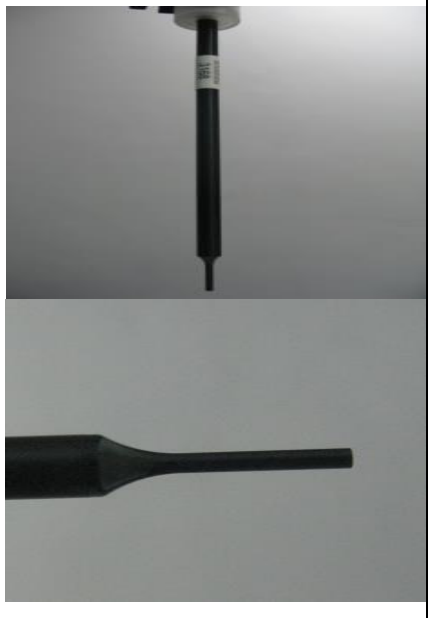
Construction	Symmetrical design with triangular core Interleaved sensors Built-in shielding against static charges PEEK enclosure material (resistant to organic solvents, e.g., DGBE)	
Calibration	ISO/IEC 17025 calibration service available.	
Frequency	10 MHz to 4 GHz; Linearity: $\pm 0.2$ dB (30 MHz to 4 GHz)	
Directivity	$\pm 0.2$ dB in HSL (rotation around probe axis) $\pm 0.3$ dB in tissue material (rotation normal to probe axis)	
Dynamic range	5 $\mu$ W/g to > 100 mW/g; Linearity: $\pm 0.2$ dB	
Dimensions	Overall length: 337 mm (Tip: 20 mm) Tip diameter: 3.9 mm (Body: 12 mm) Distance from probe tip to dipole centers: 2.0 mm	
Application	General dosimetry up to 4 GHz Dosimetry in strong gradient fields Compliance tests of mobile phones	

### Isotropic E-Field Probe EX3DV4 for Dosimetric Measurements

Construction	Symmetrical design with triangular core Built-in shielding against static charges PEEK enclosure material (resistant to organic solvents, e.g., DGBE)	
Calibration	ISO/IEC 17025 calibration service available.	
Frequency	10 MHz to >6 GHz; Linearity: $\pm 0.2$ dB (30 MHz to 6 GHz)	
Directivity	$\pm 0.3$ dB in HSL (rotation around probe axis) $\pm 0.5$ dB in tissue material (rotation normal to probe axis)	
Dynamic range	10 $\mu$ W/g to > 100 mW/g; Linearity: $\pm 0.2$ dB (noise: typically < 1 $\mu$ W/g)	
Dimensions	Overall length: 337 mm (Tip: 20 mm) Tip diameter: 2.5 mm (Body: 12 mm) Typical distance from probe tip to dipole centers: 1 mm	
Application	High precision dosimetric measurements in any exposure scenario (e.g., very strong gradient fields). Only probe which enables compliance testing for frequencies up to 6 GHz with precision of better 30%	

## 2.5 Phantom description

### SAM Twin Phantom

Shell Thickness	2mm±0.2mm;The ear region:6.0±0.2mm	
Filling Volume	Approximately 25 liters	
Dimensions	Length:1000mm; Width:500mm; Height: adjustable feet	
Measurement Areas	Left hand Right hand Flat phantom	

The bottom plate contains three pairs of bolts for locking the device holder. The device holder positions are adjusted to the standard measurement positions in the three sections. A white cover is provided to cover the phantom during off-periods to prevent water evaporation and changes in the liquid parameters. Free space scans of devices on top of this phantom cover are possible. Three reference marks are provided on the phantom counter. These reference marks are used to teach the absolute phantom position relative to the robot.

The following figure shows the definition of reference point:

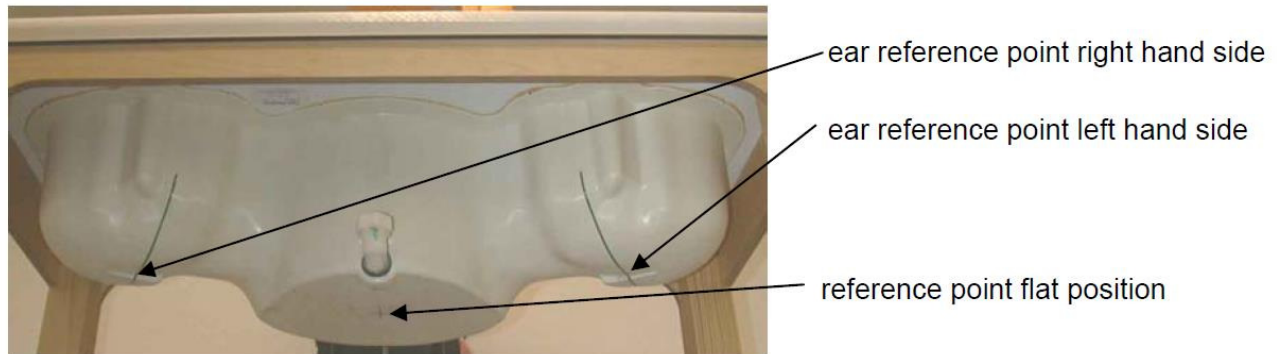

### ELI4 Phantom

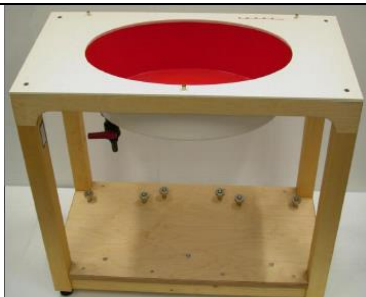
Shell Thickness	2mm±0.2mm	
Filling Volume	Approximately 30 liters	
Dimensions	Major axis:600mm; Minor axis:400mm;	
Measurement Areas	Flat phantom	

The ELI4 phantom is intended for compliance testing of handheld and body-mounted wireless devices in the frequency range of 30MHz to 6GHz. ELI4 is fully compatible with the latest draft of the standard IEC 62209-2 and all known tissue simulating liquids.

The phantom shell material is resistant to all ingredients used in the tissue-equivalent liquid recipes. The shell of the phantom including ear spacers is constructed from low permittivity and low loss material, with a relative permittivity  $2 \leq \epsilon_r \leq 5$  at  $\leq 3$  GHz,  $3 \leq \epsilon_r \leq 4$  at  $> 3$  GHz and a loss tangent  $\leq 0.05$ .

## 2.6 Device holder description

The DASY5/6 device holder has two scales for device rotation (with respect to the body axis) and the device inclination (with respect to the line between the ear openings). The plane between the ear openings and the mouth tip has a rotation angle of 65°. The bottom plate contains three pair of bolts for locking the device holder. The device holder positions are adjusted to the standard measurement positions in the three sections. This device holder is used for standard mobile phones or PDA's only. If necessary an additional support of polystyrene material is used.



The DASY device holder is constructed of low-loss POM material having the following dielectric parameters: relative permittivity  $\epsilon = 3$  and loss tangent  $\sigma = 0.02$ . The amount of dielectric material has been reduced in the closest vicinity of the device, since measurements have suggested that the influence of the clamp on the test results could thus be lowered.

The device holder permits the device to be positioned with a tolerance of  $\pm 1^\circ$  in the tilt angle.

Larger DUT's (e.g. notebooks) cannot be tested using this device holder. Instead a support of bigger polystyrene cubes and thin polystyrene plates is used to position the DUT in all relevant positions to find and measure spots with maximum SAR values.

Therefore those devices are normally only tested at the flat part of the SAM.

## 2.7 Test Equipment List

This table gives a complete overview of the SAR measurement equipment.

Devices used during the test described are marked

	Manufacturer	Device	Type	Serial number	Date of last calibration	Valid period
<input checked="" type="checkbox"/>	SPEAG	Dosimetric E-Field Probe	EX3DV4	3736	2017-04-27	One year
<input checked="" type="checkbox"/>	SPEAG	Dosimetric E-Field Probe	EX3DV4	3744	2017-07-24	One year
<input checked="" type="checkbox"/>	SPEAG	750 MHz Dipole	D750V3	1044	2017-09-21	Three years
<input checked="" type="checkbox"/>	SPEAG	835 MHz Dipole	D835V2	4d059	2016-04-20	Three years
<input checked="" type="checkbox"/>	SPEAG	1750 MHz Dipole	D1750V2	1123	2017-07-27	Three years
<input checked="" type="checkbox"/>	SPEAG	1900 MHz Dipole	D1900V2	5d143	2017-09-20	Three years
<input checked="" type="checkbox"/>	SPEAG	2450 MHz Dipole	D2450V2	860	2017-11-15	Three years
<input checked="" type="checkbox"/>	SPEAG	2600 MHz Dipole	D2600V2	1021	2017-07-21	Three years
<input checked="" type="checkbox"/>	SPEAG	5GHz Dipole	D5GHzV2	1155	2017-04-26	Three years
<input checked="" type="checkbox"/>	SPEAG	Data acquisition electronics	DAE4	852	2017-04-27	One year
<input checked="" type="checkbox"/>	SPEAG	Software	DASY 5	N/A	NCR	NCR
<input checked="" type="checkbox"/>	SPEAG	Twin Phantom	SAM3	TP-1597	NCR	NCR
<input checked="" type="checkbox"/>	SPEAG	Twin Phantom	SAM4	TP-1620	NCR	NCR
<input checked="" type="checkbox"/>	R & S	Universal Radio Communication Tester	CMU 200	111379	2017-12-30	One year
<input checked="" type="checkbox"/>	R & S	Universal Radio Communication Tester	CMW 500	158850	2017-06-13	One year
<input checked="" type="checkbox"/>	Agilent	Network Analyser	E5071C	MY46213349	2017-12-31	One year
<input checked="" type="checkbox"/>	Agilent	Dielectric Probe Kit	85070E	2484	NCR	NCR
<input checked="" type="checkbox"/>	Keysight	Signal Generator	E8257D	MY56440071	2017-12-25	One year
<input checked="" type="checkbox"/>	MINI-CIRCUITS	Amplifier	ZHL-42W	QA1402001	NCR	NCR
<input checked="" type="checkbox"/>	MINI-CIRCUITS	Amplifier	ZVE-8G+	A170521627	NCR	NCR
<input checked="" type="checkbox"/>	SHX	Dual Directional Coupler	DDTO-4-20	17121801	2018-01-02	One year
<input checked="" type="checkbox"/>	Agilent	Dual Directional Coupler	772D	MY52180173	2018-01-08	One year
<input checked="" type="checkbox"/>	AR	Directional Coupler	DC7144M1	311190	2017-05-26	One year
<input checked="" type="checkbox"/>	R & S	Power Meter	NRP	100740	2017-07-17	One year
<input checked="" type="checkbox"/>	R & S	Power Meter Sensor	NRP-Z11	106288	2017-07-07	One year
<input checked="" type="checkbox"/>	Keysight	Power Meter Sensor	E9321A	MY57150002	2017-04-20	One year
<input checked="" type="checkbox"/>	Keysight	Power Meter	E4417A	MY57160005	2017-5-6	One year

Note:

1) Per KDB865664D01 requirements for dipole calibration, the test laboratory has adopted three-year extended calibration interval. Each measured dipole is expected to evaluate with the following criteria at least on annual interval in Appendix C.

- a) There is no physical damage on the dipole;
- b) System check with specific dipole is within 10% of calibrated value;
- c) The most recent return-loss result, measured at least annually, deviates by no more than 20% from the previous measurement.
- d) The most recent measurement of the real or imaginary parts of the impedance, measured at least annually is within 5Ω from the previous measurement.

2) Network analyzer probe calibration against air, distilled water and a shorting block performed before measuring liquid parameters.

3) \*All the equipments are within the valid period when the tests are performed.



## 3 SAR Measurement Procedure

### 3.1 Scanning procedure

The DASY5/6 installation includes predefined files with recommended procedures for measurements and system check. They are read-only document files and destined as fully defined but unmeasured masks. All test positions (head or body-worn) are tested with the same configuration of test steps differing only in the grid definition for the different test positions.

- The “reference” and “drift” measurements are located at the beginning and end of the batch process. They measure the field drift at one single point in the liquid over the complete procedure. The indicated drift is mainly the variation of the DUT’s output power and should vary max. +/- 5 %.
- The “surface check” measurement tests the optical surface detection system of the DASY5/6 system by repeatedly detecting the surface with the optical and mechanical surface detector and comparing the results. The output gives the detecting heights of both systems, the difference between the two systems and the standard deviation of the detection repeatability. Air bubbles or refraction in the liquid due to separation of the sugar-water mixture gives poor repeatability (above  $\pm 0.1\text{mm}$ ). To prevent wrong results tests are only executed when the liquid is free of air bubbles. The difference between the optical surface detection and the actual surface depends on the probe and is specified with each probe. (It does not depend on the surface reflectivity or the probe angle to the surface within  $\pm 30^\circ$ .)
- The “area scan” measures the SAR above the DUT or verification dipole on a parallel plane to the surface. It is used to locate the approximate location of the peak SAR with 2D spline interpolation. The robot performs a stepped movement along one grid axis while the local electrical field strength is measured by the probe. The probe is touching the surface of the SAM during acquisition of measurement values. The standard scan uses large grid spacing for faster measurement. Standard grid spacing for head measurements is 15 mm in x- and y- dimension ( $\leq 2\text{GHz}$ ), 12 mm in x- and y- dimension (2-4 GHz) and 10mm in x- and y- dimension (4-6GHz). If a finer resolution is needed, the grid spacing can be reduced. Grid spacing and orientation have no influence on the SAR result. For special applications where the standard scan method does not find the peak SAR within the grid, e.g. mobile phones with flip cover, the grid can be adapted in orientation. Results of this coarse scan are shown in Appendix B.
- A “zoom scan” measures the field in a volume around the 2D peak SAR value acquired in the previous “coarse” scan. This is a fine grid with maximum scan spatial resolution:  $\Delta x_{\text{zoom}}, \Delta y_{\text{zoom}} \leq 2\text{GHz} - \leq 8\text{mm}$ , 2-4GHz -  $\leq 5\text{ mm}$  and 4-6 GHz- $\leq 4\text{mm}$ ;  $\Delta z_{\text{zoom}} \leq 3\text{GHz} - \leq 5\text{ mm}$ , 3-4 GHz-  $\leq 4\text{mm}$  and 4-6GHz- $\leq 2\text{mm}$  where the robot additionally moves the probe along the z-axis away from the bottom of the Phantom. DASY is also able to perform repeated zoom scans if more than 1 peak is found during area scan. In this document, the evaluated peak 1g and 10g averaged SAR values are shown in the 2D-graphics in Appendix B. Test results relevant for the specified standard (see chapter 1.4.) are shown in table form in chapter 7.2.
- A Z-axis scan measures the total SAR value at the x-and y-position of the maximum SAR value found during the cube scan. The probe is moved away in z-direction from the bottom of the SAM phantom in 2 mm steps. This measurement shows the continuity of the liquid and can - depending in the field strength – also show the liquid depth. A z-axis scan of the measurement with maximum SAR value is shown in Appendix B.

The following table summarizes the area scan and zoom scan resolutions per FCC KDB 865664D01:

Frequency	Maximun Area Scan resolution ( $\Delta x_{area}, \Delta y_{area}$ )	Maximun Zoom Scan spatial resolution ( $\Delta x_{zoom}, \Delta y_{zoom}$ )	Maximun Zoom Scan spatial resolution			Minimum zoom scan volume (x,y,z)
			Uniform Grid	Graded Grad		
			$\Delta z_{zoom}(n)$	$\Delta z_{zoom}(1)^*$	$\Delta z_{zoom}(n>1)^*$	
≤2GHz	≤15mm	≤8mm	≤5mm	≤4mm	≤1.5* $\Delta z_{zoom}(n-1)$	≥30mm
2-3GHz	≤12mm	≤5mm	≤5mm	≤4mm	≤1.5* $\Delta z_{zoom}(n-1)$	≥30mm
3-4GHz	≤12mm	≤5mm	≤4mm	≤3mm	≤1.5* $\Delta z_{zoom}(n-1)$	≥28mm
4-5GHz	≤10mm	≤4mm	≤3mm	≤2.5mm	≤1.5* $\Delta z_{zoom}(n-1)$	≥25mm
5-6GHz	≤10mm	≤4mm	≤2mm	≤2mm	≤1.5* $\Delta z_{zoom}(n-1)$	≥22mm

### 3.2 Spatial Peak SAR Evaluation

The spatial peak SAR - value for 1 and 10 g is evaluated after the Cube measurements have been done. The basis of the evaluation are the SAR values measured at the points of the fine cube grid consisting of 5 x 5 x 7 points( with 8mm horizontal resolution) or 7 x 7 x 7 points( with 5mm horizontal resolution) or 8 x 8 x 7 points( with 4mm horizontal resolution). The algorithm that finds the maximal averaged volume is separated into three different stages.

- The data between the dipole center of the probe and the surface of the phantom are extrapolated. This data cannot be measured since the center of the dipole is 2.7 mm away from the tip of the probe and the distance between the surface and the lowest measuring point is about 1 mm (see probe calibration sheet). The extrapolated data from a cube measurement can be visualized by selecting 'Graph Evaluated'.
- The maximum interpolated value is searched with a straight-forward algorithm. Around this maximum the SAR - values averaged over the spatial volumes (1g or 10 g) are computed using the 3d-spline interpolation algorithm. If the volume cannot be evaluated (i.e., if a part of the grid was cut off by the boundary of the measurement area) the evaluation will be started on the corners of the bottom plane of the cube.
- All neighboring volumes are evaluated until no neighboring volume with a higher average value is found.

#### Extrapolation

The extrapolation is based on a least square algorithm [W. Gander, Computermathematik, p.168-180]. Through the points in the first 3 cm along the z-axis, polynomials of order four are calculated. These polynomials are then used to evaluate the points between the surface and the probe tip. The points, calculated from the surface, have a distance of 1 mm from each other.

#### Interpolation

The interpolation of the points is done with a 3d-Spline. The 3d-Spline is composed of three one-dimensional splines with the "Not a knot"-condition [W. Gander, Computermathematik, p.141-150] (x, y and z -direction) [Numerical Recipes in C, Second Edition, p.123ff ].

#### Volume Averaging

At First the size of the cube is calculated. Then the volume is integrated with the trapezoidal algorithm. 8000 points (20x20x20) are interpolated to calculate the average.

#### Advanced Extrapolation

DASY5/6 uses the advanced extrapolation option which is able to compansate boundary effects on E-field probes.



### 3.3 Data Storage and Evaluation

#### Data Storage

The DASY5/6 software stores the acquired data from the data acquisition electronics as raw data (in microvolt readings from the probe sensors), together with all necessary software parameters for the data evaluation (probe calibration data, liquid parameters and device frequency and modulation data) in measurement files with the extension "DAE4". The software evaluates the desired unit and format for output each time the data is visualized or exported. This allows verification of the complete software setup even after the measurement and allows correction of incorrect parameter settings. For example, if a measurement has been performed with a wrong crest factor parameter in the device setup, the parameter can be corrected afterwards and the data can be re-evaluated.

The measured data can be visualized or exported in different units or formats, depending on the selected probe type ([V/m], [A/m], [°C], [mW/g], [mW/cm<sup>2</sup>], [dBrel], etc.). Some of these units are not available in certain situations or show meaningless results, e.g., a SAR output in a lossless media will always be zero. Raw data can also be exported to perform the evaluation with other software packages.

#### Data Evaluation by SEMCAD

The SEMCAD software automatically executes the following procedures to calculate the field units from the microvolt readings at the probe connector. The parameters used in the evaluation are stored in the configuration modules of the software:

Probe parameters:	- Sensitivity	Norm <sub>i</sub> , a <sub>i0</sub> , a <sub>i1</sub> , a <sub>i2</sub>
	- Conversion factor	ConvF <sub>i</sub>
	- Diode compression point	Dcpi
Device parameters:	- Frequency	f
	- Crest factor	cf
Media parameters:	- Conductivity	σ
	- Density	ρ

These parameters must be set correctly in the software. They can be found in the component documents or they can be imported into the software from the configuration files issued for the DASY5/6 components. In the direct measuring mode of the multimeter option, the parameters of the actual system setup are used. In the scan visualization and export modes, the parameters stored in the corresponding document files are used.

The first step of the evaluation is a linearization of the filtered input signal to account for the compression characteristics of the detector diode. The compensation depends on the input signal, the diode type and the DC-transmission factor from the diode to the evaluation electronics.

If the exciting field is pulsed, the crest factor of the signal must be known to correctly compensate for peak power. The formula for each channel can be given as:

$$V_i = U_i + U_i^2 \cdot cf/dcpi$$

with	V <sub>i</sub>	= compensated signal of channel i	(i = x, y, z)
	U <sub>i</sub>	= input signal of channel i	(i = x, y, z)
	cf	= crest factor of exciting field (DASY parameter)	
	dcpi	= diode compression point	(DASY parameter)

From the compensated input signals the primary field data for each channel can be

evaluated:

$$E_i = (V_i / \text{Norm}_i \cdot \text{ConvF})^{1/2}$$

$$H_i = (V_i)^{1/2} \cdot (a_{i0} + a_{i1}f + a_{i2}f^2)/f$$

with  $V_i$  = compensated signal of channel  $i$  ( $i = x, y, z$ )  
 $\text{Norm}_i$  = sensor sensitivity of channel  $i$  ( $i = x, y, z$ )  
 [mV/(V/m)<sup>2</sup>] for E-field Probes  
 $\text{ConvF}$  = sensitivity enhancement in solution  
 $a_{ij}$  = sensor sensitivity factors for H-field probes  
 $f$  = carrier frequency [GHz]  
 $E_i$  = electric field strength of channel  $i$  in V/m  
 $H_i$  = magnetic field strength of channel  $i$  in A/m

The RSS value of the field components gives the total field strength (Hermitian magnitude):

$$E_{\text{tot}} = (E_x^2 + E_y^2 + E_z^2)^{1/2}$$

The primary field data are used to calculate the derived field units.

$$\text{SAR} = (E_{\text{tot}}^2 \cdot \sigma) / (\rho \cdot 1000)$$

with  $\text{SAR}$  = local specific absorption rate in mW/g  
 $E_{\text{tot}}$  = total field strength in V/m  
 $\sigma$  = conductivity in [mho/m] or [Siemens/m]  
 $\rho$  = equivalent tissue density in g/cm<sup>3</sup>

Note that the density is normally set to 1 (or 1.06), to account for actual brain density rather than the density of the simulation liquid. The power flow density is calculated assuming the excitation field to be a free space field.

$$P_{\text{pwe}} = E_{\text{tot}}^2 / 3770 \quad \text{or} \quad P_{\text{pwe}} = H_{\text{tot}}^2 \cdot 37.7$$

with  $P_{\text{pwe}}$  = equivalent power density of a plane wave in mW/cm<sup>2</sup>  
 $E_{\text{tot}}$  = total electric field strength in V/m  
 $H_{\text{tot}}$  = total magnetic field strength in A/m

## 4 System Verification Procedure

### 4.1 Tissue Verification

The simulating liquids should be checked at the beginning of a series of SAR measurements to determine if the dielectric parameters are within the tolerances of the specified target values. The measured conductivity and relative permittivity should be within  $\pm 5\%$  of the target values.

The following materials are used for producing the tissue-equivalent materials.

Ingredients (% of weight)	Head Tissue					
Frequency Band (MHz)	750	835	1750	1900	2450	2600
Water	39.2	41.45	52.64	55.242	62.7	55.242
Salt (NaCl)	2.7	1.45	0.36	0.306	0.5	0.306
Sugar	57.0	56.0	0.0	0.0	0.0	0.0
HEC	0.0	1.0	0.0	0.0	0.0	0.0
Bactericide	0.0	0.1	0.0	0.0	0.0	0.0
Triton X-100	0.0	0.0	0.0	0.0	0.0	0.0
DGBE	0.0	0.0	47.0	44.542	36.8	44.452
Ingredients (% of weight)	Body Tissue					
Frequency Band (MHz)	750	835	1750	1900	2450	2600
Water	50.3	52.4	69.91	69.91	73.2	64.493
Salt (NaCl)	1.60	1.40	0.13	0.13	0.04	0.024
Sugar	47.0	45.0	0.0	0.0	0.0	0.0
HEC	0.0	1.0	0.0	0.0	0.0	0.0
Bactericide	0.0	0.1	0.0	0.0	0.0	0.0
Triton X-100	0.0	0.0	0.0	0.0	0.0	0.0
DGBE	0.0	0.0	29.96	29.96	26.7	32.252

Table 4: Tissue Dielectric Properties

Salt: 99+% Pure Sodium Chloride; Sugar: 98+% Pure Sucrose; Water: De-ionized, 16M $\Omega$ + resistivity  
 HEC: Hydroxyethyl Cellulose; DGBE: 99+% Di(ethylene glycol) butyl ether, [2-(2-butoxyethoxy)ethanol]  
 Triton X-100(ultra pure): Polyethylene glycol mono [4-(1,1,3,3-tetramethylbutyl)phenyl]ether

#### Simulating Head Liquid for 5G(HBBL3500-5800MHz), Manufactured by SPEAG:

Ingredients	(% by weight)
Water	50-65%
Mineral oil	10-30%
Emulsifiers	8-25%
Sodium salt	0-1.5%

#### Simulating Body Liquid for 5G(MBBL3500-5800MHz), Manufactured by SPEAG:

Ingredients	(% by weight)
Water	60-80%
Esters, Emulsifiers, Inhibitors	20-40%
Sodium salt	0-1.5%

Tissue Type	Target Frequency	Target Tissue		Measured Tissue		Deviation (Within +/-5% )		Liquid Temp.	Test Date
		Permit-tivity	Conduc-tivity [S/m]	Permit-tivity	Conduc-tivity [S/m]	$\Delta\epsilon_r$	$\Delta\sigma$		
750MHz Head	705	42.14	0.89	42.92	0.874	1.85%	1.85%	21.6°C	2018/2/6
	710	42.11	0.89	42.91	0.876	1.90%	1.61%		
	750	41.90	0.89	42.95	0.893	2.50%	0.37%		
835MHz Head	825	41.60	0.90	42.56	0.907	2.31%	0.72%	21.6°C	2018/2/6
	835	41.50	0.90	42.54	0.911	2.51%	1.19%		
	850	41.50	0.92	42.50	0.917	2.41%	0.32%		
1750MHz Head	1710	40.10	1.35	40.46	1.341	0.90%	0.67%	21.6°C	2018/2/6
	1730	40.10	1.36	40.45	1.355	0.87%	0.37%		
	1750	40.10	1.37	40.42	1.368	0.80%	0.15%		
	1800	40.00	1.40	40.31	1.403	0.78%	0.21%		
1900MHz Head	1850	40.00	1.40	41.54	1.419	3.85%	1.36%	21.6°C	2018/2/6
	1880	40.00	1.40	41.48	1.438	3.70%	2.71%		
	1900	40.00	1.40	41.44	1.449	3.60%	3.50%		
	1910	40.00	1.40	41.43	1.455	3.58%	3.93%		
2450MHz Head	2410	39.30	1.76	38.96	1.753	-0.87%	0.40%	21.8°C	2018/2/7
	2435	39.20	1.79	38.94	1.773	-0.66%	0.95%		
	2450	39.20	1.80	38.92	1.785	-0.71%	0.83%		
	2460	39.20	1.81	38.91	1.794	-0.74%	0.88%		
2600MHz Head	2510	39.12	1.86	40.23	1.842	2.84%	0.97%	21.6°C	2018/2/6
	2535	39.10	1.89	40.19	1.862	2.79%	1.48%		
	2560	39.00	1.92	40.15	1.884	2.95%	1.72%		
	2600	39.00	1.96	40.09	1.916	2.79%	2.24%		
5G Hz Head	5250	35.95	4.71	35.71	4.588	-0.53%	2.59%	21.8°C	2018/2/7
	5600	35.50	5.07	36.55	5.105	2.96%	0.69%		
	5750	35.35	5.22	36.10	5.382	1.98%	3.10%		

Tissue Type	Target Frequency	Target Tissue		Measured Tissue		Deviation (Within +/-5% )		Liquid Temp.	Test Date
		Permittivity	Conductivity [S/m]	Permittivity	Conductivity [S/m]	$\Delta\epsilon_r$	$\Delta\sigma$		
750MHz Body	705	55.70	0.96	53.81	0.929	-3.39%	-3.19%	21.6°C	2018/2/5
	710	55.70	0.96	53.80	0.933	-3.41%	-2.83%		
	750	55.50	0.96	53.86	0.961	-2.95%	0.10%		
835MHz Body	825	55.20	0.97	54.95	0.958	-0.45%	-1.27%	21.6°C	2018/2/5
	835	55.20	0.97	54.93	0.964	-0.49%	-0.58%		
	850	55.20	0.99	54.90	0.974	-0.54%	-1.62%		
1750MHz Body	1710	53.50	1.46	52.20	1.479	-2.43%	1.30%	21.6°C	2018/2/6
	1730	53.50	1.48	52.19	1.496	-2.45%	1.08%		
	1750	53.40	1.49	52.17	1.512	-2.30%	1.48%		
	1800	53.30	1.52	52.08	1.557	-2.29%	2.43%		
1900MHz Body	1850	53.30	1.52	51.63	1.470	-3.13%	-3.29%	21.6°C	2018/2/6
	1880	53.30	1.52	51.57	1.493	-3.25%	-1.78%		
	1900	53.30	1.52	51.54	1.508	-3.30%	-0.79%		
	1910	53.30	1.52	51.58	1.516	-3.23%	-0.26%		
2450MHz Body	2410	52.80	1.91	52.63	1.883	-0.32%	-1.41%	21.8°C	2018/2/7
	2435	52.70	1.94	52.61	1.905	-0.17%	-1.80%		
	2450	52.70	1.95	52.60	1.919	-0.19%	-1.59%		
	2460	52.70	1.96	52.59	1.929	-0.21%	-1.58%		
2600MHz Body	2510	52.62	2.03	51.68	2.001	-1.79%	-1.43%	21.6°C	2018/2/6
	2535	52.59	2.07	51.66	2.024	-1.77%	-2.22%		
	2560	52.57	2.09	51.62	2.049	-1.81%	-1.96%		
	2600	52.50	2.16	51.58	2.087	-1.75%	-3.38%		
5G Hz Body	5250	48.95	5.36	48.62	5.542	-0.57%	3.40%	21.8°C	2018/2/7
	5600	48.47	5.77	48.99	5.523	1.01%	-4.28%		
	5750	48.27	5.94	48.04	5.777	-0.54%	-2.74%		

Table 5: Measured Tissue Parameter

Note: 1) The dielectric parameters of the tissue-equivalent liquid should be measured under similar ambient conditions and within 2 °C of the conditions expected during the SAR evaluation to satisfy protocol requirements.

2) KDB 865664 was ensured to be applied for probe calibration frequencies greater than or equal to 50MHz of the EUT frequencies.

3) The above measured tissue parameters were used in the DASY software to perform interpolation via the DASY software to determine actual dielectric parameters at the test frequencies. The SAR test plots may slightly differ from the table above since the DASY rounds to three significant digits.

## 4.2 System Check

The system check is performed for verifying the accuracy of the complete measurement system and performance of the software. The system check is performed with tissue equivalent material according to IEEE 1528 (described above). The following table shows system check results for all frequency bands and tissue liquids used during the tests(Graphic Plot(s) see Appendix A).

System Check	Target SAR (Normalized to 1W)		Measured SAR (Normalized to 1W)		Deviation (Within +/-10% )		Liquid Temp.	Test Date
	1-g (mW/g)	10-g (mW/g)	1-g (mW/g)	10-g (mW/g)	Δ1-g	Δ10-g		
750MHz Head	8.26	5.35	8.36	5.56	1.21%	3.93%	21.6°C	2018/2/6
835MHz Head	9.30	6.05	9.76	6.44	4.95%	6.45%	21.6°C	2018/2/6
1750MHz Head	36.60	19.40	34.52	18.48	-5.68%	-4.74%	21.6°C	2018/2/6
1900MHz Head	39.10	20.50	40.40	21.00	3.32%	2.44%	21.6°C	2018/2/6
2450MHz Head	51.20	23.90	50.80	23.36	-0.78%	-2.26%	21.8°C	2018/2/7
2600MHz Head	58.70	26.10	54.40	24.20	-7.33%	-7.28%	21.6°C	2018/2/6
5750MHz Head	77.20	21.90	72.30	20.10	-6.35%	-8.22%	21.8°C	2018/2/7
750MHz Body	8.56	5.64	8.36	5.88	-2.34%	4.26%	21.6°C	2018/2/5
835MHz Body	9.41	6.20	9.48	6.64	0.74%	7.10%	21.6°C	2018/2/5
1750MHz Body	36.40	19.40	35.48	19.96	-2.53%	2.89%	21.6°C	2018/2/6
1900MHz Body	39.40	20.80	40.00	22.00	1.52%	5.77%	21.6°C	2018/2/6
2450MHz Body	50.10	23.50	51.20	24.96	2.20%	6.21%	21.8°C	2018/2/7
2600MHz Body	55.90	24.90	54.00	25.48	-3.40%	2.33%	21.6°C	2018/2/6
5750MHz Body	75.90	21.20	70.50	19.80	-7.11%	-6.60%	21.8°C	2018/2/7

Table 6: System Check Results

### 4.3 System check Procedure

The system check is performed by using a system check dipole which is positioned parallel to the planar part of the SAM phantom at the reference point. The distance of the dipole to the SAM phantom is determined by a plexiglass spacer. The dipole is connected to the signal source consisting of signal generator and amplifier via a directional coupler, N-connector cable and adaption to SMA. It is fed with a power of 250 mW (below 3GHz) or 100mW (3-6GHz). To adjust this power a power meter is used. The power sensor is connected to the cable before the system check to measure the power at this point and do adjustments at the signal generator. At the outputs of the directional coupler both return loss as well as forward power are controlled during the system check to make sure that emitted power at the dipole is kept constant. This can also be checked by the power drift measurement after the test (result on plot). System check results have to be equal or near the values determined during dipole calibration (target SAR in table above) with the relevant liquids and test system.

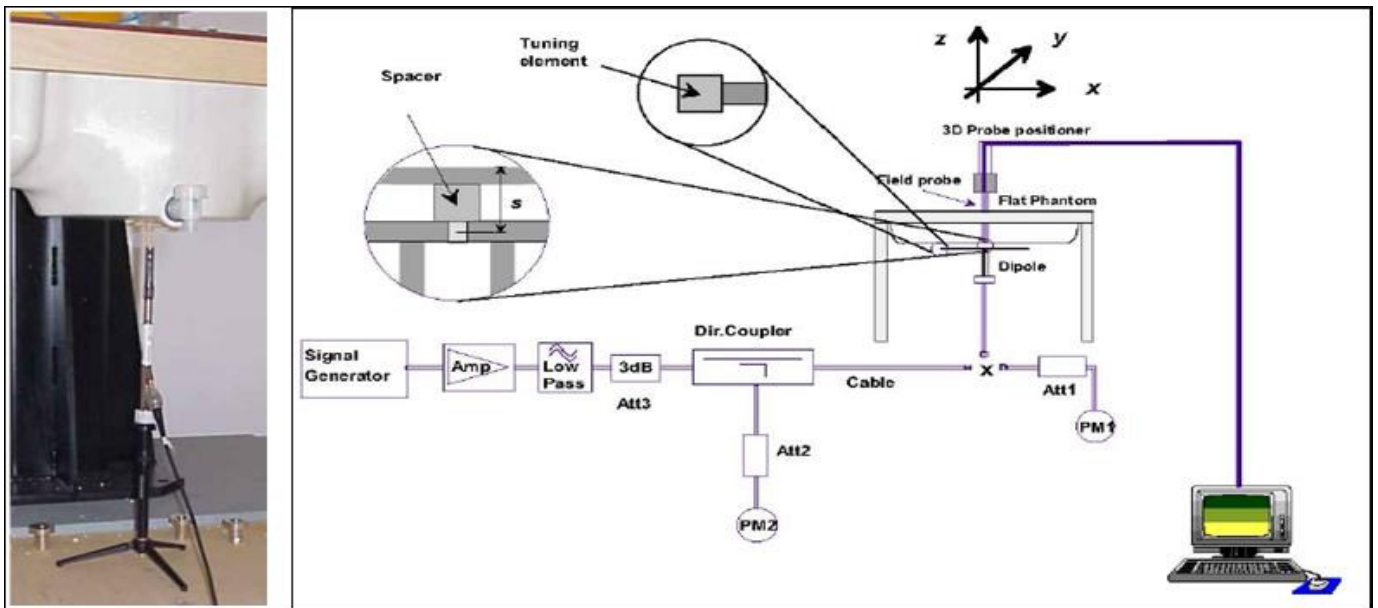

## 5 SAR measurement variability and uncertainty

### 5.1 SAR measurement variability

Per KDB865664 D01 SAR measurement 100 MHz to 6 GHz, SAR measurement variability must be assessed for each frequency band, which is determined by the SAR probe calibration point and tissue-equivalent medium used for the device measurements. The additional measurements are repeated after the completion of all measurements requiring the same head or body tissue-equivalent medium in a frequency band. The test device should be returned to ambient conditions (normal room temperature) with the battery fully charged before it is re-mounted on the device holder for the repeated measurement(s) to minimize any unexpected variations in the repeated results.

- 1) Repeated measurement is not required when the original highest measured SAR is  $< 0.80$  W/kg; steps 2) through 4) do not apply.
- 2) When the original highest measured SAR is  $\geq 0.80$  W/kg, repeat that measurement once.
- 3) Perform a second repeated measurement only if the ratio of largest to smallest SAR for the original and first repeated measurements is  $> 1.20$  or when the original or repeated measurement is  $\geq 1.45$  W/kg (~ 10% from the 1-g SAR limit).
- 4) Perform a third repeated measurement only if the original, first or second repeated measurement is  $\geq 1.5$  W/kg and the ratio of largest to smallest SAR for the original, first and second repeated measurements is  $> 1.20$ .

The same procedures should be adapted for measurements according to extremity and occupational exposure limits by applying a factor of 2.5 for extremity exposure and a factor of 5 for occupational exposure to the corresponding SAR thresholds.

The detailed repeated measurement results are shown in Section 7.2.

### 5.2 SAR measurement uncertainty

Per KDB865664 D01 SAR Measurement 100 MHz to 6 GHz when the highest measured 1-g SAR within a frequency band is  $< 1.5$  W/kg, the extensive SAR measurement uncertainty analysis described in IEEE Std 1528-2013 is not required in SAR reports submitted for equipment approval. The equivalent ratio (1.5/1.6) is applied to extremity and occupational exposure conditions.



## 6 SAR Test Configuration

### 6.1 Test Positions Configuration

#### 6.1.1 General considerations

Per IEEE 1528-2013, two imaginary lines on the handset were established: the vertical centerline and the horizontal line (See Figure 1).

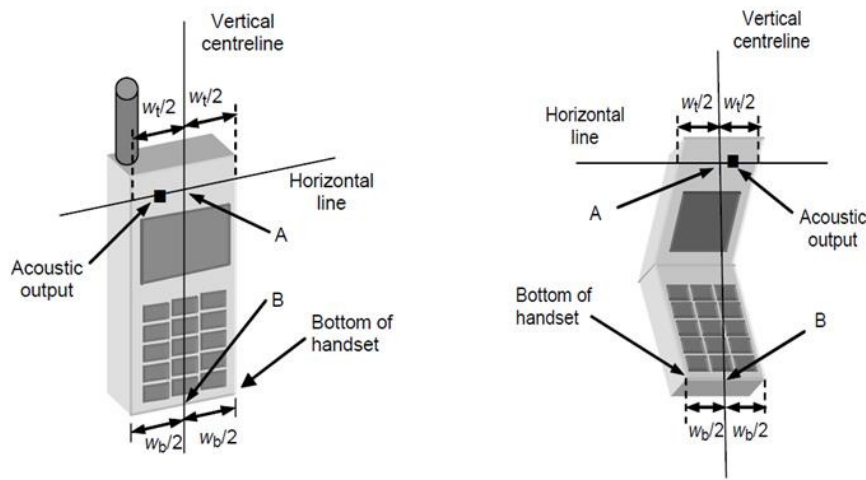

Figure 1 Hand Vertical Center & Horizontal Line Reference Points

#### 6.1.2 Head Exposure Condition

Per IEEE 1528-2013, Head SAR measurements were made in the “cheek” position (See Figure 2) and the “tilt” position (See Figure 3). The device should be tested in both positions on left and right sides of the SAM phantom.

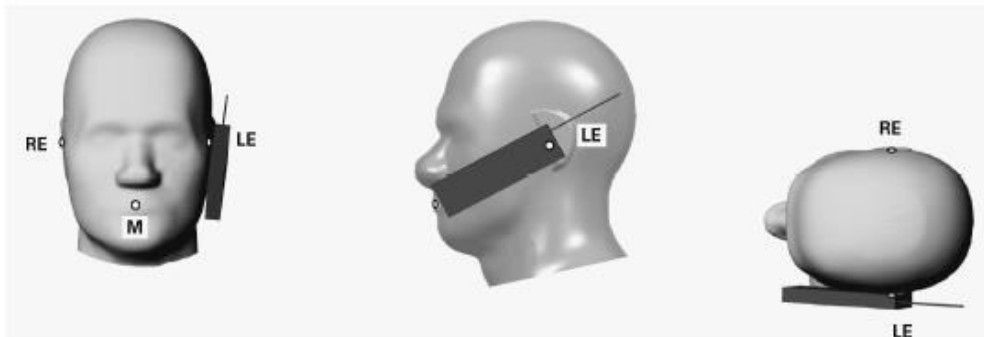

Figure 2 Front, Side and Top View of Cheek Position

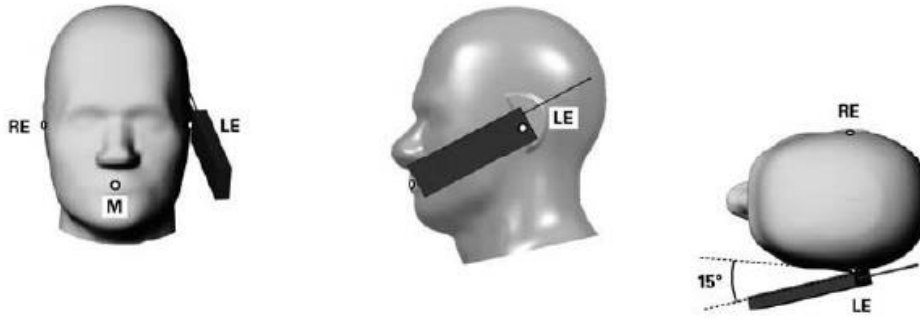

Figure 3 Front, Side and Top View of Tilt 15° Position

Note:

M Mouth reference point

LE Left ear reference point (ERP)

RE Right ear reference point(ERP)

### 6.1.3 Body-worn Exposure Condition

Body-worn operating configurations are tested with the holder attached to the device and positioned against a flat phantom with test separation distance of 15mm in a normal use configuration (See Figure 4). Per FCC KDB648474 D04, Body-worn accessory exposure is typically related to voice mode operations when handsets are carried in body-worn accessories. The body-worn accessory procedures in FCC KDB 447498 should be used to test for body-worn accessory SAR compliance, without a headset connected to it. When the reported SAR for a body-worn accessory, measured without a headset connected to the handset, is  $> 1.2 \text{ W/kg}$ , the highest reported SAR configuration for that wireless mode and frequency band should be repeated for that body-worn accessory with a headset attached to the handset.

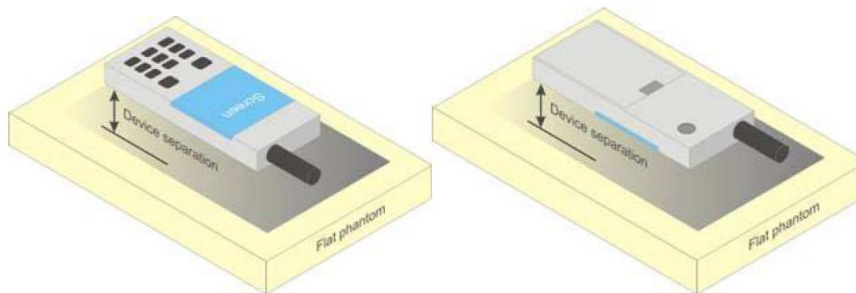

Figure 4 Test position for Body-Worn device

### 6.1.4 Hotspot Exposure Condition

Per FCC KDB 941225D06, The SAR test separation distance for hotspot mode is determined according to device form factor. When the overall length and width of a device is  $> 9 \text{ cm} \times 5 \text{ cm}$ , a test separation distance of 10 mm is required for hotspot mode SAR measurements. A test separation distance of 5 mm or less is required for smaller devices. Hotspot mode SAR is measured for all edges and surfaces of the device with a transmitting antenna located within 25 mm from that surface or edge; for the data modes, wireless technologies and frequency bands supporting hotspot mode. The SAR results are used to determine simultaneous transmission SAR test exclusion for hotspot mode; otherwise, simultaneous transmission SAR measurement is required.

## 6.2 3G SAR Test Reduction Procedure

Per KDB941225 D01, in the following procedures, the mode tested for SAR is referred to as the primary mode. The equivalent modes considered for SAR test reduction are denoted as secondary modes. Both primary and secondary modes must be in the same frequency band. When the maximum output power and tune-up tolerance specified for production units in a secondary mode is  $\leq \frac{1}{4}$  dB higher than the primary mode or when the highest *reported* SAR of the primary mode is scaled by the ratio of specified maximum output power and tune-up tolerance of secondary to primary mode and the adjusted SAR is  $\leq 1.2$  W/kg, SAR measurement is not required for the secondary mode. This is referred to as the 3G SAR test reduction procedure in the following SAR test guidance, where the primary mode is identified in the applicable wireless mode test procedures and the secondary mode is wireless mode being considered for SAR test reduction by that procedure. When the 3G SAR test reduction procedure is not satisfied, it is identified as “otherwise” in the applicable procedures; SAR measurement is required for the secondary mode.

## 6.3 GSM Test Configuration

SAR tests for GSM850 and GSM1900, a communication link is set up with a base station by air link. Using CMU200 the power lever is set to “5” and “0” in SAR of GSM850 and GSM1900. The tests in the band of GSM850 and GSM1900 are performed in the mode of GPRS/EGPRS function. Since the GPRS class is 10 for this EUT, it has at most 2 timeslots in uplink and at most 4 timeslots in downlink, the maximum total timeslot is 5. The EGPRS class is 10 for this EUT, it has at most 2 timeslots in uplink, and at most 4 timeslots in downlink, the maximum total timeslot is 5.

When SAR tests for EGPRS mode is necessary, GMSK modulation should be used to minimize SAR measurement error due to higher peak-to-average power (PAR) ratios inherent in 8-PSK.

## 6.4 UMTS Test Configuration

### 1) Output Power Verification

Maximum output power is verified on the high, middle and low channels according to procedures described in section 5.2 of 3GPP TS 34.121, using the appropriate RMC or AMR with TPC (transmit power control) set to all “1’s” for WCDMA/HSDPA or by applying the required inner loop power control procedures to maintain maximum output power while HSUPA is active. Results for all applicable physical channel configurations (DPCCH, DPDCHn and spreading codes, HSDPA, HSPA) are required in the SAR report. All configurations that are not supported by the handset or cannot be measured due to technical or equipment limitations must be clearly identified.

### 2) WCDMA

#### a. Head SAR Measurements

SAR for next to the ear head exposure is measured using a 12.2 kbps RMC with TPC bits configured to all “1’s”. The 3G SAR test reduction procedure is applied to AMR configurations with 12.2 kbps RMC as the primary mode.

#### b. Body SAR Measurements

SAR for body-worn accessory configurations is measured using a 12.2 kbps RMC with TPC bits configured to all “1’s”. The 3G SAR test reduction procedure is applied to other spreading codes and multiple DPDCHn configurations supported by the handset with 12.2 kbps RMC as the primary mode

### 3) HSDPA

SAR for body exposure configurations is measured according to the “Body SAR Measurements” procedures of 3G device. When the maximum output power and tune-up tolerance specified for production units in a secondary mode is  $\leq \frac{1}{4}$  dB higher than the primary mode or when the highest reported SAR of the primary mode is scaled by the ratio of specified maximum output power and tune-up tolerance of secondary to primary mode and the adjusted SAR is  $\leq 1.2$  W/kg, SAR measurement is not required for the secondary mode. This is referred to as the 3G SAR test reduction procedure in the following SAR test guidance, where the primary mode is identified in the applicable wireless mode test procedures and the secondary mode is wireless mode being considered for SAR test reduction by that procedure. When the 3G SAR test reduction procedure is not satisfied, it is identified as “otherwise” in the applicable procedures; SAR measurement is required for the secondary mode.

Per KDB941225 D01, the 3G SAR test reduction procedure is applied to HSDPA body configurations with 12.2 kbps RMC as the primary mode. Otherwise, SAR is measured for HSDPA using the HSDPA body SAR procedures for the highest reported SAR body exposure configuration in 12.2 kbps RMC.

HSDPA should be configured according to UE category of a test device. The number of HS-DSCH/HS-PDSCHs, HARQ processes, minimum inter-TTI interval, transport block sizes and RV coding sequence are defined by the H-set. To maintain a consistent test configuration and stable transmission condition, QPSK is used in the H-set for SAR testing. HS-DPCCH should be configured with a CQI feedback cycle of 4ms with a CQI repetition factor of 2 to maintain a constant rate of active CQI slots. The  $\beta_c$  and  $\beta_d$  gain factors for DPCCH and DPDCH were set according to the values in the below table,  $\beta_{hs}$  for HS-DPCCH is set automatically to the correct value when  $\Delta ACK, \Delta NACK, \Delta CQI = 8$ . The variation of the  $\beta_c / \beta_d$  ratio causes a power reduction at sub-tests 2 - 4.

Sub-test <sup>1</sup>	$\beta_c$ <sup>2</sup>	$\beta_d$ <sup>2</sup>	$\beta_d$ (SF) <sup>2</sup>	$\beta_c / \beta_d$ <sup>2</sup>	$\beta_{hs}$ (1) <sup>2</sup>	CM(dB)(2) <sup>2</sup>	MPR (dB) <sup>2</sup>
1 <sup>2</sup>	2/15 <sup>2</sup>	15/15 <sup>2</sup>	64 <sup>2</sup>	2/15 <sup>2</sup>	4/15 <sup>2</sup>	0.0 <sup>2</sup>	0 <sup>2</sup>
2 <sup>2</sup>	12/15(3) <sup>2</sup>	15/15(3) <sup>2</sup>	64 <sup>2</sup>	12/15(3) <sup>2</sup>	24/15 <sup>2</sup>	1.0 <sup>2</sup>	0 <sup>2</sup>
3 <sup>2</sup>	15/15 <sup>2</sup>	8/15 <sup>2</sup>	64 <sup>2</sup>	15/8 <sup>2</sup>	30/15 <sup>2</sup>	1.5 <sup>2</sup>	0.5 <sup>2</sup>
4 <sup>2</sup>	15/15 <sup>2</sup>	4/15 <sup>2</sup>	64 <sup>2</sup>	15/4 <sup>2</sup>	30/15 <sup>2</sup>	1.5 <sup>2</sup>	0.5 <sup>2</sup>

Note 1:  $\Delta ACK, \Delta NACK$  and  $\Delta CQI = 8$      $A_{hs} = \beta_{hs} / \beta_c = 30/15$      $\beta_{hs} = 30/15 * \beta_c$   
 Note 2: CM=1 for  $\beta_c / \beta_d = 12/15, \beta_{hs} / \beta_c = 24/15$ . For all other combinations of DPDCH, DPCCH and HS-DPCCH the MPR is based on the relative CM difference. This is applicable for only UEs that support HSDPA in release 6 and later releases.<sup>2</sup>  
 Note 3: For subtest 2 the  $\beta_c / \beta_d$  ratio of 12/15 for the TFC during the measurement period (TF1, TF0) is achieved by setting the signalled gain factors for the reference TFC (TF1, TF1) to  $\beta_c = 11/15$  and  $\beta_d = 15/15$ <sup>2</sup>

Table 7: Sub-tests for UMTS Release 5 HSDPA

The measurements were performed with a Fixed Reference Channel (FRC) and H-Set 1 QPSK.

Parameter	Value
Nominal average inf. bit rate	534 kbit/s
Inter-TTI Distance	3 TTI's
Number of HARQ Processes	2 Processes
Information Bit Payload	3202 Bits
MAC-d PDU size	336 Bits
Number Code Blocks	1 Block

Binary Channel Bits Per TTI	4800 Bits
Total Available SMLs in UE	19200 SMLs
Number of SMLs per HARQ Process	9600 SMLs
Coding Rate	0.67
Number of Physical Channel Codes	5

Table 8: settings of required H-Set 1 QPSK acc. to 3GPP 34.121

HS-DSCH Category	Maximum HS-DSCH Codes Received	Minimum Inter-TTI Interval	Maximum HS-DSCH Transport Block Bits/HS-DSCH TTI	Total Soft Channel Bits
1	5	3	7298	19200
2	5	3	7298	28800
3	5	2	7298	28800
4	5	2	7298	38400
5	5	1	7298	57600
6	5	1	7298	67200
7	10	1	14411	115200
8	10	1	14411	134400
9	15	1	25251	172800
10	15	1	27952	172800
11	5	2	3630	14400
12	5	1	3630	28800
13	15	1	34800	259200
14	15	1	42196	259200
15	15	1	23370	345600
16	15	1	27952	345600

Table 9: HSDPA UE category

#### 4) HSUPA

SAR for body exposure configurations is measured according to the “Body SAR Measurements” procedures of 3G device. When the maximum output power and tune-up tolerance specified for production units in a secondary mode is  $\leq \frac{1}{4}$  dB higher than the primary mode or when the highest *reported* SAR of the primary mode is scaled by the ratio of specified maximum output power and tune-up tolerance of secondary to primary mode and the adjusted SAR is  $\leq 1.2$  W/kg, SAR measurement is not required for the secondary mode.

Per KDB941225 D01, the 3G SAR test reduction procedure is applied to HSPA (HSUPA/HSDPA with RMC) body configurations with 12.2 kbps RMC as the primary mode. Otherwise, SAR is measured for HSPA using the HSPA body SAR procedures for the highest reported body exposure SAR configuration in 12.2 kbps RMC.

Due to inner loop power control requirements in HSDPA, a commercial communication test set should be used for the output power and SAR tests. The 12.2 kbps RMC, FRC H-set 1 and E-DCH

configurations for HSDPA should be configured according to the values indicated below as well as other applicable procedures described in the 'WCDMA Handset' and 'Release 5 HSDPA Data Device' sections of 3G device.

Sub-test <sup>Ⓢ</sup>	$\beta_{c^{\circ}}$	$\beta_{d^{\circ}}$	$\beta_d$ (SF) <sup>Ⓢ</sup>	$\beta_c/\beta_d^{\circ}$	$\beta_{hs}^{(1)}$ <sup>Ⓢ</sup>	$\beta_{ec^{\circ}}$	$\beta_{ed^{\circ}}$	$\beta_{e^{\circ}}$ (SF) <sup>Ⓢ</sup>	$\beta_{ed^{\circ}}$ (code) <sup>Ⓢ</sup>	CM <sup>(2)</sup> <sup>Ⓢ</sup> (dB) <sup>Ⓢ</sup>	MP R <sup>Ⓢ</sup> (dB) <sup>Ⓢ</sup>	AG <sup>(4)</sup> <sup>Ⓢ</sup> Index <sup>Ⓢ</sup>	E-TFC I <sup>Ⓢ</sup>
1 <sup>Ⓢ</sup>	11/15 <sup>(3)</sup> <sup>Ⓢ</sup>	15/15 <sup>(3)</sup> <sup>Ⓢ</sup>	64 <sup>Ⓢ</sup>	11/15 <sup>(3)</sup> <sup>Ⓢ</sup>	22/15 <sup>Ⓢ</sup>	209/225 <sup>Ⓢ</sup>	1039/225 <sup>Ⓢ</sup>	4 <sup>Ⓢ</sup>	1 <sup>Ⓢ</sup>	1.0 <sup>Ⓢ</sup>	0.0 <sup>Ⓢ</sup>	20 <sup>Ⓢ</sup>	75 <sup>Ⓢ</sup>
2 <sup>Ⓢ</sup>	6/15 <sup>Ⓢ</sup>	15/15 <sup>Ⓢ</sup>	64 <sup>Ⓢ</sup>	6/15 <sup>Ⓢ</sup>	12/15 <sup>Ⓢ</sup>	12/15 <sup>Ⓢ</sup>	94/75 <sup>Ⓢ</sup>	4 <sup>Ⓢ</sup>	1 <sup>Ⓢ</sup>	3.0 <sup>Ⓢ</sup>	2.0 <sup>Ⓢ</sup>	12 <sup>Ⓢ</sup>	67 <sup>Ⓢ</sup>
3 <sup>Ⓢ</sup>	15/15 <sup>Ⓢ</sup>	9/15 <sup>Ⓢ</sup>	64 <sup>Ⓢ</sup>	15/9 <sup>Ⓢ</sup>	30/15 <sup>Ⓢ</sup>	30/15 <sup>Ⓢ</sup>	$\beta_{ed1}:47/15^{\circ}$ $\beta_{ed2}:47/15^{\circ}$	4 <sup>Ⓢ</sup>	2 <sup>Ⓢ</sup>	2.0 <sup>Ⓢ</sup>	1.0 <sup>Ⓢ</sup>	15 <sup>Ⓢ</sup>	92 <sup>Ⓢ</sup>
4 <sup>Ⓢ</sup>	2/15 <sup>Ⓢ</sup>	15/15 <sup>Ⓢ</sup>	64 <sup>Ⓢ</sup>	2/15 <sup>Ⓢ</sup>	4/15 <sup>Ⓢ</sup>	2/15 <sup>Ⓢ</sup>	56/75 <sup>Ⓢ</sup>	4 <sup>Ⓢ</sup>	1 <sup>Ⓢ</sup>	3.0 <sup>Ⓢ</sup>	2.0 <sup>Ⓢ</sup>	17 <sup>Ⓢ</sup>	71 <sup>Ⓢ</sup>
5 <sup>Ⓢ</sup>	15/15 <sup>(4)</sup> <sup>Ⓢ</sup>	15/15 <sup>(4)</sup> <sup>Ⓢ</sup>	64 <sup>Ⓢ</sup>	15/15 <sup>(4)</sup> <sup>Ⓢ</sup>	30/15 <sup>Ⓢ</sup>	24/15 <sup>Ⓢ</sup>	134/15 <sup>Ⓢ</sup>	4 <sup>Ⓢ</sup>	1 <sup>Ⓢ</sup>	1.0 <sup>Ⓢ</sup>	0.0 <sup>Ⓢ</sup>	21 <sup>Ⓢ</sup>	81 <sup>Ⓢ</sup>

Note 1:  $\Delta ACK, \Delta NACK$  and  $\Delta CQI = 8$      $A_{hs} = \beta_{hs}/\beta_c = 30/15$      $\beta_{hs} = 30/15 * \beta_{c^{\circ}}$   
Note 2: CM = 1 for  $\beta_c/\beta_d = 12/15, \beta_{hs}/\beta_c = 24/15$ . For all other combinations of DPDCH, DPCCH, HS-DPCCH, E-DPDCH and E-DPCCH the MPR is based on the relative CM difference<sup>Ⓢ</sup>  
Note 3 : For subtest 1 the  $\beta_c/\beta_d$  ratio of 11/15 for the TFC during the measurement period (TF1, TF0) is achieved by setting the signalled gain factors for the reference TFC (TF1, TF1) to  $\beta_c = 10/15$  and  $\beta_d = 15/15^{\circ}$   
Note 4 : For subtest 5 the  $\beta_c/\beta_d$  ratio of 15/15 for the TFC during the measurement period (TF1, TF0) is achieved by setting the signalled gain factors for the reference TFC (TF1, TF1) to  $\beta_c = 14/15$  and  $\beta_d = 15/15^{\circ}$   
Note 5 : Testing UE using E-DPDCH Physical Layer category 1 Sub-test 3 is not required according to TS 25.306 Table 5.1g<sup>Ⓢ</sup>  
Note 6:  $\beta_{ed}$  can not be set directly; it is set by Absolute Grant Value.<sup>Ⓢ</sup>

Table 10:Subtests for UMTS Release 6 HSUPA

UE E-DCH Category	Maximum E-DCH Codes Transmitted	Number of HARQ Processes	E-DCH TTI(ms)	Minimum Spreading Factor	Maximum E-DCH Transport Block Bits	Max Rate (Mbps)
1	1	4	10	4	7110	0.7296
2	2	8	2	4	2798	1.4592
	2	4	10	4	14484	
3	2	4	10	4	14484	1.4592
4	2	8	2	2	5772	2.9185
	2	4	10	2	20000	2.00
5	2	4	10	2	20000	2.00
6 (No DPDCH)	4	8	10	2SF2&2SF	11484	5.76
	4	4	2	4	20000	2.00
7 (No DPDCH)	4	8	2	2SF2&2SF	22996	?
	4	4	10	4	20000	?

NOTE: When 4 codes are transmitted in parallel, two codes shall be transmitted with SF2 and two with SF4. UE categories 1 to 6 support QPSK only. UE category 7 supports QPSK and 16QAM. (TS25.306-7.3.0).

Table 11:HSUPA UE category



## 5) DC-HSDPA

SAR is required for Rel. 8 DC-HSDPA when SAR is required for Rel. 5 HSDPA; otherwise, the 3G SAR test reduction procedure is applied to DC-HSDPA with 12.2 kbps RMC as the primary mode. Power is measured for DC-HSDPA according to the H-Set 12, FRC configuration in Table C.8.1.12 of 3GPP TS 34.121-1 to determine SAR test reduction. A primary and a Second serving HS-DSCH Cell are required to perform the power measurement and for the results to be acceptable.

The following tests were completed according to procedures in section 7.3.13 of 3GPP TS 34.108 v9.5.0. A summary of these settings are illustrated below:

Downlink Physical Channels are set as per 3GPP TS34.121-1 v9.0.0 E.5.0

**Table E.5.0: Levels for HSDPA connection setup**

Parameter During Connection setup	Unit	Value
P-CPICH_Ec/Ior	dB	-10
P-CCPCH and SCH_Ec/Ior	dB	-12
PICH_Ec/Ior	dB	-15
HS-PDSCH	dB	off
HS-SCCH_1	dB	off
DPCH_Ec/Ior	dB	-5
OCNS_Ec/Ior	dB	-3.1

Call is set up as per 3GPP TS34.108 v9.5.0 sub clause 7.3.13

The configurations of the fixed reference channels for HSDPA RF tests are described in 3GPP TS 34.121, annex C for FDD and 3GPP TS 34.122.

The measurements were performed with a Fixed Reference Channel (FRC) H-Set 12 with QPSK

Parameter	Value
Nominal average inf. bit rate	60 kbit/s
Inter-TTI Distance	1 TTI's
Number of HARQ Processes	6 Processes
Information Bit Payload	120 Bits
Number Code Blocks	1 Block
Binary Channel Bits Per TTI	960 Bits
Total Available SMLs in UE	19200 SMLs
Number of SMLs per HARQ Process	3200 SMLs
Coding Rate	0.15
Number of Physical Channel Codes	1

Table 12: settings of required H-Set 12 QPSK acc. to 3GPP 34.121

Note:

- 1.The RMC is intended to be used for DC-HSDPA mode and both cells shall transmit with identical parameters as listed in the table above.
- 2.Maximum number of transmission is limited to 1,i.e.,retransmission is not allowed. The redundancy and constellation version 0 shall be used.

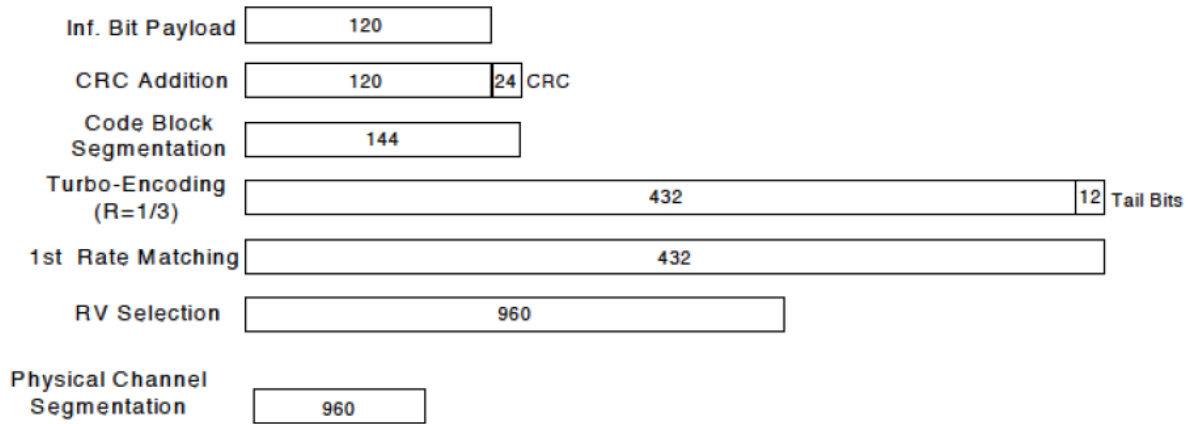

**Figure C.8.19: Coding rate for Fixed reference Channel H-Set 12 (QPSK)**

The following 4 Sub-tests for HSDPA were completed according to Release 5 procedures. A summary of subtest settings are illustrated below:

Sub-test <sup>o</sup>	$\beta_c$ <sup>o</sup>	$\beta_d$ <sup>o</sup>	$\beta_d$ (SF) <sup>o</sup>	$\beta_c/\beta_d$ <sup>o</sup>	$\beta_{hs}(1)$ <sup>o</sup>	CM(dB)(2) <sup>o</sup>	MPR (dB) <sup>o</sup>
1 <sup>o</sup>	2/15 <sup>o</sup>	15/15 <sup>o</sup>	64 <sup>o</sup>	2/15 <sup>o</sup>	4/15 <sup>o</sup>	0.0 <sup>o</sup>	0 <sup>o</sup>
2 <sup>o</sup>	12/15(3) <sup>o</sup>	15/15(3) <sup>o</sup>	64 <sup>o</sup>	12/15(3) <sup>o</sup>	24/15 <sup>o</sup>	1.0 <sup>o</sup>	0 <sup>o</sup>
3 <sup>o</sup>	15/15 <sup>o</sup>	8/15 <sup>o</sup>	64 <sup>o</sup>	15/8 <sup>o</sup>	30/15 <sup>o</sup>	1.5 <sup>o</sup>	0.5 <sup>o</sup>
4 <sup>o</sup>	15/15 <sup>o</sup>	4/15 <sup>o</sup>	64 <sup>o</sup>	15/4 <sup>o</sup>	30/15 <sup>o</sup>	1.5 <sup>o</sup>	0.5 <sup>o</sup>

Note 1:  $\Delta ACK$ ,  $\Delta NACK$  and  $\Delta CQI=8$      $A_{hs} = \beta_{hs}/\beta_c = 30/15$      $\beta_{hs} = 30/15 * \beta_c$ <sup>o</sup>

Note 2: CM=1 for  $\beta_c/\beta_d=12/15$ ,  $\beta_{hs}/\beta_c=24/15$ . For all other combinations of DPDCH, DPCCH and HS-DPCCH the MPR is based on the relative CM difference. This is applicable for only UEs that support HSDPA in release 6 and later releases.<sup>o</sup>

Note 3: For subtest 2 the  $\beta_c/\beta_d$  ratio of 12/15 for the TFC during the measurement period (TF1, TF0) is achieved by setting the signalled gain factors for the reference TFC (TF1, TF1) to  $\beta_c=11/15$  and  $\beta_d=15/15$ <sup>o</sup>

Up commands are set continuously to set the UE to Max power.

Note:

1. The Dual Carriers transmission only applies to HSDPA physical channels
2. The Dual Carriers belong to the same Node and are on adjacent carriers.
3. The Dual Carriers do not support MIMO to serve UEs configured for dual cell operation
4. The Dual Carriers operate in the same frequency band .
5. The device doesn't support the modulation of 16QAM in uplink but 64QAM in downlink for DC-HSDPA mode.
6. The device doesn't support carrier aggregation for it just can operate in Release 8.



## 6.5 LTE Test Configuration

SAR for LTE band exposure configurations is measured according to the procedures of KDB 941225 D05 SAR for LTE Devices. The CMW500 WideBand Radio Communication Tester was used for LTE output power measurements and SAR testing. Closed loop power control was used so the UE transmits with maximum output power during SAR testing. SAR test were performed with the same number of RB and RB offsets transmitting on all TTI frames (Maximum TTI)

### 1) Spectrum Plots for RB configurations

A properly configured base station simulator was used for LTE output power measurements and SAR testing. Therefore, spectrum plots for RB configurations were not required to be included in this report.

### 2) MPR

When MPR is implemented permanently within the UE, regardless of network requirements, only those RB configurations allowed by 3GPP for the channel bandwidth and modulation combinations may be tested with MPR active. Configurations with RB allocations less than the RB thresholds required by 3GPP must be tested without MPR.

The allowed Maximum Power Reduction (MPR) for the maximum output power due to higher order modulation and transmit bandwidth configuration (resource blocks) is specified in Table 6.2.3-1 of the 3GPP TS36.101.

**Table 6.2.3-1: Maximum Power Reduction (MPR) for Power Class 3**

Modulation	Channel bandwidth / Transmission bandwidth (RB)						MPR (dB)
	1.4 MHz	3.0 MHz	5 MHz	10 MHz	15 MHz	20 MHz	
QPSK	> 5	> 4	> 8	> 12	> 16	> 18	≤ 1
16 QAM	≤ 5	≤ 4	≤ 8	≤ 12	≤ 16	≤ 18	≤ 1
16 QAM	> 5	> 4	> 8	> 12	> 16	> 18	≤ 2

### 3) A-MPR

A-MPR (Additional MPR) has been disabled for all SAR tests by using Network Signalling Value of "NS\_01" on the base station simulator.

### 4) LTE procedures for SAR testing

#### A) Largest channel bandwidth standalone SAR test requirements

##### i) QPSK with 1 RB allocation

Start with the largest channel bandwidth and measure SAR for QPSK with 1 RB allocation, using the RB offset and required test channel combination with the highest maximum output power for RB offsets at the upper edge, middle and lower edge of each required test channel. When the reported SAR is ≤ 0.8 W/kg, testing of the remaining RB offset configurations and required test channels is not required for 1 RB allocation; otherwise, SAR is required for the remaining required test channels and only for the RB offset configuration with the highest output power for that channel. When the reported SAR of a required test channel is > 1.45 W/kg, SAR is required for all three RB offset configurations for that required test channel.

##### ii) QPSK with 50% RB allocation

The procedures required for 1 RB allocation in i) are applied to measure the SAR for QPSK with 50% RB allocation.

iii) QPSK with 100% RB allocation

For QPSK with 100% RB allocation, SAR is not required when the highest maximum output power for 100 % RB allocation is less than the highest maximum output power in 50% and 1 RB allocations and the highest reported SAR for 1 RB and 50% RB allocation in i) and ii) are  $\leq 0.8$  W/kg. Otherwise, SAR is measured for the highest output power channel and if the reported SAR is  $> 1.45$  W/kg, the remaining required test channels must also be tested.

iv) Higher order modulations

For each modulation besides QPSK; e.g., 16-QAM, 64-QAM, apply the QPSK procedures in above sections to determine the QAM configurations that may need SAR measurement. For each configuration identified as required for testing, SAR is required only when the highest maximum output power for the configuration in the higher order modulation is  $> \frac{1}{2}$  dB higher than the same configuration in QPSK or when the reported SAR for the QPSK configuration is  $> 1.45$  W/kg.

B) Other channel bandwidth standalone SAR test requirements

For the other channel bandwidths used by the device in a frequency band, apply all the procedures required for the largest channel bandwidth in section A) to determine the channels and RB configurations that need SAR testing and only measure SAR when the highest maximum output power of a configuration requiring testing in the smaller channel bandwidth is  $> \frac{1}{2}$  dB higher than the equivalent channel configurations in the largest channel bandwidth configuration or the reported SAR of a configuration for the largest channel bandwidth is  $> 1.45$  W/kg.

## 6.6 WiFi Test Configuration

For WiFi SAR testing, a communication link is set up with the testing software for WiFi mode test. During the test, at the each test frequency channel, the EUT is operated at the RF continuous emission mode. The RF signal utilized in SAR measurement has 100% duty cycle and its crest factor is 1. The test procedures in KDB 248227D01 are applied. (Refer to KDB 248227D01 for more details)

### 6.6.1 Initial Test Position Procedure

For exposure condition with multiple test position, such as handsets operating next to the ear, devices with hotspot mode or UMPC mini-tablet, procedures for initial test position can be applied. Using the transmission mode determined by the DSSS procedure or initial test configuration, area scans are measured for all position in an exposure condition. The test position with the highest extrapolated (peak) SAR is used as the initial test position. When reported SAR for the initial test position is  $\leq 0.4$  W/kg, no additional testing for the remaining test position is required. Otherwise, SAR is evaluated at the subsequent highest peak SAR position until the reported SAR result is  $\leq 0.8$  W/kg or all test position are measured. For all positions/configurations tested using the initial test position and subsequent test positions, when the *reported* SAR is  $> 0.8$  W/kg, SAR is measured for these test positions/configurations on the subsequent next highest measured output power channel(s) until the *reported* SAR is  $\leq 1.2$  W/kg or all required channels are tested.

### 6.6.2 Initial Test Configuration Procedure

An initial test configuration is determined for OFDM transmission modes according to the channel bandwidth, modulation and data rate combination(s) with the highest maximum output power specified for production units in each standalone and aggregated frequency band. SAR is measured using the highest measured maximum output power channel. For configurations with the same specified or measured maximum output power, additional transmission mode and test channel selection procedures are required (see section 5.3.2 of KDB 248227D01). SAR test reduction of subsequent highest output test channels is based on the *reported* SAR of the initial test configuration.

For next to the ear, hotspot mode and UMC mini-tablet exposure configurations where multiple test positions are required, the initial test position procedure is applied to minimize the number of test positions required for SAR measurement using the initial test configuration transmission mode. For fixed exposure conditions that do not have multiple SAR test positions, SAR is measured in the transmission mode determined by the initial test configuration.

When the *reported* SAR of the initial test configuration is  $> 0.8$  W/kg, SAR measurement is required for the subsequent next highest measured output power channel(s) in the initial test configuration until the *reported* SAR is  $\leq 1.2$  W/kg or all required channels are tested.

### 6.6.3 Sub Test Configuration Procedure

SAR measurement requirements for the remaining 802.11 transmission mode configurations that have not been tested in the initial test configuration are determined separately for each standalone and aggregated frequency band, in each exposure condition, according to the maximum output power specified for production units.

When the highest reported SAR for the initial test configuration, according to the initial test position or fixed exposure position requirements, is adjusted by the ratio of the subsequent test configuration to initial test configuration specified maximum output power and the adjusted SAR is  $\leq 1.2$  W/kg, SAR is not required for that subsequent test configuration.

#### 6.6.4 WiFi 2.4G SAR Test Procedures

Separate SAR procedures are applied to DSSS and OFDM configurations in the 2.4 GHz band to simplify DSSS test requirements. For 802.11b DSSS SAR measurements, DSSS SAR procedure applies to fixed exposure test position and initial test position procedure applies to multiple exposure test positions.

##### A) 802.11b DSSS SAR Test Requirements

SAR is measured for 2.4 GHz 802.11b DSSS using either a fixed test position or, when applicable, the initial test position procedure. SAR test reduction is determined according to the following:

- 1) When the *reported* SAR of the highest measured maximum output power channel (section 3.1 of of KDB 248227D01) for the exposure configuration is  $\leq 0.8$  W/kg, no further SAR testing is required for 802.11b DSSS in that exposure configuration.
- 2) When the *reported* SAR is  $> 0.8$  W/kg, SAR is required for that exposure configuration using the next highest measured output power channel. When any *reported* SAR is  $> 1.2$  W/kg, SAR is required for the third channel; i.e., all channels require testing.

##### B) 2.4GHz 802.11g/n OFDM SAR Test Exclusion Requirements

When SAR measurement is required for 2.4 GHz 802.11g/n OFDM configurations, the measurement and test reduction procedures for OFDM are applied (section 5.3 of of KDB 248227D01). SAR is not required for the following 2.4 GHz OFDM conditions.

- 1) When KDB Publication 447498 SAR test exclusion applies to the OFDM configuration.
- 2) When the highest *reported* SAR for DSSS is adjusted by the ratio of OFDM to DSSS specified maximum output power and the adjusted SAR is  $\leq 1.2$  W/kg.

##### C) SAR Test Requirements for OFDM configurations

When SAR measurement is required for 802.11 a/g/n/ac OFDM configurations, each standalone and frequency aggregated band is considered separately for SAR test reduction. When the same transmitter and antenna(s) are used for U-NII-1 and U-NII-2A bands, additional SAR test reduction applies. When band gap channels between U-NII-2C band and 5.8 GHz U-NII-3 or §15.247 band are supported, the highest maximum output power transmission mode configuration and maximum output power channel across the bands must be used to determine SAR test reduction, according to the initial test configuration and subsequent test configuration requirements. In applying the initial test configuration and subsequent test configuration procedures, the 802.11 transmission configuration with the highest specified maximum output power and the channel within a test configuration with the highest measured maximum output power should be clearly distinguished to apply the procedures.

## 6.6.5 WiFi 5G SAR Test Procedures

### A) U-NII-1 and U-NII-2A Bands

For devices that operate in only one of the U-NII-1 and U-NII-2A bands, the normally required SAR procedures for OFDM configurations are applied. For devices that operate in both U-NII bands using the same transmitter and antenna(s), SAR test reduction is determined according to the following:

- 1) When the same maximum output power is specified for both bands, begin SAR measurement in U-NII-2A band by applying the OFDM SAR requirements. If the highest reported SAR for a test configuration is  $\leq 1.2$  W/kg, SAR is not required for U-NII-1 band for that configuration (802.11 mode and exposure condition); otherwise, both bands are tested independently for SAR.
- 2) When different maximum output power is specified for the bands, begin SAR measurement in the band with higher specified maximum output power. The highest reported SAR for the tested configuration is adjusted by the ratio of lower to higher specified maximum output power for the two bands. When the adjusted SAR is  $\leq 1.2$  W/kg, SAR is not required for the band with lower maximum output power in that test configuration; otherwise, both bands are tested independently for SAR.
- 3) The two U-NII bands may be aggregated to support a 160 MHz channel on channel number 50. Without additional testing, the maximum output power for this is limited to the lower of the maximum output power certified for the two bands. When SAR measurement is required for at least one of the bands and the highest reported SAR adjusted by the ratio of specified maximum output power of aggregated to standalone band is  $> 1.2$  W/kg, SAR is required for the 160 MHz channel. This procedure does not apply to an aggregated band with maximum output higher than the standalone band(s); the aggregated band must be tested independently for SAR. SAR is not required when the 160 MHz channel is operating at a reduced maximum power and also qualifies for SAR test exclusion.

### B) U-NII-2C and U-NII-3 Bands

The frequency range covered by these bands is 380 MHz (5.47 – 5.85 GHz), which requires a minimum of at least two SAR probe calibration frequency points to support SAR measurements. When Terminal Doppler Weather Radar (TDWR) restriction applies, all channels that operate at 5.60 – 5.65 GHz must be included to apply the SAR test reduction and measurement procedures.

When the same transmitter and antenna(s) are used for U-NII-2C band and U-NII-3 band or 5.8 GHz band of §15.247, the bands may be aggregated to enable additional channels with 20, 40 or 80 MHz bandwidth to span across the band gap, as illustrated in Appendix B. The maximum output power for the additional band gap channels is limited to the lower of those certified for the bands. Unless band gap channels are permanently disabled, they must be considered for SAR testing. The frequency range covered by these bands is 380 MHz (5.47 – 5.85 GHz), which requires a minimum of at least two SAR probe calibration frequency points to support SAR measurements. To maintain SAR measurement accuracy and to facilitate test reduction, the channels in U-NII-2C band above 5.65 GHz may be grouped with the 5.8 GHz channels in U-NII-3 or §15.247 band to enable two SAR probe calibration frequency points to cover the bands, including the band gap channels. When band gap channels are supported and the bands are not aggregated for SAR testing, band gap channels must be considered independently in each band according to the normally required OFDM SAR measurement and probe calibration frequency points requirements.

### C) OFDM Transmission Mode SAR Test Configuration and Channel Selection Requirements

The initial test configuration for 5 GHz OFDM transmission modes is determined by the 802.11 configuration with the highest maximum output power specified for production units, including tune-up tolerance, in each standalone and aggregated frequency band. SAR for the initial test configuration is measured using the highest maximum output power channel determined by the default power measurement procedures. When multiple configurations in a frequency band have the same specified maximum output power, the initial test configuration is determined according to the following steps applied sequentially.

- 1) The largest channel bandwidth configuration is selected among the multiple configurations with the same specified maximum output power.
  - 2) If multiple configurations have the same specified maximum output power and largest channel bandwidth, the lowest order modulation among the largest channel bandwidth configurations is selected.
  - 3) If multiple configurations have the same specified maximum output power, largest channel bandwidth and lowest order modulation, the lowest data rate configuration among these configurations is selected.
  - 4) When multiple transmission modes (802.11a/g/n/ac) have the same specified maximum output power, largest channel bandwidth, lowest order modulation and lowest data rate, the lowest order 802.11 mode is selected; i.e., 802.11a is chosen over 802.11n then 802.11ac or 802.11g is chosen over 802.11n.
- After an initial test configuration is determined, if multiple test channels have the same measured maximum output power, the channel chosen for SAR measurement is determined according to the following. These channel selection procedures apply to both the initial test configuration and subsequent test configuration(s), with respect to the default power measurement procedures or additional power measurements required for further SAR test reduction. The same procedures also apply to subsequent highest output power channel(s) selection.
- 1) The channel closest to mid-band frequency is selected for SAR measurement.
  - 2) For channels with equal separation from mid-band frequency; for example, high and low channels or two mid-band channels, the higher frequency (number) channel is selected for SAR measurement.

### D) SAR Test Requirements for OFDM configurations

When SAR measurement is required for 802.11 a/n/ac OFDM configurations, each standalone and frequency aggregated band is considered separately for SAR test reduction. When the same transmitter and antenna(s) are used for U-NII-1 and U-NII-2A bands, additional SAR test reduction applies. When band gap channels between U-NII-2C band and 5.8 GHz U-NII-3 or §15.247 band are supported, the highest maximum output power transmission mode configuration and maximum output power channel across the bands must be used to determine SAR test reduction, according to the initial test configuration and subsequent test configuration requirements. In applying the initial test configuration and subsequent test configuration procedures, the 802.11 transmission configuration with the highest specified maximum output power and the channel within a test configuration with the highest measured maximum output power should be clearly distinguished to apply the procedures.



## 7 SAR Measurement Results

### 7.1 Conducted power measurements

For the measurements a Rohde & Schwarz Radio Communication Tester CMU 200&CMW500 was used. SAR drift measured at the same position in liquid before and after each SAR test as below 7.2 chapter.

Note: CMU200 measures GSM peak and average output power for active timeslots. For SAR the timebased average power is relevant. The difference in between depends on the duty cycle of the TDMA signal :

<b>No. of timeslots</b>	<b>1</b>	<b>2</b>	<b>3</b>	<b>4</b>
Duty Cycle	1:8.3	1:4.1	1:2.77	1:2.08
timebased avg. power compared to slotted avg. power	-9.19dB	-6.13dB	-4.42dB	-3.18dB

The signalling modes differ as follows:

<b>mode</b>	<b>coding scheme</b>	<b>modulation</b>
GPRS	CS1 to CS4	GMSK
EDGE	MCS1 to MCS4	GMSK
EDGE	MCS5 to MCS9	8PSK

Apart from modulation change (GMSK/8PSK) coding schemes differ in code rate without influence on the RF signal. Therefore one coding scheme per mode was selected for conducted power measurements.

### 7.1.1 Conducted power measurements of GSM850 (Main Antenna)

GSM850		Burst-Averaged output Power (dBm)				Division Factors	Frame-Averaged output Power (dBm)			
		Tune-up	128CH	190CH	251CH		Tune-up	128CH	190CH	251CH
GSM (CS)		34.00	32.44	32.68	32.74	-9.19	24.81	23.25	23.49	23.55
GPRS /EDGE (GMSK)	1 Tx Slot	34.00	32.44	32.71	32.78	-9.19	24.81	23.25	23.52	23.59
	2 Tx Slots	31.50	30.01	30.39	30.48	-6.13	<b>25.37</b>	23.88	24.26	24.35
EDGE (8PSK)	1 Tx Slot	27.00	25.39	25.52	25.50	-9.19	17.81	16.2	16.33	16.31
	2 Tx Slots	25.00	23.23	23.35	23.57	-6.13	18.87	17.1	17.22	17.44

Table 13: Conducted power measurement results of GSM850(Full power)

Note:

- 1) Frame-averaged output power was calculated from the measured burst-averaged output power by converting the slot powers into linear units and calculating the energy over 8 timeslots.
- 2) Per KDB941225 D01, SAR test reduction for GPRS and EDGE modes is determined by the source-based time-averaged output power specified for production units, including tune-up tolerance. The data mode with highest specified time-averaged output power should be tested for SAR compliance in the applicable exposure conditions. For modes with the same specified maximum output power and tolerance, the higher number time-slot configuration should be tested.



### 7.1.2 Conducted power measurements of GSM1900 (Main Antenna)

GSM1900		Burst-Averaged output Power (dBm)				Division Factors	Frame-Averaged output Power (dBm)			
		Tune-up	512CH	661CH	810CH		Tune-up	512CH	661CH	810CH
GSM (CS)		31.00	30.12	29.90	29.81	-9.19	21.81	20.93	20.71	20.62
GPRS /EDGE (GMSK)	1 Tx Slot	31.00	30.13	29.89	29.75	-9.19	21.81	20.94	20.70	20.56
	2 Tx Slots	29.00	27.94	27.81	27.91	-6.13	22.87	21.81	21.68	21.78
EDGE (8PSK)	1 Tx Slot	26.00	25.22	24.98	24.94	-9.19	16.81	16.03	15.79	15.75
	2 Tx Slots	24.00	23.00	22.63	22.67	-6.13	17.87	16.87	16.50	16.54

Table 14:Conducted power measurement results of GSM1900(Full power)

GSM1900		Burst-Averaged output Power (dBm)				Division Factors	Frame-Averaged output Power (dBm)			
		Tune-up	512CH	661CH	810CH		Tune-up	512CH	661CH	810CH
GSM (CS)		29.00	27.88	27.72	27.69	-9.19	19.81	18.69	18.53	18.50
GPRS /EDGE (GMSK)	1 Tx Slot	29.00	27.89	27.70	27.67	-9.19	19.81	18.70	18.51	18.48
	2 Tx Slots	26.50	25.51	25.27	25.30	-6.13	<b>20.37</b>	<b>19.38</b>	<b>19.23</b>	<b>19.17</b>
EDGE (8PSK)	1 Tx Slot	27.00	25.16	25.09	25.04	-9.19	17.81	15.97	15.90	15.85
	2 Tx Slots	25.00	23.02	23.06	23.01	-6.13	18.87	16.89	16.93	16.88

Table 15:Conducted power measurement results of GSM1900(After Hotspot activated)

Note:

- 1) Frame-averaged output power was calculated from the measured burst-averaged output power by converting the slot powers into linear units and calculating the energy over 8 timeslots.
- 2) Per KDB941225 D01, SAR test reduction for GPRS and EDGE modes is determined by the source-based time-averaged output power specified for production units, including tune-up tolerance. The data mode with highest specified time-averaged output power should be tested for SAR compliance in the applicable exposure conditions. For modes with the same specified maximum output power and tolerance, the higher number time-slot configuration should be tested.

### 7.1.3 Conducted power measurements of UMTS Band 2 (Main Antenna)

UMTS 1900 ( Band 2)		Tune-up	Average Power (dBm)		
			9262CH	9400CH	9538CH
WCDMA	12.2kbps RMC	<b>25.00</b>	<b>23.53</b>	<b>23.92</b>	<b>23.54</b>
	12.2kbps AMR	25.00	23.45	23.90	23.46
HSDPA	Subtest 1	23.50	22.10	22.18	22.07
	Subtest 2	22.50	21.43	21.54	21.43
	Subtest 3	21.50	20.42	20.51	20.39
	Subtest 4	21.50	20.41	20.49	20.38
HSUPA	Subtest 1	21.50	19.94	19.88	19.80
	Subtest 2	21.00	19.29	19.35	19.31
	Subtest 3	21.00	19.57	19.73	19.43
	Subtest 4	21.50	20.22	20.17	20.32
	Subtest 5	21.50	20.21	20.27	20.10
DC-HSDPA	Subtest 1	23.50	21.98	22.02	21.95
	Subtest 2	22.50	21.29	21.40	21.32
	Subtest 3	21.50	20.30	20.34	20.21
	Subtest 4	21.50	20.24	20.38	20.19

Table 16: Conducted power measurement results of UMTS Band 2(Full power)

UMTS 1900 ( Band 2)		Tune-up	Average Power (dBm)		
			9262CH	9400CH	9538CH
WCDMA	12.2kbps RMC	<b>24.00</b>	<b>22.71</b>	<b>22.81</b>	<b>22.73</b>
	12.2kbps AMR	24.00	22.68	22.78	22.75
HSDPA	Subtest 1	22.50	21.39	21.45	21.35
	Subtest 2	21.50	20.75	20.81	20.72
	Subtest 3	20.50	19.69	19.78	19.69
	Subtest 4	20.50	19.68	19.77	19.67
HSUPA	Subtest 1	20.50	19.43	19.21	19.26
	Subtest 2	20.00	19.33	19.14	19.04
	Subtest 3	20.00	19.18	18.83	18.87
	Subtest 4	20.50	20.04	20.37	20.29
	Subtest 5	20.50	20.18	20.28	20.13
DC-HSDPA	Subtest 1	22.50	21.29	21.32	21.17
	Subtest 2	21.50	20.63	20.65	20.55
	Subtest 3	20.50	19.56	19.65	19.56
	Subtest 4	20.50	19.53	19.60	19.48

Table 17: Conducted power measurement results of UMTS Band 2(After Synchronous transmission with WiFi station)

UMTS 1900 ( Band 2)		Tune-up	Average Power (dBm)		
			9262CH	9400CH	9538CH
WCDMA	12.2kbps RMC	<b>20.00</b>	<b>18.41</b>	<b>18.48</b>	<b>18.31</b>
	12.2kbps AMR	20.00	18.41	18.50	18.38
HSDPA	Subtest 1	18.50	17.11	17.19	17.08
	Subtest 2	17.50	16.51	16.59	16.49
	Subtest 3	16.50	15.33	15.00	15.08
	Subtest 4	16.50	15.44	15.46	15.28
HSUPA	Subtest 1	16.50	15.63	15.40	16.03
	Subtest 2	16.00	14.47	14.30	14.16
	Subtest 3	16.00	15.14	15.00	14.88
	Subtest 4	16.50	16.27	16.12	15.96
	Subtest 5	16.50	16.34	16.23	16.38
DC-HSDPA	Subtest 1	18.50	17.02	17.11	17.00
	Subtest 2	17.50	16.44	16.49	16.50
	Subtest 3	16.50	15.36	15.05	15.12
	Subtest 4	16.50	15.39	15.43	15.24

Table 18: Conducted power measurement results of UMTS Band 2(After Hotspot activated)

Note: 1) The conducted power of UMTS Band 2 is measured with RMS detector.

2) The bolded 12.2kbps RMC mode was selected for SAR testing(the primary mode).

3) Per KDB941225 D01, When the maximum output power and tune-up tolerance specified for production units in a Second mode is  $\leq \frac{1}{4}$  dB higher than the primary mode or when the highest reported SAR of the primary mode is scaled by the ratio of specified maximum output power and tune-up tolerance of Second to primary mode and the adjusted SAR is  $\leq 1.2$  W/kg, SAR measurement is not required for the Second mode.

#### 7.1.4 Conducted power measurements of UMTS Band 4 (Main Antenna)

UMTS 1700 ( Band 4)		Tune-up	Average Power (dBm)		
			1312CH	1413CH	1513CH
WCDMA	12.2kbps RMC	<b>25.00</b>	<b>23.34</b>	<b>23.20</b>	<b>23.26</b>
	12.2kbps AMR	25.00	23.35	23.21	23.28
HSDPA	Subtest 1	24.00	22.01	22.02	22.05
	Subtest 2	23.00	21.36	21.22	21.41
	Subtest 3	22.00	20.31	20.17	20.36
	Subtest 4	22.00	20.30	20.15	20.34
HSUPA	Subtest 1	21.50	19.82	19.66	19.70
	Subtest 2	21.00	19.34	19.10	19.45
	Subtest 3	21.00	19.63	19.36	19.61
	Subtest 4	21.50	20.39	19.61	19.57
	Subtest 5	21.50	20.38	20.01	20.42
DC-HSDPA	Subtest 1	24.00	22.04	22.03	22.01
	Subtest 2	23.00	21.22	21.05	21.29
	Subtest 3	22.00	20.15	20.01	20.23
	Subtest 4	22.00	20.18	20.08	20.19

Table 19: Conducted power measurement results of UMTS Band 4(Full power)

UMTS 1700 ( Band 4)		Tune-up	Average Power (dBm)		
			1312CH	1413CH	1513CH
WCDMA	12.2kbps RMC	<b>24.00</b>	<b>22.48</b>	<b>22.30</b>	<b>22.40</b>
	12.2kbps AMR	24.00	22.50	22.27	22.38
HSDPA	Subtest 1	23.00	21.11	21.04	21.03
	Subtest 2	22.00	20.46	20.21	20.38
	Subtest 3	21.00	19.43	19.17	19.35
	Subtest 4	21.00	19.42	19.16	19.35
HSUPA	Subtest 1	20.50	19.08	18.72	18.53
	Subtest 2	20.00	18.38	18.28	18.60
	Subtest 3	20.00	18.63	19.20	19.15
	Subtest 4	20.50	19.61	18.80	19.12
	Subtest 5	20.50	19.12	18.94	19.24
DC-HSDPA	Subtest 1	23.00	21.07	21.04	21.05
	Subtest 2	22.00	20.36	20.08	20.28
	Subtest 3	21.00	19.27	19.03	19.21
	Subtest 4	21.00	19.27	19.02	19.16

Table 20: Conducted power measurement results of UMTS Band 4(After Synchronous transmission with WiFi station)

UMTS 1700 ( Band 4)		Tune-up	Average Power (dBm)		
			1312CH	1413CH	1513CH
WCDMA	12.2kbps RMC	20.50	18.90	19.16	19.14
	12.2kbps AMR	20.50	18.93	19.16	19.30
HSDPA	Subtest 1	19.50	18.06	17.89	18.05
	Subtest 2	18.50	17.45	17.27	17.42
	Subtest 3	17.00	15.80	15.48	15.92
	Subtest 4	17.00	15.78	15.48	15.93
HSUPA	Subtest 1	17.50	16.21	16.43	16.44
	Subtest 2	17.00	15.88	16.07	16.12
	Subtest 3	17.00	15.75	16.00	16.04
	Subtest 4	17.50	17.06	17.27	17.31
	Subtest 5	17.50	17.16	17.33	17.24
DC-HSDPA	Subtest 1	19.50	18.02	17.88	17.93
	Subtest 2	18.50	17.33	17.14	17.41
	Subtest 3	17.00	15.74	15.40	15.88
	Subtest 4	17.00	15.72	15.45	15.81

Table 21: Conducted power measurement results of UMTS Band 4(After Hotspot activated)

Note: 1) The conducted power of UMTS Band 4 is measured with RMS detector.

2) The bolded 12.2kbps RMC mode was selected for SAR testing(the primary mode).

3) Per KDB941225 D01, When the maximum output power and tune-up tolerance specified for production units in a Second mode is  $\leq \frac{1}{4}$  dB higher than the primary mode or when the highest reported SAR of the primary mode is scaled by the ratio of specified maximum output power and tune-up tolerance of Second to primary mode and the adjusted SAR is  $\leq 1.2$  W/kg, SAR measurement is not required for the Second mode.

### 7.1.5 Conducted power measurements of UMTS Band 5 (Main Antenna)

UMTS850 ( Band 5)		Tune-up	Average Power (dBm)		
			4132CH	4182CH	4233CH
WCDMA	12.2kbps RMC	<b>25.50</b>	<b>24.03</b>	<b>24.11</b>	<b>24.01</b>
	12.2kbps AMR	25.50	24.05	24.10	24.00
HSDPA	Subtest 1	24.50	22.78	22.85	22.85
	Subtest 2	23.50	22.13	22.22	22.23
	Subtest 3	22.50	20.98	21.02	21.07
	Subtest 4	22.50	20.96	21.02	21.07
HSUPA	Subtest 1	22.00	20.80	20.56	20.51
	Subtest 2	21.00	20.06	20.05	19.98
	Subtest 3	21.00	20.10	20.27	20.13
	Subtest 4	22.00	21.76	21.98	21.75
	Subtest 5	22.00	21.12	21.12	21.10
DC-HSDPA	Subtest 1	24.50	22.63	22.71	22.69
	Subtest 2	23.50	21.95	22.07	22.04
	Subtest 3	22.50	20.87	20.86	20.92
	Subtest 4	22.50	20.85	20.84	20.97

Table 22: Conducted power measurement results of UMTS Band 5(Full power)

Note: 1) The conducted power of UMTS Band 5 is measured with RMS detector.

2) The bolded 12.2kbps RMC mode was selected for SAR testing(the primary mode).

3) Per KDB941225 D01, When the maximum output power and tune-up tolerance specified for production units in a Second mode is  $\leq \frac{1}{4}$  dB higher than the primary mode or when the highest reported SAR of the primary mode is scaled by the ratio of specified maximum output power and tune-up tolerance of Second to primary mode and the adjusted SAR is  $\leq 1.2$  W/kg, SAR measurement is not required for the Second mode.

### 7.1.6 Conducted power measurements of LTE Band 2 (Main Antenna)

LTE Band 2					Conducted Power(dBm)		
Bandwidth	Modulation	RB size	RB offset	Tune-up	Channel	Channel	Channel
					18607CH	18900CH	19193CH
1.4MHz	QPSK	1	0	24.00	22.08	22.69	22.47
		1	3	24.00	22.12	22.67	22.40
		1	5	24.00	22.05	22.55	22.27
		3	0	24.00	22.03	22.69	22.38
		3	2	24.00	22.02	22.65	22.35
		3	3	24.00	22.01	22.62	22.31
	16QAM	6	0	22.50	20.92	21.56	21.28
		1	0	23.00	21.04	21.67	21.59
		1	3	23.00	21.16	21.66	21.48
		1	5	23.00	21.19	21.58	21.35
		3	0	23.00	21.03	21.54	21.36
		3	2	23.00	21.09	21.57	21.21
		3	3	23.00	21.09	21.57	21.31
		6	0	22.00	20.92	21.63	21.26
Bandwidth	Modulation	RB size	RB offset	Tune-up	Channel	Channel	Channel
					18615CH	18900CH	19185CH
3MHz	QPSK	1	0	24.00	22.06	22.52	22.50
		1	7	24.00	22.22	22.75	22.60
		1	14	24.00	22.01	22.43	22.16
		8	0	22.50	20.99	21.62	21.39
		8	4	22.50	21.10	21.62	21.38
		8	7	22.50	20.97	21.55	21.20
		15	0	22.50	21.04	21.60	21.34
	16QAM	1	0	23.00	21.07	21.61	21.50
		1	7	23.00	21.20	21.83	21.53
		1	14	23.00	21.07	21.60	21.21
		8	0	22.00	21.03	21.66	21.27
		8	4	22.00	21.10	21.62	21.26
		8	7	22.00	21.05	21.61	21.07
		15	0	22.00	20.96	21.56	21.27

Bandwidth	Modulation	RB size	RB offset	Tune-up	Channel	Channel	Channel
					18625CH	18900CH	19175CH
5MHz	QPSK	1	0	24.00	22.01	22.49	22.36
		1	13	24.00	22.42	22.90	22.67
		1	24	24.00	22.04	22.54	22.14
		12	0	22.50	21.26	21.58	21.47
		12	6	22.50	21.25	21.74	21.53
		12	13	22.50	21.12	21.58	21.18
		25	0	22.50	21.14	21.62	21.27
	16QAM	1	0	23.00	21.11	21.39	21.45
		1	13	23.00	21.42	21.84	21.66
		1	24	23.00	21.13	21.53	21.18
		12	0	22.00	21.29	21.68	21.47
		12	6	22.00	21.27	21.77	21.47
		12	13	22.00	21.15	21.60	21.31
		25	0	22.00	21.10	21.61	21.22
Bandwidth	Modulation	RB size	RB offset	Tune-up	Channel	Channel	Channel
					18650CH	18900CH	19150CH
10MHz	QPSK	1	0	24.00	22.83	22.89	22.89
		1	25	24.00	22.47	22.84	22.60
		1	49	24.00	22.70	22.90	22.66
		25	0	22.50	21.11	21.34	21.51
		25	13	22.50	21.21	21.67	21.40
		25	25	22.50	21.24	21.63	21.20
		50	0	22.50	21.21	21.64	21.37
	16QAM	1	0	23.00	22.12	22.19	22.51
		1	25	23.00	21.67	22.00	21.80
		1	49	23.00	21.90	22.42	21.89
		25	0	22.00	21.06	21.36	21.52
		25	13	22.00	21.17	21.68	21.40
		25	25	22.00	21.12	21.63	21.17
		50	0	22.00	21.14	21.61	21.32



Bandwidth	Modulation	RB size	RB offset	Tune-up	Channel	Channel	Channel
					18675CH	18900CH	19125CH
15MHz	QPSK	1	0	24.00	22.15	22.08	22.06
		1	38	24.00	22.51	22.87	22.93
		1	74	24.00	22.02	22.40	22.17
		36	0	22.50	21.31	21.38	21.21
		36	18	22.50	21.43	21.72	21.58
		36	39	22.50	21.20	21.67	21.19
		75	0	22.50	21.25	21.42	21.39
	16QAM	1	0	23.00	21.04	21.06	21.10
		1	38	23.00	21.61	22.00	21.73
		1	74	23.00	21.07	21.53	21.03
		36	0	22.00	21.27	21.39	21.16
		36	18	22.00	21.31	21.71	21.47
		36	39	22.00	21.15	21.67	21.13
		75	0	22.00	21.18	21.39	21.34
Bandwidth	Modulation	RB size	RB offset	Tune-up	Channel	Channel	Channel
					18700CH	18900CH	19100CH
20MHz	QPSK	1	0	24.00	22.28	22.18	22.74
		1	50	24.00	22.29	22.57	22.22
		1	99	24.00	<b>22.64</b>	<b>22.84</b>	<b>22.52</b>
		50	0	22.50	20.87	20.67	21.01
		50	25	22.50	20.89	<b>21.36</b>	21.30
		50	50	22.50	20.65	21.12	20.83
		100	0	22.50	20.81	20.81	<b>20.89</b>
	16QAM	1	0	23.00	21.60	21.39	22.02
		1	50	23.00	21.71	21.88	21.58
		1	99	23.00	21.94	22.83	22.52
		50	0	22.00	20.82	20.67	20.99
		50	25	22.00	20.82	21.36	21.25
		50	50	22.00	20.55	21.12	20.78
		100	0	22.00	20.75	20.83	20.86

Table 23: Conducted power measurement results of LTE Band 2(Full power)

LTE Band 2					Conducted Power(dBm)		
Bandwidth	Modulation	RB size	RB offset	Tune-up	Channel	Channel	Channel
					18607CH	18900CH	19193CH
1.4MHz	QPSK	1	0	22.50	20.70	21.35	21.14
		1	3	22.50	20.74	21.31	21.04
		1	5	22.50	20.70	21.24	20.91
		3	0	22.50	20.69	21.31	21.04
		3	2	22.50	20.67	21.28	20.94
		3	3	22.50	20.66	21.24	20.94
		6	0	22.00	20.62	21.25	21.06
	16QAM	1	0	22.00	20.76	21.57	21.20
		1	3	22.00	20.73	21.64	21.15
		1	5	22.00	20.71	21.46	20.98
		3	0	22.00	20.80	21.21	21.21
		3	2	22.00	20.65	21.31	21.17
		3	3	22.00	20.79	21.27	21.15
		6	0	21.50	19.59	20.08	20.07
Bandwidth	Modulation	RB size	RB offset	Tune-up	Channel	Channel	Channel
					18615CH	18900CH	19185CH
3MHz	QPSK	1	0	22.50	20.59	21.19	21.04
		1	7	22.50	20.87	21.37	21.16
		1	14	22.50	20.58	21.09	20.76
		8	0	22.00	20.71	21.31	21.10
		8	4	22.00	20.79	21.34	21.06
		8	7	22.00	20.72	21.27	20.95
		15	0	22.00	20.74	21.31	21.03
	16QAM	1	0	22.00	20.69	21.45	21.20
		1	7	22.00	20.93	21.61	21.22
		1	14	22.00	20.66	21.37	20.87
		8	0	21.50	19.53	20.20	20.02
		8	4	21.50	19.77	20.15	19.90
		8	7	21.50	19.64	20.11	19.79
		15	0	21.50	19.71	20.08	19.87

Bandwidth	Modulation	RB size	RB offset	Tune-up	Channel	Channel	Channel
					18625CH	18900CH	19175CH
5MHz	QPSK	1	0	22.50	20.60	21.02	20.90
		1	13	22.50	20.94	21.45	21.16
		1	24	22.50	20.63	21.09	20.67
		12	0	22.00	20.91	21.37	21.14
		12	6	22.00	20.90	21.46	21.18
		12	13	22.00	20.76	21.29	21.01
		25	0	22.00	20.79	21.33	20.97
	16QAM	1	0	22.00	20.70	21.10	21.23
		1	13	22.00	21.04	21.49	21.41
		1	24	22.00	20.76	21.15	21.01
		12	0	21.50	19.78	20.13	20.12
		12	6	21.50	19.93	20.29	20.16
		12	13	21.50	19.80	20.13	19.87
		25	0	21.50	19.79	20.18	19.82
Bandwidth	Modulation	RB size	RB offset	Tune-up	Channel	Channel	Channel
					18650CH	18900CH	19150CH
10MHz	QPSK	1	0	22.50	21.57	21.69	21.63
		1	25	22.50	21.15	21.49	21.22
		1	49	22.50	21.37	21.54	21.32
		25	0	22.00	20.85	21.10	21.26
		25	13	22.00	20.94	21.42	21.13
		25	25	22.00	20.95	21.37	20.92
		50	0	22.00	20.93	21.37	21.07
	16QAM	1	0	22.00	21.52	21.65	21.67
		1	25	22.00	21.29	21.57	21.31
		1	49	22.00	21.50	21.64	21.38
		25	0	21.50	19.80	19.91	20.20
		25	13	21.50	19.86	20.26	20.08
		25	25	21.50	19.87	20.22	19.79
		50	0	21.50	19.87	20.21	20.00

Bandwidth	Modulation	RB size	RB offset	Tune-up	Channel	Channel	Channel
					18675CH	18900CH	19125CH
15MHz	QPSK	1	0	22.50	20.70	20.76	20.69
		1	38	22.50	21.11	21.45	21.29
		1	74	22.50	20.75	20.97	20.54
		36	0	22.00	20.97	21.13	20.87
		36	18	22.00	21.14	21.45	21.23
		36	39	22.00	20.92	21.40	20.89
		75	0	22.00	20.97	21.16	21.07
	16QAM	1	0	22.00	20.75	20.65	20.85
		1	38	22.00	21.38	21.69	21.49
		1	74	22.00	20.60	21.16	20.71
		36	0	21.50	20.00	19.95	19.83
		36	18	21.50	20.06	20.28	20.21
		36	39	21.50	19.79	20.23	19.77
		75	0	21.50	19.87	19.99	19.89
Bandwidth	Modulation	RB size	RB offset	Tune-up	Channel	Channel	Channel
					18700CH	18900CH	19100CH
20MHz	QPSK	1	0	22.50	21.15	21.00	21.58
		1	50	22.50	21.40	21.49	21.19
		1	99	22.50	21.62	22.49	22.16
		50	0	22.00	20.92	20.69	21.07
		50	25	22.00	20.93	21.40	21.33
		50	50	22.00	20.60	21.17	20.83
		100	0	22.00	20.85	20.90	20.97
	16QAM	1	0	22.00	21.58	21.37	21.83
		1	50	22.00	21.69	21.80	21.58
		1	99	22.00	21.94	21.82	21.79
		50	0	21.50	19.85	19.58	19.92
		50	25	21.50	19.77	20.26	20.15
		50	50	21.50	19.53	20.03	19.73
		100	0	21.50	19.75	19.81	19.76

Table 24: Conducted power measurement results of LTE Band 2(After Synchronous transmission with WiFi station)

LTE Band 2					Conducted Power(dBm)		
Bandwidth	Modulation	RB size	RB offset	Tune-up	Channel	Channel	Channel
					18607CH	18900CH	19193CH
1.4MHz	QPSK	1	0	19.50	17.59	18.13	17.89
		1	3	19.50	17.51	18.08	17.83
		1	5	19.50	17.52	17.94	17.68
		3	0	19.00	17.51	18.12	17.81
		3	2	19.00	17.52	18.07	17.80
		3	3	19.00	17.51	18.01	17.82
	16QAM	6	0	18.00	16.30	17.04	16.67
		1	0	18.00	16.36	17.03	16.68
		1	3	18.00	16.43	17.49	16.72
		1	5	18.00	16.41	17.36	16.54
		3	0	18.00	16.32	17.11	16.69
		3	2	18.00	16.36	17.03	16.61
		3	3	18.00	16.30	16.98	16.60
		6	0	17.00	15.38	16.05	15.73
Bandwidth	Modulation	RB size	RB offset	Tune-up	Channel	Channel	Channel
					18615CH	18900CH	19185CH
3MHz	QPSK	1	0	19.50	17.64	17.95	17.82
		1	7	19.50	17.60	18.20	18.06
		1	14	19.50	17.51	17.87	17.55
		8	0	18.00	16.41	17.06	16.80
		8	4	18.00	16.50	17.04	16.73
		8	7	18.00	16.45	16.95	16.64
		15	0	18.00	16.48	16.98	16.72
	16QAM	1	0	18.00	16.50	16.78	16.74
		1	7	18.00	16.65	17.28	16.74
		1	14	18.00	16.48	16.96	16.53
		8	0	17.00	15.46	16.09	15.73
		8	4	17.00	15.59	16.05	15.73
		8	7	17.00	15.53	15.97	15.63
		15	0	17.00	15.47	15.93	15.75

Bandwidth	Modulation	RB size	RB offset	Tune-up	Channel	Channel	Channel
					18625CH	18900CH	19175CH
5MHz	QPSK	1	0	19.50	17.52	17.77	17.77
		1	13	19.50	17.60	18.17	17.98
		1	24	19.50	17.59	17.83	17.75
		12	0	18.00	16.61	17.05	17.03
		12	6	18.00	16.68	17.16	16.92
		12	13	18.00	16.59	17.00	16.66
		25	0	18.00	16.60	17.00	16.70
	16QAM	1	0	18.00	16.49	16.89	16.79
		1	13	18.00	16.82	17.20	16.95
		1	24	18.00	16.61	16.87	16.58
		12	0	17.00	15.65	16.10	15.87
		12	6	17.00	15.73	16.16	15.91
		12	13	17.00	15.65	16.01	15.70
		25	0	17.00	15.67	16.00	15.70
Bandwidth	Modulation	RB size	RB offset	Tune-up	Channel	Channel	Channel
					18650CH	18900CH	19150CH
10MHz	QPSK	1	0	19.50	18.22	18.50	18.75
		1	25	19.50	17.67	18.21	18.07
		1	49	19.50	18.04	18.40	18.05
		25	0	18.00	16.56	16.87	17.17
		25	13	18.00	16.73	17.12	17.06
		25	25	18.00	16.69	17.07	16.67
		50	0	18.00	16.71	17.11	16.87
	16QAM	1	0	18.00	17.61	17.64	17.91
		1	25	18.00	17.17	17.42	17.33
		1	49	18.00	17.40	17.73	17.25
		25	0	17.00	15.64	15.72	16.03
		25	13	17.00	15.82	16.08	15.85
		25	25	17.00	15.82	16.04	15.61
		50	0	17.00	15.74	16.03	15.80

Bandwidth	Modulation	RB size	RB offset	Tune-up	Channel	Channel	Channel
					18675CH	18900CH	19125CH
15MHz	QPSK	1	0	19.50	17.55	17.68	17.70
		1	38	19.50	17.67	18.21	18.18
		1	74	19.50	17.64	17.58	17.62
		36	0	18.00	16.76	16.89	16.71
		36	18	18.00	16.84	17.15	17.06
		36	39	18.00	16.70	17.06	16.66
		75	0	18.00	16.72	16.94	16.90
	16QAM	1	0	18.00	16.37	16.40	16.49
		1	38	18.00	16.96	17.45	17.12
		1	74	18.00	16.43	16.85	16.37
		36	0	17.00	15.81	15.74	15.66
		36	18	17.00	15.96	16.10	15.99
		36	39	17.00	15.77	16.03	15.59
		75	0	17.00	15.80	15.74	15.84
Bandwidth	Modulation	RB size	RB offset	Tune-up	Channel	Channel	Channel
					18700CH	18900CH	19100CH
20MHz	QPSK	1	0	19.50	17.54	17.57	17.92
		1	50	19.50	18.00	18.20	18.05
		1	99	19.50	<b>18.37</b>	<b>18.80</b>	<b>18.79</b>
		50	0	18.00	<b>16.73</b>	16.45	16.78
		50	25	18.00	16.69	<b>17.08</b>	<b>17.06</b>
		50	50	18.00	16.51	16.87	16.64
		100	0	18.00	16.68	16.65	<b>16.75</b>
	16QAM	1	0	18.00	16.93	16.91	17.22
		1	50	18.00	17.35	17.51	17.31
		1	99	18.00	17.62	17.68	17.73
		50	0	17.00	15.71	15.39	15.81
		50	25	17.00	15.77	16.04	16.08
		50	50	17.00	15.55	15.73	15.63
		100	0	17.00	15.71	15.55	15.74

Table 25: Conducted power measurement results of LTE Band 2(After Hotspot activated)

### 7.1.7 Conducted power measurements of LTE Band 4 (Main Antenna)

LTE Band 4					Conducted Power(dBm)		
Bandwidth	Modulation	RB size	RB offset	Tune-up	Channel	Channel	Channel
					19957CH	20175CH	20393CH
1.4MHz	QPSK	1	0	23.5	22.05	22.09	22.46
		1	3	23.5	22.14	22.10	22.45
		1	5	23.5	22.12	21.93	22.39
		3	0	23.5	22.13	22.05	22.48
		3	2	23.5	22.19	22.01	22.43
		3	3	23.5	22.22	21.99	22.41
		6	0	22.5	21.21	21.18	21.54
	16QAM	1	0	22.8	21.60	21.19	21.73
		1	3	22.8	21.70	21.24	21.64
		1	5	22.8	21.29	21.12	21.72
		3	0	22.8	21.48	21.34	21.74
		3	2	22.8	21.43	21.29	21.61
		3	3	22.8	21.50	21.30	21.53
		6	0	21.8	21.23	21.28	21.49
Bandwidth	Modulation	RB size	RB offset	Tune-up	Channel	Channel	Channel
					19965CH	20175CH	20385CH
3MHz	QPSK	1	0	23.5	22.02	21.91	22.45
		1	7	23.5	22.45	22.18	22.54
		1	14	23.5	22.24	21.86	22.19
		8	0	22.5	21.26	21.12	21.52
		8	4	22.5	21.40	21.20	21.57
		8	7	22.5	21.36	21.14	21.46
		15	0	22.5	21.32	21.17	21.58
	16QAM	1	0	22.8	21.33	21.18	21.54
		1	7	22.8	21.67	21.41	21.91
		1	14	22.8	21.51	21.11	21.65
		8	0	21.8	21.27	21.11	21.45
		8	4	21.8	21.30	21.15	21.48
		8	7	21.8	21.33	21.12	21.40
		15	0	21.8	21.30	21.18	21.49



Bandwidth	Modulation	RB size	RB offset	Tune-up	Channel	Channel	Channel
					19975CH	20175CH	20375CH
5MHz	QPSK	1	0	23.5	22.32	22.21	22.75
		1	13	23.5	22.75	22.48	22.84
		1	24	23.5	22.54	22.16	22.49
		12	0	22.5	21.56	21.42	21.82
		12	6	22.5	21.70	21.50	21.87
		12	13	22.5	21.66	21.44	21.76
		25	0	22.5	21.62	21.47	21.88
	16QAM	1	0	22.8	21.63	21.48	21.84
		1	13	22.8	21.97	21.71	22.21
		1	24	22.8	21.81	21.41	21.95
		12	0	21.8	21.57	21.41	21.75
		12	6	21.8	21.60	21.45	21.78
		12	13	21.8	21.63	21.42	21.70
		25	0	21.8	21.60	21.48	21.79
Bandwidth	Modulation	RB size	RB offset	Tune-up	Channel	Channel	Channel
					20000CH	20175CH	20350CH
10MHz	QPSK	1	0	23.5	21.97	21.85	22.49
		1	25	23.5	22.74	22.19	22.68
		1	49	23.5	22.62	22.84	22.62
		25	0	22.5	21.44	21.16	21.66
		25	13	22.5	21.62	21.27	21.66
		25	25	22.5	21.41	21.24	21.55
		50	0	22.5	21.46	21.20	21.80
	16QAM	1	0	22.8	21.29	21.24	21.82
		1	25	22.8	22.04	21.63	22.16
		1	49	22.8	21.82	21.83	22.09
		25	0	21.8	21.39	21.17	21.62
		25	13	21.8	21.53	21.25	21.64
		25	25	21.8	21.32	21.20	21.53
		50	0	21.8	21.40	21.17	21.75

Bandwidth	Modulation	RB size	RB offset	Tune-up	Channel	Channel	Channel
					20025CH	20175CH	20325CH
15MHz	QPSK	1	0	23.5	22.08	21.96	22.31
		1	38	23.5	22.64	22.15	22.87
		1	74	23.5	21.93	21.99	22.25
		36	0	22.5	21.61	21.18	21.70
		36	18	22.5	21.69	21.34	21.75
		36	39	22.5	21.47	21.23	21.89
		75	0	22.5	21.48	21.21	21.84
	16QAM	1	0	22.8	21.26	21.30	21.62
		1	38	22.8	21.80	21.60	22.04
		1	74	22.8	21.13	21.45	21.51
		36	0	21.8	21.57	21.18	21.68
		36	18	21.8	21.63	21.30	21.73
		36	39	21.8	21.41	21.24	21.78
		75	0	21.8	21.40	21.18	21.78
Bandwidth	Modulation	RB size	RB offset	Tune-up	Channel	Channel	Channel
					20050CH	20175CH	20300CH
20MHz	QPSK	1	0	23.5	22.61	22.38	22.53
		1	50	23.5	<b>22.77</b>	22.60	<b>22.97</b>
		1	99	23.5	22.54	<b>22.84</b>	21.92
		50	0	22.5	21.82	21.65	21.78
		50	25	22.5	21.45	21.47	21.76
		50	50	22.5	21.56	21.46	<b>22.18</b>
		100	0	22.5	21.80	21.53	21.90
	16QAM	1	0	22.8	21.50	21.38	21.50
		1	50	22.8	21.88	21.67	22.18
		1	99	22.8	21.63	22.11	22.03
		50	0	21.8	21.53	21.29	21.30
		50	25	21.8	21.41	21.23	21.68
		50	50	21.8	21.22	21.11	21.79
		100	0	21.8	21.47	21.19	21.54

Table 26: Conducted power measurement results of LTE Band 4(Full power)

LTE Band 4					Conducted Power(dBm)		
Bandwidth	Modulation	RB size	RB offset	Tune-up	Channel	Channel	Channel
					19957CH	20175CH	20393CH
1.4MHz	QPSK	1	0	22.5	21.35	21.45	21.78
		1	3	22.5	21.38	21.48	21.83
		1	5	22.5	21.46	21.40	21.68
		3	0	22.5	21.39	21.47	21.77
		3	2	22.5	21.41	21.44	21.81
		3	3	22.5	21.42	21.36	21.71
		6	0	22	21.42	21.39	21.76
	16QAM	1	0	22	21.66	21.62	21.97
		1	3	22	21.87	21.73	21.90
		1	5	22	21.78	21.60	21.88
		3	0	22	21.45	21.53	21.84
		3	2	22	21.47	21.52	21.82
		3	3	22	21.47	21.46	21.74
		6	0	21	20.41	20.43	20.79
Bandwidth	Modulation	RB size	RB offset	Tune-up	Channel	Channel	Channel
					19965CH	20175CH	20385CH
3MHz	QPSK	1	0	22.5	21.26	21.21	21.80
		1	7	22.5	21.72	21.46	21.95
		1	14	22.5	21.48	21.23	21.60
		8	0	22	21.50	21.39	21.82
		8	4	22	21.59	21.43	21.83
		8	7	22	21.56	21.34	21.69
		15	0	22	21.51	21.37	21.82
	16QAM	1	0	22	21.41	21.50	21.66
		1	7	22	21.88	21.78	21.78
		1	14	22	21.59	21.39	21.45
		8	0	21	20.38	20.45	20.72
		8	4	21	20.50	20.37	20.80
		8	7	21	20.49	20.40	20.68
		15	0	21	20.48	20.39	20.80

Bandwidth	Modulation	RB size	RB offset	Tune-up	Channel	Channel	Channel
					19975CH	20175CH	20375CH
5MHz	QPSK	1	0	22.5	21.33	21.27	21.73
		1	13	22.5	21.79	21.60	21.92
		1	24	22.5	21.42	21.20	21.33
		12	0	22	21.63	21.42	21.82
		12	6	22	21.78	21.49	21.93
		12	13	22	21.54	21.36	21.70
		25	0	22	21.51	21.42	21.93
	16QAM	1	0	22	21.48	21.25	21.99
		1	13	22	21.95	21.56	21.85
		1	24	22	21.60	21.17	21.52
		12	0	21	20.60	20.51	20.82
		12	6	21	20.72	20.62	20.88
		12	13	21	20.58	20.47	20.71
		25	0	21	20.52	20.44	20.84
Bandwidth	Modulation	RB size	RB offset	Tune-up	Channel	Channel	Channel
					20000CH	20175CH	20350CH
10MHz	QPSK	1	0	22.5	21.20	21.13	21.66
		1	25	22.5	21.93	21.56	22.08
		1	49	22.5	21.84	21.64	21.98
		25	0	22	21.60	21.38	21.89
		25	13	22	21.73	21.49	21.86
		25	25	22	21.53	21.43	21.78
		50	0	22	21.61	21.40	21.96
	16QAM	1	0	22	21.58	21.42	21.97
		1	25	22	21.70	21.88	21.86
		1	49	22	21.88	21.99	21.80
		25	0	21	20.63	20.40	20.88
		25	13	21	20.66	20.49	20.87
		25	25	21	20.49	20.45	20.70
		50	0	21	20.61	20.41	20.97

Bandwidth	Modulation	RB size	RB offset	Tune-up	Channel	Channel	Channel
					20025CH	20175CH	20325CH
15MHz	QPSK	1	0	22.5	21.39	21.34	21.54
		1	38	22.5	21.86	21.55	22.04
		1	74	22.5	21.17	21.20	21.53
		36	0	22	21.78	21.42	21.84
		36	18	22	21.87	21.57	21.99
		36	39	22	21.76	21.40	21.79
		75	0	22	21.75	21.41	21.95
	16QAM	1	0	22	21.62	21.61	21.84
		1	38	22	21.60	21.85	21.87
		1	74	22	21.39	21.52	21.77
		36	0	21	20.74	20.39	20.83
		36	18	21	20.82	20.58	20.91
		36	39	21	20.74	20.36	20.88
		75	0	21	20.66	20.41	20.98
Bandwidth	Modulation	RB size	RB offset	Tune-up	Channel	Channel	Channel
					20050CH	20175CH	20300CH
20MHz	QPSK	1	0	22.5	21.39	21.25	21.30
		1	50	22.5	21.87	21.55	21.97
		1	99	22.5	21.51	21.75	21.78
		50	0	22	21.82	21.58	21.57
		50	25	22	21.72	21.50	21.88
		50	50	22	21.49	21.33	21.89
		100	0	22	21.74	21.44	21.82
	16QAM	1	0	22	21.91	21.58	21.86
		1	50	22	21.86	21.93	21.77
		1	99	22	21.96	21.89	21.69
		50	0	21	20.74	20.54	20.57
		50	25	21	20.61	20.48	20.90
		50	50	21	20.47	20.24	20.94
		100	0	21	20.71	20.37	20.72

Table 27: Conducted power measurement results of LTE Band 4(After Synchronous transmission with WiFi station)

LTE Band 4					Conducted Power(dBm)		
Bandwidth	Modulation	RB size	RB offset	Tune-up	Channel	Channel	Channel
					19957CH	20175CH	20393CH
1.4MHz	QPSK	1	0	20	19.09	19.33	19.41
		1	3	20	19.19	19.40	19.58
		1	5	20	19.18	19.25	19.51
		3	0	20	19.13	19.32	19.57
		3	2	20	19.14	19.38	19.56
		3	3	20	19.15	19.32	19.47
		6	0	19	18.17	18.28	18.39
	16QAM	1	0	19.3	18.29	18.51	18.64
		1	3	19.3	18.47	18.42	18.71
		1	5	19.3	18.41	18.45	18.40
		3	0	19.3	18.22	18.39	18.54
		3	2	19.3	18.29	18.39	18.55
		3	3	19.3	18.27	18.34	18.47
		6	0	18.3	17.08	17.18	17.34
Bandwidth	Modulation	RB size	RB offset	Tune-up	Channel	Channel	Channel
					19965CH	20175CH	20385CH
3MHz	QPSK	1	0	20	18.98	19.11	19.38
		1	7	20	19.31	19.40	19.53
		1	14	20	19.19	19.10	19.25
		8	0	19	18.19	18.25	18.49
		8	4	19	18.38	18.26	18.47
		8	7	19	18.34	18.20	18.35
		15	0	19	18.26	18.24	18.47
	16QAM	1	0	19.3	18.18	18.04	18.46
		1	7	19.3	18.54	18.67	18.71
		1	14	19.3	18.32	18.05	18.38
		8	0	18.3	17.06	17.19	17.37
		8	4	18.3	17.20	17.22	17.45
		8	7	18.3	17.14	17.15	17.32
		15	0	18.3	17.05	17.14	17.43

Bandwidth	Modulation	RB size	RB offset	Tune-up	Channel	Channel	Channel
					19975CH	20175CH	20375CH
5MHz	QPSK	1	0	20	18.97	19.04	19.40
		1	13	20	19.47	19.49	19.63
		1	24	20	19.00	19.07	19.11
		12	0	19	18.31	18.29	18.48
		12	6	19	18.41	18.34	18.57
		12	13	19	18.24	18.17	18.36
		25	0	19	18.22	18.23	18.66
	16QAM	1	0	19.3	18.23	18.26	18.53
		1	13	19.3	18.63	18.57	18.77
		1	24	19.3	18.32	18.23	18.25
		12	0	18.3	17.21	17.20	17.38
		12	6	18.3	17.37	17.30	17.47
		12	13	18.3	17.20	17.15	17.34
		25	0	18.3	17.11	17.17	17.60
Bandwidth	Modulation	RB size	RB offset	Tune-up	Channel	Channel	Channel
					20000CH	20175CH	20350CH
10MHz	QPSK	1	0	20	18.84	18.94	19.22
		1	25	20	19.49	19.45	19.54
		1	49	20	19.43	19.54	19.71
		25	0	19	18.31	18.24	18.50
		25	13	19	18.39	18.33	18.44
		25	25	19	18.16	18.29	18.42
		50	0	19	18.27	18.27	18.58
	16QAM	1	0	19.3	18.28	18.29	18.39
		1	25	19.3	18.88	18.80	18.71
		1	49	19.3	18.73	18.97	18.76
		25	0	18.3	17.15	17.15	17.44
		25	13	18.3	17.28	17.26	17.43
		25	25	18.3	17.08	17.22	17.35
		50	0	18.3	17.16	17.16	17.51



Bandwidth	Modulation	RB size	RB offset	Tune-up	Channel	Channel	Channel
					20025CH	20175CH	20325CH
15MHz	QPSK	1	0	20	18.94	19.09	19.27
		1	38	20	19.46	19.46	19.58
		1	74	20	18.93	19.11	19.28
		36	0	19	18.44	18.26	18.47
		36	18	19	18.50	18.36	18.56
		36	39	19	18.37	18.23	18.75
		75	0	19	18.40	18.23	18.62
	16QAM	1	0	19.3	18.33	18.25	18.59
		1	38	19.3	18.75	18.62	18.94
		1	74	19.3	18.29	18.31	18.51
		36	0	18.3	17.33	17.08	17.43
		36	18	18.3	17.40	17.30	17.52
		36	39	18.3	17.32	17.11	17.63
		75	0	18.3	17.21	17.10	17.58
Bandwidth	Modulation	RB size	RB offset	Tune-up	Channel	Channel	Channel
					20050CH	20175CH	20300CH
20MHz	QPSK	1	0	20	19.02	19.02	19.21
		1	50	20	<b>19.45</b>	19.47	<b>19.70</b>
		1	99	20	19.38	<b>19.62</b>	19.64
		50	0	19	18.45	18.37	18.32
		50	25	19	18.38	18.36	18.59
		50	50	19	18.27	18.20	<b>18.66</b>
		100	0	19	18.44	18.25	<b>18.48</b>
	16QAM	1	0	19.3	18.42	18.12	18.51
		1	50	19.3	18.87	18.62	18.98
		1	99	19.3	18.74	18.80	18.84
		50	0	18.3	17.33	17.19	17.19
		50	25	18.3	17.27	17.25	17.50
		50	50	18.3	17.13	17.03	17.61
		100	0	18.3	17.31	17.13	17.40

Table 28: Conducted power measurement results of LTE Band 4(After Hotspot activated)

### 7.1.8 Conducted power measurements of LTE Band 5 (Main Antenna)

LTE Band 5					Conducted Power(dBm)		
Bandwidth	Modulation	RB size	RB offset	Tune-up	Channel	Channel	Channel
					20407CH	20525CH	20643CH
1.4MHz	QPSK	1	0	24.00	22.76	22.91	22.93
		1	3	24.00	22.98	23.06	22.89
		1	5	24.00	22.90	22.94	22.80
		3	0	24.00	22.88	22.94	22.83
		3	2	24.00	22.93	22.96	22.76
		3	3	24.00	22.91	23.01	22.82
	16QAM	6	0	23.00	21.96	22.06	22.01
		1	0	23.00	21.92	22.00	22.10
		1	3	23.00	22.04	22.20	21.96
		1	5	23.00	21.98	22.01	21.84
		3	0	23.00	21.90	21.95	21.92
		3	2	23.00	22.00	21.99	21.92
		3	3	23.00	21.99	22.01	21.86
		6	0	22.00	20.95	20.98	21.09
Bandwidth	Modulation	RB size	RB offset	Tune-up	Channel	Channel	Channel
					20415CH	20525CH	20635CH
3MHz	QPSK	1	0	24.00	22.73	22.85	22.97
		1	7	24.00	23.07	23.01	23.05
		1	14	24.00	22.80	22.87	22.69
		8	0	23.00	21.99	22.04	22.08
		8	4	23.00	22.09	22.09	22.03
		8	7	23.00	22.02	22.11	21.93
		15	0	23.00	22.01	22.06	22.07
	16QAM	1	0	23.00	21.77	21.99	22.11
		1	7	23.00	22.24	22.06	22.26
		1	14	23.00	21.93	21.99	21.88
		8	0	22.00	20.93	20.90	21.00
		8	4	22.00	21.04	20.98	20.93
		8	7	22.00	20.96	20.95	20.95
		15	0	22.00	20.92	20.94	21.01

Bandwidth	Modulation	RB size	RB offset	Tune-up	Channel	Channel	Channel
					20425CH	20525CH	20625CH
5MHz	QPSK	1	0	24.00	22.39	22.57	22.73
		1	13	24.00	23.08	23.03	23.02
		1	24	24.00	22.77	22.70	22.43
		12	0	23.00	21.73	21.77	22.01
		12	6	23.00	22.10	22.10	22.20
		12	13	23.00	21.93	22.02	21.81
		25	0	23.00	21.93	22.09	22.16
	16QAM	1	0	23.00	21.44	21.68	21.97
		1	13	23.00	22.19	22.10	22.31
		1	24	23.00	21.77	21.85	21.87
		12	0	22.00	20.66	20.81	20.96
		12	6	22.00	21.10	21.09	21.23
		12	13	22.00	20.99	21.04	20.84
		25	0	22.00	20.95	20.99	21.10
Bandwidth	Modulation	RB size	RB offset	Tune-up	Channel	Channel	Channel
					20450CH	20525CH	20600CH
10MHz	QPSK	1	0	24.00	22.01	22.10	22.18
		1	25	24.00	<b>22.66</b>	22.50	<b>22.90</b>
		1	49	24.00	22.50	<b>22.57</b>	22.38
		25	0	23.00	22.38	22.32	22.44
		25	13	23.00	22.60	22.47	<b>22.70</b>
		25	25	23.00	22.27	22.25	22.56
		50	0	23.00	22.39	22.29	22.56
	16QAM	1	0	23.00	22.13	22.08	22.22
		1	25	23.00	22.84	22.56	22.75
		1	49	23.00	22.75	22.56	22.42
		25	0	22.00	21.35	21.29	21.35
		25	13	22.00	21.52	21.41	21.61
		25	25	22.00	21.20	21.22	21.49
		50	0	22.00	21.24	21.27	21.50

Table 29: Conducted power measurement results of LTE Band 5(Full power)

### 7.1.9 Conducted power measurements of LTE Band 7 (Main Antenna)

LTE Band 7					Conducted Power(dBm)		
Bandwidth	Modulation	RB size	RB offset	Tune-up	Channel	Channel	Channel
					20775CH	21100CH	21425CH
5MHz	QPSK	1	0	23.00	22.03	22.10	22.10
		1	13	23.00	22.11	22.23	22.02
		1	24	23.00	21.99	22.04	21.87
		12	0	22.50	21.57	21.73	21.73
		12	6	22.50	21.62	21.79	21.67
		12	13	22.50	21.46	21.56	21.44
		25	0	22.50	21.51	21.60	21.56
	16QAM	1	0	22.50	21.21	21.58	21.74
		1	13	22.50	21.53	21.69	21.81
		1	24	22.50	21.21	21.24	21.40
		12	0	21.50	20.48	20.65	20.79
		12	6	21.50	20.55	20.70	20.74
		12	13	21.50	20.38	20.50	20.52
		25	0	21.50	20.41	20.49	20.60
Bandwidth	Modulation	RB size	RB offset	Tune-up	Channel	Channel	Channel
					20800CH	21100CH	21400CH
10MHz	QPSK	1	0	23.00	22.07	22.17	22.16
		1	25	23.00	22.13	22.19	22.08
		1	49	23.00	22.24	22.18	21.89
		25	0	22.50	21.51	21.70	21.69
		25	13	22.50	21.57	21.65	21.63
		25	25	22.50	21.58	21.49	21.48
		50	0	22.50	21.68	21.56	21.72
	16QAM	1	0	22.50	21.27	21.81	21.83
		1	25	22.50	21.67	21.91	22.08
		1	49	22.50	21.79	21.81	22.04
		25	0	21.50	20.38	20.61	20.70
		25	13	21.50	20.46	20.56	20.67
		25	25	21.50	20.54	20.42	20.52
		50	0	21.50	20.59	20.48	20.72

Bandwidth	Modulation	RB size	RB offset	Tune-up	Channel	Channel	Channel
					20825CH	21100CH	21375CH
15MHz	QPSK	1	0	23.00	21.82	22.13	22.05
		1	38	23.00	22.16	22.17	22.28
		1	74	23.00	22.20	21.75	21.73
		36	0	22.50	21.56	21.67	21.76
		36	18	22.50	21.72	21.68	21.74
		36	39	22.50	21.67	21.40	21.50
		75	0	22.50	21.64	21.55	21.93
	16QAM	1	0	22.50	21.16	21.71	21.60
		1	38	22.50	21.97	21.96	22.03
		1	74	22.50	21.64	21.32	21.26
		36	0	21.50	20.50	20.63	20.81
		36	18	21.50	20.69	20.62	20.80
		36	39	21.50	20.66	20.36	20.50
		75	0	21.50	20.57	20.45	20.94
Bandwidth	Modulation	RB size	RB offset	Tune-up	Channel	Channel	Channel
					20850CH	21100CH	21350CH
20MHz	QPSK	1	0	23.00	22.00	<b>21.98</b>	<b>22.04</b>
		1	50	23.00	22.04	21.83	21.78
		1	99	23.00	<b>22.15</b>	21.86	21.99
		50	0	22.50	21.85	21.78	<b>21.90</b>
		50	25	22.50	21.77	21.72	21.73
		50	50	22.50	21.81	21.75	21.83
		100	0	22.50	21.35	21.32	21.76
	16QAM	1	0	22.50	21.44	21.84	21.89
		1	50	22.50	21.71	21.60	21.96
		1	99	22.50	21.86	21.56	21.78
		50	0	21.50	20.26	20.20	20.79
		50	25	21.50	20.26	20.24	20.74
		50	50	21.50	20.19	20.20	20.11
		100	0	21.50	20.29	20.20	20.79

Table 30: Conducted power measurement results of LTE Band 7(Full power)

LTE Band 7					Conducted Power(dBm)		
Bandwidth	Modulation	RB size	RB offset	Tune-up	Channel	Channel	Channel
					20775CH	21100CH	21425CH
5MHz	QPSK	1	0	22.00	20.65	20.99	21.02
		1	13	22.00	21.10	21.19	21.11
		1	24	22.00	20.75	20.65	20.71
		12	0	21.50	21.13	21.29	21.31
		12	6	21.50	21.18	21.32	21.24
		12	13	21.50	21.01	21.10	20.97
		25	0	21.50	21.04	21.12	21.15
	16QAM	1	0	21.50	20.92	21.21	21.22
		1	13	21.50	21.28	21.37	21.33
		1	24	21.50	20.81	20.89	20.82
		12	0	20.50	20.07	20.20	20.44
		12	6	20.50	20.14	20.27	20.40
		12	13	20.50	20.00	20.05	20.13
		25	0	20.50	19.98	20.05	20.22
Bandwidth	Modulation	RB size	RB offset	Tune-up	Channel	Channel	Channel
					20800CH	21100CH	21400CH
10MHz	QPSK	1	0	22.00	20.71	21.03	21.08
		1	25	22.00	21.23	21.10	21.33
		1	49	22.00	21.42	20.99	21.25
		25	0	21.50	21.10	21.25	21.30
		25	13	21.50	21.17	21.24	21.23
		25	25	21.50	21.24	21.09	21.07
		50	0	21.50	21.32	21.15	21.25
	16QAM	1	0	21.50	21.05	21.41	21.23
		1	25	21.50	21.44	21.46	21.45
		1	49	21.50	21.45	21.41	21.31
		25	0	20.50	19.99	20.22	20.33
		25	13	20.50	19.97	20.17	20.31
		25	25	20.50	20.08	19.95	20.15
		50	0	20.50	20.18	20.00	20.38

Bandwidth	Modulation	RB size	RB offset	Tune-up	Channel	Channel	Channel
					20825CH	21100CH	21375CH
15MHz	QPSK	1	0	22.00	20.44	20.89	20.98
		1	38	22.00	21.38	21.11	21.33
		1	74	22.00	20.87	20.37	20.46
		36	0	21.50	21.18	21.28	21.41
		36	18	21.50	21.36	21.26	21.37
		36	39	21.50	21.29	20.97	21.03
		75	0	21.50	21.24	21.08	21.42
	16QAM	1	0	21.50	20.58	21.07	21.05
		1	38	21.50	21.47	21.28	21.36
		1	74	21.50	21.09	20.68	20.56
		36	0	20.50	20.10	20.13	20.35
		36	18	20.50	20.21	20.16	20.35
		36	39	20.50	20.16	19.87	20.13
		75	0	20.50	20.14	19.98	20.38
Bandwidth	Modulation	RB size	RB offset	Tune-up	Channel	Channel	Channel
					20850CH	21100CH	21350CH
20MHz	QPSK	1	0	22.00	21.01	21.46	21.43
		1	50	22.00	21.46	21.16	21.44
		1	99	22.00	<b>21.57</b>	21.14	21.11
		50	0	21.50	<b>21.37</b>	21.18	<b>21.42</b>
		50	25	21.50	21.27	<b>21.19</b>	21.38
		50	50	21.50	21.30	21.10	21.13
		100	0	21.50	21.18	21.19	<b>21.36</b>
	16QAM	1	0	21.50	21.38	21.43	21.35
		1	50	21.50	21.32	21.33	21.35
		1	99	21.50	21.44	21.30	21.40
		50	0	20.50	20.23	20.13	20.41
		50	25	20.50	20.15	20.15	20.42
		50	50	20.50	20.17	20.11	20.18
		100	0	20.50	20.25	20.13	20.44

Table 31: Conducted power measurement results of LTE Band 7(After Hotspot actinated)

### 7.1.10 Conducted power measurements of LTE Band 12 (Main Antenna)

LTE Band 12					Conducted Power(dBm)		
Bandwidth	Modulation	RB size	RB offset	Tune-up	Channel	Channel	Channel
					23017CH	23095CH	23173CH
1.4MHz	QPSK	1	0	24.50	22.87	22.90	23.38
		1	3	24.50	23.03	23.03	23.06
		1	5	24.50	23.05	22.91	22.69
		3	0	24.50	22.96	22.93	23.22
		3	2	24.50	23.08	22.99	23.03
		3	3	24.50	23.12	22.99	22.84
		6	0	23.50	22.26	22.08	22.18
	16QAM	1	0	23.50	22.12	22.02	22.58
		1	3	23.50	22.26	22.39	22.13
		1	5	23.50	22.38	22.29	21.77
		3	0	23.50	22.19	22.03	22.29
		3	2	23.50	22.28	22.11	22.06
		3	3	23.50	22.29	22.01	21.92
		6	0	22.50	21.35	21.12	21.30
Bandwidth	Modulation	RB size	RB offset	Tune-up	Channel	Channel	Channel
					23025CH	23095CH	23165CH
3MHz	QPSK	1	0	24.50	22.84	22.80	23.63
		1	7	24.50	23.39	23.09	23.57
		1	14	24.50	23.38	22.89	22.52
		8	0	23.50	22.30	22.00	22.63
		8	4	23.50	22.49	22.06	22.49
		8	7	23.50	22.47	21.98	22.21
		15	0	23.50	22.24	22.01	22.40
	16QAM	1	0	23.50	22.04	21.99	22.76
		1	7	23.50	22.52	22.22	22.78
		1	14	23.50	22.41	22.09	21.82
		8	0	22.50	21.29	21.03	21.65
		8	4	22.50	21.49	21.08	21.59
		8	7	22.50	21.45	20.97	21.24
		15	0	22.50	21.24	21.01	21.39



Bandwidth	Modulation	RB size	RB offset	Tune-up	Channel	Channel	Channel
					23035CH	23095CH	23155CH
5MHz	QPSK	1	0	24.50	22.52	22.59	22.74
		1	13	24.50	23.99	23.38	23.99
		1	24	24.50	22.66	22.53	22.53
		12	0	23.50	22.75	22.47	23.14
		12	6	23.50	23.07	22.51	23.22
		12	13	23.50	22.72	22.49	22.68
		25	0	23.50	22.76	22.54	22.82
	16QAM	1	0	23.50	21.52	21.56	22.03
		1	13	23.50	23.09	22.54	23.30
		1	24	23.50	21.55	21.54	21.60
		12	0	22.50	21.76	21.48	22.14
		12	6	22.50	22.13	21.53	22.24
		12	13	22.50	21.82	21.57	21.73
		25	0	22.50	21.73	21.49	21.87
Bandwidth	Modulation	RB size	RB offset	Tune-up	Channel	Channel	Channel
					23060CH	23095CH	23130CH
10MHz	QPSK	1	0	24.50	23.12	<b>23.48</b>	22.93
		1	25	24.50	<b>23.36</b>	23.10	<b>23.52</b>
		1	49	24.50	22.75	23.39	22.77
		25	0	23.50	22.37	22.10	22.07
		25	13	23.50	22.13	22.14	<b>22.55</b>
		25	25	23.50	21.90	22.12	22.35
		50	0	23.50	22.17	22.07	22.35
	16QAM	1	0	23.50	22.44	22.69	22.28
		1	25	23.50	22.52	22.37	22.93
		1	49	23.50	22.10	22.50	21.99
		25	0	22.50	21.37	21.10	21.08
		25	13	22.50	21.21	21.12	21.61
		25	25	22.50	20.95	21.08	21.42
		50	0	22.50	21.18	21.10	21.34

Table 32: Conducted power measurement results of LTE Band 12(Full power)

### 7.1.11 Conducted power measurements of LTE Band 17 (Main Antenna)

LTE Band 17					Conducted Power(dBm)		
Bandwidth	Modulation	RB size	RB offset	Tune-up	Channel	Channel	Channel
					23755CH	23790CH	238CH25
5MHz	QPSK	1	0	25.00	23.19	23.08	23.10
		1	13	25.00	23.99	23.87	24.67
		1	24	25.00	24.23	24.75	24.77
		12	0	24.00	23.19	22.84	23.52
		12	6	24.00	23.13	23.11	23.83
		12	13	24.00	22.79	23.02	23.76
	16QAM	25	0	24.00	23.02	23.06	23.59
		1	0	24.00	22.32	22.01	22.18
		1	13	24.00	23.14	23.07	23.89
		1	24	24.00	23.40	23.89	23.94
		12	0	23.00	22.27	21.98	22.50
		12	6	23.00	22.20	22.26	22.82
		12	13	23.00	21.91	22.02	22.72
		25	0	23.00	22.06	22.07	22.51
Bandwidth	Modulation	RB size	RB offset	Tune-up	Channel	Channel	Channel
					23780CH	23790	23800CH
10MHz	QPSK	1	0	25.00	24.21	24.10	23.95
		1	25	25.00	23.76	23.93	24.06
		1	49	25.00	<b>24.62</b>	<b>24.61</b>	<b>24.57</b>
		25	0	24.00	22.90	22.77	22.77
		25	13	24.00	22.85	23.07	23.21
		25	25	24.00	22.98	23.01	<b>23.43</b>
		50	0	24.00	22.94	23.07	23.15
	16QAM	1	0	24.00	23.54	23.37	23.14
		1	25	24.00	23.07	23.30	23.27
		1	49	24.00	23.98	23.92	23.83
		25	0	23.00	21.93	21.78	21.78
		25	13	23.00	21.89	22.07	22.17
		25	25	23.00	21.90	21.99	22.31
		50	0	23.00	21.87	22.07	22.09

Table 33: Conducted power measurement results of LTE Band 17(Full power)

### 7.1.12 Conducted power measurements of Downlink LTE CA

In this section, the following conducted power measurement results of downlink LTE carrier aggregation are provided to quantify downlink only carrier aggregation SAR test exclusion per KDB 941225 D05A.

Uplink maximum output power is measured with downlink carrier aggregation active, using the channel with highest measured maximum output power when downlink carrier aggregation is inactive, to confirm that when downlink carrier aggregation is active uplink maximum output power remains within the specified tune-up tolerance limits and not more than ¼ dB higher than the maximum output power measured when downlink carrier aggregation inactive.

Power test equipment: a R&S Radio Communication Tester CMW500 was used.

Initial Conditions							
Test Environment as specified in TS 36.508[7] subclause 4.1				NC[, TL/VL, TL/VH, TH/VL, TH/VH]			
Test Frequencies as specified in TS36.508 [7] subclause 4.3.1 for different CA bandwidth classes.				A: Mid range for PCC and SCC			
Test CC Combination setting ( $N_{RB\_agg}$ ) as specified in subclause 5.4.2A.1 for the CA Configuration				Lowest $N_{RB\_agg}$ Highest $N_{RB\_agg}$			
Test Parameters for CA Configurations							
CA Configuration / $N_{RB\_agg}$		DL Allocation		CC MOD	UL Allocation		
PCC $N_{RB}$	SCCs $N_{RB}$	PCC & SCC RB allocation			$N_{RB\_alloc}$	PCC RB allocations ( $L_{CRB}$ @ $RB_{start}$ )	
6	25	N/A for this test		QPSK	5	P_5@0	-
15	25			QPSK	4	P_4@0	-
25	50			QPSK	8	P_8@0	-
50	75			QPSK	12	P_12@0	-
75	100			QPSK	16	P_16@0	-
100	75			QPSK	18	P_18@0	-
Note 1: CA Configuration Test CC Combination settings are checked separately for each CA Configuration, which applicable aggregated channel bandwidths are specified in Table 5.4.2A.1-1							



Table 34: Conducted power measurement setup of LTE CA per 3GPP TS 36.521-1 V12.6.0

A) The conducted power measurement results of downlink LTE CA Condued Power are as below(Main antenna):

DL LTE CA Class	PCC								SCC			Power	
	PCC Band	PCC Bandwidth (MHz)	PCC UL RB size	PCC UL RB offset	PCC DL RB size	PCC DL RB offset	PCC UL Channel	PCC DL Channel	SCC Band	SCC Bandwidth (MHz)	SCC DL Channel	Rel 8 LTE Tx Power(dBm)	Rel 10 DL LTE CA Tx Power(dBm)
CA_2C	2	15	1	38	75	0	19125	1125	2	15	975	22.93	22.81
CA_2A_4A	2	10	1	49	50	0	18900	900	4	10	2175	22.90	22.85
	4	10	1	49	50	0	20175	2175	2	10	900	22.84	22.90
CA_2A-5A	2	10	1	49	50	0	18900	900	5	10	2450	22.90	22.78
	5	10	1	25	50	0	20600	2600	2	10	1150	22.90	22.86
CA_2A-12A	2	10	1	49	50	0	18900	900	12	10	5060	22.90	22.91
	12	10	1	25	50	0	23060	5060	2	10	900	23.36	23.19
CA_2A-17A	2	10	1	49	50	0	18900	900	17	10	5790	22.90	23.01
	17	10	1	49	50	0	23790	5790	2	10	900	24.61	24.52
CA_4A-5A	4	10	1	49	50	0	20175	2175	5	10	2450	22.84	22.95
	5	10	1	25	50	0	20600	2600	4	10	2350	22.90	22.82
CA_4A-12A	4	10	1	49	50	0	20175	2175	12	10	5130	22.84	22.81
CA_4A-17A	4	10	1	49	50	0	20175	2175	17	10	5230	22.84	22.98

Note: Testing is not required in bands or modes not intended/allowed for US operation.

### 7.1.13 Conducted power measurements of WiFi 2.4G

Mode	Channel	Frequency (MHz)	Tune-up	Average Power (dBm)	SAR Test (Yes/No)
802.11b	1	2412	18	17.19	Yes
	6	2437	18	<b>17.71</b>	
	11	2462	18	17.01	
802.11g	1	2412	17	No Required	No
	6	2437	17	No Required	
	11	2462	17	No Required	
802.11n (20M)	1	2412	17	No Required	No
	6	2437	17	No Required	
	11	2462	17	No Required	

Table 35: Conducted power measurement results of WiFi 2.4G (Full power)

Mode	Channel	Frequency (MHz)	Tune-up	Average Power (dBm)	SAR Test (Yes/No)
802.11b	1	2412	14	12.35	Yes
	6	2437	14	12.81	
	11	2462	14	<b>13.41</b>	
802.11g	1	2412	13	No Required	No
	6	2437	13	No Required	
	11	2462	13	No Required	
802.11n (20M)	1	2412	13	No Required	No
	6	2437	13	No Required	
	11	2462	13	No Required	

Table 36: Conducted power measurement results of WiFi 2.4G (Main antenna +WiFi antenna )

#### 7.1.14 Conducted power measurements of WiFi 5G

Mode	Channel	Frequency (MHz)	Tune-up	Average Power (dBm)	SAR Test (Yes/No)
802.11a	CH 36	5180*	15	13.33	Yes
	CH 40	5200	15	14.45	
	CH 44	5220	15	14.32	
	CH 48	5240*	15	14.08	
	CH 52	5260*	15	<b>14.43</b>	Yes
	CH 56	5280	15	14.16	
	CH 60	5300	15	14.21	
	CH 64	5320*	15	13.22	
	CH 100	5500	15	13.25	Yes
	CH 104	5520*	15	14.37	
	CH 108	5540	15	14.30	
	CH 112	5560	15	14.25	
	CH 116	5580*	15	14.34	
	CH 120	5600	15	14.33	
	CH 124	5620	15	<b>14.38</b>	
	CH 128	5640	15	14.31	
	CH 132	5660	15	14.15	
	CH 136	5680*	15	13.96	
	CH 140	5700	15	13.01	
	CH 144	5720	15	13.62	
	CH 149	5745*	14	12.75	Yes
	CH 153	5765	14	13.42	
	CH 157	5785	14	<b>13.62</b>	
	CH 161	5805*	14	13.57	
CH 165	5825	14	12.80		

Mode	Channel	Frequency (MHz)	Tune-up	Average Power (dBm)	SAR Test (Yes/No)
802.11n 20M (5GHz)	CH 36	5180	14.5	No Required	NO
	CH 40	5200	14.5	No Required	
	CH 44	5220	14.5	No Required	
	CH 48	5240	14.5	No Required	
	CH 52	5260	14.5	No Required	NO
	CH 56	5280	14.5	No Required	
	CH 60	5300	14.5	No Required	
	CH 64	5320	14.5	No Required	
	CH 100	5500	14.5	No Required	NO
	CH 104	5520	14.5	No Required	
	CH 108	5540	14.5	No Required	
	CH 112	5560	14.5	No Required	
	CH 116	5580	14.5	No Required	
	CH 120	5600	14.5	No Required	
	CH 124	5620	14.5	No Required	
	CH 128	5640	14.5	No Required	
	CH 132	5660	14.5	No Required	NO
	CH 136	5680	14.5	No Required	
	CH 140	5700	14.5	No Required	
	CH 144	5720	14.5	No Required	
CH 149	5745	13.5	No Required		
CH 153	5765	13.5	No Required		
CH 157	5785	13.5	No Required		
CH 161	5805	13.5	No Required		
CH 165	5825	13.5	No Required		

Mode	Channel	Frequency (MHz)	Tune-up	Average Power (dBm)	SAR Test (Yes/No)
802.11n 40M (5GHz)	CH 38	5190	14.5	No Required	NO
	CH 46	5230	14.5	No Required	
	CH 54	5270	14.5	No Required	NO
	CH 62	5310	14.5	No Required	
	CH 102	5510	14.5	No Required	NO
	CH 110	5550	14.5	No Required	
	CH 118	5590	14.5	No Required	
	CH 126	5630	14.5	No Required	
	CH 134	5670	14.5	No Required	
	CH 142	5710	14.5	No Required	
	CH 151	5755	13.5	No Required	NO
	CH 159	5795	13.5	No Required	

Mode	Channel	Frequency (MHz)	Tune-up	Average Power (dBm)	SAR Test (Yes/No)
802.11ac-20M (5GHz)	CH 36	5180	14.5	No Required	NO
	CH 40	5200	14.5	No Required	
	CH 44	5220	14.5	No Required	
	CH 48	5240	14.5	No Required	
	CH 52	5260	14.5	No Required	
	CH 56	5280	14.5	No Required	NO
	CH 60	5300	14.5	No Required	
	CH 64	5320	14.5	No Required	
	CH 100	5500	14.5	No Required	
	CH 104	5520	14.5	No Required	
	CH 108	5540	14.5	No Required	NO
	CH 112	5560	14.5	No Required	
	CH 116	5580	14.5	No Required	
	CH 120	5600	14.5	No Required	
	CH 124	5620	14.5	No Required	
	CH 128	5640	14.5	No Required	
	CH 132	5660	14.5	No Required	
	CH 136	5680	14.5	No Required	
	CH 140	5700	14.5	No Required	
	CH 144	5720	14.5	No Required	
CH 149	5745	13.5	No Required	NO	
CH 153	5765	13.5	No Required		
CH 157	5785	13.5	No Required		
CH 161	5805	13.5	No Required		
CH 165	5825	13.5	No Required		



Mode	Channel	Frequency (MHz)	Tune-up	Average Power (dBm)	SAR Test (Yes/No)
802.11ac-40M (5GHz)	CH 38	5190	14.5	No Required	NO
	CH 46	5230	14.5	No Required	
	CH 54	5270	14.5	No Required	NO
	CH 62	5310	14.5	No Required	
	CH 102	5510	14.5	No Required	NO
	CH 110	5550	14.5	No Required	
	CH 118	5590	14.5	No Required	
	CH 126	5630	14.5	No Required	
	CH 134	5670	14.5	No Required	
	CH 142	5710	14.5	No Required	NO
	CH 151	5755	13.5	No Required	
	CH 159	5795	13.5	No Required	

Mode	Channel	Frequency (MHz)	Tune-up	Average Power (dBm)	SAR Test (Yes/No)
802.11ac 80M (5GHz)	CH 42	5210	14.5	No Required	NO
	CH 58	5290	14.5	No Required	NO
	CH 106	5530	14.5	No Required	NO
	CH 122	5610	14.5	No Required	
	CH 138	5690	14.5	No Required	NO
	CH 155	5775	13.5	No Required	

Table 37: Conducted power measurement results of WiFi 5G (Full power).

Note: The Average conducted power of WiFi is measured with RMS detector.

Mode	Channel	Frequency (MHz)	Tune-up	Average Power (dBm)	SAR Test (Yes/No)
802.11a	CH 36	5180*	11	10.10	Yes
	CH 40	5200	11	9.89	
	CH 44	5220	11	9.94	
	CH 48	5240*	11	9.97	
	CH 52	5260*	11	10.65	Yes
	CH 56	5280	11	10.50	
	CH 60	5300	11	10.44	
	CH 64	5320*	11	<b>10.76</b>	
	CH 100	5500	11	9.65	Yes
	CH 104	5520*	11	9.63	
	CH 108	5540	11	9.58	
	CH 112	5560	11	9.47	
	CH 116	5580*	11	9.64	
	CH 120	5600	11	9.53	
	CH 124	5620	11	<b>9.73</b>	
	CH 128	5640	11	9.64	
	CH 132	5660	11	9.51	
	CH 136	5680*	11	9.07	
	CH 140	5700	11	9.11	
	CH 144	5720	11	9.12	
	CH 149	5745*	10.5	9.85	Yes
	CH 153	5765	10.5	9.90	
	CH 157	5785	10.5	9.76	
	CH 161	5805*	10.5	<b>10.16</b>	
CH 165	5825	10.5	9.99		

Mode	Channel	Frequency (MHz)	Tune-up	Average Power (dBm)	SAR Test (Yes/No)
802.11n 20M (5GHz)	CH 36	5180	10.5	No Required	NO
	CH 40	5200	10.5	No Required	
	CH 44	5220	10.5	No Required	
	CH 48	5240	10.5	No Required	
	CH 52	5260	10.5	No Required	NO
	CH 56	5280	10.5	No Required	
	CH 60	5300	10.5	No Required	
	CH 64	5320	10.5	No Required	
	CH 100	5500	10.5	No Required	NO
	CH 104	5520	10.5	No Required	
	CH 108	5540	10.5	No Required	
	CH 112	5560	10.5	No Required	
	CH 116	5580	10.5	No Required	
	CH 120	5600	10.5	No Required	
	CH 124	5620	10.5	No Required	
	CH 128	5640	10.5	No Required	
	CH 132	5660	10.5	No Required	NO
	CH 136	5680	10.5	No Required	
	CH 140	5700	10.5	No Required	
	CH 144	5720	10.5	No Required	
CH 149	5745	10	No Required		
CH 153	5765	10	No Required		
CH 157	5785	10	No Required		
CH 161	5805	10	No Required		
CH 165	5825	10	No Required		

Mode	Channel	Frequency (MHz)	Tune-up	Average Power (dBm)	SAR Test (Yes/No)
802.11n 40M (5GHz)	CH 38	5190	10.5	No Required	NO
	CH 46	5230	10.5	No Required	
	CH 54	5270	10.5	No Required	NO
	CH 62	5310	10.5	No Required	
	CH 102	5510	10.5	No Required	NO
	CH 110	5550	10.5	No Required	
	CH 118	5590	10.5	No Required	
	CH 126	5630	10.5	No Required	
	CH 134	5670	10.5	No Required	
	CH 142	5710	10.5	No Required	NO
	CH 151	5755	10	No Required	
	CH 159	5795	10	No Required	

Mode	Channel	Frequency (MHz)	Tune-up	Average Power (dBm)	SAR Test (Yes/No)
802.11ac-20M (5GHz)	CH 36	5180	10.5	No Required	NO
	CH 40	5200	10.5	No Required	
	CH 44	5220	10.5	No Required	
	CH 48	5240	10.5	No Required	
	CH 52	5260	10.5	No Required	NO
	CH 56	5280	10.5	No Required	
	CH 60	5300	10.5	No Required	
	CH 64	5320	10.5	No Required	
	CH 100	5500	10.5	No Required	NO
	CH 104	5520	10.5	No Required	
	CH 108	5540	10.5	No Required	
	CH 112	5560	10.5	No Required	
	CH 116	5580	10.5	No Required	
	CH 120	5600	10.5	No Required	
	CH 124	5620	10.5	No Required	
	CH 128	5640	10.5	No Required	
	CH 132	5660	10.5	No Required	
	CH 136	5680	10.5	No Required	
	CH 140	5700	10.5	No Required	NO
	CH 144	5720	10.5	No Required	
CH 149	5745	10	No Required		
CH 153	5765	10	No Required		
CH 157	5785	10	No Required		
CH 161	5805	10	No Required		
CH 165	5825	10	No Required		

Mode	Channel	Frequency (MHz)	Tune-up	Average Power (dBm)	SAR Test (Yes/No)
802.11ac-40M (5GHz)	CH 38	5190	10.5	No Required	NO
	CH 46	5230	10.5	No Required	
	CH 54	5270	10.5	No Required	NO
	CH 62	5310	10.5	No Required	
	CH 102	5510	10.5	No Required	NO
	CH 110	5550	10.5	No Required	
	CH 118	5590	10.5	No Required	
	CH 126	5630	10.5	No Required	
	CH 134	5670	10.5	No Required	
	CH 142	5710	10.5	No Required	NO
	CH 151	5755	10	No Required	
	CH 159	5795	10	No Required	

Mode	Channel	Frequency (MHz)	Tune-up	Average Power (dBm)	SAR Test (Yes/No)
802.11ac 80M (5GHz)	CH 42	5210	10.5	No Required	NO
	CH 58	5290	10.5	No Required	NO
	CH 106	5530	10.5	No Required	NO
	CH 122	5610	10.5	No Required	
	CH 138	5690	10.5	No Required	NO
	CH 155	5775	10	No Required	

Table 38: Conducted power measurement results of WiFi 5G (2G&3G&4G + WiFi simultaneous transmission)

Note: The Average conducted power of WiFi is measured with RMS detector.

### 7.1.15 Conducted power measurements of BT

The output power of BT antenna is as following:

BT 2450	Tune-up	Average Conducted Power (dBm)		
		0CH	39CH	78CH
DH5	10.0	<b>9.75</b>	9.45	7.73
2DH5	10.0	5.77	4.25	4.44
3DH5	10.0	5.48	5.36	4.30

BT 2450	Tune-up	Average Conducted Power (dBm)		
		0CH	19CH	39CH
BT 4.0	10.0	6.57	6.91	5.44

Table 39: Conducted power measurement results of BT.

Note: The conducted power of BT is measured with RMS detector.

## 7.2 SAR measurement Results

### General Notes:

- 1) Per KDB447498 D01, all SAR measurement results are scaled to the maximum tune-up tolerance limit to demonstrate SAR compliance.
- 2) Per KDB447498 D01, testing of other required channels within the operating mode of a frequency band is not required when the reported 1-g or 10-g SAR for the mid-band or highest output power channel is:
  - $\leq 0.8\text{W/kg}$  for 1-g or  $2.0\text{W/kg}$  for 10-g respectively, when the transmission band is  $\leq 100\text{MHz}$ .
  - $\leq 0.6\text{ W/kg}$  or  $1.5\text{ W/kg}$ , for 1-g or 10-g respectively, when the transmission band is between 100 MHz and 200 MHz.
  - $\leq 0.4\text{ W/kg}$  or  $1.0\text{ W/kg}$ , for 1-g or 10-g respectively, when the transmission band is  $\geq 200\text{ MHz}$ .When the maximum output power variation across the required test channels is  $> \frac{1}{2}\text{ dB}$ , instead of the middle channel, the highest output power channel must be used.
- 3) Per KDB865664 D01, for each frequency band, repeated SAR measurement is required only when the measured SAR is  $\geq 0.8\text{W/Kg}$ ; if the deviation among the repeated measurement is  $\leq 20\%$ , and the measured SAR  $< 1.45\text{W/Kg}$ , only one repeated measurement is required.
- 4) Per KDB941225 D06, the DUT Dimension is bigger than  $9\text{ cm} \times 5\text{ cm}$ , so 10mm is chosen as the test separation distance for Hotspot mode. When the antenna-to-edge distance is greater than 2.5cm, such position does not need to be tested.
- 5) Per KDB648474 D04, SAR is evaluated without a headset connected to the device. When the standalone reported body-worn SAR is  $\leq 1.2\text{ W/kg}$ , no additional SAR evaluations using a headset are required.
- 6) Per KDB865664 D02, SAR plot is only required for the highest measured SAR in each exposure configuration, wireless mode and frequency band combination; Plots are also required when the measured SAR is  $> 1.5\text{ W/kg}$ , or  $> 7.0\text{ W/kg}$  for occupational exposure. The published RF exposure KDB procedures may require additional plots; for example, to support SAR to peak location separation ratio test exclusion and/or volume scan post-processing(Refer to appendix B for details).
- 7) Additional SAR tests at reduced power levels in Wi-Fi and 2G&3G&4G antenna simultaneous transmission power reduction scenarios may be tested for some frequency bands and test positions, which are only used to ensure simultaneous transmission SAR test exclusion.

### GSM Notes:

- 1) Per KDB941225 D01, SAR test reduction for GPRS and EDGE modes is determined by the source-based time-averaged output power specified for production units, including tune-up tolerance. The data mode with highest specified time-averaged output power should be tested for SAR compliance in the applicable exposure conditions. For modes with the same specified maximum output power and tolerance, the higher number time-slot configuration should be tested.
- 2) Per KDB648474 D04, the device does not support DTM function. Body-worn accessory testing is typically associated with voice operations. Therefore, GSM voice was evaluated for body-worn SAR.

UMTS Notes:

1) Per KDB941225 D01, When the maximum output power and tune-up tolerance specified for production units in a Second mode is  $\leq \frac{1}{4}$  dB higher than the primary mode or when the highest reported SAR of the primary mode is scaled by the ratio of specified maximum output power and tune-up tolerance of Second to primary mode and the adjusted SAR is  $\leq 1.2$  W/kg, SAR measurement is not required for the Second mode.

LTE Notes:

1) The LTE test configurations are determined according to KDB941225 D05 SAR for LTE Devices .The general test procedures used for SAR testing can be found in Section 6.5.

2) A-MPR was disabled for all SAR test by setting NS\_01 on the base station simulator.SAR tests were performed with the same number of RB and RB offsets transmitting on all TTI frames(maximum TTI)

WiFi Notes:

Per KDB248227D01:

1) When reported SAR for the initial test position is  $\leq 0.4$ W/kg, no additional testing for the remaining test position is required. Otherwise, SAR is evaluated at the subsequent highest peak SAR position until the reported SAR result is  $\leq 0.8$ W/kg or all test position are measured. For all positions/configurations tested using the initial test position and subsequent test positions, when the *reported* SAR is  $> 0.8$  W/kg, SAR is measured for these test positions/configurations on the subsequent next highest measured output power channel(s) until the *reported* SAR is  $\leq 1.2$  W/kg or all required channels are tested..

2) When the DSSS *reported* SAR of the highest measured maximum output power channel for the exposure configuration is  $\leq 0.8$  W/kg, no further SAR testing is required for 802.11b DSSS in that exposure configuration.

3) When the highest *reported* SAR for DSSS is adjusted by the ratio of OFDM to DSSS specified maximum output power and the adjusted SAR is  $\leq 1.2$  W/kg, SAR measurement is required for 2.4 GHz 802.11g/n OFDM configurations

4) The highest SAR measured for the initial test position or initial test configuration should be used to determine SAR test exclusion according to the sum of 1-g SAR and SAR peak to location ratio provisions in KDB 447498. In addition, a test lab may also choose to perform standalone SAR measurements for test positions and 802.11 configurations that are not required by the initial test position or initial test configuration procedures and apply the results to determine simultaneous transmission SAR test exclusion, according to sum of 1-g and SAR peak to location ratio requirements to reduce the number of simultaneous transmission SAR measurements.



### 7.2.1 SAR measurement Result of GSM850 (Main Antenna)

Test Position of Head	Test channel /Freq.(MHz)	Test Mode	SAR Value (W/kg)		Power Drift (dB)	Conducted Power (dBm)	Tune-up Limit (dBm)	Reported SAR1-g (W/kg)	SAR Plot.
			1-g	10-g					
Test data of FRD-L04 from original report (report NO.:SYBH(Z-SAR)007052016-2)									
Test data with battery 1#									
Left touch	190/836.6	GSM	0.162	0.113	0.04	32.68	34.00	0.220	/
Left tilt	190/836.6	GSM	0.102	0.070	0.00	32.68	34.00	0.138	/
Right touch	190/836.6	GSM	<b>0.227</b>	0.174	-0.06	32.68	34.00	<b>0.308</b>	/
Right tilt	190/836.6	GSM	0.101	0.071	0.06	32.68	34.00	0.137	/
Right touch	128/824.2	GSM	0.198	0.138	0.14	32.44	34.00	0.284	/
Right touch	251/848.8	GSM	0.183	0.127	0.10	32.74	34.00	0.245	/
Tested at the worst position with battery 2#									
Right touch	190/836.6	GSM	0.210	0.162	-0.02	32.68	34.00	0.285	/
Tested at the worst position with battery 3#									
Right touch	190/836.6	GSM	0.201	0.156	0.05	32.68	34.00	0.272	/
FRD-L24 Test at the worst case from original report with Battery 1#									
Right touch	190/836.6	GSM	<b>0.275</b>	0.217	-0.08	32.68	34.00	<b>0.373</b>	Yes

Table 40: Head SAR test results of GSM850

Test Position of Body-Worn with 15mm	Test channel /Freq.(MHz)	Test Mode	SAR Value (W/kg)		Power Drift (dB)	Conducted Power (dBm)	Tune-up Power (dBm)	Reported SAR1-g (W/kg)	SAR Plot.
			1-g	10-g					
Test data of FRD-L04 from original report (report NO.:SYBH(Z-SAR)007052016-2)									
Test data with battery 1#									
Front Side	190/836.6	GSM	0.277	0.169	-0.08	32.68	34.00	0.375	/
Back Side	190/836.6	GSM	0.295	0.178	-0.07	32.68	34.00	0.400	/
Tested at the worst position with battery 2#									
Back Side	190/836.6	GSM	0.327	0.198	-0.70	32.68	34.00	0.443	/
Tested at the worst position with battery 3#									
Back Side	190/836.6	GSM	<b>0.350</b>	0.210	-0.12	32.68	34.00	<b>0.474</b>	/
FRD-L24 Test at the worst case from original report with Battery 3#									
Back Side	190/836.6	GSM	<b>0.301</b>	0.246	-0.05	32.68	34.00	<b>0.408</b>	Yes

Table 41: Body-Worn SAR test results of GSM850

Test Position of Hotspot with 10mm	Test channel /Freq.(MHz)	Test Mode	SAR Value (W/kg)		Power Drift (dB)	Conducted Power (dBm)	Tune-up Power (dBm)	Reported SAR 1-g (W/kg)	SAR Plot.
			1-g	10-g					
Test data of FRD-L04 from original report (report NO.:SYBH(Z-SAR)007052016-2)									
Test data with battery 1#									
Front Side	190/836.6	GPRS 2TS	0.323	0.228	-0.05	30.39	31.50	0.417	/
Back Side	190/836.6	GPRS 2TS	0.350	0.212	0.07	30.39	31.50	0.452	/
Left Side	190/836.6	GPRS 2TS	0.168	0.112	-0.05	30.39	31.50	0.217	/
Right Side	190/836.6	GPRS 2TS	0.315	0.215	-0.13	30.39	31.50	0.407	/
Bottom Side	190/836.6	GPRS 2TS	0.154	0.082	-0.06	30.39	31.50	0.199	/
Tested at the worst position with battery 2#									
Back Side	190/836.6	GPRS 2TS	0.349	0.215	0.02	30.39	31.50	0.451	/
Tested at the worst position with battery 3#									
Back Side	190/836.6	GPRS 2TS	<b>0.429</b>	0.262	-0.18	30.39	31.50	<b>0.554</b>	/
FRD-L24 Test at the worst case from original report with Battery 3#									
Back Side	190/836.6	GPRS 2TS	<b>0.307</b>	0.188	-0.12	30.39	31.50	<b>0.396</b>	Yes

Table 42: Hotspot SAR test results of GSM850

## 7.2.2 SAR measurement Result of GSM1900 (Main Antenna)

Test Position of Head	Test channel /Freq.(MHz)	Test Mode	SAR Value (W/kg)		Power Drift (dB)	Conducted Power (dBm)	Tune-up Limit (dBm)	Reported SAR1-g (W/kg)	SAR Plot.
			1-g	10-g					
Test data of FRD-L04 from original report (report NO.:SYBH(Z-SAR)007052016-2)									
Test data with battery 1#									
Left touch	661/1880	GSM	0.151	0.093	0.15	29.90	31.00	0.195	/
Left tilt	661/1880	GSM	0.038	0.020	0.12	29.90	31.00	0.048	/
Right touch	661/1880	GSM	0.100	0.062	0.08	29.90	31.00	0.128	/
Right tilt	661/1880	GSM	0.064	0.036	0.12	29.90	31.00	0.082	/
Left touch	512/1850.2	GSM	0.130	0.078	0.13	30.12	31.00	0.159	/
Left touch	810/1909.8	GSM	<b>0.160</b>	0.098	0.16	29.81	31.00	<b>0.210</b>	/
Tested at the worst position with battery 2#									
Left touch	810/1909.8	GSM	0.139	0.083	0.11	29.81	31.00	0.183	/
Tested at the worst position with battery 3#									
Left touch	810/1909.8	GSM	0.142	0.084	0.03	29.81	31.00	0.187	/
FRD-L24 Test at the worst case from original report with Battery 1#									
Left touch	810/1909.8	GSM	<b>0.098</b>	0.061	-0.15	29.81	31.00	<b>0.129</b>	Yes

Table 43: Head SAR test results of GSM1900

Test Position of Body-Worn with 15mm	Test channel /Freq.(MHz)	Test Mode	SAR Value (W/kg)		Power Drift (dB)	Conducted Power (dBm)	Tune-up Power (dBm)	Reported SAR 1-g (W/kg)	SAR Plot.
			1-g	10-g					
Test data of FRD-L04 from original report (report NO.:SYBH(Z-SAR)007052016-2)									
Test data with battery 1#									
Front Side	661/1880	GSM	0.365	0.207	0.04	29.90	31.00	0.470	/
Back Side	661/1880	GSM	0.362	0.215	0.12	29.90	31.00	0.466	/
Tested at the worst position with battery 2#									
Front Side	661/1880	GSM	<b>0.440</b>	0.258	-0.02	29.90	31.00	<b>0.567</b>	/
Tested at the worst position with battery 3#									
Front Side	661/1880	GSM	0.424	0.249	0.14	29.90	31.00	0.546	/
FRD-L24 Test at the worst case from original report with Battery 2#									
Front Side	661/1880	GSM	<b>0.289</b>	0.179	-0.03	29.90	31.00	<b>0.372</b>	Yes

Table 44: Body-Worn SAR test results of GSM1900

Test Position of Hotspot with 10mm	Test channel /Freq.(MHz)	Test Mode	SAR Value (W/kg)		Power Drift (dB)	Conducted Power (dBm)	Tune-up Power (dBm)	Reported SAR 1-g (W/kg)	SAR Plot.
			1-g	10-g					
Test data of FRD-L04 from original report (report NO.:SYBH(Z-SAR)007052016-2)									
Test data with battery 1#									
Front Side	661/1880	GPRS 2TS	0.491	0.270	0.08	25.27	26.50	0.652	/
Back Side	661/1880	GPRS 2TS	0.469	0.259	0.07	25.27	26.50	0.623	/
Left Side	661/1880	GPRS 2TS	0.122	0.065	0.03	25.27	26.50	0.162	/
Right Side	661/1880	GPRS 2TS	0.051	0.028	0.17	25.27	26.50	0.067	/
Bottom Side	661/1880	GPRS 2TS	1.020	0.556	0.14	25.27	26.50	1.354	/
Bottom Side	512/1850.2	GPRS 2TS	0.936	0.514	0.17	25.51	26.50	1.176	/
Bottom Side	810/1909.8	GPRS 2TS	0.922	0.502	-0.10	25.30	26.50	1.215	/
Tested at the worst position with battery 2#									
Bottom Side	661/1880	GPRS 2TS	<b>1.040</b>	0.568	0.10	25.27	26.50	<b>1.380</b>	/
Bottom Side with Repeated	661/1880	GPRS 2TS	0.958	0.523	0.11	25.27	26.50	1.272	/
Tested at the worst position with battery 3#									
Bottom Side	661/1880	GPRS 2TS	0.964	0.514	-0.04	25.27	26.50	1.280	/
FRD-L24 Test at the worst case from original report with Battery 2#									
Bottom Side	661/1880	GPRS 2TS	<b>0.615</b>	0.349	-0.10	25.27	26.50	<b>0.816</b>	Yes

Table 45: Hotspot SAR test results of GSM1900

### 7.2.3 SAR measurement Result of UMTS Band 2 (Main Antenna)

Test Position of Head	Test channel /Freq.(MHz)	Test Mode	SAR Value (W/kg)		Power Drift (dB)	Conducted Power (dBm)	Tune-up Limit (dBm)	Reported SAR 1-g (W/kg)	SAR Plot.
			1-g	10-g					
Test data of FRD-L04 from original report (report NO.:SYBH(Z-SAR)007052016-2)									
Test data with battery 1#									
Left touch	9400/1880	RMC	0.369	0.226	0.19	23.92	25.00	0.473	/
Left tilt	9400/1880	RMC	0.135	0.072	0.08	23.92	25.00	0.173	/
Right touch	9400/1880	RMC	0.236	0.138	0.13	23.92	25.00	0.303	/
Right tilt	9400/1880	RMC	0.175	0.101	-0.04	23.92	25.00	0.224	/
Left touch	9262/1852.4	RMC	0.359	0.225	-0.11	23.53	25.00	0.504	/
Left touch	9538/1907.6	RMC	0.315	0.188	0.15	23.54	25.00	0.441	/
Tested at the worst position with battery 2#									
Left touch	9262/1852.4	RMC	0.328	0.197	0.02	23.53	25.00	0.460	/
Tested at the worst position with battery 3#									
Left touch	9262/1852.4	RMC	<b>0.365</b>	0.227	0.19	23.53	25.00	<b>0.512</b>	/
FRD-L24 Test at the worst case from original report with Battery 3#									
Left touch	9262/1852.4	RMC	<b>0.326</b>	0.201	-0.15	23.53	25.00	<b>0.457</b>	Yes

Table 46: Head SAR test results of UMTS Band 2

Test Position of Body-Worn with 15mm	Test channel /Freq.(MHz)	Test Mode	SAR Value (W/kg)		Power Drift (dB)	Conducted Power (dBm)	Tune-up Power (dBm)	Reported SAR 1-g (W/kg)	SAR Plot.
			1-g	10-g					
Test data of FRD-L04 from original report (report NO.:SYBH(Z-SAR)007052016-2)									
Test data with battery 1#									
Front Side	9400/1880	RMC	0.617	0.366	-0.09	23.92	25.00	0.791	/
Back Side	9400/1880	RMC	0.737	0.434	0.03	23.92	25.00	0.945	/
Back Side	9262/1852.4	RMC	0.665	0.398	-0.08	23.53	25.00	0.933	/
Back Side	9538/1907.6	RMC	0.720	0.418	-0.07	23.54	25.00	1.008	/
Tested at the worst position with battery 2#									
Back Side	9538/1907.6	RMC	0.697	0.410	0.07	23.54	25.00	0.976	/
Tested at the worst position with battery 3#									
Back Side	9538/1907.6	RMC	<b>0.797</b>	0.473	0.03	23.54	25.00	<b>1.115</b>	/
FRD-L24 Test at the worst case from original report with Battery 3#									
Back Side	9538/1907.6	RMC	<b>0.648</b>	0.397	-0.09	23.54	25.00	<b>0.907</b>	Yes

Table 47: Body-Worn SAR test results of UMTS Band 2

Test Position of Hotspot with 10mm	Test channel /Freq.(MHz)	Test Mode	SAR Value (W/kg)		Power Drift (dB)	Conducted Power (dBm)	Tune-up Power (dBm)	Reported SAR 1-g (W/kg)	SAR Plot.
			1-g	10-g					
Test data of FRD-L04 from original report (report NO.:SYBH(Z-SAR)007052016-2)									
Test data with battery 1#									
Front Side	9400/1880	RMC	0.395	0.220	0.02	18.48	20.00	0.561	/
Back Side	9400/1880	RMC	0.396	0.221	0.03	18.48	20.00	0.562	/
Left Side	9400/1880	RMC	0.108	0.058	0.13	18.48	20.00	0.153	/
Right Side	9400/1880	RMC	0.024	0.014	0.05	18.48	20.00	0.034	/
Bottom Side	9400/1880	RMC	0.723	0.388	-0.18	18.48	20.00	1.026	/
Bottom Side	9262/1852.4	RMC	0.710	0.386	-0.09	18.41	20.00	1.024	/
Bottom Side	9538/1907.6	RMC	0.660	0.353	-0.10	18.31	20.00	0.974	/
Tested at the worst position with battery 2#									
Bottom Side	9400/1880	RMC	<b>0.724</b>	0.387	0.09	18.48	20.00	<b>1.027</b>	/
Tested at the worst position with battery 3#									
Bottom Side	9400/1880	RMC	0.704	0.377	0.09	18.48	20.00	0.999	/
FRD-L24 Test at the worst case from original report with Battery 2#									
Bottom Side	9400/1880	RMC	<b>0.786</b>	0.448	-0.13	18.48	20.00	<b>1.115</b>	Yes

Table 48: Hotspot SAR test results of UMTS Band 2

### 7.2.4 SAR measurement Result of UMTS Band 4 (Main Antenna)

Test Position of Head	Test channel /Freq.(MHz)	Test Mode	SAR Value (W/kg)		Power Drift (dB)	Conducted Power (dBm)	Tune-up Limit (dBm)	Reported SAR 1-g (W/kg)	SAR Plot.
			1-g	10-g					
Test data of FRD-L04 from original report (report NO.:SYBH(Z-SAR)007052016-2)									
Test data with battery 1#									
Left touch	1413/1732.6	RMC	0.324	0.206	0.12	23.20	25.00	0.490	/
Left tilt	1413/1732.6	RMC	0.091	0.051	0.11	23.20	25.00	0.137	/
Right touch	1413/1732.6	RMC	0.184	0.109	0.10	23.20	25.00	0.278	/
Right tilt	1413/1732.6	RMC	0.097	0.056	0.13	23.20	25.00	0.147	/
Left touch	1312/1712.4	RMC	0.338	0.218	0.18	23.34	25.00	0.495	/
Left touch	1513/1752.6	RMC	0.313	0.199	0.12	23.26	25.00	0.467	/
Tested at the worst position with battery 2#									
Left touch	1312/1712.4	RMC	<b>0.350</b>	0.225	0.16	23.34	25.00	<b>0.513</b>	/
Tested at the worst position with battery 3#									
Left touch	1312/1712.4	RMC	0.348	0.224	0.15	23.34	25.00	0.510	/
FRD-L24 Test at the worst case from original report with Battery 2#									
Left touch	1312/1712.4	RMC	<b>0.295</b>	0.189	-0.02	23.34	25.00	<b>0.432</b>	Yes

Table 49: Head SAR test results of UMTS Band 4

Test Position of Body-Worn with 15mm	Test channel /Freq.(MHz)	Test Mode	SAR Value (W/kg)		Power Drift (dB)	Conducted Power (dBm)	Tune-up Power (dBm)	Reported SAR 1-g (W/kg)	SAR Plot.
			1-g	10-g					
Test data of FRD-L04 from original report (report NO.:SYBH(Z-SAR)007052016-2)									
Test data with battery 1#									
Front Side	1413/1732.6	RMC	0.620	0.352	0.06	23.20	25.00	0.938	/
Front Side	1312/1712.4	RMC	0.609	0.346	0.06	23.34	25.00	0.893	/
Front Side	1513/1752.6	RMC	0.633	0.358	0.04	23.26	25.00	0.945	/
Back Side	1413/1732.6	RMC	0.689	0.419	0.02	23.20	25.00	1.043	/
Back Side	1312/1712.4	RMC	0.714	0.435	-0.07	23.34	25.00	1.046	/
Back Side	1513/1752.6	RMC	0.691	0.419	-0.02	23.26	25.00	1.032	/
Tested at the worst position with battery 2#									
Back Side	1312/1712.4	RMC	0.685	0.419	0.03	23.34	25.00	1.004	/
Tested at the worst position with battery 3#									
Back Side	1312/1712.4	RMC	<b>0.724</b>	0.441	0.03	23.34	25.00	<b>1.061</b>	/
FRD-L24 Test at the worst case from original report with Battery 3#									
Back Side	1312/1712.4	RMC	<b>0.708</b>	0.458	-0.17	23.34	25.00	<b>1.038</b>	Yes

Table 50: Body-Worn SAR test results of UMTS Band 4

Test Position of Hotspot with 10mm	Test channel /Freq.(MHz)	Test Mode	SAR Value (W/kg)		Power Drift (dB)	Conducted Power (dBm)	Tune-up Power (dBm)	Reported SAR 1-g (W/kg)	SAR Plot.
			1-g	10-g					
Test data of FRD-L04 from original report (report NO.:SYBH(Z-SAR)007052016-2)									
Test data with battery 1#									
Front Side	1413/1732.6	RMC	0.454	0.249	0.00	19.16	20.50	0.618	/
Back Side	1413/1732.6	RMC	0.507	0.294	0.06	19.16	20.50	0.690	/
Left Side	1413/1732.6	RMC	0.084	0.047	-0.09	19.16	20.50	0.115	/
Right Side	1413/1732.6	RMC	0.052	0.027	-0.14	19.16	20.50	0.071	/
Bottom Side	1413/1732.6	RMC	0.782	0.425	-0.13	19.16	20.50	1.065	/
Bottom Side	1312/1712.4	RMC	0.828	0.451	-0.12	18.90	20.50	1.197	/
Bottom Side	1513/1752.6	RMC	0.777	0.422	-0.12	19.14	20.50	1.063	/
Tested at the worst position with battery 2#									
Bottom Side	1312/1712.4	RMC	0.761	0.418	-0.03	18.90	20.50	1.100	/
Tested at the worst position with battery 3#									
Bottom Side	1312/1712.4	RMC	<b>0.850</b>	0.465	-0.13	18.90	20.50	<b>1.229</b>	/
Bottom Side-Repeated	1312/1712.4	RMC	0.808	0.443	0.00	18.90	20.50	1.168	/
FRD-L24 Test at the worst case from original report with Battery 3#									
Bottom Side	1312/1712.4	RMC	<b>0.915</b>	0.533	-0.11	18.90	20.50	<b>1.323</b>	Yes

Table 51: Hotspot SAR test results of UMTS Band 4



### 7.2.5 SAR measurement Result of UMTS Band 5 (Main Antenna)

Test Position of Head	Test channel /Freq.(MHz)	Test Mode	SAR Value (W/kg)		Power Drift (dB)	Conducted Power (dBm)	Tune-up Limit (dBm)	Reported SAR 1-g (W/kg)	SAR Plot.
			1-g	10-g					
Test data of FRD-L04 from original report (report NO.:SYBH(Z-SAR)007052016-2)									
Test data with battery 1#									
Left touch	4182/836.4	RMC	0.168	0.117	0.06	24.11	25.50	0.231	/
Left tilt	4182/836.4	RMC	0.128	0.089	-0.04	24.11	25.50	0.176	/
Right touch	4182/836.4	RMC	0.234	0.181	0.02	24.11	25.50	0.322	/
Right tilt	4182/836.4	RMC	0.112	0.076	0.02	24.11	25.50	0.154	/
Right touch	4132/826.4	RMC	0.251	0.195	0.16	24.03	25.50	0.352	/
Right touch	4233/846.6	RMC	0.220	0.152	0.11	24.01	25.50	0.310	/
Tested at the worst position with battery 2#									
Right touch	4132/826.4	RMC	<b>0.274</b>	0.211	0.18	24.03	25.50	<b>0.384</b>	/
Tested at the worst position with battery 3#									
Right touch	4132/826.4	RMC	0.259	0.181	0.12	24.03	25.50	0.363	/
FRD-L24 Test at the worst case from original report with Battery 2#									
Right touch	4132/826.4	RMC	<b>0.297</b>	0.236	-0.13	24.03	25.50	<b>0.417</b>	Yes

Table 52: Head SAR test results of UMTS Band 5

Test Position of Body-Worn with 15mm	Test channel /Freq.(MHz)	Test Mode	SAR Value (W/kg)		Power Drift (dB)	Conducted Power (dBm)	Tune-up Power (dBm)	Reported SAR 1-g (W/kg)	SAR Plot.
			1-g	10-g					
Test data of FRD-L04 from original report (report NO.:SYBH(Z-SAR)007052016-2)									
Test data with battery 1#									
Front Side	4182/836.4	RMC	0.245	0.184	-0.13	24.11	25.50	0.337	/
Back Side	4182/836.4	RMC	0.254	0.191	-0.07	24.11	25.50	0.350	/
Tested at the worst position with battery 2#									
Back Side	4182/836.4	RMC	0.225	0.157	-0.10	24.11	25.50	0.310	/
Tested at the worst position with battery 3#									
Back Side	4182/836.4	RMC	<b>0.308</b>	0.233	-0.09	24.11	25.50	<b>0.424</b>	/
FRD-L24 Test at the worst case from original report with Battery 3#									
Back Side	4182/836.4	RMC	<b>0.332</b>	0.272	-0.07	24.11	25.50	<b>0.457</b>	Yes

Table 53: Body-Worn SAR test results of UMTS Band 5

Test Position of Hotspot with 10mm	Test channel /Freq.(MHz)	Test Mode	SAR Value (W/kg)		Power Drift (dB)	Conducted Power (dBm)	Tune-up Power (dBm)	Reported SAR 1-g (W/kg)	SAR Plot.
			1-g	10-g					
Test data of FRD-L04 from original report (report NO.:SYBH(Z-SAR)007052016-2)									
Test data with battery 1#									
Front Side	4182/836.4	RMC	0.354	0.228	-0.09	24.11	25.50	0.488	/
Back Side	4182/836.4	RMC	0.388	0.231	0.04	24.11	25.50	0.534	/
Left Side	4182/836.4	RMC	0.147	0.099	-0.10	24.11	25.50	0.202	/
Right Side	4182/836.4	RMC	0.383	0.260	-0.09	24.11	25.50	0.527	/
Bottom Side	4182/836.4	RMC	0.204	0.101	-0.08	24.11	25.50	0.281	/
Tested at the worst position with battery 2#									
Back Side	4182/836.4	RMC	<b>0.462</b>	0.276	-0.08	24.11	25.50	<b>0.636</b>	/
Tested at the worst position with battery 3#									
Back Side	4182/836.4	RMC	0.346	0.209	-0.06	24.11	25.50	0.477	/
FRD-L24 Test at the worst case from original report with Battery 2#									
Back Side	4182/836.4	RMC	<b>0.383</b>	0.235	-0.16	24.11	25.50	<b>0.527</b>	Yes

Table 54: Hotspot SAR test results of UMTS Band 5

## 7.2.6 SAR measurement Result of LTE Band 2 (Main Antenna)

Test Position of Head	Test channel /Freq.(MHz)	Test Mode	SAR Value (W/kg)		Power Drift (dB)	Conducted Power (dBm)	Tune-up Power (dBm)	Reported SAR 1-g (W/kg)	SAR Plot.
			1-g	10-g					
Test data of FRD-L04 from original report (report NO.:SYBH(Z-SAR)007052016-2)									
Test data with battery 1#									
1RB									
Left touch	18900/1880	20M QPSK 1RB#99	0.469	0.290	0.10	22.84	24.00	0.613	/
Left tilt	18900/1880	20M QPSK 1RB#99	0.181	0.096	0.16	22.84	24.00	0.236	/
Right touch	18900/1880	20M QPSK 1RB#99	0.284	0.179	0.07	22.84	24.00	0.371	/
Right tilt	18900/1880	20M QPSK 1RB#99	0.222	0.127	0.11	22.84	24.00	0.290	/
Left touch	18700/1860	20M QPSK 1RB#99	0.214	0.128	0.15	22.64	24.00	0.293	/
Left touch	19100/1900	20M QPSK 1RB#99	0.339	0.201	0.12	22.52	24.00	0.477	/
50%RB									
Left touch	18900/1880	20M QPSK 50%RB#50	0.324	0.193	0.15	21.36	22.50	0.421	/
Left tilt	18900/1880	20M QPSK 50%RB#50	0.141	0.075	0.14	21.36	22.50	0.183	/
Right touch	18900/1880	20M QPSK 50%RB#50	0.202	0.118	0.16	21.36	22.50	0.263	/
Right tilt	18900/1880	20M QPSK 50%RB#50	0.164	0.094	0.12	21.36	22.50	0.213	/
Tested at the worst position with battery 2#									
Left touch	18900/1880	20M QPSK 1RB#99	0.419	0.249	0.15	22.84	24.00	0.547	/
Tested at the worst position with battery 3#									
Left touch	18900/1880	20M QPSK 1RB#99	<b>0.523</b>	0.317	0.13	22.84	24.00	<b>0.683</b>	/
FRD-L24 Test at the worst case from original report with Battery 3#									
Left touch	18900/1880	20M QPSK 1RB#99	<b>0.310</b>	0.190	-0.19	22.84	24.00	<b>0.405</b>	Yes

Table 55: Head SAR test results of LTE Band 2

Test Position of Body-Worn with 15mm	Test channel /Freq.(MHz)	Test Mode	SAR Value (W/kg)		Power Drift (dB)	Conducted Power (dBm)	Tune-up Power (dBm)	Reported SAR 1-g (W/kg)	SAR Plot.
			1-g	10-g					
Test data of FRD-L04 from original report (report NO.:SYBH(Z-SAR)007052016-2)									
Test data with battery 1#									
1RB									
Front Side	18900/1880	20M QPSK 1RB#99	0.884	0.519	0.09	22.84	24.00	1.155	/
Front Side	18700/1860	20M QPSK 1RB#99	0.415	0.238	0.10	22.64	24.00	0.568	/
Front Side	19100/1900	20M QPSK 1RB#99	0.733	0.418	0.08	22.52	24.00	1.031	/
Back Side	18900/1880	20M QPSK 1RB#99	<b>0.907</b>	0.532	0.05	22.84	24.00	<b>1.185</b>	/
Back Side-Repeated	18900/1880	20M QPSK 1RB#99	0.873	0.514	0.13	22.84	24.00	1.140	/
Back Side	18700/1860	20M QPSK 1RB#99	0.402	0.237	-0.04	22.64	24.00	0.550	/
Back Side	19100/1900	20M QPSK 1RB#99	0.618	0.354	0.04	22.52	24.00	0.869	/
50%RB									
Front Side	18900/1880	20M QPSK 50%RB#50	0.534	0.305	0.13	21.36	22.50	0.694	/
Back Side	18900/1880	20M QPSK 50%RB#50	0.583	0.331	0.08	21.36	22.50	0.758	/
100%RB									
Front Side	19100/1900	20M QPSK 100%RB#0	0.354	0.205	-0.02	20.89	22.50	0.513	/
Back Side	19100/1900	20M QPSK 100%RB#0	0.431	0.246	0.09	20.89	22.50	0.624	/
Tested at the worst position with battery 2#									
Back Side	18900/1880	20M QPSK 1RB#99	0.830	0.485	-0.01	22.84	24.00	1.084	/
Tested at the worst position with battery 3#									
Back Side	18900/1880	20M QPSK 1RB#99	0.806	0.471	0.02	22.84	24.00	1.053	/
FRD-L24 Test at the worst case from original report with Battery 1#									
Back Side	18900/1880	20M QPSK 1RB#99	<b>0.735</b>	0.455	-0.14	22.84	24.00	<b>0.960</b>	Yes

Table 56: Body-Worn SAR test results of LTE Band 2

Test Position of Hotspot with 10mm	Test channel /Freq.(MHz)	Test Mode	SAR Value (W/kg)		Power Drift (dB)	Conducted Power (dBm)	Tune-up Power (dBm)	Reported SAR 1-g (W/kg)	SAR Plot.
			1-g	10-g					
Test data of FRD-L04 from original report (report NO.:SYBH(Z-SAR)007052016-2)									
Test data with battery 1#									
1RB									
Front Side	18900/1880	20M QPSK 1RB#99	0.930	0.505	0.13	18.80	19.50	1.093	/
Front Side	18700/1860	20M QPSK 1RB#99	0.350	0.198	0.18	18.37	19.50	0.454	/
Front Side	19100/1900	20M QPSK 1RB#99	0.682	0.383	0.04	18.79	19.50	0.803	/
Back Side	18900/1880	20M QPSK 1RB#99	0.859	0.470	0.11	18.80	19.50	1.009	/
Back Side	18700/1860	20M QPSK 1RB#99	0.329	0.183	0.17	18.37	19.50	0.427	/
Back Side	19100/1900	20M QPSK 1RB#99	0.620	0.343	0.06	18.79	19.50	0.730	/
Left Side	18900/1880	20M QPSK 1RB#99	0.237	0.124	0.13	18.80	19.50	0.278	/
Right Side	18900/1880	20M QPSK 1RB#99	0.060	0.034	0.17	18.80	19.50	0.071	/
Bottom Side	18900/1880	20M QPSK 1RB#99	1.020	0.548	-0.10	18.80	19.50	1.198	/
Bottom Side	18700/1860	20M QPSK 1RB#99	0.529	0.265	0.05	18.37	19.50	0.686	/
Bottom Side	19100/1900	20M QPSK 1RB#99	1.060	0.566	0.05	18.79	19.50	1.248	/
50%RB									
Front Side	18900/1880	20M QPSK 50%RB#25	0.418	0.236	0.12	17.08	18.00	0.517	/
Back Side	18900/1880	20M QPSK 50%RB#25	0.392	0.220	-0.02	17.08	18.00	0.484	/
Left Side	18900/1880	20M QPSK 50%RB#25	0.138	0.072	0.06	17.08	18.00	0.171	/
Right Side	18900/1880	20M QPSK 50%RB#25	0.041	0.023	0.17	17.08	18.00	0.051	/
Bottom Side	18900/1880	20M QPSK 50%RB#25	0.676	0.347	0.02	17.08	18.00	0.836	/
Bottom Side	18700/1860	20M QPSK 50%RB#0	0.665	0.342	0.01	16.73	18.00	0.891	/
Bottom Side	19100/1900	20M QPSK 50%RB#25	0.687	0.352	0.05	17.06	18.00	0.853	/
100%RB									
Front Side	19100/1900	20M QPSK 100%RB#0	0.292	0.164	0.13	16.75	18.50	0.437	/
Back Side	19100/1900	20M QPSK 100%RB#0	0.271	0.150	0.17	16.75	18.50	0.405	/
Bottom Side	19100/1900	20M QPSK 100%RB#0	0.517	0.265	0.16	16.75	18.50	0.774	/

Tested at the worst position with battery 2#									
Bottom Side	19100/1900	20M QPSK 1RB#99	1.020	0.546	0.05	18.79	19.50	1.201	/
Tested at the worst position with battery 3#									
Bottom Side	19100/1900	20M QPSK 1RB#99	1.060	0.570	0.15	18.79	19.50	1.248	/
Bottom Side- Repeated	19100/1900	20M QPSK 1RB#99	<b>1.150</b>	0.614	0.13	18.79	19.50	<b>1.354</b>	/
FRD-L24 Test at the worst case from original report with Battery 3#									
Bottom Side	19100/1900	20M QPSK 1RB#99	<b>0.787</b>	0.445	-0.13	18.79	19.50	<b>0.927</b>	Yes

Table 57: Hotspot SAR test results of LTE Band 2

### 7.2.7 SAR measurement Result of LTE Band 4 (Main Antenna)

Test Position of Head	Test channel /Freq.(MHz)	Test Mode	SAR Value (W/kg)		Power Drift (dB)	Conducted Power (dBm)	Tune-up Power (dBm)	Reported SAR 1-g (W/kg)	SAR Plot.
			1-g	10-g					
Test data of FRD-L04 from original report (report NO.:SYBH(Z-SAR)007052016-2)									
Test data with battery 1#									
1RB									
Left touch	20300/1745	20M QPSK 1RB#50	0.280	0.169	0.17	22.97	23.50	0.316	/
Left tilt	20300/1745	20M QPSK 1RB#50	0.064	0.034	0.07	22.97	23.50	0.072	/
Right touch	20300/1745	20M QPSK 1RB#50	0.146	0.095	-0.05	22.97	23.50	0.165	/
Right tilt	20300/1745	20M QPSK 1RB#50	0.088	0.049	0.10	22.97	23.50	0.100	/
Left touch	20050/1720	20M QPSK 1RB#50	<b>0.420</b>	0.270	0.12	22.77	23.50	<b>0.497</b>	/
Left touch	20175/1732.5	20M QPSK 1RB#99	0.227	0.137	0.17	22.84	23.50	0.264	/
50%RB									
Left touch	20300/1745	20M QPSK 50%RB#50	0.242	0.146	0.11	22.18	22.50	0.261	/
Left tilt	20300/1745	20M QPSK 50%RB#50	0.078	0.042	0.08	22.18	22.50	0.084	/
Right touch	20300/1745	20M QPSK 50%RB#50	0.153	0.091	0.14	22.18	22.50	0.165	/
Right tilt	20300/1745	20M QPSK 50%RB#50	0.090	0.047	0.17	22.18	22.50	0.097	/
Tested at the worst position with battery 2#									
Left touch	20050/1720	20M QPSK 1RB#50	0.398	0.255	0.08	22.77	23.50	0.471	/
Tested at the worst position with battery 3#									
Left touch	20050/1720	20M QPSK 1RB#50	0.351	0.214	0.12	22.77	23.50	0.415	/
FRD-L24 Test at the worst case from original report with Battery 1#									
Left touch	20050/1720	20M QPSK 1RB#50	<b>0.264</b>	0.171	-0.11	22.77	23.50	<b>0.312</b>	Yes

Table 58: Head SAR test results of LTE Band 4

Test Position of Body-Worn with 15mm	Test channel /Freq.(MHz)	Test Mode	SAR Value (W/kg)		Power Drift (dB)	Conducted Power (dBm)	Tune-up Power (dBm)	Reported SAR 1-g (W/kg)	SAR Plot.
			1-g	10-g					
Test data of FRD-L04 from original report (report NO.:SYBH(Z-SAR)007052016-2)									
Test data with battery 1#									
1RB									
Front Side	20300/1745	20M QPSK 1RB#50	0.413	0.249	0.12	22.97	23.50	0.467	/
Back Side	20300/1745	20M QPSK 1RB#50	0.448	0.271	0.04	22.97	23.50	0.506	/
50%RB									
Front Side	20300/1745	20M QPSK 50%RB#50	0.423	0.249	0.03	22.18	22.50	0.455	/
Back Side	20300/1745	20M QPSK 50%RB#50	0.442	0.253	0.03	22.18	22.50	0.476	/
Tested at the worst position with battery 2#									
Back Side	20300/1745	20M QPSK 1RB#50	<b>0.464</b>	0.281	0.17	22.97	23.50	<b>0.524</b>	/
Tested at the worst position with battery 3#									
Back Side	20300/1745	20M QPSK 1RB#50	0.444	0.270	0.03	22.97	23.50	0.502	/
FRD-L24 Test at the worst case from original report with Battery 2#									
Back Side	20300/1745	20M QPSK 1RB#50	<b>0.426</b>	0.275	-0.16	22.97	23.50	<b>0.481</b>	Yes

Table 59: Body-Worn SAR test results of LTE Band 4



Test Position of Hotspot with 10mm	Test channel /Freq.(MHz)	Test Mode	SAR Value (W/kg)		Power Drift (dB)	Conducted Power (dBm)	Tune-up Power (dBm)	Reported SAR 1-g (W/kg)	SAR Plot.
			1-g	10-g					
Test data of FRD-L04 from original report (report NO.:SYBH(Z-SAR)007052016-2)									
Test data with battery 1#									
1RB									
Front Side	20300/1745	20M QPSK 1RB#50	0.433	0.250	0.08	19.70	20.00	0.464	/
Back Side	20300/1745	20M QPSK 1RB#50	0.460	0.268	-0.11	19.70	20.00	0.493	/
Left Side	20300/1745	20M QPSK 1RB#50	0.083	0.046	0.17	19.70	20.00	0.089	/
Right Side	20300/1745	20M QPSK 1RB#50	0.049	0.027	0.08	19.70	20.00	0.053	/
Bottom Side	20300/1745	20M QPSK 1RB#50	0.821	0.446	-0.18	19.70	20.00	0.880	/
Bottom Side	20050/1720	20M QPSK 1RB#50	0.917	0.499	-0.18	19.45	20.00	1.041	/
Bottom Side	20175/1732.5	20M QPSK 1RB#99	0.910	0.495	-0.14	19.62	20.00	0.993	/
50%RB									
Front Side	20300/1745	20M QPSK 50%RB#50	0.435	0.251	0.12	18.66	19.00	0.470	/
Back Side	20300/1745	20M QPSK 50%RB#50	0.455	0.265	-0.03	18.66	19.00	0.492	/
Left Side	20300/1745	20M QPSK 50%RB#50	0.090	0.051	0.10	18.66	19.00	0.098	/
Right Side	20300/1745	20M QPSK 50%RB#50	0.055	0.031	0.14	18.66	19.00	0.060	/
Bottom Side	20300/1745	20M QPSK 50%RB#50	0.736	0.399	-0.18	18.66	19.00	0.796	/
100%RB									
Bottom Side	20300/1745	20M QPSK 100%RB#0	0.723	0.392	-0.17	18.48	19.00	0.815	/
Tested at the worst position with battery 2#									
Bottom Side	20050/1720	20M QPSK 1RB#50	0.826	0.455	0.07	19.45	20.00	0.938	/
Tested at the worst position with battery 3#									
Bottom Side	20050/1720	20M QPSK 1RB#50	<b>0.939</b>	0.510	0.08	19.45	20.00	<b>1.066</b>	/
Bottom Side-repeated	20050/1720	20M QPSK 1RB#50	0.913	0.498	0.05	19.45	20.00	1.036	/
FRD-L24 Test at the worst case from original report with Battery 3#									
Bottom Side	20050/1720	20M QPSK 1RB#50	<b>0.792</b>	0.465	-0.15	19.45	20.00	<b>0.899</b>	Yes

Table 60: Hotspot SAR test results of LTE Band 4

### 7.2.8 SAR measurement Result of LTE Band 5 (Main Antenna)

Test Position of Head	Test channel /Freq.(MHz)	Test Mode	SAR Value (W/kg)		Power Drift (dB)	Conducted Power (dBm)	Tune-up Power (dBm)	Reported SAR 1-g (W/kg)	SAR Plot.
			1-g	10-g					
Test data of FRD-L04 from original report (report NO.:SYBH(Z-SAR)007052016-2)									
Test data with battery 1#									
1RB									
Left touch	20600/844	10M QPSK 1RB#25	0.158	0.123	0.17	22.90	24.00	0.204	/
Left tilt	20600/844	10M QPSK 1RB#25	0.136	0.090	0.05	22.90	24.00	0.175	/
Right touch	20600/844	10M QPSK 1RB#25	0.204	0.157	0.12	22.90	24.00	0.263	/
Right tilt	20600/844	10M QPSK 1RB#25	0.113	0.074	0.02	22.90	24.00	0.146	/
Right touch	20450/829	10M QPSK 1RB#25	0.259	0.199	0.09	22.66	24.00	0.353	/
Right touch	20525/836.5	10M QPSK 1RB#49	0.171	0.119	0.18	22.57	24.00	0.238	/
50%RB									
Left touch	20600/844	10M QPSK 50%RB#13	0.132	0.101	0.12	22.70	23.00	0.141	/
Left tilt	20600/844	10M QPSK 50%RB#13	0.111	0.073	0.02	22.70	23.00	0.119	/
Right touch	20600/844	10M QPSK 50%RB#13	0.168	0.129	0.18	22.70	23.00	0.180	/
Right tilt	20600/844	10M QPSK 50%RB#13	0.094	0.061	0.01	22.70	23.00	0.100	/
Tested at the worst position with battery 2#									
Right touch	20450/829	10M QPSK 1RB#25	<b>0.278</b>	0.214	0.16	22.66	24.00	<b>0.378</b>	/
Tested at the worst position with battery 3#									
Right touch	20450/829	10M QPSK 1RB#25	0.276	0.192	0.12	22.66	24.00	0.376	/
FRD-L24 Test at the worst case from original report with Battery 2#									
Right touch	20450/829	10M QPSK 1RB#25	<b>0.287</b>	0.229	-0.11	22.66	24.00	<b>0.391</b>	Yes

Table 61: Head SAR test results of LTE Band 5

Test Position of Body-Worn with 15mm	Test channel /Freq.(MHz)	Test Mode	SAR Value (W/kg)		Power Drift (dB)	Conducted Power (dBm)	Tune-up Power (dBm)	Reported SAR 1-g (W/kg)	SAR Plot.
			1-g	10-g					
Test data of FRD-L04 from original report (report NO.:SYBH(Z-SAR)007052016-2)									
Test data with battery 1#									
1RB									
Front Side	20600/844	10M QPSK 1RB#25	0.230	0.170	0.01	22.90	24.00	0.296	/
Back Side	20600/844	10M QPSK 1RB#25	<b>0.237</b>	0.175	0.00	22.90	24.00	<b>0.305</b>	/
50%RB									
Front Side	20600/844	10M QPSK 50%RB#13	0.187	0.138	0.02	22.70	23.00	0.200	/
Back Side	20600/844	10M QPSK 50%RB#13	0.192	0.142	-0.01	22.70	23.00	0.206	/
Tested at the worst position with battery 2#									
Back Side	20600/844	10M QPSK 1RB#25	0.189	0.130	-0.06	22.90	24.00	0.243	/
Tested at the worst position with battery 3#									
Back Side	20600/844	10M QPSK 1RB#25	0.227	0.157	0.07	22.90	24.00	0.292	/
FRD-L24 Test at the worst case from original report with Battery 1#									
Back Side	20600/844	10M QPSK 1RB#25	<b>0.316</b>	0.256	-0.04	22.90	24.00	<b>0.407</b>	Yes

Table 62: Body-Worn SAR test results of LTE Band 5

Test Position of Hotspot with 10mm	Test channel /Freq.(MHz)	Test Mode	SAR Value (W/kg)		Power Drift (dB)	Conducted Power (dBm)	Tune-up Power (dBm)	Reported SAR 1-g (W/kg)	SAR Plot.
			1-g	10-g					
Test data of FRD-L04 from original report (report NO.:SYBH(Z-SAR)007052016-2)									
Test data with battery 1#									
1RB									
Front Side	20600/844	10M QPSK 1RB#25	0.343	0.203	-0.02	22.90	24.00	0.442	/
Back Side	20600/844	10M QPSK 1RB#25	<b>0.369</b>	0.219	0.02	22.90	24.00	<b>0.475</b>	/
Left Side	20600/844	10M QPSK 1RB#25	0.113	0.076	0.09	22.90	24.00	0.146	/
Right Side	20600/844	10M QPSK 1RB#25	0.368	0.250	-0.05	22.90	24.00	0.474	/
Bottom Side	20600/844	10M QPSK 1RB#25	0.176	0.094	-0.11	22.90	24.00	0.227	/
50%RB									
Front Side	20600/844	10M QPSK 50%RB#13	0.304	0.194	-0.04	22.70	23.00	0.326	/
Back Side	20600/844	10M QPSK 50%RB#13	0.307	0.182	0.04	22.70	23.00	0.329	/
Left Side	20600/844	10M QPSK 50%RB#13	0.093	0.062	0.14	22.70	23.00	0.099	/
Right Side	20600/844	10M QPSK 50%RB#13	0.305	0.204	0.13	22.70	23.00	0.327	/
Bottom Side	20600/844	10M QPSK 50%RB#13	0.145	0.078	-0.02	22.70	23.00	0.155	/
Tested at the worst position with battery 2#									
Back Side	20600/844	10M QPSK 1RB#25	0.314	0.203	-0.16	22.90	24.00	0.405	/
Tested at the worst position with battery 3#									
Back Side	20600/844	10M QPSK 1RB#25	0.354	0.211	-0.12	22.90	24.00	0.456	/
FRD-L24 Test at the worst case from original report with Battery 1#									
Back Side	20600/844	10M QPSK 1RB#25	<b>0.402</b>	0.247	-0.07	22.90	24.00	<b>0.518</b>	Yes

Table 63: Hotspot SAR test results of LTE Band 5

### 7.2.9 SAR measurement Result of LTE Band 7 (Main Antenna)

Test Position of Head	Test channel /Freq.(MHz)	Test Mode	SAR Value (W/kg)		Power Drift (dB)	Conducted Power (dBm)	Tune-up Power (dBm)	Reported SAR 1-g (W/kg)	SAR Plot.
			1-g	10-g					
Test data of FRD-L04 from original report (report NO.:SYBH(Z-SAR)007052016-2)									
Test data with battery 1#									
1RB									
Left touch	20850/2510	20M QPSK 1RB#99	0.044	0.022	0.17	22.15	23.00	0.054	/
Left tilt	20850/2510	20M QPSK 1RB#99	0.023	0.011	0.17	22.15	23.00	0.028	/
Right touch	20850/2510	20M QPSK 1RB#99	0.072	0.039	0.16	22.15	23.00	0.087	/
Right tilt	20850/2510	20M QPSK 1RB#99	0.020	0.011	0.00	22.15	23.00	0.024	/
Right touch	21100/2535	20M QPSK 50%RB#25	0.046	0.025	0.19	21.98	23.00	0.058	/
Right touch	21350/2560	20M QPSK 50%RB#0	0.063	0.034	-0.19	22.04	23.00	0.078	/
50%RB									
Left touch	21350/2560	20M QPSK 50%RB#0	0.057	0.029	0.19	21.90	22.50	0.066	/
Left tilt	21350/2560	20M QPSK 50%RB#0	0.036	0.017	0.19	21.90	22.50	0.041	/
Right touch	21350/2560	20M QPSK 50%RB#0	0.075	0.042	0.11	21.90	22.50	0.086	/
Right tilt	21350/2560	20M QPSK 50%RB#0	0.029	0.013	0.13	21.90	22.50	0.034	/
Tested at the worst position with battery 2#									
Right touch	20850/2510	20M QPSK 1RB#99	0.047	0.023	0.19	22.15	23.00	0.057	/
Tested at the worst position with battery 3#									
Right touch	20850/2510	20M QPSK 1RB#99	<b>0.088</b>	0.047	0.05	22.15	23.00	<b>0.107</b>	/
FRD-L24 Test at the worst case from original report with Battery 3#									
Right touch	20850/2510	20M QPSK 1RB#99	<b>0.081</b>	0.046	0.00	22.15	23.00	<b>0.098</b>	Yes

Table 64: Head SAR test results of LTE Band 7

Test Position of Body-Worn with 15mm	Test channel /Freq.(MHz)	Test Mode	SAR Value (W/kg)		Power Drift (dB)	Conducted Power (dBm)	Tune-up Power (dBm)	Reported SAR 1-g (W/kg)	SAR Plot.
			1-g	10-g					
Test data of FRD-L04 from original report (report NO.:SYBH(Z-SAR)007052016-2) Test data of FRD-L04 from original report (report NO.:SYBH(Z-SAR)007052016-2)									
Test data with battery 1#									
1RB									
Front Side	20850/2510	20M QPSK 1RB#99	0.231	0.128	0.19	22.15	23.00	0.281	/
Back Side	20850/2510	20M QPSK 1RB#99	0.282	0.150	0.13	22.15	23.00	0.343	/
50%RB									
Front Side	21350/2560	20M QPSK 50%RB#0	0.257	0.143	0.16	21.90	22.50	0.295	/
Back Side	21350/2560	20M QPSK 50%RB#0	0.324	0.176	-0.07	21.90	22.50	0.372	/
Tested at the worst position with battery 2#									
Back Side	21350/2560	20M QPSK 50%RB#0	0.322	0.175	0.07	22.15	23.00	0.392	/
Tested at the worst position with battery 3#									
Back Side	21350/2560	20M QPSK 50%RB#0	<b>0.330</b>	0.179	0.16	22.15	23.00	<b>0.401</b>	/
FRD-L24 Test at the worst case from original report with Battery 3#									
Back Side	21350/2560	20M QPSK 50%RB#0	<b>0.366</b>	0.206	-0.16	22.15	23.00	<b>0.445</b>	Yes

Table 65: Body-Worn SAR test results of LTE Band 7

Test Position of Hotspot with 10mm	Test channel /Freq.(MHz)	Test Mode	SAR Value (W/kg)		Power Drift (dB)	Conducted Power (dBm)	Tune-up Power (dBm)	Reported SAR 1-g (W/kg)	SAR Plot.
			1-g	10-g					
Test data of FRD-L04 from original report (report NO.:SYBH(Z-SAR)007052016-2)									
Test data with battery 1#									
1RB									
Front Side	20850/2510	20M QPSK 1RB#99	0.416	0.210	-0.17	21.57	22.00	0.459	/
Back Side	20850/2510	20M QPSK 1RB#99	0.502	0.250	0.11	21.57	22.00	0.554	/
Left Side	20850/2510	20M QPSK 1RB#99	0.034	0.018	0.14	21.57	22.00	0.038	/
Right Side	20850/2510	20M QPSK 1RB#99	0.052	0.024	-0.17	21.57	22.00	0.057	/
Bottom Side	20850/2510	20M QPSK 1RB#99	0.530	0.295	-0.05	21.57	22.00	0.585	/
50%RB									
Front Side	21350/2560	20M QPSK 50%RB#0	0.453	0.232	0.09	21.42	21.50	0.461	/
Back Side	21350/2560	20M QPSK 50%RB#0	0.554	0.277	0.16	21.42	21.50	0.564	/
Left Side	21350/2560	20M QPSK 50%RB#0	0.045	0.023	-0.06	21.42	21.50	0.046	/
Right Side	21350/2560	20M QPSK 50%RB#0	0.066	0.028	-0.12	21.42	21.50	0.067	/
Bottom Side	21350/2560	20M QPSK 50%RB#0	<b>0.814</b>	0.453	-0.19	21.42	21.50	<b>0.829</b>	/
Bottom Side-repeated	21350/2560	20M QPSK 50%RB#0	0.809	0.450	-0.18	21.42	21.50	0.824	/
Bottom Side	20850/2510	20M QPSK 50%RB#0	0.601	0.335	0.06	21.37	21.50	0.619	/
Bottom Side	21100/2535	20M QPSK 50%RB#25	0.467	0.247	-0.05	21.19	21.50	0.502	/
100%RB									
Bottom Side	21350/2560	20M QPSK 100%RB#0	0.608	0.338	-0.02	21.36	21.50	0.628	/
Tested at the worst position with battery 2#									
Bottom Side	21350/2560	20M QPSK 50%RB#0	0.769	0.428	-0.09	21.42	21.50	0.783	/
Tested at the worst position with battery 3#									
Bottom Side	21350/2560	20M QPSK 50%RB#0	0.725	0.404	-0.17	21.42	21.50	0.738	/
FRD-L24 Test at the worst case from original report with Battery 1#									
Bottom Side	21350/2560	20M QPSK 50%RB#0	<b>0.437</b>	0.252	-0.16	21.42	21.50	<b>0.445</b>	Yes

Table 66: Hotspot SAR test results of LTE Band 7

### 7.2.10 SAR measurement Result of LTE Band 12 (Main Antenna)

Test Position of Head	Test channel /Freq.(MHz)	Test Mode	SAR Value (W/kg)		Power Drift (dB)	Conducted Power (dBm)	Tune-up Power (dBm)	Reported SAR 1-g (W/kg)	SAR Plot.
			1-g	10-g					
Test data of FRD-L04 from original report (report NO.:SYBH(Z-SAR)007052016-2)									
Test data with battery 1#									
1RB									
Left touch	23130/711	10M QPSK 1RB#25	0.167	0.132	0.02	23.52	24.50	0.209	/
Left tilt	23130/711	10M QPSK 1RB#25	0.111	0.073	0.09	23.52	24.50	0.139	/
Right touch	23130/711	10M QPSK 1RB#25	<b>0.181</b>	0.143	0.13	23.52	24.50	<b>0.227</b>	/
Right tilt	23130/711	10M QPSK 1RB#25	0.076	0.054	0.11	23.52	24.50	0.095	/
Right touch	23060/704	10M QPSK 1RB#25	0.174	0.124	0.16	23.36	24.50	0.226	/
Right touch	23095/707.5	10M QPSK 1RB#0	0.168	0.119	0.17	23.48	24.50	0.212	/
50%RB									
Left touch	23095/707.5	10M QPSK 50%RB#13	0.129	0.091	0.06	22.55	23.50	0.161	/
Left tilt	23095/707.5	10M QPSK 50%RB#13	0.083	0.055	0.10	22.55	23.50	0.103	/
Right touch	23095/707.5	10M QPSK 50%RB#13	0.136	0.096	0.18	22.55	23.50	0.169	/
Right tilt	23095/707.5	10M QPSK 50%RB#13	0.065	0.047	0.04	22.55	23.50	0.081	/
Tested at the worst position with battery 2#									
Right touch	23130/711	10M QPSK 1RB#25	0.171	0.121	0.16	23.52	24.50	0.214	/
Tested at the worst position with battery 3#									
Right touch	23130/711	10M QPSK 1RB#25	0.173	0.122	0.17	23.52	24.50	0.217	/
FRD-L24 Test at the worst case from original report with Battery 1#									
Right touch	23130/711	10M QPSK 1RB#25	<b>0.206</b>	0.166	-0.15	23.52	24.50	<b>0.258</b>	Yes

Table 67: Head SAR test results of LTE Band 12



Test Position of Body-Worn with 15mm	Test channel /Freq.(MHz)	Test Mode	SAR Value (W/kg)		Power Drift (dB)	Conducted Power (dBm)	Tune-up Power (dBm)	Reported SAR 1-g (W/kg)	SAR Plot.
			1-g	10-g					
Test data of FRD-L04 from original report (report NO.:SYBH(Z-SAR)007052016-2)									
Test data with battery 1#									
1RB									
Front Side	23130/711	10M QPSK 1RB#25	0.250	0.184	0.01	23.52	24.50	0.313	/
Back Side	23130/711	10M QPSK 1RB#25	<b>0.262</b>	0.192	0.04	23.52	24.50	<b>0.328</b>	/
50%RB									
Front Side	23130/711	10M QPSK 50%RB#13	0.197	0.145	-0.03	22.55	23.50	0.245	/
Back Side	23130/711	10M QPSK 50%RB#13	0.207	0.151	-0.03	22.55	23.50	0.258	/
Tested at the worst position with battery 2#									
Back Side	23130/711	10M QPSK 1RB#25	0.259	0.182	0.03	23.52	24.50	0.325	/
Tested at the worst position with battery 3#									
Back Side	23130/711	10M QPSK 1RB#25	0.219	0.154	-0.15	23.52	24.50	0.274	/
FRD-L24 Test at the worst case from original report with Battery 1#									
Back Side	23130/711	10M QPSK 1RB#25	<b>0.303</b>	0.237	-0.05	23.52	24.50	<b>0.380</b>	Yes

Table 68: Body-Worn SAR test results of LTE Band 12

Test Position of Hotspot with 10mm	Test channel /Freq.(MHz)	Test Mode	SAR Value (W/kg)		Power Drift (dB)	Conducted Power (dBm)	Tune-up Power (dBm)	Reported SAR 1-g (W/kg)	SAR Plot.
			1-g	10-g					
Test data of FRD-L04 from original report (report NO.:SYBH(Z-SAR)007052016-2)									
Test data with battery 1#									
1RB									
Front Side	23130/711	10M QPSK 1RB#25	0.344	0.243	0.00	23.52	24.50	0.431	/
Back Side	23130/711	10M QPSK 1RB#25	0.363	0.253	0.01	23.52	24.50	0.455	/
Left Side	23130/711	10M QPSK 1RB#25	0.144	0.099	-0.04	23.52	24.50	0.180	/
Right Side	23130/711	10M QPSK 1RB#25	0.251	0.174	-0.04	23.52	24.50	0.315	/
Bottom Side	23130/711	10M QPSK 1RB#25	0.154	0.079	0.12	23.52	24.50	0.193	/
50%RB									
Front Side	23095/707.5	10M QPSK 50%RB#13	0.246	0.175	0.00	22.55	23.50	0.306	/
Back Side	23095/707.5	10M QPSK 50%RB#13	0.267	0.018	0.12	22.55	23.50	0.332	/
Left Side	23095/707.5	10M QPSK 50%RB#13	0.115	0.079	-0.01	22.55	23.50	0.143	/
Right Side	23095/707.5	10M QPSK 50%RB#13	0.177	0.122	0.01	22.55	23.50	0.220	/
Bottom Side	23095/707.5	10M QPSK 50%RB#13	0.097	0.058	0.04	22.55	23.50	0.120	/
Tested at the worst position with battery 2#									
Back Side	23130/711	10M QPSK 1RB#25	0.309	0.213	-0.19	23.52	24.50	0.387	/
Tested at the worst position with battery 3#									
Back Side	23130/711	10M QPSK 1RB#25	<b>0.364</b>	0.254	-0.18	23.52	24.50	<b>0.456</b>	/
FRD-L24 Test at the worst case from original report with Battery 1#									
Back Side	23130/711	10M QPSK 1RB#25	<b>0.421</b>	0.317	-0.10	23.52	24.50	<b>0.528</b>	Yes

Table 69: Hotspot SAR test results of LTE Band 12

### 7.2.11 SAR measurement Result of LTE Band 17 (Main Antenna)

Test Position of Head	Test channel /Freq.(MHz)	Test Mode	SAR Value (W/kg)		Power Drift (dB)	Conducted Power (dBm)	Tune-up Power (dBm)	Reported SAR 1-g (W/kg)	SAR Plot.
			1-g	10-g					
Test data of FRD-L04 from original report (report NO.:SYBH(Z-SAR)007052016-2)									
Test data with battery 1#									
1RB									
Left touch	23780/709	10M QPSK 1RB#49	0.175	0.139	0.14	24.62	25.00	0.191	/
Left tilt	23780/709	10M QPSK 1RB#49	0.127	0.081	0.04	24.62	25.00	0.139	/
Right touch	23780/709	10M QPSK 1RB#49	0.197	0.156	0.17	24.62	25.00	0.215	/
Right tilt	23780/709	10M QPSK 1RB#49	0.084	0.057	0.08	24.62	25.00	0.092	/
Right touch	23790/710	10M QPSK 1RB#49	0.193	0.153	0.11	24.61	25.00	0.211	/
Right touch	23800/711	10M QPSK 1RB#49	0.172	0.121	0.16	24.57	25.00	0.190	/
50%RB									
Left touch	23800/711	10M QPSK 50%RB#25	0.131	0.103	0.04	23.43	24.00	0.149	/
Left tilt	23800/711	10M QPSK 50%RB#25	0.092	0.059	0.06	23.43	24.00	0.105	/
Right touch	23800/711	10M QPSK 50%RB#25	0.144	0.114	0.11	23.43	24.00	0.164	/
Right tilt	23800/711	10M QPSK 50%RB#25	0.062	0.042	0.06	23.43	24.00	0.070	/
Tested at the worst position with battery 2#									
Right touch	23780/709	10M QPSK 1RB#49	<b>0.273</b>	0.216	0.10	24.62	25.00	<b>0.298</b>	/
Tested at the worst position with battery 3#									
Right touch	23780/709	10M QPSK 1RB#49	0.186	0.131	0.16	24.62	25.00	0.203	/
FRD-L24 Test at the worst case from original report with Battery 2#									
Right touch	23780/709	10M QPSK 1RB#49	<b>0.185</b>	0.149	-0.11	24.62	25.00	<b>0.202</b>	Yes

Table 70: Head SAR test results of LTE Band 17

Test Position of Body-Worn with 15mm	Test channel /Freq.(MHz)	Test Mode	SAR Value (W/kg)		Power Drift (dB)	Conducted Power (dBm)	Tune-up Power (dBm)	Reported SAR 1-g (W/kg)	SAR Plot
			1-g	10-g					
Test data of FRD-L04 from original report (report NO.:SYBH(Z-SAR)007052016-2)									
Test data with battery 1#									
1RB									
Front Side	23780/709	10M QPSK 1RB#49	0.252	0.187	-0.03	24.62	25.00	0.275	/
Back Side	23780/709	10M QPSK 1RB#49	0.269	0.199	0.02	24.62	25.00	0.294	/
50%RB									
Front Side	23800/711	10M QPSK 50%RB#25	0.185	0.137	0.03	23.43	24.00	0.211	/
Back Side	23800/711	10M QPSK 50%RB#25	0.199	0.140	0.01	23.43	24.00	0.227	/
Tested at the worst position with battery 2#									
Back Side	23780/709	10M QPSK 1RB#49	0.252	0.185	-0.07	24.62	25.00	0.275	/
Tested at the worst position with battery 3#									
Back Side	23780/709	10M QPSK 1RB#49	<b>0.378</b>	0.277	-0.01	24.62	25.00	<b>0.413</b>	/
FRD-L24 Test at the worst case from original report with Battery 3#									
Back Side	23780/709	10M QPSK 1RB#49	<b>0.276</b>	0.217	-0.04	24.62	25.00	<b>0.301</b>	Yes

Table 71: Body-Worn SAR test results of LTE Band 17

Test Position of Hotspot with 10mm	Test channel /Freq.(MHz)	Test Mode	SAR Value (W/kg)		Power Drift (dB)	Conducted Power (dBm)	Tune-up Power (dBm)	Reported SAR 1-g (W/kg)	SAR Plot.
			1-g	10-g					
Test data of FRD-L04 from original report (report NO.:SYBH(Z-SAR)007052016-2)									
Test data with battery 1#									
1RB									
Front Side	23780/709	10M QPSK 1RB#49	0.300	0.211	0.00	24.62	25.00	0.327	/
Back Side	23780/709	10M QPSK 1RB#49	0.321	0.222	-0.06	24.62	25.00	0.350	/
Left Side	23780/709	10M QPSK 1RB#49	0.159	0.109	-0.12	24.62	25.00	0.174	/
Right Side	23780/709	10M QPSK 1RB#49	0.268	0.184	-0.02	24.62	25.00	0.293	/
Bottom Side	23780/709	10M QPSK 1RB#49	0.134	0.081	-0.09	24.62	25.00	0.146	/
50%RB									
Front Side	23800/711	10M QPSK 50%RB#25	0.275	0.189	-0.02	23.43	24.00	0.314	/
Back Side	23800/711	10M QPSK 50%RB#25	0.306	0.208	-0.02	23.43	24.00	0.349	/
Left Side	23800/711	10M QPSK 50%RB#25	0.117	0.080	-0.02	23.43	24.00	0.133	/
Right Side	23800/711	10M QPSK 50%RB#25	0.201	0.138	0.01	23.43	24.00	0.229	/
Bottom Side	23800/711	10M QPSK 50%RB#25	0.103	0.062	-0.12	23.43	24.00	0.117	/
Tested at the worst position with battery 2#									
Back Side	23780/709	10M QPSK 1RB#49	0.407	0.276	-0.01	24.62	25.00	0.444	/
Tested at the worst position with battery 3#									
Back Side	23780/709	10M QPSK 1RB#49	<b>0.414</b>	0.287	-0.18	24.62	25.00	<b>0.452</b>	/
FRD-L24 Test at the worst case from original report with Battery 3#									
Back Side	23780/709	10M QPSK 1RB#49	<b>0.371</b>	0.281	-0.07	24.62	25.00	<b>0.405</b>	Yes

Table 72: Hotspot SAR test results of LTE Band 17

## 7.2.12 SAR measurement Result of WiFi 2.4G

Test Position of Head	Test channel /Freq. (MHz)	Test Mode	SAR Value (W/kg)		Power Drift (dB)	Conducted Power (dBm)	Tune-up Power (dBm)	Scaled 1-g SAR (W/kg)	Actual duty factor	Reported SAR1-g (W/kg)	SAR Plot.
			Area Scan	Zoom Scan							
			1-g	1-g							
Test data of FRD-L04 from original report (report NO.:SYBH(Z-SAR)007052016-2)											
Left touch	11/2462	802.11 b	0.916	<b>0.780</b>	0.110	16.43	17.00	0.889	98.30%	0.905	/
Left touch	1/2412	802.11 b	0.868	0.718	0.050	15.54	17.00	1.005	98.30%	<b>1.022</b>	/
Left tilt	11/2462	802.11 b	0.742	0.640	0.120	16.43	17.00	0.730	98.30%	0.742	/
Right touch	11/2462	802.11 b	0.172	0.176	0.070	16.43	17.00	0.201	98.30%	0.204	/
Right tilt	11/2462	802.11 b	0.162	0.167	0.050	16.43	17.00	0.190	98.30%	0.194	/
Left touch	6/2437	802.11 b	0.829	0.660	0.150	15.93	17.00	0.844	98.30%	0.859	/
Tested at the worst position with battery 2#											
Left touch	1/2412	802.11 b	0.939	0.647	-0.110	15.54	17.00	0.906	98.30%	0.921	/
Tested at the worst position with battery 3#											
Left touch	1/2412	802.11 b	0.903	0.658	0.160	15.54	17.00	0.921	98.30%	0.937	/
FRD-L24 Test at the worst case from original report with Battery 1#											
Left touch	1/2412	802.11 b	0.606	<b>0.469</b>	-0.02	13.41	14.00	0.537	98.30%	<b>0.547</b>	Yes

Table 73: Head SAR test results of WiFi 2450MHz

Note: The device does not support WiFi VOIP. Wi-Fi Head SAR is evaluated at reduced power levels according to the real simultaneous transmission usage scenarios.

Test Position of Body-Worn with 15mm	Test channel /Freq. (MHz)	Test Mode	SAR Value (W/kg)		Power Drift (dB)	Conducted Power (dBm)	Tune-up Power (dBm)	Scaled 1-g SAR (W/kg)	Actual duty factor	Reported SAR1-g (W/kg)	SAR Plot.
			Area Scan	Zoom Scan							
			1-g	1-g							
Test data of FRD-L04 from original report (report NO.:SYBH(Z-SAR)007052016-2)											
Front Side	6/2437	802.11 b	0.097	/	0.07	17.71	18.00	/	98.30%	/	/
Back Side	6/2437	802.11 b	0.105	<b>0.108</b>	0.12	17.71	18.00	0.115	98.30%	<b>0.117</b>	/
Tested at the worst position with battery 2#											
Back Side	6/2437	802.11 b	0.087	0.092	0.07	17.71	18.00	0.099	98.30%	0.100	/
Tested at the worst position with battery 3#											
Back Side	6/2437	802.11 b	0.091	0.094	-0.04	17.71	18.00	0.101	98.30%	0.103	/
FRD-L24 Test at the worst case from original report with Battery 1#											
Back Side	6/2437	802.11 b	0.093	<b>0.098</b>	-0.02	17.71	18.00	0.105	98.30%	<b>0.106</b>	Yes

Table 74: Body-Worn SAR test results of WiFi 2450MHz

Test Position of Hotspot with 10mm	Test channel /Freq. (MHz)	Test Mode	SAR Value (W/kg)		Power Drift (dB)	Conducted Power (dBm)	Tune-up Power (dBm)	Scaled 1-g SAR (W/kg)	Actual duty factor	Reported SAR1-g (W/kg)	SAR Plot.
			Area Scan	Zoom Scan							
			1-g	1-g							
Test data of FRD-L04 from original report (report NO.:SYBH(Z-SAR)007052016-2)											
Front Side	11/2462	802.11 b	0.173	/	-0.05	16.43	17.00	/	98.30%	/	/
Back Side	11/2462	802.11 b	0.175	/	0.11	16.43	17.00	/	98.30%	/	/
Left Side	11/2462	802.11 b	0.017	/	-0.13	16.43	17.00	/	98.30%	/	/
Right Side	11/2462	802.11 b	0.212	0.214	-0.08	16.43	17.00	0.244	98.30%	0.248	/
Front Side	11/2462	802.11 b	0.173	/	-0.05	16.43	17.00	/	98.30%	/	/
Tested at the worst position with battery 2#											
Right Side	11/2462	802.11 b	0.198	0.202	-0.18	16.43	17.00	0.230	98.30%	0.234	/
Tested at the worst position with battery 3#											
Right Side	11/2462	802.11 b	0.225	<b>0.231</b>	-0.15	16.43	17.00	0.263	98.30%	<b>0.268</b>	/
FRD-L24 Test at the worst case from original report with Battery 3#											
Right Side	11/2462	802.11 b	0.188	<b>0.203</b>	-0.12	16.43	17.00	0.231	98.30%	<b>0.235</b>	Yes

Table 75: Hotspot SAR test results of WiFi 2450MHz

Note: WiFi 2.4G hotspot SAR is tested at the more conservative output power reduction level between Second Ant + WiFi hotspot and Main Ant + WiFi hotspot usage scenarios. The more conservative SAR test results at the higher output power level are used for Simultaneous Transmission SAR evaluation.



### 7.2.13 SAR measurement Result of WiFi 5G

Test Position of Head	Test channel /Freq. (MHz)	Test Mode	SAR Value (W/kg)		Power Drift (dB)	Conducted Power (dBm)	Tune-up Power (dBm)	Scaled 1-g SAR (W/kg)	Actual duty factor	Reported SAR1-g (W/kg)	SAR Plot.
			Area Scan	Zoom Scan							
			1-g	1-g							
Test data of FRD-L04 from original report (report NO.:SYBH(Z-SAR)007052016-2)											
Test data of 5.3GHz band											
Left touch	64/5320	802.11a	0.758	0.770	-0.05	10.76	11.00	0.814	90.00%	0.904	/
Left touch	52/5260	802.11a	0.687	0.684	-0.02	10.65	11.00	0.741	90.00%	0.824	/
Left tilt	64/5320	802.11a	0.622	0.662	0.16	10.76	11.00	0.700	90.00%	0.777	/
Right touch	64/5320	802.11a	0.299	0.313	-0.14	10.76	11.00	0.331	90.00%	0.368	/
Right tilt	64/5320	802.11a	0.274	0.283	-0.03	10.76	11.00	0.299	90.00%	0.332	/
Test data of 5.5GHz band											
Left touch	124/5620	802.11a	0.521	0.580	0.04	9.73	11.00	0.777	90.00%	0.863	/
Left touch	100/5500	802.11a	0.493	0.537	0.19	9.65	11.00	0.733	90.00%	0.814	/
Left tilt	124/5620	802.11a	0.462	0.511	-0.12	9.73	11.00	0.685	90.00%	0.761	/
Right touch	124/5620	802.11a	0.288	0.299	0.02	9.73	11.00	0.401	90.00%	0.445	/
Right tilt	124/5620	802.11a	0.250	0.262	-0.13	9.73	11.00	0.351	90.00%	0.390	/
Test data of 5.8GHz band											
Left touch	161/5805	802.11a	0.804	0.794	0.15	10.16	10.50	0.859	90.00%	0.954	/
Left touch	165/5825	802.11a	0.775	0.773	0.10	9.99	10.50	0.869	90.00%	0.966	/
Left tilt	161/5805	802.11a	0.619	0.631	0.13	10.16	10.50	0.682	90.00%	0.758	/
Right touch	161/5805	802.11a	0.340	0.369	-0.05	10.16	10.50	0.399	90.00%	0.443	/
Right tilt	161/5805	802.11a	0.282	0.302	0.10	10.16	10.50	0.327	90.00%	0.363	/
Left touch	149/5745	802.11a	0.794	0.802	-0.06	9.85	10.50	0.931	90.00%	1.035	/
Left touch	153/5765	802.11a	0.838	<b>0.839</b>	-0.18	9.90	10.50	0.963	90.00%	<b>1.070</b>	/
Left touch-repeated	153/5765	802.11a	0.805	0.788	0.06	9.90	10.50	0.905	90.00%	1.005	/

Left touch	157/5785	802.11a	0.776	0.780	0.07	9.76	10.50	0.925	90.00%	1.028	/
Test at the worst position with battery 2#											
Left touch	153/5765	802.11a	0.728	0.744	0.04	9.90	10.50	0.854	90.00%	0.949	/
Test at the worst position with battery 3#											
Left touch	153/5765	802.11a	0.714	0.731	0.00	9.90	10.50	0.839	90.00%	0.933	/
FRD-L24 Test at the worst case from original report with Battery 1#											
Left touch	153/5765	802.11a	0.506	<b>0.523</b>	-0.04	9.90	10.50	0.600	90.00%	<b>0.667</b>	Yes

Table 76: Head SAR test results of WiFi 5GHz

Note: For Head SAR

- 1) The device does not support WiFi VOIP. Wi-Fi Head SAR is evaluated at reduced power levels according to the real simultaneous transmission usage scenarios.
- 2) Per KDB 248227D01, as the same maximum output power is specified for U-NII-1(5.2G) and U-NII-2A(5.3G) bands, begin SAR measurement in U-NII-2A band by applying the OFDM SAR requirements. as the highest reported SAR for a test configuration is  $\leq 1.2$  W/kg, SAR is not required for U-NII-1 band for that configuration.
- 3) The 802.11a mode is selected as Initial Test Configuration for SAR test according to the specified maximum output power. as the highest reported SAR for the initial test configuration is adjusted by the ratio of the subsequent test configuration to initial test configuration specified maximum output power and the adjusted SAR is  $\leq 1.2$  W/kg, SAR test for the other 802.11 modes are not required.

Test Position of Body-Worn with 15mm	Test channel /Freq. (MHz)	Test Mode	SAR Value (W/kg)		Power Drift (dB)	Conducted Power (dBm)	Tune-up Power (dBm)	Scaled 1-g SAR (W/kg)	Actual duty factor	Reported SAR1-g (W/kg)	SAR Plot.
			Area Scan	Zoom Scan							
			1-g	1-g							
Test data of FRD-L04 from original report (report NO.:SYBH(Z-SAR)007052016-2)											
Test data of 5.3GHz band											
Front Side	52/5260	802.11a	0.140	0.152	0.11	14.43	15.00	0.173	90.00%	0.193	/
Back Side	52/5260	802.11a	0.127	/	-0.08	14.43	15.00	/	90.00%	/	/
Test data of 5.5GHz band											
Front Side	124/5620	802.11a	0.153	0.159	-0.08	14.38	15.00	0.183	90.00%	0.204	/
Back Side	124/5620	802.11a	0.142	/	0.00	14.38	15.00	/	90.00%	/	/
Test data of 5.8GHz band											
Front Side	157/5785	802.11a	0.176	<b>0.197</b>	-0.05	13.62	14.00	0.215	90.00%	<b>0.239</b>	/
Back Side	157/5785	802.11a	0.134	/	0.03	13.62	14.00	/	90.00%	/	/
Test at the worst position with battery 2#											
Front Side	157/5785	802.11a	0.160	0.169	-0.11	13.62	14.00	0.184	90.00%	0.205	/
Test at the worst position with battery 3#											
Front Side	157/5785	802.11a	0.162	0.172	0.02	13.62	14.00	0.188	90.00%	0.209	/
FRD-L24 Test at the worst case from original report with Battery 1#											
Front Side	157/5785	802.11a	0.251	<b>0.228</b>	-0.06	13.62	14.00	0.249	90.00%	<b>0.276</b>	Yes

Table 77: Body-Worn SAR test results of WiFi 5GHz

Note : For Body-worn SAR

2) Per KDB 248227D01, as the same maximum output power is specified for U-NII-1(5.2G) and U-NII-2A(5.3G) bands, begin SAR measurement in U-NII-2A band by applying the OFDM SAR requirements. as the highest reported SAR for a test configuration is  $\leq 1.2$  W/kg, SAR is not required for U-NII-1 band for that configuration.

3) The 802.11a mode is selected as Initial Test Configuration for SAR test according to the specified maximum output power. as the highest reported SAR for the initial test configuration is adjusted by the ratio of the subsequent test configuration to initial test configuration specified maximum output power and the adjusted SAR is  $\leq 1.2$  W/kg, SAR test for the other 802.11 modes are not required.

Test Position of Hotspot with 10mm	Test channel /Freq. (MHz)	Test Mode	SAR Value (W/kg)		Power Drift (dB)	Conducted Power (dBm)	Tune-up Power (dBm)	Scaled 1-g SAR (W/kg)	Actual duty factor	Reported SAR1-g (W/kg)	SAR Plot.
			Area Scan	Zoom Scan							
			1-g	1-g							
Test data of FRD-L04 from original report (report NO.:SYBH(Z-SAR)007052016-2)											
Test data of 5.2GHz band											
Front Side	36/5180	802.11a	0.072	/	-0.16	10.10	11.00	/	90.00%	/	/
Back Side	36/5180	802.11a	0.059	/	0.02	10.10	11.00	/	90.00%	/	/
Right Side	36/5180	802.11a	0.099	0.105	-0.02	10.10	11.00	0.129	90.00%	0.144	/
Top Side	36/5180	802.11a	0.033	/	0.00	10.10	11.00	/	90.00%	/	/
Test data of 5.8GHz band											
Front Side	161/5805	802.11a	0.078	/	-0.09	10.16	10.50	/	90.00%	/	/
Back Side	161/5805	802.11a	0.077	/	-0.06	10.16	10.50	/	90.00%	/	/
Right Side	161/5805	802.11a	0.150	<b>0.138</b>	-0.13	10.16	10.50	0.149	90.00%	<b>0.166</b>	/
Top Side	161/5805	802.11a	0.037	/	-0.14	10.16	10.50	/	90.00%	/	/
Test at the worst position with battery 2#											
Right Side	161/5805	802.11a	0.104	0.115	-0.09	10.16	10.50	0.124	90.00%	0.138	/
Test at the worst position with battery 3#											
Right Side	161/5805	802.11a	0.110	0.124	-0.12	10.16	10.50	0.134	90.00%	0.149	/
FRD-L24 Test at the worst case from original report with Battery 1#											
Right Side	161/5805	802.11a	0.142	<b>0.130</b>	-0.19	10.16	10.50	0.141	90.00%	<b>0.156</b>	Yes

Table 78: Hotspot SAR test results of WiFi 5GHz

Note: WiFi 5G hotspot is only supported for U-NII-1 and U-NII-3 bands, therefore U-NII-2A and U-NII-2C were not evaluated for hotspot condition.

### 7.3 Multiple Transmitter Evaluation

The following tables list information which is relevant for the decision if a simultaneous transmit evaluation is necessary according to FCC KDB 447498D01.

The location of the antennas inside the device is shown as below picture(Unit:mm):

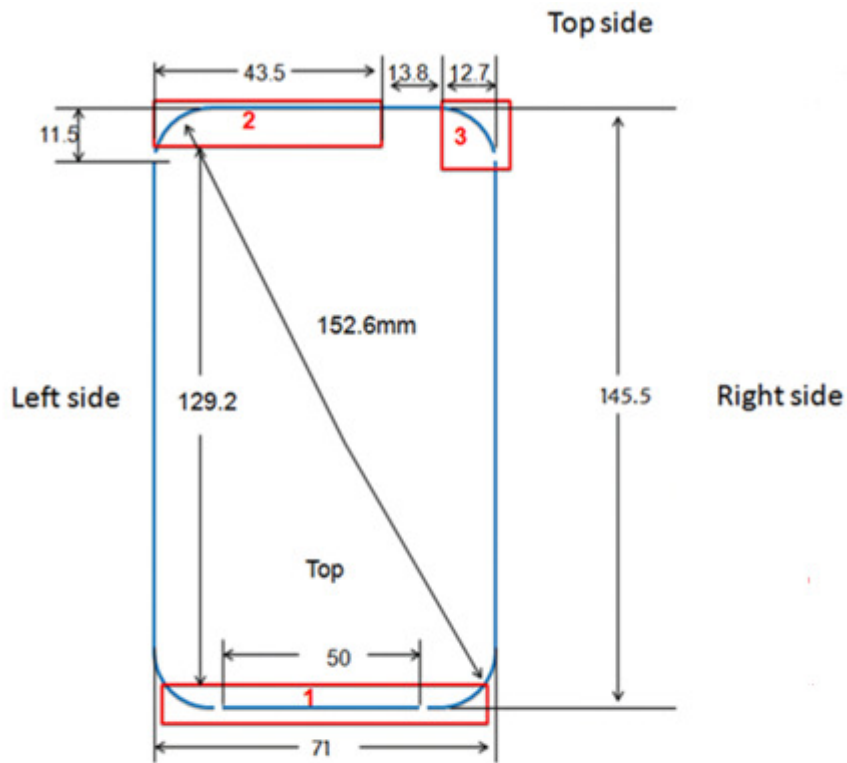

- <Front View>
- 1.Main Ant (Tx & Rx)
  - 2.Second Ant(Rx only).
  - 3.GPS/WiFi-2.4G/5G/BT Ant

Note:

- 1) Second Ant does not support transmitter function.
- 2) Per KDB 941225 D06, particular DUT edges were not required to be evaluated for Hotspot SAR if the antenna-to-edge distance is greater than 2.5cm.

Mode	Exposure Condition	Front Side	Back Side	Left Side	Right Side	Top Side	Bottom Side
Main ant	Hotspot	Yes	Yes	Yes	Yes	No	Yes
WiFi/BT ant	Hotspot	Yes	Yes	No	Yes	Yes	No

Table 79: Sides for Hotspot SAR testing

### 7.3.1 Stand-alone SAR test exclusion

Per FCC KDB 447498D01, the 1-g SAR and 10-g SAR test exclusion thresholds for 100 MHz to 6 GHz at test separation distances  $\leq 50$  mm are determined by:

$[(\text{max. power of channel, including tune-up tolerance, mW})/(\text{min. test separation distance, mm})] \cdot [\sqrt{f(\text{GHz})}] \leq 3.0$  for 1-g SAR and  $\leq 7.5$  for 10-g extremity SAR, where:

- $f(\text{GHz})$  is the RF channel transmit frequency in GHz
- Power and distance are rounded to the nearest mW and mm before calculation
- The result is rounded to one decimal place for comparison

When the minimum test separation distance is  $< 5$  mm, a distance of 5 mm is applied to determine SAR test exclusion.

Mode	Position	$P_{\text{max}}$ (dBm)*	$P_{\text{max}}$ (mW)	Distance (mm)	f (GHz)	Calculation Result	SAR Exclusion threshold	SAR test exclusion
BT	Body-Worn	10.00	10.00	15	2.480	1.05	3.00	Yes

Table 80: Standalone SAR test exclusion for BT

Note:

- 1)\* - maximum possible output power declared by manufacturer
- 2) Held to ear configurations are not applicable to Bluetooth for this device.

When standalone SAR test exclusion applies to an antenna that transmits simultaneously with other antennas, the standalone SAR must be estimated according to following to determine simultaneous transmission SAR test exclusion:

$(\text{max. power of channel, including tune-up tolerance, mW})/(\text{min. test separation distance, mm}) \cdot [\sqrt{f(\text{GHz})/x}] \text{ W/kg}$  for test separation distances  $\leq 50$  mm, where  $x = 7.5$  for 1-g SAR and  $x = 18.75$  for 10-g SAR.

When the minimum test separation distance is  $< 5$  mm, a distance of 5 mm is applied to determine SAR test exclusion

Mode	Position	$P_{\text{max}}$ (dBm)*	$P_{\text{max}}$ (mW)	Distance (mm)	f (GHz)	X	Estimated SAR (W/kg)*
BT	Body-worn	10.00	10.00	15	2.480	7.50	0.140

Table 81: Estimated SAR calculation for BT

Note:

- 1) \* - maximum possible output power declared by manufacturer
- 2) Held to ear configurations are not applicable to Bluetooth and therefore were not considered for simultaneous transmission.

### 7.3.2 Simultaneous Transmission Possibilities

The Simultaneous Transmission Possibilities of this device are as below:

No.	Configuration	Head	Body-worn	Hotspot
1	GSM (Voice) + WiFi 2.4G	Yes	Yes	N/A
2	GPRS/EDGE (DATA) + WiFi 2.4G	N/A	N/A	Yes
3	GSM (Voice) + WiFi 5G	Yes	Yes	N/A
4	GPRS/EDGE (DATA) + WiFi 5G	N/A	N/A	Yes
5	GSM (Voice) +BT	N/A	Yes	N/A
6	GPRS/EDGE (DATA) + BT	N/A	N/A	N/A
7	UMTS (Voice) + WiFi 2.4G	Yes	Yes	N/A
8	UMTS (DATA) + WiFi 2.4G	N/A	Yes	Yes
9	UMTS (Voice) + WiFi 5G	Yes	Yes	N/A
10	UMTS (DATA) + WiFi 5G	N/A	Yes	Yes
11	UMTS (Voice)+BT	N/A	Yes	N/A
12	UMTS (DATA) +BT	N/A	Yes	N/A
13	LTE + WiFi 2.4G	Yes	Yes	Yes
14	LTE + WiFi 5G	Yes	Yes	Yes
15	LTE + BT	N/A	Yes	N/A

Table 82: Simultaneous Transmission Possibilities

Note:

- 1) WiFi 2.4G and WiFi 5G can't transmit simutanously.
- 2) WiFi 2.4G/5G and BT can't transmit simutanously.
- 3) WiFi 5G hotspot is only supported for U-NII-1 and U-NII-3 bands, therefore U-NII-2A and U-NII-2C were not evaluated for hotspot condition.
- 4) The device does not support GSM DTM function. Body-worn accessory testing is typically associated with voice operations. Therefore, GSM voice was evaluated for body-worn SAR.
- 5) Held to ear configurations are not applicable to Bluetooth for this device.
- 6) The device does not support WiFi VOIP function.
- 7) The device supports VoLTE function.



### 7.3.3 SAR Summation Scenario

The green color SAR test data in the following summed SAR tables represent that the additional SAR test results in simultaneous transmission fixed power reduction scenario are used to ensure simultaneous transmission SAR test exclusion (Also see Section 7.3). For the other SAR test data in the summed SAR tables, the more conservative SAR test results at the maximum output power level without any power reduction are used.

Test Position		Main antenna SAR <sub>Max</sub>											WiFi/BT antenna SAR <sub>Max</sub>			Σ1-g SAR (1.6W/kg Limit)	SPLSR	Volume scan
		GSM850	GSM1900	UMTS Band 2	UMTS Band 4	UMTS Band 5	LTE Band 2	LTE Band 4	LTE Band 5	LTE Band 7	LTE Band 12	LTE Band 17	WiFi 2.4G	WiFi 5G	BT			
Head	Left touch	0.220	0.195	0.512	0.513	0.231	0.683	0.497	0.204	0.066	0.209	0.191	1.022	1.070	/	1.753	Yes	N/A
	Left tilt	0.138	0.048	0.173	0.137	0.176	0.236	0.072	0.175	0.061	0.139	0.139	0.742	0.777	/	1.013	N/A	N/A
	Right touch	0.373	0.210	0.303	0.278	0.417	0.371	0.165	0.391	0.107	0.258	0.298	0.204	0.445	/	0.862	N/A	N/A
Body-worn 15mm	Right tilt	0.137	0.082	0.224	0.147	0.154	0.290	0.100	0.146	0.034	0.095	0.092	0.194	0.390	/	0.680	N/A	N/A
	Front side	0.375	0.567	0.791	0.945	0.337	1.115	0.467	0.179	0.281	0.313	0.275	0.117	0.276	0.140	1.391	N/A	N/A
Hotspot 10mm	Back side	0.474	0.466	1.115	1.061	0.457	1.185	0.524	0.407	0.445	0.380	0.413	0.117	0.239	0.140	1.424	N/A	N/A
	Front side	0.417	0.652	0.561	0.618	0.488	1.093	0.470	0.442	0.461	0.431	0.327	0.268	0.166	/	1.361	N/A	N/A
	Back side	0.554	0.623	0.562	0.690	0.636	1.009	0.493	0.518	0.564	0.528	0.452	0.268	0.166	/	1.277	N/A	N/A
	Left side	0.217	0.162	0.153	0.115	0.202	0.278	0.098	0.146	0.046	0.180	0.174	/	/	/	0.278	N/A	N/A
	Right side	0.407	0.067	0.034	0.071	0.527	0.071	0.060	0.474	0.067	0.315	0.293	0.268	0.166	/	0.795	N/A	N/A
	Top side	/	/	/	/	/	/	/	/	/	/	/	0.268	0.166	/	0.268	N/A	N/A
	Bottom side	0.199	1.380	1.115	1.323	0.281	1.354	1.066	0.227	0.829	0.193	0.146	/	/	/	1.380	N/A	N/A

Table 83: 1-g SAR Simultaneous Tx Combination of GSM/UMTS/LTE(Main Antenna) and WiFi/BT.

Test Position		Main antenna SAR <sub>Max</sub>											WiFi antenna	Σ1-g SAR (1.6W/kg Limit)	SPLSR	Volume scan	
		GSM850	GSM1900	UMTS Band 2	UMTS Band 4	UMTS Band 5	LTE Band 2	LTE Band 4	LTE Band 5	LTE Band 7	LTE Band 12	LTE Band 17	WiFi 5G				
Head	Left touch	0.220	/	/	/	/	/	/	/	/	/	/	/	1.070	1.290	N/A	N/A
	Left touch	/	0.195	/	/	/	/	/	/	/	/	/	/	1.070	1.265	N/A	N/A
	Left touch	/	/	0.512	/	/	/	/	/	/	/	/	/	1.070	1.582	N/A	N/A
	Left touch	/	/	/	0.513	/	/	/	/	/	/	/	/	1.070	1.583	N/A	N/A
	Left touch	/	/	/	/	0.231	/	/	/	/	/	/	/	1.070	1.301	N/A	N/A
	Left touch	/	/	/	/	/	0.683	/	/	/	/	/	/	1.070	1.753	0.026	N/A
	Left touch	/	/	/	/	/	/	0.497	/	/	/	/	/	1.070	1.567	N/A	N/A
	Left touch	/	/	/	/	/	/	/	0.204	/	/	/	/	1.070	1.274	N/A	N/A
	Left touch	/	/	/	/	/	/	/	/	0.066	/	/	/	1.070	1.136	N/A	N/A
	Left touch	/	/	/	/	/	/	/	/	/	0.209	/	/	1.070	1.279	N/A	N/A
	Left touch	/	/	/	/	/	/	/	/	/	/	0.191	/	1.070	1.261	N/A	N/A

Table 84: 1-g SAR Simultaneous Tx Combination of GSM/UMTS/LTE(Main Antenna) and WiFi 5G on the Left touch position.

Test Position		Main antenna SAR <sub>Max</sub>											WiFi antenna	Σ1-g SAR (1.6W/kg Limit)	SPLSR	Volume scan	
		GSM850	GSM1900	UMTS Band 2	UMTS Band 4	UMTS Band 5	LTE Band 2	LTE Band 4	LTE Band 5	LTE Band 7	LTE Band 12	LTE Band 17	WiFi 2.4G				
Head	Left touch	0.220	/	/	/	/	/	/	/	/	/	/	/	1.022	1.242	N/A	N/A
	Left touch	/	0.195	/	/	/	/	/	/	/	/	/	/	1.022	1.217	N/A	N/A
	Left touch	/	/	0.512	/	/	/	/	/	/	/	/	/	1.022	1.534	N/A	N/A
	Left touch	/	/	/	0.513	/	/	/	/	/	/	/	/	1.022	1.535	N/A	N/A
	Left touch	/	/	/	/	0.231	/	/	/	/	/	/	/	1.022	1.253	N/A	N/A
	Left touch	/	/	/	/	/	0.683	/	/	/	/	/	/	1.022	1.705	0.024	N/A
	Left touch	/	/	/	/	/	/	0.497	/	/	/	/	/	1.022	1.519	N/A	N/A
	Left touch	/	/	/	/	/	/	/	0.204	/	/	/	/	1.022	1.226	N/A	N/A
	Left touch	/	/	/	/	/	/	/	/	0.066	/	/	/	1.022	1.088	N/A	N/A
	Left touch	/	/	/	/	/	/	/	/	/	0.209	/	/	1.022	1.231	N/A	N/A
	Left touch	/	/	/	/	/	/	/	/	/	/	0.191	/	1.022	1.213	N/A	N/A

Table 85: 1-g Simultaneous Tx Combination of GSM/UMTS/LTE(Main Antenna) and WiFi 2.4G on the Left touch position.

### 7.3.4 SPLSR Evaluation Analysis

According to KDB447498 D01, When the sum of SAR is larger than the limit, SAR test exclusion is determined by the SAR to peak location separation ratio(SPLSR).When the SAR to peak location ratio for each pair of antennas is  $\leq 1\text{-g } 0.04$  and  $10\text{-g } 0.10$ , simultaneous SAR evaluation is not required. When SAR is measured for both antennas in the pair, the peak location separation distance is computed by the following fomula:

$$\text{Distance}_{\text{Tx1-Tx2}} = R_i = \sqrt{(x_1 - x_2)^2 + (y_1 - y_2)^2 + (z_1 - z_2)^2}$$

$$\text{SPLS Ratio} = (\text{SAR}_1 + \text{SAR}_2)^{1.5}/R_i$$

When standalone test exclusion applies, SAR is estimated; the peak location is assumed to be at the feed-point or geometric center of the antenna.

- 1) The sum of aggregate 1-g SAR was above 1.6W/Kg for left touch configuration with LTE Band 2 (Main Antenna) and WiFi 5G.

The Peak SAR location plot is as below:

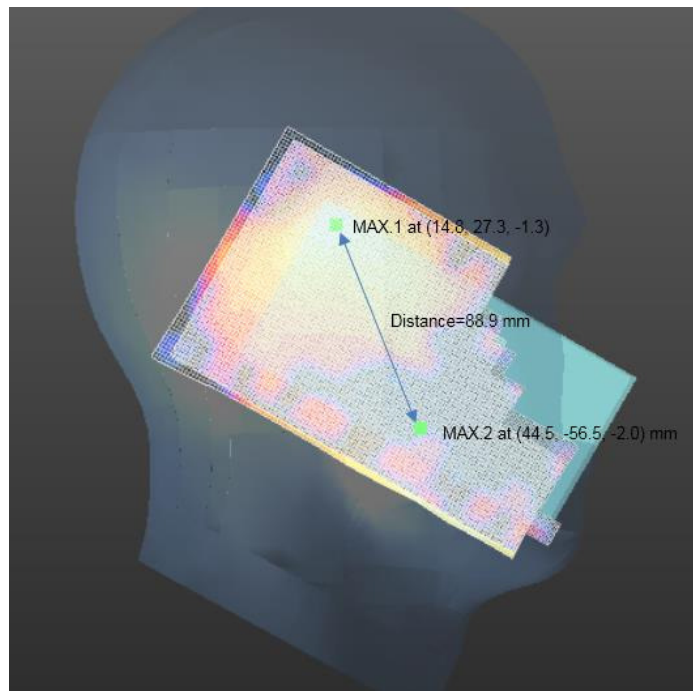

The SAR to peak location ratio calculation is as below:

Case No.	Exposure Condition	Test Position	Band	MAX Scaled SAR	$\Sigma$ SAR(W/kg)	Ri(mm)	SPLSR	Ratio Limit	Volum scan Simultaneous SAR
1	Head	Left touch	LTE Band II	0.683	1.753	88.9	0.026	0.04	Not required
			WiFi 5G	1.070					

- 2) The sum of aggregate 1-g SAR was above 1.6W/Kg for left touch configuration with LTE Band 2 (Main Antenna) and WiFi 2.4G.

The Peak SAR location plot is as below:

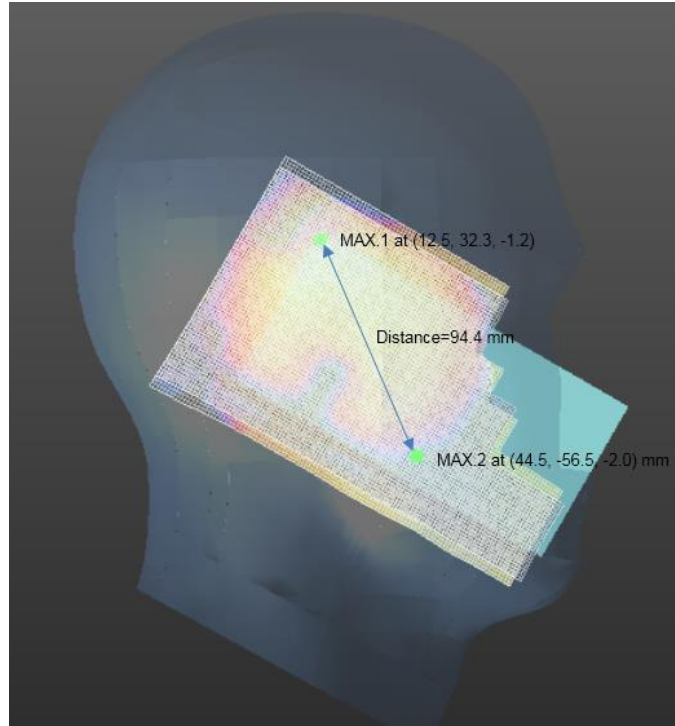

The SAR to peak location ratio calculation is as below:

Case No.	Exposure Condition	Test Position	Band	MAX Scaled SAR	$\Sigma$ SAR(W/kg)	Ri(mm)	SPLSR	Ratio Limit	Volum scan Simultaneous SAR
2	Head	Left touch	LTE Band II	0.683	1.705	94.4	0.024	0.04	Not required
			WiFi 2.4G	1.022					

### **7.3.5 Simultaneous Transmission Conclusion**

The above numeral summed SAR results and SPLSR analysis is sufficient to determine that simultaneous transmission cases will not exceed the SAR limit and therefore simultaneous transmission SAR with Volume Scans is not required per KDB 447498 D01.

**Appendix A. System Check Plots**

(Pls See Appendix No.: SYBH(Z-SAR)20171223016001-2A, total: 18 pages)

**Appendix B. SAR Measurement Plots**

(Pls See Appendix No.: SYBH(Z-SAR)20171223016001-2B, total: 40 pages)

**Appendix C. Calibration Certificate**

(Pls See Appendix No.: SYBH(Z-SAR)20171223016001-2C, total: 91 pages)

**Appendix D. Photo documentation**

(Pls See Appendix No.: SYBH(Z-SAR)20171223016001-2D, total: 6 pages)

---

**End**