

# FCC DFS Test Report

## FCC ID: QISFRD-L24

This report concerns (check one): Original Grant Class II Change

**Project No.** : 1605C119B  
**Equipment** : smart phone  
**Model Name** : FRD-L24  
**Applicant** : Huawei Technologies Co., Ltd.  
**Address** : Administration Building, Headquarters of Huawei Technologies Co., Ltd., Bantian, Longgang District, Shenzhen, 518129, P.R.C

**Date of Receipt** : May 16, 2016  
Mar. 05, 2018  
**Date of Test** : May 16, 2016 ~ Jun. 06, 2016  
**Issued Date** : Mar. 07, 2018  
**Tested by** : BTL Inc.

**Testing Engineer** :

*Shawn Xiao*

(Shawn Xiao)

**Technical Manager** :

*David Mao*

(David Mao)

**Authorized Signatory** :

*Steven Lu*

(Steven Lu)

# **B T L I N C .**

No.3, Jinshagang 1st Road, Shixia, Dalang Town, Dongguan  
Guangdong, China.

TEL: +86-769-8318-3000 FAX: +86-769-8319-6000



**Declaration**

**BTL** represents to the client that testing is done in accordance with standard procedures as applicable and that test instruments used has been calibrated with standards traceable to international standard(s) and/or national standard(s).

**BTL's** reports apply only to the specific samples tested under conditions. It is manufacture's responsibility to ensure that additional production units of this model are manufactured with the identical electrical and mechanical components. **BTL** shall have no liability for any declarations, inferences or generalizations drawn by the client or others from **BTL** issued reports.

**BTL's** report must not be used by the client to claim product certification, approval, or endorsement by NVLAP, NIST, or any agency of the Federal Government.

This report is the confidential property of the client. As a mutual protection to the clients, the public and **BTL-self**, extracts from the test report shall not be reproduced except in full with **BTL's** authorized written approval.

**BTL's** laboratory quality assurance procedures are in compliance with the **ISO Guide 17025** requirements, and accredited by the conformity assessment authorities listed in this test report.

**Limitation**

For the use of the authority's logo is limited unless the Test Standard(s)/Scope(s)/Item(s) mentioned in this test report is (are) included in the conformity assessment authorities acceptance respective.

<b>Table of Contents</b>	<b>Page</b>
<b>1 . CERTIFICATION</b>	<b>6</b>
<b>2 . EUT INFORMATION</b>	<b>7</b>
2.1 EUT SPECIFICATION TABLE	7
<b>3 . U-NII DFS RULE REQUIREMENTS</b>	<b>8</b>
3.1 WORKING MODES AND REQUIRED TEST ITEMS	8
3.2 TEST LIMITS AND RADAR SIGNAL PARAMETERS	9
<b>4 . TEST INSTRUMENTS</b>	<b>13</b>
<b>5 . EMC EMISSION TEST</b>	<b>14</b>
5.1 DFS MEASUREMENT SYSTEM:	14
5.2 CALIBRATION OF DFS DETECTION THRESHOLD LEVEL:	16
5.3 DEVIATION FROM TEST STANDARD	16
<b>6 . TEST RESULTS</b>	<b>17</b>
6.1 SUMMARY OF TEST RESULT	17
6.2 DELETED TEST RESULTS	18
6.2.1 TEST MODE: DEVICE OPERATING IN MASTER MODE.	18
6.2.2 DFS DETECTION THRESHOLD	18
6.2.3 CHANNEL CLOSING TRANSMISSION AND CHANNEL MOVE TIME WLAN TRAFFIC	19
6.2.4 NON- OCCUPANCY PERIOD	22

### REPORT ISSUED HISTORY

Issued No.	Description	Issued Date
BTL-FCCP-2-1605C119	Original Report.	Jun. 07, 2016
BTL-FCCP-2-1605C119B	Compared with the previous report (BTL-FCCP-2-1605C119), The model name is changed which does not affected the test result. The rest are the same. Differences please see the below table.	Mar. 06, 2018
RVC-1803005	The brand name is changed and differences table is updated.	Mar. 07, 2018

Model	FRD-L04	FRD-L24
GSM four bands	B2/B3/B5/B8	B2/B3/B5/B8
WCDMA bands	B1 /B2/B4/B5/B8	B1 /B2/B4/B5/B8
LTE bands	B1/B2/B3/B4/B5/B7/B8/B12/B17/B20	B2/ B4/B5/B7/ B12/B17
FCC bands	850/1900 /B2/B4/B5 /B2/ B4/B5/B7/B12/B17	850/1900 /B2/B4/B5 /B2/B4/B5/B7/B12/B17
SIM card	One	One
NFC	Support	Not support
FM	The same	The same
External camera	the same	the same
internal camera	the same	the same
FLASH	the same	the same
Mainboard	with NFC ROM:32GB No B40, B38 function, but keep the circuit	Without NFC, ROM:64GB No B40, B38 function and circuit Board ID:Make a change
PCB layout	the same	the same
Appearance	the same	the same
Bluetooth mode	the same	the same
WLAN mode	the same	the same
BT/ WLAN antenna	the same	the same
GSM/ WCDMA /LTE antenna	the antenna structure and shape is the same	the antenna structure and shape is the same
Adapter	the same	the same
Battery	the same	the same
Chipset	the same	the same
Memory	32GB	64GB
RF Parameter	The same	The same
Dimension	the same	the same
Main Frequency NV	The same NV in the same band	The same NV in the same band
Power reduction in SAR	WiFi antenna: 1)WiFi 2.4G antenna + Main antenna (wifi station):0db 2)WiFi 2.4G + Mian antenna (wifi hotspot):-1db 3)WiFi 5G antenna + Main antenna (wifi station):0db Main antenna:The same Second antenna: Support	WiFi antenna: 1)WiFi 2.4G antenna + Main antenna (wifi station):-4db 2)WiFi 2.4G + Mian antenna (wifi hotspot):-4db 3)WiFi 5G antenna + Main antenna (wifi station):-4db Main antenna:The same Second antenna:no support second antenna
Switching antenna	Can switch to the upper antenna	It is not able to switch to the upper antenna and does not support the upper antenna.

## 1. CERTIFICATION

Equipment : smart phone  
Trade Name : honor  
Model Name. : FRD-L24  
Applicant : Huawei Technologies Co., Ltd.  
Manufacturer : Huawei Technologies Co., Ltd.  
Address : Administration Building, Huawei Base, Bantian, Longgang District ,Shenzhen  
518129, P.R.China  
Date of Test: : May 16, 2016 ~ Jun. 06, 2016  
Test Sample : Engineering Sample  
Standard(s) : FCC Part 15, Subpart E (Section 15.407) FCC 06-96

The above equipment has been tested and found compliance with the requirement of the relative standards by BTL Inc.

The test data, data evaluation, and equipment configuration contained in our test report (Ref No. BTL-FCCP-2-1605C119B) were obtained utilizing the test procedures, test instruments, test sites that has been accredited by the Authority of NVLAP according to the ISO-17025 quality assessment standard and technical standard(s).

## 2. EUT INFORMATION

### 2.1 EUT SPECIFICATION TABLE

Table 1: Specification of EUT

<b>Product name</b>	smart phone
<b>Brand Name</b>	honor
<b>Model</b>	FRD-L24
<b>Operational Mode</b>	Slave
<b>Operating Frequency</b>	5250MHz~5350MHz&5470MHz~5725MHz
<b>Modulation</b>	OFDM

**Note:** This device was functioned as a  Master  Slave device during the DFS

Mode		Work Frequency	
		Transmitt Frequency(MHz)	Receive Frequency (MHz)
GSM	GSM 850	824 - 849	869 - 894
	PCS1900	1850-1910	1930-1990
W850		824 - 849	869 - 894
1700		1710-1755	2110-2155
W1900		1850-1910	1930-1990
LTE B2		1850 -1910	1930 -1990
LTE B4		1710 -1755	2110 -2155
LTE B5		824-849	869-894
LTE B7		2500 -2570	2620 -2690
LTE B12		699-716	729-746
LTE B17		704-716	734-746
Bluetooth		2402-2480	
2.4G Wi-Fi		2412-2462	
5G Wi-Fi		5150-5250,5250-5350, 5470-5725, 5725-5850	
GPS		1575.42	

### 3. U-NII DFS RULE REQUIREMENTS

#### 3.1 WORKING MODES AND REQUIRED TEST ITEMS

The manufacturer shall state whether the UUT is capable of operating as a Master and/or a Client. If the UUT is capable of operating in more than one operating mode then each operating mode shall be tested separately. See tables 1 and 2 for the applicability of DFS requirements for each of the operational modes.

Table 5: Applicability of DFS requirements prior to use a channel

Requirement	Operational Mode		
	Master	Client without radar detection	Client with radar detection
Non-Occupancy Period	√	√	√
DFS Detection Threshold	√	Not required	√
Channel Availability Check Time	√	Not required	Not required
Uniform Spreading	√	Not required	Not required
U-NII Detection Bandwidth	√	Not required	√

Table 6: Applicability of DFS requirements during normal operation.

Requirement	Operational Mode		
	Master	Client without radar detection	Client with radar detection
DFS Detection Threshold	√	Not required	√
Channel Closing Transmission Time	√	√	√
Channel Move Time	√	√	√
U-NII Detection Bandwidth	√	Not required	√



### 3.2 TEST LIMITS AND RADAR SIGNAL PARAMETERS

#### DETECTION THRESHOLD VALUES

Table 7: DFS Detection Thresholds for Master Devices and Client Devices With Radar Detection.

Maximum Transmit Power	Value (See Notes 1 and 2)
≥ 200 milliwatt	-64 dBm
< 200 milliwatt	-62 dBm

Note 1: This is the level at the input of the receiver assuming a 0 dBi receive antenna.

Note 2: Throughout these test procedures an additional 1 dB has been added to the amplitude of the test transmission waveforms to account for variations in measurement equipment. This will ensure that the test signal is at or above the detection threshold level to trigger a DFS response.

Table 8: DFS Response Requirement Values

Parameter	Value
Non-occupancy period	Minimum 30 minutes
Channel Availability Check Time	60 seconds
Channel Move Time	10 seconds See Note 1.
Channel Closing Transmission Time	200 milliseconds + an aggregate of 60 milliseconds over remaining 10 second period. See Notes 1 and 2.
U-NII Detection Bandwidth	Minimum 80% of the UNII 99% transmission power bandwidth. See Note 3.

**Note 1:** The instant that the Channel Move Time and the Channel Closing Transmission Time begins is as follows:

- For the Short Pulse Radar Test Signals this instant is the end of the Burst.
- For the Frequency Hopping radar Test Signal, this instant is the end of the last radar Burst generated.
- For the Long Pulse Radar Test Signal this instant is the end of the 12 second period defining the Radar Waveform.

**Note 2:** The Channel Closing Transmission Time is comprised of 200 milliseconds starting at the beginning of the Channel Move Time plus any additional intermittent control signals required to facilitate a Channel move (an aggregate of 60 milliseconds) during the remainder of the 10 second period. The aggregate duration of control signals will not count quiet periods in between transmissions.

**Note 3:** During the U-NII Detection Bandwidth detection test, radar type 1 is used and for each frequency step the minimum percentage of detection is 90 percent. Measurements are performed with no data traffic.

### PARAMETERS OF DFS TEST SIGNALS

Step intervals of 0.1 microsecond for Pulse Width, 1 microsecond for PRI, 1 MHz for chirp width and 1 for the number of pulses will be utilized for the random determination of specific test waveforms.

Table 9: Short Pulse Radar Test Waveforms.

Radar Type	Pulse Width (μsec)	PRI (μsec)	Number of Pulses	Minimum Percentage of Successful Detection	Minimum Number of Trials
0	1	1428	18	See Note 1	See Note 1
1	1	Test A: 15 unique PRI values randomly selected from the list of 23 PRI values in Table 5a	Roundup $\left\{ \begin{matrix} \left( \frac{1}{360} \right) \cdot \\ \left( \frac{19 \cdot 10^6}{\text{PRI}_{\mu\text{sec}}} \right) \end{matrix} \right\}$	60%	30
		Test B: 15 unique PRI values randomly selected within the range of 518-3066 μsec, with a minimum increment of 1 μsec, excluding PRI values selected in Test A			
2	1-5	150-230	23-29	60%	30
3	6-10	200-500	16-18	60%	30
4	11-20	200-500	12-16	60%	30
Aggregate (Radar Types 1-4)				80%	120
<b>Note 1:</b> Short Pulse Radar Type 0 shall only be used for the channel availability and detection bandwidth tests. It should be noted that any of the radar test waveforms 0 – 4 can be used for the channel availability and detection bandwidth tests.					

Table 10: Long Pulse Radar Test Waveform

Radar Type	Pulse Width (μsec)	Chirp Width (MHz)	PRI (μsec)	Number of Pulses per Burst	Number of Bursts	Minimum Percentage of Successful Detection	Minimum Number of Trials
5	50-100	5-20	1000-2000	1-3	8-20	80%	30

Table 11: Frequency Hopping Radar Test Waveform

Radar Type	Pulse Width (μsec)	Chirp Width (MHz)	PRI (μsec)	Number of Pulses per Burst	Number of Bursts	Minimum Percentage of Successful Detection	Minimum Number of Trials
6	1	333	9	0.333	300	70%	30

Note:

**Table 5a - Pulse Repetition Intervals Values for Test A**

<b>Pulse Repetition Frequency Number</b>	<b>Pulse Repetition Frequency (Pulses Per Second)</b>	<b>Pulse Repetition Interval (Microseconds)</b>
1	1930.5	518
2	1858.7	538
3	1792.1	558
4	1730.1	578
5	1672.2	598
6	1618.1	618
7	1567.4	638
8	1519.8	658
9	1474.9	678
10	1432.7	698
11	1392.8	718
12	1355	738
13	1319.3	758
14	1285.3	778
15	1253.1	798
16	1222.5	818
17	1193.3	838
18	1165.6	858
19	1139	878
20	1113.6	898
21	1089.3	918
22	1066.1	938
23	326.2	3066

#### 4. TEST INSTRUMENTS

Table 1: Test instruments list.

DESCRIPTION	MANUFACTURER	MODEL NO.	Serial No	Calibration Until
EXA Spectrum Analyzer	Agilent	N9010A	MY50520044	Mar. 27, 2017
Signal Generator	Agilent	E4438C	MY49071316	Mar. 27, 2017
POWER SPLITTER	Mini-Circuits	ZFRSC-123-S+	331000910-1	Feb. 26, 2017
POWER SPLITTER	Mini-Circuits	ZN4PD1-63-S+	SF9335D1045-1	Feb. 23, 2017
Attenuator	WOKEN	6SM3502	VAS1214NL	Mar. 02, 2017

Note: Calibration interval of instruments listed above is one year.

## 5. EMC EMISSION TEST

### 5.1 DFS MEASUREMENT SYSTEM:

#### CONDUCTED METHOD SYSTEM BLOCK DIAGRAM

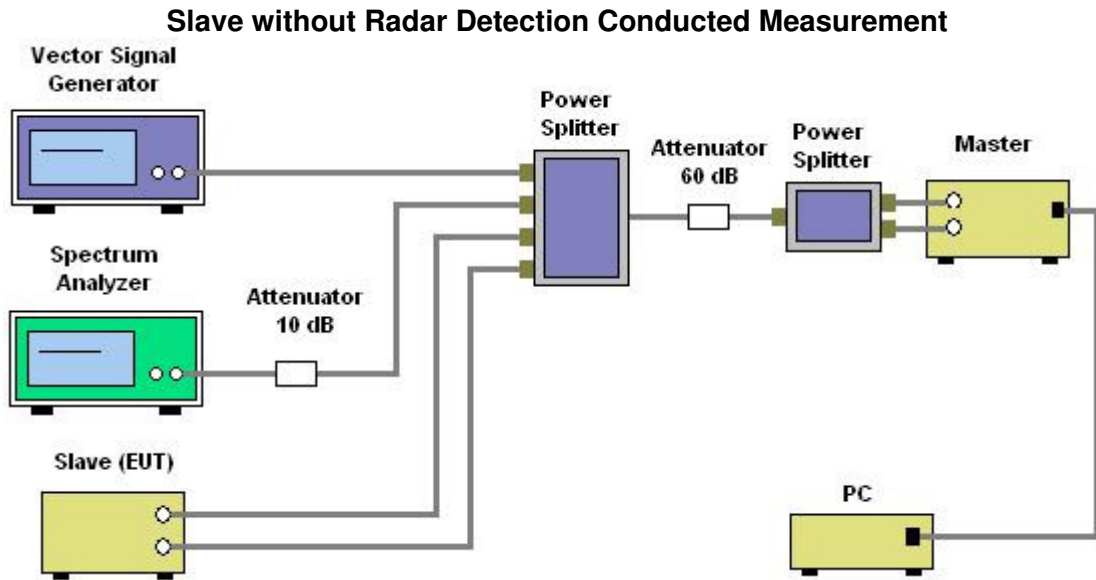

#### SYSTEM OVERVIEW

The short pulse and long pulse signal generating system utilizes the NTIA software. The Vector Signal Generator has been validated by the NTIA. The hopping signal generating system utilizes the CCS simulated hopping method and system, which has been validated by the DoD, FCC and NTIA. The software selects waveform parameters from within the bounds of the signal type on a random basis using uniform distribution.

The short pulse types 2, 3 and 4, and the long pulse type 5 parameters are randomized at run-time.

The hopping type 6 pulse parameters are fixed while the hopping sequence is based on the August 2005 NTIA Hopping Frequency List. The initial starting point randomized at run-time and each subsequent starting point is incremented by 475. Each frequency in the 100-length segment is compared to the boundaries of the EUT Detection Bandwidth and the software creates a hopping burst pattern in accordance with Section 7.4.1.3 Method #2 Simulated Frequency Hopping Radar Waveform Generating Subsystem of FCC 06-96. The frequency of the signal generator is incremented in 1 MHz steps from FL to FH for each successive trial. This incremental sequence is repeated as required to generate a minimum of 30 total trials and to maintain a uniform frequency distribution over the entire Detection Bandwidth.

The signal monitoring equipment consists of a spectrum analyzer set to display 8001 bins on the horizontal axis. The time-domain resolution is 2 msec / bin with a 16 second sweep time, meeting the 10 second short pulse reporting criteria. The aggregate ON time is calculated by multiplying the number of bins above a threshold during a particular observation period by the dwell time per bin, with the analyzer set to peak detection and max hold.

Should multiple RF ports be utilized for the Master and/or Slave devices (for example, for diversity or MIMO implementations), additional combiner/dividers are inserted between the Master Combiner/Divider and the pad connected to the Master Device (and/or between the Slave Combiner/Divider and the pad connected to the Slave Device). Additional pads are utilized such that there is one pad at each RF port on each EUT.

**5.2 CALIBRATION OF DFS DETECTION THRESHOLD LEVEL:**

A 50 ohm load is connected in place of the spectrum analyzer, and the spectrum analyzer is connected in place of the master device and the signal generator is set to CW mode. The amplitude of the signal generator is adjusted to yield a level of -62 dBm as measured on the spectrum analyzer.

Without changing any of the instrument settings, the spectrum analyzer is reconnected to the Common port of the Spectrum Analyzer Combiner/Divider. Measure the amplitude and calculate the difference from -62 dBm. Adjust the Reference Level Offset of the spectrum analyzer to this difference.

The spectrum analyzer displays the level of the signal generator as received at the antenna ports of the Master Device. The interference detection threshold may be varied from the calibrated value of -62 dBm and the spectrum analyzer will still indicate the level as received by the Master Device.

Set the signal generator to produce a radar waveform, trigger a burst manually and measure the level on the spectrum analyzer. Readjust the amplitude of the signal generator as required so that the peak level of the waveform is at a displayed level equal to the required or desired interference detection threshold. Separate signal generator amplitude settings are determined as required for each radar type.

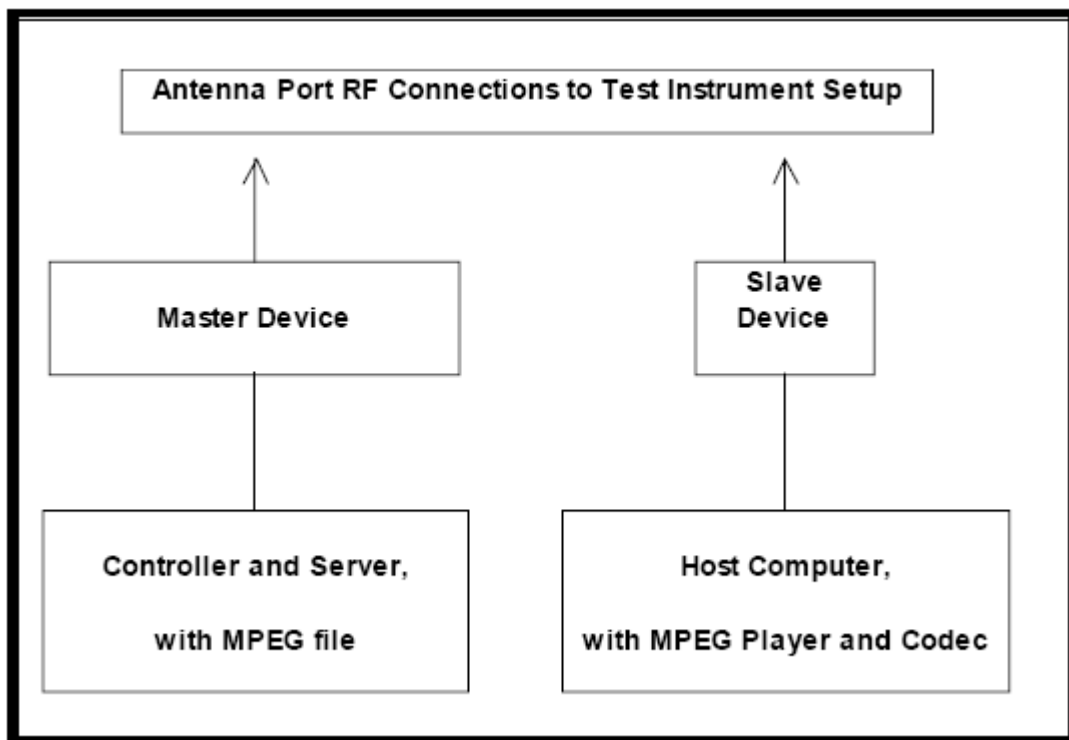

**5.3 DEVIATION FROM TEST STANDARD**

No deviation.



## 6. TEST RESULTS

### 6.1 SUMMARY OF TEST RESULT

Clause	Test Parameter	Remarks	Pass/Fail
15.407	DFS Detection Threshold	No Applicable	N/A
15.407	Channel Availability Check Time	Not Applicable	N/A
15.407	Channel Move Time	Applicable	Pass
15.407	Channel Closing Transmission Time	Applicable	Pass
15.407	Non- Occupancy Period	Applicable	Pass
15.407	Uniform Spreading	Not Applicable	N/A
15.407	U-NII Detection Bandwidth	Not Applicable	N/A

## 6.2 DETELED TEST RESULTS

Clause	Test Parameter	Remarks	Pass/Fail
15.407	DFS Detection Threshold	No Applicable	N/A
15.407	Channel Availability Check Time	Not Applicable	N/A
15.407	Channel Move Time	Applicable	Pass
15.407	Channel Closing Transmission Time	Applicable	Pass
15.407	Non- Occupancy Period	Applicable	Pass
15.407	Uniform Spreading	Not Applicable	N/A
15.407	U-NII Detection Bandwidth	Not Applicable	N/A

### 6.2.1 TEST MODE: DEVICE OPERATING IN MASTER MODE.

The EUT is slave equipment, it need a master device when testing.  
 Master with injection at the Master. (Radar Test Waveforms are injected into the Master)

### 6.2.2 DFS DETECTION THRESHOLD

Calibration:

The EUT is slave equipment and it with a max gain is 2 dBi.  
 For a detection threshold level of -62dBm and the master (Brand: Alcatel-Lucent, Model: G-240W-B, FCC ID: 2ADZRG240WB) antenna gain is 2.90 dBi, required detection threshold is -59.10 dBm (= -62+2.90).

Note: Maximum Transmit Power is less than 200 milliwatt in this report, so detection threshold level is -62dBm.

### 6.2.3 CHANNEL CLOSING TRANSMISSION AND CHANNEL MOVE TIME WLAN TRAFFIC

TX (11a Mode)

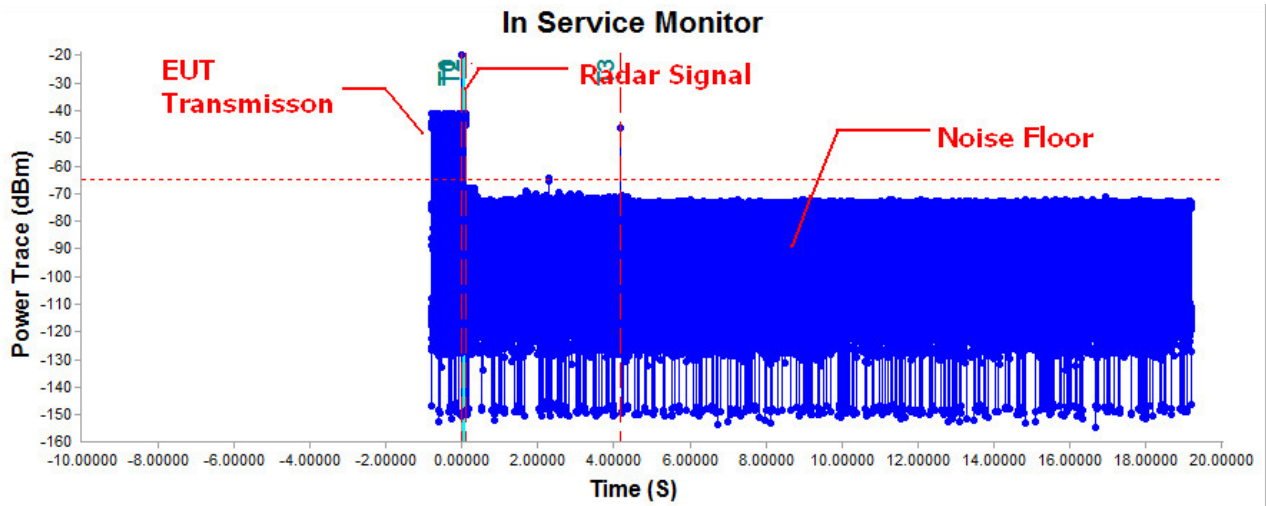

Time Index Info

T0 : -0.0240 S (Radar Injection Start)	Time Per Bin: 0.4999875	Channel Move Time: 4.1808955 S
T1 : 0.0000 S (Radar Injection Stop)	T2~T3 Bins Over Threshold: = 3 Bins	Channel Close Time: 0.0015 S
T2 : 0.1000 S (200msec Interval)		
T3 : 4.1809 S (Channel Move Time)		

**Note:** T0 denotes the start of Channel Move Time upon the end of the last Radar burst.  
 T1 denotes the data transmission time of 200ms from T0.  
 T2 denotes the end of Channel Move Time.  
 T3 denotes the 10 second from T0 to observe the aggregate duration of transmissions.

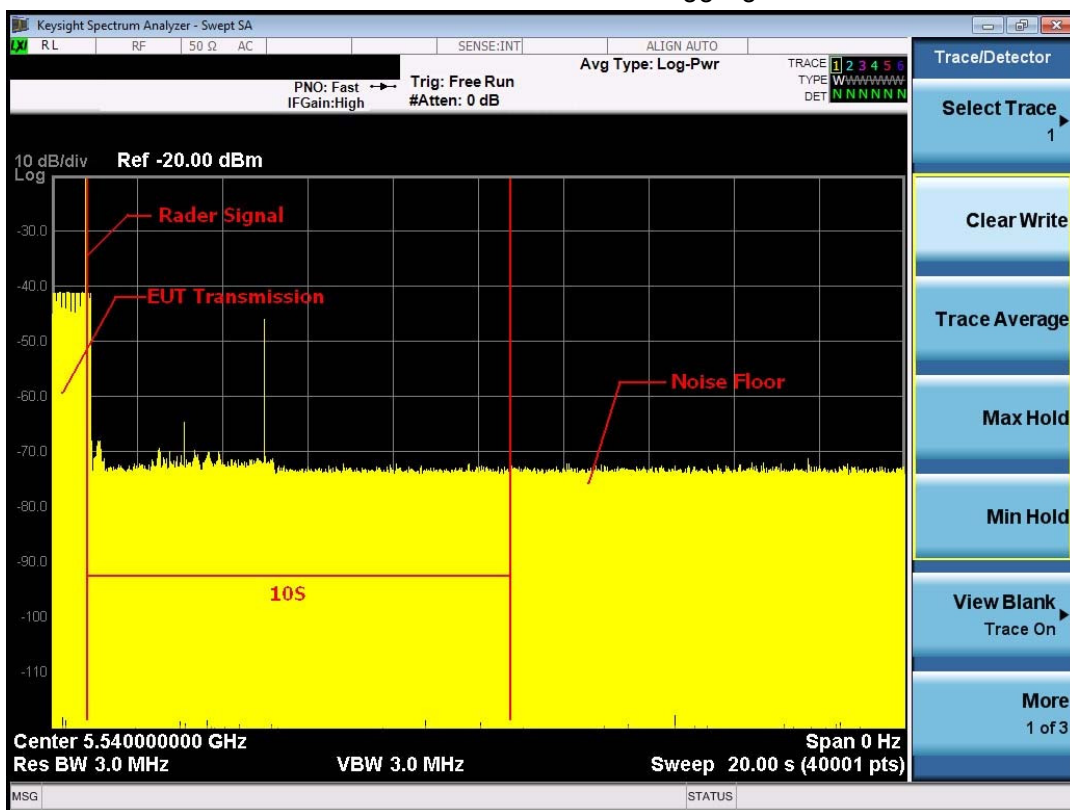

**Note:** An expanded plot for the device vacates the channel in the required 500ms

TX (11n 40MHz Mode)

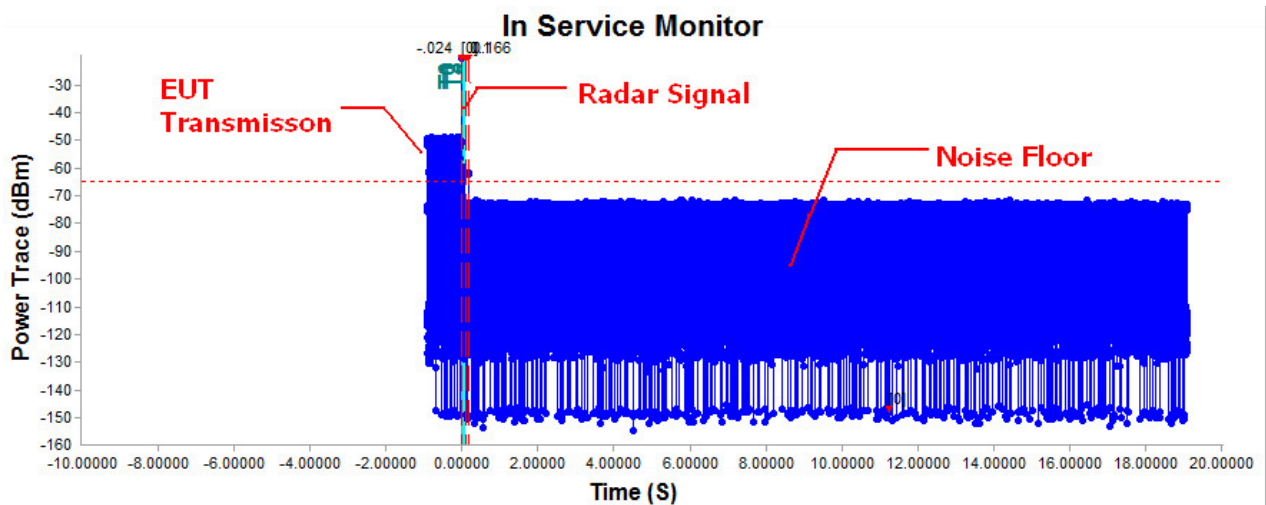

Time Index Info

T0 : -0.0240 S (Radar Injection Start)	Time Per Bin: 0.4999875	Channel Move Time: 0.1659959 S
T1 : 0.0000 S (Radar Injection Stop)	T2~T3 Bins Over Threshold: = 2 Bins	Channel Close Time: 0.001 S
T2 : 0.1000 S (200msec Interval)		
T3 : 0.1660 S (Channel Move Time)		

**Note:** T0 denotes the start of Channel Move Time upon the end of the last Radar burst.  
 T1 denotes the data transmission time of 200ms from T0.  
 T2 denotes the end of Channel Move Time.  
 T3 denotes the 10 second from T0 to observe the aggregate duration of transmissions.

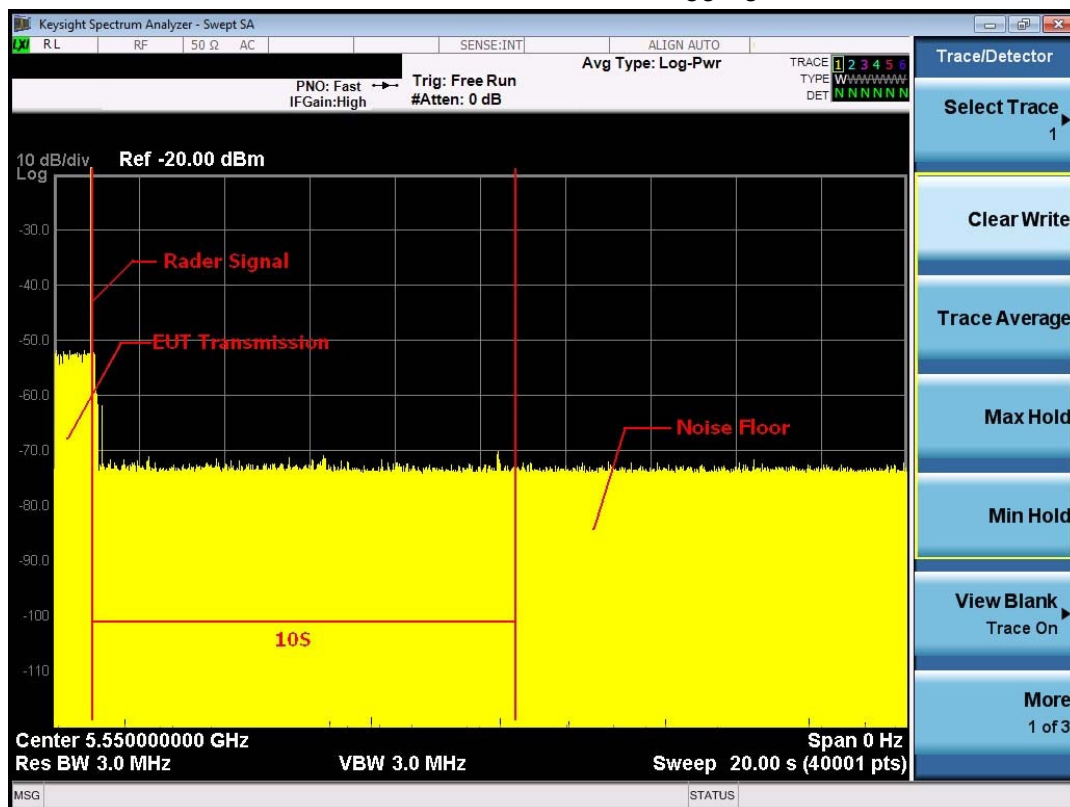

**Note:** An expanded plot for the device vacates the channel in the required 500ms

TX (11ac 80MHz Mode)

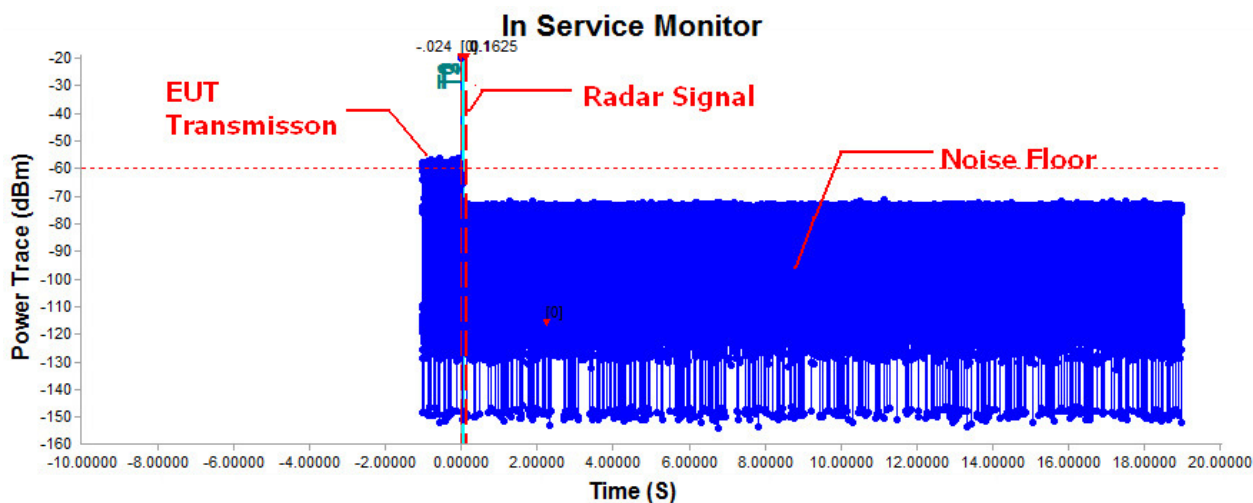

Time Index Info

T0 : -0.0240 S (Radar Injection Start)	Time Per Bin: 0.4999875	Channel Move Time: 0.1624959 S
T1 : 0.0000 S (Radar Injection Stop)	T2~T3 Bins Over Threshold: = 0 Bins	Channel Close Time: 0.0 S
T2 : 0.1000 S (200msec Interval)		
T3 : 0.1625 S (Channel Move Time)		

**Note:** T0 denotes the start of Channel Move Time upon the end of the last Radar burst.  
 T1 denotes the data transmission time of 200ms from T0.  
 T2 denotes the end of Channel Move Time.  
 T3 denotes the 10 second from T0 to observe the aggregate duration of transmissions.

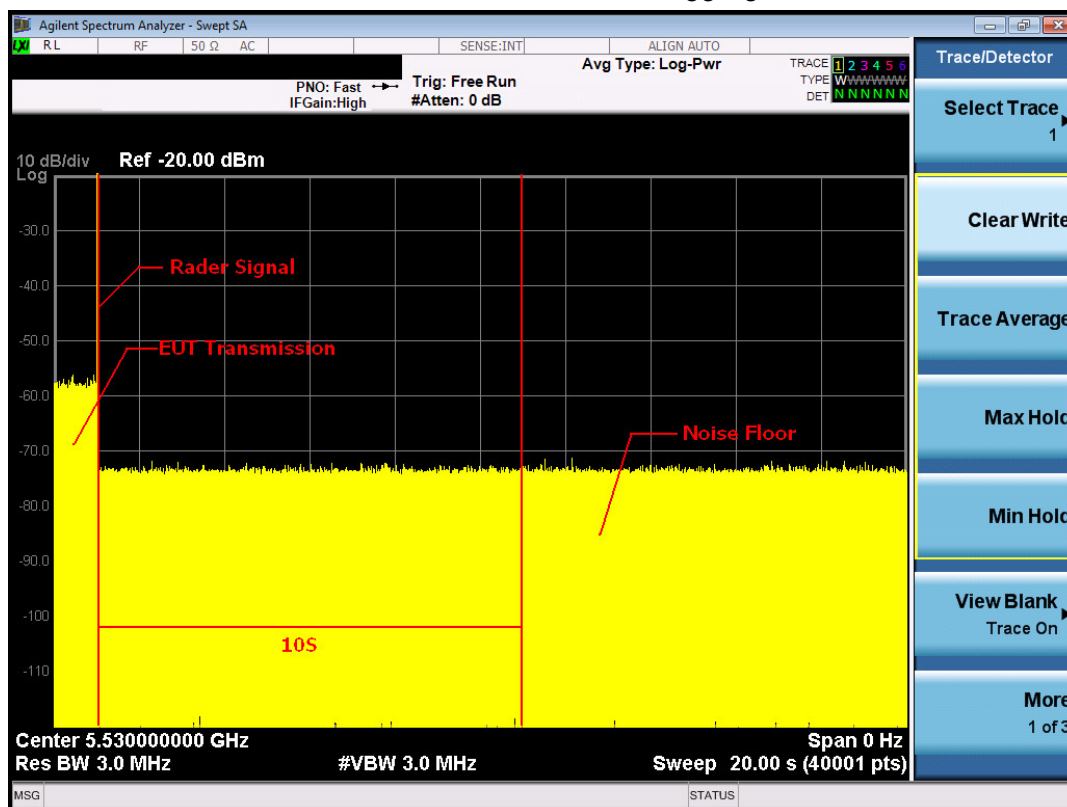

**Note:** An expanded plot for the device vacates the channel in the required 500ms

### 6.2.4 NON- OCCUPANCY PERIOD

During the 30 minutes observation time, UUT did not make any transmissions on a channel after a radar signal was detected on that channel by either the Channel Availability Check or the In-Service Monitoring.

TX (11a Mode)

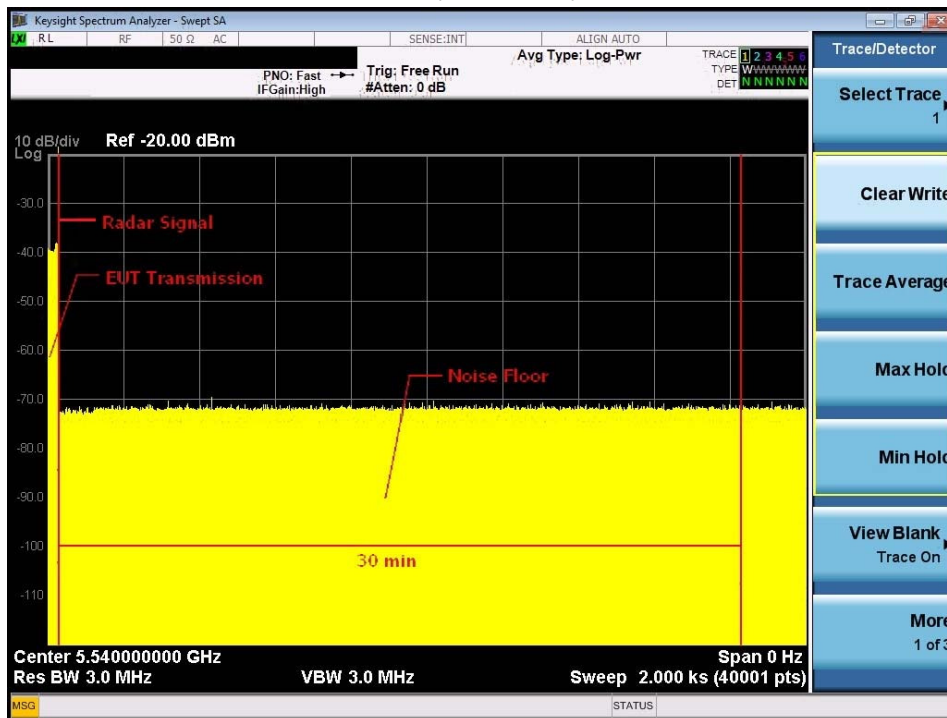

TX (11n 40MHz Mode)

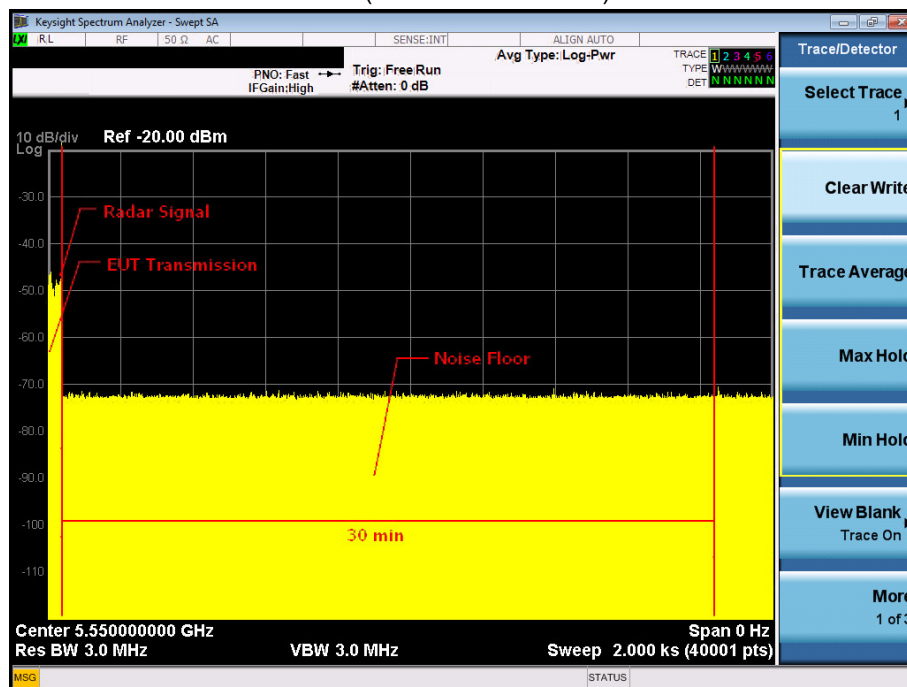

### TX (11ac 80MHz Mode)

