



中国认可
国际互认
检测
TESTING
CNAS L0310



FCC HAC (T-Coil) Compliance Test Report

Product Name: Smart Phone

Model: FRD-L24

Report No.: SYBH(Z-HAC)20171223016001-H2

FCC ID: QISFRD-L24

	APPROVED (Lab Manager)	PREPARED (Test Engineer)
BY	<i>Wei Huanbin</i>	<i>Deng Zhao</i>
DATE	2018-02-27	2018-02-27

Reliability Laboratory of Huawei Technologies Co., Ltd.

(Global Compliance and Testing Center of Huawei Technologies Co., Ltd)

Administration Building, Headquarters of Huawei Technologies Co., Ltd., Bantian, Longgang
District, Shenzhen, 518129, P.R.C

Tel: +86 755 28780808 Fax: +86 755 89652518

※ ※ Notice ※ ※

1. The laboratory has passed the accreditation by China National Accreditation Service for Conformity Assessment (CNAS). The accreditation number is L0310.
2. The laboratory has passed the accreditation by The American Association for Laboratory Accreditation (A2LA). The accreditation number is 2174.01 & 2174.02 & 2174.03
3. The laboratory (Reliability Lab of Huawei Technologies Co., Ltd) is also named “Global Compliance and Testing Center of Huawei Technologies Co., Ltd”, the both names have coexisted since 2009.
4. The test report is invalid if not marked with the signatures of the persons responsible for preparing and approving the test report.
5. The test report is invalid if there is any evidence of erasure and/or falsification.
6. The test report is only valid for the test samples.
7. Content of the test report, in part or in full, cannot be used for publicity and/or promotional purposes without prior written approval from the laboratory.

Table of Contents

1	General Information	5
1.1	Statement of Compliance	5
1.2	EUT Description	6
1.2.1	General Description	8
1.2.2	List of air interfaces/frequency bands	9
1.2.3	Antenna specification	10
1.3	Test specification(s)	11
1.4	Testing laboratory	11
1.5	Applicant and Manufacturer	11
1.6	Application details	11
1.7	Ambient Condition	11
2	HAC(T-Coil) Measurement System	12
2.1	T-Coil Measurement Set-up	12
2.2	Probe description	13
2.3	AMCC	14
2.4	AMMI	14
2.5	Test Arch Phantom & Phone Positioner	14
2.6	Test Equipment List	15
2.7	Measurement Uncertainty Evaluation	16
3	HAC(T-Coil) Measurement	17
3.1	T-Coil measurement points and reference plane	17
3.2	T-Coil Measurement Procedure	18
3.3	T-Coil Performance Requirements	20
4	HAC(T-Coil) Test Configuration	22
4.1	General Description	22
4.2	GSM Test Configuration	22
4.3	UMTS Test Configuration	22
4.4	LTE Test Configuration	22
5	HAC(T-Coil) Measurement Results	25
5.1	HAC(T-Coil) Measurement Results of GSM and UMTS	25
5.2	HAC(T-Coil) Measurement Results of VoLTE	26
	Appendix A. T-Coil Measurement Plots	32
	Appendix B. Calibration Certificate	32
	Appendix C. Photo documentation	32

※ ※ **Modified History** ※ ※

REV.	DESCRIPTION	ISSUED DATE	REMARK
Rev.1.0	Initial Test Report Release	2018-02-27	Deng Zhao

1 General Information

1.1 Statement of Compliance

The T-rating of Hearing-Aid Compatibility (HAC) found during testing for FRD-L24 are as below Table 1. So the T-rating of FRD-L24 is **T3**.

Band	T-rating
GSM850	T3
GSM1900	T4
UMTS Band 2	T4
UMTS Band 4	T4
UMTS Band 5	T4
LTE Band 2	T4
LTE Band 4	T4
LTE Band 5	T4
LTE Band 7	T4
LTE Band 12	T4
LTE Band 17	T4

Table 1: Summary of test results

Note:

1) This portable wireless equipment has been shown to be hearing-aid compatible under the above rated category, specified in ANSI/IEEE Std.C63.19-2011 and had been tested in accordance with the specified measurement procedures, Hear-Aid Compatibility is based on the assumption that all production units will be designed electrically identical to the device tested in this report. Test results reported herein relate only to the item(s) tested and are for North American Bands only.

1.2 EUT Description

Device Information:			
DUT Name:	FRD-L24		
Type Identification:	Smart Phone		
FCC ID :	QISFRD-L24		
SN:	1#:7ECDU17C20000064 2#:7ECDU17C20000122		
Device Type :	Portable device		
Exposure Category:	Uncontrolled environment / general population		
Device Phase:	Identical Prototype		
Hardware Version :	HL1FRDL04M		
Software Version :	FRD-L24C567B100		
Antenna Type :	Internal		
Others Accessories	Headset		
Device Operating Configurations:			
Supporting Mode(s)	GSM850/1900;UMTS Band 2/4/5; LTE Band 2/4/5/7/12/17, WiFi 2.4G/5G;BT		
Test Modulation	GSM(GMSK),UMTS(QPSK),LTE(QPSK/16QAM)		
HSDPA UE category	14		
HSUPA UE category	6		
DC-HSDPA UE category	24		
Operating Frequency Range(s)	Band(MHz)	Tx (MHz)	Rx (MHz)
	GSM850	824-849	869-894
	GSM1900	1850-1910	1930-1990
	UMTS Band 2	1850-1910	1930-1990
	UMTS Band 4	1710-1755	2110-2155
	UMTS Band 5	824 - 849	869 - 894
	LTE Band 2	1850-1910	1930-1990
	LTE Band 4	1710-1755	2110-2155
	LTE Band 5	824-849	869-894
	LTE Band 7	2500-2570	2620-2690
	LTE Band 12	699-716	729-746
	LTE Band 17	704-716	734-746
	WiFi 5G	5150-5350 5470-5850	
	WiFi 2.4G	2412-2462	
BT	2402-2480		
Power Class :	4, tested with power level 5(GSM850)		
	1, tested with power level 0(GSM1900)		
	3, tested with power control "all 1"(UMTS Band 2)		
	3, tested with power control "all 1"(UMTS Band 4)		
	3, tested with power control "all 1"(UMTS Band 5)		
	3, tested with power control all Max.(LTE Band 2)		
	3, tested with power control all Max.(LTE Band 4)		
	3, tested with power control all Max.(LTE Band 5)		
	3, tested with power control all Max.(LTE Band 7)		
	3, tested with power control all Max.(LTE Band 12)		
	3, tested with power control all Max.(LTE Band 17)		
Test Channels (mid) :	190CH(GSM850)		
	661CH(GSM1900)		
	9400CH(UMTS Band 2)		
	1413CH(UMTS Band 4)		
	4182CH(UMTS Band 5)		

	18900(LTE Band 2 BW=1.4MHz)
	18900(LTE Band 2 BW=3MHz)
	18900(LTE Band 2 BW=5MHz)
	18900(LTE Band 2 BW=10MHz)
	18900(LTE Band 2 BW=15MHz)
	18900(LTE Band 2 BW=20MHz)
	20175(LTE Band 4 BW=20MHz)
	20525(LTE Band 5 BW=10MHz)
	21100(LTE Band 7 BW=20MHz)
	23095(LTE Band 12 BW=10MHz)
	23790(LTE Band 17 BW=10MHz)

Table 2: Device information and operating configuration

1.2.1 General Description

FRD-L24 is subscriber equipment in the GSM/WCDMA/LTE/CDMA system. The GSM frequency band is GSM850 and GSM900 and DCS1800 and PCS1900. The UMTS frequency band is B1 and B2 and B4 and B5 and B8. The LTE frequency band is B2 and B4 and B5 and B7 and B12 and B17. But only GSM850 and GSM1900, UMTS frequency B2 and B4 and B5, LTE frequency B2 and B4 and B5 and B7 and B12 and B17 bands test data included in this report. The Mobile Phone implements such functions as RF signal receiving/transmitting, LTE/HSPA/UMTS and GSM/GPRS/EDGE protocol processing, voice, video MMS service, GPS, AGPS and WIFI etc. Externally it provides one micro SD card (it can also used as SIM card interface), earphone port (to provide voice service) and one SIM card interface. FRD-L24 is single SIM smart phone. It also provides Bluetooth module to synchronize data between a PC and the phone, or to use the built-in modem of the phone to access the Internet with a PC, or to exchange data with other Bluetooth devices.

Battery information:

Name	Manufacture	Serials number	Description
Rechargeable Li-ion	Desay	NA	Battery Model: HB366481ECW Rated capacity: 2900mAh Nominal Voltage: \approx +3.82V Charging Voltage: \approx +4.40V

1.2.2 List of air interfaces/frequency bands

Air-Interface	Bands (MHz)	Type	C63.19 HAC tested	Simultaneous Transmitter	Name of Voice Service	Additional GSM power reduction
GSM	850	VO	Yes	WiFi/BT	CMRS Voice*	N/A
	1900	VO	Yes	WiFi/BT		N/A
	GPRS/EDGE	DT	N/A	WiFi/BT	N/A	N/A
UMTS	Band 2(1900)	VO	Yes	WiFi/BT	CMRS Voice*	N/A
	Band 4(1750)	VO	Yes	WiFi/BT		N/A
	Band 5(850)	VO	Yes	WiFi/BT		N/A
	HSPA/DC-HSDPA	DT	N/A	WiFi/BT	N/A	N/A
LTE	Band 2	VD	Yes	WiFi/BT	VoLTE*	N/A
	Band 4	VD	Yes	WiFi/BT		N/A
	Band 5	VD	Yes	WiFi/BT		N/A
	Band 7	VD	Yes	WiFi/BT		N/A
	Band 12	VD	Yes	WiFi/BT		N/A
	Band 17	VD	Yes	WiFi/BT		N/A
WiFi	2450	DT	N/A	GSM/UMTS/LTE	N/A	N/A
	5200 (U-NII-1)	DT	N/A	GSM/UMTS/LTE		N/A
	5300 (U-NII-2A)	DT	N/A	GSM/UMTS/LTE		N/A
	5500 (U-NII-2C)	DT	N/A	GSM/UMTS/LTE		N/A
	5800 (U-NII-3)	DT	N/A	GSM/UMTS/LTE		N/A
BT	2450	DT	N/A	GSM/UMTS/LTE	N/A	N/A

Note:

- 1) * - Ref Lev in accordance with 7.4.2.1 of ANSI C63.19-2011 and the July 2012 VoLTE interpretation.
- 2) The device supports VoLTE.
- 3) The device does not support Wi-Fi calling or other pre-installed OTT voice services that are not defined in ANSI C63.19-2011.

1.2.3 Antenna specification

The device has one 2G/3G/4G Tx antenna (Main Antenna) and one WIFI/BT Tx antenna. The 2G/3G/4G Second Antenna does not support Tx function. The location of the antennas inside the device is shown as below picture(Unit:mm):

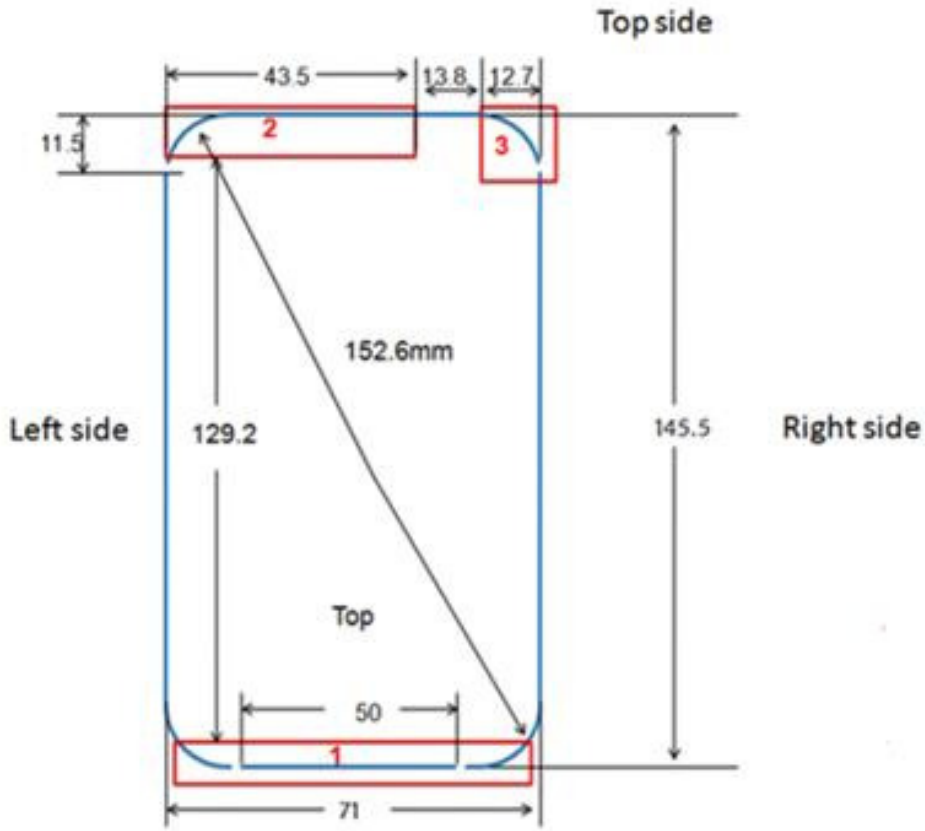

- <Front View>
1. Main Ant (Tx & Rx)
 2. Second Ant (Rx only)
 3. GPS/WiFi 2.4G/5G/BT Ant

1.3 Test specification(s)

ANSI C63.19-2011	American National Standard for Methods of Measurement of Compatibility between Wireless Communication Devices
KDB 285076 D01	HAC Guidance v05
KDB 285076 D02	T-Coil testing v03
KDB 285076 D03	HAC FAQ v01
CFR 47 FCC Part 20	§20.19 Hearing aid-compatible mobile handsets.

1.4 Testing laboratory

Test Site	Reliability Laboratory of Huawei Technologies Co., Ltd.
Test Location	Section G1, Huawei Base Bantian, Longgang District, Shenzhen 518129, P.R. China
Telephone	+86 755 28780808
Fax	+86 755 89652518
State of accreditation	The Test laboratory (area of testing) is accredited according to ISO/IEC 17025. CNAS Registration number: L0310 A2LA TESTING CERT #2174.01 &2174.02 & 2174.03

1.5 Applicant and Manufacturer

Company Name	HUAWEI TECHNOLOGIES CO., LTD
Address	Administration Building, Headquarters of Huawei Technologies Co., Ltd., Bantian, Longgang District, Shenzhen, 518129, P.R.C

1.6 Application details

Start Date of test	2018-02-06
End Date of test	2018-02-26

1.7 Ambient Condition

Ambient temperature	18°C – 25°C
Relative Humidity	30% – 70%

2 HAC(T-Coil) Measurement System

2.1 T-Coil Measurement Set-up

These measurements are performed using the DASY5 NEO automated dosimetric assessment system. It is made by Schmid & Partner Engineering AG (SPEAG) in Zurich, Switzerland. It consists of high precision robotics system (Stäubli), robot controller, Lenovo Intel Core i5 3.1 GHz computer, near-field probe, probe alignment sensor. The robot is a six-axis industrial robot performing precise movements. A cell controller system contains the power supply, robot controller, teach pendant (Joystick), and remote control, is used to drive the robot motors. The PC consists of Lenovo Intel Core i5 3.1 GHz computer with Windows 7 system and HAC Measurement Software DASY5 NEO, A/D interface card, monitor, mouse, and keyboard. The Stäubli Robot is connected to the cell controller to allow software manipulation of the robot. A data acquisition electronic (DAE) circuit performs the signal amplification, signal multiplexing, AD-conversion, offset measurements, mechanical surface detection, collision detection, etc. is connected to the Electro-optical coupler (EOC). The EOC performs the conversion from the optical into digital electric signal of the DAE and transfers data to the PC plug-in card.

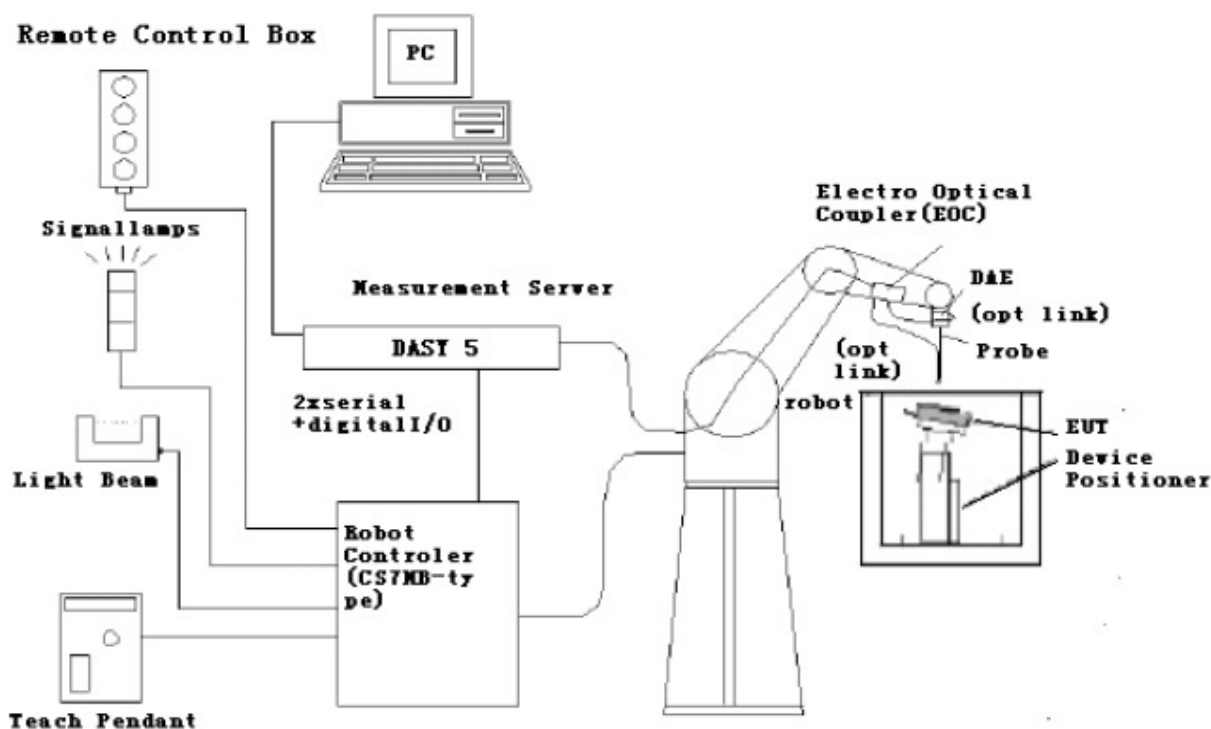

Fig. 1 HAC Test Measurement Set-up

The DAE4 consists of a highly sensitive electrometer-grade preamplifier with auto-zeroing, a channel and gain-switching multiplexer, a fast 16 bit AD-converter and a command decoder and control logic unit. Transmission to the PC-card is accomplished through an optical downlink for data and status information and an optical uplink for commands and clock lines. The mechanical probe mounting device includes two different sensor systems for frontal and sidewise probe contacts. They are also used for mechanical surface detection and probe collision detection. The robot uses its own controller with a built in VME-bus computer.

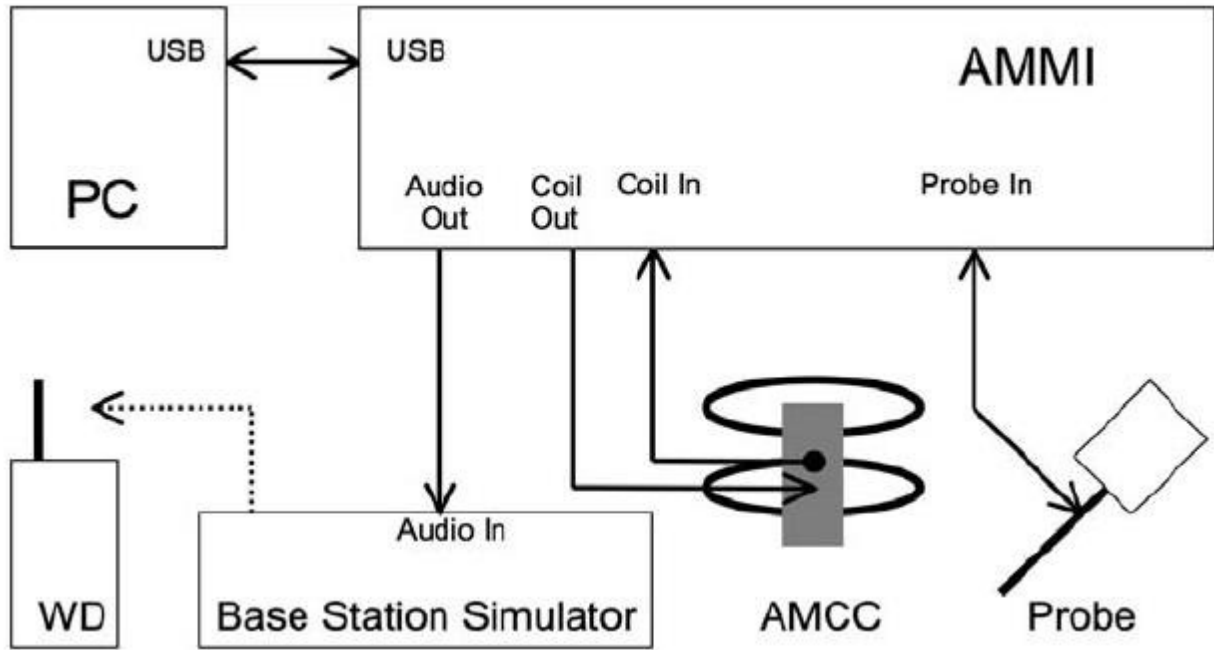



Fig. 2 T-Coil setup with HAC Test Arch and AMCC

2.2 Probe description

AM1D probe Description

The AM1D probe is an active probe with a single sensor. It is fully RF-shielded and has a rounded tip 6mm in diameter incorporating a pickup coil with its center offset 3mm from the tip and the sides. The symmetric signal preamplifier in the probe is fed via the shielded symmetric output cable from the AMMI with a 48V "phantom" voltage supply. The 7-pin connector on the back in the axis of the probe does not carry any signals. It is mounted to the DAE for the correct orientation of the sensor. If the probe axis is tilted 54.7 degree from the vertical, the sensor is approximately vertical when the signal connector is at the underside of the probe (cable hanging downwards).

Frequency range	0.1~20kHz (RF sensitivity < -100dB, fully RF shielded)	
Sensitivity	< -50dB A/m @ 1kHz	
Pre-amplifier	40dB, symmetric	
Dimensions	Tip diameter/length: 6/290mm, sensor according to ANSI-C63.19	

2.3 AMCC

The Audio Magnetic Calibration coil is a Helmholtz Coil designed for calibration of the AM1D probe. The two horizontal coils generate a homogeneous magnetic field in the z direction. The DC input resistance is adjusted by a series resistor to approximately 50Ohm, and a shunt resistor of 100Ohm permits monitoring the current with a scale of 1:10.

Port description:

Signal	Connector	Resistance
Coil In	BNC	Typically 50Ohm
Coil Monitor	BNO	100Ohm \pm 1% (100mV corresponding to 1 A/m)

Specification:

Dimensions	370 x 370 x 196 mm, according to ANSI-C63.19
------------	--

2.4 AMMI



Figure 3 AMMI front panel

The Audio Magnetic Measuring Instrument (AMMI) is a desktop 19-inch unit containing a sampling unit, a waveform generator for test and calibration signals, and a USB interface.

Sampling rate	48 kHz / 24 bit
Dynamic range	85 dB
Test signal generation	User selectable and predefined (vis PC)
Calibration	Auto-calibration / full system calibration using AMCC with monitor output
Dimensions	482 x 65 x 270 mm

2.5 Test Arch Phantom & Phone Positioner

The Test Arch phantom should be positioned horizontally on a stable surface. Reference markings on the Phantom allow the complete setup of all predefined phantom positions and measurement grids by manually teaching three points in the robot. It enables easy and well defined positioning of the phone and validation dipoles as well as simple teaching of the robot (Dimensions: 370 x 370 x 370 mm).

The Phone Positioner supports accurate and reliable positioning of any phone with effect on near field \pm 0.5 dB.

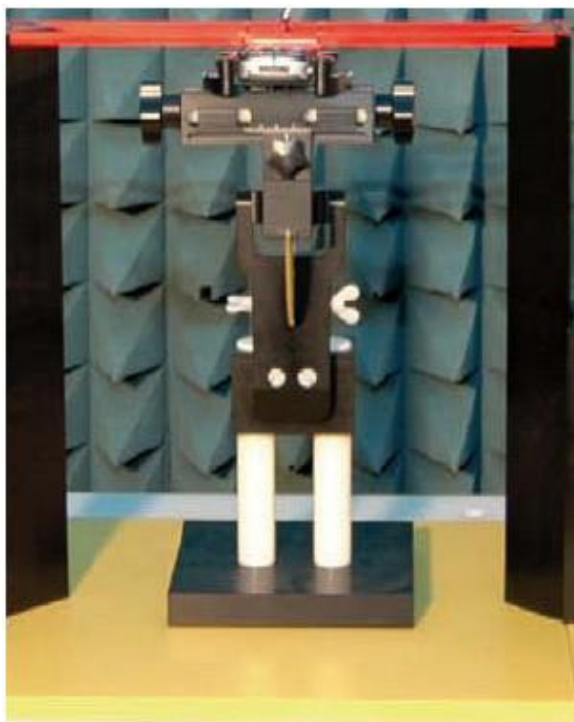

Fig. 4 HAC Phantom & Device Holder

2.6 Test Equipment List

This table gives a complete overview of the HAC measurement equipment. Devices used during the test described are marked ☒

No.	Manufacturer	Device	Type	Serial number	Date of last calibration	Valid period
☒	SPEAG	Audio Magnetic Field Probe	AM1DV3	3126	2017-07-20	One year
☒	SPEAG	Audio Magnetic Calibration Coil	AMCC	1053	NCR	NCR
☒	SPEAG	Audio Magnetic Measuring Instrument	AMMI	1028	NCR	NCR
☒	SPEAG	HAC Test Arch	SD HAC P01 BA	1053	NCR	NCR
☒	SPEAG	Data acquisition electronics	DAE4	1236	2017-07-21	One year
☒	SPEAG	Software	DASY5	N/A	NCR	NCR
☒	R & S	Universal Radio Communication Tester	CMW500	158850	2017-06-13	One year

2.7 Measurement Uncertainty Evaluation

Error Description	Uncertainty Value	Probability Dist.	Divi-sor	ci ABM1	ci ABM2	Standard Uncertainty ABM1	Standard Uncertainty ABM2
Probe Sensitivity							
Reference Level	±3.0%	N	1	1	1	±3.0%	±3.0%
AMCC Geometry	±0.4%	R	√3	1	1	±0.2%	±0.2%
AMCC Current	±1.0%	R	√3	1	1	±0.6%	±0.6%
Probe Positioning during Calibration.	± 0.1%	R	√3	1	1	±0.1%	±0.1%
Noise Contribution	± 0.7%	R	√3	0.01	1	±0.0%	±0.4%
Frequency Slope	± 5.9%	R	√3	0.1	1	±0.3%	±3.5%
Probe System							
Repeatability / Drift	± 1.0%	R	√3	1	1	±0.6%	±0.6%
Linearity/Dynamic Range	± 0.6%	R	√3	1	1	±0.4%	±0.4%
Acoustic Noise	± 1.0%	R	√3	0.1	1	±0.1%	±0.6%
Probe Angle	± 2.3%	R	√3	1	1	±1.4%	±1.4%
Spectral Processing	± 0.9%	R	√3	1	1	±0.5%	±0.5%
Integration Time	± 0.6%	N	1	1	5	±0.6%	±3.0%
Field Disturbation	± 0.2%	R	√3	0	1	±0.1%	±0.1%
Test Signal							
Ref. Signal Spectral Response	± 0.6%	R	√3	1	1	±0.1%	± 0.4%
Positioning							
Probe Positioning	± 1.9%	R	√3	1	1	±1.1%	±1.1%
Phantom Thickness	± 0.9%	R	√3	1	1	±0.5%	±0.5%
DUT Positioning	± 1.9%	R	√3	1	1	±1.1%	±1.1%
External Contributions							
RF Interference	± 0.0%	R	√3	1	0.3	±0.0%	±0.0%
Test Signal Variation	± 2.0%	R	√3	1	1	±1.2%	±1.2%
Combined Uncertainty							
Combined Std. Uncertainty (ABM Field)						±4.1%	±6.1%
Expanded Std. Uncertainty						±8.1%	±12.3%

Table 3: Measurement uncertainties for T-Coil

3 HAC(T-Coil) Measurement

3.1 T-Coil measurement points and reference plane

Figure 5 illustrates the three standard probe orientations. Position 1 is the axial orientation of the probe coil; orientation 2 and orientation 3 are radial orientations. The space between the measurement positions is not fixed. It is recommended that a scan of the WD be done for each probe coil orientation and that the maximum level recorded be used as the reading for that orientation of the probe coil.

1) The reference plane is the planar area that contains the highest point in the area of the phone that normally rests against the user's ear. It is parallel to the centerline of the receiver area of the phone and is defined by the points of the receiver-end of the WD handset, which, in normal handset use, rest against the ear.

2) The measurement plane is parallel to, and 10 mm in front of, the reference plane.

3) The reference axis is normal to the reference plane and passes through the center of the receiver speaker section (or the center of the hole array); or may be centered on a secondary inductive source. The actual location of the measurement point shall be noted in the test report as the measurement reference point.

4) The measurement points may be located where the axial and radial field intensity measurements are optimum with regard to the requirements. However, the measurement points should be near the acoustic output of the WD and shall be located in the same half of the phone as the WD receiver. In a WD handset with a centered receiver and a circularly symmetrical magnetic field, the measurement axis and the reference axis would coincide.

5) The relative spacing of each measurement orientation is not fixed. The axial and two radial orientations should be chosen to select the optimal position.

6) The measurement point for the axial position is located 10 mm from the reference plane on the measurement axis. The actual location of the measurement point shall be noted in test reports and designated as the measurement reference point.

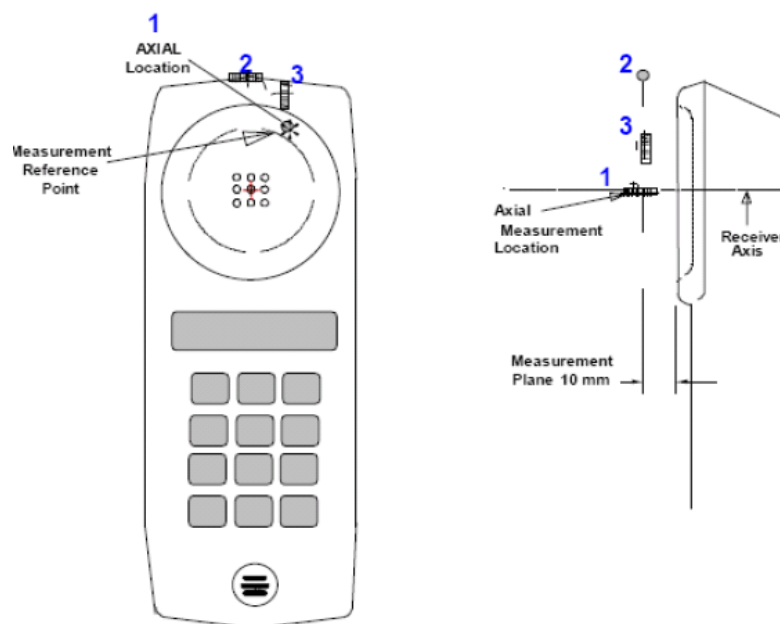

Figure 5 Axis and planes for WD audio frequency magnetic field measurements

3.2 T-Coil Measurement Procedure

According to ANSI C63.19-2011, section 7.4:

This section describes the procedures used to measure the ABM (T-Coil) performance of the WD. In addition to measuring the absolute signal levels, the A-weighted magnitude of the unintended signal shall also be determined. To assure that the required signal quality is measured, the measurement of the intended signal and the measurement of the unintended signal must be made at the same location for each measurement position. In addition, the RF field strength at each measurement location must be at or below that required for the assigned category.

Measurements shall not include undesired properties from the WD's RF field; therefore, use of a coaxial connection to a base station simulator or nonradiating load might be necessary. However, even with a coaxial connection to a base station simulator or nonradiating load, there might still be RF leakage from the WD, which can interfere with the desired measurement. Premeasurement checks should be made to avoid this possibility. All measurements shall be performed with the WD operating on battery power with an appropriate normal speech audio signal input level given in ANSI C63.19-2011 Table 7.1. If the device display can be turned off during a phone call, then that may be done during the measurement as well.

Measurements shall be performed at two locations specified in ANSI C63.19-2011 A.3, with the correct probe orientation for a particular location, in a multistage sequence by first measuring the field intensity of the desired T-Coil signal (ABM1) that is useful to a hearing aid T-Coil. The undesired magnetic components (ABM2) shall be examined for each probe orientation to determine the possible effects from the WD display and battery current paths that might disrupt the desired T-Coil signal. The undesired magnetic signal (ABM2) must be measured at the same location as the desired ABM or T-Coil signal (ABM1), and the ratio of desired to undesired ABM signals must be calculated. For the perpendicular field location, only the ABM1 frequency response shall be determined in a third measurement stage.

The following steps summarize the basic test flow for determining ABM1 and ABM2. These steps assume that a sine-wave or narrowband 1/3 octave signal can be used for the measurement of ABM1.

- a) A validation of the test setup and instrumentation may be performed using a TMFS or Helmholtz coil. Measure the emissions and confirm that they are within the specified tolerance.
- b) Position the WD in the test setup and connect the WD RF connector to a base station simulator or a nonradiating load as shown in ANSI C63.19-2011 Figure 7.1 or Figure 7.2. Confirm that the equipment that requires calibration has been calibrated and that the noise level meets the requirements of ANSI C63.19-2011 clause 7.3.1.
- c) The drive level to the WD is set such that the reference input level specified in ANSI C63.19-2011 Table 7.1 is input to the base station simulator (or manufacturer's test mode equivalent) in the 1 kHz, 1/3 octave band. This drive level shall be used for the T-Coil signal test (ABM1) at $f = 1$ kHz. Either a sine wave at 1025 Hz or a voice-like signal, band-limited to the 1 kHz 1/3 octave, as defined in C63.19-2011 clause 7.4.2, shall be used for the reference audio signal. If interference is found at 1025 Hz, an alternative nearby reference audio signal frequency may be used.⁴⁷ The same drive level shall be used for the ABM1 frequency response measurements at each 1/3 octave band center frequency. The WD volume control may be set at any level up to maximum, provided that a signal at any frequency at maximum modulation would not result in clipping or signal overload.

d) Determine the magnetic measurement locations for the WD device (A.3), if not already specified by the manufacturer, as described in C63.19-2011 clause 7.4.4.1.1 and 7.4.4.2.

e) At each measurement location, measure and record the desired T-Coil magnetic signals (ABM1 at f_i) as specified in C63.19-2011 clause 7.4.4.2 in each ISO 266-1975 R10 standard 1/3 octave band. The desired audio band input frequency (f_i) shall be centered in each 1/3 octave band maintaining the same drive level as determined in item c) and the reading taken for that band.

Equivalent methods of determining the frequency response may also be employed, such as fast Fourier transform (FFT) analysis using noise excitation or input–output comparison using simulated speech. The full-band integrated or half-band integrated probe output, as specified in D.9, may be used, as long as the appropriate calibration curve is applied to the measured result, so as to yield an accurate measurement of the field magnitude. (The resulting measurement shall be an accurate measurement in dB A/m.)

All measurements of the desired signal shall be shown to be of the desired signal and not of an undesired signal. This may be shown by turning the desired signal ON and OFF with the probe measuring the same location. If the scanning method is used, the scans shall show that all measurement points selected for the ABM1 measurement meet the ambient and test system noise criteria in C63.19-2011 clause 7.3.1.

f) At the measurement location for each orientation, measure and record the undesired broadband audio magnetic signal (ABM2) as specified in C63.19-2011 clause 7.4.4.4 with no audio signal applied (or digital zero applied, if appropriate) using A-weighting⁴⁹ and the half-band integrator. Calculate the ratio of the desired to undesired signal strength (i.e., signal quality).

g) Determine the category that properly classifies the signal quality, based on C63.19-2011 Table 8.5.

3.3 T-Coil Performance Requirements

In order to be rated for T-Coil use, a WD shall meet the requirements for signal level and signal quality contained in this part.

1) T-Coil coupling field intensity

When measured as specified in ANSI C63.19, the T-Coil signal shall be ≥ -18 dB (A/m) at 1 kHz, in a 1/3 octave band filter for all orientations.

2) Frequency response

The frequency response of the axial component of the magnetic field, measured in 1/3 octave bands, shall follow the response curve specified in this sub-clause, over the frequency range 300 Hz to 3000 Hz. Figure 6 and Figure 7 provide the boundaries for the specified frequency.

These response curves are for true field strength measurements of the T-Coil signal. Thus the 6 dB/octave probe response has been corrected from the raw readings.

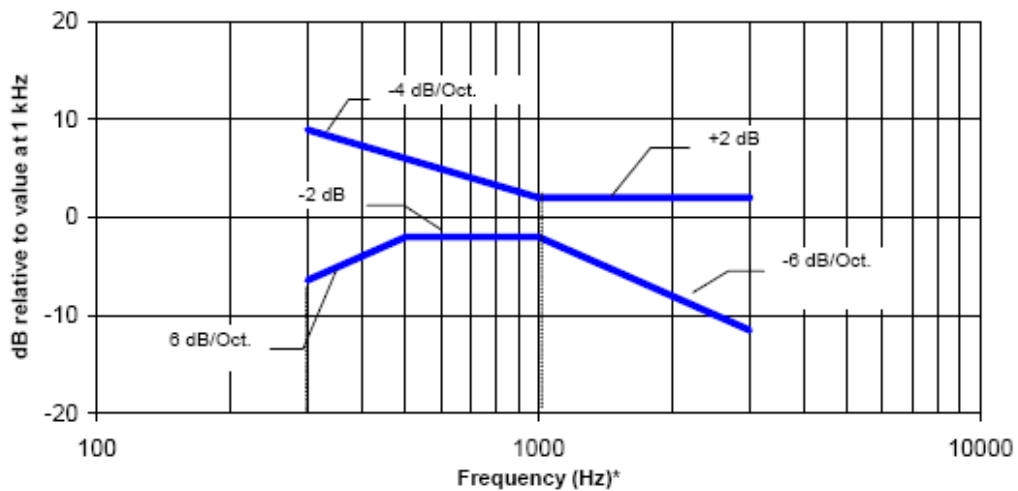

NOTE—Frequency response is between 300 Hz and 3000 Hz.

Figure 6—Magnetic field frequency response for WDs with a field ≤ -15 dB (A/m) at 1 kHz

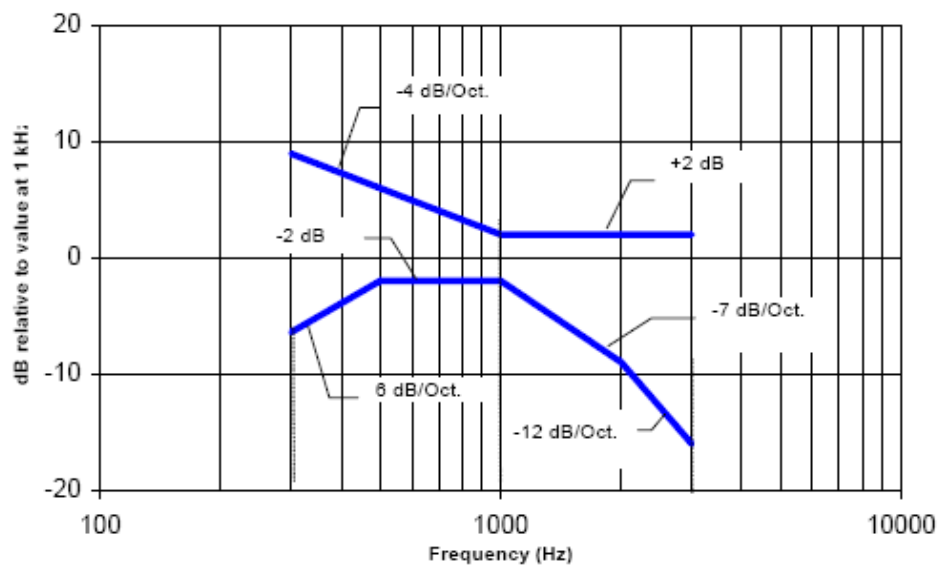

NOTE—Frequency response is between 300 Hz and 3000 Hz.

Figure 7 —Magnetic field frequency response for WDs with a field that exceeds -15 dB(A/m) at 1 kHz

3) Signal quality

This part provides the signal quality requirement for the intended T-Coil signal from a WD. Only the RF immunity of the hearing aid is measured in T-Coil mode. It is assumed that a hearing aid can have no immunity to an interference signal in the audio band, which is the intended reception band for this mode. So, the only criteria that can be measured is the RF immunity in T-Coil mode. This is measured using the same procedure as for the audio coupling mode and at the same levels.

The worst signal quality of the three T-Coil signal measurements shall be used to determine the T-Coil mode category per Table 4

Category	Telephone parameters WD signal quality [(signal + noise) – to – noise ratio in decibels]
Category T1	0 dB to 10 dB
Category T2	10 dB to 20 dB
Category T3	20 dB to 30 dB
Category T4	> 30 dB

Table 4: T-Coil signal quality categories

4 HAC(T-Coil) Test Configuration

4.1 General Description

The phone was tested in all normal configurations for the ear use. The EUT is mounted in the device holder equivalent as for classic dosimeter measurements. The acoustic output of the EUT shall coincide with the center point of the area formed by the dielectric wire and the middle bar of the arch's top frame. The EUT shall be moved vertically upwards until it touches the frame. The fine adjustment is possible by sliding the complete. The EUT holder is on the yellow base plate of the Test Arch phantom. These test configurations are tested at the middle frequency channels of each applicable operating mode; for example, GSM, WCDMA(UMTS),CDMA and TDMA.

No correction gain factors were measured for GSM/UMTS/ LTE due to the Rohde & Schwarz CMW500, hosting a calibrated audio board. The gains used to measure GSM/UMTS/ LTE are set to 100.

The volume is adjusted to the maximum level and the backlight turned off during the test.

4.2 GSM Test Configuration

A communication link is set up with a System Simulator (SS) by RF cable, and a call is established. The Absolute Radio Frequency Channel Number(ARFCN) are allocated to 190CH respectively in the case of GSM850, allocated to 661CH respectively in the case of GSM1900. T-Coil configurations is measured in Speechcod/Handset Low using System Simulator (SS) of CMW500, at the same time the EUT shall be operated at its maximum RF output power setting.

4.3 UMTS Test Configuration

A communication link is set up with a System Simulator (SS) by RF cable, and a call is established. The Absolute Radio Frequency Channel Number(ARFCN) are allocated to 9400CH respectively in the case of UMTS Band 2, allocated to 1413CH respectively in the case of UMTS Band 4, allocated to 4182CH respectively in the case of UMTS Band 5. T-Coil configurations is measured in voice mode(Voice Coder: Speechcodec Low) using System Simulator (SS) of CMW500, at the same time the EUT shall be operated at its maximum RF output power setting.

4.4 LTE Test Configuration

The applied reference input level applied at the calibrated reference point for legacy protocols fixed to specific air-interfaces are defined in 7.4.2.1 Table 7.1 of ANSI C63.19-2011 or the ANSI C63.19-2011 VoLTE interpretation of July 2012 with -16 dBm0.

A communication link is set up with a System Simulator (SS) by RF cable, and a call is established. The Absolute Radio Frequency Channel Number(ARFCN) are allocated to 18900CH respectively in the case of LTE Band 2, allocated to 20175CH respectively in the case of LTE Band 4, allocated to 20525CH respectively in the case of LTE Band 5, allocated to 21100CH respectively in the case of LTE Band 7, allocated to 23095CH respectively in the case of LTE Band 12, allocated to 23790CH respectively in the case of LTE Band 17. T-Coil configurations is measured in voice mode(Voice Coder:Wideband-23.85kbit/s ,6.60kbit/s or Narrowband-12.20kbit/s, 4.75kbit/s). using System Simulator (SS) of CMW500, at the same time the EUT shall be operated at its maximum RF output power setting. (The detailed simplified test procedure of the worst-case configuration is in chapter 5.2)

Per KDB 285076D02, reporting results involves a two-step process: (1) Codec Investigation to determine the worst-case codec for each voice service, and (2) Air Interface Investigation. Using the worst-case codec for a voice service, a range of channels and bands shall be tested.

- a) **Codec Investigation:** For a voice service/air interface, investigate the variations of codec configurations (WB, NB bit rate) and document the parameters (ABM1, ABM2, S+N/N, frequency response) for that voice service. It is only necessary to document this for one channel/band. However, the tester should spot check other combinations to insure that the channel/band used represents the worst-case codec.
- b) **Air Interface Investigation:** Use the worst-case codec test and document a limited set of bands/channels/bandwidth. Observe the effect of changing the band and bandwidth to ensure that there are no unexpected variations. Using the knowledge of the observed variations, it is necessary to report only a set band/channel/bandwidth for each orientation for a voice service/air interface. Consult with the manufacturer for any abnormal results.

See below table for VoLTE T-coil Air Interface Investigation:

Band	Test Mode	Test channel /Freq (MHz)	Probe Orientation	Measurement Position (x mm, y mm)	ABM2 [dB(A/m)]	ABM1 [dB(A/m)]	SNR (ABM1/AB M2 dB)	T Category	Frequency Response
LTE B2	20M QPSK 1RB#0 Voice Wideband AMR Codec: 23.85kbit/s	18900 /1880	Y (Transversal)	(4.2,-8.3)	-47.40	4.16	51.56	T4	/
			Z (Axial)	(4.2,-4.2)	-41.42	11.35	52.77	T4	Pass
	20M QPSK 1RB#50 Voice Wideband AMR Codec: 23.85kbit/s	18900 /1880	Y (Transversal)	(4.2,4.2)	-45.92	5.73	51.65	T4	/
			Z (Axial)	(0,-4.2)	-44.81	8.22	53.03	T4	Pass
	20M QPSK 1RB#99 Voice Wideband AMR Codec: 23.85kbit/s	18900 /1880	Y (Transversal)	(0,-8.3)	-47.20	2.81	50.01	T4	/
			Z (Axial)	(-4.2,0)	-47.42	5.78	53.20	T4	Pass
	20M QPSK 50%RB#0 Voice Wideband AMR Codec: 23.85kbit/s	18900 /1880	Y (Transversal)	(4.2,-8.3)	-49.66	3.79	53.45	T4	/
			Z (Axial)	(-4.2,0)	-47.95	5.64	53.59	T4	Pass
	20M QPSK 50%RB#25 Voice Wideband AMR Codec: 23.85kbit/s	18900 /1880	Y (Transversal)	(-8.3,-8.3)	-50.79	-3.41	47.38	T4	/
			Z (Axial)	(-4.2,0)	-39.73	5.38	45.11	T4	Pass
	20M QPSK 50%RB#50 Voice Wideband AMR Codec: 23.85kbit/s	18900 /1880	Y (Transversal)	(8.3,-12.5)	-47.54	3.09	50.63	T4	/
			Z (Axial)	(0,-4.2)	-47.51	5.34	52.85	T4	Pass
	20M QPSK 100%RB#0 Voice Wideband AMR Codec: 23.85kbit/s	18900 /1880	Y (Transversal)	(12.5,-12.5)	-48.46	6.18	54.64	T4	/
			Z (Axial)	(0,-4.2)	-45.58	8.20	53.78	T4	Pass
	20M 16QAM 50%RB#25 Voice Wideband AMR Codec: 23.85kbit/s	18900 /1880	Y (Transversal)	(8.3,4.2)	-44.34	9.25	53.59	T4	/
			Z (Axial)	(4.2,-4.2)	-41.07	11.71	52.78	T4	Pass

Table 5: Pre-Test Results for VoLTE T-coil Air Interface Investigation

See below table for VoLTE T-coil Codec Investigation:

Band	Test Mode	Test channel /Freq (MHz)	Probe Orientation	Measurement Position (x mm, y mm)	ABM2 [dB(A/m)]	ABM1 [dB(A/m)]	SNR (ABM1/AB M2 dB)	T Category	Frequency Response
LTE B2	20M QPSK 50%RB#25 Voice Wideband AMR Codec: 23.85kbit/s	18900 /1880	Y (Transversal)	(-8.3,-8.3)	-50.79	-3.41	47.38	T4	/
			Z (Axial)	(-4.2,0)	-39.73	5.38	45.11	T4	Pass
	20M QPSK 50%RB#25 Voice Wideband AMR Codec:6.6kbit/s	18900 /1880	Y (Transversal)	(8.3,-8.3)	-49.33	-0.32	49.01	T4	/
			Z (Axial)	(-4.2,-4.2)	-51.03	-1.53	49.50	T4	Pass
	20M QPSK 50%RB#25 Voice Narrowband AMR Codec:12.20kbit/s	18900 /1880	Y (Transversal)	(8.3,-8.3)	-47.91	5.38	53.29	T4	/
			Z (Axial)	(4.2,-4.2)	-43.33	10.66	53.99	T4	Pass
20M QPSK 50%RB#25 Voice Narrowband AMR Codec:4.75kbit/s	18900 /1880	Y (Transversal)	(8.3,-8.3)	-49.18	0.87	50.05	T4	/	
		Z (Axial)	(-4.2,-4.2)	-50.94	-1.87	49.07	T4	Pass	

Table 6: Pre-Test Results for VoLTE T-coil Codec Investigation

Note: The device does not support VoLTE EVS Codec.

5 HAC(T-Coil) Measurement Results

5.1 HAC(T-Coil) Measurement Results of GSM and UMTS

Band	Mode	Channel/ Freq.(MHz)	Probe Orientation	Position (x mm,y _{mm})	ABM2 (dB A/m)	ABM1 (dB A/m)	SNR (dB)	T- Rating	Frequency Response
GSM 850	Voice	190/836.6	Y (Transversal)	(-12.5,-12.5)	-49.56	-11.40	38.16	T4	/
			Z (Axial)	(4.2,-4.2)	-18.82	9.63	28.45	T3	PASS
GSM 1900	Voice	661/1880	Y (Transversal)	(0,-12.5)	-37.98	1.01	38.99	T4	/
			Z (Axial)	(4.2,0)	-22.34	11.35	33.69	T4	PASS
UMTS B2	Voice	9400/1880	Y (Transversal)	(8.3,-8.3)	-43.18	5.43	48.61	T4	/
			Z (Axial)	(0,0)	-39.69	9.87	49.56	T4	PASS
UMTS B4	Voice	1413/1732.6	Y (Transversal)	(8.3,8.3)	-45.46	5.67	51.13	T4	/
			Z (Axial)	(0,0)	-43.19	9.44	52.63	T4	PASS
UMTS B5	Voice	4182/836.4	Y (Transversal)	(4.2,-8.3)	-50.81	4.48	55.29	T4	/
			Z (Axial)	(4.2,-4.2)	-45.24	11.05	56.29	T4	PASS

Table 7: Test Result of GSM and UMTS Bands

Note:

- 1) The Hearing Aid mode of the software on this DUT is turned on during the test.
- 2) The volume is adjusted to the maximum level and the backlight turned off during the test.

5.2 HAC(T-Coil) Measurement Results of VoLTE

An investigation was performed on the worst-case LTE Band and bandwidth combination to determine the modulation and RB configuration to be used for testing. QPSK,50%RB,mid RB offset,Wideband AMR Codec was used for the testing as the worst-case configuration for the handset. See the below specific test data:

Band	Test Mode	Test channel /Freq. (MHz)	Probe Orientation	Measurement Position (x mm, y mm)	ABM2 [dB(A/m)]	ABM1 [dB(A/ m)]	SNR (ABM1/AB M2 dB)	T Category	Frequency Response
LTE B2	20M QPSK 50%RB#25 Voice Wideband AMR Codec: 23.85kbit/s	18900 /1880	Y (Transversal)	(-8.3,-8.3)	-50.79	-3.41	47.38	T4	/
			Z (Axial)	(-4.2,0)	-39.73	5.38	45.11	T4	Pass
LTE B4	20M QPSK 50%RB#25 Voice Wideband AMR Codec: 23.85kbit/s	20175 /1732.5	Y (Transversal)	(8.3,-8.3)	-47.17	6.83	54.00	T4	/
			Z (Axial)	(4.2,-4.2)	-42.40	11.21	53.61	T4	Pass
LTE B5	10M QPSK 50%RB#13 Voice Wideband AMR Codec: 23.85kbit/s	20525 /836.5	Y (Transversal)	(8.3,-8.3)	-46.56	6.46	53.02	T4	/
			Z (Axial)	(4.2,-4.2)	-42.95	11.11	54.06	T4	Pass
LTE B7	20M QPSK 50%RB#25 Voice Wideband AMR Codec: 23.85kbit/s	21100 /2535	Y (Transversal)	(8.3,-12.5)	-47.77	6.21	53.98	T4	/
			Z (Axial)	(4.2,-4.2)	-42.47	11.66	54.13	T4	Pass
LTE B12	10M QPSK 50%RB#13 Voice Wideband AMR Codec: 23.85kbit/s	23095 /707.5	Y (Transversal)	(12.5,-12.5)	-48.33	5.22	53.55	T4	/
			Z (Axial)	(0,-4.2)	-45.12	7.98	53.10	T4	Pass
LTE B17	10M QPSK 50%RB#13 Voice Wideband AMR Codec: 23.85kbit/s	23790 /710	Y (Transversal)	(8.3,-8.3)	-47.95	6.39	54.34	T4	/
			Z (Axial)	(4.2,-4.2)	-44.22	10.58	54.80	T4	Pass

Table 8: Test Result of LTE Bands

Note:

- 1) The Hearing Aid mode of the software on this DUT is turned on during the test.
- 2) The volume is adjusted to the maximum level and the backlight turned off during the test.

Spot checks for other LTE bandwidths based on the worst case of all LTE bands above are done to insure the worst-case as below table:

Band	Test Mode	Test channel /Frequency	Probe Orientation	Measurement Position (x mm, y mm)	ABM2 [dB(A/m)]	ABM1 \geq -18dB (A/m)	SNR (ABM1/ABM2 dB)	T Category	Frequency Response
LTE B2	20M QPSK 50%RB#25 Voice Wideband AMR Codec: 23.85kbit/s	18900 /1880	Y (Transversal)	(-8.3,-8.3)	-50.79	-3.41	47.38	T4	/
			Z (Axial)	(-4.2,0)	-39.73	5.38	45.11	T4	Pass
	15M QPSK 50%RB#18 Voice Wideband AMR Codec: 23.85kbit/s	18900 /1880	Y (Transversal)	(12.5,-12.5)	-49.21	5.96	55.17	T4	/
			Z (Axial)	(0,-4.2)	-48.01	7.73	55.74	T4	Pass
	10M QPSK 50%RB#13 Voice Wideband AMR Codec: 23.85kbit/s	18900 /1880	Y (Transversal)	(12.5,-12.5)	-50.20	5.38	55.58	T4	/
			Z (Axial)	(0,-4.2)	-48.99	7.74	56.73	T4	Pass
	5M QPSK 50%RB#6 Voice Wideband AMR Codec: 23.85kbit/s	18900 /1880	Y (Transversal)	(8.3,-12.5)	-49.30	5.99	55.29	T4	/
			Z (Axial)	(0,-4.2)	-48.17	7.72	55.89	T4	Pass
	3M QPSK 50%RB#4 Voice Wideband AMR Codec: 23.85kbit/s	18900 /1880	Y (Transversal)	(8.3,-12.5)	-49.40	5.90	55.30	T4	/
			Z (Axial)	(0,-4.2)	-48.44	7.74	56.18	T4	Pass
	1.4M QPSK 50%RB#2 Voice Wideband AMR Codec: 23.85kbit/s	18900 /1880	Y (Transversal)	(8.3,-12.5)	-47.64	5.92	53.56	T4	/
			Z (Axial)	(0,-4.2)	-47.79	7.70	55.49	T4	Pass

Table 9: Spot check Results of other LTE bandwidths

Note:

- 1) The Hearing Aid mode of the software on this DUT is turned on during the test.
- 2) The volume is adjusted to the maximum level and the backlight turned off during the test.

The Frequency response plots of T-Coil are as below:

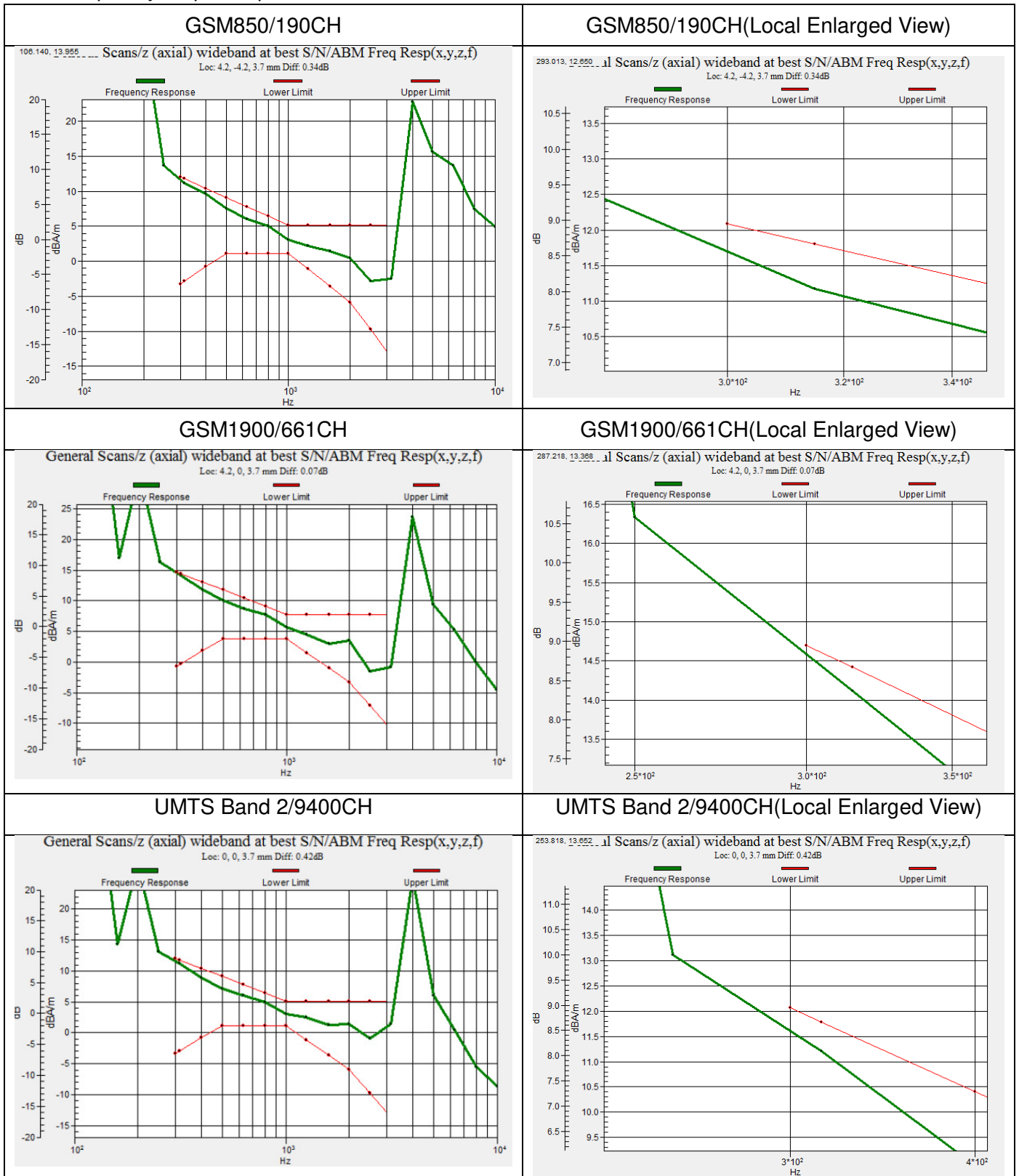

UMTS Band 4/1413CH

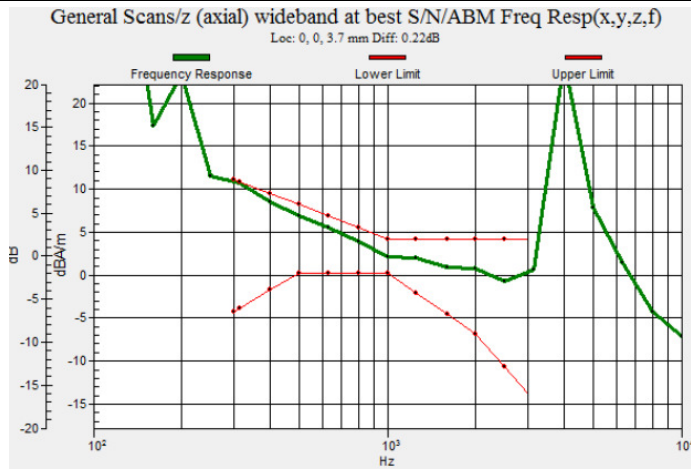

UMTS Band 4/1413CH(Local Enlarged View)

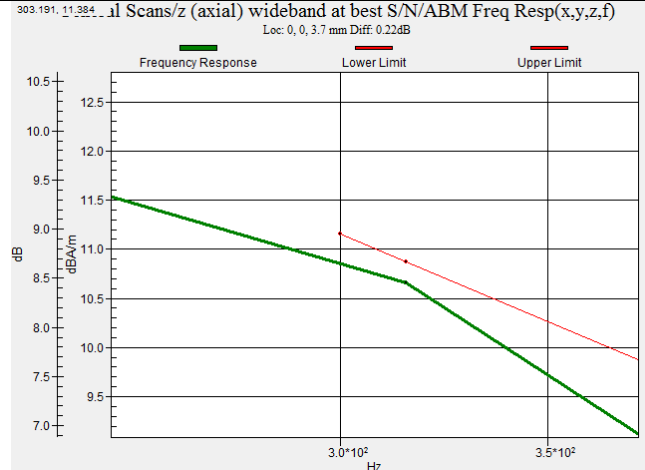

UMTS Band 5/4182CH

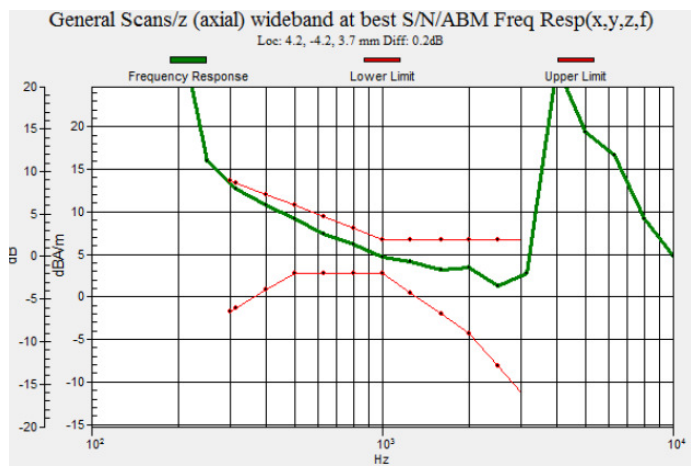

UMTS Band 5/4182CH(Local Enlarged View)

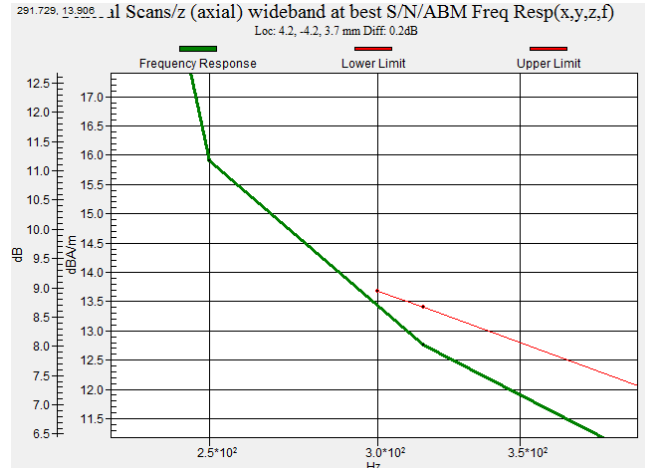

LTE B2/18900CH

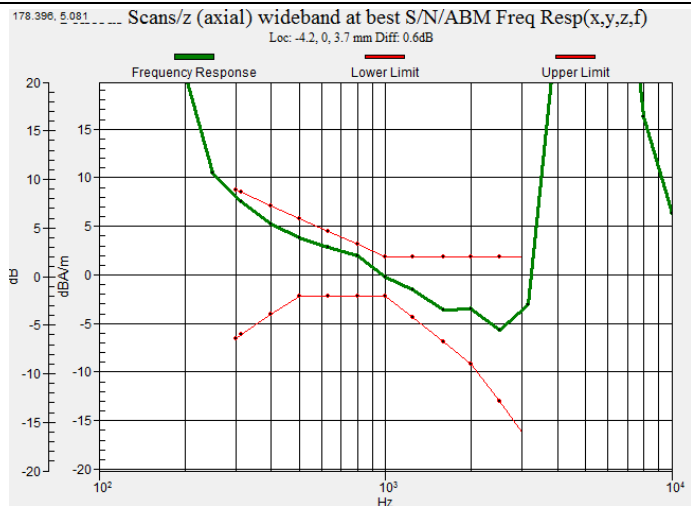

LTE B2/18900CH(Local Enlarged View)

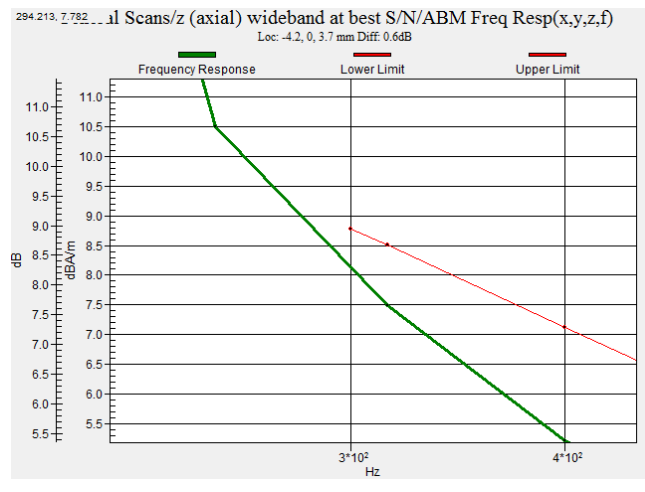

LTE B4/20175CH

General Scans/z (axial) wideband at best S/N/ABM Freq Resp(x,y,z,f)
Loc: 4.2, -4.2, 3.7 mm Diff: 0.09dB

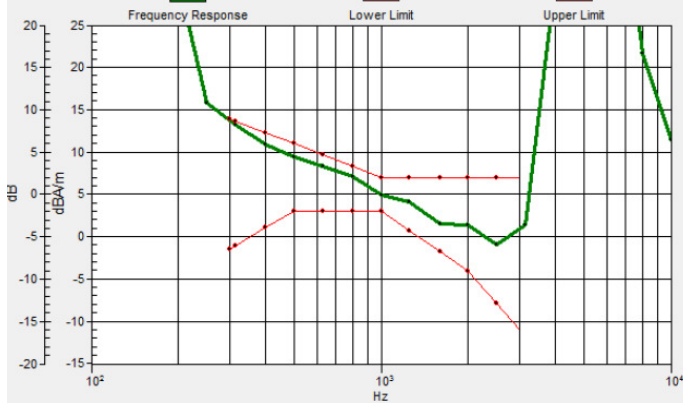

LTE B4/20175CH(Local Enlarged View)

237.478...12.840...al Scans/z (axial) wideband at best S/N/ABM Freq Resp(x,y,z,f)
Loc: 4.2, -4.2, 3.7 mm Diff: 0.09dB

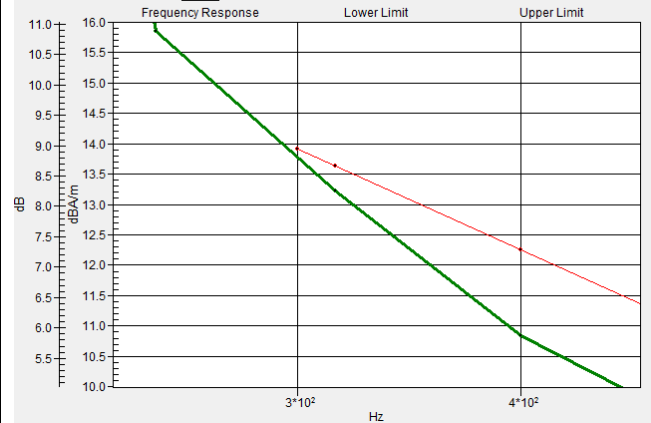

LTE B5/20525CH

General Scans/z (axial) wideband at best S/N/ABM Freq Resp(x,y,z,f)
Loc: 4.2, -4.2, 3.7 mm Diff: 0.06dB

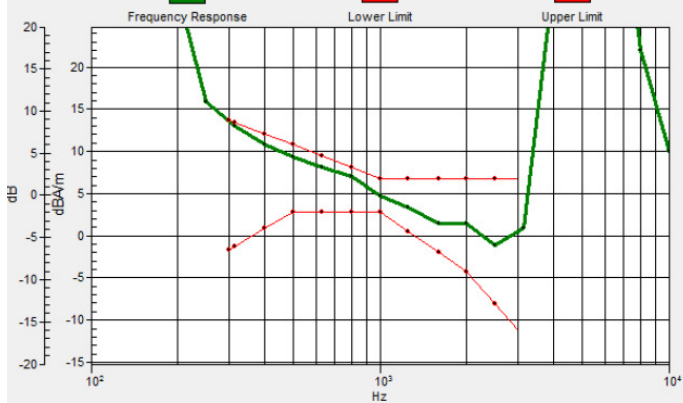

LTE B5/20525CH(Local Enlarged View)

258.085...13.432...al Scans/z (axial) wideband at best S/N/ABM Freq Resp(x,y,z,f)
Loc: 4.2, -4.2, 3.7 mm Diff: 0.06dB

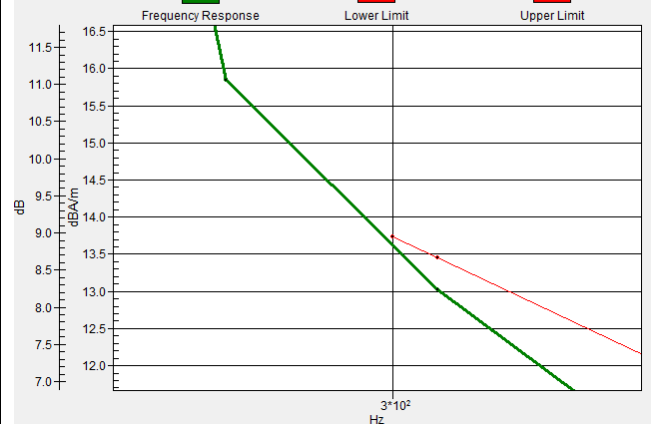

LTE B7/21100CH

General Scans/z (axial) wideband at best S/N/ABM Freq Resp(x,y,z,f)
Loc: 4.2, -4.2, 3.7 mm Diff: 0.35dB

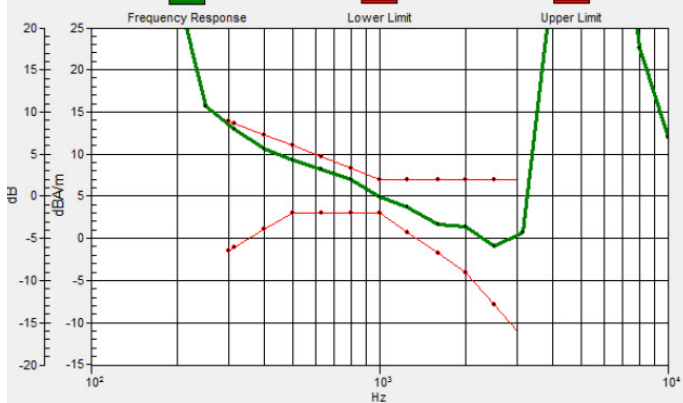

LTE B7/21100CH(Local Enlarged View)

271.215...14.305...al Scans/z (axial) wideband at best S/N/ABM Freq Resp(x,y,z,f)
Loc: 4.2, -4.2, 3.7 mm Diff: 0.35dB

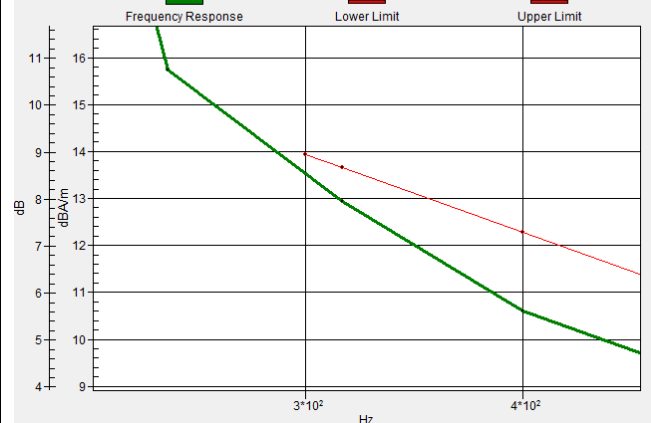

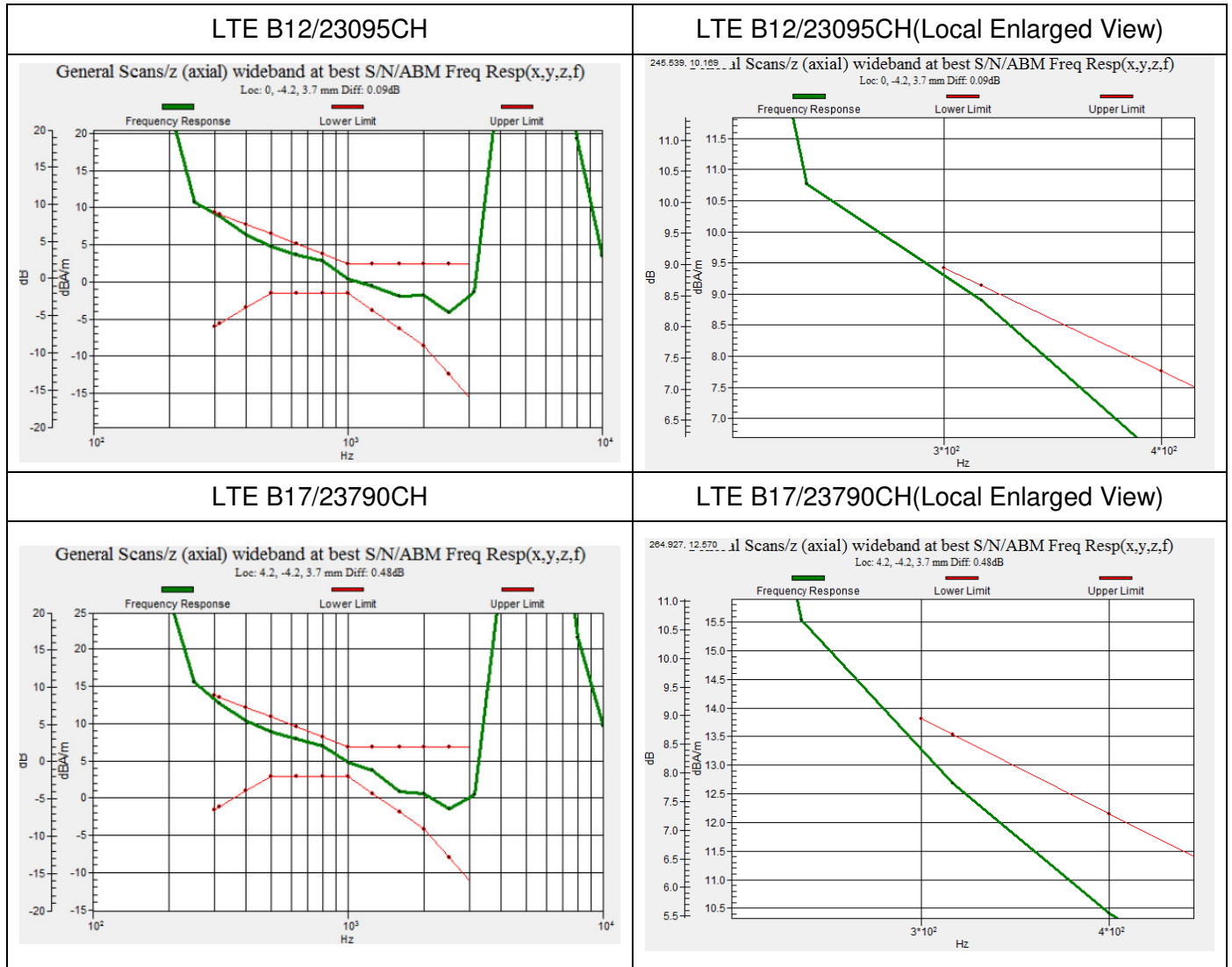

Table 10: Frequency response plots of T-Coil

Appendix A. T-Coil Measurement Plots

(Pls See Appendix No.: SYBH(Z-HAC)20171223016001-H2A, total: 78 pages)

Appendix B. Calibration Certificate

(Pls See Appendix No.: SYBH(Z-HAC)20171223016001-H2B, total:10 pages)

Appendix C. Photo documentation

(Pls See Appendix No.: SYBH(Z-HAC)20171223016001-H2C, total: 2 pages)

END