



中国认可
国际互认
检测
TESTING
CNAS L0310



FCC RF Test Report

Product Name: Smart Phone

Model Number: FRD-L24

Report No.: SYBH(Z-RF)20171223016001-2001

FCC ID: QISFRD-L24

Reliability Laboratory of Huawei Technologies Co., Ltd.

(Global Compliance and Testing Center of Huawei Technologies Co., Ltd)

Administration Building, Headquarters of Huawei Technologies Co., Ltd., Bantian, Longgang District,
Shenzhen, 518129, P.R.C

Tel: +86 755 28780808 Fax: +86 755 89652518



Notice

1. The laboratory has passed the accreditation by China National Accreditation Service for Conformity Assessment (CNAS). The accreditation number is L0310.
2. The laboratory has passed the accreditation by The American Association for Laboratory Accreditation (A2LA). The accreditation number is 2174.01
3. The laboratory has been recognized by the US Federal Communications Commission (FCC) to perform compliance testing subject to the Commission's Certification rules. The Designation Number is CN1173, and the Test Firm Registration Number is 294140.
4. The laboratory has been listed by Industry Canada to perform electromagnetic emission measurements. The recognition numbers of test site are 6369A-1.
5. The laboratory (Reliability Lab of Huawei Technologies Co., Ltd) is also named "Global Compliance and Testing Center of Huawei Technologies Co., Ltd", the both names have coexisted since 2009.
6. The test report is invalid if not marked with the signatures of the persons responsible for preparing and approving the test report.
7. The test report is invalid if there is any evidence of erasure and/or falsification.
8. The test report is only valid for the test samples.
9. Content of the test report, in part or in full, cannot be used for publicity and/or promotional purposes without prior written approval from the laboratory.



Applicant: Huawei Technologies Co., Ltd.
Address: Administration Building, Headquarters of Huawei Technologies Co., Ltd.,
 Bantian, Longgang District, Shenzhen, 518129, P.R.C

Date of Receipt Sample: 2018-02-09
Start Date of Test: 2018-02-09
End Date of Test: 2018-02-14

Test Result: Pass

Approved by Senior Engineer:	2018-02-14	Roger Zhang	<i>Roger Zhang</i>
	Date	Name	Signature

Prepared by:	2018-02-14	Zhang Shuangxia	<i>Zhang Shuangxia</i>
	Date	Name	Signature



CONTENT

1 General Information.....5

1.1 Applied Standard.....5

1.2 Test Location5

1.3 Test Environment Condition.....5

2 Test Summary6

2.1 Cellular Band (824-849 MHz paired with 869-894 MHz)6

2.2 PCS Band (1850-1910 MHz paired with 1930-1990 MHz).....7

2.3 AWS Band (1710-1755 MHz paired with 2110-2155 MHz)8

2.4 BRS&EBS Band (2500-2570 MHz paired with 2620-2690 MHz)9

2.5 Band12 (699-716MHz paired with 729-746 MHz) 11

2.6 Band17 (704-716MHz paired with 734-746 MHz) 12

3 Description of the Equipment under Test (EUT)..... 13

3.1 General Description 13

3.2 EUT Identity 16

3.3 Technical Specification 17

4 General Test Conditions / Configurations20

4.1 Test Modes20

4.2 Test Environment.....20

4.3 Test Frequency21

4.4 DESCRIPTION OF TESTS28

4.5 Test Setups34

4.6 Test Conditions37

5 Main Test Instruments39

6 Measurement Uncertainty.....40



1 General Information

1.1 Applied Standard

Applied Rules: 47 CFR FCC Part 02
 47 CFR FCC Part 22
 47 CFR FCC Part 24
 47 CFR FCC Part 27

Test Method: FCC KDB 971168 D01 Power Meas License Digital Systems v03

1.2 Test Location

Test Location : Reliability Laboratory of Huawei Technologies Co., Ltd.
Address: Administration Building, Headquarters of Huawei Technologies Co., Ltd.,
 Bantian, Longgang District, Shenzhen, 518129, P.R.C

1.3 Test Environment Condition

Ambient Temperature: 19.5 to 25 °C
Ambient Relative Humidity: 40 to 55 %
Atmospheric Pressure: Not applicable



2 Test Summary

2.1 Cellular Band (824-849 MHz paired with 869-894 MHz)

Test Item	FCC Rule No.	Requirements	Test Result	Verdict(Note1)
Effective (Isotropic) Radiated Power Output Data	§2.1046, §22.913	FCC: ERP ≤ 7 W.	Appendix A	refer to SYBH(Z-RF)00 2052016-2001 of FRD-L04
Peak-Average Ratio	---	Limits≤13 dB	Appendix B	refer to SYBH(Z-RF)00 2052016-2001 of FRD-L04
Modulation Characteristics	§2.1047	Digital modulation	Appendix C	refer to SYBH(Z-RF)00 2052016-2001 of FRD-L04
Bandwidth	§2.1049	OBW: No limit. EBW: No limit.	Appendix D	refer to SYBH(Z-RF)00 2052016-2001 of FRD-L04
Band Edges Compliance	§2.1051, §22.917	≤ -13 dBm/1%*EBW, in 1 MHz bands immediately outside and adjacent to the frequency block.	Appendix E	refer to SYBH(Z-RF)00 2052016-2001 of FRD-L04
Spurious Emission at Antenna Terminals	§2.1051, §22.917	FCC: ≤ -13 dBm/100 kHz, from 9 kHz to 10 th harmonics but outside authorized operating frequency ranges.	Appendix F	refer to SYBH(Z-RF)00 2052016-2001 of FRD-L04
Field Strength of Spurious Radiation	§2.1053, §22.917	FCC: ≤ -13 dBm/100 kHz.	Appendix G	refer to SYBH(Z-RF)00 2052016-2001 of FRD-L04
Frequency Stability	§2.1055, §22.355	≤ ±2.5ppm.	Appendix H	refer to SYBH(Z-RF)00 2052016-2001 of FRD-L04
NOTE 1: For the verdict, the "N/A" denotes "not applicable", the "N/T" denotes "not tested".				

**2.2 PCS Band (1850-1910 MHz paired with 1930-1990 MHz)**

Test Item	FCC Rule No.	Requirements	Test Result	Verdict (Note1)
Effective (Isotropic) Radiated Power Output Data	§2.1046, §24.232	$EIRP \leq 2\text{ W}$	Appendix A	refer to SYBH(Z-RF)00 2052016-2001 of FRD-L04
Peak-Average Ratio	§2.1046, §24.232	Limit \leq 13 dB	Appendix B	refer to SYBH(Z-RF)00 2052016-2001 of FRD-L04
Modulation Characteristics	§2.1047	Digital modulation	Appendix C	refer to SYBH(Z-RF)00 2052016-2001 of FRD-L04
Bandwidth	§2.1049	OBW: No limit. EBW: No limit.	Appendix D	refer to SYBH(Z-RF)00 2052016-2001 of FRD-L04
Band Edges Compliance	§2.1051, §24.238	$\leq -13\text{ dBm}/1\%*EBW$, in 1 MHz bands immediately outside and adjacent to the frequency block.	Appendix E	refer to SYBH(Z-RF)00 2052016-2001 of FRD-L04
Spurious Emission at Antenna Terminals	§2.1051, §24.238	$\leq -13\text{ dBm}/1\text{ MHz}$, from 9 kHz to 10 th harmonics but outside authorized operating frequency ranges.	Appendix F	refer to SYBH(Z-RF)00 2052016-2001 of FRD-L04
Field Strength of Spurious Radiation	§2.1053, §24.238	$\leq -13\text{ dBm}/1\text{ MHz}$.	Appendix G	refer to SYBH(Z-RF)00 2052016-2001 of FRD-L04
Frequency Stability	§2.1055, §24.235	$\leq \pm 2.5\text{ ppm}$.	Appendix H	refer to SYBH(Z-RF)00 2052016-2001 of FRD-L04
NOTE 1: For the verdict, the "N/A" denotes "not applicable", the "N/T" denotes "not tested"				

**2.3 AWS Band (1710-1755 MHz paired with 2110-2155 MHz)**

Test Item	FCC Rule No.	Requirements	Test Result	Verdict (Note1)
Effective (Isotropic) Radiated Power Output Data	§2.1046, §27.50(d)	$EIRP \leq 1\text{ W}$	Appendix A	refer to SYBH(Z-RF)002 052016-2001 of FRD-L04
Peak-Average Ratio	§2.1046, §27.50(d)	Limit \leq 13 dB	Appendix B	refer to SYBH(Z-RF)002 052016-2001 of FRD-L04
Modulation Characteristics	§2.1047	Digital modulation	Appendix C	refer to SYBH(Z-RF)002 052016-2001 of FRD-L04
Bandwidth	§2.1049	OBW: No limit. EBW: No limit.	Appendix D	refer to SYBH(Z-RF)002 052016-2001 of FRD-L04
Band Edges Compliance	§2.1051, §27.53(h)	$\leq -13\text{ dBm}/1\%*EBW$, in 1 MHz bands immediately outside and adjacent to the frequency block.	Appendix E	refer to SYBH(Z-RF)002 052016-2001 of FRD-L04
Spurious Emission at Antenna Terminals	§2.1051, §27.53(h)	$\leq -13\text{ dBm}/1\text{ MHz}$, from 9 kHz to 10 th harmonics but outside authorized operating frequency ranges.	Appendix F	refer to SYBH(Z-RF)002 052016-2001 of FRD-L04
Field Strength of Spurious Radiation	§2.1053, §27.53(h)	$\leq -13\text{ dBm}/1\text{ MHz}$.	Appendix G	refer to SYBH(Z-RF)002 052016-2001 of FRD-L04
Frequency Stability	§2.1055, §27.54	$\leq \pm 2.5\text{ ppm}$.	Appendix H	refer to SYBH(Z-RF)002 052016-2001 of FRD-L04
NOTE 1: For the verdict, the "N/A" denotes "not applicable", the "N/T" denotes "not tested".				

2.4 BRS&EBS Band (2500-2570 MHz paired with 2620-2690 MHz)

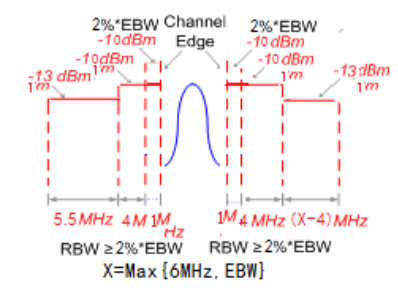
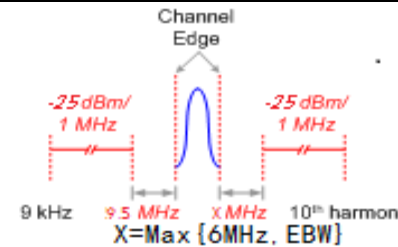
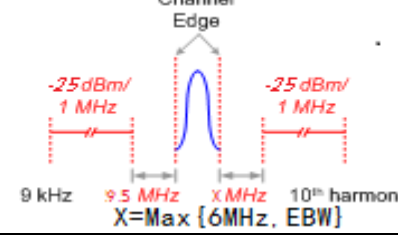
Test Item	FCC Rule No.	Requirements	Test Result	Verdict (Note1)
Effective (Isotropic) Radiated Power Output Data	§2.1046, §27.50(h)	EIRP ≤ 2W	Appendix A	refer to SYBH(Z-RF)002 052016-2001 of FRD-L04
Peak-Average Ratio	§27.50(a)	Limit ≤ 13 dB	Appendix B	refer to SYBH(Z-RF)002 052016-2001 of FRD-L04
Modulation Characteristics	§2.1047	Digital modulation	Appendix C	refer to SYBH(Z-RF)002 052016-2001 of FRD-L04
Bandwidth	§2.1049	OBW: No limit. EBW: No limit.	Appendix D	refer to SYBH(Z-RF)002 052016-2001 of FRD-L04
Band Edges Compliance	§2.1051, §27.53(m4)	FCC: 	Appendix E	refer to SYBH(Z-RF)002 052016-2001 of FRD-L04
Spurious Emission at Antenna Terminals	§2.1051, §27.53(m)		Appendix F	refer to SYBH(Z-RF)002 052016-2001 of FRD-L04
Field Strength of Spurious Radiation	§2.1053, §27.53(m)		Appendix G	refer to SYBH(Z-RF)002 052016-2001 of FRD-L04
Frequency Stability	§2.1055, §27.54	Within authorized bands of operation/frequency block.	Appendix H	refer to SYBH(Z-RF)002 052016-2001 of



Test Item	FCC Rule No.	Requirements	Test Result	Verdict (Note1)
				FRD-L04

NOTE 1: For the verdict, the "N/A" denotes "not applicable", the "N/T" denotes "not tested".

**2.5 Band12 (699-716MHz paired with 729-746 MHz)**

Test Item	FCC Rule No	Requirements	Test Result	Verdict (Note1)
Effective (Isotropic) Radiated Power Output Data	§27.50(c)	FCC: ERP ≤ 3 W..	Appendix A	refer to SYBH(Z-RF)0020 52016-2001 of FRD-L04
Peak-Average Ratio	§2.1046, §27.50(c)	Limit≤13 dB	Appendix B	refer to SYBH(Z-RF)0020 52016-2001 of FRD-L04
Modulation Characteristics	§2.1047	Digital modulation	Appendix C	refer to SYBH(Z-RF)0020 52016-2001 of FRD-L04
Bandwidth	§2.1049	OBW: No limit. EBW: No limit.	Appendix D	refer to SYBH(Z-RF)0020 52016-2001 of FRD-L04
Band Edges Compliance	§2.1051, §27.53(g)	≤ -13 dBm/1%*EBW, in 1 MHz bands immediately outside and adjacent to the frequency block.	Appendix E	refer to SYBH(Z-RF)0020 52016-2001 of FRD-L04
Spurious Emission at Antenna Terminals	§2.1051, §27.53(g)	FCC: ≤ -13 dBm/100 kHz, from 9 kHz to 10 th harmonics but outside authorized operating frequency ranges.	Appendix F	refer to SYBH(Z-RF)0020 52016-2001 of FRD-L04
Field Strength of Spurious Radiation	§2.1051, §27.53(g)	FCC: ≤ -13 dBm/100 kHz.	Appendix G	refer to SYBH(Z-RF)0020 52016-2001 of FRD-L04
Frequency Stability	§2.1055, §27.54	≤ ±2.5ppm.	Appendix H	refer to SYBH(Z-RF)0020 52016-2001 of FRD-L04
NOTE 1: For the verdict, the "N/A" denotes "not applicable", the "N/T" denotes "not tested"				

**2.6 Band17 (704-716MHz paired with 734-746 MHz)**

Test Item	FCC Rule No.	Requirements	Test Result	Verdict (Note1)
Effective (Isotropic) Radiated Power Output Data	§27.50(c).	FCC: ERP ≤ 3 W.	Appendix A	refer to SYBH(Z-RF)002 052016-2001 of FRD-L04
Peak-Average Ratio	§2.1046, §27.50(c)	Limit≤13 dB	Appendix B	refer to SYBH(Z-RF)002 052016-2001 of FRD-L04
Modulation Characteristics	§2.1047	Digital modulation	Appendix C	refer to SYBH(Z-RF)002 052016-2001 of FRD-L04
Bandwidth	§2.1049	OBW: No limit. EBW: No limit.	Appendix D	refer to SYBH(Z-RF)002 052016-2001 of FRD-L04
Band Edges Compliance	§2.1051, §27.53(g)	≤ -13 dBm/1%*EBW, in 1 MHz bands immediately outside and adjacent to the frequency block.	Appendix E	refer to SYBH(Z-RF)002 052016-2001 of FRD-L04
Spurious Emission at Antenna Terminals	§2.1051, §27.53(g)	FCC: ≤ -13 dBm/100 kHz, from 9 kHz to 10 th harmonics but outside authorized operating frequency ranges.	Appendix F	refer to SYBH(Z-RF)002 052016-2001 of FRD-L04
Field Strength of Spurious Radiation	§2.1051, §27.53(g)	FCC: ≤ -13 dBm/100 kHz.	Appendix G	refer to SYBH(Z-RF)002 052016-2001 of FRD-L04
Frequency Stability	§2.1055, §27.54	≤ ±2.5ppm.	Appendix H	refer to SYBH(Z-RF)002 052016-2001 of FRD-L04
NOTE 1: For the verdict, the "N/A" denotes "not applicable", the "N/T" denotes "not tested"				

3 Description of the Equipment under Test (EUT)

3.1 General Description

FRD-L24 is subscriber equipment in the GSM/WCDMA/LTE/CDMA system. The GSM frequency band is GSM850 and GSM900 and DCS1800 and PCS1900. The UMTS frequency band is B1 and B2 and B4 and B5 and B8. The LTE frequency band is B2 and B4 and B5 and B7 and B12 and B17. The Mobile Phone implements such functions as RF signal receiving/transmitting, LTE/HSPA/UMTS and GSM/GPRS/EDGE protocol processing, voice, video MMS service, GPS, AGPS and WIFI etc. Externally it provides one micro SD card (it can also used as SIM card interface), earphone port (to provide voice service) and one SIM card interface. FRD-L24 is single SIM smart phone. It also provides Bluetooth module to synchronize data between a PC and the phone, or to use the built-in modem of the phone to access the Internet with a PC, or to exchange data with other Bluetooth devices.

Note1: only GSM850 and GSM1900,UMTS frequency B2 and B4 and B5,LTE frequency B2 and B4 and B5 and B7 and B12 and B17 bands test data included in this report.

The differences between FRD-L24 and FRD-L04 are showed in the following table.

	FRD-L04	FRD-L24
GSM four bands	B2/B3/B5/B8	B2/B3/B5/B8
WCDMA bands	B1 /B2/B4/B5/B8	B1 /B2/B4/B5/B8
LTE bands	B1/B2/B3/B4/B5/B7/B8/B12/B17/B20	B2/B4/B5/B7/B12/B17
FCC bands	850/1900 B2/B4/B5 B2/B4/B5/B7/B12/B17	850/1900 B2/B4/B5 B2/B4/B5/B7/B12/B17
SIM card	One	One
NFC	Support	Not support
FM	The same	The same
External camera	the same	the same
internal camera	the same	the same
FLASH	the same	the same
Mainboard	with NFC ROM:32GB No B40, B38 function, but keep the circuit	Without NFC, ROM:64GB No B40, B38 function and circuit Board ID : Make a change



PCB layout	the same	the same
Appearance	the same	the same
Bluetooth mode	the same	the same
WLAN mode	the same	the same
BT/ WLAN antenna	the same	the same
GSM/ WCDMA /LTE antenna	the antenna structure and shape is the same	the antenna structure and shape is the same
Adapter	the same	the same
Battery	the same	the same
Chipset	the same	the same
Memory	32GB	64GB
RF Parameter	The same	The same
Dimension	the same	the same
Main Frequency NV	The same NV in the same band	The same NV in the same band
Power reduction in SAR	<p>WiFi antenna:</p> <p>1)WiFi 2.4G antenna + Main antenna (wifi station):0db</p> <p>2)WiFi 2.4G + Mian antenna (wifi hotspot):-1db</p> <p>3)WiFi 5G antenna + Main antenna (wifi station):0db</p> <p>Main antenna:The same</p> <p>Second antenna: Support</p>	<p>WiFi antenna:</p> <p>1)WiFi 2.4G antenna + Main antenna (wifi station):-4db</p> <p>2)WiFi 2.4G + Mian antenna (wifi hotspot):-4db</p> <p>3)WiFi 5G antenna + Main antenna (wifi station):-4db</p> <p>Main antenna:The same</p> <p>Second antenna: no support second antenna</p>
Switching antenna	Can switch to the upper antenna	It is not able to switch to the upper antenna and does not support the upper antenna.



Note2: For FRD-L24, RSE of worst case had been tested, Since the result didn't worsen, So

1, For GSM, UMTS, LTE bands of FRD-L24, all test data can refer to No. SYBH(Z-RF)002052016-2001 of FRD-L04.

2, For 2.4G WLAN of FRD-L24, all test data can refer to No. SYBH(Z-RF)002052016-2002 of FRD-L04.

3, For Bluetooth of FRD-L24, all test data can refer to No. SYBH(Z-RF)002052016-2003 of FRD-L04.

4, For Bluetooth BLE of FRD-L24, all test data can refer to No. SYBH(Z-RF)002052016-2004 of FRD-L04.

5, For 5G WLAN of FRD-L24, all test data can refer to No. SYBH(Z-RF)002052016-2005 of FRD-L04.











3.2 EUT Identity

NOTE: Unless otherwise noted in the report, the functional boards installed in the units shall be selected from the below list, but not means all the functional boards listed below shall be installed in one unit.

3.2.1 Board

Board		
Description	Hardware Version	Software Version
Main Board	HL1FRDL04M	FRD-L24C567B100

3.2.2 Sub-Assembly

Sub-Assembly			
Sub-Assembly Name	Model	Manufacturer	Description
Adapter	HW-059200EHQ	Huawei Technologies Co., Ltd.	Input Voltage: ~100-240V 50/60Hz 0.5 A Output Voltage: 5V  2A or 9V  2A
Adapter	HW-059200BHQ	Huawei Technologies Co., Ltd.	Input Voltage: ~100-240V 50/60Hz 0.5 A Output Voltage: 5V  2A or 9V  2A
Adapter	HW-059200AHQ	Huawei Technologies Co., Ltd.	Input Voltage: ~100-240V 50/60Hz 0.5 A Output Voltage: 5V  2A or 9V  2A
Adapter	HW-059200UHQ	Huawei Technologies Co., Ltd.	Input Voltage: ~100-240V 50/60Hz 0.5 A Output Voltage: 5V  2A or 9V  2A
Li-Polymer Battery	HB366481ECW	Huawei Technologies Co., Ltd.	Rated capacity: 2900mAh Nominal Voltage:  +3.82V Charging Voltage:  +4.40V



3.3 Technical Specification

Characteristics	Description	
Radio System Type	<input checked="" type="checkbox"/> GSM <input checked="" type="checkbox"/> UMTS <input checked="" type="checkbox"/> LTE	
Supported Frequency Range	GSM850/ WCDMA850	Transmission (TX): 824 to 849 MHz
		Receiving (RX): 869 to 894 MHz
	GSM1900/ WCDMA1900	Transmission (TX): 1850 to 1910 MHz
		Receiving (RX): 1930 to 1990 MHz
	WCDMA1700	Transmission (TX): 1710 to 1755 MHz
		Receiving (RX): 2110 to 2155 MHz
	LTE BAND2	Transmission (TX): 1850 to 1910 MHz
		Receiving (RX): 1930 to 1990 MHz
	LTE BAND4	Transmission (TX): 1710 to 1755 MHz
		Receiving (RX): 2110 to 2155 MHz
	LTE BAND5	Transmission (TX): 824 to 849 MHz
		Receiving (RX): 869 to 894 MHz
	LTE BAND7	Transmission (TX): 2500 to 2570 MHz
		Receiving (RX): 2620 to 2690 MHz
LTE BAND12	Transmission (TX): 699 to 716 MHz	
	Receiving (RX): 729 to 746 MHz	
LTE BAND17	Transmission (TX): 704 to 716 MHz	
	Receiving (RX): 734 to 746 MHz	
TX and RX Antenna Ports	TX & RX port:	2
	TX-only port:	0
	RX-only port:	1
Target TX Output Power	GSM850: 33dBm GSM1900 30dBm UMTS850 24.5dBm UMTS1900: 24dBm UMTS1700 23dBm LTE BAND2: 23dBm LTE BAND4: 22.5dBm LTE BAND5: 23 dBm LTE BAND7: 22 dBm LTE BAND12: 23dBm LTE BAND17: 23.5dBm	
Supported Channel Bandwidth	GSM system:	<input checked="" type="checkbox"/> 200 kHz
	UMTS system:	<input checked="" type="checkbox"/> 5 MHz
	LTE band 2	<input checked="" type="checkbox"/> 1.4 MHz, <input checked="" type="checkbox"/> 3 MHz, <input checked="" type="checkbox"/> 5 MHz, <input checked="" type="checkbox"/> 10 MHz, <input checked="" type="checkbox"/> 15 MHz, <input checked="" type="checkbox"/> 20 MHz



Characteristics	Description	
	LTE band 4	<input checked="" type="checkbox"/> 1.4 MHz, <input checked="" type="checkbox"/> 3 MHz, <input checked="" type="checkbox"/> 5 MHz, <input checked="" type="checkbox"/> 10 MHz, <input checked="" type="checkbox"/> 15 MHz, <input checked="" type="checkbox"/> 20 MHz
	LTE band 5	<input checked="" type="checkbox"/> 1.4 MHz, <input checked="" type="checkbox"/> 3 MHz, <input checked="" type="checkbox"/> 5 MHz, <input checked="" type="checkbox"/> 10 MHz
	LTE band 7	<input checked="" type="checkbox"/> 5MHz, <input checked="" type="checkbox"/> 10MHz , <input checked="" type="checkbox"/> 15MHz , <input checked="" type="checkbox"/> 20MHz
	LTE band 12	<input checked="" type="checkbox"/> 1.4 MHz, <input checked="" type="checkbox"/> 3 MHz, <input checked="" type="checkbox"/> 5 MHz, <input checked="" type="checkbox"/> 10 MHz
	LTE band 17	<input checked="" type="checkbox"/> 5 MHz, <input checked="" type="checkbox"/> 10 MHz
Designation of Emissions (Note: the necessary bandwidth of which is the worst value from the measured occupied bandwidths for each type of channel bandwidth configuration.)	GSM850:	246KGXW, 255KG7W
	GSM1900:	246KGXW, 250KG7W
	UMTS850:	4M15F9W
	UMTS1900:	4M16F9W
	UMTS1700:	4M16F9W
	LTE BAND2:	1M10G7D (1.4 MHz QPSK modulation), 1M10W7D (1.4 MHz 16QAM modulation) 2M71G7D (3 MHz QPSK modulation), 2M71W7D (3 MHz 16QAM modulation) 4M52G7D (5 MHz QPSK modulation), 4M52W7D (5 MHz 16QAM modulation) 9M00G7D (10 MHz QPSK modulation), 9M03W7D (10 MHz 16QAM modulation) 13M5G7D (15 MHz QPSK modulation), 13M5W7D (15 MHz 16QAM modulation) 18M0G7D (20 MHz QPSK modulation), 18M0W7D (20 MHz 16QAM modulation)
	LTE BAND4:	1M10G7D (1.4 MHz QPSK modulation), 1M10W7D (1.4 MHz 16QAM modulation) 2M71G7D (3 MHz QPSK modulation), 2M72W7D (3 MHz 16QAM modulation) 4M51G7D (5 MHz QPSK modulation), 4M52W7D (5 MHz 16QAM modulation) 9M01G7D (10 MHz QPSK modulation), 9M01W7D (10 MHz 16QAM modulation) 13M5G7D (15 MHz QPSK modulation), 13M5W7D (15 MHz 16QAM modulation) 18M0G7D (20 MHz QPSK modulation), 18M1W7D (20 MHz 16QAM modulation)
	LTE BAND5:	1M09G7D (1.4 MHz QPSK modulation), 1M09W7D (1.4 MHz 16QAM modulation) 2M71G7D (3 MHz QPSK modulation), 2M72W7D (3 MHz 16QAM modulation) 4M51G7D (5 MHz QPSK modulation), 4M52W7D (5 MHz 16QAM modulation) 9M02G7D (10 MHz QPSK modulation),

Characteristics	Description	
		9M03W7D (10 MHz 16QAM modulation)
	LTE BAND7:	4M52G7D (5 MHz QPSK modulation), 4M52W7D (5 MHz 16QAM modulation) 9M01G7D (10 MHz QPSK modulation), 9M02W7D (10 MHz 16QAM modulation) 13M5G7D (15 MHz QPSK modulation), 13M6W7D (15 MHz 16QAM modulation) 18M0G7D (20 MHz QPSK modulation), 18M0W7D (20 MHz 16QAM modulation)
	LTE BAND12:	1M10G7D (1.4 MHz QPSK modulation), 1M10W7D (1.4 MHz 16QAM modulation) 2M71G7D (3 MHz QPSK modulation), 2M72W7D (3 MHz 16QAM modulation) 4M54G7D (5 MHz QPSK modulation), 4M53W7D (5 MHz 16QAM modulation) 9M03G7D (10 MHz QPSK modulation), 9M02W7D (10 MHz 16QAM modulation)
	LTE BAND17:	4M52G7D (5 MHz QPSK modulation), 4M52W7D (5 MHz 16QAM modulation) 9M04G7D (10 MHz QPSK modulation), 9M03W7D (10 MHz 16QAM modulation)



4 General Test Conditions / Configurations

4.1 Test Modes

NOTE: The test mode(s) are selected according to relevant radio technology specifications.

Test Mode	Test Modes Description
GSM/TM1	GSM system, GSM/GPRS, GMSK modulation
GSM/TM2	GSM system, EDGE, 8PSK modulation
UMTS/TM1	WCDMA system, QPSK modulation
LTE/TM1	LTE system, QPSK modulation
LTE/TM2	LTE system, 16QAM modulation

4.2 Test Environment

Environment Parameter	Selected Values During Tests	
Relative Humidity	Ambient	
Temperature	TN	Ambient
Voltage	VL	3.6V
	VN	3.82V
	VH	4.35V

NOTE: VL= lower extreme test voltage
VN= nominal voltage
VH= upper extreme test voltage
TN= normal temperature

4.3 Test Frequency

Test Mode	TX / RX	RF Channel		
		Low (L)	Middle (M)	High (H)
GSM850	TX	Channel 128	Channel 190	Channel 251
		824.2MHz	836.6MHz	848.8MHz
	RX	Channel 128	Channel 190	Channel 251
		869.2MHz	881.6MHz	893.8MHz
WCDMA850	TX	Channel 4132	Channel 4182	Channel 4233
		826.4MHz	836.4MHz	846.6MHz
	RX	Channel 4357	Channel 4407	Channel 4458
		871.4MHz	881.4MHz	891.6MHz
Test Mode	TX / RX	RF Channel		
		Low (L)	Middle (M)	High (H)
GSM1900	TX	Channel 512	Channel 661	Channel 810
		1850.2MHz	1880.0MHz	1909.8MHz
	RX	Channel 512	Channel 661	Channel 810
		1930.2 MHz	1960.0 MHz	1989.8 MHz
WCDMA1900	TX	Channel 9262	Channel9400	Channel9538
		1852.4MHz	1880.0MHz	1907.6MHz
	RX	Channel 9662	Channel 9800	Channel 9938
		1932.4 MHz	1960.0 MHz	1987.6 MHz
Test Mode	TX / RX	RF Channel		
		Low (L)	Middle (M)	High (H)
WCDMA1700	TX	Channel1312	Channel1413	Channel1513
		1712.4MHz	1732.6MHz	1752.6MHz



Test Mode	TX / RX	RF Channel		
		Low (L)	Middle (M)	High (H)
	RX	Channel 1537	Channel 1638	Channel 1738
		2112.4 MHz	2132.6 MHz	2152.6 MHz

Test Mode	TX / RX	RF Channel		
		Low (B)	Middle (M)	High (T)
LTE Band 2	TX(1.4M)	Channel 18607	Channel 18900	Channel 19193
		1850.7 MHz	1880 MHz	1909.3 MHz
	TX(3M)	Channel 18615	Channel 18900	Channel 19185
		1851.5 MHz	1880 MHz	1908.5 MHz
	TX(5M)	Channel 18625	Channel 18900	Channel 19175
		1852.5 MHz	1880 MHz	1907.5 MHz
	TX(10M)	Channel 18650	Channel 18900	Channel 19150
		1855 MHz	1880 MHz	1905 MHz
	TX(15M)	Channel 18675	Channel 18900	Channel 19125
		1857.5 MHz	1880 MHz	1902.5 MHz
	TX(20M)	Channel 18700	Channel 18900	Channel 19100
		1860 MHz	1880 MHz	1900 MHz
	RX(1.4M)	Channel 607	Channel 900	Channel 1193
		1930.7 MHz	1960 MHz	1989.3 MHz
	RX(3M)	Channel 615	Channel 900	Channel 1185
		1931.5 MHz	1960 MHz	1988.5 MHz
	RX(5M)	Channel 625	Channel 900	Channel 1175
		1932.5 MHz	1960 MHz	1987.5 MHz



Test Mode	TX / RX	RF Channel		
		Low (B)	Middle (M)	High (T)
	RX(10M)	Channel 650	Channel 900	Channel 1150
		1935 MHz	1960 MHz	1985 MHz
	RX(15M)	Channel 675	Channel 900	Channel 1125
		1937.5 MHz	1960 MHz	1982.5 MHz
	RX(20M)	Channel 700	Channel 900	Channel 1100
		1940 MHz	1960 MHz	1980 MHz

Test Mode	TX / RX	RF Channel		
		Low (B)	Middle (M)	High (T)
LTE Band 4	TX(1.4M)	Channel 19957	Channel 20175	Channel 20393
		1710.7 MHz	1732.5 MHz	1754.3 MHz
	TX(3M)	Channel 19965	Channel 20175	Channel 20385
		1711.5 MHz	1732.5 MHz	1753.5 MHz
	TX(5M)	Channel 19975	Channel 20175	Channel 20375
		1712.5 MHz	1732.5 MHz	1752.5 MHz
	TX(10M)	Channel 20000	Channel 20175	Channel 20350
		1715 MHz	1732.5 MHz	1750 MHz
	TX(15M)	Channel 20025	Channel 20175	Channel 20325
		1717.5 MHz	1732.5 MHz	1747.5 MHz
	TX(20M)	Channel 20050	Channel 20175	Channel 20300
		1720 MHz	1732.5 MHz	1745 MHz
	RX(1.4M)	Channel 1975	Channel 2175	Channel 2375
		2112.5 MHz	2132.5MHz	2152.5 MHz



Test Mode	TX / RX	RF Channel		
		Low (B)	Middle (M)	High (T)
	RX(3M)	Channel 2000	Channel 2175	Channel 2350
		2115 MHz	2132.5MHz	2150 MHz
	RX(5M)	Channel 1975	Channel 2175	Channel 2375
		2112.5 MHz	2132.5MHz	2152.5 MHz
	RX(10M)	Channel 2000	Channel 2175	Channel 2350
		2115 MHz	2132.5MHz	2150 MHz
	RX(15M)	Channel 2025	Channel 2175	Channel 2325
		2117.5 MHz	2132.5MHz	2147.5 MHz
	RX(20M)	Channel 2050	Channel 2175	Channel 2300
		2120 MHz	2132.5MHz	2145 MHz

Test Mode	TX / RX	RF Channel		
		Low (B)	Middle (M)	High (T)
LTE Band 5	TX(1.4M)	Channel 20407	Channel 20525	Channel 20643
		824.7 MHz	836.5 MHz	848.3 MHz
	TX(3M)	Channel 20415	Channel 20525	Channel 20635
		825.5 MHz	836.5 MHz	847.5 MHz
	TX(5M)	Channel 20425	Channel 20525	Channel 20625
		826.5 MHz	836.5 MHz	846.5 MHz
	TX(10M)	Channel 20450	Channel 20525	Channel 20600
		829 MHz	836.5 MHz	844 MHz
	RX(1.4M)	Channel 2407	Channel 2525	Channel 2643
		869.7 MHz	881.5 MHz	893.3 MHz
	RX (3M)	Channel 2415	Channel 2525	Channel 2635



Test Mode	TX / RX	RF Channel		
		Low (B)	Middle (M)	High (T)
		870.5 MHz	881.5 MHz	892.5 MHz
		Channel 2425	Channel 2525	Channel 2625
	RX(5M)	871.5 MHz	881.5 MHz	891.5 MHz
		Channel 2450	Channel 2525	Channel 2600
	RX (10M)	874 MHz	881.5 MHz	889 MHz

Test Mode	TX / RX	RF Channel		
		Low (B)	Middle (M)	High (T)
LTE Band 7	TX (5M)	Channel 20775	Channel 21100	Channel 21425
		2502.5 MHz	2535 MHz	2567.5 MHz
	TX (10M)	Channel 20800	Channel 21100	Channel 21400
		2505 MHz	2535 MHz	2565 MHz
	TX (15M)	Channel 20825	Channel 21100	Channel 21375
		2507.5 MHz	2535 MHz	2562.5 MHz
	TX (20M)	Channel 20850	Channel 21100	Channel 21350
		2510 MHz	2535 MHz	2560 MHz
	RX (5M)	Channel 2775	Channel 3100	Channel 3425
		2622.5 MHz	2655 MHz	2687.5 MHz
	RX (10M)	Channel 2800	Channel 3100	Channel 3400
		2625 MHz	2655 MHz	2685 MHz
	RX (15M)	Channel 2825	Channel 3100	Channel 3375
		2627.5 MHz	2655 MHz	2682.5 MHz
	RX (20M)	Channel 2850	Channel 3100	Channel 3350



Test Mode	TX / RX	RF Channel		
		Low (B)	Middle (M)	High (T)
		2630 MHz	2655 MHz	2680 MHz

Test Mode	TX / RX	RF Channel		
		Low (B)	Middle (M)	High (T)
LTE Band 12	TX(1.4M)	Channel 23017	Channel 23095	Channel 23173
		699.7 MHz	707.5 MHz	715.3 MHz
	TX(3M)	Channel 23025	Channel 23095	Channel 23165
		700.5 MHz	707.5 MHz	714.5 MHz
	TX(5M)	Channel 23035	Channel 23095	Channel 23155
		701.5 MHz	707.5 MHz	713.5 MHz
	TX(10M)	Channel 23060	Channel 23095	Channel 23130
		704 MHz	707.5 MHz	711 MHz
	RX(1.4M)	Channel 5017	Channel 5095	Channel 5173
		729.7 MHz	737.5 MHz	745.3 MHz
	RX (3M)	Channel 5025	Channel 5095	Channel 5165
		730.5 MHz	737.5 MHz	744.5 MHz
	RX(5M)	Channel 5035	Channel 5095	Channel 5155
		731.5 MHz	737.5 MHz	743.5 MHz
	RX (10M)	Channel 5060	Channel 5095	Channel 5130
		734 MHz	737.5 MHz	741 MHz



Test Mode	TX / RX	RF Channel		
		Low (B)	Middle (M)	High (T)
LTE Band 17	TX (5M)	Channel 23755	Channel 23790	Channel 23825
		706.5 MHz	710 MHz	713.5 MHz
	TX (10M)	Channel 23780	Channel 23790	Channel 23800
		709 MHz	710 MHz	711 MHz
	RX (5M)	Channel 5755	Channel 5790	Channel 5825
		736.5 MHz	740 MHz	743.5 MHz
	RX (10M)	Channel 5780	Channel 5790	Channel 5800

4.4 DESCRIPTION OF TESTS

4.4.1 Radiated Power and Radiated Spurious Emissions

Radiated spurious emissions are investigated indoors in a semi-anechoic chamber to determine the frequencies producing the worst case emissions. Final measurements for radiated power and radiated spurious emissions are performed on the 3 meter OATS per the guidelines of ANSI/TIA-603-D-2010. The equipment under test was transmitting while connected to its integral antenna and is placed on a wooden turntable 80cm above the ground plane and 3 meters from the receive antenna. The spectrum is scanned from the lowest frequency generated in the equipment up to a frequency including its 10th harmonic. The receive antenna height is adjusted between 1 and 4 meter height, the turntable is rotated through 360 degrees, and the EUT is manipulated through all orthogonal planes representative of its typical use to achieve the highest reading on the receive spectrum analyzer. Emissions are also investigated with the receive antenna horizontally and vertically polarized.

A portable or small unlicensed wireless device shall be placed on a non-metallic test fixture or other non-metallic support during testing. The supporting fixture shall permit orientation of the EUT in each of three orthogonal (x, y, z) axis positions such that emissions from the EUT are maximized. Measure the EUT maximum RF power and record the result.

A half-wave dipole is then substituted in place of the EUT. For emissions above 3GHz, a horn antenna is substituted in place of the EUT. The substitute antenna is driven by a signal generator with the level of the signal generator being adjusted to obtain the same receive spectrum analyzer level previously recorded from the spurious emission from the EUT.

The power of the emission is calculated using the following formula:

$$P_d [\text{dBm}] = P_g [\text{dBm}] - \text{cable loss} [\text{dB}] + \text{antenna gain} [\text{dBd/dBi}]$$

Where, P_d is the dipole equivalent power, P_g is the generator output into the substitution antenna, and the antenna gain is the gain of the substitute antenna used relative to either a half-wave dipole (dBd) or an isotropic source (dBi). The substitute level is equal to $P_g [\text{dBm}] - \text{cable loss} [\text{dB}]$.

The calculated P_d levels are then compared to the absolute spurious emission limit of -13dBm which is equivalent to the required minimum attenuation of $43 + 10\log_{10}(\text{Power} [\text{Watts}])$.

Test Procedures Used

KDB 971168 D01 v03-Section 5.2.2 / KDB 971168 D01 v03-Section 5.8

ANSI/TIA-603-D-2010-Section 2.2.17 / ANSI/TIA-603-D-2010-Section 2.2.12

Note: Reference test setup 3



4.4.2 Peak-Average Ratio

A peak to average ratio measurement is performed at the conducted port of the EUT. For WCDMA signals, the spectrum analyzers Complementary Cumulative Distribution Function (CCDF) measurement profile is used to determine the largest deviation between the average and the peak power of the EUT in a given bandwidth. The CCDF curve shows how much time the peak waveform spends at or above a given average power level. The percent of time the signal spends at or above the level defines the probability for that particular power level. For GSM signals, an average and a peak trace are used on a spectrum analyzer to determine the largest deviation between the average and the peak power of the EUT in a bandwidth greater than the emission bandwidth. The traces are generated with the spectrum analyzer set to zero span mode.

Test Procedures Used

KDB 971168 D01 v03-Section 5.7.2

Test Settings

- 1、 The signal analyzer's CCDF measurement profile enabled
- 2、 Frequency= carrier center frequency
- 3、 Measurement BW > EBW of signal
- 4、 for continuous transmissions, set to 1ms
- 5、 Record the maximum PAPR level associated with a probability of 0.1%.

Note: Reference test setup 1



4.4.3 Occupied Bandwidth

The occupied bandwidth, that is the frequency bandwidth such that, below its lower and above its upper frequency limits, the mean powers radiated are each equal to 0.5 percent of the total mean power radiated by a given emission shall be measured. The span of the analyzer shall be set to capture all products of the modulation process, including the emission skirts. The resolution bandwidth shall be set to as close to 1 percent of the selected span as is possible without being below 1 percent. The video bandwidth shall be set to 3 times the resolution bandwidth. Video averaging is not permitted. Where practical, a sampling detector shall be used since a peak or, peak hold, may produce a wider bandwidth than actual. The trace data points are recovered and are directly summed in linear terms. The recovered amplitude data points, beginning at the lowest frequency, are placed in a running sum until 0.5 percent of the total is reached and that frequency recorded. The process is repeated for the highest frequency data points. This frequency is recorded. The span between the two recorded frequencies is the occupied bandwidth.

Test Procedures Used

KDB 971168 D01 v03-Section 4.3

Test Settings

- 1、 SET RBW=1-5% of OBW
- 2、 SET VBW ≥ 3 *RBW
- 3、 Detector: Peak
- 4、 Trace mode= max hold.
- 5、 Sweep= auto couple
- 6、 Steps 1-5 were repeated after it is stable

Note: Reference test setup 1.



4.4.4 Band Edge Compliance

the 1 MHz bands immediately outside and adjacent to the frequency block a resolution bandwidth of at least one percent of the emission bandwidth of the fundamental emission of the transmitter may be employed. The emission power must be attenuated below the transmitting power (P) by a factor of at least $43+10\log_{10}P$ dB.

Test Procedures Used

KDB 971168 D01 v03-Section 6

Test Settings

- 1、 SET RBW \geq 1% of Emission BW.
- 2、 SET VBW about three times of RBW
- 3、 Detector: RMS
- 4、 Trace mode= max hold.
- 5、 Span= 2MHz

Note: Reference test setup 1.

4.4.5 Spurious and Harmonic Emissions at Antenna Terminal

The level of the carrier and the various conducted spurious and harmonic frequencies is measured by means of a calibrated spectrum analyzer. The spectrum is scanned from the lowest frequency generated in the equipment up to a frequency including its 10th harmonic. On any frequency outside a licensee's frequency block, the power of any emission shall be attenuated below the transmitter power (P) by at least $43 + 10 \log(P)$ dB. Compliance with these provisions is based on the use of measurement instrumentation employing a resolution bandwidth of 1 MHz or greater. However, in the 1 MHz bands immediately outside and adjacent to the frequency block a resolution bandwidth of at least one percent of the emission bandwidth of the fundamental emission of the transmitter may be employed. The emission bandwidth is defined as the width of the signal between two points, one below the carrier center frequency and one above the carrier center frequency, outside of which all emission are attenuated at least 26 dB below the transmitter power.

Test Procedures Used

KDB 971168 D01 v03-Section 6

Test Settings

- 1、 9kHz~150kHz, $RBW = 1\text{KHz}$, $VBW \geq 3 \times RBW$,
150kHz~30MHz, $RBW = 10\text{KHz}$, $VBW \geq 3 \times RBW$,
30MHz~1GHz, $RBW = 100\text{ kHz}$, $VBW = 300\text{ kHz}$.
Above 1GHz, $RBW = 1\text{ MHz}$, $VBW = 3\text{ MHz}$.

2、 Detector: Peak

3、 Trace mode= max hold.

Note: Reference test setup 1.



4.4.6 Frequency Stability / Temperature Variation

Frequency stability testing is performed in accordance with the guidelines of ANSI/TIA-603-D-2010. The frequency stability of the transmitter is measured by:

- a.) **Temperature:** The temperature is varied from -30°C to +50°C in 10°C increments using an environmental chamber.
- b.) **Primary Supply Voltage:** The primary supply voltage is varied from 85% to 115% of the nominal value for non hand-carried battery and AC powered equipment. For hand-carried, battery-powered equipment, primary supply voltage is reduced to the battery operating end point which shall be specified by the manufacturer.

Specification – The frequency stability shall be sufficient to ensure that the fundamental emission stays within the authorized frequency block. The frequency stability of the transmitter shall be maintained within $\pm 0.00025\%$ (± 2.5 ppm) of the center frequency.

Time Period and Procedure:

1. The carrier frequency of the transmitter is measured at room temperature (20°C to provide a reference).
2. The equipment is turned on in a “standby” condition for fifteen minutes before applying power to the transmitter. Measurement of the carrier frequency of the transmitter is made within one minute after applying power to the transmitter.
3. Frequency measurements are made at 10°C intervals ranging from -30°C to +50°C. A period of at least one half-hour is provided to allow stabilization of the equipment at each temperature level.

Test Procedures Used

ANSI/TIA-603-D-2010

Note: Reference test setup 2.

4.5 Test Setups

4.5.1 Test Setup 1

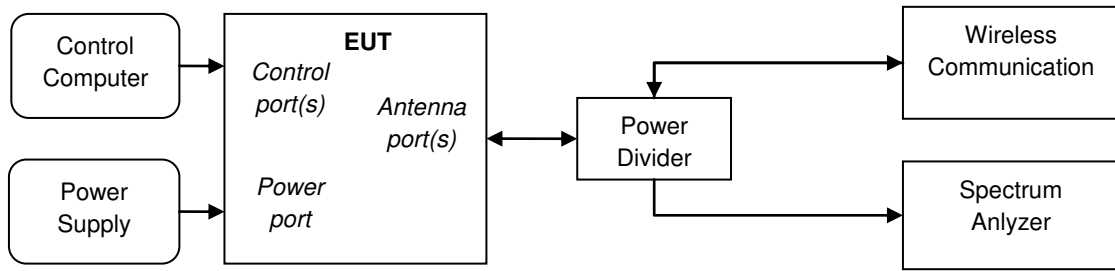

4.5.2 Test Setup 2

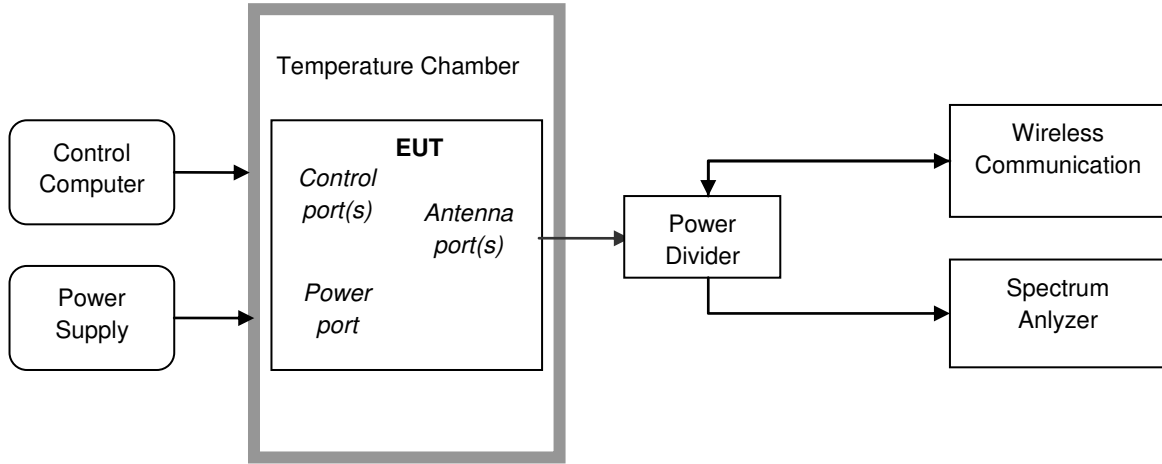

4.5.3 Test Setup 3

NOTE: Effective radiated power (ERP) and Equivalent Isotropic Radiated Power(EIRP) refers to the radiation power output of the EUT, assuming all emissions are radiated from half-wave dipole antennas.

4.5.3.1 Step 1: Pre-test

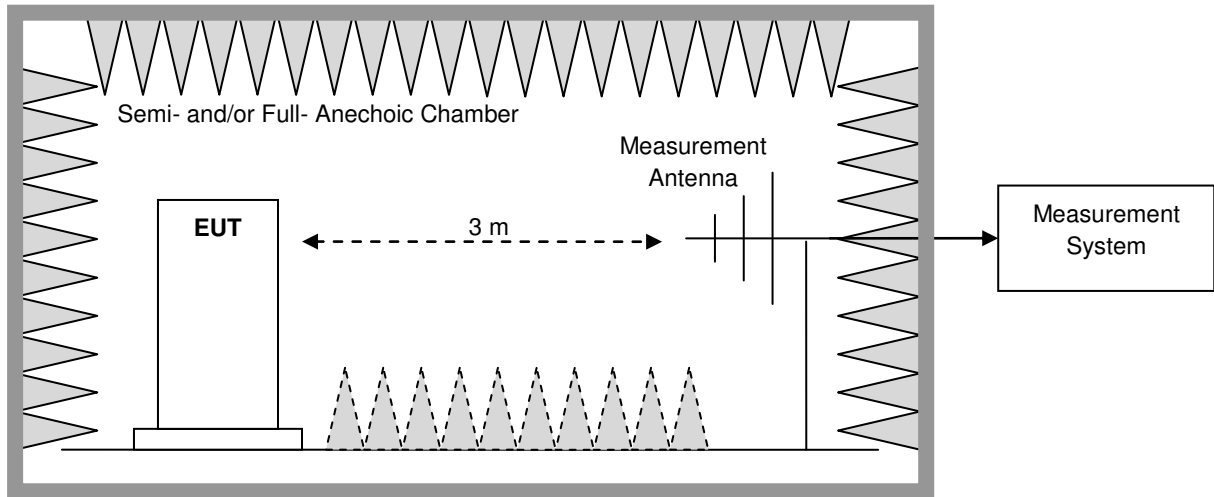

4.5.3.2 Step 2: Substitution method to verify the maximum ERP/EIRP

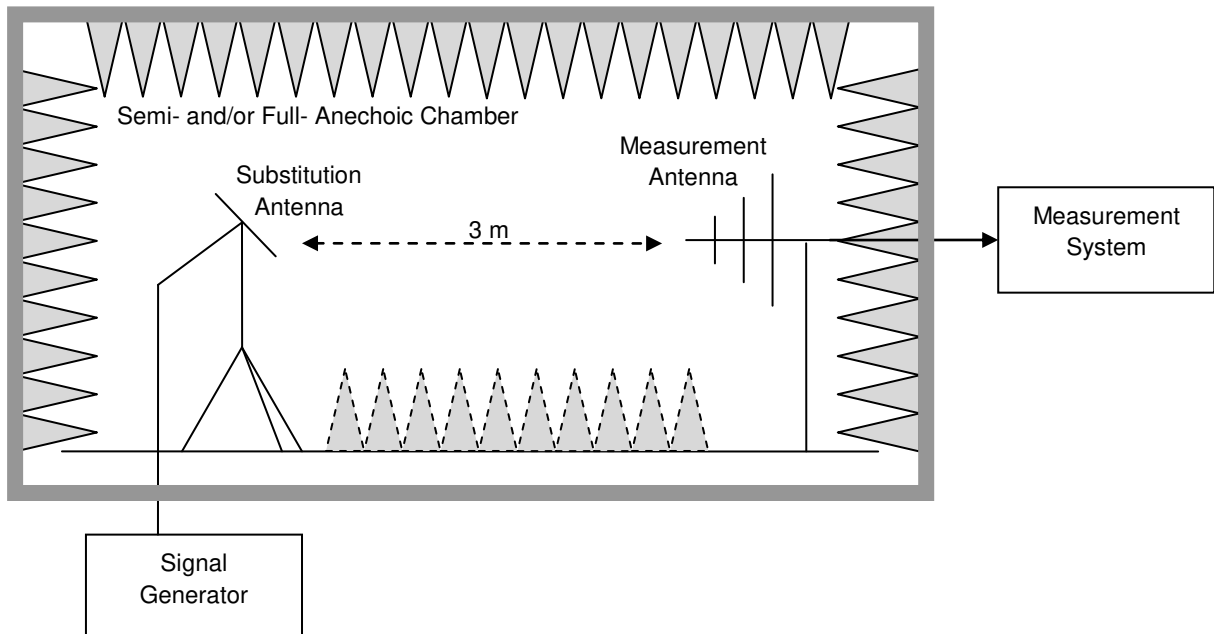

4.6 Test Conditions

Test Case		Test Conditions	
Transmit Output Power Data	Average Power, Total	Test Env.	Ambient Climate & Rated Voltage
		Test Setup	Test Setup 1
		RF Channels (TX)	L, M, H (L= low channel, M= middle channel, H= high channel)
		Test Mode	GSM/TM1,GSM/TM2,UMTS/TM1,LTE/TM1,LTE/TM2
	Average Power, Spectral Density (if required)	Test Env.	Ambient Climate & Rated Voltage
		Test Setup	Test Setup 1
		RF Channels (TX)	L, M, H (L= low channel, M= middle channel, H= high channel)
		Test Mode	GSM/TM1,GSM/TM2,UMTS/TM1,LTE/TM1,LTE/TM2
Peak-to-Average Ratio (if required)		Test Env.	Ambient Climate & Rated Voltage
		Test Setup	Test Setup 1
		RF Channels (TX)	L, M, H (L= low channel, M= middle channel, H= high channel)
		Test Mode	GSM/TM1,GSM/TM2,UMTS/TM1,LTE/TM1,LTE/TM2
Modulation Characteristics		Test Env.	Ambient Climate & Rated Voltage
		Test Setup	Test Setup 1
		RF Channels (TX)	M (L= low channel, M= middle channel, H= high channel)
		Test Mode	GSM/TM1,GSM/TM2,UMTS/TM1,LTE/TM1,LTE/TM2
Bandwidth	Occupied Bandwidth	Test Env.	Ambient Climate & Rated Voltage
		Test Setup	Test Setup 1
		RF Channels (TX)	L, M, H (L= low channel, M= middle channel, H= high channel)
		Test Mode	GSM/TM1,GSM/TM2,UMTS/TM1,LTE/TM1,LTE/TM2
	Emission Bandwidth (if required)	Test Env.	Ambient Climate & Rated Voltage
		Test Setup	Test Setup 1
		RF Channels (TX)	L, M, H (L= low channel, M= middle channel, H= high channel)
		Test Mode	GSM/TM1,GSM/TM2,UMTS/TM1,LTE/TM1,LTE/TM2
Band Edges Compliance		Test Env.	Ambient Climate & Rated Voltage
		Test Setup	Test Setup 1
		RF Channels (TX)	L, H (L= low channel, M= middle channel, H= high channel)
		Test Mode	GSM/TM1,GSM/TM2,UMTS/TM1,LTE/TM1,LTE/TM2
Spurious Emission at Antenna Terminals		Test Env.	Ambient Climate & Rated Voltage
		Test Setup	Test Setup 1
		RF Channels (TX)	L, M, H (L= low channel, M= middle channel, H= high channel)



Test Case	Test Conditions	
	Test Mode	GSM/TM1,GSM/TM2,UMTS/TM1,LTE/TM1,LTE/TM2
Field Strength of Spurious Radiation	Test Env.	Ambient Climate & Rated Voltage
	Test Setup	Test Setup 3
	Test Mode	GSM/TM1,GSM/TM2,UMTS/TM1,LTE/TM1,LTE/TM2 NOTE: If applicable, the EUT conf. that has maximum power density (based on the equivalent power level) is selected.
	RF Channels (TX)	L, M, H (L= low channel, M= middle channel, H= high channel)
Frequency Stability	Test Env.	(1) -30 °C to +50 °C with step 10 °C at Rated Voltage; (2) VL, VN and VH of Rated Voltage at Ambient Climate.
	Test Setup	Test Setup 2
	RF Channels (TX)	L, M, H (L= low channel, M= middle channel, H= high channel)
	Test Mode	GSM/TM1,GSM/TM2,UMTS/TM1,LTE/TM1,LTE/TM2

**5 Main Test Instruments**

Main Test Equipments					
Equipment Name	Manufacturer	Model	Serial Number	Cal Date	Cal- Due
Power supply	KEITHLEY	2303	000500E	2017/5/31	2018/5/30
Wireless Communication Test set	Agilent	N4010A	MY49081592	2017/7/31	2018/7/30
Universal Radio Communication Tester	R&S	CMU200	110932	2017/5/2	2018/5/1
Spectrum Analyzer	Agilent	N9030B	MY57140531	2017/12/19	2018/12/18
Universal Radio Communication Tester	R & S	CMW500	126854	2017/10/19	2018/10/18
Signal Analyzer	R&S	FSQ31	200021	2017/7/31	2018/7/30
Spectrum Analyzer	Agilent	N9030A	MY49431698	2017/7/31	2018/7/30
Temperature Chamber	WEISS	WKL64	56246002940010	2017/12/13	2018/12/12
Signal generator	Agilent	E8257D	MY49281095	2017/7/31	2018/7/30
Vector Signal Generator	R&S	SMU200A	104162	2017/7/31	2018/7/30
Test receiver	R&S	ESU26	100387	2017/2/21	2018/2/20
Test receiver	R&S	ESCI	101163	2017/2/21	2018/2/20
Spectrum analyzer	R&S	FSU3	200474	2017/2/21	2018/2/20
Spectrum analyzer	R&S	FSU43	100144	2017/2/21	2018/2/20
LOOP Antennas(9kHz-30MHz)	R&S	HFH2-Z2	100262	2017/4/25	2019/4/25
LOOP Antennas(9kHz-30MHz)	R&S	HFH2-Z2	100263	2017/4/25	2019/4/25
Trilog Broadband Antenna (30M~3GHz)	SCHWARZBECK	VULB 9163	9163-490	2017/3/29	2019/3/29
Trilog Broadband Antenna (30M~3GHz)	SCHWARZBECK	VULB 9163	9163-521	2017/4/9	2019/4/9
Double-Ridged Waveguide Horn Antenna (1G~18GHz)	R&S	HF907	100304	2017/5/27	2019/5/27
Pyramidal Horn Antenna(18GHz-26.5GHz)	ETS-Lindgren	3160-09	206665	2017/3/24	2018/3/23
Artificial Main Network	R&S	ENV4200	100134	2017/5/15	2018/5/14
Line Impedance Stabilization Network	R&S	ENV216	100382	2017/5/15	2018/5/14
Power Detecting & Sampling Unit	R&S	OSP-B157	100914	2017/7/31	2018/7/30
Software Information					
Test Item	Software Name		Manufacturer	Version	
RSE	EMC32		R&S	V8.40.0	



6 Measurement Uncertainty

For a 95% confidence level ($k = 2$), the measurement expanded uncertainties for defined systems, in accordance with the recommendations of ISO 17025 as following:

Test Item		Extended Uncertainty
Transmit Output Power Data	Power [dBm]	U = 0.42 dB
Bandwidth	Magnitude [%]	U = 0.2%
Band Edge Compliance	Disturbance Power [dBm]	U = 1.24 dB
Spurious Emissions, Conducted	Disturbance Power [dBm]	U = 1.62 dB
Field Strength of Spurious Radiation	ERP [dBm]	For 3 m Chamber: U = 4.9 dB (30 MHz to 26.5GHz)
Frequency Stability	Frequency Accuracy [ppm]	U = 0.017 ppm

END