

**ELECTROMAGNETIC EMISSIONS COMPLIANCE REPORT**  
**INTENTIONAL RADIATOR CERTIFICATION TO**  
**FCC PART 90S REQUIREMENT**

OF

**Applicant:** Huawei Technologies Co., Ltd.  
Administration Building, Headquarters of Huawei Technologies Co., Ltd., Bantian, Longgang District, Shenzhen, 518129, P.R.C

**Product Name:** Smart Phone

**Brand Name:** HUAWEI

**Model No.:** EML-L29

**Model Difference:** N/A

**FCC ID:** QISEML-L29

**Report Number:** ER/2018/10040

**FCC Rule Part:** 90S

**Issue Date:** Jan. 22, 2018

**Date of Test:** Jan. 11, 2018~Jan. 22, 2018

**Date of EUT Received:** Jan. 08, 2018

**We hereby certify that:**

The above equipment was tested by SGS Taiwan Ltd. Electronics & Communication Laboratory. The test data, data evaluation, test procedures, and equipment configurations shown in this report were made in accordance with the procedures given in ANSI C63.26-2015 and the energy emitted by the sample EUT tested as described in this report is in compliance with conducted and radiated emission limits.

The test results of this report relate only to the tested sample identified in this report.

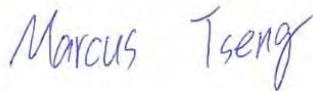
**Tested By:****Marcus Tseng / Engineer****Approved By:****Jim Chang / Asst. Manager**

Unless otherwise stated the results shown in this test report refer only to the sample(s) tested and such sample(s) are retained for 90 days only.

除非另有說明，此報告結果僅對測試之樣品負責，同時此樣品僅保留90天。本報告未經本公司書面許可，不可部份複製。

This document is issued by the Company subject to its General Conditions of Service printed overleaf, available on request or accessible at [www.sgs.com/terms\\_and\\_conditions.htm](http://www.sgs.com/terms_and_conditions.htm) and, for electronic format documents, subject to Terms and Conditions for Electronic Documents at [www.sgs.com/terms\\_e-document.htm](http://www.sgs.com/terms_e-document.htm). Attention is drawn to the limitation of liability, indemnification and jurisdiction issues defined therein. Any holder of this document is advised that information contained hereon reflects the Company's findings at the time of its intervention only and within the limits of Client's instructions, if any. The Company's sole responsibility is to its Client and this document does not exonerate parties to a transaction from exercising all their rights and obligations under the transaction documents. This document cannot be reproduced except in full, without prior written approval of the Company. Any unauthorized alteration, forgery or falsification of the content or appearance of this document is unlawful and offenders may be prosecuted to the fullest extent of the law.

SGS Taiwan Ltd.

No.134,WuKungRoad,NewTaipeiIndustrialPark,WukuDistrict,NewTaipeiCity,Taiwan24803/新北市五股區新北產業園區五工路 134 號

台灣檢驗科技股份有限公司

t (886-2) 2299-3279

f (886-2) 2298-0488

www.tw.sgs.com

Member of SGS Group

## Revision History

Report Number	Revision	Description	Effected Page	Issue Date	Revised By
ER/2018/10040	Rev.00	Initial creation of document	All	Jan. 22, 2018	Allen Tsai

Unless otherwise stated the results shown in this test report refer only to the sample(s) tested and such sample(s) are retained for 90 days only.

除非另有說明，此報告結果僅對測試之樣品負責，同時此樣品僅保留90天。本報告未經本公司書面許可，不可部份複製。

This document is issued by the Company subject to its General Conditions of Service printed overleaf, available on request or accessible at [www.sgs.com/terms\\_and\\_conditions.htm](http://www.sgs.com/terms_and_conditions.htm) and, for electronic format documents, subject to Terms and Conditions for Electronic Documents at [www.sgs.com/terms\\_e-document.htm](http://www.sgs.com/terms_e-document.htm). Attention is drawn to the limitation of liability, indemnification and jurisdiction issues defined therein. Any holder of this document is advised that information contained hereon reflects the Company's findings at the time of its intervention only and within the limits of Client's instructions, if any. The Company's sole responsibility is to its Client and this document does not exonerate parties to a transaction from exercising all their rights and obligations under the transaction documents. This document cannot be reproduced except in full, without prior written approval of the Company. Any unauthorized alteration, forgery or falsification of the content or appearance of this document is unlawful and offenders may be prosecuted to the fullest extent of the law.

SGS Taiwan Ltd.

No.134,WuKungRoad,NewTaipeiIndustrialPark,WukuDistrict,NewTaipeiCity,Taiwan24803/新北市五股區新北產業園區五工路 134 號

台灣檢驗科技股份有限公司

t (886-2) 2299-3279

f (886-2) 2298-0488

[www.tw.sgs.com](http://www.tw.sgs.com)

Member of SGS Group

## Contents

1. GENERAL PRODUCT INFORMATION .....	4
2. SYSTEM TEST CONFIGURATION .....	7
3. SUMMARY OF TEST RESULTS .....	10
4. DESCRIPTION OF TEST MODES .....	10
5. MEASUREMENT UNCERTAINTY .....	12
6. RF CONDUCTED OUTPUT POWER MEASUREMENT .....	13
7. EFFECTIVE RADIATED POWER AND EQUIVALENT ISOTROPIC RADIATED POWER MEASUREMENT .....	17
8. OCCUPIED BANDWIDTH MEASUREMENT .....	25
9. OUT OF BAND EMISSION AT ANTENNA TERMINALS .....	32
10. FIELD STRENGTH OF SPURIOUS RADIATION MEASUREMENT .....	55
11. FREQUENCY STABILITY MEASUREMENT .....	63
12. PEAK TO AVERAGE RATIO .....	66

Unless otherwise stated the results shown in this test report refer only to the sample(s) tested and such sample(s) are retained for 90 days only.

除非另有說明，此報告結果僅對測試之樣品負責，同時此樣品僅保留90天。本報告未經本公司書面許可，不可部份複製。

This document is issued by the Company subject to its General Conditions of Service printed overleaf, available on request or accessible at [www.sgs.com/terms\\_and\\_conditions.htm](http://www.sgs.com/terms_and_conditions.htm) and, for electronic format documents, subject to Terms and Conditions for Electronic Documents at [www.sgs.com/terms\\_e-document.htm](http://www.sgs.com/terms_e-document.htm). Attention is drawn to the limitation of liability, indemnification and jurisdiction issues defined therein. Any holder of this document is advised that information contained hereon reflects the Company's findings at the time of its intervention only and within the limits of Client's instructions, if any. The Company's sole responsibility is to its Client and this document does not exonerate parties to a transaction from exercising all their rights and obligations under the transaction documents. This document cannot be reproduced except in full, without prior written approval of the Company. Any unauthorized alteration, forgery or falsification of the content or appearance of this document is unlawful and offenders may be prosecuted to the fullest extent of the law.

SGS Taiwan Ltd.

No.134,WuKungRoad,NewTaipeiIndustrialPark,WukuDistrict,NewTaipeiCity,Taiwan24803/新北市五股區新北產業園區五工路 134 號

台灣檢驗科技股份有限公司

t (886-2) 2299-3279

f (886-2) 2298-0488

[www.tw.sgs.com](http://www.tw.sgs.com)

Member of SGS Group

## 1. GENERAL PRODUCT INFORMATION

### 1.1. Product Description

General:

Product Name:	Smart Phone
Brand Name:	HUAWEI
Model No.:	EML-L29
Model Difference:	N/A
Hardware Version:	HL1EMILYM
Software Version:	EML-L29 8.1.0.71(SP9C900)
Power Supply:	3.82 Vdc from Rechargeable Li-polymer Battery
IMEI:	867128030016175, 867128030023007

#### FCC general description

EML-L29 is subscriber equipment in the LTE/ WCDMA/GSM system. The LTE frequency band is Band 1,Band 2,Band 3,Band 4,Band 5, Band 6, Band 7,Band 8, Band 9,Band 12,Band17, Band 18 ,Band 19, Band 20, Band 26, Band 28, Band 32,Band 34,Band 38,Band39, Band 40 and Band 41. The HSUPA/HSDPA/UMTS frequency band is Band I, Band II, Band IV, Band V, Band VI, Band VIII and Band XIX, The GSM/GPRS/EDGE frequency band includes GSM850 and GSM900 and DCS1800 and PCS1900. But only LTE Band 26(814-824) test data included in this report . The Mobile Phone implements such functions as RF signal receiving/transmitting, LTE/ WCDMA /GSM protocol processing, voice, video, MMS service, GPS, NFC and WIFI etc. Externally it provides earphone port (to provide voice service) and dual USIM card interfaces. It also provides Bluetooth module to synchronize data between a PC and the phone, or to use the built-in modem of the phone to access the Internet with a PC, or to exchange data with other Bluetooth devices.

Unless otherwise stated the results shown in this test report refer only to the sample(s) tested and such sample(s) are retained for 90 days only.

除非另有說明，此報告結果僅對測試之樣品負責，同時此樣品僅保留90天。本報告未經本公司書面許可，不可部份複製。

This document is issued by the Company subject to its General Conditions of Service printed overleaf, available on request or accessible at [www.sgs.com/terms\\_and\\_conditions.htm](http://www.sgs.com/terms_and_conditions.htm) and, for electronic format documents, subject to Terms and Conditions for Electronic Documents at [www.sgs.com/terms\\_e-document.htm](http://www.sgs.com/terms_e-document.htm). Attention is drawn to the limitation of liability, indemnification and jurisdiction issues defined therein. Any holder of this document is advised that information contained hereon reflects the Company's findings at the time of its intervention only and within the limits of Client's instructions, if any. The Company's sole responsibility is to its Client and this document does not exonerate parties to a transaction from exercising all their rights and obligations under the transaction documents. This document cannot be reproduced except in full, without prior written approval of the Company. Any unauthorized alteration, forgery or falsification of the content or appearance of this document is unlawful and offenders may be prosecuted to the fullest extent of the law.

SGS Taiwan Ltd.

No.134,WuKungRoad,NewTaipeiIndustrialPark,WukuDistrict,NewTaipeiCity,Taiwan24803/新北市五股區新北產業園區五工路 134 號

台灣檢驗科技股份有限公司

t (886-2) 2299-3279

f (886-2) 2298-0488

[www.tw.sgs.com](http://www.tw.sgs.com)

Member of SGS Group

### 1.2. WCDMA / LTE: Cellular Phone Standards Frequency Range

LTE Band	BW (MHz)	Operation Frequency (MHz)		
26 Part90	1.4	814.7	-	823.3
	3	815.5	-	822.5
	5	816.5	-	821.5
	10	819.0		

### 1.3. Type of Emission & Max ERP/EIRP Power Measurement Result:

LTE Band	BW (MHz)	Modulation	ERP / EIRP (dBm)		(W)	Type of Emission
26 Part90	1.4	QPSK	12.55	ERP	0.018	1M10G7D
	1.4	16QAM	12.19	ERP	0.017	1M10D7W
	1.4	64QAM	12.26	ERP	0.017	1M10D7W
	3	QPSK	12.17	ERP	0.016	2M71G7D
	3	16QAM	12.37	ERP	0.017	2M73D7W
	3	64QAM	11.92	ERP	0.016	2M71D7W
	5	QPSK	12.52	ERP	0.018	4M54G7D
	5	16QAM	12.26	ERP	0.017	4M52D7W
	5	64QAM	12.27	ERP	0.017	4M53D7W
	10	QPSK	12.75	ERP	0.019	9M07G7D
	10	16QAM	12.05	ERP	0.016	9M03D7W
	10	64QAM	12.01	ERP	0.016	9M05D7W

Unless otherwise stated the results shown in this test report refer only to the sample(s) tested and such sample(s) are retained for 90 days only.

除非另有說明，此報告結果僅對測試之樣品負責，同時此樣品僅保留90天。本報告未經本公司書面許可，不可部份複製。

This document is issued by the Company subject to its General Conditions of Service printed overleaf, available on request or accessible at [www.sgs.com/terms\\_and\\_conditions.htm](http://www.sgs.com/terms_and_conditions.htm) and, for electronic format documents, subject to Terms and Conditions for Electronic Documents at [www.sgs.com/terms\\_e-document.htm](http://www.sgs.com/terms_e-document.htm). Attention is drawn to the limitation of liability, indemnification and jurisdiction issues defined therein. Any holder of this document is advised that information contained hereon reflects the Company's findings at the time of its intervention only and within the limits of Client's instructions, if any. The Company's sole responsibility is to its Client and this document does not exonerate parties to a transaction from exercising all their rights and obligations under the transaction documents. This document cannot be reproduced except in full, without prior written approval of the Company. Any unauthorized alteration, forgery or falsification of the content or appearance of this document is unlawful and offenders may be prosecuted to the fullest extent of the law.

SGS Taiwan Ltd.

No.134,WuKungRoad,NewTaipeiIndustrialPark,WukuDistrict,NewTaipeiCity,Taiwan24803/新北市五股區新北產業園區五工路 134 號

台灣檢驗科技股份有限公司

t (886-2) 2299-3279

f (886-2) 2298-0488

www.tw.sgs.com

Member of SGS Group

#### 1.4. Test Methodology of Applied Standards

CC 47 CFR Part 2, Part 90S.

ANSI C63.26-2015

KDB971168 D01 Power Meas license Digital System v03

TS 151 010-1 is used to set, and measure the output power.

Note: All test items have been performed and record as per the above standards.

#### 1.5. Test Facility

SGS Taiwan Ltd. Electronics & Communication Laboratory No.134, Wu Kung Road, New Taipei Industrial Park, Wuku District, New Taipei City, Taiwan 24803 code 0513)

FCC Registration Numbers are: 735305 / TW0002

#### 1.6. Special Accessories

No special accessories were used during testing.

#### 1.7. Equipment Modifications

There were no modifications incorporated into the EUT.

Unless otherwise stated the results shown in this test report refer only to the sample(s) tested and such sample(s) are retained for 90 days only.

除非另有說明，此報告結果僅對測試之樣品負責，同時此樣品僅保留90天。本報告未經本公司書面許可，不可部份複製。

This document is issued by the Company subject to its General Conditions of Service printed overleaf, available on request or accessible at [www.sgs.com/terms\\_and\\_conditions.htm](http://www.sgs.com/terms_and_conditions.htm) and, for electronic format documents, subject to Terms and Conditions for Electronic Documents at [www.sgs.com/terms\\_e-document.htm](http://www.sgs.com/terms_e-document.htm). Attention is drawn to the limitation of liability, indemnification and jurisdiction issues defined therein. Any holder of this document is advised that information contained hereon reflects the Company's findings at the time of its intervention only and within the limits of Client's instructions, if any. The Company's sole responsibility is to its Client and this document does not exonerate parties to a transaction from exercising all their rights and obligations under the transaction documents. This document cannot be reproduced except in full, without prior written approval of the Company. Any unauthorized alteration, forgery or falsification of the content or appearance of this document is unlawful and offenders may be prosecuted to the fullest extent of the law.

SGS Taiwan Ltd.

No.134,WuKungRoad,NewTaipeiIndustrialPark,WukuDistrict,NewTaipeiCity,Taiwan24803/新北市五股區新北產業園區五工路 134 號

台灣檢驗科技股份有限公司

t (886-2) 2299-3279

f (886-2) 2298-0488

[www.tw.sgs.com](http://www.tw.sgs.com)

Member of SGS Group



## 2. SYSTEM TEST CONFIGURATION

### 2.1. EUT Configuration

The EUT configuration for testing is installed on RF field strength measurement to meet the Commissions requirement and operating in a manner which intends to maximize its emission characteristics in a continuous normal application.

### 2.2. EUT Exercise

The EUT (Transmitter) was operated in the continuous transmission mode employed with the simulator of the Base Station that fixates at test default channels to fix the Tx frequency which was for the purpose of the measurements.

### 2.3. Test Procedure

#### 2.3.1 Conducted Measurement at Antenna Port

According to measurement procured ANSI C63.26-2015, the EUT is placed on a turn table which is 0.8 m above ground plane. A low loss of RF cable was used to connect the antenna port of EUT to measurement equipment.

#### 2.3.2 Radiated Emissions (ERP/EIRP)

According to measurement procured ANSI C63.26-2015, The EUT is a placed on as turn table, for emission measurements below 1 GHz is 0.8 m above ground plane, for emission measurements above 1 GHz, the table height shall be 1.5 m. The turn table shall rotate 360 degrees to determine the position of maximum emission level. EUT is set 3m away from the receiving antenna which varied from 1m to 4m to find out the highest emission. And also, each emission was to be maximized by changing the polarization of receiving antenna both Horizontal and Vertical. In order to find out the max. emission, the relative positions of this hand-held transmitter (EUT) was rotated through three orthogonal axes and measurement procedures for electric field radiated emissions above 1 GHz the EUT measurement is to be made "while keeping the antenna in the 'cone of radiation' from that area and pointed at the area both in azimuth and elevation, with polarization oriented for maximum response." is still within the 3dB illumination BW of the measurement antenna according to the requirements in Section 8 and 13.

### 2.4. Measurement Results Explanation Example

#### For all conducted test items:

The offset level is set in the spectrum analyzer to compensate the RF cable loss and attenuation factor between EUT conducted port and spectrum analyzer. With the offset compensation, the spectrum analyzer reading level is exactly EUT RF output level.

Unless otherwise stated the results shown in this test report refer only to the sample(s) tested and such sample(s) are retained for 90 days only.

除非另有說明，此報告結果僅對測試之樣品負責，同時此樣品僅保留90天。本報告未經本公司書面許可，不可部份複製。

This document is issued by the Company subject to its General Conditions of Service printed overleaf, available on request or accessible at [www.sgs.com/terms\\_and\\_conditions.htm](http://www.sgs.com/terms_and_conditions.htm) and, for electronic format documents, subject to Terms and Conditions for Electronic Documents at [www.sgs.com/terms\\_e-document.htm](http://www.sgs.com/terms_e-document.htm). Attention is drawn to the limitation of liability, indemnification and jurisdiction issues defined therein. Any holder of this document is advised that information contained hereon reflects the Company's findings at the time of its intervention only and within the limits of Client's instructions, if any. The Company's sole responsibility is to its Client and this document does not exonerate parties to a transaction from exercising all their rights and obligations under the transaction documents. This document cannot be reproduced except in full, without prior written approval of the Company. Any unauthorized alteration, forgery or falsification of the content or appearance of this document is unlawful and offenders may be prosecuted to the fullest extent of the law.

**Note:**

The spectrum analyzer offset is derived from RF cable loss and attenuator factor.  
Following shows an offset computation in physical test.

	RF cable loss (dB)	Attenuation factor(dB)	offset(dB)
Low Band (Below 1GHz)	5	10	15

**2.5. Final Amplifier Voltage and Current Information:**

Test Mode	DC voltage (V)	DC current (mA)
LTE Band 26 (Part 90S)	3.82	751

Unless otherwise stated the results shown in this test report refer only to the sample(s) tested and such sample(s) are retained for 90 days only.

除非另有說明，此報告結果僅對測試之樣品負責，同時此樣品僅保留90天。本報告未經本公司書面許可，不可部份複製。

This document is issued by the Company subject to its General Conditions of Service printed overleaf, available on request or accessible at [www.sgs.com/terms\\_and\\_conditions.htm](http://www.sgs.com/terms_and_conditions.htm) and, for electronic format documents, subject to Terms and Conditions for Electronic Documents at [www.sgs.com/terms\\_e-document.htm](http://www.sgs.com/terms_e-document.htm). Attention is drawn to the limitation of liability, indemnification and jurisdiction issues defined therein. Any holder of this document is advised that information contained hereon reflects the Company's findings at the time of its intervention only and within the limits of Client's instructions, if any. The Company's sole responsibility is to its Client and this document does not exonerate parties to a transaction from exercising all their rights and obligations under the transaction documents. This document cannot be reproduced except in full, without prior written approval of the Company. Any unauthorized alteration, forgery or falsification of the content or appearance of this document is unlawful and offenders may be prosecuted to the fullest extent of the law.

SGS Taiwan Ltd.

No.134,WuKungRoad,NewTaipeiIndustrialPark,WukuDistrict,NewTaipeiCity,Taiwan24803/新北市五股區新北產業園區五工路 134 號

台灣檢驗科技股份有限公司

t (886-2) 2299-3279

f (886-2) 2298-0488

[www.tw.sgs.com](http://www.tw.sgs.com)

Member of SGS Group



## 2.6. Configuration of Tested System

**Fig. 2-1 Configuration of Tested System (Fixed Channel-Conducted)**

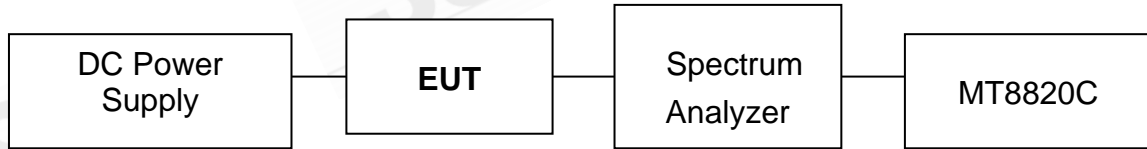

**Fig. 2-2 Configuration of Tested System (Fixed Channel-Radiated)**

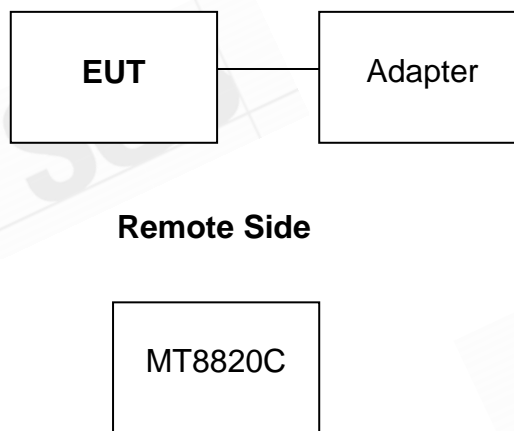

**Table 2-1 Equipment Used in**

Item	Equipment	Mfr/Brand	Model/ Type No.	Series No.	Data Cable	Power Cord
1.	Universal Radio Communication Tester	Anritsu	MT8820C	6200307563	shielded	Un-shielded

Unless otherwise stated the results shown in this test report refer only to the sample(s) tested and such sample(s) are retained for 90 days only.

除非另有說明，此報告結果僅對測試之樣品負責，同時此樣品僅保留90天。本報告未經本公司書面許可，不可部份複製。

This document is issued by the Company subject to its General Conditions of Service printed overleaf, available on request or accessible at [www.sgs.com/terms\\_and\\_conditions.htm](http://www.sgs.com/terms_and_conditions.htm) and, for electronic format documents, subject to Terms and Conditions for Electronic Documents at [www.sgs.com/terms\\_e-document.htm](http://www.sgs.com/terms_e-document.htm). Attention is drawn to the limitation of liability, indemnification and jurisdiction issues defined therein. Any holder of this document is advised that information contained hereon reflects the Company's findings at the time of its intervention only and within the limits of Client's instructions, if any. The Company's sole responsibility is to its Client and this document does not exonerate parties to a transaction from exercising all their rights and obligations under the transaction documents. This document cannot be reproduced except in full, without prior written approval of the Company. Any unauthorized alteration, forgery or falsification of the content or appearance of this document is unlawful and offenders may be prosecuted to the fullest extent of the law.

SGS Taiwan Ltd.

No.134,WuKungRoad,NewTaipeiIndustrialPark,WukuDistrict,NewTaipeiCity,Taiwan24803/新北市五股區新北產業園區五工路 134 號

台灣檢驗科技股份有限公司

t (886-2) 2299-3279

f (886-2) 2298-0488

www.tw.sgs.com

Member of SGS Group

### 3. SUMMARY OF TEST RESULTS

FCC Rules	Description Of Test	Result
§2.1046(a)	RF Power Output	Compliant
§2.1046(a) §90.635	ERP/ EIRP measurement	Compliant
§2.1049(h)	99% & 26dB Occupied Bandwidth	Compliant
§2.1051 §90.691	Out of Band Emissions at Antenna Terminals and Band Edge / Emission mask requirements	Compliant
§2.1053 §90.691(a)(1)(2)	Field Strength of Spurious Radiation	Compliant
§24.232(d)	Peak to Average Ratio	Compliant
§2.1055(a)(1) §90.213	Frequency Stability	Compliant

### 4. DESCRIPTION OF TEST MODES

#### 4.1. The Worst Test Modes and Channel Details

- The EUT has been tested under operating condition.
- Pre-Scan has been conducted to determine the worst-case mode from all possible combinations between available modulations, data rates, X(E1)Y(E2)Z(H) axis and antenna ports. The worst case was found as listed below. Following channel(s) was (were) selected for the final test as listed below:

BAND	ERP/EIRP	RADIATED EMISSION
LTE Band 26 (Part 90S)	H-plan	H-plan

Unless otherwise stated the results shown in this test report refer only to the sample(s) tested and such sample(s) are retained for 90 days only.

除非另有說明，此報告結果僅對測試之樣品負責，同時此樣品僅保留90天。本報告未經本公司書面許可，不可部份複製。

This document is issued by the Company subject to its General Conditions of Service printed overleaf, available on request or accessible at [www.sgs.com/terms\\_and\\_conditions.htm](http://www.sgs.com/terms_and_conditions.htm) and, for electronic format documents, subject to Terms and Conditions for Electronic Documents at [www.sgs.com/terms\\_e-document.htm](http://www.sgs.com/terms_e-document.htm). Attention is drawn to the limitation of liability, indemnification and jurisdiction issues defined therein. Any holder of this document is advised that information contained hereon reflects the Company's findings at the time of its intervention only and within the limits of Client's instructions, if any. The Company's sole responsibility is to its Client and this document does not exonerate parties to a transaction from exercising all their rights and obligations under the transaction documents. This document cannot be reproduced except in full, without prior written approval of the Company. Any unauthorized alteration, forgery or falsification of the content or appearance of this document is unlawful and offenders may be prosecuted to the fullest extent of the law.

SGS Taiwan Ltd.

No.134,WuKungRoad,NewTaipeiIndustrialPark,WukuDistrict,NewTaipeiCity,Taiwan24803/新北市五股區新北產業園區五工路 134 號

台灣檢驗科技股份有限公司

t (886-2) 2299-3279

f (886-2) 2298-0488

www.tw.sgs.com

Member of SGS Group

## LTE Band 26 for 90S MODE

TEST ITEM	AVAILABLE CHANNEL	TESTED CHANNEL	CHANNEL BANDWIDTH	MODULATION	MODE
ERP	26697 to 26783	26697, 26740, 26783	1.4MHz	QPSK, 16QAM, 64QAM	1 RB/ 0,5 RB Offest
	26705 to 26775	26705, 26740, 26775	3MHz	QPSK, 16QAM, 64QAM	1 RB/ 0,14 RB Offest
	26715 to 26765	26715, 26740, 26765	5MHz	QPSK, 16QAM, 64QAM	1 RB/ 0,24 RB Offest
	26740	26740	10MHz	QPSK, 16QAM, 64QAM	1 RB/ 0,49 RB Offest
FREQUENCY STABILITY	26697 to 26783	26740	1.4MHz	QPSK,	Full RB
OCCUPIED BANDWIDTH	26697 to 26783	26697, 26740, 26783	1.4MHz	QPSK, 16QAM, 64QAM	Full RB
	26705 to 26775	26705, 26740, 26775	3MHz	QPSK, 16QAM, 64QAM	Full RB
	26715 to 26765	26715, 26740, 26765	5MHz	QPSK, 16QAM, 64QAM	Full RB
	26740	26740	10MHz	QPSK, 16QAM, 64QAM	Full RB
PEAK TO AVERAGE RATIO	26697 to 26783	26697, 26740, 26783	1.4MHz	16QAM	Full RB
	26705 to 26775	26705, 26740, 26775	3MHz	16QAM	Full RB
	26715 to 26765	26715, 26740, 26765	5MHz	16QAM	Full RB
	26740	26740	10MHz	16QAM	Full RB
BAND EDGE	26697 to 26783	26697, 26740, 26783	1.4MHz	QPSK,	1 RB/ 0,5 RB Offes Full RB
	26705 to 26775	26705, 26740, 26775	3MHz	QPSK,	1 RB/ 0,14 RB Offest Full RB
	26715 to 26765	26715, 26740, 26765	5MHz	QPSK,	1 RB/ 0,24 RB Offest Full RB
	26740	26740	10MHz	QPSK,	1 RB/ 0,49 RB Offest Full RB
CONDCUDED EMISSION	26697 to 26783	26697, 26740, 26783	1.4MHz	QPSK,	1 RB, 0 RB Offest
	26705 to 26775	26705, 26740, 26775	3MHz	QPSK,	1 RB, 0 RB Offest
	26715 to 26765	26715, 26740, 26765	5MHz	QPSK,	1 RB, 0 RB Offest
	26740	26740	10MHz	QPSK,	1 RB, 0 RB Offest
RADIATED EMISSION	26740	26740	10MHz	QPSK,	1 RB, 0 RB Offest

Unless otherwise stated the results shown in this test report refer only to the sample(s) tested and such sample(s) are retained for 90 days only.

除非另有說明，此報告結果僅對測試之樣品負責，同時此樣品僅保留90天。本報告未經本公司書面許可，不可部份複製。

This document is issued by the Company subject to its General Conditions of Service printed overleaf, available on request or accessible at [www.sgs.com/terms\\_and\\_conditions.htm](http://www.sgs.com/terms_and_conditions.htm) and, for electronic format documents, subject to Terms and Conditions for Electronic Documents at [www.sgs.com/terms\\_e-document.htm](http://www.sgs.com/terms_e-document.htm). Attention is drawn to the limitation of liability, indemnification and jurisdiction issues defined therein. Any holder of this document is advised that information contained hereon reflects the Company's findings at the time of its intervention only and within the limits of Client's instructions, if any. The Company's sole responsibility is to its Client and this document does not exonerate parties to a transaction from exercising all their rights and obligations under the transaction documents. This document cannot be reproduced except in full, without prior written approval of the Company. Any unauthorized alteration, forgery or falsification of the content or appearance of this document is unlawful and offenders may be prosecuted to the fullest extent of the law.

SGS Taiwan Ltd.

No.134,WuKungRoad,NewTaipeiIndustrialPark,WukuDistrict,NewTaipeiCity,Taiwan24803/新北市五股區新北產業園區五工路 134 號

台灣檢驗科技股份有限公司

t (886-2) 2299-3279

f (886-2) 2298-0488

www.tw.sgs.com

Member of SGS Group

## 5. MEASUREMENT UNCERTAINTY

Test Items	Uncertainty
RF Power Output	+/- 1.10 dB
ERP/ EIRP measurement	Vertical Polarization = +/- 4.74dB Horizontal Polarization = +/- 4.62dB
99% Occupied Bandwidth	+/- 5.19 Hz
Out of Band Emissions at Antenna Terminals and Band Edge	+/- 0.70 dB
Peak to Average Ratio	+/- 0.70 dB
Frequency Stability vs. Temperature	+/- 5.19 Hz
Frequency Stability vs. Voltage	+/- 5.19 Hz
Temperature	+/- 0.65 °C
Humidity	+/- 4.6 %
DC / AC Power Source	DC= +/- 0.13%, AC= +/- 0.2%

### Radiated Spurious Emission:

Measurement uncertainty (Polarization : <b>Vertical</b> )	9kHz – 30MHz: +/- 2.87 dB
	30MHz - 180MHz: +/- 3.37dB
	180MHz -417MHz: +/- 3.19dB
	0.417GHz-1GHz: +/- 3.19dB
	1GHz - 18GHz: +/- 4.04dB
	18GHz - 40GHz: +/- 4.04dB

Measurement uncertainty (Polarization : <b>Horizontal</b> )	9kHz – 30MHz: +/- 2.87 dB
	30MHz - 167MHz: +/- 4.22dB
	167MHz -500MHz: +/- 3.44dB
	0.5GHz-1GHz: +/- 3.39dB
	1GHz - 18GHz: +/- 4.08dB
	18GHz - 40GHz: +/- 4.08dB

This uncertainty represents an expanded uncertainty expressed at approximately the 95% confidence level using a coverage factor of k=2.

Unless otherwise stated the results shown in this test report refer only to the sample(s) tested and such sample(s) are retained for 90 days only.

除非另有說明，此報告結果僅對測試之樣品負責，同時此樣品僅保留90天。本報告未經本公司書面許可，不可部份複製。

This document is issued by the Company subject to its General Conditions of Service printed overleaf, available on request or accessible at [www.sgs.com/terms\\_and\\_conditions.htm](http://www.sgs.com/terms_and_conditions.htm) and, for electronic format documents, subject to Terms and Conditions for Electronic Documents at [www.sgs.com/terms\\_e-document.htm](http://www.sgs.com/terms_e-document.htm). Attention is drawn to the limitation of liability, indemnification and jurisdiction issues defined therein. Any holder of this document is advised that information contained hereon reflects the Company's findings at the time of its intervention only and within the limits of Client's instructions, if any. The Company's sole responsibility is to its Client and this document does not exonerate parties to a transaction from exercising all their rights and obligations under the transaction documents. This document cannot be reproduced except in full, without prior written approval of the Company. Any unauthorized alteration, forgery or falsification of the content or appearance of this document is unlawful and offenders may be prosecuted to the fullest extent of the law.

SGS Taiwan Ltd.

No.134,WuKungRoad,NewTaipeiIndustrialPark,WukuDistrict,NewTaipeiCity,Taiwan24803/新北市五股區新北產業園區五工路 134 號

台灣檢驗科技股份有限公司

t (886-2) 2299-3279

f (886-2) 2298-0488

www.tw.sgs.com

Member of SGS Group

## 6. RF CONDUCTED OUTPUT POWER MEASUREMENT

### 6.1. Standard Applicable

A base station simulator was used to establish communication with the EUT. Its parameters were set to transmit the maximum power on the EUT. The measured power in the radio frequency on the transmitter output terminals.

### 6.2. Test Set-up

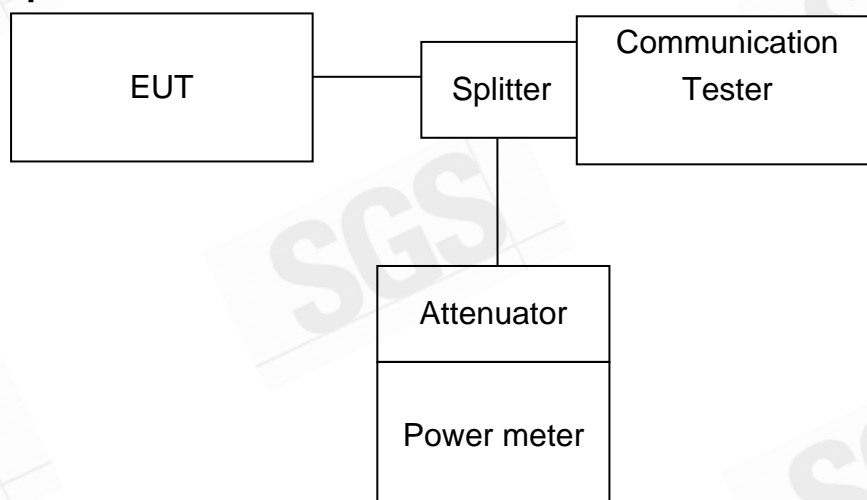

**Note:** Measurement setup for testing on Antenna connector

### 6.3. Measurement Procedure

The transmitter output was connected to a calibrated attenuator, the other end of which was connected to a power meter. Transmitter output was read off the power meter in dBm. The power output at the transmitter antenna port was determined by adding the value of the attenuator to the power meter reading. TS 151 010-1 is reference to conduct the test measurement of output power.

The Procedure of KDB 971168 D01 Power Meas License Digital System as the supplemental test methodology to adjust the proper setting obtaining the measurement results

Unless otherwise stated the results shown in this test report refer only to the sample(s) tested and such sample(s) are retained for 90 days only.

除非另有說明，此報告結果僅對測試之樣品負責，同時此樣品僅保留90天。本報告未經本公司書面許可，不可部份複製。

This document is issued by the Company subject to its General Conditions of Service printed overleaf, available on request or accessible at [www.sgs.com/terms\\_and\\_conditions.htm](http://www.sgs.com/terms_and_conditions.htm) and, for electronic format documents, subject to Terms and Conditions for Electronic Documents at [www.sgs.com/terms\\_e-document.htm](http://www.sgs.com/terms_e-document.htm). Attention is drawn to the limitation of liability, indemnification and jurisdiction issues defined therein. Any holder of this document is advised that information contained hereon reflects the Company's findings at the time of its intervention only and within the limits of Client's instructions, if any. The Company's sole responsibility is to its Client and this document does not exonerate parties to a transaction from exercising all their rights and obligations under the transaction documents. This document cannot be reproduced except in full, without prior written approval of the Company. Any unauthorized alteration, forgery or falsification of the content or appearance of this document is unlawful and offenders may be prosecuted to the fullest extent of the law.

SGS Taiwan Ltd.

No.134,WuKungRoad,NewTaipeiIndustrialPark,WukuDistrict,NewTaipeiCity,Taiwan24803/新北市五股區新北產業園區五工路134號

台灣檢驗科技股份有限公司

t (886-2) 2299-3279

f (886-2) 2298-0488

www.tw.sgs.com

Member of SGS Group

#### 6.4. Measurement Equipment Used

EQUIPMENT TYPE	MFR	MODEL NUMBER	SERIAL NUMBER	LAST CAL. (yyyy/mm/dd)	CAL DUE. (yyyy/mm/dd)
Radio Communication Analyzer	Anritsu	MT8820C	6201465317	2018/01/15	2019/1/14

Unless otherwise stated the results shown in this test report refer only to the sample(s) tested and such sample(s) are retained for 90 days only.

除非另有說明，此報告結果僅對測試之樣品負責，同時此樣品僅保留90天。本報告未經本公司書面許可，不可部份複製。

This document is issued by the Company subject to its General Conditions of Service printed overleaf, available on request or accessible at [www.sgs.com/terms\\_and\\_conditions.htm](http://www.sgs.com/terms_and_conditions.htm) and, for electronic format documents, subject to Terms and Conditions for Electronic Documents at [www.sgs.com/terms\\_e-document.htm](http://www.sgs.com/terms_e-document.htm). Attention is drawn to the limitation of liability, indemnification and jurisdiction issues defined therein. Any holder of this document is advised that information contained hereon reflects the Company's findings at the time of its intervention only and within the limits of Client's instructions, if any. The Company's sole responsibility is to its Client and this document does not exonerate parties to a transaction from exercising all their rights and obligations under the transaction documents. This document cannot be reproduced except in full, without prior written approval of the Company. Any unauthorized alteration, forgery or falsification of the content or appearance of this document is unlawful and offenders may be prosecuted to the fullest extent of the law.

SGS Taiwan Ltd.

No.134,WuKungRoad,NewTaipeiIndustrialPark,WukuDistrict,NewTaipeiCity,Taiwan24803/新北市五股區新北產業園區五工路 134 號

台灣檢驗科技股份有限公司

t (886-2) 2299-3279

f (886-2) 2298-0488

[www.tw.sgs.com](http://www.tw.sgs.com)

Member of SGS Group



## 6.5. Measurement Result

### LTE Result:

#### LTE Band 26 for Part 90S

LTE Band 26_Uplink frequency band : 814 to 824 MHz											
BW (MHz)	RB Size	RB Offset	Conducted power (dBm)								
			QPSK			16QAM			64QAM		
			CH (Low)	CH (Mid)	CH (High)	CH (Low)	CH (Mid)	CH (High)	CH (Low)	CH (Mid)	CH (High)
			26697	26740	26783	26697	26740	26783	26697	26740	26783
1.4	1	0	23.03	22.97	23.01	22.19	22.06	<b>22.28</b>	21.29	21.09	21.48
	1	5	<b>23.10</b>	23.01	23.07	22.12	22.04	22.14	21.90	21.96	21.88
	3	2	22.77	22.91	22.98	21.83	21.76	21.86	21.98	21.85	<b>21.99</b>
	6	0	21.20	21.13	21.22	20.89	20.72	20.65	20.93	20.90	20.87

LTE Band 26_Uplink frequency band : 814 to 824 MHz											
BW (MHz)	RB Size	RB Offset	Conducted power (dBm)								
			QPSK			16QAM			64QAM		
			CH (Low)	CH (Mid)	CH (High)	CH (Low)	CH (Mid)	CH (High)	CH (Low)	CH (Mid)	CH (High)
			26705	26740	26775	26705	26740	26775	26705	26740	26775
3	1	0	23.21	23.15	23.27	22.03	22.09	<b>22.38</b>	21.59	<b>21.96</b>	21.57
	1	14	23.19	23.08	<b>23.29</b>	22.20	22.24	22.37	21.78	21.94	21.60
	8	4	21.18	21.21	22.16	21.02	21.11	21.00	20.59	20.66	20.88
	15	0	22.11	21.21	21.78	21.04	21.06	21.22	20.63	20.78	20.77

LTE Band 26_Uplink frequency band : 814 to 824 MHz											
BW (MHz)	RB Size	RB Offset	Conducted power (dBm)								
			QPSK			16QAM			64QAM		
			CH (Low)	CH (Mid)	CH (High)	CH (Low)	CH (Mid)	CH (High)	CH (Low)	CH (Mid)	CH (High)
			26715	26740	26765	26715	26740	26765	26715	26740	26765
5	1	0	23.12	23.11	23.17	22.40	22.38	21.95	21.53	<b>21.98</b>	21.94
	1	24	23.20	<b>23.25</b>	23.21	22.22	<b>22.51</b>	21.64	21.93	21.96	21.59
	12	6	21.22	21.31	21.40	20.97	21.05	21.17	20.72	20.84	20.71
	25	0	22.02	21.24	21.37	20.66	21.02	21.11	20.67	20.72	20.84

Unless otherwise stated the results shown in this test report refer only to the sample(s) tested and such sample(s) are retained for 90 days only.

除非另有說明，此報告結果僅對測試之樣品負責，同時此樣品僅保留90天。本報告未經本公司書面許可，不可部份複製。

This document is issued by the Company subject to its General Conditions of Service printed overleaf, available on request or accessible at [www.sgs.com/terms\\_and\\_conditions.htm](http://www.sgs.com/terms_and_conditions.htm) and, for electronic format documents, subject to Terms and Conditions for Electronic Documents at [www.sgs.com/terms\\_e-document.htm](http://www.sgs.com/terms_e-document.htm). Attention is drawn to the limitation of liability, indemnification and jurisdiction issues defined therein. Any holder of this document is advised that information contained hereon reflects the Company's findings at the time of its intervention only and within the limits of Client's instructions, if any. The Company's sole responsibility is to its Client and this document does not exonerate parties to a transaction from exercising all their rights and obligations under the transaction documents. This document cannot be reproduced except in full, without prior written approval of the Company. Any unauthorized alteration, forgery or falsification of the content or appearance of this document is unlawful and offenders may be prosecuted to the fullest extent of the law.

LTE Band 26_Uplink frequency band : 814 to 824 MHz					
BW (MHz)	RB Size	RB Offset	Conducted power (dBm)		
			QPSK	16QAM	64QAM
			CH (Mid) 26740	CH (Mid) 26740	CH (Mid) 26740
10	1	0	23.24	22.17	21.88
	1	49	23.22	21.86	21.85
	25	12	22.07	21.20	20.94
	50	0	21.74	21.12	20.90

Unless otherwise stated the results shown in this test report refer only to the sample(s) tested and such sample(s) are retained for 90 days only.

除非另有說明，此報告結果僅對測試之樣品負責，同時此樣品僅保留90天。本報告未經本公司書面許可，不可部份複製。

This document is issued by the Company subject to its General Conditions of Service printed overleaf, available on request or accessible at [www.sgs.com/terms\\_and\\_conditions.htm](http://www.sgs.com/terms_and_conditions.htm) and, for electronic format documents, subject to Terms and Conditions for Electronic Documents at [www.sgs.com/terms\\_e-document.htm](http://www.sgs.com/terms_e-document.htm). Attention is drawn to the limitation of liability, indemnification and jurisdiction issues defined therein. Any holder of this document is advised that information contained hereon reflects the Company's findings at the time of its intervention only and within the limits of Client's instructions, if any. The Company's sole responsibility is to its Client and this document does not exonerate parties to a transaction from exercising all their rights and obligations under the transaction documents. This document cannot be reproduced except in full, without prior written approval of the Company. Any unauthorized alteration, forgery or falsification of the content or appearance of this document is unlawful and offenders may be prosecuted to the fullest extent of the law.

SGS Taiwan Ltd.

No.134,WuKungRoad,NewTaipeiIndustrialPark,WukuDistrict,NewTaipeiCity,Taiwan24803/新北市五股區新北產業園區五工路 134 號

台灣檢驗科技股份有限公司

t (886-2) 2299-3279

f (886-2) 2298-0488

[www.tw.sgs.com](http://www.tw.sgs.com)

Member of SGS Group

## 7. EFFECTIVE RADIATED POWER AND EQUIVALENT ISOTROPIC RADIATED POWER MEASUREMENT

### 7.1. Standard Applicable

According to FCC §2.1046

FCC 90.635(b) Mobile station is limited to 100W ERP

### 7.2. Test SET-UP

#### (A) Radiated Power Test Set-Up, Frequency Below 1000MHz

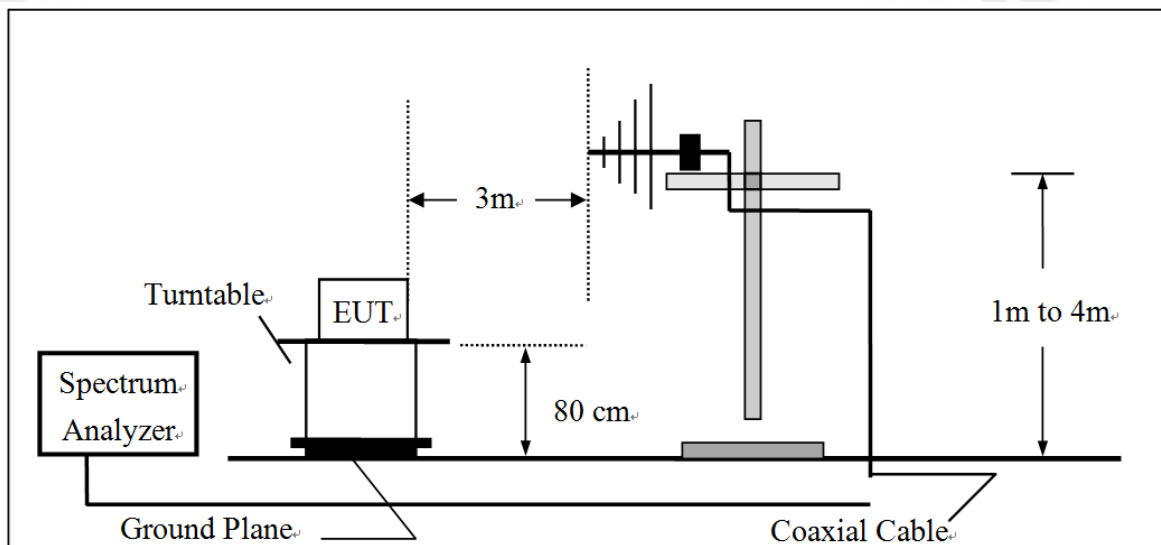

Unless otherwise stated the results shown in this test report refer only to the sample(s) tested and such sample(s) are retained for 90 days only.

除非另有說明，此報告結果僅對測試之樣品負責，同時此樣品僅保留90天。本報告未經本公司書面許可，不可部份複製。

This document is issued by the Company subject to its General Conditions of Service printed overleaf, available on request or accessible at [www.sgs.com/terms\\_and\\_conditions.htm](http://www.sgs.com/terms_and_conditions.htm) and, for electronic format documents, subject to Terms and Conditions for Electronic Documents at [www.sgs.com/terms\\_e-document.htm](http://www.sgs.com/terms_e-document.htm). Attention is drawn to the limitation of liability, indemnification and jurisdiction issues defined therein. Any holder of this document is advised that information contained hereon reflects the Company's findings at the time of its intervention only and within the limits of Client's instructions, if any. The Company's sole responsibility is to its Client and this document does not exonerate parties to a transaction from exercising all their rights and obligations under the transaction documents. This document cannot be reproduced except in full, without prior written approval of the Company. Any unauthorized alteration, forgery or falsification of the content or appearance of this document is unlawful and offenders may be prosecuted to the fullest extent of the law.

SGS Taiwan Ltd.

No.134,WuKungRoad,NewTaipeiIndustrialPark,WukuDistrict,NewTaipeiCity,Taiwan24803/新北市五股區新北產業園區五工路 134 號

台灣檢驗科技股份有限公司

t (886-2) 2299-3279

f (886-2) 2298-0488

[www.tw.sgs.com](http://www.tw.sgs.com)

Member of SGS Group

(B) Radiated Power Test Set-UP Frequency Over 1 GHz

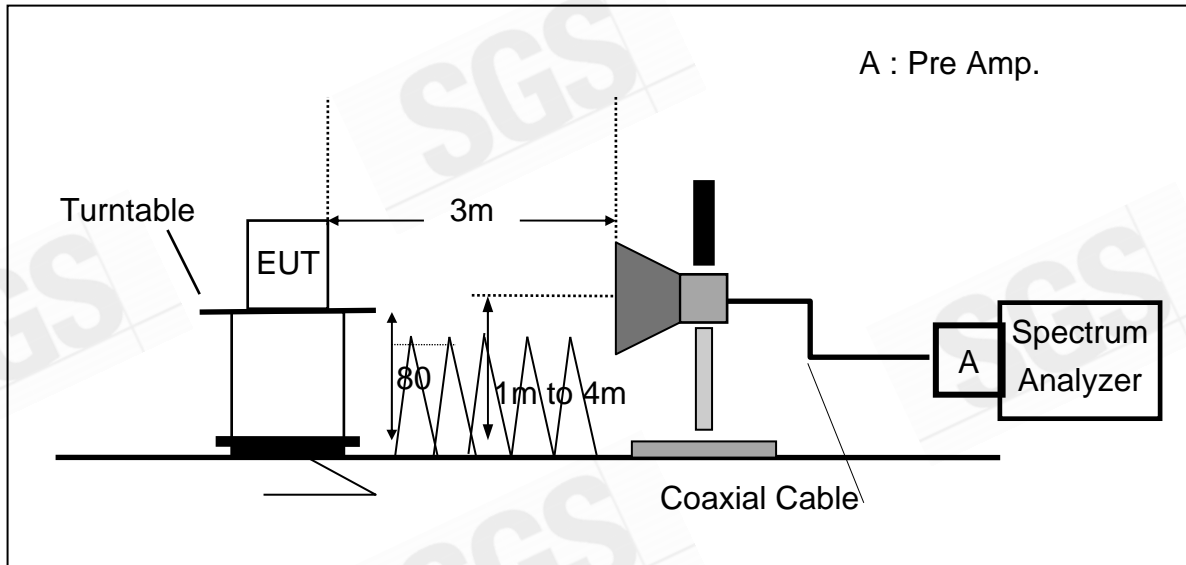

(C) Substituted Method Test Set-UP

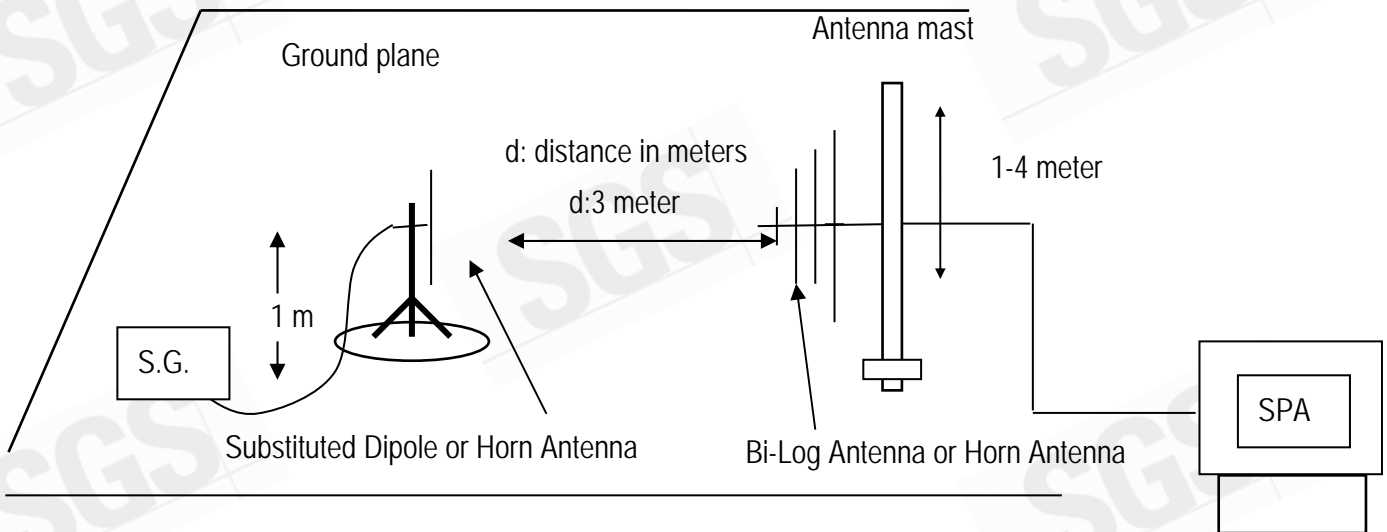

Unless otherwise stated the results shown in this test report refer only to the sample(s) tested and such sample(s) are retained for 90 days only.  
除非另有說明，此報告結果僅對測試之樣品負責，同時此樣品僅保留90天。本報告未經本公司書面許可，不可部份複製。

This document is issued by the Company subject to its General Conditions of Service printed overleaf, available on request or accessible at [www.sgs.com/terms\\_and\\_conditions.htm](http://www.sgs.com/terms_and_conditions.htm) and, for electronic format documents, subject to Terms and Conditions for Electronic Documents at [www.sgs.com/terms\\_e-document.htm](http://www.sgs.com/terms_e-document.htm). Attention is drawn to the limitation of liability, indemnification and jurisdiction issues defined therein. Any holder of this document is advised that information contained hereon reflects the Company's findings at the time of its intervention only and within the limits of Client's instructions, if any. The Company's sole responsibility is to its Client and this document does not exonerate parties to a transaction from exercising all their rights and obligations under the transaction documents. This document cannot be reproduced except in full, without prior written approval of the Company. Any unauthorized alteration, forgery or falsification of the content or appearance of this document is unlawful and offenders may be prosecuted to the fullest extent of the law.

### 7.3. Measurement Procedure

1. The testing follows the Measurement Procedure of FCC KDB 971168 D01
2. The EUT was placed on a non-conductive turntable using a non-conductive support. The radiated emission at the fundamental frequency was measured at 3 m with a test antenna and EMI spectrum analyzer.
3. During the measurement, the EUT was communication with the station. The highest emission was recorded with the rotation of the turntable and the lowering of the test antenna from 4m to 1m. The reading was recorded and the field strength (E in dBuV/m) was calculated
4. The testing follows the Measurement Procedure of FCC KDB 971168 D01
5. The substitution horn antenna is substituted for EUT at the same position and signals generator export the CW signal to the substitution antenna via a tx cable. Rotated the Turn Table and moved receiving antenna to find the maximum radiation power. Adjust output power level of S.G to get a Value of spectrum reading equal to "Read Value" of step b. Record the power level of S.G.
6.  $ERP = S.G. \text{ output (dBm)} + \text{Antenna Gain (dBd)} - \text{Cable Loss (dB)}$
7.  $ERP = S.G. \text{ output (dBm)} + \text{Antenna Gain (dBd)} - \text{Cable Loss (dB)}$
8. Spectrum setting:
  - (1) Detector = Peak, marker the highest value of the detector by maximum hold, set RBW wide enough to capture the entire signal of emission, and  $VBW \geq 3 \times RBW$ .
  - (2) KDB 971168 D01 is adopted, and the procedure as lists under item 4, Measurement of the Average Power over the Fundamental Signal Bandwidth, is followed to set correspondingly for the acquisition of proper measurement data.  
Set frequency = nominal signal center frequency;  
Set span = 2 X occupied BW;  
Set RBW  $\approx$  1~5% of the span, not to exceed 1 MHz  
Set VBW = 3 x RBW;  
Select average power (RMS) detector  
Set sweep time and number of measurement points to achieve a minimum of 1 millisecond/pt integration time (ex. Point = 601points, then sweep time =  $601 \times 10^{-3} = 6s$ .

Activate trace averaging routine over a minimum of 10 sweeps;

Activate marker/span pair and set span = signal or channel bandwidth;

Activate the band/interval power marker function;

Record the band power level;

Record adjusted value as the average signal power level. Then activate the occupied bandwidth measurement function.

The proper adjustment due to limitation of spectrum capability is given compensated to spectrum with conversion factor of  $10 \times \log(TBW/RBW)$ , where TBW is the transmission of UE exceeding the maximum BW UE can extends, and RBW is the resolution BW in UE.

Unless otherwise stated the results shown in this test report refer only to the sample(s) tested and such sample(s) are retained for 90 days only.

除非另有說明，此報告結果僅對測試之樣品負責，同時此樣品僅保留90天。本報告未經本公司書面許可，不可部份複製。

This document is issued by the Company subject to its General Conditions of Service printed overleaf, available on request or accessible at [www.sgs.com/terms\\_and\\_conditions.htm](http://www.sgs.com/terms_and_conditions.htm) and, for electronic format documents, subject to Terms and Conditions for Electronic Documents at [www.sgs.com/terms\\_e-document.htm](http://www.sgs.com/terms_e-document.htm). Attention is drawn to the limitation of liability, indemnification and jurisdiction issues defined therein. Any holder of this document is advised that information contained hereon reflects the Company's findings at the time of its intervention only and within the limits of Client's instructions, if any. The Company's sole responsibility is to its Client and this document does not exonerate parties to a transaction from exercising all their rights and obligations under the transaction documents. This document cannot be reproduced except in full, without prior written approval of the Company. Any unauthorized alteration, forgery or falsification of the content or appearance of this document is unlawful and offenders may be prosecuted to the fullest extent of the law.

SGS Taiwan Ltd.

No.134,WuKungRoad,NewTaipeiIndustrialPark,WukuDistrict,NewTaipeiCity,Taiwan24803/新北市五股區新北產業園區五工路 134 號

台灣檢驗科技股份有限公司

t (886-2) 2299-3279

f (886-2) 2298-0488

[www.tw.sgs.com](http://www.tw.sgs.com)

Member of SGS Group

## 7.4. Measurement Equipment Used

EQUIPMENT TYPE	MFR	MODEL NUMBER	SERIAL NUMBER	LAST CAL. (YYYY.MM.DD)	CAL DUE. (YYYY.MM.DD)
Bi-log Antenna	SCHWAZBECK	VULB9168	378	2017/12/29	2018/12/28
Bi-log Antenna	SCHWAZBECK	VULB9168	300	2017/12/20	2018/12/19
Horn Antenna	Schwarzbeck	BBHA9120D	309	2018/01/04	2019/1/3
Horn Antenna	Schwarzbeck	BBHA9120D	1441	2017/08/04	2018/8/3
Spectrum Analyzer	Agilent	E4446A	MY51100003	2017/05/10	2018/5/9
EMI Test Receiver	R&S	ESCI7	100760	2017/06/06	2018/6/5
Network Analyze	Anritsu	MS4644A	1216312	2017/05/25	2018/5/24
Radio Communication Analyer	Anritsu	MT8820C	6201465317	2018/01/15	2019/1/14
Pre-Amplifier	HP	8449B	3008A00578	2018/01/02	2019/1/1
Pre-Amplifier	HP	8447D	2944A07676	2018/01/02	2019/1/1
Attenuator	Mini-Circuit	BW-S10W2+		2018/01/02	2019/1/1
Filter 800-1000	Micro-Tronics	EWT	M1	2018/01/02	2019/1/1
1GHz High Pass Filter	Micro-Tronics	HPM50108	32	2018/01/02	2019/1/1
Low Loss Cable	Huber Suhner	966_RX	9	2018/01/02	2019/1/1
Low Loss Cable	Huber Suhner	966 TX	1	2018/01/02	2019/1/1

Unless otherwise stated the results shown in this test report refer only to the sample(s) tested and such sample(s) are retained for 90 days only.

除非另有說明，此報告結果僅對測試之樣品負責，同時此樣品僅保留90天。本報告未經本公司書面許可，不可部份複製。

This document is issued by the Company subject to its General Conditions of Service printed overleaf, available on request or accessible at [www.sgs.com/terms\\_and\\_conditions.htm](http://www.sgs.com/terms_and_conditions.htm) and, for electronic format documents, subject to Terms and Conditions for Electronic Documents at [www.sgs.com/terms\\_e-document.htm](http://www.sgs.com/terms_e-document.htm). Attention is drawn to the limitation of liability, indemnification and jurisdiction issues defined therein. Any holder of this document is advised that information contained hereon reflects the Company's findings at the time of its intervention only and within the limits of Client's instructions, if any. The Company's sole responsibility is to its Client and this document does not exonerate parties to a transaction from exercising all their rights and obligations under the transaction documents. This document cannot be reproduced except in full, without prior written approval of the Company. Any unauthorized alteration, forgery or falsification of the content or appearance of this document is unlawful and offenders may be prosecuted to the fullest extent of the law.

SGS Taiwan Ltd.

No.134,WuKungRoad,NewTaipeiIndustrialPark,WukuDistrict,NewTaipeiCity,Taiwan24803/新北市五股區新北產業園區五工路 134 號

台灣檢驗科技股份有限公司

t (886-2) 2299-3279

f (886-2) 2298-0488

[www.tw.sgs.com](http://www.tw.sgs.com)

Member of SGS Group



**7.5. Measurement Result: (Peak) –using option of peak measurement**

EUT			Measurement					
Operation Band	Fundamental Frequency	CH	Antenna Pol.	S.G. Output	Antenna Gain	Cable Loss	ERP	Limit
	MHz		V/H	dBm	dBd	dB	dBm	dBm
LTE BAND 26 BW: 1.4M QPSK RB: 1,0	814.7	26697	V	11.42	3.32	-2.89	11.85	50.00
			H	11.89	3.32	-2.89	12.32	50.00
	819.0	26740	V	10.83	3.32	-2.89	11.26	50.00
			H	10.10	3.32	-2.89	10.53	50.00
LTE BAND 26 BW: 1.4M QPSK RB: 1,5	814.7	26697	V	11.66	3.32	-2.89	12.09	50.00
			H	10.94	3.32	-2.89	11.37	50.00
	819.0	26740	V	12.12	3.32	-2.89	12.55	50.00
			H	11.31	3.32	-2.89	11.74	50.00
LTE BAND 26 BW: 1.4M 16QAM RB: 1,0	814.7	26697	V	10.70	3.32	-2.89	11.13	50.00
			H	9.62	3.32	-2.89	10.05	50.00
	819.0	26740	V	11.69	3.32	-2.89	12.12	50.00
			H	10.29	3.32	-2.89	10.72	50.00
LTE BAND 26 BW: 1.4M 16QAM RB: 1,5	814.7	26697	V	10.97	3.32	-2.89	11.40	50.00
			H	11.08	3.32	-2.89	11.51	50.00
	819.0	26740	V	11.45	3.32	-2.89	11.88	50.00
			H	11.20	3.32	-2.89	11.63	50.00
LTE BAND 26 BW: 1.4M 64QAM RB: 1,0	814.7	26697	V	10.88	3.32	-2.89	11.31	50.00
			H	11.61	3.32	-2.89	12.04	50.00
	819.0	26740	V	11.83	3.32	-2.89	12.26	50.00
			H	10.60	3.32	-2.89	11.03	50.00
LTE BAND 26 BW: 1.4M 64QAM RB: 1,5	814.7	26697	V	10.85	3.32	-2.89	11.28	50.00
			H	11.72	3.32	-2.89	12.15	50.00
	819.0	26740	V	11.25	3.32	-2.89	11.68	50.00
			H	9.87	3.32	-2.89	10.30	50.00
823.3	26783	V	10.12	3.32	-2.90	10.54	50.00	
		H	11.57	3.32	-2.89	12.00	50.00	

Remark : (1)The RBW,VBW of SPA for frequency RBW= 8MHz , VBW= 8MHz

Unless otherwise stated the results shown in this test report refer only to the sample(s) tested and such sample(s) are retained for 90 days only.  
除非另有說明，此報告結果僅對測試之樣品負責，同時此樣品僅保留90天。本報告未經本公司書面許可，不可部份複製。

This document is issued by the Company subject to its General Conditions of Service printed overleaf, available on request or accessible at [www.sgs.com/terms\\_and\\_conditions.htm](http://www.sgs.com/terms_and_conditions.htm) and, for electronic format documents, subject to Terms and Conditions for Electronic Documents at [www.sgs.com/terms\\_e-document.htm](http://www.sgs.com/terms_e-document.htm). Attention is drawn to the limitation of liability, indemnification and jurisdiction issues defined therein. Any holder of this document is advised that information contained hereon reflects the Company's findings at the time of its intervention only and within the limits of Client's instructions, if any. The Company's sole responsibility is to its Client and this document does not exonerate parties to a transaction from exercising all their rights and obligations under the transaction documents. This document cannot be reproduced except in full, without prior written approval of the Company. Any unauthorized alteration, forgery or falsification of the content or appearance of this document is unlawful and offenders may be prosecuted to the fullest extent of the law.

EUT			Measurement					
Operation Band	Fundamental Frequency	CH	Antenna Pol.	S.G. Output	Antenna Gain	Cable Loss	ERP	Limit
	MHz		V/H	dBm	dBd	dB	dBm	dBm
LTE BAND 26 BW: 3M QPSK RB: 1,0	815.5	26705	V	10.53	3.32	-2.89	10.96	50.00
			H	11.44	3.32	-2.89	11.87	50.00
	819.0	26740	V	11.49	3.32	-2.89	11.92	50.00
			H	10.79	3.32	-2.89	11.22	50.00
	822.5	26775	V	10.57	3.32	-2.90	10.99	50.00
			H	11.74	3.32	-2.89	12.17	50.00
LTE BAND 26 BW: 3M QPSK RB: 1,14	815.5	26705	V	10.56	3.32	-2.89	10.99	50.00
			H	11.66	3.32	-2.89	12.09	50.00
	819.0	26740	V	11.48	3.32	-2.89	11.91	50.00
			H	10.69	3.32	-2.89	11.12	50.00
	822.5	26775	V	10.51	3.32	-2.90	10.93	50.00
			H	11.21	3.32	-2.89	11.64	50.00
LTE BAND 26 BW: 3M 16QAM RB: 1,0	815.5	26705	V	10.74	3.32	-2.89	11.17	50.00
			H	11.33	3.32	-2.89	11.76	50.00
	819.0	26740	V	11.51	3.32	-2.89	11.94	50.00
			H	11.28	3.32	-2.89	11.71	50.00
	822.5	26775	V	10.37	3.32	-2.90	10.79	50.00
			H	11.68	3.32	-2.89	12.11	50.00
LTE BAND 26 BW: 3M 16QAM RB: 1,14	815.5	26705	V	11.10	3.32	-2.89	11.53	50.00
			H	11.55	3.32	-2.89	11.98	50.00
	819.0	26740	V	11.94	3.32	-2.89	12.37	50.00
			H	11.25	3.32	-2.89	11.68	50.00
	822.5	26775	V	10.07	3.32	-2.90	10.49	50.00
			H	11.71	3.32	-2.89	12.14	50.00
LTE BAND 26 BW: 3M 64QAM RB: 1,0	815.5	26705	V	10.54	3.32	-2.89	10.97	50.00
			H	10.98	3.32	-2.89	11.41	50.00
	819.0	26740	V	11.43	3.32	-2.89	11.86	50.00
			H	11.07	3.32	-2.89	11.50	50.00
	822.5	26775	V	10.11	3.32	-2.90	10.53	50.00
			H	11.49	3.32	-2.89	11.92	50.00
LTE BAND 26 BW: 3M 64QAM RB: 1,14	815.5	26705	V	10.55	3.32	-2.89	10.98	50.00
			H	11.11	3.32	-2.89	11.54	50.00
	819.0	26740	V	11.45	3.32	-2.89	11.88	50.00
			H	11.33	3.32	-2.89	11.76	50.00
	822.5	26775	V	9.98	3.32	-2.90	10.40	50.00
			H	11.01	3.32	-2.89	11.44	50.00

Remark : (1) The RBW, VBW of SPA for frequency RBW= 8MHz , VBW= 8MHz

Unless otherwise stated the results shown in this test report refer only to the sample(s) tested and such sample(s) are retained for 90 days only.

除非另有說明，此報告結果僅對測試之樣品負責，同時此樣品僅保留90天。本報告未經本公司書面許可，不可部份複製。

This document is issued by the Company subject to its General Conditions of Service printed overleaf, available on request or accessible at [www.sgs.com/terms\\_and\\_conditions.htm](http://www.sgs.com/terms_and_conditions.htm) and, for electronic format documents, subject to Terms and Conditions for Electronic Documents at [www.sgs.com/terms\\_e-document.htm](http://www.sgs.com/terms_e-document.htm). Attention is drawn to the limitation of liability, indemnification and jurisdiction issues defined therein. Any holder of this document is advised that information contained hereon reflects the Company's findings at the time of its intervention only and within the limits of Client's instructions, if any. The Company's sole responsibility is to its Client and this document does not exonerate parties to a transaction from exercising all their rights and obligations under the transaction documents. This document cannot be reproduced except in full, without prior written approval of the Company. Any unauthorized alteration, forgery or falsification of the content or appearance of this document is unlawful and offenders may be prosecuted to the fullest extent of the law.

SGS Taiwan Ltd.

No.134,WuKungRoad,NewTaipeiIndustrialPark,WukuDistrict,NewTaipeiCity,Taiwan24803/新北市五股區新北產業園區五工路 134 號

台灣檢驗科技股份有限公司

t (886-2) 2299-3279

f (886-2) 2298-0488

www.tw.sgs.com

Member of SGS Group

EUT			Measurement					
Operation Band	Fundamental Frequency	CH	Antenna Pol.	S.G. Output	Antenna Gain	Cable Loss	ERP	Limit
	MHz		V/H	dBm	dBd	dB	dBm	dBm
LTE BAND 26 BW: 5M QPSK RB: 1,0	816.5	26715	V	10.52	3.32	-2.89	10.95	50.00
			H	11.01	3.32	-2.89	11.44	50.00
	819.0	26740	V	12.09	3.32	-2.89	12.52	50.00
			H	10.68	3.32	-2.89	11.11	50.00
821.5	26765	V	9.75	3.32	-2.90	10.17	50.00	
		H	11.09	3.32	-2.89	11.52	50.00	
LTE BAND 26 BW: 5M QPSK RB: 1,24	816.5	26715	V	11.38	3.32	-2.89	11.81	50.00
			H	11.38	3.32	-2.89	11.81	50.00
	819.0	26740	V	12.04	3.32	-2.89	12.47	50.00
			H	10.87	3.32	-2.89	11.30	50.00
821.5	26765	V	10.38	3.32	-2.90	10.80	50.00	
		H	11.15	3.32	-2.89	11.58	50.00	
LTE BAND 26 BW: 5M 16QAM RB: 1,0	816.5	26715	V	11.35	3.32	-2.89	11.78	50.00
			H	11.23	3.32	-2.89	11.66	50.00
	819.0	26740	V	11.83	3.32	-2.89	12.26	50.00
			H	11.09	3.32	-2.89	11.52	50.00
821.5	26765	V	10.43	3.32	-2.90	10.85	50.00	
		H	11.44	3.32	-2.89	11.87	50.00	
LTE BAND 26 BW: 5M 16QAM RB: 1,24	816.5	26715	V	11.12	3.32	-2.89	11.55	50.00
			H	11.38	3.32	-2.89	11.81	50.00
	819.0	26740	V	11.57	3.32	-2.89	12.00	50.00
			H	10.86	3.32	-2.89	11.29	50.00
821.5	26765	V	10.11	3.32	-2.90	10.53	50.00	
		H	11.02	3.32	-2.89	11.45	50.00	
LTE BAND 26 BW: 5M 64QAM RB: 1,0	816.5	26715	V	10.43	3.32	-2.89	10.86	50.00
			H	11.16	3.32	-2.89	11.59	50.00
	819.0	26740	V	11.64	3.32	-2.89	12.07	50.00
			H	10.73	3.32	-2.89	11.16	50.00
821.5	26765	V	10.38	3.32	-2.90	10.80	50.00	
		H	10.85	3.32	-2.89	11.28	50.00	
LTE BAND 26 BW: 5M 64QAM RB: 1,24	816.5	26715	V	11.18	3.32	-2.89	11.61	50.00
			H	11.84	3.32	-2.89	12.27	50.00
	819.0	26740	V	11.41	3.32	-2.89	11.84	50.00
			H	10.79	3.32	-2.89	11.22	50.00
821.5	26765	V	9.84	3.32	-2.90	10.26	50.00	
		H	11.65	3.32	-2.89	12.08	50.00	

Remark : (1)The RBW,VBW of SPA for frequency RBW= 8MHz , VBW= 8MHz

Unless otherwise stated the results shown in this test report refer only to the sample(s) tested and such sample(s) are retained for 90 days only.  
除非另有說明，此報告結果僅對測試之樣品負責，同時此樣品僅保留90天。本報告未經本公司書面許可，不可部份複製。

This document is issued by the Company subject to its General Conditions of Service printed overleaf, available on request or accessible at [www.sgs.com/terms\\_and\\_conditions.htm](http://www.sgs.com/terms_and_conditions.htm) and, for electronic format documents, subject to Terms and Conditions for Electronic Documents at [www.sgs.com/terms\\_e-document.htm](http://www.sgs.com/terms_e-document.htm). Attention is drawn to the limitation of liability, indemnification and jurisdiction issues defined therein. Any holder of this document is advised that information contained hereon reflects the Company's findings at the time of its intervention only and within the limits of Client's instructions, if any. The Company's sole responsibility is to its Client and this document does not exonerate parties to a transaction from exercising all their rights and obligations under the transaction documents. This document cannot be reproduced except in full, without prior written approval of the Company. Any unauthorized alteration, forgery or falsification of the content or appearance of this document is unlawful and offenders may be prosecuted to the fullest extent of the law.

EUT			Measurement					
Operation Band	Fundamental Frequency	CH	Antenna Pol.	S.G. Output	Antenna Gain	Cable Loss	ERP	Limit
LTE BAND 26 BW: 10M	MHz		V/H	dBm	dBd	dB	dBm	dBm
QPSK RB: 1,0	819.0	26740	V	12.32	3.32	-2.89	12.75	50.00
			H	10.93	3.32	-2.89	11.36	50.00
QPSK RB: 1,49	819.0	26740	V	11.98	3.32	-2.89	12.41	50.00
			H	10.93	3.32	-2.89	11.36	50.00
16QAM RB: 1,0	819.0	26740	V	11.62	3.32	-2.89	12.05	50.00
			H	11.28	3.32	-2.89	11.71	50.00
16QAM RB: 1,49	819.0	26740	V	10.87	3.32	-2.89	11.30	50.00
			H	10.76	3.32	-2.89	11.19	50.00
64QAM RB: 1,0	819.0	26740	V	11.58	3.32	-2.89	12.01	50.00
			H	10.66	3.32	-2.89	11.09	50.00
64QAM RB: 1,49	819.0	26740	V	11.50	3.32	-2.89	11.93	50.00
			H	10.74	3.32	-2.89	11.17	50.00

Remark : (1) The RBW, VBW of SPA for frequency RBW= 8MHz , VBW= 8MHz

Unless otherwise stated the results shown in this test report refer only to the sample(s) tested and such sample(s) are retained for 90 days only.  
除非另有說明，此報告結果僅對測試之樣品負責，同時此樣品僅保留90天。本報告未經本公司書面許可，不可部份複製。

This document is issued by the Company subject to its General Conditions of Service printed overleaf, available on request or accessible at [www.sgs.com/terms\\_and\\_conditions.htm](http://www.sgs.com/terms_and_conditions.htm) and, for electronic format documents, subject to Terms and Conditions for Electronic Documents at [www.sgs.com/terms\\_e-document.htm](http://www.sgs.com/terms_e-document.htm). Attention is drawn to the limitation of liability, indemnification and jurisdiction issues defined therein. Any holder of this document is advised that information contained hereon reflects the Company's findings at the time of its intervention only and within the limits of Client's instructions, if any. The Company's sole responsibility is to its Client and this document does not exonerate parties to a transaction from exercising all their rights and obligations under the transaction documents. This document cannot be reproduced except in full, without prior written approval of the Company. Any unauthorized alteration, forgery or falsification of the content or appearance of this document is unlawful and offenders may be prosecuted to the fullest extent of the law.

SGS Taiwan Ltd.

No.134, WuKungRoad, NewTaipeiIndustrialPark, WukuDistrict, NewTaipeiCity, Taiwan24803/新北市五股區新北產業園區五工路 134 號

台灣檢驗科技股份有限公司

t (886-2) 2299-3279

f (886-2) 2298-0488

www.tw.sgs.com

Member of SGS Group

## 8. OCCUPIED BANDWIDTH MEASUREMENT

### 8.1. Standard Applicable

The occupied bandwidth is the frequency bandwidth such that, below its lower and above its upper frequency limits, the mean powers radiated are each equal to 0.5 percent of the total mean power.

### 8.2. Test Set-up

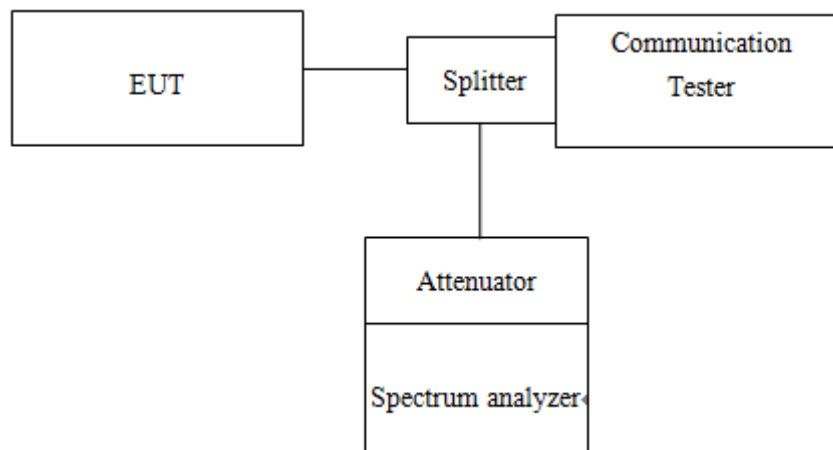

### 8.3. Measurement Procedure

#### **99% &26dB Bandwidth with detector peak**

The EUT's output RF connector was connected with a short cable to the spectrum analyzer, RBW was set to about 1% of emission BW, VBW= 3 times RBW, -26dBc display line was placed on the screen (or 26dB bandwidth), the occupied bandwidth is the delta frequency between the two points where the display line intersects the signal trace. Then set RBW to 99% bandwidth, RBW= 1%, VBW= 3 RBW, with span > 2 \* Signal BW, set % Power = 99%.

#### **99% Bandwidth with detector sample**

The EUT's output RF connector was connected with a short cable to the spectrum analyzer, RBW was set to about 1% ~ 5% of emission BW, VBW= 3 times RBW, -20dBc display line was placed on the screen (or 20dB bandwidth). Set RBW to 99% bandwidth, RBW= 1% ~ 5%, VBW= 3 RBW, with span > 2 \* Signal BW, set % Power = 99%.

Unless otherwise stated the results shown in this test report refer only to the sample(s) tested and such sample(s) are retained for 90 days only.

除非另有說明，此報告結果僅對測試之樣品負責，同時此樣品僅保留90天。本報告未經本公司書面許可，不可部份複製。

This document is issued by the Company subject to its General Conditions of Service printed overleaf, available on request or accessible at [www.sgs.com/terms\\_and\\_conditions.htm](http://www.sgs.com/terms_and_conditions.htm) and, for electronic format documents, subject to Terms and Conditions for Electronic Documents at [www.sgs.com/terms\\_e-document.htm](http://www.sgs.com/terms_e-document.htm). Attention is drawn to the limitation of liability, indemnification and jurisdiction issues defined therein. Any holder of this document is advised that information contained hereon reflects the Company's findings at the time of its intervention only and within the limits of Client's instructions, if any. The Company's sole responsibility is to its Client and this document does not exonerate parties to a transaction from exercising all their rights and obligations under the transaction documents. This document cannot be reproduced except in full, without prior written approval of the Company. Any unauthorized alteration, forgery or falsification of the content or appearance of this document is unlawful and offenders may be prosecuted to the fullest extent of the law.

SGS Taiwan Ltd.

No.134,WuKungRoad,NewTaipeiIndustrialPark,WukuDistrict,NewTaipeiCity,Taiwan24803/新北市五股區新北產業園區五工路 134 號

台灣檢驗科技股份有限公司

t (886-2) 2299-3279

f (886-2) 2298-0488

www.tw.sgs.com

Member of SGS Group



### 8.4. Measurement Equipment Used

EQUIPMENT TYPE	MFR	MODEL NUMBER	SERIAL NUMBER	LAST CAL.	CAL DUE.
Bi-log Antenna	SCHWAZBECK	VULB9168	378	2017/12/29	2018/12/28
Bi-log Antenna	SCHWAZBECK	VULB9168	300	2017/12/20	2018/12/19
Horn Antenna	Schwarzbeck	BBHA9120D	309	2018/01/04	2019/1/3
Horn Antenna	Schwarzbeck	BBHA9120D	1441	2017/08/04	2018/8/3
Spectrum Analyzer	Agilent	E4446A	MY51100003	2017/05/10	2018/5/9
EMI Test Receiver	R&S	ESC17	100760	2017/06/06	2018/6/5
Network Analyze	Anritsu	MS4644A	1216312	2017/05/25	2018/5/24
Radio Communication Analyer	Anritsu	MT8820C	6201465317	01/15/2018	01/14/2019
Pre-Amplifier	HP	8449B	3008A00578	2018/01/02	2019/1/1
Pre-Amplifier	HP	8447D	2944A07676	2018/01/02	2019/1/1
Attenuator	Mini-Circuit	BW-S10W2+	2	2018/01/02	2019/1/1
Filter 800-1000	Micro-Tronics	EWT	M1	2018/01/02	2019/1/1
1GHz High Pass Filter	Micro-Tronics	HPM50108	32	2018/01/02	2019/1/1
Low Loss Cable	Huber Suhner	966_RX	9	2018/01/02	2019/1/1
Low Loss Cable	Huber Suhner	966 TX	1	2018/01/02	2019/1/1

### 8.5. Measurement Result

LTE BAND 26 for part 90S Channel bandwidth: 1.4MHz							
Freq. (MHz)	CH	99% BW (MHz)			26 dB BW (MHz)		
		QPSK	16QAM	64QAM	QPSK	16QAM	64QAM
814.7	26697	1.1031	1.1015	1.1002	1.2430	1.2460	1.2550
819.0	26740	1.0997	1.0994	1.0984	1.2540	1.2460	1.2400
823.3	26783	1.0993	1.1024	1.0983	1.2570	1.2510	1.2390

LTE BAND 26 for part 90S Channel bandwidth: 3MHz							
Freq. (MHz)	CH	99% BW (MHz)			26 dB BW (MHz)		
		QPSK	16QAM	64QAM	QPSK	16QAM	64QAM
815.5	26705	2.7047	2.7113	2.7103	2.9820	2.9790	2.9840
819.0	26740	2.7138	2.7268	2.7113	3.0010	2.9940	2.9720
822.5	26775	2.7093	2.7239	2.7143	2.9810	2.9940	2.9750

LTE BAND 26 for part 90S Channel bandwidth: 5MHz							
Freq. (MHz)	CH	99% BW (MHz)			26 dB BW (MHz)		
		QPSK	16QAM	64QAM	QPSK	16QAM	64QAM
816.5	26715	4.5315	4.5063	4.5253	4.9920	4.9610	4.9470
819.0	26740	4.5355	4.5207	4.5185	4.9830	4.9980	4.9720
821.5	26765	4.5249	4.5243	4.5013	4.9540	4.9820	4.9840

LTE BAND 26 for part 90S Channel bandwidth: 10MHz							
Freq. (MHz)	CH	99% BW (MHz)			26 dB BW (MHz)		
		QPSK	16QAM	64QAM	QPSK	16QAM	64QAM
819.0	26740	9.0722	9.0265	9.0452	9.9750	9.9110	9.9190

Unless otherwise stated the results shown in this test report refer only to the sample(s) tested and such sample(s) are retained for 90 days only.

除非另有說明，此報告結果僅對測試之樣品負責，同時此樣品僅保留90天。本報告未經本公司書面許可，不可部份複製。

This document is issued by the Company subject to its General Conditions of Service printed overleaf, available on request or accessible at [www.sgs.com/terms\\_and\\_conditions.htm](http://www.sgs.com/terms_and_conditions.htm) and, for electronic format documents, subject to Terms and Conditions for Electronic Documents at [www.sgs.com/terms\\_e-document.htm](http://www.sgs.com/terms_e-document.htm). Attention is drawn to the limitation of liability, indemnification and jurisdiction issues defined therein. Any holder of this document is advised that information contained hereon reflects the Company's findings at the time of its intervention only and within the limits of Client's instructions, if any. The Company's sole responsibility is to its Client and this document does not exonerate parties to a transaction from exercising all their rights and obligations under the transaction documents. This document cannot be reproduced except in full, without prior written approval of the Company. Any unauthorized alteration, forgery or falsification of the content or appearance of this document is unlawful and offenders may be prosecuted to the fullest extent of the law.

SGS Taiwan Ltd.

No.134,WuKungRoad,NewTaipeiIndustrialPark,WukuDistrict,NewTaipeiCity,Taiwan24803/新北市五股區新北產業園區五工路 134 號

台灣檢驗科技股份有限公司

t (886-2) 2299-3279

f (886-2) 2298-0488

www.tw.sgs.com

Member of SGS Group



Part 90\_Band26\_1\_4MHz\_QPSK\_6\_0\_LowCH26697

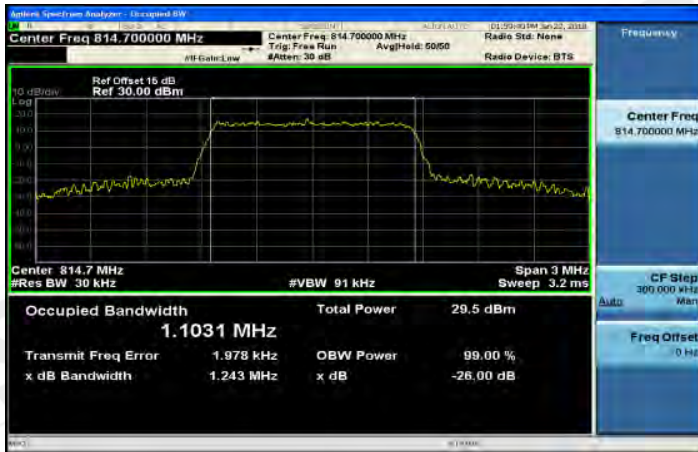

Part 90\_Band26\_1\_4MHz\_16QAM\_6\_0\_LowCH26697

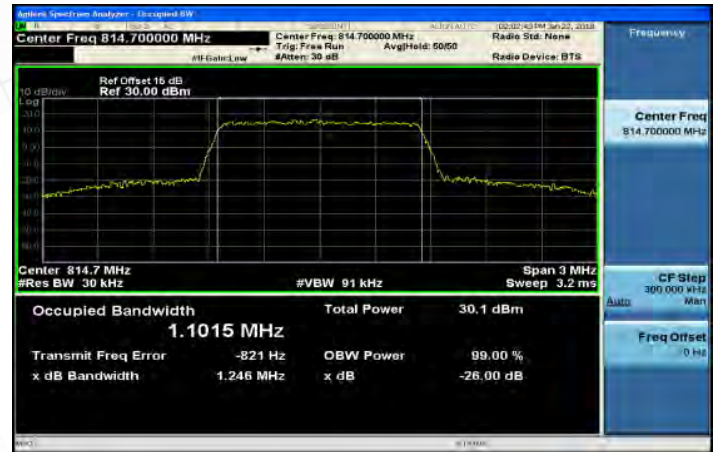

Part 90\_Band26\_1\_4MHz\_QPSK\_6\_0\_MidCH26740



Part 90\_Band26\_1\_4MHz\_16QAM\_6\_0\_MidCH26740

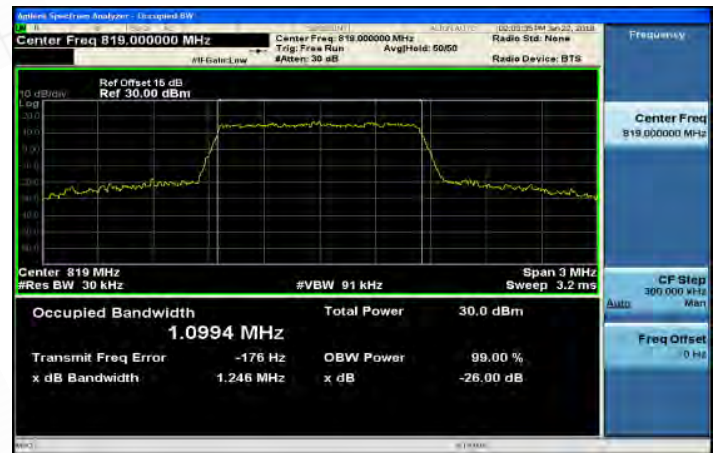

Part 90\_Band26\_1\_4MHz\_QPSK\_6\_0\_HighCH26783

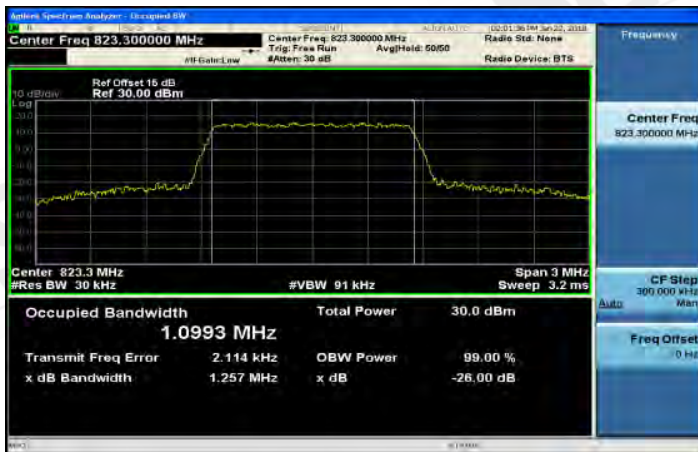

Part 90\_Band26\_1\_4MHz\_16QAM\_6\_0\_HighCH26873

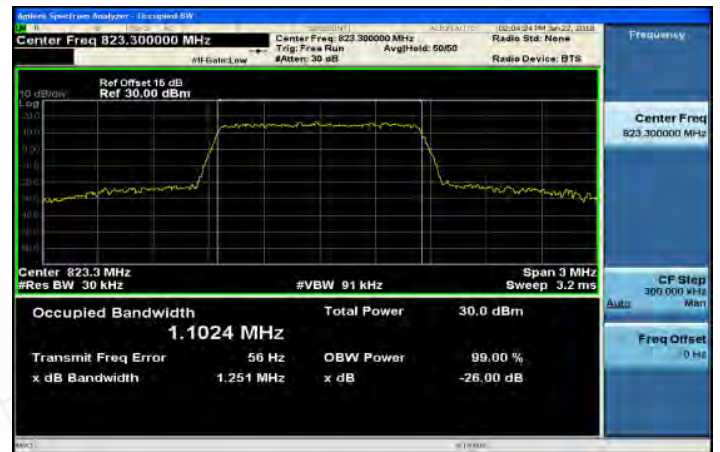

Unless otherwise stated the results shown in this test report refer only to the sample(s) tested and such sample(s) are retained for 90 days only.

除非另有說明，此報告結果僅對測試之樣品負責，同時此樣品僅保留90天。本報告未經本公司書面許可，不可部份複製。

This document is issued by the Company subject to its General Conditions of Service printed overleaf, available on request or accessible at [www.sgs.com/terms\\_and\\_conditions.htm](http://www.sgs.com/terms_and_conditions.htm) and, for electronic format documents, subject to Terms and Conditions for Electronic Documents at [www.sgs.com/terms\\_e-document.htm](http://www.sgs.com/terms_e-document.htm). Attention is drawn to the limitation of liability, indemnification and jurisdiction issues defined therein. Any holder of this document is advised that information contained hereon reflects the Company's findings at the time of its intervention only and within the limits of Client's instructions, if any. The Company's sole responsibility is to its Client and this document does not exonerate parties to a transaction from exercising all their rights and obligations under the transaction documents. This document cannot be reproduced except in full, without prior written approval of the Company. Any unauthorized alteration, forgery or falsification of the content or appearance of this document is unlawful and offenders may be prosecuted to the fullest extent of the law.

SGS Taiwan Ltd.

No. 134, WuKungRoad, New Taipei Industrial Park, WuKu District, New Taipei City, Taiwan 24803/新北市五股區新北產業園區五工路 134 號

台灣檢驗科技股份有限公司

t (886-2) 2299-3279

f (886-2) 2298-0488

www.tw.sgs.com

Member of SGS Group

Part 90\_Band26\_1\_4MHz\_64QAM\_6\_0\_LowCH26697

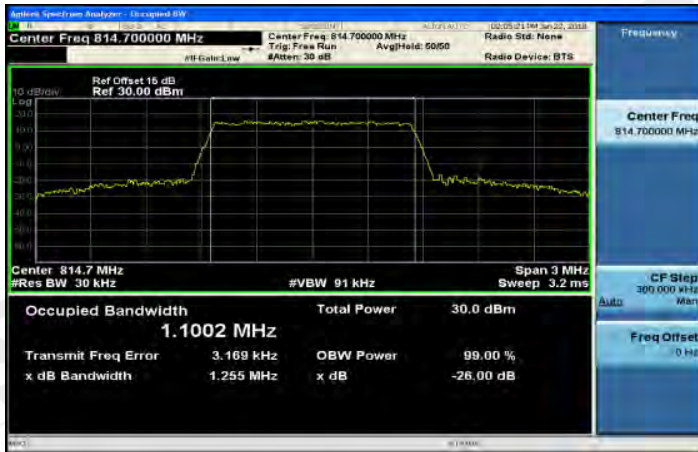

Part 90\_Band26\_3MHz\_QPSK\_15\_0\_LowCH26705

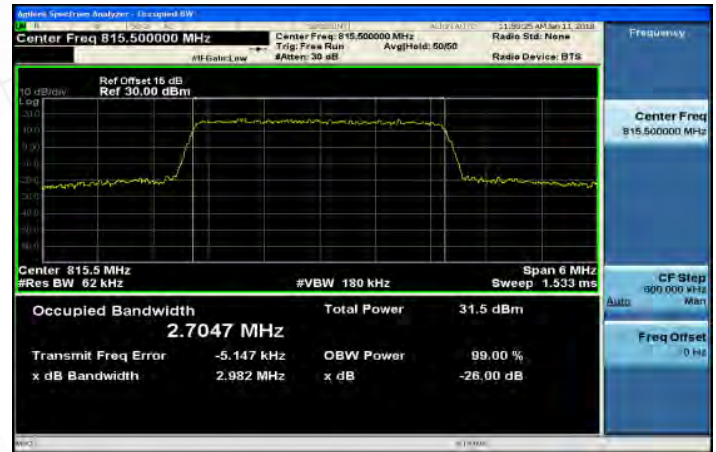

Part 90\_Band26\_1\_4MHz\_64QAM\_6\_0\_MidCH26740



Part 90\_Band26\_3MHz\_QPSK\_15\_0\_MidCH26740

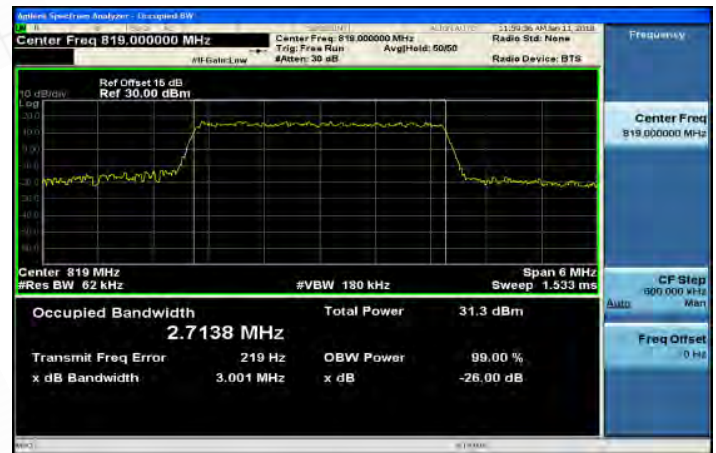

Part 90\_Band26\_1\_4MHz\_64QAM\_6\_0\_HighCH26783



Part 90\_Band26\_3MHz\_QPSK\_15\_0\_HighCH26775

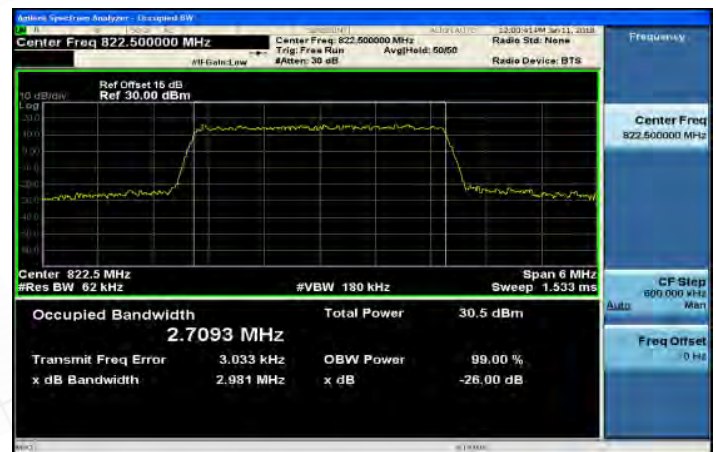

Unless otherwise stated the results shown in this test report refer only to the sample(s) tested and such sample(s) are retained for 90 days only.

除非另有說明，此報告結果僅對測試之樣品負責，同時此樣品僅保留90天。本報告未經本公司書面許可，不可部份複製。

This document is issued by the Company subject to its General Conditions of Service printed overleaf, available on request or accessible at [www.sgs.com/terms\\_and\\_conditions.htm](http://www.sgs.com/terms_and_conditions.htm) and, for electronic format documents, subject to Terms and Conditions for Electronic Documents at [www.sgs.com/terms\\_e-document.htm](http://www.sgs.com/terms_e-document.htm). Attention is drawn to the limitation of liability, indemnification and jurisdiction issues defined therein. Any holder of this document is advised that information contained hereon reflects the Company's findings at the time of its intervention only and within the limits of Client's instructions, if any. The Company's sole responsibility is to its Client and this document does not exonerate parties to a transaction from exercising all their rights and obligations under the transaction documents. This document cannot be reproduced except in full, without prior written approval of the Company. Any unauthorized alteration, forgery or falsification of the content or appearance of this document is unlawful and offenders may be prosecuted to the fullest extent of the law.



Part 90\_Band26\_3MHz\_16QAM\_15\_0\_LowCH26705

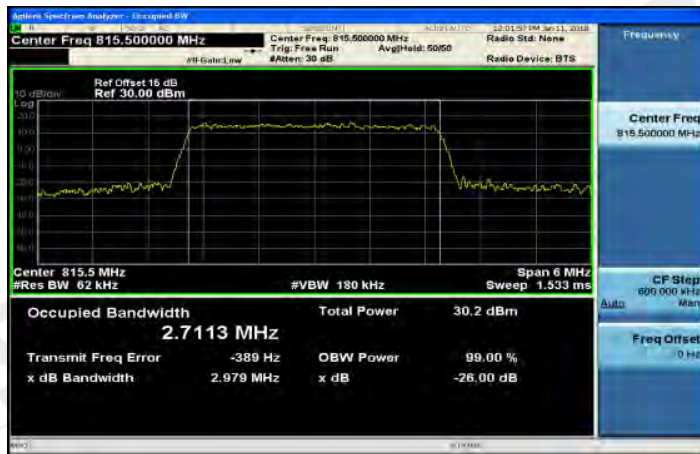

Part 90\_Band26\_3MHz\_64QAM\_15\_0\_LowCH26705

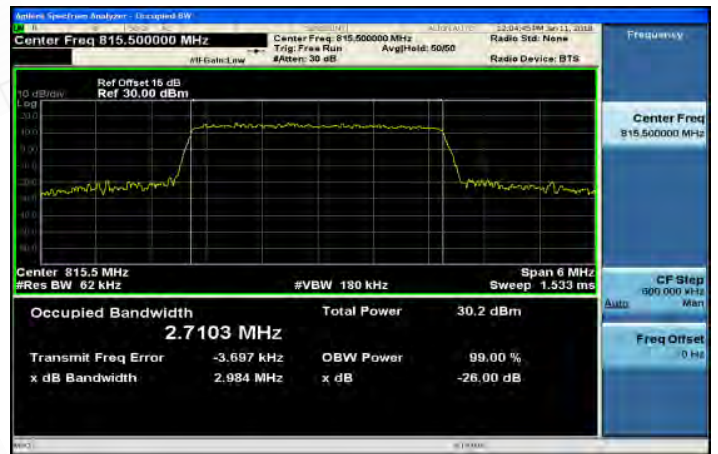

Part 90\_Band26\_3MHz\_16QAM\_15\_0\_MidCH26740

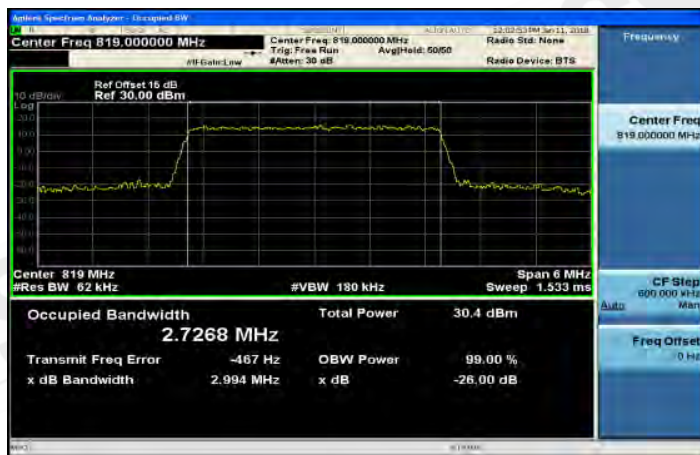

Part 90\_Band26\_3MHz\_64QAM\_15\_0\_MidCH26740

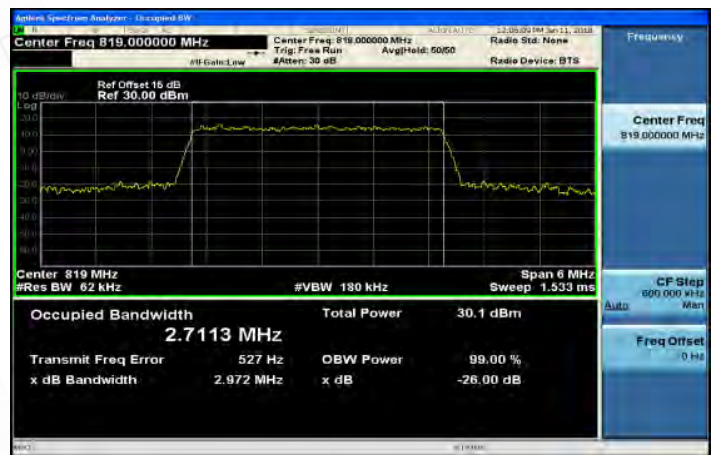

Part 90\_Band26\_3MHz\_16QAM\_15\_0\_HighCH26775

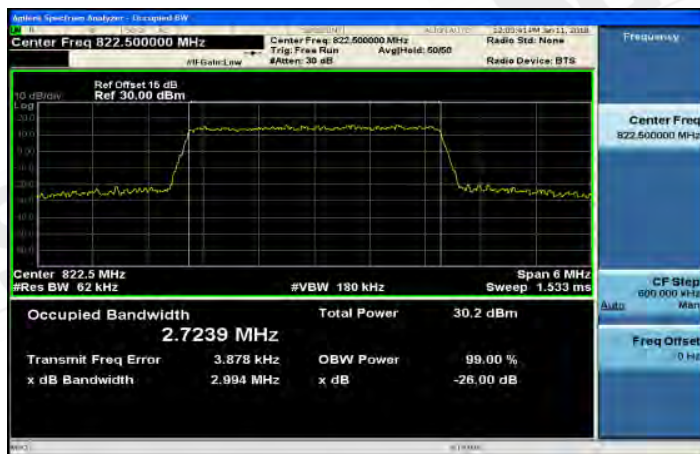

Part 90\_Band26\_3MHz\_64QAM\_15\_0\_HighCH26775

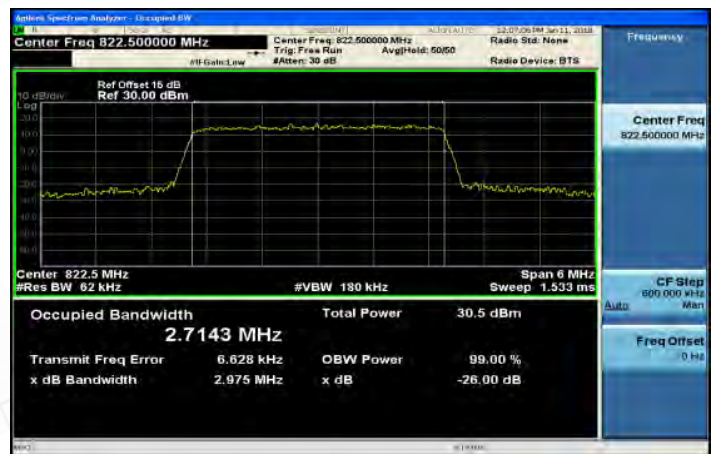

Unless otherwise stated the results shown in this test report refer only to the sample(s) tested and such sample(s) are retained for 90 days only.

除非另有說明，此報告結果僅對測試之樣品負責，同時此樣品僅保留90天。本報告未經本公司書面許可，不可部份複製。

This document is issued by the Company subject to its General Conditions of Service printed overleaf, available on request or accessible at [www.sgs.com/terms\\_and\\_conditions.htm](http://www.sgs.com/terms_and_conditions.htm) and, for electronic format documents, subject to Terms and Conditions for Electronic Documents at [www.sgs.com/terms\\_e-document.htm](http://www.sgs.com/terms_e-document.htm). Attention is drawn to the limitation of liability, indemnification and jurisdiction issues defined therein. Any holder of this document is advised that information contained hereon reflects the Company's findings at the time of its intervention only and within the limits of Client's instructions, if any. The Company's sole responsibility is to its Client and this document does not exonerate parties to a transaction from exercising all their rights and obligations under the transaction documents. This document cannot be reproduced except in full, without prior written approval of the Company. Any unauthorized alteration, forgery or falsification of the content or appearance of this document is unlawful and offenders may be prosecuted to the fullest extent of the law.

SGS Taiwan Ltd.

No. 134, WuKungRoad, New Taipei Industrial Park, WuKu District, New Taipei City, Taiwan 24803/新北市五股區新北產業園區五工路 134 號

台灣檢驗科技股份有限公司

t (886-2) 2299-3279

f (886-2) 2298-0488

www.tw.sgs.com

Member of SGS Group

Part 90\_Band26\_5MHz\_QPSK\_25\_0\_LowCH26715



Part 90\_Band26\_5MHz\_16QAM\_25\_0\_LowCH26715



Part 90\_Band26\_5MHz\_QPSK\_25\_0\_MidCH26740



Part 90\_Band26\_5MHz\_16QAM\_25\_0\_MidCH26740

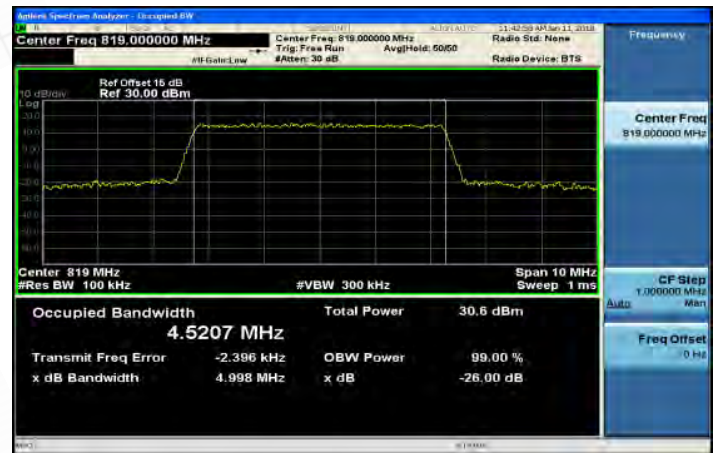

Part 90\_Band26\_5MHz\_QPSK\_25\_0\_HighCH26765

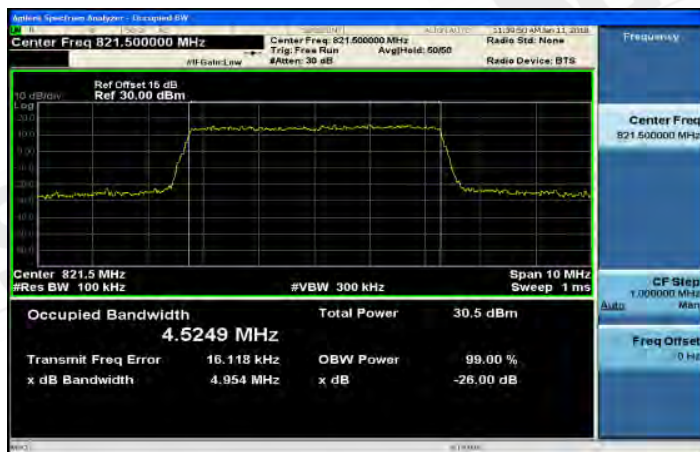

Part 90\_Band26\_5MHz\_16QAM\_25\_0\_HighCH26765

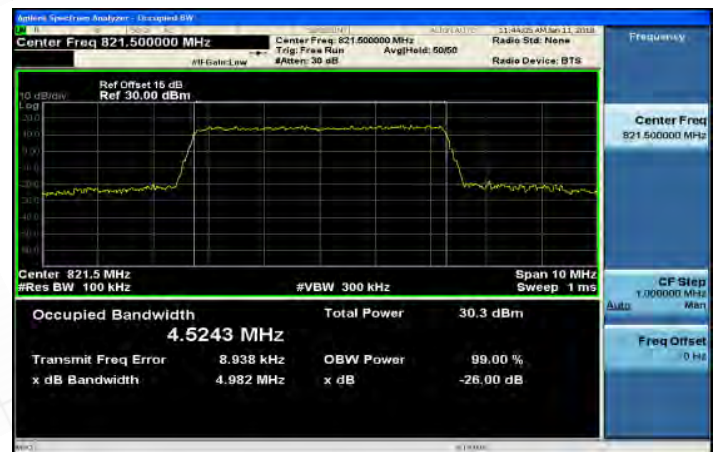

Unless otherwise stated the results shown in this test report refer only to the sample(s) tested and such sample(s) are retained for 90 days only.

除非另有說明，此報告結果僅對測試之樣品負責，同時此樣品僅保留90天。本報告未經本公司書面許可，不可部份複製。

This document is issued by the Company subject to its General Conditions of Service printed overleaf, available on request or accessible at [www.sgs.com/terms\\_and\\_conditions.htm](http://www.sgs.com/terms_and_conditions.htm) and, for electronic format documents, subject to Terms and Conditions for Electronic Documents at [www.sgs.com/terms\\_e-document.htm](http://www.sgs.com/terms_e-document.htm). Attention is drawn to the limitation of liability, indemnification and jurisdiction issues defined therein. Any holder of this document is advised that information contained hereon reflects the Company's findings at the time of its intervention only and within the limits of Client's instructions, if any. The Company's sole responsibility is to its Client and this document does not exonerate parties to a transaction from exercising all their rights and obligations under the transaction documents. This document cannot be reproduced except in full, without prior written approval of the Company. Any unauthorized alteration, forgery or falsification of the content or appearance of this document is unlawful and offenders may be prosecuted to the fullest extent of the law.

SGS Taiwan Ltd.

No. 134, WuKungRoad, New Taipei Industrial Park, WuKu District, New Taipei City, Taiwan 24803/新北市五股區新北產業園區五工路 134 號

台灣檢驗科技股份有限公司

t (886-2) 2299-3279

f (886-2) 2298-0488

www.tw.sgs.com

Member of SGS Group



Part 90\_Band26\_5MHz\_64QAM\_25\_0\_LowCH26715

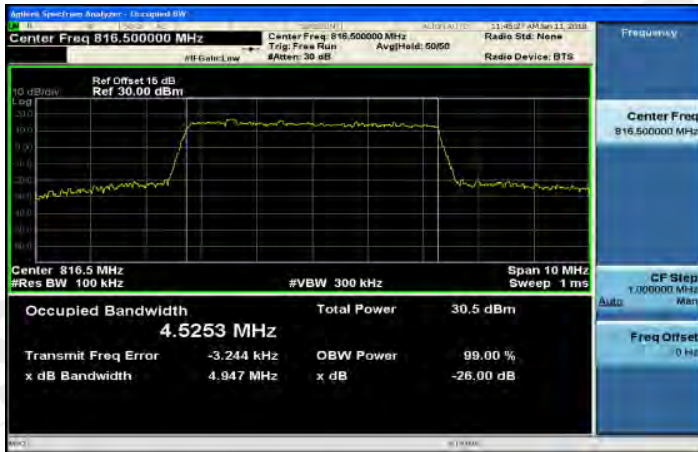

Part 90\_Band26\_10MHz\_QPSK\_50\_0\_MidCH26740

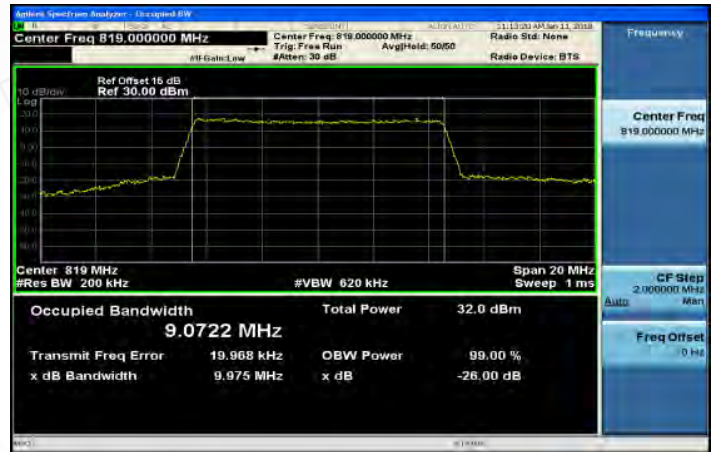

Part 90\_Band26\_5MHz\_64QAM\_25\_0\_MidCH26740



Part 90\_Band26\_10MHz\_16QAM\_50\_0\_MidCH26740

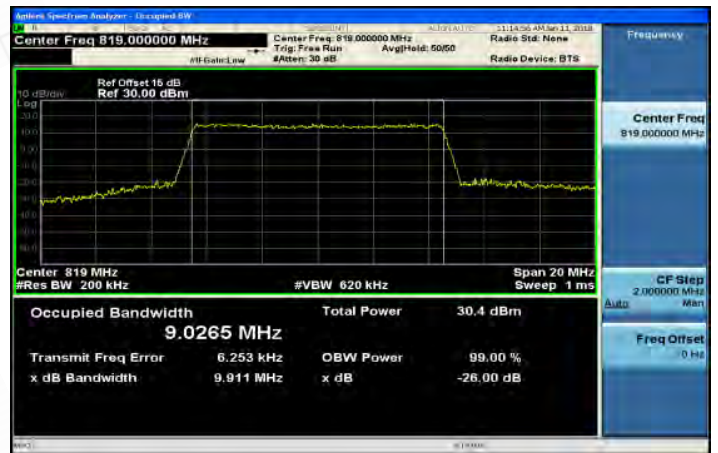

Part 90\_Band26\_5MHz\_64QAM\_25\_0\_HighCH26765

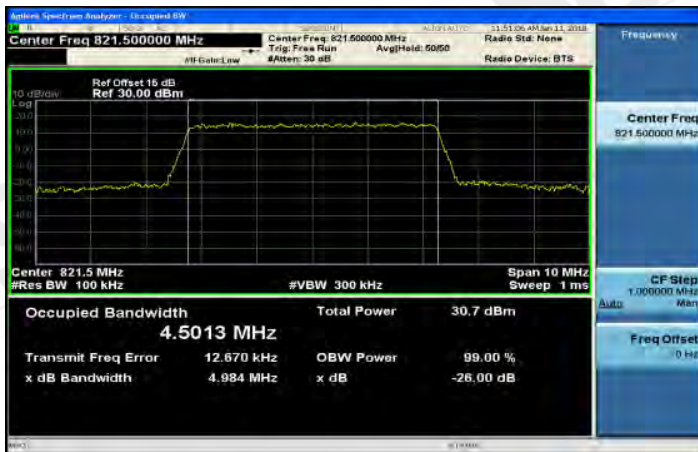

Part 90\_Band26\_10MHz\_64QAM\_50\_0\_MidCH26740

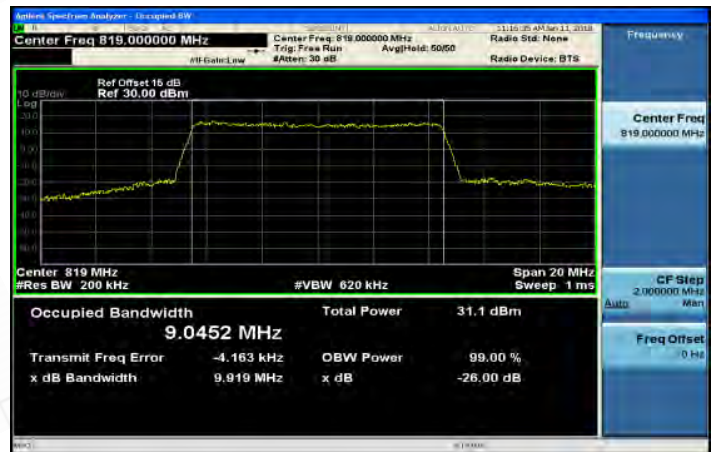

Unless otherwise stated the results shown in this test report refer only to the sample(s) tested and such sample(s) are retained for 90 days only.

除非另有說明，此報告結果僅對測試之樣品負責，同時此樣品僅保留90天。本報告未經本公司書面許可，不可部份複製。

This document is issued by the Company subject to its General Conditions of Service printed overleaf, available on request or accessible at [www.sgs.com/terms\\_and\\_conditions.htm](http://www.sgs.com/terms_and_conditions.htm) and, for electronic format documents, subject to Terms and Conditions for Electronic Documents at [www.sgs.com/terms\\_e-document.htm](http://www.sgs.com/terms_e-document.htm). Attention is drawn to the limitation of liability, indemnification and jurisdiction issues defined therein. Any holder of this document is advised that information contained hereon reflects the Company's findings at the time of its intervention only and within the limits of Client's instructions, if any. The Company's sole responsibility is to its Client and this document does not exonerate parties to a transaction from exercising all their rights and obligations under the transaction documents. This document cannot be reproduced except in full, without prior written approval of the Company. Any unauthorized alteration, forgery or falsification of the content or appearance of this document is unlawful and offenders may be prosecuted to the fullest extent of the law.

SGS Taiwan Ltd.

No. 134, WuKungRoad, New Taipei Industrial Park, WuKu District, New Taipei City, Taiwan 24803 / 新北市五股區新北產業園區五工路 134 號

台灣檢驗科技股份有限公司

t (886-2) 2299-3279

f (886-2) 2298-0488

www.tw.sgs.com

Member of SGS Group

## 9. OUT OF BAND EMISSION AT ANTENNA TERMINALS

### 9.1. Standard Applicable

FCC §22.917(a), Out of band emissions. The power of any emission outside of the authorized operating frequency ranges must be attenuated below the transmitting power (P) by a factor of at least  $43 + 10 \log(P)$  dB.

§90.691 Emission mask requirements for EA-based systems.

(a) Out-of-band emission requirement shall apply only to the "outer" channels included in an EA license and to spectrum adjacent to interior channels used by incumbent licensees. The emission limits are as follows:

(1) For any frequency removed from the EA licensee's frequency block by up to and including 37.5 kHz, the power of any emission shall be attenuated below the transmitter power (P) in watts by at least  $116 \log_{10}(f/6.1)$  decibels or  $50 + 10 \log_{10}(P)$  decibels or 80 decibels, whichever is the lesser attenuation, where f is the frequency removed from the center of the outer channel in the block in kilohertz and where f is greater than 12.5 kHz.

(2) For any frequency removed from the EA licensee's frequency block greater than 37.5 kHz, the power of any emission shall be attenuated below the transmitter power (P) in watts by at least  $43 + 10 \log_{10}(P)$  decibels or 80 decibels, whichever is the lesser attenuation, where f is the frequency removed from the center of the outer channel in the block in kilohertz and where f is greater than 37.5 kHz.

Unless otherwise stated the results shown in this test report refer only to the sample(s) tested and such sample(s) are retained for 90 days only.

除非另有說明，此報告結果僅對測試之樣品負責，同時此樣品僅保留90天。本報告未經本公司書面許可，不可部份複製。

This document is issued by the Company subject to its General Conditions of Service printed overleaf, available on request or accessible at [www.sgs.com/terms\\_and\\_conditions.htm](http://www.sgs.com/terms_and_conditions.htm) and, for electronic format documents, subject to Terms and Conditions for Electronic Documents at [www.sgs.com/terms\\_e-document.htm](http://www.sgs.com/terms_e-document.htm). Attention is drawn to the limitation of liability, indemnification and jurisdiction issues defined therein. Any holder of this document is advised that information contained hereon reflects the Company's findings at the time of its intervention only and within the limits of Client's instructions, if any. The Company's sole responsibility is to its Client and this document does not exonerate parties to a transaction from exercising all their rights and obligations under the transaction documents. This document cannot be reproduced except in full, without prior written approval of the Company. Any unauthorized alteration, forgery or falsification of the content or appearance of this document is unlawful and offenders may be prosecuted to the fullest extent of the law.

SGS Taiwan Ltd.

台灣檢驗科技股份有限公司

No. 134, WuKungRoad, New Taipei Industrial Park, Wuku District, New Taipei City, Taiwan 24803 / 新北市五股區新北產業園區五工路 134 號

t (886-2) 2299-3279

f (886-2) 2298-0488

[www.tw.sgs.com](http://www.tw.sgs.com)

Member of SGS Group



## 9.2. Test SET-UP

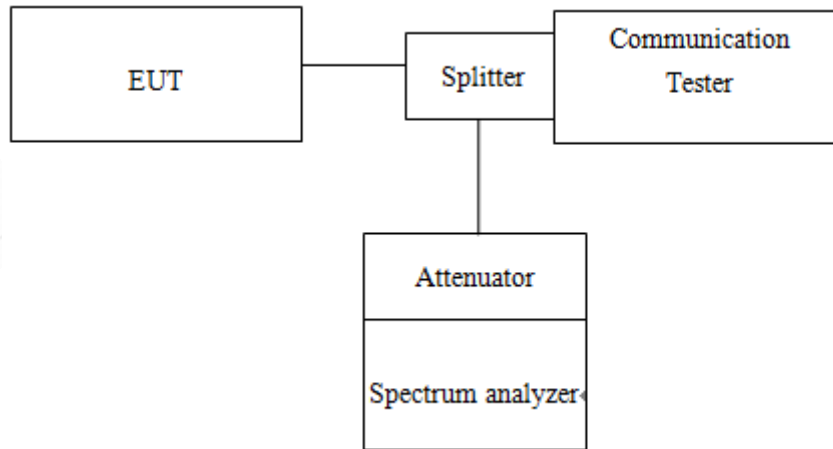

## 9.3. Measurement Procedure

### Conducted Emission

The RF output of the transceiver was connected to a spectrum analyzer through appropriate attenuation. The resolution bandwidth of the spectrum analyzer was set at 1MHz, sufficient scans were taken to show the out of band Emissions if any up to 10th harmonic.

1. To connect Antenna Port of EUT to Spectrum.
2. Set RBW = 1MHz & VBW = 1MHz on Spectrum.
3. Allow trace to fully stabilize
4. Repeat above procedures until all default test channel measured were complete.

### Band Edge

1. To connect Antenna Port of EUT to Spectrum.
2. The band edge of low and high channels for the highest RF powers was measured. Setting  $RBW \geq 1\% EBW$ .
3. Allow trace to fully stabilize
4. Repeat above procedures until all default test channel measured were complete.

Unless otherwise stated the results shown in this test report refer only to the sample(s) tested and such sample(s) are retained for 90 days only.

除非另有說明，此報告結果僅對測試之樣品負責，同時此樣品僅保留90天。本報告未經本公司書面許可，不可部份複製。

This document is issued by the Company subject to its General Conditions of Service printed overleaf, available on request or accessible at [www.sgs.com/terms\\_and\\_conditions.htm](http://www.sgs.com/terms_and_conditions.htm) and, for electronic format documents, subject to Terms and Conditions for Electronic Documents at [www.sgs.com/terms\\_e-document.htm](http://www.sgs.com/terms_e-document.htm). Attention is drawn to the limitation of liability, indemnification and jurisdiction issues defined therein. Any holder of this document is advised that information contained hereon reflects the Company's findings at the time of its intervention only and within the limits of Client's instructions, if any. The Company's sole responsibility is to its Client and this document does not exonerate parties to a transaction from exercising all their rights and obligations under the transaction documents. This document cannot be reproduced except in full, without prior written approval of the Company. Any unauthorized alteration, forgery or falsification of the content or appearance of this document is unlawful and offenders may be prosecuted to the fullest extent of the law.

#### 9.4. Measurement Equipment Used

EQUIPMENT TYPE	MFR	MODEL NUMBER	SERIAL NUMBER	LAST CAL. (YYYY.MM.DD)	CAL DUE. (YYYY.MM.DD)
EXA Spectrum Analyzer	Agilent	N9010A	MY54200716	2017/10/16	2018/10/15
Radio Communication Analyzer	Anritsu	MT8820C	6201465317	2018/01/15	2019/1/14
Attenuator	Mini-Circuit	BW-S10W2+	2	2018/01/02	2019/1/1
DC Block	Mini-Circuits	BLK-18-S+	1	2018/01/02	2019/1/1
Splitter	RF-LAMBAD	RFLT2W1G18G	11-JSPF412-018	2018/01/02	2019/1/1
Coaxial Cable	Huber Suhner	SUCOFLEX 102EPA	MY2616/2	2018/01/02	2019/1/1

#### 9.5. Measurement Result:

Refer to next pages.

Unless otherwise stated the results shown in this test report refer only to the sample(s) tested and such sample(s) are retained for 90 days only.

除非另有說明，此報告結果僅對測試之樣品負責，同時此樣品僅保留90天。本報告未經本公司書面許可，不可部份複製。

This document is issued by the Company subject to its General Conditions of Service printed overleaf, available on request or accessible at [www.sgs.com/terms\\_and\\_conditions.htm](http://www.sgs.com/terms_and_conditions.htm) and, for electronic format documents, subject to Terms and Conditions for Electronic Documents at [www.sgs.com/terms\\_e-document.htm](http://www.sgs.com/terms_e-document.htm). Attention is drawn to the limitation of liability, indemnification and jurisdiction issues defined therein. Any holder of this document is advised that information contained hereon reflects the Company's findings at the time of its intervention only and within the limits of Client's instructions, if any. The Company's sole responsibility is to its Client and this document does not exonerate parties to a transaction from exercising all their rights and obligations under the transaction documents. This document cannot be reproduced except in full, without prior written approval of the Company. Any unauthorized alteration, forgery or falsification of the content or appearance of this document is unlawful and offenders may be prosecuted to the fullest extent of the law.

SGS Taiwan Ltd.

台灣檢驗科技股份有限公司

No.134,WuKungRoad,NewTaipeiIndustrialPark,WukuDistrict,NewTaipeiCity,Taiwan24803/新北市五股區新北產業園區五工路134號

t (886-2) 2299-3279

f (886-2) 2298-0488

www.tw.sgs.com

Member of SGS Group

Part 90\_Band26\_1\_4MHz\_QPSK\_1\_0\_LowCH26697-814.7



Part 90\_Band26\_1\_4MHz\_QPSK\_6\_0\_HighCH26783



Part 90\_Band26\_1\_4MHz\_QPSK\_1\_5\_HighCH26783



Part 90\_Band26\_3MHz\_QPSK\_1\_0\_LowCH26705



Part 90\_Band26\_1\_4MHz\_QPSK\_6\_0\_LowCH26697



Part 90\_Band26\_3MHz\_QPSK\_1\_14\_HighCH26775



Unless otherwise stated the results shown in this test report refer only to the sample(s) tested and such sample(s) are retained for 90 days only.

除非另有說明，此報告結果僅對測試之樣品負責，同時此樣品僅保留90天。本報告未經本公司書面許可，不可部份複製。

This document is issued by the Company subject to its General Conditions of Service printed overleaf, available on request or accessible at [www.sgs.com/terms\\_and\\_conditions.htm](http://www.sgs.com/terms_and_conditions.htm) and, for electronic format documents, subject to Terms and Conditions for Electronic Documents at [www.sgs.com/terms\\_e-document.htm](http://www.sgs.com/terms_e-document.htm). Attention is drawn to the limitation of liability, indemnification and jurisdiction issues defined therein. Any holder of this document is advised that information contained hereon reflects the Company's findings at the time of its intervention only and within the limits of Client's instructions, if any. The Company's sole responsibility is to its Client and this document does not exonerate parties to a transaction from exercising all their rights and obligations under the transaction documents. This document cannot be reproduced except in full, without prior written approval of the Company. Any unauthorized alteration, forgery or falsification of the content or appearance of this document is unlawful and offenders may be prosecuted to the fullest extent of the law.

SGS Taiwan Ltd.

No. 134, WuKungRoad, NewTaipeiIndustrialPark, WukuDistrict, NewTaipeiCity, Taiwan24803/新北市五股區新北產業園區五工路 134 號

台灣檢驗科技股份有限公司

t (886-2) 2299-3279

f (886-2) 2298-0488

www.tw.sgs.com

Member of SGS Group



Part 90\_Band26\_3MHz\_QPSK\_15\_0\_LowCH26705



Part 90\_Band26\_5MHz\_QPSK\_1\_24\_HighCH26765



Part 90\_Band26\_3MHz\_QPSK\_15\_0\_HighCH26775



Part 90\_Band26\_5MHz\_QPSK\_25\_0\_LowCH26715



Part 90\_Band26\_5MHz\_QPSK\_1\_0\_LowCH26715



Part 90\_Band26\_5MHz\_QPSK\_25\_0\_HighCH26765



Unless otherwise stated the results shown in this test report refer only to the sample(s) tested and such sample(s) are retained for 90 days only.

除非另有說明，此報告結果僅對測試之樣品負責，同時此樣品僅保留90天。本報告未經本公司書面許可，不可部份複製。

This document is issued by the Company subject to its General Conditions of Service printed overleaf, available on request or accessible at [www.sgs.com/terms\\_and\\_conditions.htm](http://www.sgs.com/terms_and_conditions.htm) and, for electronic format documents, subject to Terms and Conditions for Electronic Documents at [www.sgs.com/terms\\_e-document.htm](http://www.sgs.com/terms_e-document.htm). Attention is drawn to the limitation of liability, indemnification and jurisdiction issues defined therein. Any holder of this document is advised that information contained hereon reflects the Company's findings at the time of its intervention only and within the limits of Client's instructions, if any. The Company's sole responsibility is to its Client and this document does not exonerate parties to a transaction from exercising all their rights and obligations under the transaction documents. This document cannot be reproduced except in full, without prior written approval of the Company. Any unauthorized alteration, forgery or falsification of the content or appearance of this document is unlawful and offenders may be prosecuted to the fullest extent of the law.

SGS Taiwan Ltd.

No. 134, WuKungRoad, NewTaipeiIndustrialPark, WukuDistrict, NewTaipeiCity, Taiwan24803/新北市五股區新北產業園區五工路 134 號

台灣檢驗科技股份有限公司

t (886-2) 2299-3279

f (886-2) 2298-0488

www.tw.sgs.com

Member of SGS Group

Part 90\_Band26\_10MHz\_QPSK\_1\_0\_LowCH26740



Part 90\_Band26\_10MHz\_QPSK\_50\_0\_HighCH26740



Part 90\_Band26\_10MHz\_QPSK\_1\_49\_HighCH26740



Part 90\_Band26\_10MHz\_QPSK\_50\_0\_LowCH26740



Unless otherwise stated the results shown in this test report refer only to the sample(s) tested and such sample(s) are retained for 90 days only.

除非另有說明，此報告結果僅對測試之樣品負責，同時此樣品僅保留90天。本報告未經本公司書面許可，不可部份複製。

This document is issued by the Company subject to its General Conditions of Service printed overleaf, available on request or accessible at [www.sgs.com/terms\\_and\\_conditions.htm](http://www.sgs.com/terms_and_conditions.htm) and, for electronic format documents, subject to Terms and Conditions for Electronic Documents at [www.sgs.com/terms\\_e-document.htm](http://www.sgs.com/terms_e-document.htm). Attention is drawn to the limitation of liability, indemnification and jurisdiction issues defined therein. Any holder of this document is advised that information contained hereon reflects the Company's findings at the time of its intervention only and within the limits of Client's instructions, if any. The Company's sole responsibility is to its Client and this document does not exonerate parties to a transaction from exercising all their rights and obligations under the transaction documents. This document cannot be reproduced except in full, without prior written approval of the Company. Any unauthorized alteration, forgery or falsification of the content or appearance of this document is unlawful and offenders may be prosecuted to the fullest extent of the law.

SGS Taiwan Ltd.

No. 134, WuKungRoad, NewTaipeiIndustrialPark, WukuDistrict, NewTaipeiCity, Taiwan24803/新北市五股區新北產業園區五工路 134 號

台灣檢驗科技股份有限公司

t (886-2) 2299-3279

f (886-2) 2298-0488

www.tw.sgs.com

Member of SGS Group



Part 90\_Band 26\_1.4M\_QPSK\_LOW\_RB1,0



Part 90\_Band 26\_1.4M\_QPSK\_MID\_RB1,0

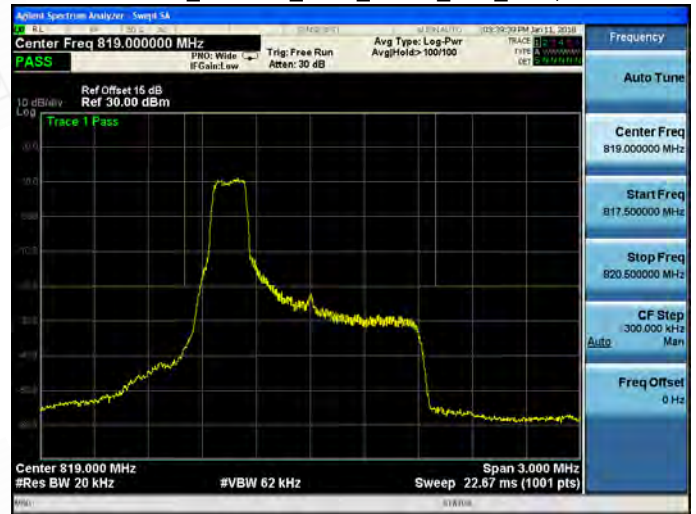

Part 90\_Band 26\_1.4M\_QPSK\_LOW\_RB1,5

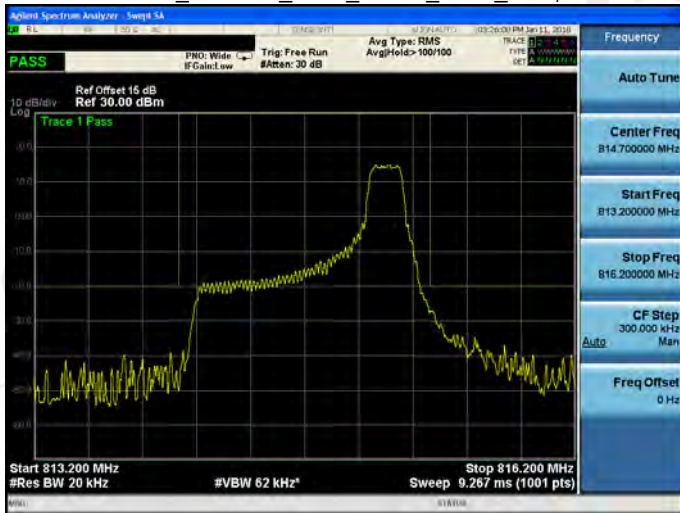

Part 90\_Band 26\_1.4M\_QPSK\_MID\_RB1,5

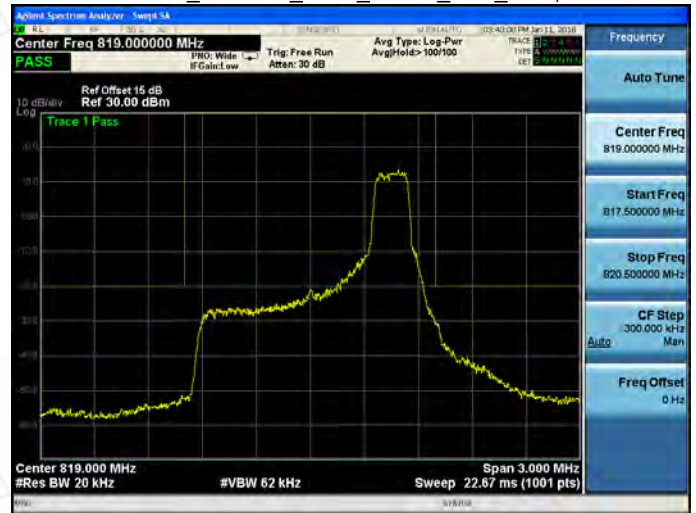

Part 90\_Band 26\_1.4M\_QPSK\_LOW\_RB6.0

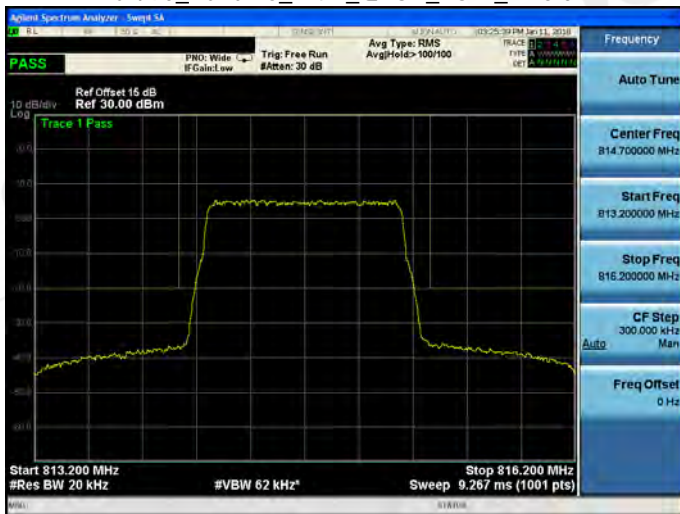

Part 90\_Band 26\_1.4M\_QPSK\_MID\_RB6.0



Unless otherwise stated the results shown in this test report refer only to the sample(s) tested and such sample(s) are retained for 90 days only.

除非另有說明，此報告結果僅對測試之樣品負責，同時此樣品僅保留90天。本報告未經本公司書面許可，不可部份複製。

This document is issued by the Company subject to its General Conditions of Service printed overleaf, available on request or accessible at [www.sgs.com/terms\\_and\\_conditions.htm](http://www.sgs.com/terms_and_conditions.htm) and, for electronic format documents, subject to Terms and Conditions for Electronic Documents at [www.sgs.com/terms\\_e-document.htm](http://www.sgs.com/terms_e-document.htm). Attention is drawn to the limitation of liability, indemnification and jurisdiction issues defined therein. Any holder of this document is advised that information contained hereon reflects the Company's findings at the time of its intervention only and within the limits of Client's instructions, if any. The Company's sole responsibility is to its Client and this document does not exonerate parties to a transaction from exercising all their rights and obligations under the transaction documents. This document cannot be reproduced except in full, without prior written approval of the Company. Any unauthorized alteration, forgery or falsification of the content or appearance of this document is unlawful and offenders may be prosecuted to the fullest extent of the law.

SGS Taiwan Ltd.

No. 134, WuKungRoad, New Taipei Industrial Park, WuKu District, New Taipei City, Taiwan 24803/新北市五股區新北產業園區五工路 134 號

台灣檢驗科技股份有限公司

t (886-2) 2299-3279

f (886-2) 2298-0488

www.tw.sgs.com

Member of SGS Group



Part 90\_Band 26\_1.4M\_QPSK\_HIGH\_RB1,0

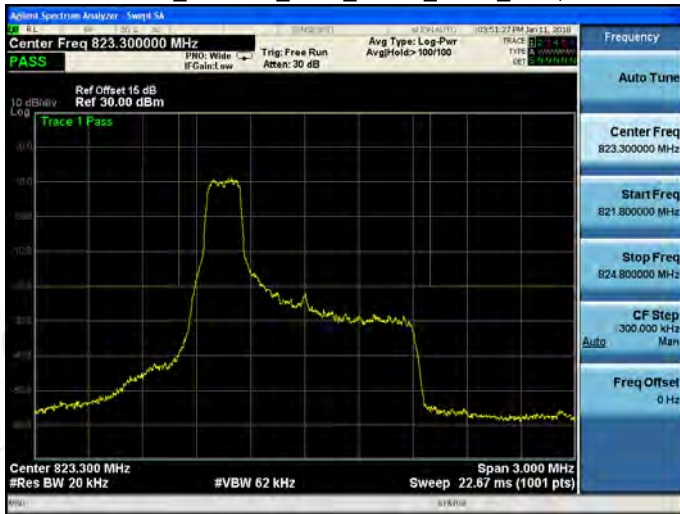

Part 90\_Band 26\_1.4M\_16QAM\_LOW\_RB1,0



Part 90\_Band 26\_1.4M\_QPSK\_HIGH\_RB1,5

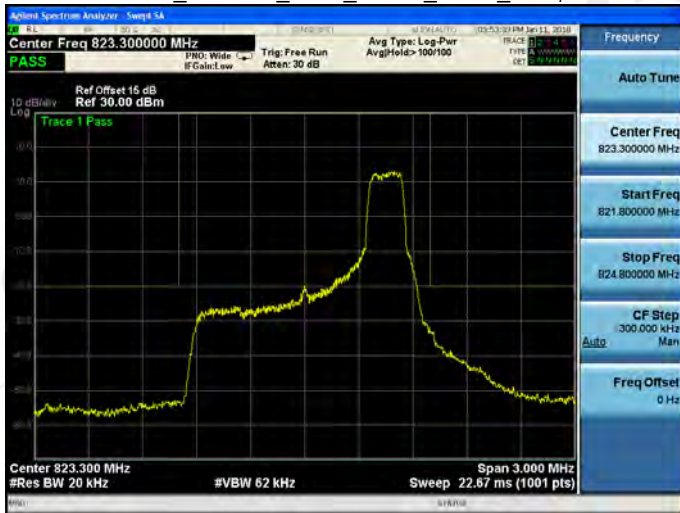

Part 90\_Band 26\_1.4M\_16QAM\_LOW\_RB1,5

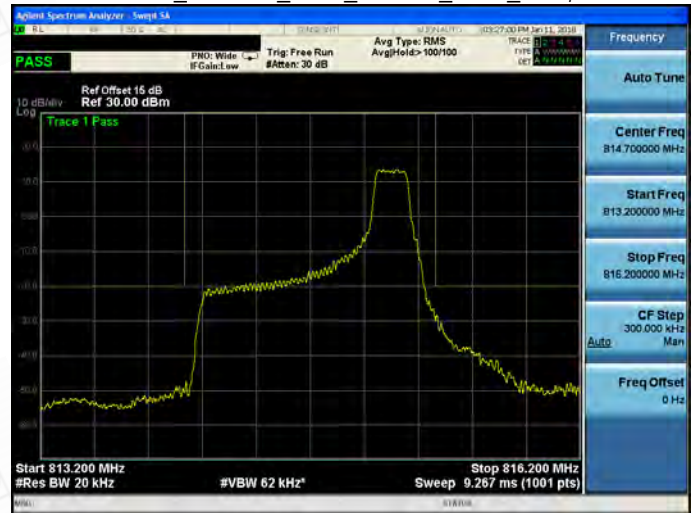

Part 90\_Band 26\_1.4M\_QPSK\_HIGH\_RB6,0

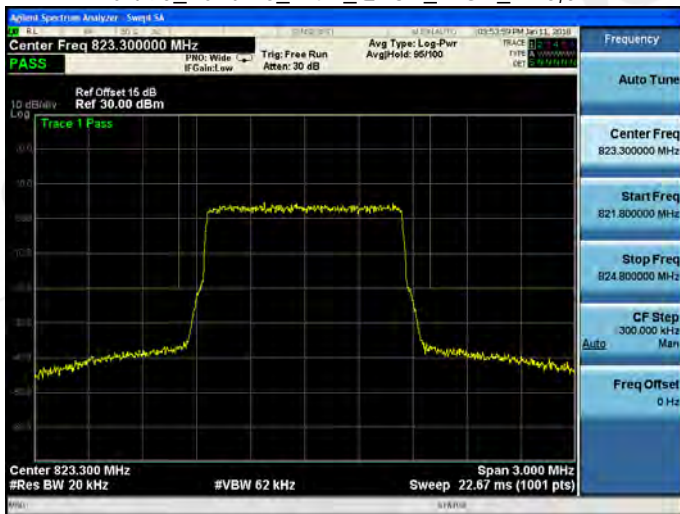

Part 90\_Band 26\_1.4M\_16QAM\_LOW\_RB6,0

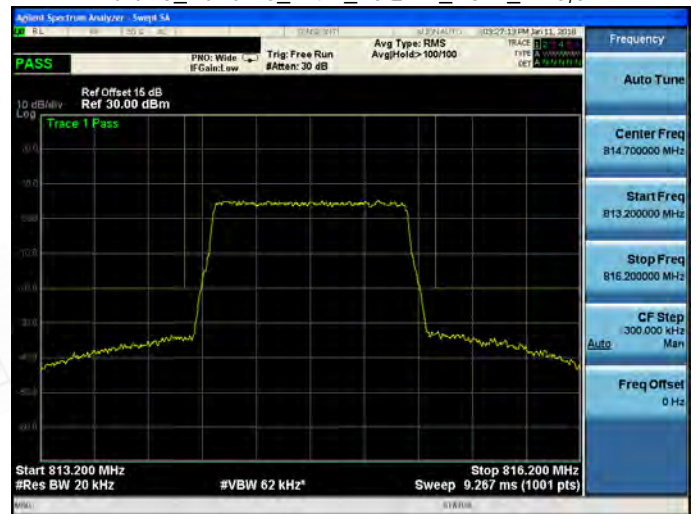

Unless otherwise stated the results shown in this test report refer only to the sample(s) tested and such sample(s) are retained for 90 days only.  
除非另有說明，此報告結果僅對測試之樣品負責，同時此樣品僅保留90天。本報告未經本公司書面許可，不可部份複製。

This document is issued by the Company subject to its General Conditions of Service printed overleaf, available on request or accessible at [www.sgs.com/terms\\_and\\_conditions.htm](http://www.sgs.com/terms_and_conditions.htm) and, for electronic format documents, subject to Terms and Conditions for Electronic Documents at [www.sgs.com/terms\\_e-document.htm](http://www.sgs.com/terms_e-document.htm). Attention is drawn to the limitation of liability, indemnification and jurisdiction issues defined therein. Any holder of this document is advised that information contained hereon reflects the Company's findings at the time of its intervention only and within the limits of Client's instructions, if any. The Company's sole responsibility is to its Client and this document does not exonerate parties to a transaction from exercising all their rights and obligations under the transaction documents. This document cannot be reproduced except in full, without prior written approval of the Company. Any unauthorized alteration, forgery or falsification of the content or appearance of this document is unlawful and offenders may be prosecuted to the fullest extent of the law.



Part 90\_Band 26\_1.4M\_16QAM\_MID\_RB1,0

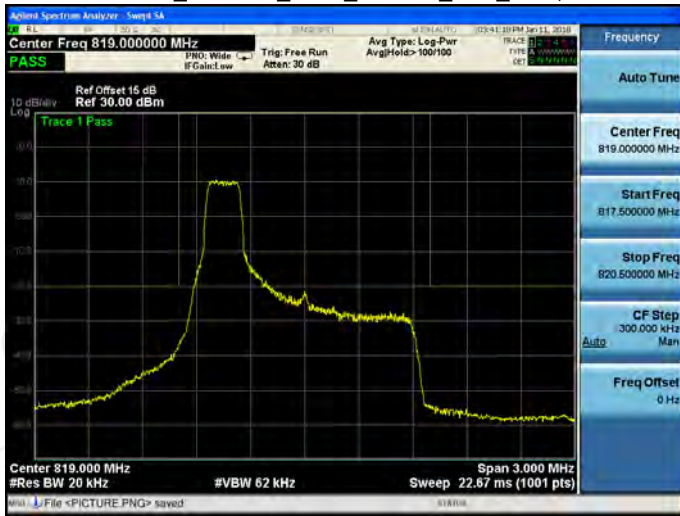

Part 90\_Band 26\_1.4M\_16QAM\_HIGH\_RB1,0

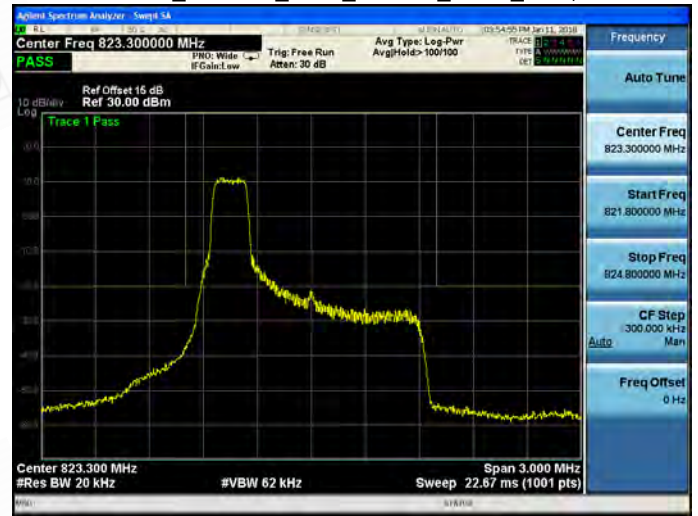

Part 90\_Band 26\_1.4M\_16QAM\_MID\_RB1,5

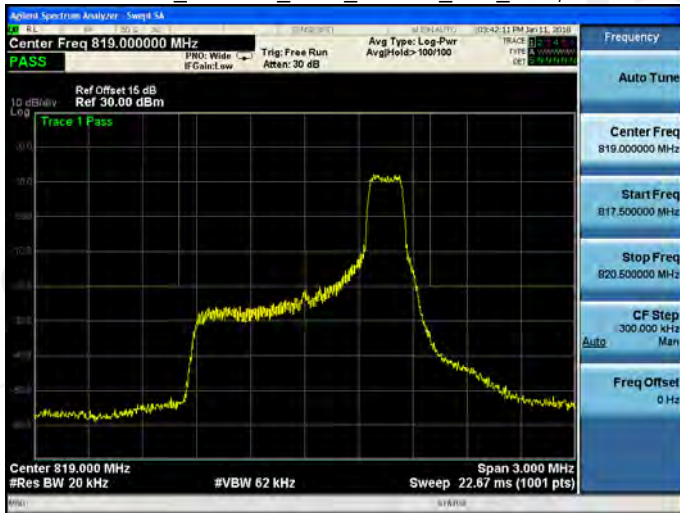

Part 90\_Band 26\_1.4M\_16QAM\_HIGH\_RB1,5

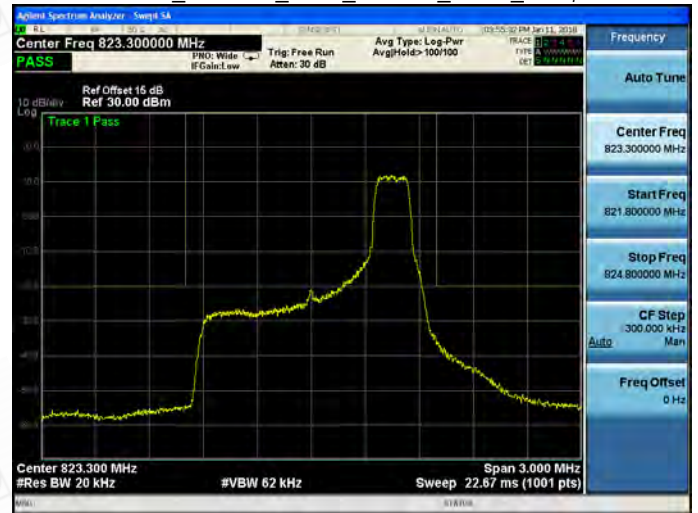

Part 90\_Band 26\_1.4M\_16QAM\_MID\_RB6,0



Part 90\_Band 26\_1.4M\_16QAM\_HIGH\_RB6,0

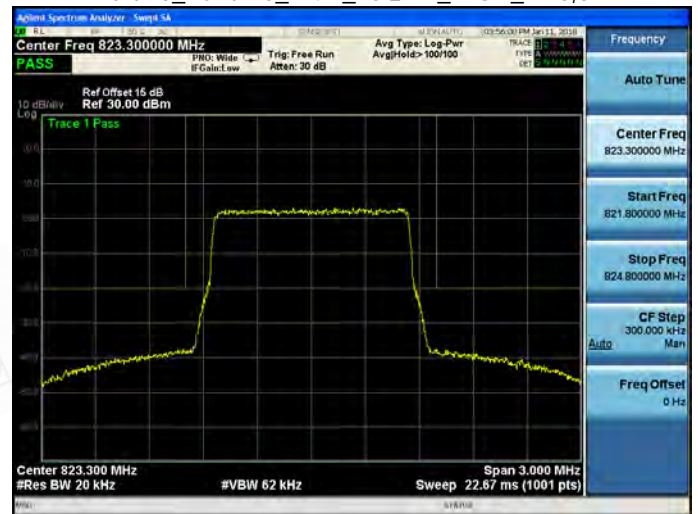

Unless otherwise stated the results shown in this test report refer only to the sample(s) tested and such sample(s) are retained for 90 days only.

除非另有說明，此報告結果僅對測試之樣品負責，同時此樣品僅保留90天。本報告未經本公司書面許可，不可部份複製。

This document is issued by the Company subject to its General Conditions of Service printed overleaf, available on request or accessible at [www.sgs.com/terms\\_and\\_conditions.htm](http://www.sgs.com/terms_and_conditions.htm) and, for electronic format documents, subject to Terms and Conditions for Electronic Documents at [www.sgs.com/terms\\_e-document.htm](http://www.sgs.com/terms_e-document.htm). Attention is drawn to the limitation of liability, indemnification and jurisdiction issues defined therein. Any holder of this document is advised that information contained hereon reflects the Company's findings at the time of its intervention only and within the limits of Client's instructions, if any. The Company's sole responsibility is to its Client and this document does not exonerate parties to a transaction from exercising all their rights and obligations under the transaction documents. This document cannot be reproduced except in full, without prior written approval of the Company. Any unauthorized alteration, forgery or falsification of the content or appearance of this document is unlawful and offenders may be prosecuted to the fullest extent of the law.

SGS Taiwan Ltd.

No. 134, WuKungRoad, NewTaipeiIndustrialPark, WukuDistrict, NewTaipeiCity, Taiwan24803/新北市五股區新北產業園區五工路 134 號

台灣檢驗科技股份有限公司

t (886-2) 2299-3279

f (886-2) 2298-0488

www.tw.sgs.com

Member of SGS Group



Part 90\_Band 26\_1.4M\_64QAM\_LOW\_RB1,0

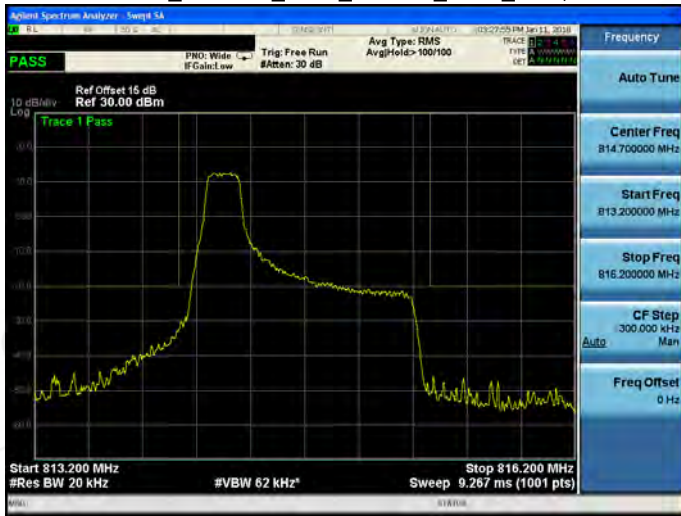

Part 90\_Band 26\_1.4M\_64QAM\_MID\_RB1,0

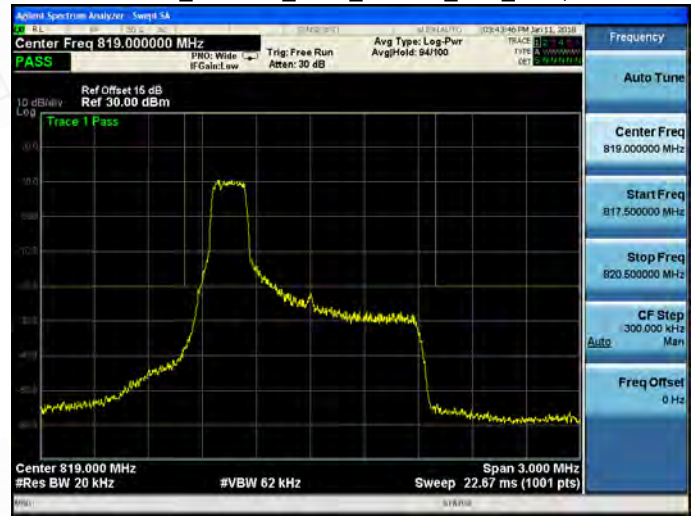

Part 90\_Band 26\_1.4M\_64QAM\_LOW\_RB1,5

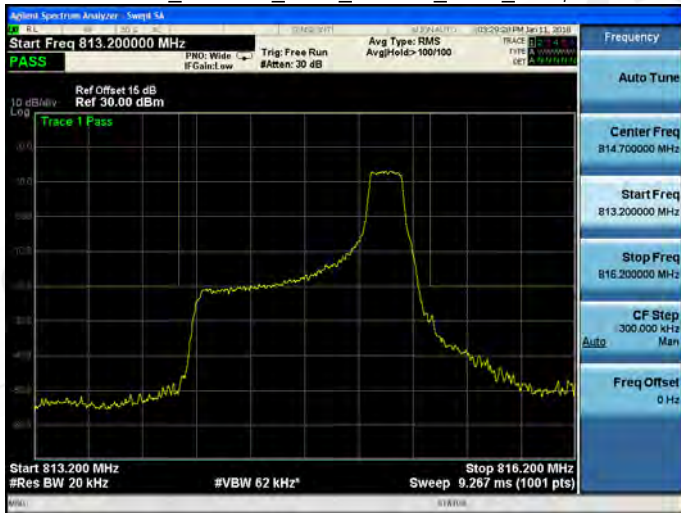

Part 90\_Band 26\_1.4M\_64QAM\_MID\_RB1,5

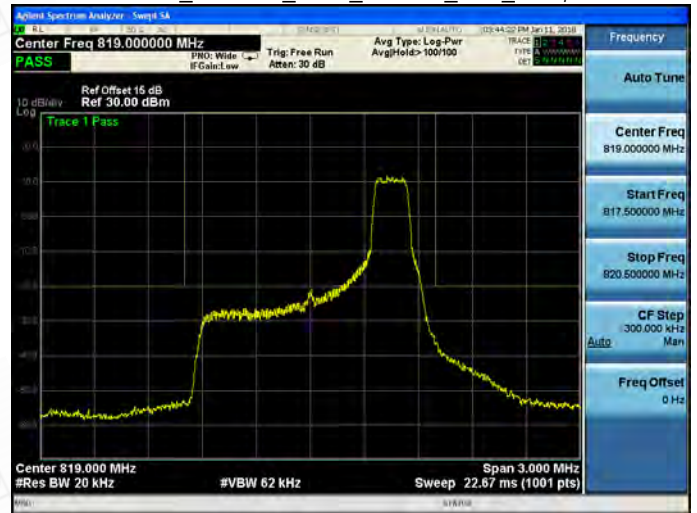

Part 90\_Band 26\_1.4M\_64QAM\_LOW\_RB6,0

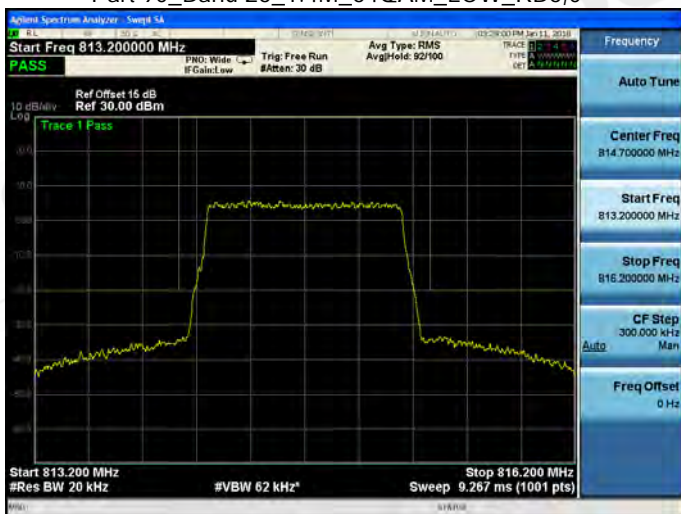

Part 90\_Band 26\_1.4M\_64QAM\_MID\_RB6,0



Unless otherwise stated the results shown in this test report refer only to the sample(s) tested and such sample(s) are retained for 90 days only. 除非另有說明，此報告結果僅對測試之樣品負責，同時此樣品僅保留90天。本報告未經本公司書面許可，不可部份複製。

This document is issued by the Company subject to its General Conditions of Service printed overleaf, available on request or accessible at [www.sgs.com/terms\\_and\\_conditions.htm](http://www.sgs.com/terms_and_conditions.htm) and, for electronic format documents, subject to Terms and Conditions for Electronic Documents at [www.sgs.com/terms\\_e-document.htm](http://www.sgs.com/terms_e-document.htm). Attention is drawn to the limitation of liability, indemnification and jurisdiction issues defined therein. Any holder of this document is advised that information contained hereon reflects the Company's findings at the time of its intervention only and within the limits of Client's instructions, if any. The Company's sole responsibility is to its Client and this document does not exonerate parties to a transaction from exercising all their rights and obligations under the transaction documents. This document cannot be reproduced except in full, without prior written approval of the Company. Any unauthorized alteration, forgery or falsification of the content or appearance of this document is unlawful and offenders may be prosecuted to the fullest extent of the law.



Part 90\_Band 26\_1.4M\_64QAM\_HIGH\_RB1,0

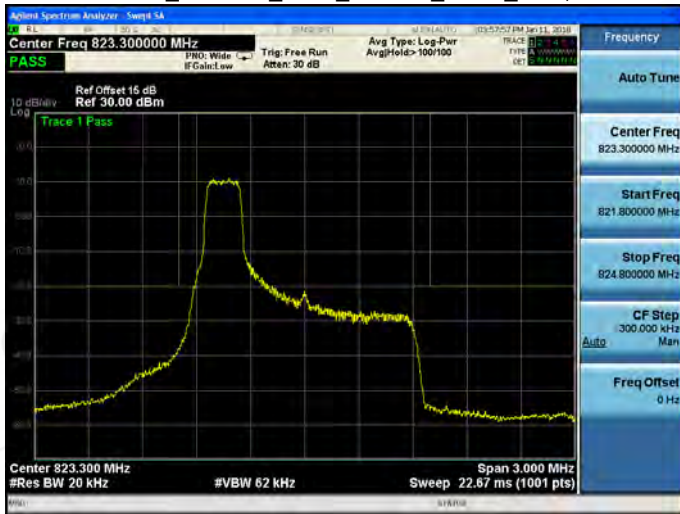

Part 90\_Band 26\_3M\_QPSK\_LOW\_RB1,0

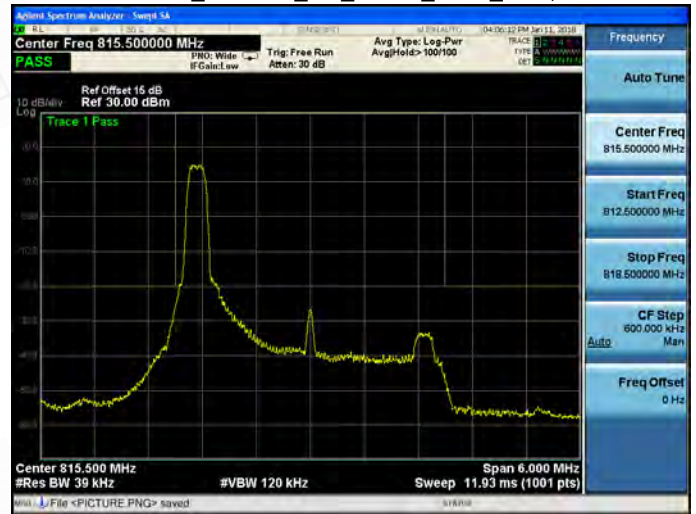

Part 90\_Band 26\_1.4M\_64QAM\_HIGH\_RB1,5

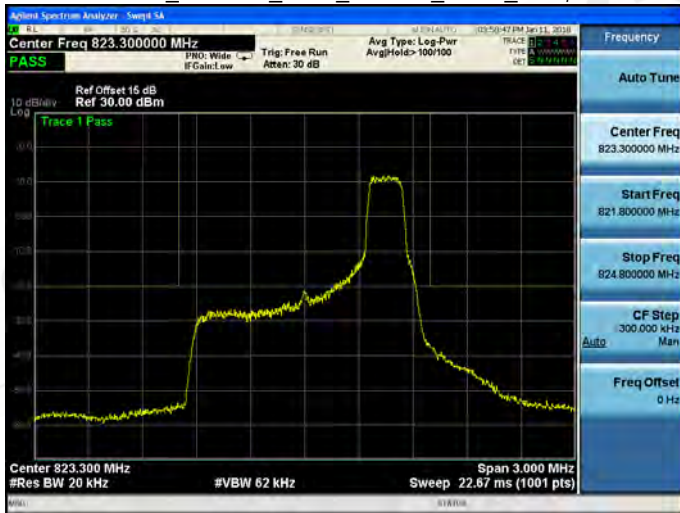

Part 90\_Band 26\_3M\_QPSK\_LOW\_RB1,14

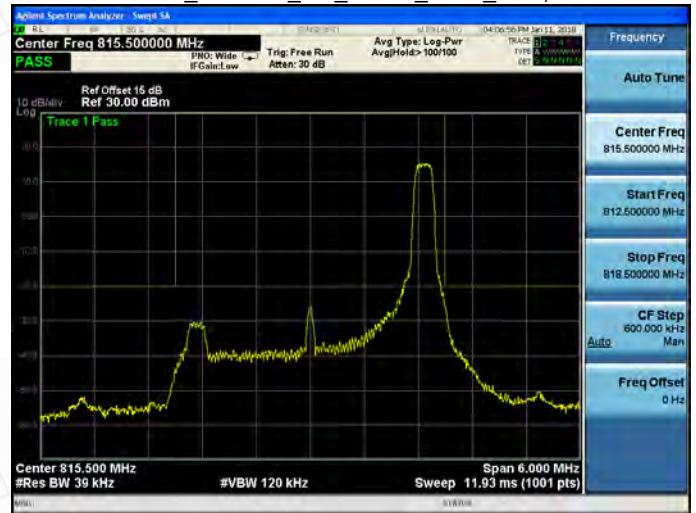

Part 90\_Band 26\_1.4M\_64QAM\_HIGH\_RB6,0

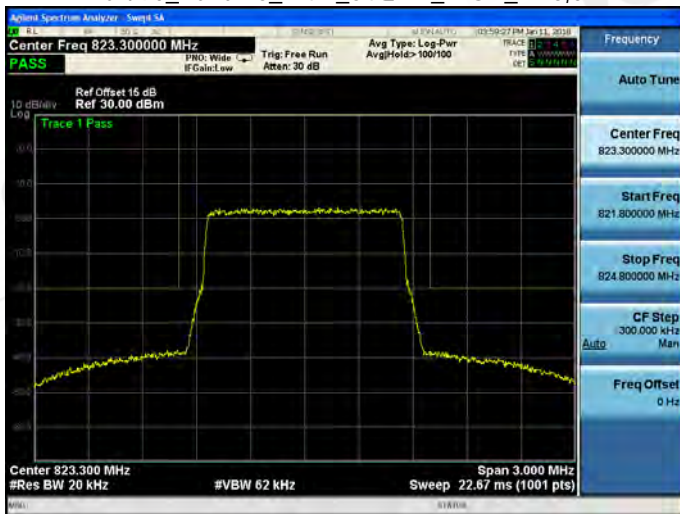

Part 90\_Band 26\_3M\_QPSK\_LOW\_RB15,0

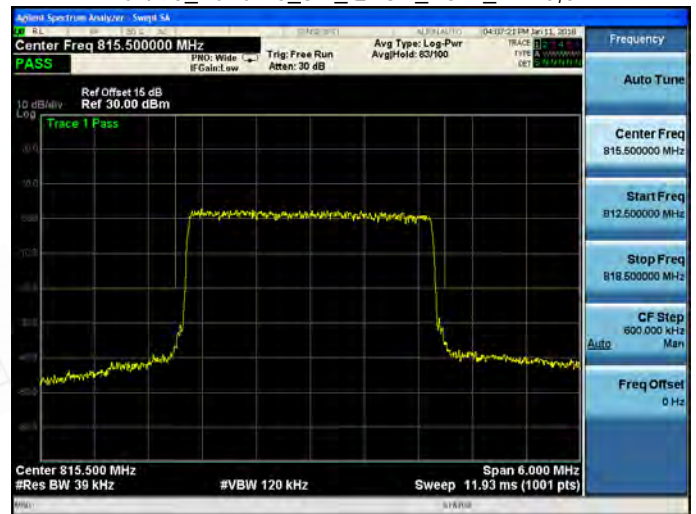

Unless otherwise stated the results shown in this test report refer only to the sample(s) tested and such sample(s) are retained for 90 days only.

除非另有說明，此報告結果僅對測試之樣品負責，同時此樣品僅保留90天。本報告未經本公司書面許可，不可部份複製。

This document is issued by the Company subject to its General Conditions of Service printed overleaf, available on request or accessible at [www.sgs.com/terms\\_and\\_conditions.htm](http://www.sgs.com/terms_and_conditions.htm) and, for electronic format documents, subject to Terms and Conditions for Electronic Documents at [www.sgs.com/terms\\_e-document.htm](http://www.sgs.com/terms_e-document.htm). Attention is drawn to the limitation of liability, indemnification and jurisdiction issues defined therein. Any holder of this document is advised that information contained herein reflects the Company's findings at the time of its intervention only and within the limits of Client's instructions, if any. The Company's sole responsibility is to its Client and this document does not exonerate parties to a transaction from exercising all their rights and obligations under the transaction documents. This document cannot be reproduced except in full, without prior written approval of the Company. Any unauthorized alteration, forgery or falsification of the content or appearance of this document is unlawful and offenders may be prosecuted to the fullest extent of the law.

SGS Taiwan Ltd.

No. 134, WuKungRoad, NewTaipeiIndustrialPark, WukuDistrict, NewTaipeiCity, Taiwan24803/新北市五股區新北產業園區五工路 134 號

台灣檢驗科技股份有限公司

t (886-2) 2299-3279

f (886-2) 2298-0488

www.tw.sgs.com

Member of SGS Group



Part 90\_Band 26\_3M\_QPSK\_MID\_RB1,0

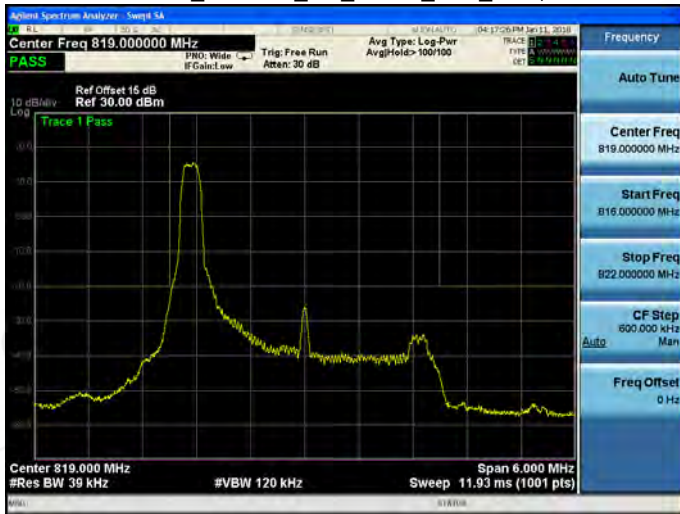

Part 90\_Band 26\_3M\_QPSK\_HIGH\_RB1,0

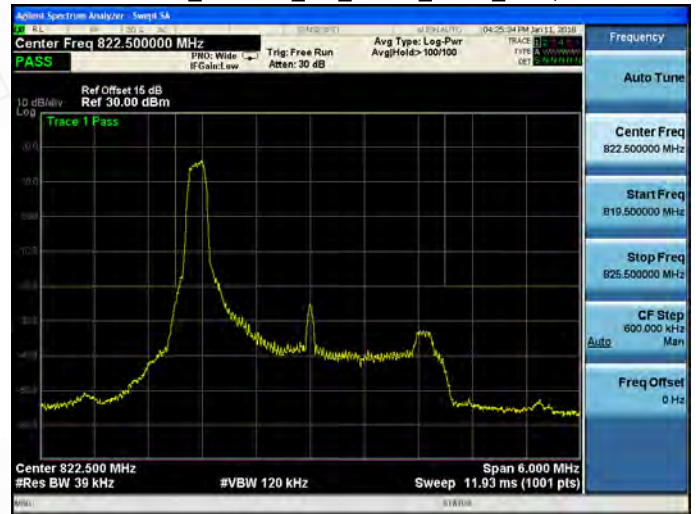

Part 90\_Band 26\_3M\_QPSK\_MID\_RB1,14

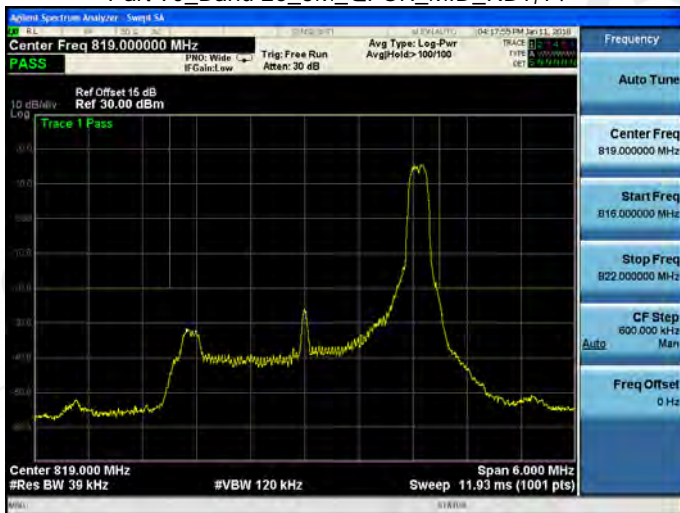

Part 90\_Band 26\_3M\_QPSK\_HIGH\_RB1,14

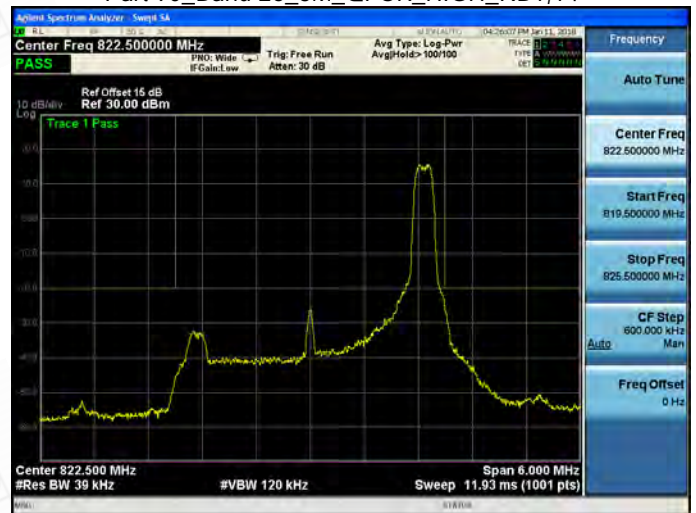

Part 90\_Band 26\_3M\_QPSK\_MID\_RB15,0

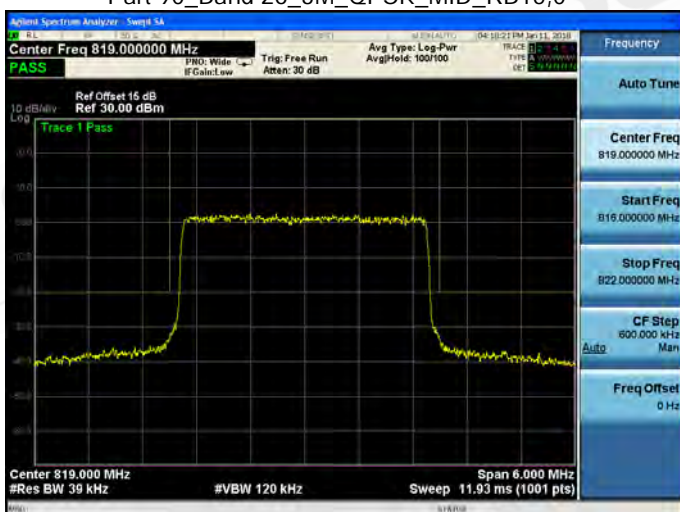

Part 90\_Band 26\_3M\_QPSK\_HIGH\_RB15,0



Unless otherwise stated the results shown in this test report refer only to the sample(s) tested and such sample(s) are retained for 90 days only.

除非另有說明，此報告結果僅對測試之樣品負責，同時此樣品僅保留90天。本報告未經本公司書面許可，不可部份複製。

This document is issued by the Company subject to its General Conditions of Service printed overleaf, available on request or accessible at [www.sgs.com/terms\\_and\\_conditions.htm](http://www.sgs.com/terms_and_conditions.htm) and, for electronic format documents, subject to Terms and Conditions for Electronic Documents at [www.sgs.com/terms\\_e-document.htm](http://www.sgs.com/terms_e-document.htm). Attention is drawn to the limitation of liability, indemnification and jurisdiction issues defined therein. Any holder of this document is advised that information contained herein reflects the Company's findings at the time of its intervention only and within the limits of Client's instructions, if any. The Company's sole responsibility is to its Client and this document does not exonerate parties to a transaction from exercising all their rights and obligations under the transaction documents. This document cannot be reproduced except in full, without prior written approval of the Company. Any unauthorized alteration, forgery or falsification of the content or appearance of this document is unlawful and offenders may be prosecuted to the fullest extent of the law.

SGS Taiwan Ltd.

No. 134, WuKungRoad, NewTaipeiIndustrialPark, WukuDistrict, NewTaipeiCity, Taiwan24803/新北市五股區新北產業園區五工路 134 號

台灣檢驗科技股份有限公司

t (886-2) 2299-3279

f (886-2) 2298-0488

www.tw.sgs.com

Member of SGS Group



Part 90\_Band 26\_3M\_16QAM\_LOW\_RB1,0

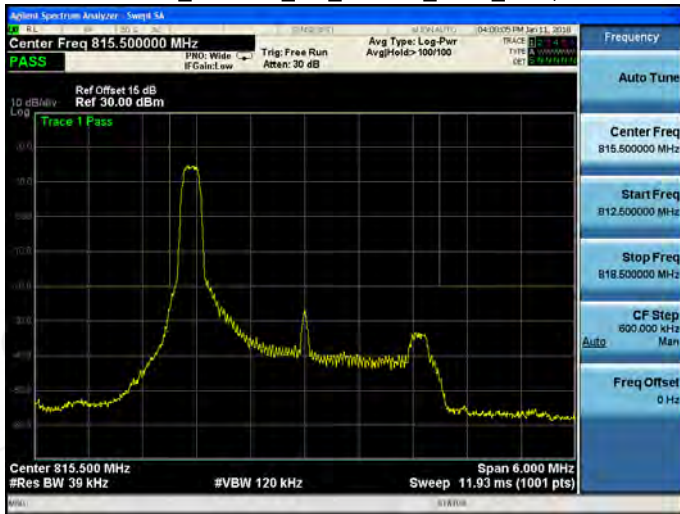

Part 90\_Band 26\_3M\_16QAM\_MID\_RB1,0

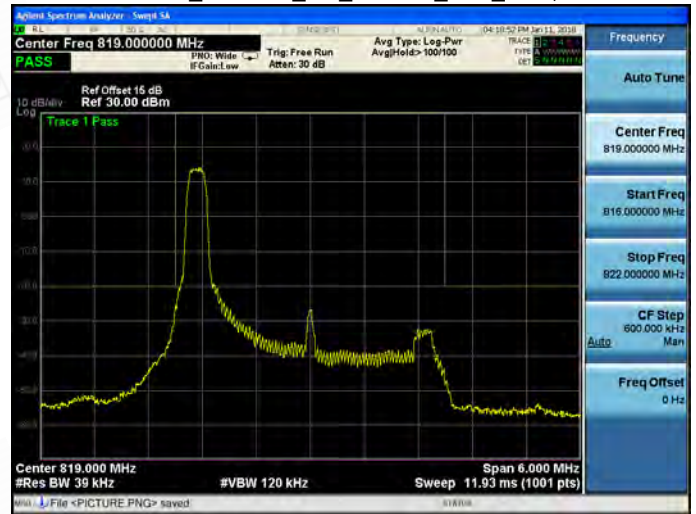

Part 90\_Band 26\_3M\_16QAM\_LOW\_RB1,14

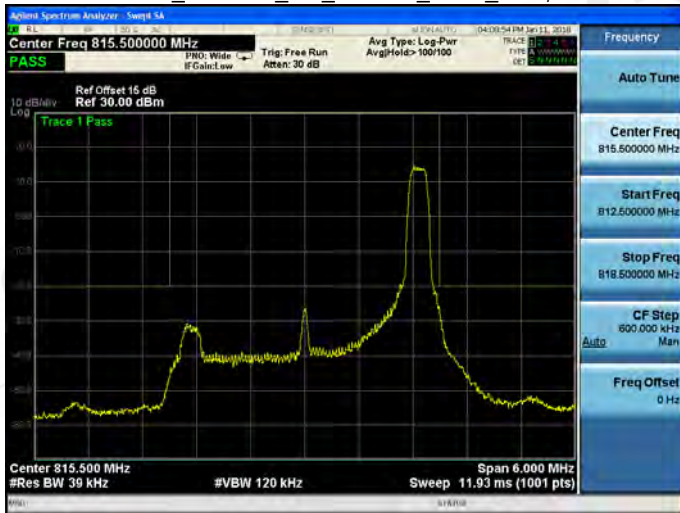

Part 90\_Band 26\_3M\_16QAM\_MID\_RB1,14

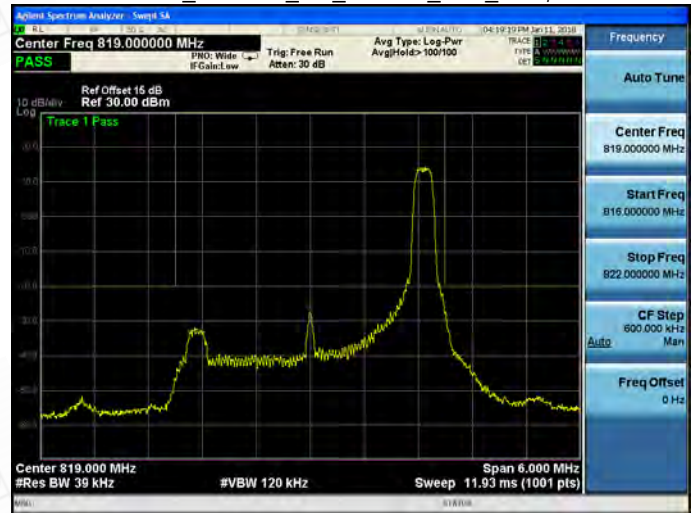

Part 90\_Band 26\_3M\_16QAM\_LOW\_RB15,0

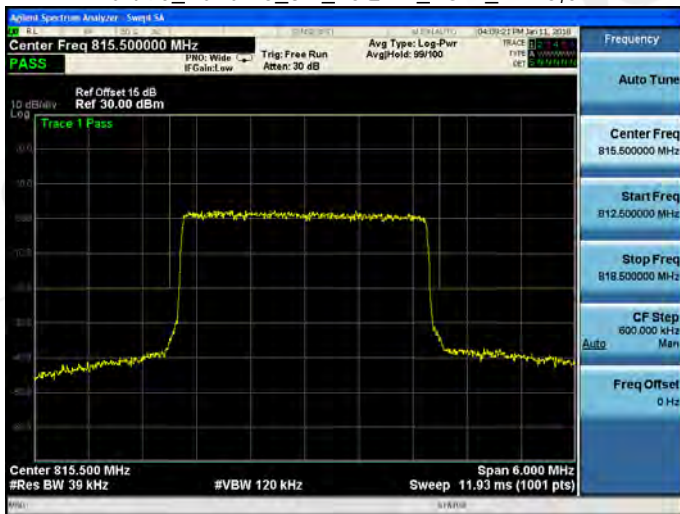

Part 90\_Band 26\_3M\_16QAM\_MID\_RB15,0



Unless otherwise stated the results shown in this test report refer only to the sample(s) tested and such sample(s) are retained for 90 days only.

除非另有說明，此報告結果僅對測試之樣品負責，同時此樣品僅保留90天。本報告未經本公司書面許可，不可部份複製。

This document is issued by the Company subject to its General Conditions of Service printed overleaf, available on request or accessible at [www.sgs.com/terms\\_and\\_conditions.htm](http://www.sgs.com/terms_and_conditions.htm) and, for electronic format documents, subject to Terms and Conditions for Electronic Documents at [www.sgs.com/terms\\_e-document.htm](http://www.sgs.com/terms_e-document.htm). Attention is drawn to the limitation of liability, indemnification and jurisdiction issues defined therein. Any holder of this document is advised that information contained hereon reflects the Company's findings at the time of its intervention only and within the limits of Client's instructions, if any. The Company's sole responsibility is to its Client and this document does not exonerate parties to a transaction from exercising all their rights and obligations under the transaction documents. This document cannot be reproduced except in full, without prior written approval of the Company. Any unauthorized alteration, forgery or falsification of the content or appearance of this document is unlawful and offenders may be prosecuted to the fullest extent of the law.

SGS Taiwan Ltd.

No. 134, WuKungRoad, NewTaipeiIndustrialPark, WukuDistrict, NewTaipeiCity, Taiwan24803/新北市五股區新北產業園區五工路 134 號

台灣檢驗科技股份有限公司

t (886-2) 2299-3279

f (886-2) 2298-0488

www.tw.sgs.com

Member of SGS Group



Part 90\_Band 26\_3M\_16QAM\_HIGH\_RB1,0

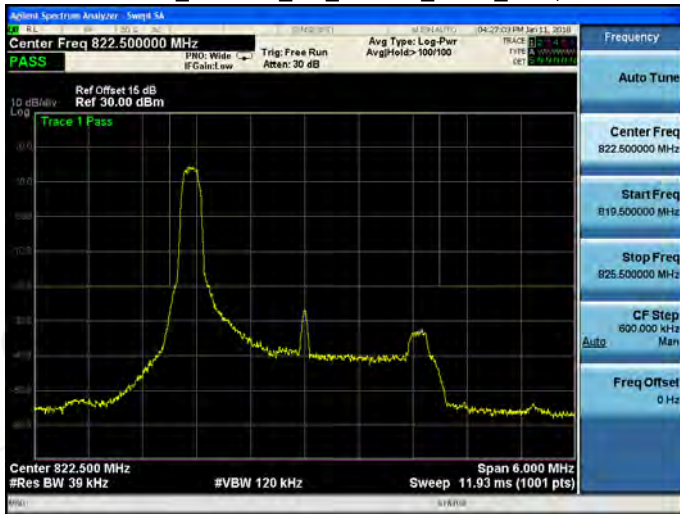

Part 90\_Band 26\_3M\_64QAM\_LOW\_RB1,0

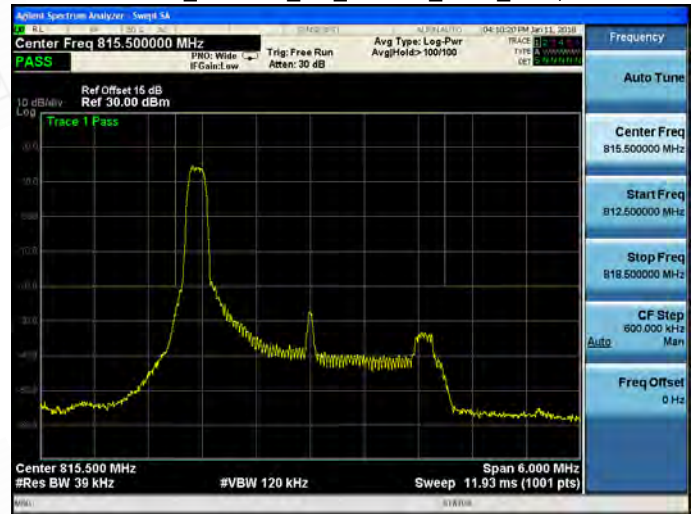

Part 90\_Band 26\_3M\_16QAM\_HIGH\_RB1,14

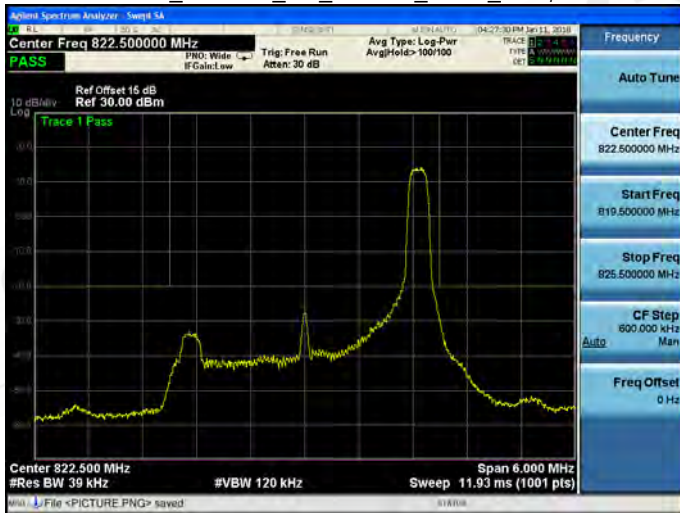

Part 90\_Band 26\_3M\_64QAM\_LOW\_RB1,14

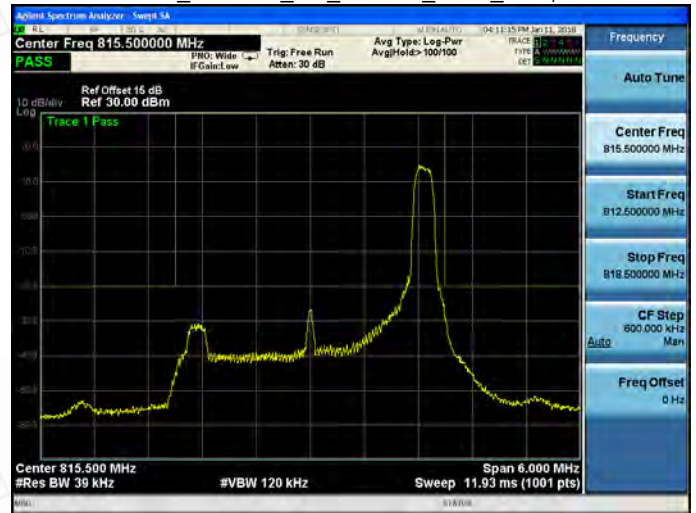

Part 90\_Band 26\_3M\_16QAM\_HIGH\_RB15,0

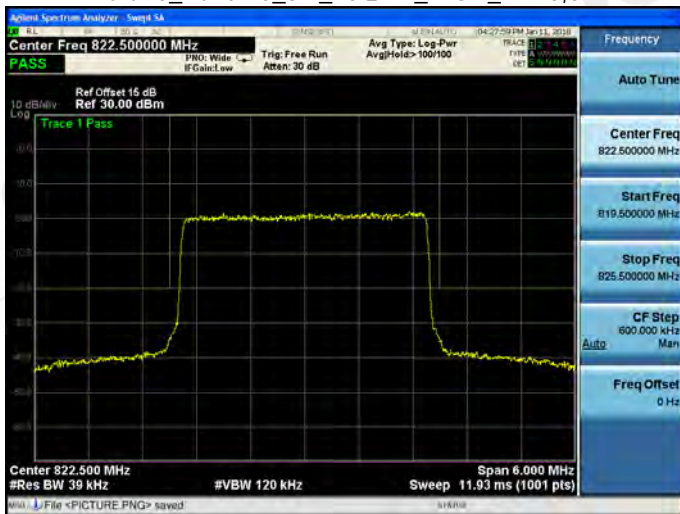

Part 90\_Band 26\_3M\_64QAM\_LOW\_RB15,0

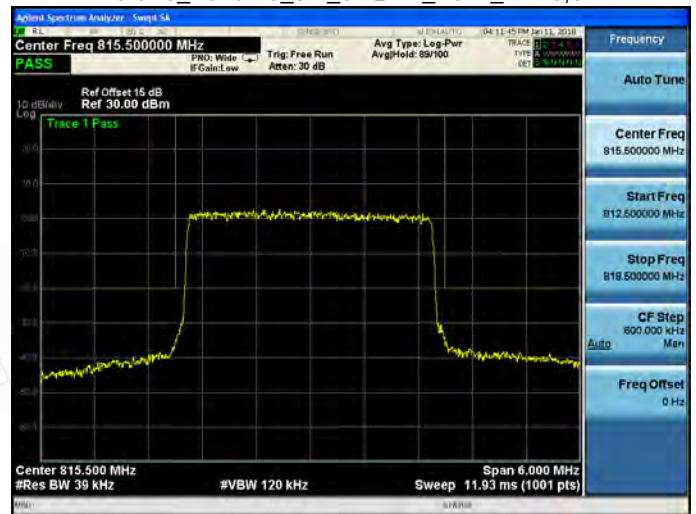

Unless otherwise stated the results shown in this test report refer only to the sample(s) tested and such sample(s) are retained for 90 days only.

除非另有說明，此報告結果僅對測試之樣品負責，同時此樣品僅保留90天。本報告未經本公司書面許可，不可部份複製。

This document is issued by the Company subject to its General Conditions of Service printed overleaf, available on request or accessible at [www.sgs.com/terms\\_and\\_conditions.htm](http://www.sgs.com/terms_and_conditions.htm) and, for electronic format documents, subject to Terms and Conditions for Electronic Documents at [www.sgs.com/terms\\_e-document.htm](http://www.sgs.com/terms_e-document.htm). Attention is drawn to the limitation of liability, indemnification and jurisdiction issues defined therein. Any holder of this document is advised that information contained hereon reflects the Company's findings at the time of its intervention only and within the limits of Client's instructions, if any. The Company's sole responsibility is to its Client and this document does not exonerate parties to a transaction from exercising all their rights and obligations under the transaction documents. This document cannot be reproduced except in full, without prior written approval of the Company. Any unauthorized alteration, forgery or falsification of the content or appearance of this document is unlawful and offenders may be prosecuted to the fullest extent of the law.

SGS Taiwan Ltd.

No. 134, WuKungRoad, NewTaipeiIndustrialPark, WukuDistrict, NewTaipeiCity, Taiwan24803/新北市五股區新北產業園區五工路 134 號

台灣檢驗科技股份有限公司

t (886-2) 2299-3279

f (886-2) 2298-0488

www.tw.sgs.com

Member of SGS Group



Part 90\_Band 26\_3M\_64QAM\_MID\_RB1,0

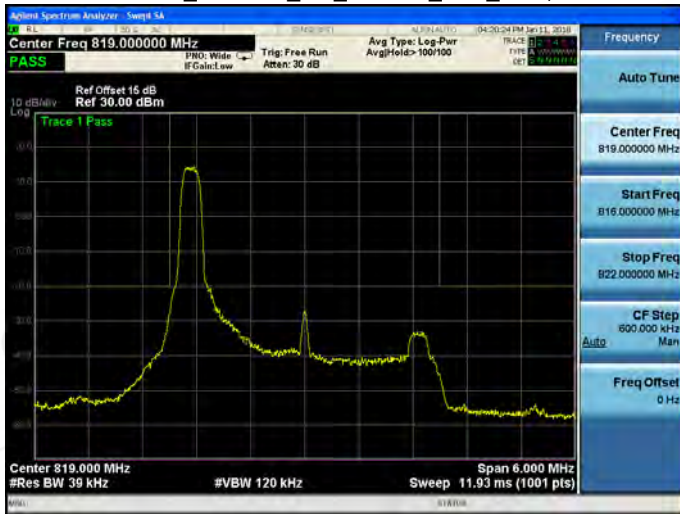

Part 90\_Band 26\_3M\_16QAM\_HIGH\_RB1,0

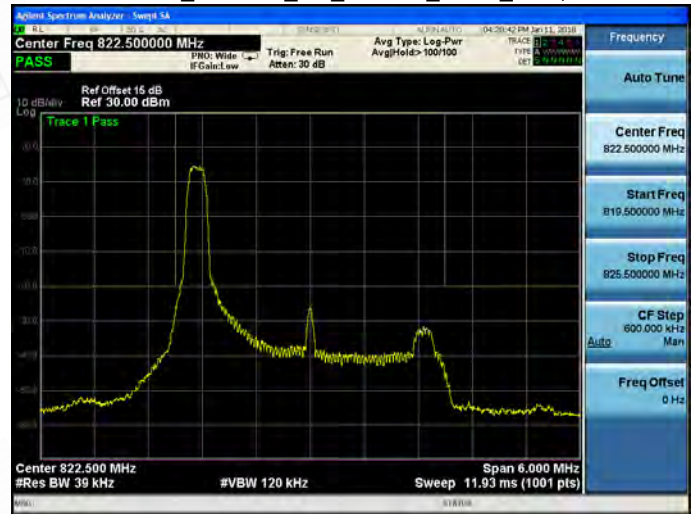

Part 90\_Band 26\_3M\_64QAM\_MID\_RB1,14

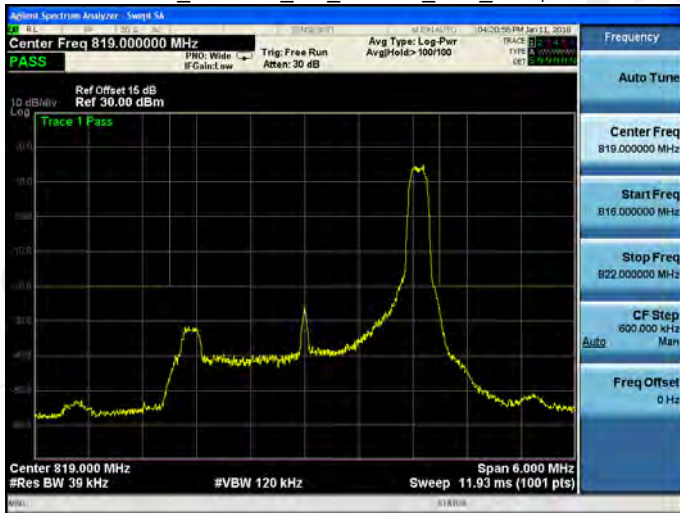

Part 90\_Band 26\_3M\_16QAM\_HIGH\_RB1,14

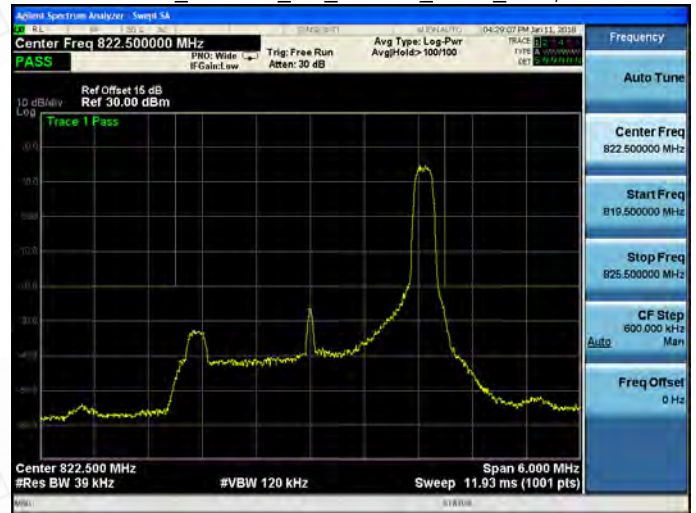

Part 90\_Band 26\_3M\_64QAM\_MID\_RB15,0



Part 90\_Band 26\_3M\_16QAM\_HIGH\_RB15,0



Unless otherwise stated the results shown in this test report refer only to the sample(s) tested and such sample(s) are retained for 90 days only.

除非另有說明，此報告結果僅對測試之樣品負責，同時此樣品僅保留90天。本報告未經本公司書面許可，不可部份複製。

This document is issued by the Company subject to its General Conditions of Service printed overleaf, available on request or accessible at [www.sgs.com/terms\\_and\\_conditions.htm](http://www.sgs.com/terms_and_conditions.htm) and, for electronic format documents, subject to Terms and Conditions for Electronic Documents at [www.sgs.com/terms\\_e-document.htm](http://www.sgs.com/terms_e-document.htm). Attention is drawn to the limitation of liability, indemnification and jurisdiction issues defined therein. Any holder of this document is advised that information contained herein reflects the Company's findings at the time of its intervention only and within the limits of Client's instructions, if any. The Company's sole responsibility is to its Client and this document does not exonerate parties to a transaction from exercising all their rights and obligations under the transaction documents. This document cannot be reproduced except in full, without prior written approval of the Company. Any unauthorized alteration, forgery or falsification of the content or appearance of this document is unlawful and offenders may be prosecuted to the fullest extent of the law.

SGS Taiwan Ltd.

No. 134, WuKungRoad, NewTaipeiIndustrialPark, WukuDistrict, NewTaipeiCity, Taiwan24803/新北市五股區新北產業園區五工路 134 號

台灣檢驗科技股份有限公司

t (886-2) 2299-3279

f (886-2) 2298-0488

www.tw.sgs.com

Member of SGS Group



Part 90\_Band 26\_5M\_QPSK\_LOW\_RB1,0

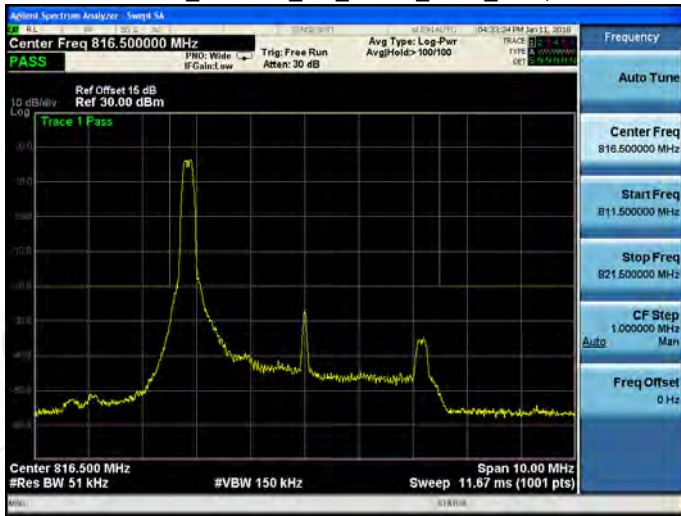

Part 90\_Band 26\_5M\_QPSK\_MID\_RB1,0

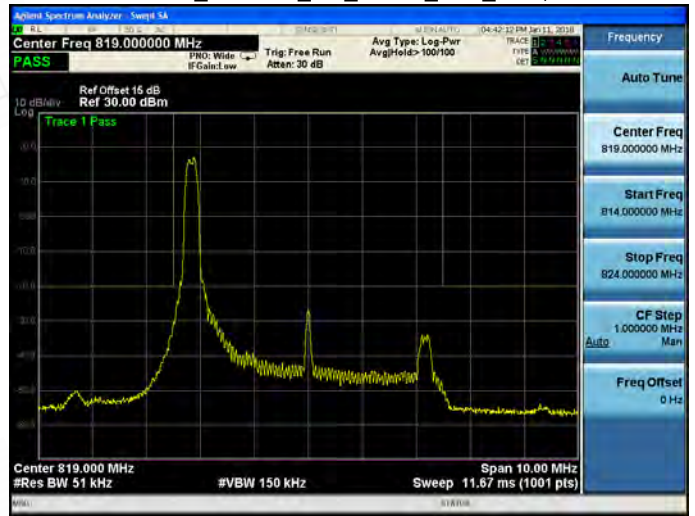

Part 90\_Band 26\_5M\_QPSK\_LOW\_RB1,24

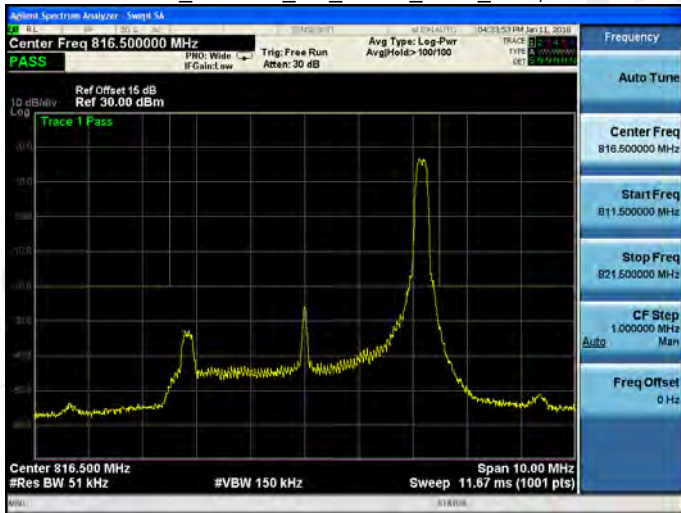

Part 90\_Band 26\_5M\_QPSK\_MID\_RB1,24

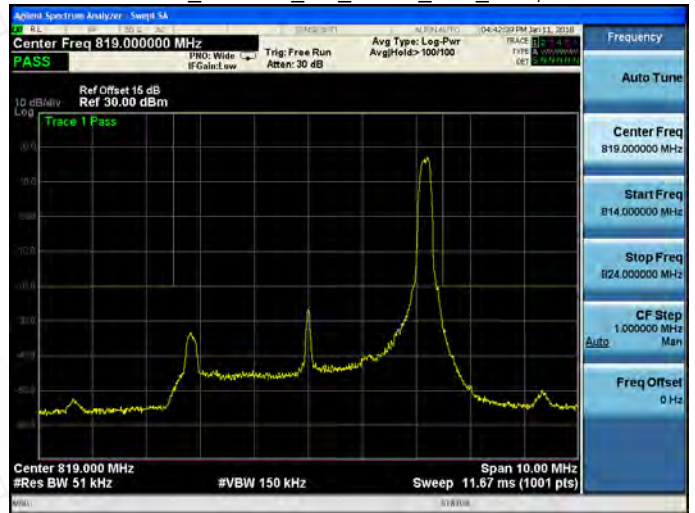

Part 90\_Band 26\_5M\_QPSK\_LOW\_RB25,0

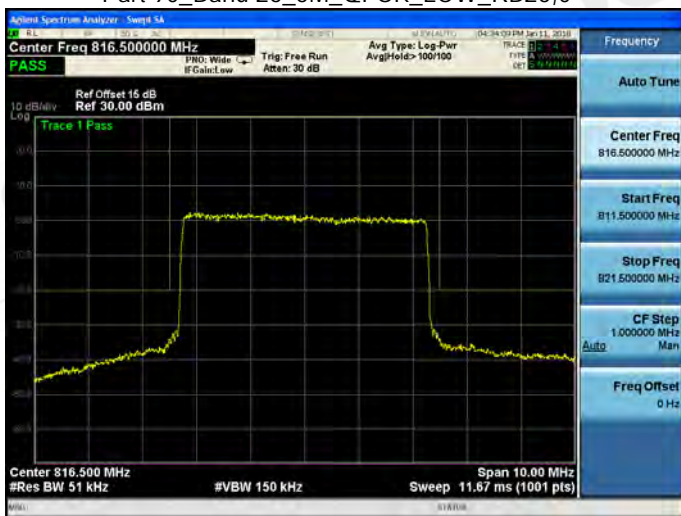

Part 90\_Band 26\_5M\_QPSK\_MID\_RB25,0

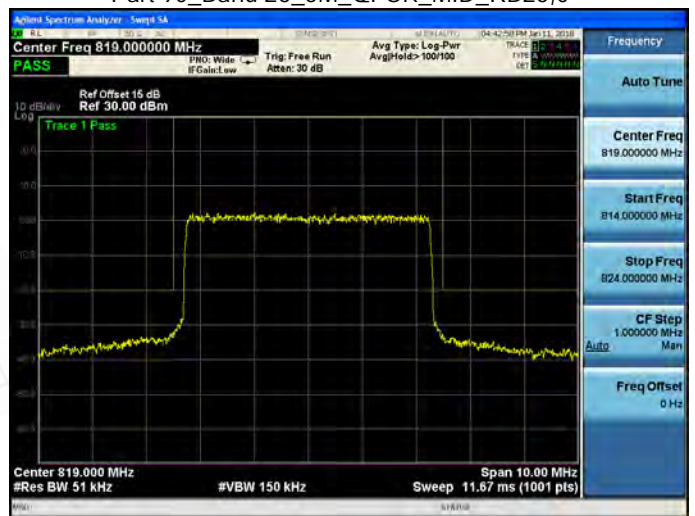

Unless otherwise stated the results shown in this test report refer only to the sample(s) tested and such sample(s) are retained for 90 days only.

除非另有說明，此報告結果僅對測試之樣品負責，同時此樣品僅保留90天。本報告未經本公司書面許可，不可部份複製。

This document is issued by the Company subject to its General Conditions of Service printed overleaf, available on request or accessible at [www.sgs.com/terms\\_and\\_conditions.htm](http://www.sgs.com/terms_and_conditions.htm) and, for electronic format documents, subject to Terms and Conditions for Electronic Documents at [www.sgs.com/terms\\_e-document.htm](http://www.sgs.com/terms_e-document.htm). Attention is drawn to the limitation of liability, indemnification and jurisdiction issues defined therein. Any holder of this document is advised that information contained hereon reflects the Company's findings at the time of its intervention only and within the limits of Client's instructions, if any. The Company's sole responsibility is to its Client and this document does not exonerate parties to a transaction from exercising all their rights and obligations under the transaction documents. This document cannot be reproduced except in full, without prior written approval of the Company. Any unauthorized alteration, forgery or falsification of the content or appearance of this document is unlawful and offenders may be prosecuted to the fullest extent of the law.

SGS Taiwan Ltd.

No. 134, WuKungRoad, NewTaipeiIndustrialPark, WuKuDistrict, NewTaipeiCity, Taiwan24803/新北市五股區新北產業園區五工路 134 號

台灣檢驗科技股份有限公司

t (886-2) 2299-3279

f (886-2) 2298-0488

www.tw.sgs.com

Member of SGS Group



Part 90\_Band 26\_5M\_QPSK\_HIGH\_RB1,0

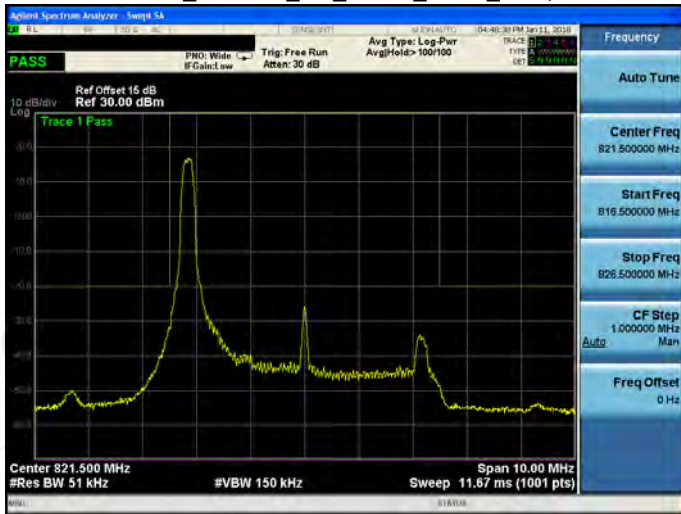

Part 90\_Band 26\_5M\_16QAM\_LOW\_RB1,0

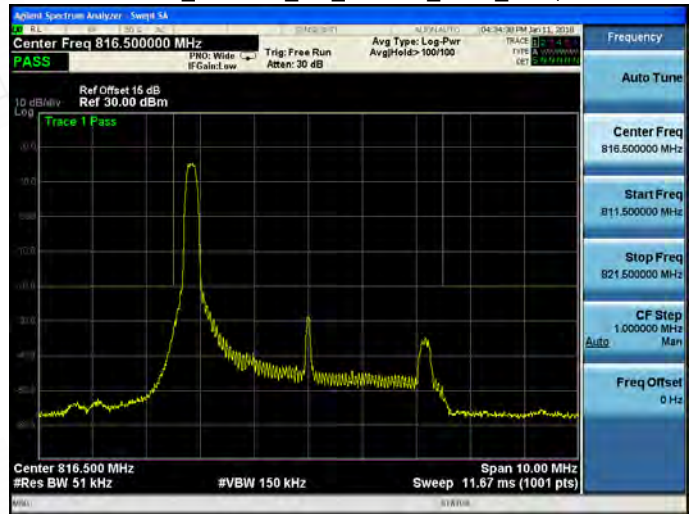

Part 90\_Band 26\_5M\_QPSK\_HIGH\_RB1,24

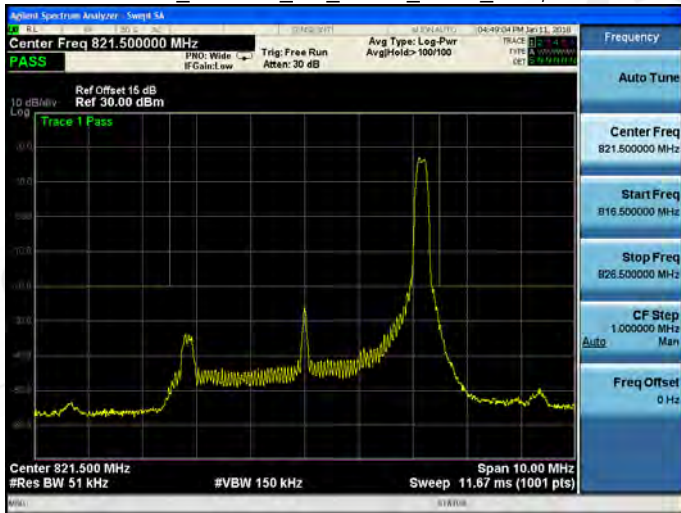

Part 90\_Band 26\_5M\_16QAM\_LOW\_RB1,24

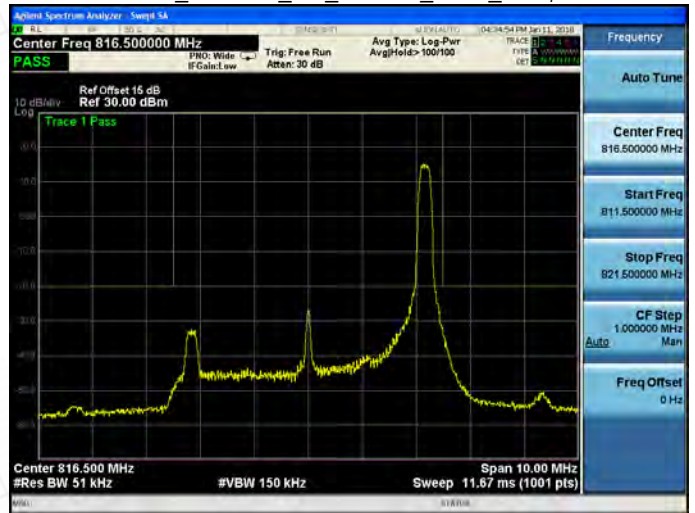

Part 90\_Band 26\_5M\_QPSK\_HIGH\_RB25,0

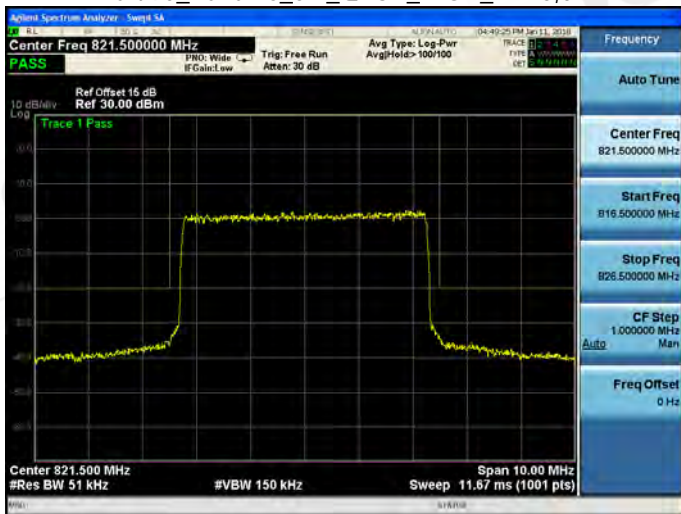

Part 90\_Band 26\_5M\_16QAM\_LOW\_RB25,0

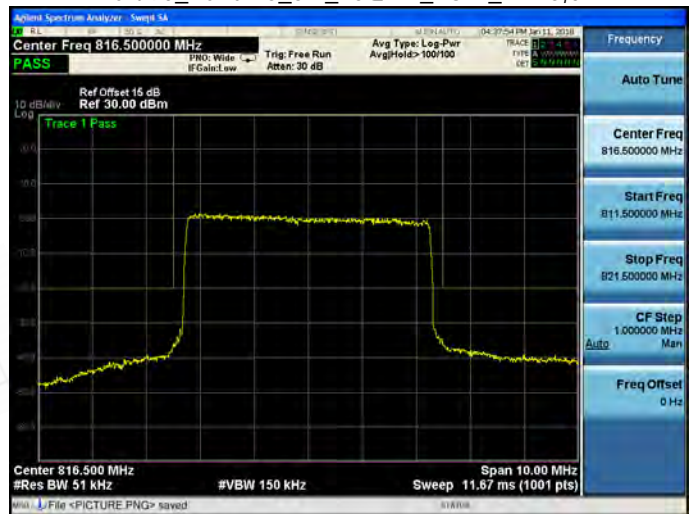

Unless otherwise stated the results shown in this test report refer only to the sample(s) tested and such sample(s) are retained for 90 days only.

除非另有說明，此報告結果僅對測試之樣品負責，同時此樣品僅保留90天。本報告未經本公司書面許可，不可部份複製。

This document is issued by the Company subject to its General Conditions of Service printed overleaf, available on request or accessible at [www.sgs.com/terms\\_and\\_conditions.htm](http://www.sgs.com/terms_and_conditions.htm) and, for electronic format documents, subject to Terms and Conditions for Electronic Documents at [www.sgs.com/terms\\_e-document.htm](http://www.sgs.com/terms_e-document.htm). Attention is drawn to the limitation of liability, indemnification and jurisdiction issues defined therein. Any holder of this document is advised that information contained herein reflects the Company's findings at the time of its intervention only and within the limits of Client's instructions, if any. The Company's sole responsibility is to its Client and this document does not exonerate parties to a transaction from exercising all their rights and obligations under the transaction documents. This document cannot be reproduced except in full, without prior written approval of the Company. Any unauthorized alteration, forgery or falsification of the content or appearance of this document is unlawful and offenders may be prosecuted to the fullest extent of the law.

SGS Taiwan Ltd.

No. 134, WuKungRoad, NewTaipeiIndustrialPark, WukuDistrict, NewTaipeiCity, Taiwan24803/新北市五股區新北產業園區五工路 134 號

台灣檢驗科技股份有限公司

t (886-2) 2299-3279

f (886-2) 2298-0488

www.tw.sgs.com

Member of SGS Group



Part 90\_Band 26\_5M\_16QAM\_MID\_RB1,0

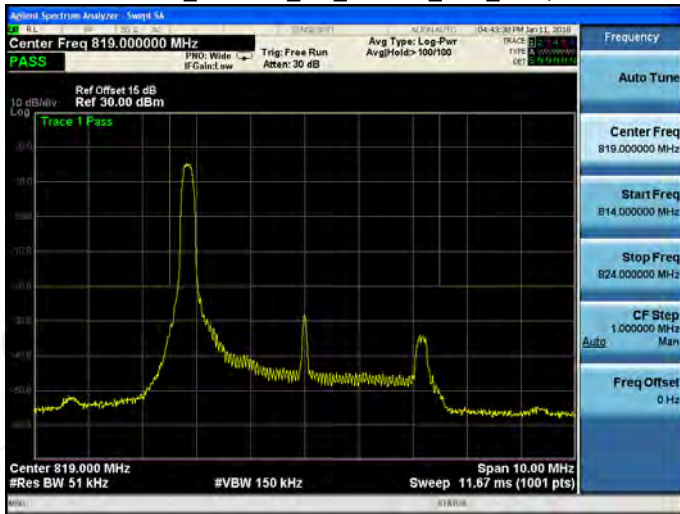

Part 90\_Band 26\_5M\_16QAM\_HIGH\_RB1,0

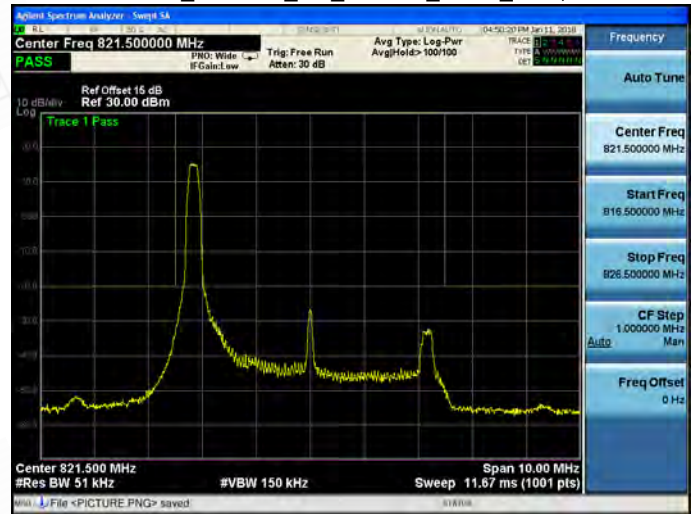

Part 90\_Band 26\_5M\_16QAM\_MID\_RB1,24

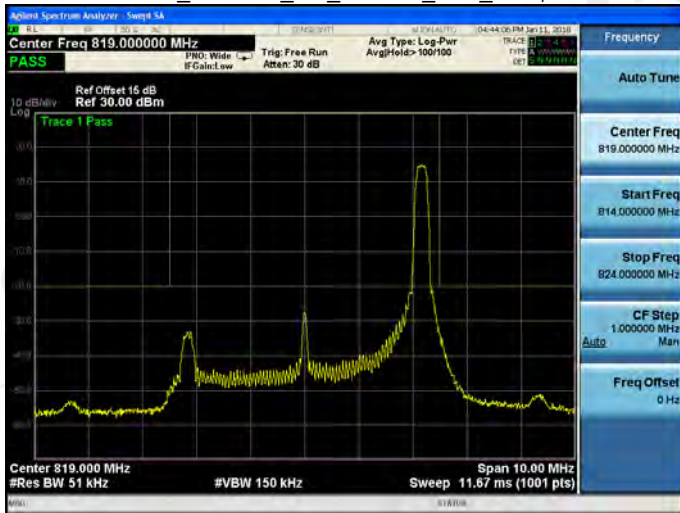

Part 90\_Band 26\_5M\_16QAM\_HIGH\_RB1,24

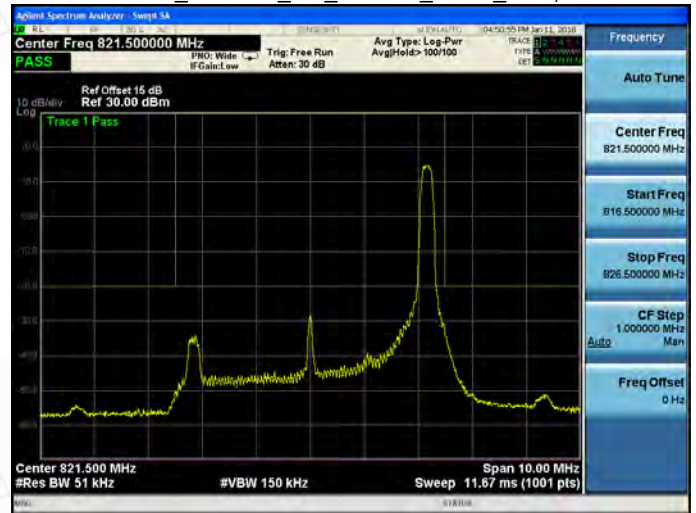

Part 90\_Band 26\_5M\_16QAM\_MID\_RB25,0

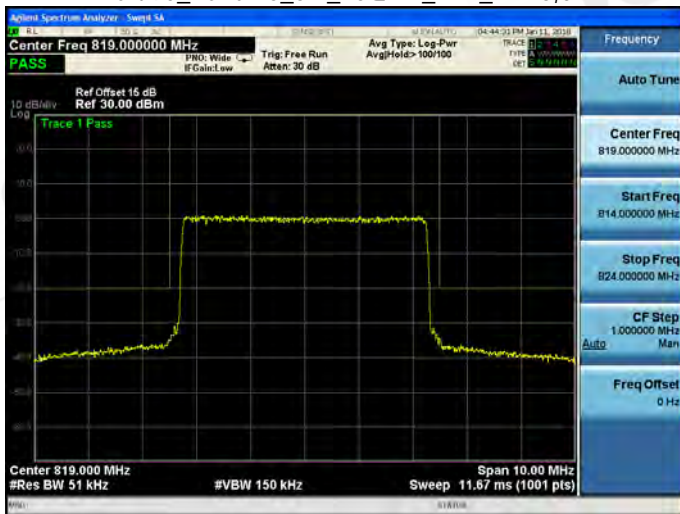

Part 90\_Band 26\_5M\_16QAM\_HIGH\_RB25,0

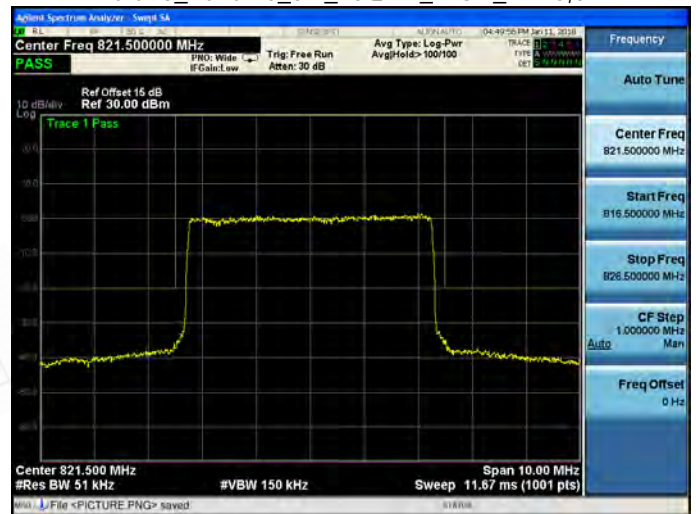

Unless otherwise stated the results shown in this test report refer only to the sample(s) tested and such sample(s) are retained for 90 days only.

除非另有說明，此報告結果僅對測試之樣品負責，同時此樣品僅保留90天。本報告未經本公司書面許可，不可部份複製。

This document is issued by the Company subject to its General Conditions of Service printed overleaf, available on request or accessible at [www.sgs.com/terms\\_and\\_conditions.htm](http://www.sgs.com/terms_and_conditions.htm) and, for electronic format documents, subject to Terms and Conditions for Electronic Documents at [www.sgs.com/terms\\_e-document.htm](http://www.sgs.com/terms_e-document.htm). Attention is drawn to the limitation of liability, indemnification and jurisdiction issues defined therein. Any holder of this document is advised that information contained hereon reflects the Company's findings at the time of its intervention only and within the limits of Client's instructions, if any. The Company's sole responsibility is to its Client and this document does not exonerate parties to a transaction from exercising all their rights and obligations under the transaction documents. This document cannot be reproduced except in full, without prior written approval of the Company. Any unauthorized alteration, forgery or falsification of the content or appearance of this document is unlawful and offenders may be prosecuted to the fullest extent of the law.

SGS Taiwan Ltd.

No. 134, WuKungRoad, NewTaipeiIndustrialPark, WukuDistrict, NewTaipeiCity, Taiwan24803/新北市五股區新北產業園區五工路 134 號

台灣檢驗科技股份有限公司

t (886-2) 2299-3279

f (886-2) 2298-0488

www.tw.sgs.com

Member of SGS Group



Part 90\_Band 26\_5M\_64QAM\_LOW\_RB1,0

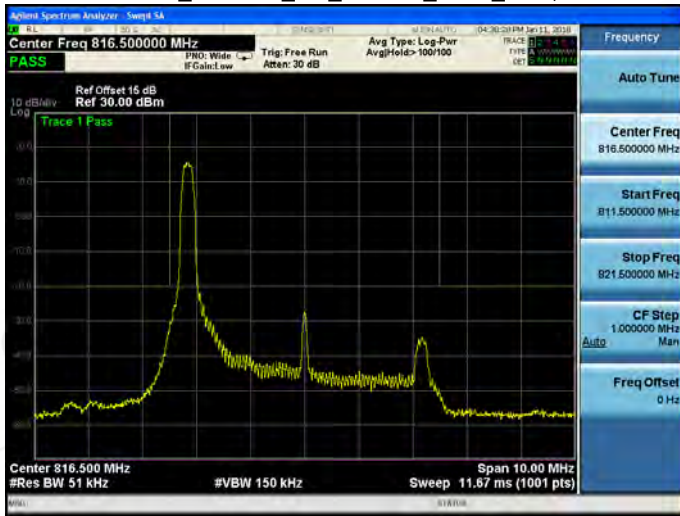

Part 90\_Band 26\_5M\_64QAM\_MID\_RB1,0

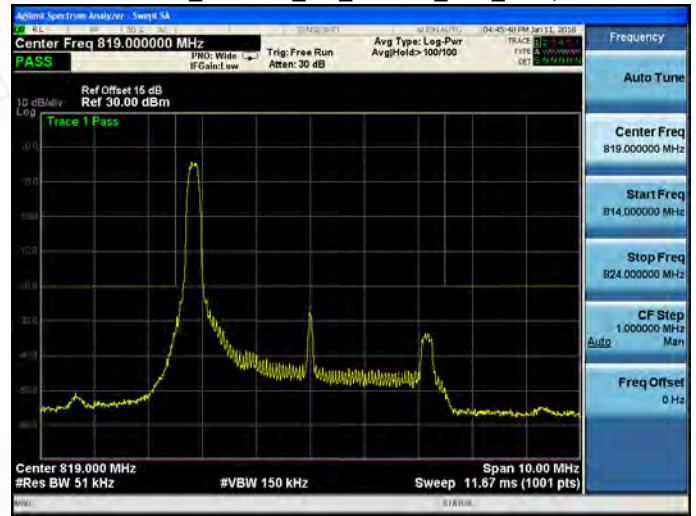

Part 90\_Band 26\_5M\_64QAM\_LOW\_RB1,24

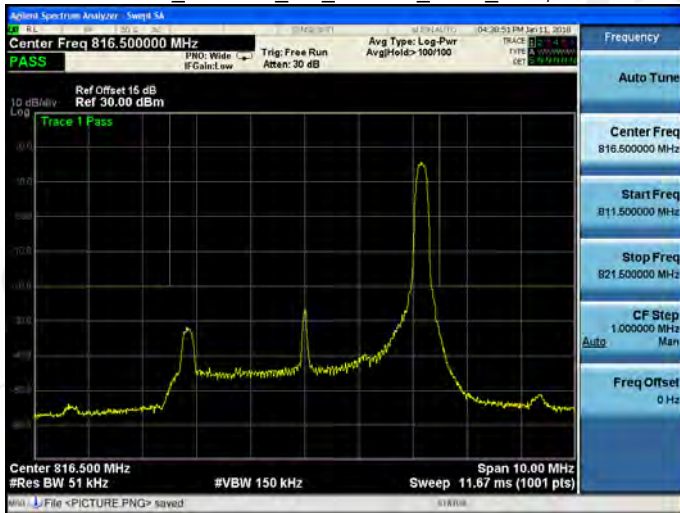

Part 90\_Band 26\_5M\_64QAM\_MID\_RB1,24

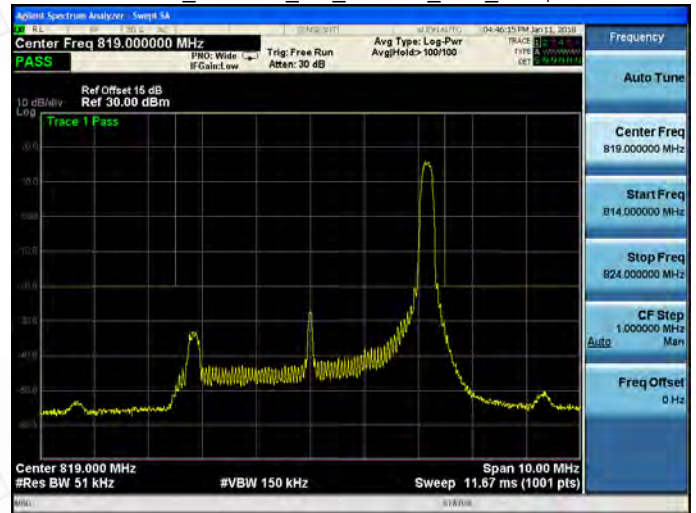

Part 90\_Band 26\_5M\_64QAM\_LOW\_RB25,0

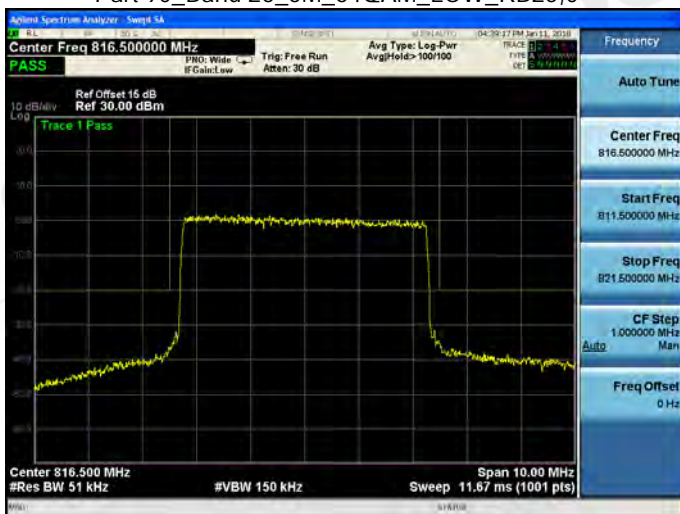

Part 90\_Band 26\_5M\_64QAM\_MID\_RB25,0



Unless otherwise stated the results shown in this test report refer only to the sample(s) tested and such sample(s) are retained for 90 days only.

除非另有說明，此報告結果僅對測試之樣品負責，同時此樣品僅保留90天。本報告未經本公司書面許可，不可部份複製。

This document is issued by the Company subject to its General Conditions of Service printed overleaf, available on request or accessible at [www.sgs.com/terms\\_and\\_conditions.htm](http://www.sgs.com/terms_and_conditions.htm) and, for electronic format documents, subject to Terms and Conditions for Electronic Documents at [www.sgs.com/terms\\_e-document.htm](http://www.sgs.com/terms_e-document.htm). Attention is drawn to the limitation of liability, indemnification and jurisdiction issues defined therein. Any holder of this document is advised that information contained herein reflects the Company's findings at the time of its intervention only and within the limits of Client's instructions, if any. The Company's sole responsibility is to its Client and this document does not exonerate parties to a transaction from exercising all their rights and obligations under the transaction documents. This document cannot be reproduced except in full, without prior written approval of the Company. Any unauthorized alteration, forgery or falsification of the content or appearance of this document is unlawful and offenders may be prosecuted to the fullest extent of the law.

SGS Taiwan Ltd.

No. 134, WuKungRoad, NewTaipeiIndustrialPark, WukuDistrict, NewTaipeiCity, Taiwan24803/新北市五股區新北產業園區五工路 134 號

台灣檢驗科技股份有限公司

t (886-2) 2299-3279

f (886-2) 2298-0488

www.tw.sgs.com

Member of SGS Group



Part 90\_Band 26\_5M\_16QAM\_HIGH\_RB1,0

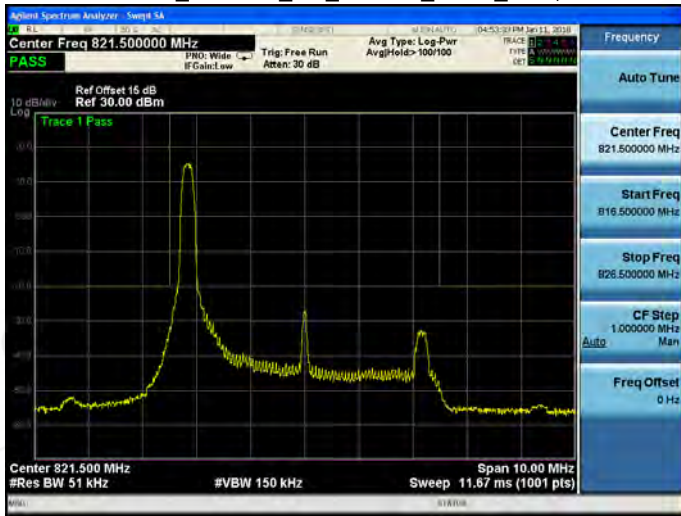

Part 90\_Band 26\_10M\_QPSK\_MID\_RB1,0

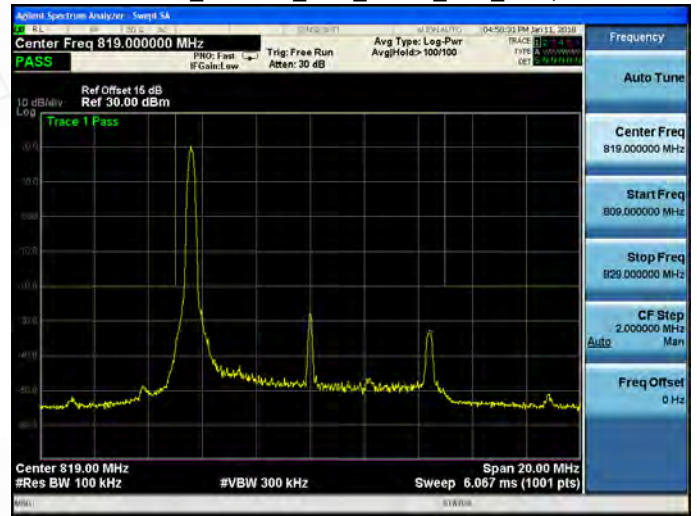

Part 90\_Band 26\_5M\_64QAM\_HIGH\_RB1,24

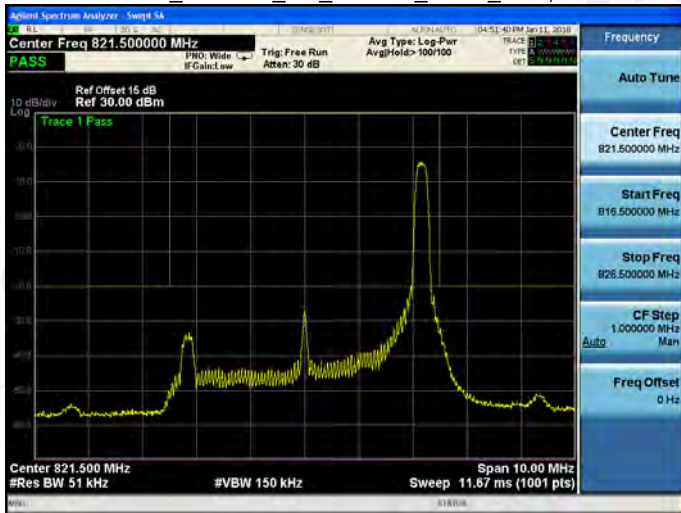

Part 90\_Band 26\_10M\_QPSK\_MID\_RB1,49

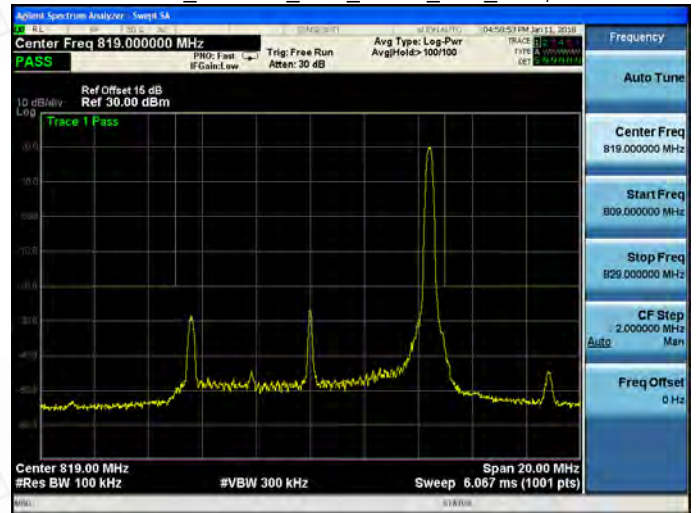

Part 90\_Band 26\_5M\_64QAM\_HIGH\_RB25,0

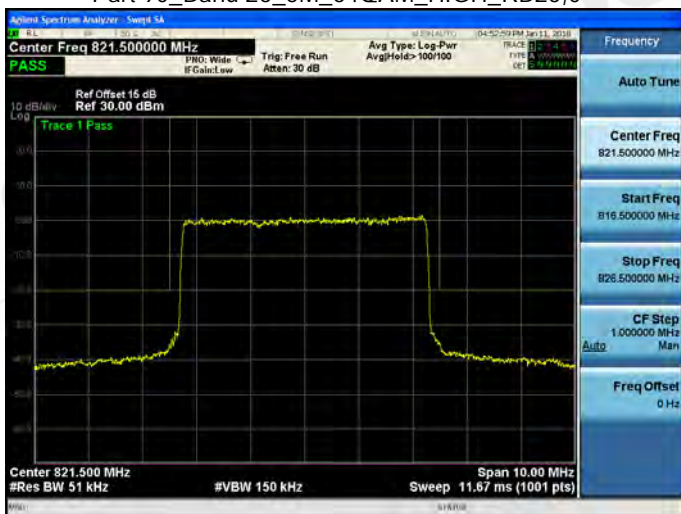

Part 90\_Band 26\_10M\_QPSK\_MID\_RB50,0



Unless otherwise stated the results shown in this test report refer only to the sample(s) tested and such sample(s) are retained for 90 days only.

除非另有說明，此報告結果僅對測試之樣品負責，同時此樣品僅保留90天。本報告未經本公司書面許可，不可部份複製。

This document is issued by the Company subject to its General Conditions of Service printed overleaf, available on request or accessible at [www.sgs.com/terms\\_and\\_conditions.htm](http://www.sgs.com/terms_and_conditions.htm) and, for electronic format documents, subject to Terms and Conditions for Electronic Documents at [www.sgs.com/terms\\_e-document.htm](http://www.sgs.com/terms_e-document.htm). Attention is drawn to the limitation of liability, indemnification and jurisdiction issues defined therein. Any holder of this document is advised that information contained herein reflects the Company's findings at the time of its intervention only and within the limits of Client's instructions, if any. The Company's sole responsibility is to its Client and this document does not exonerate parties to a transaction from exercising all their rights and obligations under the transaction documents. This document cannot be reproduced except in full, without prior written approval of the Company. Any unauthorized alteration, forgery or falsification of the content or appearance of this document is unlawful and offenders may be prosecuted to the fullest extent of the law.



Part 90\_Band 26\_10M\_16QAM\_MID\_RB1,0

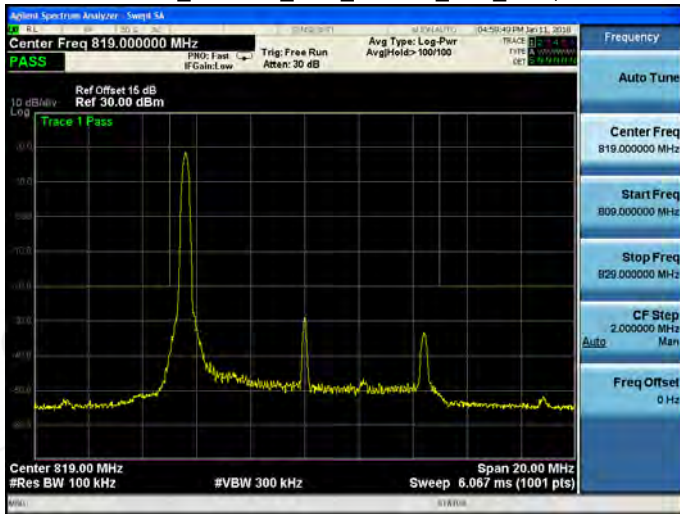

Part 90\_Band 26\_10M\_64QAM\_MID\_RB1,0

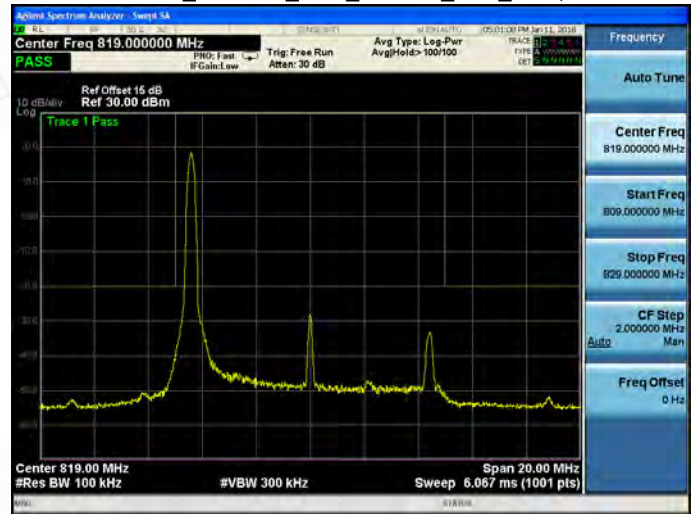

Part 90\_Band 26\_10M\_16QAM\_MID\_RB1,49

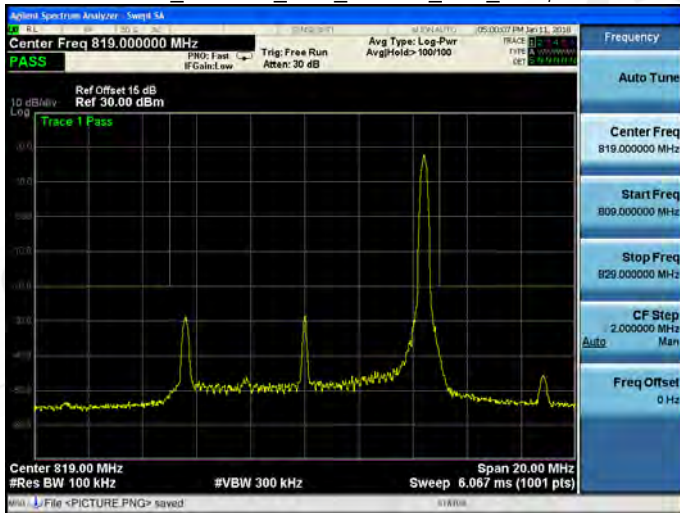

Part 90\_Band 26\_10M\_64QAM\_MID\_RB1,49

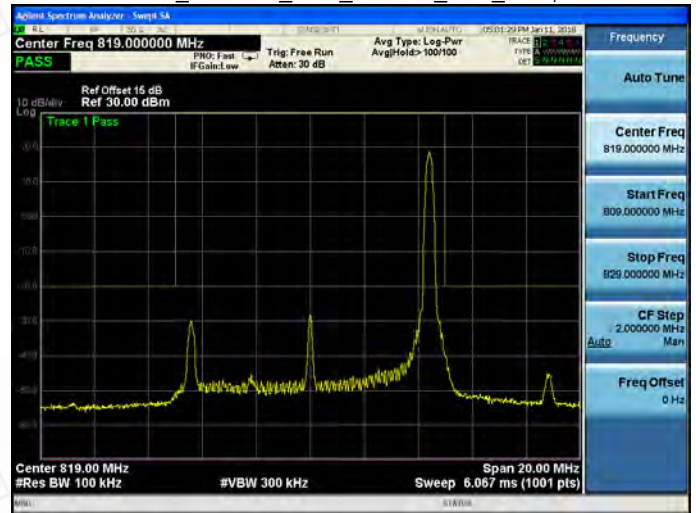

Part 90\_Band 26\_10M\_16QAM\_MID\_RB50,0

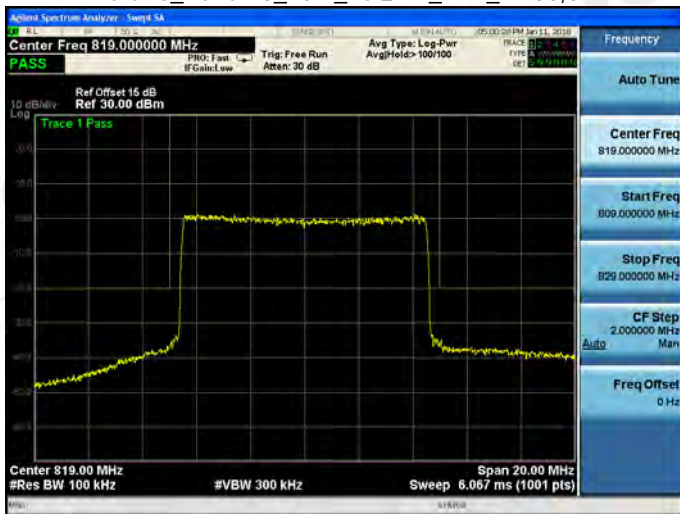

Part 90\_Band 26\_10M\_64QAM\_MID\_RB50,0

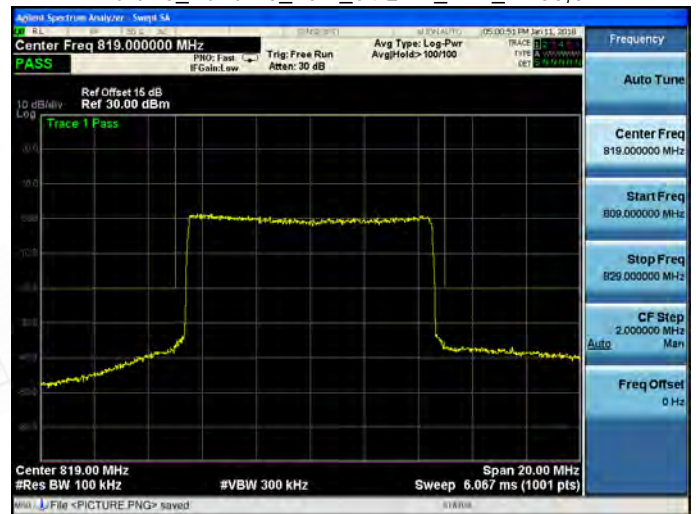

Unless otherwise stated the results shown in this test report refer only to the sample(s) tested and such sample(s) are retained for 90 days only.

除非另有說明，此報告結果僅對測試之樣品負責，同時此樣品僅保留90天。本報告未經本公司書面許可，不可部份複製。

This document is issued by the Company subject to its General Conditions of Service printed overleaf, available on request or accessible at [www.sgs.com/terms\\_and\\_conditions.htm](http://www.sgs.com/terms_and_conditions.htm) and, for electronic format documents, subject to Terms and Conditions for Electronic Documents at [www.sgs.com/terms\\_e-document.htm](http://www.sgs.com/terms_e-document.htm). Attention is drawn to the limitation of liability, indemnification and jurisdiction issues defined therein. Any holder of this document is advised that information contained hereon reflects the Company's findings at the time of its intervention only and within the limits of Client's instructions, if any. The Company's sole responsibility is to its Client and this document does not exonerate parties to a transaction from exercising all their rights and obligations under the transaction documents. This document cannot be reproduced except in full, without prior written approval of the Company. Any unauthorized alteration, forgery or falsification of the content or appearance of this document is unlawful and offenders may be prosecuted to the fullest extent of the law.

SGS Taiwan Ltd.

No. 134, WuKungRoad, NewTaipeiIndustrialPark, WukuDistrict, NewTaipeiCity, Taiwan24803/新北市五股區新北產業園區五工路 134 號

台灣檢驗科技股份有限公司

t (886-2) 2299-3279

f (886-2) 2298-0488

www.tw.sgs.com

Member of SGS Group



## Out of Band Emission

### 30MHz-3GHz\_Band26\_3MHz\_QPSK\_1\_0\_LowCH26705

#### 30MHz-3GHz\_Band26\_1\_4MHz\_QPSK\_1\_0\_LowCH26697-814.7

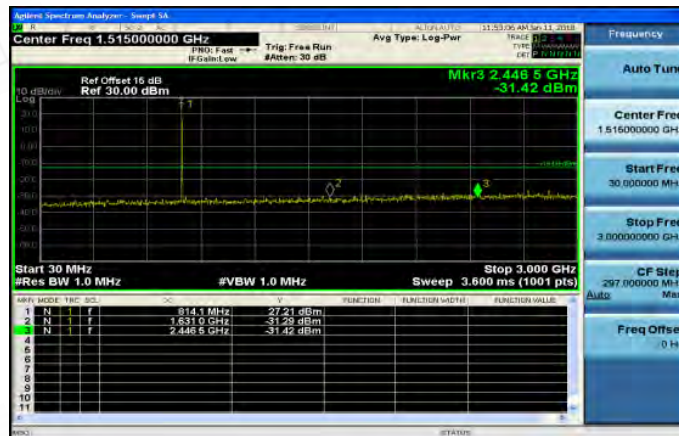
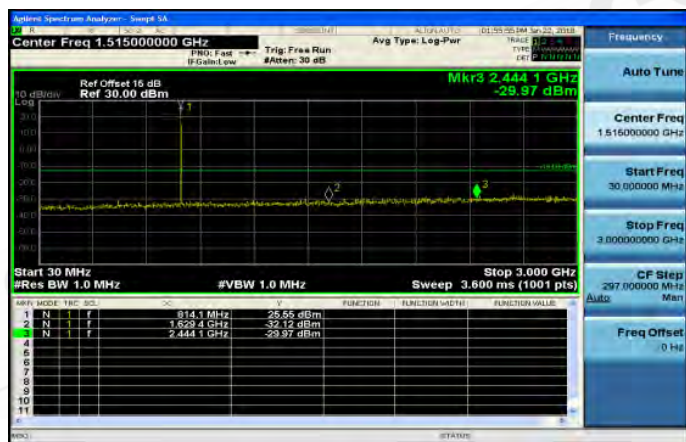

#### 30MHz-3GHz\_Band26\_1\_4MHz\_QPSK\_1\_0\_MidCH26740

### 30MHz-3GHz\_Band26\_3MHz\_QPSK\_1\_0\_MidCH26740

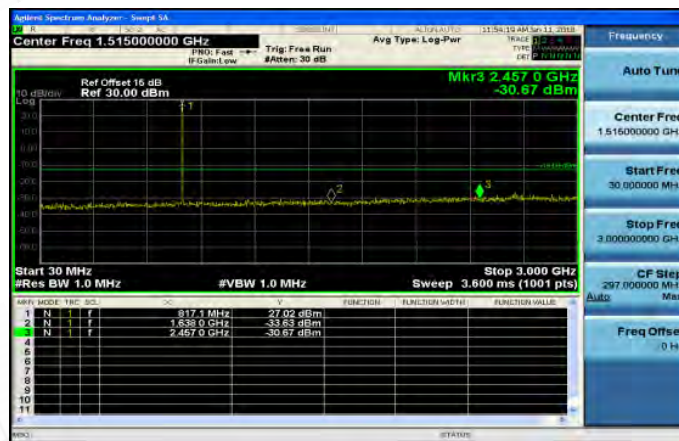
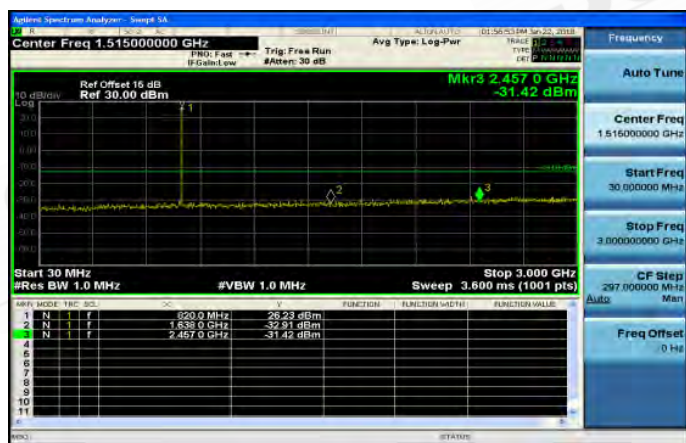

#### 30MHz-3GHz\_Band26\_1\_4MHz\_QPSK\_1\_0\_HighCH26783

### 30MHz-3GHz\_Band26\_3MHz\_QPSK\_1\_0\_HighCH26775

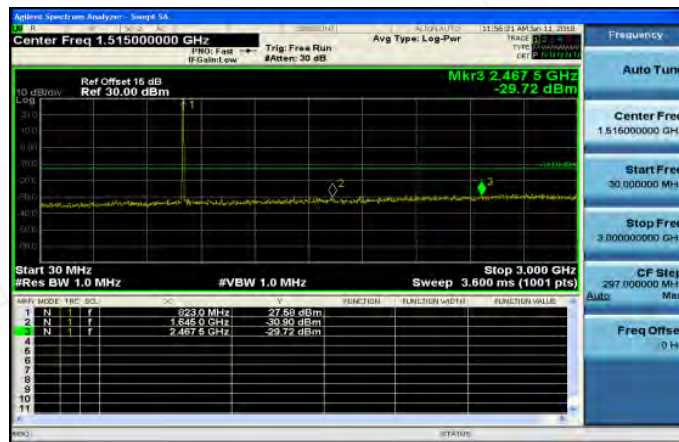
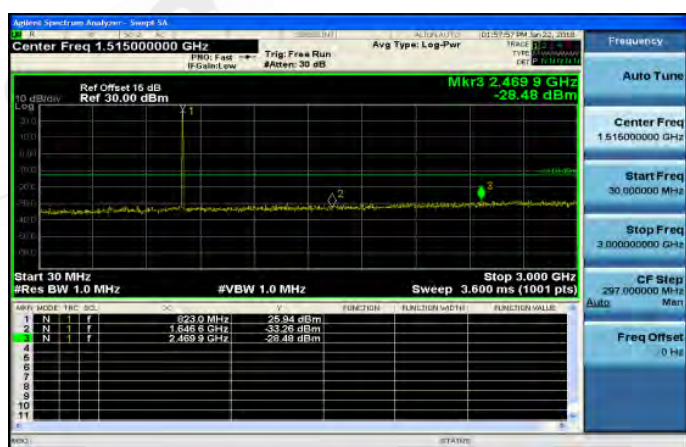

Unless otherwise stated the results shown in this test report refer only to the sample(s) tested and such sample(s) are retained for 90 days only. 除非另有說明，此報告結果僅對測試之樣品負責，同時此樣品僅保留90天。本報告未經本公司書面許可，不可部份複製。

This document is issued by the Company subject to its General Conditions of Service printed overleaf, available on request or accessible at [www.sgs.com/terms\\_and\\_conditions.htm](http://www.sgs.com/terms_and_conditions.htm) and, for electronic format documents, subject to Terms and Conditions for Electronic Documents at [www.sgs.com/terms\\_e-document.htm](http://www.sgs.com/terms_e-document.htm). Attention is drawn to the limitation of liability, indemnification and jurisdiction issues defined therein. Any holder of this document is advised that information contained hereon reflects the Company's findings at the time of its intervention only and within the limits of Client's instructions, if any. The Company's sole responsibility is to its Client and this document does not exonerate parties to a transaction from exercising all their rights and obligations under the transaction documents. This document cannot be reproduced except in full, without prior written approval of the Company. Any unauthorized alteration, forgery or falsification of the content or appearance of this document is unlawful and offenders may be prosecuted to the fullest extent of the law.



30MHz~3GHz\_Band26\_5MHz\_QPSK\_1\_0\_LowCH26715



30MHz~3GHz\_Band26\_10MHz\_QPSK\_1\_0\_MidCH26740

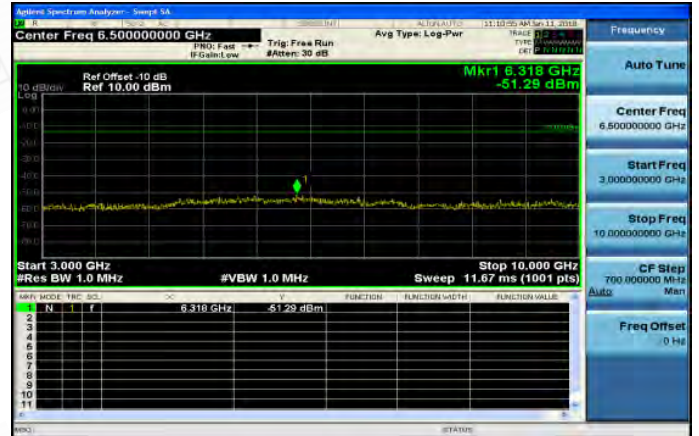

30MHz~3GHz\_Band26\_5MHz\_QPSK\_1\_0\_MidCH26740



30MHz~3GHz\_Band26\_5MHz\_QPSK\_1\_0\_HighCH26765

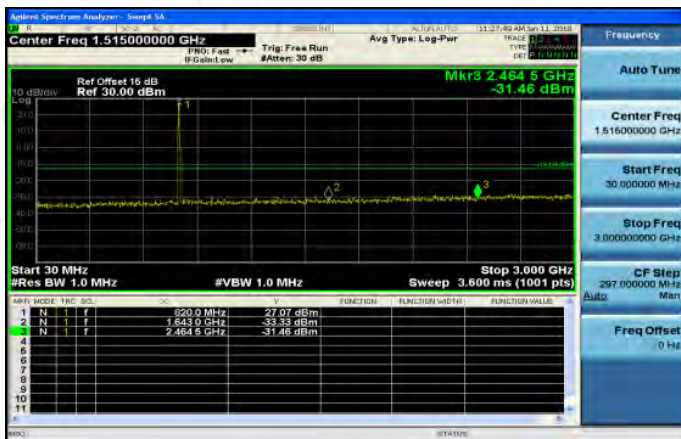

Unless otherwise stated the results shown in this test report refer only to the sample(s) tested and such sample(s) are retained for 90 days only. 除非另有說明，此報告結果僅對測試之樣品負責，同時此樣品僅保留90天。本報告未經本公司書面許可，不可部份複製。

This document is issued by the Company subject to its General Conditions of Service printed overleaf, available on request or accessible at [www.sgs.com/terms\\_and\\_conditions.htm](http://www.sgs.com/terms_and_conditions.htm) and, for electronic format documents, subject to Terms and Conditions for Electronic Documents at [www.sgs.com/terms\\_e-document.htm](http://www.sgs.com/terms_e-document.htm). Attention is drawn to the limitation of liability, indemnification and jurisdiction issues defined therein. Any holder of this document is advised that information contained hereon reflects the Company's findings at the time of its intervention only and within the limits of Client's instructions, if any. The Company's sole responsibility is to its Client and this document does not exonerate parties to a transaction from exercising all their rights and obligations under the transaction documents. This document cannot be reproduced except in full, without prior written approval of the Company. Any unauthorized alteration, forgery or falsification of the content or appearance of this document is unlawful and offenders may be prosecuted to the fullest extent of the law.

## 10. FIELD STRENGTH OF SPURIOUS RADIATION MEASUREMENT

### 10.1. Standard Applicable

According to FCC §2.1053,

FCC §22.917(a), the magnitude of each spurious and harmonic emission that can be detected when the equipment is operated under the conditions specified in the instruction manual and/or alignment procedure, shall not be less than  $43 + 10 \log$  (mean output power in watts) dBc below the mean power output outside a license's frequency block (-13dBm).

**Table 2 — Unwanted Emissions for Mobile, Portable and Low-Power Fixed Subscriber Equipment**

Frequency (MHz)	Attenuation (dB)
<2200	$43 + 10 \log_{10}(p)$
2200 - 2288	$70 + 10 \log_{10}(p)$
2288 - 2292	$67 + 10 \log_{10}(p)$
2292 - 2296	$61 + 10 \log_{10}(p)$
2296 - 2300	$55 + 10 \log_{10}(p)$
2300 - 2305	$43 + 10 \log_{10}(p)$
2305 - 2320	$43 + 10 \log_{10}(p)$ <sup>Note</sup>
2320 - 2324	$55 + 10 \log_{10}(p)$
2324 - 2328	$61 + 10 \log_{10}(p)$
2328 - 2337	$67 + 10 \log_{10}(p)$
2337 - 2341	$61 + 10 \log_{10}(p)$
2341 - 2345	$55 + 10 \log_{10}(p)$
2345 - 2360	$43 + 10 \log_{10}(p)$ <sup>Note</sup>
2360 - 2365	$43 + 10 \log_{10}(p)$
2365 - 2395	$70 + 10 \log_{10}(p)$
>2395	$43 + 10 \log_{10}(p)$

**Note:** Measured at the edges of the highest and lowest frequency range(s) in which the equipment is designed to operate. See Section 1.2 for the permitted frequency ranges for various equipment types.

Unless otherwise stated the results shown in this test report refer only to the sample(s) tested and such sample(s) are retained for 90 days only.

除非另有說明，此報告結果僅對測試之樣品負責，同時此樣品僅保留90天。本報告未經本公司書面許可，不可部份複製。

This document is issued by the Company subject to its General Conditions of Service printed overleaf, available on request or accessible at [www.sgs.com/terms\\_and\\_conditions.htm](http://www.sgs.com/terms_and_conditions.htm) and, for electronic format documents, subject to Terms and Conditions for Electronic Documents at [www.sgs.com/terms\\_e-document.htm](http://www.sgs.com/terms_e-document.htm). Attention is drawn to the limitation of liability, indemnification and jurisdiction issues defined therein. Any holder of this document is advised that information contained hereon reflects the Company's findings at the time of its intervention only and within the limits of Client's instructions, if any. The Company's sole responsibility is to its Client and this document does not exonerate parties to a transaction from exercising all their rights and obligations under the transaction documents. This document cannot be reproduced except in full, without prior written approval of the Company. Any unauthorized alteration, forgery or falsification of the content or appearance of this document is unlawful and offenders may be prosecuted to the fullest extent of the law.

SGS Taiwan Ltd.

No.134,WuKungRoad,NewTaipeiIndustrialPark,WukuDistrict,NewTaipeiCity,Taiwan24803/新北市五股區新北產業園區五工路 134 號

台灣檢驗科技股份有限公司

t (886-2) 2299-3279

f (886-2) 2298-0488

[www.tw.sgs.com](http://www.tw.sgs.com)

Member of SGS Group

## 10.2. EUT Setup

### Radiated Emission Test Set-Up, Frequency Below 1000MHz

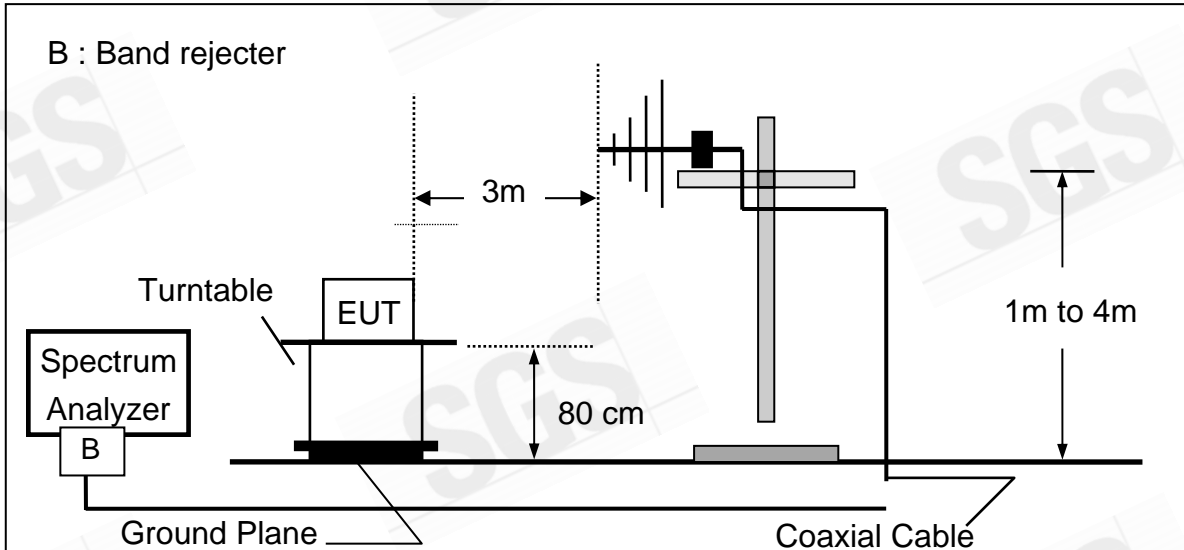

### Radiated Emission Test Set-UP Frequency Over 1 GHz

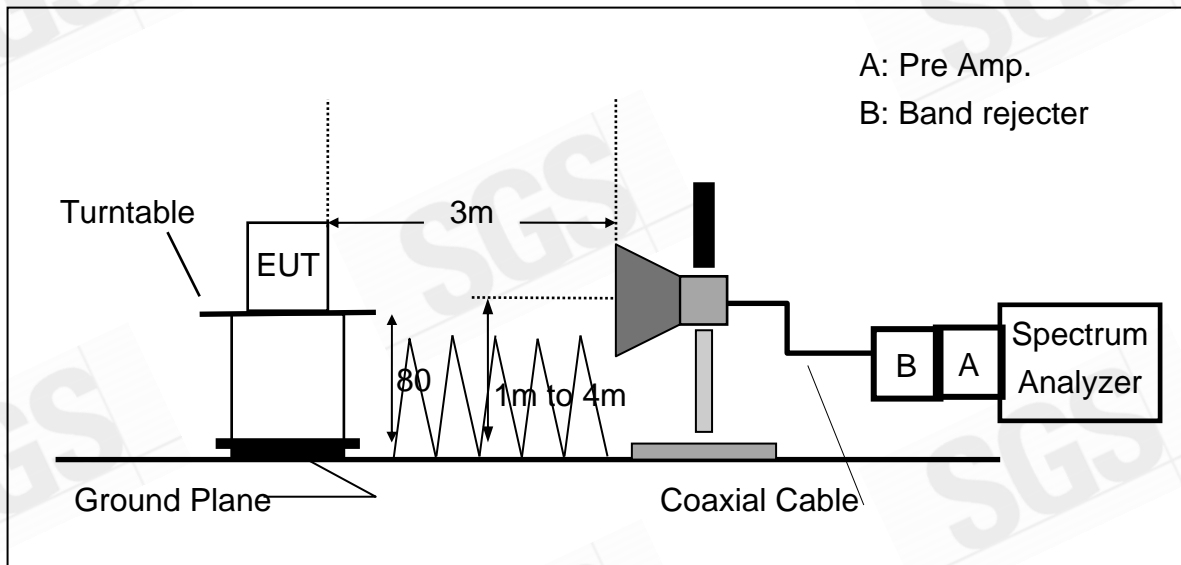

Unless otherwise stated the results shown in this test report refer only to the sample(s) tested and such sample(s) are retained for 90 days only.

除非另有說明，此報告結果僅對測試之樣品負責，同時此樣品僅保留90天。本報告未經本公司書面許可，不可部份複製。

This document is issued by the Company subject to its General Conditions of Service printed overleaf, available on request or accessible at [www.sgs.com/terms\\_and\\_conditions.htm](http://www.sgs.com/terms_and_conditions.htm) and, for electronic format documents, subject to Terms and Conditions for Electronic Documents at [www.sgs.com/terms\\_e-document.htm](http://www.sgs.com/terms_e-document.htm). Attention is drawn to the limitation of liability, indemnification and jurisdiction issues defined therein. Any holder of this document is advised that information contained hereon reflects the Company's findings at the time of its intervention only and within the limits of Client's instructions, if any. The Company's sole responsibility is to its Client and this document does not exonerate parties to a transaction from exercising all their rights and obligations under the transaction documents. This document cannot be reproduced except in full, without prior written approval of the Company. Any unauthorized alteration, forgery or falsification of the content or appearance of this document is unlawful and offenders may be prosecuted to the fullest extent of the law.



### 10.3. Measurement Procedure:

The EUT was placed on a non-conductive; the measurement antenna was placed at a distance of 3 meters from the EUT. During the tests, the antenna height and the EUT azimuth were varied in order to identify the maximum level of emissions from the EUT. This maximization process was repeated with the EUT positioned in each of its three orthogonal orientations.

The frequency range up to tenth harmonic was investigated for each of three fundamental frequencies (low, middle and high channels). Once spurious emission was identified, the power of the emission was determined using the substitution method.

The spurious emissions attenuation was calculated as the difference between radiated power at the fundamental frequency and the spurious emissions frequency.

$$\text{ERP (dBm)} = \text{SG Level(dBm)} + \text{Antenna Gain(dBd)} + \text{Cable Loss(dB)}$$

$$\text{EIRP (dBm)} = \text{SG Level(dBm)} + \text{Antenna Gain(dBi)} + \text{Cable Loss(dB)}$$

Note : "F" : denotes Fundamental Frequency. ; "H" : denotes Harmonic Frequency.

"E" : denotes Band Edge Frequency. ; "S" : denotes Spurious Frequency.

"---" : denotes Noise Floor.

Unless otherwise stated the results shown in this test report refer only to the sample(s) tested and such sample(s) are retained for 90 days only.

除非另有說明，此報告結果僅對測試之樣品負責，同時此樣品僅保留90天。本報告未經本公司書面許可，不可部份複製。

This document is issued by the Company subject to its General Conditions of Service printed overleaf, available on request or accessible at [www.sgs.com/terms\\_and\\_conditions.htm](http://www.sgs.com/terms_and_conditions.htm) and, for electronic format documents, subject to Terms and Conditions for Electronic Documents at [www.sgs.com/terms\\_e-document.htm](http://www.sgs.com/terms_e-document.htm). Attention is drawn to the limitation of liability, indemnification and jurisdiction issues defined therein. Any holder of this document is advised that information contained hereon reflects the Company's findings at the time of its intervention only and within the limits of Client's instructions, if any. The Company's sole responsibility is to its Client and this document does not exonerate parties to a transaction from exercising all their rights and obligations under the transaction documents. This document cannot be reproduced except in full, without prior written approval of the Company. Any unauthorized alteration, forgery or falsification of the content or appearance of this document is unlawful and offenders may be prosecuted to the fullest extent of the law.

SGS Taiwan Ltd.

No.134,WuKungRoad,NewTaipeiIndustrialPark,WukuDistrict,NewTaipeiCity,Taiwan24803/新北市五股區新北產業園區五工路 134 號

台灣檢驗科技股份有限公司

t (886-2) 2299-3279

f (886-2) 2298-0488

[www.tw.sgs.com](http://www.tw.sgs.com)

Member of SGS Group

#### 10.4. Measurement Equipment Used:

EQUIPMENT TYPE	MFR	MODEL NUMBER	SERIAL NUMBER	LAST CAL. (yyyy/mm/dd)	CAL DUE. (yyyy/mm/dd)
Bi-log Antenna	SCHWAZBECK	VULB9168	378	2017/12/29	2018/12/28
Bi-log Antenna	SCHWAZBECK	VULB9168	300	2017/12/20	2018/12/19
Horn Antenna	Schwarzbeck	BBHA9120D	309	2018/01/04	2019/1/3
Horn Antenna	Schwarzbeck	BBHA9120D	1441	2017/08/04	2018/8/3
Spectrum Analyzer	Agilent	E4446A	MY51100003	2017/05/10	2018/5/9
EMI Test Receiver	R&S	ESC17	100760	2017/06/06	2018/6/5
Network Analyze	Anritsu	MS4644A	1216312	2017/05/25	2018/5/24
Radio Communication Analyer	Anritsu	MT8820C	6201465317	2018/01/05	2019/1/1
Pre-Amplifier	HP	8449B	3008A00578	2018/01/02	2019/1/1
Pre-Amplifier	HP	8447D	2944A07676	2018/01/02	2019/1/1
Attenuator	Mini-Circuit	BW-S10W2+	2	2018/01/02	2019/1/1
Filter 800-1000	Micro-Tronics	EWT	M1	2018/01/02	2019/1/1
1GHz High Pass Filter	Micro-Tronics	HPM50108	32	2018/01/02	2019/1/1
Low Loss Cable	Huber Suhner	966_RX	9	2018/01/02	2019/1/1
Low Loss Cable	Huber Suhner	966_TX	1	2018/01/02	2019/1/1

Unless otherwise stated the results shown in this test report refer only to the sample(s) tested and such sample(s) are retained for 90 days only.

除非另有說明，此報告結果僅對測試之樣品負責，同時此樣品僅保留90天。本報告未經本公司書面許可，不可部份複製。

This document is issued by the Company subject to its General Conditions of Service printed overleaf, available on request or accessible at [www.sgs.com/terms\\_and\\_conditions.htm](http://www.sgs.com/terms_and_conditions.htm) and, for electronic format documents, subject to Terms and Conditions for Electronic Documents at [www.sgs.com/terms\\_e-document.htm](http://www.sgs.com/terms_e-document.htm). Attention is drawn to the limitation of liability, indemnification and jurisdiction issues defined therein. Any holder of this document is advised that information contained hereon reflects the Company's findings at the time of its intervention only and within the limits of Client's instructions, if any. The Company's sole responsibility is to its Client and this document does not exonerate parties to a transaction from exercising all their rights and obligations under the transaction documents. This document cannot be reproduced except in full, without prior written approval of the Company. Any unauthorized alteration, forgery or falsification of the content or appearance of this document is unlawful and offenders may be prosecuted to the fullest extent of the law.

SGS Taiwan Ltd.

No.134,WuKungRoad,NewTaipeiIndustrialPark,WukuDistrict,NewTaipeiCity,Taiwan24803/新北市五股區新北產業園區五工路 134 號

台灣檢驗科技股份有限公司

t (886-2) 2299-3279

f (886-2) 2298-0488

[www.tw.sgs.com](http://www.tw.sgs.com)

Member of SGS Group

### 10.5. Measurement Result:

#### Radiated Spurious Emission Measurement Result: LTE-Band 26 for Part 90S (The Worst Case)

##### Uplink Antenna

Operation Band	:LTE B26	Temp./Humi.	:22.1 deg_C / 68 RH
Fundamental Frequency	:819 MHz	Engineer	:Tin
Operation Mode	:Tx CH MID	Measurement Antenna	:VERTICAL
EUT Pol.	:H Plane	Pol.	

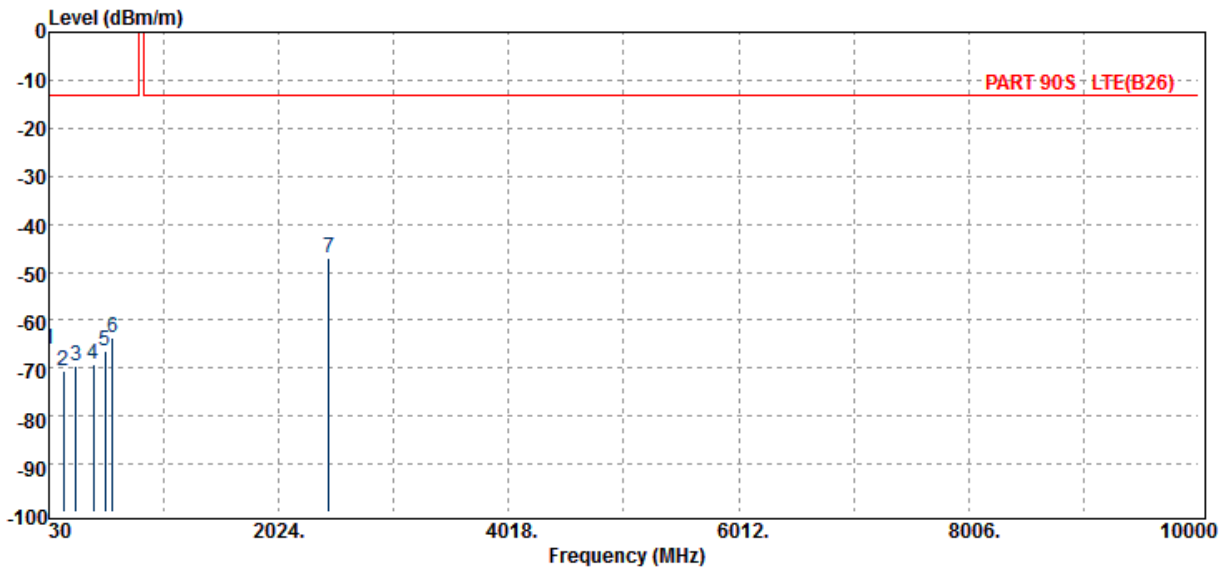

Freq. MHz	Note F/H/E/S	ERP/EIRP dBm	SG Output Level dBm	Antenna Gain dBd/dBi	Cable Loss dB	Limit dBm	Margin dB
30.00	S	-66.15	-50.41	-14.78	-0.96	-13.00	-53.15
159.01	S	-70.43	-67.28	-1.68	-1.47	-13.00	-57.43
265.71	S	-69.63	-71.41	3.58	-1.80	-13.00	-56.63
415.09	S	-69.16	-70.56	3.77	-2.37	-13.00	-56.16
519.85	S	-66.31	-67.67	3.75	-2.39	-13.00	-53.31
584.84	S	-63.56	-64.11	3.34	-2.79	-13.00	-50.56
2457.00	H	-47.00	-50.52	8.71	-5.19	-13.00	-34.00

Unless otherwise stated the results shown in this test report refer only to the sample(s) tested and such sample(s) are retained for 90 days only.

除非另有說明，此報告結果僅對測試之樣品負責，同時此樣品僅保留90天。本報告未經本公司書面許可，不可部份複製。

This document is issued by the Company subject to its General Conditions of Service printed overleaf, available on request or accessible at [www.sgs.com/terms\\_and\\_conditions.htm](http://www.sgs.com/terms_and_conditions.htm) and, for electronic format documents, subject to Terms and Conditions for Electronic Documents at [www.sgs.com/terms\\_e-document.htm](http://www.sgs.com/terms_e-document.htm). Attention is drawn to the limitation of liability, indemnification and jurisdiction issues defined therein. Any holder of this document is advised that information contained hereon reflects the Company's findings at the time of its intervention only and within the limits of Client's instructions, if any. The Company's sole responsibility is to its Client and this document does not exonerate parties to a transaction from exercising all their rights and obligations under the transaction documents. This document cannot be reproduced except in full, without prior written approval of the Company. Any unauthorized alteration, forgery or falsification of the content or appearance of this document is unlawful and offenders may be prosecuted to the fullest extent of the law.



Operation Band :LTE B26      Temp./Humi. :22.1 deg\_C / 68 RH  
 Fundamental Frequency :819 MHz      Engineer :Tin  
 Operation Mode :Tx CH MID  
 EUT Pol. :H Plane      Measurement Pol. Antenna :HORIZONTAL

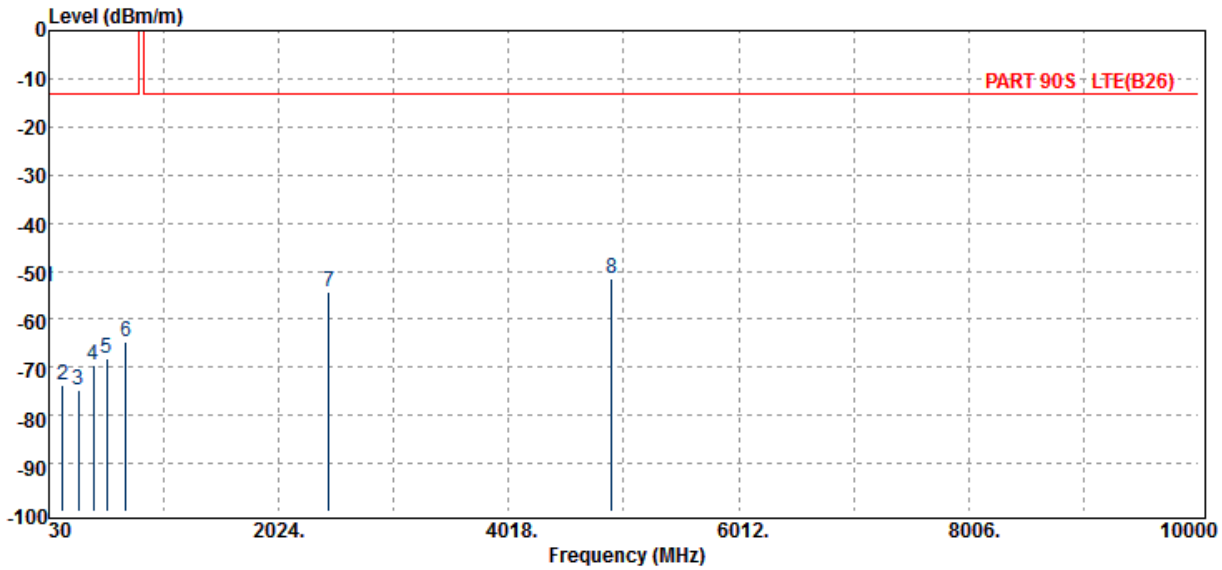

Freq. MHz	Note F/H/E/S	ERP/EIRP dBm	SG Output Level dBm	Antenna Gain dBd/dBi	Cable Loss dB	Limit dBm	Margin dB
30.00	S	-53.43	-37.70	-14.78	-0.96	-13.00	-40.43
146.40	S	-73.65	-69.92	-2.31	-1.42	-13.00	-60.65
284.14	S	-74.61	-76.14	3.43	-1.89	-13.00	-61.61
418.00	S	-69.51	-70.92	3.76	-2.35	-13.00	-56.51
531.49	S	-68.32	-69.50	3.69	-2.51	-13.00	-55.32
697.36	S	-64.60	-64.75	3.08	-2.93	-13.00	-51.60
2457.00	H	-54.27	-57.79	8.71	-5.19	-13.00	-41.27
4914.00	H	-51.63	-54.49	10.55	-7.69	-13.00	-38.63

Unless otherwise stated the results shown in this test report refer only to the sample(s) tested and such sample(s) are retained for 90 days only.

除非另有說明，此報告結果僅對測試之樣品負責，同時此樣品僅保留90天。本報告未經本公司書面許可，不可部份複製。

This document is issued by the Company subject to its General Conditions of Service printed overleaf, available on request or accessible at [www.sgs.com/terms\\_and\\_conditions.htm](http://www.sgs.com/terms_and_conditions.htm) and, for electronic format documents, subject to Terms and Conditions for Electronic Documents at [www.sgs.com/terms\\_e-document.htm](http://www.sgs.com/terms_e-document.htm). Attention is drawn to the limitation of liability, indemnification and jurisdiction issues defined therein. Any holder of this document is advised that information contained hereon reflects the Company's findings at the time of its intervention only and within the limits of Client's instructions, if any. The Company's sole responsibility is to its Client and this document does not exonerate parties to a transaction from exercising all their rights and obligations under the transaction documents. This document cannot be reproduced except in full, without prior written approval of the Company. Any unauthorized alteration, forgery or falsification of the content or appearance of this document is unlawful and offenders may be prosecuted to the fullest extent of the law.

SGS Taiwan Ltd.

No.134,WuKungRoad,NewTaipeiIndustrialPark,WukuDistrict,NewTaipeiCity,Taiwan24803/新北市五股區新北產業園區五工路 134 號

台灣檢驗科技股份有限公司

t (886-2) 2299-3279

f (886-2) 2298-0488

www.tw.sgs.com

Member of SGS Group

### Downlink Antenna

Operation Band :LTE B26 Temp./Humi. :22.1 deg\_C / 68 RH  
 Fundamental Frequency :819 MHz Engineer :Tin  
 Operation Mode :Tx CH MID  
 EUT Pol. :H Plane Measurement Pol. Antenna :VERTICAL

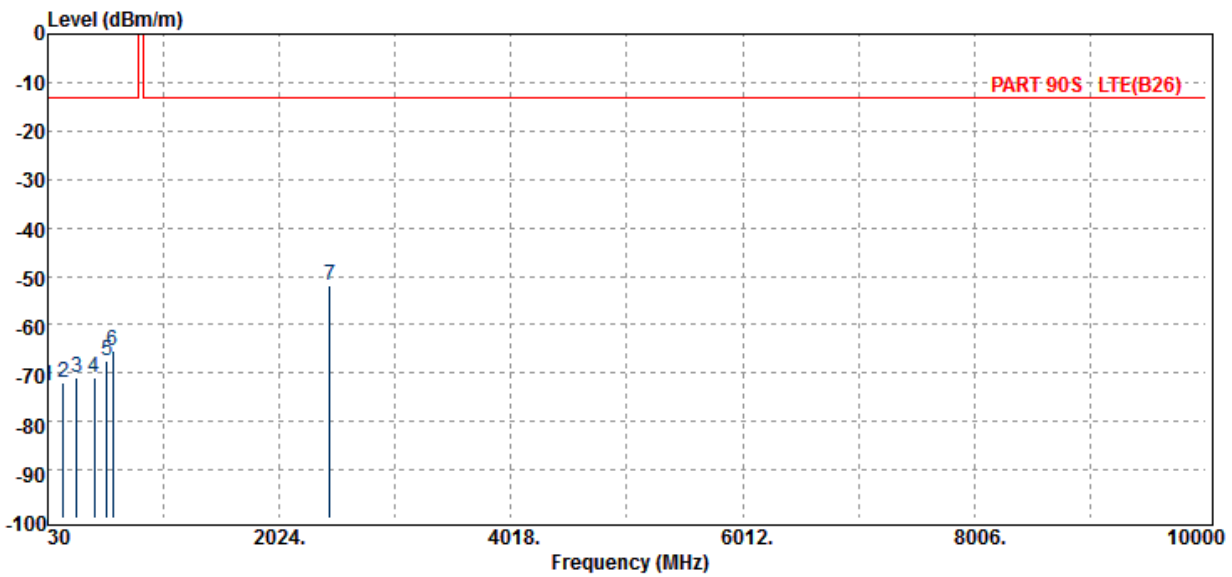

Freq. MHz	Note F/H/E/S	ERP/EIRP dBm	SG Output Level dBm	Antenna Gain dBd/dBi	Cable Loss dB	Limit dBm	Margin dB
33.88	S	-72.57	-58.36	-13.61	-0.61	-13.00	-59.57
165.80	S	-72.01	-69.82	-0.88	-1.31	-13.00	-59.01
282.20	S	-70.89	-72.56	3.42	-1.75	-13.00	-57.89
432.55	S	-70.77	-72.35	3.60	-2.02	-13.00	-57.77
538.28	S	-67.47	-69.44	4.00	-2.03	-13.00	-54.47
588.72	S	-65.33	-66.74	3.63	-2.22	-13.00	-52.33
2457.00	H	-52.00	-54.85	8.33	-5.47	-13.00	-39.00

Unless otherwise stated the results shown in this test report refer only to the sample(s) tested and such sample(s) are retained for 90 days only.

除非另有說明，此報告結果僅對測試之樣品負責，同時此樣品僅保留90天。本報告未經本公司書面許可，不可部份複製。

This document is issued by the Company subject to its General Conditions of Service printed overleaf, available on request or accessible at [www.sgs.com/terms\\_and\\_conditions.htm](http://www.sgs.com/terms_and_conditions.htm) and, for electronic format documents, subject to Terms and Conditions for Electronic Documents at [www.sgs.com/terms\\_e-document.htm](http://www.sgs.com/terms_e-document.htm). Attention is drawn to the limitation of liability, indemnification and jurisdiction issues defined therein. Any holder of this document is advised that information contained hereon reflects the Company's findings at the time of its intervention only and within the limits of Client's instructions, if any. The Company's sole responsibility is to its Client and this document does not exonerate parties to a transaction from exercising all their rights and obligations under the transaction documents. This document cannot be reproduced except in full, without prior written approval of the Company. Any unauthorized alteration, forgery or falsification of the content or appearance of this document is unlawful and offenders may be prosecuted to the fullest extent of the law.

SGS Taiwan Ltd.

No.134,WuKungRoad,NewTaipeiIndustrialPark,WukuDistrict,NewTaipeiCity,Taiwan24803/新北市五股區新北產業園區五工路 134 號

台灣檢驗科技股份有限公司

t (886-2) 2299-3279

f (886-2) 2298-0488

www.tw.sgs.com

Member of SGS Group

Operation Band :LTE B26                      Temp./Humi. :22.1 deg\_C / 68 RH  
 Fundamental Frequency :819 MHz                      Engineer :Tin  
 Operation Mode :Tx CH MID  
 EUT Pol. :H Plane                      Measurement Pol.                      Antenna :HORIZONTAL

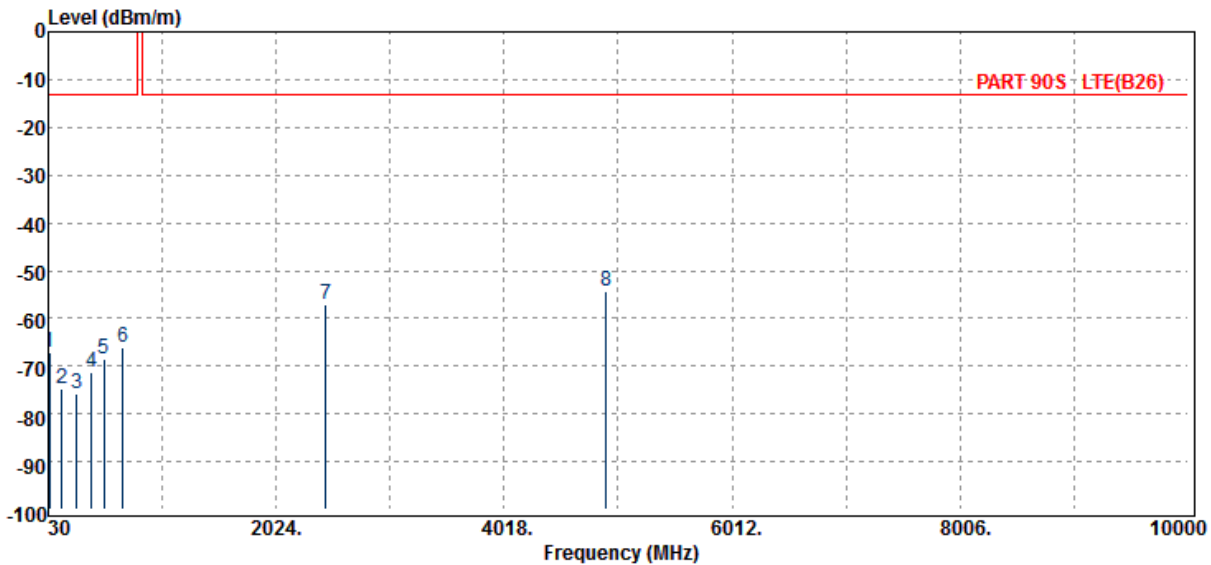

Freq. MHz	Note F/H/E/S	ERP/EIRP dBm	SG Output Level dBm	Antenna Gain dBd/dBi	Cable Loss dB	Limit dBm	Margin dB
41.64	S	-67.17	-54.03	-12.47	-0.67	-13.00	-54.17
152.22	S	-74.71	-71.73	-1.68	-1.29	-13.00	-61.71
281.23	S	-75.90	-77.57	3.42	-1.75	-13.00	-62.90
407.33	S	-71.30	-72.85	3.69	-2.14	-13.00	-58.30
519.85	S	-68.67	-70.18	4.02	-2.51	-13.00	-55.67
682.81	S	-66.21	-66.75	3.73	-3.19	-13.00	-53.21
2457.00	H	-57.01	-59.86	8.33	-5.47	-13.00	-44.01
4914.00	H	-54.27	-56.74	10.38	-7.92	-13.00	-41.27

Unless otherwise stated the results shown in this test report refer only to the sample(s) tested and such sample(s) are retained for 90 days only.

除非另有說明，此報告結果僅對測試之樣品負責，同時此樣品僅保留90天。本報告未經本公司書面許可，不可部份複製。

This document is issued by the Company subject to its General Conditions of Service printed overleaf, available on request or accessible at [www.sgs.com/terms\\_and\\_conditions.htm](http://www.sgs.com/terms_and_conditions.htm) and, for electronic format documents, subject to Terms and Conditions for Electronic Documents at [www.sgs.com/terms\\_e-document.htm](http://www.sgs.com/terms_e-document.htm). Attention is drawn to the limitation of liability, indemnification and jurisdiction issues defined therein. Any holder of this document is advised that information contained hereon reflects the Company's findings at the time of its intervention only and within the limits of Client's instructions, if any. The Company's sole responsibility is to its Client and this document does not exonerate parties to a transaction from exercising all their rights and obligations under the transaction documents. This document cannot be reproduced except in full, without prior written approval of the Company. Any unauthorized alteration, forgery or falsification of the content or appearance of this document is unlawful and offenders may be prosecuted to the fullest extent of the law.



## 11. FREQUENCY STABILITY MEASUREMENT

### 11.1. Standard Applicabl

The frequency stability shall be sufficient to ensure that the fundamental emission stays within the authorized frequency block.

### 11.2. Test Set-up

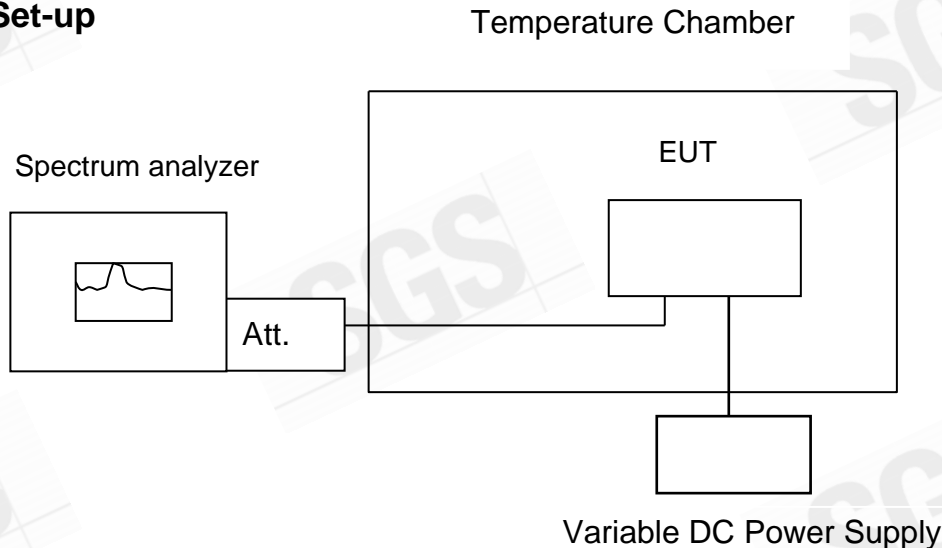

**Note:** Measurement setup for testing on Antenna connector

Unless otherwise stated the results shown in this test report refer only to the sample(s) tested and such sample(s) are retained for 90 days only.

除非另有說明，此報告結果僅對測試之樣品負責，同時此樣品僅保留90天。本報告未經本公司書面許可，不可部份複製。

This document is issued by the Company subject to its General Conditions of Service printed overleaf, available on request or accessible at [www.sgs.com/terms\\_and\\_conditions.htm](http://www.sgs.com/terms_and_conditions.htm) and, for electronic format documents, subject to Terms and Conditions for Electronic Documents at [www.sgs.com/terms\\_e-document.htm](http://www.sgs.com/terms_e-document.htm). Attention is drawn to the limitation of liability, indemnification and jurisdiction issues defined therein. Any holder of this document is advised that information contained hereon reflects the Company's findings at the time of its intervention only and within the limits of Client's instructions, if any. The Company's sole responsibility is to its Client and this document does not exonerate parties to a transaction from exercising all their rights and obligations under the transaction documents. This document cannot be reproduced except in full, without prior written approval of the Company. Any unauthorized alteration, forgery or falsification of the content or appearance of this document is unlawful and offenders may be prosecuted to the fullest extent of the law.

SGS Taiwan Ltd.

No.134,WuKungRoad,NewTaipeiIndustrialPark,WukuDistrict,NewTaipeiCity,Taiwan24803/新北市五股區新北產業園區五工路 134 號

台灣檢驗科技股份有限公司

t (886-2) 2299-3279

f (886-2) 2298-0488

[www.tw.sgs.com](http://www.tw.sgs.com)

Member of SGS Group

### 11.3. Measurement Procedure

The equipment under test was connected to an external AC or DC power supply and input rated voltage. RF output was connected to a frequency counter or spectrum analyzer via feed through attenuators. The EUT was placed inside the temperature chamber. Set the spectrum analyzer RBW low enough to obtain the desired frequency resolution and measure EUT 25°C operating frequency as reference frequency. Turn EUT off and set the chamber temperature to -30°C. After the temperature stabilized for approximately 30 minutes recorded the frequency. Repeat step measure with 10°C increased per stage until the highest temperature of +50°C reached.

Set chamber temperature to 25 . Use a variable AC power supply / DC power source to power the EUT and set the voltage to rated voltage. Set the spectrum analyzer RBW low enough to obtain the desired frequency resolution and recorded the frequency.

Reduce the input voltage to specify extreme voltage variation (+/- 15%) and endpoint as declared by the manufacturer, record the maximum frequency change.

### 11.4. Measurement Equipment Used

EQUIPMENT TYPE	MFR	MODEL NUMBER	SERIAL NUMBER	LAST CAL. (yyyy/mm/dd)	CAL DUE. (yyyy/mm/dd)
EXA Spectrum Analyzer	Agilent	N9010A	MY54200716	2017/10/16	2018/10/15
Radio Communication Analyzer	Anritsu	MT8820C	6201465317	2018/01/15	2019/1/14
Attenuator	Mini-Circuit	BW-S10W2+	2	2018/01/02	2019/1/1
DC Block	Mini-Circuits	BLK-18-S+	1	2018/01/02	2019/1/1
Splitter	RF-LAMBAD	RFLT2W1G18G	11-JSPF412-018	2018/01/02	2019/1/1
Coaxial Cable	Huber Suhner	SUCOFLEX 102EPA	MY2616/2	2018/01/02	2019/1/1

Unless otherwise stated the results shown in this test report refer only to the sample(s) tested and such sample(s) are retained for 90 days only.

除非另有說明，此報告結果僅對測試之樣品負責，同時此樣品僅保留90天。本報告未經本公司書面許可，不可部份複製。

This document is issued by the Company subject to its General Conditions of Service printed overleaf, available on request or accessible at [www.sgs.com/terms\\_and\\_conditions.htm](http://www.sgs.com/terms_and_conditions.htm) and, for electronic format documents, subject to Terms and Conditions for Electronic Documents at [www.sgs.com/terms\\_e-document.htm](http://www.sgs.com/terms_e-document.htm). Attention is drawn to the limitation of liability, indemnification and jurisdiction issues defined therein. Any holder of this document is advised that information contained hereon reflects the Company's findings at the time of its intervention only and within the limits of Client's instructions, if any. The Company's sole responsibility is to its Client and this document does not exonerate parties to a transaction from exercising all their rights and obligations under the transaction documents. This document cannot be reproduced except in full, without prior written approval of the Company. Any unauthorized alteration, forgery or falsification of the content or appearance of this document is unlawful and offenders may be prosecuted to the fullest extent of the law.

SGS Taiwan Ltd.

No.134,WuKungRoad,NewTaipeiIndustrialPark,WukuDistrict,NewTaipeiCity,Taiwan24803/新北市五股區新北產業園區五工路 134 號

台灣檢驗科技股份有限公司

t (886-2) 2299-3279

f (886-2) 2298-0488

[www.tw.sgs.com](http://www.tw.sgs.com)

Member of SGS Group

## 11.5. Measurement Result

### FREQUENCY ERROR vs. VOLTAGE (LTE B26 for Part 90S)

Reference Freq.:		LTE B26 Mid Channel		819 MHz	10M QPSK CH 26740
Power Supply Vdc	Temp. ( )	Freq. (MHz)	Delta (Hz)	Limit = +/- 2.5 ppm (Hz)	
<b>Freq. ERROR vs. VOLTAGE</b>					
4.5	25	819.000001	7	2091	
3.82	25	818.999994	0	2091	
3.55	25	819.000009	15	2091	
3 (End Point)	25	819.000003	9	2091	
<b>Freq. ERROR vs. Temp.</b>					
3.82	-30	819.000012	8	2091	
3.82	-20	818.999994	-10	2091	
3.82	-10	818.999992	-12	2091	
3.82	0	819.000011	7	2091	
3.82	10	819.000013	9	2091	
3.82	20	819.000004	0	2091	
3.82	30	818.999998	-6	2091	
3.82	40	818.999993	-11	2091	
3.82	50	819.000001	-3	2091	

Unless otherwise stated the results shown in this test report refer only to the sample(s) tested and such sample(s) are retained for 90 days only.

除非另有說明，此報告結果僅對測試之樣品負責，同時此樣品僅保留90天。本報告未經本公司書面許可，不可部份複製。

This document is issued by the Company subject to its General Conditions of Service printed overleaf, available on request or accessible at [www.sgs.com/terms\\_and\\_conditions.htm](http://www.sgs.com/terms_and_conditions.htm) and, for electronic format documents, subject to Terms and Conditions for Electronic Documents at [www.sgs.com/terms\\_e-document.htm](http://www.sgs.com/terms_e-document.htm). Attention is drawn to the limitation of liability, indemnification and jurisdiction issues defined therein. Any holder of this document is advised that information contained hereon reflects the Company's findings at the time of its intervention only and within the limits of Client's instructions, if any. The Company's sole responsibility is to its Client and this document does not exonerate parties to a transaction from exercising all their rights and obligations under the transaction documents. This document cannot be reproduced except in full, without prior written approval of the Company. Any unauthorized alteration, forgery or falsification of the content or appearance of this document is unlawful and offenders may be prosecuted to the fullest extent of the law.

SGS Taiwan Ltd.

No.134,WuKungRoad,NewTaipeiIndustrialPark,WukuDistrict,NewTaipeiCity,Taiwan24803/新北市五股區新北產業園區五工路 134 號

台灣檢驗科技股份有限公司

t (886-2) 2299-3279

f (886-2) 2298-0488

[www.tw.sgs.com](http://www.tw.sgs.com)

Member of SGS Group



## 12. PEAK TO AVERAGE RATIO

### 12.1. Standard Applicable

The peak-to-average ratio (PAR) of the transmission may not exceed 13dB.

### 12.2. Test SET-UP

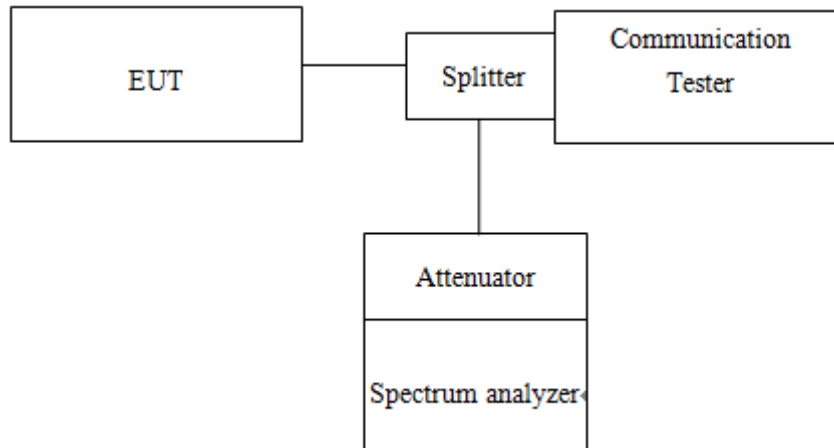

### 12.3. Measurement Procedure

1. KDB 971168 D01 is employed as the following procedure is proper adjusted accordingly:
2. Set resolution/measurement bandwidth  $\geq$  signal's occupied bandwidth; & internal =1ms
3. Set the number of counts to a value that stabilizes the measured CCDF curve.

### 12.4. Measurement Equipment Used

EQUIPMENT TYPE	MFR	MODEL NUMBER	SERIAL NUMBER	LAST CAL. (yyyy/mm/dd)	CAL DUE. (yyyy/mm/dd)
EXA Spectrum Analyzer	Agilent	N9010A	MY54200716	2017/10/16	2018/10/15
Radio Communication Analyer	Anritsu	MT8820C	6201465317	2018/01/15	2019/1/14
Attenuator	Mini-Circuit	BW-S10W2+	2	2018/01/02	2019/1/1
DC Block	Mini-Circuits	BLK-18-S+	1	2018/01/02	2019/1/1
Splitter	RF-LAMBAD	RFLT2W1G18G	11-JSPF412-018	2018/01/02	2019/1/1
Coaxial Cable	Huber Suhner	SUCOFLEX 102EPA	MY2616/2	2018/01/02	2019/1/1

Unless otherwise stated the results shown in this test report refer only to the sample(s) tested and such sample(s) are retained for 90 days only.

除非另有說明，此報告結果僅對測試之樣品負責，同時此樣品僅保留90天。本報告未經本公司書面許可，不可部份複製。

This document is issued by the Company subject to its General Conditions of Service printed overleaf, available on request or accessible at [www.sgs.com/terms\\_and\\_conditions.htm](http://www.sgs.com/terms_and_conditions.htm) and, for electronic format documents, subject to Terms and Conditions for Electronic Documents at [www.sgs.com/terms\\_e-document.htm](http://www.sgs.com/terms_e-document.htm). Attention is drawn to the limitation of liability, indemnification and jurisdiction issues defined therein. Any holder of this document is advised that information contained hereon reflects the Company's findings at the time of its intervention only and within the limits of Client's instructions, if any. The Company's sole responsibility is to its Client and this document does not exonerate parties to a transaction from exercising all their rights and obligations under the transaction documents. This document cannot be reproduced except in full, without prior written approval of the Company. Any unauthorized alteration, forgery or falsification of the content or appearance of this document is unlawful and offenders may be prosecuted to the fullest extent of the law.

## 12.5. Measurement Result

### Tabular Results:

LTE BAND 26 for part 90S							
Channel bandwidth: 1.4MHz				Channel bandwidth: 3MHz			
Freq. (MHz)	CH	PAPR (dB)		Freq. (MHz)	CH	PAPR (dB)	
		64QAM	Limit			64QAM	Limit
814.7	26697	5.92	13	815.5	26705	6.03	13
819	26740	5.85	13	819	26740	5.89	13
823.3	26783	6.04	13	822.5	26775	6.15	13

LTE BAND 26 for part 90S							
Channel bandwidth: 5MHz				Channel bandwidth: 10MHz			
Freq. (MHz)	CH	PAPR (dB)		Freq. (MHz)	CH	PAPR (dB)	
		64QAM	Limit			64QAM	Limit
816.5	26715	5.95	13	819.0	26740	6.28	13
819	26740	5.93	13				
821.5	26765	6.04	13				

### Measurement Results:

Please refer to next page.

Unless otherwise stated the results shown in this test report refer only to the sample(s) tested and such sample(s) are retained for 90 days only.

除非另有說明，此報告結果僅對測試之樣品負責，同時此樣品僅保留90天。本報告未經本公司書面許可，不可部份複製。

This document is issued by the Company subject to its General Conditions of Service printed overleaf, available on request or accessible at [www.sgs.com/terms\\_and\\_conditions.htm](http://www.sgs.com/terms_and_conditions.htm) and, for electronic format documents, subject to Terms and Conditions for Electronic Documents at [www.sgs.com/terms\\_e-document.htm](http://www.sgs.com/terms_e-document.htm). Attention is drawn to the limitation of liability, indemnification and jurisdiction issues defined therein. Any holder of this document is advised that information contained hereon reflects the Company's findings at the time of its intervention only and within the limits of Client's instructions, if any. The Company's sole responsibility is to its Client and this document does not exonerate parties to a transaction from exercising all their rights and obligations under the transaction documents. This document cannot be reproduced except in full, without prior written approval of the Company. Any unauthorized alteration, forgery or falsification of the content or appearance of this document is unlawful and offenders may be prosecuted to the fullest extent of the law.

SGS Taiwan Ltd.

No.134,WuKungRoad,NewTaipeiIndustrialPark,WukuDistrict,NewTaipeiCity,Taiwan24803/新北市五股區新北產業園區五工路 134 號

台灣檢驗科技股份有限公司

t (886-2) 2299-3279

f (886-2) 2298-0488

[www.tw.sgs.com](http://www.tw.sgs.com)

Member of SGS Group

Part 90\_LTE\_Band26\_1\_4MHz\_64QAM\_6\_0\_LowCH26697



Part 90\_LTE\_Band26\_3MHz\_64QAM\_15\_0\_LowCH26705

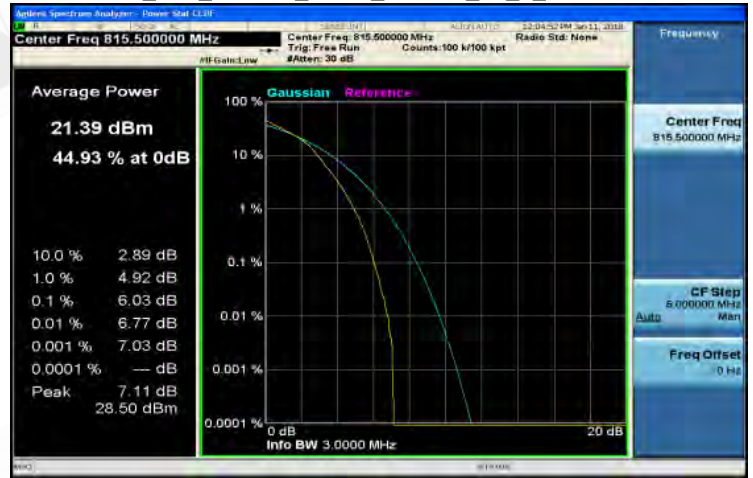

Part 90\_LTE\_Band26\_1\_4MHz\_64QAM\_6\_0\_MidCH26740



Part 90\_LTE\_Band26\_3MHz\_64QAM\_15\_0\_MidCH26740



Part 90\_LTE\_Band26\_1\_4MHz\_64QAM\_6\_0\_HighCH26783



Part 90\_LTE\_Band26\_3MHz\_64QAM\_15\_0\_HighCH26775



Unless otherwise stated the results shown in this test report refer only to the sample(s) tested and such sample(s) are retained for 90 days only.

除非另有說明，此報告結果僅對測試之樣品負責，同時此樣品僅保留90天。本報告未經本公司書面許可，不可部份複製。

This document is issued by the Company subject to its General Conditions of Service printed overleaf, available on request or accessible at [www.sgs.com/terms\\_and\\_conditions.htm](http://www.sgs.com/terms_and_conditions.htm) and, for electronic format documents, subject to Terms and Conditions for Electronic Documents at [www.sgs.com/terms\\_e-document.htm](http://www.sgs.com/terms_e-document.htm). Attention is drawn to the limitation of liability, indemnification and jurisdiction issues defined therein. Any holder of this document is advised that information contained hereon reflects the Company's findings at the time of its intervention only and within the limits of Client's instructions, if any. The Company's sole responsibility is to its Client and this document does not exonerate parties to a transaction from exercising all their rights and obligations under the transaction documents. This document cannot be reproduced except in full, without prior written approval of the Company. Any unauthorized alteration, forgery or falsification of the content or appearance of this document is unlawful and offenders may be prosecuted to the fullest extent of the law.



Part 90\_LTE\_Band26\_5MHz\_64QAM\_25\_0\_LowCH26715



Part 90\_LTE\_Band26\_10MHz\_64QAM\_50\_0\_MidCH26740

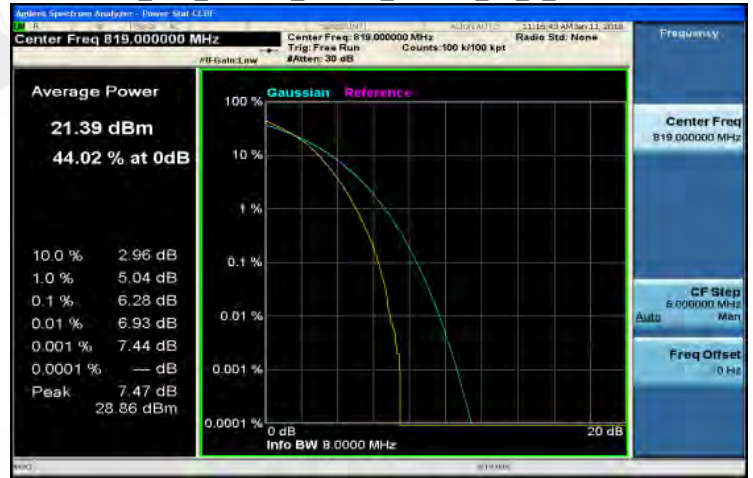

Part 90\_LTE\_Band26\_5MHz\_64QAM\_25\_0\_MidCH26740



Part 90\_LTE\_Band26\_5MHz\_64QAM\_25\_0\_HighCH26765



Unless otherwise stated the results shown in this test report refer only to the sample(s) tested and such sample(s) are retained for 90 days only.  
除非另有說明，此報告結果僅對測試之樣品負責，同時此樣品僅保留90天。本報告未經本公司書面許可，不可部份複製。

This document is issued by the Company subject to its General Conditions of Service printed overleaf, available on request or accessible at [www.sgs.com/terms\\_and\\_conditions.htm](http://www.sgs.com/terms_and_conditions.htm) and, for electronic format documents, subject to Terms and Conditions for Electronic Documents at [www.sgs.com/terms\\_e-document.htm](http://www.sgs.com/terms_e-document.htm). Attention is drawn to the limitation of liability, indemnification and jurisdiction issues defined therein. Any holder of this document is advised that information contained hereon reflects the Company's findings at the time of its intervention only and within the limits of Client's instructions, if any. The Company's sole responsibility is to its Client and this document does not exonerate parties to a transaction from exercising all their rights and obligations under the transaction documents. This document cannot be reproduced except in full, without prior written approval of the Company. Any unauthorized alteration, forgery or falsification of the content or appearance of this document is unlawful and offenders may be prosecuted to the fullest extent of the law.

~ End of Report ~

SGS

SGS

SGS

SGS

SGS

SGS

SGS

SGS

SGS

SGS

Unless otherwise stated the results shown in this test report refer only to the sample(s) tested and such sample(s) are retained for 90 days only.

除非另有說明，此報告結果僅對測試之樣品負責，同時此樣品僅保留90天。本報告未經本公司書面許可，不可部份複製。

This document is issued by the Company subject to its General Conditions of Service printed overleaf, available on request or accessible at [www.sgs.com/terms\\_and\\_conditions.htm](http://www.sgs.com/terms_and_conditions.htm) and, for electronic format documents, subject to Terms and Conditions for Electronic Documents at [www.sgs.com/terms\\_e-document.htm](http://www.sgs.com/terms_e-document.htm). Attention is drawn to the limitation of liability, indemnification and jurisdiction issues defined therein. Any holder of this document is advised that information contained hereon reflects the Company's findings at the time of its intervention only and within the limits of Client's instructions, if any. The Company's sole responsibility is to its Client and this document does not exonerate parties to a transaction from exercising all their rights and obligations under the transaction documents. This document cannot be reproduced except in full, without prior written approval of the Company. Any unauthorized alteration, forgery or falsification of the content or appearance of this document is unlawful and offenders may be prosecuted to the fullest extent of the law.

SGS Taiwan Ltd.

No.134,WuKungRoad,NewTaipeiIndustrialPark,WukuDistrict,NewTaipeiCity,Taiwan24803/新北市五股區新北產業園區五工路 134 號

台灣檢驗科技股份有限公司

t (886-2) 2299-3279

f (886-2) 2298-0488

[www.tw.sgs.com](http://www.tw.sgs.com)

Member of SGS Group