



EMC Test Report

Product Name: EML-L09

Model Number: Smart Phone

Report No: SYBH(Z-EMC) 20181128006001-2

**FCC ID: QISEML-L09
IC:6369A-EMLL09**

Reliability Laboratory of Huawei Technologies Co., Ltd.

**Global Compliance and Testing Center of Huawei Technologies
Co., Ltd**

Administration Building, Headquarters of Huawei Technologies Co., Ltd., Bantian, Longgang District,
Shenzhen, 518129, P.R.C

Tel: +86 755 28780808 Fax: +86 755 89652518



Notice

1. The laboratory has obtained the accreditation of China National Accreditation Service for Conformity Assessment (CNAS), and accreditation number: L0310.
2. The laboratory has passed the accreditation by The American Association for Laboratory Accreditation (A2LA). The accreditation number is 2174.01
3. The laboratory has been listed by Industry Canada to perform electromagnetic emission measurements. The recognition numbers of test site are 6369A-1.
4. The laboratory (Reliability Lab of Huawei Technologies Co., Ltd) is also named as “Global Compliance and Testing Center of Huawei Technologies Co., Ltd”, the both names have coexisted since 2009.
5. The laboratory has been recognized by the US Federal Communications Commission (FCC) to perform compliance testing subject to the Commission's Declaration Of Conformity (DOC) and Certification rules. The Designation Number is CN1173, and the Test Firm Registration Number is 294140.”
6. The test report is invalid if not marked with the stamps or the signatures of the persons responsible for performing, revising and approving the test report.
7. The test report is invalid if there is any evidence of erasure and/or falsification.
8. If there is any dissidence for the test report, please file objection to the test centre within 15 days from the date of receiving the test report.
9. Normally, the test report is only responsible for the samples that have undergone the test.
10. Context of the test report cannot be used partially or in full for publicity and/or promotional purposes without previous written approval of the laboratory.



Applicant: Huawei Technologies Co., Ltd.
Address: Administration Building, Headquarters of Huawei
Technologies Co., Ltd., Bantian, Longgang District,
Shenzhen, 518129, P.R.C

Date of Receipt Test Item: 2019-01-01
Start Date of Test: 2019-01-01
End Date of Test: 2019-01-07

Test Result: Pass

**Approved By
(Lab Manager)**

2019-01-10
Date

He Hao
Name

He Hao
Signature

**Prepared by
(Test Engineer)**

2019-01-09
Date

Peng Shao Hua
Name

Peng Shao Hua
Signature



Modification Record

No.	Last Report No.	Modification Description
1	NA	First Report.
2	SYBH(Z-EMC) 20180131016001-2	Second report: detail please refer to 1.2 on page 8.



TABLE OF CONTENT

1	General Information	6
1.1	EUT Description	6
1.2	Differences Description	8
1.3	Test Site Information	9
1.4	Applied Standards	9
2	Summary of Results.....	10
3	System Configuration during EMC Test.....	11
3.1	Test Mode	11
3.2	Test System Configuration.....	12
3.3	Cables Used during Test.....	14
3.4	Associated Equipment Used during Test.....	14
4	Electromagnetic Interference (EMI).....	15
4.1	Radiated Disturbance 30MHz to 40GHz	15
4.2	Conducted Disturbance 0.15 MHz to 30MHz.....	18
5	Main Test Instruments.....	19
6	System Measurement Uncertainty	19
7	Test Data and Graph.....	20
7.1	Radiated Disturbance	20
7.2	Conducted Disturbance.....	23





1 General Information

1.1 EUT Description

EUT Description	
Product Name	Smart Phone
Model Number	EML-L09
Input voltage	3.82V DC
TX Frequency	GSM 850: 824MHz to 849MHz PCS 1900: 1850MHz to 1910MHz WCDMA Band II: 1850MHz to 1910MHz WCDMA Band IV: 1710MHz to 1755MHz WCDMA Band V: 824MHz to 849MHz LTE BAND 2: 1850MHz to 1910MHz LTE BAND 4: 1710MHz to 1755MHz LTE BAND 5: 824MHz to 849MHz LTE BAND 7: 2500MHz to 2570MHz LTE BAND 12: 699MHz to 716MHz LTE BAND 17: 704MHz to 716MHz LTE BAND 26: 814MHz to 849MHz (only for fcc) LTE BAND 38: 2570MHz to 2620MHz LTE BAND 40: 2305MHz to 2315MHz(only for ic) LTE BAND 41: 2545MHz to 2655MHz WIFI 2.4G: 2400MHz to 2462MHz Bluetooth: 2400MHz to 2483.5MHz WIFI 5G:5150MHz to 5350MHz 5470MHz to 5825MHz NFC: 13.56MHz
RX Frequency	GSM 850: 869MHz to 894MHz GSM 1900: 1930MHz to 1990MHz WCDMA Band II: 1930MHz to 1990MHz WCDMA Band IV: 2110MHz to 2155MHz WCDMA Band V:: 869MHz to 894MHz LTE BAND 2: 1930MHz to 1990MHz LTE BAND 4: 2110MHz to 2155MHz LTE BAND 5: 869MHz to 894MHz LTE BAND 7: 2620MHz to 2690MHz LTE BAND 12: 729MHz to 746MHz LTE BAND 17: 704MHz to 716MHz LTE BAND 26: 859MHz to 894MHz (only for fcc) LTE BAND 38: 2570MHz to 2620MHz LTE BAND 40: 2305MHz to 2315MHz(only for ic) LTE BAND 41: 2545MHz to 2655MHz WIFI 2.4G: 2400MHz to 2462MHz Bluetooth: 2400MHz to 2483.5MHz WIFI 5G:5150MHz to 5350MHz 5470MHz to 5825MHz NFC:13.56MHz GPS: 1575.42MHz
S/N	AEJ0117C11000214
HW Version	HL1EMILYM
SW Version	EML-L09 8.1.0.178(C900)



EUT Accessory	
USB(04071289)	Data Cable USB A Male to USB Type C, Shielded Manufacturer: LUXSHARE-ICT Co., Ltd. Chang Shu Honglin Technology Co.,Ltd. Fuyu Electronical Technology(Huaian) Co., Ltd. MING JI ELECTRONICS CO.,LTD.
Earphone(22040296)	Manufacturer: JIANGXI LIANCHUANG HONGSHENG ELECTRONIC CO., LTD BOLUO COUNTY QUANCHENG ELECTRONIC CO., LTD Goer Tek Inc MERRY ELECTRONICS (SHENZHEN) CO., LTD. Foster Electric Co.,(GuangZhou)LTD.
Earphone Transfer Line(22040294)	Manufacturer: JIANGXI LIANCHUANG HONGSHENG ELECTRONIC CO., LTD MERRY ELECTRONICS (SHENZHEN) CO., LTD. FOSTER ELECTRIC CO.(HONG KONG)LTD BOLUO COUNTY QUANCHENG ELECTRONIC CO., LTD
Adapter	Manufacturer: Huawei Technologies Co.,Ltd. Model: HW-050450U00 Input voltage: 100-240V 50/60Hz ,0.75A Output voltage: 5V 2A OR 5V 4.5A OR 4.5V 5A Rated Power: 10W/22.5W SN: H828K8H3V05002 K8281OH6920035 CA37Y9J7H01360 P8281OH6830035
Adapter	Manufacturer: Huawei Technologies Co.,Ltd. Model: HW-050450E00 Input voltage: 100-240V 50/60Hz ,0.75A Output voltage: 5V 2A OR 5V 4.5A OR 4.5V 5A Rated Power: 10W/22.5W SN: P8301OH7412711 H8301OH7412711 K83059H4V07826 CA37Y9J7H01229
Adapter	Manufacturer: Huawei Technologies Co.,Ltd. Model: HW-050450B00 Input voltage: 100-240V 50/60Hz ,0.75A Output voltage: 5V 2A OR 5V 4.5A OR 4.5V 5A Rated Power: 10W/22.5W SN: P82922H3J31705 H82922H3J31705 K82971H3R11886 CA37Y9J7H01187
Adapter	Manufacturer: Huawei Technologies Co.,Ltd. Model: HW-050450A00 Input voltage: 100-240V 50/60Hz ,0.75A Output voltage: 5V 2A OR 5V 4.5A OR

	4.5V  5A Rated Power: 10W/22.5W SN: H83011H3S04782 K83171H4J05584 P82922HKI31874
Rechargeable Li-ion	Manufacturer: Huawei Technologies Co.,Ltd. Battery Model: HB396285ECW Rated capacity: 3320mAh Nominal Voltage:  +3.82V Charging Voltage:  +4.4V SN:4XSCAYH325X000FS 4XTDLCH319900121 4XSDSIH405X00082

Remark: The above EUT's information is declared by manufacturer. Please refer to the specifications or user's manual for more detailed information.

1.2 Differences Description

1 the changed points:

Item	The detail software changed points
Supported uplink CA	New add to support CA_2C, CA_7C, CA_38C,CA_41C

With the consideration of identities and differences listed above, EMC need to do full test,the test data has not deteriorated, previous report's test data can be used in this report.

2 The mobile phone EML-L29 and EML-L09 are LTE/UMTS/GSM mobile phone with Bluetooth. The differences between EML-L29 and EML-L09 are showed in the following table. EML-L09 delete one SIM by software. Other parts of the mobile phone are the same, including the appearance, the antenna, Chipset, Bluetooth mode, Wifi mode, Adapter, Battery, and so on.

	EML-L29	EML-L09
GSM four bands	the same	the same
WCDMA bands	the same	the same
LTE bands	the same	the same
FCC bands	the same	the same
SIM card	Two	One
NFC	the same	the same
External camera	the same	the same
internal camera	the same	the same
FLASH	the same	the same
Mainboard	the same	the same
PCB layout	the same	the same
Appearance	the same	the same
Bluetooth mode	the same	the same
WLAN mode	the same	the same
BT/ WLAN antenna	the same	the same
GSM/ WCDMA /LTE antenna	the same	the same
Adapter	the same	the same



Battery	the same	the same
Chipset	the same	the same
Memory	the same	the same
RF Parameter	the same	the same
Dimension	the same	the same
Main Frequency NV	the same	the same

1.3 Test Site Information

Test Site 1:	RELIABILITY LABORATORY OF HUAWEI TECHNOLOGIES CO., LTD.
Test Site Location:	Administration Building, Headquarters of Huawei Technologies Co., Ltd., Bantian, Longgang District, Shenzhen, 518129, P.R.C

1.4 Applied Standards

APPLIED STANDARD

**47 CFR FCC Part 15 Subpart B
ICES-003 Issue 6**

2 Summary of Results

Summary of Results				
Test Items	Test Mode	Performance Class & Required Performance Criteria	Result	Site
<u>Radiated Emissions</u> Enclosure Port	Mode1~ Mode4 Mode6 Mode7	CLASS B	Pass	Site1
<u>Conducted Emissions</u> <input checked="" type="checkbox"/> DC Power Port <input checked="" type="checkbox"/> AC Power Port <input type="checkbox"/> Telecommunication Ports	Mode1 Mode3 Mode6 Mode7	CLASS B	Pass	Site1
Note: 1, Measurement taken is within the uncertainty of test system. 2, <input checked="" type="checkbox"/> The item has been tested; <input type="checkbox"/> The item has not been tested.				

During the measurement, the environmental conditions complied with the range listed as below.

Item	Required
Ambient temperature	15°C ~ 35°C
Relative humidity	25% ~ 75%
Atmospheric pressure	86kPa ~ 106kPa

3 System Configuration during EMC Test

3.1 Test Mode

The EUT was configured, installed, arranged and operated in a manner consistent with typical application. The following mode(s) were applied during the compliance test.

Test Mode	
Mode 1:	Charging+ Camera On + Idle
Mode 2:	Earphone + Camera On + Idle
Mode 3:	Charging+ video Playing + Idle
Mode 4:	Earphone + video Playing + Idle
Mode 5	Charging+Traffic+BT+WIFI+NFC+GPS
Mode 6	USB Copy(EUT with PC)
Mode 7	USB&DP+ Earphone +Display

Remark:

- 1) If there is one kind of accessories with different models, each one should be applied throughout the compliance test respectively, however, only the worst case will be recorded in this report.
- 2) If EUT has more than one typical operation, only the worst test mode will be recorded in this report.

Traffic Mode:

When the EUT state is switched on and with Radio Resource Control (RRC) connection established.

Idle Mode:

When the EUT state is switched on but without Radio Resource Control (RRC) connection.

Worst Case:

- 1) Radiated Emission
Adapter(Model: HW-050450U00, SN: K8281OH6920035) + Camera On + Idle
the result is the worst(30MHz~1GHz).
Adapter(Model: HW-050450U00, SN: K8281OH6920035) + Camera On + Idle
the result is the worst) the result is the worst(1GHz~40GHz).
- 2) Conducted Emission
Adapter(Model: HW-050450U00, SN: P8281OH6830035) + Camera On + Idle
the result is the worst.

3.2 Test System Configuration

Connection Diagram (Mode 2/Mode 4)

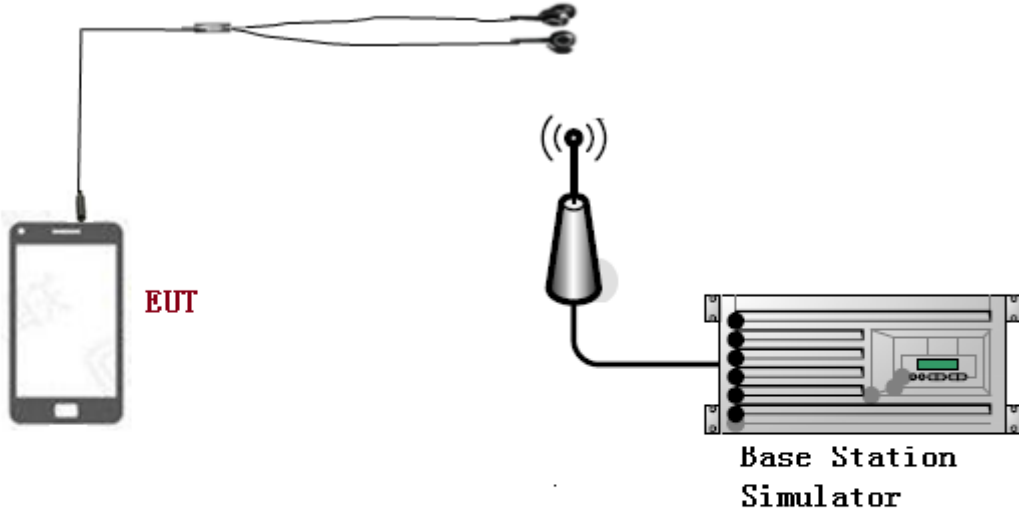

Connection Diagram (Mode 1/Mode 3/Mode 5)

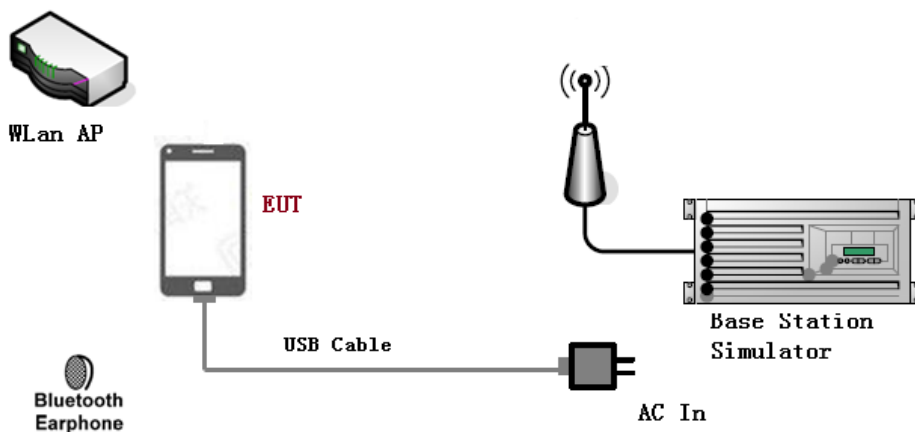

Connection Diagram (Mode 6)

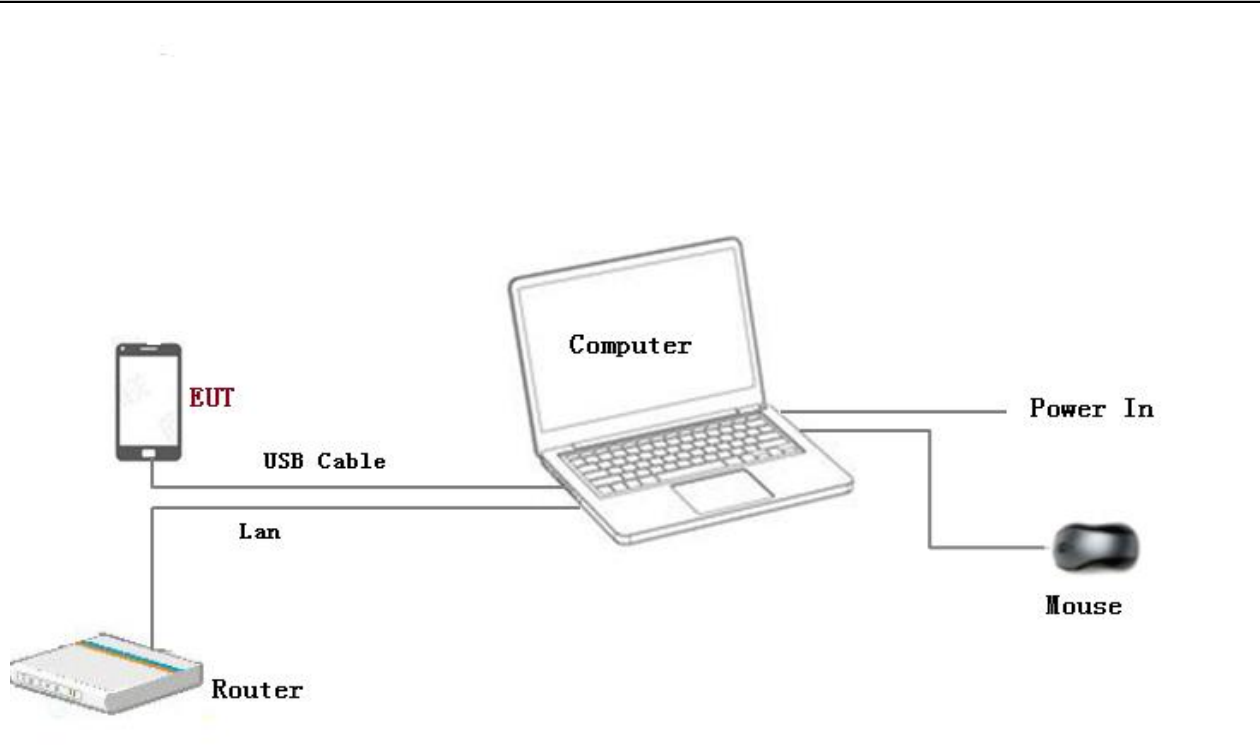

Connection Diagram (Mode 7)

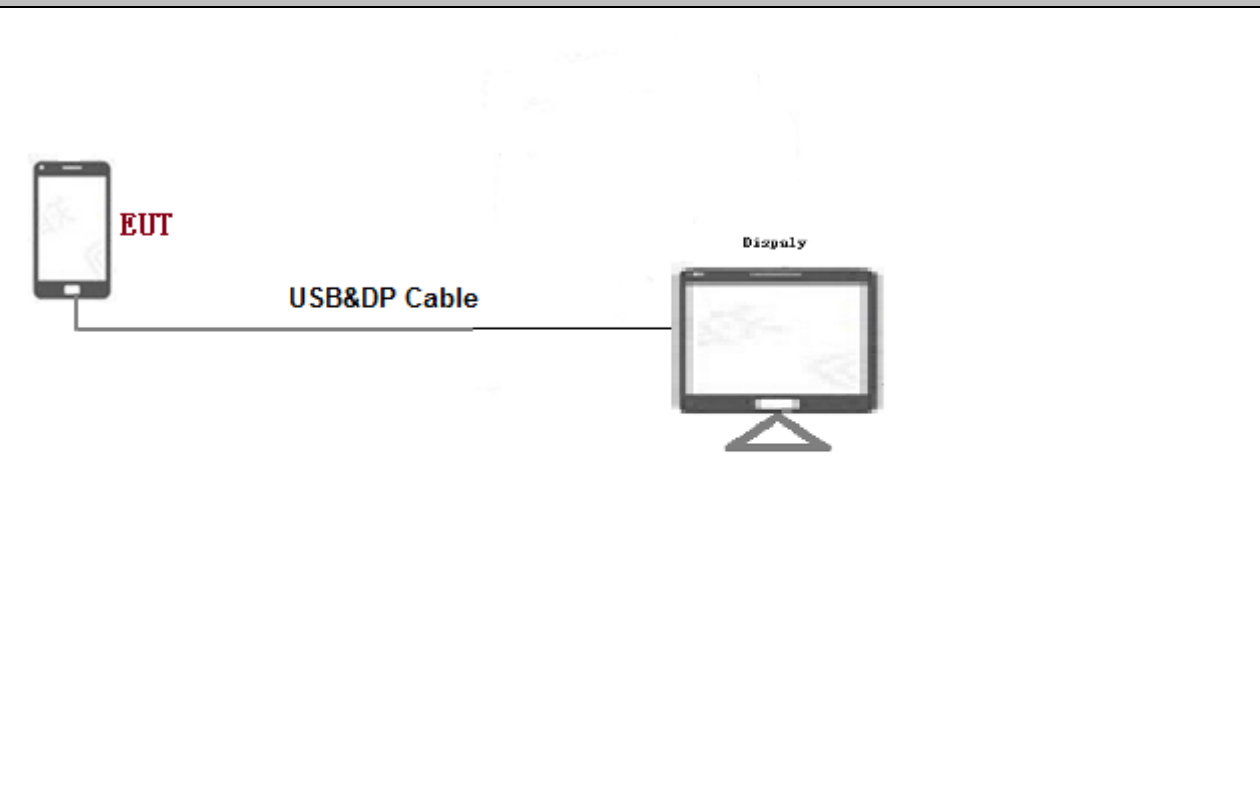

3.3 Cables Used during Test

Cable	Quantity	Length	Type of Cable
USB	1	<3m	Shielded
Earphone	1	<3m	Unshielded
VGA cable	1	<3m	Shielded

3.4 Associated Equipment Used during Test

Name	Model	Manufacturer	S/N	Calibrated Deadline	Cal interval
Radio Communication Tester	CMU200	R&S	3608082535	2019-03-01	12
Radio Communication Tester	MT8820C	Anritsu	A110518805	2019-05-15	12
Notebook	S3	ThinkPad	A140714638	/	/
Mouse	MOHQUO	HP	G1K28AA	/	/
Notebook	S3	ThinkPad	A140714638	/	/
Mouse	M-U0025-O	Lenovo	HS423HB22TB	/	/
display	L197	Lenovo	8M03373A0956983	/	/

4 Electromagnetic Interference (EMI)

4.1 Radiated Disturbance 30MHz to 40GHz

4.1.1 Test Procedure

The test site semi-anechoic chamber has met the requirement of NSA tolerance 4dB according to the standards: ANCI C63.4: 2014. The test distance was 3m. The set-up and test methods were according to ANCI C63.4: 2014.

A preliminary scan and a final scan of the emissions were made from 30 MHz to 40 GHz by using test script of software; The emissions were measured using Quasi-Peak Detector (30MHz~1GHz) and AV/PK detector (above 1GHz). The maximal emission value was acquired by adjusting the antenna height, polarisation and turntable azimuth in accordance with the software setup. Normally, the height range of antenna was 1m to 4m. The azimuth range of turntable was 0° to 360°. The receiving antenna has two polarizations V and H.

Measurement bandwidth (RBW) for 30MHz to 1000 MHz: 120 kHz;

Measurement bandwidth (RBW) for 1000MHz to 40000 MHz: 1MHz;

EUT was configured in idle mode and the test performed at worst emission state.

4.1.2 Test setup

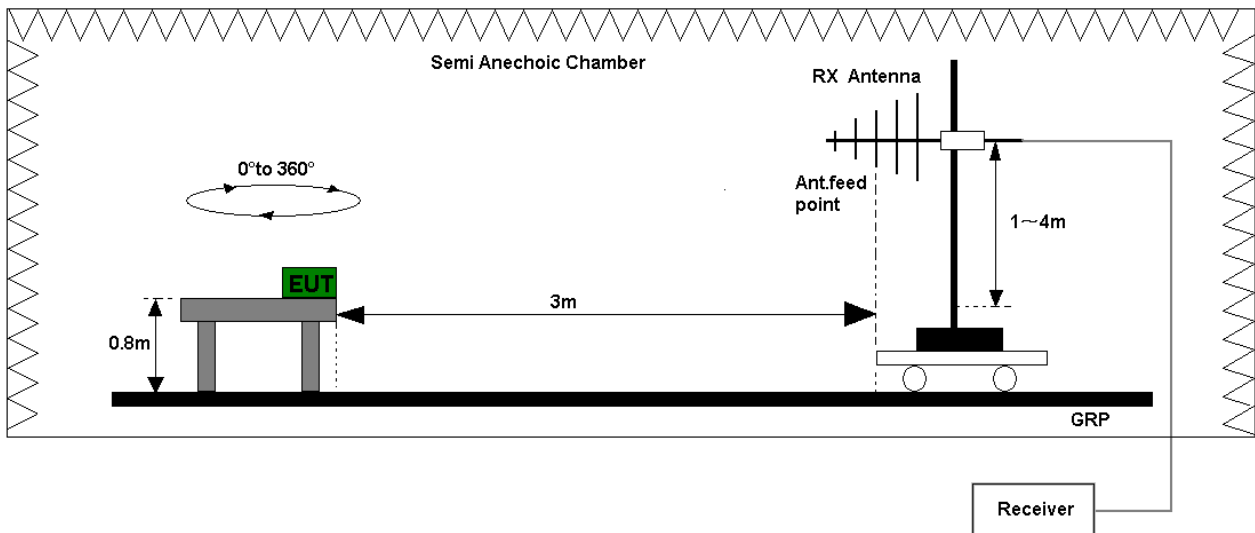

Figure 1. Test set-up of radiated disturbance(30MHz-1GHz)

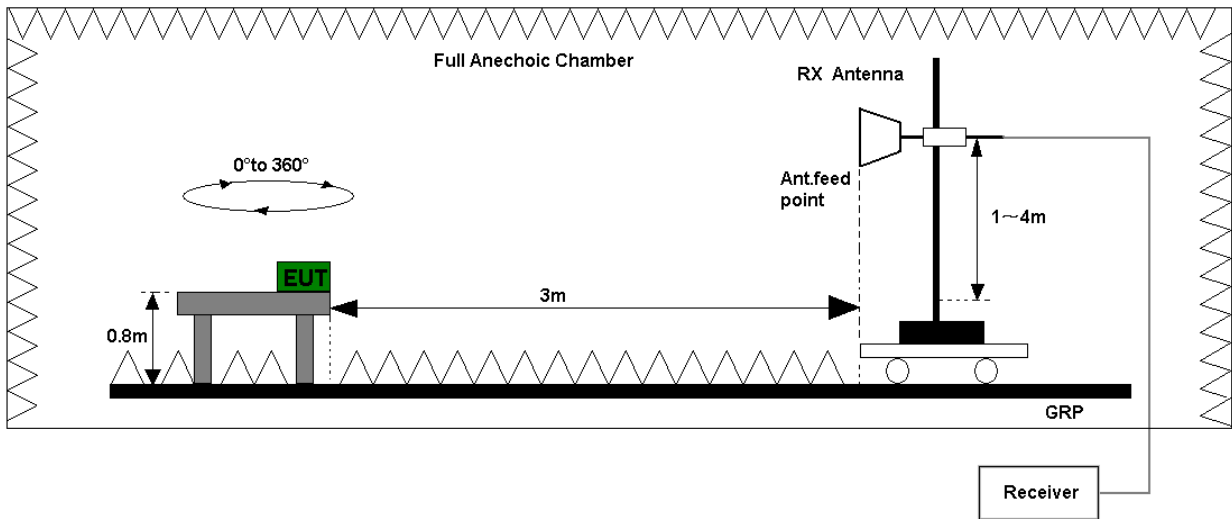

Figure 2. Test set-up of radiated disturbance(above 1GHz)



4.1.3 Test Results

The EUT has met the requirements for Radiated Emission of enclosure port.
Refer to the section 7.1.1 of this report for test data.

Test Limits (Class B)				
Frequency of Emission (MHz)	Radiated Limit			
	Unit(μ V/m)		Unit(dB μ V/m)	
30-88	100		40	
88-216	150		43.5	
216-960	200		46	
Above 960	500		54	
Above 1000	AV	PK	AV	PK
	500	5000	54	74

4.2 Conducted Disturbance 0.15 MHz to 30MHz

4.2.1 Test Procedure

The Table-top EUT was placed upon a non-metallic table 0.8 m above the horizontal metal reference ground plane. EUT was connected to LISN and LISN was connected to reference Ground Plane. EUT was 80cm away from LISN. The set-up and test methods were according to ANCI C63.4: 2014 Conducted Disturbance at AC Port measurements were undertaken on the L and N Lines. The emissions were measured using a Quasi-Peak Detector and Average Detector.

EUT was communicated with the simulator through Air interface, the simulator controls the EUT to transmitter the maximum power which defined in specification of product. The EUT operated on the typical channel.

Measurement bandwidth (RBW) for 150 kHz to 30 MHz: 9 kHz;

The EUT was set in the shielded chamber and operated under nominal conditions.

4.2.2 Test Setup

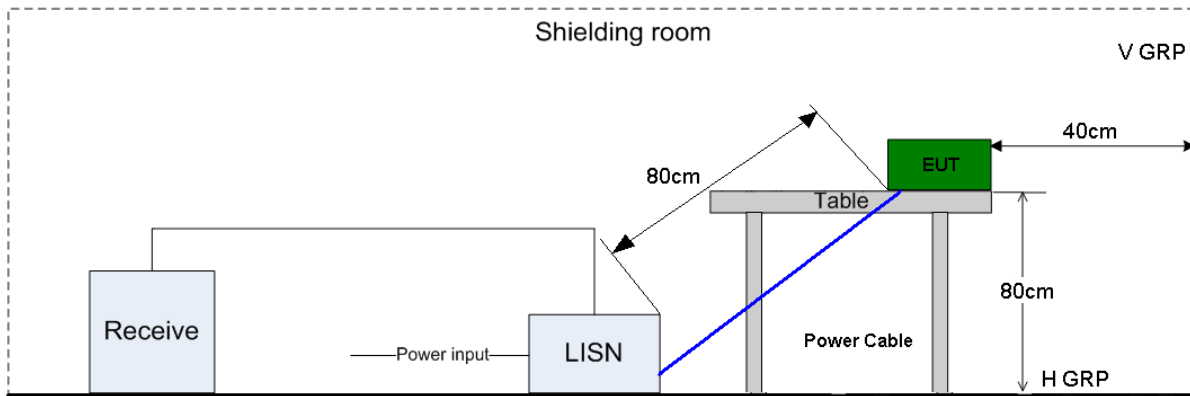

Figure 3. Test Set-up of conducted disturbance

4.2.3 Test Results

The EUT has met requirements for Conducted disturbance of power lines.

Refer to the section 7.2.1 of this report for test data.

Test Limit of AC Power Port		
Frequency range	150kHz ~ 30MHz	
Frequency	Voltage limits	
	QP (dB μ V)	AV (dB μ V)
0.15MHz~0.5MHz	66-56	56-46
0.5MHz-5MHz	56	46
5MHz~30MHz	60	50

5 Main Test Instruments

Main Test Equipments						
Test item	Test Instrument	Model	S/N	Manufacturer	Calibrated Deadline	Cal interval
RE	EMI Test receiver	ESU26	100150	R&S	Jun. 20, 2019	12
	Broadband Antenna	VULB 9163	9163-491	SCHWARZ BECK	Mar. 28, 2019	24
	Horn Antenna	HF906	100683	R&S	Mar. 28, 2019	24
CE	EMI Test receiver	ESU26	100150	R&S	May. 15, 2019	12
	Artificial Mains Network	ENV4200	100134	R&S	May. 15, 2019	12
	Artificial Mains Network	ENV216	100382	R&S	May. 15, 2019	12
Software Information						
Test Item	Software Name	Manufacturer		Version		
RE	EMC32	R&S		V9.25.0		
CE	EMC32	R&S		V9.25.0		

6 System Measurement Uncertainty

For a 95% confidence level, the measurement expanded uncertainties for defined systems, in accordance with the recommendations of ISO 17025 were:

System Measurement Uncertainty		
Items	Extended Uncertainty	
RE(30MHz-1GHz)	Field strength (dB μ V/m)	U=4.1dB; k=2
RE(1GHz-18GHz)	Field strength (dB μ V/m)	U=5.1dB; k=2
RE(18GHz-40GHz)	Field strength (dB μ V/m)	U=5.1dB; k=2
CE	Disturbance Voltage (dB μ V)	U=2.5dB; k=2

7 Test Data and Graph

Only the worst test results were shown

7.1 Radiated Disturbance

7.1.1 30MHz~1GHz

Test Mode 1: Charging+Camera On +Idle

Full Spectrum

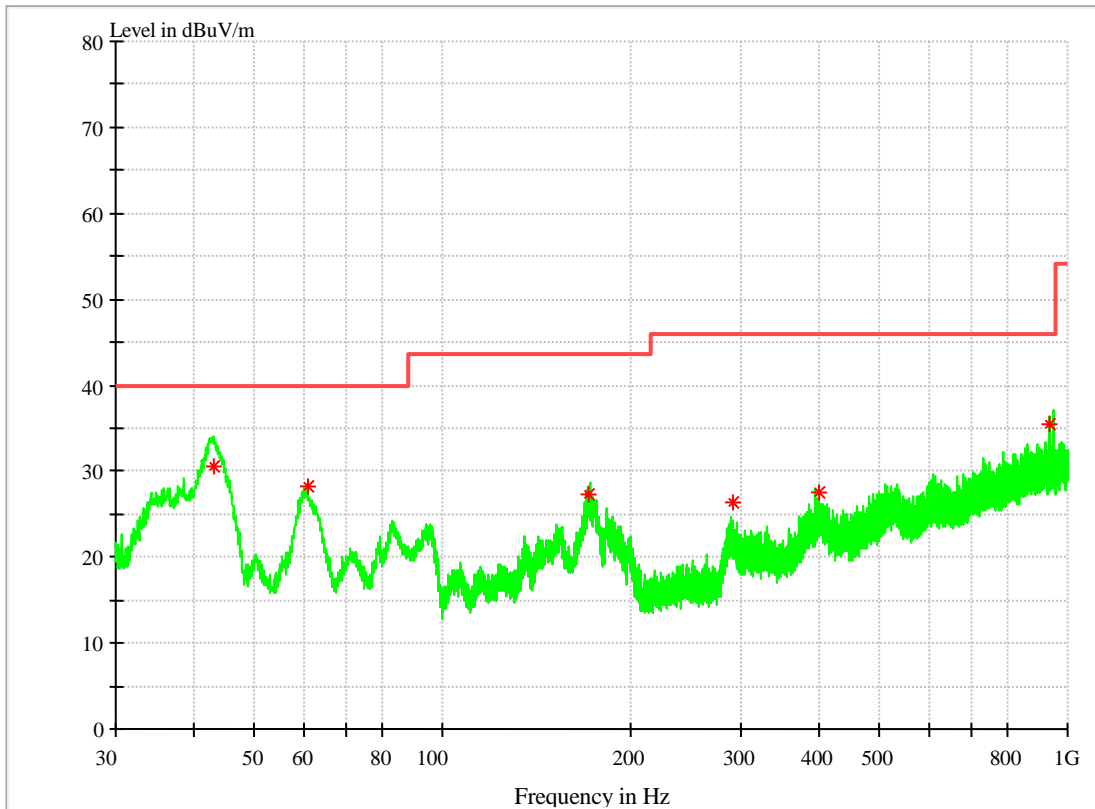

MEASUREMENT RESULT: QP Detector

Frequency MHz	Level dB μ V/m	Transd dB	Limit dB μ V/m	Margin dB	Height cm	Azimuth deg	Polarisation
43.090380	30.53	17.2	40.00	9.47	100.0	12.0	VERTICAL
60.775520	28.12	11.8	40.00	11.88	100.0	334.0	VERTICAL
171.311960	27.17	11.4	43.50	16.33	220.0	63.0	HORIZONTAL
292.011660	26.31	15.3	46.00	19.69	107.0	122.0	HORIZONTAL
399.635480	27.44	19.2	46.00	18.56	228.0	8.0	VERTICAL
935.679200	35.52	26.4	46.00	10.48	211.0	186.0	HORIZONTAL

Note:

Level = Reading level by receiver + Transd (Antenna factor + cable loss – preamplifier gain)
 The reading level is calculated by software which is not shown in the sheet.

7.1.2 1GHz~18GHz

Test Mode 1: Charging+ Camera On + Idle

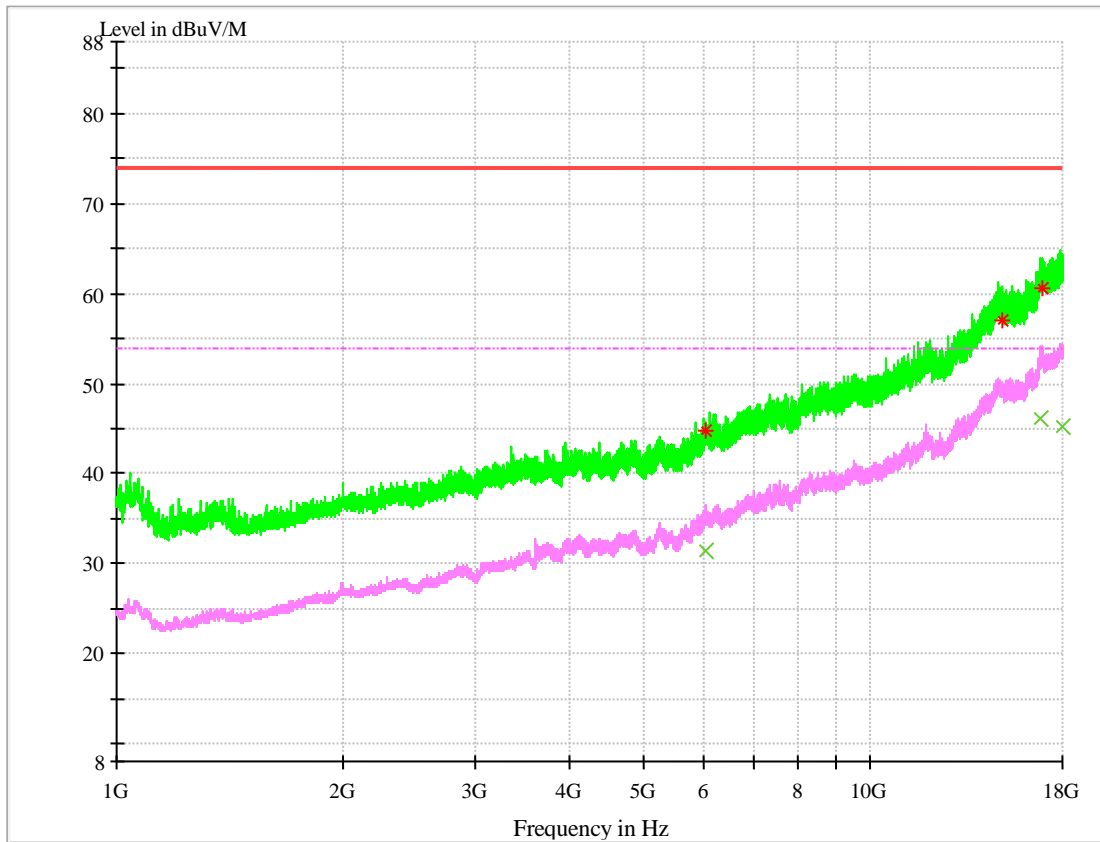

MEASUREMENT RESULT: PK Detector

Frequency MHz	Level dB μ V/m	Transd dB	Limit dB μ V/m	Margin dB	Height cm	Azimuth deg	Polarisation
6059.502666	44.79	-2.3	74.00	29.21	136.0	-36.0	HORIZONTAL
14942.498667	57.12	11.0	74.00	16.88	152.0	265.0	HORIZONTAL
16879.651333	60.49	20.5	74.00	13.51	256.0	217.0	VERTICAL

MEASUREMENT RESULT: AV Detector

Frequency MHz	Level dB μ V/m	Transd dB	Limit dB μ V/m	Margin dB	Height cm	Azimuth deg	Polarisation
6062.004667	31.47	-3.0	54.00	22.53	300.0	-44.0	HORIZONTAL
16855.130667	46.17	20.8	54.00	7.83	234.0	126.0	HORIZONTAL
17974.245333	45.15	21.6	54.00	8.85	100.0	181.0	HORIZONTAL

Note:

Level = Reading level by receiver + Transd (Antenna factor + cable loss – preamplifier gain)
 The reading level is calculated by software which is not shown in the sheet.

7.1.3 18GHz~26.5GHz

Test Mode 2: Charging+ Camera On + Idle

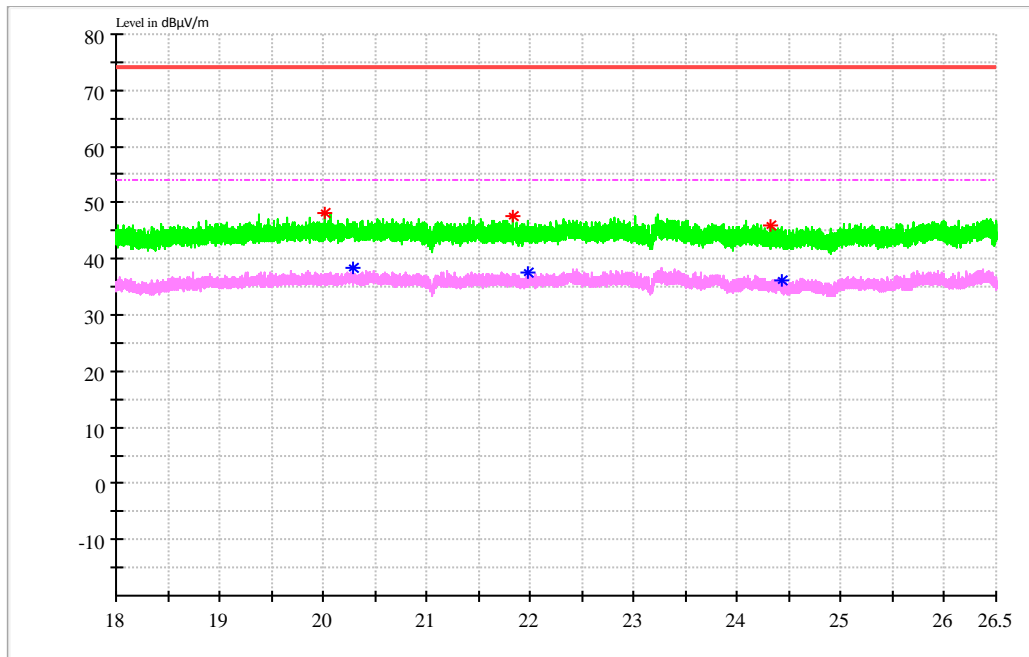

NOTE 1: The data was measured by Peak detector.

NOTE 2: No peak found in the Test Range of "18 GHz to 26.5GHz"

7.1.4 26.5GHz~40GHz

Test Mode 2: Charging+ Camera On + Idle

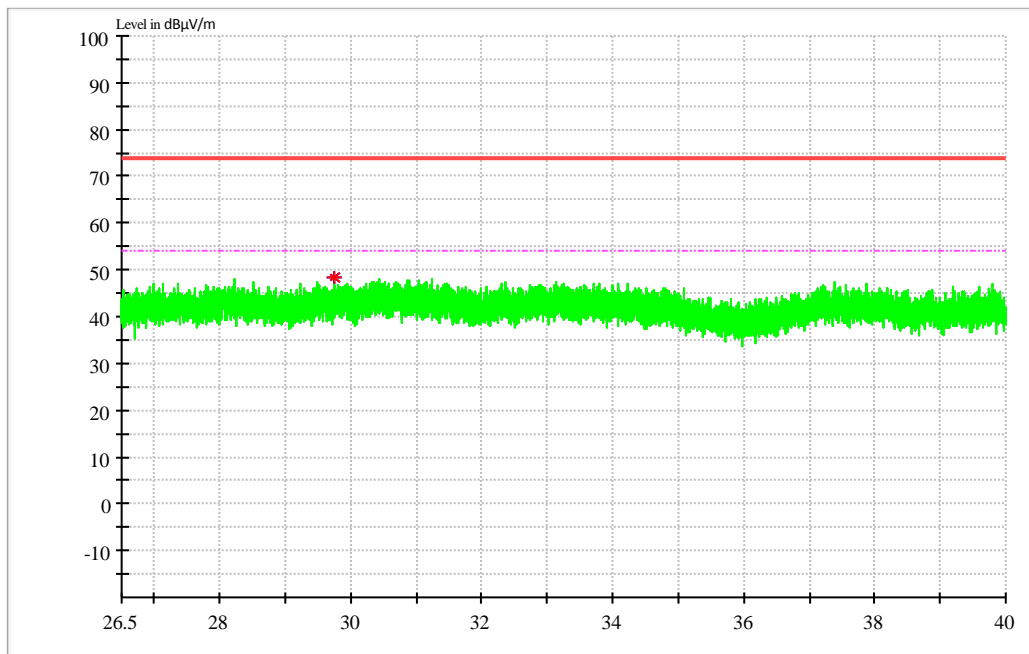

NOTE 1: The data was measured by Peak detector.

NOTE 2: No peak found in the Test Range of "26.5 GHz to 40GHz"

7.2 Conducted Disturbance

AC Port Test Data

Test Mode 1: Charging+ Camera On + Idle

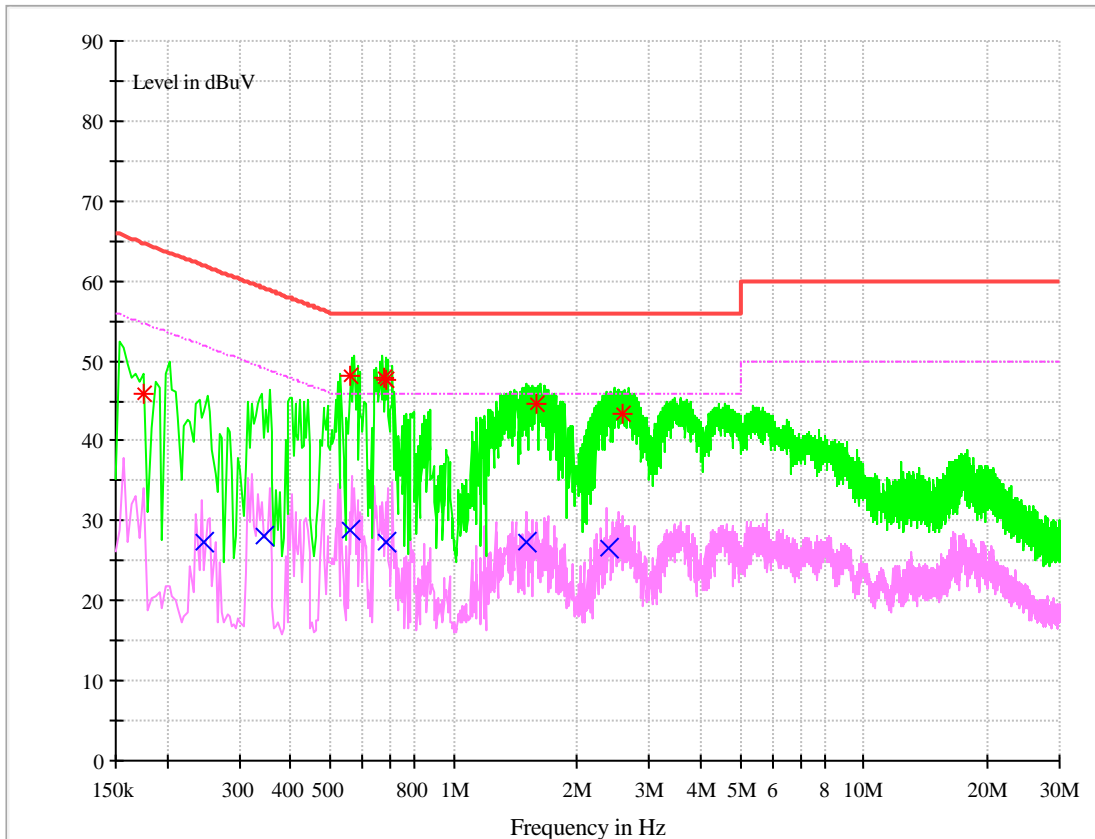

MEASUREMENT RESULT: QP Detector

Frequency MHz	Level dB μ V	Line	Transd dB	Margin dB	Limit dB μ V	PE
0.175764	45.97	N	9.7	18.71	64.68	FLO
0.559792	48.13	N	9.7	7.87	56.00	FLO
0.675082	47.81	N	9.7	8.19	56.00	FLO
0.687811	47.75	N	9.7	8.25	56.00	FLO
1.594505	44.55	N	9.7	11.45	56.00	FLO
2.582710	43.25	N	9.7	12.75	56.00	FLO

MEASUREMENT RESULT: AV Detector

Frequency MHz	Level dB μ V	Line	Transd dB	Margin dB	Limit dB μ V	PE
0.246541	27.40	L1	9.7	24.47	51.87	FLO
0.345263	28.15	N	9.7	20.93	49.08	FLO
0.561341	28.95	L1	9.7	17.05	46.00	FLO
0.682742	27.25	L1	9.7	18.75	46.00	FLO
1.510855	27.22	N	9.7	18.78	46.00	FLO
2.390304	26.61	N	9.7	19.39	46.00	FLO

END