



FCC&ISED RF Test Report

Product Name: Smart Phone

Model Number: EML-L09

Report No.: SYBH(Z-RF) 20181128006001-2001

FCC ID: QISEML-L09

IC: 6369A-EMLL09

Authorized	APPROVED (Lab Manager)	PREPARED (Test Engineer)
BY	<i>He Hao</i>	<i>Luo Wen</i>
DATE	2018-12-26	2018-12-26

Reliability Laboratory of Huawei Technologies Co., Ltd.

(Global Compliance and Testing Center of Huawei Technologies Co., Ltd)

Administration Building, Headquarters of Huawei Technologies Co., Ltd., Bantian, Longgang
District, Shenzhen, 518129, P.R.C

Tel: +86 755 28780808 Fax: +86 755 89652518

※ ※ Notice ※ ※

1. The Reliability Laboratory of Huawei Technologies Co., Ltd has passed the accreditation by The American Association for Laboratory Accreditation (A2LA). The accreditation number is 2174.01
2. The Laboratory of Sporton International (Shenzhen) Inc has passed the accreditation by National Voluntary Laboratory Accreditation Program (NVLAP). The NVLAP LAB CODE is 600156-0.
3. The Reliability Laboratory of Huawei Technologies Co., Ltd has been recognized by the US Federal Communications Commission (FCC) to perform compliance testing subject to the Commission's Certification rules. The Designation Number is CN1173, and the Test Firm Registration Number is 294140.
4. The Laboratory of Sporton International (Shenzhen) Inc has been recognized by the US Federal Communications Commission (FCC) to perform compliance testing subject to the Commission's Certification rules. The Designation Number is CN5019, and the Test Firm Registration Number is 577730.
5. The Reliability Laboratory of Huawei Technologies Co., Ltd has been listed by Industry Canada to perform electromagnetic emission measurements. The recognition numbers of test site are 6369A-1.
6. The Reliability Laboratory of Huawei Technologies Co., Ltd is also named "Global Compliance and Testing Center of Huawei Technologies Co., Ltd", the both names have coexisted since 2009.
7. The test report is invalid if not marked with the signatures of the persons responsible for preparing and approving the test report.
8. The test report is invalid if there is any evidence of erasure and/or falsification.
9. The test report is only valid for the test samples.
10. Content of the test report, in part or in full, cannot be used for publicity and/or promotional purposes without prior written approval from the laboratory.

MODIFICATION RECORD

No.	Report No	Modification Description	Testing Period
1	SYBH(Z-RF)2018013 1016001	First release.	2018.1.2~2018.2.5
2	SYBH(Z-RF) 20181128006001-2001	<p>Updated report: (1) Updated the version of the board, and added some tests according to differences and modifications of the new version, please see General Description for details:</p> <hr/> <p>Note 1: <input type="checkbox"/> The history report(s) should be withdrawn; <input checked="" type="checkbox"/> The history report(s) are still valid.</p>	2018.12.6~2018.12.26

DECLARATION

Type	Description
Multiple Models Applications	<p><input checked="" type="checkbox"/> The present report applies to single model. <input type="checkbox"/> The present report applies to several models. The practical measurements are performed with the model</p> <p>These models utilize the similar radio design, shielding, interface, physical layout and so on. The differences and modifications between these models are declared by the applicant and showed in General Description</p> <p>All others between these models are identical.</p> <p>The present report only presents the worst test case of all modes, see relevant test results for detailed.</p>

1 Table of contents

1	Table of contents.....	4
2	General Information.....	5
2.1	Test standard/s.....	5
2.2	Test Environment.....	5
2.3	Test Laboratories.....	5
2.4	Applicant and Manufacturer.....	6
2.5	Application details.....	6
3	Test Summary.....	7
3.1	PCS Band CA_2C(1850-1910 MHz paired with 1930-1990 MHz).....	7
3.2	BRS&EBS Band CA_7C (2500-2570 MHz paired with 2620-2690 MHz).....	8
3.3	BRS&EBS Band CA_38C (2570-2620 MHz paired with 2570-2620 MHz).....	11
3.4	Band CA_41C (2545-2655 MHz paired with 2545-2655 MHz).....	14
4	Description of the Equipment under Test (EUT).....	18
4.1	General Description.....	18
4.2	EUT Identity.....	19
4.3	Technical Specification.....	21
5	General Test Conditions / Configurations.....	22
5.1	Test Modes.....	22
5.2	Test Frequency.....	23
5.3	DESCRIPTION OF TESTS.....	26
5.4	Test Setups.....	30
5.5	Test Conditions.....	33
6	Main Test Instruments.....	35
6.1	Current Test Project/Report.....	35
7	Measurement Uncertainty.....	37

2 General Information

2.1 Test standard/s

Applied Rules :	47 CFR FCC Part 02 47 CFR FCC Part 24 47 CFR FCC Part 27 ISED RSS-Gen Issue 5, ISED RSS-133 Issue 6, ISED RSS-199 Issue 3
Test Method :	FCC KDB 971168 D01 Power Meas License Digital Systems v03r01 ANSI C63.26

2.2 Test Environment

Temperature :	TN	19.5 to 25	°C during room temperature tests
Ambient Relative Humidity:	40 to 55 %		
Atmospheric Pressure:	Not applicable		
Power supply :	VL	3.6	V
	VN	3.82	V DC by Battery
	VH	4.35	V

NOTE: 1) VN= nominal voltage, VL= low extreme test voltage, VH= High extreme test voltage;

TN= normal temperature, TL= low extreme test temperature, TH= High extreme test temperature.

2.3 Test Laboratories

Test Location 1 :	RELIABILITY LABORATORY OF HUAWEI TECHNOLOGIES CO., LTD.
Address of Test Location 1 :	No.2 New City Avenue Songshan Lake Sci. &Tech. Industry Park, Dongguan, Guangdong, P.R.C
Sub-contracted Test Location 1 :	Sporton International (Shenzhen) Inc.
Address of Sub-contracted Test Location 1 :	No.3 Building, the third floor of south, Shahe River west, Fengzeyuan warehouse, Nanshan District, Shenzhen, Guangdong, P.R.China

2.4 Applicant and Manufacturer

Company Name :	HUAWEI TECHNOLOGIES CO., LTD
Address :	Administration Building, Headquarters of Huawei Technologies Co., Ltd., Bantian, Longgang District, Shenzhen, 518129, P.R.C

2.5 Application details

Date of Receipt Sample:	2018-12-03
Start of test:	2018-12-06
End of test:	2018-12-26

3 Test Summary

3.1 PCS Band CA_2C(1850-1910 MHz paired with 1930-1990 MHz)

Test Item	FCC Rule No.	ISED Rule No.	Requirements	Test Result	Verdict (Note1)	Testing location
Effective (Isotropic) Radiated Power Output Data	§2.1046, §24.232	RSS-Gen, §6.12; RSS-133, §6.4	EIRP ≤ 2 W	Appendix A	Pass	Test Location 1
Peak-Average Ratio	§2.1046, §24.232	RSS-133, §6.4	Limit≤13 dB	Appendix B	Pass	Test Location 1
Modulation Characteristics	§2.1047	RSS-133, §6.2	Digital modulation	Appendix C	Pass	Test Location 1
Bandwidth	§2.1049	RSS-Gen, §6.7	OBW: No limit. EBW: No limit.	Appendix D	Pass	Test Location 1
Band Edges Compliance	§2.1051, §24.238	RSS-Gen, §6.13; RSS-133, §6.5	FCC: ≤ -13 dBm/1%*EBW, in 1 MHz bands immediately outside and adjacent to the frequency block. Note 1): EBW is -26 dBc EBW. ISED: ≤ -13 dBm/1%*EBW, in 1 MHz bands immediately outside and adjacent to the frequency block. Note 1): EBW is -20 dBc EBW, or OBW.	Appendix E	Pass	Test Location 1
Spurious Emission at Antenna Terminals	§2.1051, §24.238	RSS-Gen, §6.13; RSS-133, §6.5	FCC: ≤ -13 dBm/1 MHz, from max(lowest internal frequency, 9 kHz) to min(10 * highest fundamental frequency, 40 GHz) but outside authorized operating frequency blocks. ISED: ≤ -13 dBm/1 MHz, from max(min(lowest internal frequency, 30 MHz), 9 kHz) to min(10 * highest fundamental frequency, 40	Appendix F	Pass	Test Location 1

Test Item	FCC Rule No.	ISED Rule No.	Requirements	Test Result	Verdict (Note1)	Testing location
			GHz) but outside authorized operating frequency blocks.			
Field Strength of Spurious Radiation	§2.1053, §24.238	RSS-Gen, §6.13; RSS-133, §6.5	FCC: ≤ -13 dBm/1 MHz, from max(lowest internal frequency, 9 kHz) to min(10 * highest fundamental frequency, 40 GHz) but outside authorized operating frequency blocks. ISED: ≤ -13 dBm/1 MHz, from max(min(lowest internal frequency, 30 MHz), 9 kHz) to min(10 * highest fundamental frequency, 40 GHz) but outside authorized operating frequency blocks.	Appendix G	Pass	Test Location 1(above 30MHz);& Sub-contracted Test Location 1(9K-30MHz)
Frequency Stability	§2.1055, §24.235	RSS-Gen, §6.11; RSS-133, §6.3	FCC:Within authorized bands of operation/frequency block. ISED≤ ±2.5 ppm	Appendix H	Pass	Test Location 1
NOTE: For the verdict, the “N/A” denotes “not applicable”, the “N/T” denotes “not tested”.						

3.2 BRS&EBS Band CA_7C (2500-2570 MHz paired with 2620-2690 MHz)

Test Item	FCC Rule No.	ISED Rule No.	Requirements	Test Result	Verdict (Note1)	Testing location
Effective (Isotropic) Radiated Power Output Data	§2.1046, §27.50(h)	RSS-Gen, §6.12; RSS-199, §4.4	EIRP ≤ 2W	Appendix A	Pass	Test Location 1
Peak-Average Ratio	§27.50(a)	RSS-199, §4.4	Limit≤13 dB	Appendix B	Pass	Test Location 1
Modulation Characteristics	§2.1047	RSS-199, §4.1	Digital modulation	Appendix C	Pass	Test Location 1
Bandwidth	§2.1049	RSS-Gen, §6.7	OBW: No limit. EBW: No limit.	Appendix D	Pass	Test Location 1
Band Edges Compliance	§2.1051, §27.53(m4)	RSS-Gen, §6.13;	FCC:	Appendix E	Pass	Test Location 1

Test Item	FCC Rule No.	ISED Rule No.	Requirements	Test Result	Verdict (Note1)	Testing location
		RSS-199, §4.5; RSS-199, §4.2	<p>AND</p> <p>AND, if 2495-2496MHz is immediately outside and adjacent to the frequency block</p> <p>Note 1): EBW is -26 dBc EBW. ISED:</p> <p>AND</p>			
Spurious Emission at Antenna Terminals	§2.1051, §27.53(m)	RSS-Gen, §6.13; RSS-199, §4.5; RSS-199, §4.2	FCC: <p>AND</p> <p> <small>Fa = max(lowest internal frequency, 9 kHz) Fb = min(10 * highest fundamental frequency, 40 GHz)</small> </p> <p>Note 1): EBW is -26 dBc EBW. Note 2): MeasFrom: max(lowest internal frequency, 9 kHz). Note 3): MeasTo: min(10 * highest fundamental frequency, 40 GHz).</p>	Appendix F	Pass	Test Location 1

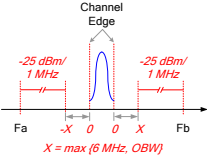
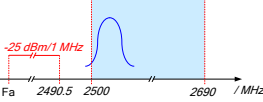
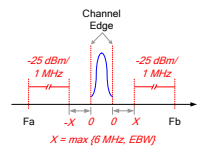
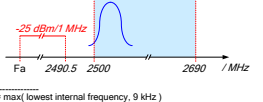
Test Item	FCC Rule No.	ISED Rule No.	Requirements	Test Result	Verdict (Note1)	Testing location
			<p>ISED:</p>  <p>AND</p>  <p>Fa = max(min(lowest internal frequency, 30 MHz), 9 kHz). Fb = min(10 * highest fundamental frequency, 40 GHz).</p> <p>Note 1): MeasFrom: max(min(lowest internal frequency, 30 MHz), 9 kHz).</p> <p>Note 2): MeasTo: min(10 * highest fundamental frequency, 40 GHz).</p>			
Field Strength of Spurious Radiation	§2.1053, §27.53(m)	RSS-Gen, §6.13; RSS-199, §4.5	<p>FCC:</p>  <p>AND</p>  <p>Fa = max(lowest internal frequency, 9 kHz) Fb = min(10 * highest fundamental frequency, 40 GHz)</p> <p>Note 1): EBW is -26 dBc EBW.</p> <p>Note 2): MeasFrom: max(lowest internal frequency, 9 kHz).</p> <p>Note 3): MeasTo: min(10 * highest fundamental frequency, 40 GHz).</p> <p>ISED:</p>	Appendix G	Pass	Test Location 1(above 30MHz);& Sub-contracted Test Location 1(9K-30MHz)

Test Item	FCC Rule No.	ISED Rule No.	Requirements	Test Result	Verdict (Note1)	Testing location
			<p>Channel Edge</p> <p>-25 dBm/1 MHz</p> <p>-25 dBm/1 MHz</p> <p>Fa 0 0 Fb</p> <p>X = max (6 MHz, OBW)</p> <p>AND</p> <p>-25 dBm/1 MHz</p> <p>-25 dBm/1 MHz</p> <p>Fa 2490.5 2500 2690 / MHz</p> <p>Fa = max(min(lowest internal frequency, 30 MHz), 9 kHz).</p> <p>Fb = min(10 * highest fundamental frequency, 40 GHz).</p> <p>Note 1): MeasFrom: max(min(lowest internal frequency, 30 MHz), 9 kHz).</p> <p>Note 2): MeasTo: min(10 * highest fundamental frequency, 40 GHz).</p>			
Frequency Stability	§2.1055, §27.54	RSS-Gen, §6.11; RSS-199, §4.3	Within authorized bands of operation/frequency block.	Appendix H	Pass	Test Location 1

NOTE: For the verdict, the "N/A" denotes "not applicable", the "N/T" denotes "not tested".

3.3 BRS&EBS Band CA_38C (2570-2620 MHz paired with 2570-2620 MHz)

Test Item	FCC Rule No.	ISED Rule No.	Requirements	Test Result	Verdict (Note1)	Testing location
Effective (Isotropic) Radiated Power Output Data	§2.1046, §27.50(h)	RSS-Gen, §6.12; RSS-199, §4.4	EIRP ≤ 2W	Appendix A	Pass	Test Location 1
Peak-Average Ratio	§27.50(a)	RSS-199, §4.4	Limit ≤ 13 dB	Appendix B	Pass	Test Location 1
Modulation Characteristics	§2.1047	RSS-199, §4.1	Digital modulation	Appendix C	Pass	Test Location 1
Bandwidth	§2.1049	RSS-Gen, §6.7	OBW: No limit. EBW: No limit.	Appendix D	Pass	Test Location 1
Band Edges Compliance	§2.1051, §27.53(m4)	RSS-Gen, §6.13; RSS-199, §4.5;	FCC:	Appendix E	Pass	Test Location 1

Test Item	FCC Rule No.	ISED Rule No.	Requirements	Test Result	Verdict (Note1)	Testing location
		RSS-199, §4.2	<p>Note 1): EBW is -26 dBc EBW.</p> <p>ISED:</p>			
Spurious Emission at Antenna Terminals	§2.1051, §27.53(m)	RSS-Gen, §6.13; RSS-199, §4.5; RSS-199, §4.2	<p>FCC:</p> <p>Note 1): EBW is -26 dBc EBW.</p> <p>Note 2): MeasFrom: max(lowest internal frequency, 9 kHz).</p> <p>Note 3): MeasTo: min(10 * highest fundamental frequency, 40 GHz).</p> <p>ISED:</p>	Appendix F	Pass	Test Location 1

Test Item	FCC Rule No.	ISED Rule No.	Requirements	Test Result	Verdict (Note1)	Testing location
			<p>Note 1): MeasFrom: max(min(lowest internal frequency, 30 MHz), 9 kHz).</p> <p>Note 2): MeasTo: min(10 * highest fundamental frequency, 40 GHz).</p>			
Field Strength of Spurious Radiation	§2.1053, §27.53(m)	RSS-Gen, §6.13; RSS-199, §4.5	<p>FCC:</p> <p>Note 1): EBW is -26 dBc EBW.</p> <p>Note 2): MeasFrom: max(lowest internal frequency, 9 kHz).</p> <p>Note 3): MeasTo: min(10 * highest fundamental frequency, 40 GHz).</p> <p>ISED:</p>	Appendix G	Pass	Test Location 1 (above 30MHz); & Sub-contracted Test Location 1 (9K-30MHz)

Test Item	FCC Rule No.	ISED Rule No.	Requirements	Test Result	Verdict (Note1)	Testing location
			<p>Note 1): MeasFrom: max(min(lowest internal frequency, 30 MHz), 9 kHz).</p> <p>Note 2): MeasTo: min(10 * highest fundamental frequency, 40 GHz).</p>			
Frequency Stability	§2.1055, §27.54	RSS-Gen, §6.11; RSS-199, §4.3	Within authorized bands of operation/frequency block.	Appendix H	Pass	Test Location 1
NOTE: For the verdict, the "N/A" denotes "not applicable", the "N/T" denotes "not tested".						

3.4 Band CA_41C (2545-2655 MHz paired with 2545-2655 MHz)

Test Item	FCC Rule No.	ISED Rule No.	Requirements	Test Result	Verdict (Note1)	Testing location
Effective (Isotropic) Radiated Power Output Data	§2.1046, §27.50(h)	RSS-Gen, §6.12; RSS-199, §4.4	$EIRP \leq 2W$	Appendix A	Pass	Test Location 1
Peak-Average Ratio	§27.50(a)	RSS-199, §4.4	Limit ≤ 13 dB	Appendix B	Pass	Test Location 1
Modulation Characteristics	§2.1047	RSS-199, §4.1	Digital modulation	Appendix C	Pass	Test Location 1
Bandwidth	§2.1049	RSS-Gen, §6.7	OBW: No limit. EBW: No limit.	Appendix D	Pass	Test Location 1
Band Edges Compliance	§2.1051, §27.53(m4)	RSS-Gen, §6.13; RSS-199, §4.5;	FCC:	Appendix E	Pass	Test Location 1

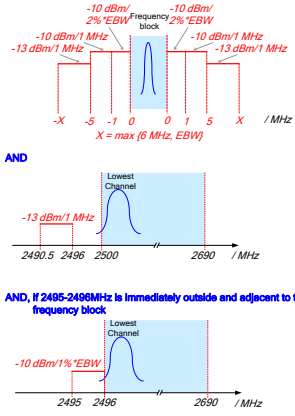
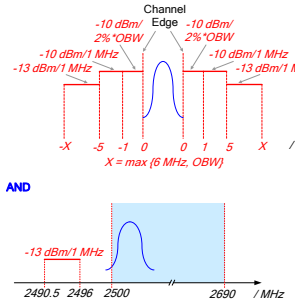
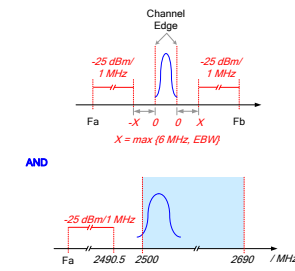
Test Item	FCC Rule No.	ISED Rule No.	Requirements	Test Result	Verdict (Note1)	Testing location
		RSS-199, §4.2	 <p>Note 1): EBW is -26 dBc EBW.</p> <p>ISED:</p> 			
Spurious Emission at Antenna Terminals	§2.1051, §27.53(m)	RSS-Gen, §6.13; RSS-199, §4.5; RSS-199, §4.2	<p>FCC:</p>  <p>Note 1): EBW is -26 dBc EBW.</p> <p>Note 2): MeasFrom: max(lowest internal frequency, 9 kHz).</p> <p>Note 3): MeasTo: min(10 * highest fundamental frequency, 40 GHz).</p> <p>ISED:</p>	Appendix F	Pass	Test Location 1

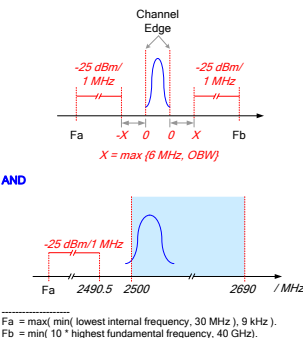
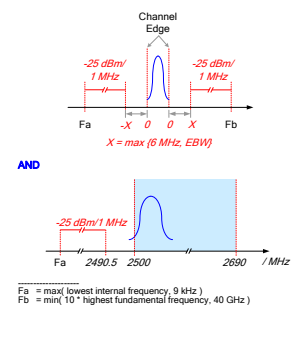
Test Item	FCC Rule No.	ISED Rule No.	Requirements	Test Result	Verdict (Note1)	Testing location
			 <p>Channel Edge</p> <p>-25 dBm/1 MHz</p> <p>-25 dBm/1 MHz</p> <p>Fa -X 0 0 X Fb</p> <p>X = max (6 MHz, OBW)</p> <p>AND</p> <p>-25 dBm/1 MHz</p> <p>Fa 2490.5 2500 2690 / MHz</p> <p>Fa = max(min(lowest internal frequency, 30 MHz), 9 kHz).</p> <p>Fb = min(10 * highest fundamental frequency, 40 GHz).</p> <p>Note 1): MeasFrom: max(min(lowest internal frequency, 30 MHz), 9 kHz).</p> <p>Note 2): MeasTo: min(10 * highest fundamental frequency, 40 GHz).</p>			
Field Strength of Spurious Radiation	§2.1053, §27.53(m)	RSS-Gen, §6.13; RSS-199, §4.5	<p>FCC:</p>  <p>Channel Edge</p> <p>-25 dBm/1 MHz</p> <p>-25 dBm/1 MHz</p> <p>Fa -X 0 0 X Fb</p> <p>X = max (6 MHz, EBW)</p> <p>AND</p> <p>-25 dBm/1 MHz</p> <p>Fa 2490.5 2500 2690 / MHz</p> <p>Fa = max(lowest internal frequency, 9 kHz).</p> <p>Fb = min(10 * highest fundamental frequency, 40 GHz).</p> <p>Note 1): EBW is -26 dBc EBW.</p> <p>Note 2): MeasFrom: max(lowest internal frequency, 9 kHz).</p> <p>Note 3): MeasTo: min(10 * highest fundamental frequency, 40 GHz).</p> <p>ISED:</p>	Appendix G	Pass	Test Location 1(above 30MHz);& Sub-contracted Test Location 1(9K-30MHz)

Test Item	FCC Rule No.	ISED Rule No.	Requirements	Test Result	Verdict (Note1)	Testing location
			<p>Channel Edge</p> <p>-25 dBm/1 MHz</p> <p>-X 0 0 X Fb</p> <p>X = max (6 MHz, OBW)</p> <p>AND</p> <p>-25 dBm/1 MHz</p> <p>Fa 2490.5 2500 2690 / MHz</p> <p>Fa = max(min(lowest internal frequency, 30 MHz), 9 kHz). Fb = min(10 * highest fundamental frequency, 40 GHz).</p> <p>Note 1): MeasFrom: max(min(lowest internal frequency, 30 MHz), 9 kHz).</p> <p>Note 2): MeasTo: min(10 * highest fundamental frequency, 40 GHz).</p>			
Frequency Stability	§2.1055, §27.54	RSS-Gen, §6.11; RSS-199, §4.3	Within authorized bands of operation/frequency block.	Appendix H	Pass	Test Location 1
NOTE: For the verdict, the "N/A" denotes "not applicable", the "N/T" denotes "not tested".						

4 Description of the Equipment under Test (EUT)

4.1 General Description

EML-L09 is subscriber equipment in the LTE/ WCDMA/GSM system. The LTE frequency band for Single Carrier is Band 1, Band 2, Band 3, Band 4, Band 5, Band 6, Band 7, Band 8, Band 9, Band 12, Band17, Band 18, Band 19, Band 20, Band 26, Band 28, Band 32, Band 34, Band 38, Band39, Band 40 and Band 41 and the LTE frequency band for Intra-band carrier aggregation uplink operation band is CA_1C, CA_2C, CA_3C, CA_7C, CA_38C, CA_39C, CA_41C . The HSUPA/HSDPA/UMTS frequency band is Band I, Band II, Band IV, Band V, Band VI, Band VIII and Band XIX. The GSM/GPRS/EDGE frequency band includes GSM850 and GSM900 and DCS1800 and PCS1900. The Mobile Phone implements such functions as RF signal receiving/transmitting, LTE/ WCDMA /GSM protocol processing, voice, video, MMS service, GPS ,NFC and WIFI etc. Externally it provides earphone port (to provide voice service) and single USIM card interfaces. It also provides Bluetooth module to synchronize data between a PC and the phone, or to use the built-in modem of the phone to access the Internet with a PC, or to exchange data with other Bluetooth devices.

The changed points:

Item	The detail software changed points
Supported uplink CA	New add to support CA_2C, CA_7C, CA_38C,CA_41C

The mobile phone EML-L29 and EML-L09 are LTE/UMTS/GSM mobile phone with Bluetooth. The differences between EML-L29 and EML-L09 are showed in the following table. EML-L09 delete one SIM by software. Other parts of the mobile phone are the same, including the appearance, the antenna, Chipset, Bluetooth mode, Wifi mode, Adapter, Battery, and so on.

	EML-L29	EML-L09
GSM four bands	B2/B3/B5/B8	B2/B3/B5/B8
WCDMA bands	B1/2/4/5/6/8/19	B1/2/4/5/6/8/19
LTE bands	FDD LTE: B1/2/3/4/5/6/7/8/9/12/17/18/19/20/ B26/28/32, CA_1C, CA_2C, CA_3C, CA_7C TDD LTE: B34/B38/39/40/41 (110M,2545-2655), CA_38C, CA_39C, CA_41C	FDD LTE: B1/2/3/4/5/6/7/8/9/12/17/18/19/20/ B26/28/32, CA_1C, CA_2C, CA_3C, CA_7C TDD LTE: B34/B38/39/40/41 (110M,2545-2655), CA_38C, CA_39C, CA_41C
FCC bands	GSM850/1900 WB2/B4/B5 LTE	GSM850/1900 WB2/B4/B5 LTE

	B2/4/5/B7/B12/B17/B26/38/B41, CA_2C, CA_7C, CA_38C, CA_41C	B2/4/5/B7/B12/B17/B26/38/B41, CA_2C, CA_7C, CA_38C, CA_41C
SIM card	Two	One
NFC	the same	the same
External camera	the same	the same
internal camera	the same	the same
FLASH	the same	the same
Mainboard	the same	the same
PCB layout	the same	the same
Appearance	the same	the same
Bluetooth mode	the same	the same
WLAN mode	the same	the same
BT/ WLAN antenna	the same	the same
GSM/ WCDMA /LTE antenna	the same	the same
Adapter	the same	the same
Battery	the same	the same
Chipset	the same	the same
Memory	the same	the same
RF Parameter	The same RF Parameter in the same band	The same RF Parameter in the same band
Dimension	the same	the same
Main Frequency NV	The same NV in the same band	The same NV in the same band

So

NOTE1: Only LTE Band CA_2C, CA_7C, CA_38C, CA_41C data included in this report and the others can refer to No.SYBH(Z-RF)20180131016001) of EML-L09(FCC ID: QISEML-L09&IC: 6369A-EMLL09) history report

NOTE2: We do not test LTE Band CA_2C, CA_7C, CA_38C, CA_41C of EML-L09, the test data refer to No. SYBH(Z-RF)20181114005001-2001 of EML-L29(FCC ID: QISEML-L29 & IC: 6369A-EMLL29) report





4.2 EUT Identity

NOTE: Unless otherwise noted in the report, the functional boards installed in the units shall be selected from the below list, but not means all the functional boards listed below shall be installed in one unit.

4.2.1 Board

Board		
Description	Software Version	Hardware Version
Main Board	EML-L09 8.1.0.178(C900)	HL1EMILYM

4.2.2 Sub-Assembly

Sub-Assembly			
Sub-Assembly Name	Model	Manufacturer	Description
Adapter	HW-050450B00	Huawei Technologies Co.,Ltd.	Input Voltage:100V-240V~50/60Hz, 0.75A Output Voltage: 5V  2A/4.5A; 4.5V 5A
Adapter	HW-050450E00	Huawei Technologies Co.,Ltd.	Input Voltage:100V-240V~50/60Hz, 0.75A Output Voltage: 5V  2A/4.5A; 4.5V 5A
Adapter	HW-050450U00	Huawei Technologies Co.,Ltd.	Input Voltage:100V-240V~50/60Hz, 0.75A Output Voltage: 5V  2A/4.5A; 4.5V 5A
Adapter	HW-050450A00	Huawei Technologies Co.,Ltd.	Input Voltage:100V-240V~50/60Hz, 0.75A Output Voltage: 5V  2A/4.5A; 4.5V 5A
Rechargeable Li-ion	HB396285ECW	Huawei Technologies Co.,Ltd.	Rated capacity: 3320mAh Nominal Voltage: +3.82V Charging Voltage: +4.4V

4.3 Technical Specification

NOTE: For the detailed technical descriptions, see the applicant/manufacturer's specifications or user manual.

4.3.1 General

Characteristics	Description	
Radio System Type	<input checked="" type="checkbox"/> LTE	
Supported Frequency Range	CA_Band_CA_2C	Transmission (TX): 1850 to 1910 MHz
		Receiving (RX): 1930 to 1990 MHz
	CA_Band_CA_7C	Transmission (TX): 2500 to 2570 MHz
		Receiving (RX): 2620 to 2690 MHz
	CA_Band_CA_38C	Transmission (TX): 2750 to 2620 MHz
		Receiving (RX): 2570 to 2620 MHz
	CA_Band_CA_41C	Transmission (TX): 2545 to 2655 MHz
		Receiving (RX): 2545 to 2655 MHz
TX and RX Antenna Ports (one band)	TX & RX port:	1
	TX-only port:	0
	RX-only port:	1
Target TX Output Power	LTE BAND CA_2C:	23dBm
	LTE BAND CA_7C:	22.8dBm
	LTE BAND CA_38C:	22.8dBm
	LTE BAND CA_41C:	23dBm
Supported Channel Bandwidth	CA_Band_CA_2C	<input checked="" type="checkbox"/> 5MHz+20MHz, <input checked="" type="checkbox"/> 10MHz+15MHz, <input checked="" type="checkbox"/> 10MHz+20MHz, <input checked="" type="checkbox"/> 15MHz+15MHz, <input checked="" type="checkbox"/> 15MHz+20MHz, <input checked="" type="checkbox"/> 20MHz+20MHz,
	CA_Band_CA_7C	<input checked="" type="checkbox"/> 10MHz+20MHz, <input checked="" type="checkbox"/> 15MHz+15MHz, <input checked="" type="checkbox"/> 15MHz+20MHz, <input checked="" type="checkbox"/> 20MHz+20MHz,
	CA_Band_CA_38C	<input checked="" type="checkbox"/> 15MHz+15MHz, 20MHz+20MHz,
	CA_Band_CA_41C	<input checked="" type="checkbox"/> 5MHz+20MHz, <input checked="" type="checkbox"/> 10MHz+20MHz, <input checked="" type="checkbox"/> 15MHz+15MHz, <input checked="" type="checkbox"/> 20MHz+20MHz,
Designation of Emissions (Note: the necessary bandwidth of which is the worst value from the measured occupied bandwidths for each type of channel bandwidth configuration.)	LTE BAN CA_2C:	23M6G7D (20+5 MHz QPSK modulation), 23M5W7D (20+5 MHz 16QAM modulation) 38M5G7D (20+20 MHz QPSK modulation), 38M4W7D (20+20 MHz 16QAM modulation)
	LTE BAND CA_7C:	29M1G7D (15+15 MHz QPSK modulation), 29M0W7D (15+15 MHz 16QAM modulation) 38M6G7D (20+20 MHz QPSK modulation), 38M6W7D (20+20 MHz 16QAM modulation)
	LTE BAND CA_38C:	29M1G7D (15+15 MHz QPSK modulation), 29M1W7D (15+15 MHz 16QAM modulation) 38M6G7D (20+20 MHz QPSK modulation),

Characteristics	Description	
		38M6W7D (20+20 MHz 16QAM modulation)
	LTE BAND CA_41C:	29M0G7D (15+15 MHz QPSK modulation), 29M0W7D (15+15 MHz 16QAM modulation), 38M5G7D (20+20 MHz QPSK modulation), 38M5W7D (20+20 MHz 16QAM modulation)

5 General Test Conditions / Configurations

5.1 Test Modes

NOTE1: The test mode(s) are selected according to relevant radio technology specifications.

NOTE2: The power of LTE system 64QAM modulation is lower than that of 16QAM, so we did not test 64QAM modulation.

Test Mode	Test Modes Description
LTE/TM1	LTE system, QPSK modulation
LTE/TM2	LTE system, 16QAM modulation

5.2 Test Frequency

Test frequencies for CA_2C											
Range	CC-Combo / N _{RB_agg} [RB]	CC1 Note1					CC2 Note1				
		BW [RB]	NUL	f _{UL} [MHz]	N _{DL}	f _{DL} [MHz]	BW [RB]	NUL	f _{UL} [MHz]	N _{DL}	f _{DL} [MHz]
Low	25+100	25	18633	1853.3	633	1933.3	100	18750	1865	750	1945
		100	18700	1860	700	1940	25	18817	1871.7	817	1951.7
	50+75	50	18653	1855.3	653	1935.3	75	18773	1867.3	773	1947.3
		75	18675	1857.5	675	1937.5	50	18795	1869.5	795	1949.5
	50+100	50	18655	1855.5	655	1935.5	100	18799	1869.9	799	1949.9
		100	18700	1860	700	1940	50	18844	1874.4	844	1954.4
	75+75	75	18675	1857.5	675	1937.5	75	18825	1872.5	825	1952.5
		75	18678	1857.8	678	1937.8	100	18849	1874.9	849	1954.9
	75+100	75	18678	1857.8	678	1937.8	100	18849	1874.9	849	1954.9
		100	18700	1860	700	1940	75	18871	1877.1	871	1957.1
100+100	100	18700	1860	700	1940	100	18898	1879.8	898	1959.8	
Mid	25+100	25	18808	1870.8	808	1950.8	100	18925	1882.5	925	1962.5
		100	18875	1877.5	875	1957.5	25	18992	1889.2	992	1969.2
	50+75	50	18829	1872.9	829	1952.9	75	18949	1884.9	949	1964.9
		75	18851	1875.1	851	1955.1	50	18971	1887.1	971	1967.1
	50+100	50	18806	1870.6	806	1950.6	100	18950	1885	950	1965
		100	18851	1875.1	851	1955.1	50	18995	1889.5	995	1969.5
	75+75	75	18825	1872.5	825	1952.5	75	18975	1887.5	975	1967.5
		75	18803	1870.3	803	1950.3	100	18974	1887.4	974	1967.4
	75+100	75	18803	1870.3	803	1950.3	100	18974	1887.4	974	1967.4
		100	18826	1872.6	826	1952.6	75	18997	1889.7	997	1969.7
100+100	100	18801	1870.1	801	1950.1	100	18999	1889.9	999	1969.9	
High	25+100	25	18983	1888.3	983	1968.3	100	19100	1900	1100	1980
		100	19050	1895	1050	1975	25	19167	1906.7	1167	1986.7
	50+75	50	19005	1890.5	1005	1970.5	75	19125	1902.5	1125	1982.5
		75	19027	1892.7	1027	1972.7	50	19147	1904.7	1147	1984.7
	50+100	50	18956	1885.6	956	1965.6	100	19100	1900	1100	1980
		100	19001	1890.1	1001	1970.1	50	19145	1904.5	1145	1984.5
	75+75	75	18975	1887.5	975	1967.5	75	19125	1902.5	1125	1982.5
		75	18929	1882.9	929	1962.9	100	19100	1900	1100	1980
	75+100	75	18929	1882.9	929	1962.9	100	19100	1900	1100	1980
		100	18951	1885.1	951	1965.1	75	19122	1902.2	1122	1982.2
100+100	100	18902	1880.2	902	1960.2	100	19100	1900	1100	1980	

Note 1: Carriers in increasing frequency order.

Test frequencies for CA_7C											
----------------------------	--	--	--	--	--	--	--	--	--	--	--

Range	CC-Combo / N _{RB_agg} [RB]	CC1 Note1					CC2 Note1				
		BW [RB]	NUL	f _{UL} [MHz]	N _{DL}	f _{DL} [MHz]	BW [RB]	NUL	f _{UL} [MHz]	N _{DL}	f _{DL} [MHz]
Low	50+100	50	20805	2505.5	2805	2625.5	100	20949	2519.9	2949	2639.9
		100	20850	2510	2850	2630	50	20994	2524.4	2994	2644.4
	75+75	75	20825	2507.5	2825	2627.5	75	20975	2522.5	2975	2642.5
	75+100	75	20828	2507.8	2828	2627.8	100	20999	2524.9	2999	2644.9
		100	20850	2510	2850	2630	75	21021	2527.1	3021	2647.1
100+100	100	20850	2510	2850	2630	100	21048	2529.8	3048	2649.8	
Mid	50+100	50	21006	2525.6	3006	2645.6	100	21150	2540	3150	2660
		100	21051	2530.1	3051	2650.1	50	21195	2544.5	3195	2664.5
	75+75	75	21025	2527.5	3025	2647.5	75	21175	2542.5	3175	2662.5
	75+100	75	21003	2525.3	3003	2645.3	100	21174	2542.4	3174	2662.4
		100	21026	2527.6	3026	2647.6	75	21197	2544.7	3197	2664.7
100+100	100	21001	2525.1	3001	2645.1	100	21199	2544.9	3199	2664.9	
High	50+100	50	21206	2545.6	3206	2665.6	100	21350	2560	3350	2680
		100	21251	2550.1	3251	2670.1	50	21395	2564.5	3395	2684.5
	75+75	75	21225	2547.5	3225	2667.5	75	21375	2562.5	3375	2682.5
	75+100	75	21179	2542.9	3179	2662.9	100	21350	2560	3350	2680
		100	21201	2545.1	3201	2665.1	75	21372	2562.2	3372	2682.2
100+100	100	21152	2540.2	3152	2660.2	100	21350	2560	3350	2680	

Note 1: Carriers in increasing frequency order.

Test frequencies for CA_38C							
Range	CC-Combo / N _{RB_agg} [RB]	CC1 Note1			CC2 Note1		
		BW [RB]	NUL/DL	f _{UL/DL} [MHz]	BW [RB]	NUL/DL	f _{UL/DL} [MHz]
Low	75+75	75	37825	2577.5	75	37975	2592.5
	100+100	100	37850	2580	100	38048	2599.8
Mid	75+75	75	37925	2587.5	75	38075	2602.5
	100+100	100	37901	2585.1	100	38099	2604.9
High	75+75	75	38025	2597.5	75	38175	2612.5
	100+100	100	37952	2590.2	100	38150	2610

Note 1: Carriers in increasing frequency order.

Test frequencies for CA_41C(2545-2655)							
Range	CC-Combo / N _{RB_agg} [RB]	CC1 Note1			CC2 Note1		
		BW [RB]	NUL/DL	f _{UL/DL} [MHz]	BW [RB]	NUL/DL	f _{UL/DL} [MHz]
Low	25+100	25	40173	2548.3	100	40290	2560

Test frequencies for CA_41C(2545-2655)							
Range	CC-Combo /	CC1 Note1			CC2 Note1		
				100	40240	2555	25
	50+100	50	40195	2550.5	100	40339	2564.9
		100	40240	2555	50	40384	2569.4
	75+75	75	40215	2552.5	75	40365	2567.5
	75+100	75	40218	2552.8	100	40389	2569.9
		100	40240	2555	75	40411	2572.1
	100+100	100	40240	2555	100	40438	2574.8
Mid	25+100	25	40598	2590.8	100	40715	2602.5
		100	40665	2597.5	25	40782	2609.2
	50+100	50	40596	2590.6	100	40740	2605
		100	40641	2595.1	50	40785	2609.5
	75+75	75	40615	2592.5	75	40765	2607.5
	75+100	75	40593	2590.3	100	40764	2607.4
		100	40616	2592.6	75	40787	2609.7
	100+100	100	41011	2632.1	100	40719	2602.9
	High	25+100	25	41023	2633.3	100	41140
100			41090	2640	25	41207	2651.7
50+100		50	40996	2630.6	100	41140	2645
		100	41041	2635.1	50	41185	2649.5
75+75		75	41015	2632.5	75	41165	2647.5
75+100		75	40969	2627.9	100	41140	2645
		100	40991	2630.1	75	41162	2647.2
100+100		100	40942	2625.2	100	41140	2645
Note 1: Carriers in increasing frequency order.							

5.3 DESCRIPTION OF TESTS

5.3.1 Radiated Power and Radiated Spurious Emissions

Radiated spurious emissions are investigated indoors in a full-anechoic chamber to determine the frequencies producing the worst case emissions. Final measurements for radiated power and radiated spurious emissions are performed on the 3 meter OATS per the guidelines of ANSI/TIA-603-E-2016. The equipment under test was transmitting while connected to its integral antenna and is placed on a wooden turntable 150cm above the ground plane and 3 meters from the receive antenna. The spectrum is scanned from the lowest frequency generated in the equipment up to a frequency including its 10th harmonic. The receive antenna height is adjusted between 1 and 4 meter height, the turntable is rotated through 360 degrees, and the EUT is manipulated through all orthogonal planes representative of its typical use to achieve the highest reading on the receive spectrum analyzer. Emissions are also investigated with the receive antenna horizontally and vertically polarized.

A portable or small unlicensed wireless device shall be placed on a non-metallic test fixture or other non-metallic support during testing. The supporting fixture shall permit orientation of the EUT in each of three orthogonal (x, y, z) axis positions such that emissions from the EUT are maximized. Measure the EUT maximum RF power and record the result.

A half-wave dipole is then substituted in place of the EUT. For emissions above 3GHz, a horn antenna is substituted in place of the EUT. The substitute antenna is driven by a signal generator with the level of the signal generator being adjusted to obtain the same receive spectrum analyzer level previously recorded from the spurious emission from the EUT.

The power of the emission is calculated using the following formula:

$$P_d \text{ [dBm]} = P_g \text{ [dBm]} - \text{cable loss [dB]} + \text{antenna gain [dBd/dBi]}$$

Where, P_d is the dipole equivalent power, P_g is the generator output into the substitution antenna, and the antenna gain is the gain of the substitute antenna used relative to either a half-wave dipole (dBd) or an isotropic source (dBi). The substitute level is equal to $P_g \text{ [dBm]} - \text{cable loss [dB]}$.

The calculated P_d levels are then compared to the absolute spurious emission limit of -13dBm which is equivalent to the required minimum attenuation of $43 + 10\log_{10}(\text{Power [Watts]})$.

Test Procedures Used

KDB 971168 D01 v03-Section 5

ANSI/TIA-603-E-2016-Section 2.2.17 / ANSI/TIA-603-E-2016-Section 2.2.12

Note: Reference test setup 3

5.3.2 Peak-Average Ratio

A peak to average ratio measurement is performed at the conducted port of the EUT. The spectrum analyzers Complementary Cumulative Distribution Function (CCDF) measurement profile is used to determine the largest deviation between the average and the peak power of the EUT in a given bandwidth.

Test Procedures Used

KDB 971168 D01 v03-Section 5.7.2

Test Settings

- 1、 The signal analyzer's CCDF measurement profile enabled
- 2、 Frequency= carrier center frequency
- 3、 Measurement BW > EBW of signal
- 4、 for continuous transmissions, set to 1ms
- 5、 Record the maximum PAPR level associated with a probability of 0.1%.

Note: Reference test setup 1

5.3.3 Occupied Bandwidth

The occupied bandwidth, that is the frequency bandwidth such that, below its lower and above its upper frequency limits, the mean powers radiated are each equal to 0.5 percent of the total mean power radiated by a given emission shall be measured. The span of the analyzer shall be set to capture all products of the modulation process, including the emission skirts. The resolution bandwidth shall be set to as close to 1 percent of the selected span as is possible without being below 1 percent. The video bandwidth shall be set to 3 times the resolution bandwidth. Video averaging is not permitted. Where practical, a sampling detector shall be used since a peak or, peak hold, may produce a wider bandwidth than actual. The trace data points are recovered and are directly summed in linear terms. The recovered amplitude data points, beginning at the lowest frequency, are placed in a running sum until 0.5 percent of the total is reached and that frequency recorded. The process is repeated for the highest frequency data points. This frequency is recorded. The span between the two recorded frequencies is the occupied bandwidth.

Test Procedures Used

KDB 971168 D01 v03-Section 4.3

Test Settings

- 1、 SET RBW=1-5% of OBW
- 2、 SET VBW \geq 3*RBW
- 3、 Detector: Peak
- 4、 Trace mode= max hold.
- 5、 Sweep= auto couple
- 6、 Steps 1-5 were repeated after it is stable

Note: Reference test setup 1.

5.3.4 Band Edge Compliance

The test complies with the requirements in clause 2 of the present report according to test procedures in KDB 971168 D01 v03-Section 6 with corresponding test settings.

Note: Reference test setup 1.

5.3.5 Spurious and Harmonic Emissions at Antenna Terminal

The test complies with the requirements in clause 2 of the present report according to test procedures in KDB 971168 D01 v03-Section 6 with corresponding test settings.

Note: Reference test setup 1.

5.3.6 Frequency Stability / Temperature Variation

Frequency stability testing is performed in accordance with the guidelines of ANSI/TIA-603-E-2016. The frequency stability of the transmitter is measured by:

- a.) **Temperature:** The temperature is varied from -30°C to +50°C in 10°C increments using an environmental chamber.
- b.) **Primary Supply Voltage:** The primary supply voltage is varied from 85% to 115% of the nominal value for non hand-carried battery and AC powered equipment. For hand-carried, battery-powered equipment, primary supply voltage is reduced to the battery operating end point which shall be specified by the manufacturer.

Specification – The frequency stability shall be sufficient to ensure that the fundamental emission stays within the authorized frequency block. The frequency stability of the transmitter shall be maintained within $\pm 0.00025\%$ (± 2.5 ppm) of the center frequency.

Time Period and Procedure:

1. The carrier frequency of the transmitter is measured at room temperature (20°C to provide a reference).
2. The equipment is turned on in a “standby” condition for fifteen minutes before applying power to the transmitter. Measurement of the carrier frequency of the transmitter is made within one minute after applying power to the transmitter.
3. Frequency measurements are made at 10°C intervals ranging from -30°C to +50°C. A period of at least one half-hour is provided to allow stabilization of the equipment at each temperature level.

Test Procedures Used

ANSI/TIA-603-E-2016

Note: Reference test setup 2.

5.4 Test Setups

5.4.1 Test Setup 1

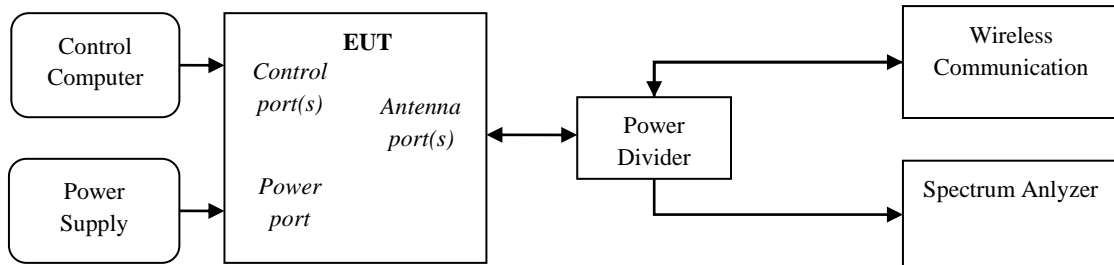

5.4.2 Test Setup 2

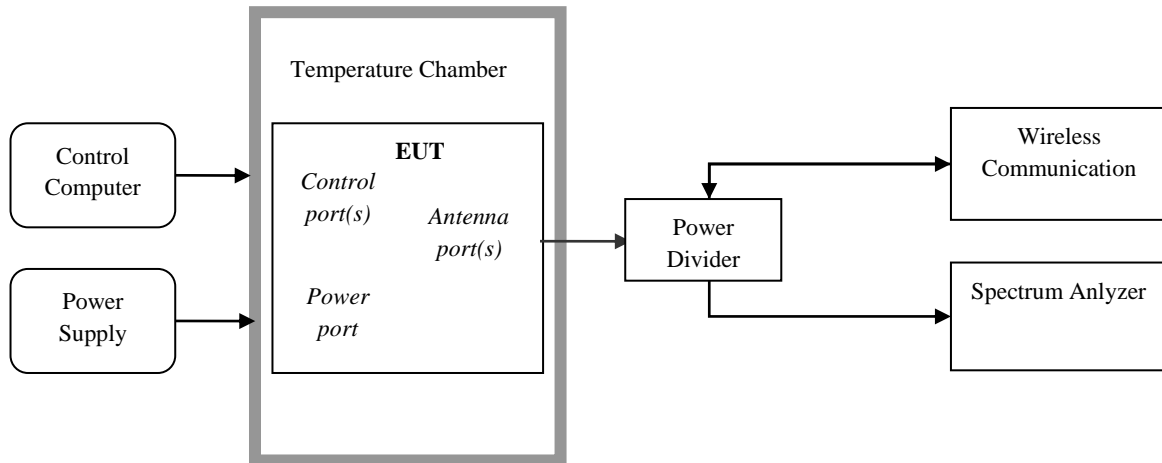

5.4.3 Test Setup 3

NOTE: Effective radiated power (ERP) and Equivalent Isotropic Radiated Power(EIRP) refers to the radiation power output of the EUT, assuming all emissions are radiated from half-wave dipole antennas.

5.4.3.1 Step 1: Pre-test

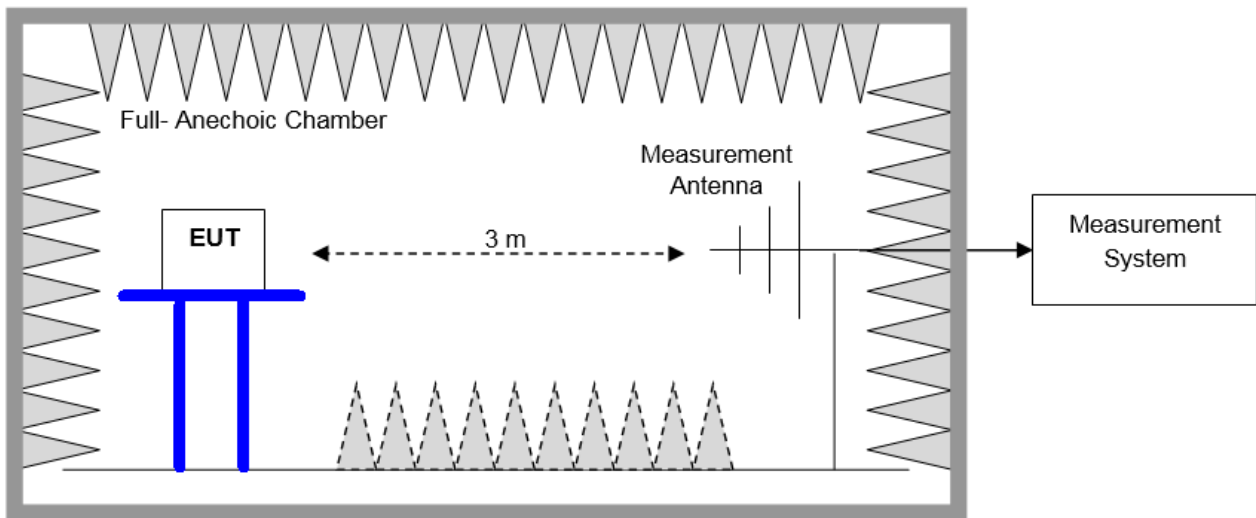

5.4.3.2 Step 2: Substitution method to verify the maximum ERP/EIRP

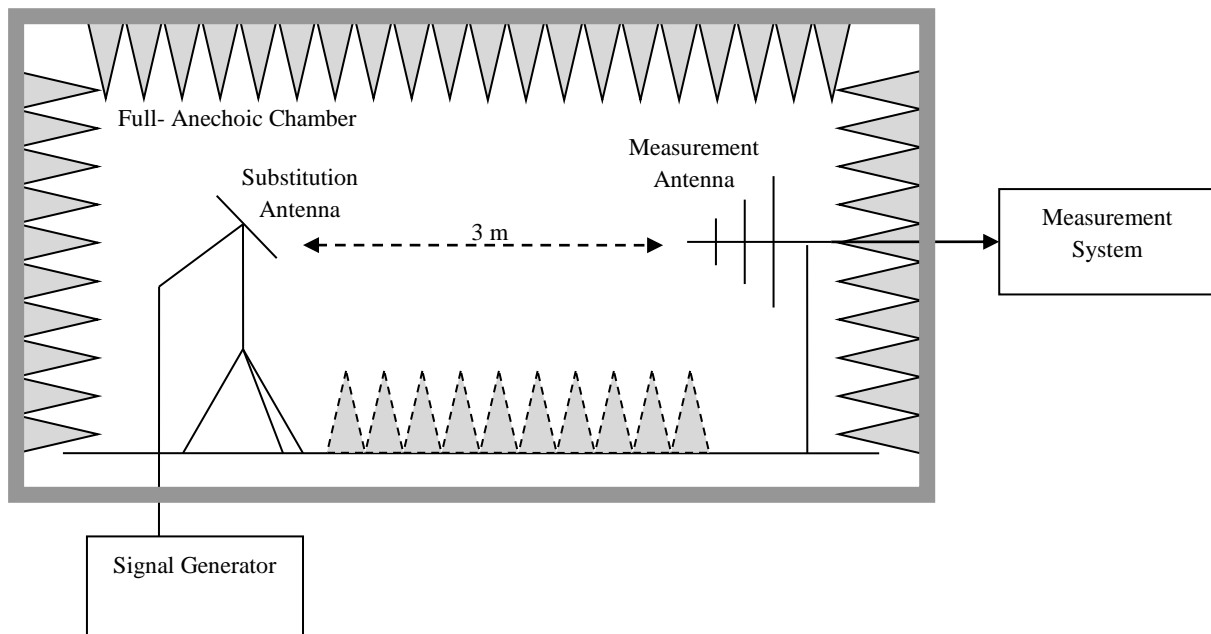

5.5 Test Conditions

Test Case		Test Conditions	
Transmit Output Power Data	Average Power, Total	Test Env.	Ambient Climate & Rated Voltage
		Test Setup	Test Setup 1
		RF Channels (TX)	L, M, H (L= low channel, M= middle channel, H= high channel)
		Test Mode	LTE/TM1,LTE/TM2
	Average Power, Spectral Density (if required)	Test Env.	Ambient Climate & Rated Voltage
		Test Setup	Test Setup 1
		RF Channels (TX)	L, M, H (L= low channel, M= middle channel, H= high channel)
		Test Mode	LTE/TM1,LTE/TM2
Peak-to-Average Ratio (if required)		Test Env.	Ambient Climate & Rated Voltage
		Test Setup	Test Setup 1
		RF Channels (TX)	L, M, H (L= low channel, M= middle channel, H= high channel)
		Test Mode	LTE/TM1,LTE/TM2
Modulation Characteristics		Test Env.	Ambient Climate & Rated Voltage
		Test Setup	Test Setup 1
		RF Channels (TX)	M (L= low channel, M= middle channel, H= high channel)
		Test Mode	LTE/TM1,LTE/TM2
Bandwidth	Occupied Bandwidth	Test Env.	Ambient Climate & Rated Voltage
		Test Setup	Test Setup 1
		RF Channels (TX)	L, M, H (L= low channel, M= middle channel, H= high channel)
		Test Mode	LTE/TM1,LTE/TM2
	Emission Bandwidth (if required)	Test Env.	Ambient Climate & Rated Voltage
		Test Setup	Test Setup 1
		RF Channels (TX)	L, M, H (L= low channel, M= middle channel, H= high channel)
		Test Mode	LTE/TM1,LTE/TM2
Band Edges Compliance		Test Env.	Ambient Climate & Rated Voltage
		Test Setup	Test Setup 1
		RF Channels (TX)	L, H (L= low channel, M= middle channel, H= high channel)
		Test Mode	LTE/TM1,LTE/TM2
Spurious Emission at Antenna Terminals		Test Env.	Ambient Climate & Rated Voltage
		Test Setup	Test Setup 1
		RF Channels (TX)	L, M, H (L= low channel, M= middle channel, H= high channel)

Test Case	Test Conditions	
	Test Mode	LTE/TM1,LTE/TM2
Field Strength of Spurious Radiation	Test Env.	Ambient Climate & Rated Voltage
	Test Setup	Test Setup 3
	Test Mode	LTE/TM1,LTE/TM2 NOTE: If applicable, the EUT conf. that has maximum power density (based on the equivalent power level) is selected.
	RF Channels (TX)	L, M, H (L= low channel, M= middle channel, H= high channel)
Frequency Stability	Test Env.	(1) -30 °C to +50 °C with step 10 °C at Rated Voltage; (2) VL, VN and VH of Rated Voltage at Ambient Climate.
	Test Setup	Test Setup 2
	RF Channels (TX)	L, M, H (L= low channel, M= middle channel, H= high channel)
	Test Mode	LTE/TM1,LTE/TM2

6 Main Test Instruments

6.1 Current Test Project/Report

6.1.1 Test Location 1:

This table gives a complete overview of the RF measurement equipment.

Devices used during the test described are marked

<input checked="" type="checkbox"/> Main Test Equipments(GSM/WCDMA/LTE test system)						
Marked	Equipment Name	Manufacturer	Model	Serial Number	Cal Date	Cal-Due
<input type="checkbox"/>	DC Power Supply	KEITHLEY	2303	1342889	2018/10/24	2019/10/24
<input type="checkbox"/>	DC Power Supply	KEITHLEY	2303	000500E	2018/05/21	2019/05/21
<input type="checkbox"/>	DC Power Supply	KEITHLEY	2303	1288003	2018/12/21	2019/12/21
<input checked="" type="checkbox"/>	DC Power Supply	KEITHLEY	2303	000381E	2018/05/21	2019/05/21
<input type="checkbox"/>	DC Power Supply	KEITHLEY	2303	000510E	2018/05/21	2019/05/21
<input type="checkbox"/>	DC Power Supply	KEITHLEY	2303	1342896	2018/10/24	2019/10/24
<input checked="" type="checkbox"/>	Temperature Chamber	WEISS	WKL64	56246002940010	2018/12/13	2019/12/13
<input type="checkbox"/>	Universal Radio Communication Tester	R&S	CMW500	159302	2018/07/23	2019/07/23
<input type="checkbox"/>	Universal Radio Communication Tester	R&S	CMW500	126854	2018/07/23	2019/07/23
<input checked="" type="checkbox"/>	Universal Radio Communication Tester	R&S	CMW500	164698	2018/06/17	2019/06/17
<input checked="" type="checkbox"/>	Universal Radio Communication Tester	R&S	CMU200	110932	2018/4/27	2019/4/27
<input type="checkbox"/>	Universal Radio Communication Tester	R&S	CMU200	123299	2018/11/23	2019/11/23
<input type="checkbox"/>	Universal Radio Communication Tester	R&S	CMU200	117341	2018/12/09	2019/12/09
<input type="checkbox"/>	Signal Analyzer	R&S	FSQ31	200021	2018/7/23	2019/7/23
<input type="checkbox"/>	Signal Analyzer	R&S	FSU26	201069	2018/11/02	2019/11/02
<input type="checkbox"/>	Spectrum Analyzer	Agilent	N9030A	MY51380032	2018/07/23	2019/07/23
<input checked="" type="checkbox"/>	Spectrum Analyzer	Agilent	N9030A	MY49431698	2018/07/23	2019/07/23
<input checked="" type="checkbox"/>	Spectrum Analyzer	Keysight	N9040B	MY57212529	2018/06/28	2019/06/28
<input type="checkbox"/>	Signal generator	Agilent	E8257D	MY51500314	2018/04/27	2019/04/27

<input checked="" type="checkbox"/>	Signal generator	Agilent	E8257D	MY49281095	2018/07/23	2019/07/23
<input checked="" type="checkbox"/>	Vector Signal Generator	R&S	SMU200A	104162	2018/07/23	2019/07/23
<input type="checkbox"/>	Vector Signal Generator	R&S	SMW200A	103447	2018/05/31	2019/05/31

<input checked="" type="checkbox"/> Main Test Equipments(RSE test system)						
Marked	Equipment Name	Manufacturer	Model	Serial Number	Cal Date	Cal-Due
<input checked="" type="checkbox"/>	Universal Radio Communication Tester	R&S	CMU200	117385	2018/05/08	2019/05/07
<input checked="" type="checkbox"/>	Universal Radio Communication Tester	R&S	MT8821C	6261760791	2018/04/02	2019/04/01
<input checked="" type="checkbox"/>	Spectrum analyzer	R&S	FSU3	200474	2018/01/20	2019/01/19
<input checked="" type="checkbox"/>	Spectrum analyzer	R&S	FSU43	100144	2018/01/20	2019/01/19
<input type="checkbox"/>	Trilog Broadband Antenna (30M~3GHz)	SCHWARZBECK	VULB 9163	9163-490	2017/03/29	2019/03/28
<input checked="" type="checkbox"/>	Trilog Broadband Antenna (30M~3GHz)	SCHWARZBECK	VULB 9163	9163-521	2018/04/09	2020/04/08
<input checked="" type="checkbox"/>	Double-Ridged Waveguide Horn Antenna (1G~18GHz)	R&S	HF907	100304	2017/05/27	2019/05/26
<input checked="" type="checkbox"/>	double ridged horn antenna (0.8G-18GHz)	R&S	HF907	100391	2017/7/20	2019/7/19
<input checked="" type="checkbox"/>	Pyramidal Horn Antenna(18GHz-26.5 GHz)	ETS-Lindgren	3160-09	5140299	2017/07/20	2019/07/19
<input type="checkbox"/>	Pyramidal Horn Antenna(18GHz-26.5 GHz)	ETS-Lindgren	3160-09	00206665	2018/4/21	2020/4/20
<input checked="" type="checkbox"/>	Pyramidal Horn Antenna(26.5GHz-40 GHz)	ETS-Lindgren	3160-10	00205695	2018/04/20	2020/04/19
<input type="checkbox"/>	Pyramidal Horn Antenna(26.5GHz-40 GHz)	ETS-Lindgren	3160-10	LM5947	2017/07/20	2019/07/19
<input checked="" type="checkbox"/>	Measurement Software	R&S	EMC32 V8.40.0	/	/	/

6.1.2 Sub-contracted Test Location 1 :

Test Location 1:Main Test Equipments					
Equipment Name	Manufacturer	Model	Serial Number	Cal Date	Cal- Due
EMI Test Receiver&SA	Agilent	N9038A	N9038A	2018/8/30	2019/8/29
Loop Antenna	R&S	HFH2-Z2	HFH2-Z2	2018/5/30	2020/5/29
Bilog Antenna	TeseQ	CBL6112D	CBL6112D	2018/6/5	2019/6/4
LF Amplifier	Burgeon	BPA-530	BPA-530	2018/4/20	2019/4/19
Software Information					
Test Item	Software Name		Manufacturer	Version	
RE	E3		AUDIX	6.2009-8-24(sporton)	

7 Measurement Uncertainty

For a 95% confidence level ($k = 2$), the measurement expanded uncertainties for defined systems, in accordance with the recommendations of ISO 17025 as following:

Test Item	Extended Uncertainty	
Transmit Output Power Conducted	Power [dBm]	U = 0.64 dB
RF Power Density, Conducted	Power [dBm]	U = 0.64 dB
Bandwidth	Magnitude [kHz]	200kHz: U=9.06kHz 1.4MHz: U=9.48kHz 3MHz: U= 10.86kHz 5MHz: U=13.84kHz 10MHz: U=22.32kHz 15MHz: U=31.9kHz 20MHz: U=41.78kHz
Band Edge Compliance	Disturbance Power [dBm]	U = 0.9 dB
Spurious Emissions, Conducted	Disturbance Power [dBm]	20MHz~3.6GHz: U=0.88dB 3.6GHz~8.4GHz: U=1.08dB 8.4GHz~13.6GHz: U=1.24dB 13.6GHz~22GHz: U=1.34dB 22GHz~26.5GHz: U=1.36dB
Field Strength of Spurious Radiation	ERP/EIRP [dBm]	For 3 m Chamber: U = 5.94 dB (30 MHz to 3GHz) U = 5.54 dB (3GHz to 18GHz) U = 4.94 dB (18GHz to 26.5GHz)
Frequency Stability	Frequency Accuracy [Hz]	800MHz: U=24.08Hz 900MHz: U=24.54Hz 1900MHz: U=34.7Hz 2100MHz: U=36.96Hz



Test Item		Extended Uncertainty
		2300MHz: U=39.24Hz 2500MHz: U=41.58Hz 2600MHz: U=42.74Hz

END