



中国认可  
国际互认  
检测  
TESTING  
CNAS L0310



## FCC SAR Compliance Test Report

**Product Name:** Smart Phone

**Model:** ELE-L29m/ELE-L09m

**Report No.:** SYBH(Z-SAR)20190401022001-2

**FCC ID:** QISELE-LX9M

|      |                           |                             |
|------|---------------------------|-----------------------------|
|      | APPROVED<br>(Lab Manager) | PREPARED<br>(Test Engineer) |
| BY   | <i>Wei Huaobin</i>        | <i>Sun Shaobin</i>          |
| DATE | 2019-05-06                | 2019-05-06                  |

**Reliability Laboratory of Huawei Technologies Co., Ltd.**

**(Global Compliance and Testing Center of Huawei Technologies Co., Ltd)**

No.2, New City Avenue, Songshan Lake Sci. & Tech. Industry Park,  
Dongguan, Guangdong, 523808, P.R.C  
Tel: +86 769 23830808 Fax: +86 769 23837628



---

※ ※ **Notice** ※ ※

1. The laboratory has passed the accreditation by China National Accreditation Service for Conformity Assessment (CNAS). The accreditation number is L0310.
2. The laboratory has passed the accreditation by The American Association for Laboratory Accreditation (A2LA). The accreditation number is 2174.01 & 2174.02 & 2174.03
3. The laboratory (Reliability Lab of Huawei Technologies Co., Ltd) is also named “Global Compliance and Testing Center of Huawei Technologies Co., Ltd”, the both names have coexisted since 2009.
4. The test report is invalid if not marked with the signatures of the persons responsible for preparing and approving the test report.
5. The test report is invalid if there is any evidence of erasure and/or falsification.
6. The test report is only valid for the test samples.
7. Content of the test report, in part or in full, cannot be used for publicity and/or promotional purposes without prior written approval from the laboratory.
8. If any question about this report, please contact the laboratory ([PublicGCTC@huawei.com](mailto:PublicGCTC@huawei.com)).

## Table of Contents

|       |   |    |
|-------|---|----|
| 1     | General Information.....  | 6  |
| 1.1   | Statement of Compliance .....   | 6  |
| 1.2   | RF exposure limits .....  | 7  |
| 1.3   | EUT Description.....  | 8  |
| 1.3.1 | General Description .....   | 11 |
| 1.4   | Test specification(s).....  | 13 |
| 1.5   | Testing laboratory .....  | 14 |
| 1.6   | Applicant and Manufacturer .....  | 14 |
| 1.7   | Application details .....   | 14 |
| 1.8   | Ambient Condition.....  | 14 |
| 2     | SAR Measurement System .....  | 15 |
| 2.1   | SAR Measurement Set-up.....   | 15 |
| 2.2   | Test environment .....  | 16 |
| 2.3   | Data Acquisition Electronics description.....                           | 16 |
| 2.4   | Probe description .....   | 17 |
| 2.5   | Phantom description .....   | 18 |
| 2.6   | Device holder description .....   | 19 |
| 2.7   | Test Equipment List .....   | 20 |
| 3     | SAR Measurement Procedure .....   | 22 |
| 3.1   | Scanning procedure.....   | 22 |
| 3.2   | Spatial Peak SAR Evaluation .....                                       | 23 |
| 3.3   | Data Storage and Evaluation .....                                       | 24 |
| 4     | System Verification Procedure .....                                     | 26 |
| 4.1   | Tissue Verification.....  | 26 |
| 4.2   | System Check.....   | 30 |
| 4.3   | System check Procedure .....  | 31 |
| 5     | SAR measurement variability and uncertainty .....                       | 32 |
| 5.1   | SAR measurement variability .....                                       | 32 |
| 5.2   | SAR measurement uncertainty.....  | 32 |
| 6     | SAR Test Configuration.....   | 33 |
| 6.1   | Test Positions Configuration .....                                      | 33 |
| 6.1.1 | General considerations .....  | 33 |
| 6.1.2 | Head Exposure Condition .....   | 33 |
| 6.1.3 | Body-worn Exposure Condition .....                                      | 34 |
| 6.1.4 | Hotspot Exposure Condition .....  | 34 |
| 6.1.5 | Product Specific 10-g SAR Exposure Condition.....                       | 35 |
| 6.2   | 3G SAR Test Reduction Procedure .....                                   | 35 |
| 6.3   | GSM Test Configuration .....  | 35 |
| 6.4   | UMTS Test Configuration .....   | 36 |
| 6.5   | LTE Test Configuration .....  | 42 |
| 6.6   | WiFi Test Configuration .....   | 46 |
| 6.6.1 | Initial Test Position Procedure .....                                   | 46 |
| 6.6.2 | Initial Test Configuration Procedure .....                              | 46 |
| 6.6.3 | Sub Test Configuration Procedure .....                                  | 46 |
| 6.6.4 | WiFi 2.4G SAR Test Procedures .....                                     | 47 |
| 6.6.5 | U-NII-1 and U-NII-2A Bands .....  | 48 |
| 6.6.6 | U-NII-2C and U-NII-3 Bands.....   | 48 |
| 6.6.7 | OFDM Transmission Mode SAR Test Channel Selection Requirements .....    | 49 |
| 6.6.8 | MIMO SAR Considerations.....  | 49 |
| 6.7   | LTE CA specification.....   | 50 |
| 6.7.1 | LTE CA combinations specification .....                                 | 50 |
| 6.7.2 | Test procedure for downlink CA .....                                    | 54 |
| 6.7.3 | Test procedure for Intra-band uplink CA.....                            | 55 |
| 6.8   | Dynamic antenna switching specification .....                           | 55 |
| 6.9   | Power Reduction Specification .....                                     | 56 |
| 6.9.1 | Power Reduction Specification of 2G/3G/4G Second Antenna.....           | 57 |
| 6.9.2 | Power Reduction Specification of WiFi Antenna .....                     | 58 |
| 6.9.3 | Power Reduction Specification of 2G/3G/4G Main Antenna .....            | 60 |
| 6.9.4 | Proximity sensor Power Reduction Test configuration and validation..... | 61 |



|        |  |     |
|--------|--|-----|
| 6.10   | BT Test Configuration.....   | 76  |
| 7      | SAR Measurement Results.....                                       | 77  |
| 7.1    | Conducted power measurements.....                                  | 77  |
| 7.1.1  | Conducted power measurements of GSM850 (Second Antenna).....       | 78  |
| 7.1.2  | Conducted power measurements of GSM850 (Main Antenna).....         | 80  |
| 7.1.3  | Conducted power measurements of GSM1900 (Second Antenna).....      | 81  |
| 7.1.4  | Conducted power measurements of GSM1900 (Main Antenna).....        | 83  |
| 7.1.5  | Conducted power measurements of UMTS Band II (Second Antenna)..... | 84  |
| 7.1.6  | Conducted power measurements of UMTS Band II (Main Antenna).....   | 86  |
| 7.1.7  | Conducted power measurements of UMTS Band IV (Second Antenna)..... | 88  |
| 7.1.8  | Conducted power measurements of UMTS Band IV (Main Antenna).....   | 90  |
| 7.1.9  | Conducted power measurements of UMTS Band V (Second Antenna).....  | 91  |
| 7.1.10 | Conducted power measurements of UMTS Band V (Main Antenna).....    | 93  |
| 7.1.11 | Conducted power measurements of LTE Band 2 (Second Antenna).....   | 94  |
| 7.1.12 | Conducted power measurements of LTE Band 2 (Main Antenna).....     | 106 |
| 7.1.13 | Conducted power measurements of LTE Band 4 (Second Antenna).....   | 122 |
| 7.1.14 | Conducted power measurements of LTE Band 4 (Main Antenna).....     | 138 |
| 7.1.15 | Conducted power measurements of LTE Band 5 (Second Antenna).....   | 146 |
| 7.1.16 | Conducted power measurements of LTE Band 5 (Main Antenna).....     | 154 |
| 7.1.17 | Conducted power measurements of LTE Band 7 (Second Antenna).....   | 156 |
| 7.1.18 | Conducted power measurements of LTE Band 7 (Main Antenna).....     | 167 |
| 7.1.19 | Conducted power measurements of LTE Band 12 (Second Antenna).....  | 182 |
| 7.1.20 | Conducted power measurements of LTE Band 12 (Main Antenna).....    | 191 |
| 7.1.21 | Conducted power measurements of LTE Band 17 (Second Antenna).....  | 193 |
| 7.1.22 | Conducted power measurements of LTE Band 17 (Main Antenna).....    | 197 |
| 7.1.23 | Conducted power measurements of LTE Band 26 (Second Antenna).....  | 198 |
| 7.1.24 | Conducted power measurements of LTE Band 26 (Main Antenna).....    | 210 |
| 7.1.25 | Conducted power measurements of LTE Band 38 (Second Antenna).....  | 213 |
| 7.1.26 | Conducted power measurements of LTE Band 38 (Main Antenna).....    | 221 |
| 7.1.27 | Conducted power measurements of LTE Band 41 (Second Antenna).....  | 225 |
| 7.1.28 | Conducted power measurements of LTE Band 41 (Main Antenna).....    | 233 |
| 7.1.29 | Conducted power measurements of Downlink LTE CA.....               | 237 |
| 7.1.30 | Conducted Power measurements of Uplink LTE CA.....                 | 243 |
| 7.1.31 | Conducted power measurements of WiFi 2.4G.....                     | 248 |
| 7.1.32 | Conducted power measurements of WiFi 5G.....                       | 252 |
| 7.1.33 | Conducted power measurements of BT.....                            | 274 |
| 7.2    | SAR measurement Results.....                                       | 277 |
| 7.2.1  | SAR measurement Results of GSM850.....                             | 279 |
| 7.2.2  | SAR measurement Results of GSM1900.....                            | 283 |
| 7.2.3  | SAR measurement Results of UMTS Band II.....                       | 287 |
| 7.2.4  | SAR measurement Results of UMTS Band IV.....                       | 291 |
| 7.2.5  | SAR measurement Results of UMTS Band V.....                        | 295 |
| 7.2.6  | SAR measurement Results of LTE Band 2.....                         | 299 |
| 7.2.7  | SAR measurement Results of LTE Band 4.....                         | 303 |
| 7.2.8  | SAR measurement Results of LTE Band 5.....                         | 307 |
| 7.2.9  | SAR measurement Results of LTE Band 7.....                         | 311 |
| 7.2.10 | SAR measurement Results of LTE Band 12.....                        | 315 |
| 7.2.11 | SAR measurement Results of LTE Band 26.....                        | 319 |
| 7.2.12 | SAR measurement Results of LTE Band 38.....                        | 323 |
| 7.2.13 | SAR measurement Results of LTE Band 41.....                        | 329 |
| 7.2.14 | SAR measurement Results of WiFi 2.4G.....                          | 333 |
| 7.2.15 | SAR measurement Results of WiFi 5G.....                            | 340 |
| 7.2.16 | SAR measurement Results of BT.....                                 | 350 |
| 7.3    | Multiple Transmitter Evaluation.....                               | 352 |
| 7.3.1  | Simultaneous Transmission Possibilities.....                       | 353 |
| 7.3.2  | SAR Summation Scenario.....  | 358 |
| 7.3.3  | Simultaneous Transmission Conclusion.....                          | 362 |
|        | Appendix A. System Check Plots.....                                | 363 |
|        | Appendix B. SAR Measurement Plots.....                             | 363 |
|        | Appendix C. Calibration Certificate.....                           | 363 |
|        | Appendix D. Photo documentation.....                               | 363 |
|        | Appendix E. Antenna Location.....                                  | 363 |



※ ※ **Modified History** ※ ※

| REV.    | DESCRIPTION                 | ISSUED DATE | REMARK      |
|---------|-----------------------------|-------------|-------------|
| Rev.1.0 | Initial Test Report Release | 2019-05-06  | Sun Shaobin |
|         |                             |             |             |
|         |                             |             |             |
|         |                             |             |             |
|         |                             |             |             |

# 1 General Information

## 1.1 Statement of Compliance

The maximum results of Specific Absorption Rate (SAR) found during testing in this report are as below Table 1.

| Band  | Max Reported SAR(W/kg) |                        |                    |                                   |
|---|------------------------|------------------------|--------------------|-----------------------------------|
|   | 1-g Head               | 1-g Body-worn (15mm) * | 1-g Hotspot (10mm) | Product Specific 10-g SAR (0mm)** |
| <b>GSM850</b>   | 0.65                   | 0.38                   | <b>0.68</b>        | /                                 |
| <b>GSM1900</b>  | 0.63                   | 0.17                   | 0.43               | /                                 |
| <b>UMTS Band II</b>   | 0.39                   | 0.39                   | 0.52               | /                                 |
| <b>UMTS Band IV</b>   | <b>0.90</b>            | 0.39                   | 0.59               | /                                 |
| <b>UMTS Band V</b>  | 0.54                   | 0.37                   | 0.54               | /                                 |
| <b>LTE Band 2</b>   | 0.53                   | 0.37                   | 0.67               | /                                 |
| <b>LTE Band 4</b>   | 0.70                   | 0.31                   | 0.52               | /                                 |
| <b>LTE Band 5</b>   | 0.56                   | <b>0.50</b>            | 0.54               | /                                 |
| <b>LTE Band 7</b>   | 0.67                   | 0.39                   | 0.46               | /                                 |
| <b>LTE Band 12</b>  | 0.54                   | 0.33                   | 0.50               | /                                 |
| <b>LTE Band 17</b>  | /                      | /                      | /                  | /                                 |
| <b>LTE Band 26</b>  | 0.48                   | 0.45                   | 0.58               | /                                 |
| <b>LTE Band 38</b>  | 0.76                   | 0.25                   | 0.46               | /                                 |
| <b>LTE Band 41</b>  | 0.58                   | 0.23                   | 0.54               | /                                 |
| <b>WiFi 2.4G</b>  | 0.32                   | 0.11                   | 0.29               | 1.26                              |
| <b>WiFi 5G</b>  | 0.63                   | 0.22                   | 0.23               | <b>1.51</b>                       |
| <b>BT</b>   | 0.39                   | 0.10                   | 0.45               | /                                 |
| <b>The highest reported SAR for Head, Body Worn, Hotspot, Product Specific 10-g SAR and Simultaneous transmission exposure conditions are 0.90 W/kg, 0.50 W/kg, 0.68 W/kg, 1.51 W/kg and 1.48 W/kg per KDB690783 D01.</b> |                        |                        |                    |                                   |

Table 1: Summary of test result

Note:

1)\* For body worn operation, this device has been tested and met FCC RF exposure guidelines when used with any accessory that contains no metal and that positions the handset a minimum of 15mm from the body. Use of other accessories may not ensure compliance with FCC RF exposure guidelines.

2)\*\* For Product Specific 10-g SAR operation, this device has been tested and meets the 10-g SAR limits of 4.0 W/kg for general population/ uncontrolled exposure according to ANSI C95.1:1992/IEEE C95.1:1991

3) \*\*\* According to TCB workshop October,2014 RF Exposure Procedures Update(Overlapping LTE Bands): SAR for Main antenna LTE Band 17 (Frequency range:704-716 MHz) is covered by LTE Band 12 (Frequency range:699-716 MHz) due to similar frequency range,same maximum tune up limit and same channel bandwidth.

The device is in compliance with Specific Absorption Rate (SAR) for general population/uncontrolled exposure limits according to the FCC rule §2.1093, the ANSI C95.1:1992/IEEE C95.1:1991, the NCRP Report Number 86 for uncontrolled environment, and had been tested in accordance with the measurement methods and procedures specified in IEEE Std 1528-2013.

## 1.2 RF exposure limits

| Human Exposure   | Uncontrolled Environment<br>General Population | Controlled Environment<br>Occupational |
|--|--|--|
| <b>Spatial Peak SAR*</b><br>(Brain/Body/Arms/Legs)     | <b>1.60 W/kg</b>                               | 8.00 W/kg                              |
| <b>Spatial Average SAR**</b><br>(Whole Body)           | 0.08 W/kg                                      | 0.40 W/kg                              |
| <b>Spatial Peak SAR***</b><br>(Hands/Feet/Ankle/Wrist) | <b>4.00 W/kg</b>                               | 20.00 W/kg                             |

Table 2: RF exposure limits

The limit applied in this test report is shown in **bold** letters

### Notes:

- \* The Spatial Peak value of the SAR averaged over any 1 gram of tissue (defined as a tissue volume in the shape of a cube) and over the appropriate averaging time.
- \*\* The Spatial Average value of the SAR averaged over the whole body.
- \*\*\* The Spatial Peak value of the SAR averaged over any 10 grams of tissue (defined as a tissue volume in the shape of a cube) and over the appropriate averaging time.

**Uncontrolled Environments** are defined as locations where there is the exposure of individuals who have no knowledge or control of their exposure.

**Controlled Environments** are defined as locations where there is exposure that may be incurred by persons who are aware of the potential for exposure, (i.e. as a result of employment or occupation

### 1.3 EUT Description

| Device Information:              |   |             |            |
|----------------------------------|---|-------------|------------|
| Product Name:                    | Smart Phone   |             |            |
| Model:                           | ELE-L29m/ELE-L09m   |             |            |
| FCC ID :                         | QISELE-LX9M   |             |            |
| SN:                              | 1#:WSV0119306000254; 2#:WSV0119306000059<br>3#:WSV0119306000147; 4#:WSV0119306000018<br>5#:WSV0119306000185; 6#:WSV0119306000016<br>7#:6RE0119330000236; 8#: 6RE0119330000207 |             |            |
| Device Type :                    | Portable device   |             |            |
| Device Phase:                    | Identical Prototype   |             |            |
| Exposure Category:               | Uncontrolled environment / general population   |             |            |
| Hardware Version :               | HL3ELLEM  |             |            |
| Software Version :               | 5.0.1.130(SP2C432E131R1P11)   |             |            |
| Antenna Type :                   | Internal antenna  |             |            |
| Others Accessories               | Headset, wireless charging protective case  |             |            |
| Device Operating Configurations: |   |             |            |
| Supporting Mode(s)               | GSM850/1900, UMTS Band II/IV/V,<br>LTE Band 2/4/5/7/12/17/26/38/41, WiFi 2.4G/5G, BT, NFC   |             |            |
| Test Modulation                  | GSM(GMSK/8PSK),UMTS(QPSK), LTE(QPSK/16QAM/64QAM),<br>WiFi(DSSS/OFDM),BT(GFSK)   |             |            |
| Device Class                     | B   |             |            |
| Operating Frequency Range(s)     | Band  | Tx (MHz)    | Rx (MHz)   |
|                                  | GSM850  | 824-849     | 869 - 894  |
|                                  | GSM1900   | 1850-1910   | 1930-1990  |
|                                  | UMTS Band II  | 1850-1910   | 1930-1990  |
|                                  | UMTS Band IV  | 1710-1755   | 2110-2155  |
|                                  | UMTS Band V   | 824-849     | 869 - 894  |
|                                  | LTE Band 2  | 1850-1910   | 1930-1990  |
|                                  | LTE Band 4  | 1710-1755   | 2110-2155  |
|                                  | LTE Band 5  | 824-849     | 869-894    |
|                                  | LTE Band 7  | 2500-2570   | 2620 -2690 |
|                                  | LTE Band 12   | 699-716     | 729-746    |
|                                  | LTE Band 17   | 704-716     | 734-746    |
|                                  | LTE Band 26   | 814-849     | 859-894    |
|                                  | LTE Band 38   | 2570-2620   |            |
|                                  | LTE Band 41   | 2535-2655   |            |
|                                  | BT  | 2400-2483.5 |            |
|                                  | WiFi 2.4G   | 2412-2462   |            |
| WiFi 5G                          | 5150-5350   |             |            |
|                                  | 5470-5725   |             |            |
|                                  | 5725-5825   |             |            |
| NFC                              | 13.56   |             |            |
| GPRS Multislot Class(12)         | Max Number of Timeslots in Uplink:  | 4           |            |
|                                  | Max Number of Timeslots in Downlink:  | 4           |            |
|                                  | Max Total Timeslot:   | 5           |            |
| EGPRS Multislot Class(12)        | Max Number of Timeslots in Uplink:  | 4           |            |
|                                  | Max Number of Timeslots in Downlink:  | 4           |            |
|                                  | Max Total Timeslot:   | 5           |            |



|  |  |
|--|--|
| HSDPA UE Category                        | 14   |
| HSUPA UE Category                        | 6  |
| DC-HSDPA UE Category                     | 24   |
| Power Class:                             | 4, tested with power level 5(GSM850)               |
|  | 1, tested with power level 0(GSM1900)              |
|  | 3, tested with power control "all 1"(UMTS Band II) |
|  | 3, tested with power control "all 1"(UMTS Band IV) |
|  | 3, tested with power control "all 1"(UMTS Band V)  |
|  | 3, tested with power control all Max.(LTE Band 2)  |
|  | 3, tested with power control all Max.(LTE Band 4)  |
|  | 3, tested with power control all Max.(LTE Band 5)  |
|  | 3, tested with power control all Max.(LTE Band 7)  |
|  | 3, tested with power control all Max.(LTE Band 12) |
|  | 3, tested with power control all Max.(LTE Band 17) |
|  | 3, tested with power control all Max.(LTE Band 26) |
|  | 3, tested with power control all Max.(LTE Band 38) |
|  | 3, tested with power control all Max.(LTE Band 41) |
|  | Test Channels (low-mid-high):                      |
| 512-661-810(GSM1900)                     |  |
| 9262-9400-9538(UMTS Band II)             |  |
| 1312-1413-1513(UMTS Band IV)             |  |
| 4132-4182-4233(UMTS Band V)              |  |
| 18607-18900-19193(LTE Band 2 BW=1.4MHz)  |  |
| 18615-18900-19185(LTE Band 2 BW=3MHz)    |  |
| 18625-18900-19175(LTE Band 2 BW=5MHz)    |  |
| 18650-18900-19150(LTE Band 2 BW=10MHz)   |  |
| 18675-18900-19125(LTE Band 2 BW=15MHz)   |  |
| 18700-18900-19100(LTE Band 2 BW=20MHz)   |  |
| 19957-20175-20393(LTE Band 4 BW=1.4MHz)  |  |
| 19965-20175-20385(LTE Band 4 BW=3MHz)    |  |
| 19975-20175-20375(LTE Band 4 BW=5MHz)    |  |
| 20000-20175-20350(LTE Band 4 BW=10MHz)   |  |
| 20025-20175-20325(LTE Band 4 BW=15MHz)   |  |
| 20050-20175-20300(LTE Band 4 BW=20MHz)   |  |
| 20407-20525-20643(LTE Band 5 BW=1.4MHz)  |  |
| 20415-20525-20635(LTE Band 5 BW=3MHz)    |  |
| 20425-20525-20625(LTE Band 5 BW=5MHz)    |  |
| 20450-20525-20600(LTE Band 5 BW=10MHz)   |  |
| 20775-21100-21425(LTE Band 7 BW=5MHz)    |  |
| 20800-21100-21400(LTE Band 7 BW=10MHz)   |  |
| 20825-21100-21375(LTE Band 7 BW=15MHz)   |  |
| 20850-21100-21350(LTE Band 7 BW=20MHz)   |  |
| 23017-23095-23173(LTE Band 12 BW=1.4MHz) |  |
| 23025-23095-23165(LTE Band 12 BW=3MHz)   |  |
| 23035-23095-23155(LTE Band 12 BW=5MHz)   |  |
| 23060-23095-23130(LTE Band 12 BW=10MHz)  |  |
| 23755-23790-23825(LTE Band 17 BW=5MHz)   |  |
| 23780-23790-23800(LTE Band 17 BW=10MHz)  |  |
| 26697-26865-27033(LTE Band 26 BW=1.4MHz) |  |
| 26705-26865-27025(LTE Band 26 BW=3MHz)   |  |
| 26715-26865-27015(LTE Band 26 BW=5MHz)   |  |
| 26740-26865-26990(LTE Band 26 BW=10MHz)  |  |
| 26765-26865-26965(LTE Band 26 BW=15MHz)  |  |

|  |   |
|--|---|
|  | 37775-38000-38225(LTE Band 38 BW=5MHz)  |
|  | 37800-38000-38200(LTE Band 38 BW=10MHz)   |
|  | 37825-38000-38175(LTE Band 38 BW=15MHz)   |
|  | 37850-38000-38150(LTE Band 38 BW=20MHz)   |
|  | 40065-40448-40832-41215(LTE Band 41 BW=5MHz)  |
|  | 40090-40457-40823-41190(LTE Band 41 BW=10MHz)   |
|  | 40115-40465-40815-41165(LTE Band 41 BW=15MHz)   |
|  | 40140-40473-40807-41140(LTE Band 41 BW=20MHz)   |
|  | 802.11b/g/n 20M:1-2-6-7-10-11-12-13 (WiFi 2.4G)   |
|  | 40M:3-4-5-6-7-8-9-10-11(WiFi 2.4G)  |
|  | 802.11a/n/ac 20M: 36-40-44-48-52-56-60-64-100-104-108-112-116-120-124-128-132-136-140-149-153-157-161-165 (WiFi 5G) |
|  | 802.11 n/ac 40M: 38-46-54-62-102-110-118-126-134-151-159 (WiFi 5G)  |
|  | 802.11ac 80M: 42-58-106-122-155 (WiFi 5G)   |
|  | 802.11ac 160M: 50-114 (WiFi 5G)   |
|  | BT : 0-3-5-6-10-11-16-19-22-31-32-33-36-39-54-67-68-73-75-76-77-78  |

Table 3: Device information and operating configuration



Note:

- 1)\*For WiFi 5G, the device does not support channel 144(20M), channel 142(40M) and channel 138(80M).
- 2)\*For WiFi 5G, U-NII-2A and U-NII-2C does not support hotspot function.

### 1.3.1 General Description

ELE-L29m/ELE-L09m is subscriber equipment in the GSM/WCDMA/LTE system. The GSM frequency band includes GSM850 and GSM900 and DCS1800 and PCS1900. The UMTS frequency band is B1 and B2 and B4 and B5 and B6 and B8 and B19. The ELE-L29m/ELE-L09m LTE frequency band is B1 and B2 and B3 and B4 and B5 and B6 and B7 and B8 and B9 and B12 and B17 and B18 and B19 and B20 and B26 and B28 and B32 and B34 and B38 and B39 and B41. The ELE-L29m LTE frequency band for intra-band carrier aggregation uplink operation band is CA\_1C and CA\_2C and CA\_3C and CA\_7C and CA\_38C and CA\_39C and CA\_41C. The Mobile Phone implements such functions as RF signal receiving/transmitting LTE/HSPA/UMTS and GSM/GPRS/EDGE protocol processing, voice, video MMS service, GPS, AGPS and WIFI etc. Externally it provides one micro SD card interface (it can also be used as SIM card interface), earphone port (to provide voice service) and one SIM card interface. ELE-L29m is dual SIM smart phone. ELE-L09m is single SIM smart phone. It also provides Bluetooth module to synchronize data between a PC and the phone, or to use the built-in modem of the phone to access the Internet with a PC, or to exchange data with other Bluetooth devices.

#### Battery information:

| Name                | Manufacturer/trademark                                   | Description  |
|---------------------|--|--|
| Rechargeable Li-ion | Huawei Technologies Co., Ltd.<br>(Manufacturer: Sunwoda) | Battery Model: HB436380ECW<br>Rated capacity: 3550mAh<br>Nominal Voltage:  +3.85V<br>Charging Voltage:  +4.43V |
|                     | Huawei Technologies Co., Ltd.<br>(Manufacturer: Desay)   |  |

**The difference between ELE-L29m and ELE-L04m:**

|                      | Model            | ELE-L04m   | ELE-L29m   |
|----------------------|------------------|--|--|
| Licensed Frequency   | LTE BAND         | FCC Band:<br>B2/B4/<br>B5/B7/B12/B17/B26/B38/<br>B41 (2535~2655MHz)<br>/B66  | FCC Band:<br>B2/B4/<br>B5/B7/B12/B17/B26/B38/<br>B41 (2535~2655MHz)  |
|                      | UMTS BAND        | the same   | the same   |
|                      | GSM              | the same   | the same   |
|                      | IC               | the same   | the same   |
|                      | Antenna          | the same   | the same   |
|                      | NFC              | the same   | the same   |
| Unlicensed Frequency | Bluetooth        | the same   | the same   |
|                      | 2.4G Wi-Fi       | the same   | the same   |
|                      | 5.8G Wi-Fi       | the same   | the same   |
|                      | IC               | the same   | the same   |
|                      | Antenna          | the same   | the same   |
| Hardware             | Ram / Rom        | the same   | the same   |
|                      | Camera           | the same   | the same   |
|                      | PCB              | the same   | the same   |
|                      | USB Port         | the same   | the same   |
|                      | SIM              | one  | two  |
|                      | Hardware version | the same   | the same   |
| RF                   | RF circuit       | The hardware channel of WCDMA B4 and LTE B2/4/7(include CA band) is different, Irrelevant to other frequency bands | The hardware channel of WCDMA B4 and LTE B2/4/7(include CA band) is different, Irrelevant to other frequency bands |
| Appearance           | Dimension        | the same   | the same   |
|                      | Color            | different  | different  |
| Accessory            | Battery          | the same   | the same   |
|                      | External Charger | the same   | the same   |
|                      | USB label        | the same   | the same   |
|                      | Earphone         | the same   | the same   |

**The difference between ELE-L29m and ELE-L09m:**

The only difference between ELE-L29m and ELE-L09m is that ELE-L09m deletes into single SIM card by software. Other parts of the two models are the same.

According to the difference description above,

1. For UMTS Band IV , LTE B2/B4/B7, new full test is performed on ELE-L29m.
2. For other same frequency bands, ELE-L29m is tested at SAR worst case of ELE-L04m.
3. The model ELE-L09m shares the same test data of ELE-L29m for the same frequency bands and operation modes.

Justification of the engineering analysis: The spot check data shows that the test results to be reused from the reference unit test results(ELE-L04m) continue to demonstrate compliance for the new device(ELE-L29m and ELE-L09m). The max SAR spot check test results did not get worse, which were within the measurement uncertainty tolerance. So the re-use of data for the same frequency bands is applicable in the application.

#### 1.4 Test specification(s)

|                                  |   |
|----------------------------------|---|
| ANSI C95.1:1992 /IEEE C95.1:1991 | Safety Levels with Respect to Human Exposure to Radio Frequency Electromagnetic Fields, 3 kHz – 300 GHz.  |
| IEEE Std 1528-2013               | Recommended Practice for Determining the Peak Spatial-Average Specific Absorption Rate (SAR) in the Human Head from Wireless Communications Devices: Measurement Techniques |
| KDB941225 D01                    | 3G SAR Procedures v03r01  |
| KDB941225 D05                    | SAR for LTE Devices v02r05  |
| KDB941225 D05A                   | LTE Rel.10 KDB Inquiry Sheet v01r02   |
| KDB941225 D06                    | Hotspot SAR v02r01  |
| KDB447498 D01                    | General RF Exposure Guidance v06  |
| KDB648474 D04                    | Handsets SAR v01r03   |
| KDB248227 D01                    | SAR Guidance for IEEE 802.11 Wi-Fi SAR v02r02   |
| KDB865664 D01                    | SAR measurement 100 MHz to 6 GHz v01r04   |
| KDB865664 D02                    | RF Exposure Reporting v01r02  |
| KDB690783 D01                    | SAR Listings on Grants v01r03   |
| KDB616217 D04                    | SAR for laptop and tablets v01r02   |



### 1.5 Testing laboratory

|                        |   |
|------------------------|---|
| Test Site              | The Reliability Laboratory of Huawei Technologies Co., Ltd.   |
| Test Location          | NO.2 New City Avenue Songshan Lake Sci. & Tech. Industry Park, Dongguan, Guangdong, P.R.C   |
| Telephone              | +86 755 28780808  |
| Fax                    | +86 755 89652518  |
| State of accreditation | The Test laboratory (area of testing) is accredited according to ISO/IEC 17025.<br>CNAS Registration number: L0310<br>A2LA TESTING CERT # 2174.01 & 2174.02 & 2174.03 |

### 1.6 Applicant and Manufacturer

|              |   |
|--------------|---|
| Company Name | HUAWEI TECHNOLOGIES CO., LTD  |
| Address      | Administration Building, Headquarters of Huawei Technologies Co., Ltd., Bantian, Longgang District, Shenzhen, 518129, P.R.C |

### 1.7 Application details

|                    |            |
|--------------------|------------|
| Start Date of test | 2019-04-09 |
| End Date of test   | 2019-04-28 |

### 1.8 Ambient Condition

|                     |             |
|---------------------|-------------|
| Ambient temperature | 18°C – 25°C |
| Relative Humidity   | 30% – 70%   |

## 2 SAR Measurement System

### 2.1 SAR Measurement Set-up

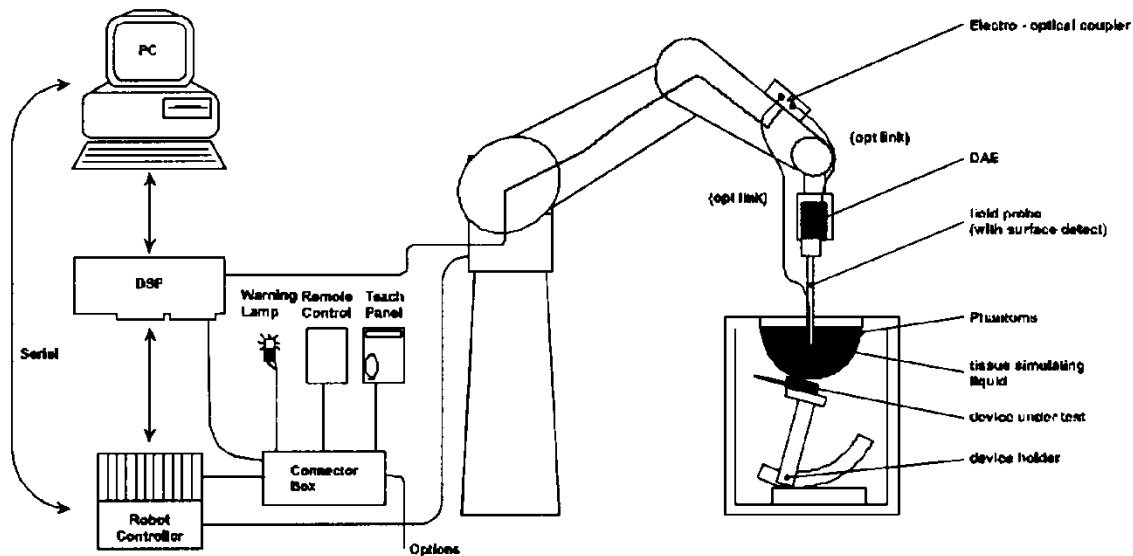

The DAS system for performing compliance tests consists of the following items:

- A standard high precision 6-axis robot (Stäubli RX family) with controller and software. An arm extension for accommodating the data acquisition electronics (DAE).
- A dosimetric probe, i.e. an isotropic E-field probe optimized and calibrated for usage in tissue simulating liquid. The probe is equipped with an optical surface detector system.
- A data acquisition electronic (DAE) which performs the signal amplification, signal multiplexing, AD-conversion, offset measurements, mechanical surface detection, collision detection, etc. The unit is battery powered with standard or rechargeable batteries. The signal is optically transmitted to the EOC.
- A unit to operate the optical surface detector which is connected to the EOC.
- The Electro-Optical Coupler (EOC) performs the conversion from the optical into a digital electric signal of the DAE. The EOC is connected to the DAS measurement server.
- The DAS measurement server, which performs all real-time data evaluation for field measurements and surface detection, controls robot movements and handles safety operation. A computer operating Windows 7.
- DAS software and SEMCAD data evaluation software.
- Remote control with teach panel and additional circuitry for robot safety such as warning lamps, etc.
- The generic twin phantom enabling the testing of left-hand and right-hand usage.
- The device holder for handheld mobile phones.
- Tissue simulating liquid mixed according to the given recipes.
- System check dipoles allowing to validate the proper functioning of the system.

## 2.2 Test environment

The DASY measurement system is placed at the head end of a room with dimensions: 5 x 2.5 x 3 m<sup>3</sup>, the SAM phantom is placed in a distance of 75 cm from the side walls and 1.1m from the rear wall. Above the test system a 1.5 x 1.5 m<sup>2</sup> array of pyramid absorbers is installed to reduce reflections from the ceiling.

Picture 1 of the photo documentation shows a complete view of the test environment.

The system allows the measurement of SAR values larger than 0.005 mW/g.

## 2.3 Data Acquisition Electronics description

The data acquisition electronics (DAE) consist of a highly sensitive electrometer-grade preamplifier with auto-zeroing, a channel and gain-switching multiplexer, a fast 16 bit AD-converte and a command decoder with a control logic unit. Transmission to the measurement server is accomplished through an optical downlink for data and status information, as well as an optical uplink for commands and the clock.

The mechanical probe mounting device includes two different sensor systems for frontal and sideways probe contacts. They are used for mechanical surface detection and probe collision detection.

### DAE

|                       |                          |  |
|-----------------------|--------------------------|--|
| Input Impedance       | 200MOhm                  |  |
| The Inputs            | symmetrical and floating |  |
| Common mode rejection | above 80 dB              |  |



## 2.4 Probe description

These probes are specially designed and calibrated for use in liquids with high permittivities. They should not be used in air, since the spherical isotropy in air is poor ( $\pm 2$  dB). The dosimetric probes have special calibrations in various liquids at different frequencies.

### Isotropic E-Field Probe ES3DV3 for Dosimetric Measurements

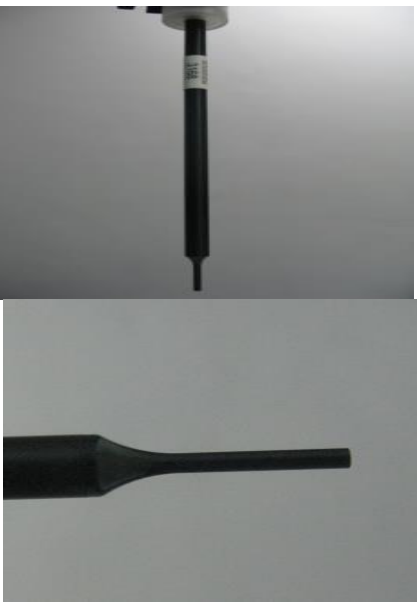
|               |  |  |
|---------------|--|--|
| Construction  | Symmetrical design with triangular core<br>Interleaved sensors<br>Built-in shielding against static charges<br>PEEK enclosure material (resistant to organic solvents, e.g., DGBE) |  |
| Calibration   | ISO/IEC 17025 calibration service available.   |  |
| Frequency     | 10 MHz to 4 GHz; Linearity: $\pm 0.2$ dB (30 MHz to 4 GHz)   |  |
| Directivity   | $\pm 0.2$ dB in HSL (rotation around probe axis)<br>$\pm 0.3$ dB in tissue material (rotation normal to probe axis)  |  |
| Dynamic range | 5 $\mu$ W/g to > 100 mW/g; Linearity: $\pm 0.2$ dB   |  |
| Dimensions    | Overall length: 337 mm (Tip: 20 mm)<br>Tip diameter: 3.9 mm (Body: 12 mm)<br>Distance from probe tip to dipole centers: 2.0 mm   |  |
| Application   | General dosimetry up to 4 GHz<br>Dosimetry in strong gradient fields<br>Compliance tests of mobile phones  |  |

### Isotropic E-Field Probe EX3DV4 for Dosimetric Measurements

|               |  |   |
|---------------|--|---|
| Construction  | Symmetrical design with triangular core<br>Built-in shielding against static charges<br>PEEK enclosure material (resistant to organic solvents, e.g., DGBE)  |  |
| Calibration   | ISO/IEC 17025 calibration service available.   |   |
| Frequency     | 10 MHz to >6 GHz; Linearity: $\pm 0.2$ dB (30 MHz to 6 GHz)  |   |
| Directivity   | $\pm 0.3$ dB in HSL (rotation around probe axis)<br>$\pm 0.5$ dB in tissue material (rotation normal to probe axis)  |   |
| Dynamic range | 10 $\mu$ W/g to > 100 mW/g;<br>Linearity: $\pm 0.2$ dB (noise: typically < 1 $\mu$ W/g)  |   |
| Dimensions    | Overall length: 337 mm (Tip: 20 mm)<br>Tip diameter: 2.5 mm (Body: 12 mm)<br>Typical distance from probe tip to dipole centers: 1 mm   |   |
| Application   | High precision dosimetric measurements in any exposure scenario (e.g., very strong gradient fields).<br>Only probe which enables compliance testing for frequencies up to 6 GHz with precision of better 30% |   |

## 2.5 Phantom description

### SAM Twin Phantom

|                   |  |   |
|-------------------|--|---|
| Shell Thickness   | 2mm±0.2mm;The ear region:6.0±0.2mm                     |  |
| Filling Volume    | Approximately 25 liters                                |   |
| Dimensions        | Length:1000mm; Width:500mm;<br>Height: adjustable feet |   |
| Measurement Areas | Left hand<br>Right hand<br>Flat phantom                |   |

The bottom plate contains three pairs of bolts for locking the device holder. The device holder positions are adjusted to the standard measurement positions in the three sections. A white cover is provided to cover the phantom during off-periods to prevent water evaporation and changes in the liquid parameters. Free space scans of devices on top of this phantom cover are possible. Three reference marks are provided on the phantom counter. These reference marks are used to teach the absolute phantom position relative to the robot.

The following figure shows the definition of reference point:

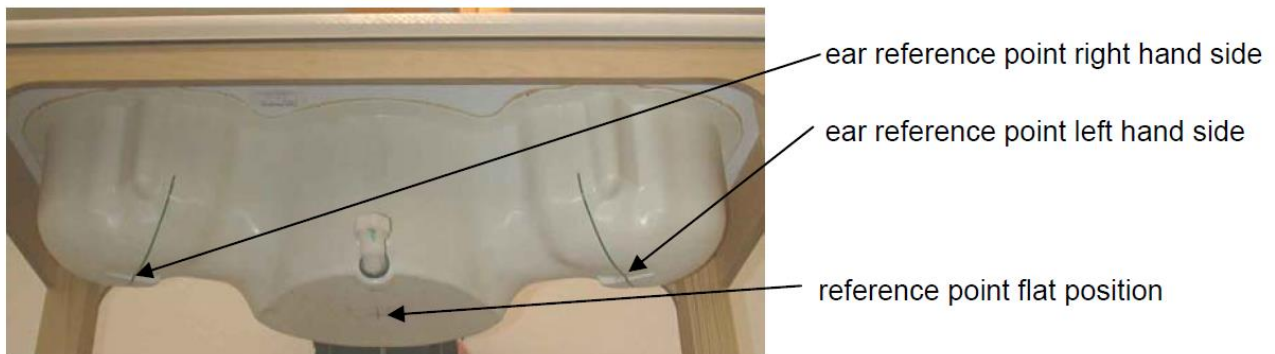

### ELI4 Phantom

|                   |                                     |   |
|-------------------|-------------------------------------|---|
| Shell Thickness   | 2mm±0.2mm                           |  |
| Filling Volume    | Approximately 30 liters             |   |
| Dimensions        | Major axis:600mm; Minor axis:400mm; |   |
| Measurement Areas | Flat phantom                        |   |

The ELI4 phantom is intended for compliance testing of handheld and body-mounted wireless devices in the frequency range of 30MHz to 6GHz. ELI4 is fully compatible with the latest draft of the standard IEC 62209-2 and all known tissue simulating liquids.

The phantom shell material is resistant to all ingredients used in the tissue-equivalent liquid recipes. The shell of the phantom including ear spacers is constructed from low permittivity and low loss material, with a relative permittivity  $2 \leq \epsilon_r \leq 5$  at  $\leq 3$  GHz,  $3 \leq \epsilon_r \leq 4$  at  $> 3$  GHz and a loss tangent  $\leq 0.05$ .

## Modular Triple Flat Phantom

|  |   |   |
|--|---|---|
| Shell Thickness (bottom plate)   | 2mm±0.2mm   |  |
| Filling Volume (Module)  | approx. 8.1 liters<br>(filling height: 155 mm)                                  |   |
| Dimensions   | Length: 292 mm<br>Width: 178 mm<br>Height: 178 mm<br>Useable area: 280 × 175 mm |   |
| Measurement Areas  | Flat phantom  |   |
| <p>The Modular Flat Phantom consists of three identical modules that can be installed and removed separately without emptying the liquid. It is used for compliance testing of small wireless devices in body-worn configurations according to IEC 62209-2, etc.</p> |   |   |

## 2.6 Device holder description

The DASY device holder has two scales for device rotation (with respect to the body axis) and the device inclination (with respect to the line between the ear openings). The plane between the ear openings and the mouth tip has a rotation angle of 65°. The bottom plate contains three pair of bolts for locking the device holder. The device holder positions are adjusted to the standard measurement positions in the three sections. This device holder is used for standard mobile phones or PDA's only. If necessary an additional support of polystyrene material is used.



The DASY device holder is constructed of low-loss POM material having the following dielectric parameters: relative permittivity  $\epsilon = 3$  and loss tangent  $\sigma = 0.02$ . The amount of dielectric material has been reduced in the closest vicinity of the device, since measurements have suggested that the influence of the clamp on the test results could thus be lowered.

The device holder permits the device to be positioned with a tolerance of  $\pm 1^\circ$  in the tilt angle.

Larger DUT's (e.g. notebooks) cannot be tested using this device holder. Instead a support of bigger polystyrene cubes and thin polystyrene plates is used to position the DUT in all relevant positions to find and measure spots with maximum SAR values.

Therefore those devices are normally only tested at the flat part of the SAM.

## 2.7 Test Equipment List

This table gives a complete overview of the SAR measurement equipment.

Devices used during the test described are marked

|                                     | Manufacturer  | Device                               | Type                     | Serial number | Date of last calibration | Valid period |
|-------------------------------------|---------------|--------------------------------------|--------------------------|---------------|--------------------------|--------------|
| <input checked="" type="checkbox"/> | SPEAG         | Dosimetric E-Field Probe             | EX3DV4                   | 3744          | 2018-07-25               | One year     |
| <input checked="" type="checkbox"/> | SPEAG         | Dosimetric E-Field Probe             | ES3DV3                   | 3168          | 2018-09-27               | One year     |
| <input checked="" type="checkbox"/> | SPEAG         | Dosimetric E-Field Probe             | EX3DV4                   | 3743          | 2018-11-19               | One year     |
| <input checked="" type="checkbox"/> | SPEAG         | Dosimetric E-Field Probe             | EX3DV4                   | 7381          | 2018-09-28               | One year     |
| <input checked="" type="checkbox"/> | SPEAG         | Dosimetric E-Field Probe             | EX3DV4                   | 7489          | 2019-02-28               | One year     |
| <input checked="" type="checkbox"/> | SPEAG         | 750 MHz Dipole                       | D750V3                   | 1044          | 2018-09-18               | Three years  |
| <input checked="" type="checkbox"/> | SPEAG         | 835 MHz Dipole                       | D835V2                   | 4d126         | 2018-07-24               | Three years  |
| <input checked="" type="checkbox"/> | SPEAG         | 835 MHz Dipole                       | D835V2                   | 4d059         | 2016-04-20               | Three years  |
| <input checked="" type="checkbox"/> | SPEAG         | 1750 MHz Dipole                      | D1750V2                  | 1145          | 2019-02-21               | Three years  |
| <input checked="" type="checkbox"/> | SPEAG         | 1900 MHz Dipole                      | D1900V2                  | 5d091         | 2018-09-19               | Three years  |
| <input checked="" type="checkbox"/> | SPEAG         | 1900 MHz Dipole                      | D1900V2                  | 5d143         | 2017-09-20               | Three years  |
| <input checked="" type="checkbox"/> | SPEAG         | 2450 MHz Dipole                      | D2450V2                  | 860           | 2018-11-17               | Three years  |
| <input checked="" type="checkbox"/> | SPEAG         | 2600 MHz Dipole                      | D2600V2                  | 1021          | 2018-07-26               | Three years  |
| <input checked="" type="checkbox"/> | SPEAG         | 2600 MHz Dipole                      | D2600V2                  | 1032          | 2018-09-17               | Three years  |
| <input checked="" type="checkbox"/> | SPEAG         | 5GHz Dipole                          | D5GHzV2                  | 1155          | 2018-06-08               | Three years  |
| <input checked="" type="checkbox"/> | SPEAG         | Data acquisition electronics         | DAE3                     | 393           | 2018-08-14               | One year     |
| <input checked="" type="checkbox"/> | SPEAG         | Data acquisition electronics         | DAE4                     | 916           | 2018-12-12               | One year     |
| <input checked="" type="checkbox"/> | SPEAG         | Data acquisition electronics         | DAE4                     | 1235          | 2018-11-14               | One year     |
| <input checked="" type="checkbox"/> | SPEAG         | Data acquisition electronics         | DAE4                     | 1236          | 2018-07-18               | One year     |
| <input checked="" type="checkbox"/> | SPEAG         | Data acquisition electronics         | DAE4                     | 1492          | 2018-11-14               | One year     |
| <input checked="" type="checkbox"/> | SPEAG         | Data acquisition electronics         | DAE4                     | 851           | 2018-07-18               | One year     |
| <input checked="" type="checkbox"/> | SPEAG         | Software                             | DASY52                   | N/A           | NCR                      | NCR          |
| <input checked="" type="checkbox"/> | SPEAG         | Twin Phantom                         | SAM                      | 1475          | NCR                      | NCR          |
| <input checked="" type="checkbox"/> | SPEAG         | Twin Phantom                         | SAM                      | 1620          | NCR                      | NCR          |
| <input checked="" type="checkbox"/> | SPEAG         | Twin Phantom                         | SAM                      | 1892          | NCR                      | NCR          |
| <input checked="" type="checkbox"/> | SPEAG         | Twin Phantom                         | SAM                      | 1940          | NCR                      | NCR          |
| <input checked="" type="checkbox"/> | SPEAG         | Twin Phantom                         | SAM                      | 1958          | NCR                      | NCR          |
| <input checked="" type="checkbox"/> | SPEAG         | Triple Flat Phantom                  | Triple Flat Phantom 5.1C | 1176/2        | NCR                      | NCR          |
| <input checked="" type="checkbox"/> | R & S         | Universal Radio Communication Tester | CMU 200                  | 123202        | 2018-12-18               | One year     |
| <input checked="" type="checkbox"/> | R & S         | Universal Radio Communication Tester | CMW 500                  | 116265        | 2019-03-11               | One year     |
| <input checked="" type="checkbox"/> | R & S         | Universal Radio Communication Tester | CMW 500                  | 166456        | 2018-10-31               | One year     |
| <input checked="" type="checkbox"/> | R & S         | Universal Radio Communication Tester | CMW 500                  | 165424        | 2018-07-07               | One year     |
| <input checked="" type="checkbox"/> | R & S         | Universal Radio Communication Tester | CMW 500                  | 158850        | 2019-03-14               | One year     |
| <input checked="" type="checkbox"/> | Anritsu       | Signal Analyzer                      | MS2690A                  | 6261767335    | 2019-03-14               | One year     |
| <input checked="" type="checkbox"/> | Anritsu       | Radio Communication Analyser         | MT8821C                  | 6201735100    | 2019-03-14               | One year     |
| <input checked="" type="checkbox"/> | Agilent       | Network Analyser                     | E5071C                   | MY46107368    | 2018-10-15               | One year     |
| <input checked="" type="checkbox"/> | Agilent       | Dielectric Probe Kit                 | 85070E                   | 2484          | NCR                      | NCR          |
| <input checked="" type="checkbox"/> | Agilent       | Signal Generator                     | N5181A                   | MY50145341    | 2018-12-18               | One year     |
| <input checked="" type="checkbox"/> | MINI-CIRCUITS | Amplifier                            | ZHL-42W                  | QA1402001     | NCR                      | NCR          |

|                                     |               |                          |           |            |            |          |
|-------------------------------------|---------------|--------------------------|-----------|------------|------------|----------|
| <input checked="" type="checkbox"/> | MINI-CIRCUITS | Amplifier                | ZVE-8G+   | 188163     | NCR        | NCR      |
| <input checked="" type="checkbox"/> | SHX           | Dual Directional Coupler | DDTO-4-20 | 17121801   | 2018-12-13 | One year |
| <input checked="" type="checkbox"/> | Agilent       | Dual Directional Coupler | 772D      | MY52180173 | 2018-12-13 | One year |
| <input checked="" type="checkbox"/> | AR            | Directional Coupler      | DC7144M1  | 311190     | 2018-05-29 | One year |
| <input checked="" type="checkbox"/> | Keysight      | Power Meter              | E4417A    | MY57160005 | 2019-03-14 | One year |
| <input checked="" type="checkbox"/> | Keysight      | Power Meter Sensor       | E9321A    | MY44420359 | 2019-01-02 | One year |
| <input checked="" type="checkbox"/> | R & S         | Power Meter              | NRP       | 100740     | 2018-07-17 | One year |
| <input checked="" type="checkbox"/> | R & S         | Power Meter Sensor       | NRP-Z11   | 106288     | 2018-07-17 | One year |

Note:

1) Per KDB865664D01 requirements for dipole calibration, the test laboratory has adopted three-year extended calibration interval. Each measured dipole is expected to evaluate with the following criteria at least on annual interval in Appendix C.

- a) There is no physical damage on the dipole;
- b) System check with specific dipole is within 10% of calibrated value;
- c) The most recent return-loss result, measured at least annually, deviates by no more than 20% from the previous measurement.
- d) The most recent measurement of the real or imaginary parts of the impedance, measured at least annually is within  $5\Omega$  from the previous measurement.

2) Network analyzer probe calibration against air, distilled water and a shorting block performed before measuring liquid parameters.

3) \*All the equipment are within the valid period when the tests are performed.

## 3 SAR Measurement Procedure

### 3.1 Scanning procedure

The DASY installation includes predefined files with recommended procedures for measurements and system check. They are read-only document files and destined as fully defined but unmeasured masks. All test positions (head or body-worn) are tested with the same configuration of test steps differing only in the grid definition for the different test positions.

- The “reference” and “drift” measurements are located at the beginning and end of the batch process. They measure the field drift at one single point in the liquid over the complete procedure. The indicated drift is mainly the variation of the DUT’s output power and should vary max. +/- 5 %.
- For power drift measurement, DASY software supports that the reference position can be either the selected section’s grid reference point or a user point. If the E-field of power reference measurement in the default grid reference point is very small, the test lab may set the reference position to the user point near the hotspot location to avoid large measurement uncertainty.
- The “surface check” measurement tests the optical surface detection system of the DASY system by repeatedly detecting the surface with the optical and mechanical surface detector and comparing the results. The output gives the detecting heights of both systems, the difference between the two systems and the standard deviation of the detection repeatability. Air bubbles or refraction in the liquid due to separation of the sugar-water mixture gives poor repeatability (above  $\pm 0.1\text{mm}$ ). To prevent wrong results tests are only executed when the liquid is free of air bubbles. The difference between the optical surface detection and the actual surface depends on the probe and is specified with each probe. (It does not depend on the surface reflectivity or the probe angle to the surface within  $\pm 30^\circ$ .)
- The “area scan” measures the SAR above the DUT or verification dipole on a parallel plane to the surface. It is used to locate the approximate location of the peak SAR with 2D spline interpolation. The robot performs a stepped movement along one grid axis while the local electrical field strength is measured by the probe. The probe is touching the surface of the SAM during acquisition of measurement values. The standard scan uses large grid spacing for faster measurement. Standard grid spacing for head measurements is 15 mm in x- and y- dimension ( $\leq 2\text{GHz}$ ), 12 mm in x- and y- dimension (2-4 GHz) and 10mm in x- and y- dimension (4-6GHz). If a finer resolution is needed, the grid spacing can be reduced. Grid spacing and orientation have no influence on the SAR result. For special applications where the standard scan method does not find the peak SAR within the grid, e.g. mobile phones with flip cover, the grid can be adapted in orientation. Results of this coarse scan are shown in Appendix B.
- A “zoom scan” measures the field in a volume around the 2D peak SAR value acquired in the previous “coarse” scan. This is a fine grid with maximum scan spatial resolution:  $\Delta x_{\text{zoom}}, \Delta y_{\text{zoom}} \leq 2\text{GHz} - \leq 8\text{mm}$ , 2-4GHz -  $\leq 5\text{ mm}$  and 4-6 GHz- $\leq 4\text{mm}$ ;  $\Delta z_{\text{zoom}} \leq 3\text{GHz} - \leq 5\text{ mm}$ , 3-4 GHz-  $\leq 4\text{mm}$  and 4-6GHz- $\leq 2\text{mm}$  where the robot additionally moves the probe along the z-axis away from the bottom of the Phantom. DASY is also able to perform repeated zoom scans if more than 1 peak is found during area scan. In this document, the evaluated peak 1g and 10g averaged SAR values are shown in the 2D-graphics in Appendix B. Test results relevant for the specified standard (see chapter 1.4.) are shown in table form in chapter.
- A Z-axis scan measures the total SAR value at the x-and y-position of the maximum SAR value found during the cube scan. The probe is moved away in z-direction from the bottom of the SAM phantom in 2 mm steps. This measurement shows the continuity of the liquid and can - depending in the field strength – also show the liquid depth. A z-axis scan of the measurement with maximum SAR value is shown in Appendix B.

The following table summarizes the area scan and zoom scan resolutions per FCC KDB 865664D01:

| Frequency          | Maximum Area Scan resolution ( $\Delta x_{area}, \Delta y_{area}$ ) | Maximum Zoom Scan spatial resolution ( $\Delta x_{Zoom}, \Delta y_{Zoom}$ ) | Maximum Zoom Scan spatial resolution |                        |                                   | Minimum zoom scan volume (x,y,z) |
|--------------------|---|---|--------------------------------------|------------------------|-----------------------------------|----------------------------------|
|                    |   |   | Uniform Grid                         | Graded Grad            |                                   |                                  |
|                    |   |   | $\Delta z_{Zoom}(n)$                 | $\Delta z_{Zoom}(1)^*$ | $\Delta z_{Zoom}(n>1)^*$          |                                  |
| $\leq 2\text{GHz}$ | $\leq 15\text{mm}$  | $\leq 8\text{mm}$   | $\leq 5\text{mm}$                    | $\leq 4\text{mm}$      | $\leq 1.5^* \Delta z_{Zoom}(n-1)$ | $\geq 30\text{mm}$               |
| 2-3GHz             | $\leq 12\text{mm}$  | $\leq 5\text{mm}$   | $\leq 5\text{mm}$                    | $\leq 4\text{mm}$      | $\leq 1.5^* \Delta z_{Zoom}(n-1)$ | $\geq 30\text{mm}$               |
| 3-4GHz             | $\leq 12\text{mm}$  | $\leq 5\text{mm}$   | $\leq 4\text{mm}$                    | $\leq 3\text{mm}$      | $\leq 1.5^* \Delta z_{Zoom}(n-1)$ | $\geq 28\text{mm}$               |
| 4-5GHz             | $\leq 10\text{mm}$  | $\leq 4\text{mm}$   | $\leq 3\text{mm}$                    | $\leq 2.5\text{mm}$    | $\leq 1.5^* \Delta z_{Zoom}(n-1)$ | $\geq 25\text{mm}$               |
| 5-6GHz             | $\leq 10\text{mm}$  | $\leq 4\text{mm}$   | $\leq 2\text{mm}$                    | $\leq 2\text{mm}$      | $\leq 1.5^* \Delta z_{Zoom}(n-1)$ | $\geq 22\text{mm}$               |

### 3.2 Spatial Peak SAR Evaluation

The spatial peak SAR - value for 1 and 10 g is evaluated after the Cube measurements have been done. The basis of the evaluation are the SAR values measured at the points of the fine cube grid consisting of 5 x 5 x 7 points( with 8mm horizontal resolution) or 7 x 7 x 7 points( with 5mm horizontal resolution) or 8 x 8 x 7 points( with 4mm horizontal resolution). The algorithm that finds the maximal averaged volume is separated into three different stages.

- The data between the dipole center of the probe and the surface of the phantom are extrapolated. This data cannot be measured since the center of the dipole is 2.7 mm away from the tip of the probe and the distance between the surface and the lowest measuring point is about 1 mm (see probe calibration sheet). The extrapolated data from a cube measurement can be visualized by selecting 'Graph Evaluated'.
- The maximum interpolated value is searched with a straight-forward algorithm. Around this maximum the SAR - values averaged over the spatial volumes (1g or 10 g) are computed using the 3d-spline interpolation algorithm. If the volume cannot be evaluated (i.e., if a part of the grid was cut off by the boundary of the measurement area) the evaluation will be started on the corners of the bottom plane of the cube.
- All neighboring volumes are evaluated until no neighboring volume with a higher average value is found.

#### Extrapolation

The extrapolation is based on a least square algorithm [W. Gander, Computermathematik, p.168-180]. Through the points in the first 3 cm along the z-axis, polynomials of order four are calculated. These polynomials are then used to evaluate the points between the surface and the probe tip. The points, calculated from the surface, have a distance of 1 mm from each other.

#### Interpolation

The interpolation of the points is done with a 3d-Spline. The 3d-Spline is composed of three one-dimensional splines with the "Not a knot"-condition [W. Gander, Computermathematik, p.141-150] (x, y and z -direction) [Numerical Recipes in C, Second Edition, p.123ff ].

#### Volume Averaging

At First the size of the cube is calculated. Then the volume is integrated with the trapezoidal algorithm. 8000 points (20x20x20) are interpolated to calculate the average.

#### Advanced Extrapolation

DASY uses the advanced extrapolation option which is able to compensate boundary effects on E-field probes.



### 3.3 Data Storage and Evaluation

#### Data Storage

The DASY software stores the acquired data from the data acquisition electronics as raw data (in microvolt readings from the probe sensors), together with all necessary software parameters for the data evaluation (probe calibration data, liquid parameters and device frequency and modulation data) in measurement files with the extension "DAE". The software evaluates the desired unit and format for output each time the data is visualized or exported. This allows verification of the complete software setup even after the measurement and allows correction of incorrect parameter settings. For example, if a measurement has been performed with a wrong crest factor parameter in the device setup, the parameter can be corrected afterwards and the data can be re-evaluated.

The measured data can be visualized or exported in different units or formats, depending on the selected probe type ([V/m], [A/m], [°C], [mW/g], [mW/cm²], [dBrel], etc.). Some of these units are not available in certain situations or show meaningless results, e.g., a SAR output in a lossless media will always be zero. Raw data can also be exported to perform the evaluation with other software packages.

#### Data Evaluation by SEMCAD

The SEMCAD software automatically executes the following procedures to calculate the field units from the microvolt readings at the probe connector. The parameters used in the evaluation are stored in the configuration modules of the software:

|                    |                           |   |
|--------------------|---------------------------|---|
| Probe parameters:  | - Sensitivity             | Norm <sub>i</sub> , a <sub>i0</sub> , a <sub>i1</sub> , a <sub>i2</sub> |
|                    | - Conversion factor       | ConvF <sub>i</sub>  |
|                    | - Diode compression point | Dcpi  |
| Device parameters: | - Frequency               | f   |
|                    | - Crest factor            | cf  |
| Media parameters:  | - Conductivity            | σ   |
|                    | - Density                 | ρ   |

These parameters must be set correctly in the software. They can be found in the component documents or they can be imported into the software from the configuration files issued for the DASY components. In the direct measuring mode of the multimeter option, the parameters of the actual system setup are used. In the scan visualization and export modes, the parameters stored in the corresponding document files are used.

The first step of the evaluation is a linearization of the filtered input signal to account for the compression characteristics of the detector diode. The compensation depends on the input signal, the diode type and the DC-transmission factor from the diode to the evaluation electronics.

If the exciting field is pulsed, the crest factor of the signal must be known to correctly compensate for peak power. The formula for each channel can be given as:

$$V_i = U_i + U_i^2 \cdot cf/dcp_i$$

|      |                  |                                   |                  |
|------|------------------|-----------------------------------|------------------|
| with | V <sub>i</sub>   | = compensated signal of channel i | (i = x, y, z)    |
|      | U <sub>i</sub>   | = input signal of channel i       | (i = x, y, z)    |
|      | cf               | = crest factor of exciting field  | (DASY parameter) |
|      | dcp <sub>i</sub> | = diode compression point         | (DASY parameter) |

From the compensated input signals the primary field data for each channel can be evaluated:



E-field probes:

$$E_i = (V_i / Norm_i \cdot ConvF)^{1/2}$$

H-field probes:

$$H_i = (V_i)^{1/2} \cdot (a_{i0} + a_{i1}f + a_{i2}f^2)/f$$

with  $V_i$  = compensated signal of channel i (i = x, y, z)  
 $Norm_i$  = sensor sensitivity of channel i (i = x, y, z)  
[mV/(V/m)<sup>2</sup>] for E-field Probes  
ConvF = sensitivity enhancement in solution  
 $a_{ij}$  = sensor sensitivity factors for H-field probes  
f = carrier frequency [GHz]  
 $E_i$  = electric field strength of channel i in V/m  
 $H_i$  = magnetic field strength of channel i in A/m

The RSS value of the field components gives the total field strength (Hermitian magnitude):

$$E_{tot} = (E_x^2 + E_y^2 + E_z^2)^{1/2}$$

The primary field data are used to calculate the derived field units.

$$SAR = (E_{tot}^2 \cdot \sigma) / (\rho \cdot 1000)$$

with SAR = local specific absorption rate in mW/g  
 $E_{tot}$  = total field strength in V/m  
 $\sigma$  = conductivity in [mho/m] or [Siemens/m]  
 $\rho$  = equivalent tissue density in g/cm<sup>3</sup>

Note that the density is normally set to 1 (or 1.06), to account for actual brain density rather than the density of the simulation liquid. The power flow density is calculated assuming the excitation field to be a free space field.

$$P_{pwe} = E_{tot}^2 / 3770 \quad \text{or} \quad P_{pwe} = H_{tot}^2 \cdot 37.7$$

with  $P_{pwe}$  = equivalent power density of a plane wave in mW/cm<sup>2</sup>  
 $E_{tot}$  = total electric field strength in V/m  
 $H_{tot}$  = total magnetic field strength in A/m

## 4 System Verification Procedure

### 4.1 Tissue Verification

The simulating liquids should be checked at the beginning of a series of SAR measurements to determine if the dielectric parameters are within the tolerances of the specified target values. The measured conductivity and relative permittivity should be within  $\pm 5\%$  of the target values.

The following materials are used for producing the tissue-equivalent materials.

| Ingredients (% of weight) | Head Tissue |       |       |        |      |        |
|---------------------------|-------------|-------|-------|--------|------|--------|
| Frequency Band (MHz)      | 750         | 835   | 1750  | 1900   | 2450 | 2600   |
| Water                     | 39.2        | 41.45 | 52.64 | 55.242 | 62.7 | 55.242 |
| Salt (NaCl)               | 2.7         | 1.45  | 0.36  | 0.306  | 0.5  | 0.306  |
| Sugar                     | 57.0        | 56.0  | 0.0   | 0.0    | 0.0  | 0.0    |
| HEC                       | 0.0         | 1.0   | 0.0   | 0.0    | 0.0  | 0.0    |
| Bactericide               | 0.0         | 0.1   | 0.0   | 0.0    | 0.0  | 0.0    |
| Triton X-100              | 0.0         | 0.0   | 0.0   | 0.0    | 0.0  | 0.0    |
| DGBE                      | 0.0         | 0.0   | 47.0  | 44.542 | 36.8 | 44.452 |
| Ingredients (% of weight) | Body Tissue |       |       |        |      |        |
| Frequency Band (MHz)      | 750         | 835   | 1750  | 1900   | 2450 | 2600   |
| Water                     | 50.3        | 52.4  | 69.91 | 69.91  | 73.2 | 64.493 |
| Salt (NaCl)               | 1.60        | 1.40  | 0.13  | 0.13   | 0.04 | 0.024  |
| Sugar                     | 47.0        | 45.0  | 0.0   | 0.0    | 0.0  | 0.0    |
| HEC                       | 0.0         | 1.0   | 0.0   | 0.0    | 0.0  | 0.0    |
| Bactericide               | 0.0         | 0.1   | 0.0   | 0.0    | 0.0  | 0.0    |
| Triton X-100              | 0.0         | 0.0   | 0.0   | 0.0    | 0.0  | 0.0    |
| DGBE                      | 0.0         | 0.0   | 29.96 | 29.96  | 26.7 | 32.252 |

Table 4: Tissue Dielectric Properties

Salt: 99+% Pure Sodium Chloride; Sugar: 98+% Pure Sucrose; Water: De-ionized, 16M $\Omega$ + resistivity  
 HEC: Hydroxyethyl Cellulose; DGBE: 99+% Di(ethylene glycol) butyl ether, [2-(2-butoxyethoxy)ethanol]  
 Triton X-100(ultra pure): Polyethylene glycol mono [4-(1,1,3,3-tetramethylbutyl)phenyl]ether

#### Simulating Head Liquid (HBBL600-6000MHz), Manufactured by SPEAG:

| Ingredients                     | (% by weight) |
|---------------------------------|---------------|
| Water                           | 50-65%        |
| Esters, Emulsifiers, Inhibitors | 10-30%        |
| Sodium salt                     | 8-25%         |

#### Simulating Body Liquid (MBBL600-6000MHz), Manufactured by SPEAG:

| Ingredients                     | (% by weight) |
|---------------------------------|---------------|
| Water                           | 60-80%        |
| Esters, Emulsifiers, Inhibitors | 20-40%        |
| Sodium salt                     | 0-1.5%        |

| Tissue Type | Target Frequency | Target Tissue |                | Measured Tissue |                | Deviation (Within +/-5% ) |                | Liquid Temp. | Test Date |
|-------------|------------------|---------------|----------------|-----------------|----------------|---------------------------|----------------|--------------|-----------|
|             |                  | $\epsilon_r$  | $\sigma$ (S/m) | $\epsilon_r$    | $\sigma$ (S/m) | $\Delta\epsilon_r$        | $\Delta\sigma$ |              |           |
| Head        | 705              | 42.2          | 0.89           | 43.18           | 0.904          | 2.32%                     | 1.57%          | 21.4°C       | 2019/4/11 |
|             | 710              | 42.1          | 0.89           | 43.17           | 0.905          | 2.54%                     | 1.73%          |              |           |
|             | 750              | 41.9          | 0.89           | 43.05           | 0.919          | 2.74%                     | 3.24%          |              |           |
| Head        | 825              | 41.6          | 0.90           | 41.04           | 0.932          | -1.35%                    | 3.54%          | 21.8°C       | 2019/4/9  |
|             | 835              | 41.5          | 0.90           | 41.01           | 0.935          | -1.17%                    | 3.78%          |              |           |
|             | 850              | 41.5          | 0.92           | 40.96           | 0.940          | -1.30%                    | 2.17%          |              |           |
| Head        | 825              | 41.6          | 0.90           | 42.93           | 0.940          | 3.20%                     | 4.47%          | 22.0°C       | 2019/4/12 |
|             | 835              | 41.5          | 0.90           | 42.88           | 0.944          | 3.33%                     | 4.90%          |              |           |
|             | 850              | 41.5          | 0.92           | 42.83           | 0.950          | 3.20%                     | 3.22%          |              |           |
| Head        | 825              | 41.6          | 0.90           | 42.80           | 0.923          | 2.88%                     | 2.50%          | 21.4°C       | 2019/4/12 |
|             | 835              | 41.5          | 0.90           | 42.76           | 0.926          | 3.04%                     | 2.89%          |              |           |
|             | 850              | 41.5          | 0.92           | 42.71           | 0.931          | 2.92%                     | 1.21%          |              |           |
| Head        | 1710             | 40.1          | 1.35           | 41.87           | 1.347          | 4.41%                     | -0.22%         | 22.0°C       | 2019/4/9  |
|             | 1730             | 40.1          | 1.36           | 41.82           | 1.356          | 4.29%                     | -0.29%         |              |           |
|             | 1750             | 40.1          | 1.37           | 41.78           | 1.365          | 4.19%                     | -0.36%         |              |           |
|             | 1800             | 40.0          | 1.40           | 41.80           | 1.387          | 4.50%                     | -0.93%         |              |           |
| Head        | 1850             | 40.0          | 1.40           | 39.08           | 1.392          | -2.30%                    | -0.57%         | 22.0°C       | 2019/4/10 |
|             | 1880             | 40.0          | 1.40           | 39.05           | 1.408          | -2.38%                    | 0.57%          |              |           |
|             | 1900             | 40.0          | 1.40           | 39.02           | 1.421          | -2.45%                    | 1.50%          |              |           |
|             | 1910             | 40.0          | 1.40           | 39.01           | 1.428          | -2.48%                    | 2.00%          |              |           |
| Head        | 1850             | 40.0          | 1.40           | 41.61           | 1.404          | 4.03%                     | 0.29%          | 22.6°C       | 2019/4/17 |
|             | 1880             | 40.0          | 1.40           | 41.56           | 1.420          | 3.90%                     | 1.43%          |              |           |
|             | 1900             | 40.0          | 1.40           | 41.53           | 1.432          | 3.83%                     | 2.29%          |              |           |
|             | 1910             | 40.0          | 1.40           | 41.53           | 1.438          | 3.83%                     | 2.71%          |              |           |
| Head        | 2410             | 39.3          | 1.76           | 39.99           | 1.825          | 1.76%                     | 3.69%          | 22.0°C       | 2019/4/10 |
|             | 2435             | 39.2          | 1.79           | 39.96           | 1.843          | 1.94%                     | 2.96%          |              |           |
|             | 2450             | 39.2          | 1.80           | 39.94           | 1.852          | 1.89%                     | 2.89%          |              |           |
|             | 2460             | 39.2          | 1.81           | 39.92           | 1.860          | 1.84%                     | 2.76%          |              |           |
| Head        | 2410             | 39.3          | 1.76           | 38.77           | 1.782          | -1.35%                    | 1.25%          | 22.0°C       | 2019/4/17 |
|             | 2435             | 39.2          | 1.79           | 38.76           | 1.793          | -1.12%                    | 0.17%          |              |           |
|             | 2450             | 39.2          | 1.80           | 38.73           | 1.801          | -1.20%                    | 0.06%          |              |           |
|             | 2460             | 39.2          | 1.81           | 38.69           | 1.811          | -1.30%                    | 0.06%          |              |           |
| Head        | 2510             | 39.1          | 1.87           | 37.80           | 1.894          | -3.32%                    | 1.28%          | 22.0°C       | 2019/4/11 |
|             | 2535             | 39.1          | 1.89           | 37.78           | 1.910          | -3.38%                    | 1.06%          |              |           |
|             | 2560             | 39.1          | 1.92           | 37.75           | 1.927          | -3.45%                    | 0.36%          |              |           |
|             | 2600             | 39.0          | 1.96           | 37.69           | 1.961          | -3.36%                    | 0.05%          |              |           |
|             | 2610             | 39.0          | 1.97           | 37.68           | 1.969          | -3.38%                    | -0.05%         |              |           |
|             | 2645             | 39.0          | 2.01           | 37.61           | 1.995          | -3.56%                    | -0.75%         |              |           |
| Head        | 2510             | 39.1          | 1.87           | 38.85           | 1.855          | -0.64%                    | -0.80%         | 21.7°C       | 2019/4/13 |
|             | 2535             | 39.1          | 1.89           | 38.79           | 1.874          | -0.79%                    | -0.85%         |              |           |
|             | 2560             | 39.1          | 1.92           | 38.80           | 1.895          | -0.77%                    | -1.30%         |              |           |
|             | 2600             | 39.0          | 1.96           | 38.76           | 1.924          | -0.62%                    | -1.84%         |              |           |
|             | 2610             | 39.0          | 1.97           | 38.74           | 1.933          | -0.67%                    | -1.88%         |              |           |
|             | 2645             | 39.0          | 2.01           | 38.68           | 1.967          | -0.82%                    | -2.14%         |              |           |



|      |      |      |      |       |       |        |        |        |           |
|------|------|------|------|-------|-------|--------|--------|--------|-----------|
| Head | 2510 | 39.1 | 1.87 | 37.69 | 1.881 | -3.61% | 0.59%  | 21.8°C | 2019/4/18 |
|      | 2535 | 39.1 | 1.89 | 37.64 | 1.899 | -3.73% | 0.48%  |        |           |
|      | 2560 | 39.1 | 1.92 | 37.59 | 1.919 | -3.86% | -0.05% |        |           |
|      | 2600 | 39.0 | 1.96 | 37.54 | 1.948 | -3.74% | -0.61% |        |           |
|      | 2610 | 39.0 | 1.97 | 37.52 | 1.954 | -3.79% | -0.81% |        |           |
|      | 2645 | 39.0 | 2.01 | 37.45 | 1.984 | -3.97% | -1.29% |        |           |
| Head | 5250 | 35.9 | 4.71 | 35.32 | 4.716 | -1.62% | 0.13%  | 22.0°C | 2019/4/13 |
|      | 5600 | 35.5 | 5.07 | 34.53 | 5.019 | -2.73% | -1.01% |        |           |
|      | 5750 | 35.4 | 5.22 | 34.30 | 5.221 | -3.11% | 0.02%  |        |           |
| Body | 705  | 55.7 | 0.96 | 54.90 | 0.963 | -1.44% | 0.28%  | 22.4°C | 2019/4/23 |
|      | 710  | 55.7 | 0.96 | 54.88 | 0.964 | -1.47% | 0.46%  |        |           |
|      | 750  | 55.5 | 0.96 | 54.84 | 0.980 | -1.19% | 2.08%  |        |           |
| Body | 825  | 55.2 | 0.97 | 54.00 | 1.005 | -2.17% | 3.61%  | 22.0°C | 2019/4/14 |
|      | 835  | 55.2 | 0.97 | 53.98 | 1.009 | -2.21% | 4.02%  |        |           |
|      | 850  | 55.2 | 0.99 | 53.93 | 1.015 | -2.30% | 2.53%  |        |           |
| Body | 825  | 55.2 | 0.97 | 52.60 | 1.012 | -4.71% | 4.33%  | 22.0°C | 2019/4/17 |
|      | 835  | 55.2 | 0.97 | 52.57 | 1.016 | -4.76% | 4.74%  |        |           |
|      | 850  | 55.2 | 0.99 | 52.52 | 1.021 | -4.86% | 3.13%  |        |           |
| Body | 825  | 55.2 | 0.97 | 53.24 | 0.990 | -3.55% | 2.07%  | 22.3°C | 2019/4/25 |
|      | 835  | 55.2 | 0.97 | 53.13 | 1.001 | -3.75% | 3.20%  |        |           |
|      | 850  | 55.2 | 0.99 | 52.95 | 1.017 | -4.08% | 2.73%  |        |           |
| Body | 1710 | 53.5 | 1.46 | 55.04 | 1.409 | 2.88%  | -3.49% | 21.5°C | 2019/4/9  |
|      | 1730 | 53.5 | 1.48 | 55.02 | 1.423 | 2.84%  | -3.85% |        |           |
|      | 1750 | 53.4 | 1.49 | 55.00 | 1.437 | 2.99%  | -3.56% |        |           |
|      | 1800 | 53.3 | 1.52 | 54.92 | 1.470 | 3.04%  | -3.29% |        |           |
| Body | 1710 | 53.5 | 1.46 | 55.49 | 1.406 | 3.72%  | -3.70% | 22.6°C | 2019/4/18 |
|      | 1730 | 53.5 | 1.48 | 55.64 | 1.423 | 4.00%  | -3.85% |        |           |
|      | 1750 | 53.4 | 1.49 | 55.53 | 1.441 | 3.99%  | -3.29% |        |           |
|      | 1800 | 53.3 | 1.52 | 55.55 | 1.475 | 4.22%  | -2.96% |        |           |
| Body | 1850 | 53.3 | 1.52 | 52.38 | 1.503 | -1.73% | -1.12% | 22.1°C | 2019/4/9  |
|      | 1880 | 53.3 | 1.52 | 52.33 | 1.527 | -1.82% | 0.46%  |        |           |
|      | 1900 | 53.3 | 1.52 | 52.30 | 1.543 | -1.88% | 1.51%  |        |           |
|      | 1910 | 53.3 | 1.52 | 52.29 | 1.550 | -1.89% | 1.97%  |        |           |
| Body | 1850 | 53.3 | 1.52 | 52.78 | 1.496 | -0.98% | -1.58% | 22.5°C | 2019/4/12 |
|      | 1880 | 53.3 | 1.52 | 52.57 | 1.551 | -1.37% | 2.04%  |        |           |
|      | 1900 | 53.3 | 1.52 | 52.50 | 1.564 | -1.50% | 2.89%  |        |           |
|      | 1910 | 53.3 | 1.52 | 52.47 | 1.571 | -1.56% | 3.36%  |        |           |
| Body | 2410 | 52.8 | 1.91 | 54.70 | 1.907 | 3.60%  | -0.16% | 23.0°C | 2019/4/22 |
|      | 2435 | 52.7 | 1.94 | 55.05 | 1.926 | 4.46%  | -0.72% |        |           |
|      | 2450 | 52.7 | 1.95 | 54.71 | 1.960 | 3.81%  | 0.51%  |        |           |
|      | 2460 | 52.7 | 1.96 | 54.22 | 1.966 | 2.88%  | 0.31%  |        |           |
| Body | 2410 | 52.8 | 1.91 | 51.50 | 1.842 | -2.46% | -3.56% | 23.2°C | 2019/4/27 |
|      | 2435 | 52.7 | 1.94 | 51.48 | 1.864 | -2.31% | -3.92% |        |           |
|      | 2450 | 52.7 | 1.95 | 51.44 | 1.877 | -2.39% | -3.74% |        |           |
|      | 2460 | 52.7 | 1.96 | 51.42 | 1.886 | -2.43% | -3.78% |        |           |
| Body | 2510 | 52.6 | 2.04 | 54.00 | 2.023 | 2.66%  | -0.83% | 21.5°C | 2019/4/9  |
|      | 2535 | 52.6 | 2.07 | 53.94 | 2.047 | 2.55%  | -1.11% |        |           |

|      |      |      |      |       |       |        |        |        |           |
|------|------|------|------|-------|-------|--------|--------|--------|-----------|
|      | 2560 | 52.6 | 2.11 | 53.91 | 2.071 | 2.49%  | -1.85% |        |           |
|      | 2600 | 52.5 | 2.16 | 53.85 | 2.107 | 2.57%  | -2.45% |        |           |
|      | 2610 | 52.5 | 2.18 | 53.83 | 2.118 | 2.53%  | -2.84% |        |           |
|      | 2645 | 52.5 | 2.23 | 53.78 | 2.153 | 2.44%  | -3.45% |        |           |
| Body | 2510 | 52.6 | 2.04 | 53.59 | 2.044 | 1.88%  | 0.20%  | 22.5°C | 2019/4/15 |
|      | 2535 | 52.6 | 2.07 | 53.56 | 2.068 | 1.83%  | -0.10% |        |           |
|      | 2560 | 52.6 | 2.11 | 53.53 | 2.089 | 1.77%  | -1.00% |        |           |
|      | 2600 | 52.5 | 2.16 | 53.49 | 2.125 | 1.89%  | -1.62% |        |           |
|      | 2610 | 52.5 | 2.18 | 53.46 | 2.134 | 1.83%  | -2.11% |        |           |
|      | 2645 | 52.5 | 2.23 | 53.42 | 2.169 | 1.75%  | -2.74% |        |           |
| Body | 2510 | 52.6 | 2.04 | 51.33 | 2.136 | -2.41% | 4.71%  | 21.5°C | 2019/4/26 |
|      | 2535 | 52.6 | 2.07 | 51.28 | 2.153 | -2.51% | 4.01%  |        |           |
|      | 2560 | 52.6 | 2.11 | 51.24 | 2.170 | -2.59% | 2.84%  |        |           |
|      | 2600 | 52.5 | 2.16 | 51.19 | 2.202 | -2.50% | 1.94%  |        |           |
|      | 2610 | 52.5 | 2.18 | 51.17 | 2.210 | -2.53% | 1.38%  |        |           |
|      | 2645 | 52.5 | 2.23 | 51.11 | 2.238 | -2.65% | 0.36%  |        |           |
| Body | 2510 | 52.6 | 2.04 | 53.54 | 2.040 | 1.79%  | 0.00%  | 22°C   | 2019/4/28 |
|      | 2535 | 52.6 | 2.07 | 53.51 | 2.064 | 1.73%  | -0.29% |        |           |
|      | 2560 | 52.6 | 2.11 | 53.48 | 2.085 | 1.67%  | -1.18% |        |           |
|      | 2600 | 52.5 | 2.16 | 53.43 | 2.121 | 1.77%  | -1.81% |        |           |
|      | 2610 | 52.5 | 2.18 | 53.41 | 2.130 | 1.73%  | -2.29% |        |           |
|      | 2645 | 52.5 | 2.23 | 53.37 | 2.164 | 1.66%  | -2.96% |        |           |
| Body | 5250 | 48.9 | 5.36 | 48.72 | 5.268 | -0.37% | -1.72% | 21.5°C | 2019/4/21 |
|      | 5600 | 48.5 | 5.77 | 48.16 | 5.712 | -0.70% | -1.01% |        |           |
|      | 5750 | 48.3 | 5.94 | 47.94 | 5.916 | -0.75% | -0.40% |        |           |
| Body | 5250 | 48.9 | 5.36 | 47.90 | 5.415 | -2.04% | 1.03%  | 21.5°C | 2019/4/24 |
|      | 5600 | 48.5 | 5.77 | 47.35 | 5.870 | -2.37% | 1.73%  |        |           |
|      | 5750 | 48.3 | 5.94 | 47.09 | 6.078 | -2.51% | 2.32%  |        |           |

Table 5: Measured Tissue Parameter

Note: 1) The dielectric parameters of the tissue-equivalent liquid should be measured under similar ambient conditions and within 2 °C of the conditions expected during the SAR evaluation to satisfy protocol requirements.

2) KDB 865664 was ensured to be applied for probe calibration frequencies greater than or equal to 50MHz of the EUT frequencies.

3) The above measured tissue parameters were used in the DASY software to perform interpolation via the DASY software to determine actual dielectric parameters at the test frequencies. The SAR test plots may slightly differ from the table above since the DASY rounds to three significant digits.

## 4.2 System Check

The system check is performed for verifying the accuracy of the complete measurement system and performance of the software. The system check is performed with tissue equivalent material according to IEEE 1528 (described above). The following table shows system check results for all frequency bands and tissue liquids used during the tests(Graphic Plot(s) see Appendix A).

| Dipole Information | System Check | Scaled factor | Target SAR (Normalized to 1W) |             | Measured SAR (Normalized to 1W) |             | Deviation (Within +/-10% ) |        | Test Date |
|--------------------|--------------|---------------|-------------------------------|-------------|---------------------------------|-------------|----------------------------|--------|-----------|
|                    |              |               | 1-g (mW/g)                    | 10-g (mW/g) | 1-g (mW/g)                      | 10-g (mW/g) | Δ1-g                       | Δ10-g  |           |
| 1044               | 750MHz Head  | 4             | 8.24                          | 5.34        | 8.48                            | 5.60        | 2.91%                      | 4.87%  | 2019/4/11 |
| 4d059              | 835MHz Head  | 4             | 9.30                          | 6.05        | 10.08                           | 6.52        | 8.39%                      | 7.77%  | 2019/4/9  |
| 4d059              | 835MHz Head  | 4             | 9.30                          | 6.05        | 9.80                            | 6.40        | 5.38%                      | 5.79%  | 2019/4/12 |
| 4d059              | 835MHz Head  | 4             | 9.30                          | 6.05        | 9.80                            | 6.44        | 5.38%                      | 6.45%  | 2019/4/12 |
| 1145               | 1750MHz Head | 4             | 35.50                         | 18.70       | 36.64                           | 19.64       | 3.21%                      | 5.03%  | 2019/4/9  |
| 5d143              | 1900MHz Head | 4             | 39.10                         | 20.50       | 40.80                           | 21.08       | 4.35%                      | 2.83%  | 2019/4/10 |
| 5d143              | 1900MHz Head | 4             | 39.10                         | 20.50       | 38.48                           | 19.88       | -1.59%                     | -3.02% | 2019/4/17 |
| 860                | 2450MHz Head | 4             | 53.10                         | 24.70       | 50.00                           | 23.48       | -5.84%                     | -4.94% | 2019/4/10 |
| 860                | 2450MHz Head | 4             | 53.10                         | 24.70       | 50.80                           | 23.84       | -4.33%                     | -3.48% | 2019/4/17 |
| 1021               | 2600MHz Head | 4             | 56.60                         | 25.50       | 57.20                           | 25.84       | 1.06%                      | 1.33%  | 2019/4/11 |
| 1021               | 2600MHz Head | 4             | 56.60                         | 25.50       | 54.00                           | 24.44       | -4.59%                     | -4.16% | 2019/4/13 |
| 1021               | 2600MHz Head | 4             | 56.60                         | 25.50       | 56.40                           | 25.40       | -0.35%                     | -0.39% | 2019/4/18 |
| 1155               | 5250MHz Head | 10            | 81.40                         | 23.50       | 76.30                           | 21.80       | -6.27%                     | -7.23% | 2019/4/13 |
| 1155               | 5600MHz Head | 10            | 85.20                         | 24.30       | 79.90                           | 22.60       | -6.22%                     | -7.00% | 2019/4/13 |
| 1155               | 5750MHz Head | 10            | 78.40                         | 22.30       | 72.30                           | 20.50       | -7.78%                     | -8.07% | 2019/4/13 |
| 1044               | 750MHz Body  | 4             | 8.54                          | 5.61        | 8.80                            | 5.80        | 3.04%                      | 3.39%  | 2019/4/23 |
| 4d126              | 835MHz Body  | 4             | 9.65                          | 6.32        | 10.44                           | 6.88        | 8.19%                      | 8.86%  | 2019/4/14 |
| 4d126              | 835MHz Body  | 4             | 9.65                          | 6.32        | 9.68                            | 6.32        | 0.31%                      | 0.00%  | 2019/4/17 |
| 4d126              | 835MHz Body  | 4             | 9.65                          | 6.32        | 10.28                           | 6.72        | 6.53%                      | 6.33%  | 2019/4/25 |
| 1145               | 1750MHz Body | 4             | 36.70                         | 19.40       | 35.88                           | 19.40       | -2.23%                     | 0.00%  | 2019/4/9  |
| 1145               | 1750MHz Body | 4             | 36.70                         | 19.40       | 37.88                           | 20.64       | 3.22%                      | 6.39%  | 2019/4/18 |
| 5d091              | 1900MHz Body | 4             | 40.40                         | 21.10       | 38.12                           | 19.64       | -5.64%                     | -6.92% | 2019/4/9  |
| 5d091              | 1900MHz Body | 4             | 40.40                         | 21.10       | 42.80                           | 22.28       | 5.94%                      | 5.59%  | 2019/4/12 |
| 860                | 2450MHz Body | 4             | 51.60                         | 24.20       | 51.60                           | 24.44       | 0.00%                      | 0.99%  | 2019/4/22 |
| 860                | 2450MHz Body | 4             | 51.60                         | 24.20       | 49.20                           | 23.40       | -4.65%                     | -3.31% | 2019/4/27 |
| 1032               | 2600MHz Body | 4             | 55.10                         | 24.50       | 54.40                           | 24.80       | -1.27%                     | 1.22%  | 2019/4/9  |
| 1032               | 2600MHz Body | 4             | 55.10                         | 24.50       | 55.20                           | 25.24       | 0.18%                      | 3.02%  | 2019/4/15 |
| 1032               | 2600MHz Body | 4             | 55.10                         | 24.50       | 56.40                           | 24.44       | 2.36%                      | -0.24% | 2019/4/26 |
| 1032               | 2600MHz Body | 4             | 55.10                         | 24.50       | 55.20                           | 25.20       | 0.18%                      | 2.86%  | 2019/4/28 |
| 1155               | 5250MHz Body | 10            | 74.70                         | 20.90       | 75.10                           | 21.20       | 0.54%                      | 1.44%  | 2019/4/21 |
| 1155               | 5250MHz Body | 10            | 74.70                         | 20.90       | 74.40                           | 21.10       | -0.40%                     | 0.96%  | 2019/4/24 |
| 1155               | 5600MHz Body | 10            | 79.60                         | 22.10       | 72.20                           | 20.30       | -9.30%                     | -8.14% | 2019/4/21 |
| 1155               | 5600MHz Body | 10            | 79.60                         | 22.10       | 79.70                           | 22.40       | 0.13%                      | 1.36%  | 2019/4/24 |
| 1155               | 5750MHz Body | 10            | 73.30                         | 20.40       | 68.60                           | 19.40       | -6.41%                     | -4.90% | 2019/4/21 |

Table 6: System Check Results

### 4.3 System check Procedure

The system check is performed by using a system check dipole which is positioned parallel to the planar part of the SAM phantom at the reference point. The distance of the dipole to the SAM phantom is determined by a plexiglass spacer. The dipole is connected to the signal source consisting of signal generator and amplifier via a directional coupler, N-connector cable and adaption to SAM. It is fed with a power of 250 mW (below 3GHz) or 100mW (3-6GHz). To adjust this power, a power meter is used. The power sensor is connected to the cable before the system check to measure the power at this point and do adjustments at the signal generator. At the outputs of the directional coupler both return loss as well as forward power are controlled during the system check to make sure that emitted power at the dipole is kept constant. This can also be checked by the power drift measurement after the test (result on plot). System check results have to be equal or near the values determined during dipole calibration (target SAR in table above) with the relevant liquids and test system.

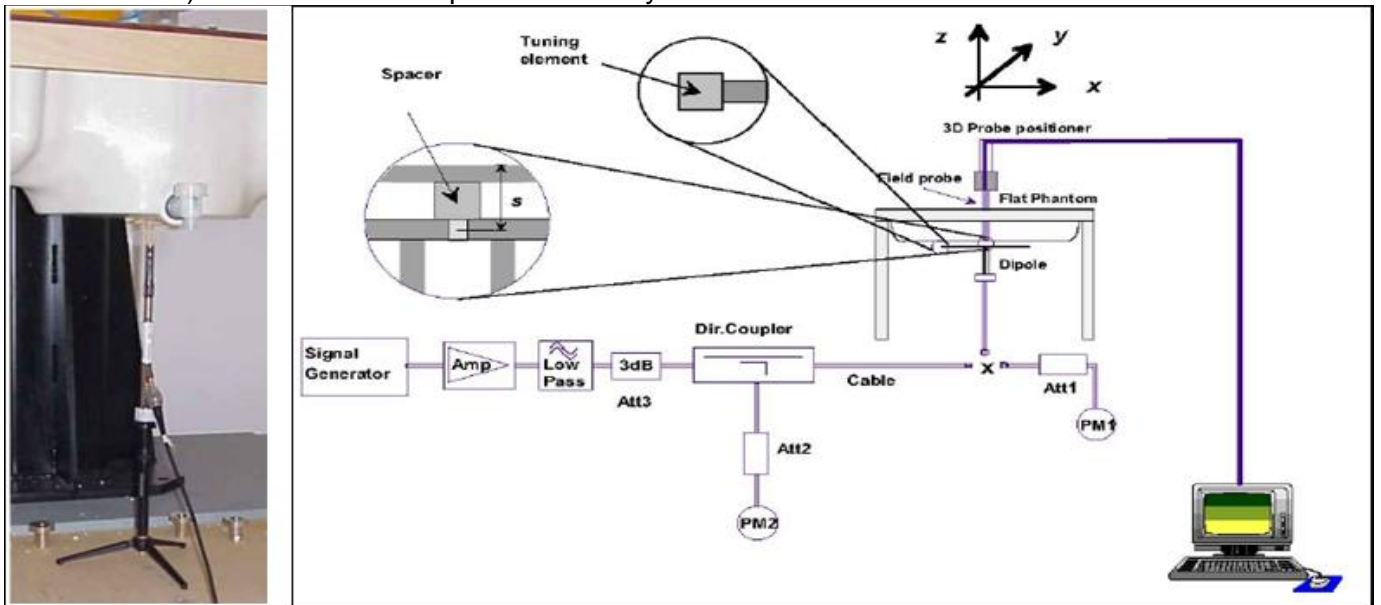

## 5 SAR measurement variability and uncertainty

### 5.1 SAR measurement variability

Per KDB 865664 D01 SAR measurement 100 MHz to 6 GHz, SAR measurement variability must be assessed for each frequency band, which is determined by the SAR probe calibration point and tissue-equivalent medium used for the device measurements. The additional measurements are repeated after the completion of all measurements requiring the same head or body tissue-equivalent medium in a frequency band. The test device should be returned to ambient conditions (normal room temperature) with the battery fully charged before it is re-mounted on the device holder for the repeated measurement(s) to minimize any unexpected variations in the repeated results.

- 1) Repeated measurement is not required when the original highest measured SAR is  $< 0.80$  W/kg; steps 2) through 4) do not apply.
- 2) When the original highest measured SAR is  $\geq 0.80$  W/kg, repeat that measurement once.
- 3) Perform a second repeated measurement only if the ratio of largest to smallest SAR for the original and first repeated measurements is  $> 1.20$  or when the original or repeated measurement is  $\geq 1.45$  W/kg ( $\sim 10\%$  from the 1-g SAR limit).
- 4) Perform a third repeated measurement only if the original, first or second repeated measurement is  $\geq 1.5$  W/kg and the ratio of largest to smallest SAR for the original, first and second repeated measurements is  $> 1.20$ .

The same procedures should be adapted for measurements according to extremity and occupational exposure limits by applying a factor of 2.5 for extremity exposure and a factor of 5 for occupational exposure to the corresponding SAR thresholds.

The detailed repeated measurement results are shown in Section 7.2.

### 5.2 SAR measurement uncertainty

Per KDB 865664 D01 SAR Measurement 100 MHz to 6 GHz, when the highest measured 1-g SAR within a frequency band is  $< 1.5$  W/kg, the extensive SAR measurement uncertainty analysis described in IEEE Std 1528-2013 is not required in SAR reports submitted for equipment approval. The equivalent ratio (1.5/1.6) is applied to extremity and occupational exposure conditions.



## 6 SAR Test Configuration

### 6.1 Test Positions Configuration

#### 6.1.1 General considerations

Per IEEE 1528-2013, two imaginary lines on the handset were established: the vertical centerline and the horizontal line (See Figure 1).

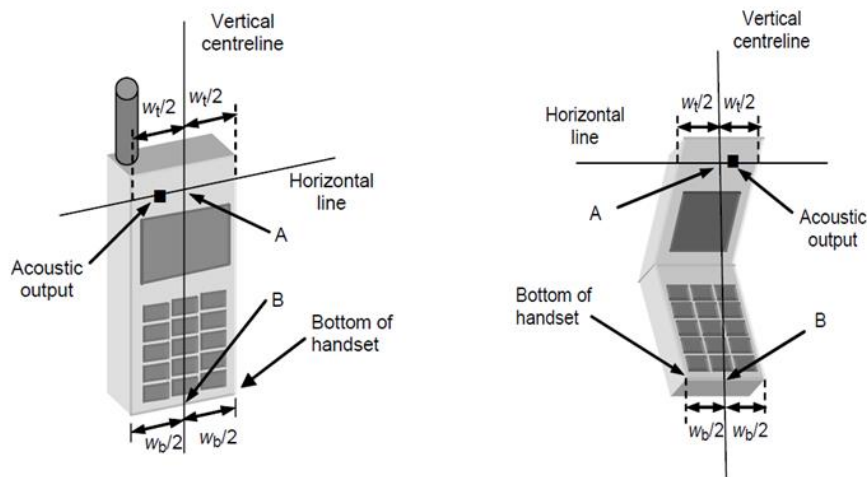

Figure 1 Hand Vertical Center & Horizontal Line Reference Points

#### 6.1.2 Head Exposure Condition

Per IEEE 1528-2013, Head SAR measurements were made in the “cheek” position (See Figure 2) and the “tilt” position (See Figure 3). The device should be tested in both positions on left and right sides of the SAM phantom.

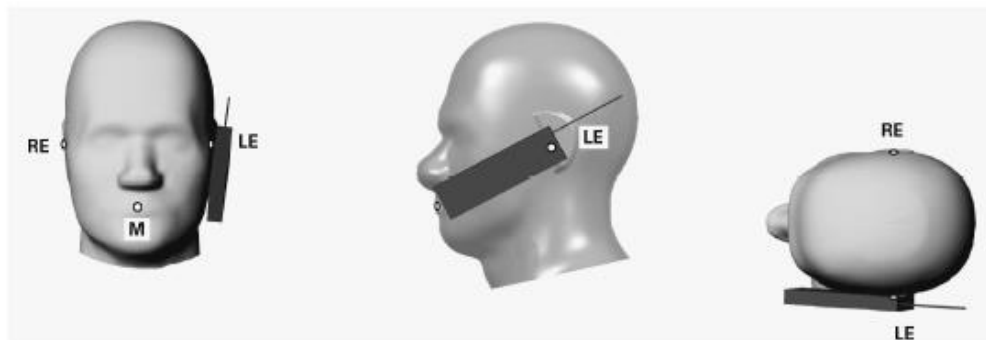

Figure 2 Front, Side and Top View of Cheek Position

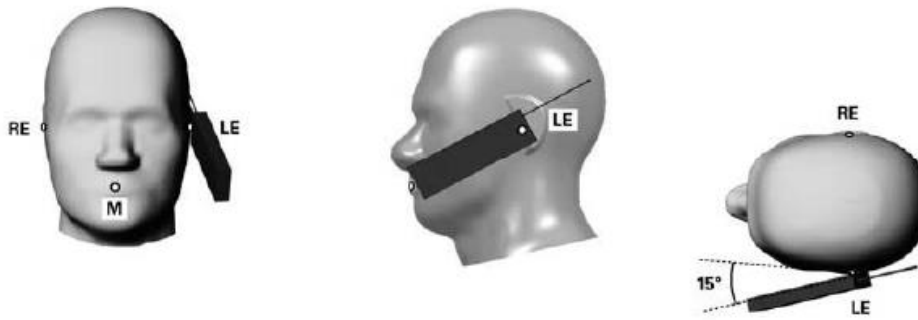

Figure 3 Front, Side and Top View of Tilt 15° Position

Note:

M Mouth reference point

LE Left ear reference point (ERP)

RE Right ear reference point(ERP)

### 6.1.3 Body-worn Exposure Condition

Body-worn operating configurations are tested with the holder attached to the device and positioned against a flat phantom with test separation distance of 15mm in a normal use configuration (See Figure 4). Per FCC KDB648474 D04, Body-worn accessory exposure is typically related to voice mode operations when handsets are carried in body-worn accessories. The body-worn accessory procedures in FCC KDB 447498 should be used to test for body-worn accessory SAR compliance, without a headset connected to it. When the reported SAR for a body-worn accessory, measured without a headset connected to the handset, is  $> 1.2 \text{ W/kg}$ , the highest reported SAR configuration for that wireless mode and frequency band should be repeated for that body-worn accessory with a headset attached to the handset.

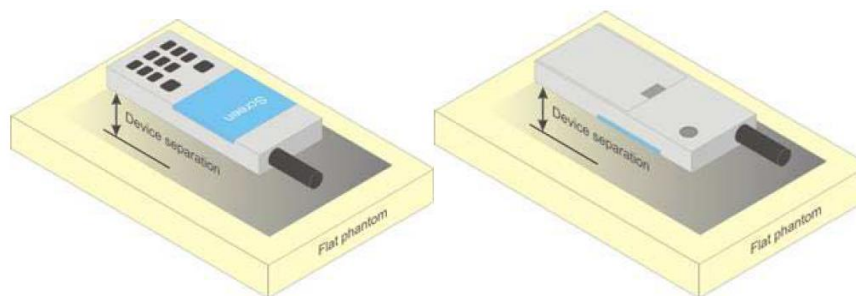

Figure 4 Test position for Body-Worn device

### 6.1.4 Hotspot Exposure Condition

Per FCC KDB 941225D06, the SAR test separation distance for hotspot mode is determined according to device form factor. When the overall length and width of a device is  $> 9 \text{ cm} \times 5 \text{ cm}$ , a test separation distance of 10 mm is required for hotspot mode SAR measurements. A test separation distance of 5 mm or less is required for smaller devices. Hotspot mode SAR is measured for all edges and surfaces of the device with a transmitting antenna located within 25 mm from that surface or edge; for the data modes, wireless technologies and frequency bands supporting hotspot mode. The SAR results are used to determine simultaneous transmission SAR test exclusion for hotspot mode; otherwise, simultaneous transmission SAR measurement is required.

### 6.1.5 Product Specific 10-g SAR Exposure Condition

Per FCC KDB 648474D04, for smart phones with a display diagonal dimension > 15.0 cm or an overall diagonal dimension > 16.0 cm that provide similar mobile web access and multimedia support found in mini-tablets or UMPC mini-tablets that support voice calls next to the ear, the device is marketed as “Phablet”.

The UMPC mini-tablet procedures must also be applied to test the SAR of all surfaces and edges with an antenna located at  $\leq 25$  mm from that surface or edge, in direct contact with a flat phantom, for Product Specific 10-g SAR according to the body-equivalent tissue dielectric parameters in KDB 865664 to address interactive hand use exposure conditions. The UMPC mini-tablet 1-g SAR at 5 mm is not required. When hotspot mode applies, Product Specific 10-g SAR is required only for the surfaces and edges with hotspot mode 1-g reported SAR > 1.2 W/kg; however, when power reduction applies to hotspot mode the measured SAR must be scaled to the maximum output power, including tolerance, allowed for phablet modes to compare with the 1.2 W/kg SAR test reduction threshold.

### 6.2 3G SAR Test Reduction Procedure

Per KDB941225 D01, in the following procedures, the mode tested for SAR is referred to as the primary mode. The equivalent modes considered for SAR test reduction are denoted as secondary modes. Both primary and secondary modes must be in the same frequency band. When the maximum output power and tune-up tolerance specified for production units in a secondary mode is  $\leq \frac{1}{4}$  dB higher than the primary mode or when the highest *reported* SAR of the primary mode is scaled by the ratio of specified maximum output power and tune-up tolerance of secondary to primary mode and the adjusted SAR is  $\leq 1.2$  W/kg, SAR measurement is not required for the secondary mode. This is referred to as the 3G SAR test reduction procedure in the following SAR test guidance, where the primary mode is identified in the applicable wireless mode test procedures and the secondary mode is wireless mode being considered for SAR test reduction by that procedure. When the 3G SAR test reduction procedure is not satisfied, it is identified as “otherwise” in the applicable procedures; SAR measurement is required for the secondary mode.

### 6.3 GSM Test Configuration

SAR tests for GSM850 and GSM1900, a communication link is set up with a base station by air link. Using CMW500 the power level is set to “5” and “0” in SAR of GSM850 and GSM1900. The tests in the band of GSM850 and GSM1900 are performed in the mode of GPRS/EGPRS function. Since the GPRS class is 12 for this EUT, it has at most 4 timeslots in uplink and at most 4 timeslots in downlink, the maximum total timeslot is 5. The EGPRS class is 12 for this EUT, it has at most 4 timeslots in uplink, and at most 4 timeslots in downlink, the maximum total timeslot is 5.

When SAR tests for EGPRS mode is necessary, GMSK modulation should be used to minimize SAR measurement error due to higher peak-to-average power (PAR) ratios inherent in 8PSK.

## 6.4 UMTS Test Configuration

### 1) Output Power Verification

Maximum output power is verified on the high, middle and low channels according to procedures described in section 5.2 of 3GPP TS 34.121, using the appropriate RMC or AMR with TPC (transmit power control) set to all “1’s” for WCDMA/HSDPA or by applying the required inner loop power control procedures to maintain maximum output power while HSUPA is active. Results for all applicable physical channel configurations (DPCCH, DPDCHn and spreading codes, HSDPA, HSPA) are required in the SAR report. All configurations that are not supported by the handset or cannot be measured due to technical or equipment limitations must be clearly identified.

### 2) WCDMA

#### a. Head SAR Measurements

SAR for next to the ear head exposure is measured using a 12.2 kbps RMC with TPC bits configured to all “1’s”. The 3G SAR test reduction procedure is applied to AMR configurations with 12.2 kbps RMC as the primary mode.

#### b. Body SAR Measurements

SAR for body-worn accessory configurations is measured using a 12.2 kbps RMC with TPC bits configured to all “1’s”. The 3G SAR test reduction procedure is applied to other spreading codes and multiple DPDCHn configurations supported by the handset with 12.2 kbps RMC as the primary mode

### 3) HSDPA

SAR for body exposure configurations is measured according to the “Body SAR Measurements” procedures of 3G device. When the maximum output power and tune-up tolerance specified for production units in a secondary mode is  $\leq \frac{1}{4}$  dB higher than the primary mode or when the highest *reported* SAR of the primary mode is scaled by the ratio of specified maximum output power and tune-up tolerance of secondary to primary mode and the adjusted SAR is  $\leq 1.2$  W/kg, SAR measurement is not required for the secondary mode. This is referred to as the 3G SAR test reduction procedure in the following SAR test guidance, where the primary mode is identified in the applicable wireless mode test procedures and the secondary mode is wireless mode being considered for SAR test reduction by that procedure. When the 3G SAR test reduction procedure is not satisfied, it is identified as “otherwise” in the applicable procedures; SAR measurement is required for the secondary mode.

Per KDB941225 D01, the 3G SAR test reduction procedure is applied to HSDPA body configurations with 12.2 kbps RMC as the primary mode. Otherwise, SAR is measured for HSDPA using the HSDPA body SAR procedures for the highest reported SAR body exposure configuration in 12.2 kbps RMC.

HSDPA should be configured according to UE category of a test device. The number of HS-DSCH/HS-PDSCHs, HAPRQ processes, minimum inter-TTI interval, transport block sizes and RV coding sequence are defined by the H-set. To maintain a consistent test configuration and stable transmission condition, QPSK is used in the H-set for SAR testing. HS-DPCCH should be configured with a CQI feedback cycle of 4ms with a CQI repetition factor of 2 to maintain a constant rate of active CQI slots. The  $\beta_c$  and  $\beta_d$  gain factors for DPCCH and DPDCH were set according to the values in the below table,  $\beta_{hs}$  for HS-DPCCH is set automatically to the correct value when  $\Delta ACK, \Delta NACK, \Delta CQI = 8$ . The variation of the  $\beta_c / \beta_d$  ratio causes a power reduction at sub-tests 2 - 4.

| Sub-test <sup>Ⓢ</sup> | $\beta_c$ <sup>Ⓢ</sup> | $\beta_{d\pm}$ <sup>Ⓢ</sup> | $\beta_d$ (SF) <sup>Ⓢ</sup> | $\beta_c/\beta_{d\pm}$ <sup>Ⓢ</sup> | $\beta_{hs}$ (1) <sup>Ⓢ</sup> | CM(dB)(2) <sup>Ⓢ</sup> | MPR (dB) <sup>Ⓢ</sup> |
|-----------------------|------------------------|-----------------------------|-----------------------------|-------------------------------------|-------------------------------|------------------------|-----------------------|
| 1 <sup>Ⓢ</sup>        | 2/15 <sup>Ⓢ</sup>      | 15/15 <sup>Ⓢ</sup>          | 64 <sup>Ⓢ</sup>             | 2/15 <sup>Ⓢ</sup>                   | 4/15 <sup>Ⓢ</sup>             | 0.0 <sup>Ⓢ</sup>       | 0 <sup>Ⓢ</sup>        |
| 2 <sup>Ⓢ</sup>        | 12/15(3) <sup>Ⓢ</sup>  | 15/15(3) <sup>Ⓢ</sup>       | 64 <sup>Ⓢ</sup>             | 12/15(3) <sup>Ⓢ</sup>               | 24/15 <sup>Ⓢ</sup>            | 1.0 <sup>Ⓢ</sup>       | 0 <sup>Ⓢ</sup>        |
| 3 <sup>Ⓢ</sup>        | 15/15 <sup>Ⓢ</sup>     | 8/15 <sup>Ⓢ</sup>           | 64 <sup>Ⓢ</sup>             | 15/8 <sup>Ⓢ</sup>                   | 30/15 <sup>Ⓢ</sup>            | 1.5 <sup>Ⓢ</sup>       | 0.5 <sup>Ⓢ</sup>      |
| 4 <sup>Ⓢ</sup>        | 15/15 <sup>Ⓢ</sup>     | 4/15 <sup>Ⓢ</sup>           | 64 <sup>Ⓢ</sup>             | 15/4 <sup>Ⓢ</sup>                   | 30/15 <sup>Ⓢ</sup>            | 1.5 <sup>Ⓢ</sup>       | 0.5 <sup>Ⓢ</sup>      |

Note 1:  $\Delta$ ACK,  $\Delta$ NACK and  $\Delta$ CQI = 8     $A_{hs} = \beta_{hs}/\beta_c = 30/15$      $\beta_{hs} = 30/15 * \beta_c$ <sup>Ⓢ</sup>  
Note 2 : CM=1 for  $\beta_c/\beta_{d\pm} = 12/15$ ,  $\beta_{hs}/\beta_c = 24/15$ . For all other combinations of DPDCH,DPCCH and HS-DPCCH the MPR is based on the relative CM difference. This is applicable for only UEs that support HSDPA in release 6 and later releases.<sup>Ⓢ</sup>  
Note 3 : For subtest 2 the  $\beta_c/\beta_d$  ratio of 12/15 for the TFC during the measurement period (TF1, TF0) is achieved by setting the signalled gain factors for the reference TFC (TF1,TF1) to  $\beta_c = 11/15$  and  $\beta_d = 15/15$ <sup>Ⓢ</sup>

Table 7: Sub-tests for UMTS Release 5 HSDPA

The measurements were performed with a Fixed Reference Channel (FRC) and H-Set 1 QPSK.

| Parameter                        | Value       |
|----------------------------------|-------------|
| Nominal average inf. bit rate    | 534 kbit/s  |
| Inter-TTI Distance               | 3 TTI's     |
| Number of HARQ Processes         | 2 Processes |
| Information Bit Payload          | 3202 Bits   |
| MAC-d PDU size                   | 336 Bits    |
| Number Code Blocks               | 1 Block     |
| Binary Channel Bits Per TTI      | 4800 Bits   |
| Total Available SMLs in UE       | 19200 SMLs  |
| Number of SMLs per HARQ Process  | 9600 SMLs   |
| Coding Rate                      | 0.67        |
| Number of Physical Channel Codes | 5           |

Table 8: settings of required H-Set 1 QPSK acc. to 3GPP 34.121

| HS-DSCH Category | Maximum HS-DSCH Codes Received | Minimum Inter-TTI Interval | Maximum HS-DSCH Transport Block Bits/HS-DSCH TTI | Total Soft Channel Bits |
|------------------|--------------------------------|----------------------------|--|-------------------------|
| 1                | 5                              | 3                          | 7298   | 19200                   |
| 2                | 5                              | 3                          | 7298   | 28800                   |
| 3                | 5                              | 2                          | 7298   | 28800                   |
| 4                | 5                              | 2                          | 7298   | 38400                   |
| 5                | 5                              | 1                          | 7298   | 57600                   |
| 6                | 5                              | 1                          | 7298   | 67200                   |
| 7                | 10                             | 1                          | 14411  | 115200                  |
| 8                | 10                             | 1                          | 14411  | 134400                  |
| 9                | 15                             | 1                          | 25251  | 172800                  |
| 10               | 15                             | 1                          | 27952  | 172800                  |
| 11               | 5                              | 2                          | 3630   | 14400                   |
| 12               | 5                              | 1                          | 3630   | 28800                   |
| 13               | 15                             | 1                          | 34800  | 259200                  |
| 14               | 15                             | 1                          | 42196  | 259200                  |
| 15               | 15                             | 1                          | 23370  | 345600                  |
| 16               | 15                             | 1                          | 27952  | 345600                  |

Table 9:HSDPA UE category

#### 4) HSUPA

SAR for body exposure configurations is measured according to the “Body SAR Measurements” procedures of 3G device. When the maximum output power and tune-up tolerance specified for production units in a secondary mode is  $\leq \frac{1}{4}$  dB higher than the primary mode or when the highest reported SAR of the primary mode is scaled by the ratio of specified maximum output power and tune-up tolerance of secondary to primary mode and the adjusted SAR is  $\leq 1.2$  W/kg, SAR measurement is not required for the secondary mode.

Per KDB941225 D01, the 3G SAR test reduction procedure is applied to HSPA (HSUPA/HSDPA with RMC) body configurations with 12.2 kbps RMC as the primary mode. Otherwise, SAR is measured for HSPA using the HSPA body SAR procedures for the highest reported body exposure SAR configuration in 12.2 kbps RMC.

Due to inner loop power control requirements in HSDPA, a commercial communication test set should be used for the output power and SAR tests. The 12.2 kbps RMC, FRC H-set 1 and E-DCH configurations for HSDPA should be configured according to the values indicated below as well as other applicable procedures described in the ‘WCDMA Handset’ and ‘Release 5 HSDPA Data Device’ sections of 3G device.

| Sub-test <sup>⊕</sup> | $\beta_c$ <sup>⊕</sup>            | $\beta_d$ <sup>⊕</sup>            | $\beta_d$ (SF) <sup>⊕</sup> | $\beta_c/\beta_d$ <sup>⊕</sup>    | $\beta_{hs}^{(1)}$ <sup>⊕</sup> | $\beta_{ec}$ <sup>⊕</sup> | $\beta_{ed}$ <sup>⊕</sup>  | $\beta_c$ (SF) <sup>⊕</sup> | $\beta_{ed}$ (code) <sup>⊕</sup> | CM <sup>(2)</sup> <sup>⊕</sup> (dB) <sup>⊕</sup> | MP R <sup>⊕</sup> (dB) <sup>⊕</sup> | AG <sup>(4)</sup> Index <sup>⊕</sup> | E-TFC I <sup>⊕</sup> |
|-----------------------|-----------------------------------|-----------------------------------|-----------------------------|-----------------------------------|---------------------------------|---------------------------|--|-----------------------------|----------------------------------|--|-------------------------------------|--------------------------------------|----------------------|
| 1 <sup>⊕</sup>        | 11/15 <sup>(3)</sup> <sup>⊕</sup> | 15/15 <sup>(3)</sup> <sup>⊕</sup> | 64 <sup>⊕</sup>             | 11/15 <sup>(3)</sup> <sup>⊕</sup> | 22/15 <sup>⊕</sup>              | 209/225 <sup>⊕</sup>      | 1039/225 <sup>⊕</sup>  | 4 <sup>⊕</sup>              | 1 <sup>⊕</sup>                   | 1.0 <sup>⊕</sup>                                 | 0.0 <sup>⊕</sup>                    | 20 <sup>⊕</sup>                      | 75 <sup>⊕</sup>      |
| 2 <sup>⊕</sup>        | 6/15 <sup>⊕</sup>                 | 15/15 <sup>⊕</sup>                | 64 <sup>⊕</sup>             | 6/15 <sup>⊕</sup>                 | 12/15 <sup>⊕</sup>              | 12/15 <sup>⊕</sup>        | 94/75 <sup>⊕</sup>   | 4 <sup>⊕</sup>              | 1 <sup>⊕</sup>                   | 3.0 <sup>⊕</sup>                                 | 2.0 <sup>⊕</sup>                    | 12 <sup>⊕</sup>                      | 67 <sup>⊕</sup>      |
| 3 <sup>⊕</sup>        | 15/15 <sup>⊕</sup>                | 9/15 <sup>⊕</sup>                 | 64 <sup>⊕</sup>             | 15/9 <sup>⊕</sup>                 | 30/15 <sup>⊕</sup>              | 30/15 <sup>⊕</sup>        | $\beta_{ed1}:47/15$ <sup>⊕</sup><br>$\beta_{ed2}:47/15$ <sup>⊕</sup> | 4 <sup>⊕</sup>              | 2 <sup>⊕</sup>                   | 2.0 <sup>⊕</sup>                                 | 1.0 <sup>⊕</sup>                    | 15 <sup>⊕</sup>                      | 92 <sup>⊕</sup>      |
| 4 <sup>⊕</sup>        | 2/15 <sup>⊕</sup>                 | 15/15 <sup>⊕</sup>                | 64 <sup>⊕</sup>             | 2/15 <sup>⊕</sup>                 | 4/15 <sup>⊕</sup>               | 2/15 <sup>⊕</sup>         | 56/75 <sup>⊕</sup>   | 4 <sup>⊕</sup>              | 1 <sup>⊕</sup>                   | 3.0 <sup>⊕</sup>                                 | 2.0 <sup>⊕</sup>                    | 17 <sup>⊕</sup>                      | 71 <sup>⊕</sup>      |
| 5 <sup>⊕</sup>        | 15/15 <sup>(4)</sup> <sup>⊕</sup> | 15/15 <sup>(4)</sup> <sup>⊕</sup> | 64 <sup>⊕</sup>             | 15/15 <sup>(4)</sup> <sup>⊕</sup> | 30/15 <sup>⊕</sup>              | 24/15 <sup>⊕</sup>        | 134/15 <sup>⊕</sup>  | 4 <sup>⊕</sup>              | 1 <sup>⊕</sup>                   | 1.0 <sup>⊕</sup>                                 | 0.0 <sup>⊕</sup>                    | 21 <sup>⊕</sup>                      | 81 <sup>⊕</sup>      |

Note 1:  $\Delta ACK, \Delta NACK$  and  $\Delta CQI = 8$   $A_{hs} = \beta_{hs}/\beta_c = 30/15$   $\beta_{hs} = 30/15 * \beta_c$

Note 2: CM = 1 for  $\beta_c/\beta_d = 12/15, \beta_{hs}/\beta_c = 24/15$ . For all other combinations of DPDCH, DPCCH, HS-DPCCH, E-DPDCH and E-DPCCH the MPR is based on the relative CM difference<sup>⊕</sup>

Note 3 : For subtest 1 the  $\beta_c/\beta_d$  ratio of 11/15 for the TFC during the measurement period (TF1, TF0) is achieved by setting the signalled gain factors for the reference TFC (TF1, TF1) to  $\beta_c = 10/15$  and  $\beta_d = 15/15$ <sup>⊕</sup>

Note 4 : For subtest 5 the  $\beta_c/\beta_d$  ratio of 15/15 for the TFC during the measurement period (TF1, TF0) is achieved by setting the signalled gain factors for the reference TFC (TF1, TF1) to  $\beta_c = 14/15$  and  $\beta_d = 15/15$ <sup>⊕</sup>

Note 5 : Testing UE using E-DPDCH Physical Layer category 1 Sub-test 3 is not required according to TS 25.306 Table 5.1g<sup>⊕</sup>

Note 6:  $\beta_{ed}$  can not be set directly; it is set by Absolute Grant Value.<sup>⊕</sup>

Table 10:Subtests for UMTS Release 6 HSUPA

| UE E-DCH Category | Maximum E-DCH Codes Transmitted | Number of HARQ Processes | E-DCH TTI(ms) | Minimum Spreading Factor | Maximum E-DCH Transport Block Bits | Max Rate (Mbps) |
|-------------------|---------------------------------|--------------------------|---------------|--------------------------|------------------------------------|-----------------|
| 1                 | 1                               | 4                        | 10            | 4                        | 7110                               | 0.7296          |
| 2                 | 2                               | 8                        | 2             | 4                        | 2798                               | 1.4592          |
|                   | 2                               | 4                        | 10            | 4                        | 14484                              |                 |
| 3                 | 2                               | 4                        | 10            | 4                        | 14484                              | 1.4592          |
| 4                 | 2                               | 8                        | 2             | 2                        | 5772                               | 2.9185          |
|                   | 2                               | 4                        | 10            | 2                        | 20000                              | 2.00            |
| 5                 | 2                               | 4                        | 10            | 2                        | 20000                              | 2.00            |
| 6<br>(No DPDCH)   | 4                               | 8                        | 10            | 2SF2&2S<br>F4            | 11484                              | 5.76            |
|                   | 4                               | 4                        | 2             |                          | 20000                              | 2.00            |
| 7<br>(No DPDCH)   | 4                               | 8                        | 2             | 2SF2&2S<br>F4            | 22996                              | ?               |
|                   | 4                               | 4                        | 10            |                          | 20000                              | ?               |

NOTE: When 4 codes are transmitted in parallel, two codes shall be transmitted with SF2 and two with SF4. UE categories 1 to 6 support QPSK only. UE category 7 supports QPSK and 16QAM.(TS25.306-7.3.0).

Table 11:HSUPA UE category

### 5) DC-HSDPA

SAR is required for Rel. 8 DC-HSDPA when SAR is required for Rel. 5 HSDPA; otherwise, the 3G SAR test reduction procedure is applied to DC-HSDPA with 12.2 kbps RMC as the primary mode. Power is measured for DC-HSDPA according to the H-Set 12, FRC configuration in Table C.8.1.12 of 3GPP TS 34.121-1 to determine SAR test reduction. A primary and a Second serving HS-DSCH Cell are required to perform the power measurement and for the results to be acceptable.

The following tests were completed according to procedures in section 7.3.13 of 3GPP TS 34.108 v9.5.0. A summary of these settings are illustrated below:

Downlink Physical Channels are set as per 3GPP TS34.121-1 v9.0.0 E.5.0

**Table E.5.0: Levels for HSDPA connection setup**

| Parameter During Connection setup | Unit | Value |
|-----------------------------------|------|-------|
| P-CPICH_Ec/Ior                    | dB   | -10   |
| P-CCPCH and SCH_Ec/Ior            | dB   | -12   |
| PICH_Ec/Ior                       | dB   | -15   |
| HS-PDSCH                          | dB   | off   |
| HS-SCCH_1                         | dB   | off   |
| DPCH_Ec/Ior                       | dB   | -5    |
| OCNS_Ec/Ior                       | dB   | -3.1  |

Call is set up as per 3GPP TS34.108 v9.5.0 sub clause 7.3.13

The configurations of the fixed reference channels for HSDPA RF tests are described in 3GPP TS 34.121, annex C for FDD and 3GPP TS 34.122.

The measurements were performed with a Fixed Reference Channel (FRC) H-Set 12 with QPSK

| Parameter                        | Value       |
|----------------------------------|-------------|
| Nominal average inf. bit rate    | 60 kbit/s   |
| Inter-TTI Distance               | 1 TTI's     |
| Number of HARQ Processes         | 6 Processes |
| Information Bit Payload          | 120 Bits    |
| Number Code Blocks               | 1 Block     |
| Binary Channel Bits Per TTI      | 960 Bits    |
| Total Available SMLs in UE       | 19200 SMLs  |
| Number of SMLs per HARQ Process  | 3200 SMLs   |
| Coding Rate                      | 0.15        |
| Number of Physical Channel Codes | 1           |

Table 12: settings of required H-Set 12 QPSK acc. to 3GPP 34.121

Note:

1. The RMC is intended to be used for DC-HSDPA mode and both cells shall transmit with identical parameters as listed in the table above.
2. Maximum number of transmission is limited to 1, i.e., retransmission is not allowed. The redundancy and constellation version 0 shall be used.

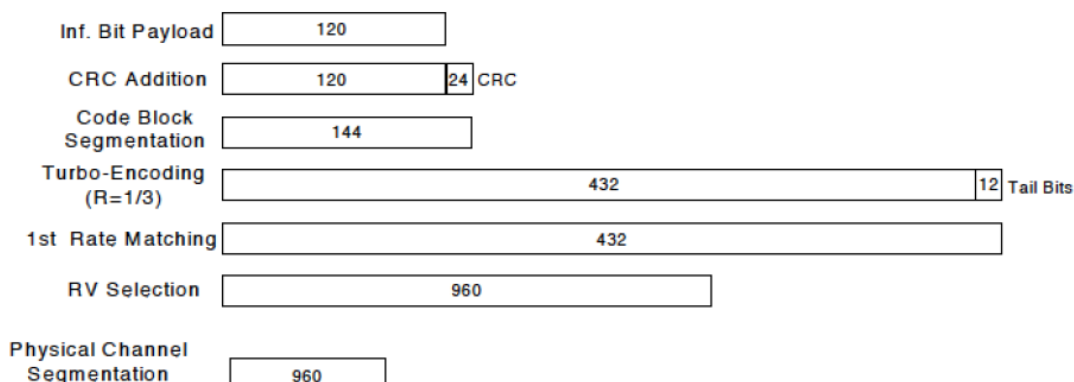

Figure C.8.19: Coding rate for Fixed reference Channel H-Set 12 (QPSK)

The following 4 Sub-tests for HSDPA were completed according to Release 5 procedures. A summary of subtest settings are illustrated below:

| Sub-test <sup>o</sup> | $\beta_c$ <sup>o</sup> | $\beta_d$ <sup>o</sup> | $\beta_d$ (SF) <sup>o</sup> | $\beta_c/\beta_d$ <sup>o</sup> | $\beta_{hs}(1)$ <sup>o</sup> | CM(dB)(2) <sup>o</sup> | MPR (dB) <sup>o</sup> |
|-----------------------|------------------------|------------------------|-----------------------------|--------------------------------|------------------------------|------------------------|-----------------------|
| 1 <sup>o</sup>        | 2/15 <sup>o</sup>      | 15/15 <sup>o</sup>     | 64 <sup>o</sup>             | 2/15 <sup>o</sup>              | 4/15 <sup>o</sup>            | 0.0 <sup>o</sup>       | 0 <sup>o</sup>        |
| 2 <sup>o</sup>        | 12/15(3) <sup>o</sup>  | 15/15(3) <sup>o</sup>  | 64 <sup>o</sup>             | 12/15(3) <sup>o</sup>          | 24/15 <sup>o</sup>           | 1.0 <sup>o</sup>       | 0 <sup>o</sup>        |
| 3 <sup>o</sup>        | 15/15 <sup>o</sup>     | 8/15 <sup>o</sup>      | 64 <sup>o</sup>             | 15/8 <sup>o</sup>              | 30/15 <sup>o</sup>           | 1.5 <sup>o</sup>       | 0.5 <sup>o</sup>      |
| 4 <sup>o</sup>        | 15/15 <sup>o</sup>     | 4/15 <sup>o</sup>      | 64 <sup>o</sup>             | 15/4 <sup>o</sup>              | 30/15 <sup>o</sup>           | 1.5 <sup>o</sup>       | 0.5 <sup>o</sup>      |

Note 1:  $\Delta$  ACK,  $\Delta$  NACK and  $\Delta$  CQI=8     $A_{hs} = \beta_{hs}/\beta_c = 30/15$      $\beta_{hs} = 30/15 * \beta_c$ <sup>o</sup>

Note 2: CM=1 for  $\beta_c/\beta_d = 12/15$ ,  $\beta_{hs}/\beta_c = 24/15$ . For all other combinations of DPDCH, DPCCH and HS-DPCCH the MPR is based on the relative CM difference. This is applicable for only UEs that support HSDPA in release 6 and later releases.<sup>o</sup>

Note 3: For subtest 2 the  $\beta_c/\beta_d$  ratio of 12/15 for the TFC during the measurement period (TF1, TF0) is achieved by setting the signalled gain factors for the reference TFC (TF1, TF1) to  $\beta_c = 11/15$  and  $\beta_d = 15/15$ <sup>o</sup>

Up commands are set continuously to set the UE to Max power.

Note:

1. The Dual Carriers transmission only applies to HSDPA physical channels
2. The Dual Carriers belong to the same Node and are on adjacent carriers.
3. The Dual Carriers do not support MIMO to serve UEs configured for dual cell operation
4. The Dual Carriers operate in the same frequency band .
5. The device doesn't support the modulation of 16QAM in uplink but 64QAM in downlink for DC-HSDPA mode.





---

6.The device doesn't support carrier aggregation for it just can operate in Release 8.

## 6.5 LTE Test Configuration

SAR for LTE band exposure configurations is measured according to the procedures of KDB 941225 D05 SAR for LTE Devices. The CMW500 WideBand Radio Communication Tester was used for LTE output power measurements and SAR testing. Closed loop power control was used so the UE transmits with maximum output power during SAR testing. SAR test were performed with the same number of RB and RB offsets transmitting on all TTI frames (Maximum TTI)

### 1) Spectrum Plots for RB configurations

A properly configured base station simulator was used for LTE output power measurements and SAR testing. Therefore, spectrum plots for RB configurations were not required to be included in this report.

### 2) MPR

When MPR is implemented permanently within the UE, regardless of network requirements, only those RB configurations allowed by 3GPP for the channel bandwidth and modulation combinations may be tested with MPR active. Configurations with RB allocations less than the RB thresholds required by 3GPP must be tested without MPR.

The allowed Maximum Power Reduction (MPR) for the maximum output power due to higher order modulation and transmit bandwidth configuration (resource blocks) is specified in Table 6.2.3-1 of the 3GPP TS36.101.

Table 6.2.3-1: Maximum Power Reduction (MPR) for Power Class 1, 2 and 3

| Modulation | Channel bandwidth / Transmission bandwidth ( $N_{RB}$ ) |          |          |           |           |           | MPR (dB) |
|------------|---|----------|----------|-----------|-----------|-----------|----------|
|            | 1.4 MHz   | 3.0 MHz  | 5 MHz    | 10 MHz    | 15 MHz    | 20 MHz    |          |
| QPSK       | > 5   | > 4      | > 8      | > 12      | > 16      | > 18      | $\leq 1$ |
| 16 QAM     | $\leq 5$  | $\leq 4$ | $\leq 8$ | $\leq 12$ | $\leq 16$ | $\leq 18$ | $\leq 1$ |
| 16 QAM     | > 5   | > 4      | > 8      | > 12      | > 16      | > 18      | $\leq 2$ |
| 64 QAM     | $\leq 5$  | $\leq 4$ | $\leq 8$ | $\leq 12$ | $\leq 16$ | $\leq 18$ | $\leq 2$ |
| 64 QAM     | > 5   | > 4      | > 8      | > 12      | > 16      | > 18      | $\leq 3$ |

### 3) A-MPR

A-MPR (Additional MPR) has been disabled for all SAR tests by using Network Signalling Value of "NS\_01" on the base station simulator.

### 4) LTE procedures for SAR testing

A) Largest channel bandwidth standalone SAR test requirements

i) QPSK with 1 RB allocation

Start with the largest channel bandwidth and measure SAR for QPSK with 1 RB allocation, using the RB offset and required test channel combination with the highest maximum output power for RB offsets at the upper edge, middle and lower edge of each required test channel. When the reported SAR is  $\leq 0.8$  W/kg, testing of the remaining RB offset configurations and required test channels is not required for 1 RB allocation; otherwise, SAR is required for the remaining required test channels and only for the RB offset configuration with the highest output power for that channel. When the reported SAR of a required test channel is  $> 1.45$  W/kg, SAR is required for all three RB offset configurations for that required test channel.

ii) QPSK with 50% RB allocation

The procedures required for 1 RB allocation in i) are applied to measure the SAR for QPSK with 50% RB allocation.

iii) QPSK with 100% RB allocation

For QPSK with 100% RB allocation, SAR is not required when the highest maximum output power for 100 % RB allocation is less than the highest maximum output power in 50% and 1 RB allocations and the highest reported SAR for 1 RB and 50% RB allocation in i) and ii) are  $\leq 0.8$  W/kg. Otherwise, SAR is measured for the highest output power channel and if the reported SAR is  $> 1.45$  W/kg, the remaining required test channels must also be tested.

iv) Higher order modulations

For each modulation besides QPSK; e.g., 16-QAM, 64-QAM, apply the QPSK procedures in above sections to determine the QAM configurations that may need SAR measurement. For each configuration identified as required for testing, SAR is required only when the highest maximum output power for the configuration in the higher order modulation is  $> \frac{1}{2}$  dB higher than the same configuration in QPSK or when the reported SAR for the QPSK configuration is  $> 1.45$  W/kg.

B) Other channel bandwidth standalone SAR test requirements

For the other channel bandwidths used by the device in a frequency band, apply all the procedures required for the largest channel bandwidth in section A) to determine the channels and RB configurations that need SAR testing and only measure SAR when the highest maximum output power of a configuration requiring testing in the smaller channel bandwidth is  $> \frac{1}{2}$  dB higher than the equivalent channel configurations in the largest channel bandwidth configuration or the reported SAR of a configuration for the largest channel bandwidth is  $> 1.45$  W/kg.

**5) TDD LTE test configuration**

According to KDB 941225 D05 SAR for LTE Devices, for Time-Division Duplex (TDD) systems, SAR must be tested using a fixed periodic duty factor according to the highest transmission duty factor implemented for the device and supported by the defined 3GPP LTE TDD configurations.

TDD LTE Band 41 supports 3GPP TS 36.211 section 4.2 for Type 2 Frame Structure and Table 4.2-2 for uplink-downlink configurations and Table 4.2-1 for Special subframe configurations.

**Figure 4.2-1: Frame structure type 2**

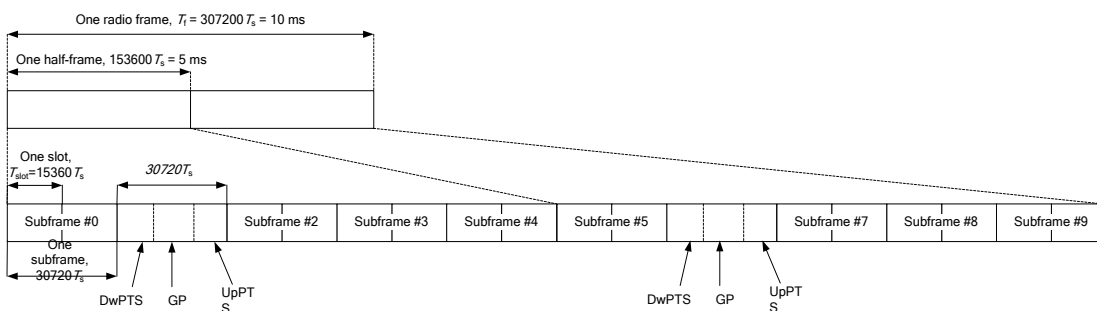

**Table 4.2-1: Configuration of special subframe (lengths of DwPTS/GP/UpPTS)**

| Special subframe configuration | Normal cyclic prefix in downlink |                                |                                  | Extended cyclic prefix in downlink |                                |                                  |
|--------------------------------|----------------------------------|--------------------------------|----------------------------------|------------------------------------|--------------------------------|----------------------------------|
|                                | DwPTS                            | UpPTS                          |                                  | DwPTS                              | UpPTS                          |                                  |
|                                |                                  | Normal cyclic prefix in uplink | Extended cyclic prefix in uplink |                                    | Normal cyclic prefix in uplink | Extended cyclic prefix in uplink |
| 0                              | $6592 T_s$                       | $2192 T_s$                     | $2560 T_s$                       | $7680 T_s$                         | $2192 T_s$                     | $2560 T_s$                       |
| 1                              | $19760 T_s$                      |                                |                                  | $20480 T_s$                        |                                |                                  |
| 2                              | $21952 T_s$                      |                                |                                  | $23040 T_s$                        |                                |                                  |
| 3                              | $24144 T_s$                      |                                |                                  | $25600 T_s$                        |                                |                                  |
| 4                              | $26336 T_s$                      |                                |                                  | $7680 T_s$                         |                                |                                  |
| 5                              | $6592 T_s$                       | $4384 T_s$                     | $5120 T_s$                       | $20480 T_s$                        | $4384 T_s$                     | $5120 T_s$                       |
| 6                              | $19760 T_s$                      |                                |                                  | $23040 T_s$                        |                                |                                  |
| 7                              | $21952 T_s$                      |                                |                                  | $12800 T_s$                        |                                |                                  |
| 8                              | $24144 T_s$                      |                                |                                  | -                                  |                                |                                  |
| 9                              | $13168 T_s$                      |                                |                                  | -                                  |                                |                                  |

**Table 4.2-2: Uplink-downlink configurations**

| Uplink-downlink configuration | Downlink-to-Uplink Switch-point periodicity | Subframe number |   |   |   |   |   |   |   |   |   |
|-------------------------------|---|-----------------|---|---|---|---|---|---|---|---|---|
|                               |   | 0               | 1 | 2 | 3 | 4 | 5 | 6 | 7 | 8 | 9 |
| 0                             | 5 ms  | D               | S | U | U | U | D | S | U | U | U |
| 1                             | 5 ms  | D               | S | U | U | D | D | S | U | U | D |
| 2                             | 5 ms  | D               | S | U | D | D | D | S | U | D | D |
| 3                             | 10 ms                                       | D               | S | U | U | U | D | D | D | D | D |
| 4                             | 10 ms                                       | D               | S | U | U | D | D | D | D | D | D |
| 5                             | 10 ms                                       | D               | S | U | D | D | D | D | D | D | D |
| 6                             | 5 ms  | D               | S | U | U | U | D | S | U | U | D |

According to Figure 4.2-1, one radio frame is configured by 10 subframes, which consist of Uplink-subframe, Downlink-subframe and Special subframe. For TDD-LTE, the Duty Cycle should be calculated on Uplink-subframes and Special subframes, due to Special subframe containing both Uplink transmissions. So for one radio frame, Duty Cycle can be calculated with formula as below. The count of Uplink subframes are according to Table 4.2-2:

$$\text{Duty cycle} = (30720T_s \cdot \text{Ups} + \text{Uplink Component} \cdot \text{Specials}) / (307200T_s)$$

About the uplink component of Special subframes, we can figure out by Table 4.2-1:

$$\text{Uplink Component} = \text{UpPTS}$$

In conclusion, for the TDD LTE Band, Duty Cycle can be calculated with formula as below .all these sets are ok when we test, or we can set as below.

$$\text{Duty cycle} = [(30720T_s \cdot \text{Ups}) + \text{UpPTS} \cdot \text{Specials}] / (307200T_s)$$

And we can get different Duty cycles under different configurations:

| Uplink-Downlink configuration | Subframe number |   |   | Configuration of special subframe |        |                                   |               |                                     |        |                                   |               |
|-------------------------------|-----------------|---|---|-----------------------------------|--------|-----------------------------------|---------------|-------------------------------------|--------|-----------------------------------|---------------|
|                               |                 |   |   | Normal cyclice prefix in downlink |        |                                   |               | Extended cyclice prefix in downlink |        |                                   |               |
|                               |                 |   |   | Normal cyclice prefix in uplink   |        | Extended cyclice prefix in uplink |               | Normal cyclice prefix in uplink     |        | Extended cyclice prefix in uplink |               |
|                               | D               | S | U | configuration                     |        |                                   |               | configuration                       |        |                                   |               |
|                               |                 |   |   | 0~4                               | 5~9    | 0~4                               | 5~9           | 0~3                                 | 4~7    | 0~3                               | 4~7           |
| 0                             | 2               | 2 | 6 | 61.43%                            | 62.85% | 61.67%                            | <b>63.33%</b> | 61.43%                              | 62.85% | 61.67%                            | <b>63.33%</b> |
| 1                             | 4               | 2 | 4 | 41.43%                            | 42.85% | 41.67%                            | 43.33%        | 41.43%                              | 42.85% | 41.67%                            | 43.33%        |
| 2                             | 6               | 2 | 2 | 21.43%                            | 22.85% | 21.67%                            | 23.33%        | 21.43%                              | 22.85% | 21.67%                            | 23.33%        |
| 3                             | 6               | 1 | 3 | 30.71%                            | 31.43% | 30.83%                            | 31.67%        | 30.71%                              | 31.43% | 30.83%                            | 31.67%        |
| 4                             | 7               | 1 | 2 | 20.71%                            | 21.43% | 20.83%                            | 21.67%        | 20.71%                              | 21.43% | 20.83%                            | 21.67%        |
| 5                             | 8               | 1 | 1 | 10.71%                            | 11.43% | 10.83%                            | 11.67%        | 10.71%                              | 11.43% | 10.83%                            | 11.67%        |
| 6                             | 3               | 2 | 5 | 51.43%                            | 52.85% | 51.67%                            | 53.33%        | 51.43%                              | 52.85% | 51.67%                            | 53.33%        |

For TDD LTE, SAR should be tested with the highest transmission duty factor (63.33%) using Uplink-downlink configuration 0 and Special subframe configuration 7 for Frame structure type 2.

## 6.6 WiFi Test Configuration

For WiFi SAR testing, a communication link is set up with some command for WiFi mode test. During the test, at the each test frequency channel, the EUT is operated at the RF continuous emission mode. Per KDB 248227D01, a minimum transmission duty factor of 85% is required to avoid certain hardware and device implementation issues related to wide range SAR scaling. The reported SAR must be scaled to 100% transmission duty factor to determine compliance at the maximum tune-up tolerance limit.

### 6.6.1 Initial Test Position Procedure

For exposure condition with multiple test position, such as handsets operating next to the ear, devices with hotspot mode or UMPC mini-tablet, procedures for initial test position can be applied. Using the transmission mode determined by the DSSS procedure or initial test configuration, area scans are measured for all position in an exposure condition. The test position with the highest extrapolated (peak) SAR is used as the initial test position. When reported SAR for the initial test position is  $\leq 0.4$  W/kg, no additional testing for the remaining test position is required. Otherwise, SAR is evaluated at the subsequent highest peak SAR position until the reported SAR result is  $\leq 0.8$  W/kg or all test position are measured. For all positions/configurations tested using the initial test position and subsequent test positions, when the *reported* SAR is  $> 0.8$  W/kg, SAR is measured for these test positions/configurations on the subsequent next highest measured output power channel(s) until the *reported* SAR is  $\leq 1.2$  W/kg or all required channels are tested.

### 6.6.2 Initial Test Configuration Procedure

An initial test configuration is determined for OFDM transmission modes according to the channel bandwidth, modulation and data rate combination(s) with the highest maximum output power specified for production units in each standalone and aggregated frequency band. SAR is measured using the highest measured maximum output power channel. For configurations with the same specified or measured maximum output power, additional transmission mode and test channel selection procedures are required (see section 5.3.2 of KDB 248227D01). SAR test reduction of subsequent highest output test channels is based on the *reported* SAR of the initial test configuration.

For next to the ear, hotspot mode and UMC mini-tablet exposure configurations where multiple test positions are required, the initial test position procedure is applied to minimize the number of test positions required for SAR measurement using the initial test configuration transmission mode. For fixed exposure conditions that do not have multiple SAR test positions, SAR is measured in the transmission mode determined by the initial test configuration.

When the *reported* SAR of the initial test configuration is  $> 0.8$  W/kg, SAR measurement is required for the subsequent next highest measured output power channel(s) in the initial test configuration until the *reported* SAR is  $\leq 1.2$  W/kg or all required channels are tested.

### 6.6.3 Sub Test Configuration Procedure

SAR measurement requirements for the remaining 802.11 transmission mode configurations that have not been tested in the initial test configuration are determined separately for each standalone and aggregated frequency band, in each exposure condition, according to the maximum output power specified for production units.

When the highest reported SAR for the initial test configuration, according to the initial test position or fixed exposure position requirements, is adjusted by the ratio of the subsequent test configuration to initial test configuration specified maximum output power and the adjusted SAR is  $\leq 1.2$  W/kg, SAR is not required

for that subsequent test configuration.

#### 6.6.4 WiFi 2.4G SAR Test Procedures

Separate SAR procedures are applied to DSSS and OFDM configurations in the 2.4 GHz band to simplify DSSS test requirements. For 802.11b DSSS SAR measurements, DSSS SAR procedure applies to fixed exposure test position and initial test position procedure applies to multiple exposure test positions.

##### A) 802.11b DSSS SAR Test Requirements

SAR is measured for 2.4 GHz 802.11b DSSS using either a fixed test position or, when applicable, the initial test position procedure. SAR test reduction is determined according to the following:

- 1) When the *reported* SAR of the highest measured maximum output power channel (section 3.1 of of KDB 248227D01) for the exposure configuration is  $\leq 0.8$  W/kg, no further SAR testing is required for 802.11b DSSS in that exposure configuration.
- 2) When the *reported* SAR is  $> 0.8$  W/kg, SAR is required for that exposure configuration using the next highest measured output power channel. When any *reported* SAR is  $> 1.2$  W/kg, SAR is required for the third channel; i.e., all channels require testing.

##### B) 2.4GHz 802.11g/n OFDM SAR Test Exclusion Requirements

When SAR measurement is required for 2.4 GHz 802.11g/n OFDM configurations, the measurement and test reduction procedures for OFDM are applied (section 5.3 of of KDB 248227D01). SAR is not required for the following 2.4 GHz OFDM conditions.

- 1) When KDB Publication 447498 SAR test exclusion applies to the OFDM configuration.
- 2) When the highest *reported* SAR for DSSS is adjusted by the ratio of OFDM to DSSS specified maximum output power and the adjusted SAR is  $\leq 1.2$  W/kg.

##### C) SAR Test Requirements for OFDM configurations

When SAR measurement is required for 802.11 a/g/n/ac OFDM configurations, each standalone and frequency aggregated band is considered separately for SAR test reduction. When the same transmitter and antenna(s) are used for U-NII-1 and U-NII-2A bands, additional SAR test reduction applies. When band gap channels between U-NII-2C band and 5.8 GHz U-NII-3 or §15.247 band are supported, the highest maximum output power transmission mode configuration and maximum output power channel across the bands must be used to determine SAR test reduction, according to the initial test configuration and subsequent test configuration requirements. In applying the initial test configuration and subsequent test configuration procedures, the 802.11 transmission configuration with the highest specified maximum output power and the channel within a test configuration with the highest measured maximum output power should be clearly distinguished to apply the procedures.

### 6.6.5 U-NII-1 and U-NII-2A Bands

For devices that operate in only one of the U-NII-1 and U-NII-2A bands, the normally required SAR procedures for OFDM configurations are applied. For devices that operate in both U-NII bands using the same transmitter and antenna(s), SAR test reduction is determined according to the following:

- 1) When the same maximum output power is specified for both bands, begin SAR measurement in U-NII-2A band by applying the OFDM SAR requirements. If the highest *reported* SAR for a test configuration is  $\leq 1.2$  W/kg, SAR is not required for U-NII-1 band for that configuration (802.11 mode and exposure condition); otherwise, both bands are tested independently for SAR.
- 2) When different maximum output power is specified for the bands, begin SAR measurement in the band with higher specified maximum output power. The highest *reported* SAR for the tested configuration is adjusted by the ratio of lower to higher specified maximum output power for the two bands. When the adjusted SAR is  $\leq 1.2$  W/kg, SAR is not required for the band with lower maximum output power in that test configuration; otherwise, both bands are tested independently for SAR.
- 3) The two U-NII bands may be aggregated to support a 160 MHz channel on channel number 50. Without additional testing, the maximum output power for this is limited to the lower of the maximum output power certified for the two bands. When SAR measurement is required for at least one of the bands and the highest *reported* SAR adjusted by the ratio of specified maximum output power of aggregated to standalone band is  $> 1.2$  W/kg, SAR is required for the 160 MHz channel. This procedure does not apply to an aggregated band with maximum output higher than the standalone band(s); the aggregated band must be tested independently for SAR. SAR is not required when the 160 MHz channel is operating at a reduced maximum power and also qualifies for SAR test exclusion.

### 6.6.6 U-NII-2C and U-NII-3 Bands

The frequency range covered by these bands is 380 MHz (5.47 – 5.85 GHz), which requires a minimum of at least two SAR probe calibration frequency points to support SAR measurements. when Terminal Doppler Weather Radar (TDWR) restriction applies, the channels at 5.60 – 5.65 GHz in U-NII-2C band must be disabled with acceptable mechanisms and documented in the equipment certification to avoid SAR requirements.<sup>10</sup> TDWR restriction does not apply under the new rules; all channels that operate at 5.60 – 5.65 GHz must be included to apply the SAR test reduction and measurement procedures.

When the same transmitter and antenna(s) are used for U-NII-2C band and U-NII-3 band or 5.8 GHz band of §15.247, the bands may be aggregated to enable additional channels with 20, 40 or 80 MHz bandwidth to span across the band gap, as illustrated in Appendix B. The maximum output power for the additional band gap channels is limited to the lower of those certified for the bands. Unless band gap channels are permanently disabled, they must be considered for SAR testing. The frequency range covered by these bands is 380 MHz (5.47 – 5.85 GHz), which requires a minimum of at least two SAR probe calibration frequency points to support SAR measurements. To maintain SAR measurement accuracy and to facilitate test reduction, the channels in U-NII-2C band above 5.65 GHz may be grouped with the 5.8 GHz channels in U-NII-3 or §15.247 band to enable two SAR probe calibration frequency points to cover the bands, including the band gap channels.<sup>11</sup> When band gap channels are supported and the bands are not aggregated for SAR testing, band gap channels must be considered independently in each band according to the normally required OFDM SAR measurement and probe calibration frequency points requirements.



### **6.6.7 OFDM Transmission Mode SAR Test Channel Selection Requirements**

For 2.4 GHz and 5 GHz bands, When the same maximum output power was specified for multiple OFDM transmission mode configurations in a frequency band or aggregated band, SAR is measured using the configuration with the largest channel bandwidth, lowest order modulation and lowest data rate. When the maximum output power of a channel is the same for equivalent OFDM configurations (for example 802.11a, 802.11n and 802.11ac, or 802.11g and 802.11n, with the same channel bandwidth, modulation, and data rate, etc), the lower order 802.11 mode (i.e., 802.11a is chosen over 802.11n then 802.11ac, or 802.11g is chosen over 802.11n) is used for SAR measurement. When the maximum output power are the same for multiple test channel, either according to the default or additional power measurement requirement, SAR is measured using the channel closest to the middle of the frequency band or aggregated band. When there are multiple channels with the same maximum output power, SAR is measured using the higher number channel.

### **6.6.8 MIMO SAR Considerations**

Per KDB 248227D01v02, simultaneous transmission provisions in KDB Publication 447498 should be used to determine simultaneous transmission SAR test exclusion for WiFi MIMO. If the sum of 1-g SAR single transmission SAR measurement is  $<1.6\text{W/kg}$ , no additional SAR measurements for MIMO are required. Alternatively, SAR for MIMO can be measured with all antennas transmitting simultaneously at the specified maximum output power of MIMO operation.

## 6.7 LTE CA specification

### 6.7.1 LTE CA combinations specification

The device supports downlink LTE Carrier Aggregation (CA) for Intra-band and inter-band, and uplink LTE Carrier Aggregation (CA) for Intra-band .

a) The LTE release and version numbers of the 3GPP documents used to implement the specific device(s):

Release 13, 3GPP TS 36.211 V13.3.0 (2016-09)

b) The associated 3GPP release and version numbers required for power measurements and RF test setup conditions:

Release 14, 3GPP TS 36.521-1 V14.4.0 (2017-09)

Release 15, 3GPP TS 36.101 V15.0.0 (2017-09)

The device supports parts of uplink and downlink Release 14 LTE carrier aggregations and the device does not support full CA features on 3GPP Release 14.

1) The device supports Intra-band uplink LTE CA for CA\_2C, CA\_7C, CA\_38C, CA\_41C with two component carriers in the uplink.

2) The device supports Intra-band and inter-band downlink LTE CA (See the table below)

3) The device does not support full CA features on 3GPP Release 14 or higher. All other uplink communications are identical to the release 8 specifications. Other LTE Rel.10 or higher features are not supported, including Enhanced SC-FDMA, Uplink MIMO or other antenna diversity configurations, Wi-Fi offloading using LTE-U, LAA or LWA related protocols etc.

**Intra-band contiguous CA operating bands**

| E-UTRA CA configuration | Uplink CA configurations (NOTE 3) | E-UTRA CA configuration / Bandwidth combination set         |                                      |                                      |                                      | Maximum aggregated bandwidth [MHz] | Bandwidth combination set |
|-------------------------|-----------------------------------|---|--------------------------------------|--------------------------------------|--------------------------------------|------------------------------------|---------------------------|
|                         |                                   | Component carriers in order of increasing carrier frequency |                                      |                                      |                                      |                                    |                           |
|                         |                                   | Channel bandwidths for carrier [MHz]                        | Channel bandwidths for carrier [MHz] | Channel bandwidths for carrier [MHz] | Channel bandwidths for carrier [MHz] |                                    |                           |
| CA_2C                   | NA                                | 5   | 20                                   |                                      |                                      | 40                                 | 0                         |
|                         |                                   | 10  | 15, 20                               |                                      |                                      |                                    |                           |
|                         |                                   | 15  | 10, 15, 20                           |                                      |                                      |                                    |                           |
|                         |                                   | 20  | 5, 10, 15, 20                        |                                      |                                      |                                    |                           |
| CA_5B                   | NA                                | 5, 10   | 10                                   |                                      |                                      | 20                                 | 0                         |
|                         |                                   | 10  | 5                                    |                                      |                                      |                                    |                           |
| CA_7C                   | CA_7C                             | 15  | 15                                   |                                      |                                      | 40                                 | 0                         |
|                         |                                   | 20  | 20                                   |                                      |                                      |                                    |                           |
|                         |                                   | 10  | 20                                   |                                      |                                      | 40                                 | 1                         |
|                         |                                   | 15  | 15, 20                               |                                      |                                      |                                    |                           |
|                         |                                   | 20  | 10, 15, 20                           |                                      |                                      | 40                                 | 2                         |
|                         |                                   | 15  | 10, 15                               |                                      |                                      |                                    |                           |
| 20                      | 15, 20                            |   |                                      |                                      |                                      |                                    |                           |
| CA_12B                  | NA                                | 5   | 5, 10                                |                                      |                                      | 15                                 | 0                         |
| CA_38C                  | CA_38C                            | 15  | 15                                   |                                      |                                      | 40                                 | 0                         |
|                         |                                   | 20  | 20                                   |                                      |                                      |                                    |                           |
| CA_41C                  | CA_41C                            | 10  | 20                                   |                                      |                                      | 40                                 | 0                         |
|                         |                                   | 15  | 15, 20                               |                                      |                                      |                                    |                           |
|                         |                                   | 20  | 10, 15, 20                           |                                      |                                      |                                    |                           |
|                         |                                   | 5, 10   | 20                                   |                                      |                                      | 40                                 | 1                         |
|                         |                                   | 15  | 15, 20                               |                                      |                                      |                                    |                           |
|                         |                                   | 20  | 5, 10, 15, 20                        |                                      |                                      | 40                                 | 2                         |
|                         |                                   | 10  | 15, 20                               |                                      |                                      |                                    |                           |
|                         |                                   | 15  | 10, 15, 20                           |                                      |                                      |                                    |                           |
|                         |                                   | 20  | 10, 15, 20                           |                                      |                                      | 40                                 | 3                         |
|                         |                                   | 10  | 20                                   |                                      |                                      |                                    |                           |
| 20                      | 20                                |   |                                      |                                      |                                      |                                    |                           |
| CA_41D                  | CA_41C                            | 10  | 20                                   | 15                                   |                                      | 60                                 | 0                         |
|                         |                                   | 10  | 15, 20                               | 20                                   |                                      |                                    |                           |
|                         |                                   | 15  | 20                                   | 10, 15                               |                                      |                                    |                           |
|                         |                                   | 15  | 10, 15, 20                           | 20                                   |                                      |                                    |                           |
|                         |                                   | 20  | 15, 20                               | 10                                   |                                      |                                    |                           |
|                         |                                   | 20  | 10, 15, 20                           | 15, 20                               |                                      |                                    |                           |

NOTE 1: The CA configuration refers to an operating band and a CA bandwidth class specified in Table 5.6A-1 (the indexing letter).  
Absence of a CA bandwidth class for an operating band implies support of all classes.

NOTE 2: For the supported CC bandwidth combinations, the CC downlink and uplink bandwidths are equal.

NOTE 3: Uplink CA configurations are the configurations supported by the present release of specifications.

**Intra-band non-contiguous CA operating bands (with two sub-blocks)**

| E-UTRA CA configuration / Bandwidth combination set |                                   |   |                                      |                                      |                                      |                                      |                                    |                           |
|---|-----------------------------------|---|--------------------------------------|--------------------------------------|--------------------------------------|--------------------------------------|------------------------------------|---------------------------|
| E-UTRACA configuration                              | Uplink CA configurations (NOTE 1) | Component carriers in order of increasing carrier frequency |                                      |                                      |                                      |                                      | Maximum aggregated bandwidth [MHz] | Bandwidth combination set |
|   |                                   | Channel bandwidths for carrier [MHz]                        | Channel bandwidths for carrier [MHz] | Channel bandwidths for carrier [MHz] | Channel bandwidths for carrier [MHz] | Channel bandwidths for carrier [MHz] |                                    |                           |
| CA_7A-7A  | NA                                | 5   | 15                                   |                                      |                                      |                                      | 40                                 | 0                         |
|   |                                   | 10  | 10, 15                               |                                      |                                      |                                      |                                    |                           |
|   |                                   | 15  | 15, 20                               |                                      |                                      |                                      |                                    |                           |
|   |                                   | 20  | 20                                   |                                      |                                      |                                      |                                    |                           |
|   |                                   | 5, 10, 15, 20   | 5, 10, 15, 20                        |                                      |                                      |                                      | 40                                 | 1                         |
|   |                                   | 5, 10, 15, 20   | 5, 10                                |                                      |                                      |                                      | 30                                 | 2                         |
|   |                                   | 10, 15, 20  | 10, 15, 20                           |                                      |                                      |                                      | 40                                 | 3                         |

**Inter-band CA operating bands (two bands)**

| E-UTRA CA configuration / Bandwidth combination set |  |              |         |       |       |        |        |        |                                    |                           |
|---|--|--------------|---------|-------|-------|--------|--------|--------|------------------------------------|---------------------------|
| E-UTRA CA Configuration                             | Uplink CA configurations (NOTE 4)                          | E-UTRA Bands | 1.4 MHz | 3 MHz | 5 MHz | 10 MHz | 15 MHz | 20 MHz | Maximum aggregated bandwidth [MHz] | Bandwidth combination set |
| CA_2A-5A  | NA   | 2            |         |       | Yes   | Yes    | Yes    | Yes    | 30                                 | 0                         |
|   |  | 5            |         |       | Yes   | Yes    |        |        |                                    |                           |
|   |  | 2            |         |       | Yes   | Yes    |        |        | 20                                 | 1                         |
|   |  | 5            |         |       | Yes   | Yes    |        |        |                                    |                           |
| CA_2A-12A   | NA   | 2            |         |       | Yes   | Yes    | Yes    | Yes    | 30                                 | 0                         |
|   |  | 12           |         |       | Yes   | Yes    |        |        |                                    |                           |
|   |  | 2            |         |       | Yes   | Yes    | Yes    | Yes    | 30                                 | 1                         |
|   |  | 12           |         | Yes   | Yes   | Yes    |        |        |                                    |                           |
|   |  | 2            |         |       | Yes   | Yes    |        |        | 20                                 | 2                         |
|   |  | 12           |         |       | Yes   | Yes    |        |        |                                    |                           |
| CA_2A-12B   | NA   | 2            |         |       | Yes   | Yes    | Yes    | Yes    | 35                                 | 0                         |
| 12  | See CA_12B Bandwidth Combination Set 0 in Table 5.4.2A.1-1 |              |         |       |       |        |        |        |                                    |                           |
| CA_2A-17A   | NA   | 2            |         |       | Yes   | Yes    |        |        | 20                                 | 0                         |
|   |  | 17           |         |       | Yes   | Yes    |        |        |                                    |                           |
| CA_4A-5A  | NA   | 4            |         |       | Yes   | Yes    |        |        | 20                                 | 0                         |
|   |  | 5            |         |       | Yes   | Yes    |        |        |                                    |                           |
|   |  | 4            |         |       | Yes   | Yes    | Yes    | Yes    | 30                                 | 1                         |
|   |  | 5            |         |       | Yes   | Yes    |        |        |                                    |                           |
| CA_4A-7A  | NA   | 4            |         |       | Yes   | Yes    |        |        | 30                                 | 0                         |
|   |  | 7            |         |       | Yes   | Yes    | Yes    | Yes    |                                    |                           |
|   |  | 4            |         |       | Yes   | Yes    | Yes    | Yes    | 40                                 | 1                         |
|   |  | 7            |         |       | Yes   | Yes    | Yes    | Yes    |                                    |                           |
| CA_4A-7C  | NA   | 4            |         |       | Yes   | Yes    | Yes    | Yes    | 60                                 | 0                         |
| 7   | See CA_7C Bandwidth Combination Set 1 in Table 5.6A.1-1    |              |         |       |       |        |        |        |                                    |                           |
| CA_4A-12A   | NA   | 4            | Yes     | Yes   | Yes   | Yes    |        |        | 20                                 | 0                         |
|   |  | 12           |         |       | Yes   | Yes    |        |        |                                    |                           |
|   |  | 4            | Yes     | Yes   | Yes   | Yes    | Yes    | Yes    | 30                                 | 1                         |
|   |  | 12           |         |       | Yes   | Yes    |        |        |                                    |                           |
|   |  | 4            |         |       | Yes   | Yes    | Yes    | Yes    | 30                                 | 2                         |
|   |  | 12           |         | Yes   | Yes   | Yes    |        |        |                                    |                           |

|           |    |    |  |     |     |     |     |     |    |   |
|-----------|----|----|--|-----|-----|-----|-----|-----|----|---|
|           |    | 4  |  |     | Yes | Yes |     |     | 20 | 3 |
|           |    | 12 |  |     | Yes | Yes |     |     |    |   |
|           |    | 4  |  |     | Yes | Yes | Yes | Yes | 30 | 4 |
|           |    | 12 |  |     | Yes | Yes |     |     |    |   |
|           |    | 4  |  |     | Yes | Yes | Yes |     | 20 | 5 |
|           |    | 12 |  |     | Yes |     |     |     |    |   |
| CA_4A-12B | NA | 4  |  |     | Yes | Yes | Yes | Yes | 35 | 0 |
|           |    | 12 | See CA_12B Bandwidth Combination Set 0 in Table 5.4.2A.1-1 |     |     |     |     |     |    |   |
| CA_4A-17A | NA | 4  |  |     | Yes | Yes |     |     | 20 | 0 |
|           |    | 17 |  |     | Yes | Yes |     |     |    |   |
|           |    | 28 |  |     | Yes | Yes | Yes | Yes |    |   |
| CA_5A-7A  | NA | 5  | Yes  | Yes | Yes | Yes |     |     | 30 | 0 |
|           |    | 7  |  |     |     | Yes | Yes | Yes |    |   |
|           |    | 5  |  |     | Yes | Yes |     |     |    |   |
| CA_5A-7C  | NA | 7  |  |     | Yes | Yes | Yes | Yes | 50 | 0 |
|           |    | 5  |  |     | Yes | Yes |     |     |    |   |
| CA_7A-12A | NA | 7  |  |     | Yes | Yes | Yes | Yes | 30 | 0 |
|           |    | 12 |  |     | Yes | Yes |     |     |    |   |
| CA_7A-12B | NA | 7  |  |     | Yes | Yes | Yes | Yes | 35 | 0 |
|           |    | 12 | See CA_12B Bandwidth combination set 0 in Table 5.6A.1-1   |     |     |     |     |     |    |   |

Note:

- 1) For the inter-band CA combinations including B4+B12, B4+B17, only Band4 can be assigned PCC.
- 2) The channel spacing and aggregated channel bandwidth for CA are identical to the associated specification in 3GPP TS 36.101 V15.0.0 (2017-09)
- 3) The reference test frequencies for CA refers to 3GPP TS 36.508 V13.1.0

## 6.7.2 Test procedure for downlink CA

According to 201804 FCC RF Exposure TCB workshop slides, the guidance does not consider Intra-band DL CA and inter-band DL CA separately.

In applying the power measurement procedures of KDB 941225 D05A for DL CA SAR test exclusion, only the CA configuration with the largest aggregated DL CA bandwidth in each frequency band group need consideration (independently for contiguous and non-contiguous CA). When the same frequency band is used for both contiguous and non-contiguous CA, power may be measured using the configuration with the largest aggregated bandwidth “and” maximum output power among the contiguous and non-contiguous CA configurations, otherwise, these are considered separately. In applying the existing power measurement procedures of KDB 941225 D05A for DL CA SAR test exclusion, only the subset with the largest number of combinations of frequency bands and CCs in each row need consideration. the configurations that require power measurements are in the table as below:

| Index   | 2CCs      | Restriction | Covered by |
|---------|-----------|-------------|------------|
| 2CCs#1  | CA_2C     |             | No         |
| 2CCs#2  | CA_5B     |             | No         |
| 2CCs#3  | CA_7C     |             | 3CCs#3     |
| 2CCs#4  | CA_12B    |             | 3CCs#2     |
| 2CCs#5  | CA_38C    |             | No         |
| 2CCs#6  | CA_41C    |             | No         |
| 2CCs#7  | CA_7A-7A  |             | No         |
| 2CCs#8  | CA_2A-5A  |             | No         |
| 2CCs#9  | CA_2A-12A |             | No         |
| 2CCs#10 | CA_2A-17A |             | No         |
| 2CCs#11 | CA_4A-5A  |             | No         |
| 2CCs#12 | CA_4A-7A  |             | No         |
| 2CCs#13 | CA_4A-12A |             | No         |
| 2CCs#14 | CA_4A-17A |             | No         |
| 2CCs#15 | CA_5A-7A  |             | No         |
| 2CCs#16 | CA_7A-12A |             | No         |

| Index  | 3CCs      | Restriction | Covered by |
|--------|-----------|-------------|------------|
| 3CCs#1 | CA_41D    |             | No         |
| 3CCs#2 | CA_2A-12B |             | No         |
| 3CCs#3 | CA_4A-7C  |             | No         |
| 3CCs#4 | CA_4A-12B |             | No         |
| 3CCs#5 | CA_5A-7C  |             | No         |
| 3CCs#6 | CA_7A-12B |             | No         |

Refer to section 7.1 of this report for detailed DL CA conducted power measurement results

### 6.7.3 Test procedure for Intra-band uplink CA

For Intra-band uplink LTE CA measurement (Uplink CA\_7C, CA\_38C, CA\_41C), the following procedure according to 201711 FCC RF Exposure TCB workshop slides is applied:

- 1) Maximum output power is measured for each UL CA configuration for the required test channels described in KDB 941225 D05 (Rel. 8)
  - UL PCC configuration is determined by the required test channel
  - SCC and subsequent CCs are added alternatively to either side of the PCC or within the transmission band for channels at the ends of a frequency band.
- 2) SAR for UL CA is required in each exposure condition and frequency band combination
- 3) For this device , as the maximum output for Intra-band uplink LTE CA ( CA\_7C, CA\_38C, CA\_41C) is  $\leq$  standalone LTE mode (without CA),
  - PCC is configured according to the highest standalone SAR configuration tested.
  - SCC and subsequent CCs are configured according to procedures used for power measurement and parameters (BW, RB etc.) similar to that used for the PCC
- 4) When the reported SAR for UL CA configuration, described above, is  $> 1.2$  W/kg, UL CA SAR is also required for all required test channels(PCC based)
- 5) UL CA SAR is also required for standalone SAR configurations  $> 1.2$  W/kg when they are scaled to the UL CA power level.

Refer to section 7.1 of this report for detailed UL CA conducted power measurement results.

### 6.8 Dynamic antenna switching specification

The device supports dynamic Tx antenna switching function for 2G/3G/4G bands. It can transmit from either Main Antenna or Second Antenna, but they can not transmit simultaneously(Refer to the Antenna location picture in the appendix for details).

Note:

- 1) Main antenna consists of two parts: MHB antenna part (Ant1) for middle & high band antenna and LB antenna part (Ant2) for low band antenna.
- 2) Second antenna consists of two parts: Up MHB Antenna part (Ant 3) Middle & High band antenna and Up LB antenna part (Ant4) for low band antenna.

SAR test procedure for dynamic antenna switching is as below:

During the SAR test, the Main Antenna and Second Antenna are set to the MAX transmit power level respectively and test the SAR respectively in all applicable RF exposure conditions. Some AT command are supplied to fix the operation state and choose the antenna so that only one TX antenna tested at a time. We can ensure that all independent antennas and modem are completely covered by the appropriate SAR measurements and all simultaneous transmission possibilities are fully considered.

## 6.9 Power Reduction Specification

This device uses the following power reduction features to reduce the transmit power and ensure SAR compliance. These power reduction features are implemented using a single fixed level of reduction through static table look-up for some wireless operating modes or frequency bands and triggered by a single event or operation. The published RF exposure KDB procedures are applicable to the specific implementation and applied for testing. So PAG is not required for these features.

- 1) A fixed level power reduction is applied for some frequency bands when hotspot mode becomes active. When the hotspot is disabled, the power value will be recovered.
- 2) A fixed level power reduction is applied for some frequency bands when 2G/3G/4G and WIFI transmit simultaneously.
- 3) This device uses the receiver to indicate whether the user is making a voice call in head scenario or not. The selection between head and body power levels is based on the receiver detection mechanism. A fixed level power reduction is applied for some frequency bands when the audio receiver is on.
- 4) This device uses the mobile country code (MCC) to indicate whether the users in CE countries or FCC countries. The selection between CE countries and FCC countries power levels is based on the country code detection mechanism. It can determine the countries where users are and set the relevant power level for WiFi antennas accordingly.

| <b>Antenna</b> | <b>MCC OF CE COUNTRY<br/>(CE standard)</b> | <b>MCC OF FCC COUNTRY<br/>(FCC standard)</b> |
|----------------|--|--|
| WiFi 2.4G Ant1 | Power Level A3                             | Power Level B3                               |
| WiFi 2.4G Ant2 | Power Level A4                             | Power Level B4                               |
| WiFi 5G Ant1   | Power Level A5                             | Power Level B5                               |
| WiFi 5G Ant2   | Power Level A6                             | Power Level B6                               |

- 5) This device uses a proximity sensor to reduce the maximum output power of 2G/3G/4G main transmitting antenna in selected wireless modes and operating configurations to ensure SAR compliance. The procedures in KDB 616217 are applied to determine proximity sensor triggering distances, and sensor coverage for normal and tilt positions.



### 6.9.1 Power Reduction Specification of 2G/3G/4G Second Antenna

The following tables summarize the key power reduction information of 2G/3G/4G second antenna triggered by specific use conditions. The detailed full power and reduced conducted power measurement results are provided in Section 7 of this report:

| Band         | Second Antenna Power Reduction Level Amount (dB) |                        |   |                        |
|--------------|--|------------------------|---|------------------------|
|              | Second Antenna only                              |                        | Second Antenna+WiFi Antenna simultaneous transmission |                        |
|              | Receiver off                                     | Receiver on            | Receiver off  | Receiver on            |
|              | Full Power                                       | Reduced Power Level D1 | Reduced Power Level D2                                | Reduced Power Level D3 |
| GSM850       | 33.00  | 29.50                  | 30.00   | 26.50                  |
| GSM1900      | 29.50  | 26.50                  | 25.00   | 22.00                  |
| UMTS Band II | 21.00  | 16.00                  | 17.00   | 12.00                  |
| UMTS Band IV | 21.00  | 18.00                  | 17.00   | 14.00                  |
| UMTS Band V  | 24.50  | 19.50                  | 21.50   | 16.50                  |
| LTE Band 2   | 21.00  | 17.50                  | 17.00   | 13.50                  |
| LTE Band 4   | 21.50  | 18.50                  | 17.50   | 14.50                  |
| LTE Band 5   | 24.50  | 19.50                  | 20.50   | 15.50                  |
| LTE Band 7   | 22.00  | 16.50                  | 18.00   | 12.50                  |
| CA_7C        | 22.00  | 16.50                  | 18.00   | 12.50                  |
| LTE Band 12  | 24.50  | 20.00                  | 21.00   | 16.50                  |
| LTE Band 17  | 24.50  | 20.00                  | 21.00   | 16.50                  |
| LTE Band 26  | 24.70  | 19.70                  | 21.70   | 16.70                  |
| LTE Band 38  | 22.13  | 18.13                  | 19.13   | 15.13                  |
| CA_38C       | 22.13  | 18.13                  | 19.13   | 15.13                  |
| LTE Band 41  | 22.33  | 18.33                  | 19.33   | 15.33                  |
| CA_41C       | 22.13  | 18.13                  | 19.13   | 15.13                  |
| LTE Band 66  | 22.70  | 18.70                  | 18.70   | 14.70                  |

Note: For Head SAR test of 2G/3G/4G Second Antenna, Standalone Head SAR should be evaluated at with audio receiver on. As the audio receiver only works in voice mode when the user is making a call in head scenario, and the lack of the third-party VoIP server and the unstandardized VOIP operating characteristics, so a test script may be used to trigger the receiver on during the test. The test script function is only used to trigger audio receiver on and simulate voice and VOIP usage scene. It can be ensured that the unmodified settings in production units, including maximum output power, amplifier gain and other RF performance or tuning parameters, are used for SAR measurement.

## 6.9.2 Power Reduction Specification of WiFi Antenna

The following tables summarize the key power reduction information of WiFi antennas. The detailed full power and reduced conducted power measurement results are provided in section 7 of this report:

| Config.            |              |                | Tune-up              |              |                     |              | WiFi conducted power validation results(dBm) |              |                     |              |
|--------------------|--------------|----------------|----------------------|--------------|---------------------|--------------|--|--------------|---------------------|--------------|
| Band               | Antenna      | Mode           | MCC of FCC Countries |              | MCC of CE Countries |              | MCC of FCC Countries                         |              | MCC of CE Countries |              |
|                    |              |                | Receiver on          | Receiver off | Receiver on         | Receiver off | Receiver on                                  | Receiver off | Receiver on         | Receiver off |
| WiFi 2.4G          | Ant5 (Core0) | 802.11b        | 11.00                | 19.00        | 15.00               | 19.00        | 10.00  | 17.49        | 12.80               | 17.32        |
|                    |              | 802.11g        | 11.00                | 18.00        | 15.00               | 18.00        | 10.15  | 15.81        | 12.81               | 16.32        |
|                    |              | 802.11n(20M)   | 11.00                | 17.00        | 15.00               | 17.00        | 10.13  | 15.13        | 12.89               | 15.47        |
|                    |              | 802.11n(40M)   | 11.00                | 17.00        | 15.00               | 17.00        | 9.69   | 15.24        | 12.66               | 15.26        |
|                    | Ant6 (Core1) | 802.11b        | 11.00                | 18.50        | 15.00               | 18.50        | 9.73   | 17.03        | 12.90               | 16.90        |
|                    |              | 802.11g        | 11.00                | 17.50        | 15.00               | 17.50        | 10.13  | 15.37        | 12.57               | 15.91        |
|                    |              | 802.11n(20M)   | 11.00                | 16.50        | 15.00               | 16.50        | 10.02  | 14.87        | 12.75               | 15.15        |
|                    |              | 802.11n(40M)   | 11.00                | 16.50        | 15.00               | 16.50        | 9.20   | 14.89        | 12.67               | 15.25        |
|                    | CDD/MIMO     | 802.11g        | 14.00                | 20.80        | 18.00               | 20.80        | 13.15  | 18.61        | 15.70               | 19.13        |
| 802.11n(20M)       |              | 14.00          | 19.80                | 18.00        | 19.80               | 13.09        | 18.01  | 15.83        | 18.32               |              |
| 802.11n(40M)       |              | 14.00          | 19.80                | 18.00        | 19.80               | 12.46        | 18.08  | 15.68        | 18.27               |              |
| U-NII-1            | Ant5 (Core0) | 802.11a        | 12.50                | 17.00        | 15.00               | 17.00        | 10.43  | 15.77        | 13.71               | 15.41        |
|                    |              | 802.11n(20M)   | 12.50                | 17.00        | 15.00               | 17.00        | 10.71  | 15.84        | 13.54               | 15.34        |
|                    |              | 802.11n(40M)   | 12.50                | 16.50        | 15.00               | 16.50        | 10.50  | 15.10        | 13.25               | 15.08        |
|                    |              | 802.11ac(20M)  | 12.50                | 17.00        | 15.00               | 17.00        | 10.64  | 14.88        | 13.59               | 15.39        |
|                    |              | 802.11ac(40M)  | 12.50                | 16.50        | 15.00               | 16.50        | 10.45  | 14.76        | 13.52               | 15.01        |
|                    |              | 802.11ac(80M)  | 9.50                 | 9.50         | 9.50                | 9.50         | 9.19   | 8.91         | 9.13                | 9.01         |
|                    | Ant6 (Core1) | 802.11a        | 12.50                | 16.50        | 15.00               | 16.50        | 10.11  | 15.34        | 13.51               | 15.18        |
|                    |              | 802.11n(20M)   | 12.50                | 16.50        | 15.00               | 16.50        | 10.41  | 14.98        | 13.16               | 15.11        |
|                    |              | 802.11n(40M)   | 12.50                | 16.00        | 15.00               | 16.00        | 10.28  | 14.74        | 13.18               | 14.90        |
|                    |              | 802.11ac(20M)  | 12.50                | 16.50        | 15.00               | 16.50        | 10.11  | 14.90        | 13.06               | 14.92        |
|                    |              | 802.11ac(40M)  | 12.50                | 16.00        | 15.00               | 16.00        | 10.03  | 14.54        | 13.27               | 14.86        |
|                    |              | 802.11ac(80M)  | 9.50                 | 9.50         | 9.50                | 9.50         | 9.17   | 8.89         | 9.13                | 9.14         |
|                    | CDD/MIMO     | 802.11a        | 15.50                | 19.80        | 18.00               | 19.80        | 13.28  | 18.57        | 16.62               | 18.31        |
|                    |              | 802.11n(20M)   | 15.50                | 19.80        | 18.00               | 19.80        | 13.57  | 18.44        | 16.36               | 18.24        |
|                    |              | 802.11n(40M)   | 15.50                | 19.30        | 18.00               | 19.30        | 13.40  | 17.93        | 16.23               | 18.00        |
|                    |              | 802.11ac(20M)  | 15.50                | 19.80        | 18.00               | 19.80        | 13.39  | 17.90        | 16.34               | 18.17        |
|                    |              | 802.11ac(40M)  | 15.50                | 19.30        | 18.00               | 19.30        | 13.26  | 17.66        | 16.41               | 17.95        |
|                    |              | 802.11ac(80M)  | 12.50                | 12.50        | 12.50               | 12.50        | 12.19  | 11.91        | 12.14               | 12.09        |
| U-NII-1 & U-NII-2A | Ant5 (Core0) | 802.11ac(160M) | 9.00                 | 9.00         | 9.00                | 9.00         | 8.24   | 8.37         | 8.43                | 8.34         |
|                    | Ant6 (Core1) | 802.11ac(160M) | 8.50                 | 8.50         | 8.50                | 8.50         | 7.45   | 7.52         | 7.62                | 8.03         |
|                    | MIMO         | 802.11ac(160M) | 11.80                | 11.80        | 11.80               | 11.80        | 10.87  | 10.98        | 11.05               | 11.20        |
| U-NII-2A           | Ant5 (Core0) | 802.11a        | 12.50                | 17.00        | 15.00               | 17.00        | 10.11  | 15.57        | 13.51               | 15.32        |
|                    |              | 802.11n(20M)   | 12.50                | 17.00        | 15.00               | 17.00        | 10.27  | 15.43        | 13.30               | 15.35        |
|                    |              | 802.11n(40M)   | 12.50                | 16.50        | 15.00               | 16.50        | 10.10  | 15.07        | 13.16               | 15.07        |
|                    |              | 802.11ac(20M)  | 12.50                | 17.00        | 15.00               | 17.00        | 10.11  | 15.41        | 12.99               | 15.28        |
|                    |              | 802.11ac(40M)  | 12.50                | 16.50        | 15.00               | 16.50        | 9.78   | 15.10        | 12.95               | 15.06        |
|                    |              | 802.11ac(80M)  | 9.50                 | 9.50         | 9.50                | 9.50         | 8.98   | 8.66         | 9.02                | 8.97         |
|                    | Ant6 (Core1) | 802.11a        | 12.50                | 16.50        | 15.00               | 16.50        | 10.38  | 14.61        | 13.70               | 14.98        |
|                    |              | 802.11n(20M)   | 12.50                | 16.50        | 15.00               | 16.50        | 10.37  | 14.64        | 13.70               | 15.02        |
|                    |              | 802.11n(40M)   | 12.50                | 16.00        | 15.00               | 16.00        | 10.26  | 14.32        | 13.77               | 14.73        |
|                    |              | 802.11ac(20M)  | 12.50                | 16.50        | 15.00               | 16.50        | 10.18  | 14.28        | 13.80               | 15.22        |
|                    |              | 802.11ac(40M)  | 12.50                | 16.00        | 15.00               | 16.00        | 9.95   | 14.37        | 13.77               | 14.85        |

|              |                 |                |       |       |       |       |       |       |       |       |
|--------------|-----------------|----------------|-------|-------|-------|-------|-------|-------|-------|-------|
|              | CDD/<br>MIMO    | 802.11ac(80M)  | 9.50  | 9.50  | 9.50  | 9.50  | 8.15  | 9.04  | 8.87  | 8.85  |
|              |                 | 802.11a        | 15.50 | 19.80 | 18.00 | 19.80 | 13.26 | 18.13 | 16.62 | 18.16 |
|              |                 | 802.11n(20M)   | 15.50 | 19.80 | 18.00 | 19.80 | 13.33 | 18.06 | 16.51 | 18.20 |
|              |                 | 802.11n(40M)   | 15.50 | 19.30 | 18.00 | 19.30 | 13.19 | 17.72 | 16.49 | 17.91 |
|              |                 | 802.11ac(20M)  | 15.50 | 19.80 | 18.00 | 19.80 | 13.16 | 17.89 | 16.42 | 18.26 |
|              |                 | 802.11ac(40M)  | 15.50 | 19.30 | 18.00 | 19.30 | 12.88 | 17.76 | 16.39 | 17.97 |
|              |                 | 802.11ac(80M)  | 12.50 | 12.50 | 12.50 | 12.50 | 11.60 | 11.86 | 11.96 | 11.92 |
| U-NII-<br>2C | Ant5<br>(Core0) | 802.11a        | 12.50 | 17.00 | 15.00 | 17.00 | 10.65 | 15.83 | 13.52 | 15.22 |
|              |                 | 802.11n(20M)   | 12.50 | 17.00 | 15.00 | 17.00 | 10.74 | 15.43 | 13.29 | 15.29 |
|              |                 | 802.11n(40M)   | 12.50 | 16.50 | 15.00 | 16.50 | 10.70 | 14.82 | 13.32 | 14.86 |
|              |                 | 802.11ac(20M)  | 12.50 | 17.00 | 15.00 | 17.00 | 10.64 | 15.09 | 13.44 | 15.38 |
|              |                 | 802.11ac(40M)  | 12.50 | 16.50 | 15.00 | 16.50 | 10.47 | 14.86 | 13.23 | 14.82 |
|              |                 | 802.11ac(80M)  | 12.50 | 9.50  | 9.50  | 9.50  | 10.16 | 8.67  | 8.94  | 8.64  |
|              |                 | 802.11ac(160M) | 9.00  | 9.00  | 9.00  | 9.00  | 8.45  | 8.27  | 8.22  | 7.24  |
|              | Ant6<br>(Core1) | 802.11a        | 12.50 | 16.50 | 15.00 | 16.50 | 10.53 | 15.33 | 13.75 | 14.76 |
|              |                 | 802.11n(20M)   | 12.50 | 16.50 | 15.00 | 16.50 | 10.73 | 15.28 | 13.67 | 14.83 |
|              |                 | 802.11n(40M)   | 12.50 | 16.00 | 15.00 | 16.00 | 10.61 | 14.89 | 13.74 | 14.53 |
|              |                 | 802.11ac(20M)  | 12.50 | 16.50 | 15.00 | 16.50 | 10.34 | 14.96 | 13.47 | 14.91 |
|              |                 | 802.11ac(40M)  | 12.50 | 16.00 | 15.00 | 16.00 | 10.36 | 14.87 | 13.53 | 14.85 |
|              |                 | 802.11ac(80M)  | 12.50 | 9.50  | 9.50  | 9.50  | 10.13 | 8.72  | 8.84  | 9.07  |
|              |                 | 802.11ac(160M) | 8.50  | 8.50  | 8.50  | 8.50  | 7.43  | 7.55  | 7.19  | 7.10  |
|              | CDD/<br>MIMO    | 802.11a        | 15.50 | 19.80 | 18.00 | 19.80 | 13.60 | 18.60 | 16.65 | 18.01 |
|              |                 | 802.11n(20M)   | 15.50 | 19.80 | 18.00 | 19.80 | 13.75 | 18.37 | 16.49 | 18.08 |
|              |                 | 802.11n(40M)   | 15.50 | 19.30 | 18.00 | 19.30 | 13.67 | 17.87 | 16.55 | 17.71 |
|              |                 | 802.11ac(20M)  | 15.50 | 19.80 | 18.00 | 19.80 | 13.50 | 18.04 | 16.47 | 18.16 |
|              |                 | 802.11ac(40M)  | 15.50 | 19.30 | 18.00 | 19.30 | 13.43 | 17.88 | 16.39 | 17.85 |
|              |                 | 802.11ac(80M)  | 15.50 | 9.50  | 12.50 | 12.50 | 13.16 | 9.17  | 11.90 | 11.87 |
|              |                 | 802.11ac(160M) | 11.80 | 11.80 | 11.80 | 11.80 | 10.98 | 10.94 | 10.75 | 10.18 |
| U-NII-3      | Ant5<br>(Core0) | 802.11a        | 11.50 | 11.50 | 11.50 | 11.50 | 9.50  | 9.64  | 9.51  | 9.28  |
|              |                 | 802.11n(20M)   | 11.50 | 11.50 | 11.50 | 11.50 | 9.87  | 9.39  | 9.60  | 9.75  |
|              |                 | 802.11n(40M)   | 11.50 | 11.50 | 11.50 | 11.50 | 9.73  | 9.37  | 9.52  | 9.80  |
|              |                 | 802.11ac(20M)  | 11.50 | 11.50 | 11.50 | 11.50 | 9.30  | 9.26  | 9.41  | 9.58  |
|              |                 | 802.11ac(40M)  | 11.50 | 11.50 | 11.50 | 11.50 | 9.11  | 9.19  | 9.30  | 9.30  |
|              |                 | 802.11ac(80M)  | 11.50 | 11.50 | 11.50 | 11.50 | 9.28  | 9.91  | 9.34  | 9.32  |
|              | Ant6<br>(Core1) | 802.11a        | 11.50 | 11.50 | 11.50 | 11.50 | 9.18  | 9.92  | 9.25  | 9.27  |
|              |                 | 802.11n(20M)   | 11.50 | 11.50 | 11.50 | 11.50 | 9.89  | 9.95  | 9.04  | 9.76  |
|              |                 | 802.11n(40M)   | 11.50 | 11.50 | 11.50 | 11.50 | 9.81  | 9.61  | 9.41  | 9.75  |
|              |                 | 802.11ac(20M)  | 11.50 | 11.50 | 11.50 | 11.50 | 9.83  | 9.67  | 9.27  | 9.81  |
|              |                 | 802.11ac(40M)  | 11.50 | 11.50 | 11.50 | 11.50 | 9.82  | 9.75  | 9.40  | 9.54  |
|              |                 | 802.11ac(80M)  | 11.50 | 11.50 | 11.50 | 11.50 | 9.76  | 9.83  | 9.45  | 9.62  |
|              | CDD/<br>MIMO    | 802.11a        | 14.50 | 14.50 | 14.50 | 14.50 | 12.35 | 12.79 | 12.39 | 12.29 |
|              |                 | 802.11n(20M)   | 14.50 | 14.50 | 14.50 | 14.50 | 12.89 | 12.69 | 12.34 | 12.77 |
|              |                 | 802.11n(40M)   | 14.50 | 14.50 | 14.50 | 14.50 | 12.78 | 12.50 | 12.48 | 12.79 |
|              |                 | 802.11ac(20M)  | 14.50 | 14.50 | 14.50 | 14.50 | 12.58 | 12.48 | 12.35 | 12.71 |
|              |                 | 802.11ac(40M)  | 14.50 | 14.50 | 14.50 | 14.50 | 12.49 | 12.49 | 12.36 | 12.43 |
|              |                 | 802.11ac(80M)  | 14.50 | 14.50 | 14.50 | 14.50 | 12.54 | 12.88 | 12.41 | 12.48 |

For FCC SAR test, WiFi SAR test should be evaluated at the power level of FCC mobile country code for each exposure conditions.

### 6.9.3 Power Reduction Specification of 2G/3G/4G Main Antenna

The following tables summarize the key power reduction information of 2G/3G/4G main antenna. The detailed full power and reduced conducted power measurement results are provided in section 7 of this report:

| Main Antenna Power Reduction Level(dBm) |                  |                        |                        |                        |                        |                        |                        |
|---|------------------|------------------------|------------------------|------------------------|------------------------|------------------------|------------------------|
| Band                                    | Other conditions | Receiver off           |                        |                        |                        |                        | Receiver on            |
|   |                  | Hotspot off            |                        | Hotspot on             |                        |                        | Hotspot on             |
|   |                  | Sensor on*             |                        | sensor off             | Sensor on*             |                        | /                      |
|   | Full power       | Reduced Power Level D1 | Reduced Power Level D2 | Reduced Power Level D3 | Reduced Power Level D4 | Reduced Power Level D5 | Reduced Power Level D6 |
| GSM1900                                 | 30.50            | 30.50                  | 30.50                  | 30.00                  | 30.00                  | 30.00                  | /                      |
| UMTS Band II                            | 24.50            | 22.50                  | 24.50                  | 22.00                  | 20.00                  | 22.00                  | 22.00                  |
| UMTS Band IV                            | 23.50            | 23.50                  | 23.50                  | 22.00                  | 22.00                  | 22.00                  | 22.00                  |
| LTE Band 2                              | 24.00            | 22.50                  | 24.00                  | 21.50                  | 20.00                  | 21.50                  | 21.50                  |
| LTE Band 4                              | 22.50            | 22.50                  | 22.50                  | 21.50                  | 21.50                  | 21.50                  | 21.50                  |
| LTE Band 7                              | 24.00            | 22.00                  | 23.50                  | 21.00                  | 19.00                  | 20.50                  | 21.00                  |
| CA_7C                                   | 24.00            | 22.00                  | 23.50                  | 21.00                  | 19.00                  | 20.50                  | 21.00                  |
| LTE Band 38                             | 23.63            | 23.63                  | 23.63                  | 22.63                  | 22.63                  | 22.63                  | 22.63                  |
| CA_38C                                  | 23.63            | 23.63                  | 23.63                  | 22.63                  | 22.63                  | 22.63                  | 22.63                  |
| LTE Band 41                             | 23.83            | 23.83                  | 23.83                  | 22.83                  | 22.83                  | 22.83                  | 22.83                  |
| CA_41C                                  | 23.63            | 23.63                  | 23.63                  | 22.63                  | 22.63                  | 22.63                  | 22.63                  |
| LTE Band 66                             | 23.70            | 23.70                  | 23.70                  | 22.70                  | 22.70                  | 22.70                  | 22.70                  |

Note:

- 1) \* Reduced Power Level D1 or Reduced Power Level D2 is determined by different sensor Trigger Distance ranges when hotspot is off;
- 2) \*\* Reduced Power Level D4 or Reduced Power Level D5 is determined by different sensor Trigger Distance range when hotspot is on;
- 3) For some frequency bands, the power reduction level amount value 0 means there is no power reduction in this frequency band and exposure conditions. The power level is the same as full power
- 4) Please refer to section 6.9.4 for detailed Proximity sensor power reduction test configuration and validation results per KDB616217.

## 6.9.4 Proximity sensor Power Reduction Test configuration and validation

Due to the operating configurations and exposure conditions required by the device, the proximity sensor is used to indicate when the device is held close to a user's body/hotspot exposure condition. It utilizes the proximity sensor to reduce the output power in specific wireless and operating modes of main antenna to ensure SAR compliance.

The following tables summarize the key power reduction information for proximity sensor. The test procedures in KDB 616217 should be applied to determine proximity sensor triggering distances, and sensor coverage for normal and tilt positions. To ensure all production units are compliant, it is generally necessary to reduce the triggering distance determined from the triggering tests by 1 mm, or more if it is necessary, and use the smallest distance for movements to and from the phantom, minus 1 mm, as the sensor triggering distance for determining the SAR measurement distance.

| Main antenna    |               |  |                            |                      |                        |
|-----------------|---------------|--|----------------------------|----------------------|------------------------|
| Band            | Test position | Sensor Trigger Distance range (DUT to Phantom) | Power reduction amount(dB) | Max Power level(dBm) | Power level            |
| UMTS Band II    | Bottom side   | 0≤distance≤9mm                                 | 2                          | 22.5                 | Reduced Power Level D1 |
|                 |               | 9<distance≤10mm                                | 0                          | 24.5                 | Full power             |
|                 |               | 10<distance                                    | 0                          | 24.5                 | Full power             |
|                 | Back side     | 0≤distance≤5mm                                 | 2                          | 22.5                 | Reduced Power Level D1 |
|                 |               | 5<distance≤8mm                                 | 0                          | 24.5                 | Full power             |
|                 |               | distance >8mm                                  | 0                          | 24.5                 | Full power             |
|                 | Front side    | 0≤distance≤2mm                                 | 2                          | 22.5                 | Reduced Power Level D1 |
|                 |               | 2<distance≤5mm                                 | 0                          | 24.5                 | Full power             |
|                 |               | 5<distance                                     | 0                          | 24.5                 | Full power             |
|                 | Left side     | ALL  | 0                          | 24.5                 | Full power             |
|                 | Right side    | ALL  | 0                          | 24.5                 | Full power             |
|                 | Top side      | ALL  | 0                          | 24.5                 | Full power             |
|                 | LTE Band 2    | Bottom side                                    | 0≤distance≤9mm             | 1.5                  | 22.5                   |
| 9<distance≤10mm |               |  | 0                          | 24.0                 | Full power             |
| 10<distance     |               |  | 0                          | 24.0                 | Full power             |
| Back side       |               | 0≤distance≤5mm                                 | 1.5                        | 22.5                 | Reduced Power Level D1 |
|                 |               | 5<distance≤8mm                                 | 0                          | 24.0                 | Full power             |
|                 |               | distance >8mm                                  | 0                          | 24.0                 | Full power             |
| Front side      |               | 0≤distance≤2mm                                 | 1.5                        | 22.5                 | Reduced Power Level D1 |
|                 |               | 2<distance≤5mm                                 | 0                          | 24.0                 | Full power             |
|                 |               | 5<distance                                     | 0                          | 24.0                 | Full power             |
| Left side       |               | ALL  | 0                          | 24.0                 | Full power             |
| Right side      |               | ALL  | 0                          | 24.0                 | Full power             |

|            |             |  |     |      |                        |
|------------|-------------|--|-----|------|------------------------|
|            | Top side    | ALL                                      | 0   | 24.0 | Full power             |
| LTE Band 7 | Bottom side | $0 \leq \text{distance} \leq 9\text{mm}$ | 1.5 | 22.0 | Reduced Power Level D1 |
|            |             | $9 < \text{distance} \leq 10\text{mm}$   | 0.5 | 23.5 | Reduced Power Level D2 |
|            |             | $10 < \text{distance}$                   | 0   | 24.0 | Full power             |
|            | Back side   | $0 \leq \text{distance} \leq 5\text{mm}$ | 1.5 | 22.0 | Reduced Power Level D1 |
|            |             | $5 < \text{distance} \leq 8\text{mm}$    | 0.5 | 23.5 | Reduced Power Level D2 |
|            |             | $\text{distance} > 8\text{mm}$           | 0   | 24.0 | Full power             |
|            | Front side  | $0 < \text{distance} \leq 2\text{mm}$    | 1.5 | 22.0 | Reduced Power Level D1 |
|            |             | $2 < \text{distance} \leq 5\text{mm}$    | 0.5 | 23.5 | Reduced Power Level D2 |
|            |             | $5 < \text{distance}$                    | 0   | 24.0 | Full power             |
|            | Left side   | ALL                                      | 0   | 22.0 | Full power             |
|            | Right side  | ALL                                      | 0   | 22.0 | Full power             |
|            | Top side    | ALL                                      | 0   | 24.0 | Full power             |

Note:

To ensure all production units are compliant, the smallest separation distance determined by the sensor triggering and sensor coverage for normal and tilt positions for all usage conditions and applicable sides, minus 1 mm, must be used as the test separation distance for additional SAR testing of each higher power stage.

For the other sides or other frequency bands of the device, SAR is still tested at the maximum full power level with sensor off.

### 1) Procedures for determining proximity sensor triggering distances

The device was tested by the test lab to determine the proximity sensor triggering distances for the front side, back side and bottom side of the device. To ensure all production units are compliant, the smallest separation distance determined by the sensor triggering minus 1 mm, must be used as the test separation distance for SAR testing.

the proximity sensor triggering distance measurement method are as below:



Picture: Proximity sensor triggering distances assessment Bottom Side



Picture: Proximity sensor triggering distances assessment Front Side and Back side

**Table: Summary of Trigger Distances**

| Band         | Reduced Power Level    | Trigger distance-Front Side |                          | Trigger distance-Back Side |                          | Trigger distance-Bottom Side |                          |
|--------------|------------------------|-----------------------------|--------------------------|----------------------------|--------------------------|------------------------------|--------------------------|
|              |                        | Moving toward phantom       | Moving away from phantom | Moving toward phantom      | Moving away from phantom | Moving toward phantom        | Moving away from phantom |
| UMTS Band II | Reduced Power Level D1 | 2mm                         | 2mm                      | 5mm                        | 5mm                      | 9mm                          | 9mm                      |
| LTE Band 2   | Reduced Power Level D1 | 2mm                         | 2mm                      | 5mm                        | 5mm                      | 9mm                          | 9mm                      |
| LTE Band 7   | Reduced Power Level D1 | 2mm                         | 2mm                      | 5mm                        | 5mm                      | 9mm                          | 9mm                      |
|              | Reduced Power Level D2 | 5mm                         | 5mm                      | 8mm                        | 8mm                      | 10mm                         | 10mm                     |
| UL CA_7C     | Reduced Power Level D1 | 2mm                         | 2mm                      | 5mm                        | 5mm                      | 9mm                          | 9mm                      |
|              | Reduced Power Level D2 | 5mm                         | 5mm                      | 8mm                        | 8mm                      | 10mm                         | 10mm                     |

Note:

- 1) \* The sensor Trigger Distance of Reduced Power Level D4 (hotspot on) and Reduced Power Level D1 (hotspot off) are the same.
- 2) \* The sensor Trigger Distance of Reduced Power Level D5 (hotspot on) and Reduced Power Level D2 (hotspot off) are the same.

The detailed conducted power measurement data to determine the triggering distances is as below:

The DUT(Front side) is moved towards the flat phantom with/without protective cover(Hotspot off):

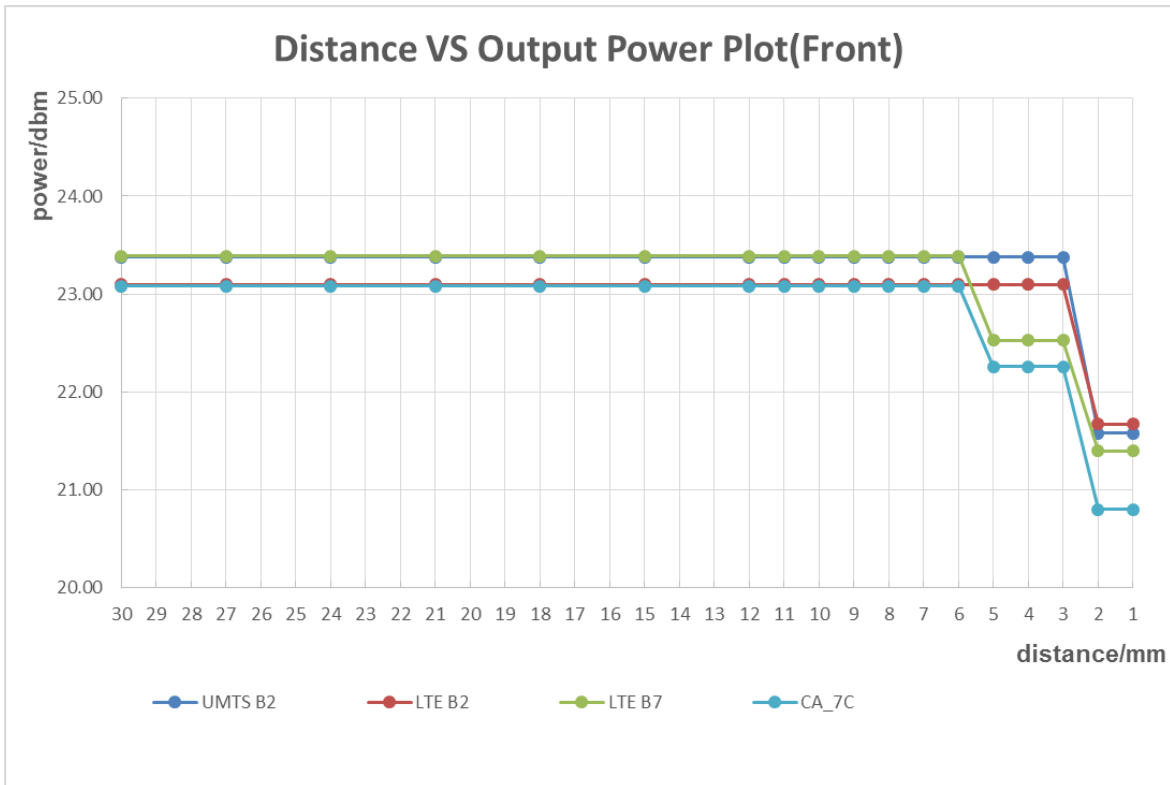

The DUT(Back side) is moved towards the flat phantom with/without protective cover(Hotspot off):

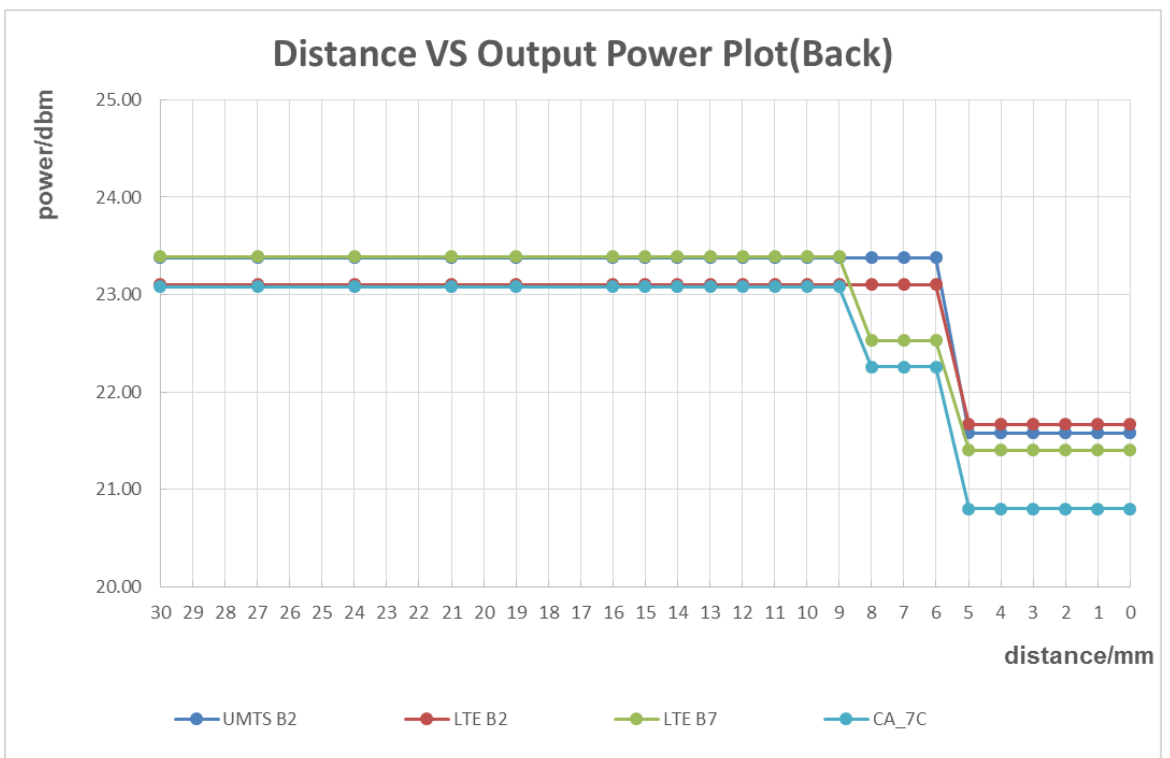



The DUT(Bottom side) is moved towards the flat phantom with/without protective cover(Hotspot off):

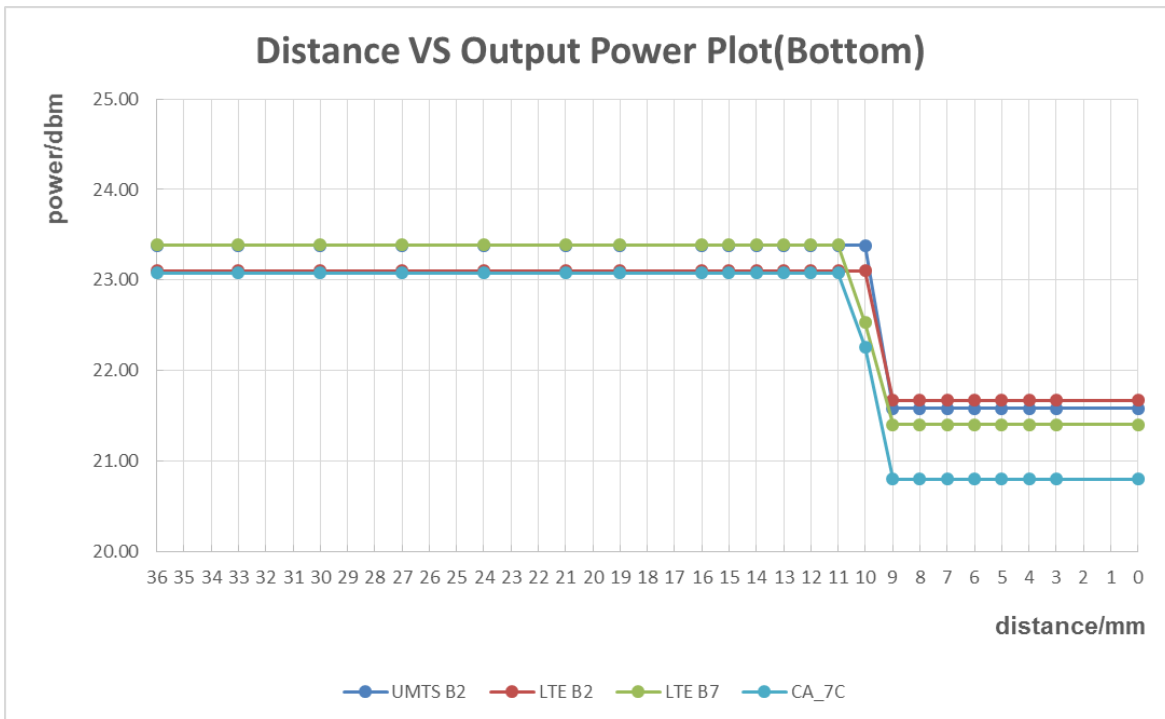

The DUT(Front side) is moved away the flat phantom with/without protective cover(Hotspot off):

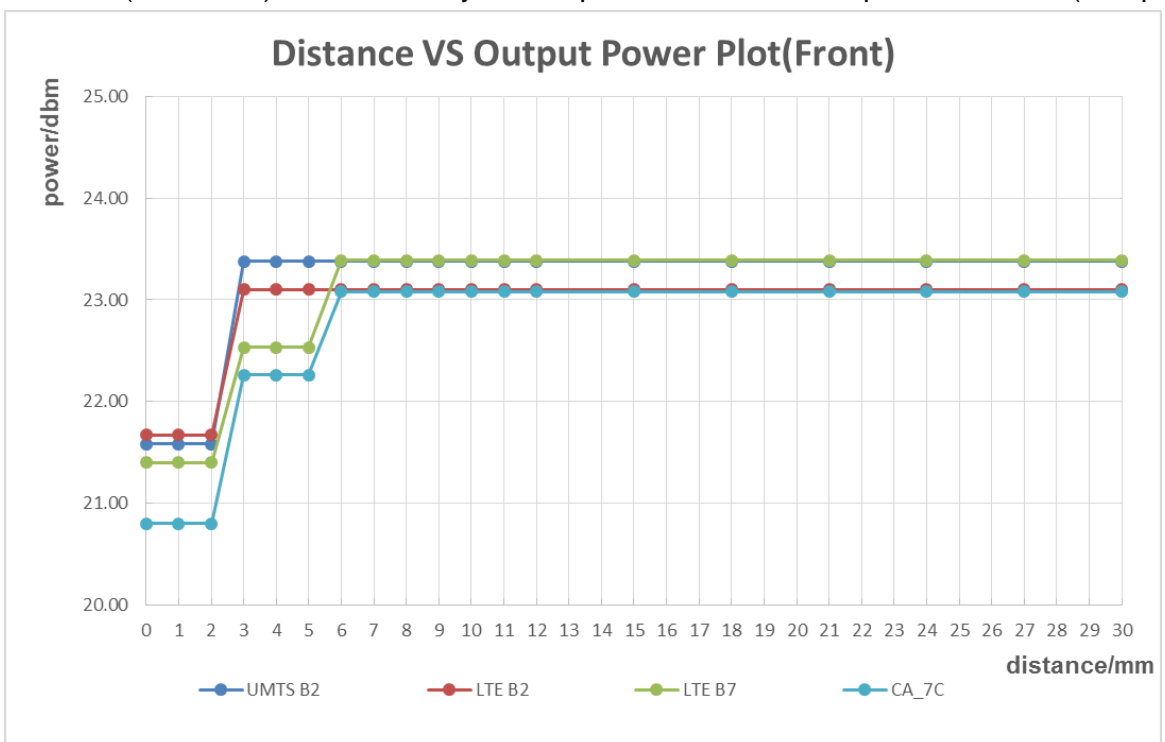

The DUT(Back side) is moved away the flat phantom with/without protective cover(Hotspot off):

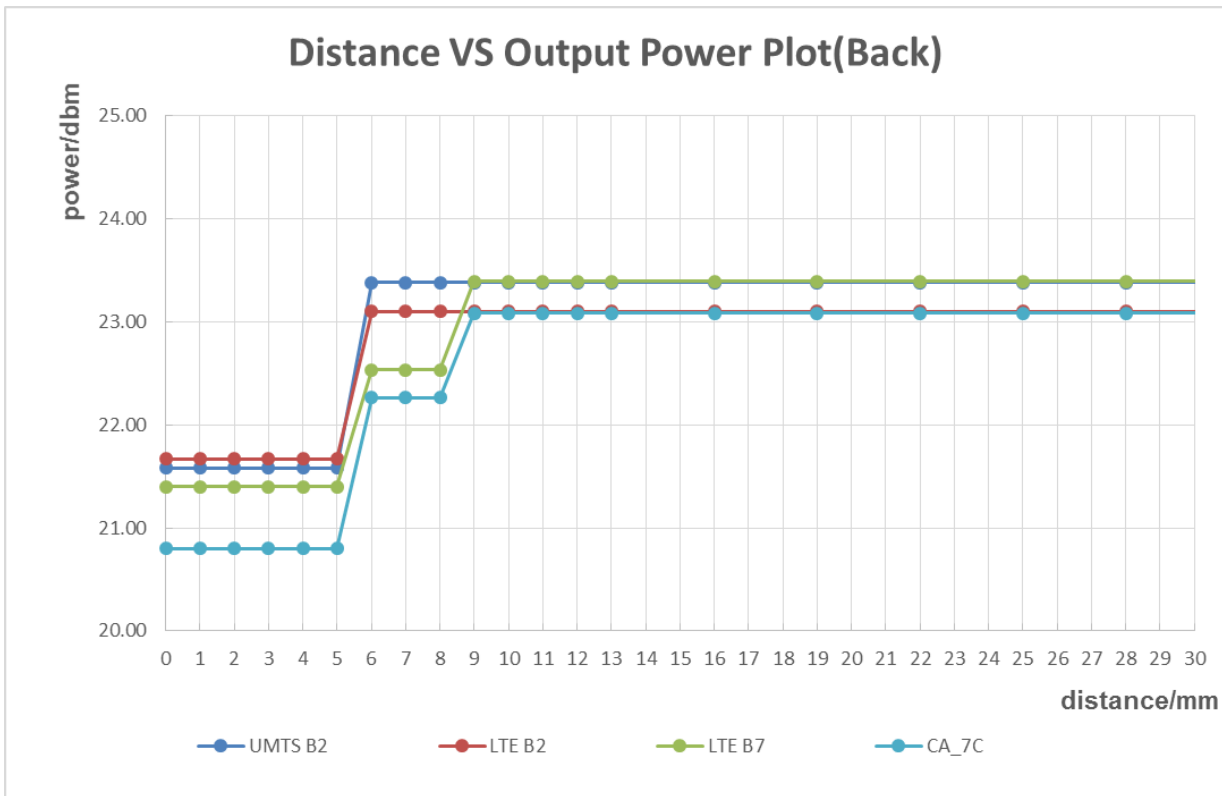

The DUT(Bottom side) is moved away the flat phantom with/without protective cover(Hotspot off):

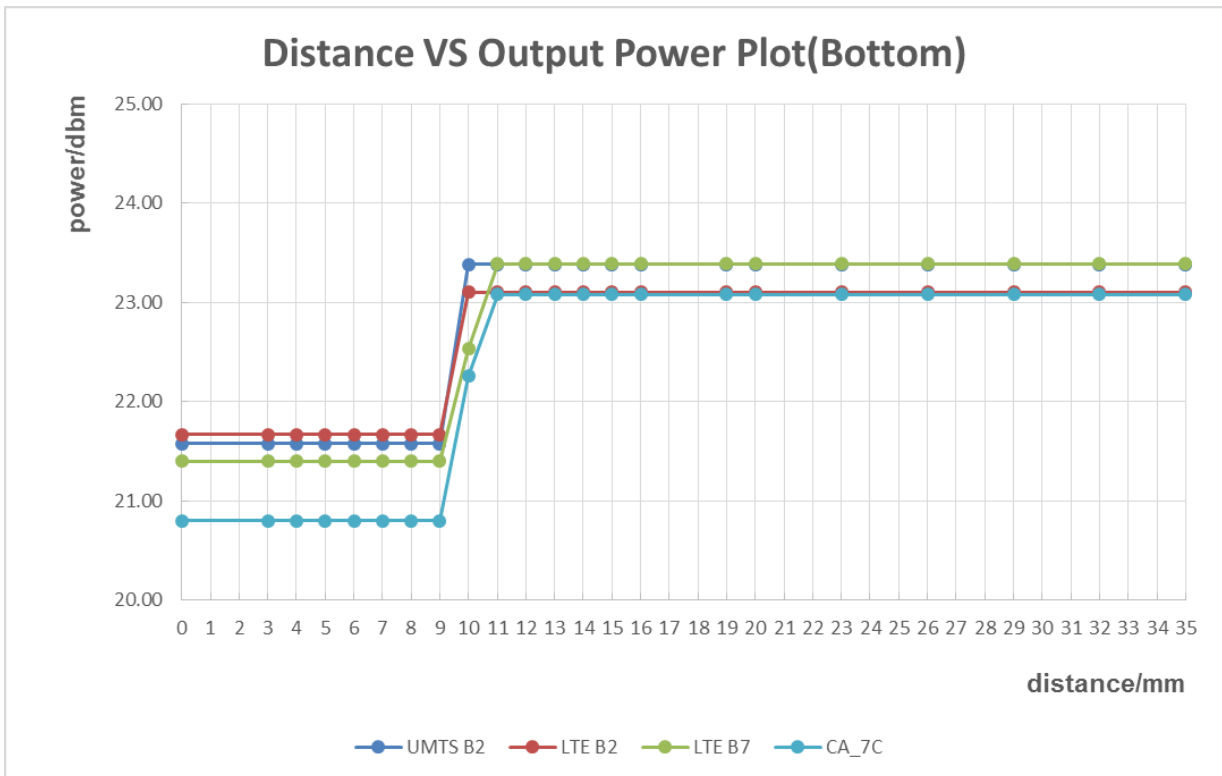

The DUT(Front side) is moved towards the flat phantom with/without protective cover(Hotspot on):

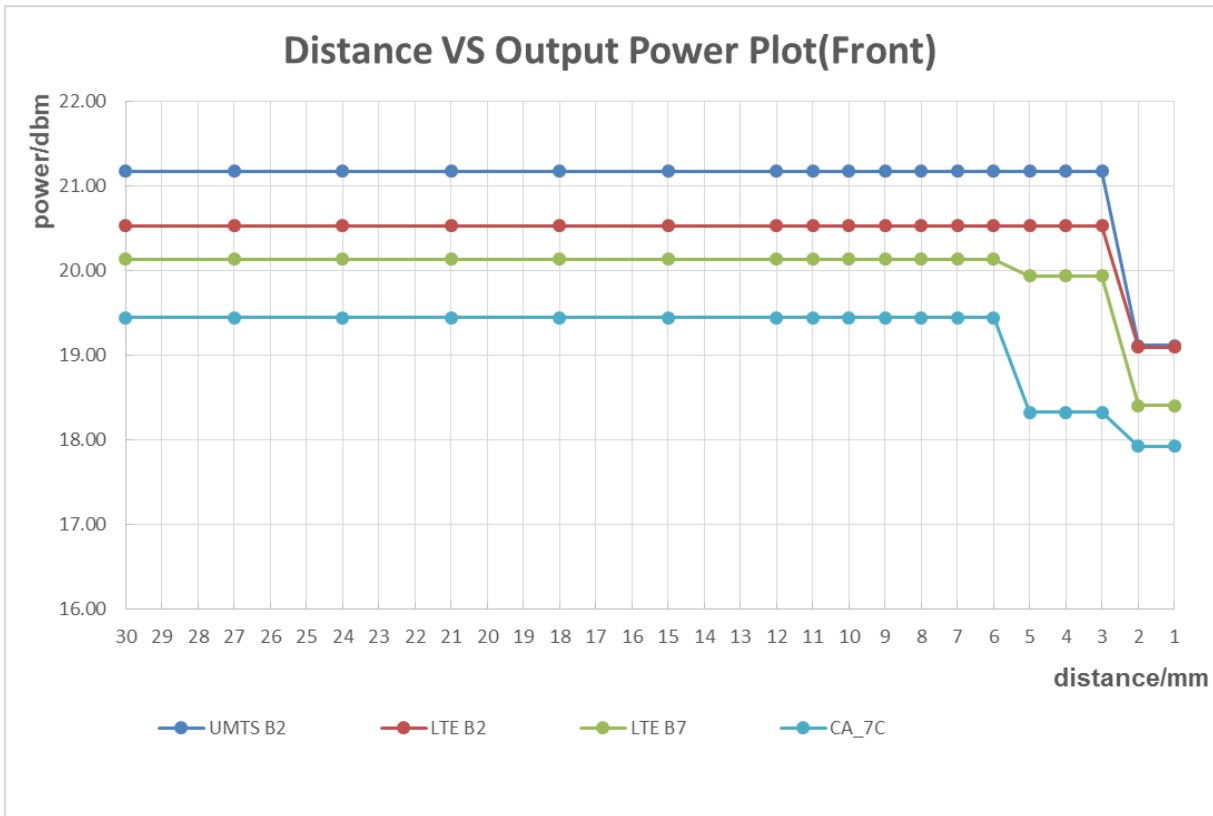

The DUT(Back side) is moved towards the flat phantom with/without protective cover(Hotspot on):

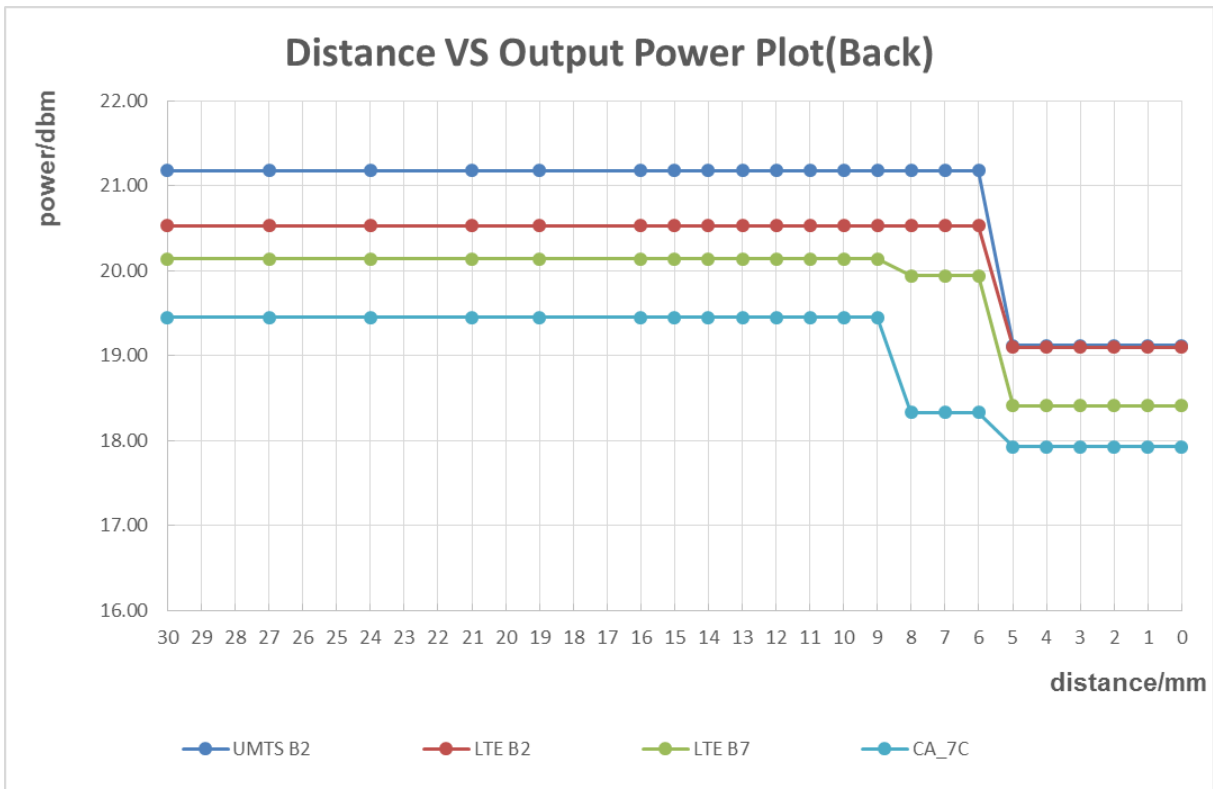

The DUT(Bottom side) is moved towards the flat phantom with/without protective cover(Hotspot on):

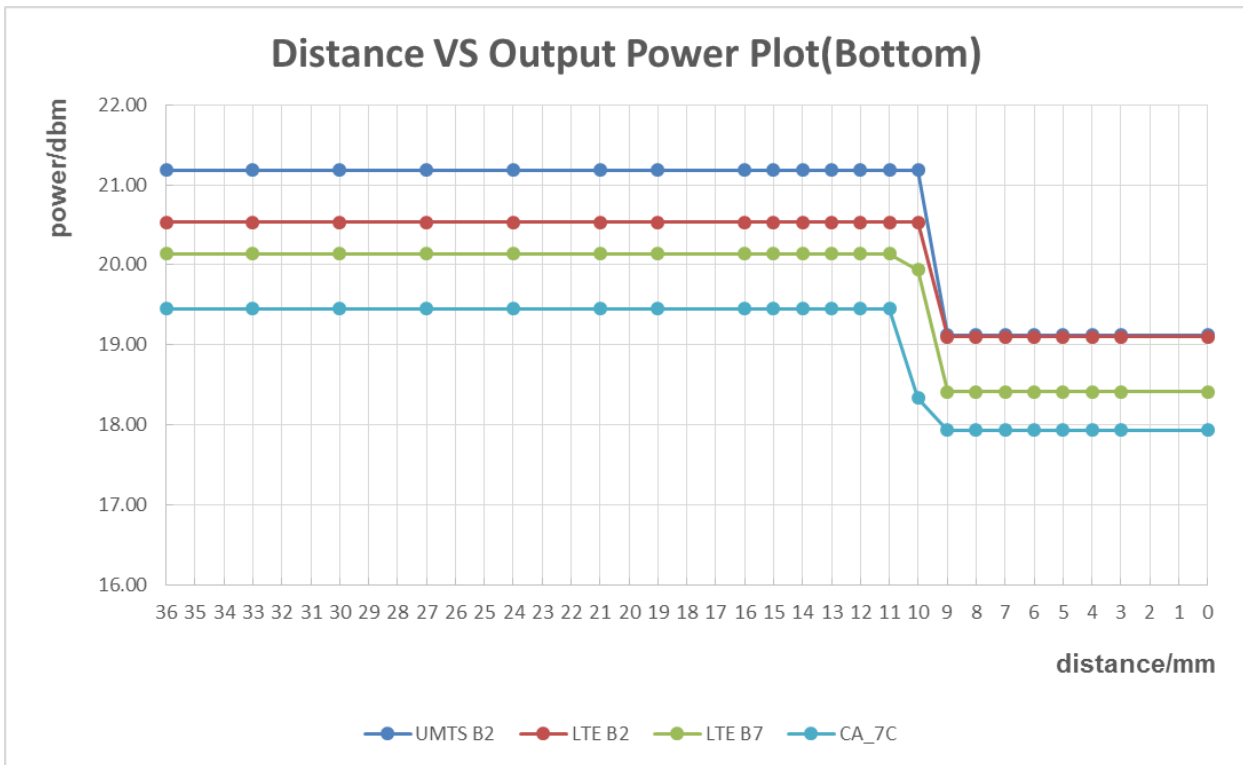

The DUT(Front side) is moved away the flat phantom with/without protective cover(Hotspot on):

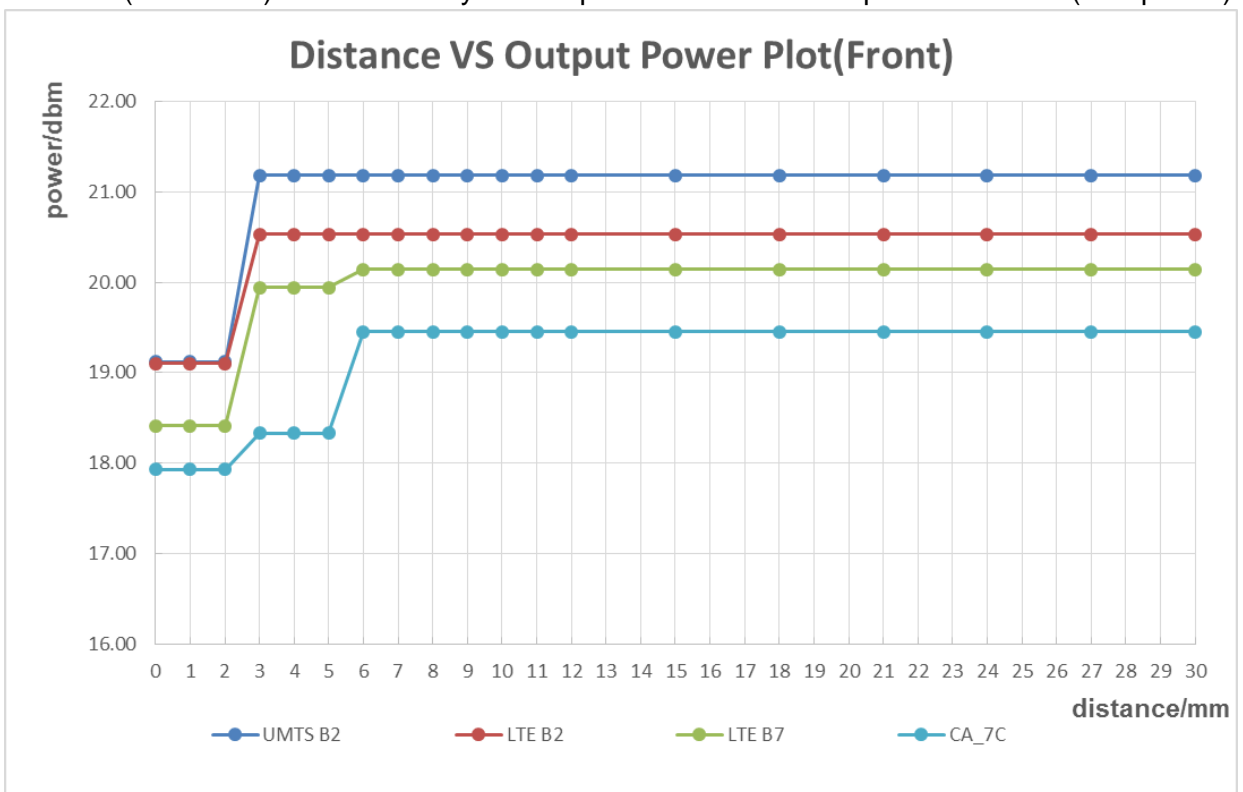

The DUT(Back side) is moved away the flat phantom with/without protective cover(Hotspot on):

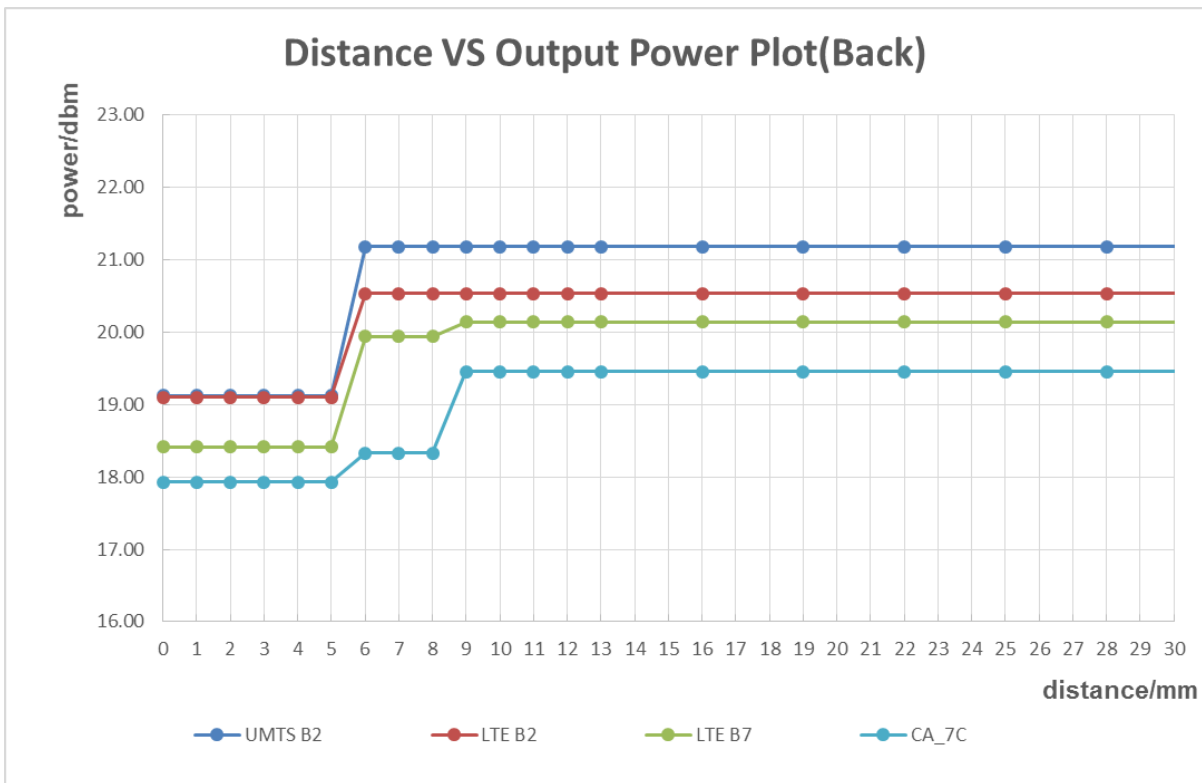

The DUT(Bottom) is moved away the flat phantom with/without protective cover(Hotspot on):

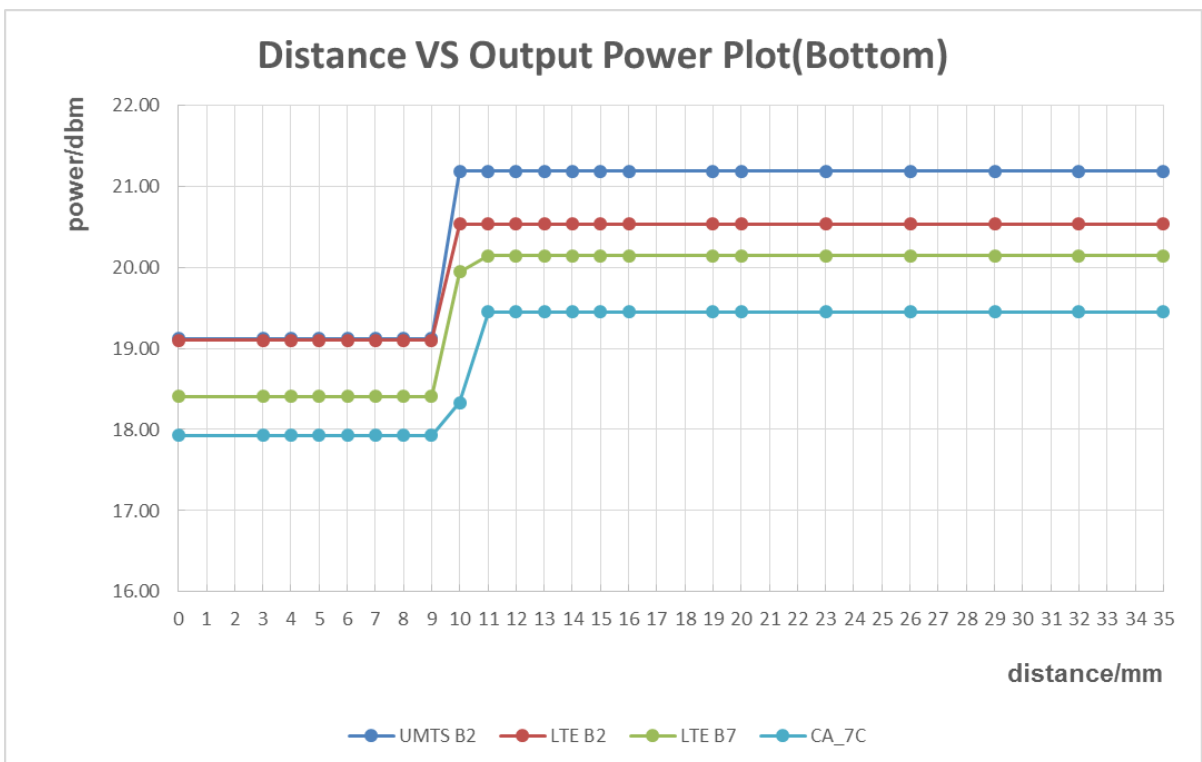

**Conclusion:** It can be ensured that the proximity sensor can be valid triggered for the body exposure condition. (UMTS Band II,LTE Band 2/7, UL CA\_7C with Main Antenna)

## 2) Procedures for determining antenna and proximity sensor coverage

According to the antenna and sensors location figure: Proximity sensor is a floating metal sheet, which cannot fully overwrite the 2G/3G/4G main antenna. So the proximity sensor coverage need to be assessed for the frequency bands and test positions supporting proximity sensor power reduction per KDB 616217:

- a) All the sides/edges (bottom side, front side and back side of the device) is positioned at a test separation distance less than or equal to the distance required for sensor triggering, with both the antenna and sensor pad located at least 20 mm laterally outside the edge (boundary) of the phantom, along the direction of maximum antenna and sensor offset.  
Each applicable edge should be positioned perpendicularly to the phantom to determine sensor coverage. For antennas and/or sensors located near the corner of a tablet, both adjacent edges must be considered.
- b) The similar sequence of steps applied to determine sensor triggering distance are used to verify the sensor coverage by moving the DUT(sensor and antenna) horizontally toward the phantom while maintaining the same vertical separation between the side or edge and the phantom.
- c) After the exact location where triggering of power reduction is determined, with respect to the sensor and antenna, the DUT movement should be continued, in 3 mm increments, until both the sensor and antenna(s) are fully under the phantom and at least 20 mm inside the phantom edge.
- d) The process is then repeated from the opposite direction, starting at the other end of the maximum antenna and sensor offset, by rotating the DUT 180° along the vertical axis.
- e) The triggering points should be documented graphically, with the antenna and sensor clearly identified, along with all relevant dimensions.
- f) If the subsequently measured peak SAR location for the antenna is not between the triggering points, established by the sensor coverage tests from opposite ends of the antenna and sensor, additional SAR tests may be required for conditions where only part of the surface or edge of the DUT corresponding to the antenna is in proximity to the user and the sensor may not be triggering as desired.

The proximity sensor coverage measurement method are as below:

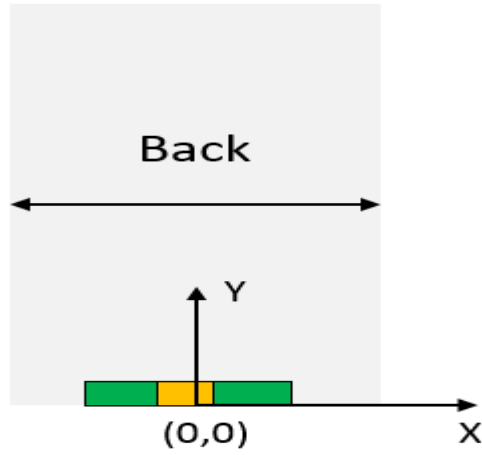

Figure: Plane coordinate system definition on the DUT

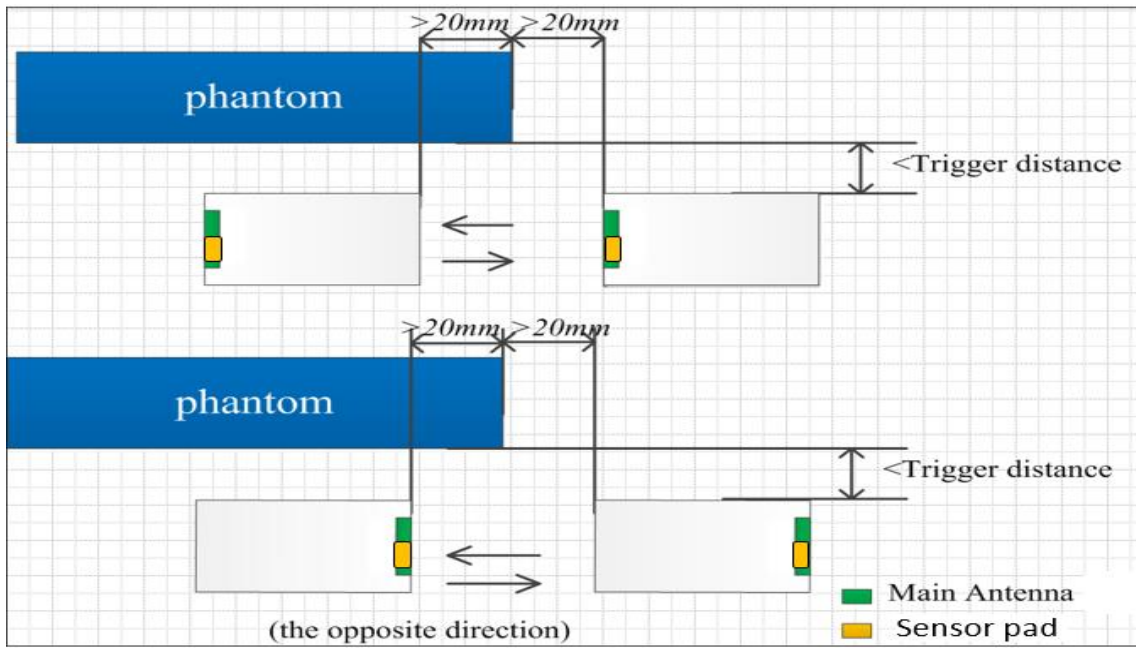

Figure: proximity sensor coverage assesment (Y coordinate direction)

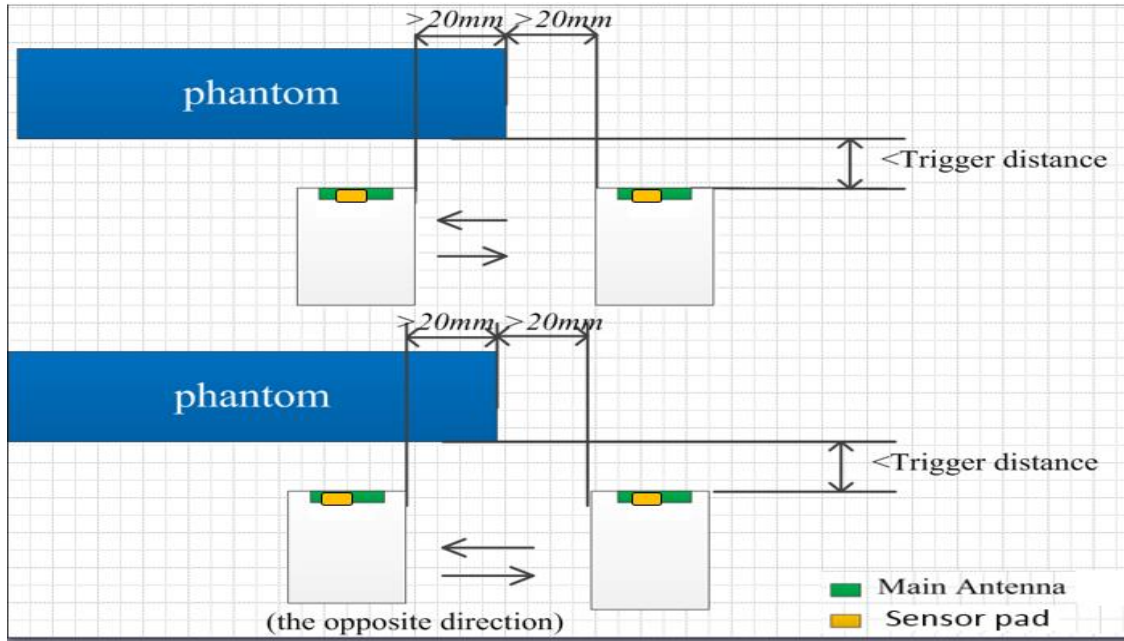
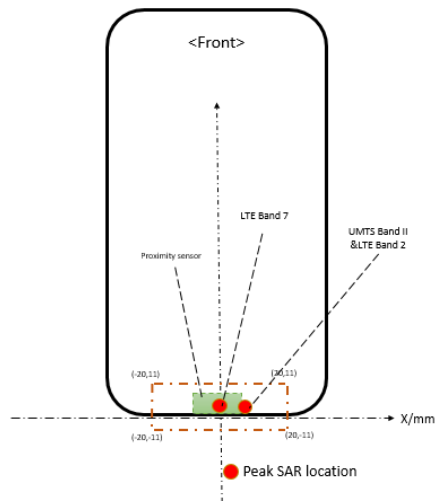

Figure: proximity sensor coverage assesment (X coordinate direction)



sensor coverage assesment results(Front side):



sensor coverage assesment results(Back side):

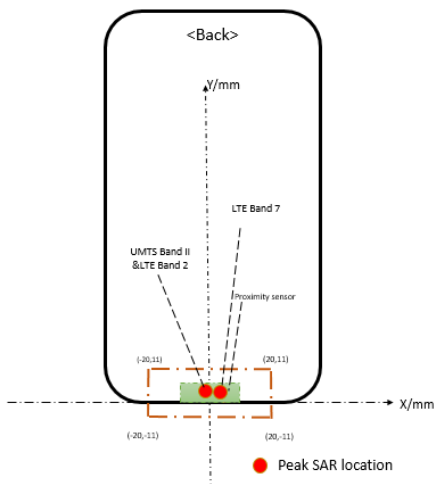

sensor coverage assesment results(Bottom side):

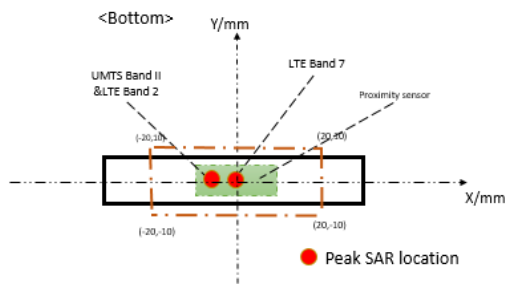

Conclusion: As the subsequently measured peak SAR location for the antenna is between the triggering points, additional SAR tests are not required for proximity sensor coverage per KDB 616217.

### 3) Procedures for determining device tilt angle influences to proximity sensor triggering

The DUT was positioned directly below the flat phantom at the minimum measured trigger distance with Bottom side parallel to the base of the flat phantom for each band.

The EUT was rotated about Bottom side for angles up to +/- 45°. If the output power increased during the rotation the DUT was moved 1mm toward the phantom and the rotation repeated. This procedure was repeated until the power remained reduced for all angles up to +/- 45°.

The proximity sensor triggering tilt angle measurement method are as below:

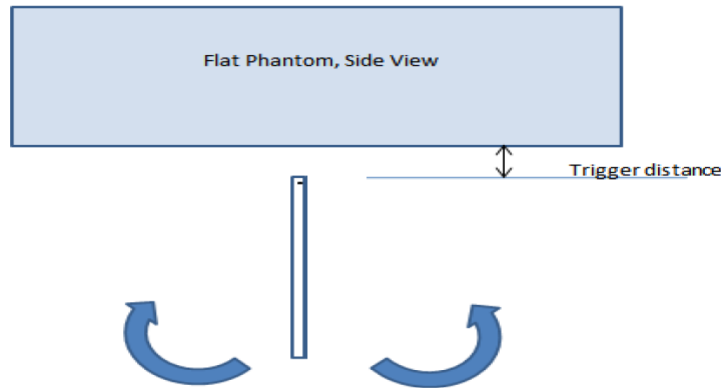

**Table: Summary of Device Tilt Angle Influence to Proximity Sensor Triggering(Bottom side)**

| Band(MHz)    | Minimum trigger distance at which power reduction was maintained over $\pm 45^\circ$ | Power Reduction Status |      |      |      |     |    |    |     |     |     |     |
|--------------|--|------------------------|------|------|------|-----|----|----|-----|-----|-----|-----|
|              |  | -45°                   | -35° | -25° | -15° | -5° | 0° | 5° | 15° | 25° | 35° | 45° |
| UMTS Band II | 9mm  | on                     | on   | on   | on   | on  | on | on | on  | on  | on  | on  |
| LTE Band 2   | 9mm  | on                     | on   | on   | on   | on  | on | on | on  | on  | on  | on  |
| LTE Band 7   | 9mm/10mm   | on                     | on   | on   | on   | on  | on | on | on  | on  | on  | on  |
| UL CA_7C     | 9mm/10mm   | on                     | on   | on   | on   | on  | on | on | on  | on  | on  | on  |

**Conclusion:** It can be ensured that the proximity sensor can be valid triggered for the DUT tilt coverage exposure condition

## 6.10 BT Test Configuration

### BT specific wireless modes and SAR test:

The device is a mobile phone. It supports a BT high power feature in specific wireless modes and operating configurations. The maximum power of BT is different on different scenarios.

The BT of this device has two different operating modes:

- 1) Low power level mode (power level B, maximum duty cycle 100%) as default mode;
- 2) High power level mode (power level A, maximum duty cycle 100%) in specific wireless modes and operating configurations when the mobile phone is connected to an external audio device;

Note: For this device, power level B is  $\leq$  power level A.

Based on the BT high power mode detection technique description above, the different exposure conditions related to BT high power mode(Power level A) are listed as below table:

| Operating modes       | Max power level | Maximum duty cycle | Exposure condition Required for SAR testing |   |
|-----------------------|-----------------|--------------------|---|---|
|                       |                 |                    | Head<br>(Audio Receiver on)                 | Body                                    |
| Low power level mode  | power level B   | 100%               | <b>Yes</b><br><b>(See Below Note 1)</b>     | <b>Yes</b><br><b>(See Below Note 1)</b> |
| High power level mode | power level A   | 100%               | N/A<br><b>(See Below Note 2)</b>            | <b>Yes</b>                              |

**Note 1:** The BT SAR results at low power level B is still required because the simultaneous transmission possibilities for BT at lower power level B and high power level A are different. The BT SAR results at low power level B should be used to evaluation the simultaneous transmission SAR conditions not supported by BT higher power level A.

**Note 2:** High power level mode (power level A, maximum duty cycle 100%) is not applicable for Head exposure condtion(Audio Receiver on) by design.

**Note 3:** Both the power level A and B results will be tested and provided in the SAR report to validate the power reduction function works.

During the BT test, a test software tool (an APK) installed on the DUT is required to configure the DUT to transmit continuously at the high power level A.The APK function is only used to trigger mobile phone always transmitting power. It can be ensured that the unmodified settings in production units, including maximum output power, amplifier gain and other RF performance or tuning parameters, are used for SAR measurement.

## 7 SAR Measurement Results

### 7.1 Conducted power measurements

For the measurements a Radio Communication Tester was used.

SAR drift measured at the same position in liquid before and after each SAR test as below 7.2 chapter.

Note: Radio Communication Tester measures GSM peak and average output power for active timeslots.

For SAR the timebased average power is relevant. The difference in between depends on the duty cycle of the TDMA signal :

| No. of timeslots                                    | 1       | 2       | 3       | 4       |
|---|---------|---------|---------|---------|
| Duty Cycle  | 1:8.3   | 1:4.1   | 1:2.77  | 1:2.08  |
| timebased avg. power compared to slotted avg. power | -9.19dB | -6.13dB | -4.42dB | -3.18dB |

The signalling modes differ as follows:

| mode | coding scheme | modulation |
|------|---------------|------------|
| GPRS | CS1 to CS4    | GMSK       |
| EDGE | MCS1 to MCS4  | GMSK       |
| EDGE | MCS5 to MCS9  | 8PSK       |

Apart from modulation change (GMSK/8PSK) coding schemes differ in code rate without influence on the RF signal. Therefore, one coding scheme per mode was selected for conducted power measurements.

A Radio Communication Tester was used for LTE output power measurements and SAR testing. Closed loop power control was used so the UE transmits with maximum output power during SAR testing.

The Radio Communication Tester measures LTE TDD peak and average output power for active timeslots. LTE TDD peak and average output power for active timeslots. For SAR the time-based average power is relevant. The difference in between depends on the duty cycle of the TDMA signal:

For Time-Division Duplex (TDD) systems, SAR must be tested using a fixed periodic duty factor according to the highest transmission duty factor implemented for the device and supported by the defined 3GPP LTE TDD configurations.

| No. of Configuration                                 | 0              | 1       | 2       | 3       | 4       | 5        | 6       |
|--|----------------|---------|---------|---------|---------|----------|---------|
| Duty Cycle   | <b>0.6333</b>  | 0.4333  | 0.2333  | 0.3167  | 0.2167  | 0.1167   | 0.5333  |
| Time-based avg. power compared to slotted avg. power | <b>-1.98dB</b> | -3.63dB | -6.32dB | -4.99dB | -6.64dB | -9.33 dB | -2.73dB |

Note: According to duty cycle of configuration 0 to 6, Max output power should be Configuration 0, so we just tested the conduction power and SAR of configuration 0.

### 7.1.1 Conducted power measurements of GSM850 (Second Antenna)

| GSM850      |            | Burst-Averaged output Power (dBm) |              |              |              | Division Factors | Frame-Averaged output Power (dBm) |       |       |       |
|-------------|------------|-----------------------------------|--------------|--------------|--------------|------------------|-----------------------------------|-------|-------|-------|
|             |            | Tune-up Max.                      | 128CH        | 190CH        | 251CH        |                  | Tune-up Max.                      | 128CH | 190CH | 251CH |
| GSM (CS)    |            | 33.00                             | <b>31.83</b> | <b>32.06</b> | <b>31.95</b> | -9.19            | 23.81                             | 22.64 | 22.87 | 22.76 |
| GPRS (GMSK) | 1 Tx Slot  | 33.00                             | 31.88        | 32.06        | 31.96        | -9.19            | 23.81                             | 22.69 | 22.87 | 22.77 |
|             | 2 Tx Slots | 31.00                             | 29.46        | 29.71        | 29.57        | -6.13            | 24.87                             | 23.33 | 23.58 | 23.44 |
|             | 3 Tx Slots | 29.00                             | 27.34        | 27.44        | 27.29        | -4.42            | 24.58                             | 22.92 | 23.02 | 22.87 |
|             | 4 Tx Slots | 27.00                             | 25.07        | 25.27        | 25.13        | -3.18            | 23.82                             | 21.89 | 22.09 | 21.95 |
| EDGE (GMSK) | 1 Tx Slot  | 33.00                             | 31.84        | 32.09        | 31.91        | -9.19            | 23.81                             | 22.65 | 22.90 | 22.72 |
|             | 2 Tx Slots | 31.00                             | 29.52        | 29.67        | 29.52        | -6.13            | 24.87                             | 23.39 | 23.54 | 23.39 |
|             | 3 Tx Slots | 29.00                             | 27.32        | 27.49        | 27.33        | -4.42            | 24.58                             | 22.90 | 23.07 | 22.91 |
|             | 4 Tx Slots | 27.00                             | 25.17        | 25.27        | 25.13        | -3.18            | 23.82                             | 21.99 | 22.09 | 21.95 |
| EDGE (8PSK) | 1 Tx Slot  | 26.50                             | 25.48        | 25.38        | 25.23        | -9.19            | 17.31                             | 16.29 | 16.19 | 16.04 |
|             | 2 Tx Slots | 25.50                             | 23.88        | 23.83        | 23.64        | -6.13            | 19.37                             | 17.75 | 17.70 | 17.51 |
|             | 3 Tx Slots | 23.50                             | 21.79        | 21.85        | 21.64        | -4.42            | 19.08                             | 17.37 | 17.43 | 17.22 |
|             | 4 Tx Slots | 22.50                             | 20.62        | 20.58        | 20.47        | -3.18            | 19.32                             | 17.44 | 17.40 | 17.29 |

Table 13:Conducted power measurement results of GSM850(Full Power)

| GSM850      |            | Burst-Averaged output Power (dBm) |              |              |              | Division Factors | Frame-Averaged output Power (dBm) |       |       |       |
|-------------|------------|-----------------------------------|--------------|--------------|--------------|------------------|-----------------------------------|-------|-------|-------|
|             |            | Tune-up Max.                      | 128CH        | 190CH        | 251CH        |                  | Tune-up Max.                      | 128CH | 190CH | 251CH |
| GSM (CS)    |            | 29.50                             | <b>28.14</b> | <b>28.21</b> | <b>28.16</b> | -9.19            | 20.31                             | 18.95 | 19.02 | 18.97 |
| GPRS (GMSK) | 1 Tx Slot  | 29.50                             | 28.11        | 28.31        | 28.08        | -9.19            | 20.31                             | 18.92 | 19.12 | 18.89 |
|             | 2 Tx Slots | 27.50                             | 25.91        | 26.12        | 25.96        | -6.13            | 21.37                             | 19.78 | 19.99 | 19.83 |
|             | 3 Tx Slots | 25.50                             | 23.71        | 23.89        | 23.73        | -4.42            | 21.08                             | 19.29 | 19.47 | 19.31 |
|             | 4 Tx Slots | 23.50                             | 21.36        | 21.61        | 21.53        | -3.18            | 20.32                             | 18.18 | 18.43 | 18.35 |
| EDGE (GMSK) | 1 Tx Slot  | 29.50                             | 28.23        | 28.22        | 28.13        | -9.19            | 20.31                             | 19.04 | 19.03 | 18.94 |
|             | 2 Tx Slots | 27.50                             | 25.95        | 26.06        | 26.03        | -6.13            | 21.37                             | 19.82 | 19.93 | 19.90 |
|             | 3 Tx Slots | 25.50                             | 23.68        | 23.83        | 23.66        | -4.42            | 21.08                             | 19.26 | 19.41 | 19.24 |
|             | 4 Tx Slots | 23.50                             | 21.33        | 21.60        | 21.55        | -3.18            | 20.32                             | 18.15 | 18.42 | 18.37 |
| EDGE (8PSK) | 1 Tx Slot  | 23.00                             | 21.77        | 21.63        | 21.49        | -9.19            | 13.81                             | 12.58 | 12.44 | 12.30 |
|             | 2 Tx Slots | 22.00                             | 20.55        | 20.48        | 20.29        | -6.13            | 15.87                             | 14.42 | 14.35 | 14.16 |
|             | 3 Tx Slots | 20.00                             | 18.23        | 18.25        | 18.06        | -4.42            | 15.58                             | 13.81 | 13.83 | 13.64 |
|             | 4 Tx Slots | 19.00                             | 16.70        | 16.74        | 16.52        | -3.18            | 15.82                             | 13.52 | 13.56 | 13.34 |

Table 14:Conducted power measurement results of GSM850(Reduced Power Level D1)

| GSM850      |            | Burst-Averaged output Power (dBm) |              |              |              | Division Factors | Frame-Averaged output Power (dBm) |       |       |       |
|-------------|------------|-----------------------------------|--------------|--------------|--------------|------------------|-----------------------------------|-------|-------|-------|
|             |            | Tune-up Max.                      | 128CH        | 190CH        | 251CH        |                  | Tune-up Max.                      | 128CH | 190CH | 251CH |
| GSM (CS)    |            | 30.00                             | 28.70        | 28.77        | 28.61        | -9.19            | 20.81                             | 19.51 | 19.58 | 19.42 |
| GPRS (GMSK) | 1 Tx Slot  | 30.00                             | 28.66        | 28.77        | 28.62        | -9.19            | 20.81                             | 19.47 | 19.58 | 19.43 |
|             | 2 Tx Slots | 28.00                             | <b>26.54</b> | <b>26.62</b> | <b>26.45</b> | -6.13            | 21.87                             | 20.41 | 20.49 | 20.32 |
|             | 3 Tx Slots | 26.00                             | 24.26        | 24.44        | 24.27        | -4.42            | 21.58                             | 19.84 | 20.02 | 19.85 |
|             | 4 Tx Slots | 24.00                             | 21.89        | 22.02        | 21.95        | -3.18            | 20.82                             | 18.71 | 18.84 | 18.77 |
| EDGE (GMSK) | 1 Tx Slot  | 30.00                             | 28.67        | 28.78        | 28.63        | -9.19            | 20.81                             | 19.48 | 19.59 | 19.44 |
|             | 2 Tx Slots | 28.00                             | 26.47        | 26.65        | 26.51        | -6.13            | 21.87                             | 20.34 | 20.52 | 20.38 |
|             | 3 Tx Slots | 26.00                             | 24.34        | 24.40        | 24.25        | -4.42            | 21.58                             | 19.92 | 19.98 | 19.83 |
|             | 4 Tx Slots | 24.00                             | 21.86        | 22.13        | 22.05        | -3.18            | 20.82                             | 18.68 | 18.95 | 18.87 |
| EDGE (8PSK) | 1 Tx Slot  | 23.50                             | 22.20        | 23.34        | 23.12        | -9.19            | 14.31                             | 13.01 | 14.15 | 13.93 |
|             | 2 Tx Slots | 22.50                             | 21.02        | 20.97        | 20.64        | -6.13            | 16.37                             | 14.89 | 14.84 | 14.51 |
|             | 3 Tx Slots | 20.50                             | 18.87        | 18.76        | 18.63        | -4.42            | 16.08                             | 14.45 | 14.34 | 14.21 |
|             | 4 Tx Slots | 19.50                             | 17.56        | 17.62        | 17.42        | -3.18            | 16.32                             | 14.38 | 14.44 | 14.24 |

Table 15: Test results conducted power measurement of GSM850 (Reduced Power Level D2)

| GSM850      |            | Burst-Averaged output Power (dBm) |       |       |       | Division Factors | Frame-Averaged output Power (dBm) |       |       |       |
|-------------|------------|-----------------------------------|-------|-------|-------|------------------|-----------------------------------|-------|-------|-------|
|             |            | Tune-up Max.                      | 128CH | 190CH | 251CH |                  | Tune-up Max.                      | 128CH | 190CH | 251CH |
| GSM (CS)    |            | 26.50                             | 25.10 | 25.27 | 25.09 | -9.19            | 17.31                             | 15.91 | 16.08 | 15.90 |
| GPRS (GMSK) | 1 Tx Slot  | 26.50                             | 25.15 | 25.26 | 25.09 | -9.19            | 17.31                             | 15.96 | 16.07 | 15.90 |
|             | 2 Tx Slots | 24.50                             | 22.96 | 23.13 | 22.94 | -6.13            | 18.37                             | 16.83 | 17.00 | 16.81 |
|             | 3 Tx Slots | 22.50                             | 20.51 | 20.78 | 20.70 | -4.42            | 18.08                             | 16.09 | 16.36 | 16.28 |
|             | 4 Tx Slots | 20.50                             | 18.27 | 18.55 | 18.46 | -3.18            | 17.32                             | 15.09 | 15.37 | 15.28 |
| EDGE (GMSK) | 1 Tx Slot  | 26.50                             | 25.21 | 25.26 | 25.02 | -9.19            | 17.31                             | 16.02 | 16.07 | 15.83 |
|             | 2 Tx Slots | 24.50                             | 22.99 | 23.07 | 22.90 | -6.13            | 18.37                             | 16.86 | 16.94 | 16.77 |
|             | 3 Tx Slots | 22.50                             | 20.60 | 20.75 | 20.65 | -4.42            | 18.08                             | 16.18 | 16.33 | 16.23 |
|             | 4 Tx Slots | 20.50                             | 18.36 | 18.54 | 18.46 | -3.18            | 17.32                             | 15.18 | 15.36 | 15.28 |
| EDGE (8PSK) | 1 Tx Slot  | 20.00                             | 18.77 | 18.60 | 18.45 | -9.19            | 10.81                             | 9.58  | 9.41  | 9.26  |
|             | 2 Tx Slots | 19.00                             | 17.07 | 17.02 | 16.85 | -6.13            | 12.87                             | 10.94 | 10.89 | 10.72 |
|             | 3 Tx Slots | 17.00                             | 15.05 | 14.99 | 14.81 | -4.42            | 12.58                             | 10.63 | 10.57 | 10.39 |
|             | 4 Tx Slots | 16.00                             | 13.93 | 13.94 | 13.76 | -3.18            | 12.82                             | 10.75 | 10.76 | 10.58 |

Table 16: Test results conducted power measurement of GSM850 (Reduced Power Level D3)

Note:

- 1) Frame-averaged output power was calculated from the measured burst-averaged output power by converting the slot powers into linear units and calculating the energy over 8 timeslots.
- 2) Per KDB941225 D01, SAR test reduction for GPRS and EDGE modes is determined by the source-based time-averaged output power specified for production units, including tune-up tolerance. The data mode with highest specified time-averaged output power should be tested for SAR compliance in the applicable exposure conditions. For modes with the same specified maximum output power and tolerance, the higher number time-slot configuration should be tested.

### 7.1.2 Conducted power measurements of GSM850 (Main Antenna)

| GSM850      |            | Burst-Averaged output Power (dBm) |              |              |              | Division Factors | Frame-Averaged output Power (dBm) |       |       |       |
|-------------|------------|-----------------------------------|--------------|--------------|--------------|------------------|-----------------------------------|-------|-------|-------|
|             |            | Tune-up Max.                      | 128CH        | 190CH        | 251CH        |                  | Tune-up Max.                      | 128CH | 190CH | 251CH |
| GSM (CS)    |            | 33.50                             | <b>32.24</b> | <b>32.61</b> | <b>32.78</b> | -9.19            | 24.31                             | 23.05 | 23.42 | 23.59 |
| GPRS (GMSK) | 1 Tx Slot  | 33.50                             | 32.26        | 32.54        | 32.82        | -9.19            | 24.31                             | 23.07 | 23.35 | 23.63 |
|             | 2 Tx Slots | 31.50                             | <b>29.89</b> | <b>30.20</b> | <b>30.34</b> | -6.13            | 25.37                             | 23.76 | 24.07 | 24.21 |
|             | 3 Tx Slots | 29.50                             | 27.62        | 27.89        | 28.09        | -4.42            | 25.08                             | 23.20 | 23.47 | 23.67 |
|             | 4 Tx Slots | 27.50                             | 25.32        | 25.75        | 25.82        | -3.18            | 24.32                             | 22.14 | 22.57 | 22.64 |
| EDGE (GMSK) | 1 Tx Slot  | 33.50                             | 32.33        | 32.63        | 32.80        | -9.19            | 24.31                             | 23.14 | 23.44 | 23.61 |
|             | 2 Tx Slots | 31.50                             | 29.88        | 30.19        | 30.33        | -6.13            | 25.37                             | 23.75 | 24.06 | 24.20 |
|             | 3 Tx Slots | 29.50                             | 27.64        | 27.91        | 28.01        | -4.42            | 25.08                             | 23.22 | 23.49 | 23.59 |
|             | 4 Tx Slots | 27.50                             | 25.34        | 25.71        | 25.82        | -3.18            | 24.32                             | 22.16 | 22.53 | 22.64 |
| EDGE (8PSK) | 1 Tx Slot  | 27.00                             | 25.82        | 25.91        | 25.97        | -9.19            | 17.81                             | 16.63 | 16.72 | 16.78 |
|             | 2 Tx Slots | 26.00                             | 24.09        | 24.32        | 24.35        | -6.13            | 19.87                             | 17.96 | 18.19 | 18.22 |
|             | 3 Tx Slots | 24.00                             | 22.07        | 22.20        | 22.21        | -4.42            | 19.58                             | 17.65 | 17.78 | 17.79 |
|             | 4 Tx Slots | 23.00                             | 20.81        | 21.01        | 21.03        | -3.18            | 19.82                             | 17.63 | 17.83 | 17.85 |

Table 17: Conducted power measurement results of GSM850(Full Power)

Note:

- 1) Frame-averaged output power was calculated from the measured burst-averaged output power by converting the slot powers into linear units and calculating the energy over 8 timeslots.
- 2) Per KDB941225 D01, SAR test reduction for GPRS and EDGE modes is determined by the source-based time-averaged output power specified for production units, including tune-up tolerance. The data mode with highest specified time-averaged output power should be tested for SAR compliance in the applicable exposure conditions. For modes with the same specified maximum output power and tolerance, the higher number time-slot configuration should be tested.



### 7.1.3 Conducted power measurements of GSM1900 (Second Antenna)

| GSM1900     |            | Burst-Averaged output Power (dBm) |              |              |              | Division Factors | Frame-Averaged output Power (dBm) |       |       |       |
|-------------|------------|-----------------------------------|--------------|--------------|--------------|------------------|-----------------------------------|-------|-------|-------|
|             |            | Tune-up Max.                      | 512CH        | 661CH        | 810CH        |                  | Tune-up Max.                      | 512CH | 661CH | 810CH |
| GSM (CS)    |            | 29.50                             | <b>29.11</b> | <b>29.12</b> | <b>29.24</b> | -9.19            | 20.31                             | 19.92 | 19.93 | 20.05 |
| GPRS (GMSK) | 1 Tx Slot  | 29.50                             | 29.07        | 29.11        | 29.25        | -9.19            | 20.31                             | 19.88 | 19.92 | 20.06 |
|             | 2 Tx Slots | 27.50                             | 26.56        | 26.75        | 26.98        | -6.13            | 21.37                             | 20.43 | 20.62 | 20.85 |
|             | 3 Tx Slots | 25.50                             | 24.44        | 24.51        | 24.72        | -4.42            | 21.08                             | 20.02 | 20.09 | 20.30 |
|             | 4 Tx Slots | 23.50                             | 22.33        | 22.49        | 22.70        | -3.18            | 20.32                             | 19.15 | 19.31 | 19.52 |
| EDGE (GMSK) | 1 Tx Slot  | 29.50                             | 29.03        | 29.19        | 29.24        | -9.19            | 20.31                             | 19.84 | 20.00 | 20.05 |
|             | 2 Tx Slots | 27.50                             | 26.55        | 26.73        | 26.97        | -6.13            | 21.37                             | 20.42 | 20.60 | 20.84 |
|             | 3 Tx Slots | 25.50                             | 24.42        | 24.50        | 24.72        | -4.42            | 21.08                             | 20.00 | 20.08 | 20.30 |
|             | 4 Tx Slots | 23.50                             | 22.32        | 22.49        | 22.68        | -3.18            | 20.32                             | 19.14 | 19.31 | 19.50 |
| EDGE (8PSK) | 1 Tx Slot  | 25.00                             | 23.95        | 24.08        | 24.46        | -9.19            | 15.81                             | 14.76 | 14.89 | 15.27 |
|             | 2 Tx Slots | 24.00                             | 22.69        | 22.88        | 23.22        | -6.13            | 17.87                             | 16.56 | 16.75 | 17.09 |
|             | 3 Tx Slots | 22.00                             | 20.65        | 20.81        | 21.16        | -4.42            | 17.58                             | 16.23 | 16.39 | 16.74 |
|             | 4 Tx Slots | 21.00                             | 19.56        | 19.71        | 20.04        | -3.18            | 17.82                             | 16.38 | 16.53 | 16.86 |

Table 18: Conducted power measurement results of GSM1900(Full Power)

| GSM1900     |            | Burst-Averaged output Power (dBm) |              |              |              | Division Factors | Frame-Averaged output Power (dBm) |       |       |       |
|-------------|------------|-----------------------------------|--------------|--------------|--------------|------------------|-----------------------------------|-------|-------|-------|
|             |            | Tune-up Max.                      | 512CH        | 661CH        | 810CH        |                  | Tune-up Max.                      | 512CH | 661CH | 810CH |
| GSM (CS)    |            | 26.50                             | <b>25.52</b> | <b>25.67</b> | <b>25.89</b> | -9.19            | 17.31                             | 16.33 | 16.48 | 16.70 |
| GPRS (GMSK) | 1 Tx Slot  | 26.50                             | 25.56        | 25.65        | 25.89        | -9.19            | 17.31                             | 16.37 | 16.46 | 16.70 |
|             | 2 Tx Slots | 24.50                             | 23.47        | 23.52        | 23.73        | -6.13            | 18.37                             | 17.34 | 17.39 | 17.60 |
|             | 3 Tx Slots | 22.50                             | 21.38        | 21.51        | 21.73        | -4.42            | 18.08                             | 16.96 | 17.09 | 17.31 |
|             | 4 Tx Slots | 20.50                             | 19.33        | 19.58        | 19.92        | -3.18            | 17.32                             | 16.15 | 16.40 | 16.74 |
| EDGE (GMSK) | 1 Tx Slot  | 26.50                             | 25.62        | 25.75        | 25.90        | -9.19            | 17.31                             | 16.43 | 16.56 | 16.71 |
|             | 2 Tx Slots | 24.50                             | 23.45        | 23.50        | 23.82        | -6.13            | 18.37                             | 17.32 | 17.37 | 17.69 |
|             | 3 Tx Slots | 22.50                             | 21.35        | 21.51        | 21.72        | -4.42            | 18.08                             | 16.93 | 17.09 | 17.30 |
|             | 4 Tx Slots | 20.50                             | 19.33        | 19.60        | 19.91        | -3.18            | 17.32                             | 16.15 | 16.42 | 16.73 |
| EDGE (8PSK) | 1 Tx Slot  | 22.00                             | 20.84        | 20.96        | 21.23        | -9.19            | 12.81                             | 11.65 | 11.77 | 12.04 |
|             | 2 Tx Slots | 21.00                             | 19.68        | 19.86        | 20.19        | -6.13            | 14.87                             | 13.55 | 13.73 | 14.06 |
|             | 3 Tx Slots | 19.00                             | 17.67        | 17.83        | 18.15        | -4.42            | 14.58                             | 13.25 | 13.41 | 13.73 |
|             | 4 Tx Slots | 18.00                             | 16.47        | 16.65        | 17.06        | -3.18            | 14.82                             | 13.29 | 13.47 | 13.88 |

Table 19: Test results conducted power measurement of GSM1900 (Reduced Power Level D1)

| GSM1900     |            | Burst-Averaged output Power (dBm) |              |              |              | Division Factors | Frame-Averaged output Power (dBm) |       |       |       |
|-------------|------------|-----------------------------------|--------------|--------------|--------------|------------------|-----------------------------------|-------|-------|-------|
|             |            | Tune-up Max.                      | 512CH        | 661CH        | 810CH        |                  | Tune-up Max.                      | 512CH | 661CH | 810CH |
| GSM (CS)    |            | 25.00                             | 24.01        | 24.17        | 24.37        | -9.19            | 15.81                             | 14.82 | 14.98 | 15.18 |
| GPRS (GMSK) | 1 Tx Slot  | 25.00                             | 23.97        | 24.16        | 24.28        | -9.19            | 15.81                             | 14.78 | 14.97 | 15.09 |
|             | 2 Tx Slots | 23.00                             | <b>21.97</b> | <b>22.04</b> | <b>22.25</b> | -6.13            | 16.87                             | 15.84 | 15.91 | 16.12 |
|             | 3 Tx Slots | 21.00                             | 19.86        | 20.00        | 20.21        | -4.42            | 16.58                             | 15.44 | 15.58 | 15.79 |
|             | 4 Tx Slots | 19.00                             | 17.93        | 18.19        | 18.39        | -3.18            | 15.82                             | 14.75 | 15.01 | 15.21 |
| EDGE (GMSK) | 1 Tx Slot  | 25.00                             | 24.06        | 24.15        | 24.38        | -9.19            | 15.81                             | 14.87 | 14.96 | 15.19 |
|             | 2 Tx Slots | 23.00                             | 21.94        | 22.02        | 22.23        | -6.13            | 16.87                             | 15.81 | 15.89 | 16.10 |
|             | 3 Tx Slots | 21.00                             | 19.85        | 19.99        | 20.20        | -4.42            | 16.58                             | 15.43 | 15.57 | 15.78 |
|             | 4 Tx Slots | 19.00                             | 17.91        | 18.18        | 18.39        | -3.18            | 15.82                             | 14.73 | 15.00 | 15.21 |
| EDGE (8PSK) | 1 Tx Slot  | 20.50                             | 19.34        | 19.45        | 19.18        | -9.19            | 11.31                             | 10.15 | 10.26 | 9.99  |
|             | 2 Tx Slots | 19.50                             | 19.27        | 18.45        | 19.43        | -6.13            | 13.37                             | 13.14 | 12.32 | 13.30 |
|             | 3 Tx Slots | 17.50                             | 17.18        | 17.34        | 17.46        | -4.42            | 13.08                             | 12.76 | 12.92 | 13.04 |
|             | 4 Tx Slots | 16.50                             | 15.09        | 15.97        | 15.57        | -3.18            | 13.32                             | 11.91 | 12.79 | 12.39 |

Table 20: Test results conducted power measurement of GSM1900 (Reduced Power Level D2)

| GSM1900     |            | Burst-Averaged output Power (dBm) |       |       |       | Division Factors | Frame-Averaged output Power (dBm) |       |       |       |
|-------------|------------|-----------------------------------|-------|-------|-------|------------------|-----------------------------------|-------|-------|-------|
|             |            | Tune-up Max.                      | 512CH | 661CH | 810CH |                  | Tune-up Max.                      | 512CH | 661CH | 810CH |
| GSM (CS)    |            | 22.00                             | 20.97 | 20.99 | 21.19 | -9.19            | 12.81                             | 11.78 | 11.80 | 12.00 |
| GPRS (GMSK) | 1 Tx Slot  | 22.00                             | 20.91 | 20.98 | 21.19 | -9.19            | 12.81                             | 11.72 | 11.79 | 12.00 |
|             | 2 Tx Slots | 20.00                             | 18.99 | 19.23 | 19.43 | -6.13            | 13.87                             | 12.86 | 13.10 | 13.30 |
|             | 3 Tx Slots | 18.00                             | 16.91 | 17.16 | 17.46 | -4.42            | 13.58                             | 12.49 | 12.74 | 13.04 |
|             | 4 Tx Slots | 16.00                             | 14.81 | 15.05 | 15.34 | -3.18            | 12.82                             | 11.63 | 11.87 | 12.16 |
| EDGE (GMSK) | 1 Tx Slot  | 22.00                             | 20.97 | 21.07 | 21.19 | -9.19            | 12.81                             | 11.78 | 11.88 | 12.00 |
|             | 2 Tx Slots | 20.00                             | 18.97 | 19.20 | 19.43 | -6.13            | 13.87                             | 12.84 | 13.07 | 13.30 |
|             | 3 Tx Slots | 18.00                             | 16.88 | 17.15 | 17.45 | -4.42            | 13.58                             | 12.46 | 12.73 | 13.03 |
|             | 4 Tx Slots | 16.00                             | 14.80 | 15.04 | 15.31 | -3.18            | 12.82                             | 11.62 | 11.86 | 12.13 |
| EDGE (8PSK) | 1 Tx Slot  | 17.50                             | 16.38 | 16.49 | 16.85 | -9.19            | 8.31                              | 7.19  | 7.30  | 7.66  |
|             | 2 Tx Slots | 16.50                             | 15.30 | 16.50 | 15.80 | -6.13            | 10.37                             | 9.17  | 10.37 | 9.67  |
|             | 3 Tx Slots | 14.50                             | 13.16 | 13.41 | 13.74 | -4.42            | 10.08                             | 8.74  | 8.99  | 9.32  |
|             | 4 Tx Slots | 13.50                             | 12.06 | 12.66 | 12.65 | -3.18            | 10.32                             | 8.88  | 9.48  | 9.47  |

Table 21: Test results conducted power measurement of GSM1900 (Reduced Power Level D3)

Note:

- 1) Frame-averaged output power was calculated from the measured burst-averaged output power by converting the slot powers into linear units and calculating the energy over 8 timeslots.
- 2) Per KDB941225 D01, SAR test reduction for GPRS and EDGE modes is determined by the source-based time-averaged output power specified for production units, including tune-up tolerance. The data mode with highest specified time-averaged output power should be tested for SAR compliance in the applicable exposure conditions. For modes with the same specified maximum output power and tolerance, the higher number time-slot configuration should be tested.

### 7.1.4 Conducted power measurements of GSM1900 (Main Antenna)

| GSM1900     |            | Burst-Averaged output Power (dBm) |              |              |              | Division Factors | Frame-Averaged output Power (dBm) |       |       |       |
|-------------|------------|-----------------------------------|--------------|--------------|--------------|------------------|-----------------------------------|-------|-------|-------|
|             |            | Tune-up Max.                      | 512CH        | 661CH        | 810CH        |                  | Tune-up Max.                      | 512CH | 661CH | 810CH |
| GSM (CS)    |            | 30.50                             | <b>30.49</b> | <b>30.46</b> | <b>30.42</b> | -9.19            | 21.31                             | 21.30 | 21.27 | 21.23 |
| GPRS (GMSK) | 1 Tx Slot  | 30.50                             | 30.49        | 30.44        | 30.38        | -9.19            | 21.31                             | 21.30 | 21.25 | 21.19 |
|             | 2 Tx Slots | 28.50                             | 27.87        | 28.00        | 28.15        | -6.13            | 22.37                             | 21.74 | 21.87 | 22.02 |
|             | 3 Tx Slots | 26.50                             | 25.60        | 25.76        | 25.88        | -4.42            | 22.08                             | 21.18 | 21.34 | 21.46 |
|             | 4 Tx Slots | 24.50                             | 23.65        | 23.71        | 23.77        | -3.18            | 21.32                             | 20.47 | 20.53 | 20.59 |
| EDGE (GMSK) | 1 Tx Slot  | 30.50                             | 30.48        | 30.44        | 30.39        | -9.19            | 21.31                             | 21.29 | 21.25 | 21.20 |
|             | 2 Tx Slots | 28.50                             | 27.84        | 28.02        | 28.02        | -6.13            | 22.37                             | 21.71 | 21.89 | 21.89 |
|             | 3 Tx Slots | 26.50                             | 25.59        | 25.77        | 25.84        | -4.42            | 22.08                             | 21.17 | 21.35 | 21.42 |
|             | 4 Tx Slots | 24.50                             | 23.55        | 23.70        | 23.75        | -3.18            | 21.32                             | 20.37 | 20.52 | 20.57 |
| EDGE (8PSK) | 1 Tx Slot  | 26.00                             | 25.03        | 25.28        | 25.42        | -9.19            | 16.81                             | 15.84 | 16.09 | 16.23 |
|             | 2 Tx Slots | 25.00                             | 23.83        | 24.03        | 24.31        | -6.13            | 18.87                             | 17.70 | 17.90 | 18.18 |
|             | 3 Tx Slots | 23.00                             | 21.70        | 21.91        | 22.12        | -4.42            | 18.58                             | 17.28 | 17.49 | 17.70 |
|             | 4 Tx Slots | 22.00                             | 20.67        | 20.86        | 20.95        | -3.18            | 18.82                             | 17.49 | 17.68 | 17.77 |

Table 22: Conducted power measurement results of GSM1900(Full Power)

| GSM1900     |            | Burst-Averaged output Power (dBm) |              |              |              | Division Factors | Frame-Averaged output Power (dBm) |       |       |       |
|-------------|------------|-----------------------------------|--------------|--------------|--------------|------------------|-----------------------------------|-------|-------|-------|
|             |            | Tune-up Max.                      | 512CH        | 661CH        | 810CH        |                  | Tune-up Max.                      | 512CH | 661CH | 810CH |
| GSM (CS)    |            | 30.00                             | 29.78        | 29.99        | 29.92        | -9.19            | 20.81                             | 20.59 | 20.80 | 20.73 |
| GPRS (GMSK) | 1 Tx Slot  | 30.00                             | 29.80        | 29.90        | 29.92        | -9.19            | 20.81                             | 20.61 | 20.71 | 20.73 |
|             | 2 Tx Slots | 28.00                             | <b>27.66</b> | <b>27.83</b> | <b>27.87</b> | -6.13            | 21.87                             | 21.53 | 21.70 | 21.74 |
|             | 3 Tx Slots | 26.00                             | 25.44        | 25.72        | 25.75        | -4.42            | 21.58                             | 21.02 | 21.30 | 21.33 |
|             | 4 Tx Slots | 24.00                             | 23.35        | 23.61        | 23.65        | -3.18            | 20.82                             | 20.17 | 20.43 | 20.47 |
| EDGE (GMSK) | 1 Tx Slot  | 30.00                             | 29.87        | 29.97        | 29.88        | -9.19            | 20.81                             | 20.68 | 20.78 | 20.69 |
|             | 2 Tx Slots | 28.00                             | 27.63        | 27.91        | 27.96        | -6.13            | 21.87                             | 21.50 | 21.78 | 21.83 |
|             | 3 Tx Slots | 26.00                             | 25.43        | 25.69        | 25.73        | -4.42            | 21.58                             | 21.01 | 21.27 | 21.31 |
|             | 4 Tx Slots | 24.00                             | 23.34        | 23.61        | 23.63        | -3.18            | 20.82                             | 20.16 | 20.43 | 20.45 |
| EDGE (8PSK) | 1 Tx Slot  | 25.50                             | 24.94        | 25.28        | 25.39        | -9.19            | 16.31                             | 15.75 | 16.09 | 16.20 |
|             | 2 Tx Slots | 24.50                             | 23.72        | 24.02        | 24.10        | -6.13            | 18.37                             | 17.59 | 17.89 | 17.97 |
|             | 3 Tx Slots | 22.50                             | 21.61        | 21.89        | 22.05        | -4.42            | 18.08                             | 17.19 | 17.47 | 17.63 |
|             | 4 Tx Slots | 21.50                             | 20.54        | 20.82        | 20.98        | -3.18            | 18.32                             | 17.36 | 17.64 | 17.80 |

Table 23: Test results conducted power measurement of GSM1900 (Reduced Power Level D3/D4/D5/D6)

Note:

- 1) Frame-averaged output power was calculated from the measured burst-averaged output power by converting the slot powers into linear units and calculating the energy over 8 timeslots.
- 2) Per KDB941225 D01, SAR test reduction for GPRS and EDGE modes is determined by the source-based time-averaged output power specified for production units, including tune-up tolerance. The data mode with highest specified time-averaged output power should be tested for SAR compliance in the applicable exposure conditions. For modes with the same specified maximum output power and tolerance, the higher number time-slot configuration should be tested.

### 7.1.5 Conducted power measurements of UMTS Band II (Second Antenna)

| UMTS Band II |              | Tune-up | Channel      | Channel      | Channel      |
|--------------|--------------|---------|--------------|--------------|--------------|
|              |              | Max.    | 9262CH       | 9400CH       | 9538CH       |
| WCDMA        | 12.2kbps RMC | 21.00   | <b>20.08</b> | <b>20.12</b> | <b>19.98</b> |
|              | 12.2kbps AMR | 21.00   | 20.19        | 20.10        | 20.00        |
| HSDPA        | Subtest 1    | 21.00   | 19.55        | 19.60        | 19.49        |
|              | Subtest 2    | 21.00   | 18.91        | 18.82        | 18.68        |
|              | Subtest 3    | 20.50   | 18.76        | 18.72        | 18.56        |
|              | Subtest 4    | 20.50   | 18.77        | 18.70        | 18.57        |
| HSUPA        | Subtest 1    | 20.50   | 18.12        | 17.86        | 18.20        |
|              | Subtest 2    | 18.50   | 16.08        | 15.84        | 15.46        |
|              | Subtest 3    | 19.50   | 16.71        | 16.34        | 16.23        |
|              | Subtest 4    | 19.00   | 15.88        | 15.88        | 15.76        |
|              | Subtest 5    | 20.00   | 18.09        | 18.13        | 18.02        |
| DC-HSDPA     | Subtest 1    | 21.00   | 19.56        | 19.61        | 19.48        |
|              | Subtest 2    | 21.00   | 18.89        | 18.82        | 18.71        |
|              | Subtest 3    | 20.50   | 18.77        | 18.70        | 18.58        |
|              | Subtest 4    | 20.50   | 18.75        | 18.73        | 18.59        |

Table 24: Conducted power measurement results of UMTS Band II(Full Power)

| UMTS Band II |              | Tune-up | Channel      | Channel      | Channel      |
|--------------|--------------|---------|--------------|--------------|--------------|
|              |              | Max.    | 9262CH       | 9400CH       | 9538CH       |
| WCDMA        | 12.2kbps RMC | 16.00   | <b>15.11</b> | <b>15.08</b> | <b>14.99</b> |
|              | 12.2kbps AMR | 16.00   | 15.21        | 15.09        | 14.98        |
| HSDPA        | Subtest 1    | 16.00   | 15.15        | 14.61        | 14.39        |
|              | Subtest 2    | 16.00   | 14.42        | 13.94        | 13.91        |
|              | Subtest 3    | 15.50   | 14.23        | 13.65        | 13.47        |
|              | Subtest 4    | 15.50   | 14.26        | 13.68        | 13.48        |
| HSUPA        | Subtest 1    | 15.50   | 13.26        | 13.05        | 12.74        |
|              | Subtest 2    | 13.50   | 11.40        | 10.32        | 10.02        |
|              | Subtest 3    | 14.50   | 12.01        | 11.68        | 11.61        |
|              | Subtest 4    | 14.00   | 11.17        | 10.30        | 10.10        |
|              | Subtest 5    | 15.00   | 13.94        | 13.25        | 13.13        |
| DC-HSDPA     | Subtest 1    | 16.00   | 15.24        | 14.61        | 14.38        |
|              | Subtest 2    | 16.00   | 14.38        | 13.91        | 13.90        |
|              | Subtest 3    | 15.50   | 14.22        | 13.65        | 13.56        |
|              | Subtest 4    | 15.50   | 14.24        | 13.69        | 13.59        |

Table 25: Conducted power measurement results of UMTS Band II(Reduced Power Level D1)

| UMTS Band II |              | Tune-up | Channel | Channel | Channel |
|--------------|--------------|---------|---------|---------|---------|
|              |              | Max.    | 9262CH  | 9400CH  | 9538CH  |
| WCDMA        | 12.2kbps RMC | 12.00   | 12.00   | 11.42   | 11.40   |
|              | 12.2kbps AMR | 12.00   | 11.93   | 11.50   | 11.59   |
| HSDPA        | Subtest 1    | 12.00   | 11.40   | 10.84   | 10.82   |
|              | Subtest 2    | 12.00   | 10.70   | 10.16   | 10.16   |
|              | Subtest 3    | 11.50   | 10.40   | 9.88    | 9.90    |
|              | Subtest 4    | 11.50   | 10.54   | 9.91    | 9.90    |
| HSUPA        | Subtest 1    | 11.50   | 11.27   | 10.11   | 10.85   |
|              | Subtest 2    | 9.50    | 7.61    | 6.51    | 6.30    |
|              | Subtest 3    | 10.50   | 8.31    | 8.02    | 7.93    |
|              | Subtest 4    | 10.00   | 7.37    | 6.58    | 6.47    |
|              | Subtest 5    | 11.00   | 10.93   | 10.83   | 10.91   |
| DC-HSDPA     | Subtest 1    | 12.00   | 11.39   | 10.84   | 10.82   |
|              | Subtest 2    | 12.00   | 10.68   | 10.13   | 10.15   |
|              | Subtest 3    | 11.50   | 10.50   | 9.88    | 9.98    |
|              | Subtest 4    | 11.50   | 10.51   | 9.92    | 10.02   |

Table 26: Conducted power measurement results of UMTS Band II(Reduced Power Level D3)

| UMTS Band II |              | Tune-up | Channel      | Channel      | Channel      |
|--------------|--------------|---------|--------------|--------------|--------------|
|              |              | Max.    | 9262CH       | 9400CH       | 9538CH       |
| WCDMA        | 12.2kbps RMC | 17.00   | <b>16.23</b> | <b>16.13</b> | <b>16.00</b> |
|              | 12.2kbps AMR | 17.00   | 16.21        | 16.14        | 15.97        |
| HSDPA        | Subtest 1    | 17.00   | 15.70        | 15.61        | 15.51        |
|              | Subtest 2    | 17.00   | 14.89        | 14.80        | 14.71        |
|              | Subtest 3    | 16.50   | 14.80        | 14.71        | 14.59        |
|              | Subtest 4    | 16.50   | 14.78        | 14.74        | 14.57        |
| HSUPA        | Subtest 1    | 16.50   | 14.15        | 13.72        | 13.81        |
|              | Subtest 2    | 14.50   | 12.26        | 11.09        | 10.98        |
|              | Subtest 3    | 15.50   | 13.00        | 12.68        | 12.38        |
|              | Subtest 4    | 15.00   | 12.03        | 11.18        | 11.10        |
|              | Subtest 5    | 16.00   | 14.78        | 14.24        | 14.22        |
| DC-HSDPA     | Subtest 1    | 17.00   | 15.66        | 15.62        | 15.52        |
|              | Subtest 2    | 17.00   | 14.88        | 14.82        | 14.69        |
|              | Subtest 3    | 16.50   | 14.81        | 14.74        | 14.60        |
|              | Subtest 4    | 16.50   | 14.81        | 14.71        | 14.58        |

Table 27: Conducted power measurement results of UMTS Band II(Reduced Power Level D2)

Note:

- 1) The bolded 12.2kbps RMC mode was selected for SAR testing (the primary mode).
- 2) Per KDB941225 D01, When the maximum output power and tune-up tolerance specified for production units in a Second mode is  $\leq \frac{1}{4}$  dB higher than the primary mode or when the highest *reported* SAR of the primary mode is scaled by the ratio of specified maximum output power and tune-up tolerance of Second to primary mode and the adjusted SAR is  $\leq 1.2$  W/kg, SAR measurement is not required for the Second mode.

### 7.1.6 Conducted power measurements of UMTS Band II (Main Antenna)

| UMTS Band II |              | Tune-up | Channel      | Channel      | Channel      |
|--------------|--------------|---------|--------------|--------------|--------------|
|              |              | Max.    | 9262CH       | 9400CH       | 9538CH       |
| WCDMA        | 12.2kbps RMC | 24.50   | <b>23.48</b> | <b>23.38</b> | <b>23.21</b> |
|              | 12.2kbps AMR | 24.50   | 23.47        | 23.33        | 23.25        |
| HSDPA        | Subtest 1    | 24.50   | 22.98        | 22.86        | 22.74        |
|              | Subtest 2    | 24.50   | 22.16        | 22.04        | 21.91        |
|              | Subtest 3    | 24.00   | 21.68        | 21.57        | 21.39        |
|              | Subtest 4    | 24.00   | 21.66        | 21.56        | 21.38        |
| HSUPA        | Subtest 1    | 24.00   | 21.75        | 21.55        | 21.32        |
|              | Subtest 2    | 22.00   | 18.96        | 18.88        | 18.26        |
|              | Subtest 3    | 23.00   | 19.71        | 19.63        | 20.15        |
|              | Subtest 4    | 22.50   | 19.21        | 19.04        | 19.30        |
|              | Subtest 5    | 23.50   | 21.46        | 21.31        | 21.20        |
| DC-HSDPA     | Subtest 1    | 24.50   | 23.05        | 22.96        | 22.81        |
|              | Subtest 2    | 24.50   | 22.32        | 22.25        | 22.13        |
|              | Subtest 3    | 24.00   | 21.58        | 21.69        | 21.74        |
|              | Subtest 4    | 24.00   | 21.71        | 21.55        | 21.69        |

Table 28: Conducted power measurement results of UMTS Band II(Full Power)

| UMTS Band II |              | Tune-up | Channel | Channel | Channel |
|--------------|--------------|---------|---------|---------|---------|
|              |              | Max.    | 9262CH  | 9400CH  | 9538CH  |
| WCDMA        | 12.2kbps RMC | 22.50   | 21.68   | 21.58   | 21.49   |
|              | 12.2kbps AMR | 22.50   | 21.79   | 21.61   | 21.49   |
| HSDPA        | Subtest 1    | 22.50   | 21.16   | 21.10   | 21.00   |
|              | Subtest 2    | 22.50   | 20.39   | 20.29   | 20.19   |
|              | Subtest 3    | 22.00   | 20.30   | 20.18   | 20.07   |
|              | Subtest 4    | 22.00   | 20.37   | 20.20   | 20.06   |
| HSUPA        | Subtest 1    | 22.00   | 20.22   | 19.41   | 19.35   |
|              | Subtest 2    | 20.00   | 17.35   | 17.20   | 17.17   |
|              | Subtest 3    | 21.00   | 17.95   | 17.90   | 18.07   |
|              | Subtest 4    | 20.50   | 17.27   | 17.43   | 17.39   |
|              | Subtest 5    | 21.50   | 19.76   | 19.57   | 19.48   |
| DC-HSDPA     | Subtest 1    | 22.50   | 21.15   | 21.05   | 21.00   |
|              | Subtest 2    | 22.50   | 20.42   | 20.28   | 20.19   |
|              | Subtest 3    | 22.00   | 20.35   | 20.15   | 20.09   |
|              | Subtest 4    | 22.00   | 20.35   | 20.18   | 20.08   |

Table 29: Test results conducted power measurement of UMTS Band II (Reduced Power Level D1)

| UMTS Band II |              | Tune-up | Channel      | Channel      | Channel      |
|--------------|--------------|---------|--------------|--------------|--------------|
|              |              | Max.    | 9262CH       | 9400CH       | 9538CH       |
| WCDMA        | 12.2kbps RMC | 22.00   | <b>21.18</b> | <b>21.18</b> | <b>21.06</b> |
|              | 12.2kbps AMR | 22.00   | 21.38        | 21.19        | 21.08        |
| HSDPA        | Subtest 1    | 22.00   | 20.75        | 20.67        | 20.55        |
|              | Subtest 2    | 22.00   | 19.98        | 19.90        | 19.78        |
|              | Subtest 3    | 21.50   | 19.93        | 19.78        | 19.67        |
|              | Subtest 4    | 21.50   | 19.95        | 19.77        | 19.69        |
| HSUPA        | Subtest 1    | 21.50   | 19.83        | 19.00        | 18.93        |
|              | Subtest 2    | 19.50   | 16.82        | 16.78        | 16.75        |
|              | Subtest 3    | 20.50   | 17.55        | 17.59        | 17.56        |
|              | Subtest 4    | 20.00   | 16.86        | 17.14        | 16.99        |
|              | Subtest 5    | 21.00   | 19.38        | 19.20        | 19.07        |
| DC-HSDPA     | Subtest 1    | 22.00   | 20.76        | 20.71        | 20.55        |
|              | Subtest 2    | 22.00   | 20.03        | 19.88        | 19.77        |
|              | Subtest 3    | 21.50   | 19.93        | 19.81        | 19.71        |
|              | Subtest 4    | 21.50   | 19.94        | 19.77        | 19.65        |

Table 30: Test results conducted power measurement of UMTS Band II (Reduced Power Level D3/D5/D6)

| UMTS Band II |              | Tune-up | Average Power (dBm) |        |        |
|--------------|--------------|---------|---------------------|--------|--------|
|              |              | Max.    | 9262CH              | 9400CH | 9538CH |
| WCDMA        | 12.2kbps RMC | 20.00   | 19.11               | 19.12  | 19.03  |
|              | 12.2kbps AMR | 20.00   | 19.08               | 19.11  | 19.05  |
| HSDPA        | Subtest 1    | 20.00   | 18.72               | 18.59  | 18.49  |
|              | Subtest 2    | 20.00   | 17.99               | 17.80  | 17.67  |
|              | Subtest 3    | 19.50   | 17.86               | 17.71  | 17.58  |
|              | Subtest 4    | 19.50   | 17.85               | 17.68  | 17.55  |
| HSUPA        | Subtest 1    | 19.50   | 16.84               | 16.94  | 16.77  |
|              | Subtest 2    | 17.50   | 14.67               | 14.75  | 14.72  |
|              | Subtest 3    | 18.50   | 15.52               | 15.42  | 15.52  |
|              | Subtest 4    | 18.00   | 14.69               | 14.99  | 14.73  |
|              | Subtest 5    | 19.00   | 17.28               | 17.09  | 16.98  |
| DC-HSDPA     | Subtest 1    | 20.00   | 18.72               | 18.59  | 18.54  |
|              | Subtest 2    | 20.00   | 17.98               | 17.78  | 17.68  |
|              | Subtest 3    | 19.50   | 17.87               | 17.71  | 17.56  |
|              | Subtest 4    | 19.50   | 17.84               | 17.70  | 17.57  |

Table 31: Test results conducted power measurement of UMTS Band II (Reduced Power Level D4)

Note:

- 1) The bolded 12.2kbps RMC mode was selected for SAR testing (the primary mode).
- 2) Per KDB941225 D01, When the maximum output power and tune-up tolerance specified for production units in a Second mode is  $\leq \frac{1}{4}$  dB higher than the primary mode or when the highest *reported* SAR of the primary mode is scaled by the ratio of specified maximum output power and tune-up tolerance of Second to primary mode and the adjusted SAR is  $\leq 1.2$  W/kg, SAR measurement is not required for the Second mode.

### 7.1.7 Conducted power measurements of UMTS Band IV (Second Antenna)

| UMTS Band IV |              | Tune-up | Channel      | Channel      | Channel      |
|--------------|--------------|---------|--------------|--------------|--------------|
|              |              | Max.    | 1312CH       | 1413CH       | 1513CH       |
| WCDMA        | 12.2kbps RMC | 21.00   | <b>20.15</b> | <b>20.07</b> | <b>19.99</b> |
|              | 12.2kbps AMR | 21.00   | 20.16        | 20.10        | 19.99        |
| HSDPA        | Subtest 1    | 21.00   | 19.60        | 19.55        | 19.45        |
|              | Subtest 2    | 21.00   | 19.21        | 19.14        | 19.05        |
|              | Subtest 3    | 21.00   | 18.69        | 18.66        | 18.54        |
|              | Subtest 4    | 21.00   | 18.67        | 18.64        | 18.52        |
| HSUPA        | Subtest 1    | 21.00   | 18.23        | 17.95        | 18.40        |
|              | Subtest 2    | 19.50   | 16.23        | 15.77        | 15.57        |
|              | Subtest 3    | 20.50   | 16.95        | 16.50        | 16.27        |
|              | Subtest 4    | 20.00   | 16.06        | 15.91        | 15.81        |
|              | Subtest 5    | 21.00   | 18.15        | 18.05        | 17.98        |
| DC-HSDPA     | Subtest 1    | 21.00   | 19.61        | 19.54        | 19.46        |
|              | Subtest 2    | 21.00   | 19.17        | 19.14        | 19.02        |
|              | Subtest 3    | 21.00   | 18.69        | 18.66        | 18.56        |
|              | Subtest 4    | 21.00   | 18.73        | 18.64        | 18.58        |

Table 32: Conducted power measurement results of UMTS Band IV(Full Power)

| UMTS Band IV |              | Tune-up | Channel      | Channel      | Channel      |
|--------------|--------------|---------|--------------|--------------|--------------|
|              |              | Max.    | 1312CH       | 1413CH       | 1513CH       |
| WCDMA        | 12.2kbps RMC | 18.00   | <b>17.15</b> | <b>17.06</b> | <b>16.99</b> |
|              | 12.2kbps AMR | 18.00   | 17.21        | 17.10        | 17.05        |
| HSDPA        | Subtest 1    | 18.00   | 16.62        | 16.56        | 16.49        |
|              | Subtest 2    | 18.00   | 16.10        | 16.03        | 16.06        |
|              | Subtest 3    | 18.00   | 15.71        | 15.65        | 15.56        |
|              | Subtest 4    | 18.00   | 15.70        | 15.65        | 15.56        |
| HSUPA        | Subtest 1    | 18.00   | 15.07        | 14.96        | 14.99        |
|              | Subtest 2    | 16.50   | 13.19        | 11.92        | 12.76        |
|              | Subtest 3    | 17.50   | 13.91        | 13.44        | 14.39        |
|              | Subtest 4    | 17.00   | 13.00        | 12.05        | 12.96        |
|              | Subtest 5    | 18.00   | 15.16        | 15.09        | 14.99        |
| DC-HSDPA     | Subtest 1    | 18.00   | 16.65        | 16.59        | 16.50        |
|              | Subtest 2    | 18.00   | 16.10        | 16.18        | 16.06        |
|              | Subtest 3    | 18.00   | 15.69        | 15.66        | 15.55        |
|              | Subtest 4    | 18.00   | 15.77        | 15.66        | 15.55        |

Table 33: Conducted power measurement results of UMTS Band IV(Reduced Power Level D1)



| UMTS Band IV |              | Tune-up | Channel      | Channel      | Channel      |
|--------------|--------------|---------|--------------|--------------|--------------|
|              |              | Max.    | 1312CH       | 1413CH       | 1513CH       |
| WCDMA        | 12.2kbps RMC | 17.00   | <b>16.16</b> | <b>16.08</b> | <b>15.98</b> |
|              | 12.2kbps AMR | 17.00   | 16.17        | 16.10        | 16.04        |
| HSDPA        | Subtest 1    | 17.00   | 15.63        | 15.56        | 15.49        |
|              | Subtest 2    | 17.00   | 15.21        | 15.17        | 15.04        |
|              | Subtest 3    | 17.00   | 14.71        | 14.67        | 14.56        |
|              | Subtest 4    | 17.00   | 14.71        | 14.66        | 14.52        |
| HSUPA        | Subtest 1    | 17.00   | 14.24        | 13.77        | 14.54        |
|              | Subtest 2    | 15.50   | 12.33        | 10.97        | 11.83        |
|              | Subtest 3    | 16.50   | 13.01        | 12.51        | 13.44        |
|              | Subtest 4    | 16.00   | 12.14        | 11.09        | 12.04        |
| DC-HSDPA     | Subtest 1    | 17.00   | 15.66        | 15.59        | 15.49        |
|              | Subtest 2    | 17.00   | 15.32        | 15.16        | 15.07        |
|              | Subtest 3    | 17.00   | 14.72        | 14.67        | 14.56        |
|              | Subtest 4    | 17.00   | 14.71        | 14.65        | 14.57        |

Table 34: Conducted power measurement results of UMTS Band IV(Reduced Power Level D2)

| UMTS Band IV |              | Tune-up | Channel | Channel | Channel |
|--------------|--------------|---------|---------|---------|---------|
|              |              | Max.    | 1312CH  | 1413CH  | 1513CH  |
| WCDMA        | 12.2kbps RMC | 14.00   | 13.14   | 13.07   | 12.99   |
|              | 12.2kbps AMR | 14.00   | 13.17   | 13.06   | 13.00   |
| HSDPA        | Subtest 1    | 14.00   | 12.63   | 12.58   | 12.44   |
|              | Subtest 2    | 14.00   | 12.46   | 12.22   | 12.51   |
|              | Subtest 3    | 14.00   | 12.31   | 11.64   | 12.23   |
|              | Subtest 4    | 14.00   | 12.31   | 11.66   | 12.25   |
| HSUPA        | Subtest 1    | 14.00   | 13.12   | 11.84   | 12.48   |
|              | Subtest 2    | 12.50   | 9.48    | 8.13    | 8.95    |
|              | Subtest 3    | 13.50   | 10.08   | 9.70    | 10.58   |
|              | Subtest 4    | 13.00   | 9.27    | 8.23    | 9.12    |
| DC-HSDPA     | Subtest 1    | 14.00   | 12.62   | 12.57   | 12.49   |
|              | Subtest 2    | 14.00   | 12.48   | 12.23   | 12.51   |
|              | Subtest 3    | 14.00   | 12.31   | 11.66   | 12.25   |
|              | Subtest 4    | 14.00   | 12.32   | 11.66   | 12.27   |

Table 35: Conducted power measurement results of UMTS Band IV(Reduced Power Level D3)

Note:

- 1) The bolded 12.2kbps RMC mode was selected for SAR testing (the primary mode).
- 2) Per KDB941225 D01, When the maximum output power and tune-up tolerance specified for production units in a Second mode is  $\leq \frac{1}{4}$  dB higher than the primary mode or when the highest *reported* SAR of the primary mode is scaled by the ratio of specified maximum output power and tune-up tolerance of Second to primary mode and the adjusted SAR is  $\leq 1.2$  W/kg, SAR measurement is not required for the Second mode.

### 7.1.8 Conducted power measurements of UMTS Band IV (Main Antenna)

| UMTS Band IV |              | Tune-up | Channel      | Channel      | Channel      |
|--------------|--------------|---------|--------------|--------------|--------------|
|              |              | Max.    | 1312CH       | 1413CH       | 1513CH       |
| WCDMA        | 12.2kbps RMC | 23.50   | <b>22.37</b> | <b>22.32</b> | <b>22.43</b> |
|              | 12.2kbps AMR | 23.50   | 22.40        | 22.39        | 22.42        |
| HSDPA        | Subtest 1    | 23.50   | 21.85        | 21.86        | 21.89        |
|              | Subtest 2    | 23.50   | 21.63        | 21.60        | 21.63        |
|              | Subtest 3    | 23.50   | 21.52        | 21.50        | 21.54        |
|              | Subtest 4    | 23.50   | 21.58        | 21.54        | 21.58        |
| HSUPA        | Subtest 1    | 23.50   | 20.72        | 20.14        | 20.12        |
|              | Subtest 2    | 22.00   | 17.82        | 18.02        | 18.03        |
|              | Subtest 3    | 23.00   | 18.64        | 18.96        | 18.75        |
|              | Subtest 4    | 22.50   | 18.67        | 18.03        | 18.17        |
|              | Subtest 5    | 23.50   | 20.37        | 20.32        | 20.29        |
| DC-HSDPA     | Subtest 1    | 23.50   | 21.88        | 21.81        | 21.89        |
|              | Subtest 2    | 23.50   | 21.64        | 21.61        | 21.67        |
|              | Subtest 3    | 23.50   | 21.54        | 21.47        | 21.59        |
|              | Subtest 4    | 23.50   | 21.52        | 21.49        | 21.57        |

Table 36: Conducted power measurement results of UMTS Band IV(Full Power)

| UMTS Band IV |              | Tune-up | Channel      | Channel      | Channel      |
|--------------|--------------|---------|--------------|--------------|--------------|
|              |              | Max.    | 1312CH       | 1413CH       | 1513CH       |
| WCDMA        | 12.2kbps RMC | 22.00   | <b>20.99</b> | <b>20.87</b> | <b>21.05</b> |
|              | 12.2kbps AMR | 22.00   | 20.94        | 20.86        | 20.88        |
| HSDPA        | Subtest 1    | 22.00   | 20.33        | 20.42        | 20.42        |
|              | Subtest 2    | 22.00   | 20.04        | 20.24        | 20.22        |
|              | Subtest 3    | 22.00   | 19.91        | 20.07        | 20.15        |
|              | Subtest 4    | 22.00   | 19.98        | 20.16        | 20.06        |
| HSUPA        | Subtest 1    | 22.00   | 19.18        | 18.61        | 18.48        |
|              | Subtest 2    | 20.50   | 16.20        | 16.53        | 16.60        |
|              | Subtest 3    | 21.50   | 17.09        | 17.39        | 17.40        |
|              | Subtest 4    | 21.00   | 17.11        | 16.65        | 16.73        |
|              | Subtest 5    | 22.00   | 18.77        | 18.80        | 18.89        |
| DC-HSDPA     | Subtest 1    | 22.00   | 20.38        | 20.38        | 20.50        |
|              | Subtest 2    | 22.00   | 20.01        | 20.10        | 20.15        |
|              | Subtest 3    | 22.00   | 20.11        | 20.08        | 20.10        |
|              | Subtest 4    | 22.00   | 20.16        | 20.06        | 20.13        |

Table 37: Conducted power measurement results of UMTS Band IV(Reduced Power Level D3/D4/D5/D6)

Note:

- 1) The bolded 12.2kbps RMC mode was selected for SAR testing (the primary mode).
- 2) Per KDB941225 D01, When the maximum output power and tune-up tolerance specified for production units in a Second mode is  $\leq \frac{1}{4}$  dB higher than the primary mode or when the highest *reported* SAR of the primary mode is scaled by the ratio of specified maximum output power and tune-up tolerance of Second to primary mode and the adjusted SAR is  $\leq 1.2$  W/kg, SAR measurement is not required for the Second mode.

### 7.1.9 Conducted power measurements of UMTS Band V (Second Antenna)

| UMTS Band V |              | Tune-up | Channel      | Channel      | Channel      |
|-------------|--------------|---------|--------------|--------------|--------------|
|             |              | Max.    | 4132CH       | 4182CH       | 4233CH       |
| WCDMA       | 12.2kbps RMC | 24.50   | <b>23.51</b> | <b>23.45</b> | <b>23.50</b> |
|             | 12.2kbps AMR | 24.50   | 23.49        | 23.42        | 23.47        |
| HSDPA       | Subtest 1    | 24.50   | 22.98        | 22.91        | 22.98        |
|             | Subtest 2    | 24.00   | 22.50        | 22.44        | 22.48        |
|             | Subtest 3    | 23.50   | 22.49        | 22.45        | 22.51        |
|             | Subtest 4    | 23.50   | 22.49        | 22.46        | 22.49        |
| HSUPA       | Subtest 1    | 23.50   | 22.62        | 22.35        | 22.25        |
|             | Subtest 2    | 21.50   | 19.97        | 20.14        | 20.09        |
|             | Subtest 3    | 22.50   | 20.70        | 20.87        | 20.90        |
|             | Subtest 4    | 22.00   | 20.26        | 20.25        | 20.29        |
|             | Subtest 5    | 23.00   | 21.48        | 21.42        | 21.45        |
| DC-HSDPA    | Subtest 1    | 24.50   | 22.98        | 22.95        | 22.98        |
|             | Subtest 2    | 24.00   | 22.49        | 22.44        | 22.49        |
|             | Subtest 3    | 23.50   | 22.50        | 22.44        | 22.48        |
|             | Subtest 4    | 23.50   | 22.50        | 22.44        | 22.46        |

Table 38: Conducted power measurement results of UMTS Band V(Full Power)

| UMTS Band V |              | Tune-up | Channel      | Channel      | Channel      |
|-------------|--------------|---------|--------------|--------------|--------------|
|             |              | Max.    | 4132CH       | 4182CH       | 4233CH       |
| WCDMA       | 12.2kbps RMC | 19.50   | <b>18.46</b> | <b>18.40</b> | <b>18.45</b> |
|             | 12.2kbps AMR | 19.50   | 18.45        | 18.37        | 18.44        |
| HSDPA       | Subtest 1    | 19.50   | 17.95        | 17.91        | 17.95        |
|             | Subtest 2    | 19.00   | 17.46        | 17.41        | 17.46        |
|             | Subtest 3    | 18.50   | 17.45        | 17.40        | 17.47        |
|             | Subtest 4    | 18.50   | 17.47        | 17.40        | 17.45        |
| HSUPA       | Subtest 1    | 18.50   | 17.16        | 17.61        | 17.43        |
|             | Subtest 2    | 16.50   | 14.14        | 14.37        | 14.33        |
|             | Subtest 3    | 17.50   | 15.86        | 16.08        | 16.02        |
|             | Subtest 4    | 17.00   | 14.37        | 14.42        | 14.49        |
|             | Subtest 5    | 18.00   | 16.50        | 16.41        | 16.46        |
| DC-HSDPA    | Subtest 1    | 19.50   | 17.95        | 17.92        | 17.94        |
|             | Subtest 2    | 19.00   | 17.52        | 17.41        | 17.45        |
|             | Subtest 3    | 18.50   | 17.45        | 17.38        | 17.44        |
|             | Subtest 4    | 18.50   | 17.47        | 17.41        | 17.44        |

Table 39: Conducted power measurement results of UMTS Band V(Reduced Power Level D1)

| UMTS Band V |              | Tune-up | Channel | Channel | Channel |
|-------------|--------------|---------|---------|---------|---------|
|             |              | Max.    | 4132CH  | 4182CH  | 4233CH  |
| WCDMA       | 12.2kbps RMC | 16.50   | 15.46   | 15.41   | 15.46   |
|             | 12.2kbps AMR | 16.50   | 15.45   | 15.39   | 15.44   |
| HSDPA       | Subtest 1    | 16.50   | 14.96   | 14.91   | 14.95   |
|             | Subtest 2    | 16.00   | 14.46   | 14.38   | 14.46   |
|             | Subtest 3    | 15.50   | 14.48   | 14.41   | 14.46   |
|             | Subtest 4    | 15.50   | 14.46   | 14.40   | 14.45   |
| HSUPA       | Subtest 1    | 15.50   | 13.25   | 13.81   | 13.77   |
|             | Subtest 2    | 13.50   | 11.29   | 11.48   | 11.45   |
|             | Subtest 3    | 14.50   | 11.99   | 12.18   | 12.24   |
|             | Subtest 4    | 14.00   | 11.48   | 11.49   | 11.56   |
|             | Subtest 5    | 15.00   | 13.35   | 13.61   | 13.76   |
| DC-HSDPA    | Subtest 1    | 16.50   | 14.94   | 14.90   | 14.98   |
|             | Subtest 2    | 16.00   | 14.48   | 14.39   | 14.46   |
|             | Subtest 3    | 15.50   | 14.46   | 14.43   | 14.47   |
|             | Subtest 4    | 15.50   | 14.44   | 14.40   | 14.45   |

Table 40: Conducted power measurement results of UMTS Band V(Reduced Power Level D3)

| UMTS Band V |              | Tune-up | Channel      | Channel      | Channel      |
|-------------|--------------|---------|--------------|--------------|--------------|
|             |              | Max.    | 4132CH       | 4182CH       | 4233CH       |
| WCDMA       | 12.2kbps RMC | 21.50   | <b>20.45</b> | <b>20.40</b> | <b>20.49</b> |
|             | 12.2kbps AMR | 21.50   | 20.47        | 20.36        | 20.42        |
| HSDPA       | Subtest 1    | 21.50   | 19.95        | 19.88        | 19.95        |
|             | Subtest 2    | 21.00   | 19.47        | 19.41        | 19.46        |
|             | Subtest 3    | 20.50   | 19.44        | 19.42        | 19.46        |
|             | Subtest 4    | 20.50   | 19.47        | 19.42        | 19.45        |
| HSUPA       | Subtest 1    | 20.50   | 18.98        | 19.45        | 19.35        |
|             | Subtest 2    | 18.50   | 17.13        | 17.20        | 17.16        |
|             | Subtest 3    | 19.50   | 17.86        | 17.93        | 17.97        |
|             | Subtest 4    | 19.00   | 16.42        | 16.39        | 16.35        |
|             | Subtest 5    | 20.00   | 18.49        | 18.39        | 18.42        |
| DC-HSDPA    | Subtest 1    | 21.50   | 19.95        | 19.88        | 19.94        |
|             | Subtest 2    | 21.00   | 19.51        | 19.41        | 19.46        |
|             | Subtest 3    | 20.50   | 19.44        | 19.42        | 19.46        |
|             | Subtest 4    | 20.50   | 19.48        | 19.42        | 19.47        |

Table 41: Conducted power measurement results of UMTS Band V(Reduced Power Level D2)

Note:

- 1) The bolded 12.2kbps RMC mode was selected for SAR testing (the primary mode).
- 2) Per KDB941225 D01, When the maximum output power and tune-up tolerance specified for production units in a Second mode is  $\leq \frac{1}{4}$  dB higher than the primary mode or when the highest *reported* SAR of the primary mode is scaled by the ratio of specified maximum output power and tune-up tolerance of Second to primary mode and the adjusted SAR is  $\leq 1.2$  W/kg, SAR measurement is not required for the Second mode.

### 7.1.10 Conducted power measurements of UMTS Band V (Main Antenna)

| UMTS Band V |              | Tune-up | Channel      | Channel      | Channel      |
|-------------|--------------|---------|--------------|--------------|--------------|
|             |              | Max.    | 4132CH       | 4182CH       | 4233CH       |
| WCDMA       | 12.2kbps RMC | 25.00   | <b>23.97</b> | <b>23.99</b> | <b>24.10</b> |
|             | 12.2kbps AMR | 25.00   | 23.99        | 23.96        | 24.07        |
| HSDPA       | Subtest 1    | 25.00   | 23.47        | 23.47        | 23.56        |
|             | Subtest 2    | 24.50   | 22.96        | 22.96        | 23.07        |
|             | Subtest 3    | 24.00   | 22.52        | 22.53        | 22.64        |
|             | Subtest 4    | 24.00   | 22.55        | 22.55        | 22.65        |
| HSUPA       | Subtest 1    | 24.00   | 22.75        | 22.77        | 22.84        |
|             | Subtest 2    | 22.00   | 20.56        | 20.74        | 19.96        |
|             | Subtest 3    | 23.00   | 21.40        | 21.36        | 21.52        |
|             | Subtest 4    | 22.50   | 19.96        | 20.06        | 20.24        |
|             | Subtest 5    | 23.50   | 21.94        | 21.92        | 22.04        |
| DC-HSDPA    | Subtest 1    | 25.00   | 23.21        | 23.32        | 23.45        |
|             | Subtest 2    | 24.50   | 23.89        | 23.01        | 23.00        |
|             | Subtest 3    | 24.00   | 23.56        | 23.54        | 23.67        |
|             | Subtest 4    | 24.00   | 23.54        | 23.55        | 23.63        |

Table 42: Conducted power measurement results of UMTS Band V(Full Power)

Note:

- 1) The bolded 12.2kbps RMC mode was selected for SAR testing (the primary mode).
- 2) Per KDB941225 D01, When the maximum output power and tune-up tolerance specified for production units in a Second mode is  $\leq \frac{1}{4}$  dB higher than the primary mode or when the highest *reported* SAR of the primary mode is scaled by the ratio of specified maximum output power and tune-up tolerance of Second to primary mode and the adjusted SAR is  $\leq 1.2$  W/kg, SAR measurement is not required for the Second mode.

### 7.1.11 Conducted power measurements of LTE Band 2 (Second Antenna)

| Bandwidth | Modulation | RB size | RB offset | Tune-up | Channel | Channel | Channel |
|-----------|------------|---------|-----------|---------|---------|---------|---------|
|           |            |         |           | Max.    | 18607CH | 18900CH | 19193CH |
| 1.4MHz    | QPSK       | 1       | 0         | 21.00   | 20.11   | 20.00   | 20.18   |
|           |            | 1       | 3         | 21.00   | 20.10   | 20.03   | 20.16   |
|           |            | 1       | 5         | 21.00   | 20.10   | 20.15   | 20.15   |
|           |            | 3       | 0         | 21.00   | 20.10   | 20.08   | 20.05   |
|           |            | 3       | 2         | 21.00   | 20.23   | 20.07   | 20.13   |
|           |            | 3       | 3         | 21.00   | 20.12   | 20.08   | 20.14   |
|           |            | 6       | 0         | 21.00   | 20.16   | 20.05   | 20.14   |
|           | 16QAM      | 1       | 0         | 21.00   | 20.27   | 20.20   | 20.14   |
|           |            | 1       | 3         | 21.00   | 20.49   | 20.25   | 20.20   |
|           |            | 1       | 5         | 21.00   | 20.47   | 20.30   | 20.17   |
|           |            | 3       | 0         | 21.00   | 20.12   | 19.96   | 20.11   |
|           |            | 3       | 2         | 21.00   | 20.02   | 20.14   | 20.07   |
|           |            | 3       | 3         | 21.00   | 20.10   | 20.18   | 20.19   |
|           |            | 6       | 0         | 21.00   | 20.22   | 20.16   | 20.10   |
|           | 64QAM      | 1       | 0         | 21.00   | 20.39   | 20.14   | 20.06   |
|           |            | 1       | 3         | 21.00   | 20.38   | 20.37   | 20.09   |
|           |            | 1       | 5         | 21.00   | 20.24   | 20.25   | 20.20   |
|           |            | 3       | 0         | 21.00   | 20.34   | 20.11   | 20.12   |
|           |            | 3       | 2         | 21.00   | 20.11   | 20.06   | 20.11   |
|           |            | 3       | 3         | 21.00   | 20.31   | 20.14   | 20.03   |
|           |            | 6       | 0         | 20.00   | 19.29   | 19.17   | 19.10   |
| Bandwidth | Modulation | RB size | RB offset | Tune-up | Channel | Channel | Channel |
|           |            |         |           | Max.    | 18615CH | 18900CH | 19185CH |
| 3MHz      | QPSK       | 1       | 0         | 21.00   | 20.29   | 20.25   | 20.03   |
|           |            | 1       | 7         | 21.00   | 20.30   | 20.27   | 20.01   |
|           |            | 1       | 14        | 21.00   | 20.34   | 20.22   | 20.05   |
|           |            | 8       | 0         | 21.00   | 20.30   | 20.26   | 20.08   |
|           |            | 8       | 4         | 21.00   | 20.33   | 20.24   | 20.06   |
|           |            | 8       | 7         | 21.00   | 20.29   | 20.24   | 20.07   |
|           |            | 15      | 0         | 21.00   | 20.33   | 20.30   | 20.08   |
|           | 16QAM      | 1       | 0         | 21.00   | 20.29   | 20.19   | 20.13   |
|           |            | 1       | 7         | 21.00   | 20.51   | 20.11   | 20.02   |
|           |            | 1       | 14        | 21.00   | 20.24   | 20.01   | 20.08   |
|           |            | 8       | 0         | 21.00   | 20.27   | 20.01   | 20.01   |
|           |            | 8       | 4         | 21.00   | 20.29   | 19.97   | 19.97   |
|           |            | 8       | 7         | 21.00   | 20.29   | 20.04   | 20.01   |
|           |            | 15      | 0         | 21.00   | 20.19   | 20.18   | 19.87   |
|           | 64QAM      | 1       | 0         | 21.00   | 20.34   | 20.23   | 19.89   |
|           |            | 1       | 7         | 21.00   | 20.23   | 20.24   | 20.00   |
|           |            | 1       | 14        | 21.00   | 20.40   | 20.20   | 19.94   |
|           |            | 8       | 0         | 20.00   | 19.32   | 19.26   | 19.08   |
|           |            | 8       | 4         | 20.00   | 19.30   | 19.23   | 19.08   |
|           |            | 8       | 7         | 20.00   | 19.24   | 19.28   | 19.11   |
|           |            | 15      | 0         | 20.00   | 19.27   | 19.25   | 19.16   |

| Bandwidth | Modulation | RB size | RB offset | Tune-up | Channel | Channel | Channel |
|-----------|------------|---------|-----------|---------|---------|---------|---------|
|           |            |         |           | Max.    | 18625CH | 18900CH | 19175CH |
| 5MHz      | QPSK       | 1       | 0         | 21.00   | 20.16   | 20.06   | 19.98   |
|           |            | 1       | 13        | 21.00   | 20.18   | 20.08   | 19.93   |
|           |            | 1       | 24        | 21.00   | 20.14   | 20.09   | 19.92   |
|           |            | 12      | 0         | 21.00   | 20.10   | 20.25   | 19.96   |
|           |            | 12      | 6         | 21.00   | 20.11   | 20.26   | 19.97   |
|           |            | 12      | 13        | 21.00   | 20.09   | 20.24   | 19.95   |
|           |            | 25      | 0         | 21.00   | 20.31   | 20.24   | 20.00   |
|           | 16QAM      | 1       | 0         | 21.00   | 20.27   | 20.10   | 20.33   |
|           |            | 1       | 13        | 21.00   | 20.24   | 20.22   | 20.26   |
|           |            | 1       | 24        | 21.00   | 20.29   | 20.16   | 20.30   |
|           |            | 12      | 0         | 21.00   | 20.07   | 20.19   | 20.13   |
|           |            | 12      | 6         | 21.00   | 20.31   | 20.20   | 20.12   |
|           |            | 12      | 13        | 21.00   | 20.08   | 20.19   | 20.10   |
|           |            | 25      | 0         | 21.00   | 20.11   | 20.14   | 20.00   |
|           | 64QAM      | 1       | 0         | 21.00   | 20.27   | 20.07   | 20.14   |
|           |            | 1       | 13        | 21.00   | 20.39   | 19.99   | 20.14   |
|           |            | 1       | 24        | 21.00   | 20.39   | 20.00   | 20.16   |
|           |            | 12      | 0         | 20.00   | 19.30   | 19.23   | 19.13   |
|           |            | 12      | 6         | 20.00   | 19.24   | 19.23   | 19.11   |
|           |            | 12      | 13        | 20.00   | 19.28   | 19.25   | 19.06   |
|           |            | 25      | 0         | 20.00   | 19.11   | 19.23   | 19.04   |
| Bandwidth | Modulation | RB size | RB offset | Tune-up | Channel | Channel | Channel |
| 10MHz     | QPSK       | 1       | 0         | 21.00   | 20.17   | 20.07   | 20.00   |
|           |            | 1       | 25        | 21.00   | 20.17   | 20.08   | 19.97   |
|           |            | 1       | 49        | 21.00   | 20.14   | 20.09   | 20.00   |
|           |            | 25      | 0         | 21.00   | 20.08   | 20.25   | 20.01   |
|           |            | 25      | 13        | 21.00   | 20.06   | 20.19   | 19.94   |
|           |            | 25      | 25        | 21.00   | 20.06   | 20.28   | 20.20   |
|           |            | 50      | 0         | 21.00   | 20.11   | 20.13   | 20.04   |
|           | 16QAM      | 1       | 0         | 21.00   | 20.01   | 20.18   | 20.15   |
|           |            | 1       | 25        | 21.00   | 20.36   | 20.14   | 20.14   |
|           |            | 1       | 49        | 21.00   | 20.01   | 20.26   | 20.07   |
|           |            | 25      | 0         | 21.00   | 20.18   | 20.15   | 20.05   |
|           |            | 25      | 13        | 21.00   | 20.18   | 20.14   | 20.03   |
|           |            | 25      | 25        | 21.00   | 20.19   | 20.11   | 19.87   |
|           |            | 50      | 0         | 21.00   | 20.20   | 20.10   | 19.91   |
|           | 64QAM      | 1       | 0         | 21.00   | 20.39   | 19.93   | 20.14   |
|           |            | 1       | 25        | 21.00   | 20.31   | 20.04   | 20.06   |
|           |            | 1       | 49        | 21.00   | 20.32   | 20.17   | 19.87   |
|           |            | 25      | 0         | 20.00   | 19.24   | 19.19   | 19.11   |
|           |            | 25      | 13        | 20.00   | 19.25   | 19.21   | 19.12   |
|           |            | 25      | 25        | 20.00   | 19.23   | 19.19   | 19.12   |
|           |            | 50      | 0         | 20.00   | 19.07   | 19.03   | 19.12   |

| Bandwidth | Modulation | RB size    | RB offset | Tune-up   | Channel      | Channel      | Channel      |              |
|-----------|------------|------------|-----------|-----------|--------------|--------------|--------------|--------------|
|           |            |            |           | Max.      | 18675CH      | 18900CH      | 19125CH      |              |
| 15MHz     | QPSK       | 1          | 0         | 21.00     | 20.16        | 20.12        | 19.97        |              |
|           |            | 1          | 38        | 21.00     | 20.12        | 20.15        | 19.94        |              |
|           |            | 1          | 74        | 21.00     | 20.15        | 20.14        | 19.96        |              |
|           |            | 36         | 0         | 21.00     | 20.18        | 20.04        | 20.01        |              |
|           |            | 36         | 18        | 21.00     | 20.14        | 20.04        | 20.03        |              |
|           |            | 36         | 39        | 21.00     | 20.15        | 20.03        | 20.00        |              |
|           |            | 75         | 0         | 21.00     | 20.15        | 20.09        | 20.11        |              |
|           | 16QAM      | 1          | 0         | 21.00     | 20.31        | 20.29        | 19.92        |              |
|           |            | 1          | 38        | 21.00     | 20.39        | 20.08        | 20.03        |              |
|           |            | 1          | 74        | 21.00     | 20.18        | 20.10        | 20.08        |              |
|           |            | 36         | 0         | 21.00     | 20.31        | 20.19        | 19.89        |              |
|           |            | 36         | 18        | 21.00     | 20.26        | 20.18        | 19.90        |              |
|           |            | 36         | 39        | 21.00     | 20.12        | 20.17        | 19.90        |              |
|           |            | 75         | 0         | 21.00     | 20.14        | 19.98        | 20.06        |              |
|           | 64QAM      | 1          | 0         | 21.00     | 20.17        | 20.11        | 20.06        |              |
|           |            | 1          | 38        | 21.00     | 20.12        | 20.21        | 19.92        |              |
|           |            | 1          | 74        | 21.00     | 20.20        | 20.13        | 20.20        |              |
|           |            | 36         | 0         | 20.00     | 19.25        | 19.18        | 19.11        |              |
|           |            | 36         | 18        | 20.00     | 19.27        | 19.18        | 19.13        |              |
|           |            | 36         | 39        | 20.00     | 19.16        | 19.21        | 19.15        |              |
|           |            | 75         | 0         | 20.00     | 19.14        | 19.19        | 19.13        |              |
|           | Bandwidth  | Modulation | RB size   | RB offset | Tune-up      | Channel      | Channel      | Channel      |
|           | 20MHz      | QPSK       | 1         | 0         | 21.00        | <b>20.35</b> | <b>20.31</b> | <b>20.17</b> |
|           |            |            | 1         | 50        | 21.00        | 20.33        | 20.27        | 20.16        |
| 1         |            |            | 99        | 21.00     | 20.34        | 20.30        | 20.10        |              |
| 50        |            |            | 0         | 21.00     | 20.31        | 20.25        | 20.18        |              |
| 50        |            |            | 25        | 21.00     | <b>20.32</b> | 20.26        | 19.93        |              |
| 50        |            |            | 50        | 21.00     | 20.31        | 20.25        | 20.18        |              |
| 100       |            |            | 0         | 21.00     | 20.12        | 20.09        | 20.17        |              |
| 16QAM     |            | 1          | 0         | 21.00     | 20.44        | 20.35        | 20.38        |              |
|           |            | 1          | 50        | 21.00     | 20.71        | 20.32        | 20.55        |              |
|           |            | 1          | 99        | 21.00     | 20.45        | 20.31        | 20.49        |              |
|           |            | 50         | 0         | 21.00     | 20.26        | 20.14        | 20.01        |              |
|           |            | 50         | 25        | 21.00     | 20.20        | 20.14        | 20.03        |              |
|           |            | 50         | 50        | 21.00     | 20.21        | 20.14        | 20.04        |              |
|           |            | 100        | 0         | 21.00     | 20.04        | 20.02        | 20.03        |              |
| 64QAM     |            | 1          | 0         | 21.00     | 20.48        | 20.34        | 20.29        |              |
|           |            | 1          | 50        | 21.00     | 20.54        | 20.18        | 20.31        |              |
|           |            | 1          | 99        | 21.00     | 20.45        | 20.22        | 20.26        |              |
|           |            | 50         | 0         | 20.00     | 19.24        | 19.18        | 19.16        |              |
|           |            | 50         | 25        | 20.00     | 19.24        | 19.21        | 19.12        |              |
|           |            | 50         | 50        | 20.00     | 19.28        | 19.20        | 19.13        |              |
|           |            | 100        | 0         | 20.00     | 19.07        | 19.19        | 19.16        |              |
| Bandwidth |            | Modulation | RB size   | RB offset | Tune-up      | Channel      | Channel      | Channel      |
|           |            |            |           |           | Max.         | 18700CH      | 18900CH      | 19100CH      |

Table 43: Conducted power measurement results of LTE Band 2(Full Power)



| Bandwidth | Modulation | RB size    | RB offset | Tune-up   | Channel | Channel | Channel |         |
|-----------|------------|------------|-----------|-----------|---------|---------|---------|---------|
|           |            |            |           | Max.      | 18607CH | 18900CH | 19193CH |         |
| 1.4MHz    | QPSK       | 1          | 0         | 17.50     | 16.85   | 16.61   | 16.61   |         |
|           |            | 1          | 3         | 17.50     | 16.87   | 16.62   | 16.65   |         |
|           |            | 1          | 5         | 17.50     | 16.86   | 16.65   | 16.59   |         |
|           |            | 3          | 0         | 17.50     | 16.71   | 16.67   | 16.62   |         |
|           |            | 3          | 2         | 17.50     | 16.66   | 16.65   | 16.61   |         |
|           |            | 3          | 3         | 17.50     | 16.67   | 16.64   | 16.60   |         |
|           |            | 6          | 0         | 17.50     | 16.84   | 16.77   | 16.71   |         |
|           | 16QAM      | 1          | 0         | 17.50     | 17.15   | 16.81   | 16.92   |         |
|           |            | 1          | 3         | 17.50     | 16.91   | 16.75   | 16.81   |         |
|           |            | 1          | 5         | 17.50     | 17.05   | 16.84   | 16.86   |         |
|           |            | 3          | 0         | 17.50     | 16.77   | 16.59   | 16.62   |         |
|           |            | 3          | 2         | 17.50     | 16.80   | 16.66   | 16.72   |         |
|           |            | 3          | 3         | 17.50     | 16.74   | 16.57   | 16.51   |         |
|           |            | 6          | 0         | 17.50     | 16.71   | 16.55   | 16.60   |         |
|           | 64QAM      | 1          | 0         | 17.50     | 17.00   | 16.58   | 16.84   |         |
|           |            | 1          | 3         | 17.50     | 17.12   | 16.68   | 16.75   |         |
|           |            | 1          | 5         | 17.50     | 16.95   | 16.81   | 16.91   |         |
|           |            | 3          | 0         | 17.50     | 16.80   | 16.62   | 16.70   |         |
|           |            | 3          | 2         | 17.50     | 16.75   | 16.72   | 16.82   |         |
|           |            | 3          | 3         | 17.50     | 16.89   | 16.70   | 16.71   |         |
|           |            | 6          | 0         | 17.50     | 16.73   | 16.72   | 16.74   |         |
|           | Bandwidth  | Modulation | RB size   | RB offset | Tune-up | Channel | Channel | Channel |
|           | 3MHz       | QPSK       | 1         | 0         | 17.50   | 16.72   | 16.62   | 16.64   |
|           |            |            | 1         | 7         | 17.50   | 16.62   | 16.63   | 16.73   |
| 1         |            |            | 14        | 17.50     | 16.64   | 16.60   | 16.79   |         |
| 8         |            |            | 0         | 17.50     | 16.68   | 16.57   | 16.77   |         |
| 8         |            |            | 4         | 17.50     | 16.67   | 16.59   | 16.78   |         |
| 8         |            |            | 7         | 17.50     | 16.69   | 16.60   | 16.73   |         |
| 15        |            |            | 0         | 17.50     | 16.87   | 16.76   | 16.72   |         |
| 16QAM     |            | 1          | 0         | 17.50     | 17.06   | 17.03   | 16.58   |         |
|           |            | 1          | 7         | 17.50     | 17.11   | 17.11   | 16.83   |         |
|           |            | 1          | 14        | 17.50     | 16.79   | 16.98   | 16.93   |         |
|           |            | 8          | 0         | 17.50     | 16.78   | 16.57   | 16.60   |         |
|           |            | 8          | 4         | 17.50     | 16.84   | 16.59   | 16.66   |         |
|           |            | 8          | 7         | 17.50     | 16.80   | 16.59   | 16.72   |         |
|           |            | 15         | 0         | 17.50     | 16.71   | 16.68   | 16.54   |         |
| 64QAM     |            | 1          | 0         | 17.50     | 17.09   | 16.77   | 16.62   |         |
|           |            | 1          | 7         | 17.50     | 16.76   | 16.77   | 16.67   |         |
|           |            | 1          | 14        | 17.50     | 16.76   | 16.77   | 16.70   |         |
|           |            | 8          | 0         | 17.50     | 16.77   | 16.79   | 16.72   |         |
|           |            | 8          | 4         | 17.50     | 16.78   | 16.70   | 16.64   |         |
|           |            | 8          | 7         | 17.50     | 16.75   | 16.72   | 16.63   |         |
|           |            | 15         | 0         | 17.50     | 16.65   | 16.72   | 16.70   |         |
| Bandwidth |            | Modulation | RB size   | RB offset | Tune-up | Channel | Channel | Channel |
|           |            |            |           |           | Max.    | 18615CH | 18900CH | 19185CH |

| Bandwidth | Modulation | RB size | RB offset | Tune-up | Channel | Channel | Channel |
|-----------|------------|---------|-----------|---------|---------|---------|---------|
|           |            |         |           | Max.    | 18625CH | 18900CH | 19175CH |
| 5MHz      | QPSK       | 1       | 0         | 17.50   | 16.74   | 16.72   | 16.64   |
|           |            | 1       | 13        | 17.50   | 16.76   | 16.75   | 16.61   |
|           |            | 1       | 24        | 17.50   | 16.74   | 16.75   | 16.62   |
|           |            | 12      | 0         | 17.50   | 16.69   | 16.81   | 16.59   |
|           |            | 12      | 6         | 17.50   | 16.92   | 16.76   | 16.59   |
|           |            | 12      | 13        | 17.50   | 16.70   | 16.82   | 16.59   |
|           |            | 25      | 0         | 17.50   | 16.81   | 16.80   | 16.61   |
|           | 16QAM      | 1       | 0         | 17.50   | 16.98   | 16.88   | 16.77   |
|           |            | 1       | 13        | 17.50   | 16.83   | 16.67   | 16.69   |
|           |            | 1       | 24        | 17.50   | 16.86   | 16.84   | 16.82   |
|           |            | 12      | 0         | 17.50   | 16.66   | 16.74   | 16.77   |
|           |            | 12      | 6         | 17.50   | 16.76   | 16.69   | 16.72   |
|           |            | 12      | 13        | 17.50   | 16.65   | 16.74   | 16.80   |
|           |            | 25      | 0         | 17.50   | 16.71   | 16.70   | 16.65   |
|           | 64QAM      | 1       | 0         | 17.50   | 17.12   | 16.67   | 16.81   |
|           |            | 1       | 13        | 17.50   | 16.90   | 16.65   | 16.79   |
|           |            | 1       | 24        | 17.50   | 16.82   | 16.81   | 16.87   |
|           |            | 12      | 0         | 17.50   | 16.76   | 16.75   | 16.67   |
|           |            | 12      | 6         | 17.50   | 16.85   | 16.66   | 16.71   |
|           |            | 12      | 13        | 17.50   | 16.85   | 16.78   | 16.67   |
|           |            | 25      | 0         | 17.50   | 16.59   | 16.75   | 16.70   |
| Bandwidth | Modulation | RB size | RB offset | Tune-up | Channel | Channel | Channel |
| 10MHz     | QPSK       | 1       | 0         | 17.50   | 16.76   | 16.78   | 16.74   |
|           |            | 1       | 25        | 17.50   | 16.77   | 16.70   | 16.67   |
|           |            | 1       | 49        | 17.50   | 16.76   | 16.73   | 16.66   |
|           |            | 25      | 0         | 17.50   | 16.63   | 16.77   | 16.80   |
|           |            | 25      | 13        | 17.50   | 16.63   | 16.74   | 16.71   |
|           |            | 25      | 25        | 17.50   | 16.64   | 16.80   | 16.72   |
|           |            | 50      | 0         | 17.50   | 16.61   | 16.72   | 16.68   |
|           | 16QAM      | 1       | 0         | 17.50   | 16.93   | 16.80   | 16.72   |
|           |            | 1       | 25        | 17.50   | 16.79   | 16.74   | 16.94   |
|           |            | 1       | 49        | 17.50   | 16.69   | 16.85   | 16.84   |
|           |            | 25      | 0         | 17.50   | 16.76   | 16.65   | 16.65   |
|           |            | 25      | 13        | 17.50   | 16.71   | 16.72   | 16.64   |
|           |            | 25      | 25        | 17.50   | 16.77   | 16.69   | 16.66   |
|           |            | 50      | 0         | 17.50   | 16.69   | 16.65   | 16.58   |
|           | 64QAM      | 1       | 0         | 17.50   | 17.00   | 16.61   | 16.49   |
|           |            | 1       | 25        | 17.50   | 16.96   | 16.46   | 16.72   |
|           |            | 1       | 49        | 17.50   | 16.86   | 16.61   | 16.64   |
|           |            | 25      | 0         | 17.50   | 16.76   | 16.67   | 16.71   |
|           |            | 25      | 13        | 17.50   | 16.71   | 16.68   | 16.70   |
|           |            | 25      | 25        | 17.50   | 16.73   | 16.68   | 16.62   |
|           |            | 50      | 0         | 17.50   | 16.58   | 16.55   | 16.65   |

| Bandwidth | Modulation | RB size    | RB offset | Tune-up   | Channel      | Channel      | Channel      |         |
|-----------|------------|------------|-----------|-----------|--------------|--------------|--------------|---------|
|           |            |            |           | Max.      | 18675CH      | 18900CH      | 19125CH      |         |
| 15MHz     | QPSK       | 1          | 0         | 17.50     | 16.74        | 16.81        | 16.68        |         |
|           |            | 1          | 38        | 17.50     | 16.77        | 16.78        | 16.68        |         |
|           |            | 1          | 74        | 17.50     | 16.76        | 16.81        | 16.68        |         |
|           |            | 36         | 0         | 17.50     | 16.65        | 16.77        | 16.59        |         |
|           |            | 36         | 18        | 17.50     | 16.65        | 16.82        | 16.59        |         |
|           |            | 36         | 39        | 17.50     | 16.85        | 16.76        | 16.59        |         |
|           |            | 75         | 0         | 17.50     | 16.81        | 16.70        | 16.78        |         |
|           | 16QAM      | 1          | 0         | 17.50     | 16.83        | 16.79        | 16.80        |         |
|           |            | 1          | 38        | 17.50     | 17.07        | 16.85        | 16.75        |         |
|           |            | 1          | 74        | 17.50     | 16.73        | 16.69        | 16.78        |         |
|           |            | 36         | 0         | 17.50     | 16.83        | 16.69        | 16.50        |         |
|           |            | 36         | 18        | 17.50     | 16.84        | 16.73        | 16.52        |         |
|           |            | 36         | 39        | 17.50     | 16.73        | 16.74        | 16.47        |         |
|           |            | 75         | 0         | 17.50     | 16.68        | 16.53        | 16.69        |         |
|           | 64QAM      | 1          | 0         | 17.50     | 16.81        | 17.00        | 16.43        |         |
|           |            | 1          | 38        | 17.50     | 16.80        | 16.87        | 16.47        |         |
|           |            | 1          | 74        | 17.50     | 16.69        | 16.91        | 16.53        |         |
|           |            | 36         | 0         | 17.50     | 16.72        | 16.70        | 16.73        |         |
|           |            | 36         | 18        | 17.50     | 16.64        | 16.73        | 16.65        |         |
|           |            | 36         | 39        | 17.50     | 16.62        | 16.70        | 16.65        |         |
|           |            | 75         | 0         | 17.50     | 16.76        | 16.76        | 16.71        |         |
|           | Bandwidth  | Modulation | RB size   | RB offset | Tune-up      | Channel      | Channel      | Channel |
|           |            |            |           |           | Max.         | 18700CH      | 18900CH      | 19100CH |
|           | 20MHz      | QPSK       | 1         | 0         | 17.50        | 16.97        | 16.93        | 16.79   |
| 1         |            |            | 50        | 17.50     | <b>17.13</b> | 16.91        | 16.78        |         |
| 1         |            |            | 99        | 17.50     | 16.97        | 16.93        | 16.77        |         |
| 50        |            |            | 0         | 17.50     | 16.86        | 16.79        | 16.74        |         |
| 50        |            |            | 25        | 17.50     | 16.85        | <b>16.87</b> | 16.70        |         |
| 50        |            |            | 50        | 17.50     | <b>16.86</b> | 16.73        | <b>16.76</b> |         |
| 100       |            |            | 0         | 17.50     | 16.76        | 16.75        | 16.59        |         |
| 16QAM     |            | 1          | 0         | 17.50     | 16.99        | 16.96        | 17.05        |         |
|           |            | 1          | 50        | 17.50     | 16.99        | 16.95        | 16.75        |         |
|           |            | 1          | 99        | 17.50     | 16.94        | 17.03        | 17.18        |         |
|           |            | 50         | 0         | 17.50     | 16.76        | 16.65        | 16.68        |         |
|           |            | 50         | 25        | 17.50     | 16.77        | 16.71        | 16.63        |         |
|           |            | 50         | 50        | 17.50     | 16.75        | 16.74        | 16.68        |         |
|           |            | 100        | 0         | 17.50     | 16.67        | 16.59        | 16.64        |         |
| 64QAM     |            | 1          | 0         | 17.50     | 16.83        | 17.13        | 17.00        |         |
|           |            | 1          | 50        | 17.50     | 16.89        | 17.12        | 16.84        |         |
|           |            | 1          | 99        | 17.50     | 16.84        | 16.97        | 17.00        |         |
|           |            | 50         | 0         | 17.50     | 16.74        | 16.67        | 16.67        |         |
|           |            | 50         | 25        | 17.50     | 16.75        | 16.72        | 16.65        |         |
|           |            | 50         | 50        | 17.50     | 16.79        | 16.70        | 16.67        |         |
|           |            | 100        | 0         | 17.50     | 16.60        | 16.77        | 16.65        |         |

Table 44: Conducted power measurement results of LTE Band 2(Reduced Power Level D1)

| Bandwidth | Modulation | RB size | RB offset | Tune-up | Channel | Channel | Channel |
|-----------|------------|---------|-----------|---------|---------|---------|---------|
|           |            |         |           | Max.    | 18607CH | 18900CH | 19193CH |
| 1.4MHz    | QPSK       | 1       | 0         | 13.50   | 12.61   | 12.47   | 12.59   |
|           |            | 1       | 3         | 13.50   | 12.60   | 12.54   | 12.57   |
|           |            | 1       | 5         | 13.50   | 12.61   | 12.48   | 12.55   |
|           |            | 3       | 0         | 13.50   | 12.57   | 12.54   | 12.61   |
|           |            | 3       | 2         | 13.50   | 12.62   | 12.53   | 12.65   |
|           |            | 3       | 3         | 13.50   | 12.64   | 12.55   | 12.64   |
|           |            | 6       | 0         | 13.50   | 12.67   | 12.59   | 12.59   |
|           | 16QAM      | 1       | 0         | 13.50   | 13.06   | 12.77   | 12.88   |
|           |            | 1       | 3         | 13.50   | 12.88   | 12.78   | 12.92   |
|           |            | 1       | 5         | 13.50   | 13.02   | 12.93   | 12.96   |
|           |            | 3       | 0         | 13.50   | 12.57   | 12.81   | 12.71   |
|           |            | 3       | 2         | 13.50   | 12.62   | 12.75   | 12.85   |
|           |            | 3       | 3         | 13.50   | 12.61   | 12.85   | 12.73   |
|           |            | 6       | 0         | 13.50   | 12.63   | 12.75   | 12.34   |
|           | 64QAM      | 1       | 0         | 13.50   | 12.71   | 12.87   | 12.50   |
|           |            | 1       | 3         | 13.50   | 12.89   | 12.76   | 12.64   |
|           |            | 1       | 5         | 13.50   | 12.79   | 12.80   | 12.49   |
|           |            | 3       | 0         | 13.50   | 12.70   | 12.78   | 12.54   |
|           |            | 3       | 2         | 13.50   | 12.90   | 12.89   | 12.50   |
|           |            | 3       | 3         | 13.50   | 12.66   | 12.76   | 12.50   |
|           |            | 6       | 0         | 13.50   | 12.78   | 12.69   | 11.29   |
| Bandwidth | Modulation | RB size | RB offset | Tune-up | Channel | Channel | Channel |
| 3MHz      | QPSK       | 1       | 0         | 13.50   | 12.68   | 12.56   | 12.59   |
|           |            | 1       | 7         | 13.50   | 12.63   | 12.52   | 12.53   |
|           |            | 1       | 14        | 13.50   | 12.64   | 12.55   | 12.56   |
|           |            | 8       | 0         | 13.50   | 12.72   | 12.67   | 12.61   |
|           |            | 8       | 4         | 13.50   | 12.71   | 12.66   | 12.58   |
|           |            | 8       | 7         | 13.50   | 12.72   | 12.66   | 12.60   |
|           |            | 15      | 0         | 13.50   | 12.67   | 12.63   | 12.57   |
|           | 16QAM      | 1       | 0         | 13.50   | 12.85   | 12.99   | 12.74   |
|           |            | 1       | 7         | 13.50   | 12.87   | 12.92   | 12.70   |
|           |            | 1       | 14        | 13.50   | 12.92   | 12.77   | 12.54   |
|           |            | 8       | 0         | 13.50   | 12.70   | 12.66   | 12.57   |
|           |            | 8       | 4         | 13.50   | 12.63   | 12.69   | 12.61   |
|           |            | 8       | 7         | 13.50   | 12.63   | 12.69   | 12.57   |
|           |            | 15      | 0         | 13.50   | 12.58   | 12.57   | 12.53   |
|           | 64QAM      | 1       | 0         | 13.50   | 12.75   | 12.89   | 12.54   |
|           |            | 1       | 7         | 13.50   | 12.85   | 12.74   | 12.63   |
|           |            | 1       | 14        | 13.50   | 12.86   | 12.65   | 12.65   |
|           |            | 8       | 0         | 13.50   | 12.74   | 12.60   | 12.00   |
|           |            | 8       | 4         | 13.50   | 12.70   | 12.62   | 12.03   |
|           |            | 8       | 7         | 13.50   | 12.68   | 12.63   | 12.04   |
|           |            | 15      | 0         | 13.50   | 12.69   | 12.61   | 11.92   |