



中国认可  
国际互认  
检测  
TESTING  
CNAS L0310



## FCC SAR Compliance Test Report

**Product Name:** Smart Phone

**Model:** ELE-L29, ELE-L09

**Report No.:** SYBH(Z-SAR)20200307009001-2

**FCC ID:** QISELE-LX9

	APPROVED (Lab Manager)	PREPARED (Test Engineer)
BY	<i>Wei Manbin</i>	<i>Sun Shaobin</i>
DATE	2020-04-15	2020-04-15

**Reliability Laboratory of Huawei Technologies Co., Ltd.**

**(Global Compliance and Testing Center of Huawei Technologies Co., Ltd)**

No.2, New City Avenue, Songshan Lake Sci. & Tech. Industry Park,  
Dongguan, Guangdong, 523808, P.R.C  
Tel: +86 769 23830808 Fax: +86 769 23837628

※ ※ **Notice** ※ ※

1. The laboratory has passed the accreditation by China National Accreditation Service for Conformity Assessment (CNAS). The accreditation number is L0310.
2. The laboratory has passed the accreditation by The American Association for Laboratory Accreditation (A2LA). The accreditation number is 2174.01 & 2174.02 & 2174.03
3. The laboratory (Reliability Lab of Huawei Technologies Co., Ltd) is also named “Global Compliance and Testing Center of Huawei Technologies Co., Ltd”, the both names have coexisted since 2009.
4. The test report is invalid if not marked with the signatures of the persons responsible for preparing and approving the test report.
5. The test report is invalid if there is any evidence of erasure and/or falsification.
6. The test report is only valid for the test samples.
7. Content of the test report, in part or in full, cannot be used for publicity and/or promotional purposes without prior written approval from the laboratory.
8. If any question about this report, please contact the laboratory (PublicGCTC@huawei.com).

# Table of Contents

1	General Information.....	7
1.1	Statement of Compliance .....	7
1.2	RF exposure limits .....	8
1.3	EUT Description.....	9
1.3.1	General Description .....	12
1.4	Test specification(s).....	15
1.5	Testing laboratory .....	15
1.6	Applicant and Manufacturer .....	15
1.7	Application details .....	15
1.8	Ambient Condition.....	15
2	SAR Measurement System .....	16
2.1	SAR Measurement Set-up.....	16
2.2	Test environment .....	17
2.3	Data Acquisition Electronics description.....	17
2.4	Probe description .....	18
2.5	Phantom description .....	19
2.6	Device holder description .....	20
2.7	Test Equipment List .....	21
3	SAR Measurement Procedure .....	24
3.1	Scanning procedure.....	24
3.2	Spatial Peak SAR Evaluation .....	25
3.3	Data Storage and Evaluation.....	26
4	System Verification Procedure .....	28
4.1	Tissue Verification.....	28
4.2	System Check.....	34
4.3	System check Procedure.....	36
5	SAR measurement variability and uncertainty .....	37
5.1	SAR measurement variability .....	37
5.2	SAR measurement uncertainty.....	37
6	SAR Test Configuration.....	38
6.1	Test Positions Configuration .....	38
6.1.1	General considerations .....	38
6.1.2	Head Exposure Condition .....	38
6.1.3	Body-worn Exposure Condition .....	39
6.1.4	Hotspot Exposure Condition .....	39
6.1.5	Product Specific 10-g SAR Exposure Condition.....	40
6.2	3G SAR Test Reduction Procedure .....	40
6.3	GSM Test Configuration .....	40
6.4	UMTS Test Configuration .....	41
6.5	LTE Test Configuration .....	46
6.6	WiFi Test Configuration .....	50
6.6.1	Initial Test Position Procedure .....	50
6.6.2	Initial Test Configuration Procedure .....	50
6.6.3	Sub Test Configuration Procedure .....	50
6.6.4	WiFi 2.4G SAR Test Procedures .....	51
6.6.5	U-NII-1 and U-NII-2A Bands .....	52
6.6.6	U-NII-2C and U-NII-3 Bands.....	52
6.6.7	OFDM Transmission Mode SAR Test Channel Selection Requirements .....	53
6.6.8	MIMO SAR Considerations.....	53
6.7	LTE CA specification.....	54
6.7.1	LTE CA combinations specification .....	54
6.7.2	Test procedure for downlink CA .....	59
6.7.3	Test procedure for Intra-band uplink CA.....	60
6.8	Dynamic antenna switching specification .....	60
6.9	Power Reduction Specification .....	61
6.9.1	Power Reduction Specification of 2G/3G/4G Second Antenna.....	62
6.9.2	Power Reduction Specification of WiFi Antenna .....	63
6.9.3	Power Reduction Specification of 2G/3G/4G Main Antenna .....	64
6.9.4	Proximity sensor Power Reduction Test configuration and validation.....	65

6.10	BT Test Configuration.....	82
7	SAR Measurement Results .....	84
7.1	Conducted power measurements.....	84
7.1.1	Conducted power measurements of GSM850 (Second Antenna) .....	85
7.1.2	Conducted power measurements of GSM850 (Main Antenna).....	86
7.1.3	Conducted power measurements of GSM1900 (Second Antenna) .....	87
7.1.4	Conducted power measurements of GSM1900 (Main Antenna).....	88
7.1.5	Conducted power measurements of UMTS Band II (Second Antenna).....	89
7.1.6	Conducted power measurements of UMTS Band II (Main Antenna) .....	91
7.1.7	Conducted power measurements of UMTS Band IV (Second Antenna) .....	93
7.1.8	Conducted power measurements of UMTS Band IV (Main Antenna).....	95
7.1.9	Conducted power measurements of UMTS Band V (Second Antenna) .....	97
7.1.10	Conducted power measurements of UMTS Band V (Main Antenna).....	99
7.1.11	Conducted power measurements of LTE Band 2 (Second Antenna) .....	100
7.1.12	Conducted power measurements of LTE Band 2 (Main Antenna).....	112
7.1.13	Conducted power measurements of LTE Band 4 (Second Antenna) .....	121
7.1.14	Conducted power measurements of LTE Band 4 (Main Antenna).....	133
7.1.15	Conducted power measurements of LTE Band 5 (Second Antenna) .....	142
7.1.16	Conducted power measurements of LTE Band 5 (Main Antenna).....	150
7.1.17	Conducted power measurements of LTE Band 7 (Second Antenna) .....	152
7.1.18	Conducted power measurements of LTE Band 7 (Main Antenna).....	160
7.1.19	Conducted power measurements of LTE Band 12 (Second Antenna) .....	170
7.1.20	Conducted power measurements of LTE Band 12 (Main Antenna).....	178
7.1.21	Conducted power measurements of LTE Band 17 (Second Antenna) .....	180
7.1.22	Conducted power measurements of LTE Band 17 (Main Antenna).....	182
7.1.23	Conducted power measurements of LTE Band 26 (Second Antenna) .....	183
7.1.24	Conducted power measurements of LTE Band 26 (Main Antenna).....	195
7.1.25	Conducted power measurements of LTE Band 38 (Second Antenna) .....	198
7.1.26	Conducted power measurements of LTE Band 38 (Main Antenna).....	206
7.1.27	Conducted power measurements of LTE Band 41 (Second Antenna) .....	216
7.1.28	Conducted power measurements of LTE Band 41 (Main Antenna).....	224
7.1.29	Conducted power measurements of Downlink LTE CA.....	230
7.1.30	Conducted Power measurements of Uplink LTE CA.....	236
7.1.31	Conducted power measurements of WiFi 2.4G.....	241
7.1.32	Conducted power measurements of WiFi 5G.....	249
7.1.33	Conducted power measurements of BT .....	282
7.2	SAR measurement Results .....	287
7.2.1	SAR measurement Results of GSM850 .....	289
7.2.2	SAR measurement Results of GSM1900 .....	292
7.2.3	SAR measurement Results of UMTS Band II.....	295
7.2.4	SAR measurement Results of UMTS Band IV .....	299
7.2.5	SAR measurement Results of UMTS Band V .....	304
7.2.6	SAR measurement Results of LTE Band 2 .....	308
7.2.7	SAR measurement Results of LTE Band 4 .....	312
7.2.8	SAR measurement Results of LTE Band 5 .....	316
7.2.9	SAR measurement Results of LTE Band 7 .....	320
7.2.10	SAR measurement Results of LTE Band 12 .....	325
7.2.11	SAR measurement Results of LTE Band 17 .....	329
7.2.12	SAR measurement Results of LTE Band 26 .....	332
7.2.13	SAR measurement Results of LTE Band 38 .....	336
7.2.14	SAR measurement Results of LTE Band 41 .....	341
7.2.15	SAR measurement Results of WiFi 2.4G .....	346
7.2.16	SAR measurement Results of WiFi 5G .....	354
7.2.17	SAR measurement Result of BT.....	362
7.3	Multiple Transmitter Evaluation .....	365
7.3.1	Simultaneous Transmission Possibilities.....	366
7.3.2	SAR Summation Scenario .....	371
7.3.3	Simultaneous Transmission Conclusion.....	376
	Appendix A. System Check Plots.....	377
	Appendix B. SAR Measurement Plots.....	377
	Appendix C. Calibration Certificate .....	377
	Appendix D. Photo documentation.....	377



---

Appendix E. Antenna Location .....377



※ ※ **Modified History** ※ ※

REV.	DESCRIPTION	ISSUED DATE	REMARK
Rev.1.0	Initial Test Report Release	2020-04-15	Sun Shaobin

# 1 General Information

## 1.1 Statement of Compliance

The maximum results of Specific Absorption Rate (SAR) found during testing in this report are as below Table 1.

Band	Max Reported SAR(W/kg)			
	1-g Head	1-g Body-worn (15mm) *	1-g Hotspot (10mm)	Product Specific 10-g SAR (0mm)**
<b>GSM850</b>	0.31	0.32	0.54	/
<b>GSM1900</b>	0.39	0.17	0.59	/
<b>UMTS Band II</b>	0.40	0.41	0.40	/
<b>UMTS Band IV</b>	0.45	0.51	<b>0.68</b>	<b>1.82</b>
<b>UMTS Band V</b>	0.32	0.37	0.43	/
<b>LTE Band 2</b>	0.40	0.43	0.55	/
<b>LTE Band 4</b>	0.35	0.44	0.41	/
<b>LTE Band 5</b>	0.44	0.44	0.63	/
<b>LTE Band 7</b>	0.41	<b>0.54</b>	0.68	/
<b>LTE Band 12</b>	<b>0.53</b>	0.37	0.57	/
<b>LTE Band 17***</b>	0.42	0.13	0.21	/
<b>LTE Band 26</b>	0.49	0.41	0.62	/
<b>LTE Band 38</b>	0.44	0.25	0.59	/
<b>LTE Band 41</b>	0.42	0.31	0.50	/
<b>WiFi 2.4G</b>	0.51	0.22	0.44	1.66
<b>WiFi 5G</b>	0.28	0.27	0.20	1.75
<b>BT</b>	0.31	0.17	0.34	/
<b>The highest reported SAR for Head, Body Worn, Hotspot, Simultaneous transmission and Product Specific 10-g SAR exposure conditions are 0.53 W/kg, 0.54 W/kg, 0.68 W/kg, 1.04W/kg and 1.82 W/kg respectively per KDB690783 D01.</b>				

Table 1: Summary of test result

Note:

- 1)\* For body worn operation, this device has been tested and met FCC RF exposure guidelines when used with any accessory that contains no metal and that positions the handset a minimum of 15mm from the body. Use of other accessories may not ensure compliance with FCC RF exposure guidelines.
- 2)\*\* For Product Specific 10-g SAR operation, this device has been tested and meets the 10-g SAR limits of 4.0 W/kg for general population/ uncontrolled exposure according to ANSI C95.1:1992/IEEE C95.1:1991
- 3) \*\*\* According to TCB workshop October,2014 RF Exposure Procedures Update(Overlapping LTE Bands): SAR for Main antenna LTE Band 17 (Frequency range:704-716 MHz) is covered by LTE Band 12 (Frequency range:699-716 MHz) due to similar frequency range,same maximum tune up limit and same channel bandwidth.

The device is in compliance with Specific Absorption Rate (SAR) for general population/uncontrolled exposure limits according to the FCC rule §2.1093, the ANSI C95.1:1992/IEEE C95.1:1991, the NCRP Report Number 86 for uncontrolled environment, and had been tested in accordance with the measurement methods and procedures specified in IEEE Std 1528-2013.

## 1.2 RF exposure limits

Human Exposure	Uncontrolled Environment General Population	Controlled Environment Occupational
<b>Spatial Peak SAR*</b> (Brain/Body/Arms/Legs)	<b>1.60 W/kg</b>	8.00 W/kg
<b>Spatial Average SAR**</b> (Whole Body)	0.08 W/kg	0.40 W/kg
<b>Spatial Peak SAR***</b> (Hands/Feet/Ankle/Wrist)	<b>4.00 W/kg</b>	20.00 W/kg

Table 2: RF exposure limits

The limit applied in this test report is shown in **bold** letters

### **Notes:**

- \* The Spatial Peak value of the SAR averaged over any 1 gram of tissue (defined as a tissue volume in the shape of a cube) and over the appropriate averaging time.
- \*\* The Spatial Average value of the SAR averaged over the whole body.
- \*\*\* The Spatial Peak value of the SAR averaged over any 10 grams of tissue (defined as a tissue volume in the shape of a cube) and over the appropriate averaging time.

**Uncontrolled Environments** are defined as locations where there is the exposure of individuals who have no knowledge or control of their exposure.

**Controlled Environments** are defined as locations where there is exposure that may be incurred by persons who are aware of the potential for exposure, (i.e. as a result of employment or occupation



### 1.3 EUT Description

Device Information:			
Product Name:	Smart Phone		
Model:	ELE-L29, ELE-L09		
FCC ID :	QISELE-LX9		
SN:	1#:JND0118A23000175; 2#:JND0118A23000070 3#:JND0118A23000010; 4#:JND0118A23000179 5#:JND0118A23000168; 6#:JND0118A23000082 7#:JND0118A23000163; 8#:JND0118A23000160 9#: XPH0118A22000061; 10#: XPH0118A22000081 11#: XPH0118A22000108; 12#: XPH0118A22000189 13#: XPH0118A22000140; 14#: XPH0219117000025 15#: XPH0219117000022; 16#: XPH0219114000006		
Device Type :	Portable device		
Device Phase:	Identical Prototype		
Exposure Category:	Uncontrolled environment / general population		
Hardware Version :	HL1ELLEM		
Software Version :	10.1.0.190(C432E23R2P5log)		
Antenna Type :	Internal antenna		
Others Accessories	Headset, protective cover ,Wireless charging protective case		
Device Operating Configurations:			
Supporting Mode(s)	GSM850/1900, UMTS Band II/IV/V, LTE Band 2/4/5/7/12/17/26/38/41, WiFi 2.4G/5G, BT, NFC		
Test Modulation	GSM(GMSK/8PSK),UMTS(QPSK), LTE(QPSK/16QAM/64QAM), WiFi(DSSS/OFDM),BT(GFSK)		
Device Class	B		
Operating Frequency Range(s)	Band	Tx (MHz)	Rx (MHz)
	GSM850	824-849	869 - 894
	GSM1900	1850-1910	1930-1990
	UMTS Band II	1850-1910	1930-1990
	UMTS Band IV	1710-1755	2110-2155
	UMTS Band V	824-849	869 - 894
	LTE Band 2	1850-1910	1930-1990
	LTE Band 4	1710-1755	2110-2155
	LTE Band 5	824-849	869-894
	LTE Band 7	2500-2570	2620 -2690
	LTE Band 12	699-716	729-746
	LTE Band 17	704-716	734-746
	LTE Band 26	814-849	859-894
	LTE Band 38	2570-2620	
	LTE Band 41	2535-2655	
	BT	2400-2483.5	
	WiFi 2.4G	2400-2472	
WiFi 5G	5150-5350		
	5470-5725		
	5725-5850		
NFC	13.56		
GPRS Multislot Class(12)	Max Number of Timeslots in Uplink:	4	
	Max Number of Timeslots in Downlink:	4	
	Max Total Timeslot:	5	

EGPRS Multislot Class(12)	Max Number of Timeslots in Uplink:	4
	Max Number of Timeslots in Downlink:	4
	Max Total Timeslot:	5
HSDPA UE Category	14	
HSUPA UE Category	6	
DC-HSDPA UE Category	24	
Power Class:	4, tested with power level 5(GSM850)	
	1, tested with power level 0(GSM1900)	
	3, tested with power control "all 1"(UMTS Band II)	
	3, tested with power control "all 1"(UMTS Band IV)	
	3, tested with power control "all 1"(UMTS Band V)	
	3, tested with power control all Max.(LTE Band 2)	
	3, tested with power control all Max.(LTE Band 4)	
	3, tested with power control all Max.(LTE Band 5)	
	3, tested with power control all Max.(LTE Band 7)	
	3, tested with power control all Max.(LTE Band 12)	
	3, tested with power control all Max.(LTE Band 17)	
	3, tested with power control all Max.(LTE Band 26)	
	3, tested with power control all Max.(LTE Band 38)	
	3, tested with power control all Max.(LTE Band 41)	
	Test Channels (low-mid-high):	128-190-251(GSM850)
512-661-810(GSM1900)		
9262-9400-9538(UMTS Band II)		
1312-1413-1513(UMTS Band IV)		
4132-4182-4233(UMTS Band V)		
18607-18900-19193(LTE Band 2 BW=1.4MHz)		
18615-18900-19185(LTE Band 2 BW=3MHz)		
18625-18900-19175(LTE Band 2 BW=5MHz)		
18650-18900-19150(LTE Band 2 BW=10MHz)		
18675-18900-19125(LTE Band 2 BW=15MHz)		
18700-18900-19100(LTE Band 2 BW=20MHz)		
19957-20175-20393(LTE Band 4 BW=1.4MHz)		
19965-20175-20385(LTE Band 4 BW=3MHz)		
19975-20175-20375(LTE Band 4 BW=5MHz)		
20000-20175-20350(LTE Band 4 BW=10MHz)		
20025-20175-20325(LTE Band 4 BW=15MHz)		
20050-20175-20300(LTE Band 4 BW=20MHz)		
20407-20525-20643(LTE Band 5 BW=1.4MHz)		
20415-20525-20635(LTE Band 5 BW=3MHz)		
20425-20525-20625(LTE Band 5 BW=5MHz)		
20450-20525-20600(LTE Band 5 BW=10MHz)		
20775-21100-21425(LTE Band 7 BW=5MHz)		
20800-21100-21400(LTE Band 7 BW=10MHz)		
20825-21100-21375(LTE Band 7 BW=15MHz)		
20850-21100-21350(LTE Band 7 BW=20MHz)		
23017-23095-23173(LTE Band 12 BW=1.4MHz)		
23025-23095-23165(LTE Band 12 BW=3MHz)		
23035-23095-23155(LTE Band 12 BW=5MHz)		
23060-23095-23130(LTE Band 12 BW=10MHz)		
23755-23790-23825(LTE Band 17 BW=5MHz)		
23780-23790-23800(LTE Band 17 BW=10MHz)		
26697-26865-27033(LTE Band 26 BW=1.4MHz)		
26705-26865-27025(LTE Band 26 BW=3MHz)		

26715-26865-27015(LTE Band 26 BW=5MHz)
26740-26865-26990(LTE Band 26 BW=10MHz)
26765-26865-26965(LTE Band 26 BW=15MHz)
37775-38000-38225(LTE Band 38 BW=5MHz)
37800-38000-38200(LTE Band 38 BW=10MHz)
37825-38000-38175(LTE Band 38 BW=15MHz)
37850-38000-38150(LTE Band 38 BW=20MHz)
40065-40448-40832-41215(LTE Band 41 BW=5MHz)
40090-40457-40823-41190(LTE Band 41 BW=10MHz)
40115-40465-40815-41165(LTE Band 41 BW=15MHz)
40140-40473-40807-41140(LTE Band 41 BW=20MHz)
802.11b/g/n 20M:1-2-6-7-10-11-12-13 (WiFi 2.4G)
40M:3-4-5-6-7-8-9-10-11(WiFi 2.4G)
802.11a/n/ac 20M: 36-40-44-48-52-56-60-64-100-104-108-112-116-120-124-128-132-136-140-149-153-157-161-165 (WiFi 5G)
802.11 n/ac 40M: 38-46-54-62-102-110-118-126-134-151-159 (WiFi 5G)
802.11ac 80M: 42-58-106-122-155 (WiFi 5G)
802.11ac 160M: 50-114 (WiFi 5G)
BT : 0-3-5-6-10-11-16-19-22-31-32-33-36-39-54-67-68-73-75-76-77-78

Table 3:Device information and operating configuration



Note:

- 1)\*For WiFi 5G,the device does not support channel 144(20M), channel 142(40M) and channel 138(80M).
- 2)\*For WiFi 5G,U-NII-2A and U-NII-2C does not support hotspot function.

### 1.3.1 General Description

ELE-L29/ELE-L09 is subscriber equipment in the GSM/WCDMA/LTE system. The GSM frequency band includes GSM850 and GSM900 and DCS1800 and PCS1900. The UMTS frequency band is Band I, Band II, Band IV, Band V, Band VI, Band VIII and Band XIX. The ELE-L29/ELE-L09 LTE frequency band is B1 and B2 and B3 and B4 and B5 and B6 and B7 and B8 and B9 and B12 and B17 and B18 and B19 and B20 and B26 and B28 and B32 and B34 and B38 and B39 and B41. The ELE-L29/ ELE-L09 LTE frequency band for intra-band carrier aggregation uplink operation band is CA\_1C and CA\_2C and CA\_3C and CA\_7C and CA\_38C and CA\_39C and CA\_41C. But only GSM850 and GSM1900, UMTS Band II, UMTS Band IV, UMTS Band V, LTE frequency B2 and B4 and B5 and B7 and B12 and B17 and B26 and B38 and B41 bands, The ELE-L29/ELE-L09 LTE frequency band for intra-band carrier aggregation uplink operation band is CA\_2C and CA\_7C and CA\_38C and CA\_41C. test data included in this report. The Mobile Phone implements such functions as RF signal receiving/transmitting LTE/HSPA/UMTS and GSM/GPRS/EDGE protocol processing, voice, video MMS service, GPS, AGPS and WIFI etc. Externally it provides one micro SD card interface (it can also used as SIM card interface), earphone port (to provide voice service) and one SIM card interface. ELE-L29 is dual SIM smart phone. ELE-L09 is single SIM smart phone. It also provides Bluetooth module to synchronize data between a PC and the phone, or to use the built-in modem of the phone to access the Internet with a PC, or to exchange data with other Bluetooth devices.

#### Battery information:

Name	Manufacturer/trademark	Description
Li-ion Polymer Battery	HuaweiTechnologies Co., Ltd. (Manufacturer: Sunwoda)	Battery Model: HB436380ECW Rated capacity: 3550mAh Nominal Voltage:  +3.85V Charging Voltage:  +4.43V
	HuaweiTechnologies Co., Ltd. (Manufacturer: Desay)	

#### The difference between ELE-L29 and ELE-L09:

The only difference between ELE-L29 and ELE-L09 is that ELE -L09 deletes into single SIM card by software. Other parts of the two models are the same.

**Differences description:**

1) The difference between ELE-L29/ELE-L09 Version 1 and ELE-L29/ELE-L09 Version 2 is as below:

	<b>ELE-L29/ELE-L09 Version 1</b>	<b>ELE-L29/ELE-L09 Version 2</b>
GSM four bands	B2/B3/B5/B8	B2/B3/B5/B8
WCDMA bands	B1/2/4/5/6/8/19	B1/2/4/5/6/8/19
LTE bands	FDD LTE: B1/2/3/4/5/6/7/8/9/12/17/18/19/20/ B26/28/32 TDD LTE: B34/B38/39/40/41(120M,2535- 2655)	FDD LTE: B1/2/3/4/5/6/7/8/9/12/17/18/19/20/ B26/28/32 TDD LTE: B34/B38/39/40/41(120M,2535- 2655)
SIM card	the same	the same
NFC	the same	the same
External camera	the same	the same
internal camera	the same	the same
FLASH	the same	the same
Mainboard	the same	the same
PCB layout	the same	the same
Appearance	the same	the same
Bluetooth mode	the same	the same
WLAN mode	the same	the same
BT/ WLAN antenna	the same	the same
GSM/ WCDMA /LTE antenna	the same	The same
Adapter	the same	the same
Battery	the same	the same
Optional accessories	None	Wireless charging protective case
Chipset	the same	the same
Memory	the same	the same
RF Parameter	The same RF Parameter in the same band	The same RF Parameter in the same band
Dimension	the same	the same
Main Frequency NV	The same NV in the same band	The same NV in the same band

2) The BT change ELE-L29/ELE-L09 Version 3 and ELE-L29/ELE-L09 Version 2 is as below:

Item	ELE-L29/ELE-L09 Version 2	ELE-L29/ELE-L09 Version 3
BT Function	Not support BT UHD function	Support BT UHD function by upgrade software, BT UHD has 5 kinds mode, which are BLE UHD 1M GFSK, BLE UHD 2M GFSK, BLE UHD 2M $\pi/4$ -DQPSK, BLE UHD 4M $\pi/4$ -DQPSK, BLE UHD 2M 8DQPSK

**The difference between ELE-L29 and ELE-L04:**

	Model	ELE-L04	ELE-L29
Licensed Frequency	LTE BAND	FCC Band: B2/B4/ B5/B7/B12/B17/B26/B38/ B41(2535~2655MHz)/B66	FCC Band: B2/B4/ B5/B7/B12/B17/B26/B38/ B41(2535~2655MHz)
	UMTS BAND	FCC Band: II/IV/V	FCC Band: II/IV/V
	GSM	FCC Band: B2/B5	FCC Band: B2/B5
	IC	the same	the same
	Antenna	the same	the same
	NFC	the same	the same
Unlicensed Frequency	Bluetooth	the same	the same
	2.4G Wi-Fi	the same	the same
	IC	the same	the same
	Antenna	the same	the same
Hardware	Ram / Rom	the same	the same
	Camera	the same	the same
	PCB	the same	the same
	USB Port	the same	the same
	SIM	one	two
	Hardware version	HL1ELLEM	HL1ELLEM
RF	RF circuit	The hardware channel of LTE B2/4/7(include CA band) is different	The hardware channel of LTE B2/4/7(include CA band) is different
Appearance	Dimension	the same	the same
	Color	different	different
Accessory	Battery	the same	the same
	External Charger	the same	the same
	USB label	the same	the same
	Earphone	the same	the same

**According to the difference description above:**

- 1) The test plan for ELE-L29/ELE-L09 Version 3 is as below:
  - a) Additional conducted power tests are performed for BT UHD. SAR for BT UHD is not required because the maximum power of BT UHD is not higher than BT-DH5.
  - b) For other frequency bands, ELE-L29/ELE-L09 Version 3 share the same test data with ELE-L29/ELE-L09 Version 2(report no.: SYBH(Z-SAR)20190117023001-2)
- 2) The test plan for ELE-L29/ELE-L09 Version 2 is as below:
  - a) Full test is performed on ELE-L29. The model ELE-L09 shares the same test data of ELE -L29 for the same frequency bands and operation modes.
  - b) This report shares the same test data of ELE-L29/ELE-L09 Version 1 without the optional Wireless charging protective case (Report No.:SYBH(Z-SAR)20181114019001-2). The highest reported SAR for each wireless technology, frequency band, and applicable exposure condition is repeated with the optional wireless charging protective case accessory attached.
- 3) **The test plan for ELE-L29 and ELE-L09 Version 1 is as below:**
  - a) Full SAR Test is performed on ELE-L04.
  - b) For the different frequency bands(LTE B2/B4/B7), new full test is performed on ELE-L29. For the same frequency bands, ELE-L29 is tested at SAR worst case of ELE-L04.
  - c) ELE-L09 shares the same test data of ELE-L29 for the same frequency bands and operation modes.

#### 1.4 Test specification(s)

ANSI C95.1:1992/ IEEE C95.1:1991	Safety Levels with Respect to Human Exposure to Radio Frequency Electromagnetic Fields, 3 kHz – 300 GHz.
IEEE Std 1528-2013	Recommended Practice for Determining the Peak Spatial-Average Specific Absorption Rate (SAR) in the Human Head from Wireless Communications Devices: Measurement Techniques
KDB 941225 D01	3G SAR Procedures v03r01
KDB 941225 D05	SAR for LTE Devices v02r05
KDB 941225 D05A	LTE Rel.10 KDB Inquiry Sheet v01r02
KDB 941225 D06	Hotspot SAR v02r01
KDB 447498 D01	General RF Exposure Guidance v06
KDB 648474 D04	Handsets SAR v01r03
KDB 248227 D01	SAR Guidance for IEEE 802.11 Wi-Fi SAR v02r02
KDB 865664 D01	SAR measurement 100 MHz to 6 GHz v01r04
KDB 865664 D02	RF Exposure Reporting v01r02
KDB 690783 D01	SAR Listings on Grants v01r03
KDB 616217 D04	SAR for laptop and tablets v01r02

#### 1.5 Testing laboratory

Test Site	Reliability Laboratory of Huawei Technologies Co., Ltd.
Test Location	NO.2 New City Avenue Songshan Lake Sci. & Tech. Industry Park, Dongguan, Guangdong, P.R.C
Telephone	+86 755 28780808
Fax	+86 769 23837628
State of accreditation	The Test laboratory (area of testing) is accredited according to ISO/IEC 17025. CNAS Registration number: L0310 A2LA TESTING CERT # 2174.01 & 2174.02 & 2174.03

#### 1.6 Applicant and Manufacturer

Company Name	HUAWEI TECHNOLOGIES CO., LTD
Address	Administration Building, Headquarters of Huawei Technologies Co., Ltd., Bantian, Longgang District, Shenzhen, 518129, P.R.C

#### 1.7 Application details

Start Date of test	2018-12-05	2019-01-31	2020-04-08
End Date of test	2018-12-28	2019-02-14	2020-04-10

#### 1.8 Ambient Condition

Ambient temperature	18°C – 25°C
Relative Humidity	30% – 70%



## 2 SAR Measurement System

### 2.1 SAR Measurement Set-up

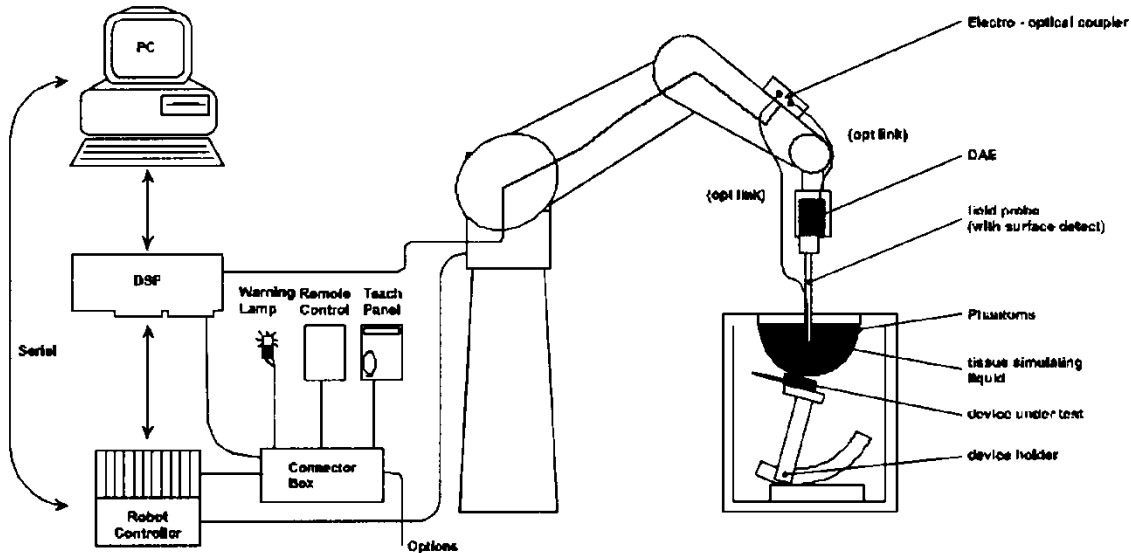

The DAS system for performing compliance tests consists of the following items:

- A standard high precision 6-axis robot (Stäubli RX family) with controller and software. An arm extension for accommodating the data acquisition electronics (DAE).
- A dosimetric probe, i.e. an isotropic E-field probe optimized and calibrated for usage in tissue simulating liquid. The probe is equipped with an optical surface detector system.
- A data acquisition electronic (DAE) which performs the signal amplification, signal multiplexing, AD-conversion, offset measurements, mechanical surface detection, collision detection, etc. The unit is battery powered with standard or rechargeable batteries. The signal is optically transmitted to the EOC.
- A unit to operate the optical surface detector which is connected to the EOC.
- The Electro-Optical Coupler (EOC) performs the conversion from the optical into a digital electric signal of the DAE. The EOC is connected to the DAS measurement server.
- The DAS measurement server, which performs all real-time data evaluation for field measurements and surface detection, controls robot movements and handles safety operation. A computer operating Windows 7.
- DAS software and SEMCAD data evaluation software.
- Remote control with teach panel and additional circuitry for robot safety such as warning lamps, etc.
- The generic twin phantom enabling the testing of left-hand and right-hand usage.
- The device holder for handheld mobile phones.
- Tissue simulating liquid mixed according to the given recipes.
- System check dipoles allowing to validate the proper functioning of the system.



## 2.2 Test environment

The DASY measurement system is placed at the head end of a room with dimensions: 5 x 2.5 x 3 m<sup>3</sup>, the SAM phantom is placed in a distance of 75 cm from the side walls and 1.1m from the rear wall. Above the test system a 1.5 x 1.5 m<sup>2</sup> array of pyramid absorbers is installed to reduce reflections from the ceiling.

Picture 1 of the photo documentation shows a complete view of the test environment.

The system allows the measurement of SAR values larger than 0.005 mW/g.

## 2.3 Data Acquisition Electronics description

The data acquisition electronics (DAE) consist of a highly sensitive electrometer-grade preamplifier with auto-zeroing, a channel and gain-switching multiplexer, a fast 16 bit AD-converte and a command decoder with a control logic unit. Transmission to the measurement server is accomplished through an optical downlink for data and status information, as well as an optical uplink for commands and the clock.

The mechanical probe mounting device includes two different sensor systems for frontal and sideways probe contacts. They are used for mechanical surface detection and probe collision detection.

### DAE

Input Impedance	200MOhm	
The Inputs	symmetrical and floating	
Common mode rejection	above 80 dB	

## 2.4 Probe description

These probes are specially designed and calibrated for use in liquids with high permittivities. They should not be used in air, since the spherical isotropy in air is poor ( $\pm 2$  dB). The dosimetric probes have special calibrations in various liquids at different frequencies.

### Isotropic E-Field Probe ES3DV3 for Dosimetric Measurements

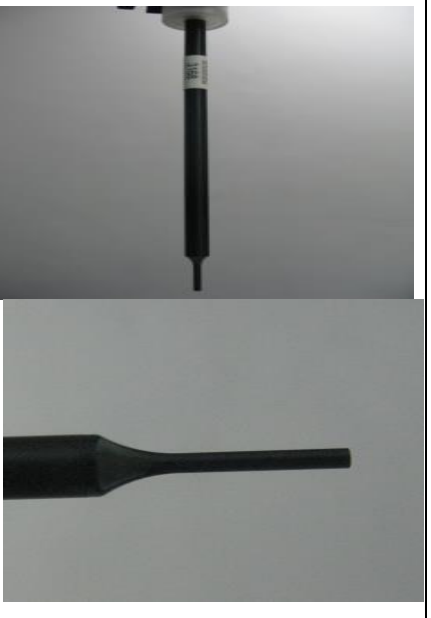
Construction	Symmetrical design with triangular core Interleaved sensors Built-in shielding against static charges PEEK enclosure material (resistant to organic solvents, e.g., DGBE)	
Calibration	ISO/IEC 17025 calibration service available.	
Frequency	10 MHz to 4 GHz; Linearity: $\pm 0.2$ dB (30 MHz to 4 GHz)	
Directivity	$\pm 0.2$ dB in HSL (rotation around probe axis) $\pm 0.3$ dB in tissue material (rotation normal to probe axis)	
Dynamic range	5 $\mu$ W/g to > 100 mW/g; Linearity: $\pm 0.2$ dB	
Dimensions	Overall length: 337 mm (Tip: 20 mm) Tip diameter: 3.9 mm (Body: 12 mm) Distance from probe tip to dipole centers: 2.0 mm	
Application	General dosimetry up to 4 GHz Dosimetry in strong gradient fields Compliance tests of mobile phones	

### Isotropic E-Field Probe EX3DV4 for Dosimetric Measurements

Construction	Symmetrical design with triangular core Built-in shielding against static charges PEEK enclosure material (resistant to organic solvents, e.g., DGBE)	
Calibration	ISO/IEC 17025 calibration service available.	
Frequency	10 MHz to >6 GHz; Linearity: $\pm 0.2$ dB (30 MHz to 6 GHz)	
Directivity	$\pm 0.3$ dB in HSL (rotation around probe axis) $\pm 0.5$ dB in tissue material (rotation normal to probe axis)	
Dynamic range	10 $\mu$ W/g to > 100 mW/g; Linearity: $\pm 0.2$ dB (noise: typically < 1 $\mu$ W/g)	
Dimensions	Overall length: 337 mm (Tip: 20 mm) Tip diameter: 2.5 mm (Body: 12 mm) Typical distance from probe tip to dipole centers: 1 mm	
Application	High precision dosimetric measurements in any exposure scenario (e.g., very strong gradient fields). Only probe which enables compliance testing for frequencies up to 6 GHz with precision of better 30%	

## 2.5 Phantom description

### SAM Twin Phantom

Shell Thickness	2mm±0.2mm;The ear region:6.0±0.2mm	
Filling Volume	Approximately 25 liters	
Dimensions	Length:1000mm; Width:500mm; Height: adjustable feet	
Measurement Areas	Left hand Right hand Flat phantom	

The bottom plate contains three pairs of bolts for locking the device holder. The device holder positions are adjusted to the standard measurement positions in the three sections. A white cover is provided to cover the phantom during off-periods to prevent water evaporation and changes in the liquid parameters. Free space scans of devices on top of this phantom cover are possible. Three reference marks are provided on the phantom counter. These reference marks are used to teach the absolute phantom position relative to the robot.

The following figure shows the definition of reference point:

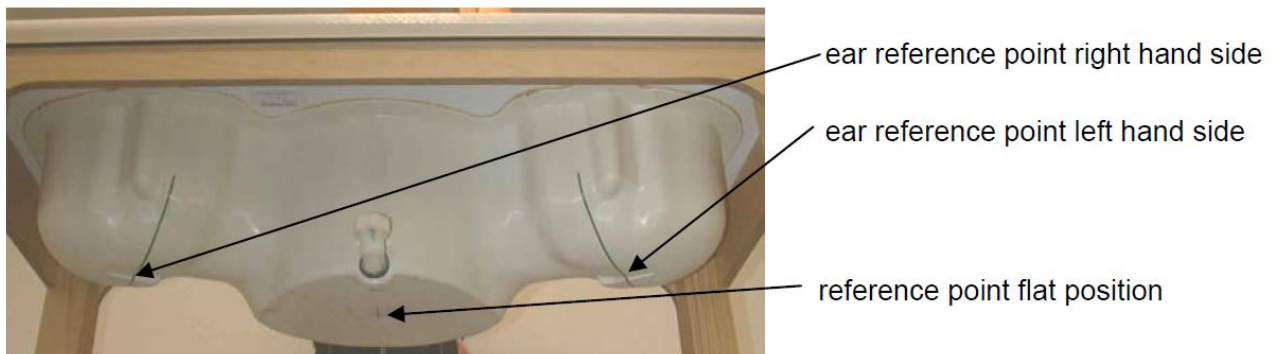

### ELI4 Phantom

Shell Thickness	2mm±0.2mm	
Filling Volume	Approximately 30 liters	
Dimensions	Major axis:600mm; Minor axis:400mm;	
Measurement Areas	Flat phantom	

The ELI4 phantom is intended for compliance testing of handheld and body-mounted wireless devices in the frequency range of 30MHz to 6GHz. ELI4 is fully compatible with the latest draft of the standard IEC 62209-2 and all known tissue simulating liquids.

The phantom shell material is resistant to all ingredients used in the tissue-equivalent liquid recipes. The shell of the phantom including ear spacers is constructed from low permittivity and low loss material, with a relative permittivity  $2 \leq \epsilon_r \leq 5$  at  $\leq 3$  GHz,  $3 \leq \epsilon_r \leq 4$  at  $> 3$  GHz and a loss tangent  $\leq 0.05$ .

### Modular Triple Flat Phantom

Shell Thickness (bottom plate)	2mm±0.2mm	
Filling Volume (Module)	approx. 8.1 liters (filling height: 155 mm)	
Dimensions	Length: 292 mm Width: 178 mm Height: 178 mm Useable area: 280 × 175 mm	
Measurement Areas	Flat phantom	
<p>The Modular Flat Phantom consists of three identical modules that can be installed and removed separately without emptying the liquid. It is used for compliance testing of small wireless devices in body-worn configurations according to IEC 62209-2, etc.</p>		

### 2.6 Device holder description

The DASY device holder has two scales for device rotation (with respect to the body axis) and the device inclination (with respect to the line between the ear openings). The plane between the ear openings and the mouth tip has a rotation angle of 65°. The bottom plate contains three pair of bolts for locking the device holder. The device holder positions are adjusted to the standard measurement positions in the three sections. This device holder is used for standard mobile phones or PDA's only. If necessary an additional support of polystyrene material is used.



The DASY device holder is constructed of low-loss POM material having the following dielectric parameters: relative permittivity  $\epsilon = 3$  and loss tangent  $\sigma = 0.02$ . The amount of dielectric material has been reduced in the closest vicinity of the device, since measurements have suggested that the influence of the clamp on the test results could thus be lowered.

The device holder permits the device to be positioned with a tolerance of  $\pm 1^\circ$  in the tilt angle.

Larger DUT's (e.g. notebooks) cannot be tested using this device holder. Instead a support of bigger polystyrene cubes and thin polystyrene plates is used to position the DUT in all relevant positions to find and measure spots with maximum SAR values.

Therefore those devices are normally only tested at the flat part of the SAM.

## 2.7 Test Equipment List

This table gives a complete overview of the SAR measurement equipment.

Devices used during the test described are marked

	Manufacturer	Device	Type	Serial number	Date of last calibration	Valid period
<input checked="" type="checkbox"/>	SPEAG	Dosimetric E-Field Probe	EX3DV4	3744	2018-07-25	One year
<input checked="" type="checkbox"/>	SPEAG	Dosimetric E-Field Probe	EX3DV4	3820	2018-06-26	One year
<input checked="" type="checkbox"/>	SPEAG	Dosimetric E-Field Probe	EX3DV4	7505	2018-06-12	One year
<input checked="" type="checkbox"/>	SPEAG	Dosimetric E-Field Probe	EX3DV4	7381	2018-09-28	One year
<input checked="" type="checkbox"/>	SPEAG	Dosimetric E-Field Probe	EX3DV4	7489	2018-01-09	One year
<input checked="" type="checkbox"/>	SPEAG	Dosimetric E-Field Probe	EX3DV4	3736	2018-04-27	One year
<input checked="" type="checkbox"/>	SPEAG	750 MHz Dipole	D750V3	1044	2018-09-18	Three years
<input checked="" type="checkbox"/>	SPEAG	835 MHz Dipole	D835V2	4d059	2016-04-20	Three years
<input checked="" type="checkbox"/>	SPEAG	835 MHz Dipole	D835V2	4d126	2018-07-24	Three years
<input checked="" type="checkbox"/>	SPEAG	1750 MHz Dipole	D1750V2	1123	2017-07-27	Three years
<input checked="" type="checkbox"/>	SPEAG	1900 MHz Dipole	D1900V2	5d091	2018-09-19	Three years
<input checked="" type="checkbox"/>	SPEAG	2450 MHz Dipole	D2450V2	978	2016-02-08	Three years
<input checked="" type="checkbox"/>	SPEAG	2600 MHz Dipole	D2600V2	1021	2018-07-26	Three years
<input checked="" type="checkbox"/>	SPEAG	2600 MHz Dipole	D2600V2	1032	2018-09-17	Three years
<input checked="" type="checkbox"/>	SPEAG	5GHz Dipole	D5GHzV2	1155	2018-06-08	Three years
<input checked="" type="checkbox"/>	SPEAG	Data acquisition electronics	DAE3	393	2018-08-14	One year
<input checked="" type="checkbox"/>	SPEAG	Data acquisition electronics	DAE4	913	2018-05-11	One year
<input checked="" type="checkbox"/>	SPEAG	Data acquisition electronics	DAE4	852	2018-04-23	One year
<input checked="" type="checkbox"/>	SPEAG	Data acquisition electronics	DAE4	1236	2018-07-18	One year
<input checked="" type="checkbox"/>	SPEAG	Data acquisition electronics	DAE4	1531	2018-01-03	One year
<input checked="" type="checkbox"/>	SPEAG	Data acquisition electronics	DAE4	851	2018-07-18	One year
<input checked="" type="checkbox"/>	SPEAG	Software	DASY52	N/A	NCR	NCR
<input checked="" type="checkbox"/>	SPEAG	Twin Phantom	SAM2	1474	NCR	NCR
<input checked="" type="checkbox"/>	SPEAG	Twin Phantom	SAM3	1597	NCR	NCR
<input checked="" type="checkbox"/>	SPEAG	Twin Phantom	SAM4	1620	NCR	NCR
<input checked="" type="checkbox"/>	SPEAG	Twin Phantom	SAM5	1892	NCR	NCR
<input checked="" type="checkbox"/>	SPEAG	Twin Phantom	SAM7	1594	NCR	NCR
<input checked="" type="checkbox"/>	SPEAG	Twin Phantom	SAM8	1940	NCR	NCR
<input checked="" type="checkbox"/>	SPEAG	Twin Phantom	SAM9	1958	NCR	NCR
<input checked="" type="checkbox"/>	SPEAG	Triple Flat Phantom	Triple Flat Phantom 5.1C	1176/2	NCR	NCR
<input checked="" type="checkbox"/>	R & S	Universal Radio Communication Tester	CMW 500	158850	2018-05-08	One year
<input checked="" type="checkbox"/>	R & S	Universal Radio Communication Tester	CMW 500	116265	2018-03-05	One year
<input checked="" type="checkbox"/>	Anritsu	Signal Analyzer	MS2690A	6261767335	2018-03-15	One year
<input checked="" type="checkbox"/>	Anritsu	Radio Communication Analyzer	MT8821C	6201735100	2018-03-15	One year
<input checked="" type="checkbox"/>	Anritsu	Radio Communication Analyzer	MT8821C	6201830585	2018-05-30	One year
<input checked="" type="checkbox"/>	Agilent	Network Analyzer	E5071C	MY46107368	2018-10-15	One year
<input checked="" type="checkbox"/>	Agilent	Dielectric Probe Kit	85070E	2484	NCR	NCR
<input checked="" type="checkbox"/>	Keysight	Signal Generator	E8257D	MY56440071	2017-12-25	One year
<input checked="" type="checkbox"/>	Agilent	Signal Generator	N5181A	MY50145341	2018-12-18	One year
<input checked="" type="checkbox"/>	MINI-CIRCUITS	Amplifier	ZHL-42W	QA1402001	NCR	NCR



<input checked="" type="checkbox"/>	MINI-CIRCUITS	Amplifier	ZVE-8G+	188163	NCR	NCR
<input checked="" type="checkbox"/>	SHX	Dual Directional Coupler	DDTO-4-20	17121801	2018-01-02	One year
<input checked="" type="checkbox"/>	Agilent	Dual Directional Coupler	772D	MY52180173	2018-01-08	One year
<input checked="" type="checkbox"/>	AR	Directional Coupler	DC7144M1	04232641	2018-04-28	One year
<input checked="" type="checkbox"/>	Keysight	Power Meter	E4417A	MY57160005	2018-03-15	One year
<input checked="" type="checkbox"/>	Keysight	Power Meter Sensor	E9321A	MY57150002	2018-03-15	One year
<input checked="" type="checkbox"/>	R & S	Power Meter	NRP	100740	2018-07-17	One year
<input checked="" type="checkbox"/>	R & S	Power Meter Sensor	NRP-Z11	106288	2018-07-17	One year

Table 4: List of Test Equipment(test date: 2018-12-05~2018-12-28)

Note:

- 1) Per KDB865664D01 requirements for dipole calibration, the test laboratory has adopted three-year extended calibration interval. Each measured dipole is expected to evaluate with the following criteria at least on annual interval in Appendix C.
  - a) There is no physical damage on the dipole;
  - b) System check with specific dipole is within 10% of calibrated value;
  - c) The most recent return-loss result, measured at least annually, deviates by no more than 20% from the previous measurement.
  - d) The most recent measurement of the real or imaginary parts of the impedance, measured at least annually is within 5Ω from the previous measurement.
- 2) Network analyzer probe calibration against air, distilled water and a shorting block performed before measuring liquid parameters.
- 3) \*All the equipment are within the valid period when the tests are performed.

	Manufacturer	Device	Type	Serial number	Date of last calibration	Valid period
<input checked="" type="checkbox"/>	SPEAG	Dosimetric E-Field Probe	EX3DV4	7505	2018-06-12	One year
<input checked="" type="checkbox"/>	SPEAG	Dosimetric E-Field Probe	EX3DV4	7381	2018-09-28	One year
<input checked="" type="checkbox"/>	SPEAG	750 MHz Dipole	D750V3	1044	2018-09-18	Three years
<input checked="" type="checkbox"/>	SPEAG	835 MHz Dipole	D835V2	4d126	2018-07-24	Three years
<input checked="" type="checkbox"/>	SPEAG	1750 MHz Dipole	D1750V2	1123	2017-07-27	Three years
<input checked="" type="checkbox"/>	SPEAG	1900 MHz Dipole	D1900V2	5d091	2018-09-19	Three years
<input checked="" type="checkbox"/>	SPEAG	1900 MHz Dipole	D1900V2	5d143	2017-09-20	Three years
<input checked="" type="checkbox"/>	SPEAG	2450 MHz Dipole	D2450V2	860	2018-11-17	Three years
<input checked="" type="checkbox"/>	SPEAG	2600 MHz Dipole	D2600V2	1021	2018-07-26	Three years
<input checked="" type="checkbox"/>	SPEAG	2600 MHz Dipole	D2600V2	1032	2018-09-17	Three years
<input checked="" type="checkbox"/>	SPEAG	5GHz Dipole	D5GHzV2	1155	2018-06-08	Three years
<input checked="" type="checkbox"/>	SPEAG	Data acquisition electronics	DAE4	1236	2018-07-18	One year
<input checked="" type="checkbox"/>	SPEAG	Data acquisition electronics	DAE4	1492	2018-11-14	One year
<input checked="" type="checkbox"/>	SPEAG	Software	DASY52	N/A	NCR	NCR
<input checked="" type="checkbox"/>	SPEAG	Twin Phantom	SAM2	1474	NCR	NCR
<input checked="" type="checkbox"/>	SPEAG	Twin Phantom	SAM7	1594	NCR	NCR
<input checked="" type="checkbox"/>	SPEAG	Triple Flat Phantom	Triple Flat Phantom 5.1C	1176/2	NCR	NCR
<input checked="" type="checkbox"/>	R & S	Universal Radio Communication Tester	CMW 500	158850	2018-05-08	One year
<input checked="" type="checkbox"/>	R & S	Universal Radio Communication Tester	CMW 500	116265	2018-03-05	One year

<input checked="" type="checkbox"/>	Anritsu	Radio Communication Analyzer	MT8821C	6201830585	2018-05-30	One year
<input checked="" type="checkbox"/>	Agilent	Network Analyzer	E5071C	MY46107368	2018-10-15	One year
<input checked="" type="checkbox"/>	Agilent	Dielectric Probe Kit	85070E	2484	NCR	NCR
<input checked="" type="checkbox"/>	Agilent	Signal Generator	N5181A	MY50145341	2018-12-18	One year
<input checked="" type="checkbox"/>	MINI-CIRCUITS	Amplifier	ZHL-42W	QA1402001	NCR	NCR
<input checked="" type="checkbox"/>	MINI-CIRCUITS	Amplifier	ZVE-8G+	188163	NCR	NCR
<input checked="" type="checkbox"/>	SHX	Dual Directional Coupler	DDTO-4-20	07122401	2018-07-21	One year
<input checked="" type="checkbox"/>	Agilent	Dual Directional Coupler	772D	MY52180295	2018-05-29	One year
<input checked="" type="checkbox"/>	AR	Directional Coupler	DC7144M1	311190	2018-05-29	One year
<input checked="" type="checkbox"/>	Agilent	Power Meter	E4417A	MY54100027	2018-03-24	One year
<input checked="" type="checkbox"/>	Keysight	Power Meter Sensor	E9321A	MY57150002	2018-03-15	One year
<input checked="" type="checkbox"/>	R & S	Power Meter	NRP	100740	2018-07-17	One year
<input checked="" type="checkbox"/>	R & S	Power Meter Sensor	NRP-Z11	106288	2018-07-17	One year

Table 5: List of Test Equipment(test date: 2019-01-31~2019-02-14)

	Manufacturer	Device	Type	Serial number	Date of last calibration	Valid period
<input checked="" type="checkbox"/>	R & S	Power Meter	NRP	100740	2019-07-04	One year
<input checked="" type="checkbox"/>	R & S	Power Meter Sensor	NRP-Z11	106288	2019-07-04	One year

Table 6: List of Test Equipment(test date: 2020-04-08 to 2020-04-10)

Note:

- 1) Per KDB865664D01 requirements for dipole calibration, the test laboratory has adopted three-year extended calibration interval. Each measured dipole is expected to evaluate with the following criteria at least on annual interval in Appendix C.
  - a) There is no physical damage on the dipole;
  - e) System check with specific dipole is within 10% of calibrated value;
  - f) The most recent return-loss result, measured at least annually, deviates by no more than 20% from the previous measurement.
  - g) The most recent measurement of the real or imaginary parts of the impedance, measured at least annually is within 5Ω from the previous measurement.
- 2) Network analyzer probe calibration against air, distilled water and a shorting block performed before measuring liquid parameters.
- 3) \*All the equipment are within the valid period when the tests are performed.

## 3 SAR Measurement Procedure

### 3.1 Scanning procedure

The DASY installation includes predefined files with recommended procedures for measurements and system check. They are read-only document files and destined as fully defined but unmeasured masks. All test positions (head or body-worn) are tested with the same configuration of test steps differing only in the grid definition for the different test positions.

- The “reference” and “drift” measurements are located at the beginning and end of the batch process. They measure the field drift at one single point in the liquid over the complete procedure. The indicated drift is mainly the variation of the DUT’s output power and should vary max. +/- 5 %.
- For power drift measurement, DASY software supports that the reference position can be either the selected section’s grid reference point or a user point. If the E-field of power reference measurement in the default grid reference point is very small, the test lab may set the reference position to the user point near the hotspot location to avoid large measurement uncertainty.
- The “surface check” measurement tests the optical surface detection system of the DASY system by repeatedly detecting the surface with the optical and mechanical surface detector and comparing the results. The output gives the detecting heights of both systems, the difference between the two systems and the standard deviation of the detection repeatability. Air bubbles or refraction in the liquid due to separation of the sugar-water mixture gives poor repeatability (above  $\pm 0.1\text{mm}$ ). To prevent wrong results tests are only executed when the liquid is free of air bubbles. The difference between the optical surface detection and the actual surface depends on the probe and is specified with each probe. (It does not depend on the surface reflectivity or the probe angle to the surface within  $\pm 30^\circ$ .)
- The “area scan” measures the SAR above the DUT or verification dipole on a parallel plane to the surface. It is used to locate the approximate location of the peak SAR with 2D spline interpolation. The robot performs a stepped movement along one grid axis while the local electrical field strength is measured by the probe. The probe is touching the surface of the SAM during acquisition of measurement values. The standard scan uses large grid spacing for faster measurement. Standard grid spacing for head measurements is 15 mm in x- and y- dimension ( $\leq 2\text{GHz}$ ), 12 mm in x- and y- dimension (2-4 GHz) and 10mm in x- and y- dimension (4-6GHz). If a finer resolution is needed, the grid spacing can be reduced. Grid spacing and orientation have no influence on the SAR result. For special applications where the standard scan method does not find the peak SAR within the grid, e.g. mobile phones with flip cover, the grid can be adapted in orientation. Results of this coarse scan are shown in Appendix B.
- A “zoom scan” measures the field in a volume around the 2D peak SAR value acquired in the previous “coarse” scan. This is a fine grid with maximum scan spatial resolution:  $\Delta x_{\text{zoom}}, \Delta y_{\text{zoom}} \leq 2\text{GHz} - \leq 8\text{mm}$ , 2-4GHz -  $\leq 5\text{ mm}$  and 4-6 GHz -  $\leq 4\text{mm}$ ;  $\Delta z_{\text{zoom}} \leq 3\text{GHz} - \leq 5\text{ mm}$ , 3-4 GHz -  $\leq 4\text{mm}$  and 4-6GHz -  $\leq 2\text{mm}$  where the robot additionally moves the probe along the z-axis away from the bottom of the Phantom. DASY is also able to perform repeated zoom scans if more than 1 peak is found during area scan. In this document, the evaluated peak 1g and 10g averaged SAR values are shown in the 2D-graphics in Appendix B. Test results relevant for the specified standard (see chapter 1.4.) are shown in table form in chapter 7.2.
- A Z-axis scan measures the total SAR value at the x-and y-position of the maximum SAR value found during the cube scan. The probe is moved away in z-direction from the bottom of the SAM phantom in 2 mm steps. This measurement shows the continuity of the liquid and can - depending in the field strength – also show the liquid depth. A z-axis scan of the measurement with maximum SAR value is shown in Appendix B.



The following table summarizes the area scan and zoom scan resolutions per FCC KDB 865664D01:

Frequency	Maximum Area Scan resolution ( $\Delta x_{area}, \Delta y_{area}$ )	Maximum Zoom Scan spatial resolution ( $\Delta x_{Zoom}, \Delta y_{Zoom}$ )	Maximum Zoom Scan spatial resolution			Minimum zoom scan volume (x,y,z)
			Uniform Grid	Graded Grad		
			$\Delta z_{Zoom}(n)$	$\Delta z_{Zoom}(1)^*$	$\Delta z_{Zoom}(n>1)^*$	
≤2GHz	≤15mm	≤8mm	≤5mm	≤4mm	≤1.5* $\Delta z_{Zoom}(n-1)$	≥30mm
2-3GHz	≤12mm	≤5mm	≤5mm	≤4mm	≤1.5* $\Delta z_{Zoom}(n-1)$	≥30mm
3-4GHz	≤12mm	≤5mm	≤4mm	≤3mm	≤1.5* $\Delta z_{Zoom}(n-1)$	≥28mm
4-5GHz	≤10mm	≤4mm	≤3mm	≤2.5mm	≤1.5* $\Delta z_{Zoom}(n-1)$	≥25mm
5-6GHz	≤10mm	≤4mm	≤2mm	≤2mm	≤1.5* $\Delta z_{Zoom}(n-1)$	≥22mm

### 3.2 Spatial Peak SAR Evaluation

The spatial peak SAR - value for 1 and 10 g is evaluated after the Cube measurements have been done. The basis of the evaluation are the SAR values measured at the points of the fine cube grid consisting of 5 x 5 x 7 points( with 8mm horizontal resolution) or 7 x 7 x 7 points( with 5mm horizontal resolution) or 8 x 8 x 7 points( with 4mm horizontal resolution). The algorithm that finds the maximal averaged volume is separated into three different stages.

- The data between the dipole center of the probe and the surface of the phantom are extrapolated. This data cannot be measured since the center of the dipole is 2.7 mm away from the tip of the probe and the distance between the surface and the lowest measuring point is about 1 mm (see probe calibration sheet). The extrapolated data from a cube measurement can be visualized by selecting 'Graph Evaluated'.
- The maximum interpolated value is searched with a straight-forward algorithm. Around this maximum the SAR - values averaged over the spatial volumes (1g or 10 g) are computed using the 3d-spline interpolation algorithm. If the volume cannot be evaluated (i.e., if a part of the grid was cut off by the boundary of the measurement area) the evaluation will be started on the corners of the bottom plane of the cube.
- All neighboring volumes are evaluated until no neighboring volume with a higher average value is found.

#### Extrapolation

The extrapolation is based on a least square algorithm [W. Gander, Computermathematik, p.168-180]. Through the points in the first 3 cm along the z-axis, polynomials of order four are calculated. These polynomials are then used to evaluate the points between the surface and the probe tip. The points, calculated from the surface, have a distance of 1 mm from each other.

#### Interpolation

The interpolation of the points is done with a 3d-Spline. The 3d-Spline is composed of three one-dimensional splines with the "Not a knot"-condition [W. Gander, Computermathematik, p.141-150] (x, y and z -direction) [Numerical Recipes in C, Second Edition, p.123ff ].

#### Volume Averaging

At First the size of the cube is calculated. Then the volume is integrated with the trapezoidal algorithm. 8000 points (20x20x20) are interpolated to calculate the average.

#### Advanced Extrapolation

DASY uses the advanced extrapolation option which is able to compensate boundary effects on E-field probes.

### 3.3 Data Storage and Evaluation

#### Data Storage

The DASY software stores the acquired data from the data acquisition electronics as raw data (in microvolt readings from the probe sensors), together with all necessary software parameters for the data evaluation (probe calibration data, liquid parameters and device frequency and modulation data) in measurement files with the extension "DAE". The software evaluates the desired unit and format for output each time the data is visualized or exported. This allows verification of the complete software setup even after the measurement and allows correction of incorrect parameter settings. For example, if a measurement has been performed with a wrong crest factor parameter in the device setup, the parameter can be corrected afterwards and the data can be re-evaluated.

The measured data can be visualized or exported in different units or formats, depending on the selected probe type ([V/m], [A/m], [°C], [mW/g], [mW/cm<sup>2</sup>], [dBrel], etc.). Some of these units are not available in certain situations or show meaningless results, e.g., a SAR output in a lossless media will always be zero. Raw data can also be exported to perform the evaluation with other software packages.

#### Data Evaluation by SEMCAD

The SEMCAD software automatically executes the following procedures to calculate the field units from the microvolt readings at the probe connector. The parameters used in the evaluation are stored in the configuration modules of the software:

Probe parameters:	- Sensitivity	Norm <sub>i</sub> , a <sub>i0</sub> , a <sub>i1</sub> , a <sub>i2</sub>
	- Conversion factor	ConvF <sub>i</sub>
	- Diode compression point	Dcpi
Device parameters:	- Frequency	f
	- Crest factor	cf
Media parameters:	- Conductivity	σ
	- Density	ρ

These parameters must be set correctly in the software. They can be found in the component documents or they can be imported into the software from the configuration files issued for the DASY components. In the direct measuring mode of the multimeter option, the parameters of the actual system setup are used. In the scan visualization and export modes, the parameters stored in the corresponding document files are used.

The first step of the evaluation is a linearization of the filtered input signal to account for the compression characteristics of the detector diode. The compensation depends on the input signal, the diode type and the DC-transmission factor from the diode to the evaluation electronics.

If the exciting field is pulsed, the crest factor of the signal must be known to correctly compensate for peak power. The formula for each channel can be given as:

$$V_i = U_i + U_i^2 \cdot cf/dcp_i$$

with	V <sub>i</sub>	= compensated signal of channel i	(i = x, y, z)
	U <sub>i</sub>	= input signal of channel i	(i = x, y, z)
	cf	= crest factor of exciting field (DASY parameter)	
	dcp <sub>i</sub>	= diode compression point	(DASY parameter)

From the compensated input signals the primary field data for each channel can be evaluated:

E-field probes:  $E_i = (V_i / Norm_i \cdot ConvF)^{1/2}$   
H-field probes:  $H_i = (V_i)^{1/2} \cdot (a_{i0} + a_{i1}f + a_{i2}f^2)/f$

- with  $V_i$  = compensated signal of channel i (i = x, y, z)  
 $Norm_i$  = sensor sensitivity of channel i (i = x, y, z)  
[mV/(V/m)<sup>2</sup>] for E-field Probes  
ConvF = sensitivity enhancement in solution  
 $a_{ij}$  = sensor sensitivity factors for H-field probes  
f = carrier frequency [GHz]  
 $E_i$  = electric field strength of channel i in V/m  
 $H_i$  = magnetic field strength of channel i in A/m

The RSS value of the field components gives the total field strength (Hermitian magnitude):

$$E_{tot} = (E_x^2 + E_y^2 + E_z^2)^{1/2}$$

The primary field data are used to calculate the derived field units.

$$SAR = (E_{tot}^2 \cdot \sigma) / (\rho \cdot 1000)$$

- with SAR = local specific absorption rate in mW/g  
 $E_{tot}$  = total field strength in V/m  
 $\sigma$  = conductivity in [mho/m] or [Siemens/m]  
 $\rho$  = equivalent tissue density in g/cm<sup>3</sup>

Note that the density is normally set to 1 (or 1.06), to account for actual brain density rather than the density of the simulation liquid. The power flow density is calculated assuming the excitation field to be a free space field.

$$P_{pwe} = E_{tot}^2 / 3770 \quad \text{or} \quad P_{pwe} = H_{tot}^2 \cdot 37.7$$

- with  $P_{pwe}$  = equivalent power density of a plane wave in mW/cm<sup>2</sup>  
 $E_{tot}$  = total electric field strength in V/m  
 $H_{tot}$  = total magnetic field strength in A/m

## 4 System Verification Procedure

### 4.1 Tissue Verification

The simulating liquids should be checked at the beginning of a series of SAR measurements to determine if the dielectric parameters are within the tolerances of the specified target values. The measured conductivity and relative permittivity should be within  $\pm 5\%$  of the target values.

The following materials are used for producing the tissue-equivalent materials.

Ingredients (% of weight)	Head Tissue					
Frequency Band (MHz)	750	835	1750	1900	2450	2600
Water	39.2	41.45	52.64	55.242	62.7	55.242
Salt (NaCl)	2.7	1.45	0.36	0.306	0.5	0.306
Sugar	57.0	56.0	0.0	0.0	0.0	0.0
HEC	0.0	1.0	0.0	0.0	0.0	0.0
Bactericide	0.0	0.1	0.0	0.0	0.0	0.0
Triton X-100	0.0	0.0	0.0	0.0	0.0	0.0
DGBE	0.0	0.0	47.0	44.542	36.8	44.452
Ingredients (% of weight)	Body Tissue					
Frequency Band (MHz)	750	835	1750	1900	2450	2600
Water	50.3	52.4	69.91	69.91	73.2	64.493
Salt (NaCl)	1.60	1.40	0.13	0.13	0.04	0.024
Sugar	47.0	45.0	0.0	0.0	0.0	0.0
HEC	0.0	1.0	0.0	0.0	0.0	0.0
Bactericide	0.0	0.1	0.0	0.0	0.0	0.0
Triton X-100	0.0	0.0	0.0	0.0	0.0	0.0
DGBE	0.0	0.0	29.96	29.96	26.7	32.252

Table 7: Tissue Dielectric Properties

Salt: 99+% Pure Sodium Chloride; Sugar: 98+% Pure Sucrose; Water: De-ionized, 16M $\Omega$ + resistivity  
 HEC: Hydroxyethyl Cellulose; DGBE: 99+% Di(ethylene glycol) butyl ether, [2-(2-butoxyethoxy)ethanol]  
 Triton X-100(ultra pure): Polyethylene glycol mono [4-(1,1,3,3-tetramethylbutyl)phenyl]ether

#### Simulating Head Liquid (HBBL600-6000MHz), Manufactured by SPEAG:

Ingredients	(% by weight)
Water	50-65%
Esters, Emulsifiers, Inhibitors	10-30%
Sodium salt	8-25%

#### Simulating Body Liquid (MBBL600-6000MHz), Manufactured by SPEAG:

Ingredients	(% by weight)
Water	60-80%
Esters, Emulsifiers, Inhibitors	20-40%
Sodium salt	0-1.5%

Tissue Type	Target Frequency	Target Tissue		Measured Tissue		Deviation (Within +/-5%)		Liquid Temp.	Test Date
		Permit-tivity	Conduc-tivity [S/m]	Permit-tivity	Conduc-tivity [S/m]	$\Delta\epsilon_r$	$\Delta\sigma$		
750MHz Head	705	42.14	0.89	40.53	0.918	-3.82%	3.16%	22.5°C	2018-12-20
	710	42.11	0.89	40.52	0.920	-3.78%	3.31%		
	750	41.90	0.89	40.42	0.932	-3.53%	4.71%		
835MHz Head	825	41.60	0.90	40.59	0.931	-2.43%	3.44%	22.5°C	2018-12-26
	835	41.50	0.90	40.56	0.934	-2.27%	3.82%		
	850	41.50	0.92	40.51	0.939	-2.39%	2.11%		
1750MHz Head	1710	40.10	1.35	40.06	1.354	-0.10%	0.30%	22.2°C	2018-12-09
	1730	40.10	1.36	40.04	1.364	-0.15%	0.29%		
	1750	40.10	1.37	40.02	1.377	-0.20%	0.51%		
	1800	40.00	1.40	39.95	1.411	-0.12%	0.79%		
1750MHz Head	1710	40.10	1.35	39.59	1.318	-1.27%	-2.37%	22.2°C	2018-12-27
	1730	40.10	1.36	39.59	1.325	-1.27%	-2.57%		
	1750	40.10	1.37	39.56	1.332	-1.35%	-2.77%		
	1800	40.00	1.40	39.53	1.360	-1.18%	-2.86%		
1900MHz Head	1850	40.00	1.40	39.17	1.394	-2.08%	-0.43%	22.0°C	2018-12-18
	1880	40.00	1.40	39.12	1.414	-2.20%	1.00%		
	1900	40.00	1.40	39.07	1.428	-2.33%	2.00%		
	1910	40.00	1.40	39.06	1.435	-2.35%	2.50%		
1900MHz Head	1850	40.00	1.40	39.46	1.390	-1.35%	-0.71%	22.0°C	2018-12-27
	1880	40.00	1.40	39.43	1.408	-1.43%	0.57%		
	1900	40.00	1.40	39.37	1.419	-1.58%	1.36%		
	1910	40.00	1.40	39.34	1.425	-1.65%	1.79%		
2450MHz Head	2410	39.30	1.76	39.17	1.812	-0.33%	2.95%	22.2°C	2018-12-26
	2435	39.20	1.79	39.15	1.834	-0.13%	2.46%		
	2450	39.20	1.80	39.13	1.843	-0.18%	2.39%		
	2460	39.20	1.81	39.12	1.848	-0.20%	2.10%		
2600MHz Head	2510	39.12	1.86	38.27	1.823	-2.17%	-1.99%	22.5°C	2018-12-05
	2535	39.10	1.89	38.20	1.849	-2.30%	-2.17%		
	2560	39.00	1.92	38.22	1.860	-2.00%	-3.12%		
	2585	39.00	1.95	38.18	1.882	-2.10%	-3.49%		
	2600	39.00	1.96	38.16	1.897	-2.15%	-3.21%		
	2610	38.98	1.97	38.15	1.903	-2.13%	-3.40%		
	2645	38.93	2.01	38.09	1.931	-2.16%	-3.93%		
2600MHz Head	2510	39.12	1.86	37.37	1.822	-4.47%	-2.04%	22.6°C	2018-12-20
	2535	39.10	1.89	37.34	1.841	-4.50%	-2.59%		
	2560	39.00	1.92	37.30	1.858	-4.36%	-3.23%		
	2585	39.00	1.95	37.27	1.878	-4.44%	-3.69%		
	2600	39.00	1.96	37.24	1.889	-4.51%	-3.62%		
	2610	38.98	1.97	37.23	1.897	-4.49%	-3.71%		
	2645	38.93	2.01	37.16	1.922	-4.55%	-4.38%		

2600MHz Head	2510	39.12	1.86	38.08	1.855	-2.66%	-0.27%	22.3°C	2018-12-27
	2535	39.10	1.89	37.95	1.859	-2.94%	-1.64%		
	2560	39.00	1.92	37.83	1.886	-3.00%	-1.77%		
	2585	39.00	1.95	37.96	1.915	-2.67%	-1.79%		
	2600	39.00	1.96	37.94	1.919	-2.72%	-2.09%		
	2610	38.98	1.97	37.87	1.921	-2.85%	-2.49%		
	2645	38.93	2.01	37.71	1.957	-3.13%	-2.64%		
5G Hz Head	5250	35.90	4.71	35.19	4.494	-1.98%	-4.59%	22.0°C	2018-12-27
	5600	35.50	5.07	34.58	4.869	-2.59%	-3.96%		
	5750	35.40	5.22	34.33	5.030	-3.02%	-3.64%		
750MHz Body	705	55.70	0.96	54.15	0.970	-2.78%	1.08%	23.2°C	2018-12-15
	710	55.70	0.96	54.14	0.972	-2.80%	1.28%		
	750	55.50	0.96	54.03	0.987	-2.65%	2.80%		
750MHz Body	705	55.70	0.96	54.91	0.956	-1.42%	-0.45%	21.0°C	2018-12-17
	710	55.70	0.96	54.90	0.957	-1.44%	-0.28%		
	750	55.50	0.96	54.83	0.974	-1.21%	1.45%		
835MHz Body	825	55.20	0.97	53.82	1.002	-2.50%	3.30%	23.2°C	2018-12-15
	835	55.20	0.97	53.80	1.006	-2.54%	3.71%		
	850	55.20	0.99	53.77	1.012	-2.59%	2.22%		
835MHz Body	825	55.20	0.97	54.56	1.003	-1.16%	3.40%	21.0°C	2018-12-17
	835	55.20	0.97	54.54	1.006	-1.20%	3.71%		
	850	55.20	0.99	54.52	1.011	-1.23%	2.12%		
835MHz Body	825	55.20	0.97	53.22	1.012	-3.59%	4.33%	22.0°C	2018-12-21
	835	55.20	0.97	53.19	1.015	-3.64%	4.64%		
	850	55.20	0.99	53.16	1.020	-3.70%	3.03%		
1750MHz Body	1710	53.50	1.46	52.21	1.433	-2.41%	-1.85%	22.1°C	2018-12-08
	1730	53.50	1.48	52.09	1.447	-2.64%	-2.23%		
	1750	53.40	1.49	52.10	1.461	-2.44%	-1.95%		
	1800	53.30	1.52	52.27	1.494	-1.93%	-1.71%		
1750MHz Body	1710	53.50	1.46	52.31	1.448	-2.22%	-0.82%	22.1°C	2018-12-27
	1730	53.50	1.48	52.19	1.462	-2.45%	-1.22%		
	1750	53.40	1.49	52.20	1.476	-2.26%	-0.94%		
	1800	53.30	1.52	52.37	1.509	-1.74%	-0.72%		
1900MHz Body	1850	53.30	1.52	50.93	1.456	-4.45%	-4.21%	22.0°C	2018-12-18
	1880	53.30	1.52	50.93	1.473	-4.45%	-3.09%		
	1900	53.30	1.52	50.94	1.487	-4.44%	-2.17%		
	1910	53.30	1.52	50.93	1.494	-4.45%	-1.71%		
1900MHz Body	1850	53.30	1.52	51.72	1.450	-2.96%	-4.61%	22.5°C	2018-12-27
	1880	53.30	1.52	51.64	1.464	-3.11%	-3.68%		
	1900	53.30	1.52	51.62	1.478	-3.15%	-2.76%		
	1910	53.30	1.52	51.61	1.484	-3.17%	-2.37%		
2450MHz Body	2410	52.80	1.91	50.82	1.986	-3.75%	3.98%	22.0°C	2018-12-21
	2435	52.70	1.94	50.79	2.010	-3.62%	3.61%		
	2450	52.70	1.95	50.77	2.024	-3.66%	3.79%		
	2460	52.70	1.96	50.75	2.032	-3.70%	3.67%		

2600MHz Body	2510	52.62	2.03	51.01	2.119	-3.06%	4.38%	21.0°C	2018-12-17
	2535	52.59	2.07	50.95	2.142	-3.12%	3.48%		
	2560	52.57	2.09	50.89	2.164	-3.20%	3.54%		
	2585	52.53	2.13	50.85	2.186	-3.20%	2.63%		
	2600	52.50	2.16	50.81	2.199	-3.22%	1.81%		
	2615	52.42	2.19	50.78	2.212	-3.13%	1.00%		
	2645	52.26	2.24	50.73	2.239	-2.93%	-0.04%		
2600MHz Body	2510	52.62	2.03	51.00	2.109	-3.08%	3.89%	22.0°C	2018-12-19
	2535	52.59	2.07	50.95	2.133	-3.12%	3.04%		
	2560	52.57	2.09	50.91	2.157	-3.16%	3.21%		
	2585	52.53	2.13	50.87	2.183	-3.16%	2.49%		
	2600	52.50	2.16	50.84	2.197	-3.16%	1.71%		
	2615	52.42	2.19	50.82	2.212	-3.05%	1.00%		
	2645	52.26	2.24	50.75	2.243	-2.89%	0.13%		
2600MHz Body	2510	52.62	2.03	50.25	2.007	-4.50%	-1.13%	22.0°C	2018-12-27
	2535	52.59	2.07	50.09	2.028	-4.75%	-2.03%		
	2560	52.57	2.09	50.06	2.058	-4.77%	-1.53%		
	2585	52.53	2.13	50.15	2.076	-4.53%	-2.54%		
	2600	52.50	2.16	50.09	2.085	-4.59%	-3.47%		
	2615	52.42	2.19	49.98	2.100	-4.65%	-4.11%		
	2645	52.26	2.24	49.97	2.139	-4.38%	-4.51%		
5G Hz Body	5250	48.90	5.36	46.89	5.386	-4.11%	0.49%	22.0°C	2018-12-22
	5600	48.50	5.77	46.22	5.884	-4.70%	1.98%		
	5750	48.30	5.94	45.94	6.106	-4.89%	2.79%		
5G Hz Body	5250	48.90	5.36	47.53	5.308	-2.80%	-0.97%	22.5°C	2018-12-25
	5600	48.50	5.77	46.92	5.808	-3.26%	0.66%		
	5750	48.30	5.94	46.66	6.028	-3.40%	1.48%		

Table 8: Measured Tissue Parameter (test date: 2018-12-05~2018-12-28)

Note: 1) The dielectric parameters of the tissue-equivalent liquid should be measured under similar ambient conditions and within 2 °C of the conditions expected during the SAR evaluation to satisfy protocol requirements.

2) KDB 865664 was ensured to be applied for probe calibration frequencies greater than or equal to 50MHz of the EUT frequencies.

3) The above measured tissue parameters were used in the DASY software to perform interpolation via the DASY software to determine actual dielectric parameters at the test frequencies. The SAR test plots may slightly differ from the table above since the DASY rounds to three significant digits.



Tissue Type	Target Frequency	Target Tissue		Measured Tissue		Deviation (Within +/-5% )		Liquid Temp.	Test Date
		Permit-tivity	Conduc-tivity [S/m]	Permit-tivity	Conduc-tivity [S/m]	$\Delta\epsilon_r$	$\Delta\sigma$		
750MHz Head	705	42.14	0.89	41.02	0.862	-2.66%	-3.12%	22.0°C	2019-02-10
	710	42.11	0.89	41.00	0.864	-2.64%	-2.97%		
	750	41.90	0.89	40.87	0.875	-2.46%	-1.70%		
835MHz Head	825	41.60	0.90	40.68	0.902	-2.21%	0.27%	22.0°C	2019-02-12
	835	41.50	0.90	40.64	0.906	-2.07%	0.64%		
	850	41.50	0.92	40.61	0.912	-2.14%	-0.92%		
1750MHz Head	1710	40.10	1.35	41.18	1.339	2.69%	-0.81%	22.2°C	2019-02-12
	1730	40.10	1.36	41.16	1.350	2.64%	-0.74%		
	1750	40.10	1.37	41.14	1.364	2.59%	-0.44%		
	1800	40.00	1.40	41.04	1.400	2.60%	0.00%		
1900MHz Head	1850	40.00	1.40	38.81	1.378	-2.97%	-1.57%	22.0°C	2019-02-12
	1880	40.00	1.40	38.74	1.400	-3.15%	0.00%		
	1900	40.00	1.40	38.68	1.414	-3.35%	1.00%		
	1910	40.00	1.40	38.66	1.421	-3.35%	1.50%		
2450MHz Head	2410	39.30	1.76	38.76	1.826	-1.37%	3.75%	22.1°C	2019-02-13
	2435	39.20	1.79	38.73	1.842	-1.20%	2.91%		
	2450	39.20	1.80	38.71	1.853	-1.25%	2.94%		
	2460	39.20	1.81	38.69	1.861	-1.30%	2.82%		
2600MHz Head	2510	39.12	1.86	38.98	1.876	-0.36%	0.86%	22.2°C	2019-02-12
	2535	39.10	1.89	38.97	1.900	-0.33%	0.53%		
	2560	39.00	1.92	38.99	1.910	-0.03%	-0.52%		
	2585	39.00	1.95	38.90	1.932	-0.26%	-0.92%		
	2600	39.00	1.96	38.90	1.949	-0.26%	-0.56%		
	2610	38.98	1.97	38.92	1.957	-0.15%	-0.66%		
	2645	38.93	2.01	38.85	1.976	-0.21%	-1.69%		
5G Hz Head	5250	35.90	4.71	34.56	4.654	-3.73%	-1.19%	22.0°C	2019-02-13
	5600	35.50	5.07	34.08	5.026	-4.00%	-0.87%		
	5750	35.40	5.22	34.04	5.076	-3.84%	-2.76%		
750MHz Body	705	55.70	0.96	56.24	0.916	0.97%	-4.64%	22.1°C	2019-01-31
	710	55.70	0.96	56.22	0.917	0.93%	-4.48%		
	750	55.50	0.96	56.14	0.930	1.15%	-3.08%		
835MHz Body	825	55.20	0.97	53.86	0.945	-2.43%	-2.56%	22.0°C	2019-01-31
	835	55.20	0.97	53.84	0.948	-2.46%	-2.23%		
	850	55.20	0.99	53.79	0.954	-2.55%	-3.68%		
1750MHz Body	1710	53.50	1.46	52.31	1.411	-2.22%	-3.36%	22.0°C	2019-01-31
	1730	53.50	1.48	52.30	1.418	-2.24%	-4.19%		
	1750	53.40	1.49	52.26	1.428	-2.13%	-4.16%		
	1800	53.30	1.52	52.28	1.459	-1.91%	-4.01%		



1900MHz Body	1850	53.30	1.52	52.23	1.497	-2.01%	-1.51%	22.0°C	2019-01-31
	1880	53.30	1.52	52.20	1.520	-2.06%	0.00%		
	1900	53.30	1.52	52.13	1.535	-2.20%	0.99%		
	1910	53.30	1.52	52.11	1.544	-2.23%	1.58%		
2450MHz Body	2410	52.80	1.91	55.05	1.907	4.26%	-0.16%	22.0°C	2019-02-13
	2435	52.70	1.94	55.01	1.930	4.38%	-0.52%		
	2450	52.70	1.95	54.97	1.943	4.31%	-0.36%		
2600MHz Body	2460	52.70	1.96	54.94	1.953	4.25%	-0.36%	22.0°C	2019-01-31
	2510	52.62	2.03	53.05	2.064	0.82%	1.67%		
	2535	52.59	2.07	52.98	2.088	0.74%	0.87%		
	2560	52.57	2.09	52.99	2.112	0.80%	1.05%		
	2585	52.53	2.13	52.98	2.139	0.86%	0.42%		
	2600	52.50	2.16	52.93	2.162	0.82%	0.09%		
2615	52.42	2.19	52.89	2.177	0.90%	-0.59%			
5G Hz Body	2645	52.26	2.24	52.82	2.209	1.07%	-1.38%	22.0°C	2019-02-13
	5250	48.90	5.36	47.12	5.290	-3.64%	-1.31%		
	5600	48.50	5.77	46.50	5.772	-4.12%	0.03%		
	5750	48.30	5.94	46.21	5.972	-4.33%	0.54%		

Table 9: Measured Tissue Parameter (test date: 2019-01-31~2019-02-14)

Note: 1) The dielectric parameters of the tissue-equivalent liquid should be measured under similar ambient conditions and within 2 °C of the conditions expected during the SAR evaluation to satisfy protocol requirements.

2) KDB 865664 was ensured to be applied for probe calibration frequencies greater than or equal to 50MHz of the EUT frequencies.

3) The above measured tissue parameters were used in the DASY software to perform interpolation via the DASY software to determine actual dielectric parameters at the test frequencies. The SAR test plots may slightly differ from the table above since the DASY rounds to three significant digits.

## 4.2 System Check

The system check is performed for verifying the accuracy of the complete measurement system and performance of the software. The system check is performed with tissue equivalent material according to IEEE 1528 (described above). The following table shows system check results for all frequency bands and tissue liquids used during the tests(Graphic Plot(s) see Appendix A).

Dipole Information	System Check	Target SAR (Normalized to 1W)		Measured SAR (Normalized to 1W)		Deviation (Within +/-10% )		Test Date
		1-g (mW/g)	10-g (mW/g)	1-g (mW/g)	10-g (mW/g)	Δ1-g	Δ10-g	
1044	750MHz Head	8.24	5.34	8.36	5.44	1.46%	1.87%	2018-12-20
4d126	835MHz Head	9.44	6.06	10.08	6.48	6.78%	6.93%	2018-12-26
1123	1750MHz Head	36.60	19.40	36.24	19.40	-0.98%	0.00%	2018-12-09
1123	1750MHz Head	36.60	19.40	35.04	18.76	-4.26%	-3.30%	2018-12-27
5d091	1900MHz Head	40.40	21.30	40.80	21.28	0.99%	-0.09%	2018-12-18
5d091	1900MHz Head	40.40	21.30	39.48	20.52	-2.28%	-3.66%	2018-12-27
978	2450MHz Head	53.30	24.90	54.40	25.28	2.06%	1.53%	2018-12-26
1021	2600MHz Head	56.60	25.50	56.00	26.56	-1.06%	4.16%	2018-12-05
1021	2600MHz Head	56.60	25.50	56.40	25.24	-0.35%	-1.02%	2018-12-20
1021	2600MHz Head	56.60	25.50	57.20	25.64	1.06%	0.55%	2018-12-27
1155	5750MHz Head	78.40	22.30	79.00	22.60	0.77%	1.35%	2018-12-27
1044	750MHz Body	8.54	5.61	8.64	6.04	1.17%	7.66%	2018-12-15
1044	750MHz Body	8.54	5.61	8.64	5.68	1.17%	1.25%	2018-12-17
4d126	835MHz Body	9.65	6.32	8.80	6.12	-8.81%	-3.16%	2018-12-15
4d059	835MHz Body	9.41	6.20	10.20	6.68	8.40%	7.74%	2018-12-17
4d126	835MHz Body	9.65	6.32	10.28	6.72	6.53%	6.33%	2018-12-21
1123	1750MHz Body	36.40	19.40	36.52	19.64	0.33%	1.24%	2018-12-08
1123	1750MHz Body	36.40	19.40	33.52	18.04	-7.91%	-7.01%	2018-12-27
5d091	1900MHz Body	40.40	21.10	39.64	20.64	-1.88%	-2.18%	2018-12-18
5d091	1900MHz Body	40.40	21.10	39.20	20.52	-2.97%	-2.75%	2018-12-27
978	2450MHz Body	52.10	24.70	51.60	23.76	-0.96%	-3.81%	2018-12-21
1032	2600MHz Body	55.10	24.50	52.80	23.48	-4.17%	-4.16%	2018-12-17
1032	2600MHz Body	55.10	24.50	58.80	26.04	6.72%	6.29%	2018-12-19
1021	2600MHz Body	55.70	25.00	52.80	23.48	-5.21%	-6.08%	2018-12-27
1155	5250MHz Body	74.70	20.90	68.90	22.10	-7.76%	5.74%	2018-12-22
1155	5250MHz Body	74.70	20.90	69.00	19.70	-7.63%	-5.74%	2018-12-25
1155	5600MHz Body	79.60	22.10	74.70	21.20	-6.16%	-4.07%	2018-12-25
1155	5750MHz Body	73.30	20.40	68.10	19.20	-7.09%	-5.88%	2018-12-25

Table 10: System Check Results(test date: 2018-12-05~2018-12-28)

Dipole Information	System Check	Target SAR (Normalized to 1W)		Measured SAR (Normalized to 1W)		Deviation (Within +/-10% )		Test Date
		1-g (mW/g)	10-g (mW/g)	1-g (mW/g)	10-g (mW/g)	Δ1-g	Δ10-g	
1044	750MHz Head	8.24	5.34	7.68	5.12	-6.80%	-4.12%	2019-02-10
4d126	835MHz Head	9.44	6.06	9.96	6.52	5.51%	7.59%	2019-02-12
1123	1750MHz Head	36.60	19.40	34.80	18.56	-4.92%	-4.33%	2019-02-12
5d091	1900MHz Head	40.40	21.30	41.20	21.40	1.98%	0.47%	2019-02-12
860	2450MHz Head	53.10	24.70	48.00	23.80	-9.60%	-3.64%	2019-02-13
1021	2600MHz Head	56.60	25.50	56.00	25.36	-1.06%	-0.55%	2019-02-12
1155	5750MHz Head	78.40	22.30	72.70	21.40	-7.27%	-4.04%	2019-02-13
1044	750MHz Body	8.54	5.61	7.80	5.40	-8.67%	-3.74%	2019-01-31
4d126	835MHz Body	9.65	6.32	9.52	6.52	-1.35%	3.16%	2019-01-31
1123	1750MHz Body	36.40	19.40	34.28	19.56	-5.82%	0.82%	2019-01-31
5d143	1900MHz Body	39.40	20.80	39.56	21.76	0.41%	4.62%	2019-01-31
860	2450MHz Body	51.60	24.20	50.00	23.68	-3.10%	-2.15%	2019-02-13
1032	2600MHz Body	55.10	24.50	52.80	23.48	-4.17%	-4.16%	2019-01-31
1155	5250MHz Body	74.70	20.90	77.20	22.70	3.35%	8.61%	2019-02-13
1155	5600MHz Body	79.60	22.10	75.80	22.00	-4.77%	-0.45%	2019-02-13
1155	5750MHz Body	73.30	20.40	68.50	19.80	-6.55%	-2.94%	2019-02-13

Table 11: System Check Results(test date: 2019-01-31~2019-02-14)

### 4.3 System check Procedure

The system check is performed by using a system check dipole which is positioned parallel to the planar part of the SAM phantom at the reference point. The distance of the dipole to the SAM phantom is determined by a plexiglass spacer. The dipole is connected to the signal source consisting of signal generator and amplifier via a directional coupler, N-connector cable and adaption to SAM. It is fed with a power of 250 mW (below 3GHz) or 100mW (3-6GHz). To adjust this power, a power meter is used. The power sensor is connected to the cable before the system check to measure the power at this point and do adjustments at the signal generator. At the outputs of the directional coupler both return loss as well as forward power are controlled during the system check to make sure that emitted power at the dipole is kept constant. This can also be checked by the power drift measurement after the test (result on plot). System check results have to be equal or near the values determined during dipole calibration (target SAR in table above) with the relevant liquids and test system.

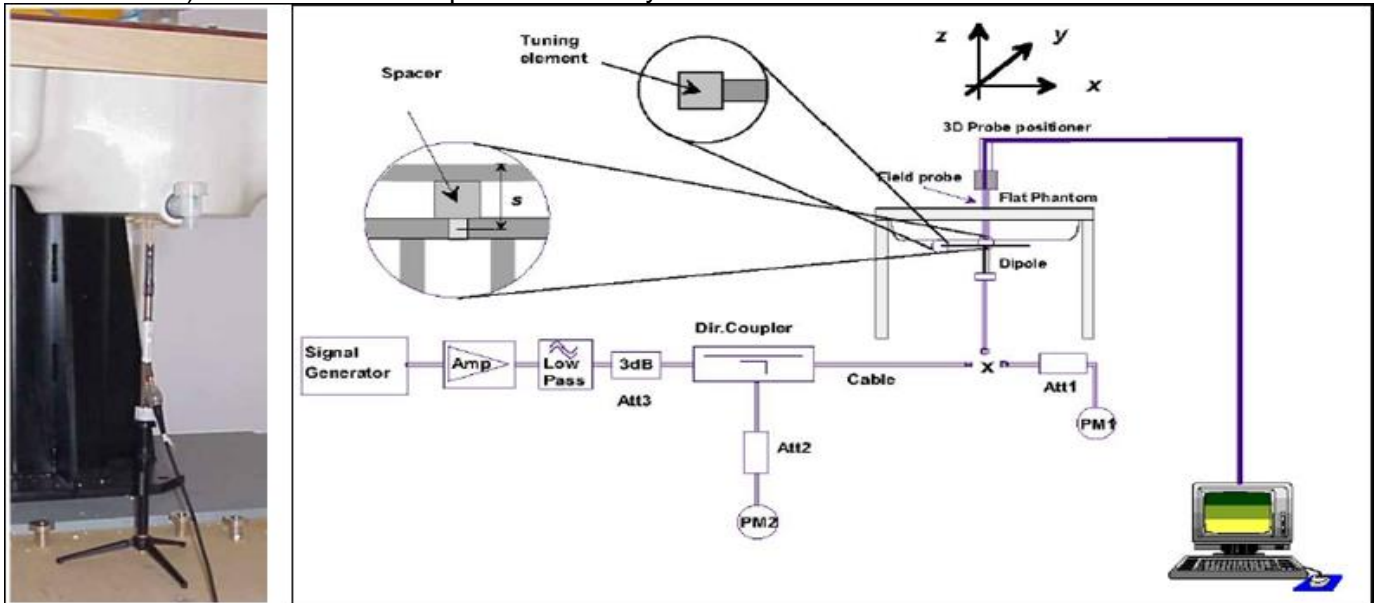

## 5 SAR measurement variability and uncertainty

### 5.1 SAR measurement variability

Per KDB 865664 D01 SAR measurement 100 MHz to 6 GHz, SAR measurement variability must be assessed for each frequency band, which is determined by the SAR probe calibration point and tissue-equivalent medium used for the device measurements. The additional measurements are repeated after the completion of all measurements requiring the same head or body tissue-equivalent medium in a frequency band. The test device should be returned to ambient conditions (normal room temperature) with the battery fully charged before it is re-mounted on the device holder for the repeated measurement(s) to minimize any unexpected variations in the repeated results.

- 1) Repeated measurement is not required when the original highest measured SAR is  $< 0.80$  W/kg; steps 2) through 4) do not apply.
- 2) When the original highest measured SAR is  $\geq 0.80$  W/kg, repeat that measurement once.
- 3) Perform a second repeated measurement only if the ratio of largest to smallest SAR for the original and first repeated measurements is  $> 1.20$  or when the original or repeated measurement is  $\geq 1.45$  W/kg ( $\sim 10\%$  from the 1-g SAR limit).
- 4) Perform a third repeated measurement only if the original, first or second repeated measurement is  $\geq 1.5$  W/kg and the ratio of largest to smallest SAR for the original, first and second repeated measurements is  $> 1.20$ .

The same procedures should be adapted for measurements according to extremity and occupational exposure limits by applying a factor of 2.5 for extremity exposure and a factor of 5 for occupational exposure to the corresponding SAR thresholds.

The detailed repeated measurement results are shown in Section 7.2.

### 5.2 SAR measurement uncertainty

Per KDB 865664 D01 SAR Measurement 100 MHz to 6 GHz, when the highest measured 1-g SAR within a frequency band is  $< 1.5$  W/kg, the extensive SAR measurement uncertainty analysis described in IEEE Std 1528-2013 is not required in SAR reports submitted for equipment approval. The equivalent ratio (1.5/1.6) is applied to extremity and occupational exposure conditions.

## 6 SAR Test Configuration

### 6.1 Test Positions Configuration

#### 6.1.1 General considerations

Per IEEE 1528-2013, two imaginary lines on the handset were established: the vertical centerline and the horizontal line (See Figure 1).

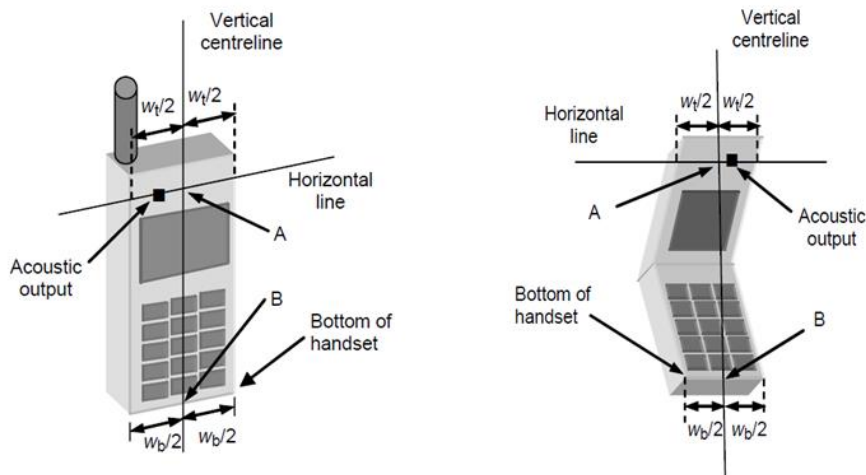

Figure 1 Hand Vertical Center & Horizontal Line Reference Points

#### 6.1.2 Head Exposure Condition

Per IEEE 1528-2013, Head SAR measurements were made in the “cheek” position (See Figure 2) and the “tilt” position (See Figure 3). The device should be tested in both positions on left and right sides of the SAM phantom.

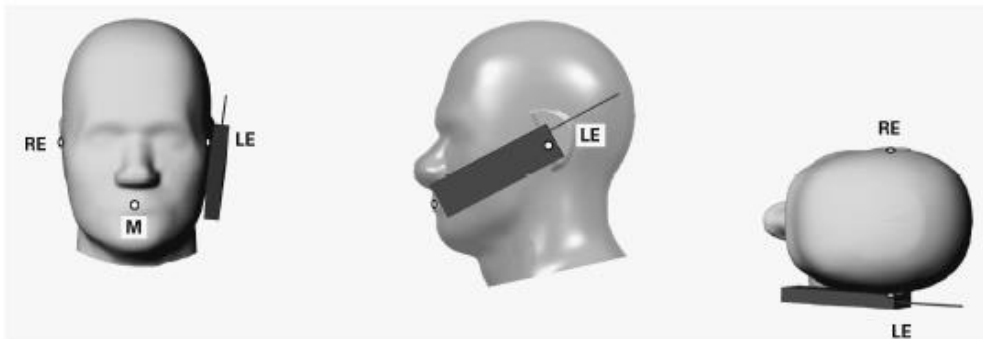

Figure 2 Front, Side and Top View of Cheek Position

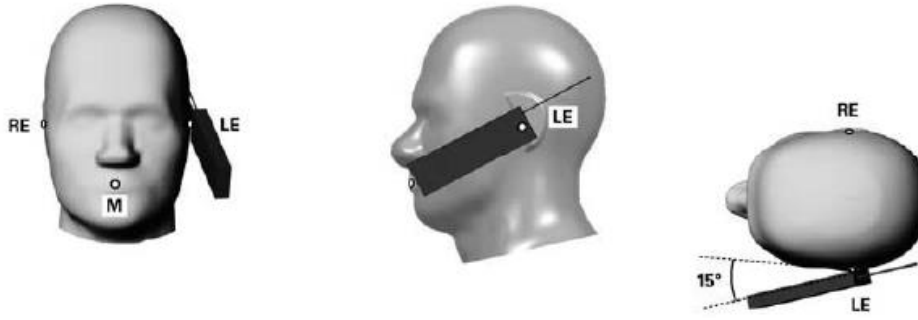

Figure 3 Front, Side and Top View of Tilt 15° Position

Note:

M Mouth reference point

LE Left ear reference point (ERP)

RE Right ear reference point(ERP)

### 6.1.3 Body-worn Exposure Condition

Body-worn operating configurations are tested with the holder attached to the device and positioned against a flat phantom with test separation distance of 15mm in a normal use configuration (See Figure 4). Per FCC KDB648474 D04, Body-worn accessory exposure is typically related to voice mode operations when handsets are carried in body-worn accessories. The body-worn accessory procedures in FCC KDB 447498 should be used to test for body-worn accessory SAR compliance, without a headset connected to it. When the reported SAR for a body-worn accessory, measured without a headset connected to the handset, is  $> 1.2 \text{ W/kg}$ , the highest reported SAR configuration for that wireless mode and frequency band should be repeated for that body-worn accessory with a headset attached to the handset.

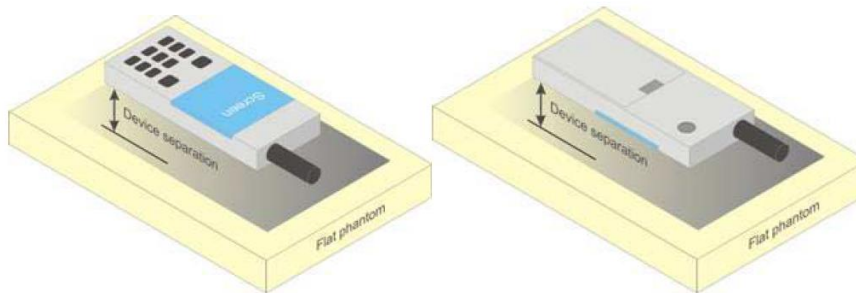

Figure 4 Test position for Body-Worn device

### 6.1.4 Hotspot Exposure Condition

Per FCC KDB 941225D06, the SAR test separation distance for hotspot mode is determined according to device form factor. When the overall length and width of a device is  $> 9 \text{ cm} \times 5 \text{ cm}$ , a test separation distance of 10 mm is required for hotspot mode SAR measurements. A test separation distance of 5 mm or less is required for smaller devices. Hotspot mode SAR is measured for all edges and surfaces of the device with a transmitting antenna located within 25 mm from that surface or edge; for the data modes, wireless technologies and frequency bands supporting hotspot mode. The SAR results are used to determine simultaneous transmission SAR test exclusion for hotspot mode; otherwise, simultaneous transmission SAR measurement is required.



### 6.1.5 Product Specific 10-g SAR Exposure Condition

Per FCC KDB 648474D04, for smart phones with a display diagonal dimension > 15.0 cm or an overall diagonal dimension > 16.0 cm that provide similar mobile web access and multimedia support found in mini-tablets or UMPC mini-tablets that support voice calls next to the ear, the device is marketed as “Phablet”.

The UMPC mini-tablet procedures must also be applied to test the SAR of all surfaces and edges with an antenna located at  $\leq 25$  mm from that surface or edge, in direct contact with a flat phantom, for Product Specific 10-g SAR according to the body-equivalent tissue dielectric parameters in KDB 865664 to address interactive hand use exposure conditions. The UMPC mini-tablet 1-g SAR at 5 mm is not required. When hotspot mode applies, Product Specific 10-g SAR is required only for the surfaces and edges with hotspot mode 1-g reported SAR > 1.2 W/kg; however, when power reduction applies to hotspot mode the measured SAR must be scaled to the maximum output power, including tolerance, allowed for phablet modes to compare with the 1.2 W/kg SAR test reduction threshold.

### 6.2 3G SAR Test Reduction Procedure

Per KDB941225 D01, in the following procedures, the mode tested for SAR is referred to as the primary mode. The equivalent modes considered for SAR test reduction are denoted as secondary modes. Both primary and secondary modes must be in the same frequency band. When the maximum output power and tune-up tolerance specified for production units in a secondary mode is  $\leq \frac{1}{4}$  dB higher than the primary mode or when the highest *reported* SAR of the primary mode is scaled by the ratio of specified maximum output power and tune-up tolerance of secondary to primary mode and the adjusted SAR is  $\leq 1.2$  W/kg, SAR measurement is not required for the secondary mode. This is referred to as the 3G SAR test reduction procedure in the following SAR test guidance, where the primary mode is identified in the applicable wireless mode test procedures and the secondary mode is wireless mode being considered for SAR test reduction by that procedure. When the 3G SAR test reduction procedure is not satisfied, it is identified as “otherwise” in the applicable procedures; SAR measurement is required for the secondary mode.

### 6.3 GSM Test Configuration

SAR tests for GSM850 and GSM1900, a communication link is set up with a base station by air link. Using CMW500 the power lever is set to “5” and “0” in SAR of GSM850 and GSM1900. The tests in the band of GSM850 and GSM1900 are performed in the mode of GPRS/EGPRS function. Since the GPRS class is 12 for this EUT, it has at most 4 timeslots in uplink and at most 4 timeslots in downlink, the maximum total timeslot is 5. The EGPRS class is 12 for this EUT, it has at most 4 timeslots in uplink, and at most 4 timeslots in downlink, the maximum total timeslot is 5.

When SAR tests for EGPRS mode is necessary, GMSK modulation should be used to minimize SAR measurement error due to higher peak-to-average power (PAR) ratios inherent in 8PSK.



## 6.4 UMTS Test Configuration

### 1) Output Power Verification

Maximum output power is verified on the high, middle and low channels according to procedures described in section 5.2 of 3GPP TS 34.121, using the appropriate RMC or AMR with TPC (transmit power control) set to all “1’s” for WCDMA/HSDPA or by applying the required inner loop power control procedures to maintain maximum output power while HSUPA is active. Results for all applicable physical channel configurations (DPCCH, DPDCHn and spreading codes, HSDPA, HSPA) are required in the SAR report. All configurations that are not supported by the handset or cannot be measured due to technical or equipment limitations must be clearly identified.

### 2) WCDMA

#### a. Head SAR Measurements

SAR for next to the ear head exposure is measured using a 12.2 kbps RMC with TPC bits configured to all “1’s”. The 3G SAR test reduction procedure is applied to AMR configurations with 12.2 kbps RMC as the primary mode.

#### b. Body SAR Measurements

SAR for body-worn accessory configurations is measured using a 12.2 kbps RMC with TPC bits configured to all “1’s”. The 3G SAR test reduction procedure is applied to other spreading codes and multiple DPDCHn configurations supported by the handset with 12.2 kbps RMC as the primary mode

### 3) HSDPA

SAR for body exposure configurations is measured according to the “Body SAR Measurements” procedures of 3G device. When the maximum output power and tune-up tolerance specified for production units in a secondary mode is  $\leq \frac{1}{4}$  dB higher than the primary mode or when the highest *reported* SAR of the primary mode is scaled by the ratio of specified maximum output power and tune-up tolerance of secondary to primary mode and the adjusted SAR is  $\leq 1.2$  W/kg, SAR measurement is not required for the secondary mode. This is referred to as the 3G SAR test reduction procedure in the following SAR test guidance, where the primary mode is identified in the applicable wireless mode test procedures and the secondary mode is wireless mode being considered for SAR test reduction by that procedure. When the 3G SAR test reduction procedure is not satisfied, it is identified as “otherwise” in the applicable procedures; SAR measurement is required for the secondary mode.

Per KDB941225 D01, the 3G SAR test reduction procedure is applied to HSDPA body configurations with 12.2 kbps RMC as the primary mode. Otherwise, SAR is measured for HSDPA using the HSDPA body SAR procedures for the highest reported SAR body exposure configuration in 12.2 kbps RMC.

HSDPA should be configured according to UE category of a test device. The number of HS-DSCH/HS-PDSCHs, HAPRQ processes, minimum inter-TTI interval, transport block sizes and RV coding sequence are defined by the H-set. To maintain a consistent test configuration and stable transmission condition, QPSK is used in the H-set for SAR testing. HS-DPCCH should be configured with a CQI feedback cycle of 4ms with a CQI repetition factor of 2 to maintain a constant rate of active CQI slots. The  $\beta_c$  and  $\beta_d$  gain factors for DPCCH and DPDCH were set according to the values in the below table,  $\beta_{hs}$  for HS-DPCCH is set automatically to the correct value when  $\Delta ACK, \Delta NACK, \Delta CQI = 8$ . The variation of the  $\beta_c / \beta_d$  ratio causes a power reduction at sub-tests 2 - 4.

Sub-test <sup>ⓐ</sup>	$\beta_c$ <sup>ⓐ</sup>	$\beta_d$ <sup>ⓐ</sup>	$\beta_d$ (SF) <sup>ⓐ</sup>	$\beta_c/\beta_d$ <sup>ⓐ</sup>	$\beta_{hs}$ (1) <sup>ⓐ</sup>	CM(dB)(2) <sup>ⓐ</sup>	MPR (dB) <sup>ⓐ</sup>
1 <sup>ⓐ</sup>	2/15 <sup>ⓐ</sup>	15/15 <sup>ⓐ</sup>	64 <sup>ⓐ</sup>	2/15 <sup>ⓐ</sup>	4/15 <sup>ⓐ</sup>	0.0 <sup>ⓐ</sup>	0 <sup>ⓐ</sup>
2 <sup>ⓐ</sup>	12/15(3) <sup>ⓐ</sup>	15/15(3) <sup>ⓐ</sup>	64 <sup>ⓐ</sup>	12/15(3) <sup>ⓐ</sup>	24/15 <sup>ⓐ</sup>	1.0 <sup>ⓐ</sup>	0 <sup>ⓐ</sup>
3 <sup>ⓐ</sup>	15/15 <sup>ⓐ</sup>	8/15 <sup>ⓐ</sup>	64 <sup>ⓐ</sup>	15/8 <sup>ⓐ</sup>	30/15 <sup>ⓐ</sup>	1.5 <sup>ⓐ</sup>	0.5 <sup>ⓐ</sup>
4 <sup>ⓐ</sup>	15/15 <sup>ⓐ</sup>	4/15 <sup>ⓐ</sup>	64 <sup>ⓐ</sup>	15/4 <sup>ⓐ</sup>	30/15 <sup>ⓐ</sup>	1.5 <sup>ⓐ</sup>	0.5 <sup>ⓐ</sup>

Note 1:  $\Delta$  ACK,  $\Delta$  NACK and  $\Delta$  CQI = 8      $A_{hs} = \beta_{hs}/\beta_c = 30/15$       $\beta_{hs} = 30/15 * \beta_c$ <sup>ⓐ</sup>  
Note 2 : CM=1 for  $\beta_c/\beta_d= 12/15$ ,  $\beta_{hs}/\beta_c = 24/15$ . For all other combinations of DPDCH, DPCCH and HS-DPCCH the MPR is based on the relative CM difference. This is applicable for only UEs that support HSDPA in release 6 and later releases.<sup>ⓐ</sup>  
Note 3 : For subtest 2 the  $\beta_c/\beta_d$  ratio of 12/15 for the TFC during the measurement period (TF1, TF0) is achieved by setting the signalled gain factors for the reference TFC (TF1, TF1) to  $\beta_c = 11/15$  and  $\beta_d = 15/15$ <sup>ⓐ</sup>

Table 12: Sub-tests for UMTS Release 5 HSDPA

The measurements were performed with a Fixed Reference Channel (FRC) and H-Set 1 QPSK.

Parameter	Value
Nominal average inf. bit rate	534 kbit/s
Inter-TTI Distance	3 TTI's
Number of HARQ Processes	2 Processes
Information Bit Payload	3202 Bits
MAC-d PDU size	336 Bits
Number Code Blocks	1 Block
Binary Channel Bits Per TTI	4800 Bits
Total Available SMLs in UE	19200 SMLs
Number of SMLs per HARQ Process	9600 SMLs
Coding Rate	0.67
Number of Physical Channel Codes	5

Table 13: settings of required H-Set 1 QPSK acc. to 3GPP 34.121

HS-DSCH Category	Maximum HS-DSCH Codes Received	Minimum Inter-TTI Interval	Maximum HS-DSCH Transport Block Bits/HS-DSCH TTI	Total Soft Channel Bits
1	5	3	7298	19200
2	5	3	7298	28800
3	5	2	7298	28800
4	5	2	7298	38400
5	5	1	7298	57600
6	5	1	7298	67200
7	10	1	14411	115200
8	10	1	14411	134400
9	15	1	25251	172800
10	15	1	27952	172800
11	5	2	3630	14400
12	5	1	3630	28800
13	15	1	34800	259200
14	15	1	42196	259200
15	15	1	23370	345600
16	15	1	27952	345600

Table 14: HSDPA UE category

#### 4) HSUPA

SAR for body exposure configurations is measured according to the “Body SAR Measurements” procedures of 3G device. When the maximum output power and tune-up tolerance specified for production units in a secondary mode is  $\leq \frac{1}{4}$  dB higher than the primary mode or when the highest reported SAR of the primary mode is scaled by the ratio of specified maximum output power and tune-up tolerance of secondary to primary mode and the adjusted SAR is  $\leq 1.2$  W/kg, SAR measurement is not required for the secondary mode.

Per KDB941225 D01, the 3G SAR test reduction procedure is applied to HSPA (HSUPA/HSDPA with RMC) body configurations with 12.2 kbps RMC as the primary mode. Otherwise, SAR is measured for HSPA using the HSPA body SAR procedures for the highest reported body exposure SAR configuration in 12.2 kbps RMC.

Due to inner loop power control requirements in HSDPA, a commercial communication test set should be used for the output power and SAR tests. The 12.2 kbps RMC, FRC H-set 1 and E-DCH configurations for HSDPA should be configured according to the values indicated below as well as other applicable procedures described in the ‘WCDMA Handset’ and ‘Release 5 HSDPA Data Device’ sections of 3G device.

Sub-test <sup>1</sup>	$\beta_c$ <sup>2</sup>	$\beta_d$ <sup>2</sup>	$\beta_d$ (SF) <sup>2</sup>	$\beta_c/\beta_d$ <sup>2</sup>	$\beta_{hs}$ <sup>(1)</sup>	$\beta_{ec}$ <sup>2</sup>	$\beta_{ed}$ <sup>2</sup>	$\beta_a$ <sup>c</sup> (SF) <sup>2</sup>	$\beta_{ed}$ <sup>c</sup> (code) <sup>2</sup>	CM <sup>(2)</sup> (dB) <sup>2</sup>	MP R <sup>c</sup> (dB) <sup>2</sup>	AG <sup>(4)</sup> Inde <sup>x</sup>	E-TFC I <sup>2</sup>
1 <sup>2</sup>	11/15 <sup>(3)</sup>	15/15 <sup>(3)</sup>	64 <sup>2</sup>	11/15 <sup>(3)</sup>	22/15 <sup>2</sup>	209/225 <sup>2</sup>	1039/225 <sup>2</sup>	4 <sup>2</sup>	1 <sup>2</sup>	1.0 <sup>2</sup>	0.0 <sup>2</sup>	20 <sup>2</sup>	75 <sup>2</sup>
2 <sup>2</sup>	6/15 <sup>2</sup>	15/15 <sup>2</sup>	64 <sup>2</sup>	6/15 <sup>2</sup>	12/15 <sup>2</sup>	12/15 <sup>2</sup>	94/75 <sup>2</sup>	4 <sup>2</sup>	1 <sup>2</sup>	3.0 <sup>2</sup>	2.0 <sup>2</sup>	12 <sup>2</sup>	67 <sup>2</sup>
3 <sup>2</sup>	15/15 <sup>2</sup>	9/15 <sup>2</sup>	64 <sup>2</sup>	15/9 <sup>2</sup>	30/15 <sup>2</sup>	30/15 <sup>2</sup>	$\beta_{ed1}:47/15$ $\beta_{ed2}:47/15$	4 <sup>2</sup>	2 <sup>2</sup>	2.0 <sup>2</sup>	1.0 <sup>2</sup>	15 <sup>2</sup>	92 <sup>2</sup>
4 <sup>2</sup>	2/15 <sup>2</sup>	15/15 <sup>2</sup>	64 <sup>2</sup>	2/15 <sup>2</sup>	4/15 <sup>2</sup>	2/15 <sup>2</sup>	56/75 <sup>2</sup>	4 <sup>2</sup>	1 <sup>2</sup>	3.0 <sup>2</sup>	2.0 <sup>2</sup>	17 <sup>2</sup>	71 <sup>2</sup>
5 <sup>2</sup>	15/15 <sup>(4)</sup>	15/15 <sup>(4)</sup>	64 <sup>2</sup>	15/15 <sup>(4)</sup>	30/15 <sup>2</sup>	24/15 <sup>2</sup>	134/15 <sup>2</sup>	4 <sup>2</sup>	1 <sup>2</sup>	1.0 <sup>2</sup>	0.0 <sup>2</sup>	21 <sup>2</sup>	81 <sup>2</sup>

Note 1:  $\Delta$  ACK,  $\Delta$  NACK and  $\Delta$  CQI = 8  $A_{hs} = \beta_{hs}/\beta_c = 30/15$   $\beta_{hs} = 30/15 * \beta_c$

Note 2: CM = 1 for  $\beta_c/\beta_d = 12/15$ ,  $\beta_{hs}/\beta_c = 24/15$ . For all other combinations of DPDCH, DPCCH, HS-DPCCH, E-DPDCH and E-DPCCH the MPR is based on the relative CM difference<sup>2</sup>

Note 3 : For subtest 1 the  $\beta_c/\beta_d$  ratio of 11/15 for the TFC during the measurement period (TF1, TF0) is achieved by setting the signalled gain factors for the reference TFC (TF1, TF1) to  $\beta_c = 10/15$  and  $\beta_d = 15/15$ <sup>2</sup>

Note 4 : For subtest 5 the  $\beta_c/\beta_d$  ratio of 15/15 for the TFC during the measurement period (TF1, TF0) is achieved by setting the signalled gain factors for the reference TFC (TF1, TF1) to  $\beta_c = 14/15$  and  $\beta_d = 15/15$ <sup>2</sup>

Note 5 : Testing UE using E-DPDCH Physical Layer category 1 Sub-test 3 is not required according to TS 25.306 Table 5.1g<sup>2</sup>

Note 6:  $\beta_{ed}$  can not be set directly; it is set by Absolute Grant Value.<sup>2</sup>

Table 15:Subtests for UMTS Release 6 HSUPA

UE E-DCH Category	Maximum E-DCH Codes Transmitted	Number of HARQ Processes	E-DCH TTI(ms)	Minimum Spreading Factor	Maximum E-DCH Transport Block Bits	Max Rate (Mbps)
1	1	4	10	4	7110	0.7296
2	2	8	2	4	2798	1.4592
	2	4	10	4	14484	
3	2	4	10	4	14484	1.4592
4	2	8	2	2	5772	2.9185
	2	4	10	2	20000	2.00
5	2	4	10	2	20000	2.00
6 (No DPDCH)	4	8	10	2SF2&2S	11484	5.76
	4	4	2	F4	20000	2.00
7 (No DPDCH)	4	8	2	2SF2&2S	22996	?
	4	4	10	F4	20000	?

NOTE: When 4 codes are transmitted in parallel, two codes shall be transmitted with SF2 and two with SF4. UE categories 1 to 6 support QPSK only. UE category 7 supports QPSK and 16QAM. (TS25.306-7.3.0).

Table 16: HSUPA UE category

### 5) DC-HSDPA

SAR is required for Rel. 8 DC-HSDPA when SAR is required for Rel. 5 HSDPA; otherwise, the 3G SAR test reduction procedure is applied to DC-HSDPA with 12.2 kbps RMC as the primary mode. Power is measured for DC-HSDPA according to the H-Set 12, FRC configuration in Table C.8.1.12 of 3GPP TS 34.121-1 to determine SAR test reduction. A primary and a Second serving HS-DSCH Cell are required to perform the power measurement and for the results to be acceptable.

The following tests were completed according to procedures in section 7.3.13 of 3GPP TS 34.108 v9.5.0. A summary of these settings are illustrated below:

Downlink Physical Channels are set as per 3GPP TS34.121-1 v9.0.0 E.5.0

**Table E.5.0: Levels for HSDPA connection setup**

Parameter During Connection setup	Unit	Value
P-CPICH_Ec/Ior	dB	-10
P-CCPCH and SCH_Ec/Ior	dB	-12
PICH_Ec/Ior	dB	-15
HS-PDSCH	dB	off
HS-SCCH_1	dB	off
DPCH_Ec/Ior	dB	-5
OCNS_Ec/Ior	dB	-3.1

Call is set up as per 3GPP TS34.108 v9.5.0 sub clause 7.3.13

The configurations of the fixed reference channels for HSDPA RF tests are described in 3GPP TS 34.121, annex C for FDD and 3GPP TS 34.122.

The measurements were performed with a Fixed Reference Channel (FRC) H-Set 12 with QPSK

Parameter	Value
Nominal average inf. bit rate	60 kbit/s
Inter-TTI Distance	1 TTI's
Number of HARQ Processes	6 Processes
Information Bit Payload	120 Bits
Number Code Blocks	1 Block
Binary Channel Bits Per TTI	960 Bits
Total Available SMLs in UE	19200 SMLs
Number of SMLs per HARQ Process	3200 SMLs
Coding Rate	0.15
Number of Physical Channel Codes	1

Table 17: settings of required H-Set 12 QPSK acc. to 3GPP 34.121

Note:

- 1.The RMC is intended to be used for DC-HSDPA mode and both cells shall transmit with identical parameters as listed in the table above.
- 2.Maximum number of transmission is limited to 1,i.e.,retransmission is not allowed. The redundancy and constellation version 0 shall be used.

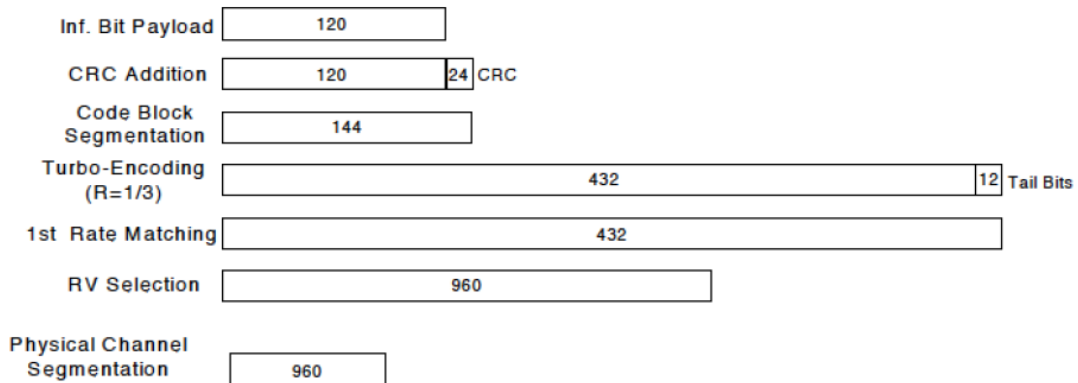

Figure C.8.19: Coding rate for Fixed reference Channel H-Set 12 (QPSK)

The following 4 Sub-tests for HSDPA were completed according to Release 5 procedures. A summary of subtest settings are illustrated below:

Sub-test <sup>o</sup>	$\beta_c$ <sup>o</sup>	$\beta_d$ <sup>o</sup>	$\beta_d$ (SF) <sup>o</sup>	$\beta_c/\beta_d$ <sup>o</sup>	$\beta_{hs}$ (1) <sup>o</sup>	CM(dB)(2) <sup>o</sup>	MPR (dB) <sup>o</sup>
1 <sup>o</sup>	2/15 <sup>o</sup>	15/15 <sup>o</sup>	64 <sup>o</sup>	2/15 <sup>o</sup>	4/15 <sup>o</sup>	0.0 <sup>o</sup>	0 <sup>o</sup>
2 <sup>o</sup>	12/15(3) <sup>o</sup>	15/15(3) <sup>o</sup>	64 <sup>o</sup>	12/15(3) <sup>o</sup>	24/15 <sup>o</sup>	1.0 <sup>o</sup>	0 <sup>o</sup>
3 <sup>o</sup>	15/15 <sup>o</sup>	8/15 <sup>o</sup>	64 <sup>o</sup>	15/8 <sup>o</sup>	30/15 <sup>o</sup>	1.5 <sup>o</sup>	0.5 <sup>o</sup>
4 <sup>o</sup>	15/15 <sup>o</sup>	4/15 <sup>o</sup>	64 <sup>o</sup>	15/4 <sup>o</sup>	30/15 <sup>o</sup>	1.5 <sup>o</sup>	0.5 <sup>o</sup>

Note 1:  $\Delta$  ACK,  $\Delta$  NACK and  $\Delta$  CQI=8  $A_{hs} = \beta_{hs}/\beta_c = 30/15$   $\beta_{hs} = 30/15 * \beta_c$   
 Note 2: CM=1 for  $\beta_c/\beta_d = 12/15$ ,  $\beta_{hs}/\beta_c = 24/15$ . For all other combinations of DPDCH, DPCCH and HS-DPCCH the MPR is based on the relative CM difference. This is applicable for only UEs that support HSDPA in release 6 and later releases.  
 Note 3: For subtest 2 the  $\beta_c/\beta_d$  ratio of 12/15 for the TFC during the measurement period (TF1, TF0) is achieved by setting the signalled gain factors for the reference TFC (TF1, TF1) to  $\beta_c = 11/15$  and  $\beta_d = 15/15$

Up commands are set continuously to set the UE to Max power.

Note:

- 1.The Dual Carriers transmission only applies to HSDPA physical channels
- 2.The Dual Carriers belong to the same Node and are on adjacent carriers.
- 3.The Dual Carriers do not support MIMO to serve UEs configured for dual cell operation
- 4.The Dual Carriers operate in the same frequency band .
- 5.The device doesn't support the modulation of 16QAM in uplink but 64QAM in downlink for DC-HSDPA mode.
- 6.The device doesn't support carrier aggregation for it just can operate in Release 8.



## 6.5 LTE Test Configuration

SAR for LTE band exposure configurations is measured according to the procedures of KDB 941225 D05 SAR for LTE Devices. The CMW500 WideBand Radio Communication Tester was used for LTE output power measurements and SAR testing. Closed loop power control was used so the UE transmits with maximum output power during SAR testing. SAR test were performed with the same number of RB and RB offsets transmitting on all TTI frames (Maximum TTI)

### 1) Spectrum Plots for RB configurations

A properly configured base station simulator was used for LTE output power measurements and SAR testing. Therefore, spectrum plots for RB configurations were not required to be included in this report.

### 2) MPR

When MPR is implemented permanently within the UE, regardless of network requirements, only those RB configurations allowed by 3GPP for the channel bandwidth and modulation combinations may be tested with MPR active. Configurations with RB allocations less than the RB thresholds required by 3GPP must be tested without MPR.

The allowed Maximum Power Reduction (MPR) for the maximum output power due to higher order modulation and transmit bandwidth configuration (resource blocks) is specified in Table 6.2.3-1 of the 3GPP TS36.101.

Table 6.2.3-1: Maximum Power Reduction (MPR) for Power Class 1, 2 and 3

Modulation	Channel bandwidth / Transmission bandwidth ( $N_{RB}$ )						MPR (dB)
	1.4 MHz	3.0 MHz	5 MHz	10 MHz	15 MHz	20 MHz	
QPSK	> 5	> 4	> 8	> 12	> 16	> 18	$\leq 1$
16 QAM	$\leq 5$	$\leq 4$	$\leq 8$	$\leq 12$	$\leq 16$	$\leq 18$	$\leq 1$
16 QAM	> 5	> 4	> 8	> 12	> 16	> 18	$\leq 2$
64 QAM	$\leq 5$	$\leq 4$	$\leq 8$	$\leq 12$	$\leq 16$	$\leq 18$	$\leq 2$
64 QAM	> 5	> 4	> 8	> 12	> 16	> 18	$\leq 3$

### 3) A-MPR

A-MPR (Additional MPR) has been disabled for all SAR tests by using Network Signalling Value of "NS\_01" on the base station simulator.

### 4) LTE procedures for SAR testing

A) Largest channel bandwidth standalone SAR test requirements

i) QPSK with 1 RB allocation

Start with the largest channel bandwidth and measure SAR for QPSK with 1 RB allocation, using the RB offset and required test channel combination with the highest maximum output power for RB offsets at the upper edge, middle and lower edge of each required test channel. When the reported SAR is  $\leq 0.8$  W/kg, testing of the remaining RB offset configurations and required test channels is not required for 1 RB allocation; otherwise, SAR is required for the remaining required test channels and only for the RB offset configuration with the highest output power for that channel. When the reported SAR of a required test channel is  $> 1.45$  W/kg, SAR is required for all three RB offset configurations for that required test channel.

ii) QPSK with 50% RB allocation

The procedures required for 1 RB allocation in i) are applied to measure the SAR for QPSK with 50% RB allocation.

iii) QPSK with 100% RB allocation

For QPSK with 100% RB allocation, SAR is not required when the highest maximum output power for 100 %

RB allocation is less than the highest maximum output power in 50% and 1 RB allocations and the highest reported SAR for 1 RB and 50% RB allocation in i) and ii) are  $\leq 0.8$  W/kg. Otherwise, SAR is measured for the highest output power channel and if the reported SAR is  $> 1.45$  W/kg, the remaining required test channels must also be tested.

iv) Higher order modulations

For each modulation besides QPSK; e.g., 16-QAM, 64-QAM, apply the QPSK procedures in above sections to determine the QAM configurations that may need SAR measurement. For each configuration identified as required for testing, SAR is required only when the highest maximum output power for the configuration in the higher order modulation is  $> \frac{1}{2}$  dB higher than the same configuration in QPSK or when the reported SAR for the QPSK configuration is  $> 1.45$  W/kg.

B) Other channel bandwidth standalone SAR test requirements

For the other channel bandwidths used by the device in a frequency band, apply all the procedures required for the largest channel bandwidth in section A) to determine the channels and RB configurations that need SAR testing and only measure SAR when the highest maximum output power of a configuration requiring testing in the smaller channel bandwidth is  $> \frac{1}{2}$  dB higher than the equivalent channel configurations in the largest channel bandwidth configuration or the reported SAR of a configuration for the largest channel bandwidth is  $> 1.45$  W/kg.

5) TDD LTE test configuration

According to KDB 941225 D05 SAR for LTE Devices, for Time-Division Duplex (TDD) systems, SAR must be tested using a fixed periodic duty factor according to the highest transmission duty factor implemented for the device and supported by the defined 3GPP LTE TDD configurations.

TDD LTE Band 41 supports 3GPP TS 36.211 section 4.2 for Type 2 Frame Structure and Table 4.2-2 for uplink-downlink configurations and Table 4.2-1 for Special subframe configurations.

Figure 4.2-1: Frame structure type 2

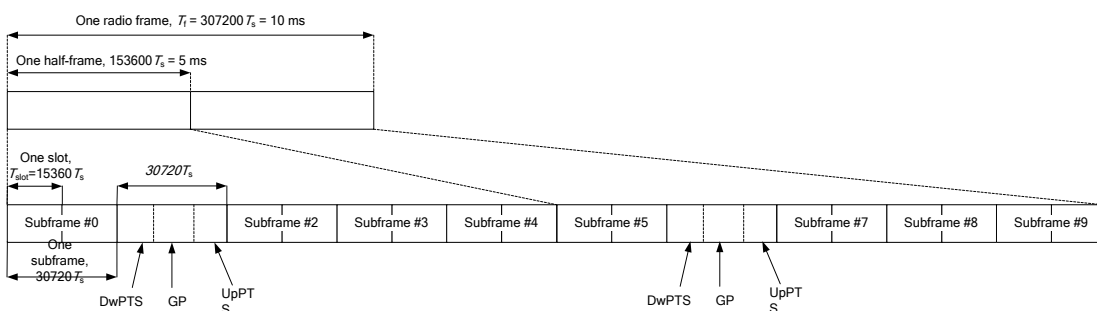

Table 4.2-1: Configuration of special subframe (lengths of DwPTS/GP/UpPTS)



Special subframe configuration	Normal cyclic prefix in downlink			Extended cyclic prefix in downlink		
	DwPTS	UpPTS		DwPTS	UpPTS	
		Normal cyclic prefix in uplink	Extended cyclic prefix in uplink		Normal cyclic prefix in uplink	Extended cyclic prefix in uplink
0	$6592 \cdot T_s$	$2192 \cdot T_s$	$2560 \cdot T_s$	$7680 \cdot T_s$	$2192 \cdot T_s$	$2560 \cdot T_s$
1	$19760 \cdot T_s$			$20480 \cdot T_s$		
2	$21952 \cdot T_s$			$23040 \cdot T_s$		
3	$24144 \cdot T_s$			$25600 \cdot T_s$		
4	$26336 \cdot T_s$	$4384 \cdot T_s$	$5120 \cdot T_s$	$7680 \cdot T_s$	$4384 \cdot T_s$	$5120 \cdot T_s$
5	$6592 \cdot T_s$			$20480 \cdot T_s$		
6	$19760 \cdot T_s$			$23040 \cdot T_s$		
7	$21952 \cdot T_s$			$12800 \cdot T_s$		
8	$24144 \cdot T_s$			-	-	-
9	$13168 \cdot T_s$			-	-	-

**Table 4.2-2: Uplink-downlink configurations**

Uplink-downlink configuration	Downlink-to-Uplink Switch-point periodicity	Subframe number										
		0	1	2	3	4	5	6	7	8	9	
0	5 ms	D	S	U	U	U	D	S	U	U	U	
1	5 ms	D	S	U	U	D	D	S	U	U	D	
2	5 ms	D	S	U	D	D	D	S	U	D	D	
3	10 ms	D	S	U	U	U	D	D	D	D	D	
4	10 ms	D	S	U	U	D	D	D	D	D	D	
5	10 ms	D	S	U	D	D	D	D	D	D	D	
6	5 ms	D	S	U	U	U	D	S	U	U	D	

According to Figure 4.2-1, one radio frame is configured by 10 subframes, which consist of Uplink-subframe, Downlink-subframe and Special subframe. For TDD-LTE, the Duty Cycle should be calculated on Uplink-subframes and Special subframes, due to Special subframe containing both Uplink transmissions. So for one radio frame, Duty Cycle can be calculated with formula as below. The count of Uplink subframes are according to Table 4.2-2:

$$\text{Duty cycle} = (30720T_s \cdot \text{Ups} + \text{Uplink Component} \cdot \text{Specials}) / (307200T_s)$$

About the uplink component of Special subframes, we can figure out by Table 4.2-1:

$$\text{Uplink Component} = \text{UpPTS}$$

In conclusion, for the TDD LTE Band, Duty Cycle can be calculated with formula as below .all these sets are ok when we test, or we can set as below.

$$\text{Duty cycle} = [(30720T_s \cdot \text{Ups}) + \text{UpPTS} \cdot \text{Specials}] / (307200T_s)$$

And we can get different Duty cycles under different configurations:

Uplink-Downlink configuration	Subframe number			Configuration of special subframe							
				Normal cycle prefix in downlink				Extended cycle prefix in downlink			
				Normal cycle prefix in uplink		Extended cycle prefix in uplink		Normal cycle prefix in uplink		Extended cycle prefix in uplink	
	D	S	U	configuration				configuration			
				0~4	5~9	0~4	5~9	0~3	4~7	0~3	4~7
0	2	2	6	61.43%	62.85%	61.67%	<b>63.33%</b>	61.43%	62.85%	61.67%	<b>63.33%</b>
1	4	2	4	41.43%	42.85%	41.67%	43.33%	41.43%	42.85%	41.67%	43.33%
2	6	2	2	21.43%	22.85%	21.67%	23.33%	21.43%	22.85%	21.67%	23.33%
3	6	1	3	30.71%	31.43%	30.83%	31.67%	30.71%	31.43%	30.83%	31.67%
4	7	1	2	20.71%	21.43%	20.83%	21.67%	20.71%	21.43%	20.83%	21.67%
5	8	1	1	10.71%	11.43%	10.83%	11.67%	10.71%	11.43%	10.83%	11.67%
6	3	2	5	51.43%	52.85%	51.67%	53.33%	51.43%	52.85%	51.67%	53.33%

For TDD LTE, SAR should be tested with the highest transmission duty factor (63.33%) using Uplink-downlink configuration 0 and Special subframe configuration 7 for Frame structure type 2.

## 6.6 WiFi Test Configuration

For WiFi SAR testing, a communication link is set up with some command for WiFi mode test. During the test, at the each test frequency channel, the EUT is operated at the RF continuous emission mode. Per KDB 248227D01, a minimum transmission duty factor of 85% is required to avoid certain hardware and device implementation issues related to wide range SAR scaling. The reported SAR must be scaled to 100% transmission duty factor to determine compliance at the maximum tune-up tolerance limit.

### 6.6.1 Initial Test Position Procedure

For exposure condition with multiple test position, such as handsets operating next to the ear, devices with hotspot mode or UMPC mini-tablet, procedures for initial test position can be applied. Using the transmission mode determined by the DSSS procedure or initial test configuration, area scans are measured for all position in an exposure condition. The test position with the highest extrapolated (peak) SAR is used as the initial test position. When reported SAR for the initial test position is  $\leq 0.4\text{W/kg}$ , no additional testing for the remaining test position is required. Otherwise, SAR is evaluated at the subsequent highest peak SAR position until the reported SAR result is  $\leq 0.8\text{W/kg}$  or all test position are measured. For all positions/configurations tested using the initial test position and subsequent test positions, when the *reported* SAR is  $> 0.8\text{ W/kg}$ , SAR is measured for these test positions/configurations on the subsequent next highest measured output power channel(s) until the *reported* SAR is  $\leq 1.2\text{ W/kg}$  or all required channels are tested.

### 6.6.2 Initial Test Configuration Procedure

An initial test configuration is determined for OFDM transmission modes according to the channel bandwidth, modulation and data rate combination(s) with the highest maximum output power specified for production units in each standalone and aggregated frequency band. SAR is measured using the highest measured maximum output power channel. For configurations with the same specified or measured maximum output power, additional transmission mode and test channel selection procedures are required (see section 5.3.2 of KDB 248227D01). SAR test reduction of subsequent highest output test channels is based on the *reported* SAR of the initial test configuration.

For next to the ear, hotspot mode and UMC mini-tablet exposure configurations where multiple test positions are required, the initial test position procedure is applied to minimize the number of test positions required for SAR measurement using the initial test configuration transmission mode. For fixed exposure conditions that do not have multiple SAR test positions, SAR is measured in the transmission mode determined by the initial test configuration.

When the *reported* SAR of the initial test configuration is  $> 0.8\text{ W/kg}$ , SAR measurement is required for the subsequent next highest measured output power channel(s) in the initial test configuration until the *reported* SAR is  $\leq 1.2\text{ W/kg}$  or all required channels are tested.

### 6.6.3 Sub Test Configuration Procedure

SAR measurement requirements for the remaining 802.11 transmission mode configurations that have not been tested in the initial test configuration are determined separately for each standalone and aggregated frequency band, in each exposure condition, according to the maximum output power specified for production units.

When the highest reported SAR for the initial test configuration, according to the initial test position or fixed exposure position requirements, is adjusted by the ratio of the subsequent test configuration to initial test configuration specified maximum output power and the adjusted SAR is  $\leq 1.2\text{ W/kg}$ , SAR is not required for that subsequent test configuration.

#### 6.6.4 WiFi 2.4G SAR Test Procedures

Separate SAR procedures are applied to DSSS and OFDM configurations in the 2.4 GHz band to simplify DSSS test requirements. For 802.11b DSSS SAR measurements, DSSS SAR procedure applies to fixed exposure test position and initial test position procedure applies to multiple exposure test positions.

##### A) 802.11b DSSS SAR Test Requirements

SAR is measured for 2.4 GHz 802.11b DSSS using either a fixed test position or, when applicable, the initial test position procedure. SAR test reduction is determined according to the following:

1) When the *reported* SAR of the highest measured maximum output power channel (section 3.1 of of KDB 248227D01) for the exposure configuration is  $\leq 0.8$  W/kg, no further SAR testing is required for 802.11b DSSS in that exposure configuration.

2) When the *reported* SAR is  $> 0.8$  W/kg, SAR is required for that exposure configuration using the next highest measured output power channel. When any *reported* SAR is  $> 1.2$  W/kg, SAR is required for the third channel; i.e., all channels require testing.

##### B) 2.4GHz 802.11g/n OFDM SAR Test Exclusion Requirements

When SAR measurement is required for 2.4 GHz 802.11g/n OFDM configurations, the measurement and test reduction procedures for OFDM are applied (section 5.3 of of KDB 248227D01). SAR is not required for the following 2.4 GHz OFDM conditions.

1) When KDB Publication 447498 SAR test exclusion applies to the OFDM configuration.

2) When the highest *reported* SAR for DSSS is adjusted by the ratio of OFDM to DSSS specified maximum output power and the adjusted SAR is  $\leq 1.2$  W/kg.

##### C) SAR Test Requirements for OFDM configurations

When SAR measurement is required for 802.11 a/g/n/ac OFDM configurations, each standalone and frequency aggregated band is considered separately for SAR test reduction. When the same transmitter and antenna(s) are used for U-NII-1 and U-NII-2A bands, additional SAR test reduction applies. When band gap channels between U-NII-2C band and 5.8 GHz U-NII-3 or §15.247 band are supported, the highest maximum output power transmission mode configuration and maximum output power channel across the bands must be used to determine SAR test reduction, according to the initial test configuration and subsequent test configuration requirements. In applying the initial test configuration and subsequent test configuration procedures, the 802.11 transmission configuration with the highest specified maximum output power and the channel within a test configuration with the highest measured maximum output power should be clearly distinguished to apply the procedures.

### 6.6.5 U-NII-1 and U-NII-2A Bands

For devices that operate in only one of the U-NII-1 and U-NII-2A bands, the normally required SAR procedures for OFDM configurations are applied. For devices that operate in both U-NII bands using the same transmitter and antenna(s), SAR test reduction is determined according to the following:

- 1) When the same maximum output power is specified for both bands, begin SAR measurement in U-NII-2A band by applying the OFDM SAR requirements. If the highest *reported* SAR for a test configuration is  $\leq 1.2$  W/kg, SAR is not required for U-NII-1 band for that configuration (802.11 mode and exposure condition); otherwise, both bands are tested independently for SAR.
- 2) When different maximum output power is specified for the bands, begin SAR measurement in the band with higher specified maximum output power. The highest *reported* SAR for the tested configuration is adjusted by the ratio of lower to higher specified maximum output power for the two bands. When the adjusted SAR is  $\leq 1.2$  W/kg, SAR is not required for the band with lower maximum output power in that test configuration; otherwise, both bands are tested independently for SAR.
- 3) The two U-NII bands may be aggregated to support a 160 MHz channel on channel number 50. Without additional testing, the maximum output power for this is limited to the lower of the maximum output power certified for the two bands. When SAR measurement is required for at least one of the bands and the highest *reported* SAR adjusted by the ratio of specified maximum output power of aggregated to standalone band is  $> 1.2$  W/kg, SAR is required for the 160 MHz channel. This procedure does not apply to an aggregated band with maximum output higher than the standalone band(s); the aggregated band must be tested independently for SAR. SAR is not required when the 160 MHz channel is operating at a reduced maximum power and also qualifies for SAR test exclusion.

### 6.6.6 U-NII-2C and U-NII-3 Bands

The frequency range covered by these bands is 380 MHz (5.47 – 5.85 GHz), which requires a minimum of at least two SAR probe calibration frequency points to support SAR measurements. when Terminal Doppler Weather Radar (TDWR) restriction applies, the channels at 5.60 – 5.65 GHz in U-NII-2C band must be disabled with acceptable mechanisms and documented in the equipment certification to avoid SAR requirements.<sup>10</sup> TDWR restriction does not apply under the new rules; all channels that operate at 5.60 – 5.65 GHz must be included to apply the SAR test reduction and measurement procedures.

When the same transmitter and antenna(s) are used for U-NII-2C band and U-NII-3 band or 5.8 GHz band of §15.247, the bands may be aggregated to enable additional channels with 20, 40 or 80 MHz bandwidth to span across the band gap, as illustrated in Appendix B. The maximum output power for the additional band gap channels is limited to the lower of those certified for the bands. Unless band gap channels are permanently disabled, they must be considered for SAR testing. The frequency range covered by these bands is 380 MHz (5.47 – 5.85 GHz), which requires a minimum of at least two SAR probe calibration frequency points to support SAR measurements. To maintain SAR measurement accuracy and to facilitate test reduction, the channels in U-NII-2C band above 5.65 GHz may be grouped with the 5.8 GHz channels in U-NII-3 or §15.247 band to enable two SAR probe calibration frequency points to cover the bands, including the band gap channels.<sup>11</sup> When band gap channels are supported and the bands are not aggregated for SAR testing, band gap channels must be considered independently in each band according to the normally required OFDM SAR measurement and probe calibration frequency points requirements.

### **6.6.7 OFDM Transmission Mode SAR Test Channel Selection Requirements**

For 2.4 GHz and 5 GHz bands, When the same maximum output power was specified for multiple OFDM transmission mode configurations in a frequency band or aggregated band, SAR is measured using the configuration with the largest channel bandwidth, lowest order modulation and lowest data rate. When the maximum output power of a channel is the same for equivalent OFDM configurations (for example 802.11a, 802.11n and 802.11ac, or 802.11g and 802.11n, with the same channel bandwidth, modulation, and data rate, etc), the lower order 802.11 mode (i.e., 802.11a is chosen over 802.11n then 802.11ac, or 802.11g is chosen over 802.11n) is used for SAR measurement. When the maximum output power are the same for multiple test channel, either according to the default or additional power measurement requirement, SAR is measured using the channel closest to the middle of the frequency band or aggregated band. When there are multiple channels with the same maximum output power, SAR is measured using the higher number channel.

### **6.6.8 MIMO SAR Considerations**

Per KDB 248227D01v02, simultaneous transmission provisions in KDB Publication 447498 should be used to determine simultaneous transmission SAR test exclusion for WiFi MIMO. If the sum of 1-g SAR single transmission SAR measurement is  $< 1.6\text{W/kg}$ , no additional SAR measurements for MIMO are required. Alternatively, SAR for MIMO can be measured with all antennas transmitting simultaneously at the specified maximum output power of MIMO operation.

## 6.7 LTE CA specification

### 6.7.1 LTE CA combinations specification

The device supports downlink LTE Carrier Aggregation (CA) for Intra-band and inter-band, and uplink LTE Carrier Aggregation (CA) for Intra-band .

a) The LTE release and version numbers of the 3GPP documents used to implement the specific device(s):

Release 13, 3GPP TS 36.211 V13.3.0 (2016-09)

b) The associated 3GPP release and version numbers required for power measurements and RF test setup conditions:

Release 14, 3GPP TS 36.521-1 V14.4.0 (2017-09)

Release 15, 3GPP TS 36.101 V15.0.0 (2017-09)

The device supports parts of uplink and downlink Release 14 LTE carrier aggregations and the device does not support full CA features on 3GPP Release 14.

- 1) The device supports Intra-band uplink LTE CA for CA\_2C, CA\_7C, CA\_38C, CA\_41C with two component carriers in the uplink.
- 2) The device supports Intra-band and inter-band downlink LTE CA (See the table below)
- 3) The device does not support full CA features on 3GPP Release 14 or higher. All other uplink communications are identical to the release 8 specifications. Other LTE Rel.10 or higher features are not supported, including Enhanced SC-FDMA, Uplink MIMO or other antenna diversity configurations, Wi-Fi offloading using LTE-U, LAA or LWA related protocols etc.



**Intra-band contiguous CA operating bands**

E-UTRA CA configuration / Bandwidth combination set							
E-UTRA CA configuration	Uplink CA configurations (NOTE 3)	Component carriers in order of increasing carrier frequency				Maximum aggregated bandwidth [MHz]	Bandwidth combination set
		Channel bandwidths for carrier [MHz]	Channel bandwidths for carrier [MHz]	Channel bandwidths for carrier [MHz]	Channel bandwidths for carrier [MHz]		
CA_2C	CA_2C	5	20			40	0
		10	15, 20				
		15	10, 15, 20				
		20	5, 10, 15, 20				
CA_5B	NA	5, 10	10			20	0
		10	5				
CA_7C	CA_7C	15	15			40	0
		20	20				
		10	20			40	1
		15	15, 20				
		20	10, 15, 20			40	2
		15	10, 15				
20	15, 20						
CA_12B	NA	5	5, 10			15	0
CA_38C	CA_38C	15	15			40	0
		20	20				
CA_41C	CA_41C	10	20			40	0
		15	15, 20				
		20	10, 15, 20				
		5, 10	20			40	1
		15	15, 20				
		20	5, 10, 15, 20			40	2
		10	15, 20				
		15	10, 15, 20				
		20	10, 15, 20			40	3
		10	20				
20	20						
CA_41D	CA_41C	10	20	15		60	0
		10	15, 20	20			
		15	20	10, 15			
		15	10, 15, 20	20			
		20	15, 20	10			
		20	10, 15, 20	15, 20			

NOTE 1: The CA configuration refers to an operating band and a CA bandwidth class specified (the indexing letter). Absence of a CA bandwidth class for an operating band implies support of all classes.  
NOTE 2: For the supported CC bandwidth combinations, the CC downlink and uplink bandwidths are equal.  
NOTE 3: Uplink CA configurations are the configurations supported by the present release of specifications.

**Intra-band non-contiguous CA operating bands (with two sub-blocks)**

E-UTRA CA configuration / Bandwidth combination set							
E-UTRACA configuration	Uplink CA configurations (NOTE 1)	Component carriers in order of increasing carrier frequency				Maximum aggregated bandwidth [MHz]	Bandwidth combination set
		Channel bandwidths for carrier [MHz]	Channel bandwidths for carrier [MHz]	Channel bandwidths for carrier [MHz]	Channel bandwidths for carrier [MHz]		
CA_7A-7A	NA	5	15			40	0
		10	10, 15				
		15	15, 20				
		20	20				
		5, 10, 15, 20	5, 10, 15, 20			40	1
		5, 10, 15, 20	5, 10			30	2
		10, 15, 20	10, 15, 20			40	3

NOTE 1: Uplink CA configurations are the configurations supported by the present release of specifications.

**Inter-band CA operating bands (two bands)**

E-UTRA CA configuration / Bandwidth combination set										
E-UTRA CA Configuration	Uplink CA configurations (NOTE 4)	E-UTRA Bands	1.4 MHz	3 MHz	5 MHz	10 MHz	15 MHz	20 MHz	Maximum aggregated bandwidth [MHz]	Bandwidth combination set
CA_2A-5A	NA	2			Yes	Yes	Yes	Yes	30	0
		5			Yes	Yes				
		2			Yes	Yes			20	1
		5			Yes	Yes				
CA_2A-12A	NA	2			Yes	Yes	Yes	Yes	30	0
		12			Yes	Yes				
		2			Yes	Yes	Yes	Yes	30	1
		12		Yes	Yes	Yes				
		2			Yes	Yes			20	2
		12			Yes	Yes				
CA_2A-12B	NA	2			Yes	Yes	Yes	Yes	35	0
		12	See CA_12B Bandwidth Combination Set 0							
CA_2A-17A	NA	2			Yes	Yes			20	0
		17			Yes	Yes				
CA_4A-5A	NA	4			Yes	Yes			20	0
		5			Yes	Yes				
		4			Yes	Yes	Yes	Yes	30	1
		5			Yes	Yes				
CA_4A-7A	NA	4			Yes	Yes			30	0
		7			Yes	Yes	Yes	Yes		
		4			Yes	Yes	Yes	Yes	40	1
		7			Yes	Yes	Yes	Yes		
CA_4A-7C	CA_7C	4			Yes	Yes	Yes	Yes	60	0
		7	See CA_7C Bandwidth Combination Set 1							
CA_4A-12A	NA	4	Yes	Yes	Yes	Yes			20	0
		12			Yes	Yes				
		4	Yes	Yes	Yes	Yes	Yes	Yes	30	1
		12			Yes	Yes				
		4			Yes	Yes	Yes	Yes	30	2
		12		Yes	Yes	Yes				
		4			Yes	Yes			20	3
		12			Yes	Yes				
		4			Yes	Yes	Yes	Yes	30	4
		12			Yes	Yes				
		4			Yes	Yes	Yes		20	5
12			Yes							
CA_4A-12B	NA	4			Yes	Yes	Yes	Yes	35	0
		12	See CA_12B Bandwidth Combination Set 0							

CA_4A-17A	NA	4			Yes	Yes			20	0
		17			Yes	Yes				
CA_5A-7A	NA	5	Yes	Yes	Yes	Yes			30	0
		7				Yes	Yes	Yes		
		5			Yes	Yes			30	1
		7				Yes	Yes	Yes		
CA_5A-7C	CA_7C	5			Yes	Yes			50	0
		7	See CA_7C Bandwidth Combination Set 1							
CA_7A-12A	NA	7			Yes	Yes	Yes	Yes	30	0
		12			Yes	Yes				
CA_7A-12B	NA	7			Yes	Yes	Yes	Yes	35	0
		12	See CA_12B Bandwidth combination set 0							
CA_26A-41A	NA	26			Yes	Yes	Yes		35	0
		41			Yes	Yes	Yes	Yes		
CA_26A-41C	NA	26			Yes	Yes	Yes		55	0
	CA_41C	41	See CA_41C Bandwidth Combination Set 1							

NOTE 1: The CA Configuration refers to a combination of an operating band and a CA bandwidth class specified in Table (the indexing letter). Absence of a CA bandwidth class for an operating band implies support of all classes.

NOTE 2: For each band combination, all combinations of indicated bandwidths belong to the set.

NOTE 3: For the supported CC bandwidth combinations, the CC downlink and uplink bandwidths are equal.

NOTE 4: Uplink CA configurations are the configurations supported by the present release of specifications.

NOTE 5: For TDD inter-band Carrier Aggregation only non-simultaneous Rx/Tx uplink CA configurations can be supported by UE supporting corresponding DL CA configuration without simultaneous Rx/Tx.

NOTE 6: Void

NOTE 7: For the corresponding CA configuration, UE may not support Pcell transmissions in this E-UTRA band

Note:

- 1) For the inter-band CA combinations, B17 and B12 cannot be PCC, other the listed CA bands above can be used as PCC or SCC.
- 2) The channel spacing and aggregated channel bandwidth for CA are identical to the associated specification in 3GPP TS 36.101 V15.0.0 (2017-09)
- 3) The reference test frequencies for CA refers to 3GPP TS 36.508 V13.1.0

### 6.7.2 Test procedure for downlink CA

According to 201804 FCC RF Exposure TCB workshop slides, the guidance does not consider Intra-band DL CA and inter-band DL CA separately.

In applying the power measurement procedures of KDB 941225 D05A for DL CA SAR test exclusion, only the CA configuration with the largest aggregated DL CA bandwidth in each frequency band group need consideration (independently for contiguous and non-contiguous CA). When the same frequency band is used for both contiguous and non-contiguous CA, power may be measured using the configuration with the largest aggregated bandwidth “and” maximum output power among the contiguous and non-contiguous CA configurations, otherwise, these are considered separately. In applying the existing power measurement procedures of KDB 941225 D05A for DL CA SAR test exclusion, only the subset with the largest number of combinations of frequency bands and CCs in each row need consideration. the configurations that require power measurements are in the table as below:

Index	2CCs	Restriction	Compl etel y Covered by Measurement Super set	Index	3CCs	Restriction	Compl etel y Covered by Measurement Super set
2CCs #1	CA 2C		Nb	3CCs #1	CA 41D		Nb
2CCs #2	CA 5B		Nb	3CCs #2	CA 2A-12B		Nb
2CCs #3	CA 7C		3CCs #3	3CCs #3	CA 4A-7C		Nb
2CCs #4	CA 12B		3CCs #2	3CCs #4	CA 4A-12B		Nb
2CCs #5	CA 38C		Nb	3CCs #5	CA 5A-7C		Nb
2CCs #6	CA 41C		3CCs #7	3CCs #6	CA 7A-12B		Nb
2CCs #7	CA 7A-7A		Nb	3CCs #7	CA 26A-41C		Nb
2CCs #8	CA 2A-5A		Nb				
2CCs #9	CA 2A-12A		Nb				
2CCs #10	CA 2A-17A		Nb				
2CCs #11	CA 4A-5A		Nb				
2CCs #12	CA 4A-7A		Nb				
2CCs #13	CA 4A-12A		Nb				
2CCs #14	CA 4A-17A		Nb				
2CCs #15	CA 5A-7A		Nb				
2CCs #16	CA 7A-12A		Nb				
2CCs #17	CA 26A-41A		Nb				

Refer to section 7.1 of this report for detailed DL CA conducted power measurement results

### 6.7.3 Test procedure for Intra-band uplink CA

For Intra-band uplink LTE CA measurement (Uplink CA\_2C, CA\_7C, CA\_38C, CA\_41C), the following procedure according to 201711 FCC RF Exposure TCB workshop slides is applied:

- 1) Maximum output power is measured for each UL CA configuration for the required test channels described in KDB 941225 D05 (Rel. 8)
  - UL PCC configuration is determined by the required test channel
  - SCC and subsequent CCs are added alternatively to either side of the PCC or within the transmission band for channels at the ends of a frequency band.
- 2) SAR for UL CA is required in each exposure condition and frequency band combination
- 3) For this device, as the maximum output for Intra-band uplink LTE CA (Uplink CA\_2C, CA\_7C, CA\_38C, CA\_41C) is  $\leq$  standalone LTE mode (without CA),
  - PCC is configured according to the highest standalone SAR configuration tested.
  - SCC and subsequent CCs are configured according to procedures used for power measurement and parameters (BW, RB etc.) similar to that used for the PCC
- 4) When the reported SAR for UL CA configuration, described above, is  $> 1.2$  W/kg, UL CA SAR is also required for all required test channels(PCC based)
- 5) UL CA SAR is also required for standalone SAR configurations  $> 1.2$  W/kg when they are scaled to the UL CA power level.

Refer to section 7.1 of this report for detailed UL CA conducted power measurement results.

### 6.8 Dynamic antenna switching specification

The device supports dynamic Tx antenna switching function for 2G/3G/4G bands. It can transmit from either Main Antenna or Second Antenna, but they can not transmit simultaneously(Refer to the Antenna location picture in the appendix for details).

Note:

- 1) Main antenna consists of two parts: MHB antenna part (Ant1) for middle & high band antenna and LB antenna part (Ant2) for low band antenna.
- 2) Second antenna consists of two parts: Up MHB Antenna part (Ant 3) Middle & High band antenna and Up LB antenna part (Ant4) for low band antenna.

SAR test procedure for dynamic antenna switching is as below:

During the SAR test, the Main Antenna and Second Antenna are set to the MAX transmit power level respectively and test the SAR respectively in all applicable RF exposure conditions. Some AT command are supplied to fix the operation state and choose the antenna so that only one TX antenna tested at a time. We can ensure that all independent antennas and modem are completely covered by the appropriate SAR measurements and all simultaneous transmission possibilities are fully considered.

## 6.9 Power Reduction Specification

This device uses the following power reduction features to reduce the transmit power and ensure SAR compliance. These power reduction features are implemented using a single fixed level of reduction through static table look-up for some wireless operating modes or frequency bands and triggered by a single event or operation. The published RF exposure KDB procedures are applicable to the specific implementation and applied for testing. So PAG is not required for these features.

- 1) A fixed level power reduction is applied for some frequency bands when hotspot mode becomes active. When the hotspot is disabled, the power value will be recovered.
- 2) A fixed level power reduction is applied for some frequency bands when 2G/3G/4G and WIFI transmit simultaneously.
- 3) This device uses the receiver to indicate whether the user is making a voice call in head scenario or not. The selection between head and body power levels is based on the receiver detection mechanism. A fixed level power reduction is applied for some frequency bands when the audio receiver is on.
- 4) This device uses the mobile country code (MCC) to indicate whether the users in CE countries or FCC countries. The selection between CE countries and FCC countries power levels is based on the country code detection mechanism. It can determine the countries where users are and set the relevant power level for WiFi antennas accordingly.

<b>Antenna</b>	<b>MCC OF CE COUNTRY (CE standard)</b>	<b>MCC OF FCC COUNTRY (FCC standard)</b>
WiFi 2.4G Ant1	Power Level A3	Power Level B3
WiFi 2.4G Ant2	Power Level A4	Power Level B4
WiFi 5G Ant1	Power Level A5	Power Level B5
WiFi 5G Ant2	Power Level A6	Power Level B6

- 5) This device uses a proximity sensor to reduce the maximum output power of 2G/3G/4G main transmitting antenna in selected wireless modes and operating configurations to ensure SAR compliance. The procedures in KDB 616217 are applied to determine proximity sensor triggering distances, and sensor coverage for normal and tilt positions.



### 6.9.1 Power Reduction Specification of 2G/3G/4G Second Antenna

The following tables summarize the key power reduction information of 2G/3G/4G second antenna triggered by specific use conditions. The detailed full power and reduced conducted power measurement results are provided in Section 7 of this report:

Band	Second Antenna Power Reduction Level Amount (dB)			
	Second Antenna only		Second Antenna+WiFi Antenna simultaneous transmission	
	Receiver off	Receiver on	Receiver off	Receiver on
	Full Power	Reduced Power Level D1	Reduced Power Level D2	Reduced Power Level D3
GSM850	0	0.5	0	0.5
UMTS Band II	0	6.0	4.5	10.5
UMTS Band IV	0	7.5	4.0	11.0
UMTS Band V	0	6.5	3.0	9.5
LTE Band 2	0	5.0	4.0	9.0
LTE Band 4	0	7.0	3.2	10.2
LTE Band 5	0	6.0	3.5	9.5
LTE Band 7	0	6.5	2.5	8.5
LTE Band 12	0	2.0	1.5	3.5
LTE Band 17	0	2.0	0	2.0
LTE Band 26	0	5.5	3.0	8.5
LTE Band 38	0	7.0	1.5	8.5
LTE Band 41	0	8.0	1.5	9.5

Note: For Head SAR test of 2G/3G/4G Second Antenna, Standalone Head SAR should be evaluated at with audio receiver on. As the audio receiver only works in voice mode when the user is making a call in head scenario, and the lack of the third-party VoIP server and the unstandardized VOIP operating characteristics, so a test script may be used to trigger the receiver on during the test. The test script function is only used to trigger audio receiver on and simulate voice and VOIP usage scene. It can be ensured that the unmodified settings in production units, including maximum output power, amplifier gain and other RF performance or tuning parameters, are used for SAR measurement.

## 6.9.2 Power Reduction Specification of WiFi Antenna

The following tables summarize the key power reduction information of WiFi antennas. The detailed full power and reduced conducted power measurement results are provided in section 7 of this report:

Power Reduction Level Amount (dB)				
Band/Mode(Ant)	WiFi Antenna			
	MCC OF CE COUNTRY		MCC OF FCC COUNTRY	
	Receiver on	Receiver off (Full Power)	Receiver on	Receiver off (Full Power)
WiFi 2.4G 802.11b Ant5	7.0	0	8.5	0
WiFi 2.4G 802.11b Ant6	6.5	0	8.0	0
WiFi 2.4G 802.11g Ant5	6.0	0	7.5	0
WiFi 2.4G 802.11g Ant6	5.5	0	7.0	0
WiFi 2.4G 802.11n(20M) Ant5	5.0	0	6.5	0
WiFi 2.4G 802.11n(40M) Ant6	5.0	0	6.5	0
WiFi 2.4G 802.11n(20M) Ant5	4.5	0	6.0	0
WiFi 2.4G 802.11n(40M) Ant6	4.5	0	6.0	0
WiFi 2.4G 802.11g CDD	5.8	0	7.3	0
WiFi 2.4G 802.11n MIMO(20M)	4.8	0	6.3	0
WiFi 2.4G 802.11n MIMO(40M)	4.8	0	6.3	0
WiFi 5G 802.11a Ant5	3.5	0	8.5	0
WiFi 5G 802.11a Ant6	3.0	0	8.0	0
WiFi 5G 802.11n(20M) Ant5	3.5	0	8.5	0
WiFi 5G 802.11n (20M)Ant6	3.0	0	8.0	0
WiFi 5G 802.11 n(40M) Ant5	3.0	0	8.0	0
WiFi 5G 802.11n(40M) Ant6	2.5	0	7.5	0
WiFi 5G 802.11ac(20M) Ant5	3.5	0	8.5	0
WiFi 5G 802.11ac(20M) Ant6	3.0	0	8.0	0
WiFi 5G 802.11ac(40M) Ant5	3.0	0	8.0	0
WiFi 5G 802.11ac(40M) Ant6	2.5	0	7.5	0
WiFi 5G 802.11ac(80M) Ant5	0	0	2.0	0
WiFi 5G 802.11ac(80M) Ant6	0	0	2.0	0
WiFi 5G 802.11ac(160M) Ant5	0	0	0.5	0
WiFi 5G 802.11ac(160M) Ant6	0	0	0.5	0
WiFi 5G 802.11a CDD	3.5	0	8.3	0
WiFi 5G 802.11n (20M)MIMO	3.5	0	8.3	0
WiFi 5G 802.11n(40M) MIMO	2.8	0	7.8	0
WiFi 5G 802.11ac(20M) MIMO	3.5	0	8.3	0
WiFi 5G 802.11ac(40M) MIMO	2.8	0	7.8	0
WiFi 5G 802.11ac(80M) MIMO	0	0	1.0	0
WiFi 5G 802.11ac(160M) MIMO	0	0	0.3	0

For FCC SAR test, WiFi SAR test should be evaluated at the power level of FCC mobile country code for each exposure conditions.

### 6.9.3 Power Reduction Specification of 2G/3G/4G Main Antenna

The following tables summarize the key power reduction information of 2G/3G/4G main antenna. The detailed full power and reduced conducted power measurement results are provided in section 7 of this report:

Band	2G/3G/4G Main Antenna Power Reduction Level Amount (dB)					
	Full power (Other conditions)	Receiver off				
		hotspot off		hotspot on		
		sensor on*		sensor off	sensor on**	
	Full Power	Reduced Power Level D1	Reduced Power Level D2	Reduced Power Level D3	Reduced Power Level D4	Reduced Power Level D5
GSM1900	0	2.0	0	0	2	0
UMTS Band II	0	2.5	0	2.5	5.0	2.5
UMTS Band IV	0	3.0	0	3.0	6.0	3.0
LTE Band 2	0	2.0	0	2.0	4.0	2.0
UL CA_2C	0	2.0	0	2.0	4.0	2.0
LTE Band 4	0	3.0	0	3.0	6.0	3.0
LTE Band 7	0	4.0	2.5	2.5	6.5	5.0
UL CA_7C	0	4.0	2.5	2.5	6.5	5.0
LTE Band 38	0	2.0	0.5	2.0	4.0	2.5
UL CA_38C	0	2.0	0.5	2.0	4.0	2.5
LTE Bnad 41	0	2.0	0	2.0	4.0	2.0
UL CA_41C	0	2.0	0	2.0	4.0	2.0

Note:

- 1) \* Reduced Power Level D1 or Reduced Power Level D2 is determined by different sensor Trigger Distance ranges when hotspot is off;
- 2) \*\* Reduced Power Level D4 or Reduced Power Level D5 is determined by different sensor Trigger Distance range when hotspot is on;
- 3) For some frequency bands, the power reduction level amount value 0 means there is no power reduction in this frequency band and exposure conditions. The power level is the same as full power
- 4) Please refer to section 6.9.4 for detailed Proximity sensor power reduction test configuration and validation results per KDB616217.

### 6.9.4 Proximity sensor Power Reduction Test configuration and validation

Due to the operating configurations and exposure conditions required by the device, the proximity sensor is used to indicate when the device is held close to a user's body/hotspot exposure condition. It utilizes the proximity sensor to reduce the output power in specific wireless and operating modes of main antenna to ensure SAR compliance. **It is also set an output power leveled to the lowest one to make sure that in any case of SAR sensor hardware failure the SAR requirements can still be satisfied.**

The following tables summarize the key power reduction information for proximity sensor. The test procedures in KDB 616217 should be applied to determine proximity sensor triggering distances, and sensor coverage for normal and tilt positions. To ensure all production units are compliant, it is generally necessary to reduce the triggering distance determined from the triggering tests by 1 mm, or more if it is necessary, and use the smallest distance for movements to and from the phantom, minus 1 mm, as the sensor triggering distance for determining the SAR measurement distance.

2G/3G/4G Main antenna (hotspot off)					
Band	Test position	Sensor Trigger Distance range(DUT to Phantom)	Power reduction amount(dB)	Max Power level (dBm)	Power level
GSM 1900	Bottom side	0mm ≤ distance ≤ 8mm	2.0	29.0	Reduced Power Level D1
		8mm < distance	0	31.0	Full Power
	Back side	0mm ≤ distance ≤ 6mm	2.0	29.0	Reduced Power Level D1
		6mm < distance	0	31.0	Full Power
	Front side	0mm ≤ distance ≤ 2mm	2.0	29.0	Reduced Power Level D1
		2mm < distance	0	31.0	Full Power
	Left side	ALL	0	31.0	Full Power
	Right side	ALL	0	31.0	Full Power
	Top side	ALL	0	31.0	Full Power
	UMTS Band II	Bottom side	0mm ≤ distance ≤ 8mm	2.5	22.5
8mm < distance			0	25.0	Full Power
Back side		0mm ≤ distance ≤ 6mm	2.5	22.5	Reduced Power Level D1
		6mm < distance	0	25.0	Full Power
Front side		0mm ≤ distance ≤ 2mm	2.5	22.5	Reduced Power Level D1
		2mm < distance	0	25.0	Full Power
Left side		ALL	0	25.0	Full Power

	Right side	ALL	0	25.0	Full Power
	Top side	ALL	0	25.0	Full Power
UMTS Band IV	Bottom side	$0\text{mm} \leq \text{distance} \leq 8\text{mm}$	3.0	22.0	Reduced Power Level D1
		$8\text{mm} < \text{distance}$	0	25.0	Full Power
	Back side	$0\text{mm} \leq \text{distance} \leq 6\text{mm}$	3.0	22.0	Reduced Power Level D1
		$6\text{mm} < \text{distance}$	0	25.0	Full Power
	Front side	$0\text{mm} \leq \text{distance} \leq 2\text{mm}$	3.0	22.0	Reduced Power Level D1
		$2\text{mm} < \text{distance}$	0	25.0	Full Power
	Left side	ALL	0	25.0	Full Power
	Right side	ALL	0	25.0	Full Power
	Top side	ALL	0	25.0	Full Power
	LTE B2	Bottom side	$0\text{mm} \leq \text{distance} \leq 8\text{mm}$	2.0	22.7
$8\text{mm} < \text{distance}$			0	24.7	Full Power
Back side		$0\text{mm} \leq \text{distance} \leq 6\text{mm}$	2.0	22.7	Reduced Power Level D1
		$6\text{mm} < \text{distance}$	0	24.7	Full Power
Front side		$0\text{mm} \leq \text{distance} \leq 2\text{mm}$	2.0	22.7	Reduced Power Level D1
		$2\text{mm} < \text{distance}$	0	24.7	Full Power
Left side		ALL	0	24.7	Full Power
Right side		ALL	0	24.7	Full Power
Top side		ALL	0	24.7	Full Power
LTE B4		Bottom side	$0\text{mm} \leq \text{distance} \leq 8\text{mm}$	3.0	22.2
	$8\text{mm} < \text{distance}$		0	25.2	Full Power
	Back side	$0\text{mm} \leq \text{distance} \leq 6\text{mm}$	3.0	22.2	Reduced Power Level D1
		$6\text{mm} < \text{distance}$	0	25.2	Full Power
	Front side	$0\text{mm} \leq \text{distance} \leq 2\text{mm}$	3.0	22.2	Reduced Power Level D1
		$2\text{mm} < \text{distance}$	0	25.2	Full Power
	Left side	ALL	0	25.2	Full Power
	Right side	ALL	0	25.2	Full Power

	Top side	ALL	0	25.2	Full Power
LTE B7	Bottom side	0mm ≤ distance ≤ 8mm	4.0	20.7	Reduced Power Level D1
		8mm < distance ≤ 11mm	2.5	22.2	Reduced Power Level D2
		distance > 11mm	0	24.7	Full Power
	Back side	0mm ≤ distance ≤ 6mm	4.0	20.7	Reduced Power Level D1
		6mm < distance ≤ 9mm	2.5	22.2	Reduced Power Level D2
		distance > 9mm	0	24.7	Full Power
	Front side	0mm ≤ distance ≤ 2mm	4.0	20.7	Reduced Power Level D1
		2mm < distance ≤ 6mm	2.5	22.2	Reduced Power Level D2
		distance > 6mm	0	24.7	Full Power
	Left side	ALL	0	24.7	Full Power
	Right side	ALL	0	24.7	Full Power
	Top side	ALL	0	24.7	Full Power
	LTE B38	Bottom side	0mm ≤ distance ≤ 8mm	2.0	23.0
8mm < distance ≤ 11mm			0.5	24.5	Reduced Power Level D2
distance > 11mm			0	25.0	Full Power
Back side		0mm ≤ distance ≤ 6mm	2.0	23.0	Reduced Power Level D1
		6mm < distance ≤ 9mm	0.5	24.5	Reduced Power Level D2
		distance > 9mm	0	25.0	Full Power
Front side		0mm ≤ distance ≤ 2mm	2.0	23.0	Reduced Power Level D1
		2mm < distance ≤ 6mm	0.5	24.5	Reduced Power Level D2
		distance > 6mm	0	25.0	Full Power
Left side		ALL	0	25.0	Full Power
Right side		ALL	0	25.0	Full Power
Top side		ALL	0	25.0	Full Power

LTE B41	Bottom side	$0\text{mm} \leq \text{distance} \leq 8\text{mm}$	2.0	23.2	Reduced Power Level D1
		$8\text{mm} < \text{distance}$	0	25.2	Full Power
	Back side	$0\text{mm} \leq \text{distance} \leq 6\text{mm}$	2.0	23.2	Reduced Power Level D1
		$6\text{mm} < \text{distance}$	0	25.2	Full Power
	Front side	$0\text{mm} \leq \text{distance} \leq 2\text{mm}$	2.0	23.2	Reduced Power Level D1
		$2\text{mm} < \text{distance}$	0	25.2	Full Power
	Left side	ALL	0	25.2	Full Power
	Right side	ALL	0	25.2	Full Power
	Top side	ALL	0	25.2	Full Power

Note:

To ensure all production units are compliant, the smallest separation distance determined by the sensor triggering and sensor coverage for normal and tilt positions for all usage conditions and applicable sides, minus 1 mm, must be used as the test separation distance for additional SAR testing of each higher power stage.

For the other sides or other frequency bands of the device, SAR is still tested at the maximum full power level with sensor off.



### 1) Procedures for determining proximity sensor triggering distances

The device was tested by the test lab to determine the proximity sensor triggering distances for the front side, back side and bottom side of the device. To ensure all production units are compliant, the smallest separation distance determined by the sensor triggering minus 1 mm, must be used as the test separation distance for SAR testing.

the proximity sensor triggering distance measurement method are as below:

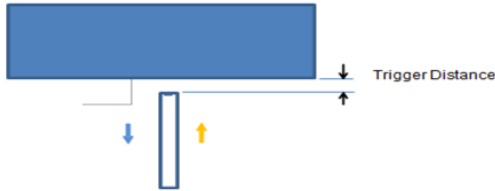

Picture: Proximity sensor triggering distances assessment Bottom Side



Picture: Proximity sensor triggering distances assessment Front Side and Back side

**Table: Summary of Trigger Distances**

Band	Reduced Power Level	Trigger distance-Front Side		Trigger distance-Back Side		Trigger distance-Bottom Side	
		Moving toward phantom	Moving away from phantom	Moving toward phantom	Moving away from phantom	Moving toward phantom	Moving away from phantom
GSM1900	Reduced Power Level D1	2mm	2mm	6mm	6mm	8mm	8mm
UMTS Band II	Reduced Power Level D1	2mm	2mm	6mm	6mm	8mm	8mm
UMTS Band IV	Reduced Power Level D1	2mm	2mm	6mm	6mm	8mm	8mm
LTE Band 2	Reduced Power Level D1	2mm	2mm	6mm	6mm	8mm	8mm
UL CA_2C	Reduced Power Level D1	2mm	2mm	6mm	6mm	8mm	8mm
LTE Band 4	Reduced Power Level D1	2mm	2mm	6mm	6mm	8mm	8mm
LTE Band 7	Reduced Power Level D1	2mm	2mm	6mm	6mm	8mm	8mm
	Reduced Power Level D2	6mm	6mm	9mm	9mm	11mm	11mm
UL CA_7C	Reduced Power Level D1	2mm	2mm	6mm	6mm	8mm	8mm
	Reduced Power Level D2	6mm	6mm	9mm	9mm	11mm	11mm

LTE Band 38	Reduced Power Level D1	2mm	2mm	6mm	6mm	8mm	8mm
	Reduced Power Level D2	6mm	6mm	9mm	9mm	11mm	11mm
UL CA_38C	Reduced Power Level D1	2mm	2mm	6mm	6mm	8mm	8mm
	Reduced Power Level D2	6mm	6mm	9mm	9mm	11mm	11mm
LTE Band 41	Reduced Power Level D1	2mm	2mm	6mm	6mm	8mm	8mm
UL CA_41C	Reduced Power Level D1	2mm	2mm	6mm	6mm	8mm	8mm

Note:

- 1) \* The sensor Trigger Distance of Reduced Power Level D4 (hotspot on) and Reduced Power Level D1 (hotspot off) are the same.
- 2) \* The sensor Trigger Distance of Reduced Power Level D5 (hotspot on) and Reduced Power Level D2 (hotspot off) are the same.

The detailed conducted power measurement data to determine the triggering distances is as below:

The DUT(Front side) is moved towards the flat phantom with/without protective cover/ wireless charging protective case (Hotspot off):

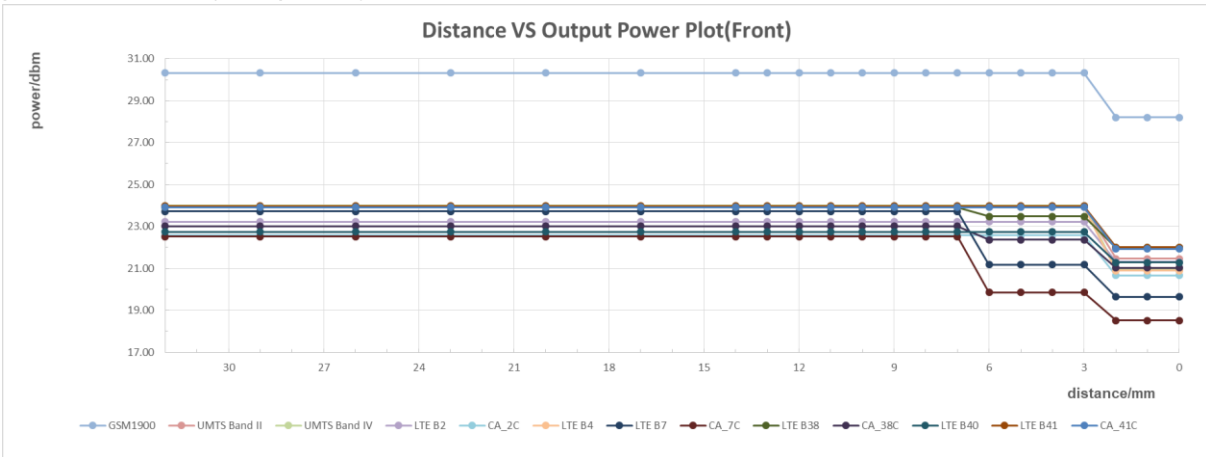

The DUT(Back side) is moved towards the flat phantom with/without protective cover/ wireless charging protective case (Hotspot off):

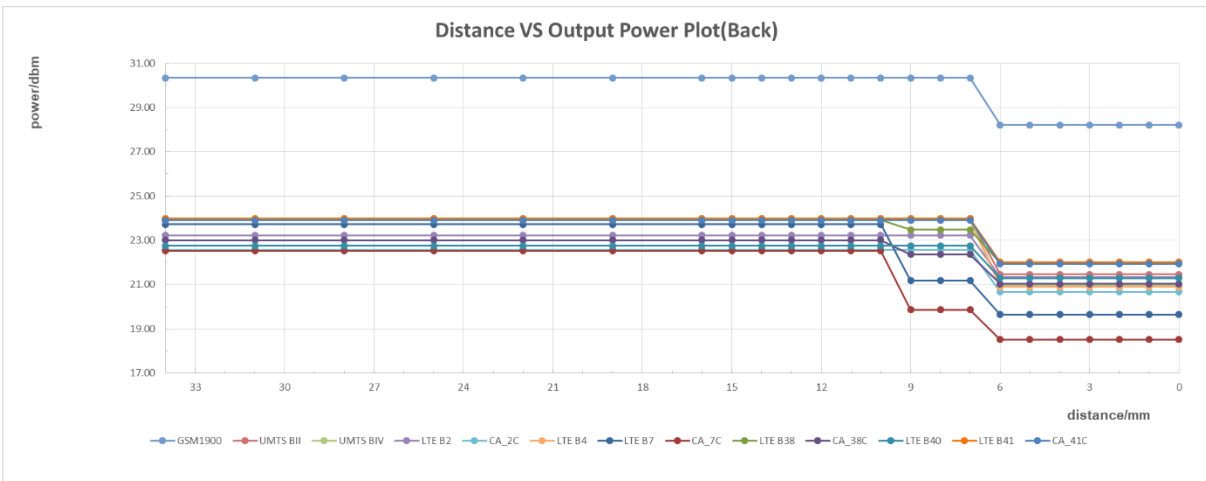

The DUT(Bottom side) is moved towards the flat phantom with/without protective cover/ wireless charging protective case (Hotspot off):

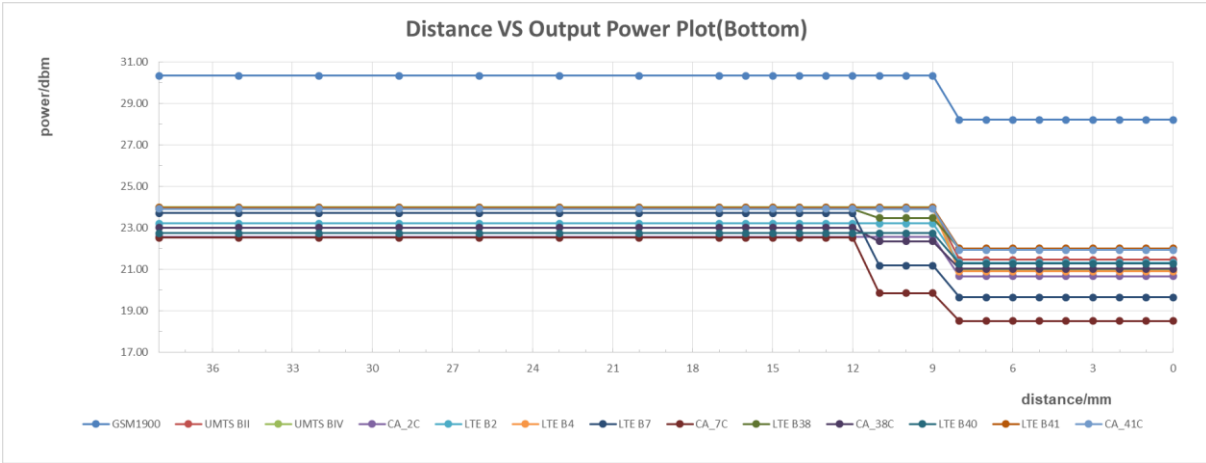

The DUT(Front side) is moved away the flat phantom with/without protective cover/ wireless charging protective case (Hotspot off):

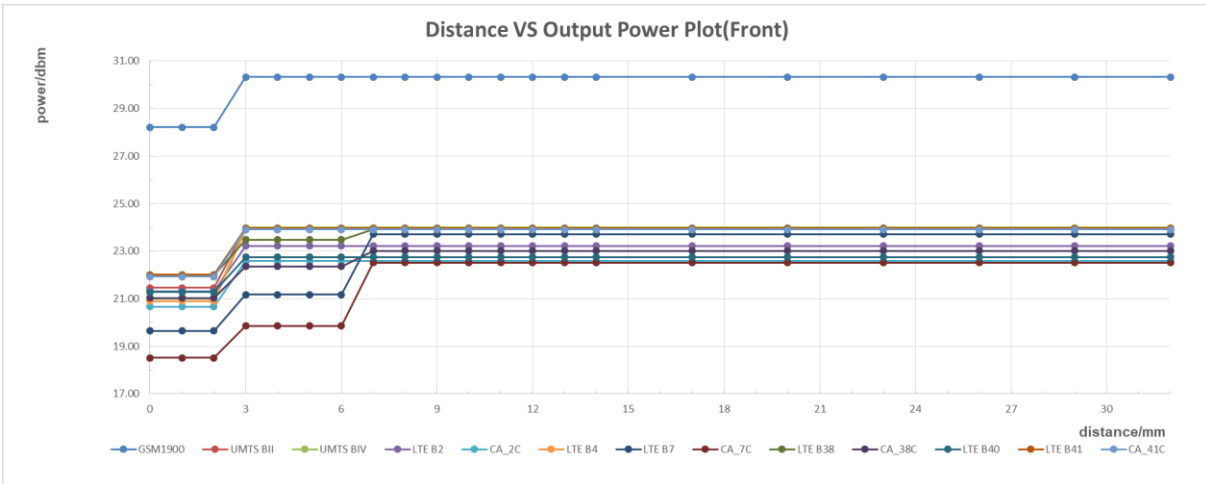

The DUT(Back side) is moved away the flat phantom with/without protective cover/ wireless charging protective case (Hotspot off):

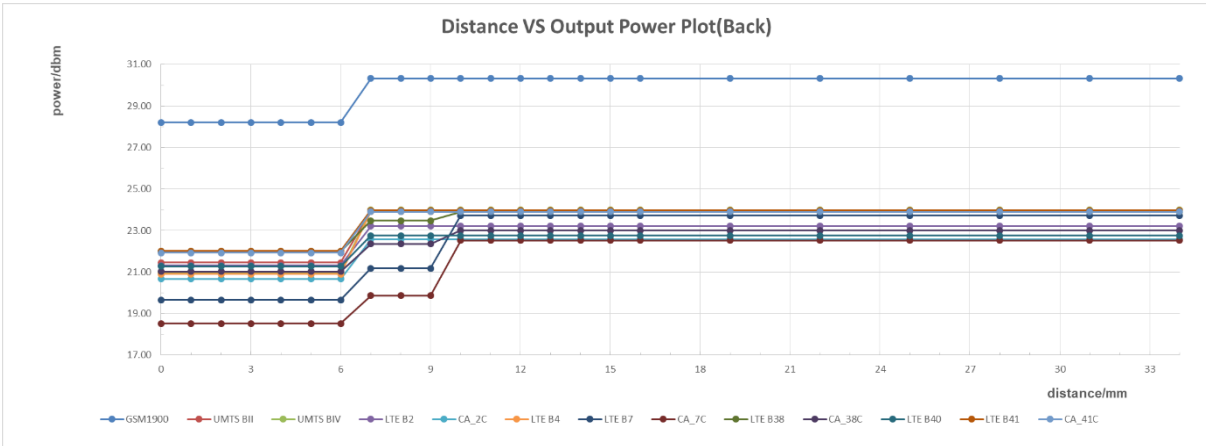

The DUT(Bottom side) is moved away the flat phantom with/without protective cover/ wireless charging protective case (Hotspot off):

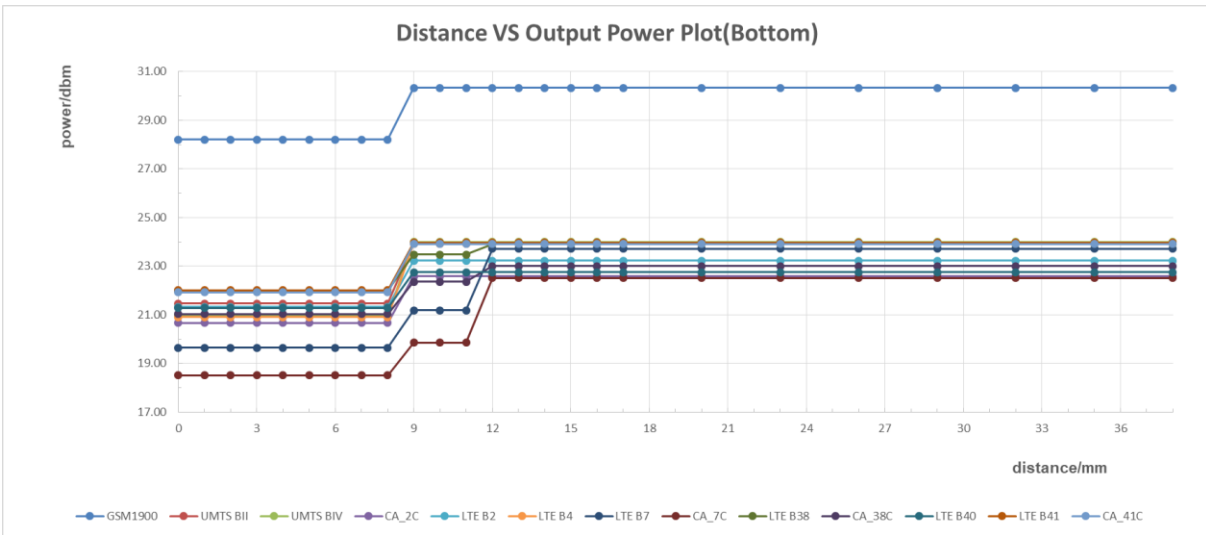

The DUT(Front side) is moved towards the flat phantom with/without protective cover/ wireless charging protective case (Hotspot on):

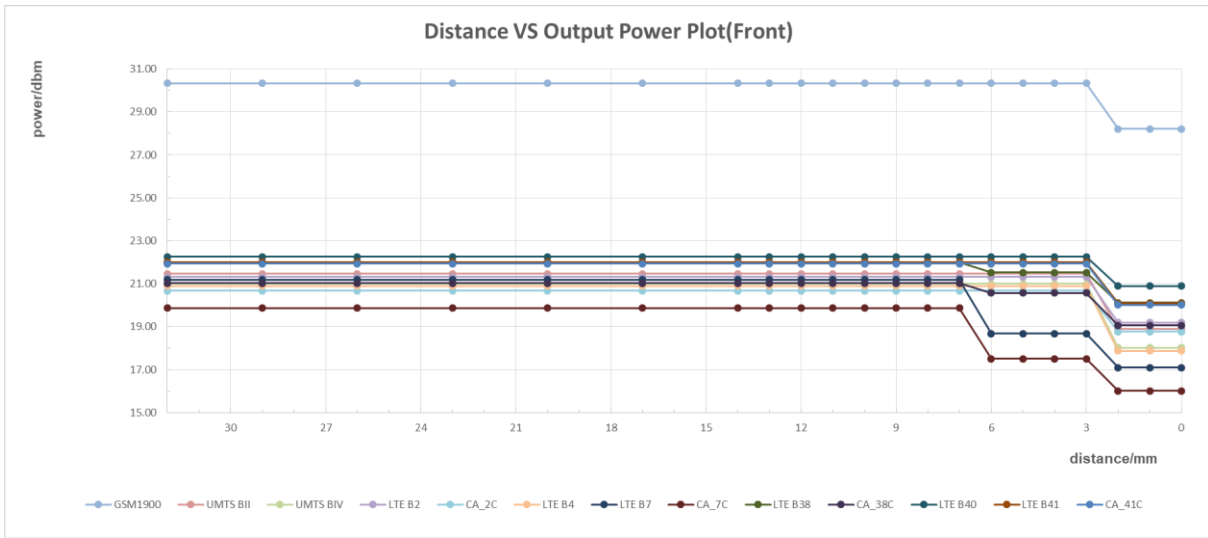

The DUT(Back side) is moved towards the flat phantom with/without protective cover/ wireless charging protective case (Hotspot on):

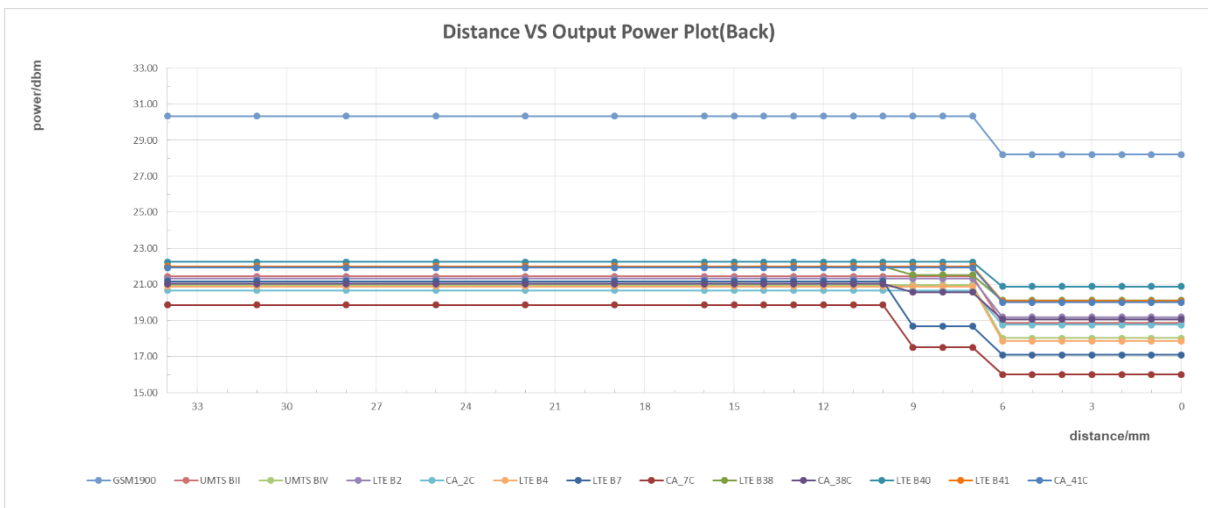

The DUT(Bottom side) is moved towards the flat phantom with/without protective cover/ wireless charging protective case (Hotspot on):

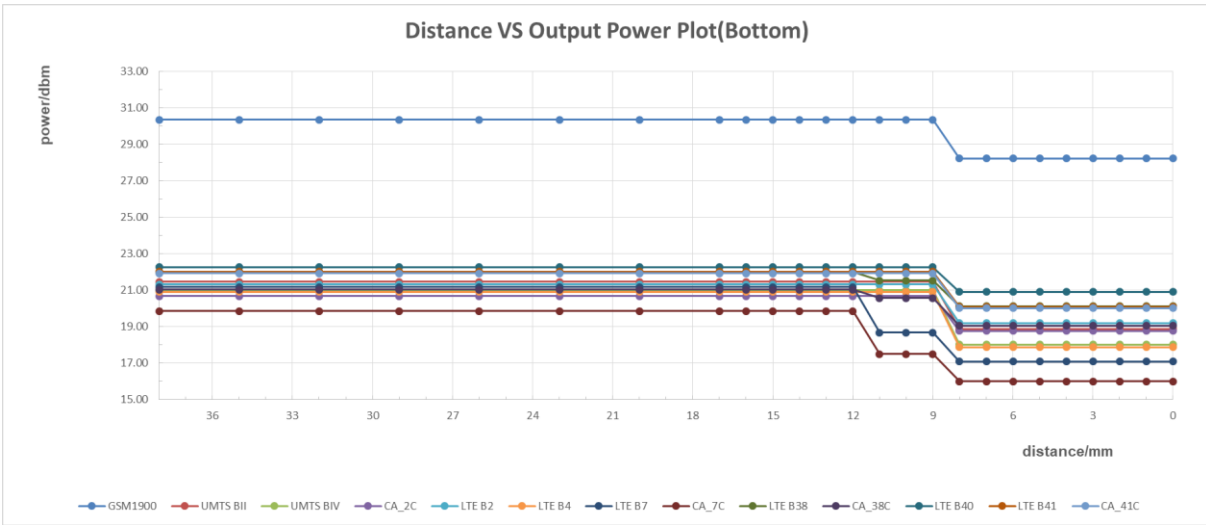

The DUT(Front side) is moved away the flat phantom with/without protective cover/ wireless charging protective case (Hotspot on):

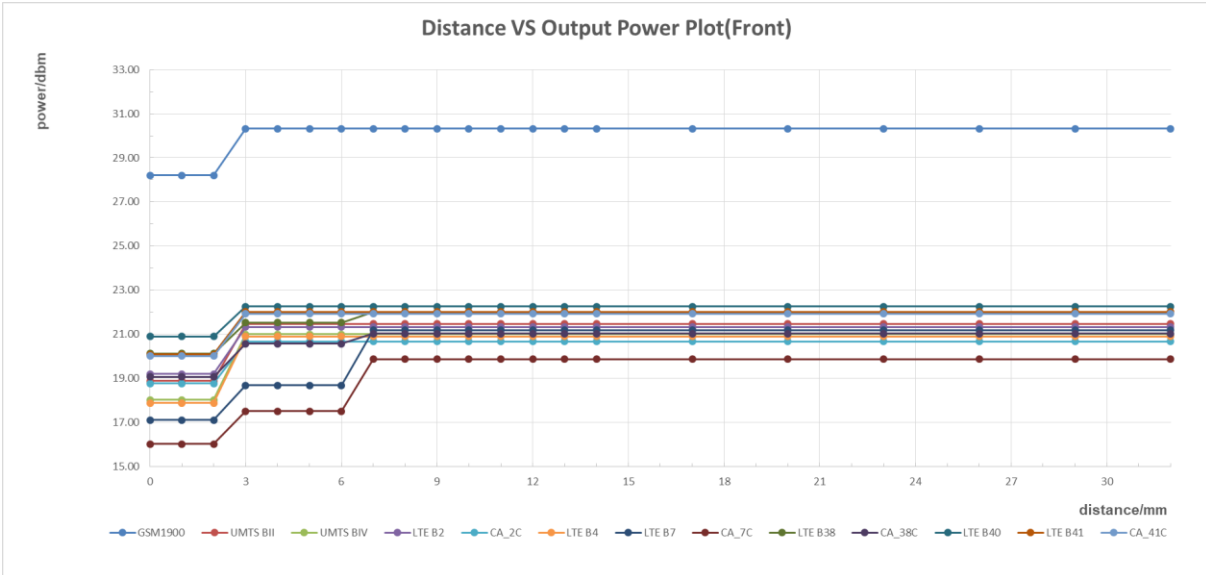



The DUT(Back side) is moved away the flat phantom with/without protective cover/ wireless charging protective case (Hotspot on):

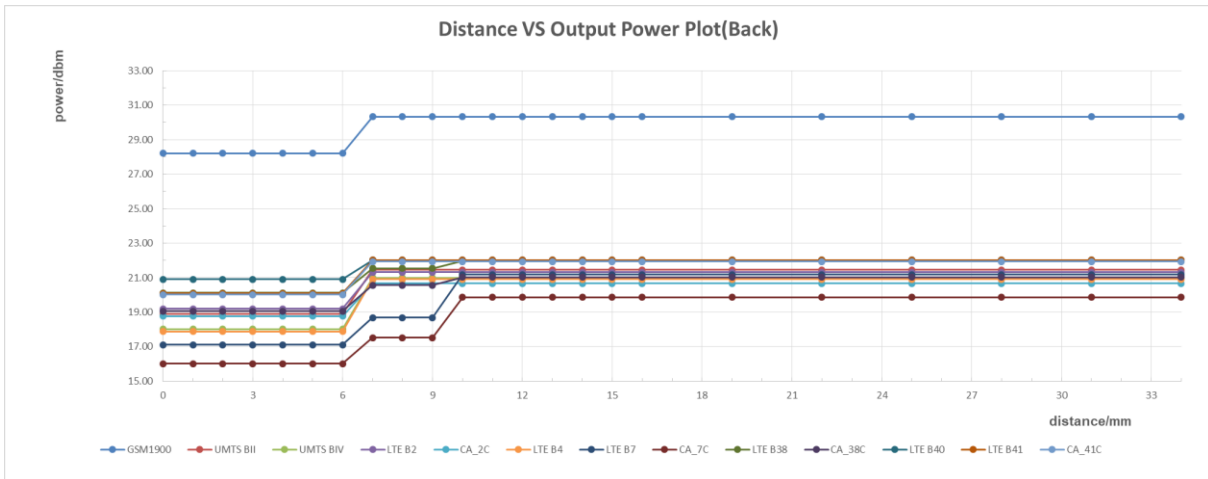

The DUT(Bottom) is moved away the flat phantom with/without protective cover/ wireless charging protective case (Hotspot on):

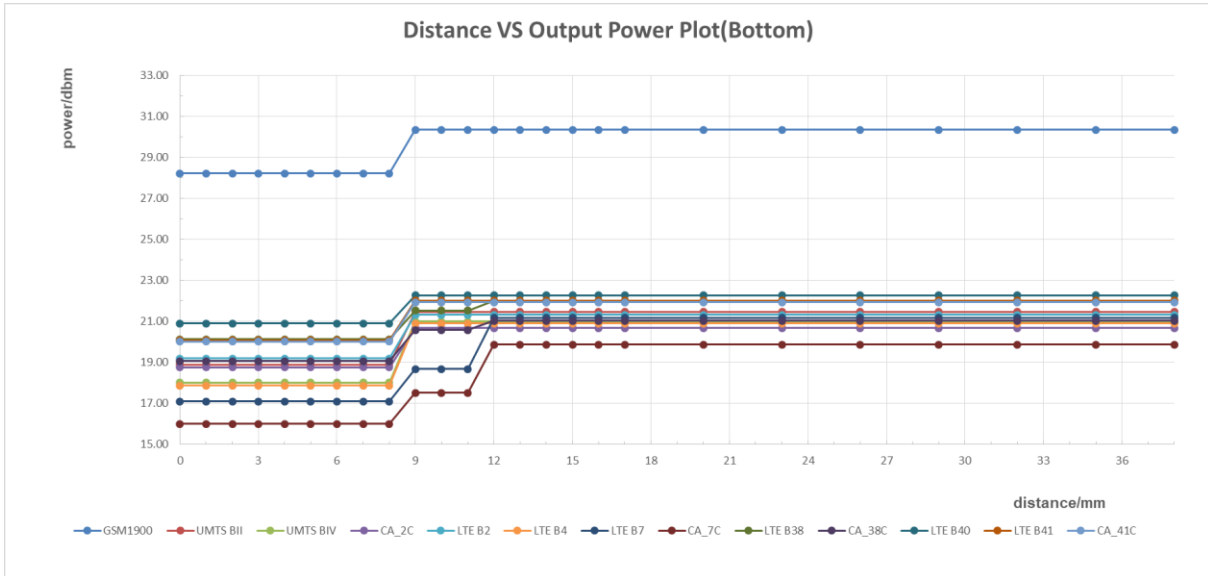

**Conclusion:** It can be ensured that the proximity sensor can be valid triggered for the body exposure condition. (GSM 1900,UMTS Band II/IV,LTE Band 2/4/7/38/41, UL CA\_2C, UL CA\_7C, UL CA\_38C, UL CA\_41C with Main Antenna)

## 2) Procedures for determining antenna and proximity sensor coverage

According to the antenna and sensors location figure: Proximity sensor is a floating metal sheet, which cannot fully overwrite the 2G/3G/4G main antenna. So the proximity sensor coverage need to be assessed for the frequency bands and test positions supporting proximity sensor power reduction per KDB 616217:

- a) All the sides/edges (bottom side, front side and back side of the device) is positioned at a test separation distance less than or equal to the distance required for sensor triggering, with both the antenna and sensor pad located at least 20 mm laterally outside the edge (boundary) of the phantom, along the direction of maximum antenna and sensor offset. Each applicable edge should be positioned perpendicularly to the phantom to determine sensor coverage. For antennas and/or sensors located near the corner of a tablet, both adjacent edges must be considered.
- b) The similar sequence of steps applied to determine sensor triggering distance are used to verify the sensor coverage by moving the DUT(sensor and antenna) horizontally toward the phantom while maintaining the same vertical separation between the side or edge and the phantom.
- c) After the exact location where triggering of power reduction is determined, with respect to the sensor and antenna, the DUT movement should be continued, in 3 mm increments, until both the sensor and antenna(s) are fully under the phantom and at least 20 mm inside the phantom edge.
- d) The process is then repeated from the opposite direction, starting at the other end of the maximum antenna and sensor offset, by rotating the DUT 180° along the vertical axis.
- e) The triggering points should be documented graphically, with the antenna and sensor clearly identified, along with all relevant dimensions.
- f) If the subsequently measured peak SAR location for the antenna is not between the triggering points, established by the sensor coverage tests from opposite ends of the antenna and sensor, additional SAR tests may be required for conditions where only part of the surface or edge of the DUT corresponding to the antenna is in proximity to the user and the sensor may not be triggering as desired.

The proximity sensor coverage measurement method are as below:

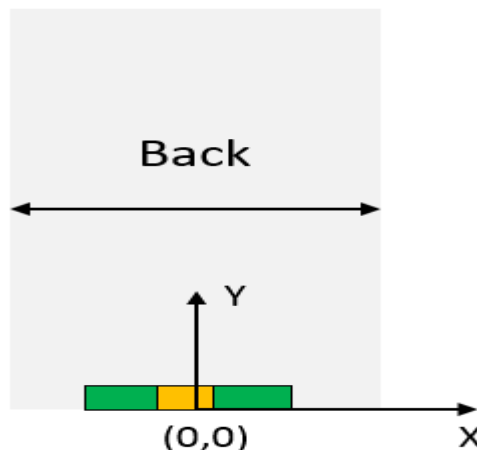

Figure: Plane coordinate system definition on the DUT

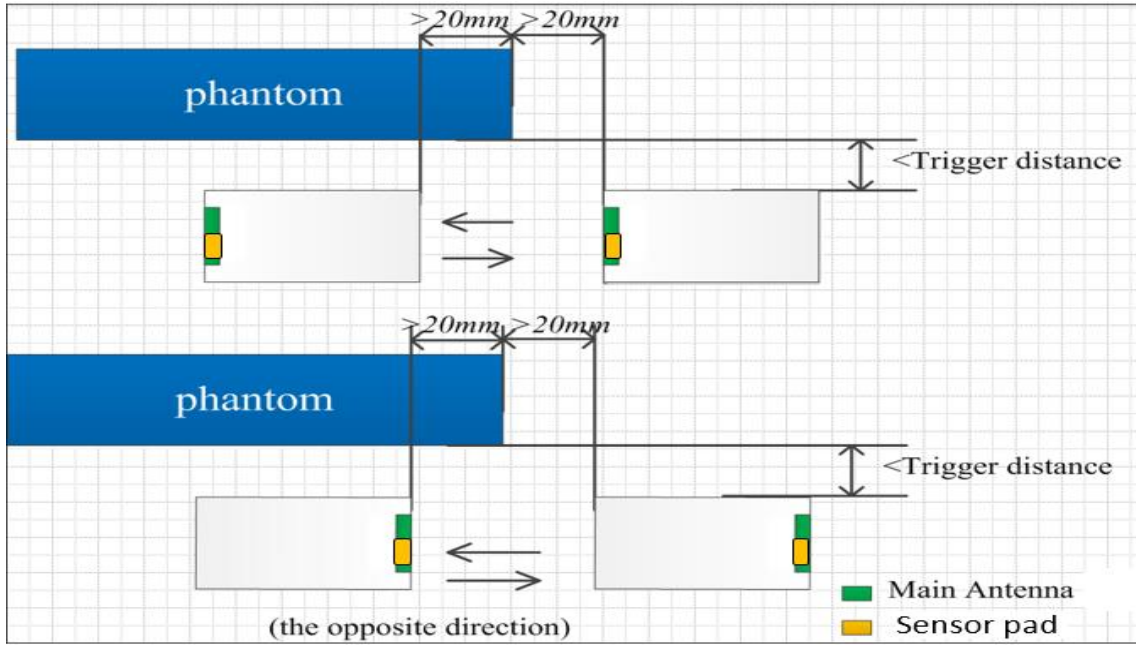

Figure: proximity sensor coverage assesment (Y coordinate direction)

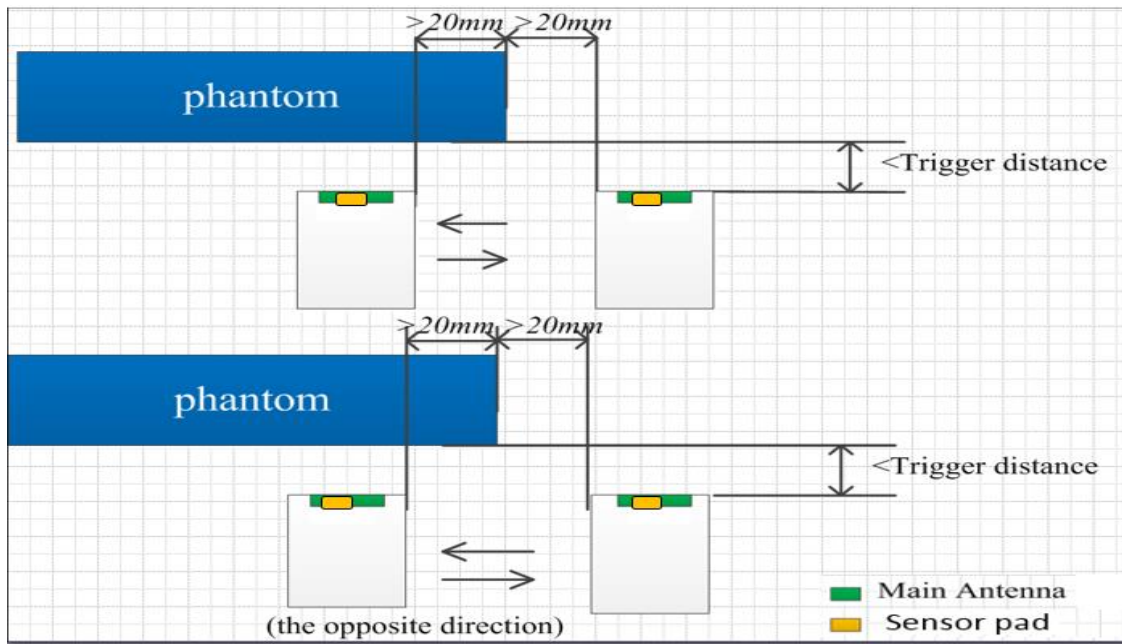
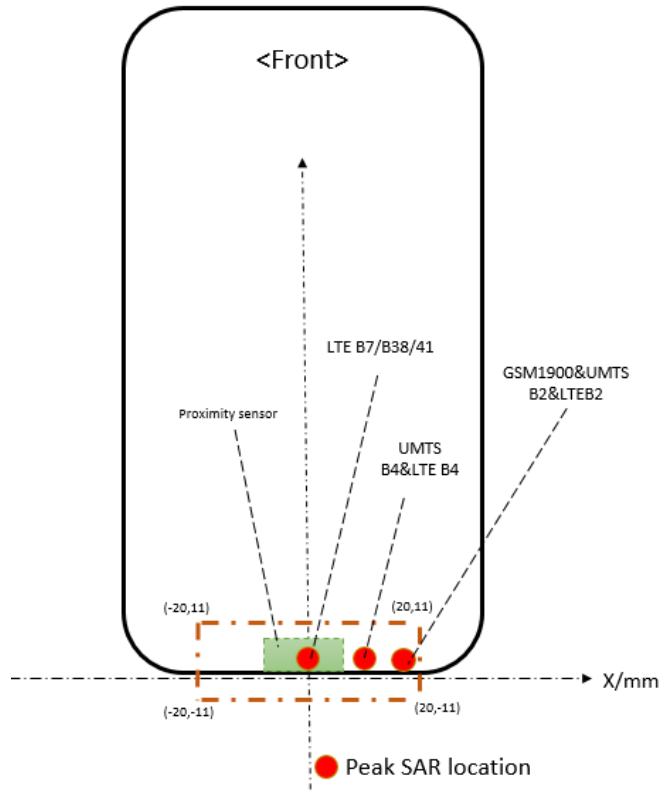
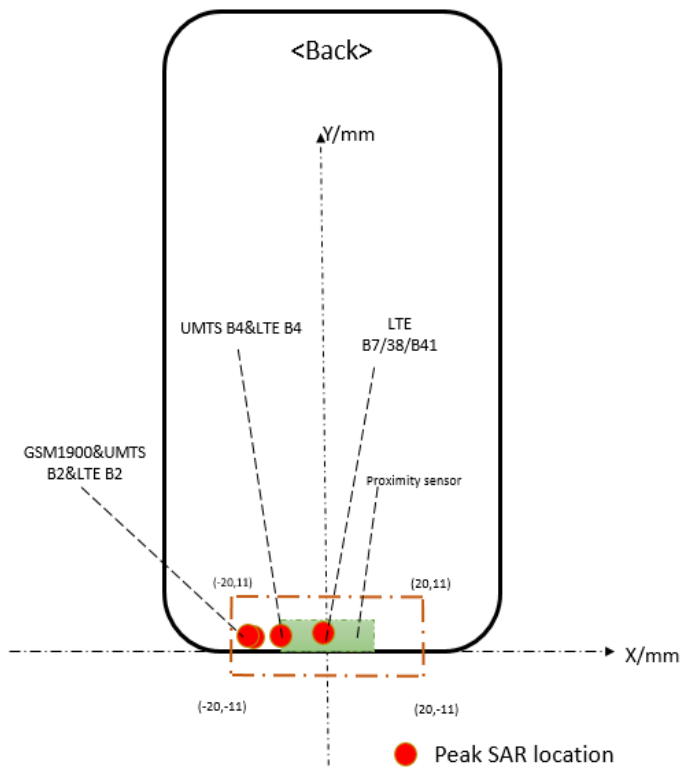

Figure: proximity sensor coverage assesment (X coordinate direction)

sensor coverage assesment results(Front side):



sensor coverage assesment results(Back side):



sensor coverage assesment results(Bottom side):

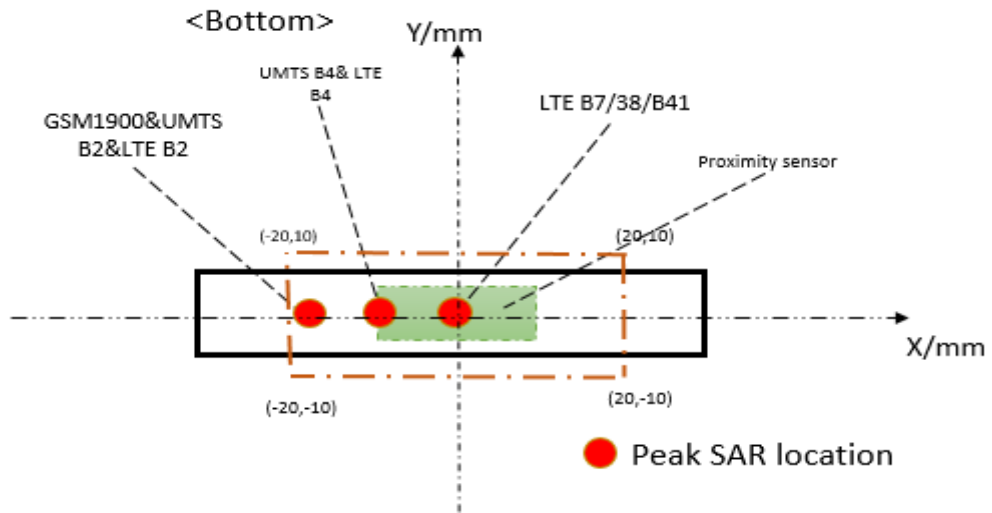

Conclusion: As the subsequently measured peak SAR location for the antenna is between the triggering points, additional SAR tests are not required for proximity sensor coverage per KDB 616217.

### 3) Procedures for determining device tilt angle influences to proximity sensor triggering

The DUT was positioned directly below the flat phantom at the minimum measured trigger distance with Bottom side parallel to the base of the flat phantom for each band.

The EUT was rotated about Bottom side for angles up to +/- 45°. If the output power increased during the rotation the DUT was moved 1mm toward the phantom and the rotation repeated. This procedure was repeated until the power remained reduced for all angles up to +/- 45°.

The proximity sensor triggering tilt angle measurement method are as below:

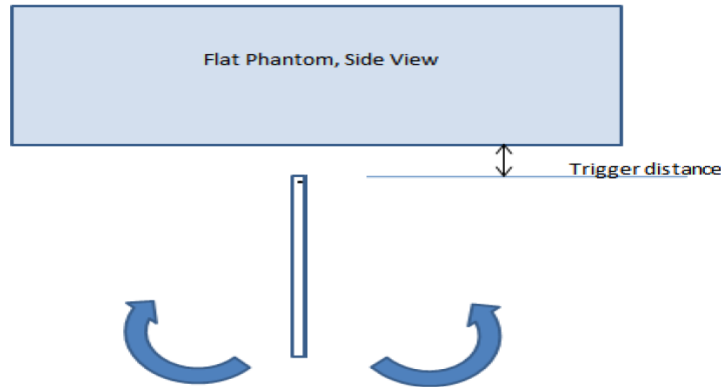

**Table: Summary of Device Tilt Angle Influence to Proximity Sensor Triggering(Bottom side)**

Band(MHz)	Minimum trigger distance at which power reduction was maintained over $\pm 45^\circ$	Power Reduction Status											
		-45°	-35°	-25°	-15°	-5°	0°	5°	15°	25°	35°	45°	
GSM1900	8mm	on	on	on	on	on	on	on	on	on	on	on	on
UMTS Band II	8mm	on	on	on	on	on	on	on	on	on	on	on	on
UMTS Band IV	8mm	on	on	on	on	on	on	on	on	on	on	on	on
LTE Band 2	8mm	on	on	on	on	on	on	on	on	on	on	on	on
UL CA_2C	8mm	on	on	on	on	on	on	on	on	on	on	on	on
LTE Band 4	8mm	on	on	on	on	on	on	on	on	on	on	on	on
LTE Band 7	8mm/11mm	on	on	on	on	on	on	on	on	on	on	on	on
UL CA_7C	8mm/11mm	on	on	on	on	on	on	on	on	on	on	on	on
LTE Band 38	8mm/11mm	on	on	on	on	on	on	on	on	on	on	on	on
UL CA_38C	8mm/11mm	on	on	on	on	on	on	on	on	on	on	on	on
LTE Band 41	8mm	on	on	on	on	on	on	on	on	on	on	on	on
UL CA_41C	8mm	on	on	on	on	on	on	on	on	on	on	on	on

**Conclusion:** It can be ensured that the proximity sensor can be valid triggered for the DUT tilt coverage exposure condition

## 6.10 BT Test Configuration

### BT specific wireless modes and SAR test:

The device supports a BT high power and low duty cycle feature in specific wireless modes and operating configurations. The BT of this device has three different operating modes:

- 1) Low power level mode (power level B, maximum duty cycle 100%);
- 2) High power level mode (power level A, maximum duty cycle 100%);
- 3) Sleep mode (power level A, maximum duty cycle 2%);

Note: For this device, power level B is  $\leq$  power level A.

The exposure condition related to each BT operating modes and SAR test plan are as below table according to FCC guidance:

Operating modes	Max power level	Maximum duty cycle	Exposure condition Required for SAR testing	
			Head (Audio Receiver on)	Body-worn/Hotspot/Product Specific 10-g
Low power level mode	power level B	100%	<b>Yes</b> (See Below Note 1)	<b>Yes</b> (See Below Note 1)
High power level mode	power level A	100%	N/A (See Below Note 3)	<b>Yes</b>
Sleep mode	power level A	2%	<b>Yes</b> (See Below Note 2)	Not required

**Note 1:** The BT SAR results at low power level B is still required because the simultaneous transmission possibilities for BT at lower power level B and high power level A are different. The BT SAR results at low power level B should be used to evaluation the simultaneous transmission SAR conditions not supported by BT higher power level A(Refer to Section 7.3 for details).

**Note 2:** Sleep mode (power level A, maximum duty cycle 2%) random transmission characteristics are not suitable for configuring devices to support SAR measurements in the test lab environment. So the alternative method is to test the SAR at power level A with maximum duty cycle 100% and then multiply by a duty cycle scaling factor 2%(Refer to Section 7.2 for details).

**Note 3:** High power level mode (power level A, maximum duty cycle 100%) is not applicable for Head exposure condtion(Audio Receiver on) by design.

**Note 4:** Both the power level A and B results will be tested and provided in the SAR report to validate the power reduction function works(Refer to section 7.1 for detailed conducted power results). During the BT test, a test software tool (an APK) installed on the DUT is required to configure the DUT to transmit continuously at the maximum power level A using the highest transmission duty factor(100%). The APK function is only used to trigger mobile phone always transmitting power. It can be ensured that the unmodified settings in production units, including maximum output power, amplifier gain and other RF performance or tuning parameters, are used for SAR measurement.



The following setup can be used to validate the BT high power A and Low duty cycle(2%) mode:

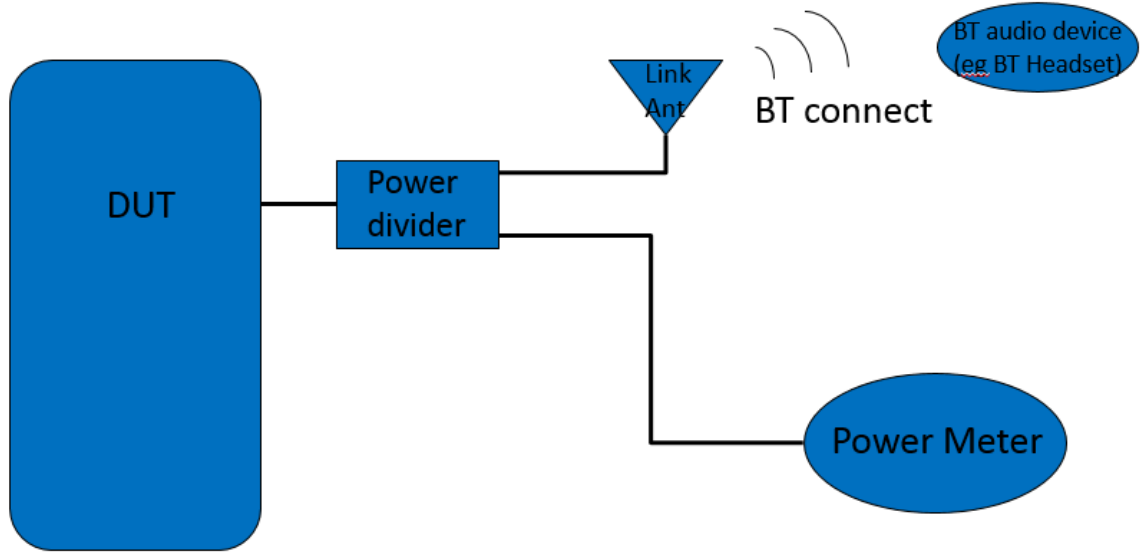

Figure: The BT Sleep mode(power level A, maximum duty cycle 2%) mode validation

BT power (power level A), maximum duty cycle 2% mode validation result:

power level A, maximum duty cycle 100%		power level A, maximum duty cycle 2% (Sleep mode)		Duty cycle Calculation
dBm	mW	dBm	mW	
15.48	35.32	-1.87	0.65	1.8%

Note: During low duty cycle mode validation, the mobile phone is connected to an external audio device that can play music and/or make calls ( eg: BT headset ,BT speaker ) via BT. Because BT works in frequency hopping mode in this real usage scenes, it is difficult to fix the channel and test the power value of each separately. Only the max average value is obtained by the power meter .

## 7 SAR Measurement Results

### 7.1 Conducted power measurements

For the measurements a Radio Communication Tester was used.

SAR drift measured at the same position in liquid before and after each SAR test as below 7.2 chapter.

Note: Radio Communication Tester measures GSM peak and average output power for active timeslots.

For SAR the timebased average power is relevant. The difference in between depends on the duty cycle of the TDMA signal :

No. of timeslots	1	2	3	4
Duty Cycle	1:8.3	1:4.1	1:2.77	1:2.08
timebased avg. power compared to slotted avg. power	-9.19dB	-6.13dB	-4.42dB	-3.18dB

The signalling modes differ as follows:

mode	coding scheme	modulation
GPRS	CS1 to CS4	GMSK
EDGE	MCS1 to MCS4	GMSK
EDGE	MCS5 to MCS9	8PSK

Apart from modulation change (GMSK/8PSK) coding schemes differ in code rate without influence on the RF signal. Therefore, one coding scheme per mode was selected for conducted power measurements.

A Radio Communication Tester was used for LTE output power measurements and SAR testing. Closed loop power control was used so the UE transmits with maximum output power during SAR testing.

The Radio Communication Tester measures LTE TDD peak and average output power for active timeslots. LTE TDD peak and average output power for active timeslots. For SAR the time-based average power is relevant. The difference in between depends on the duty cycle of the TDMA signal:

For Time-Division Duplex (TDD) systems, SAR must be tested using a fixed periodic duty factor according to the highest transmission duty factor implemented for the device and supported by the defined 3GPP LTE TDD configurations.

No. of Configuration	0	1	2	3	4	5	6
Duty Cycle	<b>0.6333</b>	0.4333	0.2333	0.3167	0.2167	0.1167	0.5333
Time-based avg. power compared to slotted avg. power	<b>-1.98dB</b>	-3.63dB	-6.32dB	-4.99dB	-6.64dB	-9.33 dB	-2.73dB

Note: According to duty cycle of configuration 0 to 6, Max output power should be Configuration 0, so we just tested the conduction power and SAR of configuration 0.

### 7.1.1 Conducted power measurements of GSM850 (Second Antenna)

GSM850		Burst-Averaged output Power (dBm)				Division Factors	Frame-Averaged output Power (dBm)			
		Tune-up	128CH	190CH	251CH		Tune-up	128CH	190CH	251CH
		Max.					Max.			
GSM (CS)		28.70	<b>28.11</b>	<b>28.29</b>	<b>28.22</b>	-9.19	19.51	18.92	19.10	19.03
GPRS (GMSK)	1 Tx Slot	28.70	28.22	28.28	28.21	-9.19	19.51	19.03	19.09	19.02
	2 Tx Slots	26.70	<b>26.18</b>	<b>26.25</b>	<b>26.18</b>	-6.13	20.57	20.05	20.12	20.05
	3 Tx Slots	24.70	24.21	24.28	24.21	-4.42	20.28	19.79	19.86	19.79
	4 Tx Slots	22.70	22.13	22.20	22.14	-3.18	19.52	18.95	19.02	18.96
EDGE (GMSK)	1 Tx Slot	28.70	28.20	28.26	28.19	-9.19	19.51	19.01	19.07	19.00
	2 Tx Slots	26.70	26.17	26.24	26.17	-6.13	20.57	20.04	20.11	20.04
	3 Tx Slots	24.70	24.20	24.26	24.20	-4.42	20.28	19.78	19.84	19.78
	4 Tx Slots	22.70	22.10	22.19	22.13	-3.18	19.52	18.92	19.01	18.95
EDGE (8PSK)	1 Tx Slot	22.20	21.32	21.58	21.68	-9.19	13.01	12.13	12.39	12.49
	2 Tx Slots	21.20	20.22	20.43	20.55	-6.13	15.07	14.09	14.30	14.42
	3 Tx Slots	19.20	18.07	18.39	18.47	-4.42	14.78	13.65	13.97	14.05
	4 Tx Slots	18.20	16.95	17.18	17.24	-3.18	15.02	13.77	14.00	14.06

Table 18:Conducted power measurement results of GSM850(Full Power)

GSM850		Burst-Averaged output Power (dBm)				Division Factors	Frame-Averaged output Power (dBm)			
		Tune-up	128CH	190CH	251CH		Tune-up	128CH	190CH	251CH
		Max.					Max.			
GSM (CS)		28.20	<b>27.63</b>	<b>27.70</b>	<b>27.72</b>	-9.19	19.01	18.44	18.51	18.53
GPRS (GMSK)	1 Tx Slot	28.20	27.72	27.78	27.71	-9.19	19.01	18.53	18.59	18.52
	2 Tx Slots	26.20	25.70	25.76	25.70	-6.13	20.07	19.57	19.63	19.57
	3 Tx Slots	24.20	23.66	23.73	23.67	-4.42	19.78	19.24	19.31	19.25
	4 Tx Slots	22.20	21.63	21.71	21.65	-3.18	19.02	18.45	18.53	18.47
EDGE (GMSK)	1 Tx Slot	28.20	27.70	27.76	27.69	-9.19	19.01	18.51	18.57	18.50
	2 Tx Slots	26.20	25.68	25.76	25.69	-6.13	20.07	19.55	19.63	19.56
	3 Tx Slots	24.20	23.65	23.71	23.65	-4.42	19.78	19.23	19.29	19.23
	4 Tx Slots	22.20	21.60	21.70	21.64	-3.18	19.02	18.42	18.52	18.46
EDGE (8PSK)	1 Tx Slot	21.70	20.84	21.12	21.22	-9.19	12.51	11.65	11.93	12.03
	2 Tx Slots	20.70	19.79	19.99	20.08	-6.13	14.57	13.66	13.86	13.95
	3 Tx Slots	18.70	17.64	17.85	18.03	-4.42	14.28	13.22	13.43	13.61
	4 Tx Slots	17.70	16.55	16.77	16.83	-3.18	14.52	13.37	13.59	13.65

Table 19:Conducted power measurement results of GSM850(Reduced Power Level D1/D3)

Note:

- 1) Frame-averaged output power was calculated from the measured burst-averaged output power by converting the slot powers into linear units and calculating the energy over 8 timeslots.
- 2) Per KDB941225 D01, SAR test reduction for GPRS and EDGE modes is determined by the source-based time-averaged output power specified for production units, including tune-up tolerance. The data mode with highest specified time-averaged output power should be tested for SAR compliance in the applicable exposure conditions. For modes with the same specified maximum output power and tolerance, the higher number time-slot configuration should be tested.

### 7.1.2 Conducted power measurements of GSM850 (Main Antenna)

GSM850		Burst-Averaged output Power (dBm)				Division Factors	Frame-Averaged output Power (dBm)			
		Tune-up Max.	128CH	190CH	251CH		Tune-up Max.	128CH	190CH	251CH
GSM (CS)		34.00	<b>33.80</b>	<b>33.86</b>	<b>33.96</b>	-9.19	24.81	24.61	24.67	24.77
GPRS (GMSK)	1 Tx Slot	34.00	33.91	33.87	33.94	-9.19	24.81	24.72	24.68	24.75
	2 Tx Slots	32.00	<b>31.52</b>	<b>31.62</b>	<b>31.72</b>	-6.13	25.87	25.39	25.49	25.59
	3 Tx Slots	30.00	29.41	29.52	29.63	-4.42	25.58	24.99	25.10	25.21
	4 Tx Slots	28.00	27.36	27.48	27.60	-3.18	24.82	24.18	24.30	24.42
EDGE (GMSK)	1 Tx Slot	34.00	33.91	33.86	33.70	-9.19	24.81	24.72	24.67	24.51
	2 Tx Slots	32.00	31.51	31.61	31.70	-6.13	25.87	25.38	25.48	25.57
	3 Tx Slots	30.00	29.41	29.52	29.62	-4.42	25.58	24.99	25.10	25.20
	4 Tx Slots	28.00	27.35	27.47	27.58	-3.18	24.82	24.17	24.29	24.40
EDGE (8PSK)	1 Tx Slot	27.50	26.45	26.72	26.90	-9.19	18.31	17.26	17.53	17.71
	2 Tx Slots	26.50	25.39	25.64	25.80	-6.13	20.37	19.26	19.51	19.67
	3 Tx Slots	24.50	23.13	23.41	23.57	-4.42	20.08	18.71	18.99	19.15
	4 Tx Slots	23.50	22.01	22.37	22.51	-3.18	20.32	18.83	19.19	19.33

Table 20: Conducted power measurement results of GSM850(Full Power)

Note:

- 1) Frame-averaged output power was calculated from the measured burst-averaged output power by converting the slot powers into linear units and calculating the energy over 8 timeslots.
- 2) Per KDB941225 D01, SAR test reduction for GPRS and EDGE modes is determined by the source-based time-averaged output power specified for production units, including tune-up tolerance. The data mode with highest specified time-averaged output power should be tested for SAR compliance in the applicable exposure conditions. For modes with the same specified maximum output power and tolerance, the higher number time-slot configuration should be tested.

### 7.1.3 Conducted power measurements of GSM1900 (Second Antenna)

GSM1900		Burst-Averaged output Power (dBm)				Division Factors	Frame-Averaged output Power (dBm)			
		Tune-up	512CH	661CH	810CH		Tune-up	512CH	661CH	810CH
		Max.					Max.			
GSM (CS)		27.00	<b>26.17</b>	<b>26.24</b>	<b>26.09</b>	-9.19	17.81	16.98	17.05	16.90
GPRS (GMSK)	1 Tx Slot	27.00	26.16	26.25	26.09	-9.19	17.81	16.97	17.06	16.90
	2 Tx Slots	25.00	<b>24.14</b>	<b>24.24</b>	<b>24.07</b>	-6.13	18.87	18.01	18.11	17.94
	3 Tx Slots	23.00	22.09	22.21	22.04	-4.42	18.58	17.67	17.79	17.62
	4 Tx Slots	21.00	20.12	20.27	20.09	-3.18	17.82	16.94	17.09	16.91
EDGE (GMSK)	1 Tx Slot	27.00	26.14	26.24	26.10	-9.19	17.81	16.95	17.05	16.91
	2 Tx Slots	25.00	24.12	24.22	24.07	-6.13	18.87	17.99	18.09	17.94
	3 Tx Slots	23.00	22.10	22.21	22.05	-4.42	18.58	17.68	17.79	17.63
	4 Tx Slots	21.00	20.12	20.27	20.09	-3.18	17.82	16.94	17.09	16.91
EDGE (8PSK)	1 Tx Slot	22.50	21.46	21.43	21.13	-9.19	13.31	12.27	12.24	11.94
	2 Tx Slots	21.50	20.37	20.35	20.03	-6.13	15.37	14.24	14.22	13.90
	3 Tx Slots	19.50	18.33	18.40	18.06	-4.42	15.08	13.91	13.98	13.64
	4 Tx Slots	18.50	17.25	17.21	16.83	-3.18	15.32	14.07	14.03	13.65

Table 21: Conducted power measurement results of GSM1900(Full Power)

Note:

- 1) Frame-averaged output power was calculated from the measured burst-averaged output power by converting the slot powers into linear units and calculating the energy over 8 timeslots.
- 2) Per KDB941225 D01, SAR test reduction for GPRS and EDGE modes is determined by the source-based time-averaged output power specified for production units, including tune-up tolerance. The data mode with highest specified time-averaged output power should be tested for SAR compliance in the applicable exposure conditions. For modes with the same specified maximum output power and tolerance, the higher number time-slot configuration should be tested.

### 7.1.4 Conducted power measurements of GSM1900 (Main Antenna)

GSM1900		Burst-Averaged output Power (dBm)				Division Factors	Frame-Averaged output Power (dBm)			
		Tune-up	512CH	661CH	810CH		Tune-up	512CH	661CH	810CH
		Max.					Max.			
GSM (CS)		31.00	<b>30.32</b>	<b>30.33</b>	<b>30.14</b>	-9.19	21.81	21.13	21.14	20.95
GPRS (GMSK)	1 Tx Slot	31.00	30.28	30.34	30.14	-9.19	21.81	21.09	21.15	20.95
	2 Tx Slots	29.00	<b>28.17</b>	<b>28.19</b>	<b>28.02</b>	-6.13	22.87	22.04	22.06	21.89
	3 Tx Slots	27.00	26.16	26.15	26.01	-4.42	22.58	21.74	21.73	21.59
	4 Tx Slots	25.00	24.07	24.08	23.93	-3.18	21.82	20.89	20.90	20.75
EDGE (GMSK)	1 Tx Slot	31.00	30.25	30.29	30.11	-9.19	21.81	21.06	21.10	20.92
	2 Tx Slots	29.00	28.16	28.18	28.01	-6.13	22.87	22.03	22.05	21.88
	3 Tx Slots	27.00	26.16	26.15	26.01	-4.42	22.58	21.74	21.73	21.59
	4 Tx Slots	25.00	24.07	24.18	23.93	-3.18	21.82	20.89	21.00	20.75
EDGE (8PSK)	1 Tx Slot	26.50	25.84	25.76	25.48	-9.19	17.31	16.65	16.57	16.29
	2 Tx Slots	25.50	24.01	23.93	23.62	-6.13	19.37	17.88	17.80	17.49
	3 Tx Slots	23.50	22.01	22.02	21.70	-4.42	19.08	17.59	17.60	17.28
	4 Tx Slots	22.50	20.96	20.88	20.51	-3.18	19.32	17.78	17.70	17.33

Table 22: Conducted power measurement results of GSM1900(Full Power)

GSM1900		Burst-Averaged output Power (dBm)				Division Factors	Frame-Averaged output Power (dBm)			
		Tune-up	512CH	661CH	810CH		Tune-up	512CH	661CH	810CH
		Max.					Max.			
GSM (CS)		29.00	28.20	28.21	28.04	-9.19	19.81	19.01	19.02	18.85
GPRS (GMSK)	1 Tx Slot	29.00	28.16	28.20	28.03	-9.19	19.81	18.97	19.01	18.84
	2 Tx Slots	27.00	26.15	26.15	26.01	-6.13	20.87	20.02	20.02	19.88
	3 Tx Slots	25.00	24.17	24.17	24.02	-4.42	20.58	19.75	19.75	19.60
	4 Tx Slots	23.00	22.22	22.19	22.09	-3.18	19.82	19.04	19.01	18.91
EDGE (GMSK)	1 Tx Slot	29.00	28.15	28.17	28.01	-9.19	19.81	18.96	18.98	18.82
	2 Tx Slots	27.00	26.15	26.15	26.01	-6.13	20.87	20.02	20.02	19.88
	3 Tx Slots	25.00	24.16	24.18	24.03	-4.42	20.58	19.74	19.76	19.61
	4 Tx Slots	23.00	22.22	22.20	22.09	-3.18	19.82	19.04	19.02	18.91
EDGE (8PSK)	1 Tx Slot	24.50	23.29	23.14	23.10	-9.19	15.31	14.10	13.95	13.91
	2 Tx Slots	23.50	23.31	23.27	21.81	-6.13	17.37	17.18	17.14	15.68
	3 Tx Slots	21.50	20.12	21.24	20.39	-4.42	17.08	15.70	16.82	15.97
	4 Tx Slots	20.50	19.78	18.95	18.59	-3.18	17.32	16.60	15.77	15.41

Table 23: Conducted power measurement results of GSM1900(Reduced Power Level D1/D4)

Note:

- 1) Frame-averaged output power was calculated from the measured burst-averaged output power by converting the slot powers into linear units and calculating the energy over 8 timeslots.
- 2) Per KDB941225 D01, SAR test reduction for GPRS and EDGE modes is determined by the source-based time-averaged output power specified for production units, including tune-up tolerance. The data mode with highest specified time-averaged output power should be tested for SAR compliance in the applicable exposure conditions. For modes with the same specified maximum output power and tolerance, the higher number time-slot configuration should be tested.

### 7.1.5 Conducted power measurements of UMTS Band II (Second Antenna)

UMTS Band II		Tune-up	Channel	Channel	Channel
		Max.	9262CH	9400CH	9538CH
WCDMA	12.2kbps RMC	22.50	<b>21.68</b>	<b>21.55</b>	<b>21.45</b>
	12.2kbps AMR	22.50	21.67	21.52	21.41
HSDPA	Subtest 1	22.00	21.21	21.11	21.01
	Subtest 2	21.50	20.42	20.29	20.16
	Subtest 3	21.00	19.91	19.77	19.67
	Subtest 4	21.00	19.89	19.77	19.66
HSUPA	Subtest 1	22.50	19.78	19.74	19.58
	Subtest 2	20.50	17.65	16.84	16.73
	Subtest 3	21.50	18.49	18.59	17.60
	Subtest 4	20.50	17.43	17.12	16.91
	Subtest 5	22.50	19.67	19.54	19.42
DC-HSDPA	Subtest 1	22.00	21.21	21.08	20.97
	Subtest 2	21.50	20.38	20.33	20.20
	Subtest 3	21.00	19.87	19.80	19.64
	Subtest 4	21.00	19.85	19.77	19.70

Table 24: Conducted power measurement results of UMTS Band II(Full Power)

UMTS Band II		Tune-up	Channel	Channel	Channel
		Max.	9262CH	9400CH	9538CH
WCDMA	12.2kbps RMC	16.50	<b>15.64</b>	<b>15.57</b>	<b>15.43</b>
	12.2kbps AMR	16.50	15.68	15.50	15.41
HSDPA	Subtest 1	16.00	15.24	15.12	15.01
	Subtest 2	15.50	14.94	14.72	14.75
	Subtest 3	15.00	14.37	14.15	14.21
	Subtest 4	15.00	14.34	14.14	14.19
HSUPA	Subtest 1	16.50	14.45	14.58	14.47
	Subtest 2	14.50	11.58	11.88	11.78
	Subtest 3	15.50	13.23	12.50	12.67
	Subtest 4	14.50	12.28	12.05	12.01
	Subtest 5	16.50	14.23	14.00	13.89
DC-HSDPA	Subtest 1	16.00	15.24	15.12	15.05
	Subtest 2	15.50	14.94	14.72	14.72
	Subtest 3	15.00	14.33	14.11	14.17
	Subtest 4	15.00	14.38	14.14	14.23

Table 25: Conducted power measurement results of UMTS Band II(Reduced Power Level D1)



UMTS Band II		Tune-up	Channel	Channel	Channel
		Max.	9262CH	9400CH	9538CH
WCDMA	12.2kbps RMC	12.00	11.64	11.76	11.65
	12.2kbps AMR	12.00	11.82	11.86	11.74
HSDPA	Subtest 1	11.50	11.33	11.34	11.19
	Subtest 2	11.00	10.54	10.47	10.41
	Subtest 3	10.50	9.98	9.92	9.80
	Subtest 4	10.50	9.95	9.92	9.78
HSUPA	Subtest 1	12.00	11.31	11.63	11.32
	Subtest 2	10.00	7.61	7.09	6.93
	Subtest 3	11.00	8.33	8.66	7.74
	Subtest 4	10.00	7.25	7.36	7.04
DC-HSDPA	Subtest 1	11.50	11.29	11.38	11.15
	Subtest 2	11.00	10.50	10.44	10.41
	Subtest 3	10.50	9.94	9.88	9.80
	Subtest 4	10.50	9.99	9.96	9.82

Table 26: Conducted power measurement results of UMTS Band II(Reduced Power Level D3)

UMTS Band II		Tune-up	Channel	Channel	Channel
		Max.	9262CH	9400CH	9538CH
WCDMA	12.2kbps RMC	18.00	<b>17.23</b>	<b>17.08</b>	<b>16.98</b>
	12.2kbps AMR	18.00	17.21	17.08	16.98
HSDPA	Subtest 1	17.50	16.74	16.61	16.49
	Subtest 2	17.00	15.96	15.79	15.69
	Subtest 3	16.50	15.44	15.28	15.21
	Subtest 4	16.50	15.39	15.34	15.19
HSUPA	Subtest 1	18.00	15.44	15.54	15.38
	Subtest 2	16.00	13.44	12.81	12.82
	Subtest 3	17.00	14.29	14.54	13.69
	Subtest 4	16.00	13.17	13.14	12.90
DC-HSDPA	Subtest 1	17.50	16.74	16.57	16.53
	Subtest 2	17.00	16.00	15.79	15.65
	Subtest 3	16.50	15.40	15.31	15.21
	Subtest 4	16.50	15.39	15.38	15.19

Table 27: Conducted power measurement results of UMTS Band II(Reduced Power Level D2)

Note:

- 1) The bolded 12.2kbps RMC mode was selected for SAR testing (the primary mode).
- 2) Per KDB941225 D01, When the maximum output power and tune-up tolerance specified for production units in a Second mode is  $\leq \frac{1}{4}$  dB higher than the primary mode or when the highest *reported* SAR of the primary mode is scaled by the ratio of specified maximum output power and tune-up tolerance of Second to primary mode and the adjusted SAR is  $\leq 1.2$  W/kg, SAR measurement is not required for the Second mode.