



# FCC&ISED RF Test Report

**Product Name: Smart Phone**

**Model Number: ELE-L04**

**Report No.: SYBH(Z-RF)20181115007001-2002**

**FCC ID : QISELE-L04**

**IC: 6369A-ELEL04**

Autheorized	APPROVED (Lab Manager)	PREPARED (Test Engineer)
BY	He Hao	Zhou Bing bo
DATE	2018-12-25	2018-12-25

**Reliability Laboratory of Huawei Technologies Co., Ltd.**

**(Global Compliance and Testing Center of Huawei Technologies Co., Ltd)**

Administration Building, Headquarters of Huawei Technologies Co., Ltd., Bantian, Longgang District,  
Shenzhen, 518129, P.R.C

Tel: +86 755 28780808 Fax: +86 755 89652518

※ ※ **Notice** ※ ※

1. The Reliability Laboratory of Huawei Technologies Co., Ltd has passed the accreditation by The American Association for Laboratory Accreditation (A2LA). The accreditation number is 2174.01
2. The Laboratory of Sporton International (Shenzhen) Inc has passed the accreditation by National Voluntary Laboratory Accreditation Program (NVLAP). The NVLAP LAB CODE is 600156-0.
3. The Reliability Laboratory of Huawei Technologies Co., Ltd has been recognized by the US Federal Communications Commission (FCC) to perform compliance testing subject to the Commission's Certification rules. The Designation Number is CN1173, and the Test Firm Registration Number is 294140.
4. The Laboratory of Sporton International (Shenzhen) Inc has been recognized by the US Federal Communications Commission (FCC) to perform compliance testing subject to the Commission's Certification rules. The Designation Number is CN5019, and the Test Firm Registration Number is 577730.
5. The Reliability Laboratory of Huawei Technologies Co., Ltd has been listed by Industry Canada to perform electromagnetic emission measurements. The recognition numbers of test site are 6369A-1.
6. The Reliability Laboratory of Huawei Technologies Co., Ltd is also named “Global Compliance and Testing Center of Huawei Technologies Co., Ltd”, the both names have coexisted since 2009.
7. The test report is invalid if not marked with the signatures of the persons responsible for preparing and approving the test report.
8. The test report is invalid if there is any evidence of erasure and/or falsification.
9. The test report is only valid for the test samples.
10. Content of the test report, in part or in full, cannot be used for publicity and/or promotional purposes without prior written approval from the laboratory.

**MODIFICATION RECORD**

No.	Report No	Modification Description
1	SYBH(Z-RF)20181115007001	First release.

**DECLARATION**

Type	Description
Multiple Models Applications	<input checked="" type="checkbox"/> The present report applies to single model.
	<input type="checkbox"/> The present report applies to several models. The practical measurements are performed with the model.
	Note: The present report only presents the worst test case of all modes, see relevant test results for detailed.

## 1 Table of contents

1	Table of contents .....	4
2	General Information .....	5
2.1	Test standard/s .....	5
2.2	Test Environment .....	5
2.3	Test Laboratories .....	5
2.4	Applicant and Manufacturer .....	6
2.5	Application details .....	6
3	Test Summary .....	6
4	Description of the Equipment under Test (EUT) .....	8
4.1	EUT Identity .....	8
4.2	Technical Description .....	10
5	General Test Conditions / Configurations .....	12
5.1	Test Modes .....	12
5.2	EUT Configurations .....	12
5.3	Antenna requirements .....	15
5.4	Description of tests .....	16
5.5	Test Setups .....	18
5.6	Test Conditions .....	21
5.7	Main Instruments .....	25
6	Measurement Uncertainty .....	27
7	Appendixes .....	28

## 2 General Information

### 2.1 Test standard/s

Applied Rules :	47 CFR FCC Part 2, Subpart J 47 CFR FCC Part 15, Subpart C ISED RSS-Gen (Issue 5, April 2018) ISED RSS-247 (Issue2,February 2017)
Test Method :	FCC KDB 558074 D01 DTS Meas Guidance v05 FCC KDB 662911 D01 Multiple Transmitter Output v02r01 ANSI C63.10-2013, American National Standard for Testing Unlicensed Wireless Devices.

### 2.2 Test Environment

Temperature :	TN	15 to 30	°C during room temperature tests
Ambient Relative Humidity:	20 to 85 %		
Atmospheric Pressure:	Not applicable		
Power supply :	VL	3.6	V
	VN	3.82	V DC by Battery
	VH	4.35	V

NOTE 1: 1) VN= nominal voltage, VL= low extreme test voltage, VH= High extreme test voltage;

TN= normal temperature, TL= low extreme test temperature, TH= High extreme test temperature.

NOTE 2: The values used in the test report may be stringent than the declared.

### 2.3 Test Laboratories

Test Location 1 :	RELIABILITY LABORATORY OF HUAWEI TECHNOLOGIES CO., LTD.
Address of Test Location 1 :	No.2 New City Avenue Songshan Lake Sci. &Tech. Industry Park, Dongguan, Guangdong, P.R.C
Sub-contracted Test Location 1 :	Sporton International (Shenzhen) Inc.
Address of Sub-contracted Test Location 1 :	No.3 Building, the third floor of south, Shahe River west, Fengzeyuan warehouse, Nanshan District, Shenzhen, Guangdong, P.R.China

## 2.4 Applicant and Manufacturer

Company Name :	HUAWEI TECHNOLOGIES CO., LTD
Address :	Administration Building, Headquarters of Huawei Technologies Co., Ltd., Bantian, Longgang District, Shenzhen, 518129, P.R.C

## 2.5 Application details

Date of Receipt Sample:	2018-11-22
Start of test:	2018-11-22
End of test:	2018-12-25

## 3 Test Summary

Test Item	FCC Rule No.	ISED Rule No.	Requirements	Test Result	Verdict	Testing location
DTS (6 dB Bandwidth)	15.247(a)(2)	RSS-247, 5.2	≥ 500 kHz.	Appendix A	Pass	Test Location 1
Occupied Bandwidth	---	RSS-247, 5.2 RSS-Gen, 6.7	No limit	Appendix B	Pass	Test Location 1
Duty Cycle	KDB 558074 D01 (6.0)	--	No limit	Appendix C	Pass	Test Location 1
Maximum Average Output Power	15.247(b)(3)	RSS-247, 5.4	FCC: For directional gain: Conducted < 30 dBm – (G[dBi] – 6 [dB]); Otherwise: Conducted < 30 dBm, ISED: Conducted < 30 dBm. EIRP < 36 dBm,	Appendix D	Pass	Test Location 1
Maximum Power Spectral Density Level	15.247(e)	RSS-247, 5.2	Conducted < 8 dBm/3 kHz.	Appendix E	Pass	Test Location 1
Band Edges Compliance	15.247(d)	RSS-247, 5.5	< -30 dB/100 kHz if total average power ≤ power limit.	Appendix F	Pass	Test Location 1
Unwanted				Appendix	Pass	Test Location 1

Test Item	FCC Rule No.	ISED Rule No.	Requirements	Test Result	Verdict	Testing location
Emissions into Non-Restricted Frequency Bands				G		
Unwanted Emissions into Restricted Frequency Bands (Radiated)	15.247(d) 15.209 (NOTE 1)	RSS-247, 5.5 RSS-Gen, §6.13 RSS-Gen, 8.10	FCC Part 15.209 field strength limit; RSS-Gen 8.10 field strength limit.	Appendix H	Pass	Sub-contracted Test Location 1
AC Power Line Conducted Emissions	15.207	RSS-Gen, 8.8	FCC Part 15.207 conducted limit; RSS-Gen, 8.8 conducted limit.	Appendix I	Pass	Test Location 1
<p>NOTE 1: According to KDB 558074 D01, antenna-port conducted measurements are acceptable as an alternative to radiated measurements for demonstrating compliance to the limits in the restricted frequency bands. If conducted measurements are performed, then proper impedance matching must be ensured and an additional radiated test for cabinet/case emissions will also be required.</p> <p>NOTE2: The transmitter has an integral PCB loop antenna that is enclosed within the housing of the EUT and meets the requirements of FCC 15.203</p>						

## 4 Description of the Equipment under Test (EUT)

ELE-L04 is subscriber equipment in the GSM/WCDMA/LTE system. The GSM frequency band includes GSM850 and GSM900 and DCS1800 and PCS1900. The UMTS frequency band is B1 and B2 and B4 and B5 and B6 and B8 and B19. The ELE-L04 LTE frequency band is B1 and B2 and B3 and B4 and B5 and B6 and B7 and B8 and B9 and B12 and B17 and B18 and B19 and B20 and B26 and B28 and B34 and B38 and B39 and B40 and B41 and B66. The ELE-L04 LTE frequency band for intra-band carrier aggregation uplink operation band is CA\_1C and CA\_3C and CA\_7C and CA\_38C and CA\_39C and CA\_41C. The Mobile Phone implements such functions as RF signal receiving/transmitting LTE/HSPA/UMTS and GSM/GPRS/EDGE protocol processing, voice, video MMS service, GPS, AGPS and WIFI etc. Externally it provides one micro SD card interface, earphone port (to provide voice service) and one SIM card interface. ELE-L04 is single SIM smart phone. It also provides Bluetooth module to synchronize data between a PC and the phone, or to use the built-in modem of the phone to access the Internet with a PC, or to exchange data with other Bluetooth devices.

NOTE: Only 2.4G WLAN test data included in this report.

### 4.1 EUT Identity



















NOTE: Unless otherwise noted in the report, the functional boards installed in the units shall be selected from the below list, but not means all the functional boards listed below shall be installed in one unit.

#### 4.1.1 Board

Board		
Description	Software version	Hardware version
Main Board	5.0.1.34 ( SP1C792E8R1P7 )	HL1ELLEM



**4.1.2 Sub- Assembly**

Sub-Assembly			
Sub-Assembly Name	Model	Manufacturer	Description
Adapter	HW-050450B00	Huawei Technologies Co.,Ltd.	Input Voltage:100V-240V~50/60Hz, 0.75A Output Voltage: 5V  2A OR4.5V  5A OR 5V  4.5A
Adapter	HW-050450E00	Huawei Technologies Co.,Ltd.	Input Voltage:100V-240V~50/60Hz, 0.75A Output Voltage: 5V  2A OR4.5V  5A OR 5V  4.5A
Adapter	HW-050450U00	Huawei Technologies Co.,Ltd.	Input Voltage:100V-240V~50/60Hz, 0.75A Output Voltage: 5V  2A OR4.5V  5A OR 5V  4.5A
Adapter	HW-050450A00	Huawei Technologies Co.,Ltd.	Input Voltage:100V-240V~50/60Hz, 0.75A Output Voltage: 5V  2A OR4.5V  5A OR 5V  4.5A
Adapter	HW-050450E01	Huawei Technologies Co.,Ltd.	Input Voltage:100V-240V~50/60Hz, 0.75A Output Voltage: 5V  2A OR4.5V  5A OR 5V  4.5A
Adapter	HW-050450A01	Huawei Technologies Co.,Ltd.	Input Voltage:100V-240V~50/60Hz, 0.75A Output Voltage: 5V  2A OR4.5V  5A OR 5V  4.5A
Li-ion Polymer Battery	HB436380ECW	Huawei Technologies Co.,Ltd.	Rated capacity: 3550mAh Nominal Voltage: +3.85V Charging Voltage: +4.43V

## 4.2 Technical Description

NOTE: For the detailed technical descriptions, see the applicant/manufacturer's specifications or user manual.

Characteristics	Description	
IEEE 802.11 WLAN Mode Supported	<input checked="" type="checkbox"/> 802.11b (20 MHz channel bandwidth), <input checked="" type="checkbox"/> 802.11g (20 MHz channel bandwidth) <input checked="" type="checkbox"/> 802.11n (20 MHz channel bandwidth), <input checked="" type="checkbox"/> 802.11n (40 MHz channel bandwidth)	
TX/RX Operating Range	2412-2462 MHz band	$f_c = 2407 \text{ MHz} + N * 5 \text{ MHz}$ , where: - $f_c$ = "Operating Frequency" in MHz, - $N$ = "Channel Number" with the range from 1 to 11 for the 20 MHz channel bandwidth, or 3 to 9 for the 40 MHz channel bandwidth.
Data Rate	802.11b	1 Mbps, 2 Mbps, 5.5 Mbps, 11 Mbps
	802.11g	6 Mbps, 9 Mbps, 12 Mbps, 18 Mbps, 24 Mbps, 36 Mbps, 48 Mbps, 54 Mbps
	802.11g CDD	6 Mbps, 9 Mbps, 12 Mbps, 18 Mbps, 24 Mbps, 36 Mbps, 48 Mbps, 54 Mbps
	802.11n (SISO)	MCS 0 to MCS 7
	802.11n (MIMO)	MCS 8 to MCS 15
Modulation Type	DBPSK/DQPSK/CCK (DSSS), BPSK/QPSK/16QAM/64QAM (OFDM).	
Emission Designator	11M9G7D (for 802.11b mode), 16M6G7D (for 802.11g mod), 17M6G7D (for 802.11n20 mode) 37M1G7D (for 802.11n40 mode)	
TX Power Control	<input type="checkbox"/> Supported, <input checked="" type="checkbox"/> Not Supported	
Standby Mode	<input type="checkbox"/> Supported, <input checked="" type="checkbox"/> Not Supported	
Equipment Type	<input checked="" type="checkbox"/> Stand-alone equipment, <input type="checkbox"/> Plug-in radio device, <input type="checkbox"/> Combined equipment	
Antenna	Description	Isotropic Antenna
	Type	<input checked="" type="checkbox"/> Integral <input type="checkbox"/> External <input type="checkbox"/> Dedicated
	Ports	<input checked="" type="checkbox"/> Ant 1, <input checked="" type="checkbox"/> Ant 2, <input type="checkbox"/> Ant 3
	Smart System	<input checked="" type="checkbox"/> SISO (for 802.11b/g/n), <input checked="" type="checkbox"/> CDD (for 802.11g), 2 Tx & 2 Rx, <input checked="" type="checkbox"/> MIMO (for 802.11n), 2 Tx & 2 Rx, <input type="checkbox"/> Diversity (for 802.11b/g) :        Tx        Rx
	Gain	Ant 1: -2.56dBi (per antenna port, max.) Ant 2: -7.17dBi (per antenna port, max.)
	Remark	When the EUT is put into service, the practical maximum antenna gain should NOT exceed the value as described above.
Power Supply	Type	<input type="checkbox"/> External DC mains,



Characteristics	Description
	<input checked="" type="checkbox"/> Battery, <input type="checkbox"/> AC/DC Adapter, <input type="checkbox"/> Powered over Ethernet (PoE). <input type="checkbox"/> Other

## 5 General Test Conditions / Configurations

### 5.1 Test Modes

NOTE: Worst cases for each IEEE 802.11 mode are selected to perform tests.

Test Mode	Test Modes Description
11B	IEEE 802.11b with data rate of 1 Mbps using SISO mode.
11G	IEEE 802.11g with data rate of 6 Mbps using SISO mode.
11G CDD	IEEE 802.11g with data rate of 6 Mbps using CDD mode.
11N20	IEEE 802.11n with data rate of MCS0 and bandwidth of 20 MHz using SISO mode.
11N20m	IEEE 802.11n with data rate of MCS8 and bandwidth of 20 MHz using MIMO mode.
11N40	IEEE 802.11n with data rate of MCS0 and bandwidth of 40 MHz using SISO mode.
11N40m	IEEE 802.11n with data rate of MCS8 and bandwidth of 40 MHz using MIMO mode.

### 5.2 EUT Configurations

#### 5.2.1 General Configurations

Configuration	Description
Test Antenna Ports	Until otherwise specified, <ul style="list-style-type: none"> <li>- All TX tests are performed at all TX antenna ports of the EUT, and</li> <li>- All RX tests are performed at all RX antenna ports of the EUT.</li> </ul>
Multiple RF Sources	Other than the tested RF source of the EUT, other RF source(s) are disabled or shutdown during measurements.

#### 5.2.2 Customized Configurations

Test Mode	RF Ch.	TX Freq. [MHz]	Antenna Port	RX Freq. [MHz]	Ch. BW [MHz]	Power Conf., per Port	Duty cycle [%]
11B	L	Ch No. 1 / 2412 MHz	Ant1	---	20	17.5	99.94
			Ant2	---	20	17	99.94
	M	Ch No. 6 / 2437 MHz	Ant1	---	20	17.5	99.94
			Ant2	---	20	17	99.94
	H	Ch No. 11 / 2462 MHz	Ant1	---	20	17.5	99.94
			Ant2	---	20	17	99.94
11G	L	Ch No. 1 / 2412 MHz	Ant1	---	20	10	99.28
			Ant2	---	20	10	99.38
	L	Ch No. 2/ 2417 MHz	Ant1	---	20	16.5	99.28
			Ant2	---	20	16	99.38
	M	Ch No. 6 / 2437 MHz	Ant1	---	20	16.5	99.28

Test Mode	RF Ch.	TX Freq. [MHz]	Antenna Port	RX Freq. [MHz]	Ch. BW [MHz]	Power Conf., per Port	Duty cycle [%]	
			Ant2	---	20	16	99.38	
			Ant1	---	20	16.5	99.28	
	H	Ch No. 10 / 2457 MHz	Ant2	---	20	16	99.38	
			Ant1	---	20	10	99.28	
	H	Ch No. 11 / 2462 MHz	Ant2	---	20	10	99.34	
			Ant1	---	20	10	99.34	
	11G CDD	L	Ch No. 1 / 2412 MHz	Ant1	---	20	10	99.34
				Ant2	---	20	10	99.34
L		Ch No. 2/ 2417 MHz	Ant1	---	20	16.5	99.34	
			Ant2	---	20	16	99.34	
M		Ch No. 6 / 2437 MHz	Ant1	---	20	16.5	99.34	
			Ant2	---	20	16	99.34	
H		Ch No. 10 / 2457 MHz	Ant1	---	20	16.5	99.34	
			Ant2	---	20	16	99.34	
H	Ch No. 11 / 2462 MHz	Ant1	---	20	10	99.34		
		Ant2	---	20	10	96.85		
11N20	L	Ch No. 1 / 2412 MHz	Ant1	---	20	10	99.29	
			Ant2	---	20	10	99.29	
	L	Ch No. 2/ 2417 MHz	Ant1	---	20	15.5	99.29	
			Ant2	---	20	15	99.29	
	M	Ch No. 6 / 2437 MHz	Ant1	---	20	15.5	99.29	
			Ant2	---	20	15	99.29	
	H	Ch No. 10 / 2457 MHz	Ant1	---	20	15.5	99.29	
			Ant2	---	20	15	99.29	
H	Ch No. 11 / 2462 MHz	Ant1	---	20	10	99.29		
		Ant2	---	20	10	99.29		
11N20m	L	Ch No. 1 / 2412 MHz	Ant1	---	20	10	98.62	
			Ant2	---	20	10	98.62	
	L	Ch No. 2/ 2417 MHz	Ant1	---	20	15.5	98.62	
			Ant2	---	20	15	98.62	
	M	Ch No. 6 / 2437 MHz	Ant1	---	20	15.5	98.62	
			Ant2	---	20	15	98.62	
	H	Ch No. 10 / 2457 MHz	Ant1	---	20	15.5	98.62	
			Ant2	---	20	15	98.62	
H	Ch No. 11 / 2462 MHz	Ant1	---	20	10	98.62		
		Ant2	---	20	10	98.62		
11N40	L	Ch No. 3 / 2422 MHz	Ant1	---	40	7.5	98.56	
			Ant2	---	40	7.5	98.56	
	L	Ch No. 4 / 2427 MHz	Ant1	---	40	15.5	98.56	
			Ant2	---	40	15	98.56	
M	Ch No. 6 / 2437 MHz	Ant1	---	40	15.5	98.56		

Test Mode	RF Ch.	TX Freq. [MHz]	Antenna Port	RX Freq. [MHz]	Ch. BW [MHz]	Power Conf., per Port	Duty cycle [%]
			Ant2	---	40	15	98.56
			Ant1	---	40	6.5	98.56
	H	Ch No. 8 / 2447MHz	Ant2	---	40	6.5	98.56
			Ant1	---	40	6.5	98.56
11N40m	L	Ch No. 3 / 2422 MHz	Ant1	---	40	7.5	97.42
			Ant2	---	40	7.5	97.42
	L	Ch No. 4 / 2427 MHz	Ant1	---	40	15.5	97.42
			Ant2	---	40	15	97.42
M	Ch No. 6 / 2437 MHz	Ant1	---	40	15.5	97.42	
		Ant2	---	40	15	97.42	
H	Ch No. 8 / 2447MHz	Ant1	---	40	6.5	98.56	
		Ant2	---	40	6.5	98.56	
H	Ch No. 9 / 2452 MHz	Ant1	---	40	6.5	97.42	
		Ant2	---	40	6.5	97.42	

### 5.3 Antenna requirements

**Excerpt from §15.203 of the FCC Rules/Regulations:**

“An intentional radiator antenna shall be designed to ensure that no antenna other than that furnished by the responsible party can be used with the device. The use of a permanently attached antenna or of an antenna that uses a unique coupling to the intentional radiator shall be considered sufficient to comply with the provisions of this section.”

The antennas of the **ELE-L04** are **permanently attached**.

There are no provisions for connection to an external antenna.

**Conclusion:**

The **FCC ID: QISELE-L04** unit complies with the requirement of §15.203.

**Ch. Frequency (MHz)**

Ch.	Frequency (MHz)
01	2412
.	.
.	.
06	2437
.	.
.	.
11	2462

Frequency/ Channel Operations

## 5.4 Description of tests

### 5.4.1 Bandwidth measurement

- (a) Connect EUT test port to spectrum analyzer.
- (b) Set the EUT to transmit maximum output power at 2.4GHz, then set the measured frequency number and test the bandwidth with spectrum analyzer.

### 5.4.2 Average output power

- (a) Connect EUT test port to spectrum analyzer.
- (b) Set the EUT to transmit maximum output power at 2.4GHz.
- (c) Then set the EUT to transmit at high, middle and low frequency and measure the conducted output power separately.

### 5.4.3 Band edge spurious emission

- (a) Connect EUT test port to spectrum analyzer
- (b) Set the EUT to transmit maximum output power at 2.4GHz.
- (c) Then set the EUT to transmit at high, low frequency and measure the conducted band edge spurious separately.

### 5.4.4 Conducted RF spurious

- (a) Connect EUT test port to spectrum analyzer
- (b) Set the EUT to transmit maximum output power at 2.4GHz.
- (c) Then set the EUT to transmit at high, middle and low frequency and measure the conducted spurious separately.

### 5.4.5 Power spectral density

- (a) Connect EUT test port to spectrum analyzer
- (b) Set the EUT to transmit maximum output power at 2.4GHz.
- (c) Then set the EUT to transmit at high, middle and low frequency and measure the conducted power spectral density.

### 5.4.6 Radiated spurious emission & spurious in restricted band

For frequency below 1GHz, the test site semi-anechoic chamber has met the requirement of NSA tolerance 4dB according to the standards: ANSI C63.10 (2013). The EUT was set-up on insulator 80cm above the Ground Plane. For frequency above 1GHz, the test site full-anechoic chamber has met the requirement of ANSI C63.10 (2013). The EUT was set-up on insulator 150cm above the Ground Plane.

The set-up and test methods were according to ANSI C63.10:2013. The Radiated Disturbance measurements were made using a Rohde and Schwarz Test Receiver and control software.

A preliminary scan and a final scan of the emissions were made by using test script of software; the emissions were measured using a Quasi-Peak Detector below 1GHz, Peak Detector and AV Detector above 1GHz. The maximal emission value was acquired by adjusting the antenna height, polarisation and turntable azimuth in accordance with the software setup. Normally, the height range of antenna



was 1m to 4m, and the azimuth range of turntable was 0° to 360°. The receive antenna has two polarizations V and H.

A portable or small unlicensed wireless device shall be placed on a non-metallic test fixture or other nonmetallic support during testing. The supporting fixture shall permit orientation of the EUT in each of three orthogonal (x, y, z) axis positions such that emissions from the EUT are maximized.

The EUT communicates with the BTS simulator through Air interface. The EUT operated on the typical channel.

Measurement bandwidth: 30 MHz – 1000 MHz: 120 kHz

Measurement bandwidth: 1000 MHz – 10<sup>th</sup> Carrier Frequency: 1 MHz

#### **5.4.7 Conducted Emission at Power Port**

The Table-top EUT was placed upon a non-metallic table 0.8 m above the horizontal metal reference ground plane. EUT was connected to LISN and LISN was connected to reference Ground Plane. EUT was 80cm from LISN. The set-up and test methods were according to ANSI C63.10: 2013.

Conducted Disturbance at AC Port measurements were undertaken on the L and N Lines. The emissions were measured using a Quasi-Peak Detector and Average Detector.

The EUT communicates with the BTS simulator through Air interface, the BTS simulator controls the Wireless Modem to transmit the maximum power which defined in specification of product. The Wireless Modem operated on the typical channel.

Measurement bandwidth (RBW) for 150kHz to 30 MHz: 9 kHz;

## 5.5 Test Setups

### 5.5.1 Test Setup 1

The WLAN component's antenna ports(s) of the EUT are connected to the measurement instrument per an appropriate attenuator. The EUT is controlled by PC/software to emit the specified signals for the purpose of measurements.

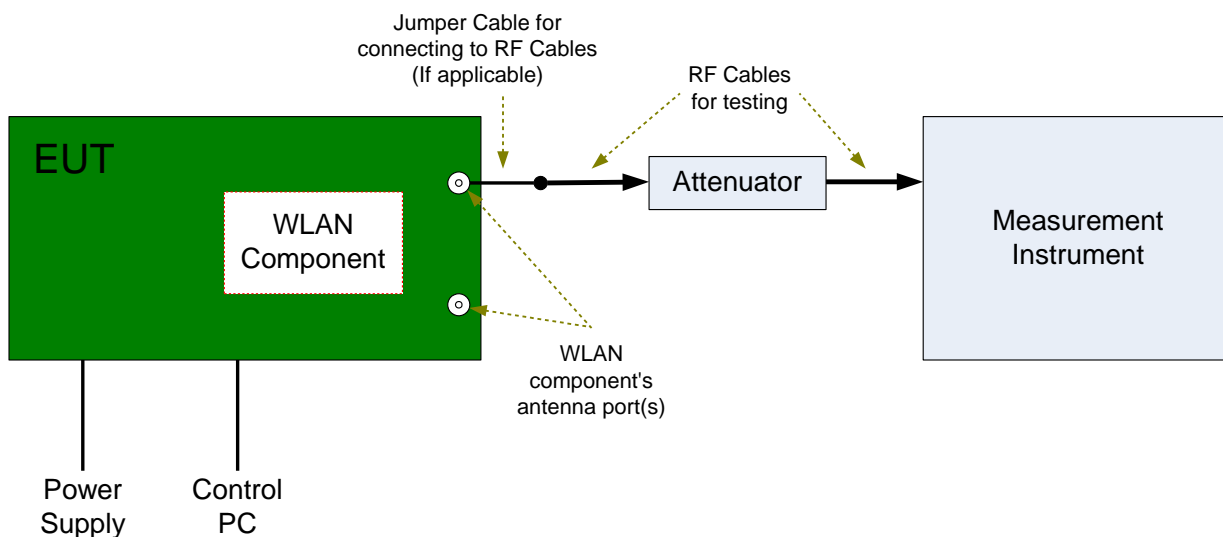

### 5.5.2 Test Setup 2

The semi-anechoic chamber and full-anechoic chamber has met the requirement of ANSI C63.4. The test distance is 3m. The setup is according to ANSI C63.4 and CAN/CSA-CEI/IEC CISPR 22.

The maximal emission value is acquired by adjusting the antenna height, polarisation and turntable azimuth. Normally, the height range of antenna is 1 m to 4 m, the azimuth range of turntable is 0° to 360°, and the receive antenna has two polarizations Vertical (V) and Horizontal (H).

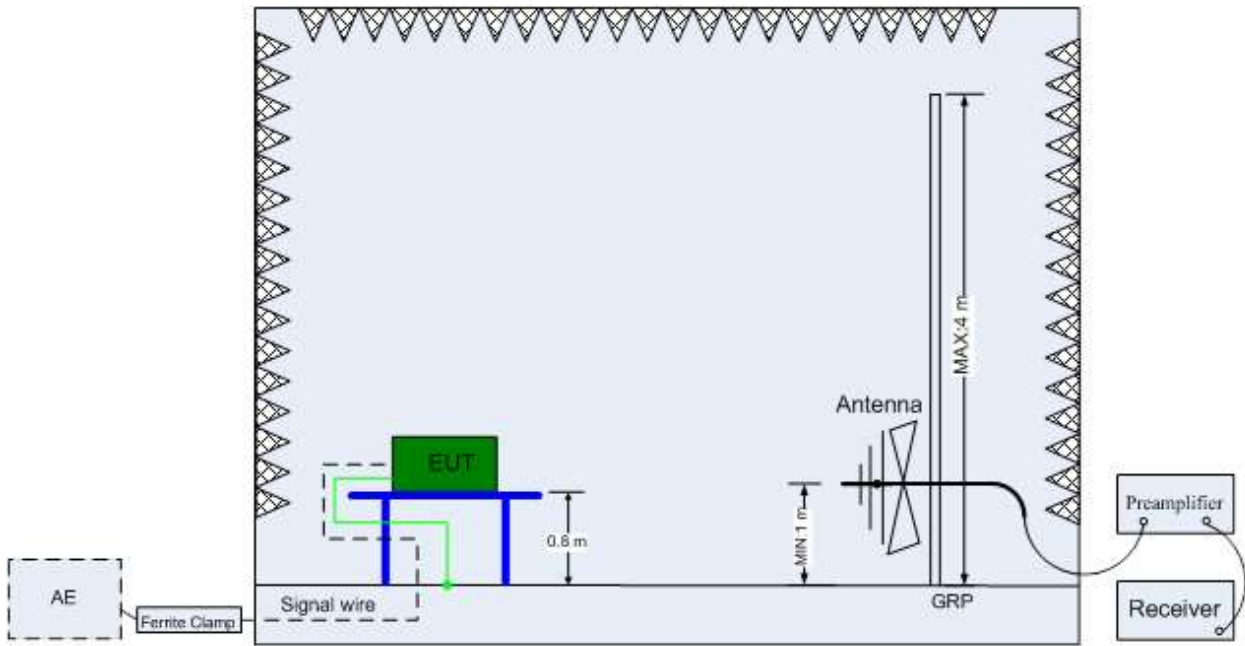

(Below 1 GHz)

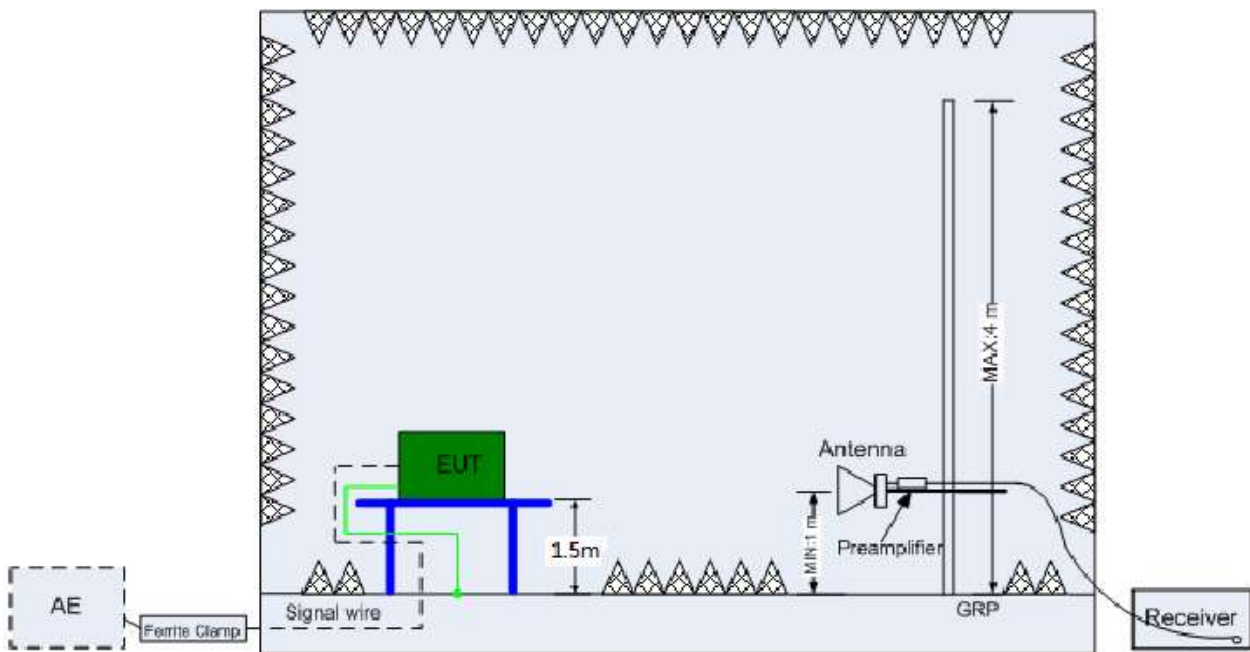

(Above 1 GHz)

### 5.5.3 Test Setup 3

The mains cable of the EUT (maybe per AC/DC Adapter) must be connected to LISN. The LISN shall be placed 0.8 m from the boundary of EUT and bonded to a ground reference plane for LISN mounted on top of the ground reference plane. This distance is between the closest points of the LISN and the EUT. All other units of the EUT and associated equipment shall be at least 0.8m from the LISN.

Ground connections, where required for safety purposes, shall be connected to the reference ground point of the LISN and, where not otherwise provided or specified by the manufacturer, shall be of same length as the mains cable and run parallel to the mains connection at a separation distance of not more than 0.1 m.

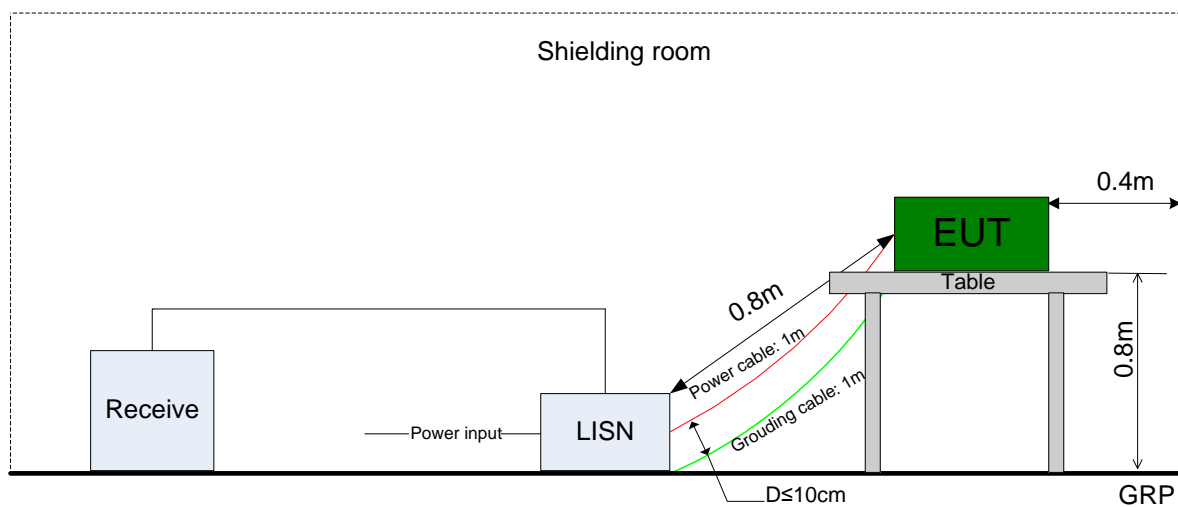

### 5.6 Test Conditions

Test Case	Test Conditions	
	Configuration	Description
DTS (6 dB) Bandwidth	Measurement Method	FCC KDB 558074 D01 §8.2 Option 2.
	Test Environment	TN/VN
	Test Setup	Test Setup 1
	EUT Configuration	11B_L@Ant1, 11B_L@Ant2, 11B_M@Ant1, 11B_M@Ant2, 11B_H@Ant1, 11B_H@Ant2, 11G_L@Ant1, 11G_L@Ant2, 11G_M@Ant1, 11G_M@Ant2, 11G_H@Ant1, 11G_H@Ant2, 11G_CDD_L@Ant1, 11G_CDD_L@Ant2, 11G_CDD_M@Ant1, 11G_CDD_M@Ant2, 11G_CDD_H@Ant1, 11G_CDD_H@Ant2, 11N20_L@Ant1, 11N20_L@Ant2, 11N20_M@Ant1, 11N20_M@Ant2, 11N20_H@Ant1, 11N20_H@Ant2, 11N20m_L@Ant1, 11N20m_L@Ant2, 11N20m_M@Ant1, 11N20m_M@Ant2, 11N20m_H@Ant1, 11N20m_H@Ant2, 11N40_L@Ant1, 11N40_L@Ant2, 11N40_M@Ant1, 11N40_M@Ant2, 11N40_H@Ant1, 11N40_H@Ant2, 11N40m_L@Ant1, 11N40m_L@Ant2, 11N40m_M@Ant1, 11N40m_M@Ant2, 11N40m_H@Ant1, 11N40m_H@Ant2,
Occupied Bandwidth	Measurement Method	FCC KDB 558074 D01 §8.2 Option 2.
	Test Environment	TN/VN
	Test Setup	Test Setup 1
	EUT Configuration	11B_L@Ant1, 11B_L@Ant2, 11B_M@Ant1, 11B_M@Ant2, 11B_H@Ant1, 11B_H@Ant2, 11G_L@Ant1, 11G_L@Ant2, 11G_M@Ant1, 11G_M@Ant2, 11G_H@Ant1, 11G_H@Ant2, 11G_CDD_L@Ant1, 11G_CDD_L@Ant2, 11G_CDD_M@Ant1, 11G_CDD_M@Ant2, 11G_CDD_H@Ant1, 11G_CDD_H@Ant2, 11N20_L@Ant1, 11N20_L@Ant2, 11N20_M@Ant1, 11N20_M@Ant2, 11N20_H@Ant1, 11N20_H@Ant2, 11N20m_L@Ant1, 11N20m_L@Ant2, 11N20m_M@Ant1, 11N20m_M@Ant2, 11N20m_H@Ant1, 11N20m_H@Ant2, 11N40_L@Ant1, 11N40_L@Ant2, 11N40_M@Ant1, 11N40_M@Ant2, 11N40_H@Ant1, 11N40_H@Ant2, 11N40m_L@Ant1, 11N40m_L@Ant2, 11N40m_M@Ant1, 11N40m_M@Ant2, 11N40m_H@Ant1, 11N40m_H@Ant2,
Maximum Conducted Average Output Power	Measurement Method	FCC KDB 558074 D01 §8.3.2.2
	Test Environment	TN/VN
	Test Setup	Test Setup 1
	EUT Configuration	11B_L@Ant1, 11B_L@Ant2, 11B_M@Ant1, 11B_M@Ant2,

Test Case	Test Conditions	
	Configuration	Description
		11B_H@Ant1, 11B_H@Ant2, 11G_L@Ant1, 11G_L@Ant2, 11G_M@Ant1, 11G_M@Ant2, 11G_H@Ant1, 11G_H@Ant2, 11G_CDD_L@Ant1, 11G_CDD_L@Ant2, 11G_CDD_M@Ant1, 11G_CDD_M@Ant2, 11G_CDD_H@Ant1, 11G_CDD_H@Ant2, 11N20_L@Ant1, 11N20_L@Ant2, 11N20_M@Ant1, 11N20_M@Ant2, 11N20_H@Ant1, 11N20_H@Ant2, 11N20m_L@Ant1, 11N20m_L@Ant2, 11N20m_M@Ant1, 11N20m_M@Ant2, 11N20m_H@Ant1, 11N20m_H@Ant2, 11N40_L@Ant1, 11N40_L@Ant2, 11N40_M@Ant1, 11N40_M@Ant2, 11N40_H@Ant1, 11N40_H@Ant2, 11N40m_L@Ant1, 11N40m_L@Ant2, 11N40m_M@Ant1, 11N40m_M@Ant2, 11N40m_H@Ant1, 11N40m_H@Ant2,
Maximum Power Spectral Density Level	Measurement Method	FCC KDB 558074 D01 §8.4
	Test Environment	TN/VN
	Test Setup	Test Setup 1
	EUT Configuration	11B_L@Ant1, 11B_L@Ant2, 11B_M@Ant1, 11B_M@Ant2, 11B_H@Ant1, 11B_H@Ant2, 11G_L@Ant1, 11G_L@Ant2, 11G_M@Ant1, 11G_M@Ant2, 11G_H@Ant1, 11G_H@Ant2, 11G_CDD_L@Ant1, 11G_CDD_L@Ant2, 11G_CDD_M@Ant1, 11G_CDD_M@Ant2, 11G_CDD_H@Ant1, 11G_CDD_H@Ant2, 11N20_L@Ant1, 11N20_L@Ant2, 11N20_M@Ant1, 11N20_M@Ant2, 11N20_H@Ant1, 11N20_H@Ant2, 11N20m_L@Ant1, 11N20m_L@Ant2, 11N20m_M@Ant1, 11N20m_M@Ant2, 11N20m_H@Ant1, 11N20m_H@Ant2, 11N40_L@Ant1, 11N40_L@Ant2, 11N40_M@Ant1, 11N40_M@Ant2, 11N40_H@Ant1, 11N40_H@Ant2, 11N40m_L@Ant1, 11N40m_L@Ant2, 11N40m_M@Ant1, 11N40m_M@Ant2, 11N40m_H@Ant1, 11N40m_H@Ant2,
Band Edges Compliance	Measurement Method	FCC KDB 558074 D01 §8.7
	Test Environment	TN/VN
	Test Setup	Test Setup 1
	EUT Configuration	11B_L@Ant1, 11B_L@Ant2, 11B_H@Ant1, 11B_H@Ant2, 11G_L@Ant1, 11G_L@Ant2, 11G_H@Ant1, 11G_H@Ant2, 11G_CDD_L@Ant1, 11G_CDD_L@Ant2, 11G_CDD_H@Ant1, 11G_CDD_H@Ant2, 11N20_L@Ant1, 11N20_L@Ant2, 11N20_H@Ant1, 11N20_H@Ant2, 11N20m_L@Ant1, 11N20m_L@Ant2, 11N20m_H@Ant1, 11N20m_H@Ant2, 11N40_L@Ant1, 11N40_L@Ant2, 11N40_H@Ant1, 11N40_H@Ant2, 11N40m_L@Ant1, 11N40m_L@Ant2, 11N40m_H@Ant1, 11N40m_H@Ant2,

Test Case	Test Conditions	
	Configuration	Description
		nt2,
Unwanted Emissions into Non-Restricted Frequency Bands	Measurement Method	FCC KDB 558074 D01 §8.5
	Test Environment	TN/VN
	Test Setup	Test Setup 1
	EUT Configuration	11B_L@Ant1, 11B_L@Ant2, 11B_M@Ant1, 11B_M@Ant2, 11B_H@Ant1, 11B_H@Ant2, 11G_L@Ant1, 11G_L@Ant2, 11G_M@Ant1, 11G_M@Ant2, 11G_H@Ant1, 11G_H@Ant2, 11G_CDD_L@Ant1, 11G_CDD_L@Ant2, 11G_CDD_M@Ant1, 11G_CDD_M@Ant2, 11G_CDD_H@Ant1, 11G_CDD_H@Ant2, 11N20_L@Ant1, 11N20_L@Ant2, 11N20_M@Ant1, 11N20_M@Ant2, 11N20_H@Ant1, 11N20_H@Ant2, 11N20m_L@Ant1, 11N20m_L@Ant2, 11N20m_M@Ant1, 11N20m_M@Ant2, 11N20m_H@Ant1, 11N20m_H@Ant2, 11N40_L@Ant1, 11N40_L@Ant2, 11N40_M@Ant1, 11N40_M@Ant2, 11N40_H@Ant1, 11N40_H@Ant2, 11N40m_L@Ant1, 11N40m_L@Ant2, 11N40m_M@Ant1, 11N40m_M@Ant2, 11N40m_H@Ant1, 11N40m_H@Ant2,
Unwanted Emissions into Restricted Frequency Bands (Radiated)	Measurement Method	ANSI C63.10; FCC KDB 558074 D01 §8.6, Radiated
	Test Environment	TN/VN
	Test Setup	Test Setup 2
	EUT Placement	<input checked="" type="checkbox"/> Flatwise, <input checked="" type="checkbox"/> Upright, <input checked="" type="checkbox"/> Hung
	EUT Configuration	(1) 30 MHz to 1 GHz: 11B_L@Ant1 (Worst Conf.). (2) 1 GHz to 3 GHz: 11B_L@Ant1, 11B_L@Ant2, 11B_H@Ant1, 11B_H@Ant2, 11G_L@Ant1, 11G_L@Ant2, 11G_H@Ant1, 11G_H@Ant2, 11G_CDD_L@Ant1, 11G_CDD_L@Ant2, 11G_CDD_H@Ant1, 11G_CDD_H@Ant2, 11N20_L@Ant1, 11N20_L@Ant2, 11N20_H@Ant1, 11N20_H@Ant2, 11N20m_L@Ant1, 11N20m_L@Ant2, 11N20m_H@Ant1, 11N20m_H@Ant2, 11N40_L@Ant1, 11N40_L@Ant2, 11N40_H@Ant1, 11N40_H@Ant2, 11N40m_L@Ant1, 11N40m_L@Ant2, 11N40m_H@Ant1, 11N40m_H@Ant2, (3) 3 GHz to 18 GHz: 11B_L@Ant1 (Worse Conf.), 11B_H@Ant1 (Worse Conf.). (4) 18 GHz to 26.5 GHz: 11B_L@Ant1 (Worse Conf.), 11B_H@Ant1 (Worse Conf.).
AC Power Line Conducted	Measurement Method	AC mains conducted.
	Test Environment	TN/VN



Test Case	Test Conditions	
	Configuration	Description
Emissions	Test Setup	Test Setup 3
	EUT Configuration	11B_L@Ant1 (Worst Conf.).



## 5.7 Main Instruments

### 5.7.1 Test Location 1:

This table gives a complete overview of the RF measurement equipment.

Devices used during the test described are marked

<input checked="" type="checkbox"/> Main Test Equipments(BT/WIFI test system)						
Marked	Equipment Name	Manufacturer	Model	Serial Number	Cal Date	Cal-Due
<input checked="" type="checkbox"/>	JS1120-3 BT/WIFI test system	JS Tonscend	JS0806-2	188060102	2018/05/30	2019/05/30
<input type="checkbox"/>	Power Detecting & Samplig Unit	R&S	OSP-B157	101429	2018/07/23	2019/07/23
<input type="checkbox"/>	Power Sensor	R&S	NRP2	103085/106211	2018/05/17	2019/05/17
<input checked="" type="checkbox"/>	DC Power Supply	KEITHLEY	2303	1342889	2018/10/24	2019/10/24
<input type="checkbox"/>	DC Power Supply	KEITHLEY	2303	000500E	2018/05/21	2019/05/21
<input type="checkbox"/>	DC Power Supply	KEITHLEY	2303	000381E	2018/05/21	2019/05/21
<input type="checkbox"/>	DC Power Supply	KEITHLEY	2303	000510E	2018/05/21	2019/05/21
<input type="checkbox"/>	Temperature Chamber	WEISS	WKL64	56246002940010	2018/12/13	2019/12/13
<input checked="" type="checkbox"/>	Spectrum Analyzer	Agilent	N9030A	MY51380032	2018/07/23	2019/07/23
<input type="checkbox"/>	Spectrum Analyzer	Agilent	N9030A	MY49431698	2018/07/23	2019/07/23
<input type="checkbox"/>	Spectrum Analyzer	Keysight	N9040B	MY57212529	2018/06/28	2019/06/28
<input type="checkbox"/>	Signal Analyzer	R&S	FSQ31	200021	2018/07/23	2019/07/23
<input type="checkbox"/>	Signal Analyzer	R&S	FSU26	201069	2018/11/2	2019/11/2
<input type="checkbox"/>	Universal Radio Communication Tester	R&S	CMW500	164699	2018/03/15	2019/03/15
<input type="checkbox"/>	Universal Radio Communication Tester	R&S	CMW500	159302	2018/07/23	2019/07/23
<input type="checkbox"/>	Wireless Communication Test set	Agilent	N4010A	MY49081592	2018/07/23	2019/07/23
<input checked="" type="checkbox"/>	Signal generator	Agilent	E8257D	MY51500314	2018/04/27	2019/04/27
<input type="checkbox"/>	Signal generator	Agilent	E8257D	MY49281095	2018/07/23	2019/07/23
<input type="checkbox"/>	Vector Signal Generator	R&S	SMW200A	103447	2018/05/31	2019/05/31
<input type="checkbox"/>	Vector Signal Generator	R&S	SMU200A	104162	2018/07/23	2019/07/23

<input checked="" type="checkbox"/> Main Test Equipments( CE test system)						
Marked	Equipment Name	Manufacturer	Model	Serial Number	Cal Date	Cal-Due
<input type="checkbox"/>	Test receiver	R&S	ESU26	100387	2018/01/20	2019/01/19
<input checked="" type="checkbox"/>	Test receiver	R&S	ESCI	101163	2018/01/20	2019/01/19
<input type="checkbox"/>	Artificial Main Network	R&S	ENV4200	100134	2018/05/08	2019/05/07
<input checked="" type="checkbox"/>	Line Impedance Stabilization Network	R&S	ENV216	100382	2018/05/08	2019/05/07

<input checked="" type="checkbox"/>	Measurement Software	R&S	EMC32 V9.25.0	/	/	/
-------------------------------------	----------------------	-----	---------------	---	---	---

**5.7.2 Sub-contracted Test Location 1 :**

Instrument	Manufacturer	Model No.	Serial No.	Characteristics	Calibration Date	Due Date	Remark
EMI Test Receiver&SA	Agilent	N9038A	MY52260185	20Hz~26.5GHz	Aug. 30, 2018	Aug.29, 2019	Radiation (03CH01-SZ)
Loop Antenna	R&S	HFH2-Z2	100354	9kHz~30MHz	May.29, 2018	May.29, 2020	Radiation (03CH01-SZ)
Bilog Antenna	TeseQ	CBL6112D	35407	30MHz-2GHz	Jun. 5, 2018	Jun. 4, 2019	Radiation (03CH01-SZ)
Double Ridge Horn Antenna	ETS Lindgren	3117	119436	1GHz~18GHz	Jun. 28, 2018	Jun. 27, 2019	Radiation (03CH01-SZ)
SHF-EHF Horn	com-power	AH-840	101071	18Ghz-40GHz	Mar.30, 2018	Mar.29, 2019	Radiation (03CH01-SZ)
LF Amplifier	Burgeon	BPA-530	102209	0.01~3000Mhz	Apr. 20, 2018	Apr.19, 2019	Radiation (03CH01-SZ)
HF Amplifier	MITEQ	AMF-7D-00101 800-30-10P-R	1707137	1GHz~18GHz	Oct.18, 2018	Oct 17, 2019	Radiation (03CH01-SZ)
HF Amplifier	KEYSIGHT	83017A	MY53270104	0.5GHz~26.5Ghz	Dec.27, 2017	Dec 26, 2018	Radiation (03CH01-SZ)
HF Amplifier	MITEQ	TTA1840-35-HG	1871923	18GHz~40GHz	Jul.17.2018	Jul.16.2019	Radiation (03CH01-SZ)
AC Power Source	Chroma	61601	616010001985	N/A	NCR	NCR	Radiation (03CH01-SZ)
Turn Table	EM	EM1000	N/A	0~360 degree	NCR	NCR	Radiation (03CH01-SZ)

Software Information			
Test Item	Software Name	Manufacturer	Version
RE	E3	AUDIX	6.2009-8-24(sporton)

## 6 Measurement Uncertainty

For a 95% confidence level ( $k = 2$ ), the measurement expanded uncertainties for defined systems, in accordance with the recommendations of ISO 17025 as following:

Test Item		Extended Uncertainty
Transmit Output Power Data	Power [dBm]	U = 0.39 dB
RF Power Density, Conducted	Power [dBm]	U = 0.64 dB
Bandwidth	Magnitude [kHz]	20MHz: U=41.78kHz 40MHz: U=82.12kHz
Band Edge Compliance	Disturbance Power [dBm]	U = 0.9 dB
Spurious Emissions, Conducted	Disturbance Power [dBm]	20MHz~3.6GHz: U=0.88dB 3.6GHz~8.4GHz: U=1.08dB 8.4GHz~13.6GHz: U=1.24dB 13.6GHz~22GHz: U=1.34dB 22GHz~26.5GHz: U=1.36dB
Field Strength of Spurious Radiation	ERP/EIRP [dBm]	For 3 m Chamber: U = 4.80 dB (30 MHz-1 GHz) U = 5.00 dB (1 GHz-18 GHz) U = 4.30 dB (18 GHz-26.5 GHz)
Frequency Stability	Frequency Accuracy [Hz]	U=41.58Hz
AC Power Line Conducted Emissions	Disturbance Voltage[dB $\mu$ V]	U=2.3 dB
Duty Cycle	Duty Cycle [%]	U= $\pm$ 2.06 %

## 7 Appendixes

Appendix No.	Description
SYBH(Z-RF)20181115007001-2002-A	Appendix for 2.4G WLAN

---

END