



FCC&ISED RF Test Report

Product Name: Smart Phone

Model Number: ELE-L29/ELE-L09

Report No.: SYBH(Z-RF)20181114019001-2003

FCC ID : QISELE-LX9

Autheorized	APPROVED (Lab Manager)	PREPARED (Test Engineer)
BY	He Hao	Zhou Bing bo
DATE	2018-12-27	2018-12-27

Reliability Laboratory of Huawei Technologies Co., Ltd.

(Global Compliance and Testing Center of Huawei Technologies Co., Ltd)

Administration Building, Headquarters of Huawei Technologies Co., Ltd., Bantian, Longgang District,
Shenzhen, 518129, P.R.C

Tel: +86 755 28780808 Fax: +86 755 89652518

※ ※ **Notice** ※ ※

1. The Reliability Laboratory of Huawei Technologies Co., Ltd has passed the accreditation by The American Association for Laboratory Accreditation (A2LA). The accreditation number is 2174.01
2. The Laboratory of Sporton International (Shenzhen) Inc has passed the accreditation by National Voluntary Laboratory Accreditation Program (NVLAP). The NVLAP LAB CODE is 600156-0.
3. The Reliability Laboratory of Huawei Technologies Co., Ltd has been recognized by the US Federal Communications Commission (FCC) to perform compliance testing subject to the Commission's Certification rules. The Designation Number is CN1173, and the Test Firm Registration Number is 294140.
4. The Laboratory of Sporton International (Shenzhen) Inc has been recognized by the US Federal Communications Commission (FCC) to perform compliance testing subject to the Commission's Certification rules. The Designation Number is CN5019, and the Test Firm Registration Number is 577730.
5. The Reliability Laboratory of Huawei Technologies Co., Ltd has been listed by Industry Canada to perform electromagnetic emission measurements. The recognition numbers of test site are 6369A-1.
6. The Reliability Laboratory of Huawei Technologies Co., Ltd is also named "Global Compliance and Testing Center of Huawei Technologies Co., Ltd", the both names have coexisted since 2009.
7. The test report is invalid if not marked with the signatures of the persons responsible for preparing and approving the test report.
8. The test report is invalid if there is any evidence of erasure and/or falsification.
9. The test report is only valid for the test samples.
10. Content of the test report, in part or in full, cannot be used for publicity and/or promotional purposes without prior written approval from the laboratory.

MODIFICATION RECORD

No.	Report No	Modification Description
1	SYBH(Z-RF)20181114019001	First release.

DECLARATION

Type	Description
Multiple Models Applications	<p><input type="checkbox"/> The present report applies to single model.</p> <p><input checked="" type="checkbox"/> The present report applies to several models. The practical measurements are performed with the model <u>ELE-L29</u>.</p> <p>These models utilize the similar radio design, shielding, interface, physical layout and so on. The differences and modifications between these models are declared by the applicant and showed in General Description</p> <p>All others between these models are identical.</p> <p>The present report only presents the worst test case of all modes, see relevant test results for detailed.</p>

1 Table of contents

1	Table of contents	4
2	General Information	5
2.1	Test standard/s	5
2.2	Test Environment	5
2.3	Test Laboratories	5
2.4	Applicant and Manufacturer	6
2.5	Application details	6
3	Test Summary	6
4	Description of the Equipment under Test (EUT)	8
4.1	General Description	8
4.2	EUT Identity	9
4.3	Technical Description	11
5	General Test Conditions / Configurations	12
5.1	EUT Configurations	12
5.2	Test Setups	13
5.3	Test Conditions	16
6	Main Test Instruments	18
7	Measurement Uncertainty	20

2 General Information

2.1 Test standard/s

Applied Rules :	47 CFR FCC Part 2, Subpart J 47 CFR FCC Part 15, Subpart C
Test Method :	FCC KDB 558074 D01 DTS Meas Guidance v05 ANSI C63.10-2013, American National Standard for Testing Unlicensed Wireless Devices.

2.2 Test Environment

Temperature :	TN	15 to 30	°C during room temperature tests
Ambient Relative Humidity:	20 to 85 %		
Atmospheric Pressure:	Not applicable		
Power supply :	VL	3.6	V
	VN	3.82	V DC by Battery
	VH	4.35	V

NOTE 1: 1) VN= nominal voltage, VL= low extreme test voltage, VH= High extreme test voltage;

TN= normal temperature, TL= low extreme test temperature, TH= High extreme test temperature.

NOTE 2: The values used in the test report may be stringent than the declared.

2.3 Test Laboratories

Test Location 1 :	RELIABILITY LABORATORY OF HUAWEI TECHNOLOGIES CO., LTD.
Address of Test Location 1 :	No.2 New City Avenue Songshan Lake Sci. &Tech. Industry Park, Dongguan, Guangdong, P.R.C
Sub-contracted Test Location 1 :	Sporton International (Shenzhen) Inc.
Address of Sub-contracted Test Location 1 :	No.3 Building, the third floor of south, Shahe River west, Fengzeyuan warehouse, Nanshan District, Shenzhen, Guangdong, P.R.China

2.4 Applicant and Manufacturer

Company Name :	HUAWEI TECHNOLOGIES CO., LTD
Address :	Administration Building, Headquarters of Huawei Technologies Co., Ltd., Bantian, Longgang District, Shenzhen, 518129, P.R.C

2.5 Application details

Date of Receipt Sample:	2018-11-22
Start of test:	2018-11-22
End of test:	2018-12-25

3 Test Summary

Test Item	FCC Rule No.	Requirements	Test Result	Verdict	Testing location
DTS (6 dB) Bandwidth	15.247(a)(2)	≥ 500 kHz.	Appendix A	Refer to NO. SYBH(Z-RF)2018111 5007001	Test Location 1
Occupied Bandwidth	---	No limit.	Appendix B	Refer to NO. SYBH(Z-RF)2018111 5007001	Test Location 1
Duty Cycle	KDB 558074 D01 (6.0)	No limit.	Appendix C	Refer to NO. SYBH(Z-RF)2018111 5007001	Test Location 1
Maximum Conducted Average Output Power	15.247(b)(3)	FCC: For directional gain: Conducted < 30 dBm – (G[dBi] – 6 [dB]); Otherwise: Conducted < 30 dBm,	Appendix D	Refer to NO. SYBH(Z-RF)2018111 5007001	Test Location 1
Maximum Power Spectral Density Level	15.247(e)	Conducted < 8 dBm/3 kHz.	Appendix E	Refer to NO. SYBH(Z-RF)2018111 5007001	Test Location 1
Band Edges Compliance	15.247(d)	< -20 dBm/100 kHz if total peak power ≤ power	Appendix F	Refer to NO. SYBH(Z-RF)2018111 5007001	Test Location 1

Test Item	FCC Rule No.	Requirements	Test Result	Verdict	Testing location
Unwanted Emissions into Non-Restricted Frequency Bands		limit.	Appendix G	Refer to NO. SYBH(Z-RF)2018111 5007001	Test Location 1
Unwanted Emissions into Restricted Frequency Bands (Radiated)	15.247(d) 15.209 (NOTE 1)	FCC Part 15.209 field strength limit;	Appendix H	Refer to NO. SYBH(Z-RF)2018111 5007001	Sub-contracted Test Location 1
AC Power Line Conducted Emissions	15.207	FCC Part 15.207 conducted limit;	Appendix I	Refer to NO. SYBH(Z-RF)2018111 5007001	Test Location 1
<p>Note1: According to KDB 558074 D01, antenna-port conducted measurements are acceptable as an alternative to radiated measurements for demonstrating compliance to the limits in the restricted frequency bands. If conducted measurements are performed, then proper impedance matching must be ensured and an additional radiated test for cabinet/case emissions will also be required.</p> <p>Note2: The transmitter has an integral PCB loop antenna that is enclosed within the housing of the EUT and meets the requirements of FCC 15.203</p>					

4 Description of the Equipment under Test (EUT)

4.1 General Description

ELE-L29/ELE-L09 is subscriber equipment in the GSM/WCDMA/LTE system. The GSM frequency band includes GSM850 and GSM900 and DCS1800 and PCS1900. The UMTS frequency band is B1 and B2 and B4 and B5 and B6 and B8 and B19. The ELE-L29/ELE-L09 LTE frequency band is B1 and B2 and B3 and B4 and B5 and B6 and B7 and B8 and B9 and B12 and B17 and B18 and B19 and B20 and B26 and B28 and B32 and B34 and B38 and B39 and B41. The ELE-L29 LTE frequency band for intra-band carrier aggregation uplink operation band is CA_1C and CA_2C and CA_3C and CA_7C and CA_38C and CA_39C and CA_41C. The Mobile Phone implements such functions as RF signal receiving/transmitting LTE/HSPA/UMTS and GSM/GPRS/EDGE protocol processing, voice, video MMS service, GPS, AGPS and WIFI etc. Externally it provides one micro SD card interface (it can also used as SIM card interface), earphone port (to provide voice service) and one SIM card interface. ELE-L29 is dual SIM smart phone. ELE-L09 is single SIM smart phone. It also provides Bluetooth module to synchronize data between a PC and the phone, or to use the built-in modem of the phone to access the Internet with a PC, or to exchange data with other Bluetooth devices.

The difference between model ELE-L04 and model ELE -L29 is show in the below table.

	Model	ELE-L04	ELE-L29
Licensed Frequency	LTE BAND	FCC Band: B2/B4/ B5/B7/B12/B17/B26/B38/ B41 (2535~2655MHz) /B66	FCC Band: B2/B4/ B5/B7/B12/B17/B26/B38/ B41 (2535~2655MHz)
	UMTS BAND	FCC Band: B2/B4/B5	FCC Band: B2/B4/B5
	GSM	FCC Band: B2/B5	FCC Band: B2/B5
	IC	the same	the same
	Antenna	the same	the same
	NFC	the same	the same
Unlicensed Frequency	Bluetooth	the same	the same
	2.4G Wi-Fi	the same	the same
	IC	the same	the same
	Antenna	the same	the same
Hardware	Ram / Rom	the same	the same
	Camera	the same	the same
	PCB	the same	the same
	USB Port	the same	the same
	SIM	one	two
	Hardware version	HL1ELLEM	HL1ELLEM
RF	RF circuit	The hardware channel of LTE	The hardware channel of LTE

		B2/4/7(include CA band) is different	B2/4/7(include CA band) is different
Appearance	Dimension	the same	the same
	Color	different	different
Accessory	Battery	the same	the same
	External Charger	the same	the same
	USB label	the same	the same
	Earphone	the same	the same

Note1: Only Bluetooth BLE test data included in this report.

Note2: We do not test Bluetooth BLE of ELE-L29/ELE-L09, all test data can refer to No. SYBH(Z-RF)20181115007001 of ELE-L04(FCC ID:QISELE-L04).

4.2 EUT Identity





NOTE: Unless otherwise noted in the report, the functional boards installed in the units shall be selected from the below list, but not means all the functional boards listed below shall be installed in one unit.

4.2.1 Board

Board		
Description	Software Version	Hardware Version
Main Board	5.0.1.73 (SP2C432E73R1P6)	HL1ELLEM

4.2.2 Sub- Assembly

Sub-Assembly			
Sub-Assembly Name	Model	Manufacturer	Description
Adapter	HW-050450B00	Huawei Technologies Co.,Ltd.	Input Voltage:100V-240V~50/60Hz, 0.75A Output Voltage: 5V === 2A OR4.5V === 5A OR 5V === 4.5A
Adapter	HW-050450E00	Huawei Technologies Co.,Ltd.	Input Voltage:100V-240V~50/60Hz, 0.75A Output Voltage: 5V === 2A OR4.5V === 5A OR 5V === 4.5A
Adapter	HW-050450U00	Huawei Technologies Co.,Ltd.	Input Voltage:100V-240V~50/60Hz, 0.75A Output Voltage: 5V === 2A OR4.5V === 5A OR 5V === 4.5A
Adapter	HW-050450A00	Huawei Technologies Co.,Ltd.	Input Voltage:100V-240V~50/60Hz, 0.75A Output Voltage: 5V === 2A OR4.5V === 5A OR 5V === 4.5A
Adapter	HW-050450E01	Huawei Technologies	Input Voltage:100V-240V~50/60Hz, 0.75A Output Voltage: 5V === 2A OR4.5V === 5A

Sub-Assembly			
Sub-Assembly Name	Model	Manufacturer	Description
		Co.,Ltd.	OR 5V  4.5A
Adapter	HW-050450A01	Huawei Technologies Co.,Ltd.	Input Voltage:100V-240V~50/60Hz, 0.75A Output Voltage: 5V  2A OR4.5V  5A OR 5V  4.5A
Li-ion Polymer Battery	HB436380ECW	Huawei Technologies Co.,Ltd.	Rated capacity: 3550mAh Nominal Voltage: +3.85V Charging Voltage: +4.43V

4.3 Technical Description

NOTE: For the detailed technical descriptions, see the applicant/manufacturer’s specifications or user manual.

Characteristics	Description	
TX/RX Operating Range	2400-2483.5 MHz band	$fc = 2402 \text{ MHz} + N * 2 \text{ MHz}$, where: - fc = “Operating Frequency” in MHz, - N = “Channel Number” with the range from 0 to 39.
Modulation Type	Digital	GFSK,
Emission Designator	GFSK for BT 4.2: 1M03FXD; GFSK for BT 5.0: 2M07FXD	
Bluetooth Power Class	Class 1	
Antenna	Description	Isotropic Antenna
	Type	<input checked="" type="checkbox"/> Integral <input type="checkbox"/> External <input type="checkbox"/> Dedicated
	Ports	<input checked="" type="checkbox"/> Ant 1, <input type="checkbox"/> Ant 2, <input type="checkbox"/> Ant 3
	Gain	-2.56dBi (per antenna port, max.)
	Remark	When the EUT is put into service, the practical maximum antenna gain should NOT exceed the value as described above.
Power Supply	Type	<input type="checkbox"/> External DC mains, <input checked="" type="checkbox"/> Battery, <input type="checkbox"/> AC/DC Adapter, <input type="checkbox"/> Powered over Ethernet (PoE). <input type="checkbox"/> Other

5 General Test Conditions / Configurations

5.1 EUT Configurations

5.1.1 General Configurations

Configuration	Description
Test Antenna Ports	Until otherwise specified, - All TX tests are performed at all TX antenna ports of the EUT, and - All RX tests are performed at all RX antenna ports of the EUT.
Multiple RF Sources	Other than the tested RF source of the EUT, other RF source(s) are disabled or shutdown during measurements.

5.1.2 Customized Configurations

# EUT Conf.	Signal Description	Operating Frequency	Duty cycle
TM1_Ch0	GFSK for BT 4.2 modulation, package type DH5, hopping off.	Ch No. 0 / 2402 MHz	60.8%
TM1_Ch19	GFSK for BT 4.2 modulation, package type DH5, hopping off.	Ch No. 19 / 2440 MHz	60.70%
TM1_Ch39	GFSK for BT 4.2 modulation, package type DH5, hopping off.	Ch No. 39 / 2480 MHz	60.8%
TM2_Ch0	GFSK for BT 5.0 modulation, package type DH5, hopping off.	Ch No. 0 / 2402 MHz	56.90%
TM2_Ch19	GFSK for BT 5.0 modulation, package type DH5, hopping off.	Ch No. 19 / 2440 MHz	56.90%
TM2_Ch39	GFSK for BT 5.0 modulation, package type DH5, hopping off.	Ch No. 39 / 2480 MHz	56.93%

5.2 Test Setups

5.2.1 Test Setup 1

The Bluetooth component's antenna ports(s) of the EUT are connected to the measurement instrument per an appropriate attenuator. The EUT is controlled by Bluetooth System Simulator and/or PC/software to emit the specified signals for the purpose of measurements.

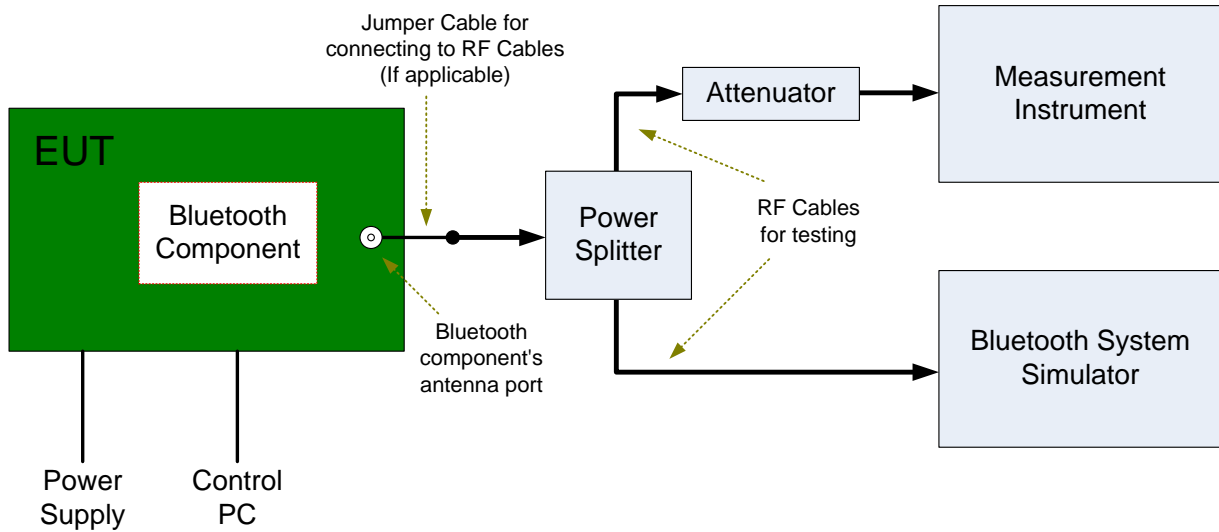

5.2.2 Test Setup 2

The semi-anechoic chamber and full-anechoic chamber has met the requirement of ANSI C63.4. The test distance is 3m. The setup is according to ANSI C63.4 and CAN/CSA-CEI/IEC CISPR 22.

The maximal emission value is acquired by adjusting the antenna height, polarisation and turntable azimuth. Normally, the height range of antenna is 1 m to 4 m, the azimuth range of turntable is 0° to 360°, and the receive antenna has two polarizations Vertical (V) and Horizontal (H).

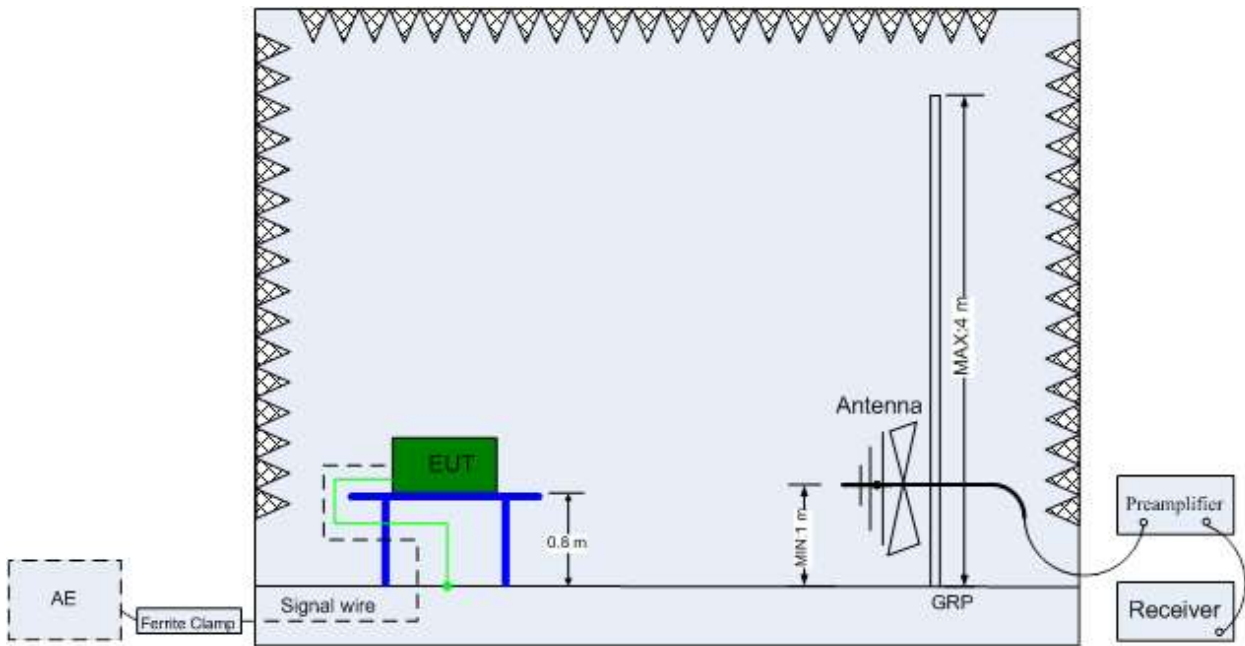

(Below 1 GHz)

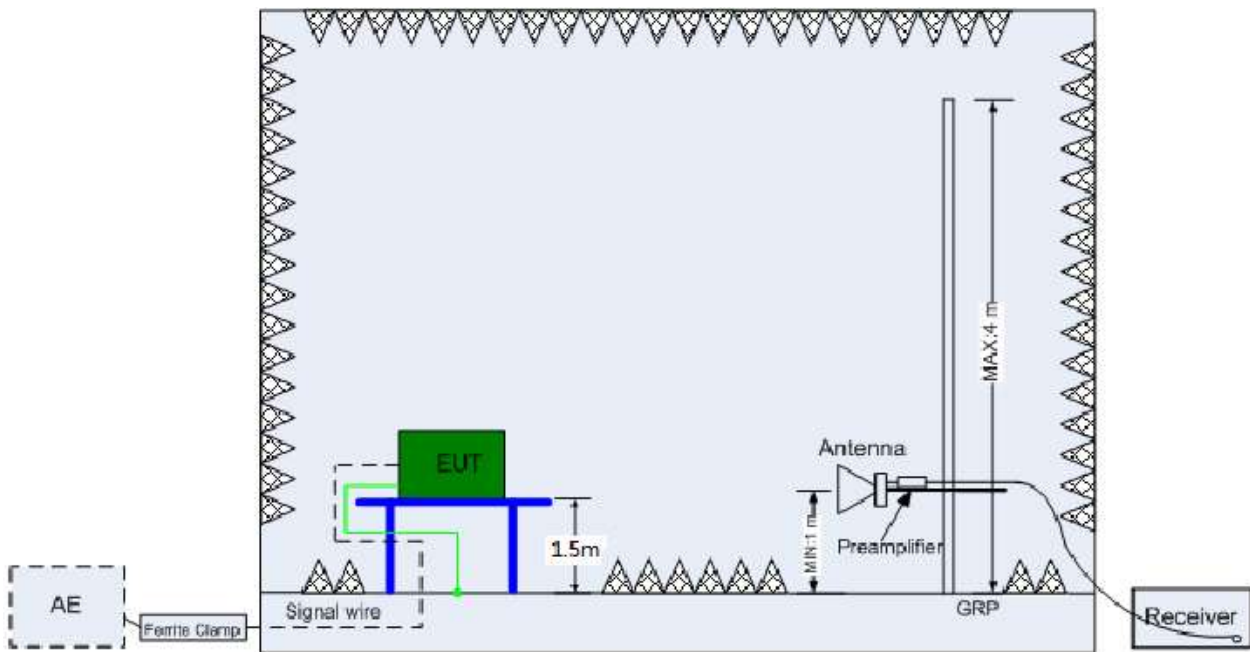

(Above 1 GHz)

5.2.3 Test Setup 3

The mains cable of the EUT (maybe per AC/DC Adapter) must be connected to LISN. The LISN shall be placed 0.8 m from the boundary of EUT and bonded to a ground reference plane for LISN mounted on top of the ground reference plane. This distance is between the closest points of the LISN and the EUT. All other units of the EUT and associated equipment shall be at least 0.8m from the LISN.

Ground connections, where required for safety purposes, shall be connected to the reference ground point of the LISN and, where not otherwise provided or specified by the manufacturer, shall be of same length as the mains cable and run parallel to the mains connection at a separation distance of not more than 0.1 m.

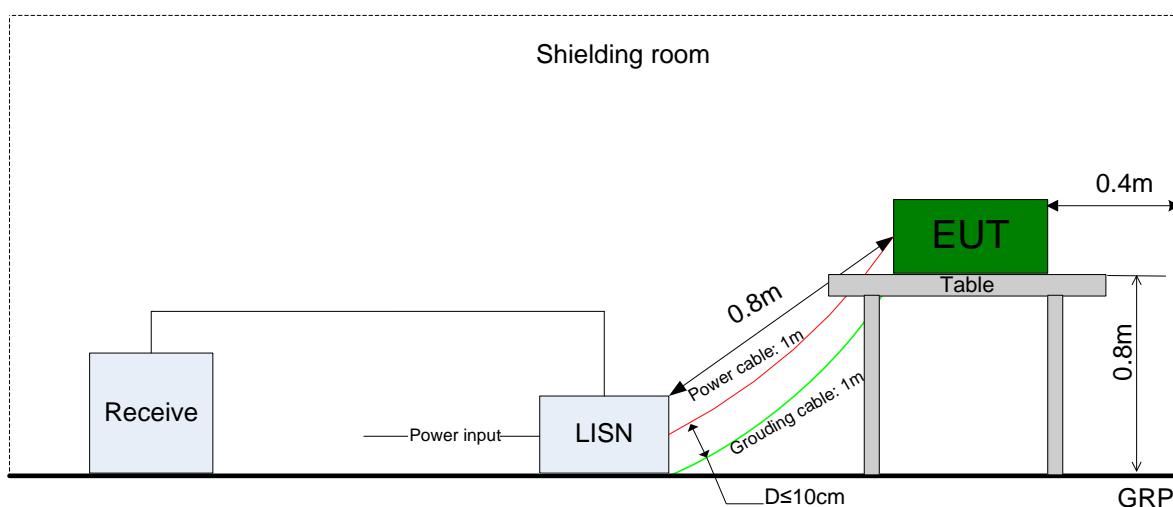

5.3 Test Conditions

Test Case	Test Conditions			
	Configuration	Description		
6dB Emission Bandwidth (EBW)	Meas. Method	FCC KDB 558074 D01 §8.2 Option 2.		
	Test Env.	TN/VN		
	Test Setup	Test Setup 1		
	EUT Conf.	TM1_Ch0, TM1_Ch19, TM1_Ch39. TM2_Ch0, TM2_Ch19, TM2_Ch39.		
Occupied Bandwidth	Meas. Method	FCC KDB 558074 D01 §8.2 Option 2.		
	Test Env.	TN/VN		
	Test Setup	Test Setup 1		
	EUT Conf.	TM1_Ch0, TM1_Ch19, TM1_Ch39. TM2_Ch0, TM2_Ch19, TM2_Ch39.		
Maximum peak Conducted Output Power	Meas. Method	FCC KDB 558074 D01 §8.3.1.1		
	Test Env.	TN/VN		
	Test Setup	Test Setup 1		
	EUT Conf.	TM1_Ch0, TM1_Ch19, TM1_Ch39. TM2_Ch0, TM2_Ch19, TM2_Ch39.		
Maximum Power Spectral Density Level	Meas. Method	FCC KDB 558074 D01 §8.4		
	Test Env.	TN/VN		
	Test Setup	Test Setup 1		
	EUT Conf.	TM1_Ch0, TM1_Ch19, TM1_Ch39. TM2_Ch0, TM2_Ch19, TM2_Ch39.		
Band edge spurious emission	Meas. Method	FCC KDB 558074 D01§8.7		
	Test Env.	TN/VN		
	Test Setup	Test Setup 1		
	EUT Conf.	TM1_Ch0, TM1_Ch39. TM2_Ch0, TM2_Ch39.		
Unwanted Emissions into Non-Restricted Frequency Bands	Meas. Method	FCC KDB 558074 D01§8.5		
	Test Env.	TN/VN		
	Test Setup	Test Setup 1		
	EUT Conf.	TM1_Ch0, TM1_Ch19, TM1_Ch39. TM2_Ch0, TM2_Ch19, TM2_Ch39.		
Unwanted Emissions into Restricted Frequency Bands (Radiated)	Meas. Method	ANSI C63.10; FCC KDB 558074 D01§8.6, Radiated		
	Test Env.	TN/VN		
	Test Setup	Test Setup 2		
	EUT Conf.	30 MHz -1 GHz	TM1_Ch0 (Worst Conf.). TM2_Ch0 (Worst Conf.).	
		1-3 GHz	TM1_Ch0, TM2_Ch39. TM2_Ch0, TM2_Ch39.	
3-18 GHz		TM1_Ch19 (Worst Conf.), TM2_Ch19 (Worst Conf.),		
18-26.5 GHz		TM1_Ch0 (Worst Conf.). TM2_Ch0 (Worst Conf.).		

Test Case	Test Conditions	
	Configuration	Description
AC Power Line Conducted Emissions	Meas. Method	AC mains conducted. Pre: RBW = 10 kHz; Det. = Peak. Final: RBW = 9 kHz; Det. = CISPR Quasi-Peak & Average.
	Test Env.	TN/VN
	Test Setup	Test Setup 3
	EUT Conf.	TM1_Ch39, TM2_Ch39,

6 Main Test Instruments

6.1.1 Test Location 1:

This table gives a complete overview of the RF measurement equipment.

Devices used during the test described are marked

<input checked="" type="checkbox"/> Main Test Equipments(BT/WIFI test system)						
Marked	Equipment Name	Manufacturer	Model	Serial Number	Cal Date	Cal-Due
<input checked="" type="checkbox"/>	JS1120-3 BT/WIFI test system	JS Tonscend	JS0806-2	188060102	2018/05/30	2019/05/30
<input type="checkbox"/>	Power Detecting & Samplig Unit	R&S	OSP-B157	101429	2018/07/23	2019/07/23
<input type="checkbox"/>	Power Sensor	R&S	NRP2	103085/106211	2018/05/17	2019/05/17
<input type="checkbox"/>	DC Power Supply	KEITHLEY	2303	1342889	2018/10/24	2019/10/24
<input type="checkbox"/>	DC Power Supply	KEITHLEY	2303	000500E	2018/05/21	2019/05/21
<input type="checkbox"/>	DC Power Supply	KEITHLEY	2303	000381E	2018/05/21	2019/05/21
<input type="checkbox"/>	DC Power Supply	KEITHLEY	2303	000510E	2018/05/21	2019/05/21
<input type="checkbox"/>	Temperature Chamber	WEISS	WKL64	56246002940010	2018/12/13	2019/12/13
<input checked="" type="checkbox"/>	Spectrum Analyzer	Agilent	N9030A	MY51380032	2018/07/23	2019/07/23
<input type="checkbox"/>	Spectrum Analyzer	Agilent	N9030A	MY49431698	2018/07/23	2019/07/23
<input type="checkbox"/>	Spectrum Analyzer	Keysight	N9040B	MY57212529	2018/06/28	2019/06/28
<input type="checkbox"/>	Signal Analyzer	R&S	FSQ31	200021	2018/07/23	2019/07/23
<input type="checkbox"/>	Signal Analyzer	R&S	FSU26	201069	2018/11/2	2019/11/2
<input type="checkbox"/>	Universal Radio Communication Tester	R&S	CMW500	164699	2018/03/15	2019/03/15
<input type="checkbox"/>	Universal Radio Communication Tester	R&S	CMW500	159302	2018/07/23	2019/07/23
<input type="checkbox"/>	Wireless Communication Test set	Agilent	N4010A	MY49081592	2018/07/23	2019/07/23
<input checked="" type="checkbox"/>	Signal generator	Agilent	E8257D	MY51500314	2018/04/27	2019/04/27
<input type="checkbox"/>	Signal generator	Agilent	E8257D	MY49281095	2018/07/23	2019/07/23
<input type="checkbox"/>	Vector Signal Generator	R&S	SMW200A	103447	2018/05/31	2019/05/31
<input type="checkbox"/>	Vector Signal Generator	R&S	SMU200A	104162	2018/07/23	2019/07/23

<input checked="" type="checkbox"/> Main Test Equipments(CE test system)						
Marked	Equipment Name	Manufacturer	Model	Serial Number	Cal Date	Cal-Due
<input type="checkbox"/>	Test receiver	R&S	ESU26	100387	2018/01/20	2019/01/19
<input checked="" type="checkbox"/>	Test receiver	R&S	ESCI	101163	2018/01/20	2019/01/19
<input type="checkbox"/>	Artificial Main Network	R&S	ENV4200	100134	2018/05/08	2019/05/07
<input checked="" type="checkbox"/>	Line Impedance Stabilization Network	R&S	ENV216	100382	2018/05/08	2019/05/07
<input checked="" type="checkbox"/>	Measurement Software	R&S	EMC32 V9.25.0	/	/	/

6.1.2 Sub-contracted Test Location 1:

Instrument	Manufacturer	Model No.	Serial No.	Characteristics	Calibration Date	Due Date	Remark
EMI Test Receiver&SA	Agilent	N9038A	MY52260185	20Hz~26.5GHz	Aug. 30, 2018	Aug.29, 2019	Radiation (03CH01-SZ)
Loop Antenna	R&S	HFH2-Z2	100354	9kHz~30MHz	May.29, 2018	May.29, 2020	Radiation (03CH01-SZ)
Bilog Antenna	TeseQ	CBL6112D	35407	30MHz-2GHz	Jun. 5, 2018	Jun. 4, 2019	Radiation (03CH01-SZ)
Double Ridge Horn Antenna	ETS Lindgren	3117	119436	1GHz~18GHz	Jun. 28, 2018	Jun. 27, 2019	Radiation (03CH01-SZ)
SHF-EHF Horn	com-power	AH-840	101071	18Ghz-40GHz	Mar.30, 2018	Mar.29, 2019	Radiation (03CH01-SZ)
LF Amplifier	Burgeon	BPA-530	102209	0.01~3000Mhz	Apr. 20, 2018	Apr.19, 2019	Radiation (03CH01-SZ)
HF Amplifier	MITEQ	AMF-7D-00101 800-30-10P-R	1707137	1GHz~18GHz	Oct.18, 2018	Oct 17, 2019	Radiation (03CH01-SZ)
HF Amplifier	KEYSIGHT	83017A	MY53270104	0.5GHz~26.5Ghz	Dec.27, 2017	Dec 26, 2018	Radiation (03CH01-SZ)
HF Amplifier	MITEQ	TTA1840-35-HG	1871923	18GHz~40GHz	Jul.17.2018	Jul.16.2019	Radiation (03CH01-SZ)
AC Power Source	Chroma	61601	616010001985	N/A	NCR	NCR	Radiation (03CH01-SZ)
Turn Table	EM	EM1000	N/A	0~360 degree	NCR	NCR	Radiation (03CH01-SZ)

Software Information			
Test Item	Software Name	Manufacturer	Version
RE	E3	AUDIX	6.2009-8-24(sporton)

7 Measurement Uncertainty

For a 95% confidence level ($k = 2$), the measurement expanded uncertainties for defined systems, in accordance with the recommendations of ISO 17025 as following:

Test Item		Extended Uncertainty
Transmit Output Power Data	Power [dBm]	U = 0.39 dB
RF Power Density, Conducted	Power [dBm]	U = 0.64 dB
Bandwidth	Magnitude [%]	U=7%
Band Edge Compliance	Disturbance Power [dBm]	U = 0.9 dB
Spurious Emissions, Conducted	Disturbance Power [dBm]	20MHz~3.6GHz: U=0.88dB 3.6GHz~8.4GHz: U=1.08dB 8.4GHz~13.6GHz: U=1.24dB 13.6GHz~22GHz: U=1.34dB 22GHz~26.5GHz: U=1.36dB
Field Strength of Spurious Radiation	ERP/EIRP [dBm]	For 3 m Chamber: U = 5.90 dB (30 MHz-1 GHz) U = 4.94 dB (1 GHz-18 GHz) U = 4.24 dB (18 GHz-26.5 GHz)
Frequency Stability	Frequency Accuracy [Hz]	U=41.58Hz
AC Power Line Conducted Emissions	Disturbance Voltage[dBμV]	U=2.3 dB
Duty Cycle	Duty Cycle [%]	U=±2.06 %

END