

RE 3-18GHz PK+AV

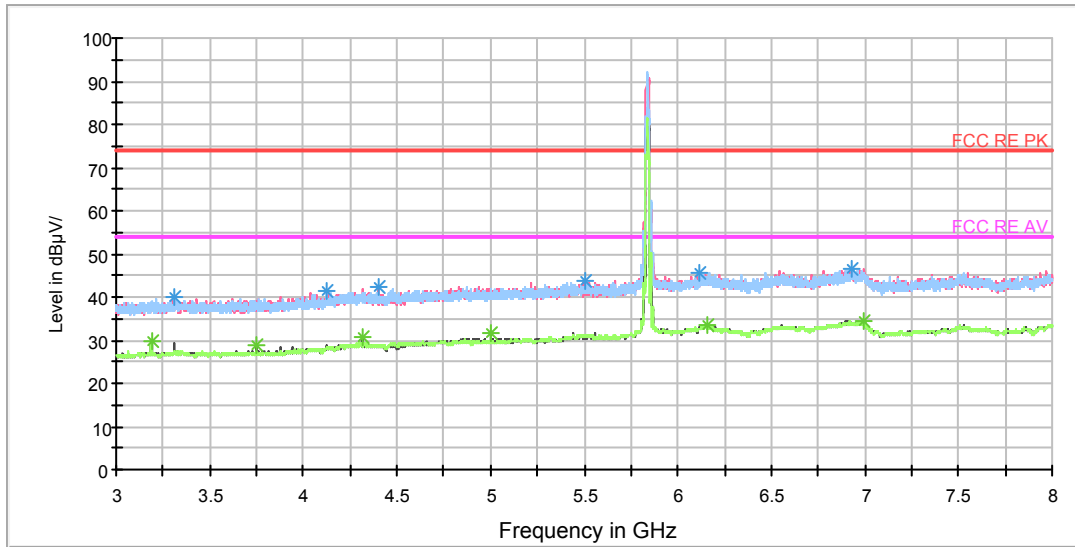

Note: The signal beyond the limit is carrier.  
Radiates Emission from 3GHz to 8GHz

Frequency (MHz)	Peak (dBuV/m)	Height (cm)	Polarization	Azimuth (deg)	Reading value (dBuV/m)	Correct Factor (dB)	Margin (dB)	Limit (dBuV/m)
3311.875000	39.9	105.0	V	124.0	42.0	-2.1	34.1	74
4120.625000	41.3	105.0	H	178.0	41.8	-0.5	32.7	74
4397.500000	42.2	105.0	V	225.0	42.1	0.1	31.8	74
5510.625000	43.8	105.0	V	250.0	40.7	3.1	30.2	74
6115.000000	45.8	105.0	H	0.0	40.5	5.3	28.2	74
6925.000000	46.5	105.0	V	0.0	40.3	6.2	27.5	74

Remark: 1. Correction Factor = Antenna factor+ Insertion loss (cable loss + amplifier gain)

Frequency (MHz)	Average (dBuV/m)	Height (cm)	Polarization	Azimuth (deg)	Reading value (dBuV/m)	Correct Factor (dB)	Margin (dB)	Limit (dBuV/m)
3187.500000	29.7	105.0	H	2.0	32.6	-2.9	24.3	54
3750.000000	28.9	105.0	V	327.0	30.6	-1.7	25.1	54
4312.500000	30.8	105.0	V	0.0	30.2	0.6	23.2	54
5000.000000	31.8	105.0	V	327.0	30.2	1.6	22.2	54
6155.625000	33.4	105.0	V	0.0	27.8	5.6	20.6	54
6995.000000	34.5	105.0	H	0.0	28.0	6.5	19.5	54

Remark: 1. Correction Factor = Antenna factor+ Insertion loss (cable loss + amplifier gain)

RE 3-18GHz PK+AV(YIPU)

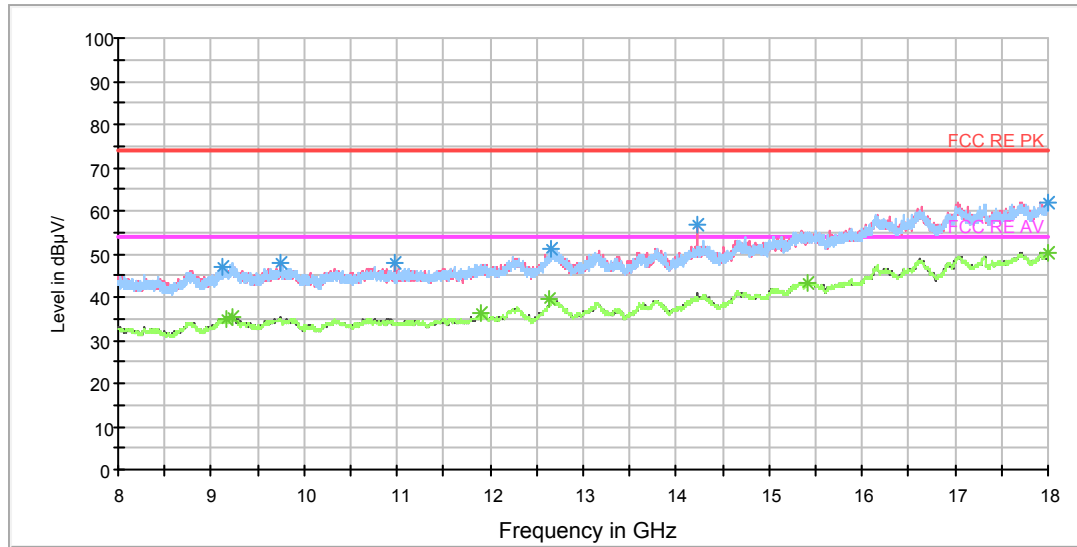

Radiates Emission from 8GHz to 18GHz

Frequency (MHz)	Peak (dBuV/m)	Height (cm)	Polarization	Azimuth (deg)	Reading value (dBuV/m)	Correct Factor (dB)	Margin (dB)	Limit (dBuV/m)
9123.750000	46.9	105.0	V	244.0	36.8	10.1	27.1	74
9738.750000	47.7	105.0	V	299.0	37.7	10.0	26.3	74
10973.750000	47.9	105.0	V	0.0	38.2	9.7	26.1	74
12656.250000	51.1	105.0	V	0.0	37.2	13.9	22.9	74
14230.000000	56.5	105.0	V	218.0	40.8	15.7	17.5	74
17993.750000	61.9	105.0	H	0.0	36.6	25.3	12.1	74

Remark: 1. Correction Factor = Antenna factor+ Insertion loss (cable loss + amplifier gain)

Frequency (MHz)	Average (dBuV/m)	Height (cm)	Polarization	Azimuth (deg)	Reading value (dBuV/m)	Correct Factor (dB)	Margin (dB)	Limit (dBuV/m)
9153.750000	35.0	105.0	V	272.0	24.8	10.2	19.0	54
9232.500000	35.4	105.0	V	0.0	25.5	9.9	18.6	54
11902.500000	36.4	105.0	H	31.0	24.2	12.2	17.6	54
12641.250000	39.7	105.0	V	0.0	25.2	14.5	14.3	54
15417.500000	43.4	105.0	H	139.0	24.1	19.3	10.6	54
17997.500000	50.2	105.0	V	272.0	24.8	25.4	3.8	54

Remark: 1. Correction Factor = Antenna factor+ Insertion loss (cable loss + amplifier gain)

RE 18-26.5GHz PK+AV

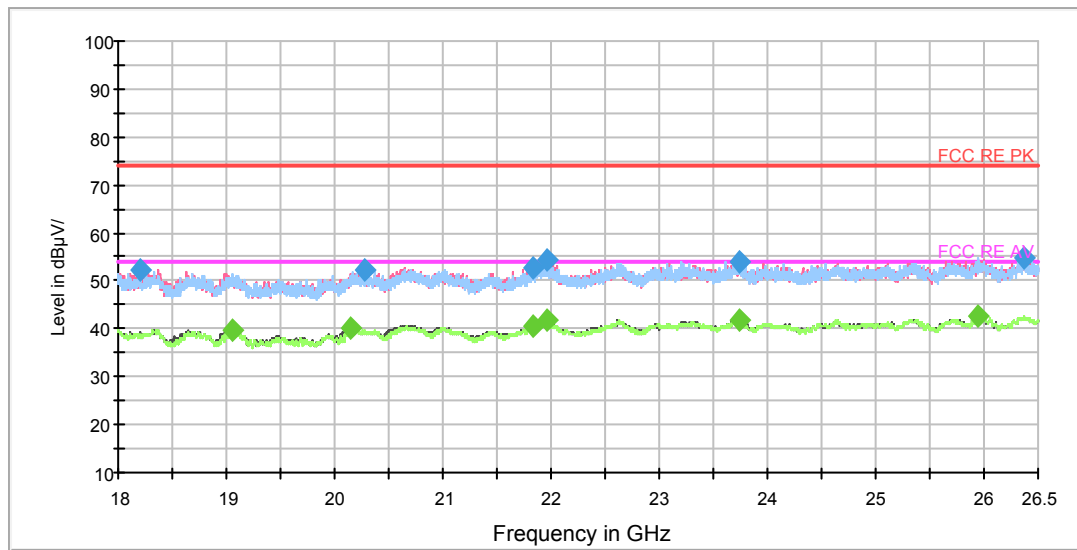

Radiates Emission from 18GHz to 26.5GHz

Frequency (MHz)	Peak (dBuV/m)	Polarization	Azimuth (deg)	Reading value (dBuV/m)	Correct Factor (dB)	Margin (dB)	Limit (dBuV/m)
18198.687500	52.2	H	17.0	54.8	-2.6	21.8	74.0
20273.750000	52.4	V	288.0	58.4	-6.0	21.6	74.0
21825.000000	52.7	H	0.0	60.7	-8.0	21.3	74.0
21957.812500	54.2	V	0.0	62.2	-8.0	19.8	74.0
23734.312500	54.0	V	77.0	59.9	-5.9	20.0	74.0
26374.625000	54.9	V	0.0	60.3	-5.4	19.1	74.0

Remark: 1. Correction Factor = Antenna factor+ Insertion loss (cable loss + amplifier gain)

Frequency (MHz)	Average (dBuV/m)	Polarization	Azimuth (deg)	Reading value (dBuV/m)	Correct Factor (dB)	Margin (dB)	Limit (dBuV/m)
19049.750000	39.9	V	156.0	45.1	-5.2	14.1	54.0
20156.875000	40.0	V	156.0	45.8	-5.8	14.0	54.0
21834.562500	40.7	V	77.0	48.7	-8.0	13.3	54.0
21962.062500	41.9	V	156.0	49.9	-8.0	12.1	54.0
23741.750000	41.8	H	44.0	47.7	-5.9	12.2	54.0
25950.687500	42.7	V	262.0	48.1	-5.4	11.3	54.0

Remark: 1. Correction Factor = Antenna factor+ Insertion loss (cable loss + amplifier gain)

RE 26.5-40GHz PK+AV

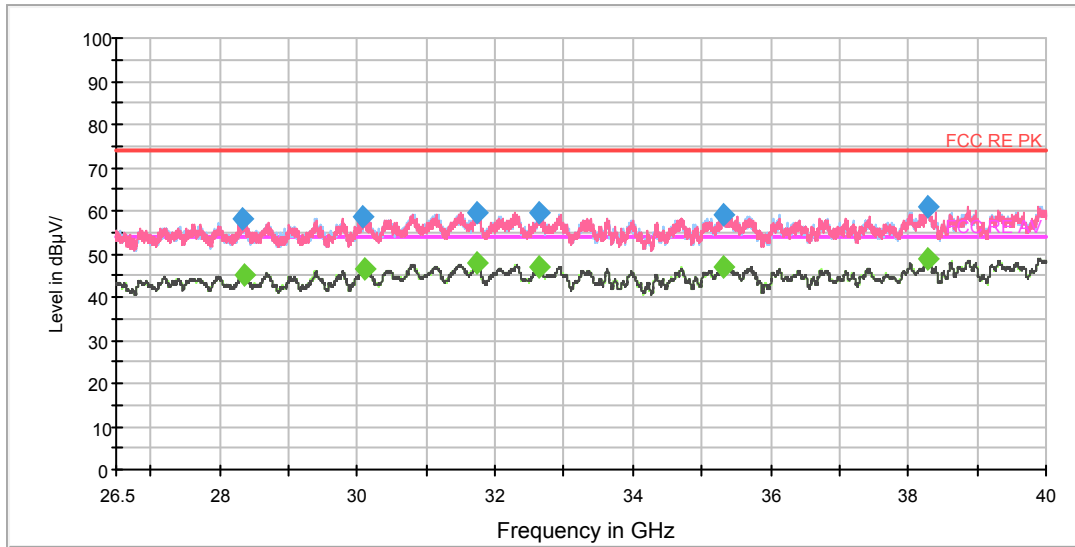

Radiates Emission from 26.5GHz to 40GHz

Frequency (MHz)	Peak (dBuV/m)	Polarization	Azimuth (deg)	Reading value (dBuV/m)	Correct Factor (dB)	Margin (dB)	Limit (dBuV/m)
28342.750000	58.0	V	30.0	59.5	-1.5	16.0	74.0
30079.187500	58.8	H	169.0	59.2	-0.4	15.2	74.0
31746.437500	59.7	V	0.0	60.2	-0.5	14.3	74.0
32637.437500	59.3	H	216.0	60.0	-0.7	14.7	74.0
35308.750000	59.3	H	355.0	59.8	-0.5	14.7	74.0
38278.750000	61.1	H	216.0	59.1	2.0	12.9	74.0

Remark: 1. Correction Factor = Antenna factor+ Insertion loss (cable loss + amplifier gain)

Frequency (MHz)	Average (dBuV/m)	Polarization	Azimuth (deg)	Reading value (dBuV/m)	Correct Factor (dB)	Margin (dB)	Limit (dBuV/m)
28352.875000	45.2	V	100.0	46.7	-1.5	8.8	54.0
30107.875000	46.4	H	0.0	46.8	-0.4	7.6	54.0
31739.687500	48.1	V	0.0	48.6	-0.5	5.9	54.0
32649.250000	47.1	H	143.0	47.8	-0.7	6.9	54.0
35317.187500	47.2	V	123.0	47.7	-0.5	6.8	54.0
38278.750000	48.8	H	216.0	46.8	2.0	5.2	54.0

Remark: 1. Correction Factor = Antenna factor+ Insertion loss (cable loss + amplifier gain)

**MIMO Antenna 3&4**  
**5735MHz**

RE 30M-1GHz QP

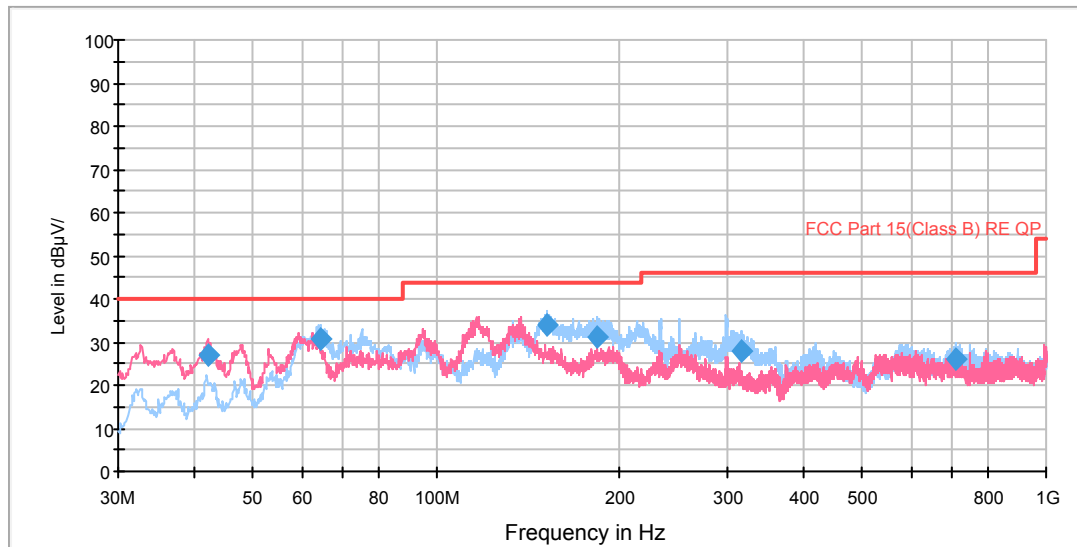

Radiates Emission from 30MHz to 1GHz

Frequency (MHz)	Quasi-Peak (dBuV/m)	Height (cm)	Polarization	Azimuth (deg)	Reading value (dBuV/m)	Correct Factor (dB)	Margin (dB)	Limit (dBuV/m)
42.219688	26.8	121.0	V	66.0	47.2	-20.4	13.2	40.0
64.593912	30.8	129.0	H	22.0	54.5	-23.7	9.2	40.0
151.513769	33.8	129.0	H	149.0	63.0	-29.2	9.7	43.5
183.402797	31.1	129.0	H	344.0	58.8	-27.7	12.4	43.5
315.238750	28.1	104.0	H	290.0	51.3	-23.2	17.9	46.0
713.126500	25.9	104.0	H	127.0	41.0	-15.1	20.1	46.0

- Remark: 1. Quasi-Peak = Reading value + Correction factor**  
**2. Correction Factor = Antenna factor+ Insertion loss(cable loss+amplifier gain)**  
**3. Margin = Limit – Quasi-Peak**

RE 1G-3GHz PK+AV

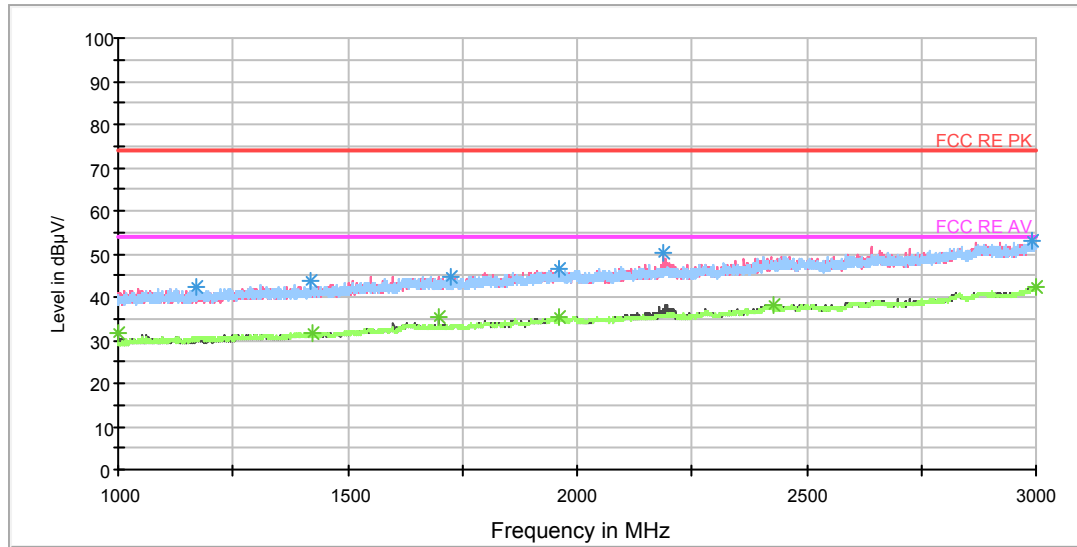

Radiates Emission from 1GHz to 3GHz

Frequency (MHz)	Peak (dBuV/m)	Height (cm)	Polarization	Azimuth (deg)	Reading value (dBuV/m)	Correct Factor (dB)	Margin (dB)	Limit (dBuV/m)
1170.000000	42.1	104.0	H	69.0	50.2	-8.1	31.9	74
1420.750000	43.8	104.0	H	32.0	50.7	-6.9	30.2	74
1727.000000	44.7	104.0	H	114.0	49.8	-5.1	29.3	74
1958.750000	46.7	104.0	V	0.0	49.9	-3.2	27.3	74
2189.250000	50.2	104.0	V	181.0	52.4	-2.2	23.8	74
2991.250000	53.2	104.0	V	0.0	51.0	2.2	20.8	74

Remark: 1. Correction Factor = Antenna factor+ Insertion loss (cable loss + amplifier gain)

Frequency (MHz)	Average (dBuV/m)	Height (cm)	Polarization	Azimuth (deg)	Reading value (dBuV/m)	Correct Factor (dB)	Margin (dB)	Limit (dBuV/m)
1000.000000	31.5	104.0	V	199.0	40.7	-9.2	22.5	54
1424.500000	31.6	104.0	H	32.0	38.5	-6.9	22.4	54
1697.500000	35.2	104.0	V	191.0	40.2	-5.0	18.8	54
1959.000000	35.5	104.0	H	96.0	38.7	-3.2	18.5	54
2428.750000	38.3	104.0	V	173.0	38.9	-0.6	15.7	54
3000.000000	42.3	104.0	H	230.0	40.0	2.3	11.7	54

Remark: 1. Correction Factor = Antenna factor+ Insertion loss (cable loss + amplifier gain)

RE 3-18GHz PK+AV

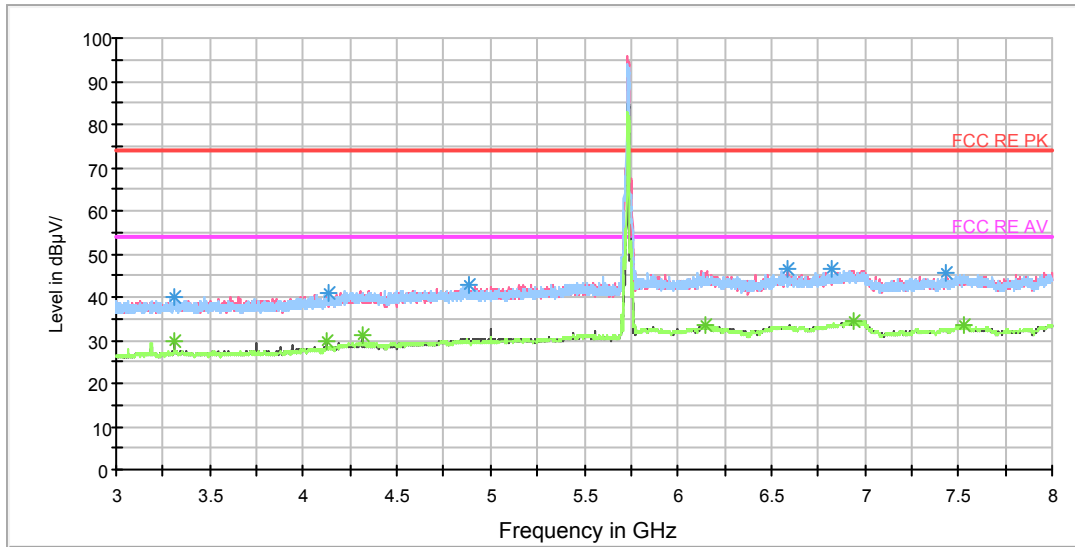

Note: The signal beyond the limit is carrier.  
Radiates Emission from 3GHz to 8GHz

Frequency (MHz)	Peak (dBuV/m)	Height (cm)	Polarization	Azimuth (deg)	Reading value (dBuV/m)	Correct Factor (dB)	Margin (dB)	Limit (dBuV/m)
3312.500000	39.9	105.0	V	0.0	42.0	-2.1	34.1	74
4133.750000	40.9	105.0	H	156.0	41.2	-0.3	33.1	74
4883.125000	42.7	105.0	V	354.0	40.8	1.9	31.3	74
6591.875000	46.5	105.0	V	74.0	40.9	5.6	27.5	74
6821.250000	46.3	105.0	H	0.0	40.5	5.8	27.7	74
7437.500000	45.4	105.0	V	354.0	38.7	6.7	28.6	74

Remark: 1. Correction Factor = Antenna factor+ Insertion loss (cable loss + amplifier gain)

Frequency (MHz)	Average (dBuV/m)	Height (cm)	Polarization	Azimuth (deg)	Reading value (dBuV/m)	Correct Factor (dB)	Margin (dB)	Limit (dBuV/m)
3312.500000	29.9	105.0	V	0.0	32.0	-2.1	24.1	54
4125.000000	29.6	105.0	V	230.0	30.0	-0.4	24.4	54
4312.500000	31.2	105.0	V	0.0	30.6	0.6	22.8	54
6146.875000	33.5	105.0	H	156.0	28.0	5.5	20.5	54
6935.625000	34.4	105.0	V	0.0	28.3	6.1	19.6	54
7528.750000	33.6	105.0	V	205.0	26.5	7.1	20.4	54

Remark: 1. Correction Factor = Antenna factor+ Insertion loss (cable loss + amplifier gain)

RE 3-18GHz PK+AV(YIPU)

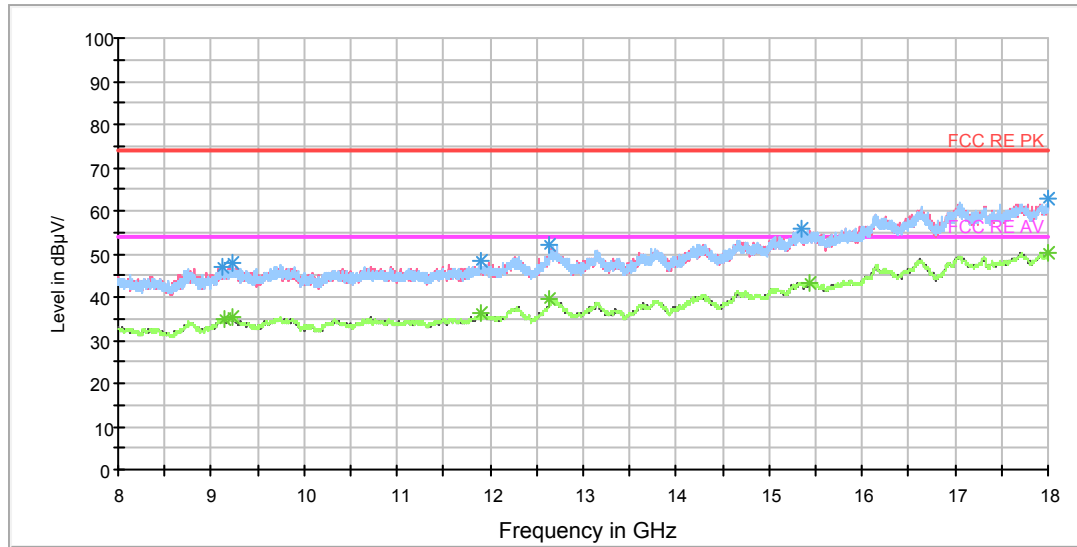

Radiates Emission from 8GHz to 18GHz

Frequency (MHz)	Peak (dBuV/m)	Height (cm)	Polarization	Azimuth (deg)	Reading value (dBuV/m)	Correct Factor (dB)	Margin (dB)	Limit (dBuV/m)
9130.000000	46.9	105.0	H	40.0	36.9	10.0	27.1	74
9228.750000	47.9	105.0	H	0.0	38.0	9.9	26.1	74
11903.750000	48.2	105.0	H	0.0	36.0	12.2	25.8	74
12640.000000	51.9	105.0	H	12.0	37.3	14.6	22.1	74
15342.500000	55.7	105.0	V	298.0	36.9	18.8	18.3	74
17996.250000	62.9	105.0	H	92.0	37.5	25.4	11.1	74

Remark: 1. Correction Factor = Antenna factor+ Insertion loss (cable loss + amplifier gain)

Frequency (MHz)	Average (dBuV/m)	Height (cm)	Polarization	Azimuth (deg)	Reading value (dBuV/m)	Correct Factor (dB)	Margin (dB)	Limit (dBuV/m)
9136.250000	35.0	105.0	V	351.0	25.0	10.0	19.0	54
9235.000000	35.5	105.0	V	0.0	25.6	9.9	18.5	54
11900.000000	36.1	105.0	H	0.0	23.8	12.3	17.9	54
12640.000000	39.6	105.0	V	0.0	25.0	14.6	14.4	54
15425.000000	43.4	105.0	V	0.0	24.0	19.4	10.6	54
18000.000000	50.3	105.0	H	0.0	24.8	25.5	3.7	54

Remark: 1. Correction Factor = Antenna factor+ Insertion loss (cable loss + amplifier gain)



RE 18-26.5GHz PK+AV

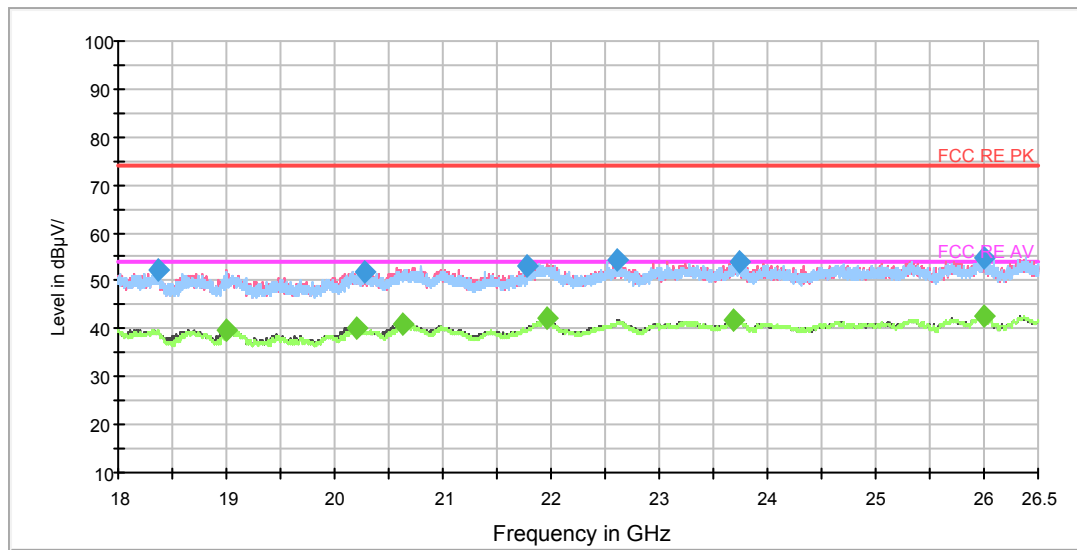

Radiates Emission from 18GHz to 26.5GHz

Frequency (MHz)	Peak (dBuV/m)	Polarization	Azimuth (deg)	Reading value (dBuV/m)	Correct Factor (dB)	Margin (dB)	Limit (dBuV/m)
18375.062500	52.3	H	283.0	55.7	-3.4	21.7	74.0
20271.625000	52.0	H	255.0	57.9	-5.9	22.0	74.0
21780.375000	53.1	V	76.0	61.1	-8.0	20.9	74.0
22602.750000	54.2	H	176.0	60.9	-6.7	19.8	74.0
23740.687500	54.1	V	129.0	60.0	-5.9	19.9	74.0
25994.250000	55.0	H	255.0	60.4	-5.4	19.0	74.0

Remark: 1. Correction Factor = Antenna factor+ Insertion loss (cable loss + amplifier gain)

Frequency (MHz)	Average (dBuV/m)	Polarization	Azimuth (deg)	Reading value (dBuV/m)	Correct Factor (dB)	Margin (dB)	Limit (dBuV/m)
19007.250000	39.9	V	312.0	45.0	-5.1	14.1	54.0
20211.062500	40.1	V	337.0	46.0	-5.9	13.9	54.0
20628.625000	40.9	V	0.0	47.4	-6.5	13.1	54.0
21966.312500	42.2	V	102.0	50.2	-8.0	11.8	54.0
23691.812500	42.0	H	149.0	47.9	-5.9	12.0	54.0
25996.375000	42.7	V	0.0	48.1	-5.4	11.3	54.0

Remark: 1. Correction Factor = Antenna factor+ Insertion loss (cable loss + amplifier gain)

RE 26.5-40GHz PK+AV

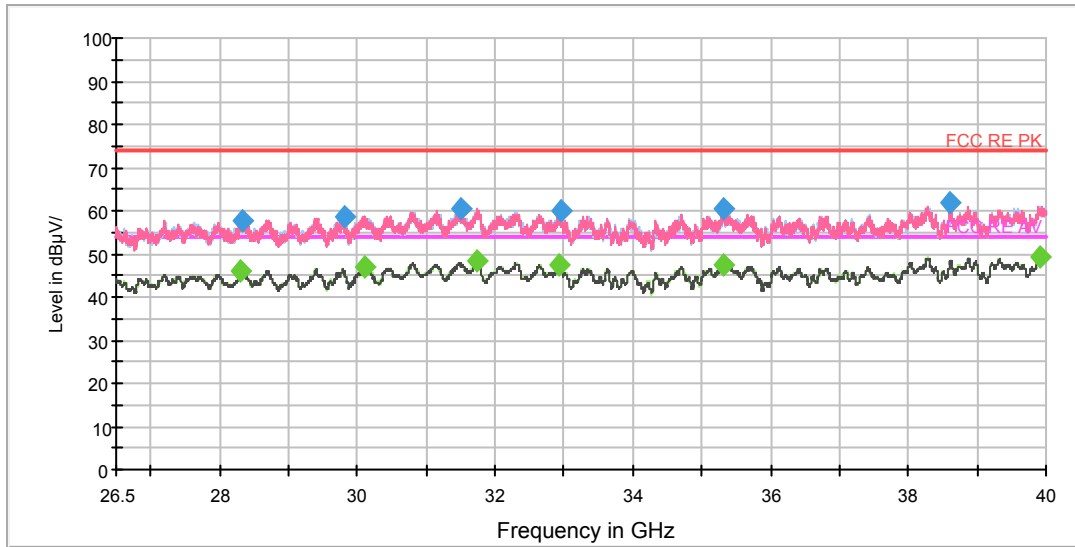

Radiates Emission from 26.5GHz to 40GHz

Frequency (MHz)	Peak (dBuV/m)	Polarization	Azimuth (deg)	Reading value (dBuV/m)	Correct Factor (dB)	Margin (dB)	Limit (dBuV/m)
28320.812500	57.9	V	218.0	59.4	-1.5	16.1	74.0
29802.437500	58.7	H	0.0	59.3	-0.6	15.3	74.0
31505.125000	60.4	H	142.0	60.9	-0.5	13.6	74.0
32954.687500	59.8	H	118.0	60.6	-0.8	14.2	74.0
35305.375000	60.3	H	94.0	60.8	-0.5	13.7	74.0
38616.250000	61.7	V	0.0	59.2	2.5	12.3	74.0

Remark: 1. Correction Factor = Antenna factor+ Insertion loss (cable loss + amplifier gain)

Frequency (MHz)	Average (dBuV/m)	Polarization	Azimuth (deg)	Reading value (dBuV/m)	Correct Factor (dB)	Margin (dB)	Limit (dBuV/m)
28314.062500	45.9	H	352.0	47.4	-1.5	8.1	54.0
30096.062500	46.9	H	165.0	47.3	-0.4	7.1	54.0
31741.375000	48.4	H	281.0	48.9	-0.5	5.6	54.0
32937.812500	47.3	V	101.0	48.1	-0.8	6.7	54.0
35310.437500	47.5	H	213.0	48.0	-0.5	6.5	54.0
39900.437500	49.1	V	53.0	46.8	2.3	4.9	54.0

Remark: 1. Correction Factor = Antenna factor+ Insertion loss (cable loss + amplifier gain)



5790MHz

RE 30M-1GHz QP

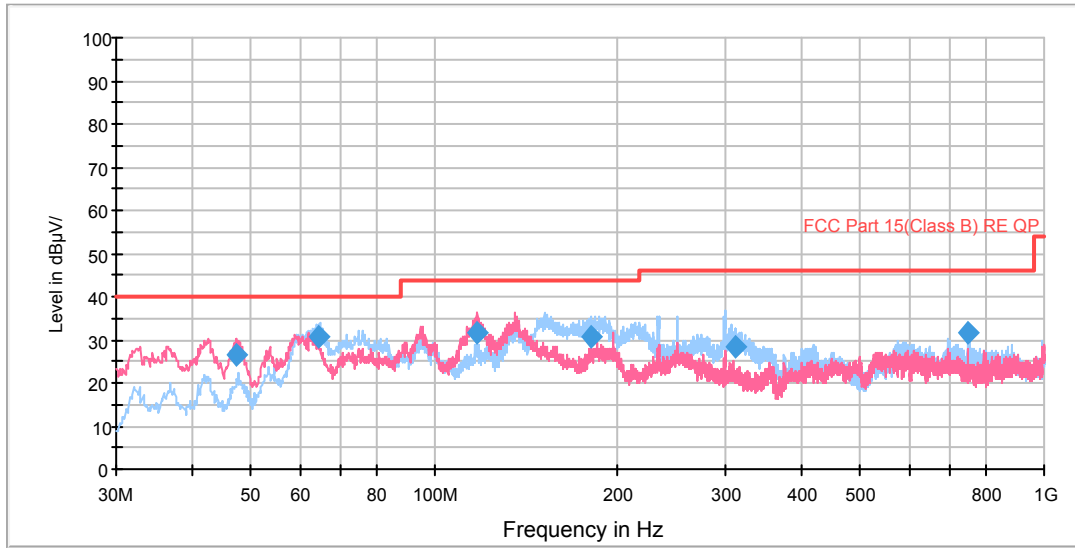

Radiates Emission from 30MHz to 1GHz

Frequency (MHz)	Quasi-Peak (dBuV/m)	Height (cm)	Polarization	Azimuth (deg)	Reading value (dBuV/m)	Correct Factor (dB)	Margin (dB)	Limit (dBuV/m)
47.335544	26.5	101.0	V	78.0	46.8	-20.3	13.5	40.0
64.676753	30.6	129.0	H	33.0	54.3	-23.7	9.4	40.0
117.286750	31.5	104.0	V	95.0	58.4	-26.9	12.0	43.5
180.679322	30.5	129.0	H	167.0	58.6	-28.1	13.0	43.5
310.520000	28.6	103.0	H	283.0	51.7	-23.1	17.4	46.0
749.988250	31.7	104.0	H	139.0	47.1	-15.4	14.3	46.0

- Remark: 1. Quasi-Peak = Reading value + Correction factor  
 2. Correction Factor = Antenna factor+ Insertion loss(cable loss+amplifier gain)  
 3. Margin = Limit – Quasi-Peak

RE 1G-3GHz PK+AV

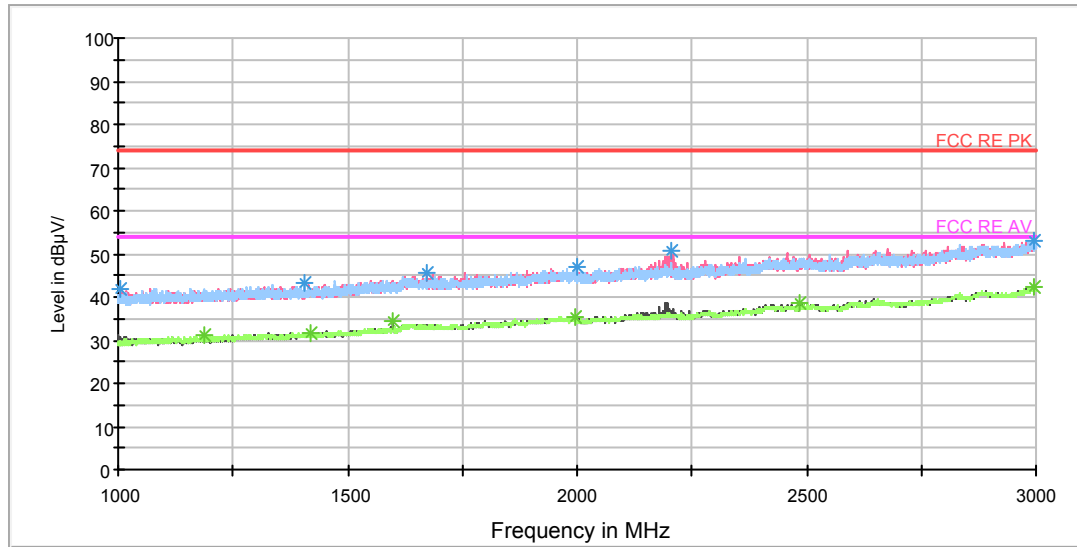

Radiates Emission from 1GHz to 3GHz

Frequency (MHz)	Peak (dBuV/m)	Height (cm)	Polarization	Azimuth (deg)	Reading value (dBuV/m)	Correct Factor (dB)	Margin (dB)	Limit (dBuV/m)
1004.500000	42.0	104.0	V	193.0	51.3	-9.3	32.0	74
1405.250000	43.1	104.0	H	64.0	50.2	-7.1	30.9	74
1671.000000	45.4	104.0	V	354.0	50.5	-5.1	28.6	74
1998.750000	46.8	104.0	H	181.0	50.2	-3.4	27.2	74
2203.750000	50.7	104.0	V	238.0	52.8	-2.1	23.3	74
2997.250000	53.2	104.0	V	165.0	50.9	2.3	20.8	74

Remark: 1. Correction Factor = Antenna factor+ Insertion loss (cable loss + amplifier gain)

Frequency (MHz)	Average (dBuV/m)	Height (cm)	Polarization	Azimuth (deg)	Reading value (dBuV/m)	Correct Factor (dB)	Margin (dB)	Limit (dBuV/m)
1189.750000	31.2	104.0	H	64.0	39.4	-8.2	22.8	54
1417.250000	31.6	104.0	H	55.0	38.5	-6.9	22.4	54
1599.750000	34.4	104.0	V	184.0	40.8	-6.4	19.6	54
1995.500000	35.4	104.0	V	346.0	38.6	-3.2	18.6	54
2486.250000	38.8	104.0	V	174.0	38.8	0.0	15.2	54
2995.750000	42.3	104.0	H	119.0	40.0	2.3	11.7	54

Remark: 1. Correction Factor = Antenna factor+ Insertion loss (cable loss + amplifier gain)

RE 3-18GHz PK+AV

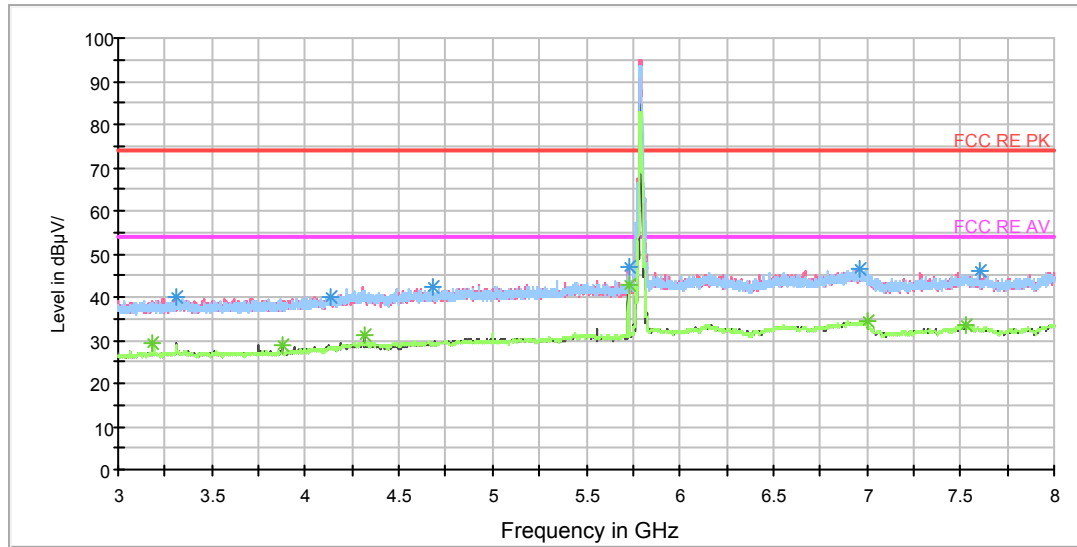

Note: The signal beyond the limit is carrier.  
Radiates Emission from 3GHz to 8GHz

Frequency (MHz)	Peak (dBuV/m)	Height (cm)	Polarization	Azimuth (deg)	Reading value (dBuV/m)	Correct Factor (dB)	Margin (dB)	Limit (dBuV/m)
3311.875000	40.2	105.0	V	0.0	42.3	-2.1	33.8	74
4133.750000	40.0	105.0	V	211.0	40.3	-0.3	34.0	74
4684.375000	42.2	105.0	H	107.0	41.4	0.8	31.8	74
5725.000000	47.1	105.0	V	358.0	43.8	3.3	26.9	74
6962.500000	46.7	105.0	H	133.0	40.5	6.2	27.3	74
7608.125000	46.1	105.0	V	134.0	39.2	6.9	27.9	74

Remark: 1. Correction Factor = Antenna factor+ Insertion loss (cable loss + amplifier gain)

Frequency (MHz)	Average (dBuV/m)	Height (cm)	Polarization	Azimuth (deg)	Reading value (dBuV/m)	Correct Factor (dB)	Margin (dB)	Limit (dBuV/m)
3186.875000	29.4	105.0	H	312.0	32.3	-2.9	24.6	54
3875.000000	28.9	105.0	V	358.0	30.3	-1.4	25.1	54
4312.500000	31.0	105.0	V	0.0	30.4	0.6	23.0	54
5725.000000	42.9	105.0	V	358.0	39.6	3.3	11.1	54
7000.000000	34.5	105.0	V	358.0	27.9	6.6	19.5	54
7530.000000	33.3	105.0	H	208.0	26.2	7.1	20.7	54

Remark: 1. Correction Factor = Antenna factor+ Insertion loss (cable loss + amplifier gain)

RE 3-18GHz PK+AV(YIPU)

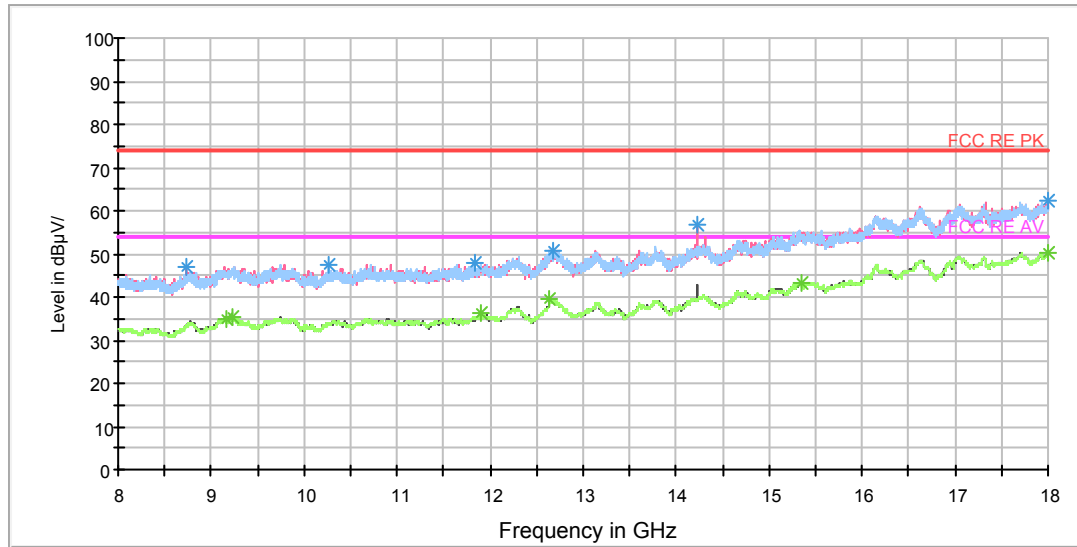

Radiates Emission from 8GHz to 18GHz

Frequency (MHz)	Peak (dBuV/m)	Height (cm)	Polarization	Azimuth (deg)	Reading value (dBuV/m)	Correct Factor (dB)	Margin (dB)	Limit (dBuV/m)
8741.250000	47.2	105.0	V	189.0	39.2	8.0	26.8	74
10261.250000	47.6	105.0	H	117.0	37.5	10.1	26.4	74
11833.750000	47.8	105.0	H	0.0	36.2	11.6	26.2	74
12680.000000	50.9	105.0	H	9.0	36.6	14.3	23.1	74
14227.500000	56.9	105.0	V	216.0	41.2	15.7	17.1	74
17998.750000	62.4	105.0	H	0.0	37.0	25.4	11.6	74

Remark: 1. Correction Factor = Antenna factor+ Insertion loss (cable loss + amplifier gain)

Frequency (MHz)	Average (dBuV/m)	Height (cm)	Polarization	Azimuth (deg)	Reading value (dBuV/m)	Correct Factor (dB)	Margin (dB)	Limit (dBuV/m)
9153.750000	34.8	105.0	H	9.0	24.6	10.2	19.2	54
9238.750000	35.3	105.0	H	9.0	25.4	9.9	18.7	54
11900.000000	36.3	105.0	V	351.0	24.0	12.3	17.7	54
12640.000000	39.7	105.0	H	198.0	25.1	14.6	14.3	54
15355.000000	43.5	105.0	H	117.0	24.8	18.7	10.5	54
17998.750000	50.2	105.0	V	0.0	24.8	25.4	3.8	54

Remark: 1. Correction Factor = Antenna factor+ Insertion loss (cable loss + amplifier gain)

RE 18-26.5GHz PK+AV

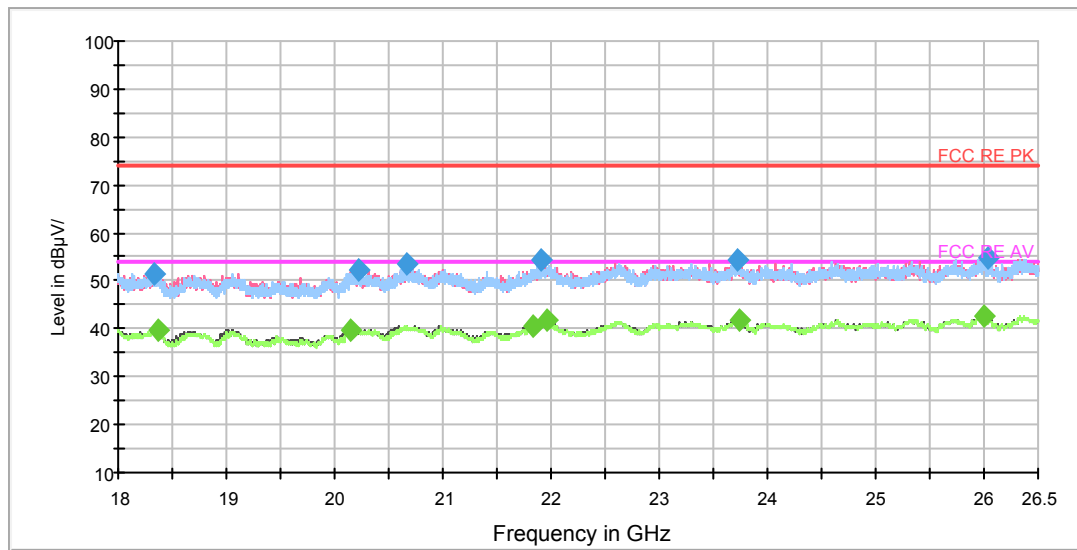

Radiates Emission from 18GHz to 26.5GHz

Frequency (MHz)	Peak (dBuV/m)	Polarization	Azimuth (deg)	Reading value (dBuV/m)	Correct Factor (dB)	Margin (dB)	Limit (dBuV/m)
18340.000000	51.6	H	0.0	54.8	-3.2	22.4	74.0
20219.562500	52.2	V	314.0	58.1	-5.9	21.8	74.0
20667.937500	53.4	V	183.0	60.0	-6.6	20.6	74.0
21898.312500	54.4	V	0.0	62.4	-8.0	19.6	74.0
23722.625000	54.3	V	209.0	60.2	-5.9	19.7	74.0
26044.187500	54.9	V	0.0	60.3	-5.4	19.1	74.0

Remark: 1. Correction Factor = Antenna factor+ Insertion loss (cable loss + amplifier gain)

Frequency (MHz)	Average (dBuV/m)	Polarization	Azimuth (deg)	Reading value (dBuV/m)	Correct Factor (dB)	Margin (dB)	Limit (dBuV/m)
18368.687500	39.7	V	314.0	43.1	-3.4	14.3	54.0
20155.812500	39.9	H	70.0	45.7	-5.8	14.1	54.0
21838.812500	40.8	V	0.0	48.8	-8.0	13.2	54.0
21962.062500	41.8	V	75.0	49.8	-8.0	12.2	54.0
23739.625000	41.7	V	157.0	47.6	-5.9	12.3	54.0
25998.500000	42.7	H	42.0	48.1	-5.4	11.3	54.0

Remark: 1. Correction Factor = Antenna factor+ Insertion loss (cable loss + amplifier gain)

RE 26.5-40GHz PK+AV

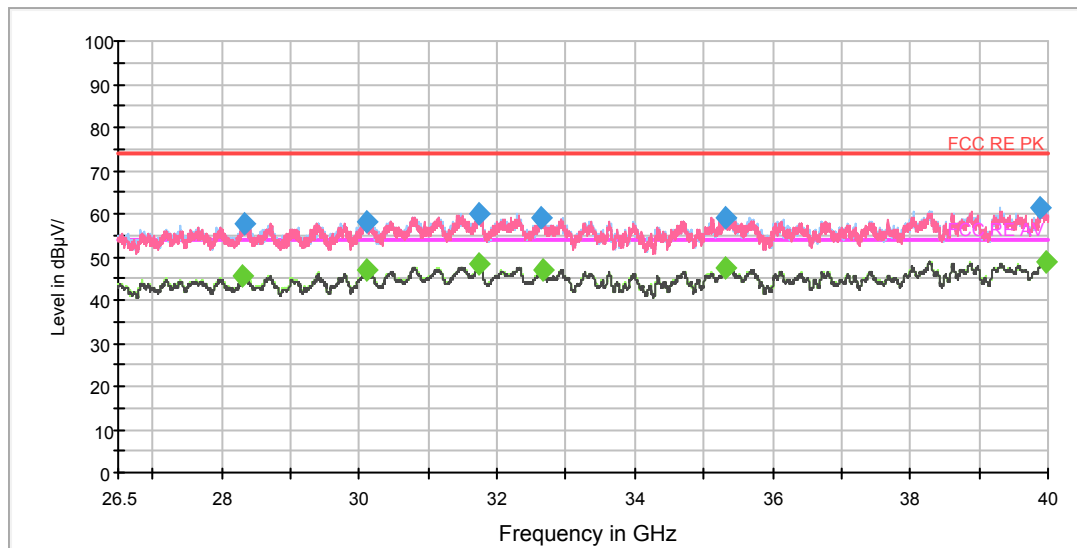

Radiates Emission from 26.5GHz to 40GHz

Frequency (MHz)	Peak (dBuV/m)	Polarization	Azimuth (deg)	Reading value (dBuV/m)	Correct Factor (dB)	Margin (dB)	Limit (dBuV/m)
28330.937500	57.7	H	260.0	59.2	-1.5	16.3	74.0
30097.750000	58.3	H	306.0	58.7	-0.4	15.7	74.0
31743.062500	60.0	V	101.0	60.5	-0.5	14.0	74.0
32652.625000	59.0	V	149.0	59.7	-0.7	15.0	74.0
35318.875000	59.3	V	78.0	59.8	-0.5	14.7	74.0
39897.062500	61.5	H	284.0	59.2	2.3	12.5	74.0

Remark: 1. Correction Factor = Antenna factor+ Insertion loss (cable loss + amplifier gain)

Frequency (MHz)	Average (dBuV/m)	Polarization	Azimuth (deg)	Reading value (dBuV/m)	Correct Factor (dB)	Margin (dB)	Limit (dBuV/m)
28309.000000	45.4	H	330.0	46.9	-1.5	8.6	54.0
30102.812500	47.0	H	330.0	47.4	-0.4	7.0	54.0
31741.375000	48.4	H	190.0	48.9	-0.5	5.6	54.0
32657.687500	47.1	H	0.0	47.8	-0.7	6.9	54.0
35302.000000	47.2	H	0.0	47.7	-0.5	6.8	54.0
39959.500000	49.0	H	284.0	46.7	2.3	5.0	54.0

Remark: 1. Correction Factor = Antenna factor+ Insertion loss (cable loss + amplifier gain)





5840MHz

RE 30M-1GHz QP

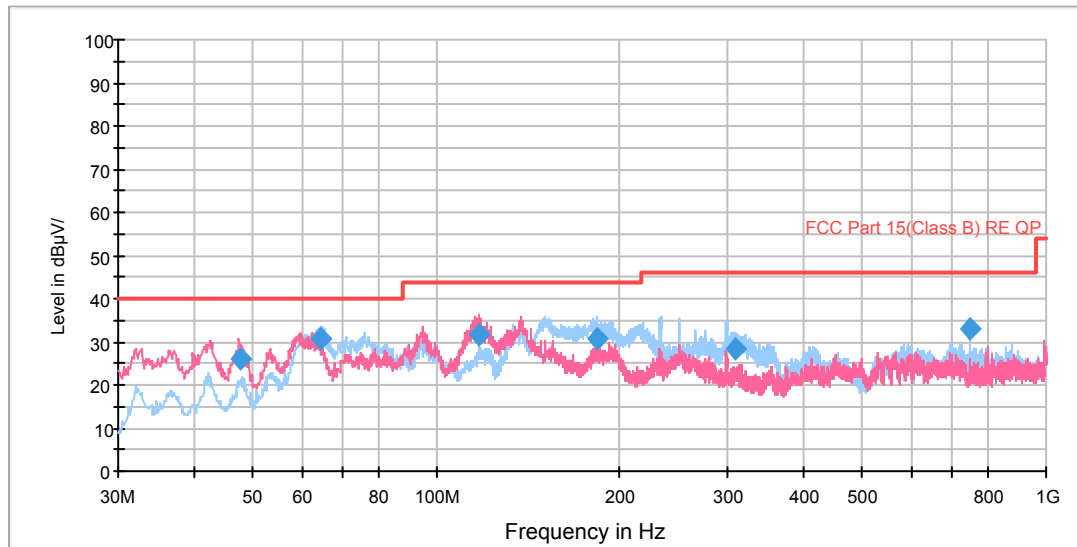

Radiates Emission from 30MHz to 1GHz

Frequency (MHz)	Quasi-Peak (dBuV/m)	Height (cm)	Polarization	Azimuth (deg)	Reading value (dBuV/m)	Correct Factor (dB)	Margin (dB)	Limit (dBuV/m)
47.457097	26.2	104.0	V	81.0	46.5	-20.3	13.8	40.0
64.676753	30.8	129.0	H	22.0	54.5	-23.7	9.2	40.0
117.405803	31.6	104.0	V	124.0	58.5	-26.9	11.9	43.5
183.400903	30.8	120.0	H	169.0	58.5	-27.7	12.7	43.5
310.158000	28.4	101.0	H	292.0	51.5	-23.1	17.6	46.0
749.988250	32.9	103.0	H	135.0	48.3	-15.4	13.1	46.0

- Remark: 1. Quasi-Peak = Reading value + Correction factor
- 2. Correction Factor = Antenna factor+ Insertion loss(cable loss+amplifier gain)
- 3. Margin = Limit – Quasi-Peak

RE 1G-3GHz PK+AV

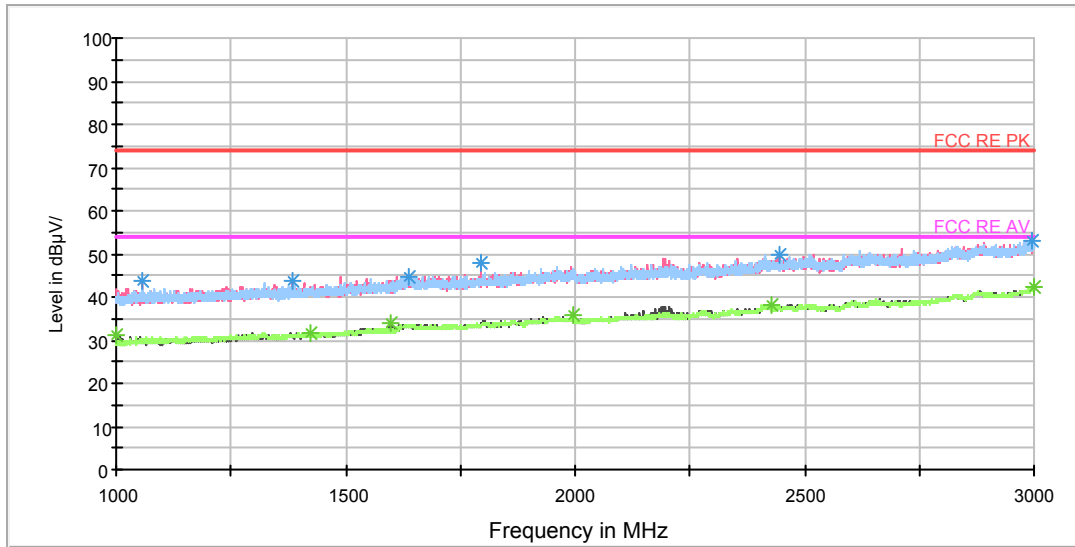

Radiates Emission from 1GHz to 3GHz

Frequency (MHz)	Peak (dBuV/m)	Height (cm)	Polarization	Azimuth (deg)	Reading value (dBuV/m)	Correct Factor (dB)	Margin (dB)	Limit (dBuV/m)
1055.750000	43.7	104.0	V	270.0	52.7	-9.0	30.3	74
1382.750000	43.5	104.0	V	226.0	50.5	-7.0	30.5	74
1635.750000	44.8	104.0	H	0.0	49.5	-4.7	29.2	74
1794.250000	47.7	104.0	V	135.0	52.0	-4.3	26.3	74
2447.000000	49.8	104.0	V	172.0	50.4	-0.6	24.2	74
2993.750000	52.9	104.0	H	11.0	50.7	2.2	21.1	74

Remark: 1. Correction Factor = Antenna factor+ Insertion loss (cable loss + amplifier gain)

Frequency (MHz)	Average (dBuV/m)	Height (cm)	Polarization	Azimuth (deg)	Reading value (dBuV/m)	Correct Factor (dB)	Margin (dB)	Limit (dBuV/m)
1000.000000	31.3	104.0	V	207.0	40.5	-9.2	22.7	54
1423.750000	31.7	104.0	H	46.0	38.6	-6.9	22.3	54
1600.000000	34.2	104.0	V	190.0	40.6	-6.4	19.8	54
1994.500000	35.7	104.0	H	19.0	38.9	-3.2	18.3	54
2427.000000	38.3	104.0	H	55.0	38.8	-0.5	15.7	54
2998.250000	42.3	104.0	H	108.0	40.0	2.3	11.7	54

Remark: 1. Correction Factor = Antenna factor+ Insertion loss (cable loss + amplifier gain)

RE 3-18GHz PK+AV

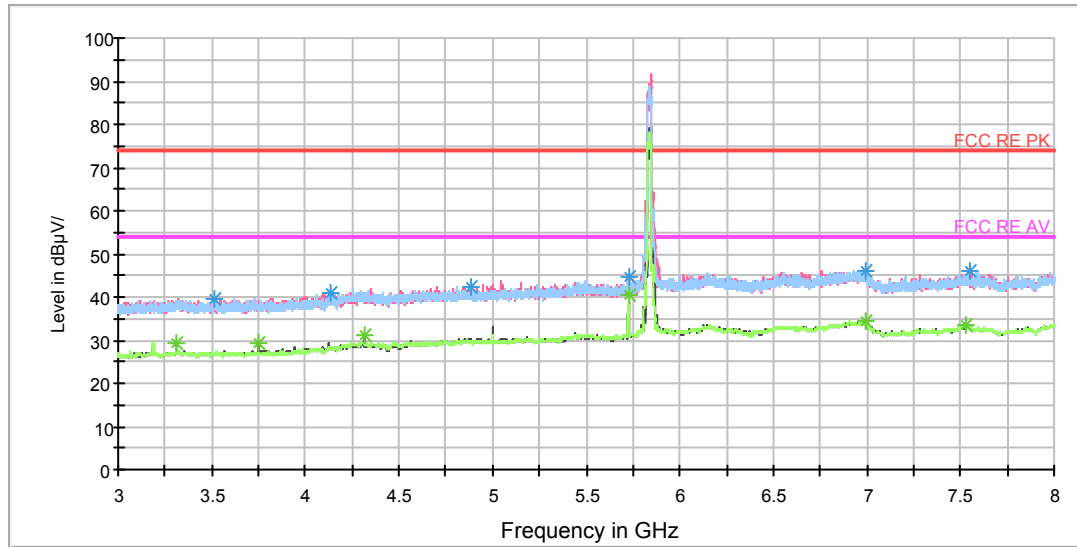

Note: The signal beyond the limit is carrier.  
Radiates Emission from 3GHz to 8GHz

Frequency (MHz)	Peak (dBuV/m)	Height (cm)	Polarization	Azimuth (deg)	Reading value (dBuV/m)	Correct Factor (dB)	Margin (dB)	Limit (dBuV/m)
3513.125000	39.7	105.0	H	134.0	41.7	-2.0	34.3	74
4133.125000	40.9	105.0	V	0.0	41.2	-0.3	33.1	74
4883.750000	42.5	105.0	V	151.0	40.6	1.9	31.5	74
5725.000000	44.7	105.0	H	0.0	41.4	3.3	29.3	74
6995.000000	46.1	105.0	H	210.0	39.6	6.5	27.9	74
7554.375000	45.9	105.0	V	0.0	38.9	7.0	28.1	74

Remark: 1. Correction Factor = Antenna factor+ Insertion loss (cable loss + amplifier gain)

Frequency (MHz)	Average (dBuV/m)	Height (cm)	Polarization	Azimuth (deg)	Reading value (dBuV/m)	Correct Factor (dB)	Margin (dB)	Limit (dBuV/m)
3312.500000	29.5	105.0	V	0.0	31.6	-2.1	24.5	54
3750.000000	29.4	105.0	V	326.0	31.1	-1.7	24.6	54
4312.500000	31.1	105.0	V	0.0	30.5	0.6	22.9	54
5725.000000	40.3	105.0	H	0.0	37.0	3.3	13.7	54
6996.875000	34.4	105.0	V	176.0	27.9	6.5	19.6	54
7530.625000	33.3	105.0	V	125.0	26.2	7.1	20.7	54

Remark: 1. Correction Factor = Antenna factor+ Insertion loss (cable loss + amplifier gain)

RE 3-18GHz PK+AV(YIPU)

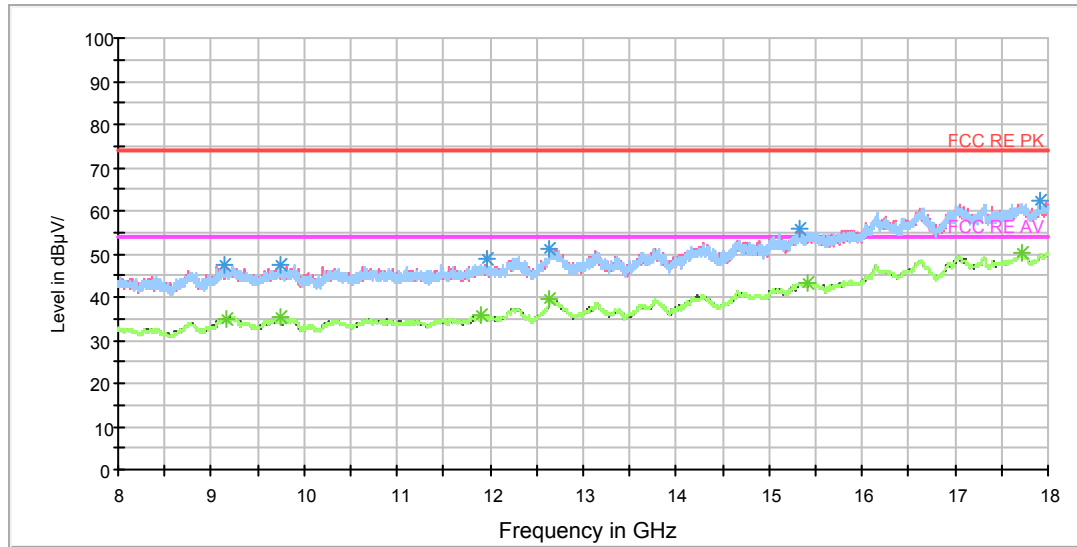

Radiates Emission from 8GHz to 18GHz

Frequency (MHz)	Peak (dBuV/m)	Height (cm)	Polarization	Azimuth (deg)	Reading value (dBuV/m)	Correct Factor (dB)	Margin (dB)	Limit (dBuV/m)
9152.500000	47.3	105.0	H	253.0	37.1	10.2	26.7	74
9752.500000	47.3	105.0	V	191.0	37.6	9.7	26.7	74
11958.750000	48.7	105.0	H	310.0	36.8	11.9	25.3	74
12641.250000	51.1	105.0	H	170.0	36.6	14.5	22.9	74
15333.750000	56.0	105.0	V	0.0	37.3	18.7	18.0	74
17908.750000	62.3	105.0	V	299.0	36.9	25.4	11.7	74

Remark: 1. Correction Factor = Antenna factor+ Insertion loss (cable loss + amplifier gain)

Frequency (MHz)	Average (dBuV/m)	Height (cm)	Polarization	Azimuth (deg)	Reading value (dBuV/m)	Correct Factor (dB)	Margin (dB)	Limit (dBuV/m)
9153.750000	34.9	105.0	V	191.0	24.7	10.2	19.1	54
9737.500000	35.4	105.0	V	0.0	25.4	10.0	18.6	54
11903.750000	36.0	105.0	H	11.0	23.8	12.2	18.0	54
12640.000000	39.7	105.0	H	0.0	25.1	14.6	14.3	54
15418.750000	43.3	105.0	V	0.0	23.9	19.4	10.7	54
17710.000000	50.2	105.0	V	0.0	25.5	24.7	3.8	54

Remark: 1. Correction Factor = Antenna factor+ Insertion loss (cable loss + amplifier gain)

RE 18-26.5GHz PK+AV

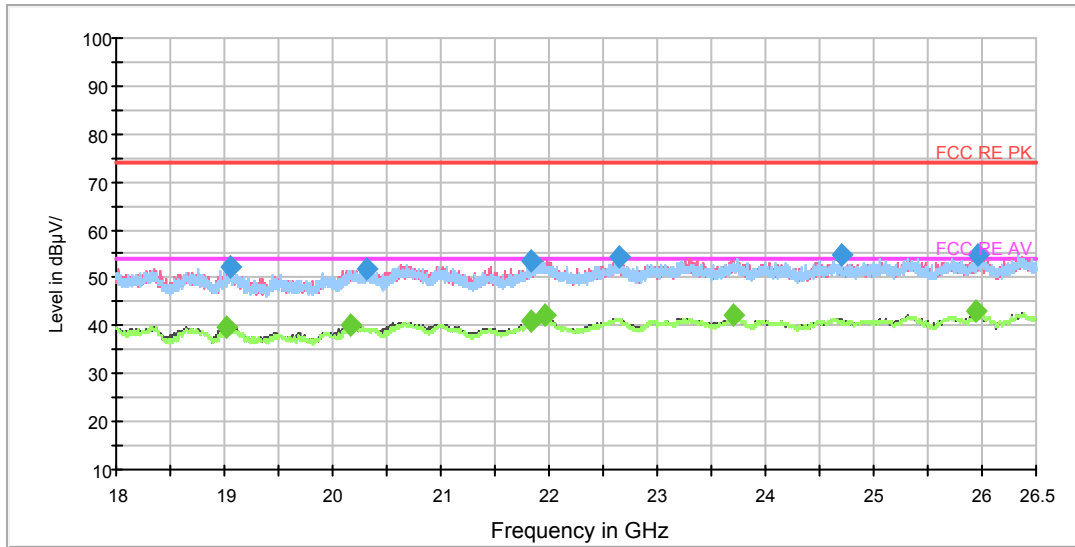

Radiates Emission from 18GHz to 26.5GHz

Frequency (MHz)	Peak (dBuV/m)	Polarization	Azimuth (deg)	Reading value (dBuV/m)	Correct Factor (dB)	Margin (dB)	Limit (dBuV/m)
19052.937500	52.4	H	227.0	57.6	-5.2	21.6	74.0
20317.312500	52.0	V	0.0	58.0	-6.0	22.0	74.0
21833.500000	53.6	V	0.0	61.6	-8.0	20.4	74.0
22656.937500	54.2	V	0.0	60.8	-6.6	19.8	74.0
24696.937500	54.8	H	0.0	60.8	-6.0	19.2	74.0
25957.062500	54.7	V	0.0	60.1	-5.4	19.3	74.0

Remark: 1. Correction Factor = Antenna factor+ Insertion loss (cable loss + amplifier gain)

Frequency (MHz)	Average (dBuV/m)	Polarization	Azimuth (deg)	Reading value (dBuV/m)	Correct Factor (dB)	Margin (dB)	Limit (dBuV/m)
19010.437500	39.8	V	209.0	44.9	-5.1	14.2	54.0
20161.125000	40.1	V	50.0	45.9	-5.8	13.9	54.0
21839.875000	40.8	H	201.0	48.8	-8.0	13.2	54.0
21963.125000	42.2	V	0.0	50.2	-8.0	11.8	54.0
23704.562500	42.1	V	0.0	48.0	-5.9	11.9	54.0
25949.625000	42.9	V	0.0	48.3	-5.4	11.1	54.0

Remark: 1. Correction Factor = Antenna factor+ Insertion loss (cable loss + amplifier gain)

RE 26.5-40GHz PK+AV

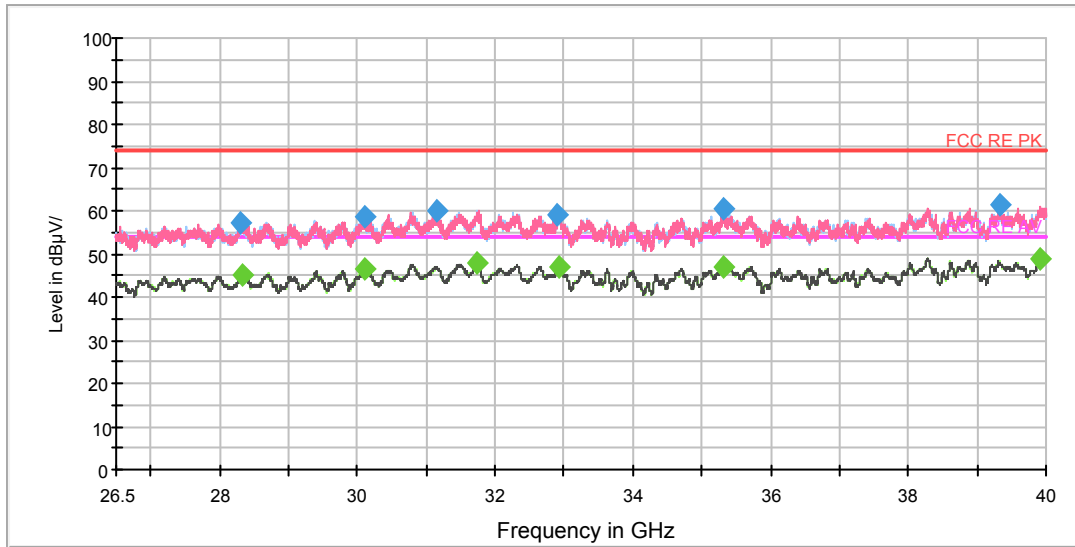

Radiates Emission from 26.5GHz to 40GHz

Frequency (MHz)	Peak (dBuV/m)	Polarization	Azimuth (deg)	Reading value (dBuV/m)	Correct Factor (dB)	Margin (dB)	Limit (dBuV/m)
28310.687500	57.1	H	266.0	58.6	-1.5	16.9	74.0
30099.437500	58.6	H	313.0	59.0	-0.4	15.4	74.0
31152.437500	60.2	H	0.0	60.6	-0.4	13.8	74.0
32905.750000	59.0	H	70.0	59.8	-0.8	15.0	74.0
35308.750000	60.3	H	98.0	60.8	-0.5	13.7	74.0
39323.312500	61.6	H	289.0	58.8	2.8	12.4	74.0

Remark: 1. Correction Factor = Antenna factor+ Insertion loss (cable loss + amplifier gain)

Frequency (MHz)	Average (dBuV/m)	Polarization	Azimuth (deg)	Reading value (dBuV/m)	Correct Factor (dB)	Margin (dB)	Limit (dBuV/m)
28339.375000	45.2	V	78.0	46.7	-1.5	8.8	54.0
30097.750000	46.4	V	55.0	46.8	-0.4	7.6	54.0
31736.312500	48.0	V	243.0	48.5	-0.5	6.0	54.0
32941.187500	47.0	H	122.0	47.8	-0.8	7.0	54.0
35313.812500	47.2	H	359.0	47.7	-0.5	6.8	54.0
39910.562500	48.9	H	0.0	46.6	2.3	5.1	54.0

Remark: 1. Correction Factor = Antenna factor+ Insertion loss (cable loss + amplifier gain)

### 5.6. Conducted spurious emissions at antenna port

#### Ambient condition

Temperature	Relative humidity	Pressure
23°C ~25°C	45%~50%	101.5kPa

#### Methods of Measurement

The EUT was connected to the spectrum analyzer through an external attenuator (20dB) and a known loss cable. Set RBW = 1MHz, VBW =3MHz for the9kHz to 10th harmonic

The conducted is measured at each antenna port. The measured results at the various antenna ports are then summed mathematically.

#### Test Setup

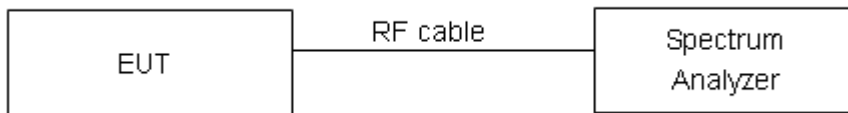

#### Limits

FCC §407 (b) Undesirable emission limits. Except as shown in paragraph (b)(7) of this section, the maximum emissions outside of the frequency bands of operation shall be attenuated in accordance with the following limits:

(4) For transmitters operating in the 5725-5850 MHz band: All emissions shall be limited to a level of -27 dBm/MHz at 75 MHz or more above or below the band edge increasing linearly to 10 dBm/MHz at 25 MHz above or below the band edge, and from 25 MHz above or below the band edge increasing linearly to a level of 15.6 dBm/MHz at 5 MHz above or below the band edge, and from 5 MHz above or below the band edge increasing linearly to a level of 27 dBm/MHz at the band edge.

Note: the following formula is used to convert the EIRP to field strength

§1、  $E[\text{dB}\mu\text{V}/\text{m}] = \text{EIRP}[\text{dBm}] - 20 \log(d[\text{meters}]) + 104.77$ , where E = field strength and

d = distance at which field strength limit is specified in the rules;

§2、  $E[\text{dB}\mu\text{V}/\text{m}] = \text{EIRP}[\text{dBm}] + 95.2$ , for d = 3 meters

(7)Unwanted spurious emissions fallen in restricted bands per FCC Part15.205 shall comply with the general field strength limits set forth in § 15.209 as below table.

Frequency of emission (MHz)	Field strength(uV/m)	Field strength(dBuV/m)
0.009–0.490	2400/F(kHz)	/
0.490–1.705	24000/F(kHz)	/
1.705–30.0	30	/
30-88	100	40
88-216	150	43.5
216-960	200	46
Above960	500	54

MHz	MHz	MHz	GHz
0.090 - 0.110	16.42 - 16.423	399.9 - 410	4.5 - 5.15
<sup>1</sup> 0.495 - 0.505	16.69475 - 16.69525	608 - 614	5.35 - 5.46
2.1735 - 2.1905	16.80425 - 16.80475	960 - 1240	7.25 - 7.75
4.125 - 4.128	25.5 - 25.67	1300 - 1427	8.025 - 8.5
4.17725 - 4.17775	37.5 - 38.25	1435 - 1626.5	9.0 - 9.2
4.20725 - 4.20775	73 - 74.6	1645.5 - 1646.5	9.3 - 9.5
6.215 - 6.218	74.8 - 75.2	1660 - 1710	10.6 - 12.7
6.26775 - 6.26825	108 - 121.94	1718.8 - 1722.2	13.25 - 13.4
6.31175 - 6.31225	123 - 138	2200 - 2300	14.47 - 14.5
8.291 - 8.294	149.9 - 150.05	2310 - 2390	15.35 - 16.2
8.362 - 8.366	156.52475 - 156.52525	2483.5 - 2500	17.7 - 21.4
8.37625 - 8.38675	156.7 - 156.9	2690 - 2900	22.01 - 23.12
8.41425 - 8.41475	162.0125 - 167.17	3260 - 3267	23.6 - 24.0
12.29 - 12.293	167.72 - 173.2	3332 - 3339	31.2 - 31.8
12.51975 - 12.52025	240 - 285	3345.8 - 3358	36.43 - 36.5
12.57675 - 12.57725	322 - 335.4	3600 - 4400	( <sup>2</sup> )
13.36 - 13.41			

**Note: Please refer to the following plots:**

A value representative of an upper bound on out-of-band antenna gain (in dBi) shall be added to the measured antenna-port conducted emission power to compute EIRP within the specified measurement bandwidth. The upper bound on antenna gain for a device with a single RF output shall be selected as the maximum in-band gain of the antenna across all operating bands or 2 dBi, whichever is greater

For MIMO mode, the manufacturer declared the transmitter output signals are SFBC modes combine with CDD modes. The signals are antenna 1,2 correlated and 3,4 correlated. And 1,2 and 3,4 are completely uncorrelated. According to KDB 662911 D01 Multiple Transmitter Output v02r01 2)E)(3): Measure value add 10 log(NANT) dB = Measure value +10 log(2)



**Test result**

**The signal beyond the limit is carrier.**

Sweep the whole frequency band through the range from 9kHz to the 10th harmonic of the carrier, and 9kHz-30MHz, the emissions more than 20 dB below the permissible value are not reported.

All spurious emissions per chain at the antenna port is lower than -55dbm, so the total emission Combined two chains is lower than -52dbm (value+10 log(2)), antenna gain is 5dbi, so compliance the requirements

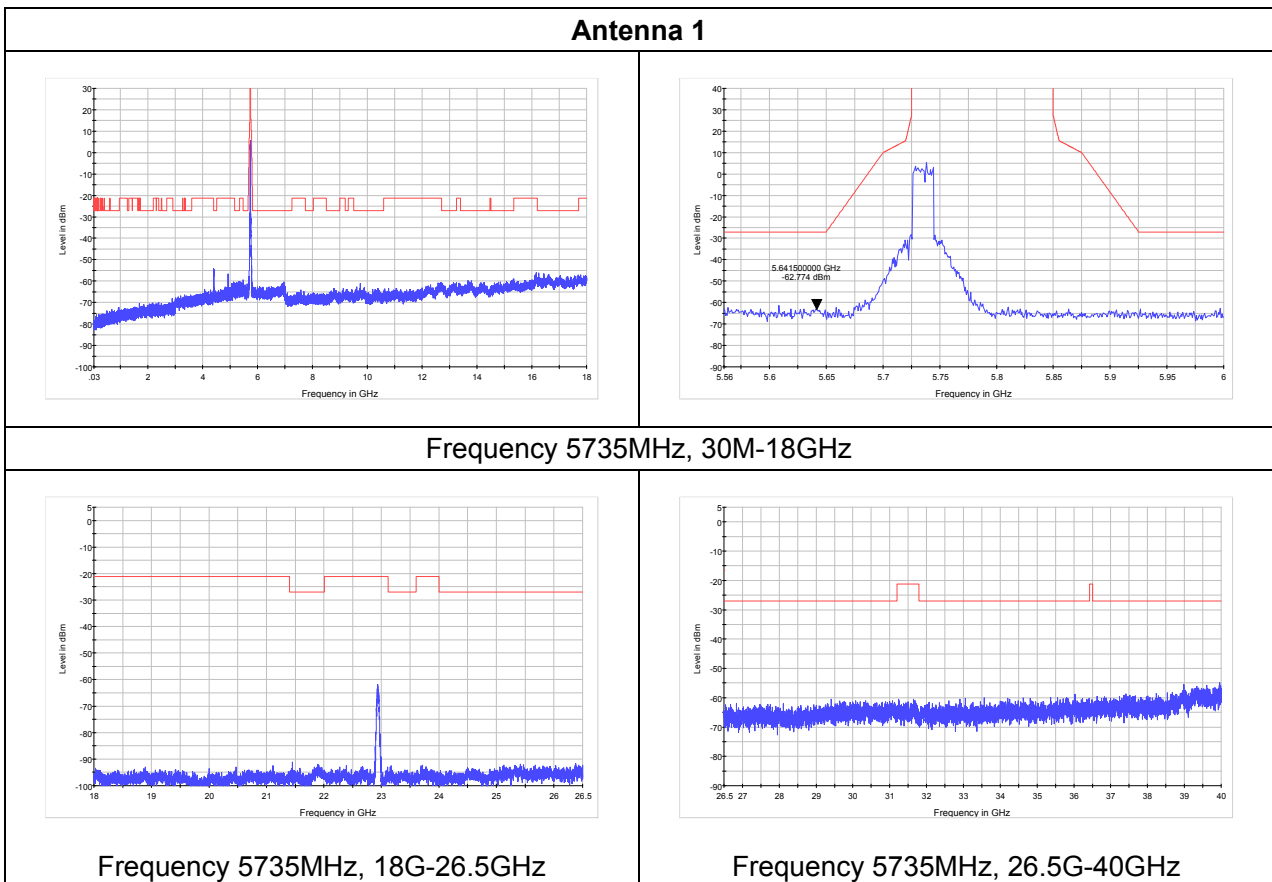

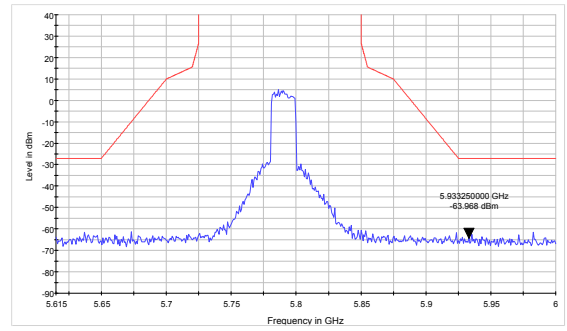
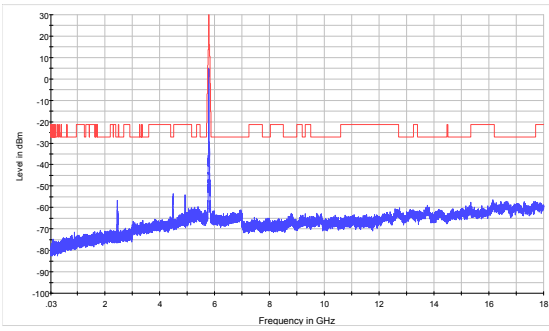

Frequency 5790MHz, 30M-18GHz

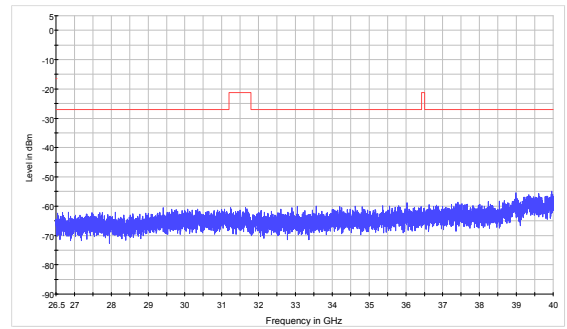
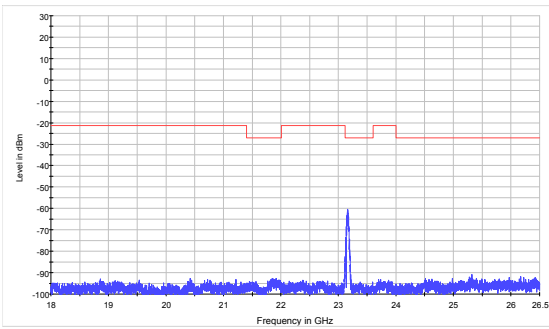

Frequency 5790MHz, 18G-26.5GHz

Frequency 5790MHz, 26.5G-40GHz

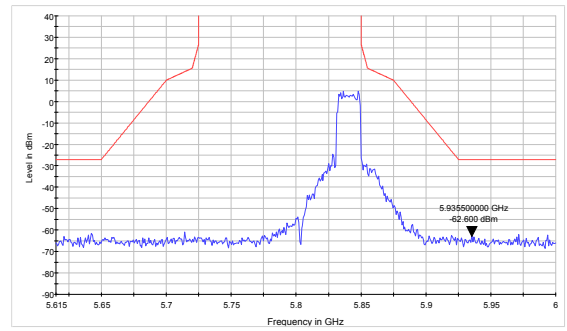
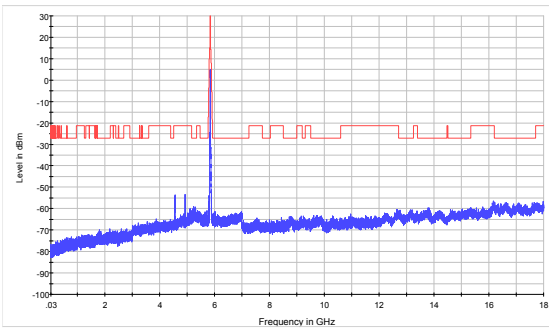

Frequency 5840MHz, 30M-18GHz

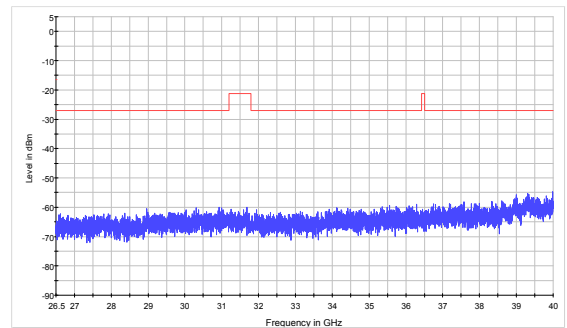
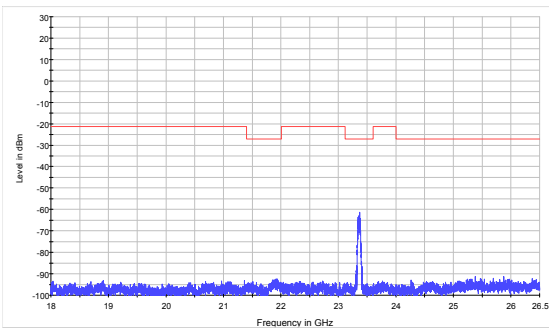

Frequency 5840MHz, 18G-26.5GHz

Frequency 5840MHz, 26.5G-40GHz



### Antenna 2

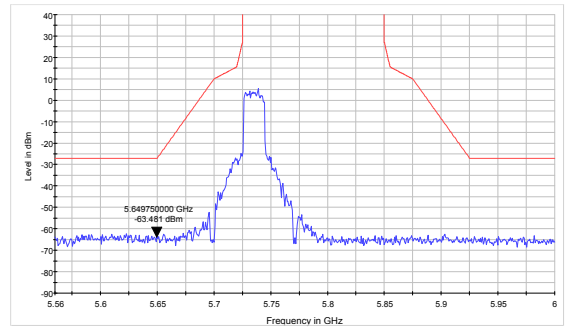
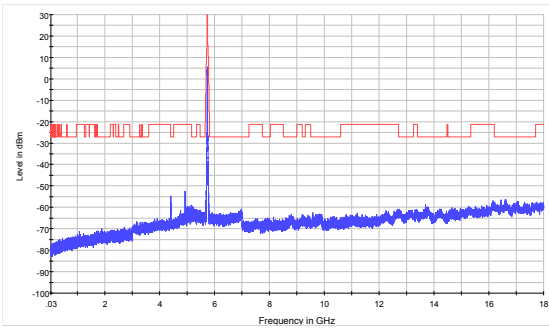

### Frequency 5735MHz, 30M-18GHz

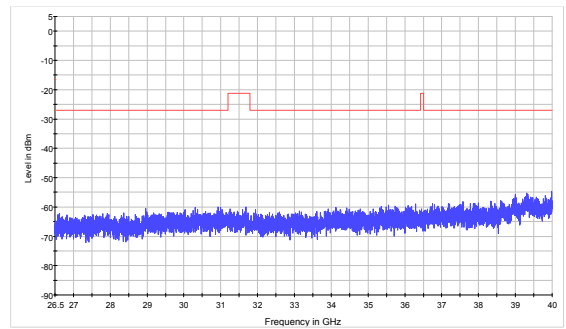
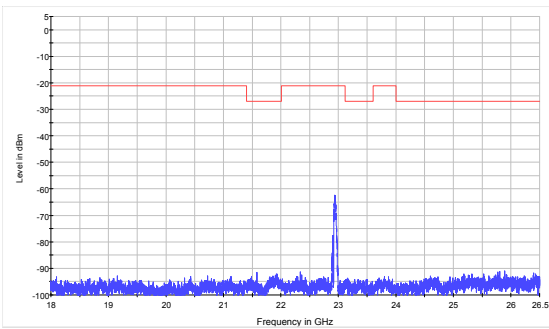

### Frequency 5735MHz, 18G-26.5GHz

### Frequency 5735MHz, 26.5G-40GHz

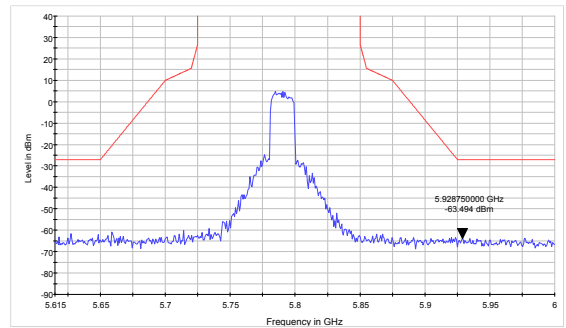
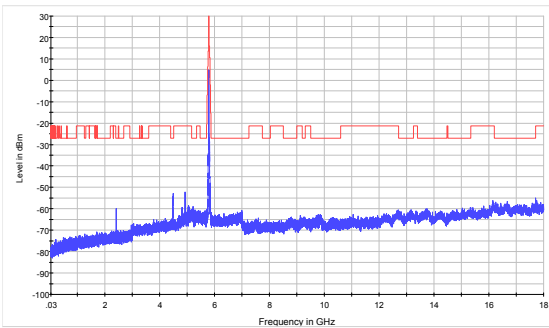

### Frequency 5790MHz, 30M-18GHz

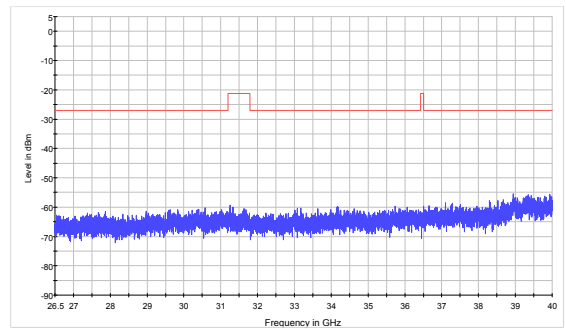
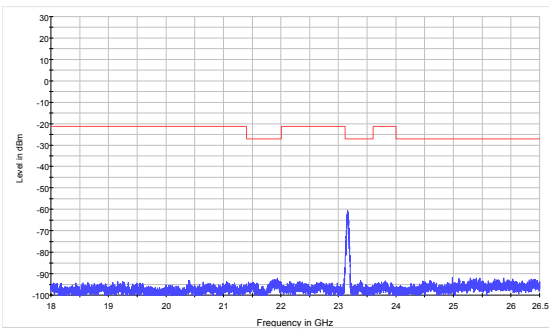

### Frequency 5790MHz, 18G-26.5GHz

### Frequency 5790MHz, 26.5G-40GHz

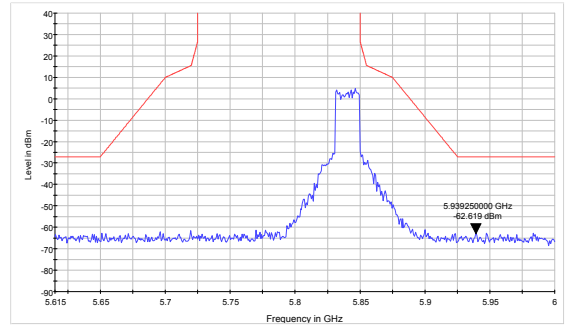
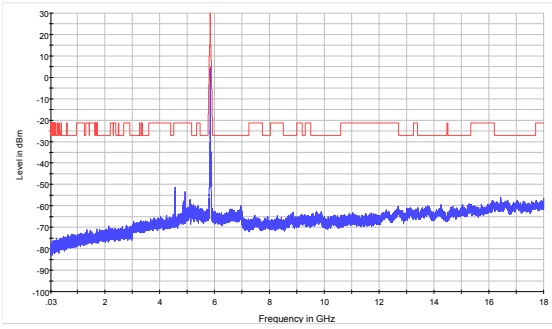

Frequency 5840MHz, 30M-18GHz

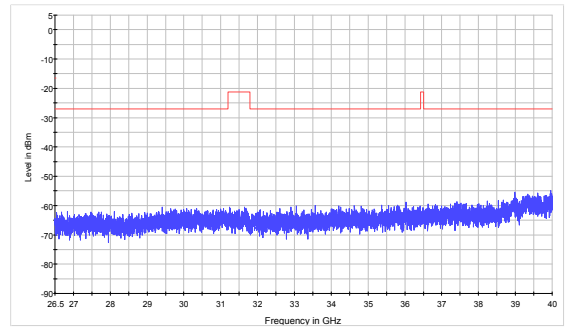
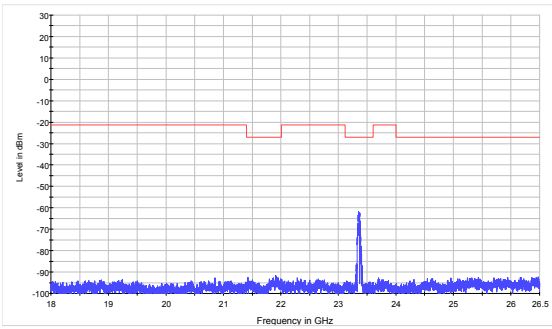

Frequency 5840MHz, 18G-26.5GHz

Frequency 5840MHz, 26.5G-40GHz

Antenna 3

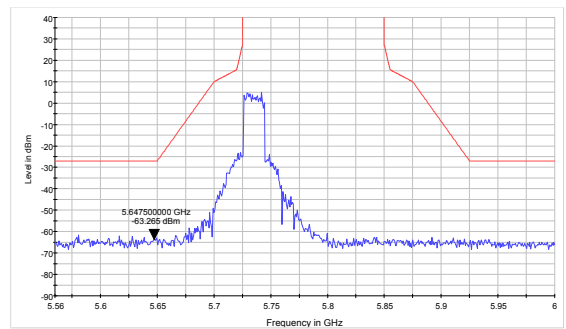
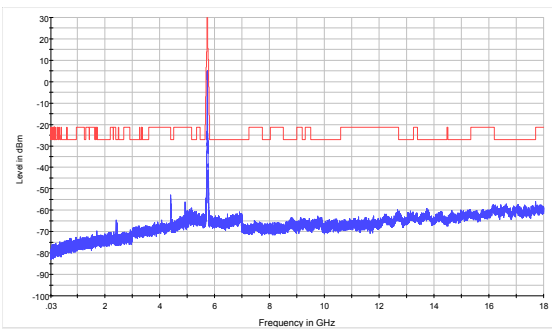

Frequency 5735MHz, 30M-18GHz

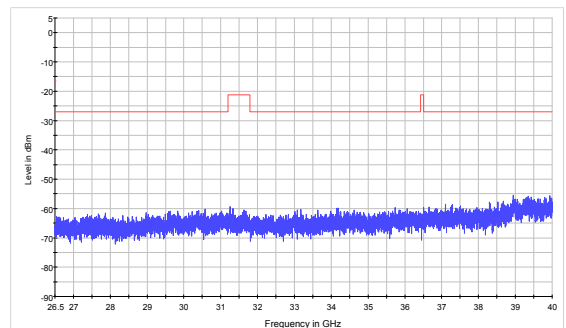
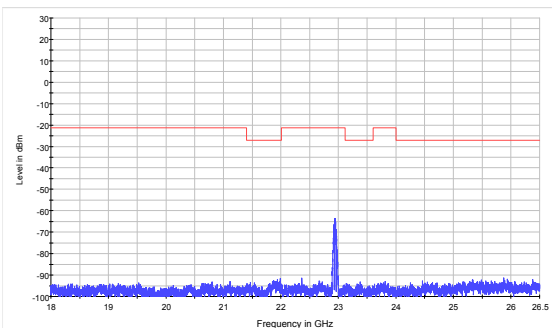

Frequency 5735MHz, 18G-26.5GHz

Frequency 5735MHz, 26.5G-40GHz

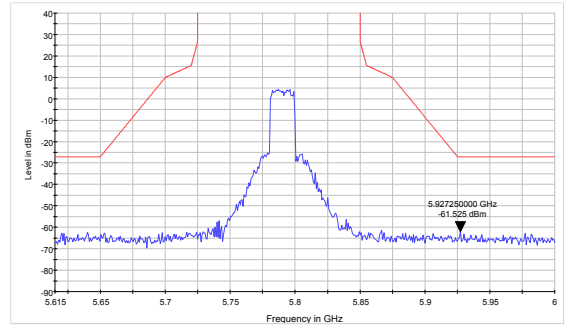
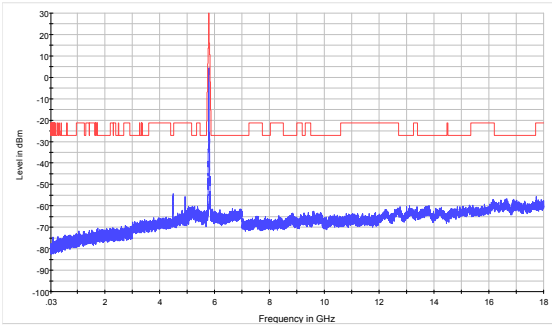

Frequency 5790MHz, 30M-18GHz

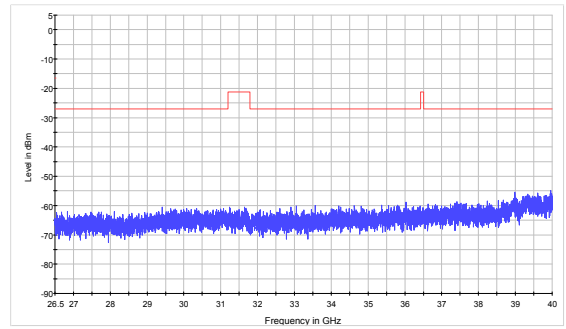
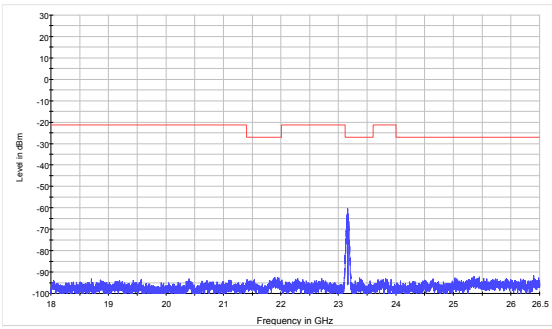

Frequency 5790MHz, 18G-26.5GHz

Frequency 5790MHz, 26.5G-40GHz

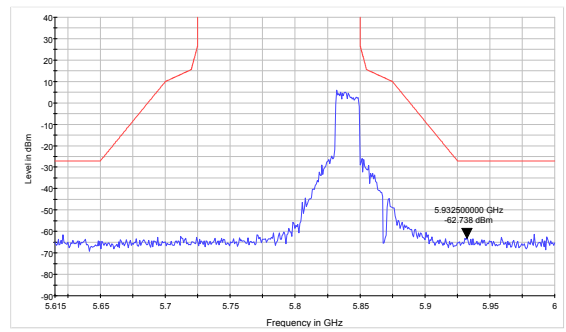
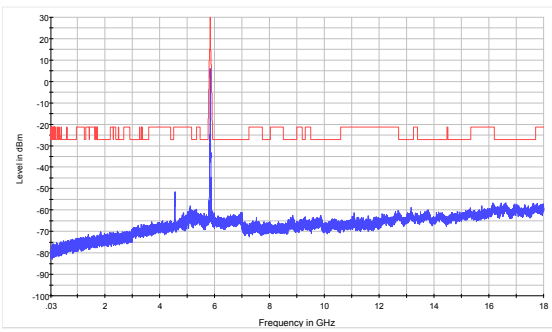

Frequency 5840MHz, 30M-18GHz

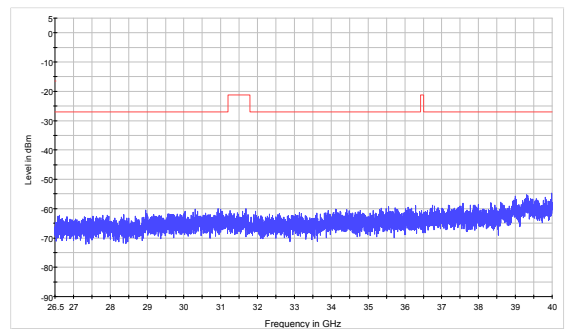
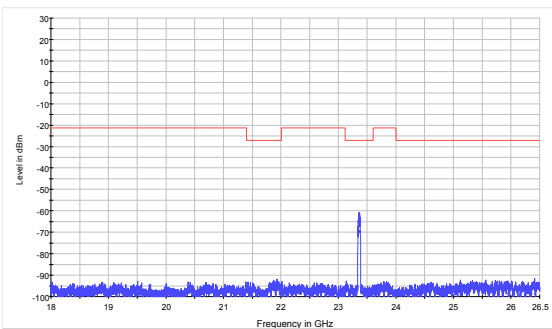

Frequency 5840MHz, 18G-26.5GHz

Frequency 5840MHz, 26.5G-40GHz



### Antenna 4

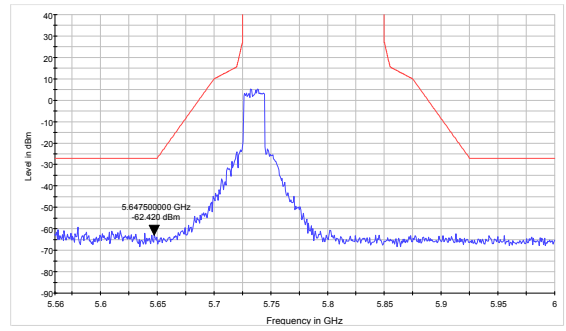
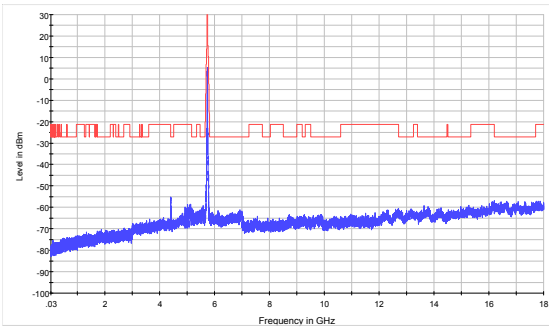

### Frequency 5735MHz, 30M-18GHz

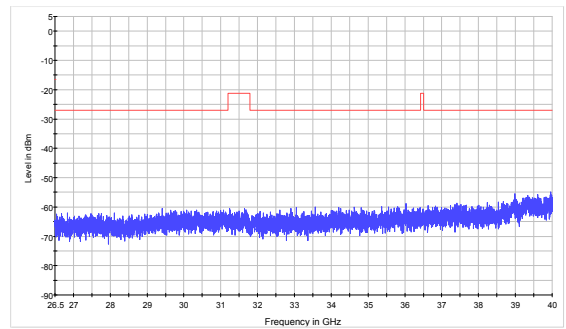
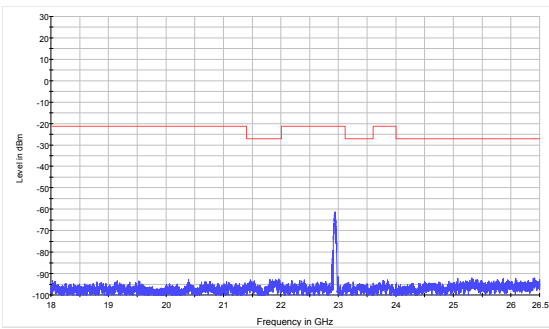

Frequency 5735MHz, 18G-26.5GHz

Frequency 5735MHz, 26.5G-40GHz

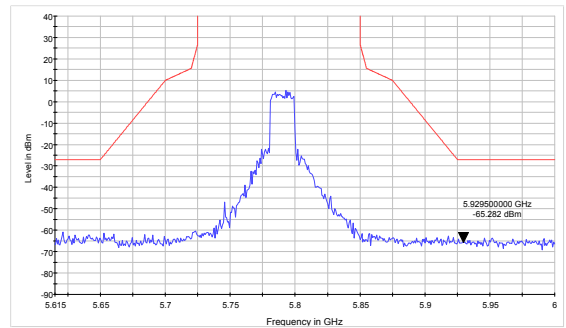
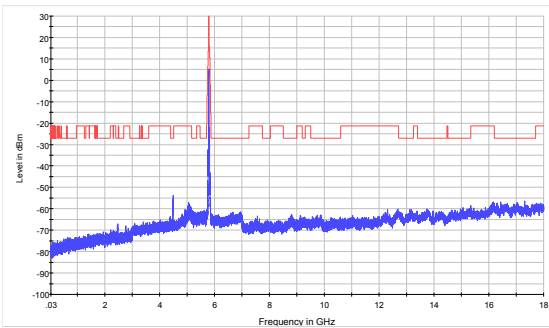

### Frequency 5790MHz, 30M-18GHz

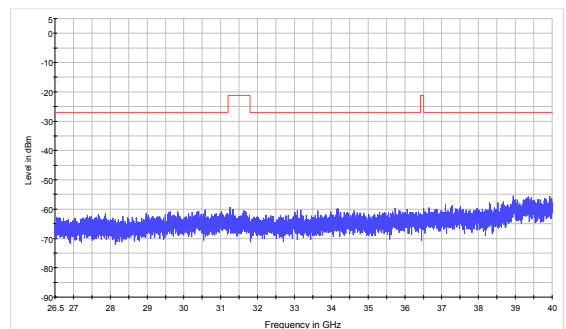
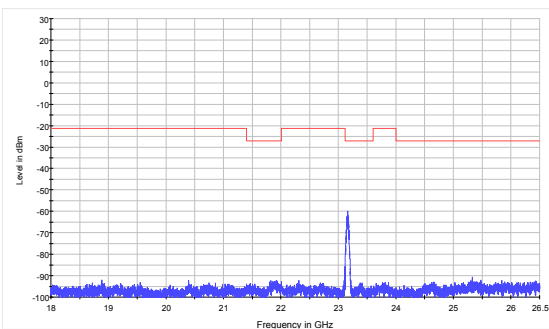

Frequency 5790MHz, 18G-26.5GHz

Frequency 5790MHz, 26.5G-40GHz

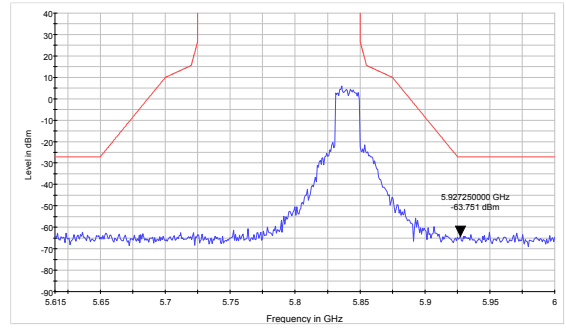
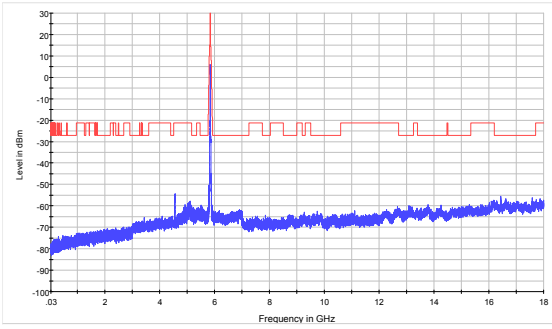

Frequency 5840MHz, 30M-18GHz

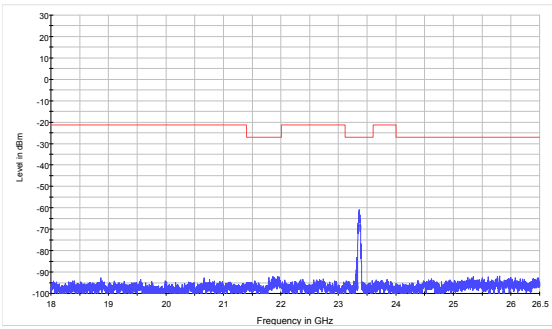

Frequency 5840MHz, 18G-26.5GHz

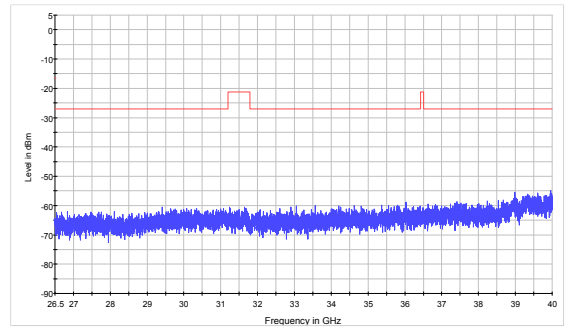

Frequency 5840MHz, 26.5G-40GHz

### 5.7. Conducted Emission

#### Ambient condition

Temperature	Relative humidity	Pressure
23°C ~25°C	45%~50%	101.5kPa

#### Methods of Measurement

The EUT IS placed on a non-metallic table of 80cm height above the horizontal metal reference ground plane. During the test, the EUT was operating in its typical mode. The test method is according to ANSI C63.10-2013. Connect the AC power line of the EUT to the LISN Use EMI receiver to detect the average and Quasi-peak value. RBW is set to 9kHz, VBW is set to 30kHz The measurement result should include both L line and N line.

The test is in transmitting mode.

#### Test Setup

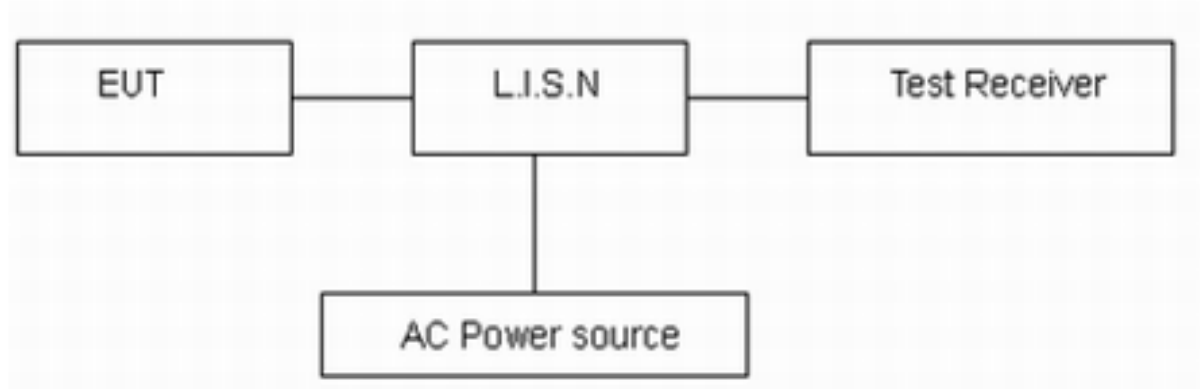

Note: AC Power source is used to change the voltage 110V/60Hz.

#### Limits

Frequency (MHz)	Conducted Limits(dBμV)	
	Quasi-peak	Average
0.15 - 0.5	66 to 56 *	56 to 46 *
0.5 - 5	56	46
5 - 30	60	50

\*: Decreases with the logarithm of the frequency.

#### Measurement Uncertainty

The assessed measurement uncertainty to ensure 95% confidence level for the normal distribution is with the coverage factor  $k = 1.96$ ,  $U = 2.69$  dB.





Test Results:

Following plots, Blue trace uses the peak detection and Green trace uses the average detection.

TM3

Antenna 1

Frequency 5735MHz, L Line

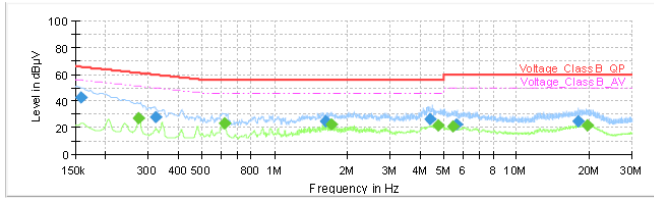

Final Result

Table with 10 columns: Frequency (MHz), QuasiPeak (dBuV), Average (dBuV), Limit (dBuV), Margin (dB), Meas. Time (ms), Bandwidth (kHz), Line, Filter, Corr. (dB). Contains 15 rows of test data.

Frequency 5735MHz, N Line

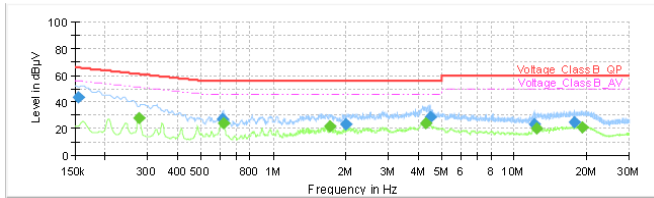

Final Result

Table with 10 columns: Frequency (MHz), QuasiPeak (dBuV), Average (dBuV), Limit (dBuV), Margin (dB), Meas. Time (ms), Bandwidth (kHz), Line, Filter, Corr. (dB). Contains 15 rows of test data.

Frequency 5840MHz, L Line

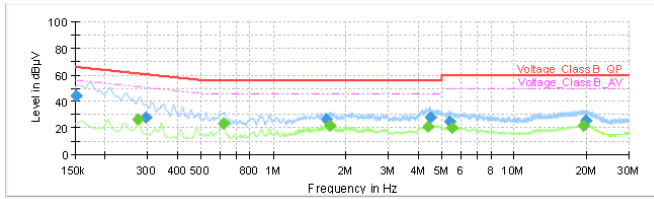

Final Result

Table with 10 columns: Frequency (MHz), QuasiPeak (dBuV), Average (dBuV), Limit (dBuV), Margin (dB), Meas. Time (ms), Bandwidth (kHz), Line, Filter, Corr. (dB). Contains 15 rows of test data.

Frequency 5840MHz, N Line

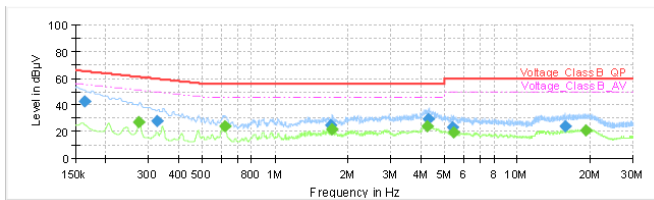

Final Result

Table with 10 columns: Frequency (MHz), QuasiPeak (dBuV), Average (dBuV), Limit (dBuV), Margin (dB), Meas. Time (ms), Bandwidth (kHz), Line, Filter, Corr. (dB). Contains 15 rows of test data.



## 6. Main Test Instruments

Name	Type	Manufacturer	Serial Number	Calibration Date	Expiration Time
Spectrum Analyzer	FSV30	R&S	100815	2016-12-16	2017-12-15
EMI Test Receiver	ESCI	R&S	100948	2017-05-20	2018-05-19
Loop Antenna	FMZB1519	SCHWARZBECK	1519-047	2017-02-18	2020-02-17
TRILOG Broadband Antenna	VULB 9163	Schwarzbeck	9163-201	2014-12-06	2017-12-05
Double Ridged Waveguide Horn Antenna	HF907	R&S	100126	2014-12-06	2017-12-05
Standard Gain Horn	3160-09	ETS-Lindgren	00102644	2015-01-30	2018-01-29
Broadband Horn Antenna	BBHA9170	Schwarzbeck	MRTSUE06024	2016-11-24	2019-11-23
EMI Test Receiver	ESCS30	R&S	100138	2016-12-16	2017-12-15
LISN	ENV216	R&S	101171	2016-12-16	2017-12-15
Spectrum Analyzer	N9010A	Agilent	MY47191109	2017-05-21	2018-05-20
RF Cable	SMA 15cm	Agilent	0001	2017-02-06	2017-08-05

\*\*\*\*\*END OF REPORT \*\*\*\*\*

# ANNEX A: EUT Appearance and Test Setup

## A.1 EUT Appearance

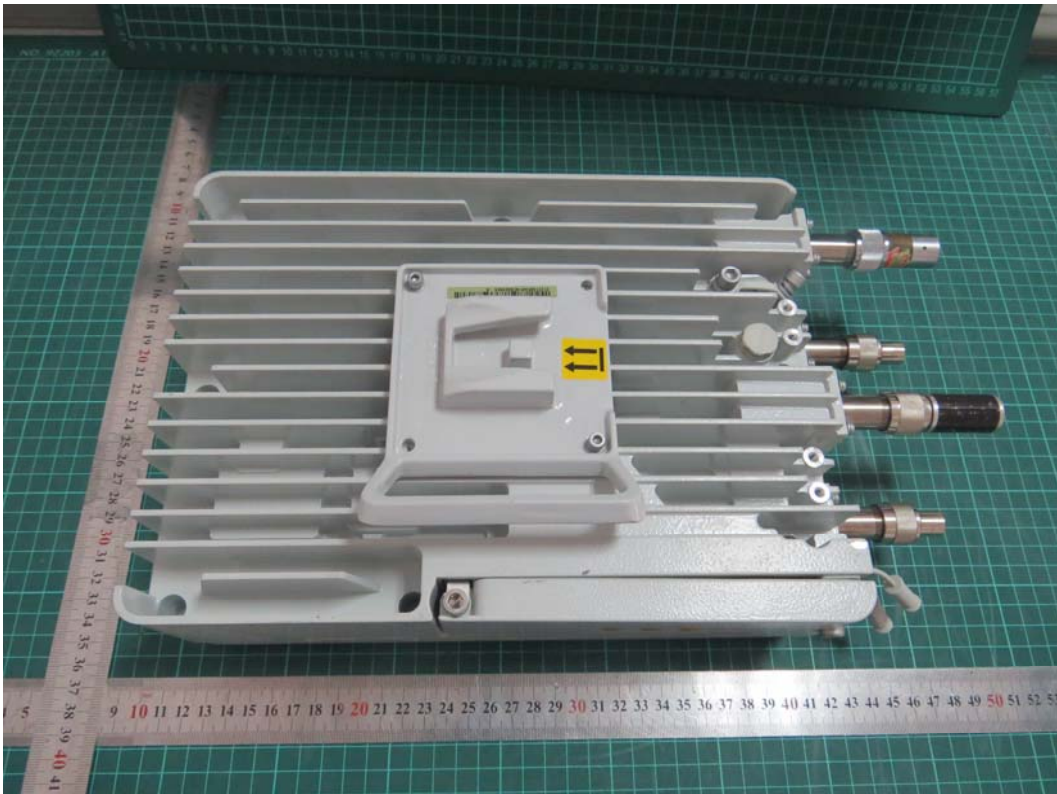

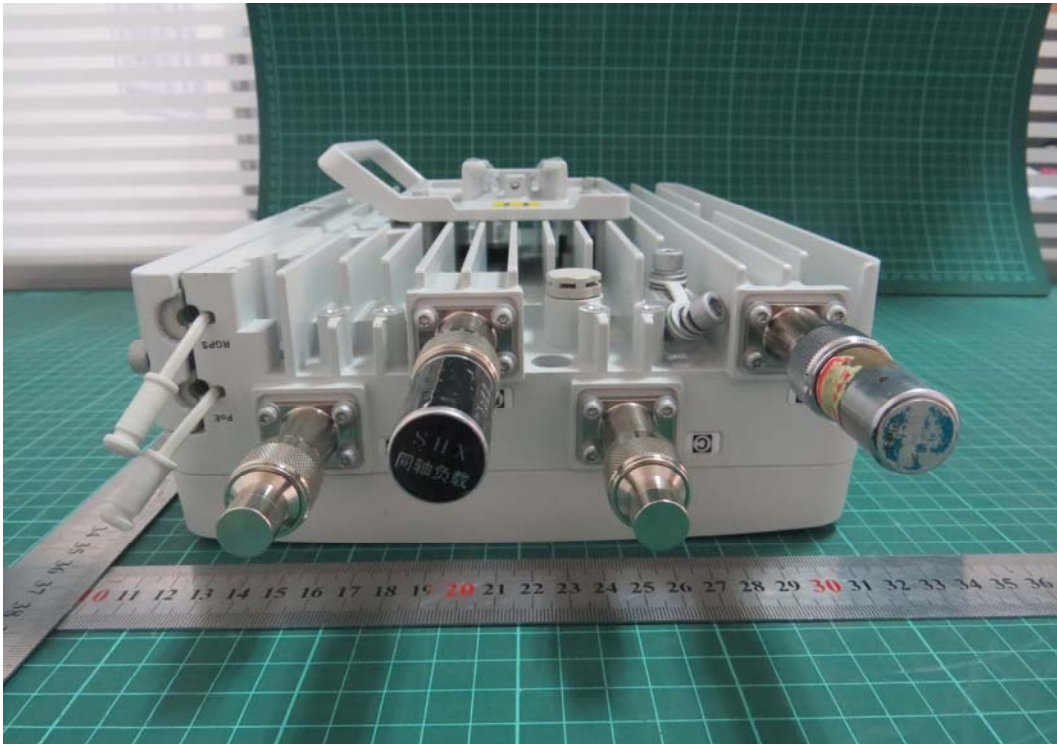

a: EUT



b: Adapter

Picture 1 EUT and Accessory

## A.2 Test Setup



30MHz-1GHz



Above 1GHz

**Picture 2 Radiated Emission Test Setup**



Picture 3 Conducted Emission Test Setup