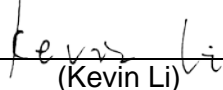

# FCC Test Report

## FCC ID: QISEA380-135

**Project No.** : 1612C268  
**Equipment** : LTE CPE  
**Model Name** : eA380-135  
**Applicant** : Huawei Technologies Co., Ltd.  
**Address** : Administration Building, Headquarters of Huawei Technologies Co., Ltd., Bantian, Longgang District Shenzhen, 518129, P.R.C

**Date of Receipt** : Dec. 27, 2016  
**Date of Test** : Dec. 27, 2016 ~ Jan. 10, 2017  
**Issued Date** : Jan. 11, 2017  
**Tested by** : BTL Inc.

**Testing Engineer** :   
(Kevin Li)

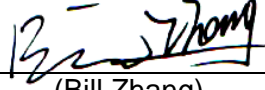
**Technical Manager** :   
(Bill Zhang)

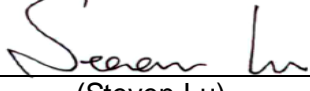
**Authorized Signatory** :   
(Steven Lu)

# **B T L I N C .**

No.3, Jinshagang 1st Road, Shixia, Dalang Town, Dongguan,  
Guangdong, China.

TEL: +86-769-8318-3000 FAX: +86-769-8319-6000



### **Declaration**

**BTL** represents to the client that testing is done in accordance with standard procedures as applicable and that test instruments used has been calibrated with standards traceable to international standard(s) and/or national standard(s).

**BTL's** reports apply only to the specific samples tested under conditions. It is manufacture's responsibility to ensure that additional production units of this model are manufactured with the identical electrical and mechanical components. **BTL** shall have no liability for any declarations, inferences or generalizations drawn by the client or others from **BTL** issued reports.

**BTL's** report must not be used by the client to claim product certification, approval, or endorsement by NVLAP, NIST, or any agency of the Federal Government.

This report is the confidential property of the client. As a mutual protection to the clients, the public and **BTL-self**, extracts from the test report shall not be reproduced except in full with **BTL's** authorized written approval.

**BTL's** laboratory quality assurance procedures are in compliance with the **ISO Guide 17025** requirements, and accredited by the conformity assessment authorities listed in this test report.

### **Limitation**

For the use of the authority's logo is limited unless the Test Standard(s)/Scope(s)/Item(s) mentioned in this test report is (are) included in the conformity assessment authorities acceptance respective.

<b>Table of Contents</b>	<b>Page</b>
<b>REPORT ISSUED HISTORY</b>	<b>4</b>
<b>1 . CERIFICATION</b>	<b>5</b>
<b>2 . SUMMARY OF TEST RESULTS</b>	<b>6</b>
2.1 TEST FACILITY	7
2.2 MEASUREMENT UNCERTAINTY	7
<b>3 . GENERAL INFORMATION</b>	<b>8</b>
3.1 GENERAL DESCRIPTION OF EUT	8
3.2 DESCRIPTION OF TEST MODES	8
3.3 EUT OPERATING CONDITIONS	9
3.4 BLOCK DIAGRAM SHOWING THE CONFIGURATION OF SYSTEM TESTED	9
3.5 DESCRIPTION OF SUPPORT UNITS	9
<b>4 . EMC EMISSION TEST</b>	<b>10</b>
4.1 CONDUCTED EMISSION MEASUREMENT	10
4.1.1 POWER LINE CONDUCTED EMISSION	10
4.1.2 MEASUREMENT INSTRUMENTS LIST	10
4.1.3 TEST PROCEDURE	11
4.1.4 DEVIATION FROM TEST STANDARD	11
4.1.5 TEST SETUP	11
4.1.6 TEST RESULTS	11
4.2 RADIATED EMISSION MEASUREMENT	14
4.2.1 LIMITS OF RADIATED EMISSION MEASUREMENT	14
4.2.2 MEASUREMENT INSTRUMENTS LIST	15
4.2.3 TEST PROCEDURE	16
4.2.4 DEVIATION FROM TEST STANDARD	16
4.2.5 TEST SETUP	17
4.2.6 TEST RESULTS-BELOW 1GHZ	17
4.2.7 TEST RESULTS-ABOVE 1GHZ	20

### REPORT ISSUED HISTORY

Issued No.	Description	Issued Date
BTL-FCCE-1-1612C268	Original Issue.	Jan. 11, 2017

## 1. CERIFICATION

Equipment : LTE CPE  
Brand Name : HUAWEI  
Model Name : eA380-135  
Applicant : Huawei Technologies Co. ,Ltd.  
Manufacturer : Huawei Technologies Co. ,Ltd.  
Address : Administration Building, Headquarters of Huawei Technologies Co., Ltd.,  
Bantian, Longgang District Shenzhen,518129, P.R.C  
Factory : Shenzhen Zowee Technology.co.,ltd  
Address : Shenzhen songgang town pond under chung industrial avenue with rich  
industrial area  
Date of Test : Dec. 27, 2016 ~ Jan. 10, 2017  
Test Sample : Engineering Sample  
Standard(s) : FCC Part 15, Subpart B  
ANSI C63.4-2014

The above equipment has been tested and found compliance with the requirement of the relative standards by BTL Inc.

The test data, data evaluation, and equipment configuration contained in our test report (Ref No. BTL-FCCE-1-1612C268) were obtained utilizing the test procedures, test instruments, test sites that has been accredited by the Authority of TAF according to the ISO-17025 quality assessment standard and technical standard(s).

## 2. SUMMARY OF TEST RESULTS

Test procedures according to the technical standard(s):

EMC Emission				
Standard(s)	Test Item	Limit	Judgment	Remark
FCC Part15, Subpart B ANSI C63.4-2014	Conducted Emission	Class B	PASS	
	Radiated emission Below 1 GHz	Class B	PASS	
	Radiated emission Above 1 GHz	Class B	PASS	NOTE(2)

**NOTE:**

- (1) " N/A" denotes test is not applicable to this device.
- (2) The EUT's max operating frequency exceeds 108 MHz, so the test will be performed.

**2.1 TEST FACILITY**

The test facilities used to collect the test data in this report is at the location of No.3, Jinshagang 1st Road, Shixia, Dalang Town, Dongguan, Guangdong, China.

**2.2 MEASUREMENT UNCERTAINTY**

Where relevant, the following measurement uncertainty levels have been estimated for tests performed on the EUT as specified in CISPR 16-4-2. The BTL measurement uncertainty is less than the CISPR 16-4-2  $U_{cispr}$  requirement.

The reported uncertainty of measurement  $y \pm U$ , where expanded uncertainty  $U$  is based on a standard uncertainty multiplied by a coverage factor of  $k=2$ , providing a level of confidence of approximately 95%.

**A. Conducted Measurement :**

Test Site	Method	Measurement Frequency Range	$U_c$ (dB)
DG-C02	CISPR	150 kHz ~ 30MHz	2.32

**B. Radiated Measurement :**

Test Site	Method	Measurement Frequency Range	Ant. H / V	$U_c$ (dB)
DG-CB03 (3m)	CISPR	9KHz ~ 30MHz	V	3.79
		9KHz ~ 30MHz	H	3.57
		30MHz ~ 200MHz	V	3.82
		30MHz ~ 200MHz	H	3.78
		200MHz ~ 1,000MHz	V	4.10
		200MHz ~ 1,000MHz	H	4.06

Test Site	Method	Measurement Frequency Range	Ant. H / V	$U_c$ (dB)
DG-CB03 (3m)	CISPR	1GHz ~ 18GHz	V	3.12
		1GHz ~ 18GHz	H	3.68
		1GHz ~ 18GHz	V	3.12
		1GHz ~ 18GHz	H	3.68

Note: Unless specifically mentioned, the uncertainty of measurement has not been taken into account to declare the compliance or non-compliance to the specification.

### 3. GENERAL INFORMATION

#### 3.1 GENERAL DESCRIPTION OF EUT

Equipment	LTE CPE		
Brand Name	HUAWEI		
Model Name	eA380-135		
Model Difference	N/A		
Frequency	Mode	Work Frequency(MHz)	
		Transmit Frequency	Receive Frequency
	LTE Band 43	3600 MHz to 3800 MHz	
	Wi-Fi 2.4G	2400-2483.5	2400-2483.5
Power Source	Supplied from PoE.		
Power Rating	I/P: AC 90V~264V, DC: 54V/650mA		
HW Version	VER.A		
SW Version	V100R001		

Note:

1. For a more detailed features description, please refer to the manufacturer’s specifications or the user's manual.

#### 3.2 DESCRIPTION OF TEST MODES

To investigate the maximum EMI emission characteristics generated from EUT, the test system was pre-scanning tested base on the consideration of following EUT operation mode or test configuration mode which possible have effect on EMI emission level. Each of these EUT operation mode(s) or test configuration mode(s) mentioned above was evaluated respectively.

Pretest Mode	Description
Mode 1	FULL SYSTEM(LTE)

For Conducted Test	
Final Test Mode	Description
Mode 1	FULL SYSTEM(LTE)

For Radiated Test	
Final Test Mode	Description
Mode 1	FULL SYSTEM(LTE)



### 3.3 EUT OPERATING CONDITIONS

The EUT exercise program used during radiated and/or conducted emission measurement was designed to exercise the various system components in a manner similar to a typical use.

### 3.4 BLOCK DIAGRAM SHOWING THE CONFIGURATION OF SYSTEM TESTED

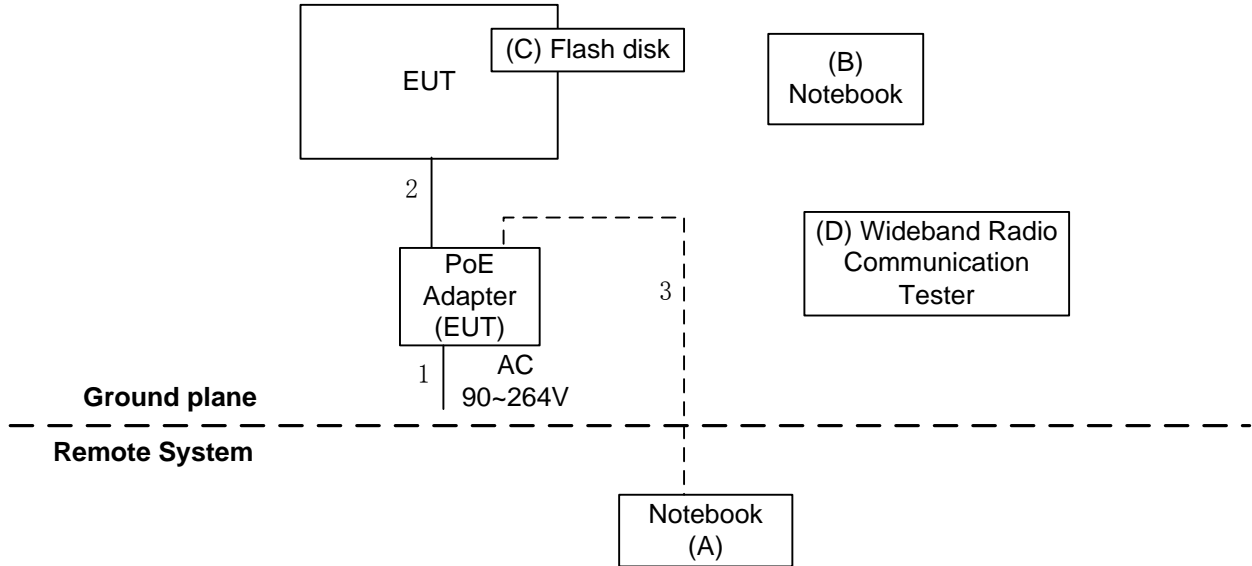

### 3.5 DESCRIPTION OF SUPPORT UNITS

The EUT has been tested as an independent unit together with other necessary accessories or support units. The following support units or accessories were used to form a representative test configuration during the tests.

Item	Equipment	Mfr/Brand	Model/Type No.	FCC ID	Series No.
A	Notebook	Lenovo	E445	N/A	MP-05Y3X6
B	Notebook	Lenovo	G40	N/A	YB09261386
C	USB Flash Disk	Kingston	N/A	DOC	N/A
D	Wideband Radio Communication Tester	RS	CMW500	N/A	122125

Item	Shielded Type	Ferrite Core	Length	Note
1	NO	NO	1.8m	AC Cable
2	NO	NO	1.8m	RJ45 Cable
3	NO	NO	15m	RJ45 Cable

## 4. EMC EMISSION TEST

### 4.1 CONDUCTED EMISSION MEASUREMENT

#### 4.1.1 POWER LINE CONDUCTED EMISSION (FREQUENCY RANGE 150KHZ-30MHZ)

FREQUENCY (MHz)	Class A (dBuV)		Class B (dBuV)	
	Quasi-peak	Average	Quasi-peak	Average
0.15 -0.5	79.00	66.00	66 - 56 *	56 - 46 *
0.50 -5.0	73.00	60.00	56.00	46.00
5.0 -30.0	73.00	60.00	60.00	50.00

Note:

- (1) The tighter limit applies at the band edges.
- (2) The limit of " \* " marked band means the limitation decreases linearly with the logarithm of the frequency in the range.
- (3) The test result calculated as following:  
 Measurement Value = Reading Level + Correct Factor  
 Correct Factor = Insertion Loss + Cable Loss + Attenuator Factor(if use)  
 Margin Level = Measurement Value - Limit Value

#### 4.1.2 MEASUREMENT INSTRUMENTS LIST

Item	Kind of Equipment	Manufacturer	Type No.	Serial No.	Calibrated until
1	Measurement Software	Farad	EZ-EMC Ver.NB-03A 1-01	N/A	N/A
2	LISN	EMCO	3816/2	00052765	Mar. 27, 2017
3	50Ω Terminator	SHX	TF2-3G-A	08122901	Mar. 27, 2017
4	TWO-LINE V-NETWORK	R&S	ENV216	101447	Mar. 27, 2017
5	Cable	emci	RG223(9K Hz-30MHz) (5m)	N/A	Mar. 10, 2017
6	EMI Test Receiver	R&S	ESCI	100382	Mar. 27, 2017

Remark: "N/A" denotes no model name, serial no. or calibration specified.

All calibration period of equipment list is one year.

### 4.1.3 TEST PROCEDURE

- a. The EUT was placed 0.8 meters from the horizontal ground plane with EUT being connected to the power mains through a line impedance stabilization network (LISN). All other support equipments powered from additional LISN(s). The LISN provide 50 Ohm/ 50uH of coupling impedance for the measuring instrument.
- b. Interconnecting cables that hang closer than 40 cm to the ground plane shall be folded back and forth in the center forming a bundle 30 to 40 cm long.
- c. I/O cables that are not connected to a peripheral shall be bundled in the center. The end of the cable may be terminated, if required, using the correct terminating impedance. The overall length shall not exceed 1 m.
- d. LISN at least 80 cm from nearest part of EUT chassis.
- e. For the actual test configuration, please refer to the related Item –EUT Test Photos.
- f. First the whole spectrum of emission caused by equipment under test(EUT) is recorded with Detector set to peak. Peak value recorded in table if the margin from QP Limit is larger than 2dB, otherwise, QP value is recorded, Measuring frequency range from 150KHz to 30MHz.

### 4.1.4 DEVIATION FROM TEST STANDARD

No deviation

### 4.1.5 TEST SETUP

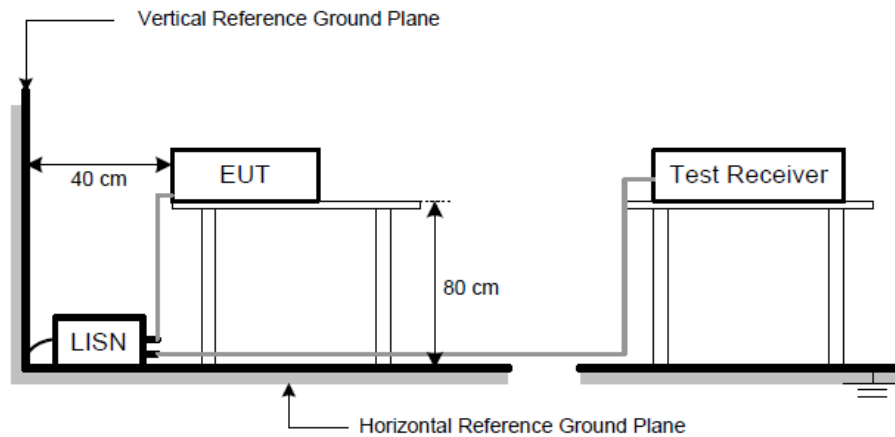

### 4.1.6 TEST RESULTS

Remark

- (1) Reading in which marked as QP means measurements by using are Quasi-Peak Mode with Detector BW=9KHz; SPA setting in RBW=10KHz, VBW =10KHz, Swp. Time = 0.3 sec./MHz. Reading in which marked as AV means measurements by using are Average Mode with instrument setting in RBW=10KHz, VBW=10KHz, Swp. Time =0.3 sec./MHz.
- (2) All readings are QP Mode value unless otherwise stated AVG in column of 『Note』. If the QP Mode Measured value compliance with the QP Limits and lower than AVG Limits, the EUT shall be deemed to meet both QP & AVG Limits and then only QP Mode was measured, but AVG Mode didn't perform. In this case, a “ \* ” marked in AVG Mode column of Interference Voltage Measured.

EUT	LTE CPE	Model Name	eA380-135
Temperature	23°C	Relative Humidity	60%
Test Voltage	AC 120V/60Hz	Phase	Line
Test Mode	FULL SYSTEM(LTE)		
Test Engineer	Kevin Li		

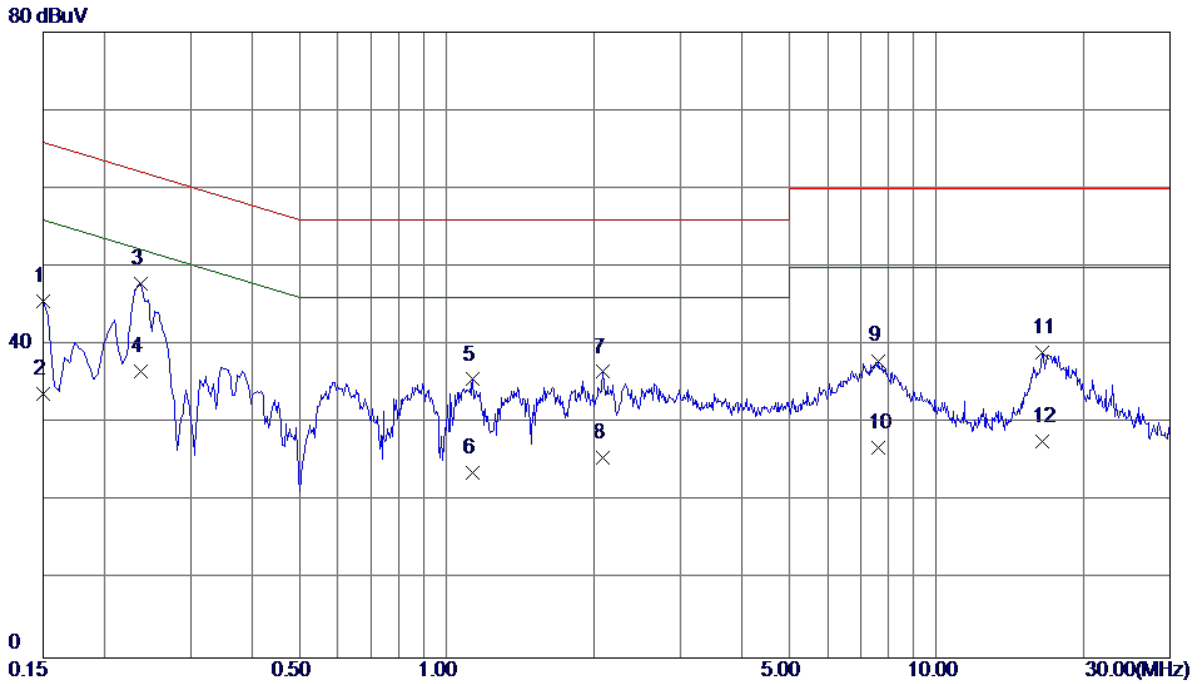

No.	Freq. MHz	Reading Level dBuV	Correct Factor dB	Measurement dBuV	Limit dBuV	Margin dB	Detector
1	0.1500	35.97	9.57	45.54	66.00	-20.46	QP
2	0.1500	24.20	9.57	33.77	56.00	-22.23	AVG
3 *	0.2380	38.30	9.57	47.87	62.17	-14.30	QP
4	0.2380	27.10	9.57	36.67	52.17	-15.50	AVG
5	1.1300	25.75	9.85	35.60	56.00	-20.40	QP
6	1.1300	13.80	9.85	23.65	46.00	-22.35	AVG
7	2.0900	26.51	10.05	36.56	56.00	-19.44	QP
8	2.0900	15.60	10.05	25.65	46.00	-20.35	AVG
9	7.6180	27.58	10.42	38.00	60.00	-22.00	QP
10	7.6180	16.50	10.42	26.92	50.00	-23.08	AVG
11	16.4500	28.31	10.73	39.04	60.00	-20.96	QP
12	16.4500	16.90	10.73	27.63	50.00	-22.37	AVG

EUT	LTE CPE	Model Name	eA380-135
Temperature	23°C	Relative Humidity	60%
Test Voltage	AC 120V/60Hz	Phase	Neutral
Test Mode	FULL SYSTEM(LTE)		
Test Engineer	Kevin Li		

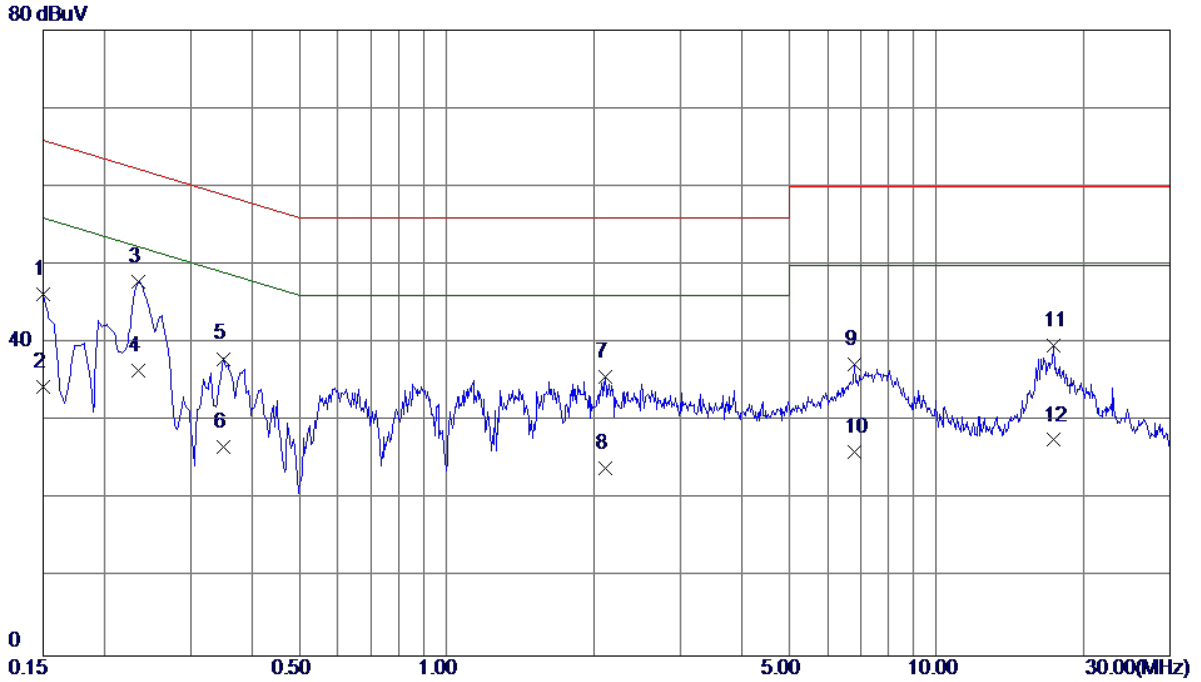

No.	Freq. MHz	Reading Level dBuV	Correct Factor dB	Measure ment dBuV	Limit dBuV	Margin dB	Detector
1	0.1500	36.65	9.57	46.22	66.00	-19.78	QP
2	0.1500	24.80	9.57	34.37	56.00	-21.63	AVG
3 *	0.2340	38.34	9.57	47.91	62.31	-14.40	QP
4	0.2340	26.90	9.57	36.47	52.31	-15.84	AVG
5	0.3500	28.42	9.58	38.00	58.96	-20.96	QP
6	0.3500	17.10	9.58	26.68	48.96	-22.28	AVG
7	2.1060	25.83	9.84	35.67	56.00	-20.33	QP
8	2.1060	14.20	9.84	24.04	46.00	-21.96	AVG
9	6.8020	27.10	10.21	37.31	60.00	-22.69	QP
10	6.8020	15.90	10.21	26.11	50.00	-23.89	AVG
11	17.3380	28.83	10.79	39.62	60.00	-20.38	QP
12	17.3380	16.81	10.79	27.60	50.00	-22.40	AVG

## 4.2 RADIATED EMISSION MEASUREMENT

### 4.2.1 LIMITS OF RADIATED EMISSION MEASUREMENT

#### Below 1 GHz

##### Measurement Method and Applied Limits:

##### ANSI C63.4:

Frequency (MHz)	Class A (at 10m)		Class B (at 3m)	
	(uV/m) Field strength	(dBuV/m) Field strength	(uV/m) Field strength	(dBuV/m) Field strength
30 - 88	90	39	100	40
88 - 216	150	43.5	150	43.5
216 - 960	210	46.4	200	46
Above 960	300	49.5	500	54

#### Above 1 GHz

##### Measurement Method and Applied Limits:

##### ANSI C63.4:

Frequency (MHz)	Class A				Class B	
	(dBuV/m) (at 3m)		(dBuV/m) (at 10m)		(dBuV/m) (at 3m)	
	Peak	Average	Peak	Average	Peak	Average
Above 1000	80	60	69.5	49.5	74	54

### FREQUENCY RANGE OF RADIATED MEASUREMENT (FOR UNINTENTIONAL RADIATORS)

Highest frequency generated or Upper frequency of measurement used in the device or on which the device operates or tunes (MHz)	Range (MHz)
Below 1.705	30
1.705 - 108	1000
108 - 500	2000
500 - 1000	5000
Above 1000	5 <sup>th</sup> harmonic of the highest frequency or 40 GHz, whichever is lower

#### NOTE:

- (1) The limit for radiated test was performed according to as following:  
FCC Part 15, Subpart B
- (2) The tighter limit applies at the band edges.
- (3) Emission level (dBuV/m) = 20log Emission level (uV/m).  
3m Emission level = 10m Emission level + 20log(10m/3m).
- (4) The test result calculated as following:  
Measurement Value = Reading Level + Correct Factor  
Correct Factor = Antenna Factor + Cable Loss - Amplifier Gain(if use)  
Margin Level = Measurement Value - Limit Value

#### 4.2.2 MEASUREMENT INSTRUMENTS LIST

Item	Kind of Equipment	Manufacturer	Type No.	Serial No.	Calibrated until
1	Antenna	Schwarbeck	VULB9160	9160-3232	Mar. 27, 2017
2	Amplifier	HP	8447D	2944A09673	Nov. 08, 2017
3	Receiver	AGILENT	N9038A	MY5213003 9	Oct. 10, 2017
4	Test Cable	emci	LMR-400(30 MHz-1GHz)	C-01	Jun. 27, 2017
5	Control	CT	SC100	N/A	N/A
6	Position Control	MF	MF-7802	MF78020841 6	N/A
7	Measurement Software	Farad	EZ-EMC Ver.NB-03A1 -01	N/A	N/A
8	Amplifier	Agilent	8449B	3008A02274	Oct. 31, 2017
9	Receiver	AGILENT	N9038A	MY5213003 9	Oct. 10, 2017
10	Test Cable	emci	EMC104-SM- SM-10000(1 GHz – 26.5GHz)	C-68	Jun. 27, 2017
11	Measurement Software	Farad	EZ-EMC Ver.NB-03A1 -01	N/A	N/A

Remark: "N/A" denotes no model name, serial no. or calibration specified.  
All calibration period of equipment list is one year.

#### 4.2.3 TEST PROCEDURE

- a. The measuring distance of 3 m shall be used for measurements. The EUT was placed on the top of a rotating table 0.8 meter above the ground at a 3 meter semi-anechoic chamber. The table was rotated 360 degrees to determine the position of the highest radiation.(below 1GHz)
- b. The measuring distance of 3 m shall be used for measurements. The EUT was placed on the top of a rotating table 0.8 meter above the ground at a 3 meter semi-anechoic chamber. The table was rotated 360 degrees to determine the position of the highest radiation.(above 1GHz)
- c. The height of the equipment or of the substitution antenna shall be 0.8 m, the height of the test antenna shall vary between 1 m to 4 m. Both horizontal and vertical polarizations of the antenna are set to make the measurement.
- d. For each suspected emission, the EUT was arranged to its worst case and then the antenna was tuned to heights find the maximum reading (used Bore sight function).
- e. The receiver system was set to peak and average detect function and specified bandwidth with maximum hold mode when the test frequency is above 1GHz.
- f. The initial step in collecting radiated emission data is a receiver peak detector mode pre-scanning the measurement frequency range. Significant peaks are then marked and then Quasi Peak detector mode re-measured.
- g. All readings are Peak unless otherwise stated QP in column of Note. Peak denotes that the Peak reading compliance with the QP Limits and then QP Mode measurement didn't perform. (below 1GHz)
- h. All readings are Peak Mode value unless otherwise stated AVG in column of Note. If the Peak Mode Measured value compliance with the Peak Limits and lower than AVG Limits, the EUT shall be deemed to meet both Peak & AVG Limits and then only Peak Mode was measured, but AVG Mode didn't perform. (above 1GHz)
- i. For the actual test configuration, please refer to the related Item - Block Diagram of system tested (please refer to 3.3).

#### 4.2.4 DEVIATION FROM TEST STANDARD

No deviation



### 4.2.5 TEST SETUP

(A) Radiated Emission Test Set-Up Frequency Below 1 GHz

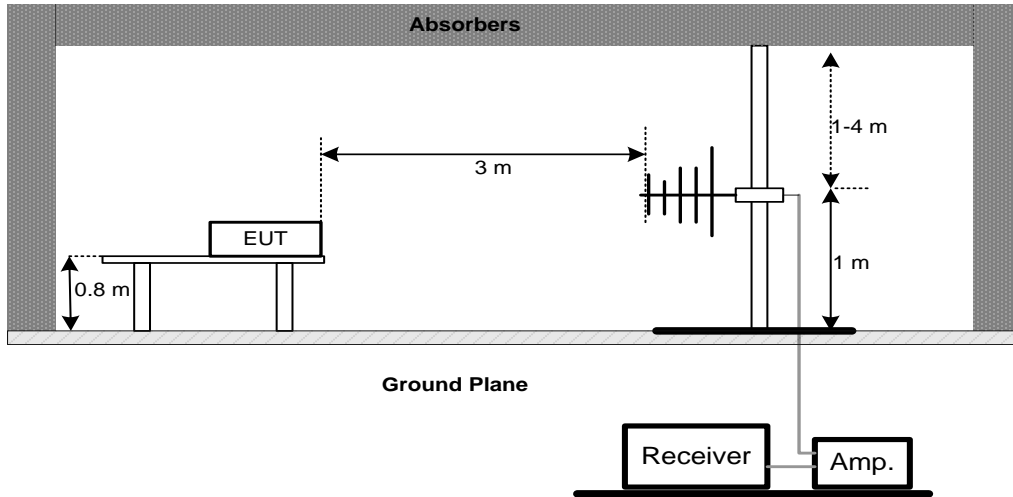

(B) Radiated Emission Test Set-Up Frequency 1 GHz

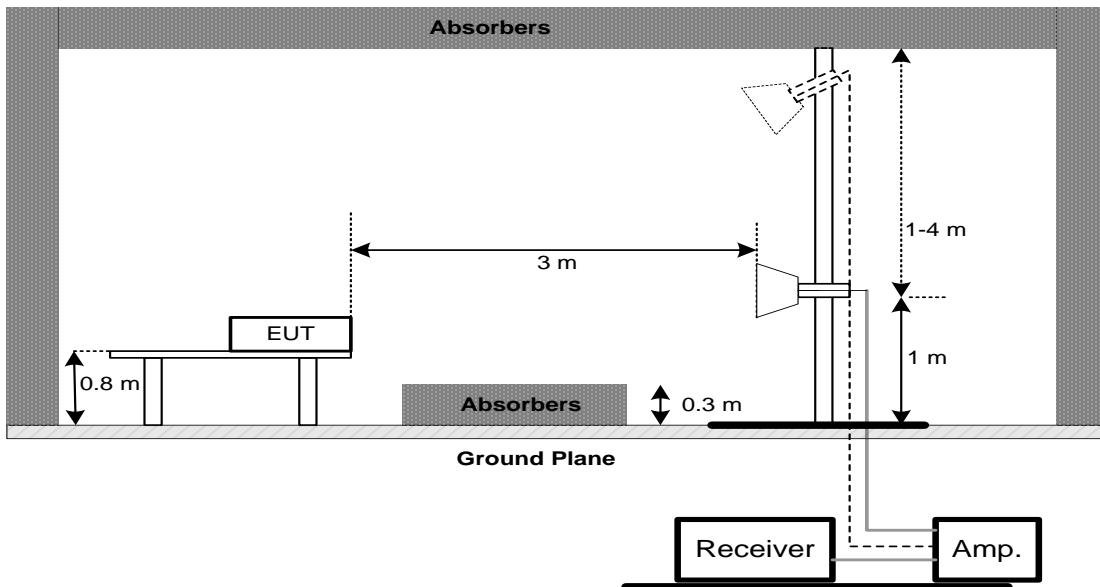

### 4.2.6 TEST RESULTS-BELOW 1GHZ

Remark :

- (1) All readings are Peak unless otherwise stated QP in column of 『Note』 . Peak denotes that the Peak reading compliance with the QP Limits and then QP Mode measurement didn't perform ◦
- (2) Measuring frequency range from 30MHz to 1000MHz ◦
- (3) If the peak scan value lower limit more than 20dB, then this signal data does not show in table ◦

EUT	LTE CPE	Model Name	eA380-135
Temperature	25°C	Relative Humidity	60%
Test Voltage	AC 120V/60Hz	Polarization	Vertical
Test Mode	FULL SYSTEM(LTE)		
Test Engineer	Kevin Li		

80 dBuV/m

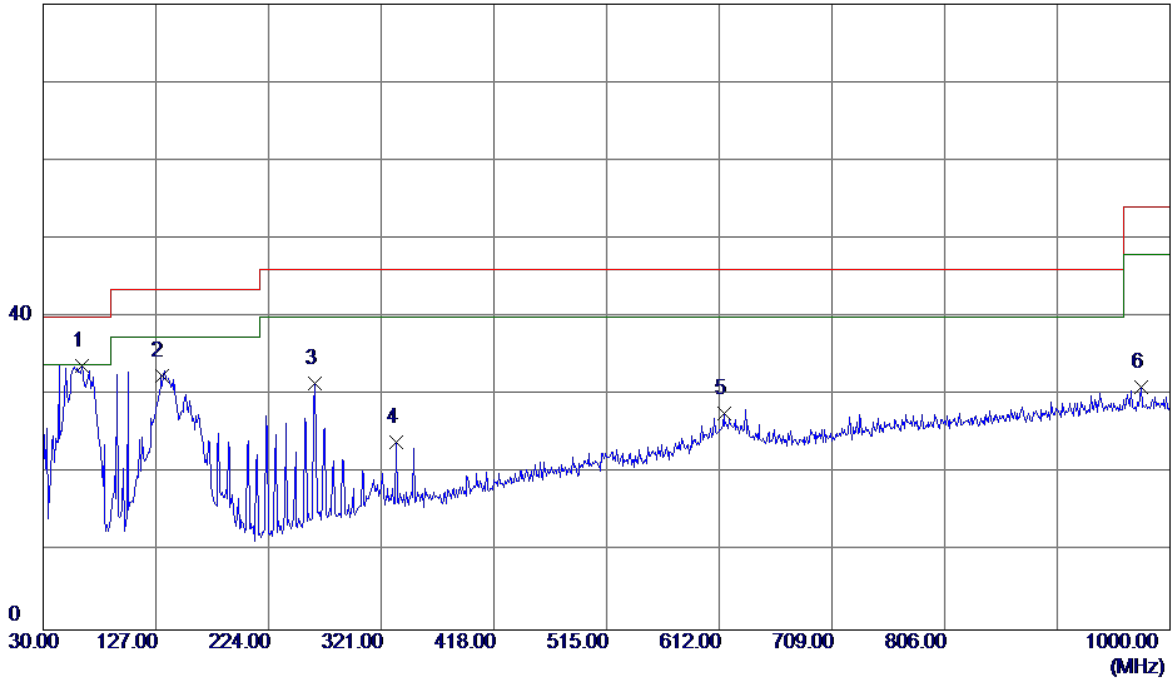

No.	Freq. MHz	Reading Level dBuV/m	Correct Factor dB	Measure ment dBuV/m	Limit dBuV/m	Margin dB	Detector
1 *	63.4650	49.13	-15.37	33.76	40.00	-6.24	QP
2	131.8500	46.39	-13.97	32.42	43.50	-11.08	QP
3	264.2550	44.63	-13.13	31.50	46.00	-14.50	QP
4	334.0950	34.81	-10.85	23.96	46.00	-22.04	QP
5	616.3650	32.71	-5.07	27.64	46.00	-18.36	QP
6	974.7800	28.84	2.14	30.98	54.00	-23.02	QP

EUT	LTE CPE	Model Name	eA380-135
Temperature	25°C	Relative Humidity	60%
Test Voltage	AC 120V/60Hz	Polarization	Horizontal
Test Mode	FULL SYSTEM(LTE)		
Test Engineer	Kevin Li		

80 dBuV/m

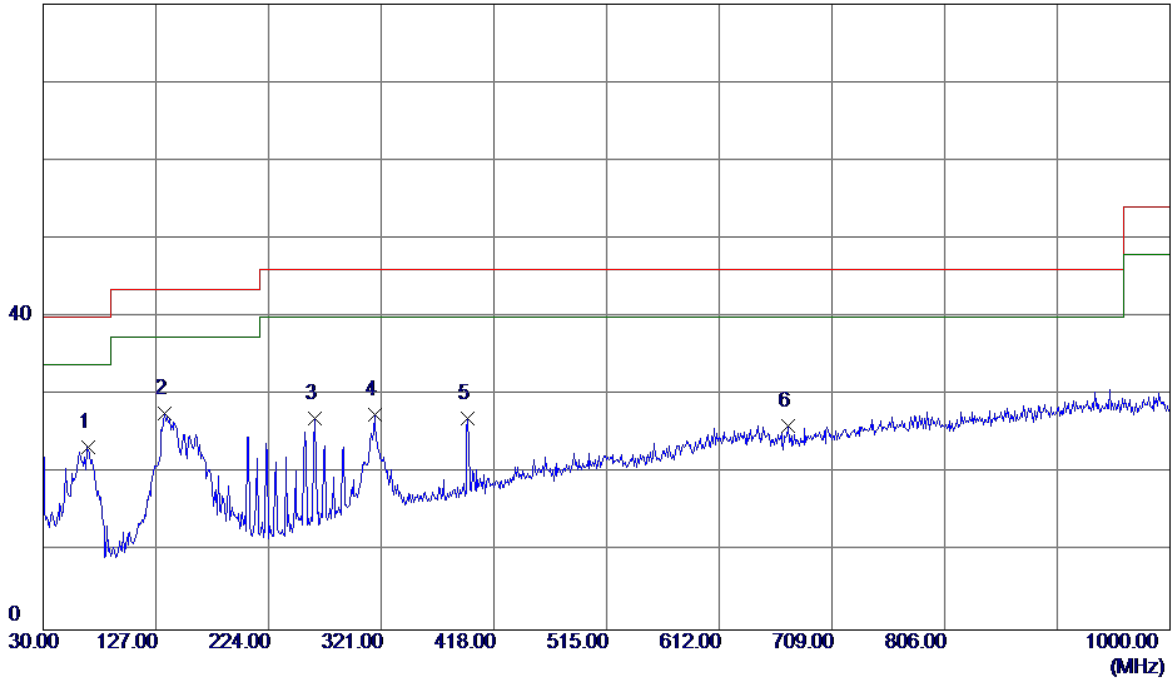

No.	Freq. MHz	Reading Level dBuV/m	Correct Factor dB	Measure ment dBuV/m	Limit dBuV/m	Margin dB	Detector
1	68.3150	39.38	-16.01	23.37	40.00	-16.63	QP
2 *	134.7600	41.32	-13.68	27.64	43.50	-15.86	QP
3	264.2550	40.24	-13.13	27.11	46.00	-18.89	QP
4	315.1800	38.77	-11.24	27.53	46.00	-18.47	QP
5	395.6900	36.17	-9.20	26.97	46.00	-19.03	QP
6	671.6550	30.01	-3.90	26.11	46.00	-19.89	QP

#### 4.2.7 TEST RESULTS-ABOVE 1GHZ

Remark :

- (1) All readings are Peak unless otherwise stated QP in column of 『Note 』. Peak denotes that the Peak reading compliance with the QP Limits and then QP Mode measurement didn't perform.
- (2) Radiated emissions measured in frequency range above 1000MHz were made with an instrument using Peak detector mode and AV detector mode of the emission.
- (3) Data of measurement within this frequency range shown “ \* ” in the table above means the reading of emissions are attenuated more than 20dB below the permissible limits or the field strength is too small to be measured.
- (4) A preamp and high pass filter were used for this test in order to provide sufficient measurement sensitivity.

EUT	LTE CPE	Model Name	eA380-135
Temperature	25°C	Relative Humidity	60%
Test Voltage	AC 120V/60Hz	Polarization	Vertical
Test Mode	FULL SYSTEM(LTE)		
Test Engineer	Kevin Li		

79.9 dBuV/m

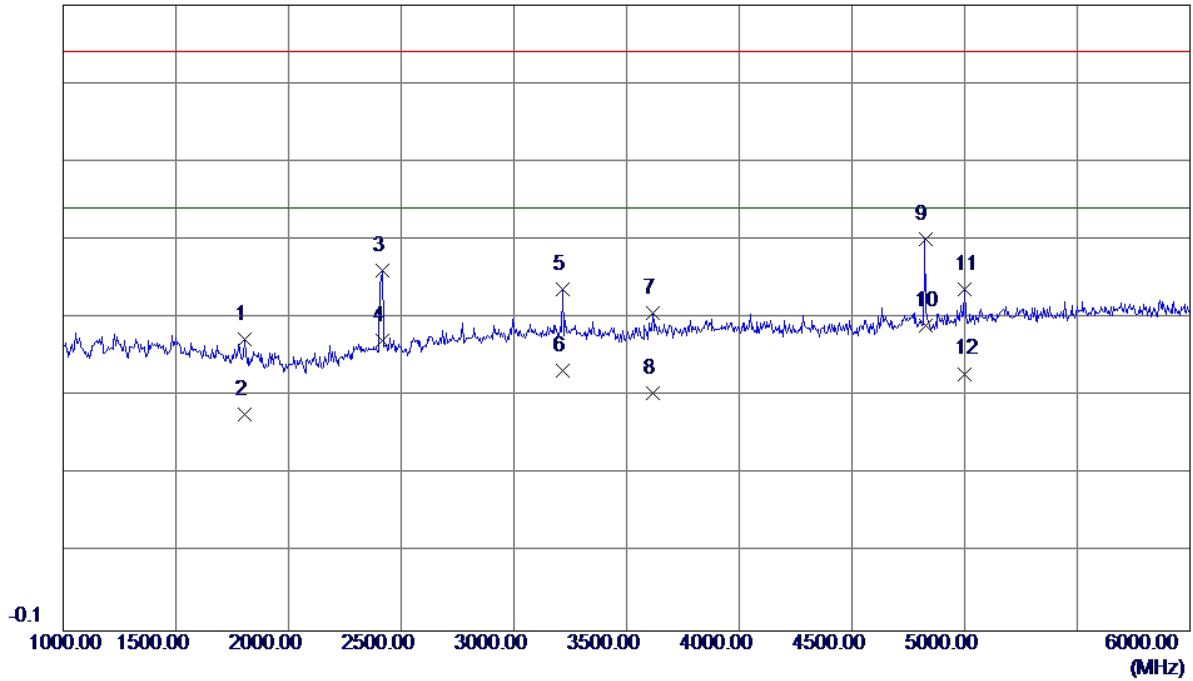

No.	Freq. MHz	Reading Level dBuV/m	Correct Factor dB	Measure ment dBuV/m	Limit dBuV/m	Margin dB	Detector
1	1807.5000	45.62	-8.44	37.18	74.00	-36.82	Peak
2	1807.5000	36.00	-8.44	27.56	54.00	-26.44	AVG
3	2415.0000	52.12	-6.07	46.05	74.00	-27.95	Peak
4	2415.0000	43.02	-6.07	36.95	54.00	-17.05	AVG
5	3215.0000	47.80	-4.21	43.59	74.00	-30.41	Peak
6	3215.0000	37.47	-4.21	33.26	54.00	-20.74	AVG
7	3615.0000	44.79	-4.25	40.54	74.00	-33.46	Peak
8	3615.0000	34.51	-4.25	30.26	54.00	-23.74	AVG
9	4825.0000	52.11	-2.19	49.92	74.00	-24.08	Peak
10 *	4825.0000	41.14	-2.19	38.95	54.00	-15.05	AVG
11	5000.0000	45.26	-1.63	43.63	74.00	-30.37	Peak
12	5000.0000	34.41	-1.63	32.78	54.00	-21.22	AVG

EUT	LTE CPE	Model Name	eA380-135
Temperature	25°C	Relative Humidity	60%
Test Voltage	AC 120V/60Hz	Polarization	Horizontal
Test Mode	FULL SYSTEM(LTE)		
Test Engineer	Kevin Li		

79.9 dBuV/m

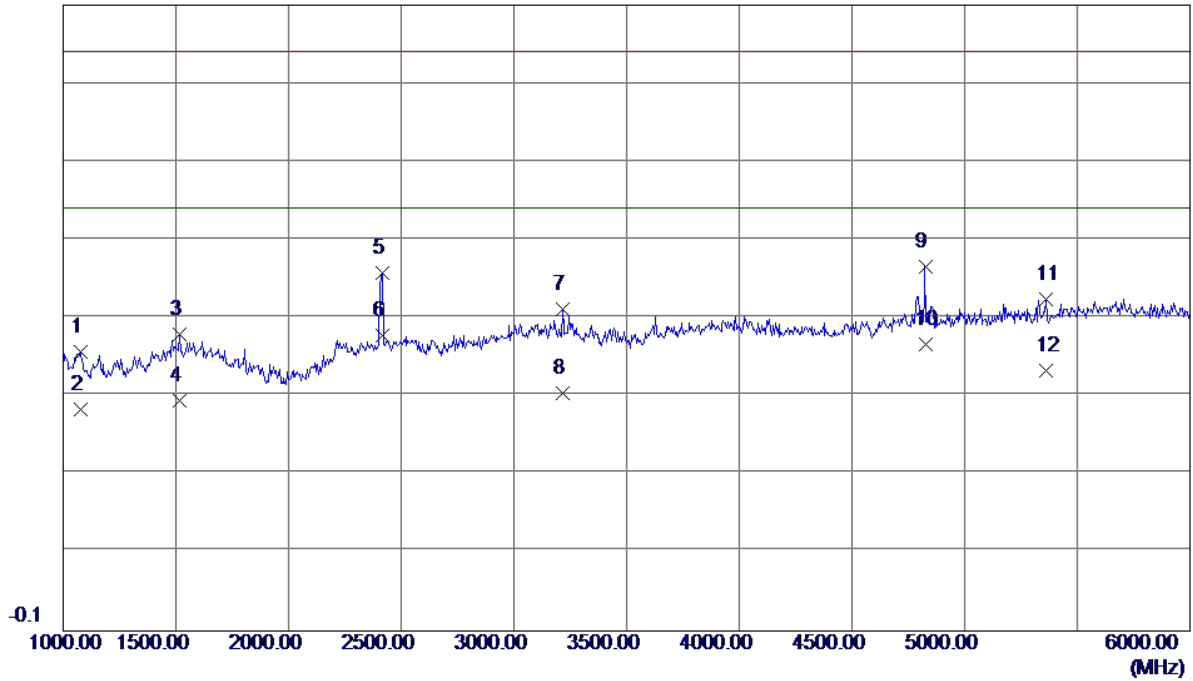

No.	Freq. MHz	Reading Level dBuV/m	Correct Factor dB	Measure ment dBuV/m	Limit dBuV/m	Margin dB	Detector
1	1077.5000	46.64	-11.01	35.63	74.00	-38.37	Peak
2	1077.5000	39.22	-11.01	28.21	54.00	-25.79	AVG
3	1517.5000	48.13	-10.30	37.83	74.00	-36.17	Peak
4	1517.5000	39.61	-10.30	29.31	54.00	-24.69	AVG
5	2415.0000	51.77	-6.07	45.70	74.00	-28.30	Peak
6 *	2415.0000	43.66	-6.07	37.59	54.00	-16.41	AVG
7	3215.0000	45.22	-4.21	41.01	74.00	-32.99	Peak
8	3215.0000	34.56	-4.21	30.35	54.00	-23.65	AVG
9	4825.0000	48.60	-2.19	46.41	74.00	-27.59	Peak
10	4825.0000	38.77	-2.19	36.58	54.00	-17.42	AVG
11	5360.0000	43.04	-0.78	42.26	74.00	-31.74	Peak
12	5360.0000	34.03	-0.78	33.25	54.00	-20.75	AVG

EUT	LTE CPE	Model Name	eA380-135
Temperature	25°C	Relative Humidity	60%
Test Voltage	AC 120V/60Hz	Polarization	Vertical
Test Mode	FULL SYSTEM(LTE)		
Test Engineer	Kevin Li		

79.9 dBuV/m

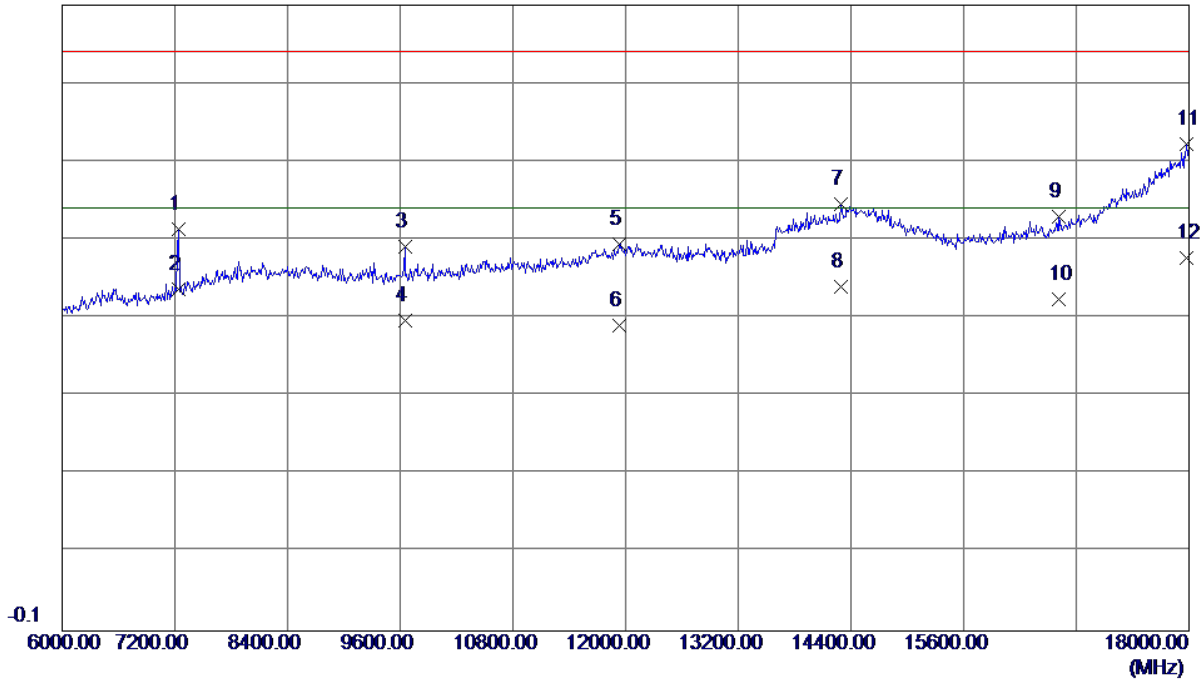

No.	Freq. MHz	Reading Level dBuV/m	Correct Factor dB	Measure ment dBuV/m	Limit dBuV/m	Margin dB	Detector
1	7236.0000	48.95	2.38	51.33	74.00	-22.67	Peak
2	7236.0000	41.18	2.38	43.56	54.00	-10.44	AVG
3	9648.0000	45.71	3.32	49.03	74.00	-24.97	Peak
4	9648.0000	36.33	3.32	39.65	54.00	-14.35	AVG
5	11934.0000	45.80	3.57	49.37	74.00	-24.63	Peak
6	11934.0000	35.38	3.57	38.95	54.00	-15.05	AVG
7	14292.0000	46.14	8.28	54.42	74.00	-19.58	Peak
8	14292.0000	35.68	8.28	43.96	54.00	-10.04	AVG
9	16608.0000	48.09	4.78	52.87	74.00	-21.13	Peak
10	16608.0000	37.58	4.78	42.36	54.00	-11.64	AVG
11	17976.0000	53.66	8.42	62.08	74.00	-11.92	Peak
12 *	17976.0000	39.23	8.42	47.65	54.00	-6.35	AVG

EUT	LTE CPE	Model Name	eA380-135
Temperature	25°C	Relative Humidity	60%
Test Voltage	AC 120V/60Hz	Polarization	Horizontal
Test Mode	FULL SYSTEM(LTE)		
Test Engineer	Kevin Li		

79.9 dBuV/m

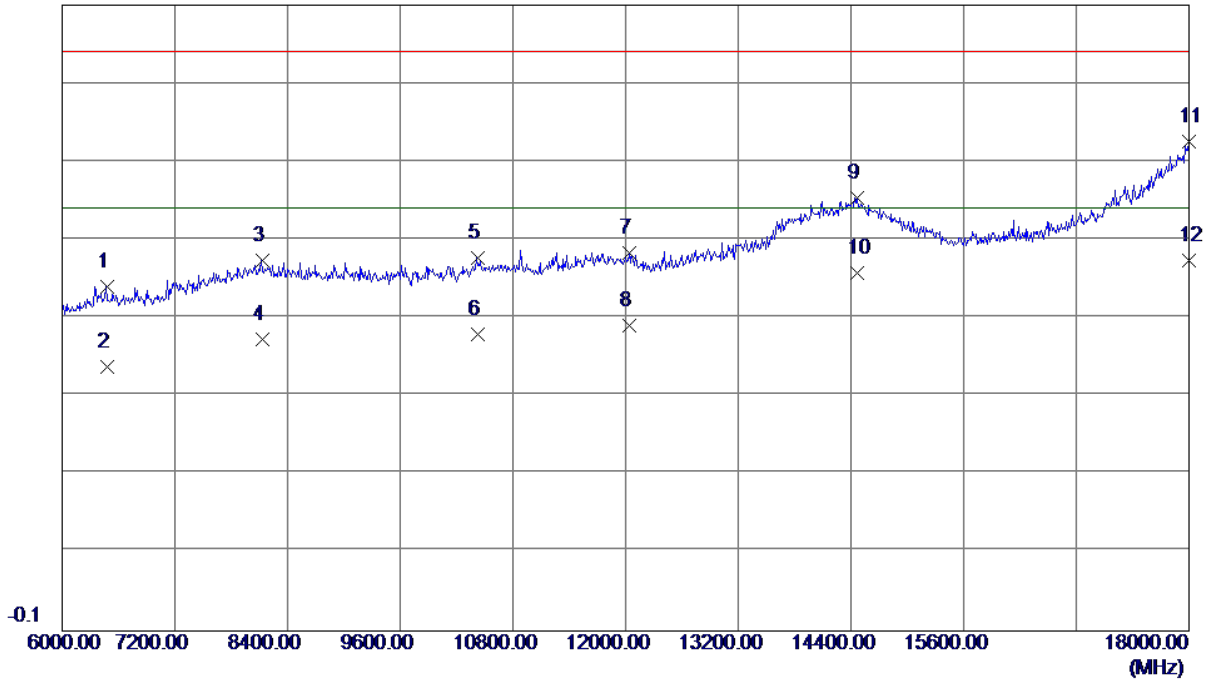

No.	Freq. MHz	Reading Level dBuV/m	Correct Factor dB	Measure ment dBuV/m	Limit dBuV/m	Margin dB	Detector
1	6474.0000	41.50	2.45	43.95	74.00	-30.05	Peak
2	6474.0000	31.24	2.45	33.69	54.00	-20.31	AVG
3	8130.0000	44.86	2.35	47.21	74.00	-26.79	Peak
4	8130.0000	34.86	2.35	37.21	54.00	-16.79	AVG
5	10422.0000	43.62	3.96	47.58	74.00	-26.42	Peak
6	10422.0000	33.93	3.96	37.89	54.00	-16.11	AVG
7	12036.0000	44.66	3.57	48.23	74.00	-25.77	Peak
8	12036.0000	35.39	3.57	38.96	54.00	-15.04	AVG
9	14472.0000	47.57	7.66	55.23	74.00	-18.77	Peak
10	14472.0000	37.97	7.66	45.63	54.00	-8.37	AVG
11	18000.0000	54.00	8.45	62.45	74.00	-11.55	Peak
12 *	18000.0000	38.80	8.45	47.25	54.00	-6.75	AVG