



中国认可
国际互认
检测
TESTING
CNAS L2264

RF TEST REPORT

Applicant Huawei Technologies Co., Ltd.
FCC ID QISEA300-8A
Product eLTE-IoT DAU
Model eA300-8a
Report No. RHA1612-0102RF01R3
Issue Date March 27, 2017

TA Technology (Shanghai) Co., Ltd. tested the above equipment in accordance with the requirements in **FCC CFR47 Part 15C (2016)**. The test results show that the equipment tested is capable of demonstrating compliance with the requirements as documented in this report.

Performed by: Xianqing Li

Approved by: Kai Xu

TA Technology (Shanghai) Co., Ltd.

No.145, Jintang Rd, Tangzhen Industry Park, Pudong Shanghai, China

TEL: +86-021-50791141/2/3

FAX: +86-021-50791141/2/3-8000

Table of Contents

1	Test Laboratory.....	4
1.1	Notes of the Test Report.....	4
1.2	Test facility.....	4
1.3	Testing Location.....	5
2	General Description of Equipment under Test.....	6
2.1	Applied Standards.....	7
3	Test Information.....	8
3.1	Peak Power Output –Conducted.....	8
3.2	Occupied Bandwidth (20dB).....	10
3.3	Frequency Separation.....	12
3.4	Time of Occupancy (Dwell Time).....	14
3.5	Band Edge Compliance.....	16
3.6	Spurious Radiated Emissions in the Restricted Band.....	19
3.7	Number of hopping Frequency.....	23
3.8	Spurious RF Conducted Emissions.....	25
3.9	Radiates Emission.....	28
3.10	Conducted Emission.....	49
4	Main Test Instruments.....	52
	ANNEX A: EUT Appearance and Test Setup.....	53
A.1	EUT Appearance.....	53
A.2	Test Setup.....	54

Summary of Measurement Results

Number	Summary of measurements of results	Clause in FCC rules	Verdict
1	Peak Power Output -Conducted	15.247(b)(2)	PASS
2	Occupied Bandwidth (20dB)	15.247(a)(1)	PASS
3	Frequency Separation	15.247(a)(1)	PASS
4	Time of Occupancy (Dwell Time)	15.247(a)(1)(i)	PASS
5	Band Edge Compliance	15.247(d)	PASS
6	Spurious Radiated Emissions in the restricted band	15.247(d),15.205,15.209	PASS
7	Number of Hopping Frequency	15.247(a)(1)(i)	PASS
8	Spurious RF Conducted Emissions	15.247(d)	PASS
9	Radiates Emission	15.247(d),15.205,15.209	PASS
10	AC Power Line Conducted Emission	15.207	PASS
Date of Testing: December 27, 2016~ March 23, 2017			

1 Test Laboratory

1.1 Notes of the Test Report

This report shall not be reproduced in full or partial, without the written approval of **TA technology (shanghai) co., Ltd.** The results documented in this report apply only to the tested sample, under the conditions and modes of operation as described herein .Measurement Uncertainties were not taken into account and are published for informational purposes only. This report is written to support regulatory compliance of the applicable standards stated above. This report must not be used by the client to claim product certification, approval, or endorsement by CNAS or any government agencies.

1.2 Test facility

CNAS (accreditation number: L2264)

TA Technology (Shanghai) Co., Ltd. has obtained the accreditation of China National Accreditation Service for Conformity Assessment (CNAS).

FCC (recognition number is 428261)

TA Technology (Shanghai) Co., Ltd. has been listed on the US Federal Communications Commission list of test facilities recognized to perform electromagnetic emissions measurements.

IC (recognition number is 8510A)

TA Technology (Shanghai) Co., Ltd. has been listed by industry Canada to perform electromagnetic emission measurement.

A2LA (Certificate Number: 3857.01)

TA Technology (Shanghai) Co., Ltd. has been listed by American Association for Laboratory Accreditation to perform electromagnetic emission measurement.

1.3 Testing Location

Company: TA Technology (Shanghai) Co., Ltd.
Address: No.145, Jintang Rd, Tangzhen Industry Park, Pudong Shanghai, China
City: Shanghai
Post code: 201201
Country: P. R. China
Contact: Xu Kai
Telephone: +86-021-50791141/2/3
Fax: +86-021-50791141/2/3-8000
Website: <http://www.ta-shanghai.com>
E-mail: xukai@ta-shanghai.com

2 General Description of Equipment under Test

Client Information

Applicant	Huawei Technologies Co., Ltd.
Applicant address	Administration Building, Headquarters of Huawei Technologies Co., Ltd., Bantian, Longgang District, Shenzhen, 518129, P.R.China.
Manufacturer	Huawei Technologies Co., Ltd.
Manufacturer address	Administration Building, Headquarters of Huawei Technologies Co., Ltd., Bantian, Longgang District, Shenzhen, 518129, P.R.China.

General information

EUT Description	
Model:	eA300-8a
S/N:	/
HW Version:	Ver. A
SW Version:	V100R001C00
Power Supply:	-48V DC
Antenna Type:	Internal Antenna
Modulation Type:	Downlink: OFDM Uplink: SC-FDMA
Max. Conducted Power	26.41dBm
Tested Frequency Range(s):	902 ~ 928 MHz
EUT Accessory	
Charger	Manufacturer: DONGGUANG SHILONG FUHUA ELECTRONIC CO. LTD Model: PoE35-54A-1
Note: 1. The information of the EUT is declared by the manufacturer. Please refer to the specifications or user manual for details.	



2.1 Applied Standards

According to the specifications of the manufacturer, it must comply with the requirements of the following standards:

Test standards

- **FCC CFR47 Part 15C (2016) Radio Frequency Devices**
- **ANSI C63.10 (2013)**
- **DA00-705 Filing and Frequency Measurement Guidelines For Frequency Hopping Spread Spectrum System (2000).**

3 Test Information

3.1 Peak Power Output –Conducted

Ambient condition

Temperature	Relative humidity	Pressure
23°C ~25°C	45%~50%	101.5kPa

Methods of Measurement

During the process of the testing, The EUT was connected to Spectrum Analyzer through an external attenuator and a known loss cable. The EUT is max power transmission with proper modulation. RBW is set to 20KHz, VBW is set to 62KHz. The peak detector is used. We use Maximum peak Conducted Output Power Level Method in DA00-705 Filing and Frequency Measurement Guidelines For Frequency Hopping Spread Spectrum System (2000) for this test.

Test Setup

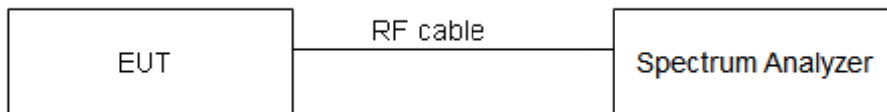

Limits

Rule Part 15.247 (b) (2) specifies that " For frequency hopping systems operating in the 902-928 MHz band: 1 watt for systems employing at least 50 hopping channels; and, 0.25 watts for systems employing less than 50 hopping channels, but at least 25 hopping channels, as permitted under paragraph (a)(1)(i) of this section."

Peak Output Power	≤ 1W (30dBm)
-------------------	--------------

Measurement Uncertainty

The assessed measurement uncertainty to ensure 95% confidence level for the normal distribution is with the coverage factor $k = 2$, $U=0.44$ dB.

Test Results

Network Standards	Carrier frequency (MHz)	Peak Output Power (dBm)	EIRP (dBm)	Limit (dBm)	Conclusion
902 ~ 928 MHz	903.3	18.255	26.26	30	PASS
	920	18.352	26.35	30	PASS
	925	18.404	26.40	30	PASS
	926.7	18.411	26.41	30	PASS

Note:1) EIRP = A (Conducted Power) + G(Antenna Gain=8dBi)

2) The measured power density (dBm) has the offset with cable loss already.

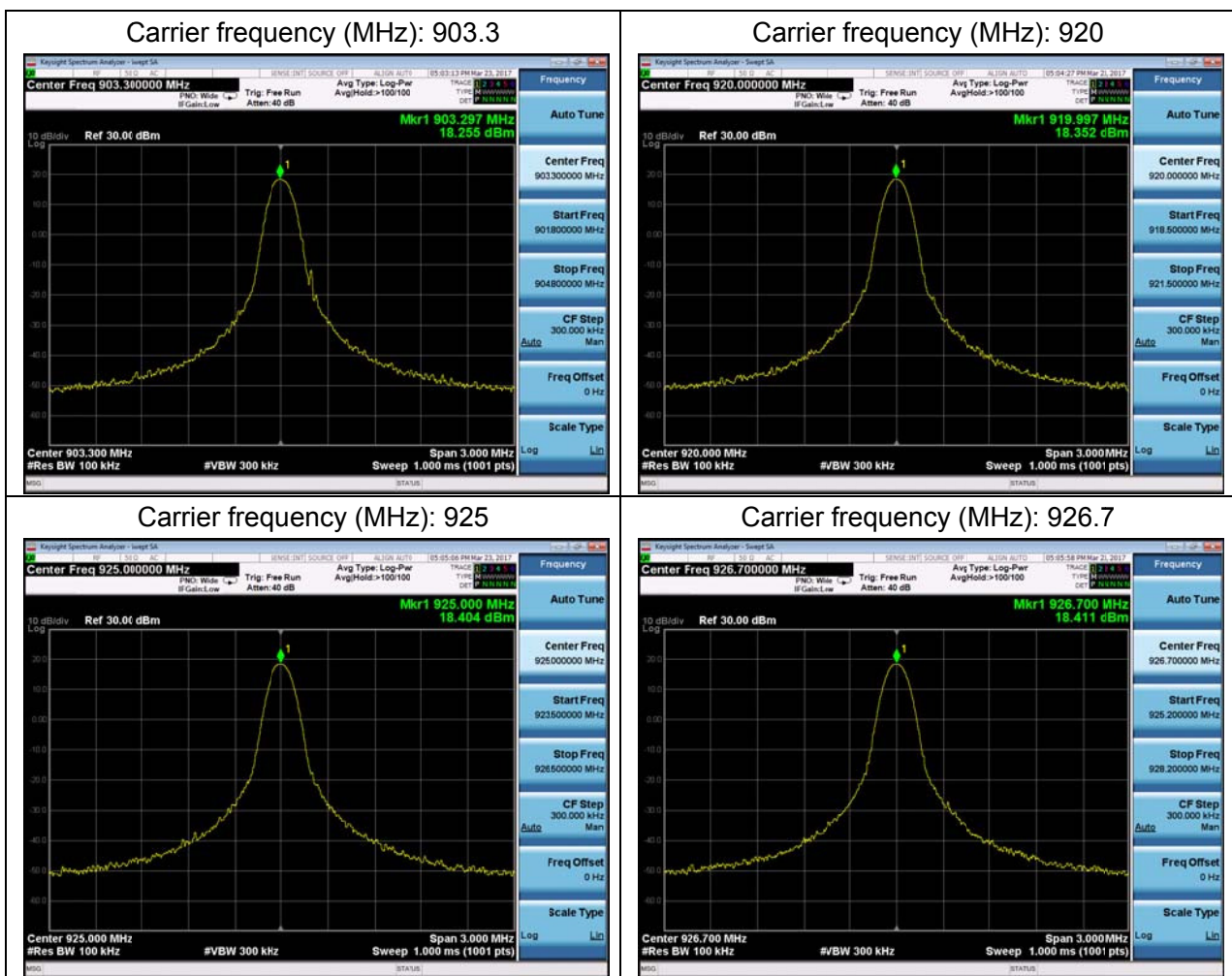

3.2 Occupied Bandwidth (20dB)

Ambient condition

Temperature	Relative humidity	Pressure
23°C ~25°C	45%~50%	101.5kPa

Method of Measurement

The EUT was connected to the spectrum analyzer with a known loss. The occupied bandwidth is measured using spectrum analyzer. RBW is set to 3.9kHz and VBW is set to 12kHz on spectrum analyzer. -20dB occupied bandwidths are recorded.

Test Setup

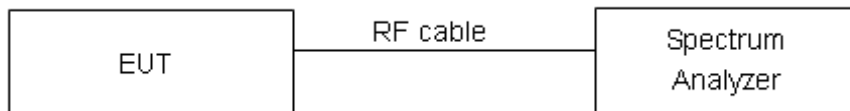

Limits

The maximum allowed 20 dB bandwidth of the hopping channel is 500 kHz.

Measurement Uncertainty

The assessed measurement uncertainty to ensure 95% confidence level for the normal distribution is with the coverage factor $k = 2$, $U=936$ Hz.

Test Results

Carrier frequency (MHz)	20dB Bandwidth(kHz)	Limit (kHz)	Conclusion
903.3	11.78	500	PASS
920	13.91	500	PASS
925	12.05	500	PASS
926.7	11.61	500	PASS

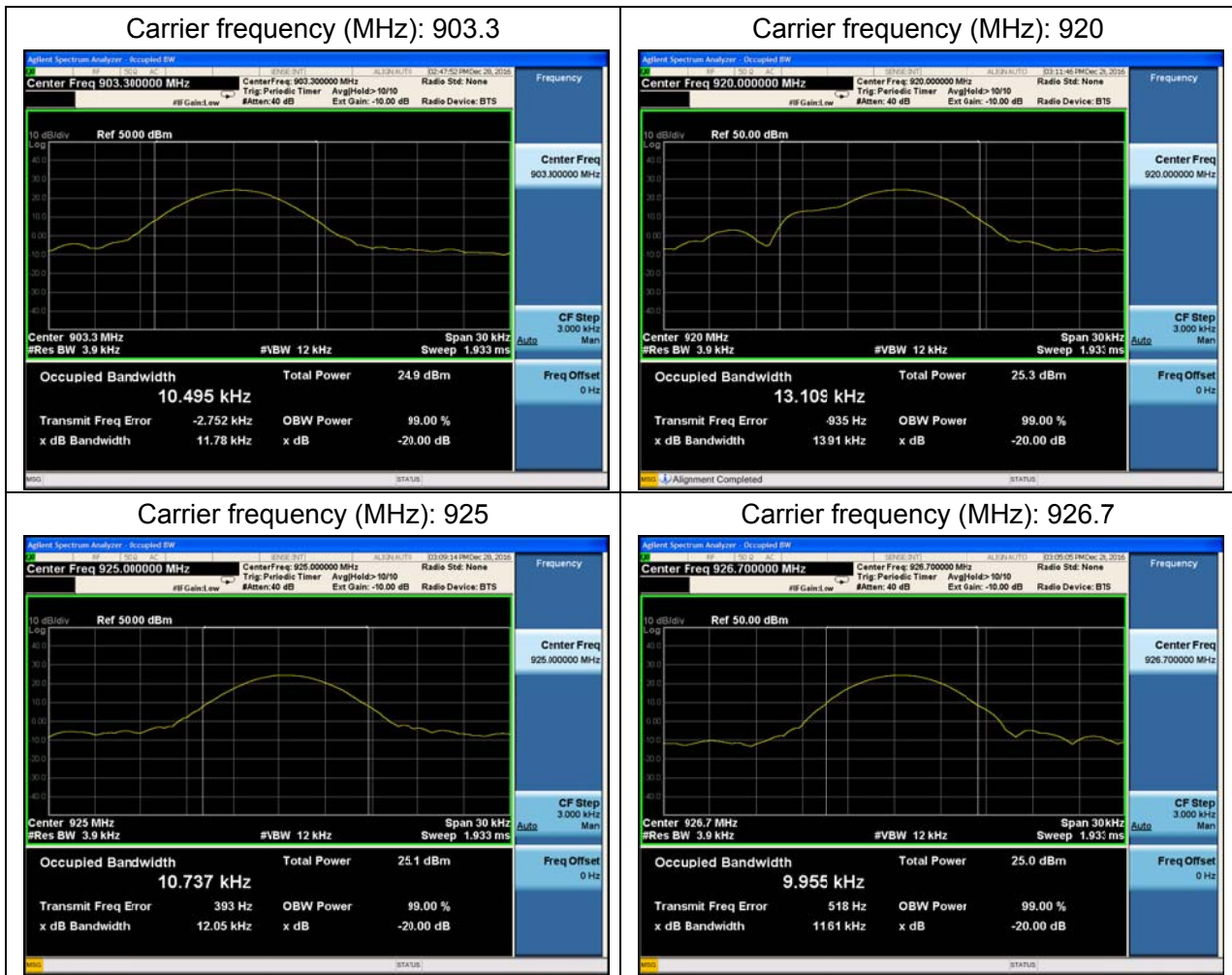

3.3 Frequency Separation

Ambient condition

Temperature	Relative humidity	Pressure
23°C ~25°C	45%~50%	101.5kPa

Method of Measurement

The EUT was connected to the spectrum analyzer with a known loss. RBW is set to 3.9 kHz and VBW is set to 12 kHz on spectrum analyzer. Set EUT on Hopping on mode.

Test setup

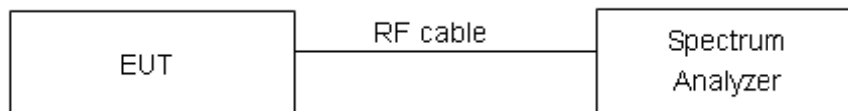

Limits

Rule Part 15.247(a)(1) specifies that “Frequency hopping systems shall have hopping channel carrier frequencies separated by a minimum of 25 kHz or the 20 dB bandwidth of the hopping channel, whichever is greater.

Measurement Uncertainty

The assessed measurement uncertainty to ensure 95% confidence level for the normal distribution is with the coverage factor $k = 2$, $U=936$ Hz.

Test Results:

Carrier frequency (MHz)	Carrier frequency separation(kHz)	Limit (kHz)	Conclusion
903.3	30	25	PASS
920	30.2	25	PASS
925	30.2	25	PASS
926.7	30.2	25	PASS

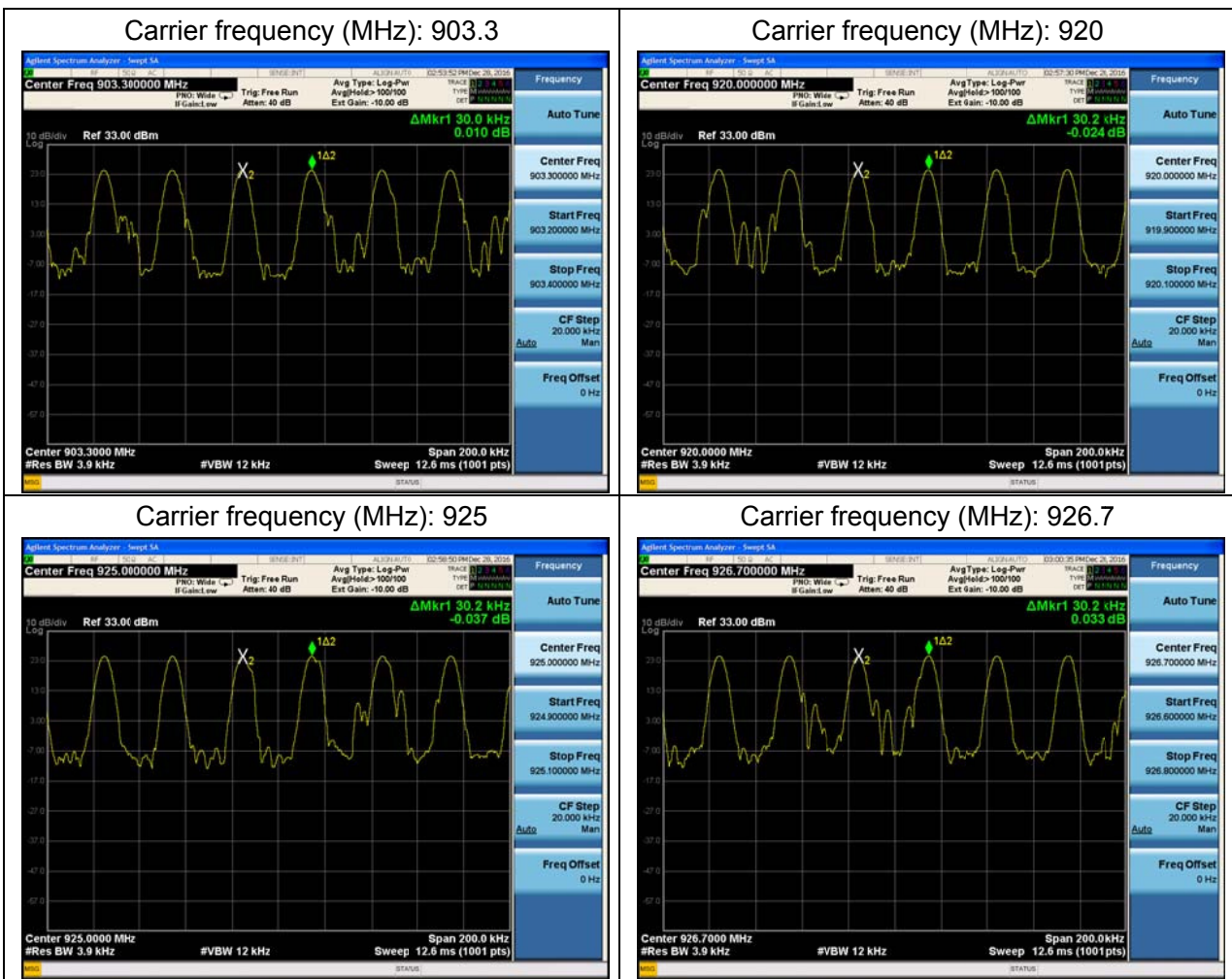

3.4 Time of Occupancy (Dwell Time)

Ambient condition

Temperature	Relative humidity	Pressure
23°C ~25°C	45%~50%	101.5kPa

Methods of Measurement

The EUT was connected to the spectrum analyzer with a known loss. RBW is set to 1MHz and VBW is set to 3MHz on spectrum analyzer.

Test Setup

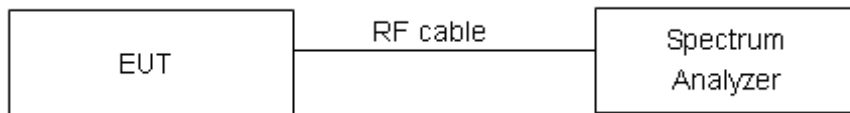

Limits

Rule Part 15(a)(i) specifies that "For frequency hopping systems operating in the 902-928 MHz band: if the 20 dB bandwidth of the hopping channel is less than 250 kHz, the system shall use at least 50 hopping frequencies and the average time of occupancy on any frequency shall not be greater than 0.4 seconds within a 20 second period;"

Dwell time	≤ 400ms
------------	---------

Measurement Uncertainty

The assessed measurement uncertainty to ensure 95% confidence level for the normal distribution is with the coverage factor $k = 2$. $U=0.70ms$

Test Results:

Carrier frequency (MHz)	Dwell time (ms)	Limit (ms)	Conclusion
903.3	160	400	PASS
920	160	400	PASS
925	160	400	PASS
926.7	160	400	PASS

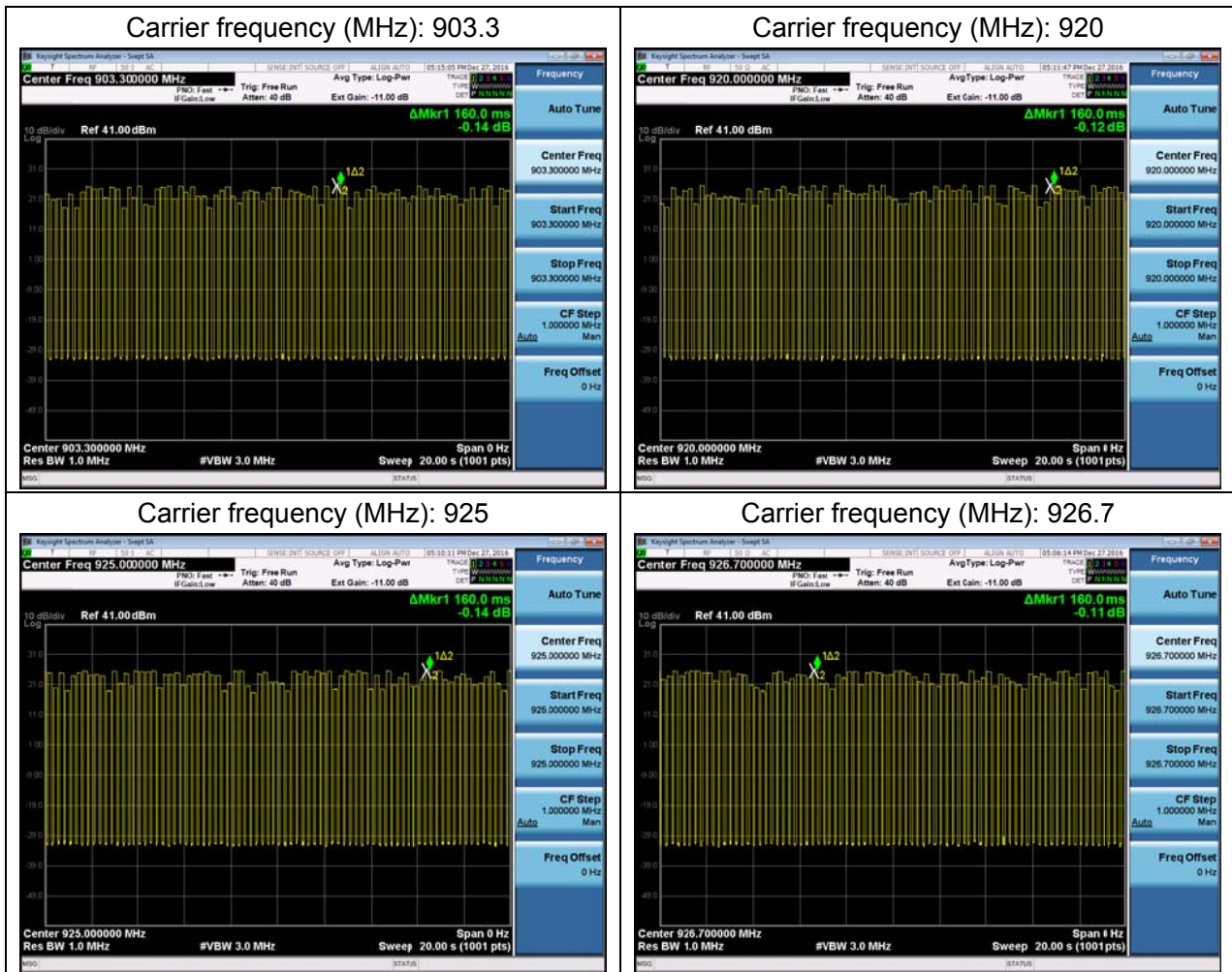

3.5 Band Edge Compliance

Ambient condition

Temperature	Relative humidity	Pressure
23°C ~25°C	45%~50%	101.5kPa

Method of Measurement

The EUT was connected to the spectrum analyzer with a known loss. The lowest and highest channels were measured. The Peak detector is used. RBW is set to 100 kHz and VBW is set to 300 kHz on spectrum analyzer. EUT test for Hopping On mode and Hopping Off mode.

Test Setup

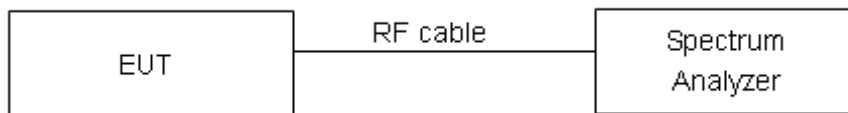

Limits

Rule Part 15.247(d) specifies that “In any 100 kHz bandwidth outside the frequency band in which the spread spectrum or digitally modulated intentional radiator is operating, the radio frequency power that is produced by the intentional radiator shall be at least 20 dB below that in the 100 kHz bandwidth within the band that contains the highest level of the desired power, based on either an RF conducted or a radiated measurement, provided the transmitter demonstrates compliance with the peak conducted power limits.” If the transmitter complies with the conducted power limits based on the use of Peak over a time interval, as permitted under paragraph (b)(3) of this section, the attenuation required under this paragraph shall be 20 dB. ”

Measurement Uncertainty

The assessed measurement uncertainty to ensure 95% confidence level for the normal distribution is with the coverage factor $k = 1.96$. $U=1.407\text{dB}$

Test Results

Hopping On, Carrier frequency (MHz): 903.3

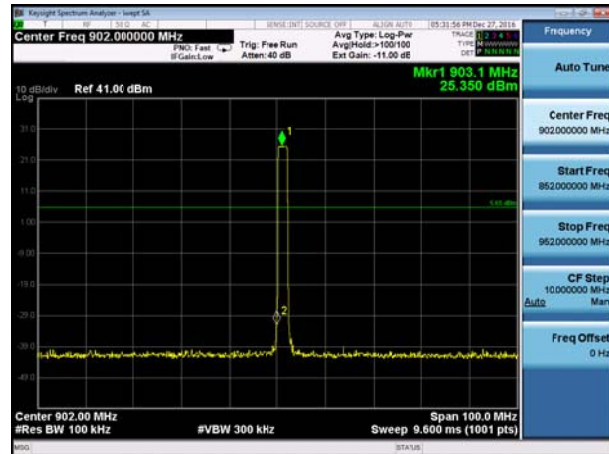

Hopping On, Carrier frequency (MHz): 920

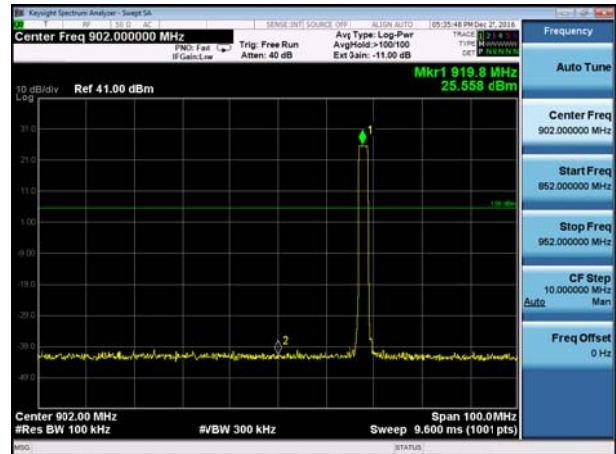

Hopping On, Carrier frequency (MHz): 925

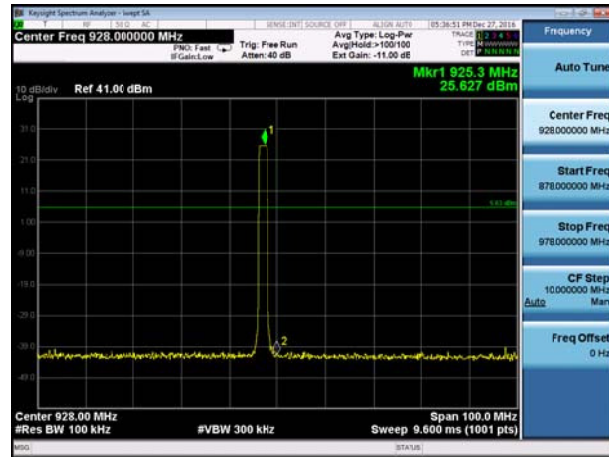

Hopping On, Carrier frequency (MHz): 926.7

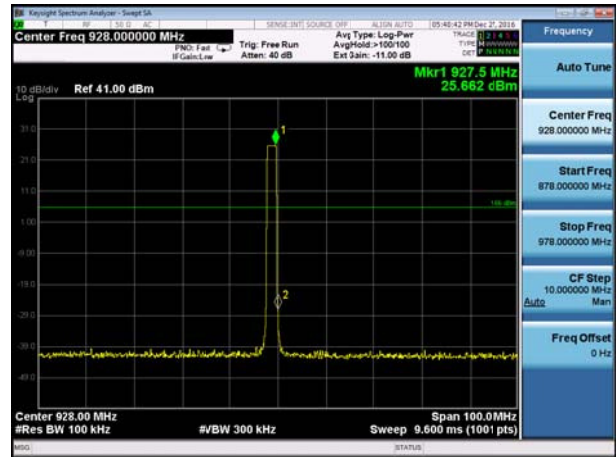



Hopping off, Carrier frequency (MHz): 903.3

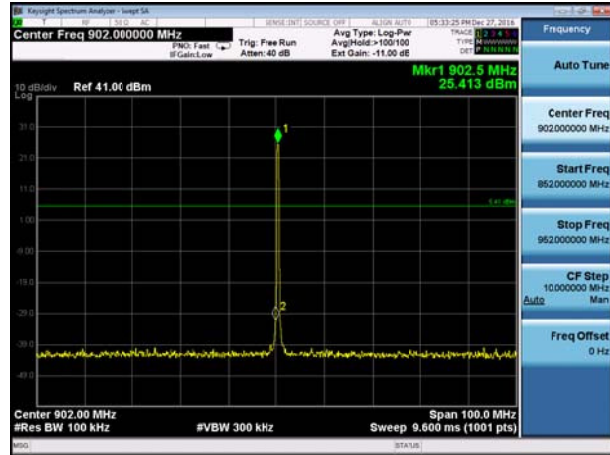

Hopping off, Carrier frequency (MHz): 920

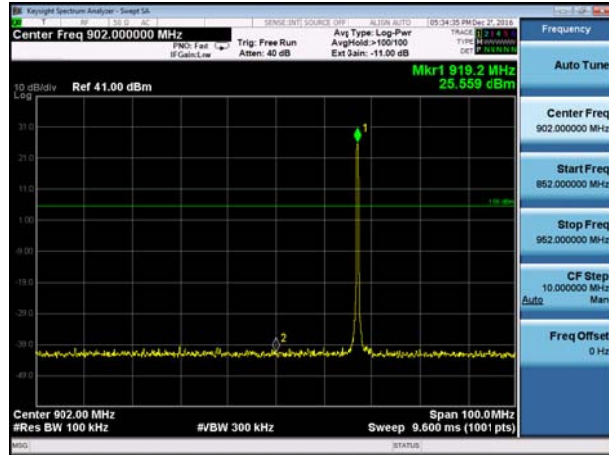

Hopping off, Carrier frequency (MHz): 925

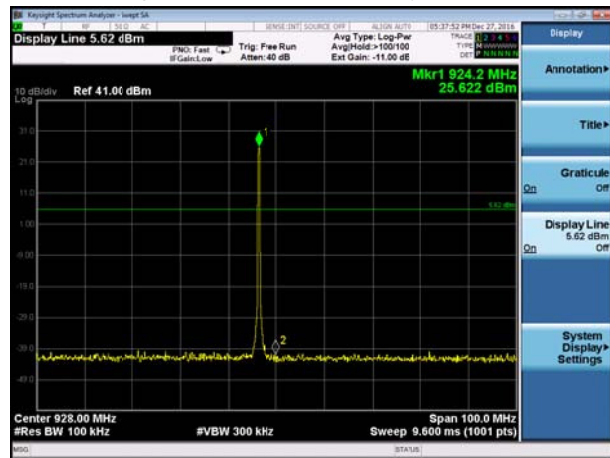

Hopping off, Carrier frequency (MHz): 926.7

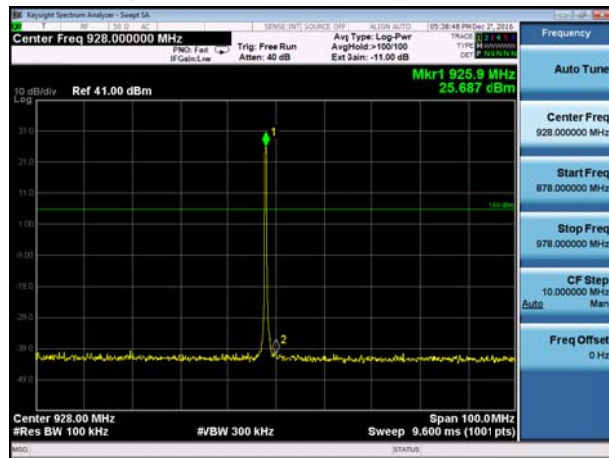

3.6 Spurious Radiated Emissions in the Restricted Band

Ambient condition

Temperature	Relative humidity	Pressure
23°C ~25°C	45%~50%	101.5kPa

The Equipment Under Test (EUT) was set up on a non-conductive table in the semi-anechoic chamber. The test was performed at the distance of 3 m between the EUT and the receiving antenna. The turntable shall be rotated from 0 to 360 degrees for detecting the maximum of radiated spurious signal level. The measurements shall be repeated with orthogonal polarization of the test antenna. The data of cable loss and antenna factor has been calibrated in full testing frequency range before the testing.

Set the spectrum analyzer in the following:

- (a) PEAK: RBW=VBW=1MHz / Sweep=AUTO
- (b) The dwell time per channel of the hopping signal is less than 100 ms, then the reading obtained with the 10 Hz VBW may be further adjusted by a “duty cycle correction factor”, derived from $20\log(\text{dwell time}/100 \text{ ms})$, in an effort to demonstrate compliance with the 15.209 limit. If the emission is pulsed, modify the unit for continuous operation; use the settings shown above, then correct the reading by subtracting the peak- average correction factor, derived from the appropriate duty cycle calculation.

This setting method can refer to **DA00-705**.

The test is in transmitting mode. The field strength of spurious emission was measured in the following position: EUT stand-up position (Z axis), lie-down position (X, Y axis) and docking mode. The worst emission was found in stand-up position (Y axis) and the worst case was recorded.

Test setup

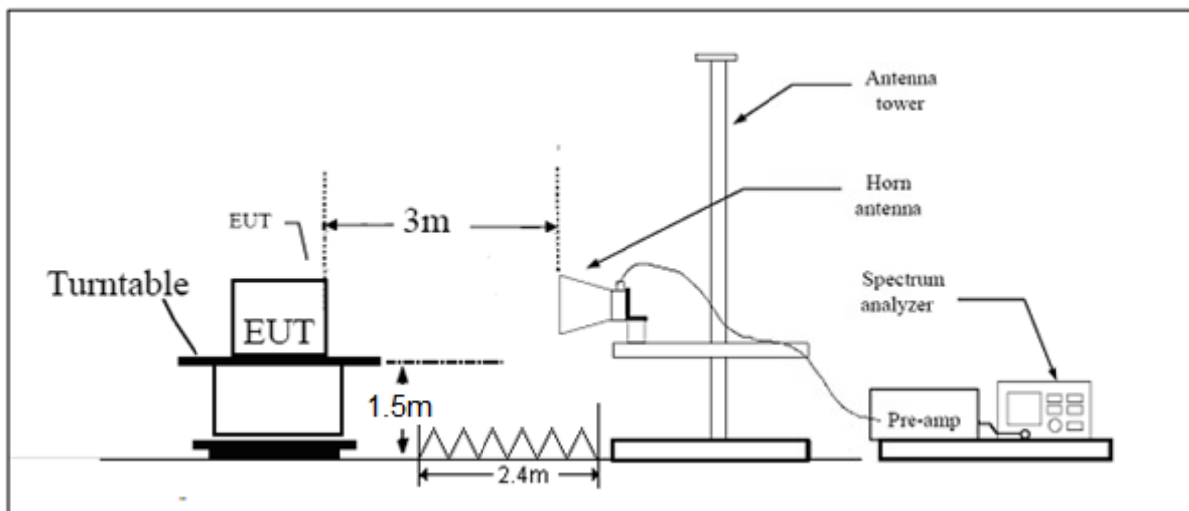

Note: Area side: 2.4mX3.6m

Limits

Spurious Radiated Emissions are permitted in any of the frequency bands listed below:

MHz	MHz	MHz	GHz
0.090 - 0.110	16.42 - 16.423	399.9 - 410	4.5 - 5.15
¹ 0.495 - 0.505	16.69475 - 16.69525	608 - 614	5.35 - 5.46
2.1735 - 2.1905	16.80425 - 16.80475	960 - 1240	7.25 - 7.75
4.125 - 4.128	25.5 - 25.67	1300 - 1427	8.025 - 8.5
4.17725 - 4.17775	37.5 - 38.25	1435 - 1626.5	9.0 - 9.2
4.20725 - 4.20775	73 - 74.6	1645.5 - 1646.5	9.3 - 9.5
6.215 - 6.218	74.8 - 75.2	1660 - 1710	10.6 - 12.7
6.26775 - 6.26825	108 - 121.94	1718.8 - 1722.2	13.25 - 13.4
6.31175 - 6.31225	123 - 138	2200 - 2300	14.47 - 14.5
8.291 - 8.294	149.9 - 150.05	2310 - 2390	15.35 - 16.2
8.362 - 8.366	156.52475 - 156.52525	2483.5 - 2500	17.7 - 21.4
8.37625 - 8.38675	156.7 - 156.9	2690 - 2900	22.01 - 23.12
8.41425 - 8.41475	162.0125 - 167.17	3260 - 3267	23.6 - 24.0
12.29 - 12.293	167.72 - 173.2	3332 - 3339	31.2 - 31.8
12.51975 - 12.52025	240 - 285	3345.8 - 3358	36.43 - 36.5
12.57675 - 12.57725	322 - 335.4	3600 - 4400	(²)
13.36 - 13.41			

Limit in restricted band

Frequency of emission (MHz)	Field strength(uV/m)	Field strength(dBuV/m)
30-88	100	40
88-216	150	43.5
216-960	200	46
Above960	500	54

§15.35(b)

There is also a limit on the radio frequency emissions, as measured using instrumentation with a peak detector function, corresponding to 20 dB above the maximum permitted average limit.

Peak Limit=74dBuV/m

Average Limit=54dBuV/m

Measurement Uncertainty

The assessed measurement uncertainty to ensure 95% confidence level for the normal distribution is with the coverage factor $k = 1.96$, $U = 3.55$ dB.

Test Results:

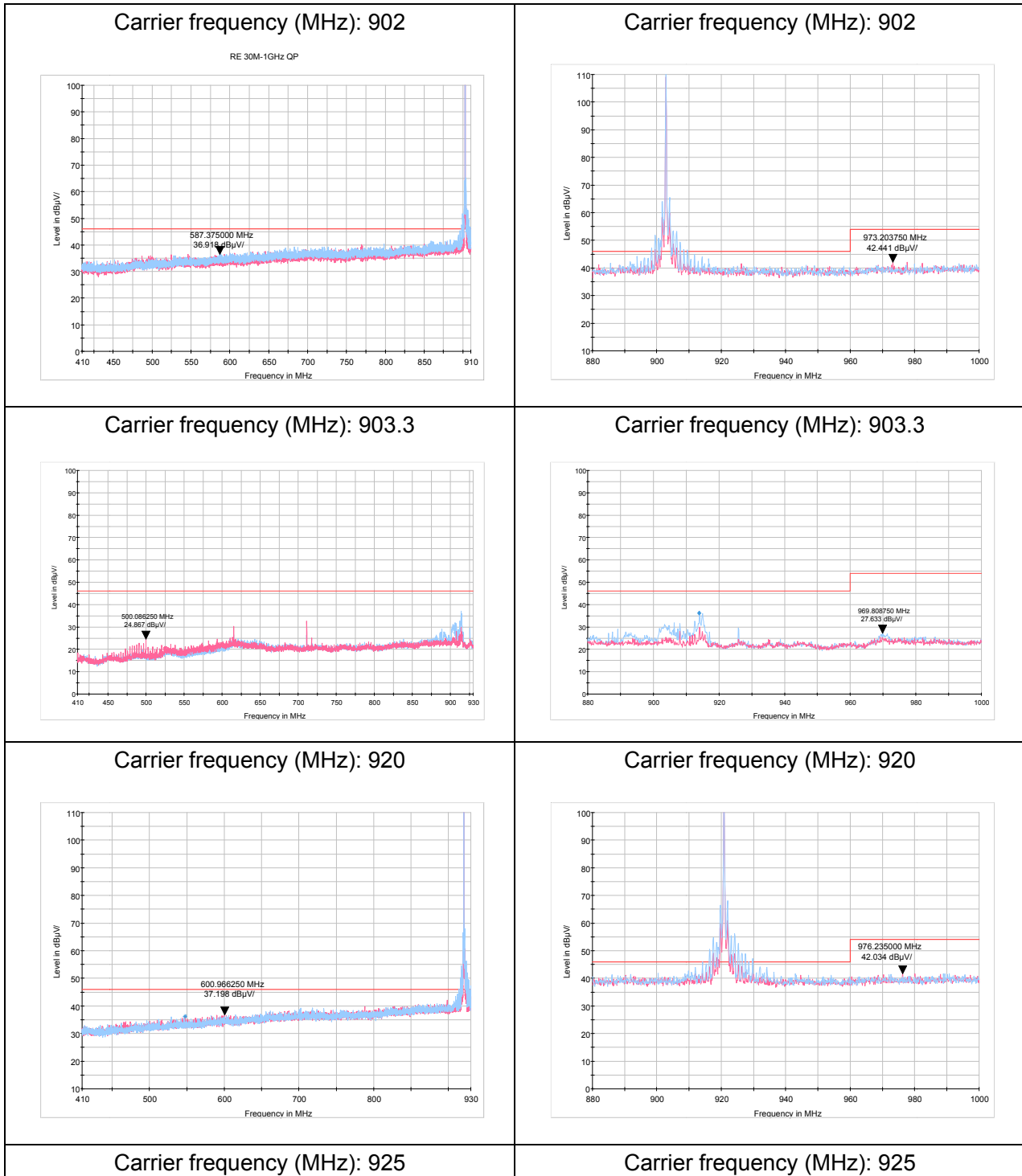

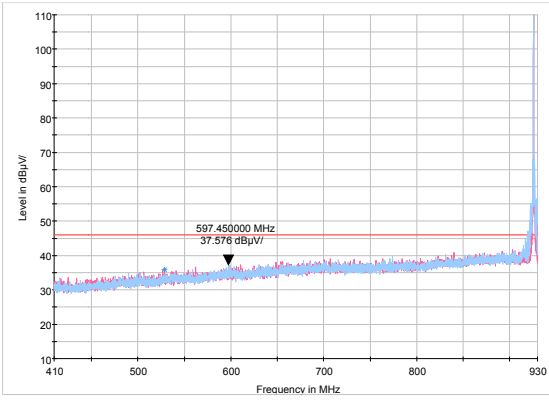

Carrier frequency (MHz): 926.7

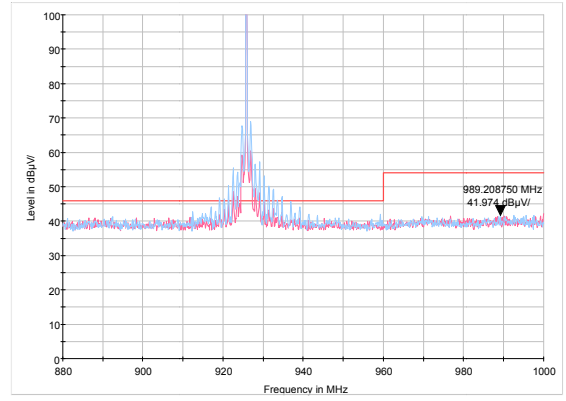

Carrier frequency (MHz): 926.7

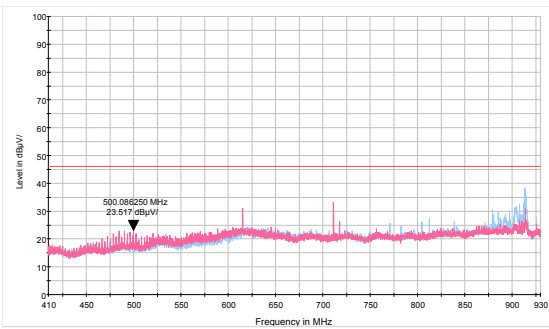

Carrier frequency (MHz): 928

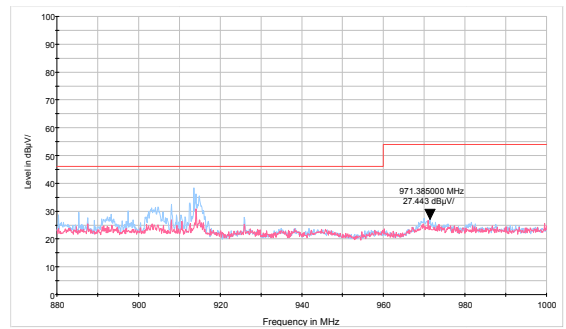

Carrier frequency (MHz): 928

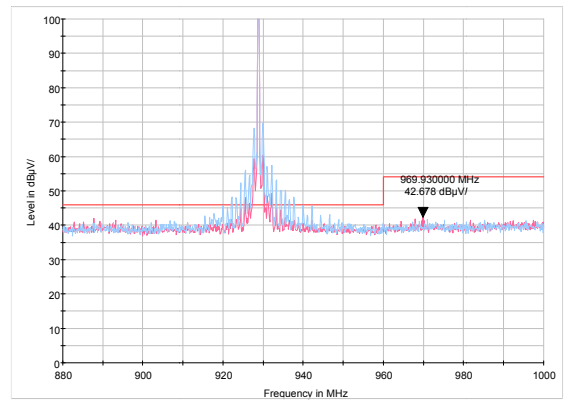
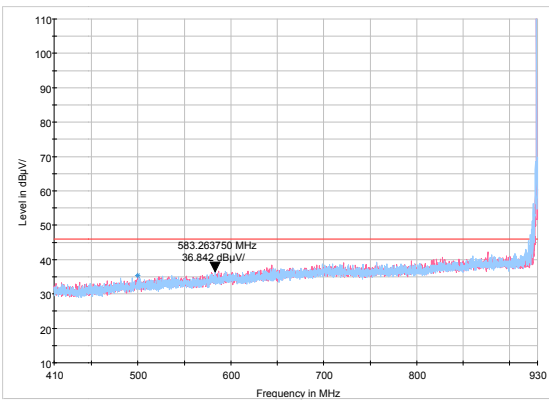

3.7 Number of hopping Frequency

Ambient condition

Temperature	Relative humidity	Pressure
23°C ~25°C	45%~50%	101.5kPa

Method of Measurement

The EUT was connected to the spectrum analyzer with a known loss. RBW is set to 1MHz and VBW is set to 1 MHz on spectrum analyzer. Set EUT on Hopping on mode.

Test setup

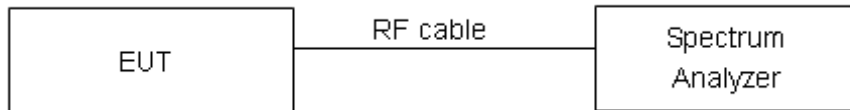

Limits

Rule Part 15.247(a) (1) (i) specifies that” For frequency hopping systems operating in the 902-928 MHz band: if the 20 dB bandwidth of the hopping channel is less than 250 kHz, the system shall use at least 50 hopping frequencies

Limits	≥ 50 channels
--------	---------------

Test Results:

Frequency(MHz)	Number of hopping channels	conclusion
903.3	53	PASS
920	53	PASS
925	53	PASS
926.7	53	PASS

Carrier frequency (MHz): 903.3

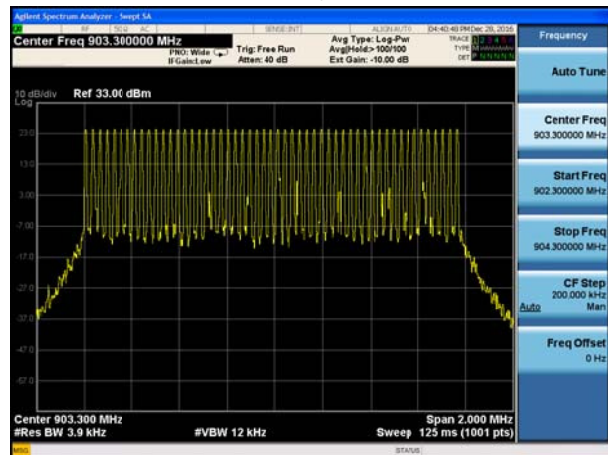

Carrier frequency (MHz): 920

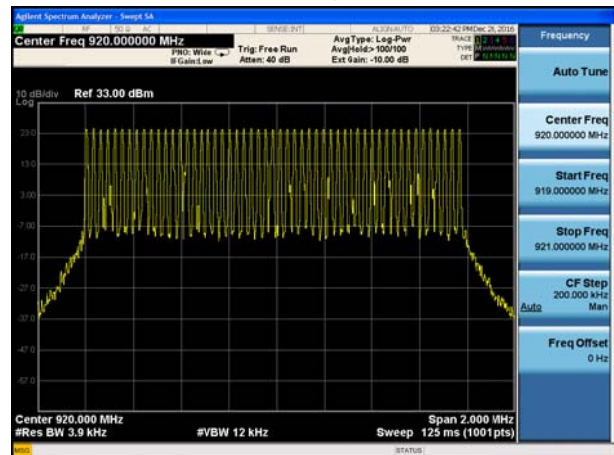

Carrier frequency (MHz): 925

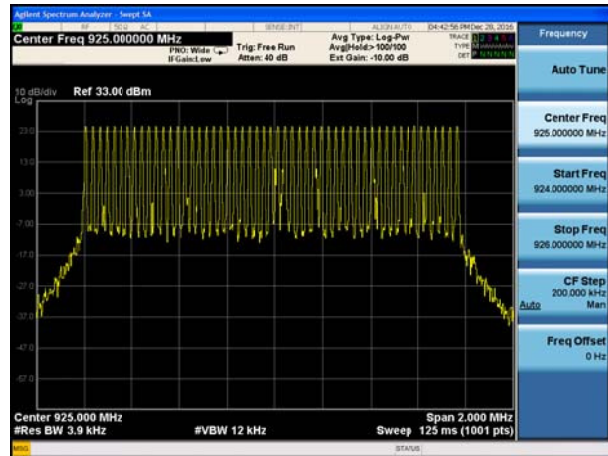

Carrier frequency (MHz): 926.7



3.8 Spurious RF Conducted Emissions

Ambient condition

Temperature	Relative humidity	Pressure
23°C ~25°C	45%~50%	101.5kPa

Method of Measurement

The EUT was connected to the spectrum analyzer and Bluetooth test set via a power splitter with a known loss. The spectrum analyzer scans from 30MHz to the 10th harmonic of the carrier. The peak detector is used. RBW and VBW are set to 100 kHz, Sweep is set to ATUO.

The test is in transmitting mode.

Test setup

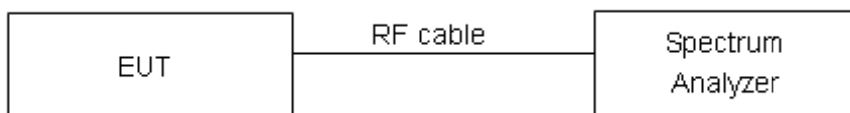

Limits

Rule Part 15.247(d) pacifies that “In any 100 kHz bandwidth outside the frequency band in which the spread spectrum intentional radiator is operating, the radio frequency power that is produced by the intentional radiator shall be at least 20 dB below that in the 100 kHz bandwidth within the band that contains the highest level of the desired power.”

Carrier frequency (MHz)	Reference value (dBm)	Limit
902	-7.259	-27.259
903.3	-10.81	-30.81
920	-5.997	-25.997
925	-5.963	-25.963
926.7	-9.166	-29.166
928	-5.775	-25.775



Measurement Uncertainty

The assessed measurement uncertainty to ensure 95% confidence level for the normal distribution is with the coverage factor $k = 1.96$.

Frequency	Uncertainty
100kHz-2GHz	0.684 dB
2GHz-26GHz	1.407 dB



Test Results:

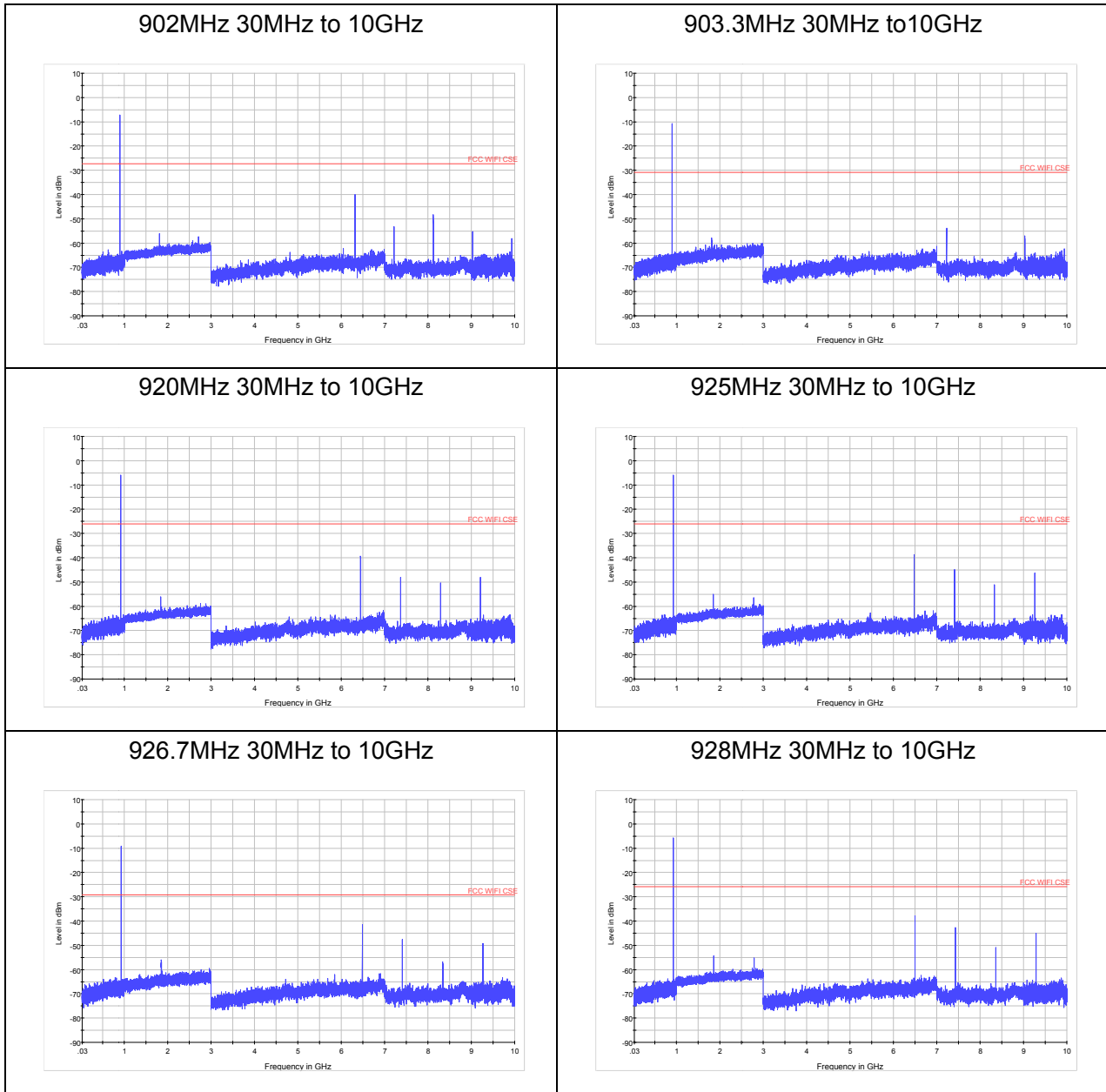

3.9 Radiates Emission

Ambient condition

Temperature	Relative humidity	Pressure
23°C ~25°C	45%~50%	102.5kPa

Method of Measurement

The test set-up was made in accordance to the general provisions of ANSI C63.10-2013. The Equipment Under Test (EUT) was set up on a non-conductive table in the semi-anechoic chamber. The test was performed at the distance of 3 m between the EUT and the receiving antenna. The radiated emissions measurements were made in a typical installation configuration.

Sweep the whole frequency band through the range from 9 kHz to the 10th harmonic of the carrier, and the emissions less than 20 dB below the permissible value are reported.

During the test, below 30MHz, the center of the loop shall be 1 meters; above 30MHz, the height of receive antenna shall be moved from 1 to 4 meters, and the antenna shall be performed under horizontal and vertical polarization. The turntable shall be rotated from 0 to 360 degrees for detecting the maximum of radiated spurious signal level. The measurements shall be repeated with orthogonal polarization of the test antenna. The data of cable loss and antenna factor has been calibrated in full testing frequency range before the testing.

Set the spectrum analyzer in the following:

Below 1GHz (detector: Peak and Quasi-Peak)

RBW=100kHz / VBW=300kHz / Sweep=AUTO

Above 1GHz(detector: Peak):

(a) PEAK: RBW=1MHz VBW=3MHz/ Sweep=AUTO

(b) AVERAGE: RBW=1MHz / VBW=10Hz / Sweep=AUTO

The radiated emission was measured in the following position: EUT stand-up position (Z axis), lie-down position (X, Y axis). The worst emission was found in stand-up position (Z axis) and the worst case was recorded. Then this mode was measured in the following mode: EUT with cradle and EUT without cradle. The worst emission was found in EUT with cradle mode and the worst case was recorded.

The test is in transmitting mode.

Test setup

9KHz~~~ 30MHz

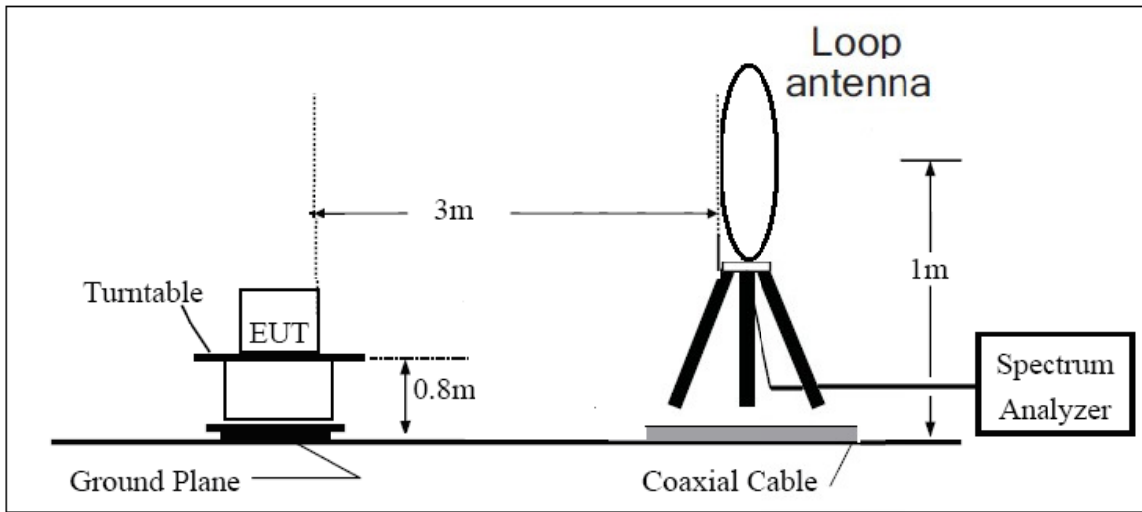

30MHz~~~ 1GHz

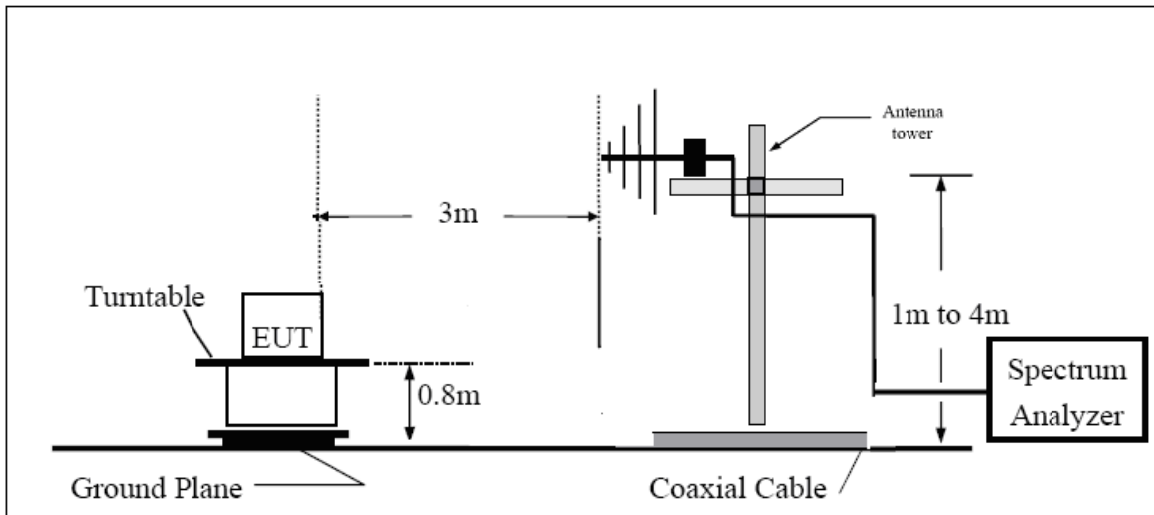

Above 1GHz

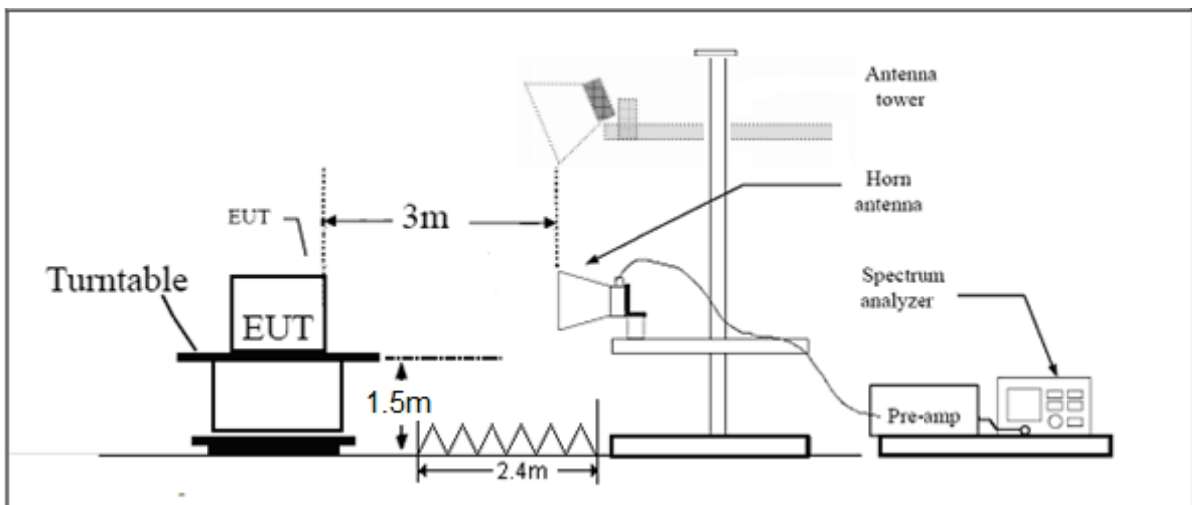

Limits

Rule Part 15.247(d) specifies that “In addition, radiated emissions which fall in the restricted bands, as defined in § 15.205(a), must also comply with the radiated emission limits specified in § 15.209(a) (see § 15.205(c)).”

Limit in restricted band

Frequency of emission (MHz)	Field strength(uV/m)	Field strength(dBuV/m)
0.009–0.490	2400/F(kHz)	/
0.490–1.705	24000/F(kHz)	/
1.705–30.0	30	/
30-88	100	40
88-216	150	43.5
216-960	200	46
Above960	500	54

§15.35(b)

There is also a limit on the radio frequency emissions, as measured using instrumentation with a peak detector function, corresponding to 20 dB above the maximum permitted average limit.

Measurement Uncertainty

The assessed measurement uncertainty to ensure 95% confidence level for the normal distribution is with the coverage factor $k = 1.96$.

Frequency	Uncertainty
9KHz-30MHz	3.55 dB
30MHz-200MHz	4.19 dB
200MHz-1GHz	3.63 dB
Above 1GHz	3.68 dB

Test result

Sweep from 9 kHz to 30MHz, and the emissions more than 20 dB below the permissible value are not reported.

The following graphs display the maximum values of horizontal and vertical by software.

For above 1GHz, Blue trace uses the peak detection, Green trace uses the average detection.

902MHz

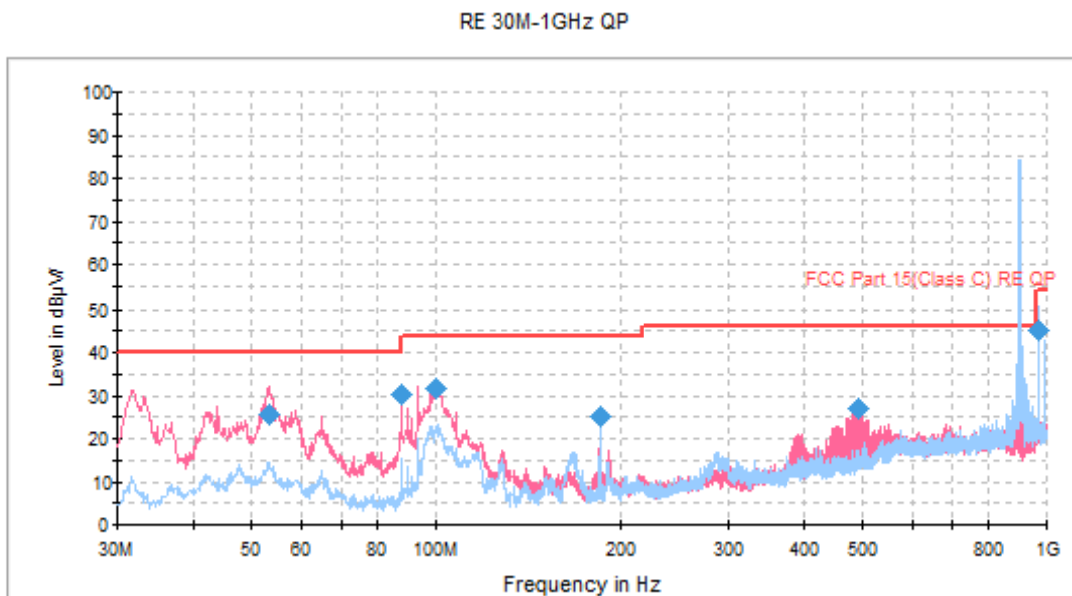

Radiates Emission from 30MHz to 1GHz

Note: This graph displays the maximum values of horizontal and vertical by software

Frequency (MHz)	Quasi-Peak (dBuV/m)	Height (cm)	Polarization	Azimuth (deg)	Reading value (dBuV/m)	Correct Factor (dB)	Margin (dB)	Limit (dBuV/m)
53.388694	25.6	101.0	V	34.0	46.3	-20.7	14.4	40.0
87.896660	30.1	121.0	V	211.0	57.3	-27.2	9.9	40.0
100.072294	31.5	121.0	V	132.0	56.8	-25.3	12.0	43.5
184.249425	25.3	121.0	V	34.0	52.9	-27.6	18.2	43.5
492.254500	26.8	101.0	V	266.0	46.3	-19.5	19.2	46.0
970.107000	45.1	126.0	H	148.0	57.2	-12.1	8.9	54.0

RE 1G-3GHz PK+AV

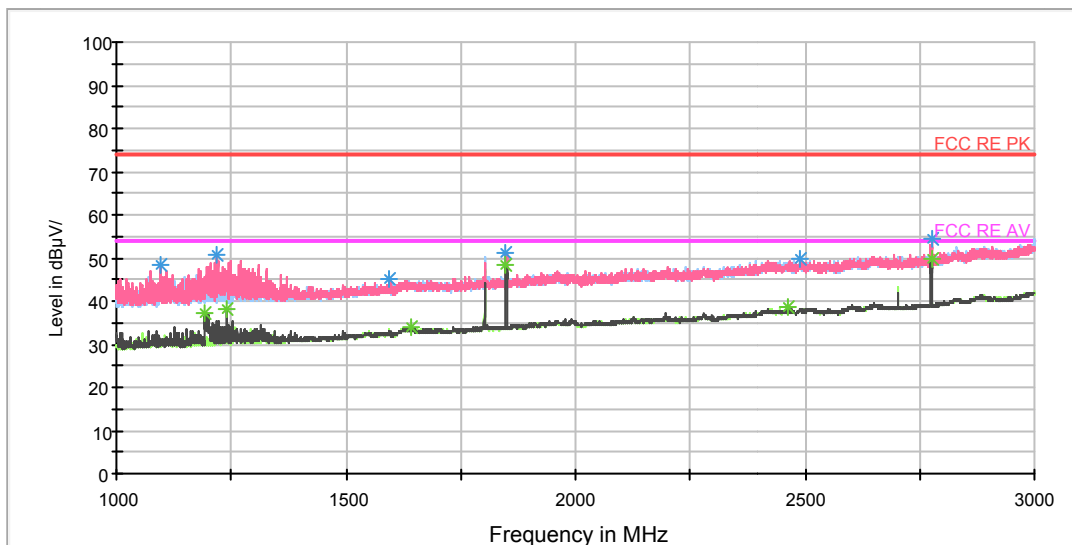

Radiates Emission from 1GHz to 3GHz
 Note: The signal beyond the limit is carrier.

Frequency (MHz)	Peak (dBuV/m)	Height (cm)	Polarization	Azimuth (deg)	Reading value (dBuV/m)	Correct Factor (dB)	Margin (dB)	Limit (dBuV/m)
1096.500000	48.2	103.0	V	232.0	57.1	-8.9	25.8	74
1216.750000	50.7	103.0	V	28.0	58.6	-7.9	23.3	74
1596.000000	45.3	103.0	V	28.0	51.7	-6.4	28.7	74
1848.750000	51.3	205.0	V	30.0	55.4	-4.1	22.7	74
2491.250000	49.7	205.0	V	321.0	49.4	0.3	24.3	74
2776.500000	54.2	205.0	V	0.0	53.4	0.8	19.8	74

Frequency (MHz)	Average (dBuV/m)	Height (cm)	Polarization	Azimuth (deg)	Reading value (dBuV/m)	Correct Factor (dB)	Margin (dB)	Limit (dBuV/m)
1194.250000	37.3	103.0	V	205.0	45.5	-8.2	16.7	54
1240.750000	38.2	103.0	V	269.0	46.2	-8.0	15.8	54
1642.250000	33.8	105.0	H	340.0	38.6	-4.8	20.2	54
1849.000000	48.4	205.0	V	30.0	52.5	-4.1	5.6	54
2461.000000	38.8	103.0	V	72.0	39.3	-0.5	15.2	54
2776.250000	49.8	205.0	V	178.0	49.0	0.8	4.2	54

Remark: 1. Correction Factor = Antenna factor+ Insertion loss (cable loss + amplifier gain)

RE 3-18GHz PK+AV

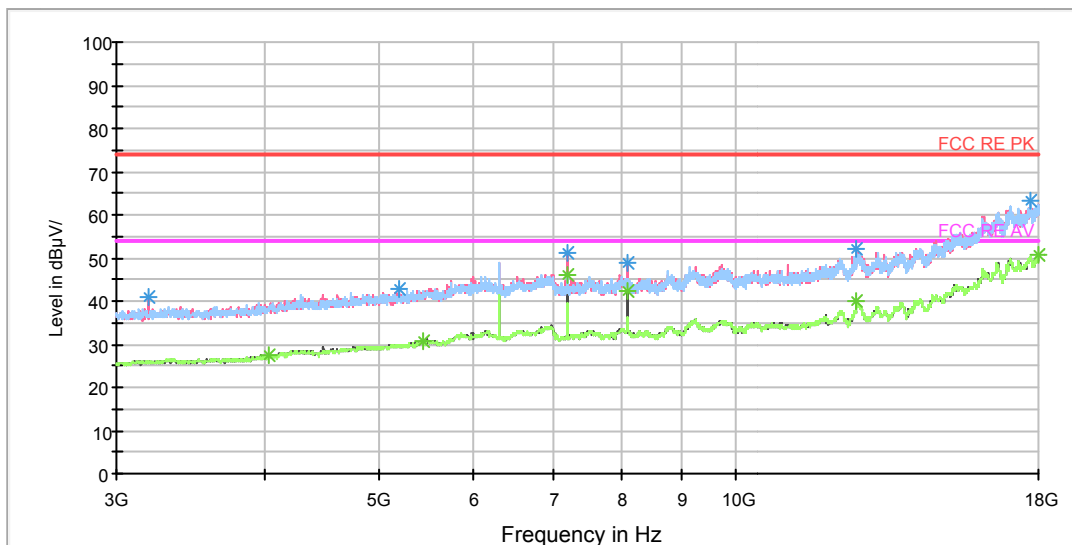

Radiates Emission from 3GHz to 18GHz

Frequency (MHz)	Peak (dBuV/m)	Height (cm)	Polarization	Azimuth (deg)	Reading value (dBuV/m)	Correct Factor (dB)	Margin (dB)	Limit (dBuV/m)
3193.125000	40.9	205.0	V	0.0	43.8	-2.9	33.1	74
5199.375000	42.6	105.0	V	277.0	40.5	2.1	31.4	74
7209.375000	51.3	205.0	V	169.0	44.9	6.4	22.7	74
8111.250000	48.8	105.0	V	194.0	41.1	7.7	25.2	74
12645.000000	52.2	205.0	V	0.0	37.8	14.4	21.8	74
17715.000000	63.4	205.0	H	163.0	38.8	24.6	10.6	74

Frequency (MHz)	Average (dBuV/m)	Height (cm)	Polarization	Azimuth (deg)	Reading value (dBuV/m)	Correct Factor (dB)	Margin (dB)	Limit (dBuV/m)
4040.625000	27.3	205.0	V	279.0	28.3	-1.0	26.7	54
5446.875000	30.7	105.0	V	0.0	27.9	2.8	23.3	54
7209.375000	46.1	205.0	V	169.0	39.7	6.4	7.9	54
8111.250000	42.3	105.0	V	194.0	34.6	7.7	11.7	54
12641.250000	39.8	205.0	V	0.0	25.3	14.5	14.2	54
18000.000000	50.7	105.0	H	0.0	25.2	25.5	3.3	54

Remark: 1. Correction Factor = Antenna factor+ Insertion loss (cable loss + amplifier gain)



903.3MHz

RE 30M-1GHz QP

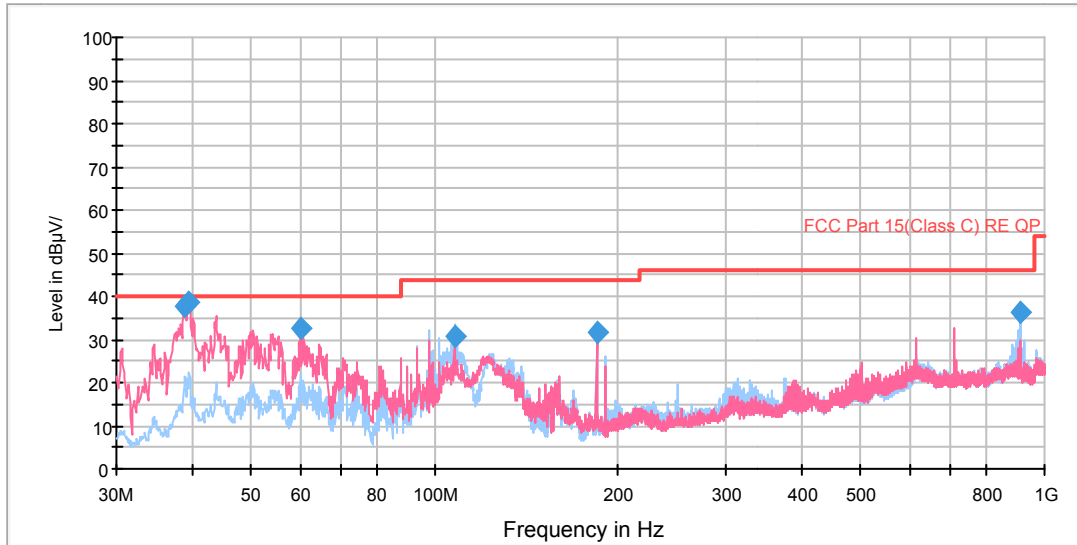

Radiates Emission from 30MHz to 1GHz

Frequency (MHz)	Quasi-Peak (dBuV/m)	Height (cm)	Polarization	Azimuth (deg)	Reading value (dBuV/m)	Correct Factor (dB)	Margin (dB)	Limit (dBuV/m)
38.955069	37.8	101.0	V	263.0	59.1	-21.3	2.2	40.0
39.478856	38.6	101.0	V	285.0	59.6	-21.0	1.4	40.0
60.200772	32.7	101.0	V	217.0	55.9	-23.2	7.3	40.0
107.691947	30.6	277.0	H	84.0	56.5	-25.9	12.9	43.5
184.249425	31.8	176.0	H	89.0	59.4	-27.6	11.7	43.5
913.988750	36.3	303.0	H	253.0	49.3	-13.0	9.7	46.0

RE 1G-3GHz PK+AV

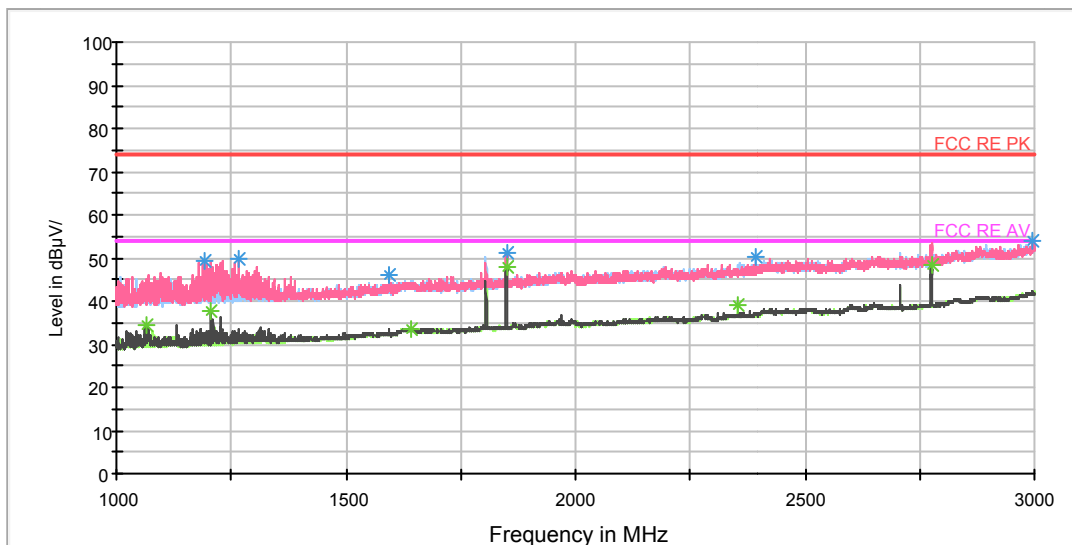

Radiates Emission from 1GHz to 3GHz
 Note: The signal beyond the limit is carrier.

Frequency (MHz)	Peak (dBuV/m)	Height (cm)	Polarization	Azimuth (deg)	Reading value (dBuV/m)	Correct Factor (dB)	Margin (dB)	Limit (dBuV/m)
1193.250000	49.2	106.0	V	207.0	57.4	-8.2	24.8	74
1265.500000	49.7	106.0	V	271.0	57.4	-7.7	24.3	74
1593.750000	46.1	106.0	V	41.0	52.5	-6.4	27.9	74
1850.000000	51.0	206.0	V	129.0	55.1	-4.1	23.0	74
2393.000000	50.3	105.0	H	147.0	51.6	-1.3	23.7	74
2996.500000	53.7	105.0	H	286.0	51.4	2.3	20.3	74

Frequency (MHz)	Average (dBuV/m)	Height (cm)	Polarization	Azimuth (deg)	Reading value (dBuV/m)	Correct Factor (dB)	Margin (dB)	Limit (dBuV/m)
1064.000000	34.5	106.0	V	190.0	43.4	-8.9	19.5	54
1204.500000	37.7	106.0	V	262.0	45.9	-8.2	16.3	54
1643.500000	33.7	205.0	H	161.0	38.5	-4.8	20.3	54
1851.250000	47.9	206.0	V	342.0	52.1	-4.2	6.1	54
2355.250000	38.9	105.0	H	137.0	40.3	-1.4	15.1	54
2775.250000	48.4	206.0	V	173.0	47.6	0.8	5.6	54

Remark: 1. Correction Factor = Antenna factor+ Insertion loss (cable loss + amplifier gain)

RE 3-18GHz PK+AV

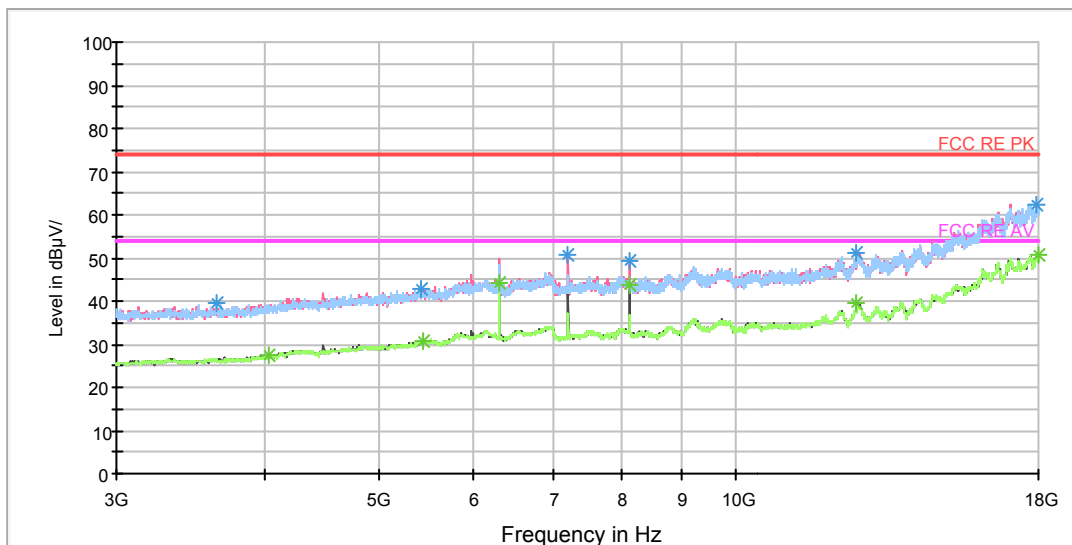

Radiates Emission from 3GHz to 18GHz

Frequency (MHz)	Peak (dBuV/m)	Height (cm)	Polarization	Azimuth (deg)	Reading value (dBuV/m)	Correct Factor (dB)	Margin (dB)	Limit (dBuV/m)
3643.125000	39.4	105.0	H	169.0	41.2	-1.8	34.6	74
5418.750000	43.0	105.0	V	251.0	40.3	2.7	31.0	74
7220.625000	50.9	205.0	V	169.0	44.5	6.4	23.1	74
8122.500000	49.4	105.0	V	192.0	41.7	7.7	24.6	74
12637.500000	51.1	205.0	H	247.0	36.8	14.3	22.9	74
17910.000000	62.3	105.0	V	359.0	36.8	25.5	11.7	74

Frequency (MHz)	Average (dBuV/m)	Height (cm)	Polarization	Azimuth (deg)	Reading value (dBuV/m)	Correct Factor (dB)	Margin (dB)	Limit (dBuV/m)
4038.750000	27.5	205.0	V	196.0	28.5	-1.0	26.5	54
5445.000000	30.8	105.0	H	88.0	27.9	2.9	23.2	54
6316.875000	44.0	105.0	V	110.0	38.7	5.3	10.0	54
8122.500000	43.6	105.0	V	192.0	35.9	7.7	10.4	54
12639.375000	39.7	205.0	V	7.0	25.2	14.5	14.3	54
18000.000000	50.8	205.0	V	115.0	25.3	25.5	3.2	54

Remark: 1. Correction Factor = Antenna factor+ Insertion loss (cable loss + amplifier gain)



RE 30M-1GHz QP

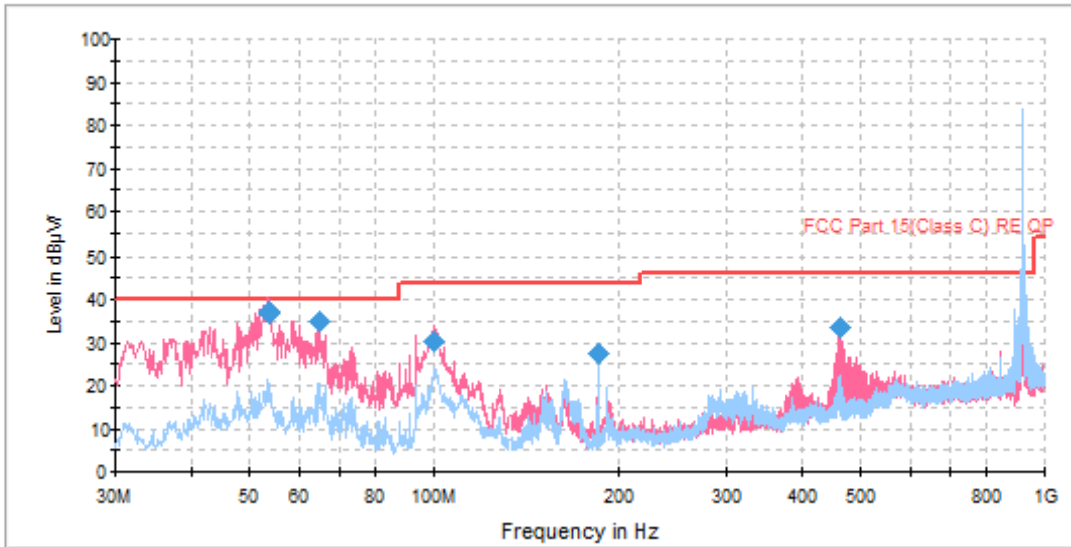

Radiates Emission from 30MHz to 1GHz

Frequency (MHz)	Quasi-Peak (dBuV/m)	Height (cm)	Polarization	Azimuth (deg)	Reading value (dBuV/m)	Correct Factor (dB)	Margin (dB)	Limit (dBuV/m)
53.588694	37.4	100.0	V	7.0	58.2	-20.8	2.6	40.0
53.830588	36.7	101.0	V	6.0	57.5	-20.8	3.3	40.0
64.795806	34.8	121.0	V	345.0	58.5	-23.7	5.2	40.0
100.073240	30.2	101.0	V	241.0	55.5	-25.3	13.3	43.5
184.249425	27.4	100.0	V	63.0	55.0	-27.6	16.1	43.5
462.704250	33.4	126.0	V	266.0	53.7	-20.3	12.6	46.0

RE 1G-3GHz PK+AV

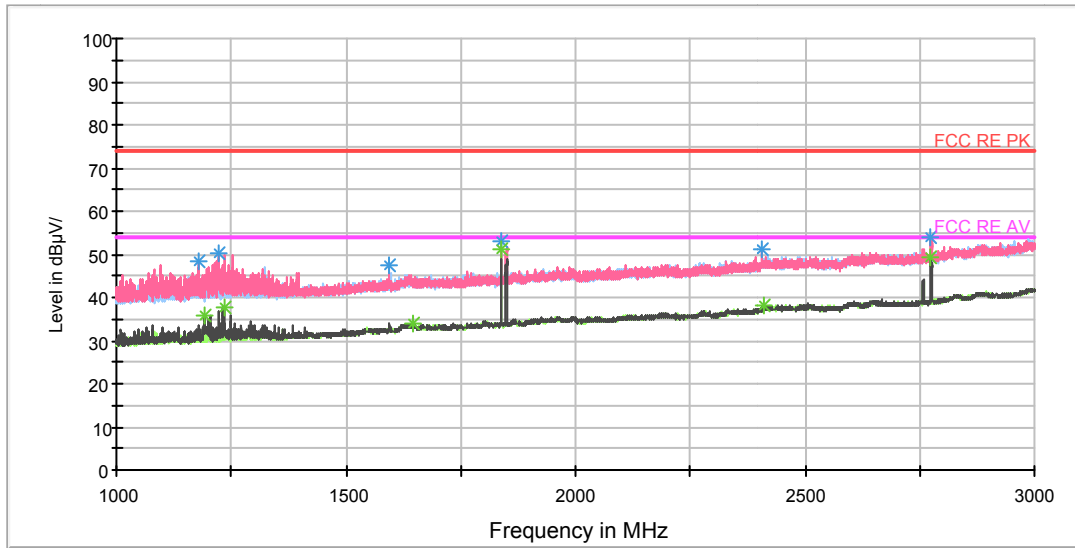

Radiates Emission from 1GHz to 3GHz
 Note: The signal beyond the limit is carrier.

Frequency (MHz)	Peak (dBuV/m)	Height (cm)	Polarization	Azimuth (deg)	Reading value (dBuV/m)	Correct Factor (dB)	Margin (dB)	Limit (dBuV/m)
1178.000000	48.3	106.0	V	124.0	56.3	-8.0	25.7	74
1221.000000	50.2	106.0	V	270.0	58.1	-7.9	23.8	74
1593.750000	47.5	106.0	V	27.0	53.9	-6.4	26.5	74
1838.750000	53.1	205.0	H	295.0	57.4	-4.3	20.9	74
2407.000000	50.9	106.0	V	62.0	51.6	-0.7	23.1	74
2774.750000	53.8	206.0	V	331.0	53.0	0.8	20.2	74

Frequency (MHz)	Average (dBuV/m)	Height (cm)	Polarization	Azimuth (deg)	Reading value (dBuV/m)	Correct Factor (dB)	Margin (dB)	Limit (dBuV/m)
1193.250000	35.8	106.0	V	106.0	44.0	-8.2	18.2	54
1233.750000	37.5	206.0	V	216.0	45.3	-7.8	16.5	54
1645.500000	33.8	305.0	H	0.0	38.7	-4.9	20.2	54
1838.500000	51.3	205.0	H	295.0	55.6	-4.3	2.7	54
2411.500000	38.1	106.0	H	152.0	38.6	-0.5	15.9	54
2774.750000	49.5	206.0	V	331.0	48.7	0.8	4.5	54

Remark: 1. Correction Factor = Antenna factor+ Insertion loss (cable loss + amplifier gain)

RE 3-18GHz PK+AV

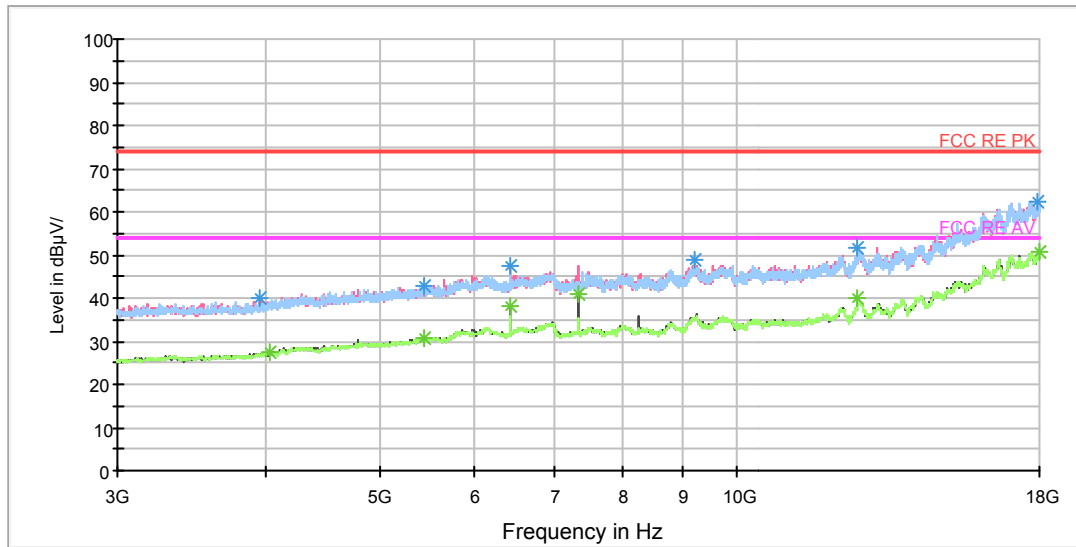

Radiates Emission from 3GHz to 18GHz

Frequency (MHz)	Peak (dBuV/m)	Height (cm)	Polarization	Azimuth (deg)	Reading value (dBuV/m)	Correct Factor (dB)	Margin (dB)	Limit (dBuV/m)
3950.625000	39.9	205.0	V	35.0	40.9	-1.0	34.1	74
5435.625000	42.6	205.0	V	280.0	39.7	2.9	31.4	74
6435.000000	47.5	105.0	V	108.0	42.6	4.9	26.5	74
9208.125000	48.7	105.0	H	0.0	38.6	10.1	25.3	74
12645.000000	51.6	105.0	H	309.0	37.2	14.4	22.4	74
17915.625000	62.5	205.0	H	0.0	36.9	25.6	11.5	74

Frequency (MHz)	Average (dBuV/m)	Height (cm)	Polarization	Azimuth (deg)	Reading value (dBuV/m)	Correct Factor (dB)	Margin (dB)	Limit (dBuV/m)
4035.000000	27.3	205.0	V	8.0	28.3	-1.0	26.7	54
5435.625000	30.7	205.0	V	280.0	27.8	2.9	23.3	54
6435.000000	38.0	105.0	V	108.0	33.1	4.9	16.0	54
7353.750000	40.8	105.0	V	191.0	33.8	7.0	13.2	54
12639.375000	39.9	205.0	V	0.0	25.4	14.5	14.1	54
18000.000000	50.5	105.0	V	299.0	25.0	25.5	3.5	54

Remark: 1. Correction Factor = Antenna factor+ Insertion loss (cable loss + amplifier gain)



925MHz

RE 30M-1GHz QP

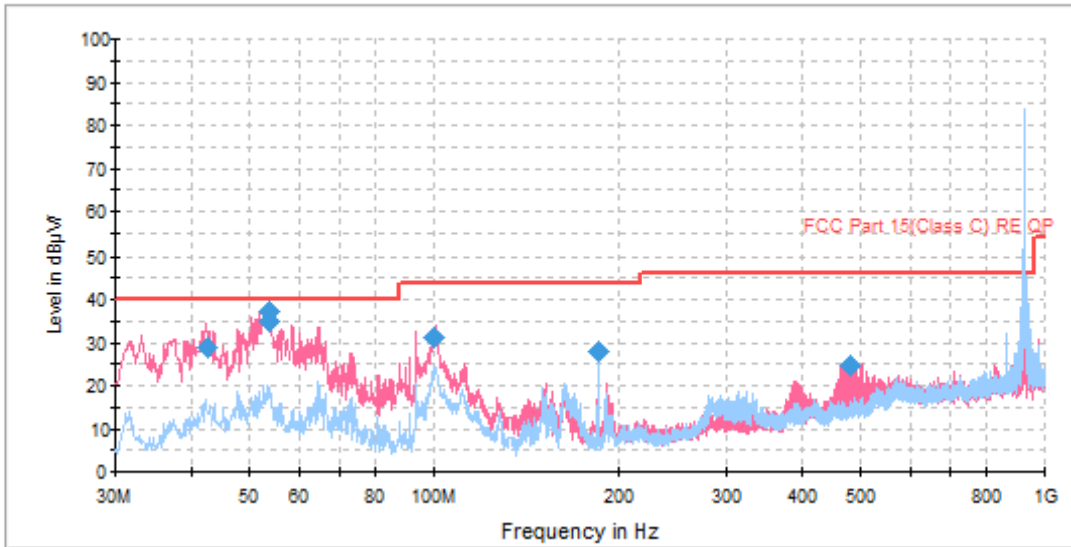

Radiates Emission from 30MHz to 1GHz

Frequency (MHz)	Quasi-Peak (dBuV/m)	Height (cm)	Polarization	Azimuth (deg)	Reading value (dBuV/m)	Correct Factor (dB)	Margin (dB)	Limit (dBuV/m)
42.351866	28.7	121.0	V	16.0	49.1	-20.4	11.3	40.0
53.588694	37.4	102.0	V	0.0	58.2	-20.8	2.6	40.0
53.831534	34.8	101.0	V	332.0	55.6	-20.8	5.2	40.0
100.395134	31.2	122.0	V	130.0	56.5	-25.3	12.3	43.5
184.249425	28.0	102.0	V	56.0	55.6	-27.6	15.5	43.5
479.596000	24.5	121.0	V	257.0	43.9	-19.4	21.5	46.0

RE 1G-3GHz PK+AV

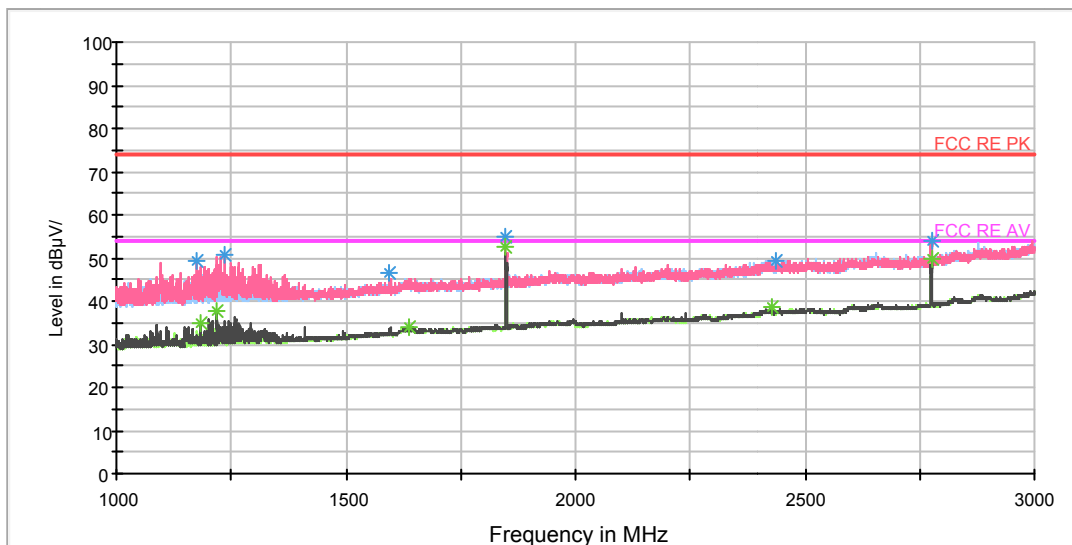

Radiates Emission from 1GHz to 3GHz
 Note: The signal beyond the limit is carrier.

Frequency (MHz)	Peak (dBuV/m)	Height (cm)	Polarization	Azimuth (deg)	Reading value (dBuV/m)	Correct Factor (dB)	Margin (dB)	Limit (dBuV/m)
1174.750000	49.3	105.0	V	47.0	57.3	-8.0	24.7	74
1236.250000	50.7	105.0	V	270.0	58.6	-7.9	23.3	74
1595.000000	46.5	105.0	V	30.0	52.9	-6.4	27.5	74
1848.500000	54.7	205.0	H	299.0	58.8	-4.1	19.3	74
2438.000000	49.4	305.0	V	17.0	49.8	-0.4	24.6	74
2776.000000	54.0	206.0	V	173.0	53.2	0.8	20.0	74

Frequency (MHz)	Average (dBuV/m)	Height (cm)	Polarization	Azimuth (deg)	Reading value (dBuV/m)	Correct Factor (dB)	Margin (dB)	Limit (dBuV/m)
1182.250000	35.1	105.0	V	262.0	43.1	-8.0	18.9	54
1220.000000	37.5	105.0	V	180.0	45.4	-7.9	16.5	54
1638.500000	33.8	305.0	H	0.0	38.5	-4.7	20.2	54
1848.500000	52.7	205.0	H	299.0	56.8	-4.1	1.3	54
2426.250000	38.4	305.0	V	0.0	38.9	-0.5	15.6	54
2775.750000	50.0	206.0	V	173.0	49.2	0.8	4.0	54

Remark: 1. Correction Factor = Antenna factor+ Insertion loss (cable loss + amplifier gain)

RE 3-18GHz PK+AV

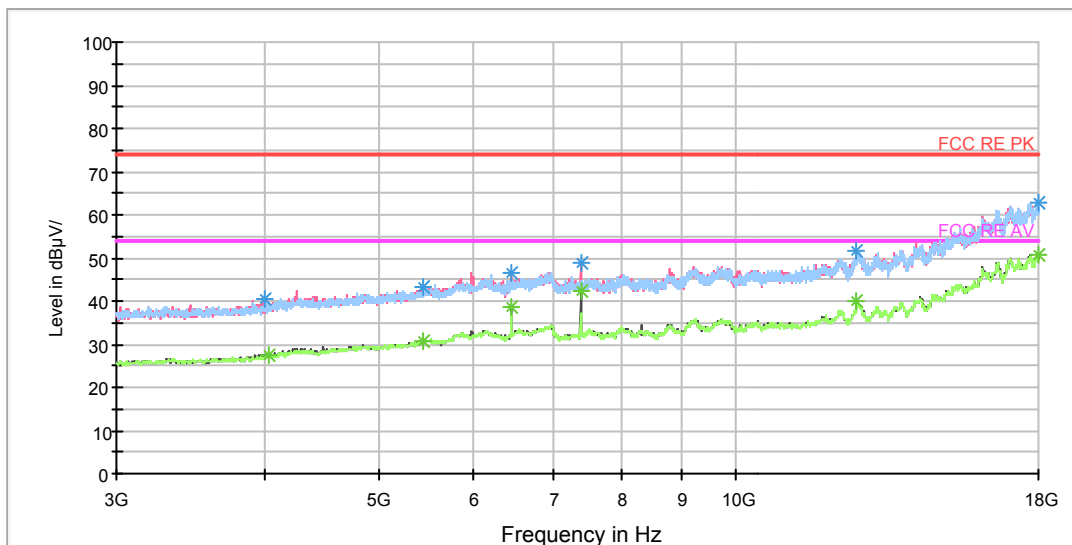

Radiates Emission from 3GHz to 18GHz

Frequency (MHz)	Peak (dBuV/m)	Height (cm)	Polarization	Azimuth (deg)	Reading value (dBuV/m)	Correct Factor (dB)	Margin (dB)	Limit (dBuV/m)
4008.750000	40.3	205.0	H	109.0	41.4	-1.1	33.7	74
5439.375000	43.2	400.0	H	0.0	40.3	2.9	30.8	74
6468.750000	46.5	105.0	V	191.0	41.4	5.1	27.5	74
7393.125000	48.9	105.0	V	191.0	42.0	6.9	25.1	74
12631.875000	51.6	205.0	H	302.0	38.0	13.6	22.4	74
17985.000000	62.6	305.0	H	0.0	37.5	25.1	11.4	74

Frequency (MHz)	Average (dBuV/m)	Height (cm)	Polarization	Azimuth (deg)	Reading value (dBuV/m)	Correct Factor (dB)	Margin (dB)	Limit (dBuV/m)
4035.000000	27.4	205.0	V	0.0	28.4	-1.0	26.6	54
5445.000000	30.9	205.0	V	280.0	28.0	2.9	23.1	54
6468.750000	38.7	105.0	V	191.0	33.6	5.1	15.3	54
7393.125000	42.2	105.0	V	191.0	35.3	6.9	11.8	54
12641.250000	40.0	105.0	V	0.0	25.5	14.5	14.0	54
18000.000000	50.8	105.0	H	0.0	25.3	25.5	3.2	54

Remark: 1. Correction Factor = Antenna factor+ Insertion loss (cable loss + amplifier gain)



926.7MHz

RE 30M-1GHz QP

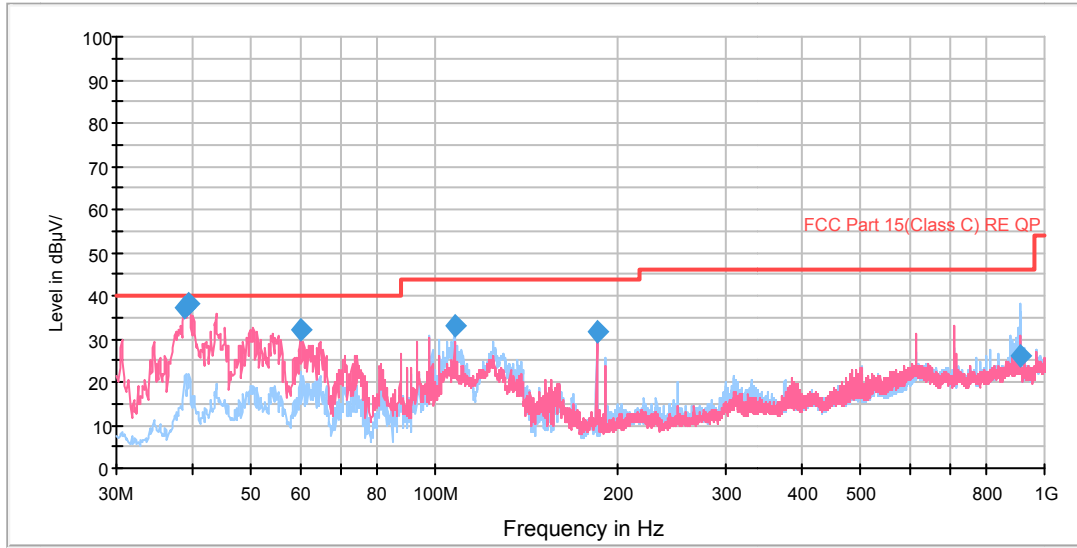

Radiates Emission from 30MHz to 1GHz

Frequency (MHz)	Quasi-Peak (dBuV/m)	Height (cm)	Polarization	Azimuth (deg)	Reading value (dBuV/m)	Correct Factor (dB)	Margin (dB)	Limit (dBuV/m)
38.955069	37.4	102.0	V	323.0	58.7	-21.3	2.6	40.0
39.478856	38.3	102.0	V	303.0	59.3	-21.0	1.7	40.0
60.200772	32.3	102.0	V	225.0	55.5	-23.2	7.7	40.0
107.691947	32.9	279.0	H	89.0	58.8	-25.9	10.6	43.5
184.249425	31.7	176.0	H	76.0	59.3	-27.6	11.8	43.5
912.544750	26.3	224.0	H	42.0	39.3	-13.0	19.7	46.0

RE 1G-3GHz PK+AV

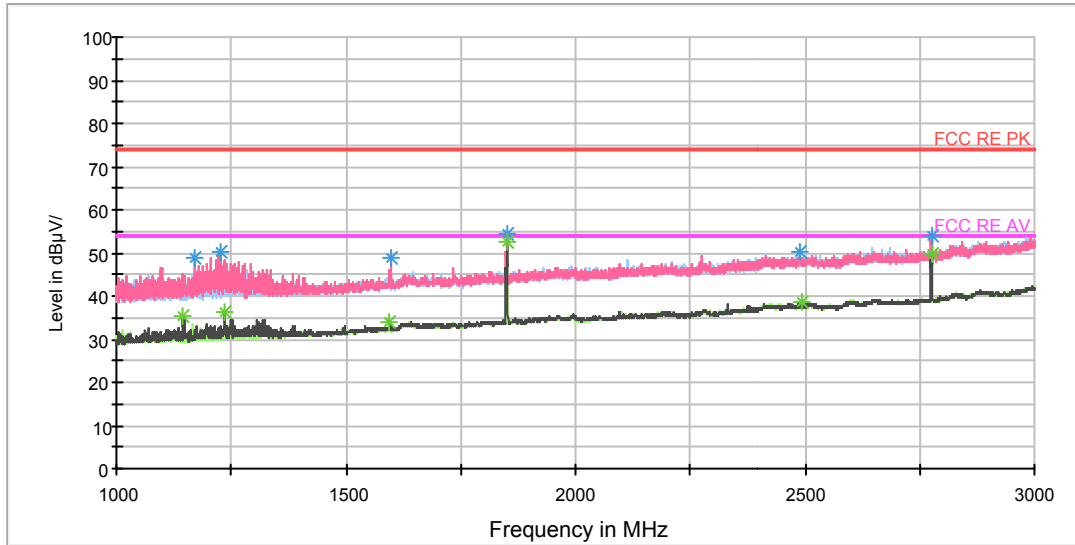

Radiates Emission from 1GHz to 3GHz
 Note: The signal beyond the limit is carrier.

Frequency (MHz)	Peak (dBuV/m)	Height (cm)	Polarization	Azimuth (deg)	Reading value (dBuV/m)	Correct Factor (dB)	Margin (dB)	Limit (dBuV/m)
1170.500000	48.8	105.0	V	163.0	56.9	-8.1	25.2	74
1226.750000	50.5	105.0	V	17.0	58.3	-7.8	23.5	74
1596.750000	48.6	105.0	V	17.0	55.0	-6.4	25.4	74
1851.750000	54.5	205.0	H	227.0	58.6	-4.1	19.5	74
2490.250000	50.3	205.0	H	329.0	50.0	0.3	23.7	74
2775.750000	53.8	205.0	V	174.0	53.0	0.8	20.2	74

Frequency (MHz)	Average (dBuV/m)	Height (cm)	Polarization	Azimuth (deg)	Reading value (dBuV/m)	Correct Factor (dB)	Margin (dB)	Limit (dBuV/m)
1146.000000	35.5	105.0	V	181.0	44.0	-8.5	18.5	54
1237.250000	36.2	105.0	V	145.0	44.1	-7.9	17.8	54
1594.750000	34.0	105.0	V	101.0	40.4	-6.4	20.0	54
1851.750000	52.5	205.0	H	227.0	56.6	-4.1	1.5	54
2491.500000	38.4	105.0	V	119.0	38.1	0.3	15.6	54
2776.000000	50.0	205.0	V	174.0	49.2	0.8	4.0	54

Remark: 1. Correction Factor = Antenna factor+ Insertion loss (cable loss + amplifier gain)

RE 3-18GHz PK+AV

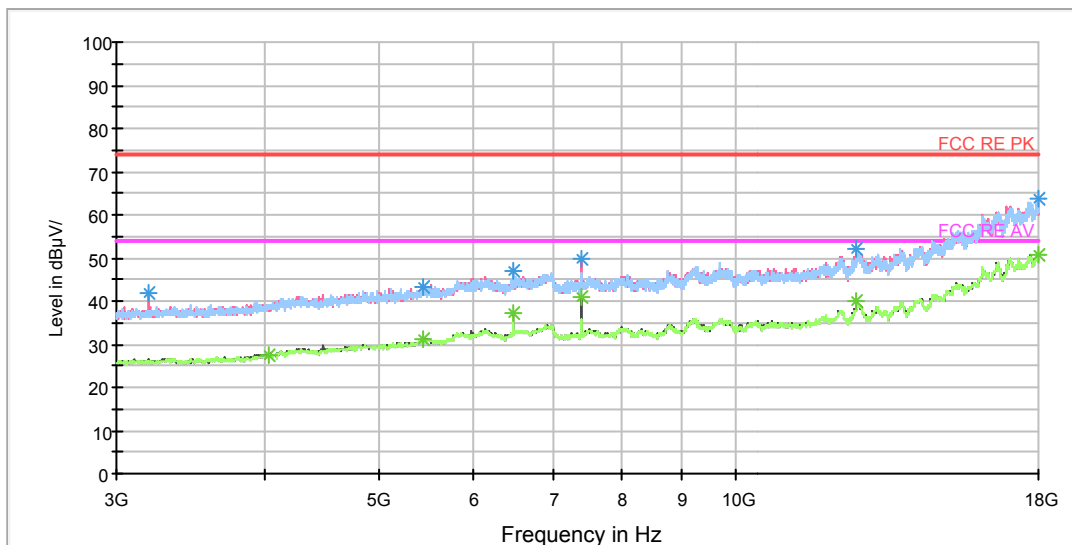

Radiates Emission from 3GHz to 18GHz

Frequency (MHz)	Peak (dBuV/m)	Height (cm)	Polarization	Azimuth (deg)	Reading value (dBuV/m)	Correct Factor (dB)	Margin (dB)	Limit (dBuV/m)
3191.250000	41.7	205.0	V	0.0	44.6	-2.9	32.3	74
5439.375000	43.2	205.0	V	0.0	40.3	2.9	30.8	74
6481.875000	47.0	106.0	V	190.0	41.9	5.1	27.0	74
7408.125000	49.8	205.0	V	114.0	42.9	6.9	24.2	74
12643.125000	52.1	400.0	H	0.0	37.7	14.4	21.9	74
17998.125000	63.8	105.0	H	31.0	38.4	25.4	10.2	74

Frequency (MHz)	Average (dBuV/m)	Height (cm)	Polarization	Azimuth (deg)	Reading value (dBuV/m)	Correct Factor (dB)	Margin (dB)	Limit (dBuV/m)
4040.625000	27.6	205.0	V	141.0	28.6	-1.0	26.4	54
5437.500000	31.1	205.0	V	279.0	28.2	2.9	22.9	54
6481.875000	37.3	106.0	V	190.0	32.2	5.1	16.7	54
7406.250000	40.7	106.0	V	299.0	33.8	6.9	13.3	54
12641.250000	40.0	205.0	V	87.0	25.5	14.5	14.0	54
18000.000000	50.7	305.0	V	165.0	25.2	25.5	3.3	54

Remark: 1. Correction Factor = Antenna factor+ Insertion loss (cable loss + amplifier gain)



928MHz

RE 30M-1GHz QP

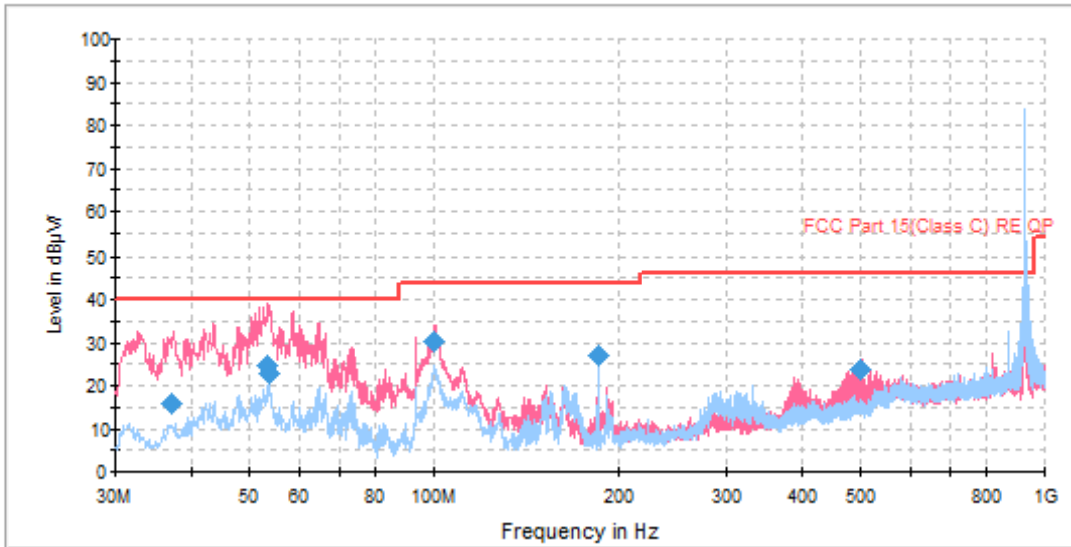

Radiates Emission from 30MHz to 1GHz

Frequency (MHz)	Quasi-Peak (dBuV/m)	Height (cm)	Polarization	Azimuth (deg)	Reading value (dBuV/m)	Correct Factor (dB)	Margin (dB)	Limit (dBuV/m)
37.181812	15.7	101.0	V	184.0	37.8	-22.1	24.3	40.0
53.468694	24.6	101.0	V	0.0	45.3	-20.7	15.4	40.0
53.951534	22.8	101.0	V	330.0	43.7	-20.9	17.2	40.0
99.750400	30.0	100.0	V	123.0	55.3	-25.3	13.5	43.5
184.249425	27.1	121.0	V	342.0	54.7	-27.6	16.4	43.5
499.996250	23.6	101.0	V	156.0	42.6	-19.0	22.4	46.0

RE 1G-3GHz PK+AV

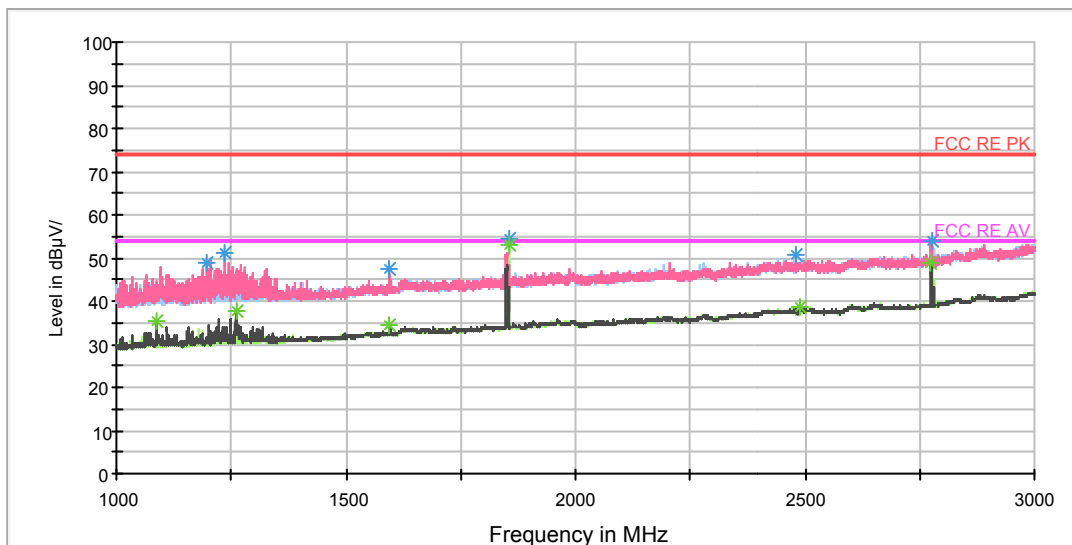

Radiates Emission from 1GHz to 3GHz
 Note: The signal beyond the limit is carrier.

Frequency (MHz)	Peak (dBuV/m)	Height (cm)	Polarization	Azimuth (deg)	Reading value (dBuV/m)	Correct Factor (dB)	Margin (dB)	Limit (dBuV/m)
1197.250000	48.7	105.0	V	12.0	56.9	-8.2	25.3	74
1236.750000	51.0	105.0	V	3.0	58.9	-7.9	23.0	74
1596.000000	47.7	105.0	V	29.0	54.1	-6.4	26.3	74
1854.500000	54.5	205.0	H	298.0	58.7	-4.2	19.5	74
2480.250000	50.9	105.0	V	57.0	51.4	-0.5	23.1	74
2775.500000	54.1	205.0	V	201.0	53.3	0.8	19.9	74

Frequency (MHz)	Average (dBuV/m)	Height (cm)	Polarization	Azimuth (deg)	Reading value (dBuV/m)	Correct Factor (dB)	Margin (dB)	Limit (dBuV/m)
1087.750000	35.2	105.0	V	146.0	44.1	-8.9	18.8	54
1262.000000	37.9	105.0	V	208.0	45.6	-7.7	16.1	54
1596.000000	34.6	105.0	V	29.0	41.0	-6.4	19.4	54
1854.500000	53.2	205.0	H	298.0	57.4	-4.2	0.8	54
2487.750000	38.8	105.0	V	76.0	38.7	0.1	15.2	54
2774.250000	48.8	205.0	V	327.0	48.0	0.8	5.2	54

Remark: 1. Correction Factor = Antenna factor+ Insertion loss (cable loss + amplifier gain)

RE 3-18GHz PK+AV

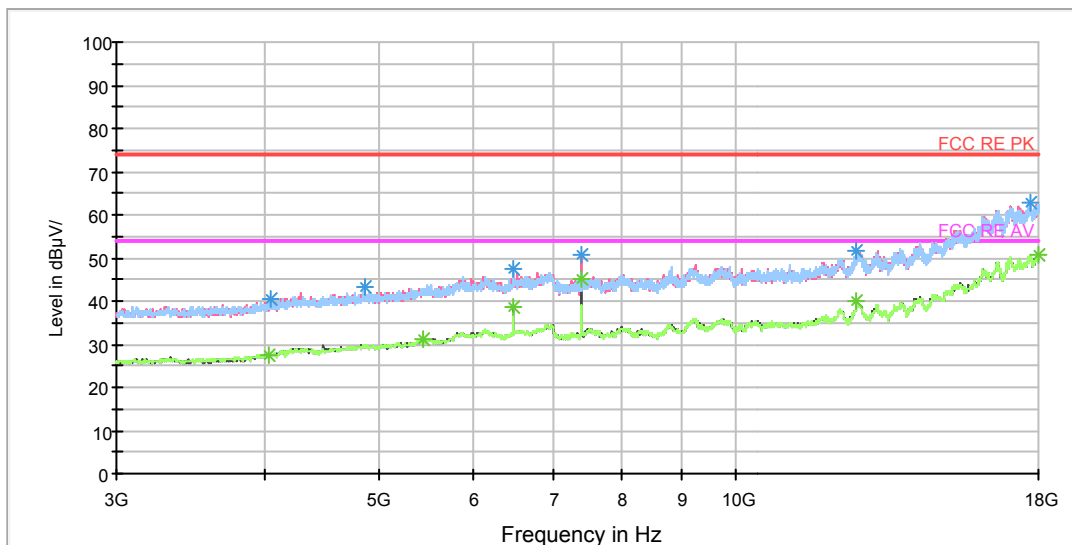

Radiates Emission from 3GHz to 18GHz

Frequency (MHz)	Peak (dBuV/m)	Height (cm)	Polarization	Azimuth (deg)	Reading value (dBuV/m)	Correct Factor (dB)	Margin (dB)	Limit (dBuV/m)
4042.500000	40.3	305.0	V	0.0	41.3	-1.0	33.7	74
4867.500000	43.1	400.0	V	4.0	41.4	1.7	30.9	74
6491.250000	47.4	105.0	V	191.0	42.2	5.2	26.6	74
7417.500000	50.8	105.0	V	191.0	43.8	7.0	23.2	74
12639.375000	51.7	205.0	V	7.0	37.2	14.5	22.3	74
17728.125000	62.9	400.0	V	0.0	38.5	24.4	11.1	74

Frequency (MHz)	Average (dBuV/m)	Height (cm)	Polarization	Azimuth (deg)	Reading value (dBuV/m)	Correct Factor (dB)	Margin (dB)	Limit (dBuV/m)
4035.000000	27.5	400.0	H	247.0	28.5	-1.0	26.5	54
5445.000000	31.1	303.0	H	6.0	28.2	2.9	22.9	54
6489.375000	38.5	105.0	V	0.0	33.3	5.2	15.5	54
7417.500000	45.0	105.0	V	191.0	38.0	7.0	9.0	54
12639.375000	40.0	105.0	V	136.0	25.5	14.5	14.0	54
18000.000000	50.8	305.0	V	329.0	25.3	25.5	3.2	54

Remark: 1. Correction Factor = Antenna factor+ Insertion loss (cable loss + amplifier gain)

3.10 Conducted Emission

Ambient condition

Temperature	Relative humidity	Pressure
23°C ~25°C	45%~50%	101.5kPa

Methods of Measurement

The EUT is placed on a non-metallic table of 80cm height above the horizontal metal reference ground plane. During the test, the EUT was operating in its typical mode. The test method is according to ANSI C63.10-2013. Connect the AC power line of the EUT to the L.I.S.N. Use EMI receiver to detect the average and Quasi-peak value. RBW is set to 9 kHz, VBW is set to 30kHz. The measurement result should include both L line and N line.

The test is in transmitting mode.

Test Setup

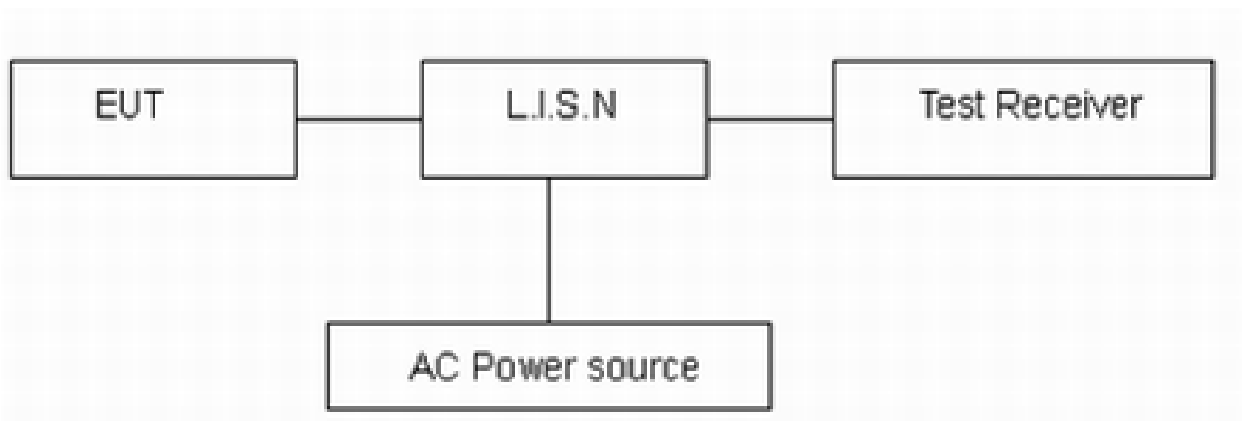

Note: AC Power source is used to change the voltage from 220V/50Hz to 110V/60Hz.

Limits

Frequency (MHz)	Conducted Limits(dBμV)	
	Quasi-peak	Average
0.15 - 0.5	66 to 56 *	56 to 46 *
0.5 - 5	56	46
5 - 30	60	50

*: Decreases with the logarithm of the frequency.

Measurement Uncertainty

The assessed measurement uncertainty to ensure 95% confidence level for the normal distribution is with the coverage factor $k = 1.96$, $U=2.69$ dB.

Test Results:

Following plots, Blue trace uses the peak detection, Green trace uses the average detection.

902MHz																																																																																																																																			
L Line																																																																																																																																			
	<table border="1"> <thead> <tr> <th>Frequency (MHz)</th> <th>QuasiPeak (dBµV)</th> <th>Average (dBµV)</th> <th>Limit (dBµV)</th> <th>Margin (dB)</th> <th>Meas. Time (ms)</th> <th>Bandwidth (kHz)</th> <th>Line</th> <th>Filter</th> <th>Corr. (dB)</th> </tr> </thead> <tbody> <tr><td>0.251250</td><td>---</td><td>46.32</td><td>51.72</td><td>5.39</td><td>1000.0</td><td>9.000</td><td>L1</td><td>ON</td><td>19.1</td></tr> <tr><td>0.255750</td><td>49.56</td><td>---</td><td>61.57</td><td>12.01</td><td>1000.0</td><td>9.000</td><td>L1</td><td>ON</td><td>19.1</td></tr> <tr><td>0.408750</td><td>---</td><td>28.88</td><td>47.67</td><td>18.79</td><td>1000.0</td><td>9.000</td><td>L1</td><td>ON</td><td>19.2</td></tr> <tr><td>0.631500</td><td>35.38</td><td>---</td><td>56.00</td><td>20.62</td><td>1000.0</td><td>9.000</td><td>L1</td><td>ON</td><td>19.3</td></tr> <tr><td>0.908250</td><td>---</td><td>24.36</td><td>46.00</td><td>21.64</td><td>1000.0</td><td>9.000</td><td>L1</td><td>ON</td><td>19.2</td></tr> <tr><td>1.680000</td><td>33.98</td><td>---</td><td>56.00</td><td>22.02</td><td>1000.0</td><td>9.000</td><td>L1</td><td>ON</td><td>19.2</td></tr> <tr><td>2.760000</td><td>34.59</td><td>---</td><td>56.00</td><td>21.41</td><td>1000.0</td><td>9.000</td><td>L1</td><td>ON</td><td>19.0</td></tr> <tr><td>2.764500</td><td>---</td><td>30.26</td><td>46.00</td><td>15.74</td><td>1000.0</td><td>9.000</td><td>L1</td><td>ON</td><td>19.0</td></tr> <tr><td>7.568250</td><td>36.61</td><td>---</td><td>60.00</td><td>23.39</td><td>1000.0</td><td>9.000</td><td>L1</td><td>ON</td><td>19.2</td></tr> <tr><td>7.572750</td><td>---</td><td>32.07</td><td>50.00</td><td>17.93</td><td>1000.0</td><td>9.000</td><td>L1</td><td>ON</td><td>19.2</td></tr> <tr><td>23.129250</td><td>---</td><td>38.39</td><td>50.00</td><td>11.61</td><td>1000.0</td><td>9.000</td><td>L1</td><td>ON</td><td>19.6</td></tr> <tr><td>23.129250</td><td>41.20</td><td>---</td><td>60.00</td><td>18.80</td><td>1000.0</td><td>9.000</td><td>L1</td><td>ON</td><td>19.6</td></tr> </tbody> </table>	Frequency (MHz)	QuasiPeak (dBµV)	Average (dBµV)	Limit (dBµV)	Margin (dB)	Meas. Time (ms)	Bandwidth (kHz)	Line	Filter	Corr. (dB)	0.251250	---	46.32	51.72	5.39	1000.0	9.000	L1	ON	19.1	0.255750	49.56	---	61.57	12.01	1000.0	9.000	L1	ON	19.1	0.408750	---	28.88	47.67	18.79	1000.0	9.000	L1	ON	19.2	0.631500	35.38	---	56.00	20.62	1000.0	9.000	L1	ON	19.3	0.908250	---	24.36	46.00	21.64	1000.0	9.000	L1	ON	19.2	1.680000	33.98	---	56.00	22.02	1000.0	9.000	L1	ON	19.2	2.760000	34.59	---	56.00	21.41	1000.0	9.000	L1	ON	19.0	2.764500	---	30.26	46.00	15.74	1000.0	9.000	L1	ON	19.0	7.568250	36.61	---	60.00	23.39	1000.0	9.000	L1	ON	19.2	7.572750	---	32.07	50.00	17.93	1000.0	9.000	L1	ON	19.2	23.129250	---	38.39	50.00	11.61	1000.0	9.000	L1	ON	19.6	23.129250	41.20	---	60.00	18.80	1000.0	9.000	L1	ON	19.6
Frequency (MHz)	QuasiPeak (dBµV)	Average (dBµV)	Limit (dBµV)	Margin (dB)	Meas. Time (ms)	Bandwidth (kHz)	Line	Filter	Corr. (dB)																																																																																																																										
0.251250	---	46.32	51.72	5.39	1000.0	9.000	L1	ON	19.1																																																																																																																										
0.255750	49.56	---	61.57	12.01	1000.0	9.000	L1	ON	19.1																																																																																																																										
0.408750	---	28.88	47.67	18.79	1000.0	9.000	L1	ON	19.2																																																																																																																										
0.631500	35.38	---	56.00	20.62	1000.0	9.000	L1	ON	19.3																																																																																																																										
0.908250	---	24.36	46.00	21.64	1000.0	9.000	L1	ON	19.2																																																																																																																										
1.680000	33.98	---	56.00	22.02	1000.0	9.000	L1	ON	19.2																																																																																																																										
2.760000	34.59	---	56.00	21.41	1000.0	9.000	L1	ON	19.0																																																																																																																										
2.764500	---	30.26	46.00	15.74	1000.0	9.000	L1	ON	19.0																																																																																																																										
7.568250	36.61	---	60.00	23.39	1000.0	9.000	L1	ON	19.2																																																																																																																										
7.572750	---	32.07	50.00	17.93	1000.0	9.000	L1	ON	19.2																																																																																																																										
23.129250	---	38.39	50.00	11.61	1000.0	9.000	L1	ON	19.6																																																																																																																										
23.129250	41.20	---	60.00	18.80	1000.0	9.000	L1	ON	19.6																																																																																																																										
N Line																																																																																																																																			
	<table border="1"> <thead> <tr> <th>Frequency (MHz)</th> <th>QuasiPeak (dBµV)</th> <th>Average (dBµV)</th> <th>Limit (dBµV)</th> <th>Margin (dB)</th> <th>Meas. Time (ms)</th> <th>Bandwidth (kHz)</th> <th>Line</th> <th>Filter</th> <th>Corr. (dB)</th> </tr> </thead> <tbody> <tr><td>0.251250</td><td>---</td><td>48.41</td><td>51.72</td><td>3.30</td><td>1000.0</td><td>9.000</td><td>N</td><td>ON</td><td>19.1</td></tr> <tr><td>0.255750</td><td>49.65</td><td>---</td><td>61.57</td><td>11.91</td><td>1000.0</td><td>9.000</td><td>N</td><td>ON</td><td>19.1</td></tr> <tr><td>0.408750</td><td>---</td><td>34.83</td><td>47.67</td><td>12.84</td><td>1000.0</td><td>9.000</td><td>N</td><td>ON</td><td>19.2</td></tr> <tr><td>0.622500</td><td>35.97</td><td>---</td><td>56.00</td><td>20.03</td><td>1000.0</td><td>9.000</td><td>N</td><td>ON</td><td>19.3</td></tr> <tr><td>1.176000</td><td>---</td><td>27.80</td><td>46.00</td><td>18.20</td><td>1000.0</td><td>9.000</td><td>N</td><td>ON</td><td>19.2</td></tr> <tr><td>1.729500</td><td>34.04</td><td>---</td><td>56.00</td><td>21.96</td><td>1000.0</td><td>9.000</td><td>N</td><td>ON</td><td>19.2</td></tr> <tr><td>2.766750</td><td>35.67</td><td>---</td><td>56.00</td><td>20.33</td><td>1000.0</td><td>9.000</td><td>N</td><td>ON</td><td>19.0</td></tr> <tr><td>2.769000</td><td>---</td><td>28.75</td><td>46.00</td><td>17.25</td><td>1000.0</td><td>9.000</td><td>N</td><td>ON</td><td>19.0</td></tr> <tr><td>7.579500</td><td>37.51</td><td>---</td><td>60.00</td><td>22.49</td><td>1000.0</td><td>9.000</td><td>N</td><td>ON</td><td>19.2</td></tr> <tr><td>7.581750</td><td>---</td><td>32.61</td><td>50.00</td><td>17.39</td><td>1000.0</td><td>9.000</td><td>N</td><td>ON</td><td>19.2</td></tr> <tr><td>23.129250</td><td>---</td><td>38.30</td><td>50.00</td><td>11.70</td><td>1000.0</td><td>9.000</td><td>N</td><td>ON</td><td>19.5</td></tr> <tr><td>23.129250</td><td>40.97</td><td>---</td><td>60.00</td><td>19.03</td><td>1000.0</td><td>9.000</td><td>N</td><td>ON</td><td>19.5</td></tr> </tbody> </table>	Frequency (MHz)	QuasiPeak (dBµV)	Average (dBµV)	Limit (dBµV)	Margin (dB)	Meas. Time (ms)	Bandwidth (kHz)	Line	Filter	Corr. (dB)	0.251250	---	48.41	51.72	3.30	1000.0	9.000	N	ON	19.1	0.255750	49.65	---	61.57	11.91	1000.0	9.000	N	ON	19.1	0.408750	---	34.83	47.67	12.84	1000.0	9.000	N	ON	19.2	0.622500	35.97	---	56.00	20.03	1000.0	9.000	N	ON	19.3	1.176000	---	27.80	46.00	18.20	1000.0	9.000	N	ON	19.2	1.729500	34.04	---	56.00	21.96	1000.0	9.000	N	ON	19.2	2.766750	35.67	---	56.00	20.33	1000.0	9.000	N	ON	19.0	2.769000	---	28.75	46.00	17.25	1000.0	9.000	N	ON	19.0	7.579500	37.51	---	60.00	22.49	1000.0	9.000	N	ON	19.2	7.581750	---	32.61	50.00	17.39	1000.0	9.000	N	ON	19.2	23.129250	---	38.30	50.00	11.70	1000.0	9.000	N	ON	19.5	23.129250	40.97	---	60.00	19.03	1000.0	9.000	N	ON	19.5
Frequency (MHz)	QuasiPeak (dBµV)	Average (dBµV)	Limit (dBµV)	Margin (dB)	Meas. Time (ms)	Bandwidth (kHz)	Line	Filter	Corr. (dB)																																																																																																																										
0.251250	---	48.41	51.72	3.30	1000.0	9.000	N	ON	19.1																																																																																																																										
0.255750	49.65	---	61.57	11.91	1000.0	9.000	N	ON	19.1																																																																																																																										
0.408750	---	34.83	47.67	12.84	1000.0	9.000	N	ON	19.2																																																																																																																										
0.622500	35.97	---	56.00	20.03	1000.0	9.000	N	ON	19.3																																																																																																																										
1.176000	---	27.80	46.00	18.20	1000.0	9.000	N	ON	19.2																																																																																																																										
1.729500	34.04	---	56.00	21.96	1000.0	9.000	N	ON	19.2																																																																																																																										
2.766750	35.67	---	56.00	20.33	1000.0	9.000	N	ON	19.0																																																																																																																										
2.769000	---	28.75	46.00	17.25	1000.0	9.000	N	ON	19.0																																																																																																																										
7.579500	37.51	---	60.00	22.49	1000.0	9.000	N	ON	19.2																																																																																																																										
7.581750	---	32.61	50.00	17.39	1000.0	9.000	N	ON	19.2																																																																																																																										
23.129250	---	38.30	50.00	11.70	1000.0	9.000	N	ON	19.5																																																																																																																										
23.129250	40.97	---	60.00	19.03	1000.0	9.000	N	ON	19.5																																																																																																																										
920MHz																																																																																																																																			
L Line																																																																																																																																			
	<table border="1"> <thead> <tr> <th>Frequency (MHz)</th> <th>QuasiPeak (dBµV)</th> <th>Average (dBµV)</th> <th>Limit (dBµV)</th> <th>Margin (dB)</th> <th>Meas. Time (ms)</th> <th>Bandwidth (kHz)</th> <th>Line</th> <th>Filter</th> <th>Corr. (dB)</th> </tr> </thead> <tbody> <tr><td>0.253500</td><td>---</td><td>48.05</td><td>51.64</td><td>3.60</td><td>1000.0</td><td>9.000</td><td>L1</td><td>ON</td><td>19.1</td></tr> <tr><td>0.253500</td><td>50.30</td><td>---</td><td>61.64</td><td>11.34</td><td>1000.0</td><td>9.000</td><td>L1</td><td>ON</td><td>19.1</td></tr> <tr><td>0.379500</td><td>---</td><td>34.21</td><td>48.29</td><td>14.08</td><td>1000.0</td><td>9.000</td><td>L1</td><td>ON</td><td>19.2</td></tr> <tr><td>0.622500</td><td>36.23</td><td>---</td><td>56.00</td><td>19.77</td><td>1000.0</td><td>9.000</td><td>L1</td><td>ON</td><td>19.3</td></tr> <tr><td>0.895750</td><td>---</td><td>28.30</td><td>46.00</td><td>17.70</td><td>1000.0</td><td>9.000</td><td>L1</td><td>ON</td><td>19.2</td></tr> <tr><td>1.774500</td><td>34.05</td><td>---</td><td>56.00</td><td>21.95</td><td>1000.0</td><td>9.000</td><td>L1</td><td>ON</td><td>19.2</td></tr> <tr><td>2.766750</td><td>---</td><td>29.27</td><td>46.00</td><td>16.73</td><td>1000.0</td><td>9.000</td><td>L1</td><td>ON</td><td>19.0</td></tr> <tr><td>2.775750</td><td>35.02</td><td>---</td><td>56.00</td><td>20.98</td><td>1000.0</td><td>9.000</td><td>L1</td><td>ON</td><td>19.0</td></tr> <tr><td>7.584000</td><td>---</td><td>32.81</td><td>50.00</td><td>17.19</td><td>1000.0</td><td>9.000</td><td>L1</td><td>ON</td><td>19.2</td></tr> <tr><td>7.588500</td><td>37.52</td><td>---</td><td>60.00</td><td>22.48</td><td>1000.0</td><td>9.000</td><td>L1</td><td>ON</td><td>19.2</td></tr> <tr><td>23.129250</td><td>---</td><td>38.36</td><td>50.00</td><td>11.64</td><td>1000.0</td><td>9.000</td><td>L1</td><td>ON</td><td>19.6</td></tr> <tr><td>23.129250</td><td>41.41</td><td>---</td><td>60.00</td><td>18.59</td><td>1000.0</td><td>9.000</td><td>L1</td><td>ON</td><td>19.6</td></tr> </tbody> </table>	Frequency (MHz)	QuasiPeak (dBµV)	Average (dBµV)	Limit (dBµV)	Margin (dB)	Meas. Time (ms)	Bandwidth (kHz)	Line	Filter	Corr. (dB)	0.253500	---	48.05	51.64	3.60	1000.0	9.000	L1	ON	19.1	0.253500	50.30	---	61.64	11.34	1000.0	9.000	L1	ON	19.1	0.379500	---	34.21	48.29	14.08	1000.0	9.000	L1	ON	19.2	0.622500	36.23	---	56.00	19.77	1000.0	9.000	L1	ON	19.3	0.895750	---	28.30	46.00	17.70	1000.0	9.000	L1	ON	19.2	1.774500	34.05	---	56.00	21.95	1000.0	9.000	L1	ON	19.2	2.766750	---	29.27	46.00	16.73	1000.0	9.000	L1	ON	19.0	2.775750	35.02	---	56.00	20.98	1000.0	9.000	L1	ON	19.0	7.584000	---	32.81	50.00	17.19	1000.0	9.000	L1	ON	19.2	7.588500	37.52	---	60.00	22.48	1000.0	9.000	L1	ON	19.2	23.129250	---	38.36	50.00	11.64	1000.0	9.000	L1	ON	19.6	23.129250	41.41	---	60.00	18.59	1000.0	9.000	L1	ON	19.6
Frequency (MHz)	QuasiPeak (dBµV)	Average (dBµV)	Limit (dBµV)	Margin (dB)	Meas. Time (ms)	Bandwidth (kHz)	Line	Filter	Corr. (dB)																																																																																																																										
0.253500	---	48.05	51.64	3.60	1000.0	9.000	L1	ON	19.1																																																																																																																										
0.253500	50.30	---	61.64	11.34	1000.0	9.000	L1	ON	19.1																																																																																																																										
0.379500	---	34.21	48.29	14.08	1000.0	9.000	L1	ON	19.2																																																																																																																										
0.622500	36.23	---	56.00	19.77	1000.0	9.000	L1	ON	19.3																																																																																																																										
0.895750	---	28.30	46.00	17.70	1000.0	9.000	L1	ON	19.2																																																																																																																										
1.774500	34.05	---	56.00	21.95	1000.0	9.000	L1	ON	19.2																																																																																																																										
2.766750	---	29.27	46.00	16.73	1000.0	9.000	L1	ON	19.0																																																																																																																										
2.775750	35.02	---	56.00	20.98	1000.0	9.000	L1	ON	19.0																																																																																																																										
7.584000	---	32.81	50.00	17.19	1000.0	9.000	L1	ON	19.2																																																																																																																										
7.588500	37.52	---	60.00	22.48	1000.0	9.000	L1	ON	19.2																																																																																																																										
23.129250	---	38.36	50.00	11.64	1000.0	9.000	L1	ON	19.6																																																																																																																										
23.129250	41.41	---	60.00	18.59	1000.0	9.000	L1	ON	19.6																																																																																																																										
N Line																																																																																																																																			
	<table border="1"> <thead> <tr> <th>Frequency (MHz)</th> <th>QuasiPeak (dBµV)</th> <th>Average (dBµV)</th> <th>Limit (dBµV)</th> <th>Margin (dB)</th> <th>Meas. Time (ms)</th> <th>Bandwidth (kHz)</th> <th>Line</th> <th>Filter</th> <th>Corr. (dB)</th> </tr> </thead> <tbody> <tr><td>0.255750</td><td>---</td><td>45.24</td><td>51.57</td><td>6.32</td><td>1000.0</td><td>9.000</td><td>N</td><td>ON</td><td>19.1</td></tr> <tr><td>0.255750</td><td>50.35</td><td>---</td><td>61.57</td><td>11.22</td><td>1000.0</td><td>9.000</td><td>N</td><td>ON</td><td>19.1</td></tr> <tr><td>0.408750</td><td>---</td><td>35.21</td><td>47.67</td><td>12.47</td><td>1000.0</td><td>9.000</td><td>N</td><td>ON</td><td>19.2</td></tr> <tr><td>0.591000</td><td>35.94</td><td>---</td><td>56.00</td><td>20.06</td><td>1000.0</td><td>9.000</td><td>N</td><td>ON</td><td>19.3</td></tr> <tr><td>0.908250</td><td>---</td><td>28.80</td><td>46.00</td><td>17.20</td><td>1000.0</td><td>9.000</td><td>N</td><td>ON</td><td>19.2</td></tr> <tr><td>1.587750</td><td>30.71</td><td>---</td><td>56.00</td><td>25.29</td><td>1000.0</td><td>9.000</td><td>N</td><td>ON</td><td>19.2</td></tr> <tr><td>2.764500</td><td>---</td><td>29.70</td><td>46.00</td><td>16.30</td><td>1000.0</td><td>9.000</td><td>N</td><td>ON</td><td>19.0</td></tr> <tr><td>2.767500</td><td>35.41</td><td>---</td><td>56.00</td><td>20.59</td><td>1000.0</td><td>9.000</td><td>N</td><td>ON</td><td>19.0</td></tr> <tr><td>7.586250</td><td>37.65</td><td>---</td><td>60.00</td><td>22.35</td><td>1000.0</td><td>9.000</td><td>N</td><td>ON</td><td>19.2</td></tr> <tr><td>7.586250</td><td>---</td><td>31.89</td><td>50.00</td><td>18.11</td><td>1000.0</td><td>9.000</td><td>N</td><td>ON</td><td>19.2</td></tr> <tr><td>23.129250</td><td>---</td><td>38.04</td><td>50.00</td><td>11.96</td><td>1000.0</td><td>9.000</td><td>N</td><td>ON</td><td>19.5</td></tr> <tr><td>23.129250</td><td>41.03</td><td>---</td><td>60.00</td><td>18.97</td><td>1000.0</td><td>9.000</td><td>N</td><td>ON</td><td>19.5</td></tr> </tbody> </table>	Frequency (MHz)	QuasiPeak (dBµV)	Average (dBµV)	Limit (dBµV)	Margin (dB)	Meas. Time (ms)	Bandwidth (kHz)	Line	Filter	Corr. (dB)	0.255750	---	45.24	51.57	6.32	1000.0	9.000	N	ON	19.1	0.255750	50.35	---	61.57	11.22	1000.0	9.000	N	ON	19.1	0.408750	---	35.21	47.67	12.47	1000.0	9.000	N	ON	19.2	0.591000	35.94	---	56.00	20.06	1000.0	9.000	N	ON	19.3	0.908250	---	28.80	46.00	17.20	1000.0	9.000	N	ON	19.2	1.587750	30.71	---	56.00	25.29	1000.0	9.000	N	ON	19.2	2.764500	---	29.70	46.00	16.30	1000.0	9.000	N	ON	19.0	2.767500	35.41	---	56.00	20.59	1000.0	9.000	N	ON	19.0	7.586250	37.65	---	60.00	22.35	1000.0	9.000	N	ON	19.2	7.586250	---	31.89	50.00	18.11	1000.0	9.000	N	ON	19.2	23.129250	---	38.04	50.00	11.96	1000.0	9.000	N	ON	19.5	23.129250	41.03	---	60.00	18.97	1000.0	9.000	N	ON	19.5
Frequency (MHz)	QuasiPeak (dBµV)	Average (dBµV)	Limit (dBµV)	Margin (dB)	Meas. Time (ms)	Bandwidth (kHz)	Line	Filter	Corr. (dB)																																																																																																																										
0.255750	---	45.24	51.57	6.32	1000.0	9.000	N	ON	19.1																																																																																																																										
0.255750	50.35	---	61.57	11.22	1000.0	9.000	N	ON	19.1																																																																																																																										
0.408750	---	35.21	47.67	12.47	1000.0	9.000	N	ON	19.2																																																																																																																										
0.591000	35.94	---	56.00	20.06	1000.0	9.000	N	ON	19.3																																																																																																																										
0.908250	---	28.80	46.00	17.20	1000.0	9.000	N	ON	19.2																																																																																																																										
1.587750	30.71	---	56.00	25.29	1000.0	9.000	N	ON	19.2																																																																																																																										
2.764500	---	29.70	46.00	16.30	1000.0	9.000	N	ON	19.0																																																																																																																										
2.767500	35.41	---	56.00	20.59	1000.0	9.000	N	ON	19.0																																																																																																																										
7.586250	37.65	---	60.00	22.35	1000.0	9.000	N	ON	19.2																																																																																																																										
7.586250	---	31.89	50.00	18.11	1000.0	9.000	N	ON	19.2																																																																																																																										
23.129250	---	38.04	50.00	11.96	1000.0	9.000	N	ON	19.5																																																																																																																										
23.129250	41.03	---	60.00	18.97	1000.0	9.000	N	ON	19.5																																																																																																																										



925MHz

L Line

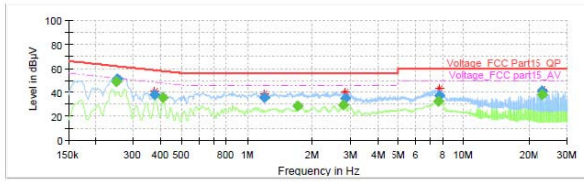

Final Result

Table with 11 columns: Frequency (MHz), QuasiPeak (dBµV), Average (dBµV), Limit (dBµV), Margin (dB), Meas. Time (ms), Bandwidth (kHz), Line, Filter, Corr. (dB). Contains 14 rows of test data.

N Line

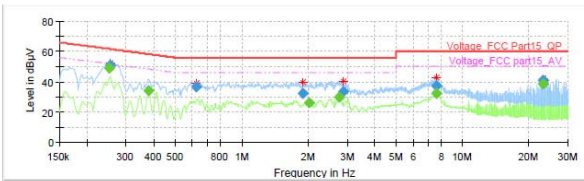

Final Result

Table with 11 columns: Frequency (MHz), QuasiPeak (dBµV), Average (dBµV), Limit (dBµV), Margin (dB), Meas. Time (ms), Bandwidth (kHz), Line, Filter, Corr. (dB). Contains 14 rows of test data.

928MHz

L Line

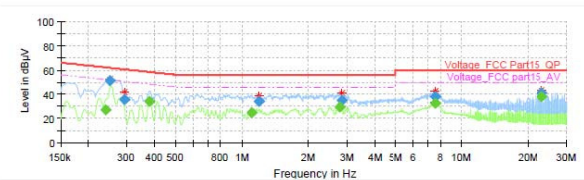

Final Result

Table with 11 columns: Frequency (MHz), QuasiPeak (dBµV), Average (dBµV), Limit (dBµV), Margin (dB), Meas. Time (ms), Bandwidth (kHz), Line, Filter, Corr. (dB). Contains 14 rows of test data.

N Line

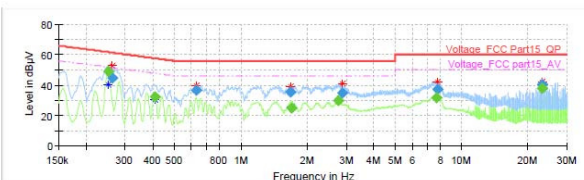

Final Result

Table with 11 columns: Frequency (MHz), QuasiPeak (dBµV), Average (dBµV), Limit (dBµV), Margin (dB), Meas. Time (ms), Bandwidth (kHz), Line, Filter, Corr. (dB). Contains 14 rows of test data.

4 Main Test Instruments

Name	Type	Manufacturer	Serial Number	Calibration Date	Expiration Time
BT Base Station Simulator	CBT	R&S	100271	2016-05-21	2017-05-20
Loop Antenna	FMZB1519	SCHWARZBEC K	1519-047	2014-02-19	2017-02-18
Loop Antenna	FMZB1519	SCHWARZBEC K	1519-047	2017-02-18	2020-02-17
EMI Test Receiver	ESCS30	R&S	100138	2016-12-17	2017-12-16
Artificial main network	ENV216	R&S	101171	2016-12-18	2017-12-17
Signal Analyzer	FSV30	R&S	100815	2015-12-17	2017-12-16
EMI Test Receiver	ESCI	R&S	100948	2016-06-01	2017-05-31
TRILOG Broadband Antenna	VULB 9163	Schwarzbeck	9163-201	2014-12-06	2017-12-05
Double Ridged Waveguide Horn Antenna	HF907	R&S	100126	2014-12-06	2017-12-05
Power Splitter	SHX-GF2-2-13	Hua Xiang	10120101	NA	NA
Spectrum Analyzer	N9010A	Agilent	MY47191109	2016-05-21	2017-05-20
Standard Gain Horn	3160-09	ETS-Lindgren	00102644	2015-01-30	2018-01-29
RF Cable	SMA 15cm	Agilent	0001	2016-12-06	2017-03-05
RF Cable	SMA 15cm	Agilent	0001	2017-03-05	2017-06-04

*****END OF REPORT *****

ANNEX A: EUT Appearance and Test Setup

A.1 EUT Appearance



a: EUT



c: Adapter

Picture 1 EUT and Accessory

A.2 Test Setup



Below 1GHz

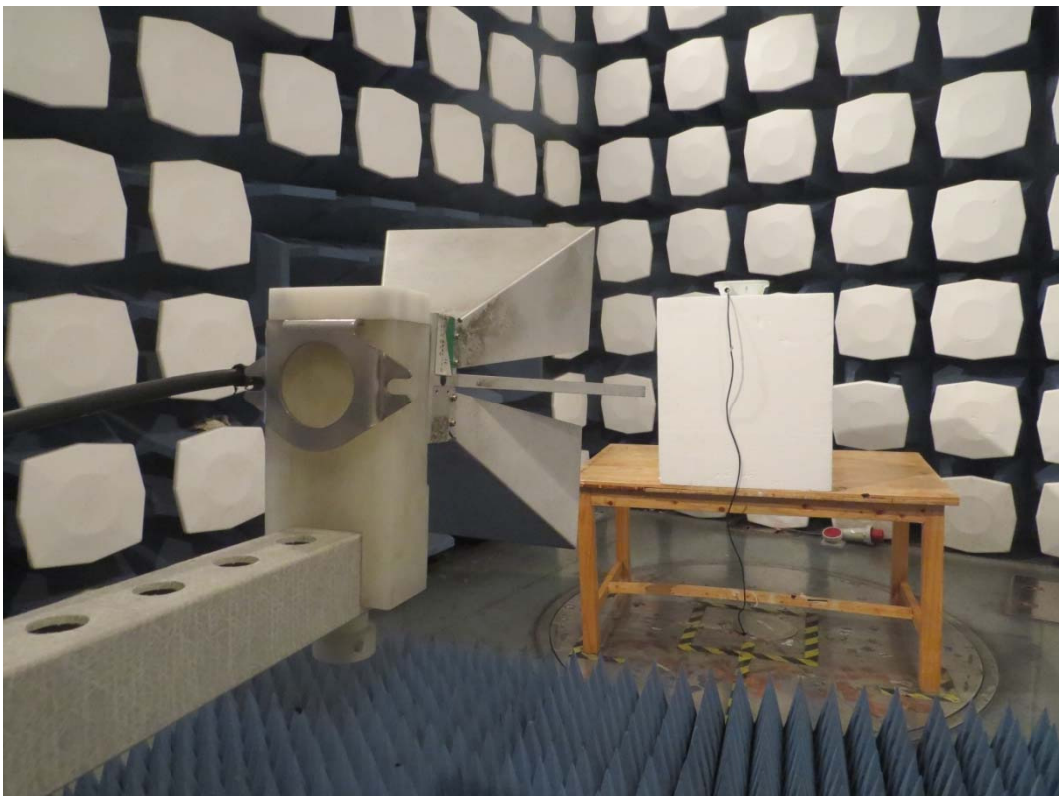

Above 1GHz

Picture 2 Radiated Emission Test Setup



Picture 3 Conducted Emission Test Setup