



## FCC PART 27

**RSS-GEN ISSUE 4, NOVEMBER 2014**

**RSS-199, ISSUE 3, DECEMBER 2016**

**RSS-195, ISSUE 2, APRIL 2014**

## MEASUREMENT AND TEST REPORT

For

### Huawei Technologies Co., Ltd

Administration Building, Headquarters of Huawei Technologies Co., Ltd, Bantian,  
Longgang District, Shenzhen, 518129, P.R.C

**Model: eA280-135**  
**FCC ID: QISEA280-135**  
**IC: 6369A-EA280135**

<b>Report Type:</b> Original Report	<b>Product Type:</b> LTE CPE
<b>Test Engineer:</b> Lorin Bian	<i>Lorin Bian</i>
<b>Report Number:</b> RDG161201012D	
<b>Report Date:</b> 2017-05-27	
<b>Reviewed By:</b> EMC Leader	Henry Ding <i>Henry Ding</i>
<b>Test Laboratory:</b>	Bay Area Compliance Laboratories Corp. (Chengdu) No.5040, Huilongwan Plaza, No.1, Shawan Road, Jinniu District, Chengdu, Sichuan, China Tel: 028-65525123, Fax: 028-65525125 www.baclcorp.com

**Note:** This test report was prepared for the customer shown above and for the device described herein. It may not be duplicated or used in part without prior written consent from Bay Area Compliance Laboratories Corp. (Chengdu). Any unauthorized alteration, forgery or falsification of the content or appearance of this document is unlawful and offenders may be prosecuted to the fullest extent of the law. This report was valid only with a valid digital signature.

## **TABLE OF CONTENTS**

<b>GENERAL INFORMATION .....</b>	<b>4</b>
PRODUCT DESCRIPTION FOR EQUIPMENT UNDER TEST (EUT) .....	4
OBJECTIVE .....	4
RELATED SUBMITTAL(S)/GRANT(S) .....	4
TEST METHODOLOGY .....	5
TEST FACILITY .....	5
<b>SYSTEM TEST CONFIGURATION .....</b>	<b>6</b>
JUSTIFICATION .....	6
EQUIPMENT MODIFICATIONS .....	6
SUPPORT EQUIPMENT LIST AND DETAILS .....	7
BLOCK DIAGRAM OF TEST SETUP .....	7
<b>SUMMARY OF TEST RESULTS .....</b>	<b>8</b>
<b>FCC §1.1310, §2.1091&amp; RSS-102 § 4 - MAXIMUM PERMISSIBLE EXPOSURE (MPE) .....</b>	<b>9</b>
APPLICABLE STANDARD .....	9
<b>FCC §2.1047, RSS-195 § 5.3, RSS-199 § 4.1 - MODULATION TYPE .....</b>	<b>12</b>
APPLICABLE STANDARD .....	12
<b>FCC § 2.1046 &amp; § 27.50(A)(H), RSS-195 § 5.5, RSS-199 § 4.4- RF OUTPUT POWER .....</b>	<b>13</b>
APPLICABLE STANDARD .....	13
TEST PROCEDURE .....	14
TEST EQUIPMENT LIST AND DETAILS .....	16
TEST DATA .....	16
<b>FCC §2.1049 &amp; §27.53, RSS-199 § 4.2, RSS-GEN § 6.6 - OCCUPIED BANDWIDTH .....</b>	<b>41</b>
APPLICABLE STANDARDS .....	41
TEST PROCEDURE .....	41
TEST EQUIPMENT LIST AND DETAILS .....	41
TEST DATA .....	42
<b>FCC §2.1051, §27.53, RSS-195 § 5.6, RSS-199 § 4.5- SPURIOUS EMISSIONS AT ANTENNA TERMINALS .....</b>	<b>106</b>
APPLICABLE STANDARDS .....	106
TEST PROCEDURE .....	108
TEST EQUIPMENT LIST AND DETAILS .....	108
TEST DATA .....	108
<b>FCC §2.1053, §27.53, RSS-195 §5.6, RSS-199 §4.5- SPURIOUS RADIATED EMISSIONS .....</b>	<b>175</b>
APPLICABLE STANDARDS .....	175
TEST PROCEDURE .....	177
TEST EQUIPMENT LIST AND DETAILS .....	178
TEST DATA .....	178
<b>FCC §27.53,RSS-195§5.6, RSS-199§4.5 - BAND EDGES .....</b>	<b>182</b>
APPLICABLE STANDARDS .....	182
TEST PROCEDURE .....	184
TEST EQUIPMENT LIST AND DETAILS .....	184
TEST DATA .....	184

<b>FCC §2.1055 &amp; §27.54 - FREQUENCY STABILITY .....</b>	<b>254</b>
APPLICABLE STANDARDS .....	254
TEST PROCEDURE .....	254
TEST EQUIPMENT LIST AND DETAILS .....	255
TEST DATA.....	255

FINAL

## GENERAL INFORMATION

### Product Description for Equipment under Test (EUT)

The **Huawei Technologies Co.,Ltd**'s product, model number: **eA280-135** (**FCC ID: QISEA280-135, IC: 6369A-EA280135**) (the "EUT") in this report was a **LTE CPE**, which was measured approximately: 9.5 cm (D) x 21 cm (H), rated input voltage: DC12.0V from adapter.

#### LTE Technical Parameters:

Equipment Type	Fixed CPE
Frequency Range	LTE-FDD Band 7:2500-2570MHz(Tx), 2620-2690MHz(Rx) LTE-TDD Band 40: 2305-2320MHz&2345-2360MHz(Tx/Rx) LTE-TDD Band 41: 2500-2690MHz(Tx/Rx)
Maximum Output Power	LTE Band 7:24dBm LTE Band 40:19dBm LTE Band 41: 25 dBm
Operation Bandwidth	LTE Band 7: 5MHz/10MHz/15MHz/20MHz/ Intra-band contiguous Carrier Aggregation LTE Band 40: 5MHz/10MHz LTE Band 41: 5MHz/10MHz/15MHz/20MHz/ Intra-band contiguous Carrier Aggregation
Maximum Antenna Gain	3 dBi

#### Switching power adapter information:

MODEL: HW-120200U6W

INPUT: 100-240V~50/60Hz, 0.8A

OUTPUT: DC12.0V 2.0A

*\*All measurement and test data in this report was gathered from final production sample, serial number: 161201012 (assigned by the BAACL, Chengdu). It may have deviation from any other sample. The EUT supplied by the applicant was received on 2016-12-01, and EUT conformed to test requirement.*

### Objective

This report is prepared on behalf of **Huawei Technologies Co., Ltd** in accordance with Part 2-Subpart J, part 27 of the Federal Communications Commission's rules. And RSS-Gen Issue 4, November 2014, RSS-199, Issue 3, December 2016, RSS-195, ISSUE 2, April 2014 of the Innovation, Science and Economic Development Canada.

### Related Submittal(s)/Grant(s)

FCC Part 15B JBP/15C DTS/15E NII/ Part 90 TNB submissions with FCC ID: QISEA280-135. RSS-195/ RSS-197/ RSS-199/RSS-247 LE-LAN/ RSS-247 DTSS submissions with IC: 6369A-EA280135.

## **Test Methodology**

All tests and measurements indicated in this document were performed in accordance with the Code of Federal Regulations Title 47 Part 2, Sub-part J, Part 27.

Applicable Standards:  
TIA/EIA 603-D-2010.

RSS-Gen Issue 4, November 2014, RSS-199, Issue 3, December 2016, RSS-195, ISSUE 2, April 2014 of the Innovation, Science and Economic Development Canada.

All emissions measurement was performed and Bay Area Compliance Laboratories Corp. (Chengdu).

## **Test Facility**

The test site used by BACL to collect test data is located in the No.5040, Huilongwan Plaza, No.1, Shawan Road, Jinniu District, Chengdu, Sichuan, China.

Test site at BACL has been fully described in reports submitted to the Federal Communication Commission (FCC). The details of these reports have been found to be in compliance with the requirements of Section 2.948 of the FCC Rules on April 24, 2015. The facility also complies with the radiated and AC line conducted test site criteria set forth in ANSI C63.4-2014.

The Federal Communications Commission has the reports on file and is listed under FCC Registration No.: 560332. The test site has been approved by the FCC for public use and is listed in the FCC Public Access Link (PAL) database.

## SYSTEM TEST CONFIGURATION

### Justification

The EUT was configured for testing according to TIA/EIA-603-D-2010.

The device operation on LTE band 7/40/41, test was performed with channels as below table:

Frequency Bands	Modes	Bandwidth (MHz)	Test Frequency (MHz)		
			Low	Middle	High
LTE Band 7	Single Carrier	5	2502.5	2535	2567.5
		10	2505	2535	2565
		15	2507.5	2535	2562.5
		20	2510	2535	2560
	Carrier Aggregation	5+20	2503.3+2515	2525.8+2537.5	2548.3+2560
		20+5	2510.0+2521.7	2532.5+2544.2	2555.0+2566.7
		10+20	2505.5+2519.9	2525.6+2540	2545.6+2560
		20+10	2510.0+2524.4	2530.1 +2544.5	2550.1+2564.5
		15+15	2507.5+2522.5	2527.5+2542.5	2547.5+2562.5
		15+20	2507.8+2524.9	2525.3+2542.4	2542.9+2560.0
LTE Band 40 2305-2315MHz	Single Carrier	5	2307.5	2310	2312.5
		10	/	2310	/
LTE Band 40 2350-2360MHz	Single Carrier	5	2352.5	2355	2357.5
		10	/	2355	/
LTE Band 41	Single Carrier	5	2502.5	2593	2687.5
		10	2505	2593	2685
		15	2507.5	2593	2682.5
		20	2510	2593	2680
	Carrier Aggregation	5+20	2503.3+2514	2583.8+2595.5	2668.3+2680
		20+5	2514.0+2521.7	2590.5+2602.2	2675.0+2686.7
		10+20	2505.5+2519.9	2583.6+2598	2665.6+2680
		20+10	2510.0+2524.4	2588.1+2602.5	2670.1+2684.5
		15+15	2507.5+2522.5	2585.5+2600.5	2667.5+2682.5
		15+20	2507.8+2524.9	2583.3+2600.4	2662.9+2680.0
LTE Band 41	Carrier Aggregation	20+15	2510.0+2527.1	2585.6+2602.7	2665.1+2682.2
		20+20	2510.0+2529.8	2585.1+2604.9	2660.2+2680.0

### Equipment Modifications

No modifications were made to the EUT.

### Support Equipment List and Details

Manufacturer	Description	Model	Serial Number
R&S	Wideband Radio Communication Tester	CMW500	106891
N/A	ANTENNA	N/A	N/A

### Block Diagram of Test Setup

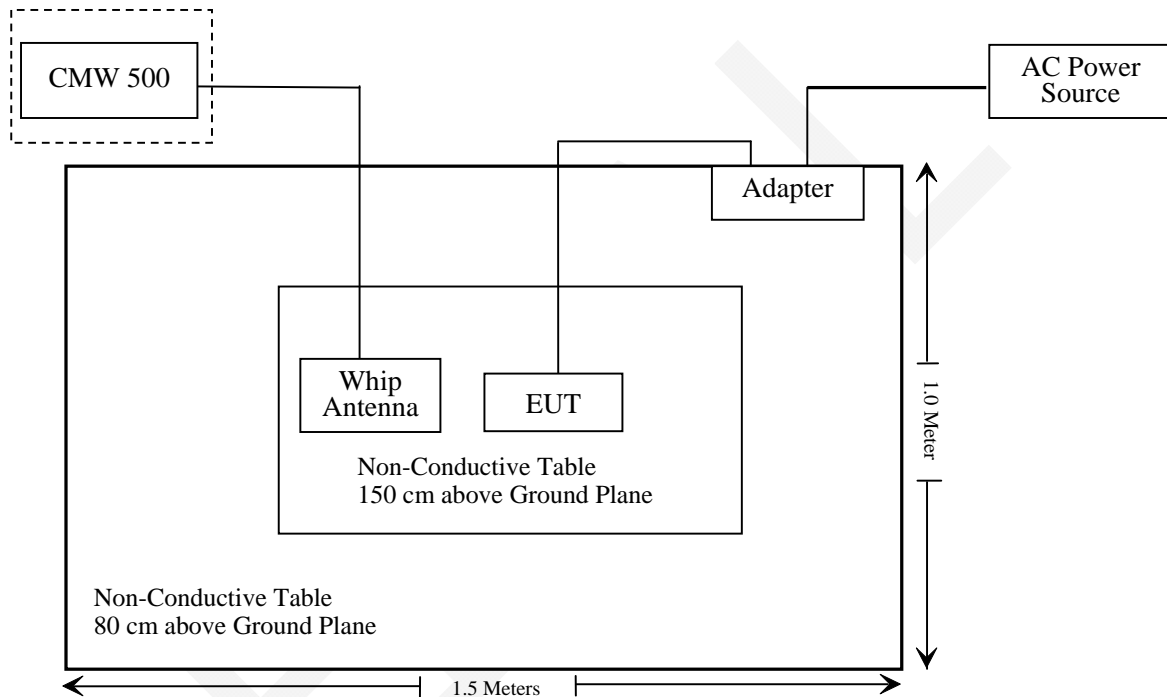

## SUMMARY OF TEST RESULTS

FCC Rules	Description of Test	Result
§1.1310, §2.1091 RSS-102§4	Maximum Permissible Exposure	Compliance
§2.1046; §27.50 RSS-195 § 5.5, RSS-199 § 4.4	RF Output Power	Compliance
§ 2.1047 RSS-195 § 5.3 RSS-199 § 4.1	Modulation Type	Compliance
§ 2.1049; §27.53 RSS-199§4.2 RSS-Gen§6.6	Occupied Bandwidth	Compliance
§ 2.1051; §27.53 RSS-195 § 5.6 RSS-199 § 4.5	Spurious Emissions at Antenna Terminal	Compliance
§ 2.1053; §27.53 RSS-195 § 5.6 RSS-199 § 4.5	Spurious Radiation Emissions	Compliance
§27.53 RSS-195 § 5.6 RSS-199 § 4.5	Band Edge	Compliance
§ 2.1055; §27.54	Frequency stability vs. temperature Frequency stability vs. voltage	Compliance



## FCC §1.1310, §2.1091 & RSS-102 § 4 - MAXIMUM PERMISSIBLE EXPOSURE (MPE)

### Applicable Standard

According to subpart §1.1310, systems operating under the provisions of this section shall be operated in a manner that ensures that the public is not exposed to radio frequency energy level in excess of the Commission's guidelines.

Limits for Maximum Permissible Exposure (MPE) (§1.1310, §2.1091)

(B) Limits for General Population/Uncontrolled Exposure				
Frequency Range (MHz)	Electric Field Strength (V/m)	Magnetic Field Strength (A/m)	Power Density (mW/cm <sup>2</sup> )	Averaging Time (minutes)
0.3–1.34	614	1.63	*(100)	30
1.34–30	824/f	2.19/f	*(180/f <sup>2</sup> )	30
30–300	27.5	0.073	0.2	30
300–1500	/	/	f/1500	30
1500–100,000	/	/	1.0	30

f = frequency in MHz; \* = Plane-wave equivalent power density;

According to §1.1310 and §2.1091 RF exposure is calculated.

According to RSS-102 § 4Table 4, RF Field Strength Limits for Devices Used by the General Public (Uncontrolled Environment)

**Table 4: RF Field Strength Limits for Devices Used by the General Public (Uncontrolled Environment)**

Frequency Range (MHz)	Electric Field (V/m rms)	Magnetic Field (A/m rms)	Power Density (W/m <sup>2</sup> )	Reference Period (minutes)
0.003-10 <sup>21</sup>	83	90	-	Instantaneous*
0.1-10	-	0.73/ f	-	6**
1.1-10	87/ f <sup>0.5</sup>	-	-	6**
10-20	27.46	0.0728	2	6
20-48	58.07/ f <sup>0.25</sup>	0.1540/ f <sup>0.25</sup>	8.944/ f <sup>0.5</sup>	6
48-300	22.06	0.05852	1.291	6
300-6000	3.142 f <sup>0.3417</sup>	0.008335 f <sup>0.3417</sup>	0.02619f <sup>0.6834</sup>	6
6000-15000	61.4	0.163	10	6
15000-150000	61.4	0.163	10	616000/ f <sup>1.2</sup>
150000-300000	0.158 f <sup>0.5</sup>	4.21 x 10 <sup>-4</sup> f <sup>0.5</sup>	6.67 x 10 <sup>-5</sup> f	616000/ f <sup>1.2</sup>

Note: f is frequency in MHz.  
 \*Based on nerve stimulation (NS).  
 \*\* Based on specific absorption rate (SAR).

**Calculation Formula:**

Prediction of power density at the distance of the applicable MPE limit:

$S = PG/4\pi R^2$  = power density (in appropriate units, e.g. mW/cm<sup>2</sup>);

P = power input to the antenna (in appropriate units, e.g., mW);

G = power gain of the antenna in the direction of interest relative to an isotropic radiator, the power gain factor, is normally numeric gain;

R = distance to the center of radiation of the antenna (appropriate units, e.g., cm);

For simultaneously transmit system, the calculated power density should comply with:

$$\sum_i \frac{S_i}{S_{Limit,i}} \leq 1$$

**Calculated Data:**

Mode	Frequency (MHz)	Antenna Gain		Tune-up Power		Evaluation Distance (cm)	Power Density		MPE Limit	
		(dBi)	(numeric)	(dBm)	(mW)		(mW/cm <sup>2</sup> )	(W/m <sup>2</sup> )	FCC (mW/cm <sup>2</sup> )	RSS-102 (W/m <sup>2</sup> )
WLAN 2.4GHz	2412-2462	2	1.58	28	630.96	20.00	0.1990	1.99	1.0	5.37
WLAN 5GHz	5150-5850	2	1.58	18	63.10	20.00	0.02	0.2	1.0	9.05
LTE Band 7	2500-2570	3	2.00	24	251.19	20.00	0.10	1.0	1.0	5.50
LTE Band 40	2305-2315	3	2.00	19	79.43	20.00	0.032	0.32	1.0	5.20
	2350-2360	3	2.00	19	79.43	20.00	0.032	0.32	1.0	5.27
LTE Band 41	2500-2690	3	2.00	25	316.23	20.00	0.1256	1.256	1.0	5.49
LTE Band 43	3650-3700	3	2.00	23	199.53	20.00	0.0792	0.792	1.0	7.12

The WLAN 2.4GHz, 5GHz and LTE can transmit simultaneously:

**For FCC:**

$$\sum_i \frac{S_i}{S_{Limit,i}}$$

= $S_{2.4}/S_{limit-2.4} + S_5/S_{limit-5} + S_{LTE}/S_{limit-LTE}$   
 = $0.199/1+0.02/1+0.1256/1$   
 = $0.3446$   
 < 1.0

**For RSS-102:**

$$\sum_i \frac{S_i}{S_{Limit,i}}$$

$$\begin{aligned} &= S_{2.4}/S_{limit-2.4} + S_5/S_{limit-5} + S_{LTE}/S_{limit-LTE} \\ &= 1.99/5.37 + 0.2/9.05 + 1.256/5.49 \\ &= 0.621 \\ &< 1.0 \end{aligned}$$

**Result: Compliance,** The device meets MPE requirement for Devices Used by the General Public (Uncontrolled Environment) at distance  $\geq 20$  cm.

FEMNAL

## **FCC §2.1047, RSS-195 § 5.3, RSS-199 § 4.1 - MODULATION TYPE**

---

### **Applicable Standard**

According to FCC § 2.1047(d), Part 27 there is no specific requirement for digital modulation, therefore modulation characteristic is not presented.

According to RSS-195 § 5.3,

The modulation used shall be digital.

According to RSS-199 § 4.1

Equipment certified under this standard shall employ digital modulation.

### **Result**

Result: Compliant, the device employs digital modulation.

## **FCC § 2.1046 & § 27.50(a)(h), RSS-195 § 5.5, RSS-199 § 4.4- RF OUTPUT POWER**

---

### **Applicable Standard**

According to FCC §2.1046 and §27.50

(a) The following power limits and related requirements apply to stations transmitting in the 2305-2320 MHz band or the 2345-2360 MHz band.

(3) Mobile and portable stations. (i) For mobile and portable stations transmitting in the 2305-2315 MHz band or the 2350-2360 MHz band, the average EIRP must not exceed 50 milliwatts within any 1 megahertz of authorized bandwidth, except that for mobile and portable stations compliant with 3GPP LTE standards or another advanced mobile broadband protocol that avoids concentrating energy at the edge of the operating band the average EIRP must not exceed 250 milliwatts within any 5 megahertz of authorized bandwidth but may exceed 50 milliwatts within any 1 megahertz of authorized bandwidth. For mobile and portable stations using time division duplexing (TDD) technology, the duty cycle must not exceed 38 percent in the 2305-2315 MHz and 2350-2360 MHz bands. Mobile and portable stations using FDD technology are restricted to transmitting in the 2305-2315 MHz band. Power averaging shall not include intervals in which the transmitter is off.

(ii) Mobile and portable stations are not permitted to transmit in the 2315-2320 MHz and 2345-2350 MHz bands.

(iii) Automatic transmit power control. Mobile and portable stations transmitting in the 2305-2315 MHz band or in the 2350-2360 MHz band must employ automatic transmit power control when operating so the stations operate with the minimum power necessary for successful communications.

(iv) Prohibition on external vehicle-mounted antennas. The use of external vehicle-mounted antennas for mobile and portable stations transmitting in the 2305-2315 MHz band or the 2350-2360 MHz band is prohibited.

(h) The following power limits shall apply in the BRS and EBS:

(2) Mobile and other user stations. Mobile stations are limited to 2.0 watts EIRP. All user stations are limited to 2.0 watts transmitter output power.

According to RSS-195 §5.5

The equivalent isotropically radiated power (e.i.r.p.) of base and fixed station equipment shall comply with the e.i.r.p. limit in SRSP-516.

The e.i.r.p. of fixed subscriber equipment shall not exceed 20 W/5 MHz.

The e.i.r.p. of mobile or portable equipment transmitting in the band 2305-2315 MHz or the band 2350-2360 MHz, employing 3GPP LTE (Third Generation Partnership Project Long Term Evolution) standards, shall not exceed 250 mW within any 5 MHz bandwidth. For other technologies, the e.i.r.p. shall not exceed 50 mW within any 1 MHz bandwidth.

According to RSS-199 §4.4

The transmitter output power shall be measured in terms of average value.

For base station equipment, refer to SRSP-517 for the maximum permissible e.i.r.p.

For mobile subscriber equipment, the e.i.r.p. shall not exceed 2 W. For fixed subscriber equipment, the transmitter output power shall not exceed 2 W and the e.i.r.p. shall be limited to 40 W.

In addition, the peak-to-average power ratio (PAPR) of the transmitter shall not exceed 13 dB for more than 0.1% of the time and shall use a signal corresponding to the highest PAPR during periods of continuous transmission.

For equipment with multiple antennas, the transmitter output power and e.i.r.p. shall be measured according to ANSI C63.26-2015.

## Test Procedure

### LTE (FDD):

The following tests were conducted according to the test requirements in 3GPP TS36.101

The following tests were conducted according to the test requirements outlined in section 6.2 of the 3GPP TS36.101 specification.

UE Power Class: 3 (23 +/- 2dBm). The allowed Maximum Power Reduction (MPR) for the maximum output power due to higher order modulation and transmit bandwidth configuration (resource blocks) is specified in Table 6.2.3-1 of the 3GPP TS36.101.

Table 6.2.3-1: Maximum Power Reduction (MPR) for Power Class 3

Modulation	Channel bandwidth / Transmission bandwidth (RB)						MPR (dB)
	1.4 MHz	3.0 MHz	5 MHz	10 MHz	15 MHz	20 MHz	
QPSK	> 5	> 4	> 8	> 12	> 16	> 18	≤ 1
16 QAM	≤ 5	≤ 4	≤ 8	≤ 12	≤ 16	≤ 18	≤ 1
64 QAM	> 5	> 4	> 8	> 12	> 16	> 18	≤ 2

The allowed A-MPR values specified below in Table 6.2.4-1 of 3GPP TS36.101 are in addition to the allowed MPR requirements. All the measurements below were performed with A-MPR disabled, by using Network Signaling Value of "NS\_01".

Table 6.2.4-1: Additional Maximum Power Reduction (A-MPR)

Network Signalling value	Requirements (sub-clause)	E-UTRA Band	Channel bandwidth (MHz)	Resources Blocks ( $N_{RB}$ )	A-MPR (dB)
NS_01	6.6.2.1.1	Table 5.5-1	1.4, 3, 5, 10, 15, 20	Table 5.6-1	NA
NS_03	6.6.2.2.1	2, 4, 10, 23, 25, 35, 36	3	>5	≤ 1
			5	>6	≤ 1
			10	>6	≤ 1
			15	>8	≤ 1
NS_04	6.6.2.2.2	41	5	>6	≤ 1
			10, 15, 20	See Table 6.2.4-4	
NS_05	6.6.3.3.1	1	10,15,20	≥ 50	≤ 1
NS_06	6.6.2.2.3	12, 13, 14, 17	1.4, 3, 5, 10	Table 5.6-1	n/a
NS_07	6.6.2.2.3	13	10	Table 6.2.4-2	Table 6.2.4-2
	6.6.3.3.2				
NS_08	6.6.3.3.3	19	10, 15	> 44	≤ 3
NS_09	6.6.3.3.4	21	10, 15	> 40	≤ 1
				> 55	≤ 2
NS_10		20	15, 20	Table 6.2.4-3	Table 6.2.4-3
NS_11	6.6.2.2.1	23	1.4, 3, 5, 10	Table 6.2.4-5	Table 6.2.4-5
..					
NS_32	-	-	-	-	-

Note 1: Applies to the lower block of Band 23, i.e. a carrier placed in the 2000-2010 MHz region.

**LTE(TDD):**

Table 4.2-1: Configuration of special subframe (lengths of DwPTS/GP/UpPTS).

Special subframe configuration	Normal cyclic prefix in downlink			Extended cyclic prefix in downlink		
	DwPTS	UpPTS		DwPTS	UpPTS	
		Normal cyclic prefix in uplink	Extended cyclic prefix in uplink		Normal cyclic prefix in uplink	Extended cyclic prefix in uplink
0	$6592 \cdot T_s$	$2192 \cdot T_s$	$2560 \cdot T_s$	$7680 \cdot T_s$	$2192 \cdot T_s$	$2560 \cdot T_s$
1	$19760 \cdot T_s$			$20480 \cdot T_s$		
2	$21952 \cdot T_s$			$23040 \cdot T_s$		
3	$24144 \cdot T_s$			$25600 \cdot T_s$		
4	$26336 \cdot T_s$	$4384 \cdot T_s$	$5120 \cdot T_s$	$7680 \cdot T_s$	$4384 \cdot T_s$	$5120 \cdot T_s$
5	$6592 \cdot T_s$			$20480 \cdot T_s$		
6	$19760 \cdot T_s$			$23040 \cdot T_s$		
7	$21952 \cdot T_s$			$12800 \cdot T_s$		
8	$24144 \cdot T_s$			-		
9	$13168 \cdot T_s$	-	-	-	-	-

Table 4.2-2: Uplink-downlink configurations.

Uplink-downlink configuration	Downlink-to-Uplink Switch-point periodicity	Subframe number									
		0	1	2	3	4	5	6	7	8	9
0	5 ms	D	S	U	U	U	D	S	U	U	U
1	5 ms	D	S	U	U	D	D	S	U	U	D
2	5 ms	D	S	U	D	D	D	S	U	D	D
3	10 ms	D	S	U	U	U	D	D	D	D	D
4	10 ms	D	S	U	U	D	D	D	D	D	D
5	10 ms	D	S	U	D	D	D	D	D	D	D
6	5 ms	D	S	U	U	U	D	S	U	U	D

**Calculated Duty Cycle**

Uplink-Downlink Configuration	Downlink-to-Uplink Switch-point Periodicity	Subframe Number										Calculated Duty Cycle (%)
		0	1	2	3	4	5	6	7	8	9	
0	5 ms	D	S	U	U	U	D	S	U	U	U	63.33
1	5 ms	D	S	U	U	D	D	S	U	U	D	43.33
2	5 ms	D	S	U	D	D	D	S	U	D	D	23.33
3	10 ms	D	S	U	U	U	D	D	D	D	D	31.67
4	10 ms	D	S	U	U	D	D	D	D	D	D	21.67
5	10 ms	D	S	U	D	D	D	D	D	D	D	11.67
6	5 ms	D	S	U	U	U	D	S	U	U	D	53.33

Calculated Duty Cycle = Extended cyclic prefix in uplink x (T<sub>s</sub>) x # of S + # of U

Example for Calculated Duty Cycle for Uplink-Downlink Configuration 0:  
 Calculated Duty Cycle = 5120 x [1/(15000 x 2048)] x 2 + 6 ms = 63.33%  
 where  
 T<sub>s</sub> = 1/(15000 x 2048) seconds

**Radiated method:**

ANSI/TIA 603-D section 2.2.17

### Test Equipment List and Details

Manufacturer	Description	Model	Serial Number	Calibration Date	Calibration Due Date
Unknown	RF Cable	Unknown	C-2	Each Time	/
R&S	Wideband Radio Communication Tester	CMW500	106891	2016-11-23	2017-11-23

\* **Statement of Traceability:** BACL(Chengdu) attests that all of the calibrations on the equipment items listed above were traceable to NIM or to another internationally recognized National Metrology Institute (NMI), and were compliant with the NIST HB 150-2016 Normative Annex B "Implementation of traceability policy in accredited laboratories".

### Test Data

#### Environmental Conditions

<b>Temperature:</b>	18~20 °C
<b>Relative Humidity:</b>	55~58 %
<b>ATM Pressure:</b>	95.2~97 kPa

*The testing was performed by Lorin Bian from 2017-02-10 to 2017-03-16.*



**Band 7, Single Carrier:**

Channel Bandwidth	Modulation	Resource Block & RB offset	Conducted Output Power (dBm)			EIRP (dBm)			
			2502.5 MHz	2535 MHz	2567.5 MHz	2502.5 MHz	2535 MHz	2567.5 MHz	Limits
5 MHz	QPSK	1#0	23.70	23.69	23.39	26.7	26.69	26.39	33
		1#12	23.64	23.64	23.35	26.64	26.64	26.35	33
		1#24	23.59	23.61	23.29	26.59	26.61	26.29	33
		12#0	23.55	23.48	23.21	26.55	26.48	26.21	33
		12#6	23.49	23.41	23.14	26.49	26.41	26.14	33
		12#11	23.38	23.33	23.02	26.38	26.33	26.02	33
		25#0	23.07	23.03	22.51	26.07	26.03	25.51	33
	16-QAM	1#0	23.74	23.46	23.56	26.74	26.46	26.56	33
		1#12	23.71	23.42	23.53	26.71	26.42	26.53	33
		1#24	23.66	23.38	23.47	26.66	26.38	26.47	33
		12#0	23.59	23.34	23.41	26.59	26.34	26.41	33
		12#6	23.47	23.29	23.21	26.47	26.29	26.21	33
		12#11	23.24	23.17	22.88	26.24	26.17	25.88	33
		25#0	23.02	23.03	22.75	26.02	26.03	25.75	33

Channel Bandwidth	Modulation	Resource Block & RB offset	Conducted Output Power (dBm)			EIRP (dBm)			
			2505 MHz	2535 MHz	2565 MHz	2505 MHz	2535 MHz	2565 MHz	Limits
10 MHz	QPSK	1#0	23.57	23.42	23.38	26.57	26.42	26.38	33
		1#24	23.53	23.39	23.33	26.53	26.39	26.33	33
		1#49	23.51	23.31	23.29	26.51	26.31	26.29	33
		25#0	23.46	23.29	23.21	26.46	26.29	26.21	33
		25#12	23.44	23.21	23.11	26.44	26.21	26.11	33
		25#24	23.38	23.17	23.03	26.38	26.17	26.03	33
		50#0	23.27	23.00	22.78	26.27	26	25.78	33
	16-QAM	1#0	23.67	23.22	23.41	26.67	26.22	26.41	33
		1#24	23.61	23.13	23.37	26.61	26.13	26.37	33
		1#49	23.59	23.08	23.35	26.59	26.08	26.35	33
		25#0	23.44	23.04	23.31	26.44	26.04	26.31	33
		25#12	23.39	23.01	23.14	26.39	26.01	26.14	33
		25#24	23.27	22.99	22.79	26.27	25.99	25.79	33
		50#0	23.10	22.97	22.68	26.1	25.97	25.68	33

Channel Bandwidth	Modulation	Resource Block & RB offset	Conducted Output Power (dBm)			EIRP (dBm)			
			2507.5 MHz	2535 MHz	2562.5 MHz	2507.5 MHz	2535 MHz	2562.5 MHz	Limits
15 MHz	QPSK	1#0	23.43	23.21	23.30	26.43	26.21	26.3	33
		1#37	23.38	23.19	23.28	26.38	26.19	26.28	33
		1#74	23.44	23.16	23.24	26.44	26.16	26.24	33
		36#0	23.37	23.07	23.21	26.37	26.07	26.21	33
		36#17	23.31	23.16	23.19	26.31	26.16	26.19	33
		36#35	23.28	23.11	23.02	26.28	26.11	26.02	33
		75#0	23.24	23.17	22.74	26.24	26.17	25.74	33
	16-QAM	1#0	23.52	23.22	23.35	26.52	26.22	26.35	33
		1#37	23.49	23.18	23.31	26.49	26.18	26.31	33
		1#74	23.38	23.14	23.24	26.38	26.14	26.24	33
		36#0	23.36	23.09	23.22	26.36	26.09	26.22	33
		36#17	23.33	23.01	23.17	26.33	26.01	26.17	33
		36#35	23.30	22.96	23.15	26.3	25.96	26.15	33
		75#0	23.28	22.91	23.12	26.28	25.91	26.12	33

Channel Bandwidth	Modulation	Resource Block & RB offset	Conducted Output Power (dBm)			EIRP (dBm)			
			2510 MHz	2535 MHz	2560 MHz	2510 MHz	2535 MHz	2560 MHz	Limits
20 MHz	QPSK	1#0	23.71	23.33	23.67	26.71	26.33	26.67	33
		1#49	23.68	23.31	23.61	26.68	26.31	26.61	33
		1#99	23.61	23.27	23.58	26.61	26.27	26.58	33
		50#0	23.59	23.22	23.50	26.59	26.22	26.5	33
		50#24	23.52	23.19	23.44	26.52	26.19	26.44	33
		50#49	23.34	23.11	23.17	26.34	26.11	26.17	33
		100#0	23.24	22.96	22.89	26.24	25.96	25.89	33
	16-QAM	1#0	23.70	23.33	23.71	26.7	26.33	26.71	33
		1#49	23.61	23.24	23.66	26.61	26.24	26.66	33
		1#99	23.58	23.19	23.62	26.58	26.19	26.62	33
		50#0	23.49	23.11	23.59	26.49	26.11	26.59	33
		50#24	23.41	23.09	23.47	26.41	26.09	26.47	33
		50#49	23.31	23.01	23.16	26.31	26.01	26.16	33
		100#0	23.26	22.96	22.85	26.26	25.96	25.85	33

Note: the device is mobile subscriber equipment.

**PAR, Band 7 (Single Carrier):**

Test Modulation		Channel Bandwidth	2510 MHz PAR (dB)	2535MHz PAR (dB)	2560MHz PAR (dB)	Limit (dB)
QPSK	1 RB	20 MHz	4.54	5.43	4.87	13
	100 RB		6.22	6.43	5.21	13
16-QAM	1 RB	20 MHz	5.12	4.66	5.23	13
	100 RB		6.33	6.23	6.32	13

Note: peak-to-average ratio (PAR) <13 dB.

F I N A L

**Carrier Aggregation:**

Bandwidth	Frequency (MHz)	Modulation	PCC RB	PCC RB	SCC1 RB	SCC1 RB	Conducted Power (dBm)	E.I.R.P. (dBm)	E.I.R.P. Limits (dBm)
			Size	Offset	Size	Offset			
5MHz + 20MHz	2503.3 + 2515	QPSK	1	24	1	0	21.43	24.43	33.00
			1	12	1	49	22.08	25.08	33.00
			25	0	100	0	23.35	26.35	33.00
		16-QAM	1	24	1	0	21.62	24.62	33.00
			1	12	1	49	22.14	25.14	33.00
			25	0	100	0	23.07	26.07	33.00
5MHz + 20MHz	2525.8 + 2537.5	QPSK	1	24	1	0	21.22	24.22	33.00
			1	12	1	49	21.05	24.05	33.00
			25	0	100	0	22.70	25.7	33.00
		16-QAM	1	24	1	0	21.35	24.35	33.00
			1	12	1	49	21.07	24.07	33.00
			25	0	100	0	22.54	25.54	33.00
5MHz + 20MHz	2548.3 + 2560	QPSK	1	24	1	0	21.41	24.41	33.00
			1	12	1	49	21.63	24.63	33.00
			25	0	100	0	22.76	25.76	33.00
		16-QAM	1	24	1	0	21.47	24.47	33.00
			1	12	1	49	21.59	24.59	33.00
			25	0	100	0	22.53	25.53	33.00
20MHz + 5MHz	2510.0 + 2521.7	QPSK	1	0	1	0	21.18	24.18	33.00
			1	0	1	24	21.04	24.04	33.00
			1	0	25	0	23.15	26.15	33.00
			1	99	1	0	21.96	24.96	33.00
			1	99	1	24	21.53	24.53	33.00
			1	99	25	0	23.04	26.04	33.00
			100	0	1	0	22.94	25.94	33.00
			100	0	1	24	22.81	25.81	33.00
			100	0	25	0	23.23	26.23	33.00
		16-QAM	1	0	1	0	22.15	25.15	33.00
			1	0	1	24	22.06	25.06	33.00
			1	0	25	0	23.01	26.01	33.00
			1	99	1	0	22.23	25.23	33.00
			1	99	1	24	22.15	25.15	33.00
			1	99	25	0	23.09	26.09	33.00
			100	0	1	0	22.81	25.81	33.00
			100	0	1	24	23.01	26.01	33.00
			100	0	25	0	23.15	26.15	33.00

Bandwidth	Frequency (MHz)	Modulation	PCC RB	PCC RB	SCC1 RB	SCC1 RB	Conducted Power (dBm)	E.I.R.P. (dBm)	E.I.R.P. Limits (dBm)
			Size	Offset	Size	Offset			
20MHz+ 5MHz	2532.5 + 2544.2	QPSK	1	0	1	0	21.62	24.62	33.00
			1	0	1	24	21.48	24.48	33.00
			1	0	25	0	22.31	25.31	33.00
			1	99	1	0	21.21	24.21	33.00
			1	99	1	24	21.19	24.19	33.00
			1	99	25	0	21.69	24.69	33.00
			100	0	1	0	20.78	23.78	33.00
			100	0	1	24	20.65	23.65	33.00
		100	0	25	0	21.43	24.43	33.00	
		16-QAM	1	0	1	0	21.89	24.89	33.00
			1	0	1	24	21.81	24.81	33.00
			1	0	25	0	21.91	24.91	33.00
			1	99	1	0	21.31	24.31	33.00
			1	99	1	24	21.23	24.23	33.00
			1	99	25	0	21.67	24.67	33.00
			100	0	1	0	20.76	23.76	33.00
100	0		1	24	20.61	23.61	33.00		
20MHz+ 5MHz	2555.0 + 2566.7	QPSK	1	0	1	0	21.47	24.47	33.00
			1	0	1	24	21.14	24.14	33.00
			1	0	25	0	22.31	25.31	33.00
			1	99	1	0	21.45	24.45	33.00
			1	99	1	24	21.01	24.01	33.00
			1	99	25	0	21.86	24.86	33.00
			100	0	1	0	22.11	25.11	33.00
			100	0	1	24	22.05	25.05	33.00
		16-QAM	100	0	25	0	21.42	24.42	33.00
			1	0	1	0	21.69	24.69	33.00
			1	0	1	24	21.22	24.22	33.00
			1	0	25	0	22.39	25.39	33.00
			1	99	1	0	21.50	24.5	33.00
			1	99	1	24	21.10	24.1	33.00
			1	99	25	0	21.93	24.93	33.00
			100	0	1	0	22.01	25.01	33.00
10MHz+ 20MHz	2505.5+ 2519.9	QPSK	100	0	1	24	22.08	25.08	33.00
			100	0	25	0	22.37	25.37	33.00
			1	49	1	0	21.74	24.74	33.00
		16-QAM	1	24	1	49	22.05	25.05	33.00
			50	0	100	0	22.17	25.17	33.00
			1	49	1	0	21.91	24.91	33.00
1	24	1	49	22.31	25.31	33.00			
50	0	100	0	22.51	25.51	33.00			

Bandwidth	Frequency (MHz)	Modulation	PCC RB	PCC RB	SCC1 RB	SCC1 RB	Conducted Power (dBm)	E.I.R.P. (dBm)	E.I.R.P. Limits (dBm)
			Size	Offset	Size	Offset			
10MHz+ 20MHz	2525.6+ 2540	QPSK	1	49	1	0	21.93	24.93	33.00
			1	24	1	49	21.65	24.65	33.00
			50	0	100	0	22.38	25.38	33.00
		16-QAM	1	49	1	0	21.86	24.86	33.00
			1	24	1	49	21.93	24.93	33.00
			50	0	100	0	22.45	25.45	33.00
10MHz+ 20MHz	2545.6+ 2560	QPSK	1	49	1	0	21.32	24.32	33.00
			1	24	1	49	21.77	24.77	33.00
			50	0	100	0	21.87	24.87	33.00
		16-QAM	1	49	1	0	21.29	24.29	33.00
			1	24	1	49	21.52	24.52	33.00
			50	0	100	0	21.91	24.91	33.00
20MHz+ 10MHz	2510.0+ 2524.4	QPSK	1	99	1	0	21.14	24.14	33.00
			100	0	50	0	22.28	25.28	33.00
		16-QAM	1	99	1	0	21.15	24.15	33.00
			100	0	50	0	22.34	25.34	33.00
20MHz+ 10MHz	2530.1 + 2544.5	QPSK	1	99	1	0	21.63	24.63	33.00
			100	0	50	0	21.92	24.92	33.00
		16-QAM	1	99	1	0	21.57	24.57	33.00
			100	0	50	0	22.14	25.14	33.00
20MHz+ 10MHz	2550.1+ 2564.5	QPSK	1	99	1	0	21.58	24.58	33.00
			100	0	50	0	21.87	24.87	33.00
		16-QAM	1	99	1	0	21.63	24.63	33.00
			100	0	50	0	22.04	25.04	33.00
15MHz+ 15MHz	2507.5 + 2522.5	QPSK	1	74	1	0	21.47	24.47	33.00
			75	0	75	0	23.14	26.14	33.00
		16-QAM	1	74	1	0	21.18	24.18	33.00
			75	0	75	0	23.12	26.12	33.00
15MHz+ 15MHz	2527.5+ 2542.5	QPSK	1	74	1	0	21.49	24.49	33.00
			75	0	75	0	23.17	26.17	33.00
		16-QAM	1	74	1	0	21.46	24.46	33.00
			75	0	75	0	23.13	26.13	33.00
15MHz+ 15MHz	2547.5 + 2562.5	QPSK	1	74	1	0	21.44	24.44	33.00
			75	0	75	0	23.11	26.11	33.00
		16-QAM	1	74	1	0	21.41	24.41	33.00
			75	0	75	0	23.08	26.08	33.00
15MHz+ 20MHz	2507.8 + 2524.9	QPSK	1	74	1	0	21.56	24.56	33.00
			1	36	1	49	21.85	24.85	33.00
			75	0	100	0	22.26	25.26	33.00
		16QAM	1	74	1	0	21.59	24.59	33.00
			1	36	1	49	22.01	25.01	33.00
			75	0	100	0	22.28	25.28	33.00

Bandwidth	Frequency (MHz)	Modulation	PCC RB	PCC RB	SCC1 RB	SCC1 RB	Conducted Power (dBm)	E.I.R.P. (dBm)	E.I.R.P. Limits (dBm)
			Size	Offset	Size	Offset			
15MHz+ 20MHz	2525.3+ 2542.4	QPSK	1	74	1	0	22.12	25.12	33.00
			1	36	1	49	21.57	24.57	33.00
			75	0	100	0	22.85	25.85	33.00
		16-QAM	1	74	1	0	21.97	24.97	33.00
			1	36	1	49	21.65	24.65	33.00
			75	0	100	0	22.61	25.61	33.00
15MHz+ 20MHz	2542.9+ 2560.0	QPSK	1	74	1	0	21.69	24.69	33.00
			1	36	1	49	21.68	24.68	33.00
			75	0	100	0	22.85	25.85	33.00
		16-QAM	1	74	1	0	21.61	24.61	33.00
			1	36	1	49	21.75	24.75	33.00
			75	0	100	0	22.61	25.61	33.00
20MHz+ 15MHz	2510.0+ 2527.1	QPSK	1	99	1	0	21.71	24.71	33.00
			100	0	75	0	22.92	25.92	33.00
		16-QAM	1	99	1	0	21.65	24.65	33.00
			100	0	75	0	22.83	25.83	33.00
20MHz+ 15MHz	2527.6+ 2544.7	QPSK	1	99	1	0	21.46	24.46	33.00
			100	0	75	0	22.24	25.24	33.00
		16-QAM	1	99	1	0	21.19	24.19	33.00
			100	0	75	0	22.31	25.31	33.00
20MHz+ 15MHz	2545.1+ 2562.2	QPSK	1	99	1	0	21.67	24.67	33.00
			100	0	75	0	22.46	25.46	33.00
		16-QAM	1	99	1	0	21.33	24.33	33.00
			100	0	75	0	22.13	25.13	33.00
20MHz+ 20MHz	2510.0+ 2529.8	QPSK	1	0	1	0	21.84	24.84	33.00
			1	0	1	99	21.16	24.16	33.00
			1	0	100	0	22.36	25.36	33.00
			1	49	1	49	21.25	24.25	33.00
			1	99	1	0	20.78	23.78	33.00
			1	99	1	99	20.14	23.14	33.00
			1	99	100	0	22.87	25.87	33.00
			100	0	1	0	21.45	24.45	33.00
			100	0	1	99	21.11	24.11	33.00
		16-QAM	100	0	100	0	23.45	26.45	33.00
			1	0	1	0	22.10	25.1	33.00
			1	0	1	99	21.36	24.36	33.00
			1	0	100	0	22.21	25.21	33.00
			1	49	1	49	21.73	24.73	33.00
			1	99	1	0	22.08	25.08	33.00
			1	99	1	99	21.76	24.76	33.00
			1	99	100	0	22.21	25.21	33.00
			100	0	1	0	20.98	23.98	33.00
100	0	1	99	21.09	24.09	33.00			
100	0	100	0	22.81	25.81	33.00			

Bandwidth	Frequency (MHz)	Modulation	PCC RB	PCC RB	SCC1 RB	SCC1 RB	Conducted Power (dBm)	E.I.R.P. (dBm)	E.I.R.P. Limits (dBm)
			Size	Offset	Size	Offset			
20MHz+ 20MHz	2525.1 + 2544.9	QPSK	1	0	1	0	21.56	24.56	33.00
			1	0	1	99	20.96	23.96	33.00
			1	0	100	0	22.81	25.81	33.00
			1	49	1	49	21.03	24.03	33.00
			1	99	1	0	21.77	24.77	33.00
			1	99	1	99	21.38	24.38	33.00
			1	99	100	0	22.07	25.07	33.00
			100	0	1	0	22.17	25.17	33.00
			100	0	1	99	22.14	25.14	33.00
		16-QAM	100	0	100	0	22.82	25.82	33.00
			1	0	1	0	20.84	23.84	33.00
			1	0	1	99	20.35	23.35	33.00
			1	0	100	0	20.68	23.68	33.00
			1	49	1	49	20.83	23.83	33.00
			1	99	1	0	21.51	24.51	33.00
			1	99	1	99	20.93	23.93	33.00
			1	99	100	0	21.48	24.48	33.00
			100	0	1	0	22.14	25.14	33.00
20MHz+ 20MHz	2540.2+ 2560.0	QPSK	100	0	1	99	22.09	25.09	33.00
			100	0	100	0	22.77	25.77	33.00
			1	0	1	0	21.21	24.21	33.00
			1	0	1	99	20.45	23.45	33.00
			1	0	100	0	21.92	24.92	33.00
			1	49	1	49	21.84	24.84	33.00
			1	99	1	0	21.78	24.78	33.00
			1	99	1	99	21.03	24.03	33.00
			1	99	100	0	21.39	24.39	33.00
		16-QAM	100	0	1	0	22.19	25.19	33.00
			100	0	1	99	22.07	25.07	33.00
			100	0	100	0	22.54	25.54	33.00
			1	0	1	0	21.27	24.27	33.00
			1	0	1	99	20.58	23.58	33.00
			1	0	100	0	22.05	25.05	33.00
			1	49	1	49	21.95	24.95	33.00
			1	99	1	0	21.85	24.85	33.00
			1	99	1	99	21.22	24.22	33.00
1	99	100	0	22.13	25.13	33.00			
100	0	1	0	22.11	25.11	33.00			
100	0	1	99	22.18	25.18	33.00			
100	0	100	0	22.46	25.46	33.00			



**PAR, Band 7 (Carrier Aggregation):**

Bandwidth	Frequency(MHz)	Modulation	PAR(dB)	Limit(dB)
5MHz+20MHz	2525.80+2537.50	QPSK	6.06	13.00
		16-QAM	6.50	13.00
10MHz+20MHz	2525.60+2540.00	QPSK	6.44	13.00
		16-QAM	6.44	13.00
15MHz+15MHz	2527.50+2542.50	QPSK	6.15	13.00
		16-QAM	6.61	13.00
15MHz+20MHz	2525.30+2542.40	QPSK	6.18	13.00
		16-QAM	6.23	13.00
20MHz+5MHz	2532.50+2544.20	QPSK	6.68	13.00
		16-QAM	6.41	13.00
20MHz+10MHz	2550.10+2564.50	QPSK	6.65	13.00
		16-QAM	6.75	13.00
20MHz+15MHz	2527.60+2544.70	QPSK	6.34	13.00
		16-QAM	5.94	13.00
20MHz+20MHz	2525.10+2544.90	QPSK	5.82	13.00
		16-QAM	6.17	13.00

Note: peak-to-average ratio (PAR) <13 dB.

**Band 40(2305-2315MHz):**

Test Bandwidth	Test Frequency (MHz)	Resource Block & RB offset	Average Output Power (dBm/5MHz)		Antenna Gain (dBi)	Average EIRP (dBm/5MHz)		Limit
			QPSK	16-QAM		QPSK	16-QAM	
5M	2307.5	1#0	17.1	17.33	3.00	20.1	20.33	24
		1#13	17.77	17.99	3.00	20.77	20.99	
		1#24	17.6	17.84	3.00	20.6	20.84	
		12#0	17.46	17.31	3.00	20.46	20.31	
		12#6	17.78	17.62	3.00	20.78	20.62	
		12#13	17.76	17.59	3.00	20.76	20.59	
		25#0	17.73	17.58	3.00	20.73	20.58	
	2310	1#0	17.85	17.83	3.00	20.85	20.83	
		1#13	17.47	17.52	3.00	20.47	20.52	
		1#24	17.66	17.59	3.00	20.66	20.59	
		12#0	18.06	18.01	3.00	21.06	21.01	
		12#6	18.25	18.22	3.00	21.25	21.22	
		12#13	18.22	18.19	3.00	21.22	21.19	
		25#0	18.22	18.07	3.00	21.22	21.07	
	2312.5	1#0	17.55	17.53	3.00	20.55	20.53	
		1#13	18.04	17.98	3.00	21.04	20.98	
		1#24	17.95	17.92	3.00	20.95	20.92	
		12#0	17.65	17.61	3.00	20.65	20.61	
		12#6	17.88	17.85	3.00	20.88	20.85	
		12#13	18.03	18.05	3.00	21.03	21.05	
		25#0	17.83	17.92	3.00	20.83	20.92	
10M	2310	1#0	14.45	14.38	3.00	17.45	17.38	
		1#25	15.26	15.33	3.00	18.26	18.33	
		1#49	15.67	15.54	3.00	18.67	18.54	
		25#0	14.98	14.89	3.00	17.98	17.89	
		25#13	14.47	15.39	3.00	17.47	18.39	
		25#25	15.34	15.43	3.00	18.34	18.43	
		50#0	15.65	15.44	3.00	18.65	18.44	

Note: the device is a mobile station. For 5MHz mode, the channel power is equal to the test result in dBm/5MHz. For 10MHz mode, the channel power as below:

Test Bandwidth	Test Frequency (MHz)	Resource Block & RB offset	Average Output Power (dBm)		Antenna Gain (dBi)	Average EIRP (dBm)	
			QPSK	16-QAM		QPSK	16-QAM
10M	2310	1#0	17.39	17.35	3.00	20.39	20.35
		1#25	18.22	18.28	3.00	21.22	21.28
		1#49	18.25	18.24	3.00	21.25	21.24
		25#0	17.8	17.78	3.00	20.8	20.78
		25#13	17.3	18.19	3.00	20.3	21.19
		25#25	18.16	18.23	3.00	21.16	21.23
		50#0	18.13	18.15	3.00	21.13	21.15

**Band 40(2350-2360MHz):**

Test Bandwidth	Test Channel	Resource Block & RB offset	Conducted Average Output Power (dBm)		Antenna Gain (dBi)	Average EIRP (dBm)		Limit (dBm)
			QPSK	16-QAM		QPSK	16-QAM	
5M	2352.5	1#0	17.64	17.69	3.00	20.64	20.69	24
		1#13	17.96	18.01	3.00	20.96	21.01	
		1#24	17.67	17.72	3.00	20.67	20.72	
		12#0	17.71	17.74	3.00	20.71	20.74	
		12#6	17.84	17.74	3.00	20.84	20.74	
		12#13	17.73	17.68	3.00	20.73	20.68	
		25#0	17.74	17.61	3.00	20.74	20.61	
	2355	1#0	18.17	17.83	3.00	21.17	20.83	
		1#13	18.25	18.09	3.00	21.25	21.09	
		1#24	18.06	17.8	3.00	21.06	20.8	
		12#0	18.18	17.44	3.00	21.18	20.44	
		12#6	18.2	17.42	3.00	21.2	20.42	
		12#13	18.17	17.38	3.00	21.17	20.38	
		25#0	18.19	17.28	3.00	21.19	20.28	
	2357.5	1#0	17.92	17.76	3.00	20.92	20.76	
		1#13	18.27	18.18	3.00	21.27	21.18	
		1#24	18.13	18.01	3.00	21.13	21.01	
		12#0	18.22	18.05	3.00	21.22	21.05	
		12#6	18.26	18.14	3.00	21.26	21.14	
		12#13	18.25	18.1	3.00	21.25	21.1	
		25#0	18.24	18.09	3.00	21.24	21.09	
10M	2355	1#0	14.89	14.87	3.00	17.89	17.87	
		1#25	15.43	15.45	3.00	18.43	18.45	
		1#49	15.44	15.27	3.00	18.44	18.27	
		25#0	14.98	14.98	3.00	17.98	17.98	
		25#13	14.96	14.88	3.00	17.96	17.88	
		25#25	14.98	14.86	3.00	17.98	17.86	
		50#0	14.99	14.89	3.00	17.99	17.89	

Note: the device is a mobile station. For 5MHz mode, the channel power is equal to the test result in dBm/5MHz. For 10MHz mode, the channel power as below:

Test Bandwidth	Test Channel	Resource Block & RB offset	Average Output Power (dBm)		Antenna Gain (dBi)	Average EIRP (dBm)	
			QPSK	16-QAM		QPSK	16-QAM
10M	2355	1#0	17.67	17.64	3.00	20.67	20.64
		1#25	18.18	18.15	3.00	21.18	21.15
		1#49	18.13	18.07	3.00	21.13	21.07
		25#0	17.84	17.82	3.00	20.84	20.82
		25#13	17.92	17.77	3.00	20.92	20.77
		25#25	17.81	17.75	3.00	20.81	20.75
		50#0	17.89	17.82	3.00	20.89	20.82

**Duty cycle:**

**Band 40(2305-2315MHz)**

Test Modulation	Test Bandwidth	Ton (ms)	Total (ms)	Duty Cycle (%)	Limit (%)
QPSK	5M	3.12	10.04	31.00	38
	10M	3.13	9.98	31.36	
16-QAM	5M	3.19	10.04	31.77	
	10M	3.18	9.98	31.86	

**Band 40(2350-2360MHz)**

Test Modulation	Test Bandwidth	Ton (ms)	Total (ms)	Duty Cycle (%)	Limit (%)
QPSK	5M	3.19	10.04	31.77	38
	10M	3.19	9.98	31.96	
16-QAM	5M	3.25	9.98	32.57	
	10M	3.13	9.98	31.36	

Note: EUT setup is as following:

Uplink Downlink configuration	Subframe number									
	0	1	2	3	4	5	6	7	8	9
3	D	S	U	U	U	D	D	D	D	D

**Band 40(2305-2315MHz)**

**QPSK, 5MHz**

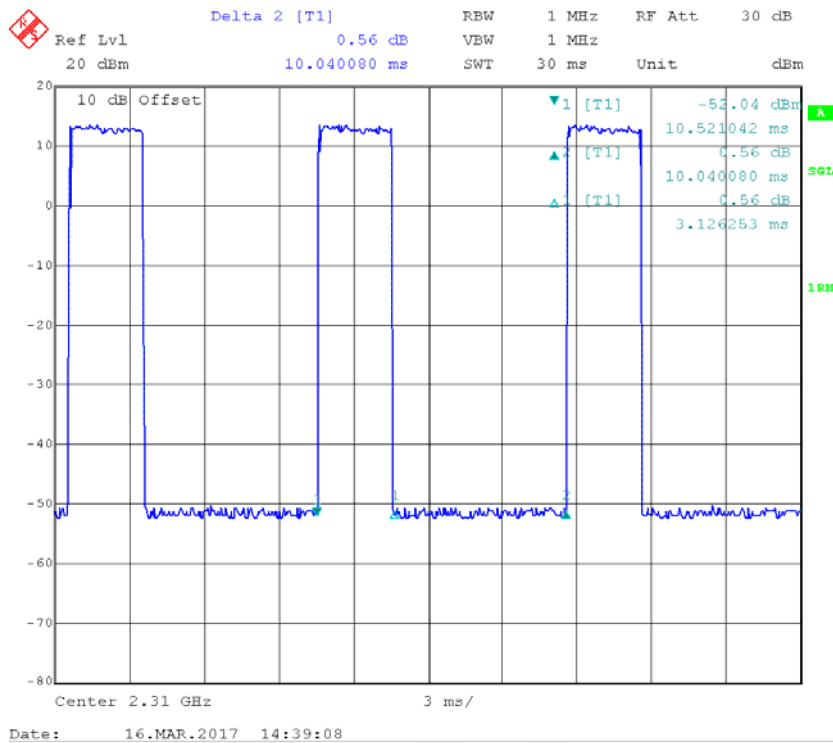

**QPSK, 10MHz**

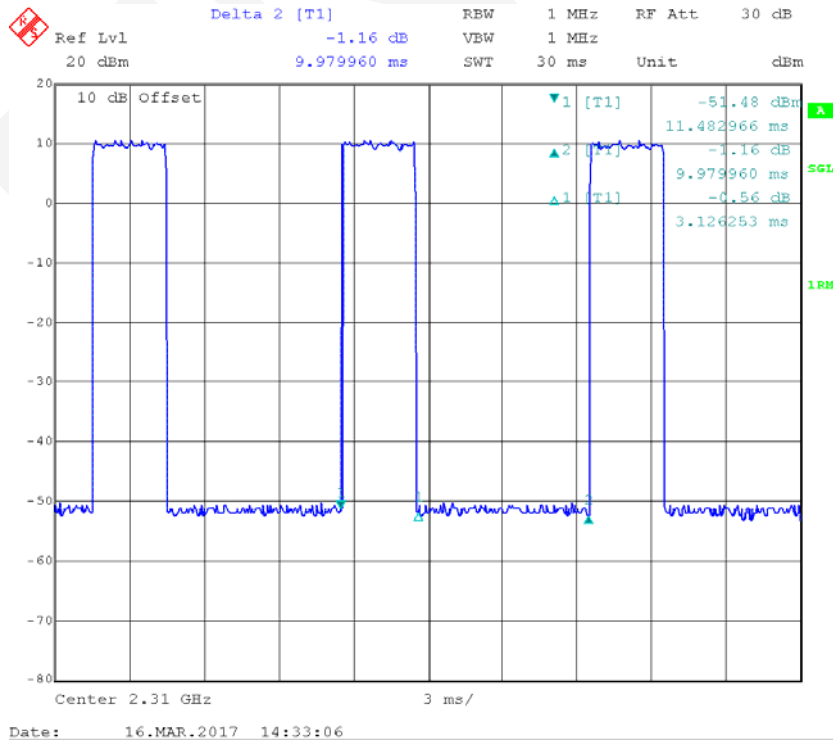

### 16-QAM, 5MHz

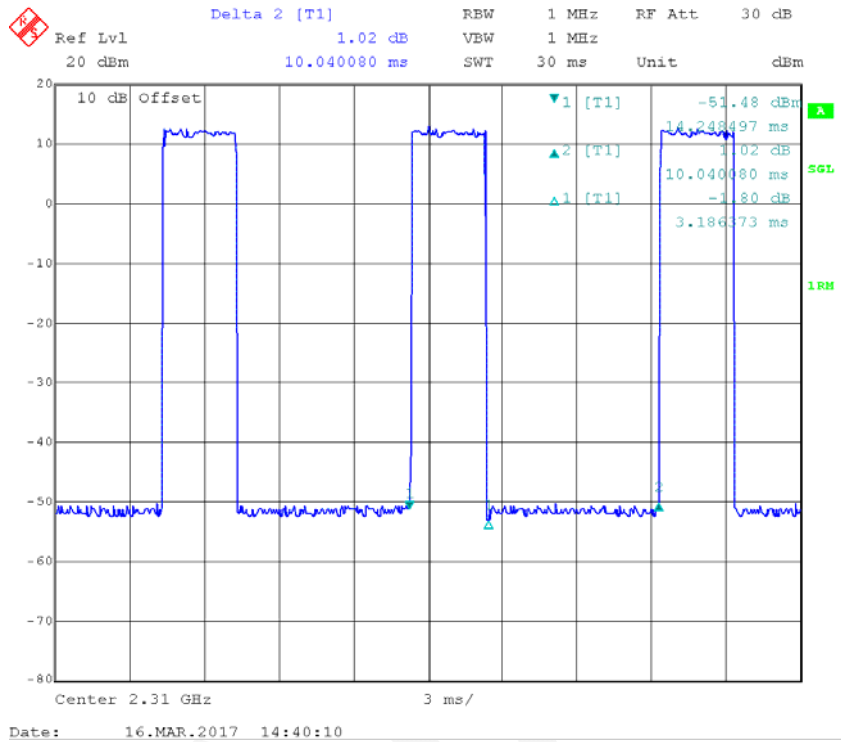

### 16-QAM, 10MHz

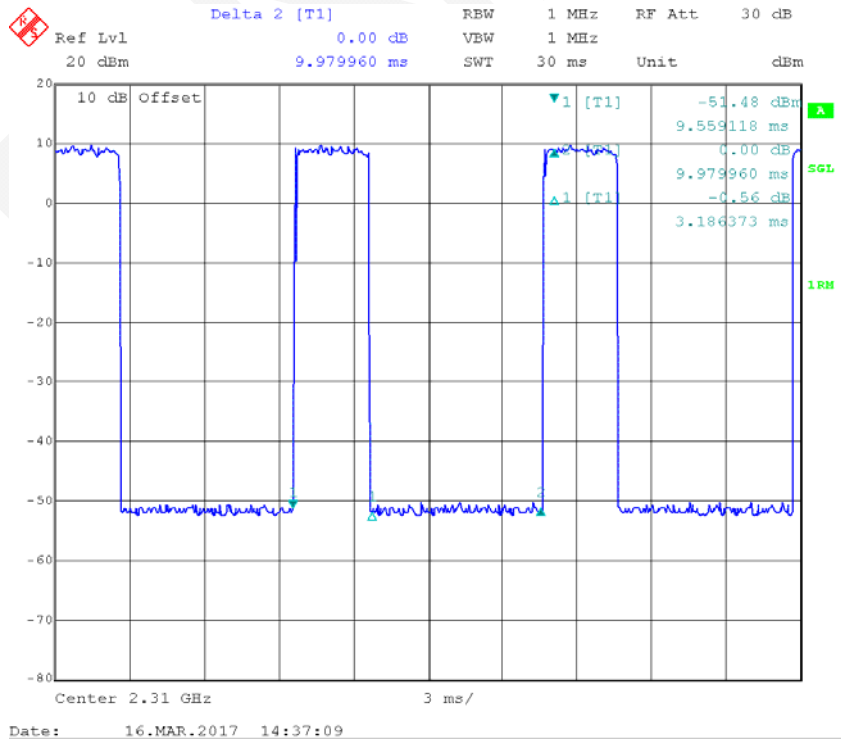

**Band 40(2350-2360MHz)**

**QPSK, 5MHz**

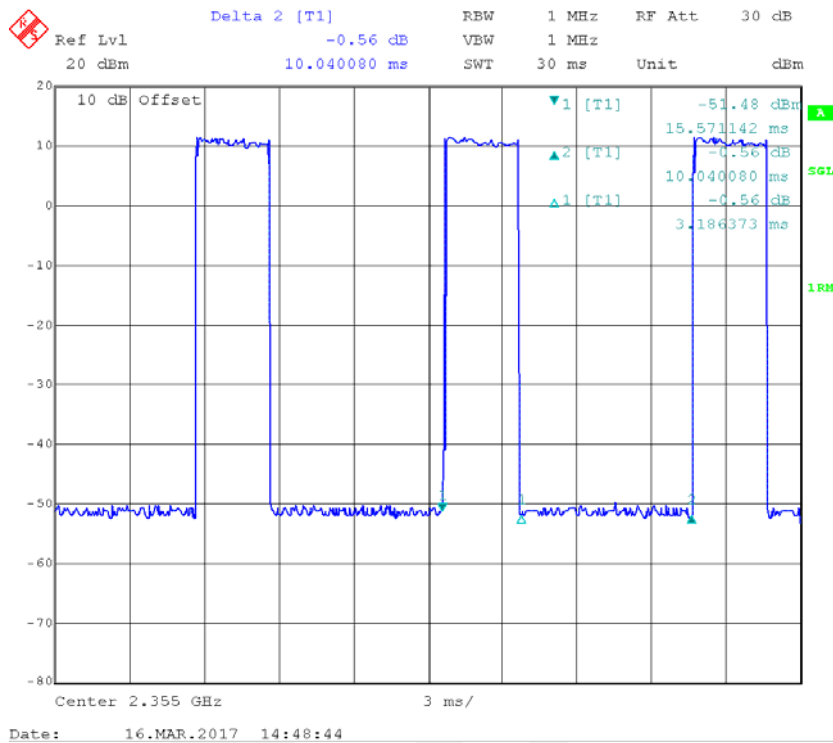

**QPSK, 10MHz**

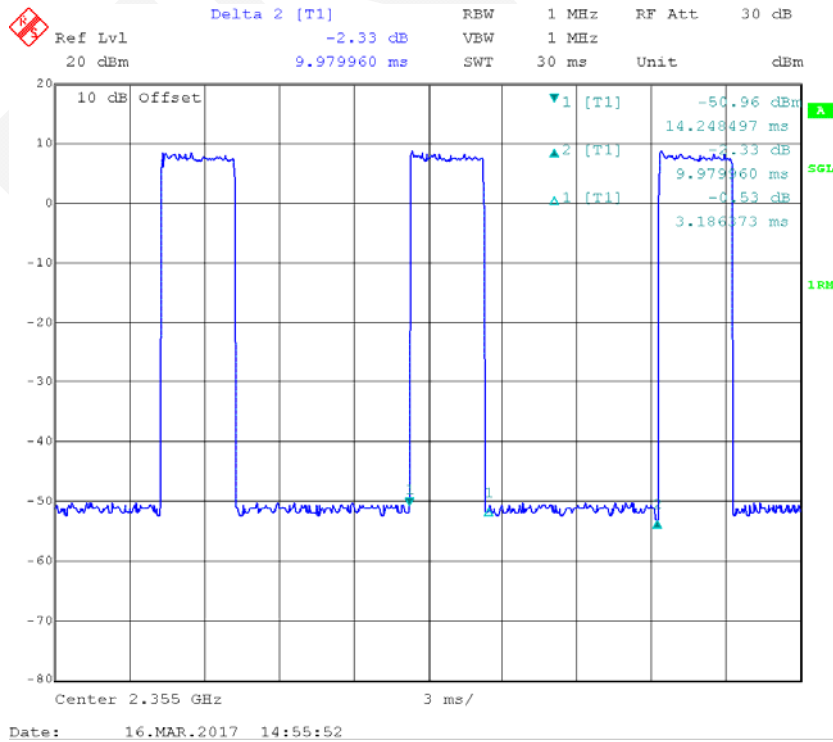

### 16-QAM, 5MHz

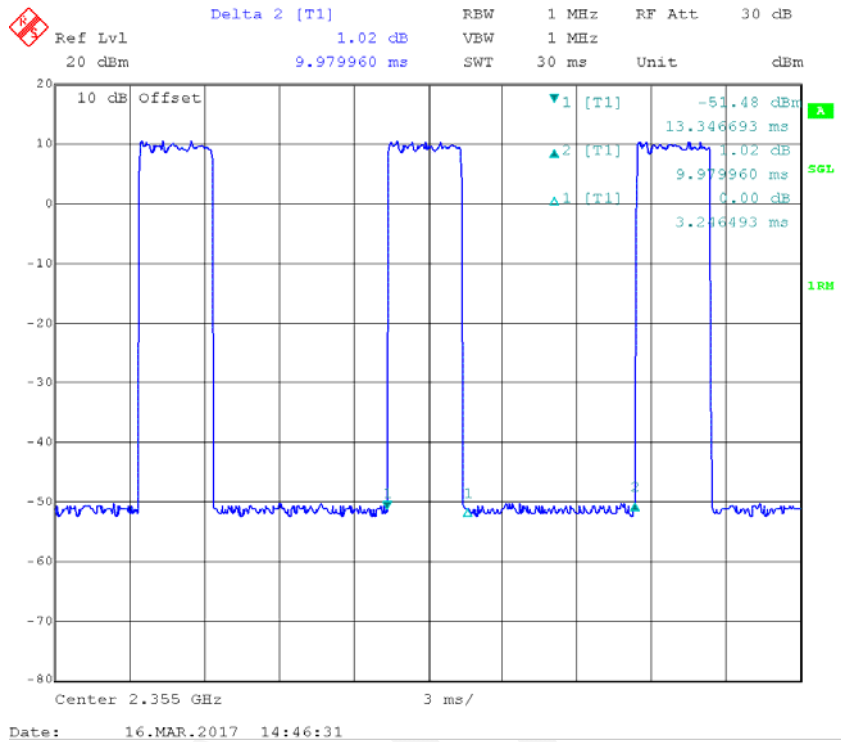

### 16-QAM, 10MHz

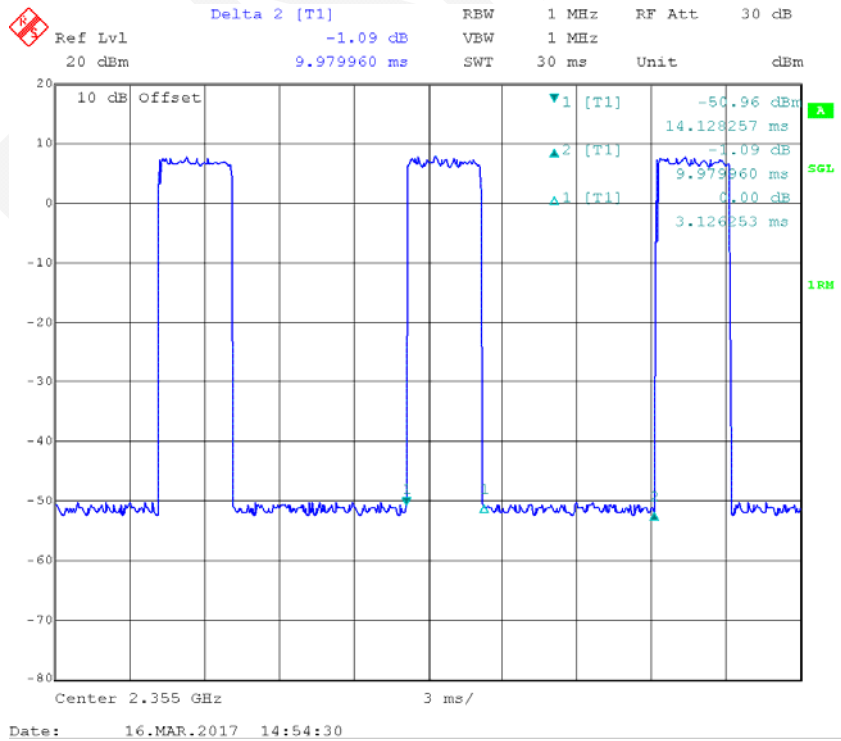



**Band 41:**

**Single Carrier:**

Channel Bandwidth	Modulation	Resource Block & RB offset	Conducted Output Power (dBm)			EIRP (dBm)			
			2502.5 MHz	2593 MHz	2687.5 MHz	2502.5 MHz	2593 MHz	2687.5 MHz	Limits
5 MHz	QPSK	1#0	23.00	24.46	23.82	26	27.46	26.82	33
		1#12	23.01	24.41	23.71	26.01	27.41	26.71	33
		1#24	23.03	24.39	23.64	26.03	27.39	26.64	33
		12#0	23.06	24.36	23.58	26.06	27.36	26.58	33
		12#6	23.09	24.31	23.51	26.09	27.31	26.51	33
		12#11	23.11	24.10	23.12	26.11	27.1	26.12	33
		25#0	23.17	23.69	23.06	26.17	26.69	26.06	33
	16-QAM	1#0	22.82	24.43	23.71	25.82	27.43	26.71	33
		1#12	22.86	24.42	23.59	25.86	27.42	26.59	33
		1#24	22.83	24.39	23.52	25.83	27.39	26.52	33
		12#0	22.74	24.37	23.41	25.74	27.37	26.41	33
		12#6	22.91	24.22	23.33	25.91	27.22	26.33	33
		12#11	22.94	24.03	23.21	25.94	27.03	26.21	33
		25#0	22.99	23.63	23.10	25.99	26.63	26.1	33

Channel Bandwidth	Modulation	Resource Block & RB offset	Conducted Output Power (dBm)			EIRP (dBm)			
			2505 MHz	2593 MHz	2685 MHz	2505 MHz	2593 MHz	2685 MHz	Limits
10 MHz	QPSK	1#0	21.78	21.80	20.69	24.78	24.8	23.69	33
		1#24	21.82	21.86	20.72	24.82	24.86	23.72	33
		1#49	21.86	21.89	20.88	24.86	24.89	23.88	33
		25#0	21.94	21.94	20.93	24.94	24.94	23.93	33
		25#12	22.11	22.14	21.24	25.11	25.14	24.24	33
		25#24	21.96	23.16	21.56	24.96	26.16	24.56	33
		50#0	23.20	23.22	22.37	26.2	26.22	25.37	33
	16-QAM	1#0	20.24	21.65	20.72	23.24	24.65	23.72	33
		1#24	20.56	21.76	20.84	23.56	24.76	23.84	33
		1#49	20.79	21.83	20.89	23.79	24.83	23.89	33
		25#0	21.36	21.99	20.96	24.36	24.99	23.96	33
		25#12	21.79	22.16	21.29	24.79	25.16	24.29	33
		25#24	22.23	22.86	22.46	25.23	25.86	25.46	33
		50#0	23.10	23.23	22.57	26.1	26.23	25.57	33

Channel Bandwidth	Modulation	Resource Block & RB offset	Conducted Output Power (dBm)			EIRP (dBm)			
			2507.5 MHz	2593 MHz	2682.5 MHz	2507.5 MHz	2593 MHz	2682.5 MHz	Limits
15 MHz	QPSK	1#0	22.68	24.32	23.66	25.68	27.32	26.66	33
		1#37	22.92	24.29	23.61	25.92	27.29	26.61	33
		1#74	22.99	24.12	23.54	25.99	27.12	26.54	33
		36#0	23.11	24.02	23.32	26.11	27.02	26.32	33
		36#17	23.24	23.96	23.28	26.24	26.96	26.28	33
		36#35	22.29	23.89	23.22	25.29	26.89	26.22	33
		75#0	23.34	23.84	23.19	26.34	26.84	26.19	33
	16-QAM	1#0	22.62	24.36	23.25	25.62	27.36	26.25	33
		1#37	22.69	24.31	23.17	25.69	27.31	26.17	33
		1#74	22.74	24.26	23.11	25.74	27.26	26.11	33
		36#0	22.81	24.22	23.08	25.81	27.22	26.08	33
		36#17	22.89	24.11	23.02	25.89	27.11	26.02	33
		36#35	23.27	23.91	23.41	26.27	26.91	26.41	33
		75#0	23.32	23.86	23.55	26.32	26.86	26.55	33

Channel Bandwidth	Modulation	Resource Block & RB offset	Conducted Output Power (dBm)			EIRP (dBm)			
			2510 MHz	2593 MHz	2680 MHz	2510 MHz	2593 MHz	2680 MHz	Limits
20 MHz	QPSK	1#0	20.21	22.09	21.25	23.21	25.09	24.25	33
		1#49	20.69	22.36	21.76	23.69	25.36	24.76	33
		1#99	20.84	22.54	21.84	23.84	25.54	24.84	33
		50#0	21.16	22.71	21.96	24.16	25.71	24.96	33
		50#24	21.89	22.84	22.11	24.89	25.84	25.11	33
		50#49	22.42	23.06	22.32	25.42	26.06	25.32	33
		100#0	23.62	23.25	22.42	26.62	26.25	25.42	33
	16-QAM	1#0	20.62	22.12	21.24	23.62	25.12	24.24	33
		1#49	20.82	22.26	21.39	23.82	25.26	24.39	33
		1#99	21.13	22.33	21.68	24.13	25.33	24.68	33
		50#0	21.64	22.41	21.91	24.64	25.41	24.91	33
		50#24	21.77	22.81	22.15	24.77	25.81	25.15	33
		50#49	22.29	23.02	22.28	25.29	26.02	25.28	33
		100#0	23.64	23.27	22.42	26.64	26.27	25.42	33

**PAR, Band 41 (Single Carrier):**

Test Modulation		Channel Bandwidth	2510 MHz PAR (dB)	2593 MHz PAR (dB)	2680 MHz PAR (dB)	Limit (dB)
QPSK	1 RB	20 MHz	5.36	5.10	4.22	13
	100 RB		5.47	6.15	4.41	13
16-QAM	1 RB	20 MHz	5.21	5.25	5.41	13
	100 RB		6.27	6.12	5.12	13

Note: peak-to-average ratio (PAR) <13 dB.

**Carrier Aggregation:**

Bandwidth	Frequency (MHz)	Modulation	PCC RB	PCC RB	SCC1 RB	SCC1 RB	Conducted Power (dBm)	EIRP (dBm)	EIRP Limit (dBm)
			Size	Offset	Size	Offset			
5MHz + 20MHz	2403.3+ 2514	QPSK	1	24	1	0	20.42	23.42	33.00
			1	12	1	49	21.07	24.07	33.00
			25	0	100	0	22.01	25.01	33.00
		16-QAM	1	24	1	0	20.41	23.41	33.00
			1	12	1	49	21.12	24.12	33.00
			25	0	100	0	21.91	24.91	33.00
5MHz + 20MHz	2583.8+ 2595.5	QPSK	1	24	1	0	20.50	23.5	33.00
			1	12	1	49	20.51	23.51	33.00
			25	0	100	0	22.25	25.25	33.00
		16-QAM	1	24	1	0	20.51	23.51	33.00
			1	12	1	49	20.46	23.46	33.00
			25	0	100	0	22.19	25.19	33.00
5MHz + 20MHz	2668.3+ 2680	QPSK	1	24	1	0	20.98	23.98	33.00
			1	12	1	49	21.11	24.11	33.00
			25	0	100	0	23.43	26.43	33.00
		16-QAM	1	24	1	0	20.97	23.97	33.00
			1	12	1	49	21.03	24.03	33.00
			25	0	100	0	23.15	26.15	33.00
20MHz+ 5MHz	2514.0 + 2521.7	QPSK	1	0	1	0	21.16	24.16	33.00
			1	0	1	24	21.14	24.14	33.00
			1	0	25	0	21.97	24.97	33.00
			1	99	1	0	20.73	23.73	33.00
			1	99	1	24	21.02	24.02	33.00
			1	99	25	0	21.97	24.97	33.00
			100	0	1	0	21.29	24.29	33.00
			100	0	1	24	21.34	24.34	33.00
			100	0	25	0	22.40	25.4	33.00
		16-QAM	1	0	1	0	21.14	24.14	33.00
			1	0	1	24	21.32	24.32	33.00
			1	0	25	0	21.99	24.99	33.00
			1	99	1	0	20.91	23.91	33.00
			1	99	1	24	20.97	23.97	33.00
			1	99	25	0	21.84	24.84	33.00
			100	0	1	0	21.29	24.29	33.00
			100	0	1	24	21.30	24.3	33.00
			100	0	25	0	22.13	25.13	33.00

Bandwidth	Frequency (MHz)	Modulation	PCC RB	PCC RB	SCC1 RB	SCC1 RB	Conducted Power (dBm)	EIRP (dBm)	EIRP Limit (dBm)
			Size	Offset	Size	Offset			
20MHz+ 5MHz	2590.5+ 2602.2	QPSK	1	0	1	0	21.24	24.24	33.00
			1	0	1	24	21.12	24.12	33.00
			1	0	25	0	22.50	25.5	33.00
			1	99	1	0	21.44	24.44	33.00
			1	99	1	24	21.37	24.37	33.00
			1	99	25	0	22.39	25.39	33.00
			100	0	1	0	22.82	25.82	33.00
			100	0	1	24	22.80	25.8	33.00
		16-QAM	100	0	25	0	23.41	26.41	33.00
			1	0	1	0	20.68	23.68	33.00
			1	0	1	24	20.75	23.75	33.00
			1	0	25	0	22.63	25.63	33.00
			1	99	1	0	20.88	23.88	33.00
			1	99	1	24	20.84	23.84	33.00
			1	99	25	0	22.57	25.57	33.00
			100	0	1	0	22.78	25.78	33.00
20MHz+ 5MHz	2675.0+ 2686.7	QPSK	100	0	1	24	22.85	25.85	33.00
			100	0	25	0	23.54	26.54	33.00
			1	0	1	0	20.55	23.55	33.00
			1	0	1	24	20.43	23.43	33.00
			1	0	25	0	21.57	24.57	33.00
			1	99	1	0	21.29	24.29	33.00
			1	99	1	24	21.28	24.28	33.00
			1	99	25	0	21.62	24.62	33.00
		16-QAM	100	0	1	0	21.42	24.42	33.00
			100	0	1	24	21.31	24.31	33.00
			100	0	25	0	22.19	25.19	33.00
			1	0	1	0	21.27	24.27	33.00
			1	0	1	24	21.25	24.25	33.00
			1	0	25	0	21.51	24.51	33.00
			1	99	1	0	21.21	24.21	33.00
			1	99	1	24	21.27	24.27	33.00
10MHz+ 20MHz	2505.5+ 2519.9	QPSK	1	99	25	0	21.49	24.49	33.00
			100	0	1	0	21.32	24.32	33.00
			100	0	1	24	21.27	24.27	33.00
		16-QAM	100	0	25	0	22.94	25.94	33.00
			1	49	1	0	20.79	23.79	33.00
			1	24	1	49	20.94	23.94	33.00
			50	0	100	0	23.15	26.15	33.00
			1	49	1	0	21.01	24.01	33.00
1	24	1	49	21.18	24.18	33.00			
50	0	100	0	23.01	26.01	33.00			

Bandwidth	Frequency (MHz)	Modulation	PCC RB	PCC RB	SCC1 RB	SCC1 RB	Conducted Power (dBm)	EIRP (dBm)	EIRP Limit (dBm)
			Size	Offset	Size	Offset			
10MHz+ 20MHz	2583.6+ 2598	QPSK	1	49	1	0	21.19	24.19	33.00
			1	24	1	49	21.32	24.32	33.00
			50	0	100	0	23.45	26.45	33.00
		16-QAM	1	49	1	0	21.28	24.28	33.00
			1	24	1	49	21.26	24.26	33.00
			50	0	100	0	23.61	26.61	33.00
10MHz+ 20MHz	2665.6+ 2680	QPSK	1	49	1	0	21.17	24.17	33.00
			1	24	1	49	21.28	24.28	33.00
			50	0	100	0	23.03	26.03	33.00
		16-QAM	1	49	1	0	21.19	24.19	33.00
			1	24	1	49	21.31	24.31	33.00
			50	0	100	0	23.01	26.01	33.00
20MHz+ 10MHz	2510.0+ 2524.4	QPSK	1	99	1	0	20.76	23.76	33.00
			100	0	50	0	23.18	26.18	33.00
		16-QAM	1	99	1	0	20.77	23.77	33.00
			100	0	50	0	23.10	26.1	33.00
20MHz+ 10MHz	2588.1 + 2602.5	QPSK	1	99	1	0	21.41	24.41	33.00
			100	0	50	0	23.26	26.26	33.00
		16-QAM	1	99	1	0	21.04	24.04	33.00
			100	0	50	0	23.34	26.34	33.00
20MHz+ 10MHz	2670.1+ 2684.5	QPSK	1	99	1	0	21.39	24.39	33.00
			100	0	50	0	23.24	26.24	33.00
		16-QAM	1	99	1	0	21.02	24.02	33.00
			100	0	50	0	23.31	26.31	33.00
15MHz+ 15MHz	2507.5+ 2522.5	QPSK	1	74	1	0	21.62	24.62	33.00
			75	0	75	0	23.45	26.45	33.00
		16-QAM	1	74	1	0	21.93	24.93	33.00
			75	0	75	0	23.34	26.34	33.00
15MHz+ 15MHz	2585.5+ 2600.5	QPSK	1	74	1	0	21.62	24.62	33.00
			75	0	75	0	23.66	26.66	33.00
		16-QAM	1	74	1	0	21.35	24.35	33.00
			75	0	75	0	23.51	26.51	33.00
15MHz+ 15MHz	2667.5+ 2682.5	QPSK	1	74	1	0	22.06	25.06	33.00
			75	0	75	0	23.66	26.66	33.00
		16-QAM	1	74	1	0	22.21	25.21	33.00
			75	0	75	0	23.60	26.6	33.00
15MHz+ 20MHz	2507.8+ 2524.9	QPSK	1	74	1	0	21.43	24.43	33.00
			1	36	1	49	22.33	25.33	33.00
			75	0	100	0	23.14	26.14	33.00
		16QAM	1	74	1	0	21.48	24.48	33.00
			1	36	1	49	22.34	25.34	33.00
			75	0	100	0	23.05	26.05	33.00

Bandwidth	Frequency (MHz)	Modulation	PCC RB	PCC RB	SCC1 RB	SCC1 RB	Conducted Power (dBm)	EIRP (dBm)	EIRP Limit (dBm)
			Size	Offset	Size	Offset			
15MHz+ 20MHz	2583.3 + 2600.4	QPSK	1	74	1	0	20.89	23.89	33.00
			1	36	1	49	20.68	23.68	33.00
			75	0	100	0	23.52	26.52	33.00
		16-QAM	1	74	1	0	20.77	23.77	33.00
			1	36	1	49	20.59	23.59	33.00
			75	0	100	0	23.47	26.47	33.00
15MHz+ 20MHz	2662.9 + 2680.0	QPSK	1	74	1	0	22.07	25.07	33.00
			1	36	1	49	22.25	25.25	33.00
			75	0	100	0	23.62	26.62	33.00
		16-QAM	1	74	1	0	22.16	25.16	33.00
			1	36	1	49	22.28	25.28	33.00
			75	0	100	0	23.63	26.63	33.00
20MHz+ 15MHz	2510.0+ 2527.1	QPSK	1	99	1	0	21.36	24.36	33.00
			100	0	75	0	23.21	26.21	33.00
		16-QAM	1	99	1	0	21.38	24.38	33.00
			100	0	75	0	23.08	26.08	33.00
20MHz+ 15MHz	2585.6+ 2602.7	QPSK	1	99	1	0	21.07	24.07	33.00
			100	0	75	0	23.21	26.21	33.00
		16-QAM	1	99	1	0	20.80	23.8	33.00
			100	0	75	0	23.45	26.45	33.00
20MHz+ 15MHz	2665.1+ 2682.2	QPSK	1	99	1	0	21.04	24.04	33.00
			100	0	75	0	23.19	26.19	33.00
		16-QAM	1	99	1	0	20.68	23.68	33.00
			100	0	75	0	23.42	26.42	33.00
20MHz+ 20MHz	2510.0+ 2529.8	QPSK	1	0	1	0	21.44	24.44	33.00
			1	0	1	99	20.61	23.61	33.00
			1	0	100	0	20.68	23.68	33.00
			1	49	1	49	21.43	24.43	33.00
			1	99	1	0	21.84	24.84	33.00
			1	99	1	99	21.69	24.69	33.00
			1	99	100	0	21.85	24.85	33.00
			100	0	1	0	21.60	24.6	33.00
			100	0	1	99	21.47	24.47	33.00
		16-QAM	100	0	100	0	22.54	25.54	33.00
			1	0	1	0	20.56	23.56	33.00
			1	0	1	99	20.51	23.51	33.00
			1	0	100	0	20.68	23.68	33.00
			1	49	1	49	21.56	24.56	33.00
			1	99	1	0	21.73	24.73	33.00
			1	99	1	99	21.61	24.61	33.00
			1	99	100	0	21.97	24.97	33.00
			100	0	1	0	21.43	24.43	33.00
100	0	1	99	21.61	24.61	33.00			
100	0	100	0	23.15	26.15	33.00			

Bandwidth	Frequency (MHz)	Modulation	PCC RB	PCC RB	SCC1 RB	SCC1 RB	Conducted Power (dBm)	EIRP (dBm)	EIRP Limit (dBm)
			Size	Offset	Size	Offset			
20MHz+ 20MHz	2585.1+ 2604.9	QPSK	1	0	1	0	21.76	24.76	33.00
			1	0	1	99	21.14	24.14	33.00
			1	0	100	0	22.09	25.09	33.00
			1	49	1	49	21.93	24.93	33.00
			1	99	1	0	21.85	24.85	33.00
			1	99	1	99	21.27	24.27	33.00
			1	99	100	0	22.21	25.21	33.00
			100	0	1	0	21.85	24.85	33.00
			100	0	1	99	20.94	23.94	33.00
		100	0	100	0	23.80	26.8	33.00	
		16-QAM	1	0	1	0	21.39	24.39	33.00
			1	0	1	99	20.69	23.69	33.00
			1	0	100	0	22.08	25.08	33.00
			1	49	1	49	20.73	23.73	33.00
			1	99	1	0	21.05	24.05	33.00
			1	99	1	99	20.34	23.34	33.00
			1	99	100	0	21.88	24.88	33.00
			100	0	1	0	21.27	24.27	33.00
100	0		1	99	20.81	23.81	33.00		
20MHz+ 20MHz	2660.2+ 2680.0	QPSK	1	0	1	0	21.88	24.88	33.00
			1	0	1	99	21.31	24.31	33.00
			1	0	100	0	22.24	25.24	33.00
			1	49	1	49	21.86	24.86	33.00
			1	99	1	0	20.97	23.97	33.00
			1	99	1	99	23.88	26.88	33.00
			1	99	100	0	20.91	23.91	33.00
			100	0	1	0	21.81	24.81	33.00
			100	0	1	99	20.91	23.91	33.00
		16-QAM	100	0	100	0	23.48	26.48	33.00
			1	0	1	0	21.86	24.86	33.00
			1	0	1	99	21.33	24.33	33.00
			1	0	100	0	22.27	25.27	33.00
			1	49	1	49	21.89	24.89	33.00
			1	99	1	0	20.98	23.98	33.00
			1	99	1	99	23.90	26.9	33.00
			1	99	100	0	20.92	23.92	33.00
			100	0	1	0	21.83	24.83	33.00
100	0	1	99	20.91	23.91	33.00			
100	0	100	0	23.51	26.51	33.00			

**PAR, Band 41:**

Bandwidth	Frequency (MHz)	Modulation	PAR (dB)	Limit (dB)
5MHz+20MHz	2583.80+2595.50	QPSK	6.82	13.00
		16-QAM	6.78	13.00
10MHz+20MHz	2583.60+2598.00	QPSK	5.68	13.00
		16-QAM	5.86	13.00
15MHz+15MHz	2585.50+2600.50	QPSK	6.57	13.00
		16-QAM	6.26	13.00
15MHz+20MHz	2583.30+2600.40	QPSK	6.21	13.00
		16-QAM	6.30	13.00
20MHz+5MHz	2590.50+2602.20	QPSK	6.70	13.00
		16-QAM	6.44	13.00
20MHz+10MHz	2588.10+2602.50	QPSK	6.54	13.00
		16-QAM	6.81	13.00
20MHz+15MHz	2585.60+2602.70	QPSK	6.32	13.00
		16-QAM	6.46	13.00
20MHz+20MHz	2583.10+2602.90	QPSK	6.46	13.00
		16-QAM	5.92	13.00

Note: peak-to-average ratio (PAR) <13 dB.



## FCC §2.1049 & §27.53, RSS-199 § 4.2, RSS-Gen § 6.6 - OCCUPIED BANDWIDTH

### Applicable Standards

FCC 47 §2.1049 and §27.53. RSS-199 § 4.2

### Test Procedure

The RF output of the transmitter was connected to the simulator and the spectrum analyzer through sufficient attenuation.

The 26 dB & 99% bandwidth was recorded.

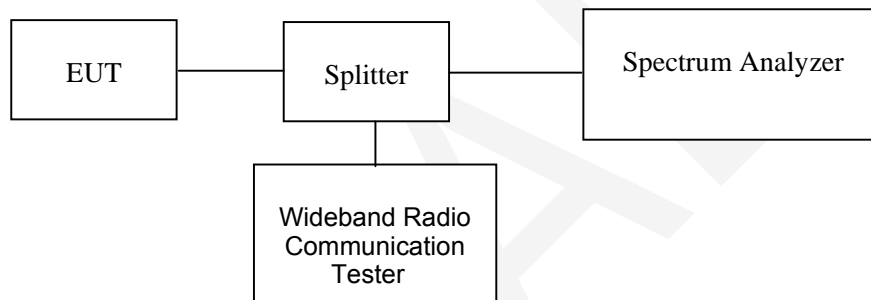

### Test Equipment List and Details

Manufacturer	Description	Model	Serial Number	Calibration Date	Calibration Due Date
Rohde & Schwarz	Signal Analyzer	FSIQ26	831929/005	2016-09-21	2017-09-20
Unknown	RF Cable	Unknown	C-2	Each Time	/
R&S	Wideband Radio Communication Tester	CMW500	106891	2016-11-23	2017-11-23

\* **Statement of Traceability:** BACL(Chengdu) attests that all of the calibrations on the equipment items listed above were traceable to NIM or to another internationally recognized National Metrology Institute (NMI), and were compliant with the NIST HB 150-2016 Normative Annex B "Implementation of traceability policy in accredited laboratories".

## Test Data

### Environmental Conditions

<b>Temperature:</b>	20 °C
<b>Relative Humidity:</b>	58 %
<b>ATM Pressure:</b>	95~95.2 kPa

The testing was performed by Lorin Bian from 2017-02-14 to 2017-03-16.

### Test Result: Compliant

#### Single Carrier:

##### Band 7:

Test Modulation	Test Bandwidth	Test Channel	99% Occupied Bandwidth (MHz)	26 dB Bandwidth (MHz)
QPSK	5M	M	4.569	5.050
	10M		9.138	10.230
	15M		13.587	15.210
	20M		18.196	20.360
16-QAM	5M		4.549	5.030
	10M		9.138	10.310
	15M		13.587	15.150
	20M		18.196	20.360

Note: the Bandwidth is more than 1MHz.

**Band 40(2305-2315MHz):**

Test Modulation	Test Bandwidth	Test Channel	99% Occupied Bandwidth (MHz)	26 dB Bandwidth (MHz)
QPSK	5M	M	4.53	5.11
	10M		8.98	9.86
16-QAM	5M		4.53	5.09
	10M		8.98	9.82

**Band 40(2350-2360MHz):**

Test Modulation	Test Bandwidth	Test Channel	99% Occupied Bandwidth (MHz)	26 dB Bandwidth (MHz)
QPSK	5M	M	4.55	4.96
	10M		8.98	9.81
16-QAM	5M		4.57	4.98
	10M		8.98	9.93

**Band 41:**

Test Modulation	Test Bandwidth	Test Channel	99% Occupied Bandwidth (MHz)	26 dB Bandwidth (MHz)
QPSK	5M	M	4.550	5.010
	10M		9.098	10.230
	15M		13.587	15.050
	20M		18.196	20.190
16-QAM	5M		4.550	5.010
	10M		9.098	10.230
	15M		13.587	15.050
	20M		18.116	20.110

Note: the Bandwidth is more than 1MHz.

**Band 7:**

**QPSK, 5MHz**

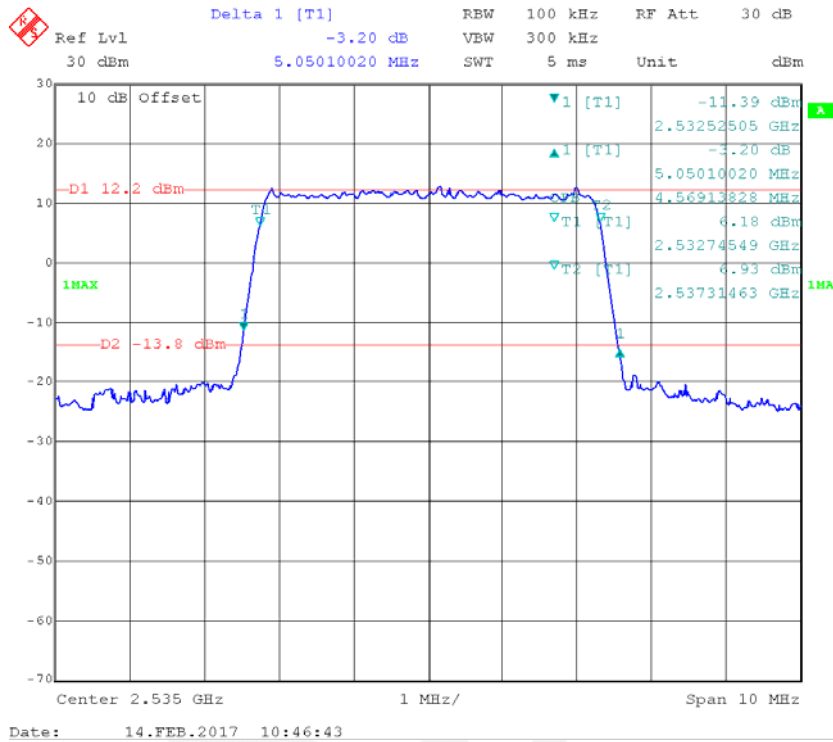

**QPSK, 10MHz**

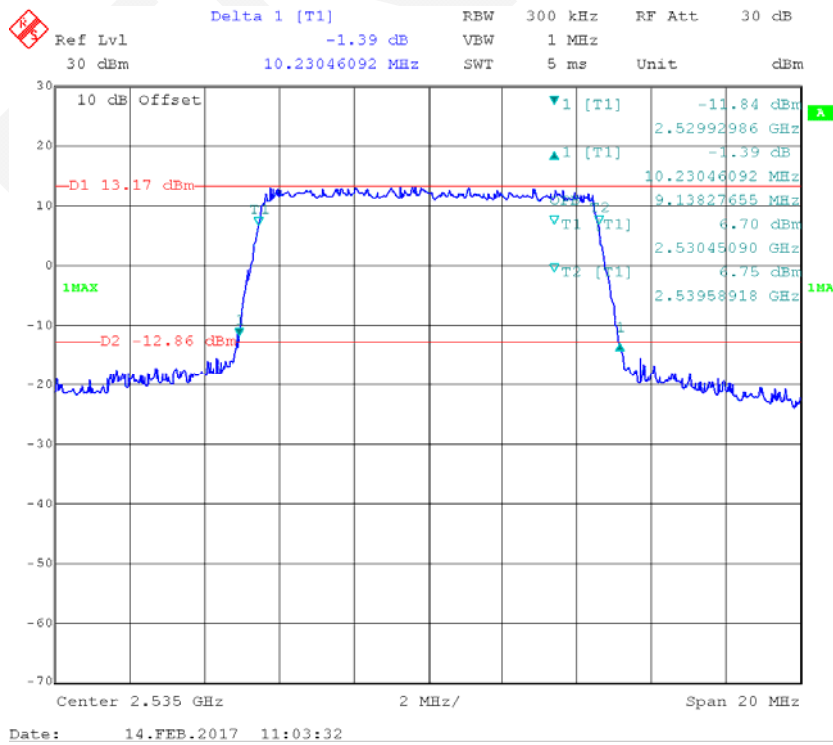

### QPSK, 15MHz

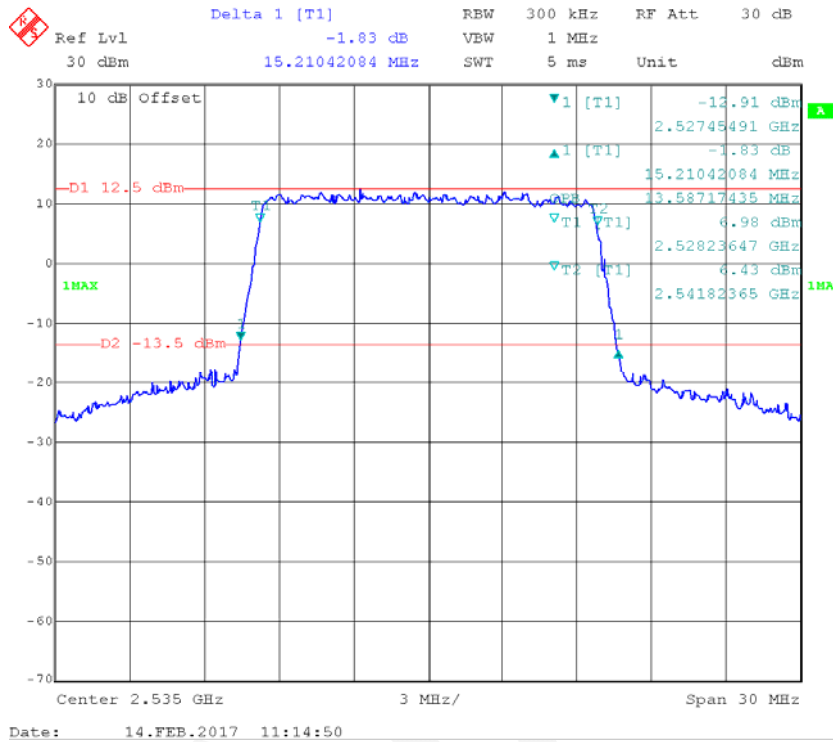

### QPSK, 20MHz

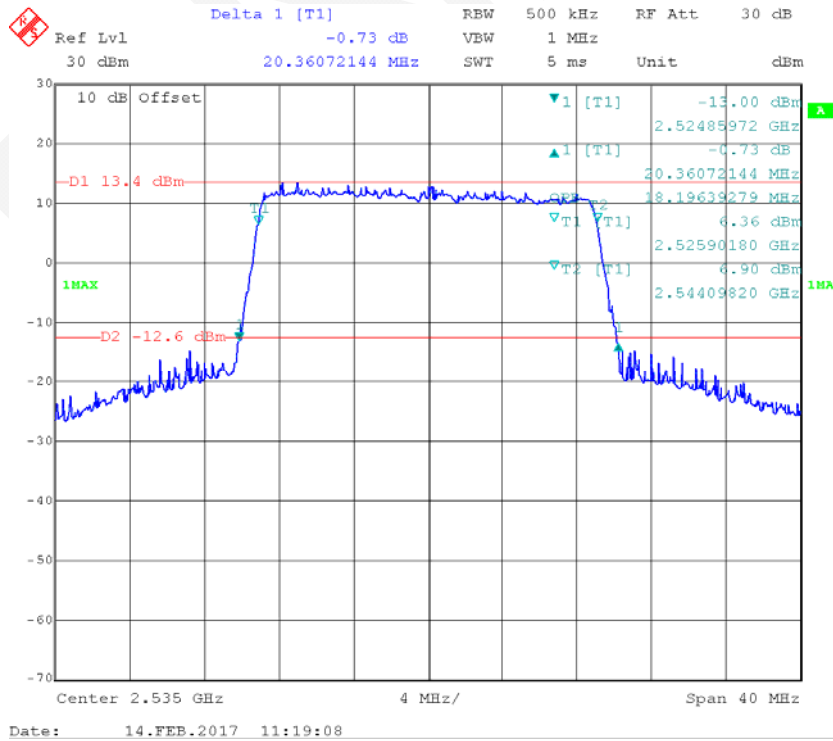

### 16-QAM, 5MHz

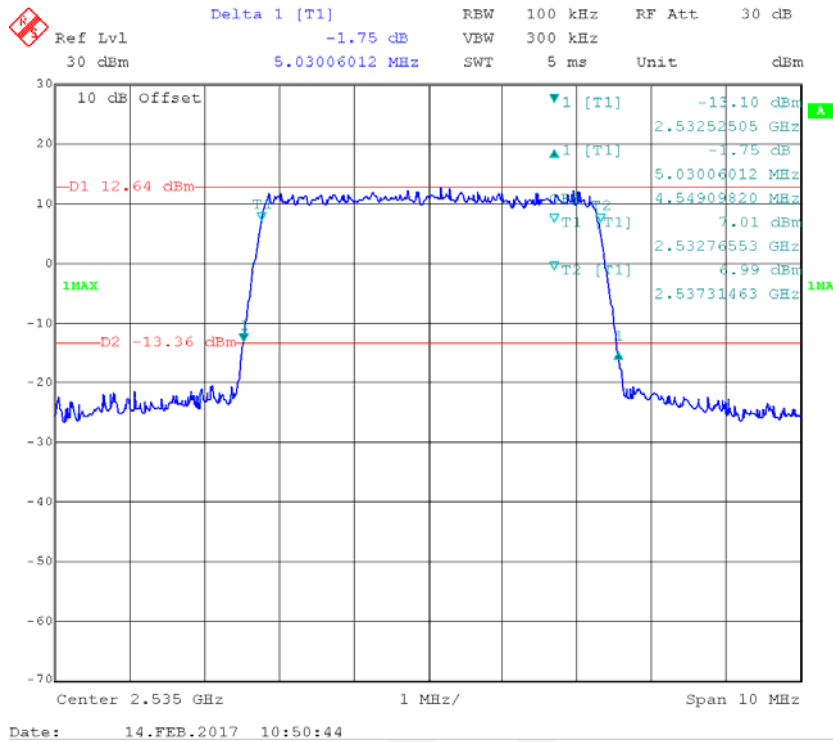

### 16-QAM, 10MHz

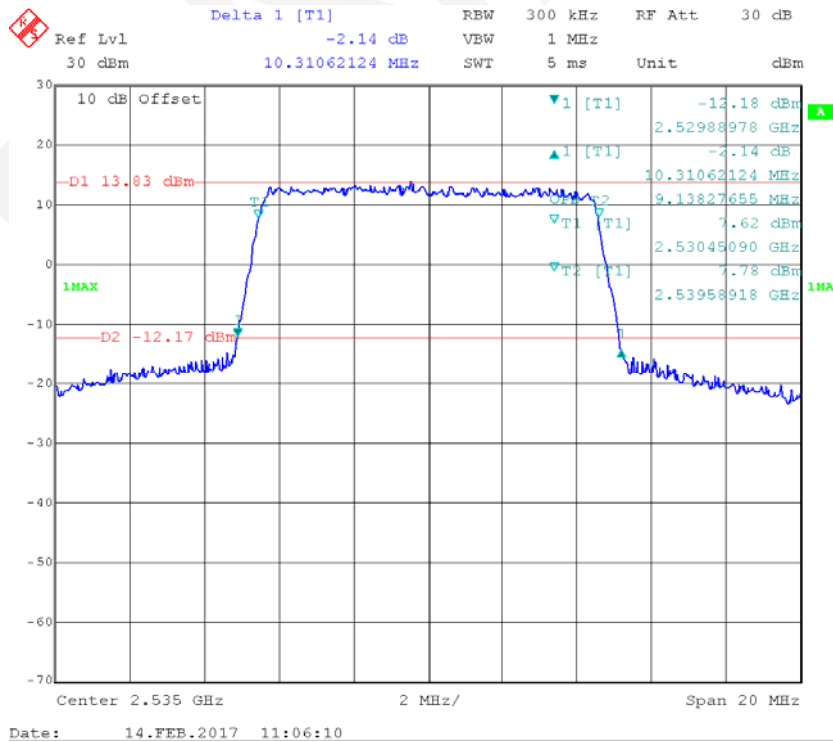

### 16-QAM, 15MHz

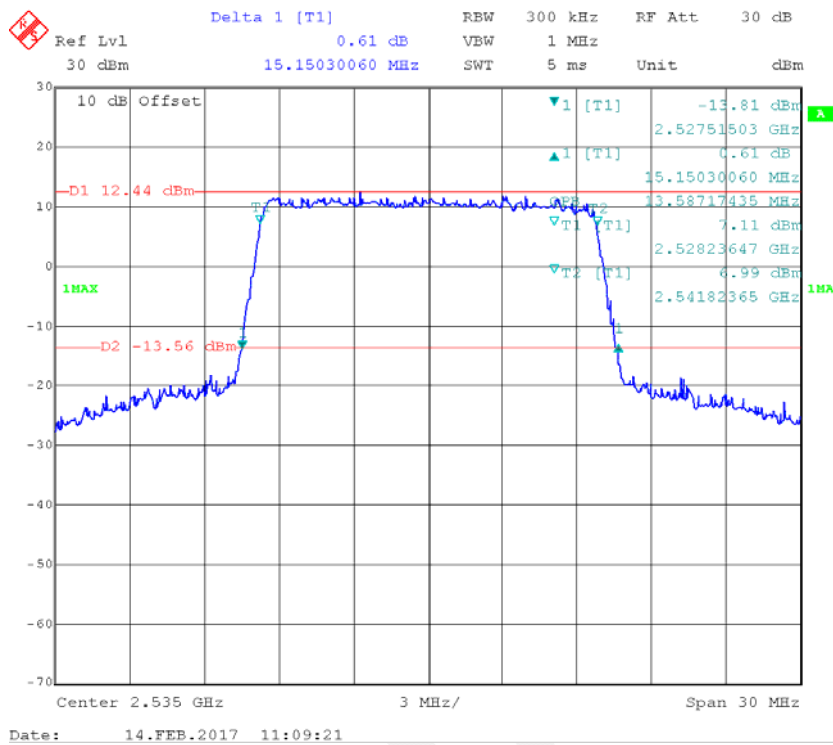

### 16-QAM, 20MHz

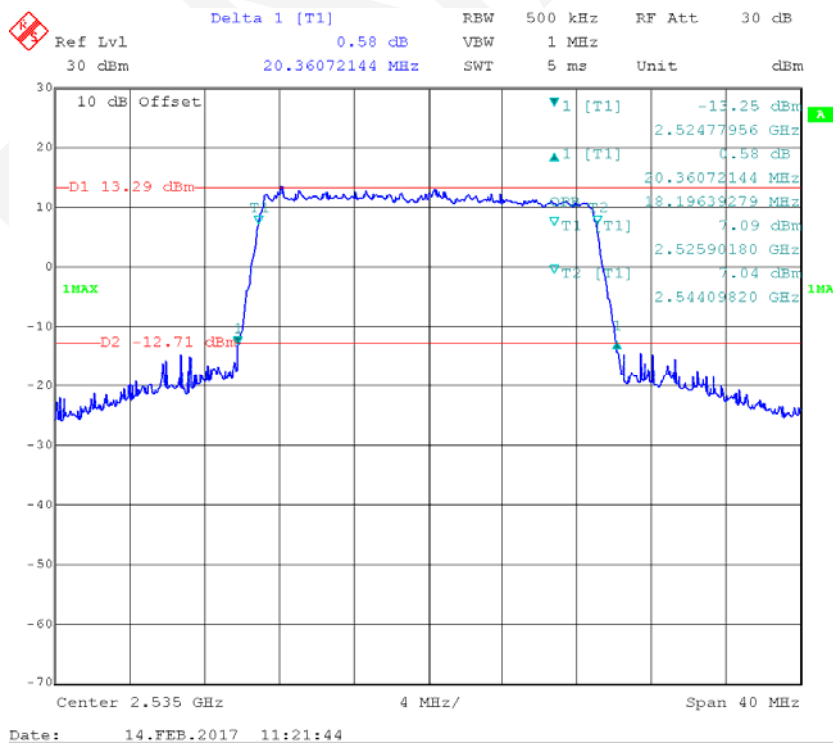

**Band 40(2305MHz-2315MHz):**

**QPSK, 5MHz**

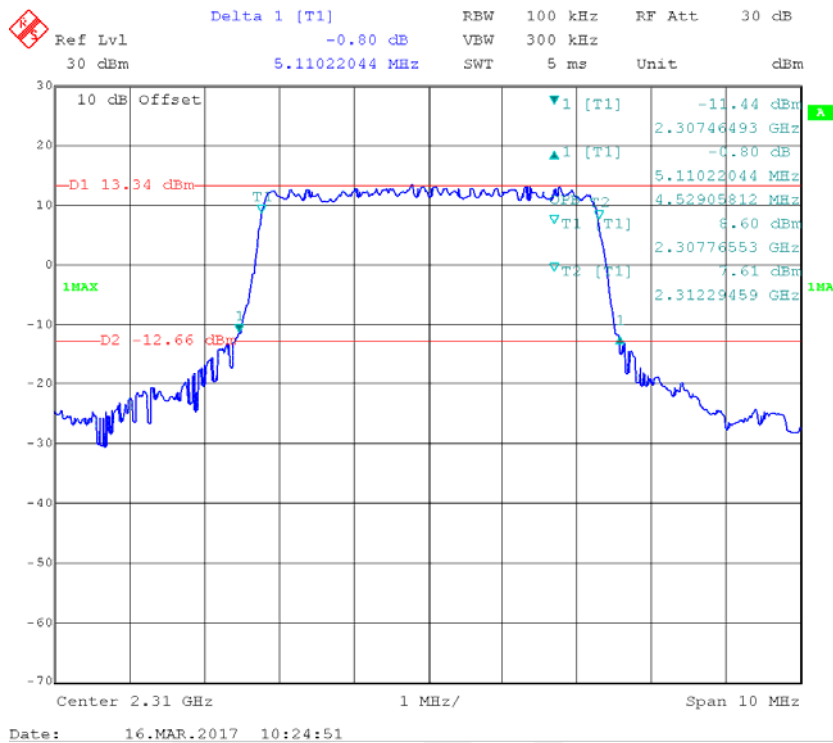

**QPSK, 10MHz**

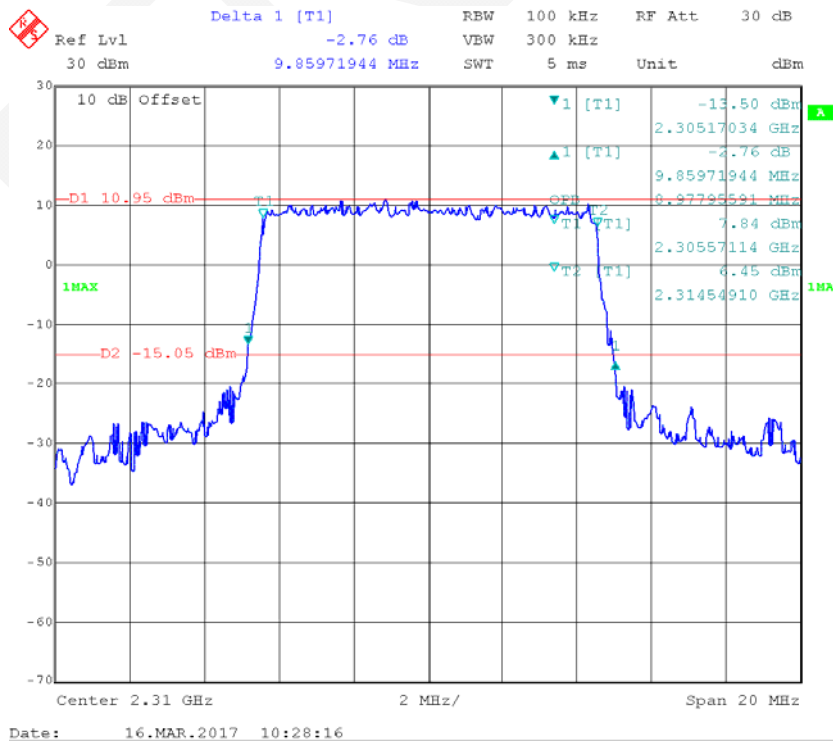



### 16-QAM, 5MHz

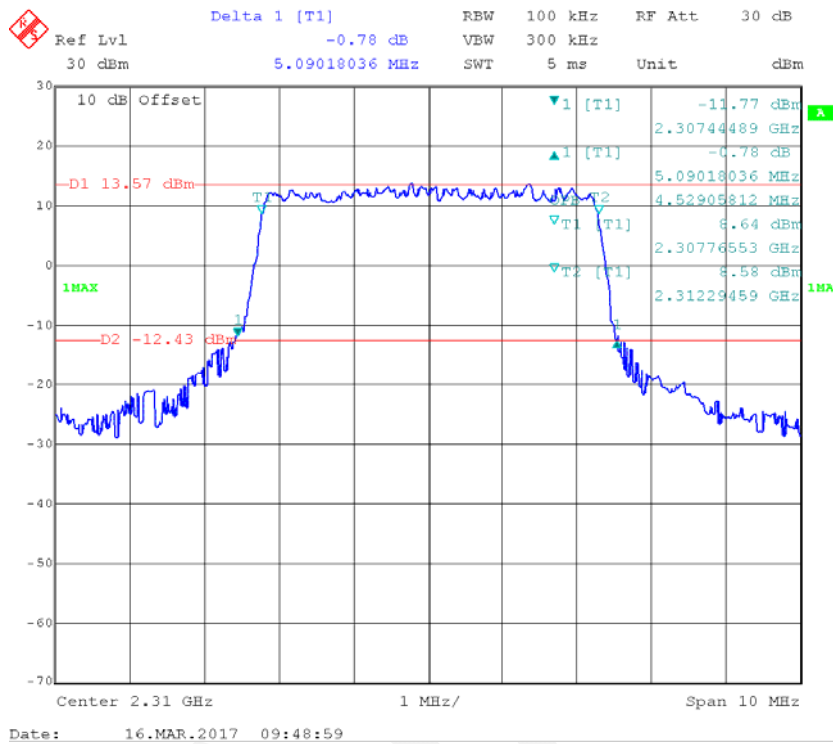

### 16-QAM, 10MHz

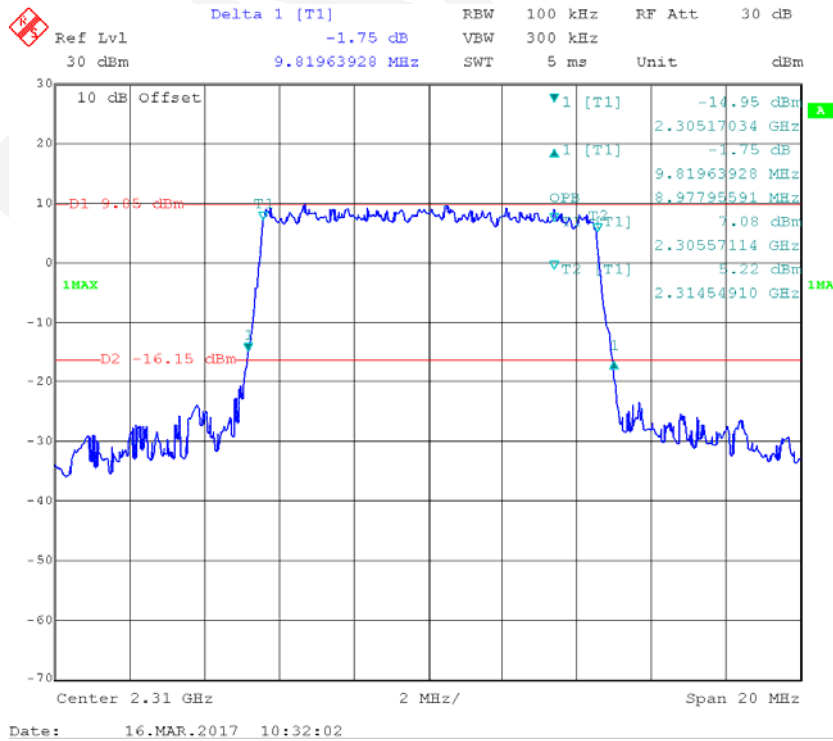

**Band 40(2350MHz-2360MHz):**

**QPSK, 5MHz**

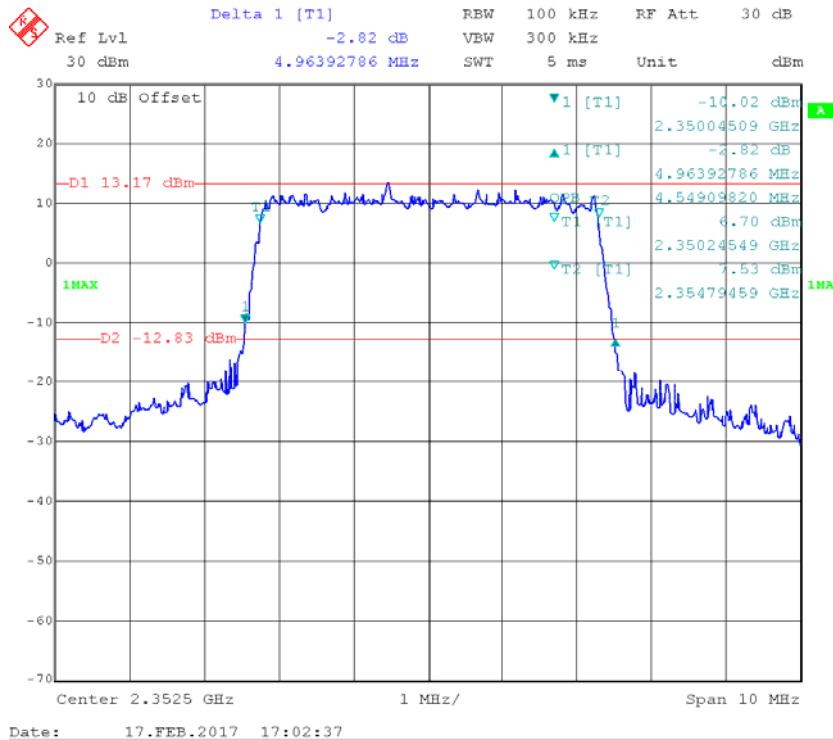

**QPSK, 10MHz**

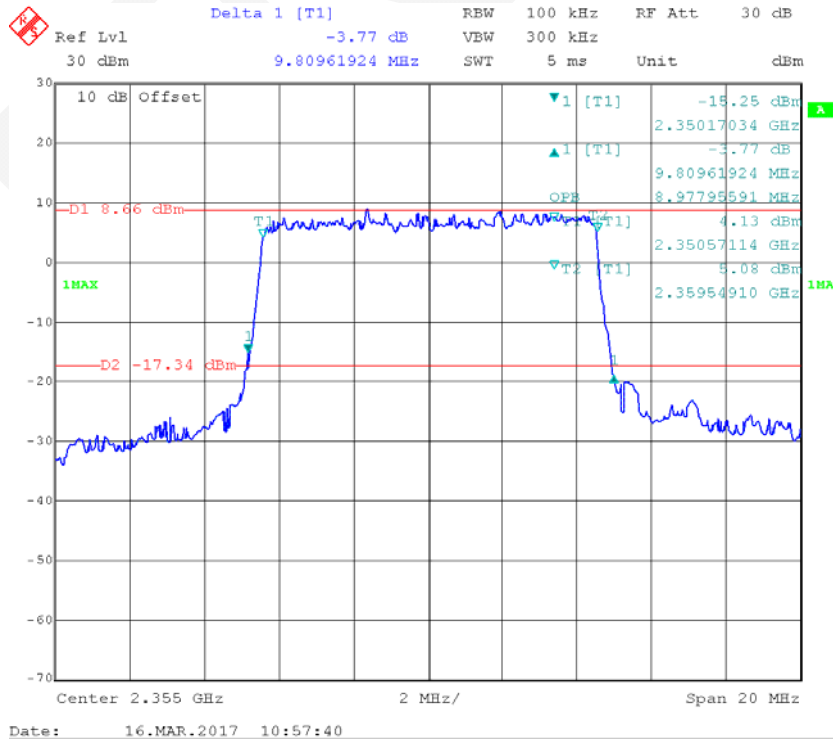

### 16-QAM, 5MHz

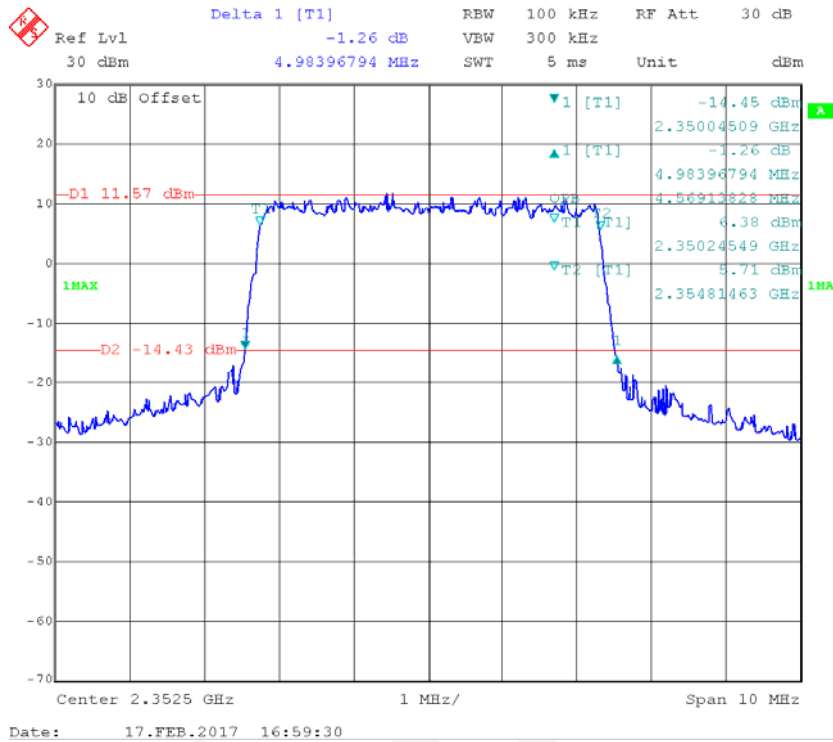

### 16-QAM, 10MHz

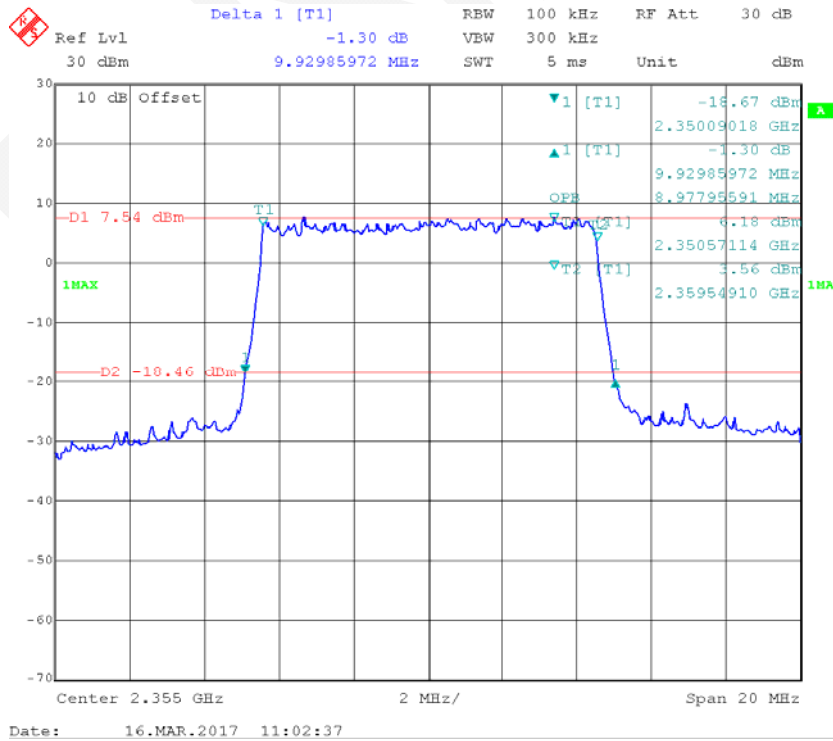

**Band 41:**

**QPSK, 5MHz**

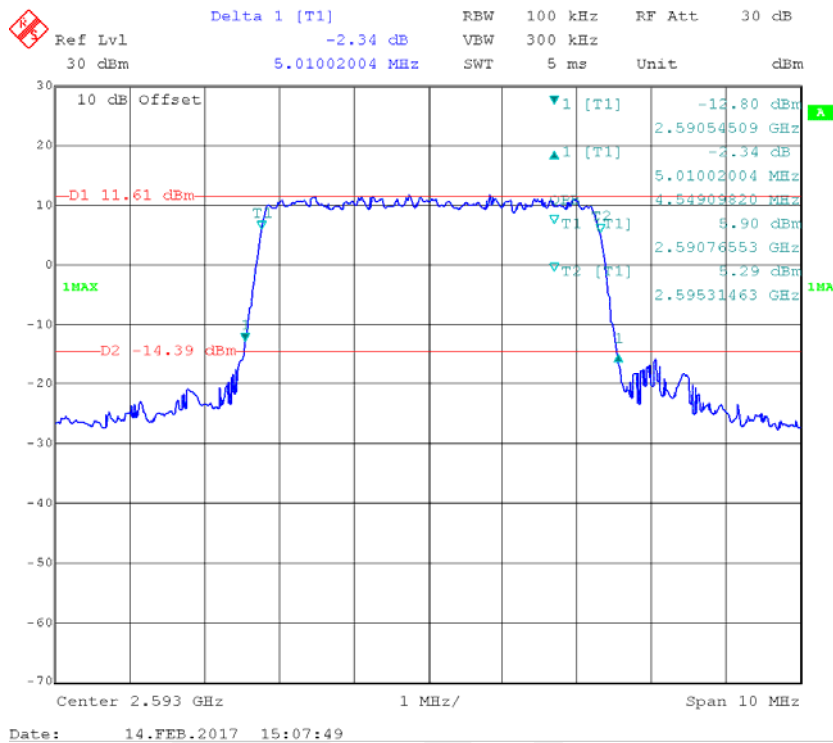

**QPSK, 10MHz**

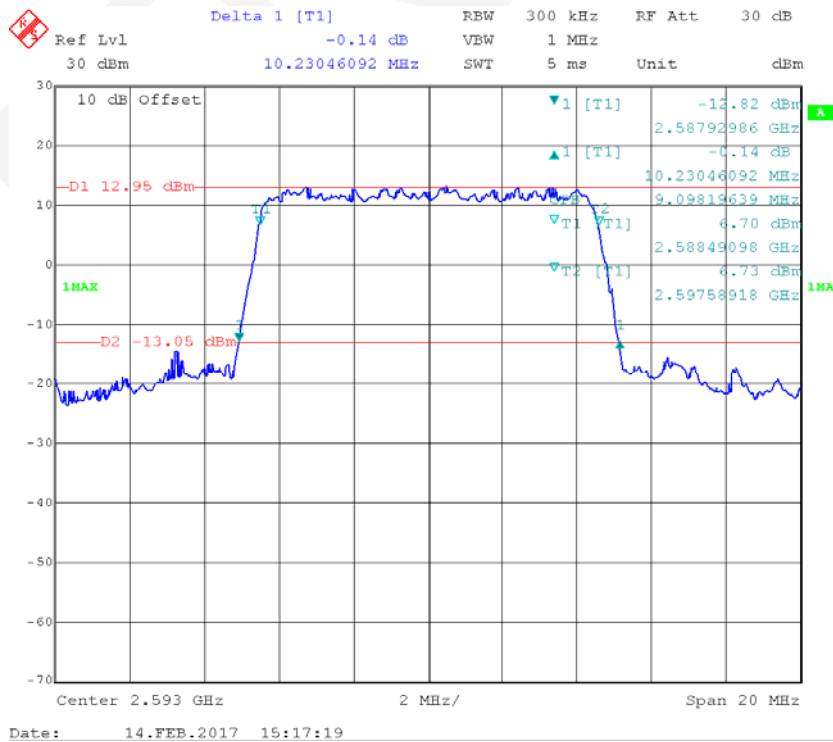

### QPSK, 15MHz

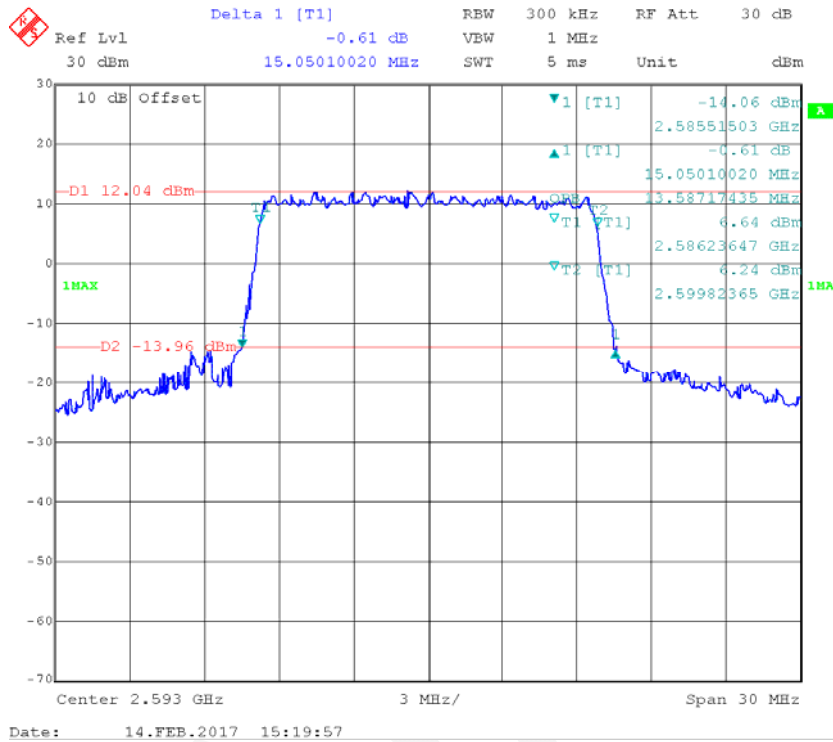

### QPSK, 20MHz

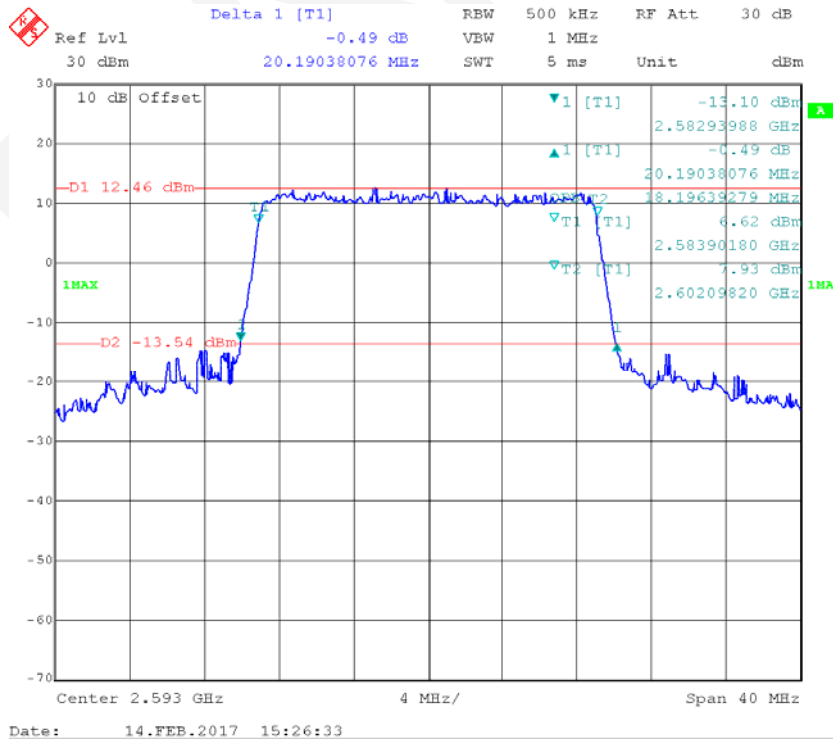

### 16-QAM, 5MHz

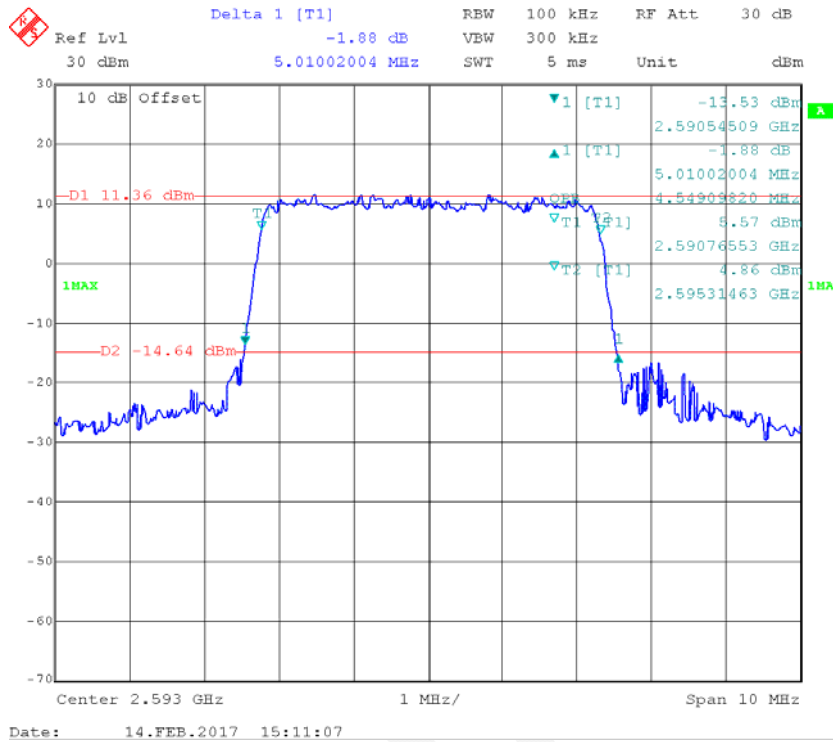

### 16-QAM, 10MHz

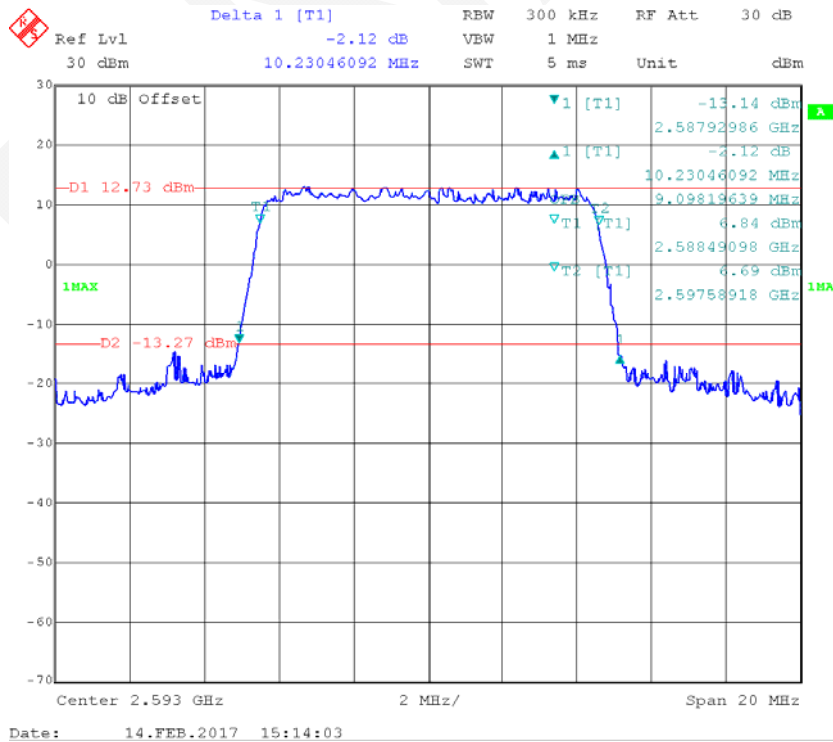

### 16-QAM, 15MHz

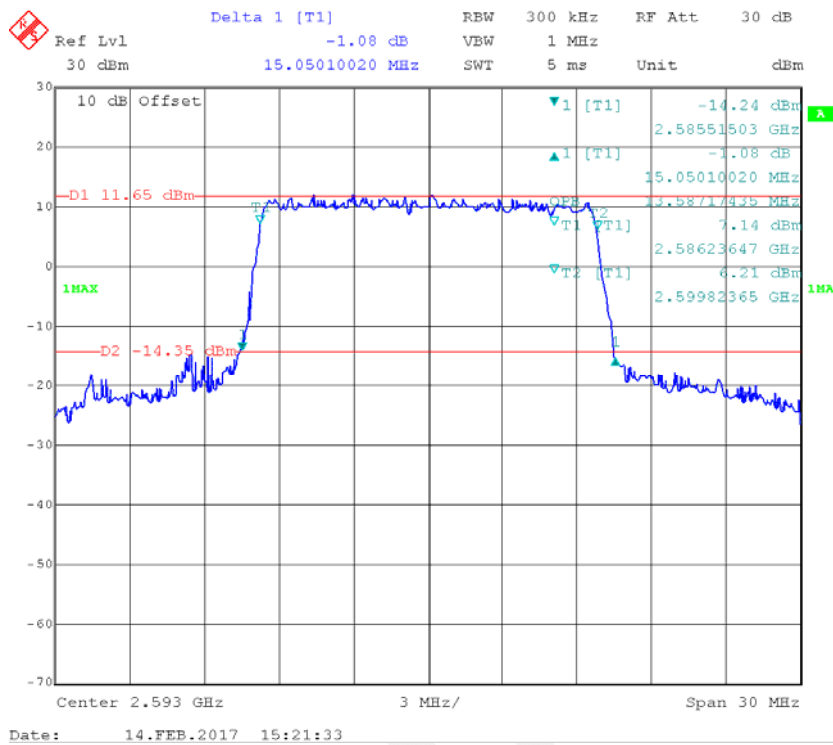

### 16-QAM, 20MHz

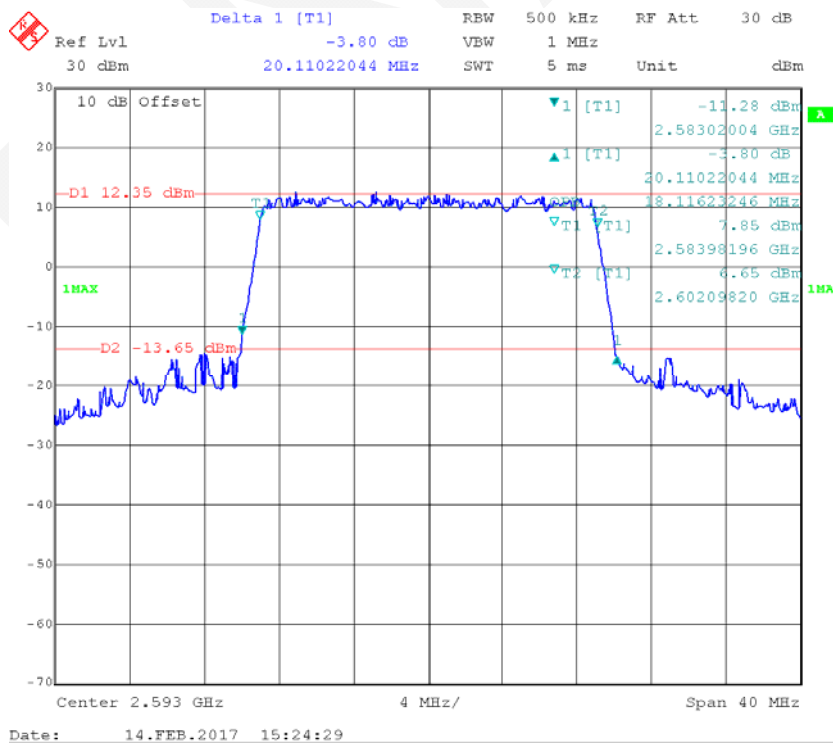

**Carrier Aggregation:**

**Band 7:**

Bandwidth (MHz)	Frequency (MHz)	Modulation	PCC RB	PCC RB	SCC1 RB	SCC1 RB	99% Occupied Bandwidth (MHz)	26dB Bandwidth (MHz)
			Size	Offset	Size	Offset		
20+5	2535.00	QPSK	100	0	25	0	23.41	26.09
		16-QAM	100	0	25	0	23.25	25.95
5	2544.20	QPSK	25	0	0	0	4.50	5.03
			1	0	0	0	0.26	0.44
		16-QAM	25	0	0	0	4.53	5.01
			1	0	0	0	0.30	0.48
20+20	2535.00	QPSK	100	0	100	0	37.68	43.36
		16-QAM	100	0	100	0	37.68	44.16
20	2544.90	QPSK	100	0	0	0	17.96	20.11
			1	0	0	0	0.32	0.49
		16-QAM	100	0	0	0	17.96	20.03
			1	0	0	0	0.32	0.57
5+20	2535.00	QPSK	25	0	100	0	23.73	25.97
		16-QAM	25	0	100	0	23.57	26.45
10+20	2535.00	QPSK	50	0	100	0	28.22	31.10
		16-QAM	50	0	100	0	28.22	30.94
20+10	2535.00	QPSK	100	0	50	0	27.66	30.87
		16-QAM	100	0	50	0	27.66	30.99
15+15	2535.00	QPSK	75	0	75	0	28.86	31.90
		16-QAM	75	0	75	0	28.86	31.90
15+20	2535.00	QPSK	75	0	100	0	33.03	36.07
		16-QAM	75	0	100	0	33.19	38.64
20+15	2535.00	QPSK	100	0	75	0	32.83	35.91
		16-QAM	100	0	75	0	32.83	36.23



**Band 41:**

Bandwidth (MHz)	Frequency (MHz)	Modulation	PCC RB	PCC RB	SCC1 RB	SCC1 RB	99% Occupied Bandwidth (MHz)	26dB Bandwidth (MHz)
			Size	Offset	Size	Offset		
20+5	2593.00	QPSK	100	0	25	0	23.73	35.43
		16-QAM	100	0	25	0	23.89	30.14
5	2602.20	QPSK	25	0	0	0	4.50	5.07
			1	0	0	0	0.26	0.50
		16-QAM	25	0	0	0	4.50	5.07
			1	0	0	0	0.30	0.42
20+20	2593.00	QPSK	100	0	100	0	38.16	56.11
		16-QAM	100	0	100	0	38.16	54.99
20	2583.10	QPSK	100	0	0	0	17.96	20.43
			1	0	0	0	0.28	0.40
		16-QAM	100	0	0	0	17.96	20.75
			1	0	0	0	0.36	0.48
5+20	2593.00	QPSK	25	0	100	0	23.89	26.78
		16-QAM	25	0	100	0	23.73	33.99
10+20	2593.00	QPSK	50	0	100	0	28.54	37.03
		16-QAM	50	0	100	0	28.54	34.63
20+10	2593.00	QPSK	100	0	50	0	28.54	53.71
		16-QAM	100	0	50	0	28.54	47.45
15+15	2593.00	QPSK	75	0	75	0	29.18	46.17
		16-QAM	75	0	75	0	29.02	58.52
15+20	2593.00	QPSK	75	0	100	0	33.35	56.75
		16-QAM	75	0	100	0	33.35	55.47
20+15	2593.00	QPSK	100	0	75	0	33.35	48.25
		16-QAM	100	0	75	0	33.35	52.91

26dB:

**Band 7\_5&20MHz\_QPSK\_P25#0&S100#0**

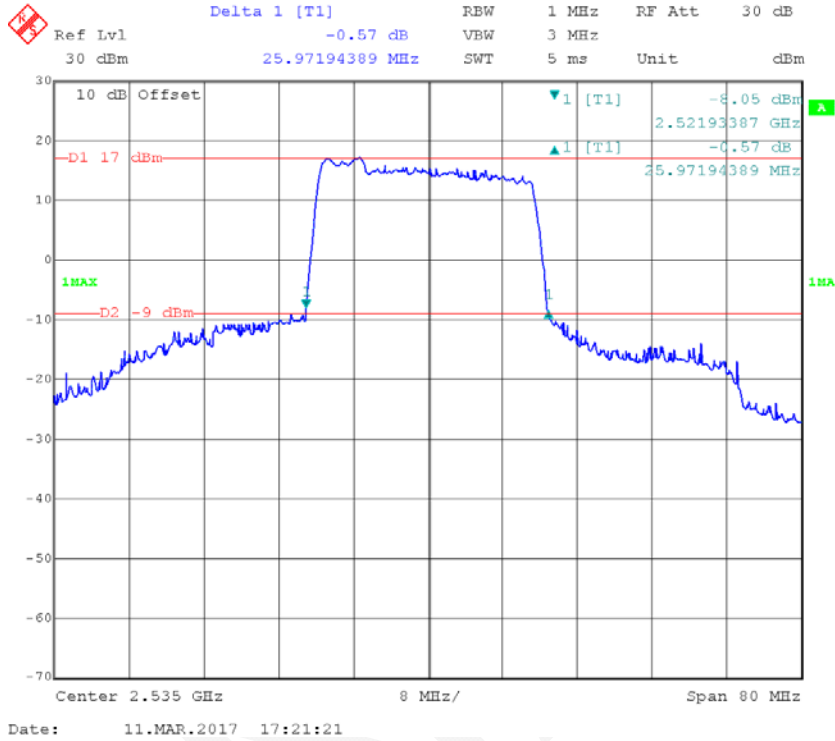

**Band 7\_5&20MHz\_16QAM\_P25#0&S100#0**

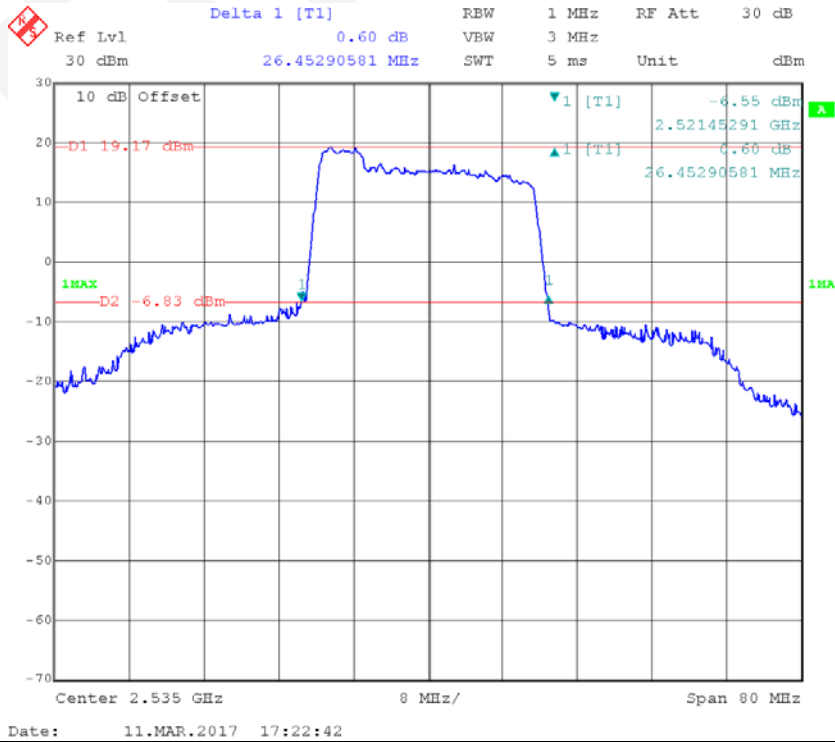

### Band 7\_5MHz\_QPSK\_RB1

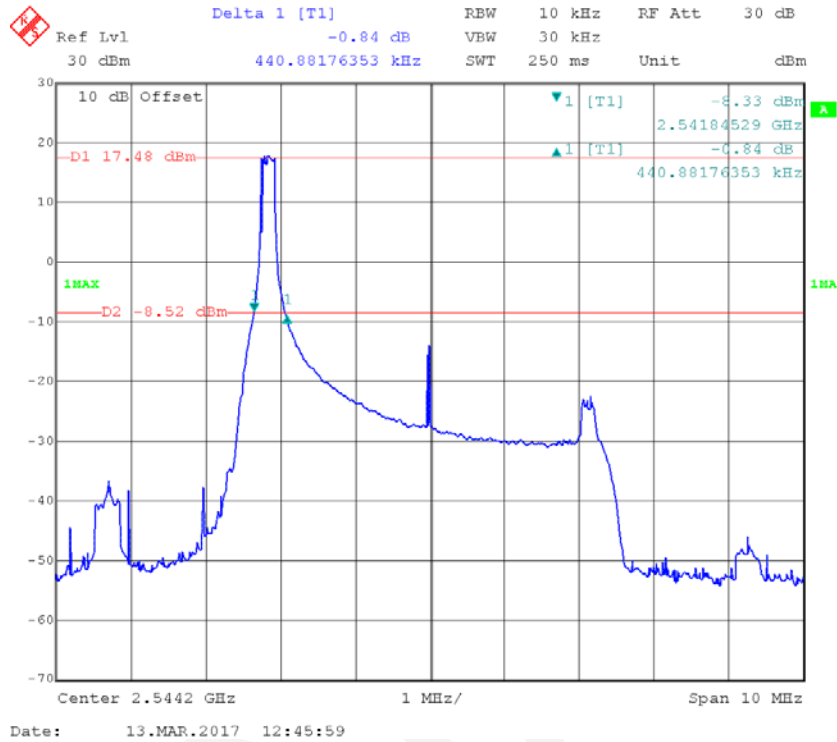

### Band 7\_5MHz\_QPSK\_RB25

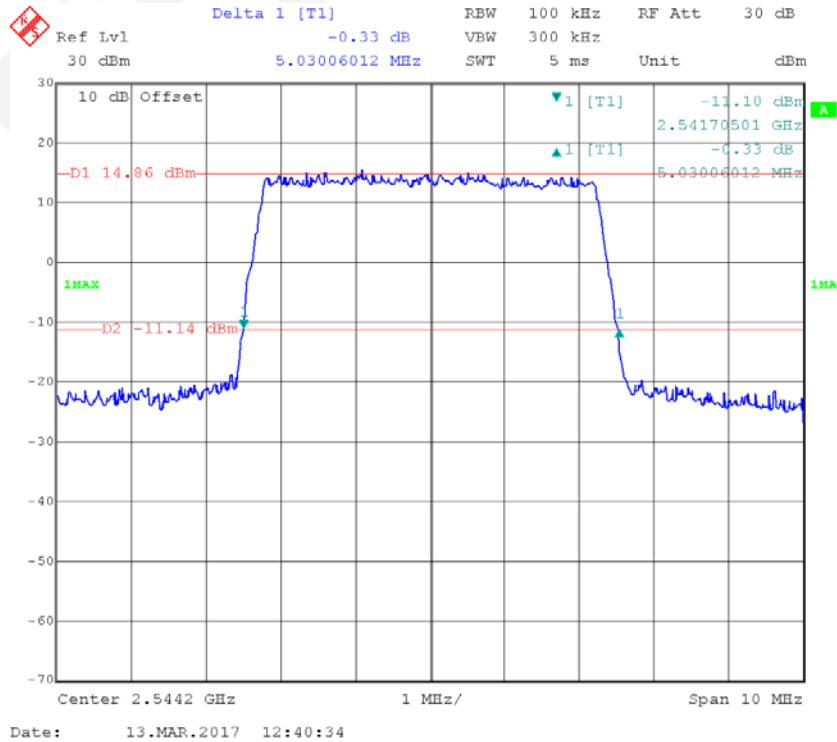

### Band 7\_5MHz\_16QAM\_RB1

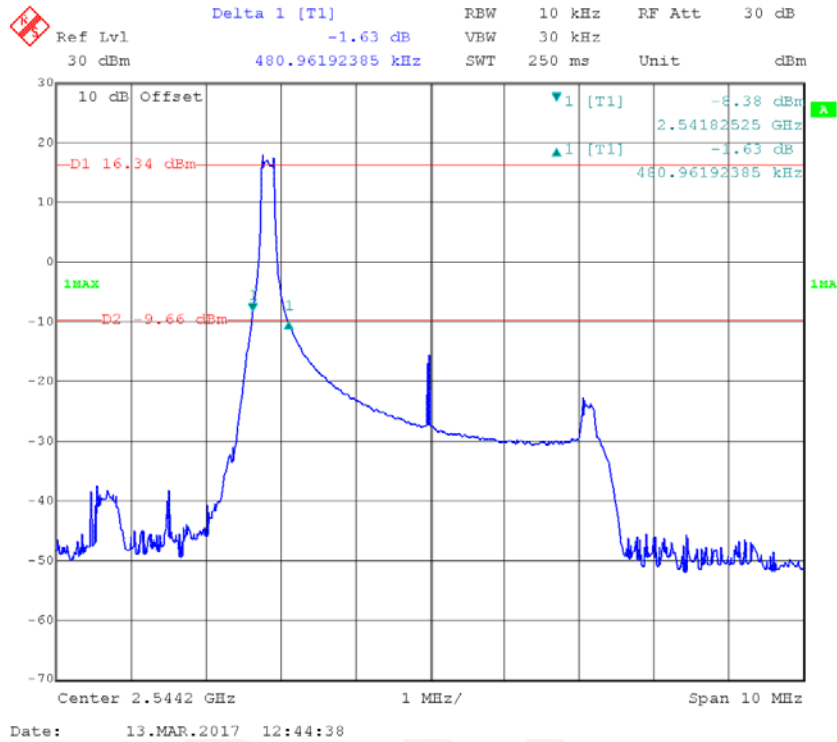

### Band 7\_5MHz\_16QAM\_RB25

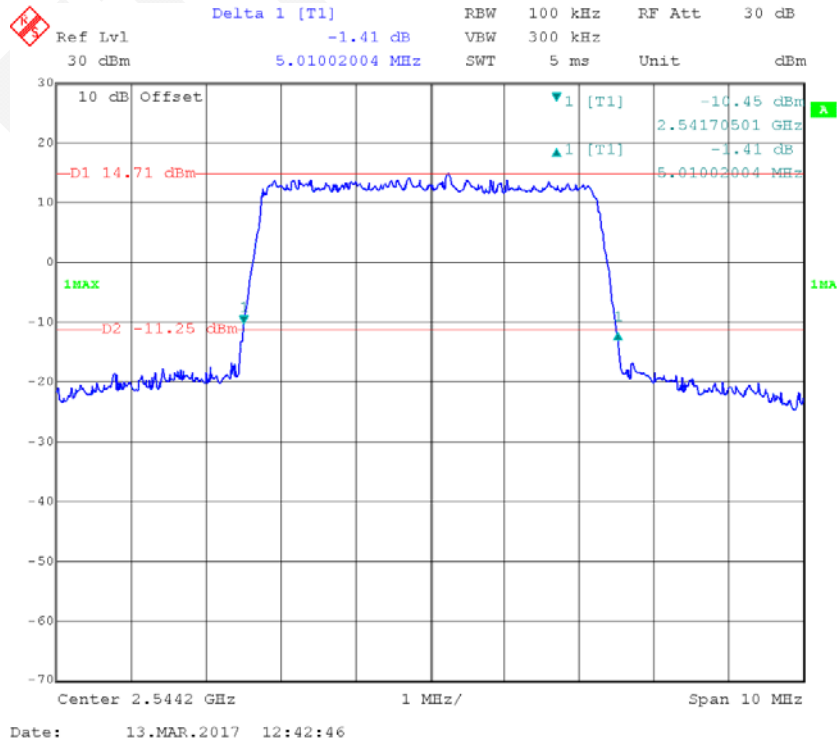

**Band 7\_10&20MHz\_QPSK\_P50#0&S100#0**

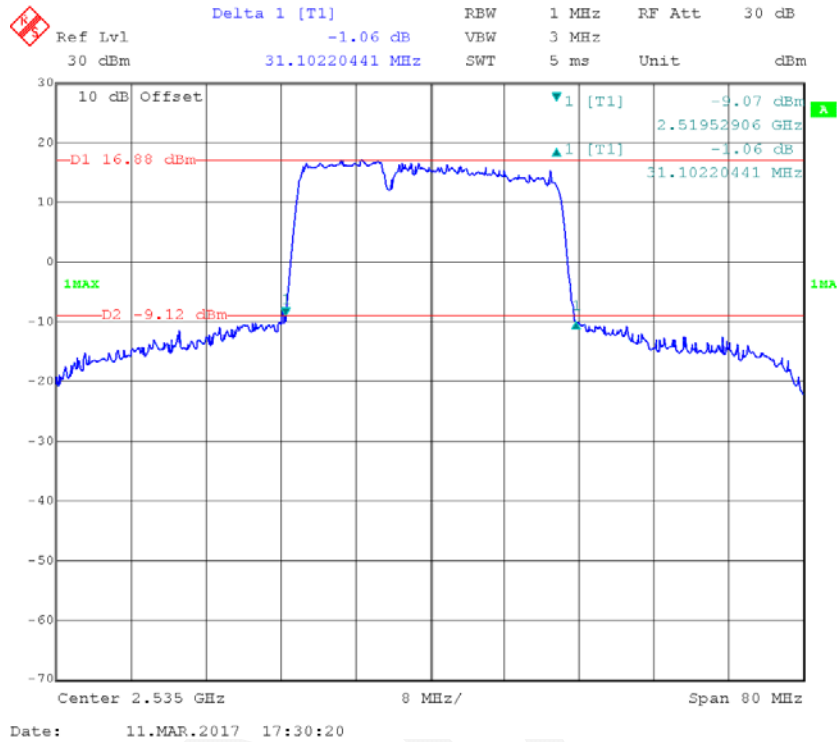

**Band 7\_10&20MHz\_16QAM\_P50#0&S100#0**

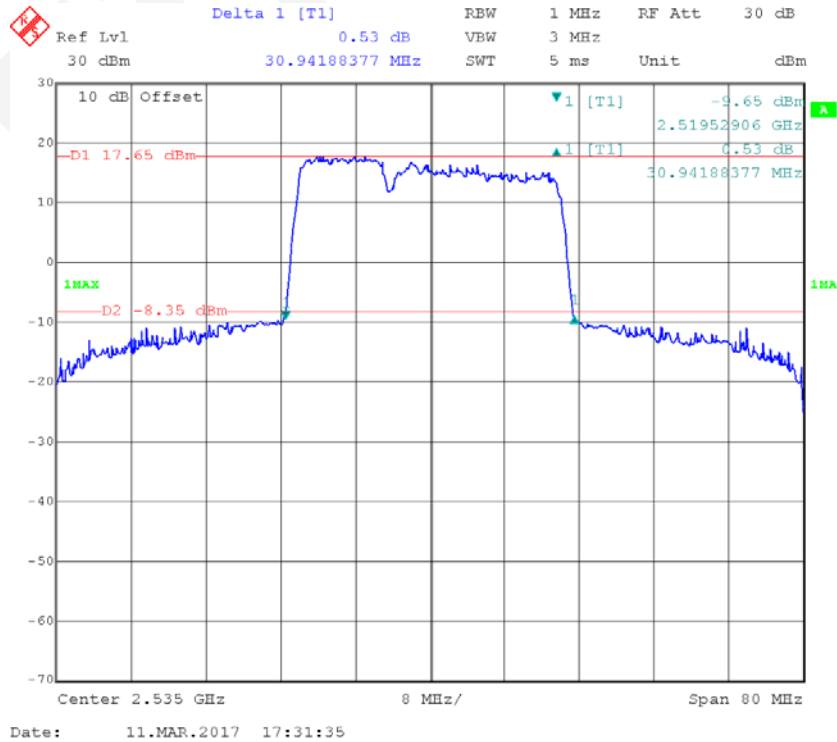

**Band 7\_15&15MHz\_QPSK\_P75#0&S75#0**

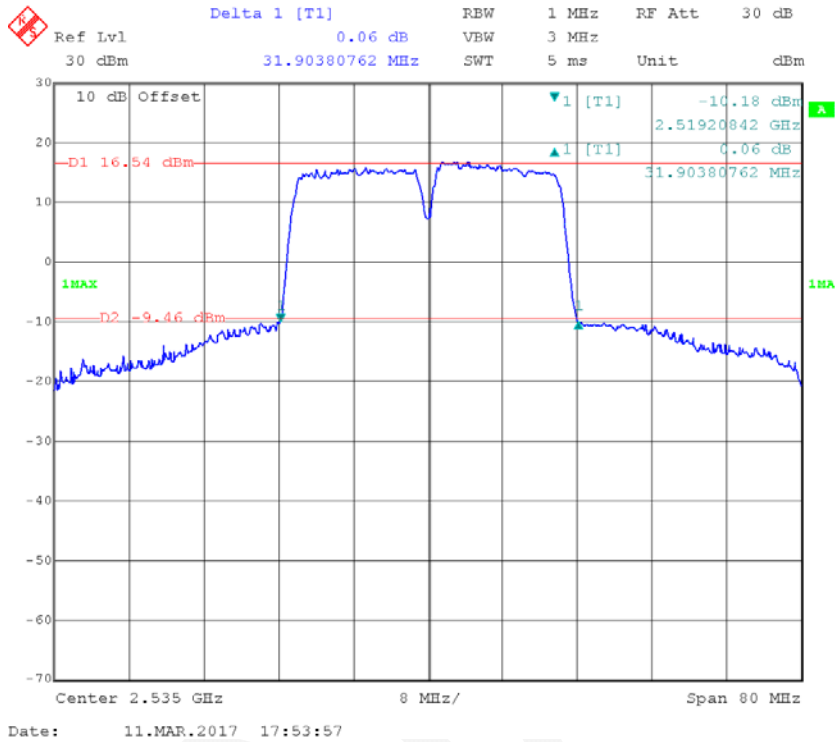

**Band 7\_15&15MHz\_16QAM\_P75#0&S75#0**

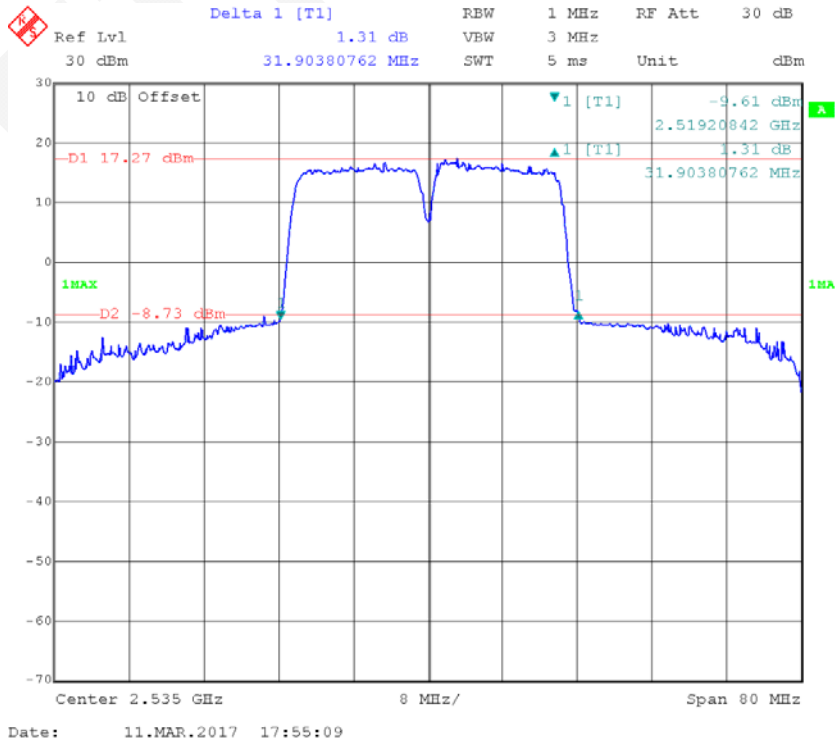

### Band 7\_15&20MHz\_QPSK\_P75#0&S100#0

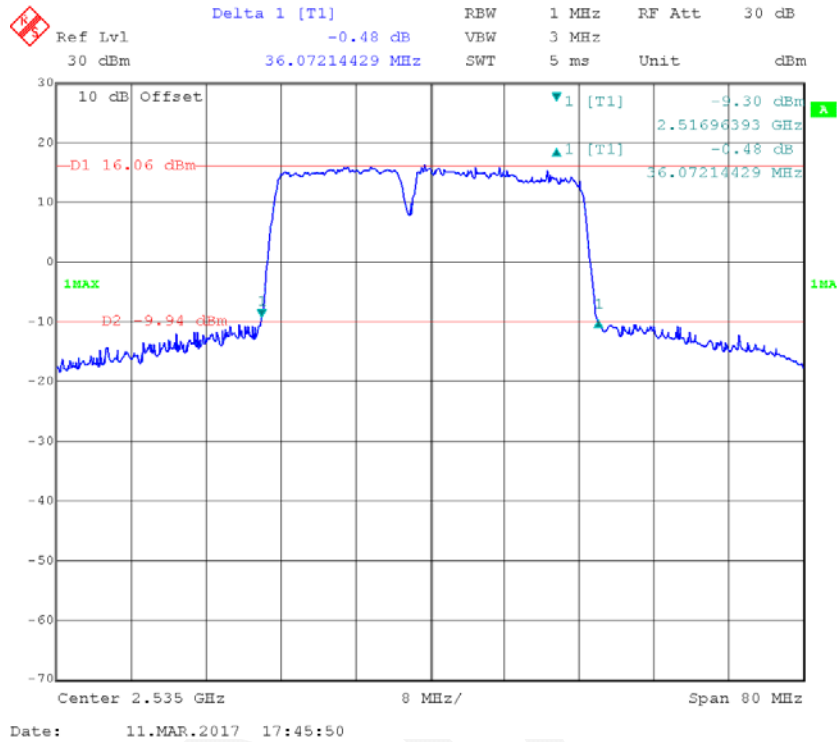

### Band 7\_15&20MHz\_16QAM\_P75#0&S100#0

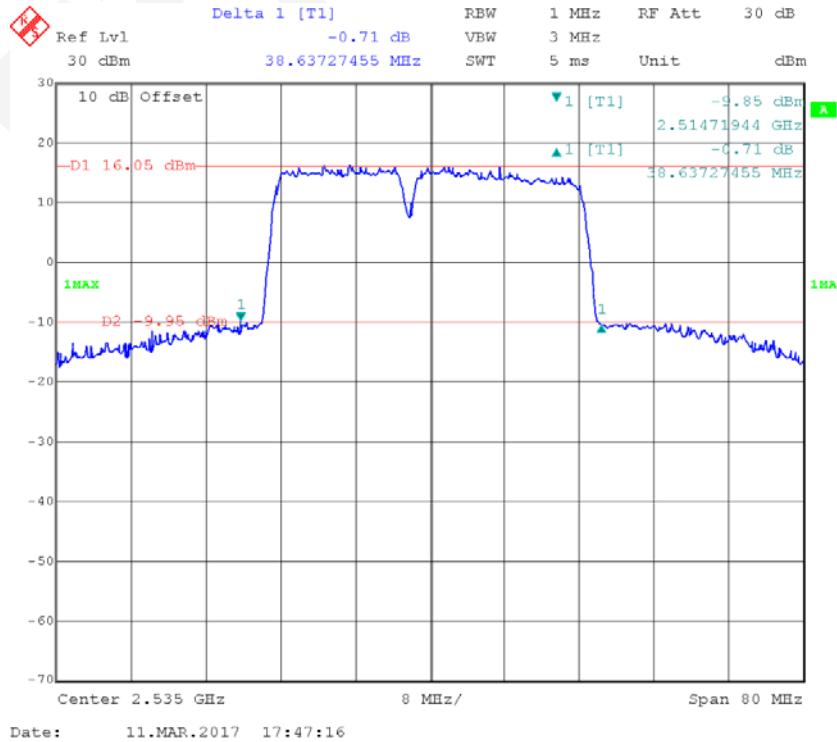

### Band 7\_20&5MHz\_QPSK\_P100#0&S25#0

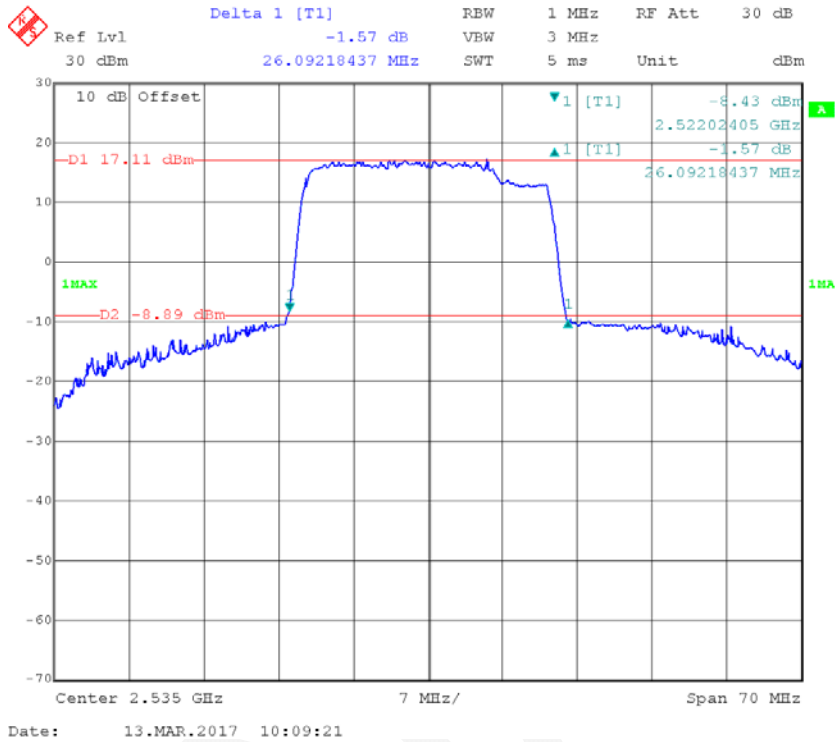

### Band 7\_20&5MHz\_16QAM\_P100#0&S25#0

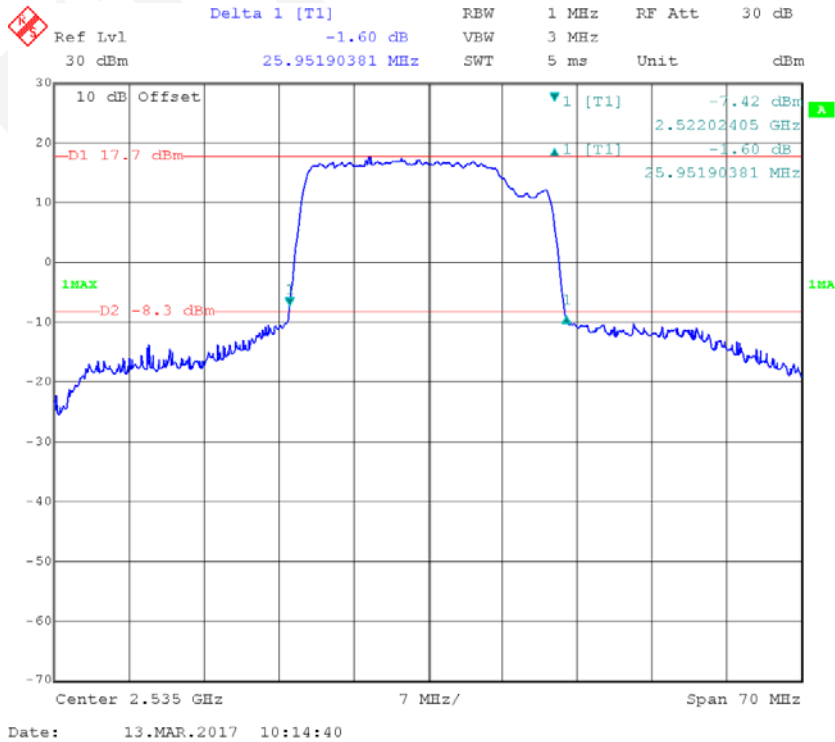



**Band 7\_20&10MHz\_QPSK\_P100#0&S50#0**

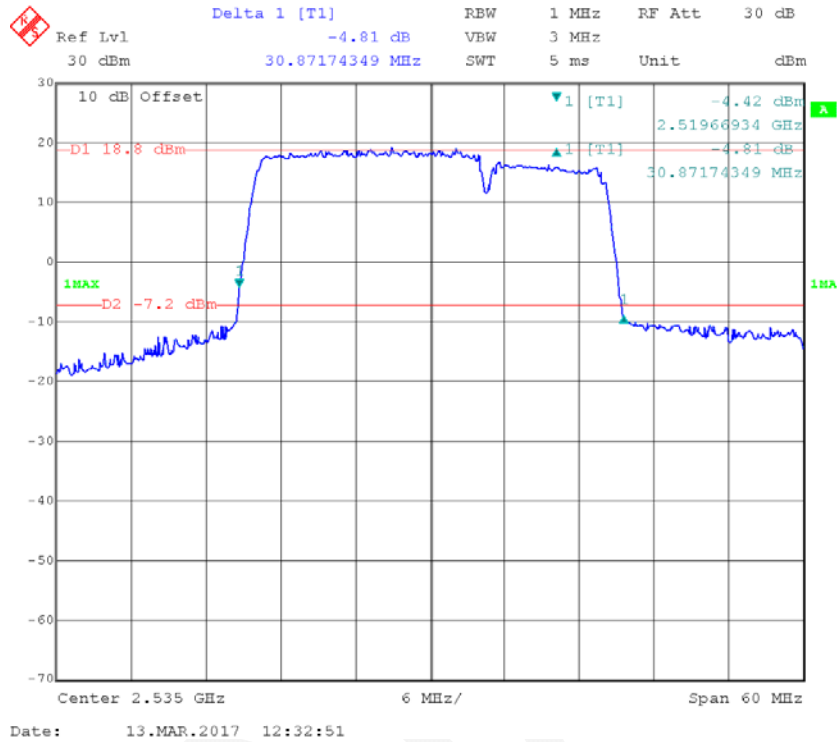

**Band 7\_20&10MHz\_16QAM\_P100#0&S50#0**

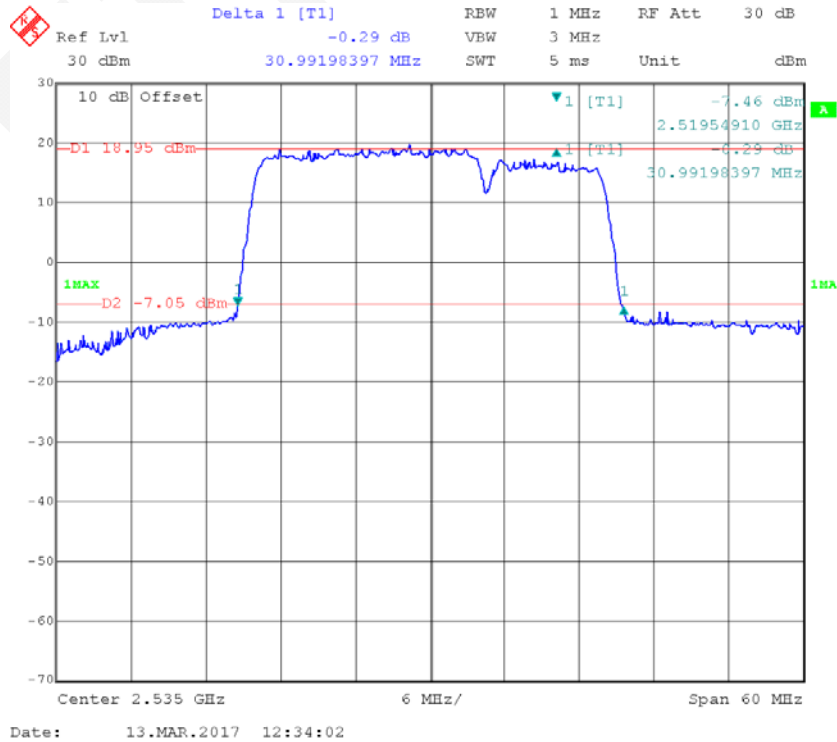

### Band 7\_20&15MHz\_QPSK\_P100#0&S75#0

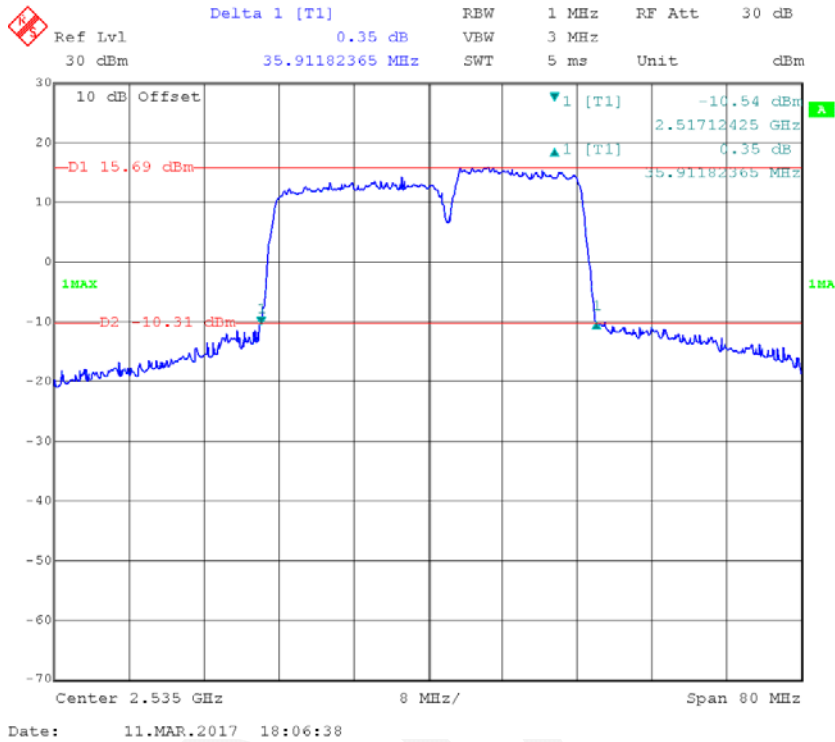

### Band 7\_20&15MHz\_16QAM\_P100#0&S75#0

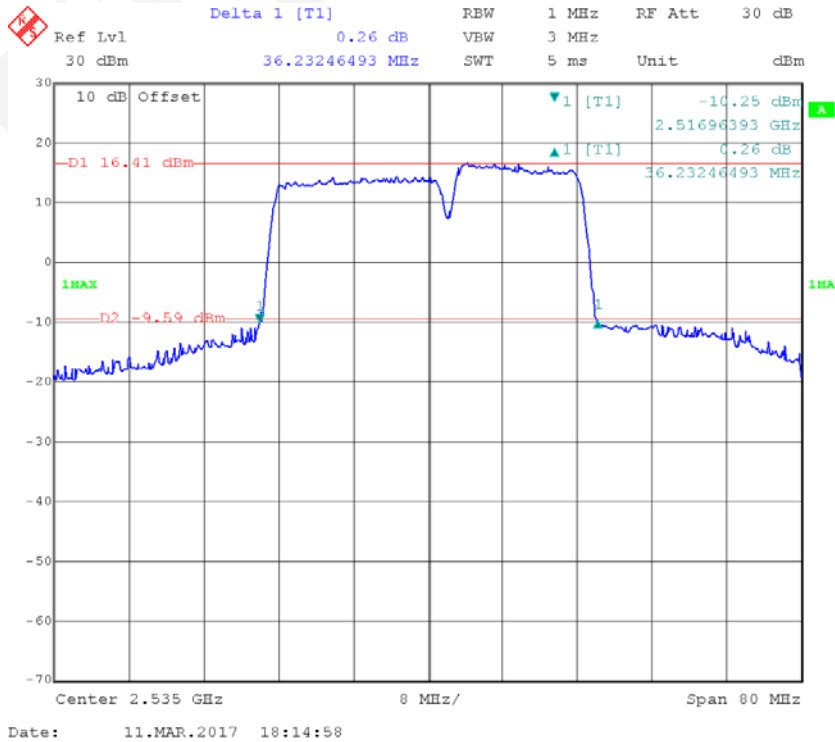

### Band 7\_20&20MHz\_QPSK\_P100#0&S100#0

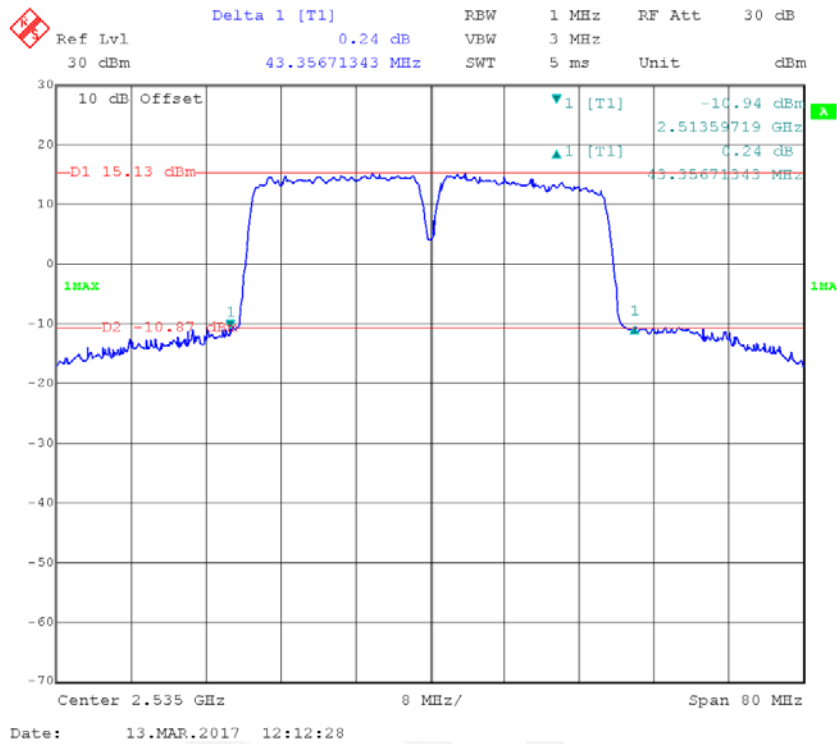

### Band 7\_20&20MHz\_16QAM\_P100#0&S100#0

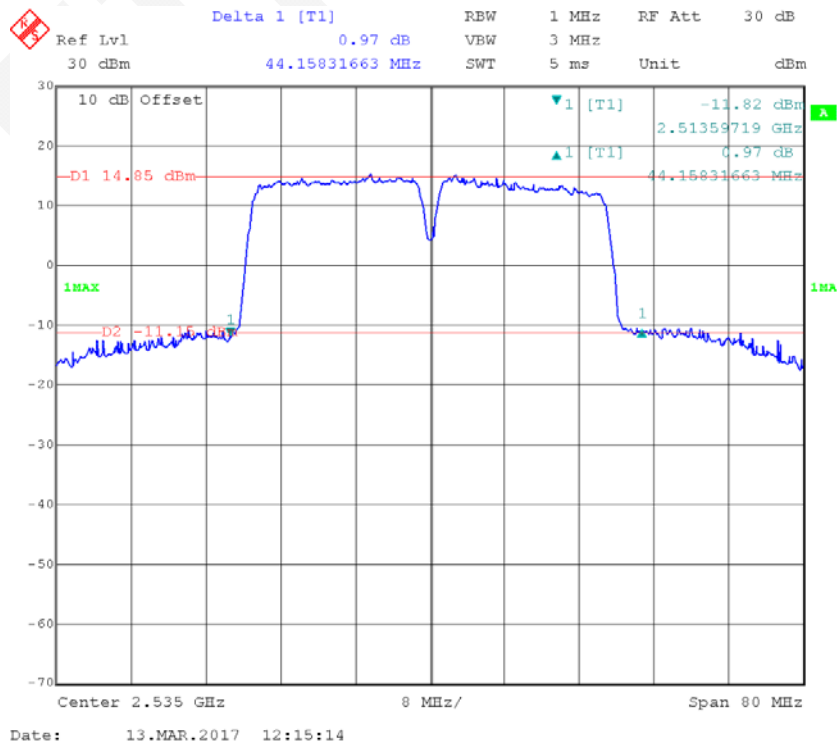

### Band 7\_20MHz\_QPSK\_RB1

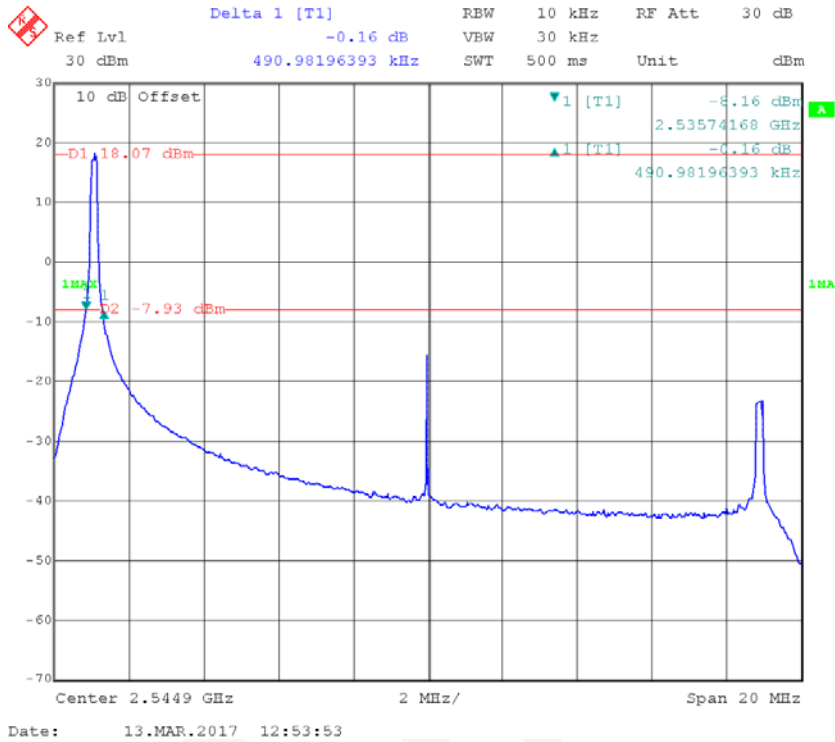

### Band 7\_20MHz\_QPSK\_RB100

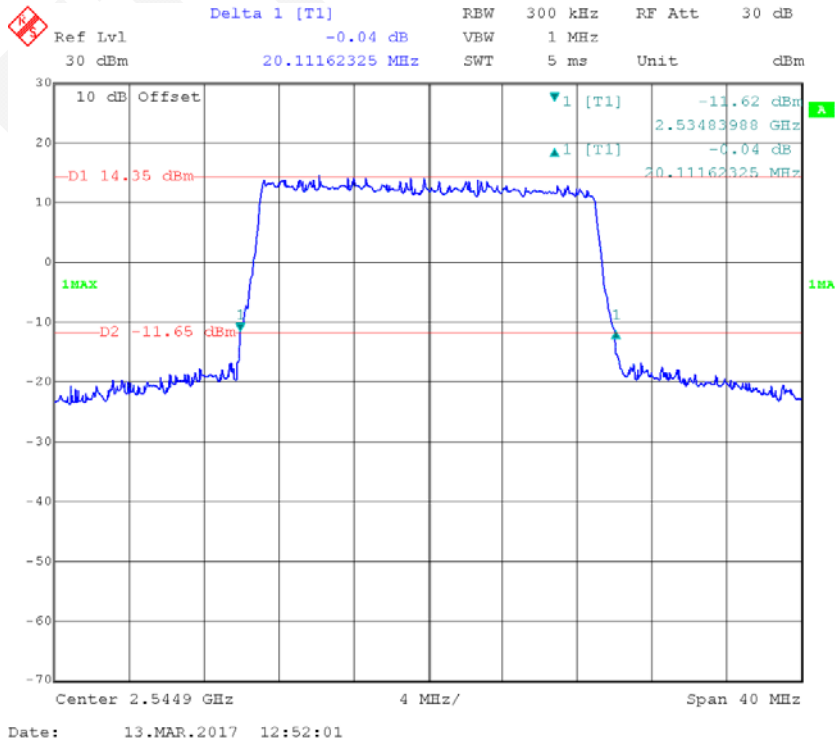

**Band 7\_20MHz\_16QAM\_RB1**

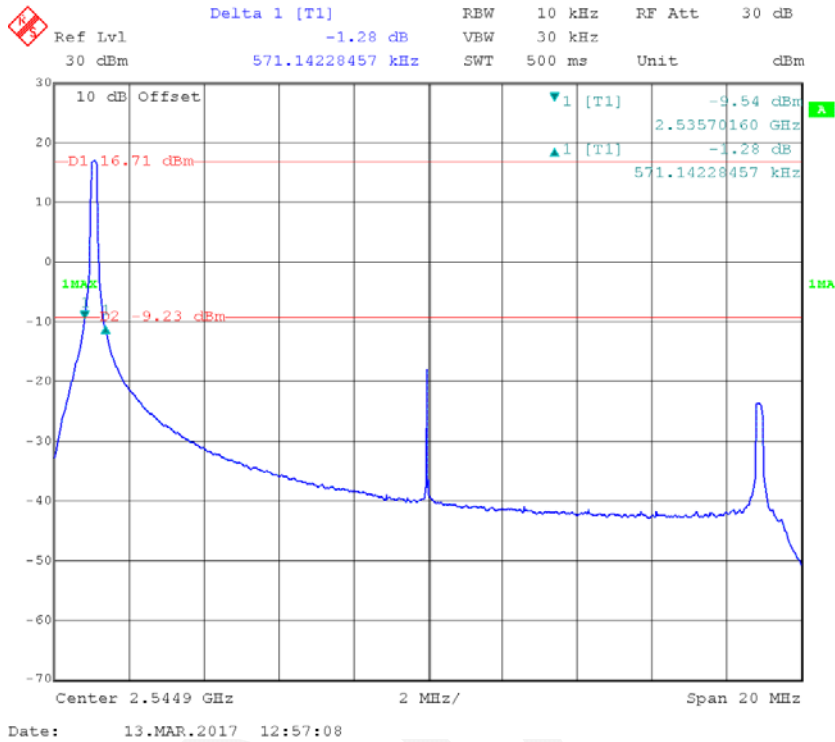

**Band 7\_20MHz\_16QAM\_RB100**

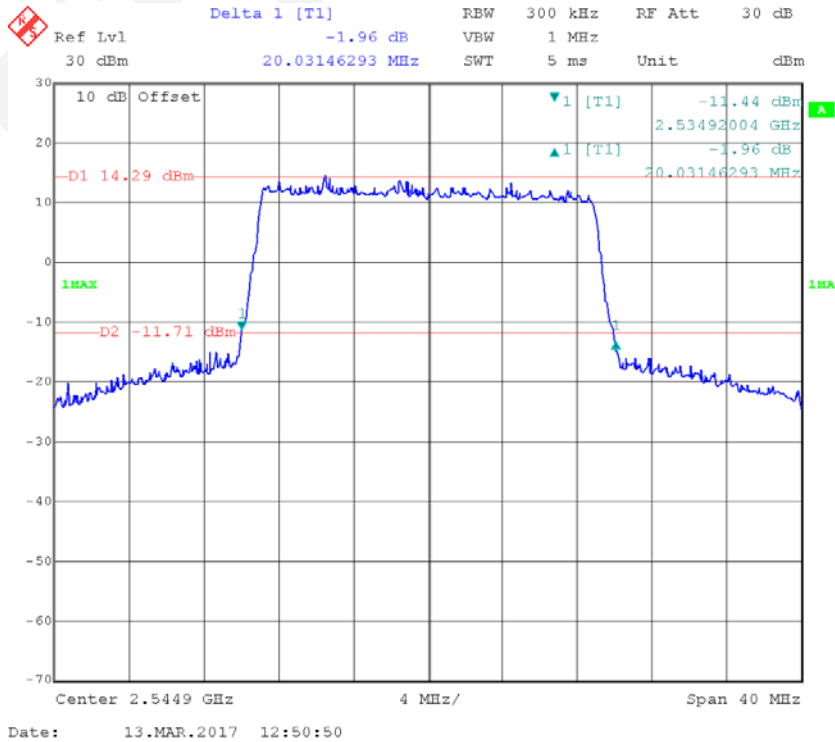

### Band 41\_5&20MHz\_QPSK\_P25#0&S100#0

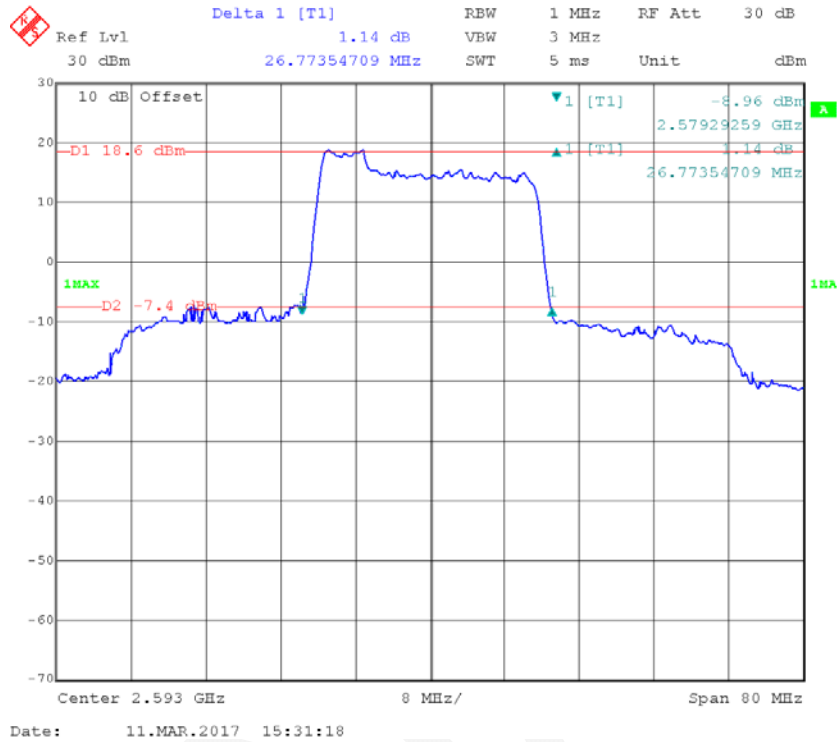

### Band 41\_5&20MHz\_16QAM\_P25#0&S100#0

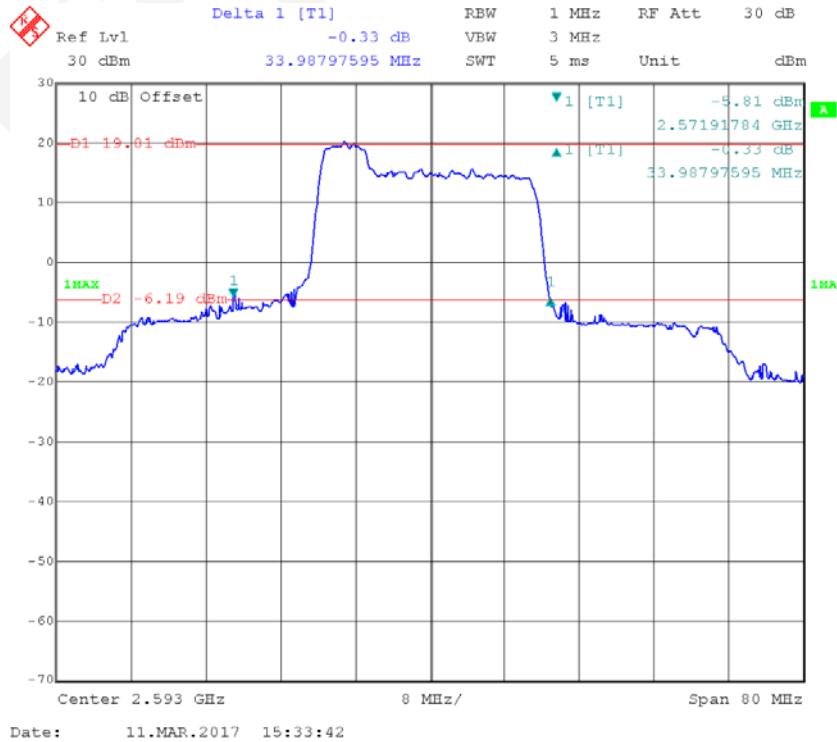

### Band 41\_5MHz\_QPSK\_RB1

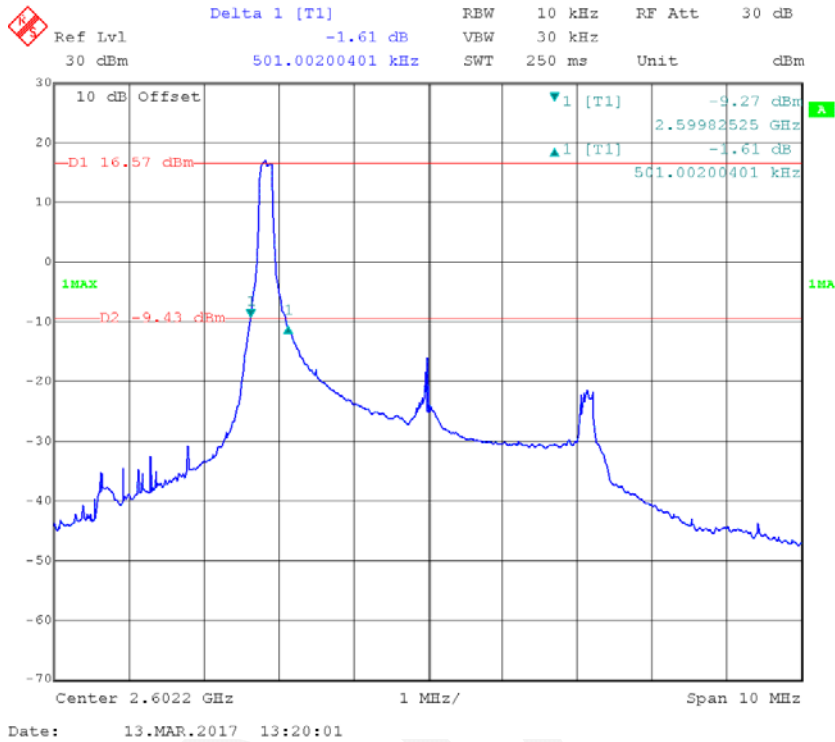

### Band 41\_5MHz\_QPSK\_RB25

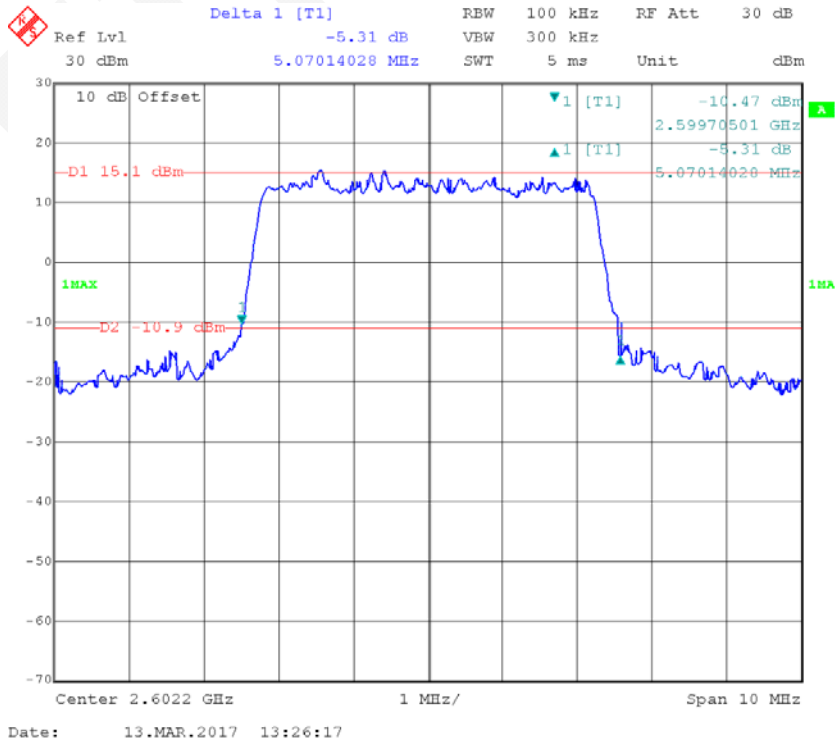

### Band 41\_5MHz\_16QAM\_RB1

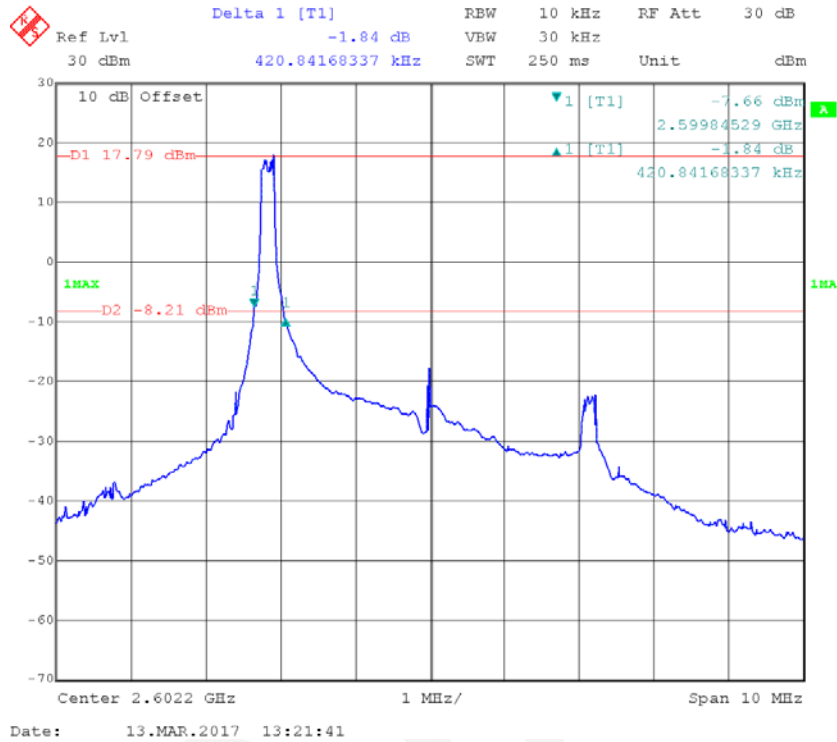

### Band 41\_5MHz\_16QAM\_RB25

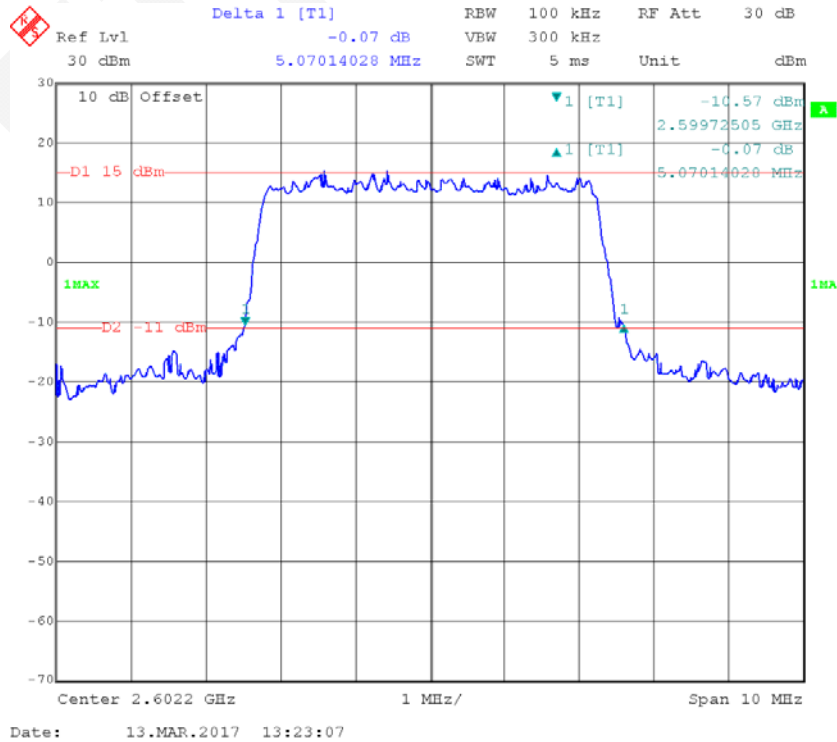



Band 41\_10&20MHz\_QPSK\_P50#0&S100#0

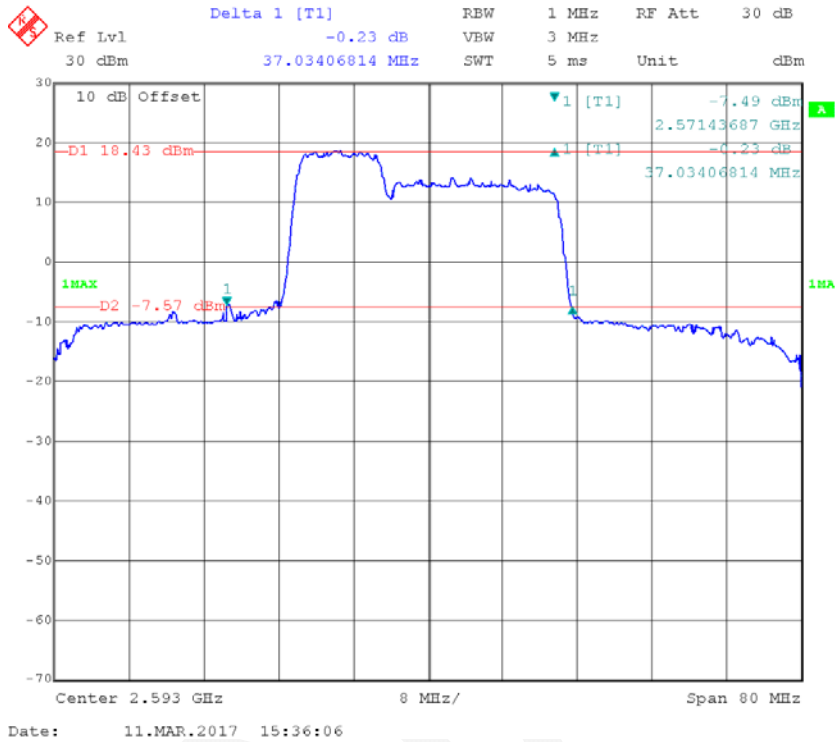

Band 41\_10&20MHz\_16QAM\_P50#0&S100#0

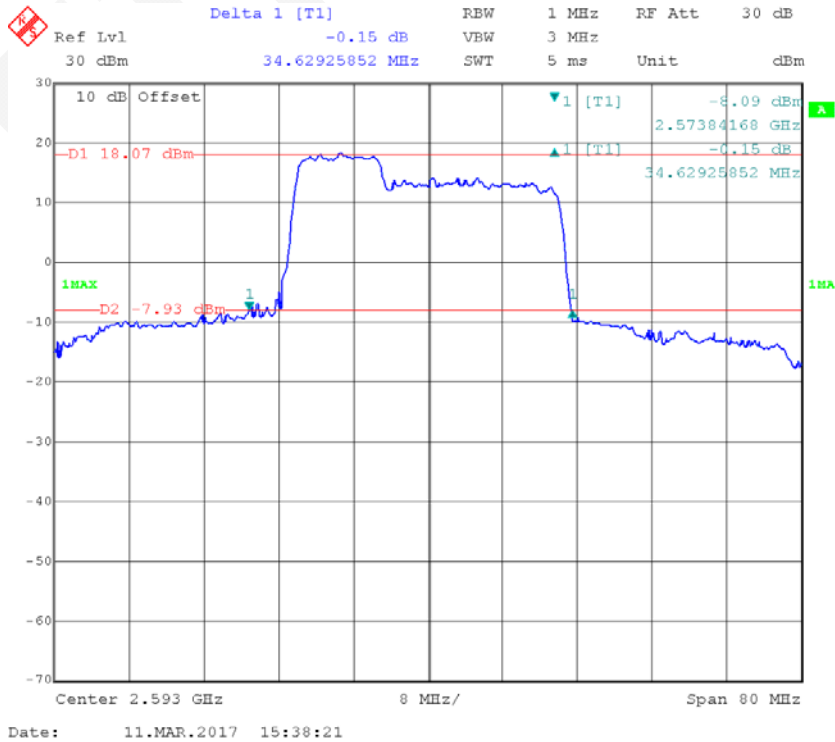

### Band 41\_15&15MHz\_QPSK\_P75#0&S75#0

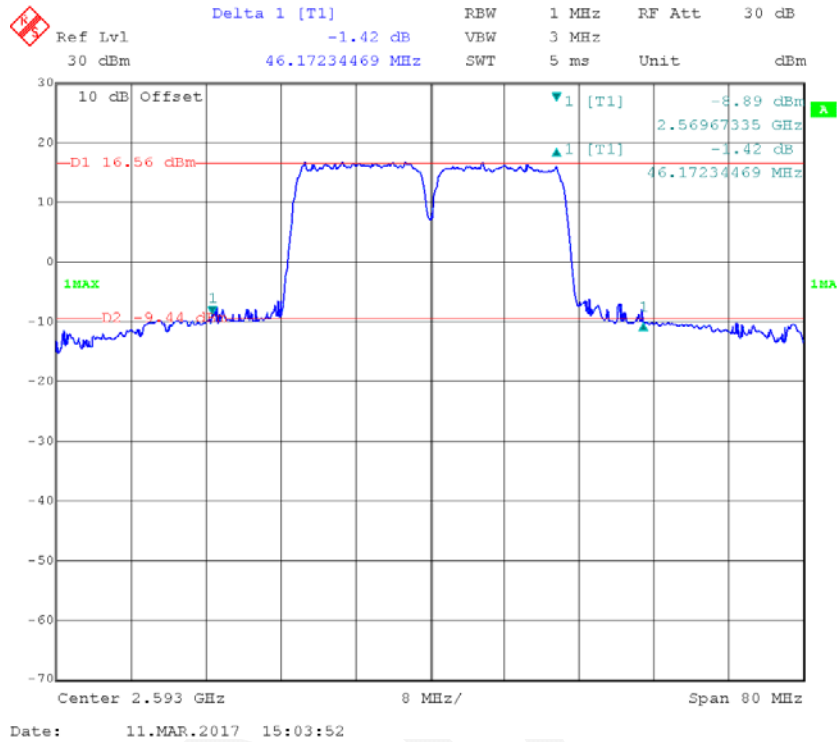

### Band 41\_15&15MHz\_16QAM\_P75#0&S75#0

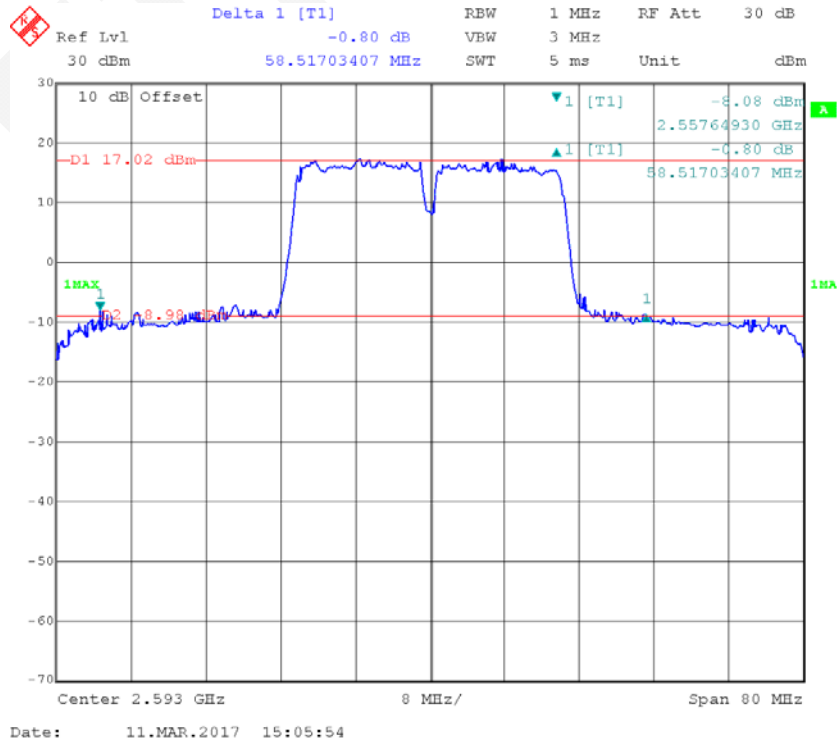

### Band 41\_15&20MHz\_QPSK\_P75#0&S100#0

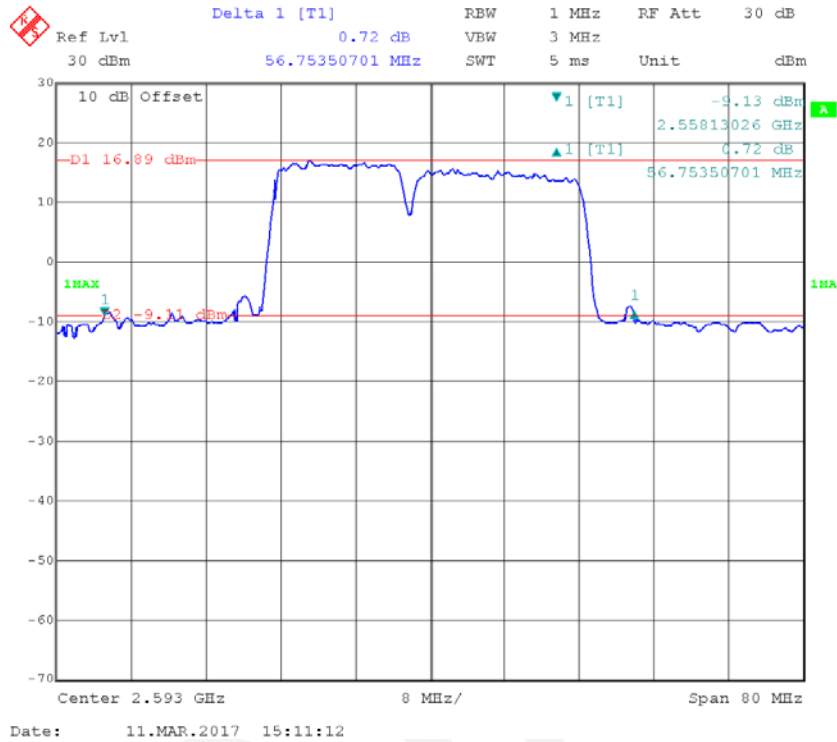

### Band 41\_15&20MHz\_16QAM\_P75#0&S100#0

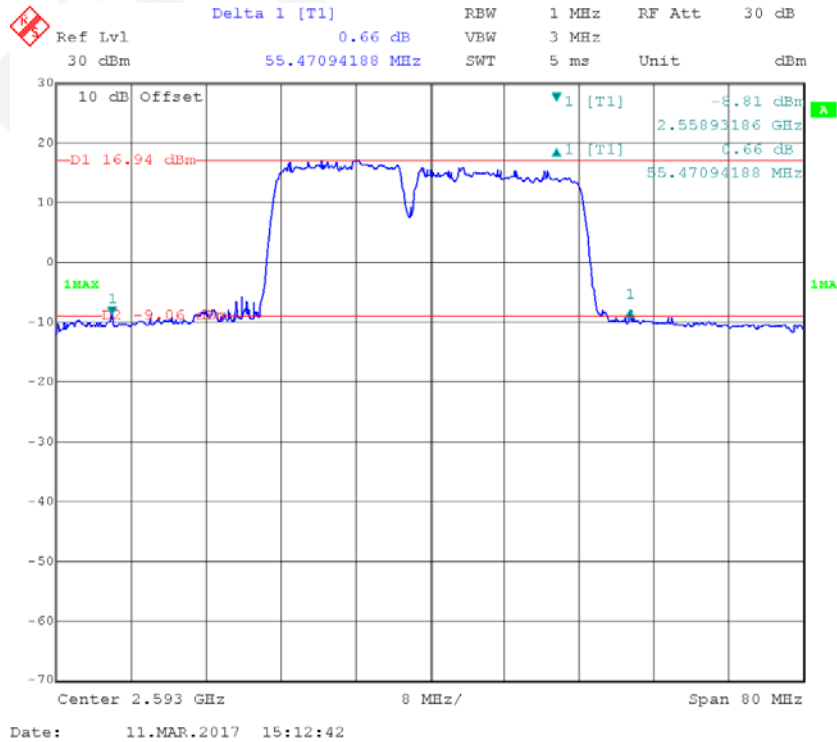

**Band 41\_20&5MHz\_QPSK\_P100#0&S25#0**

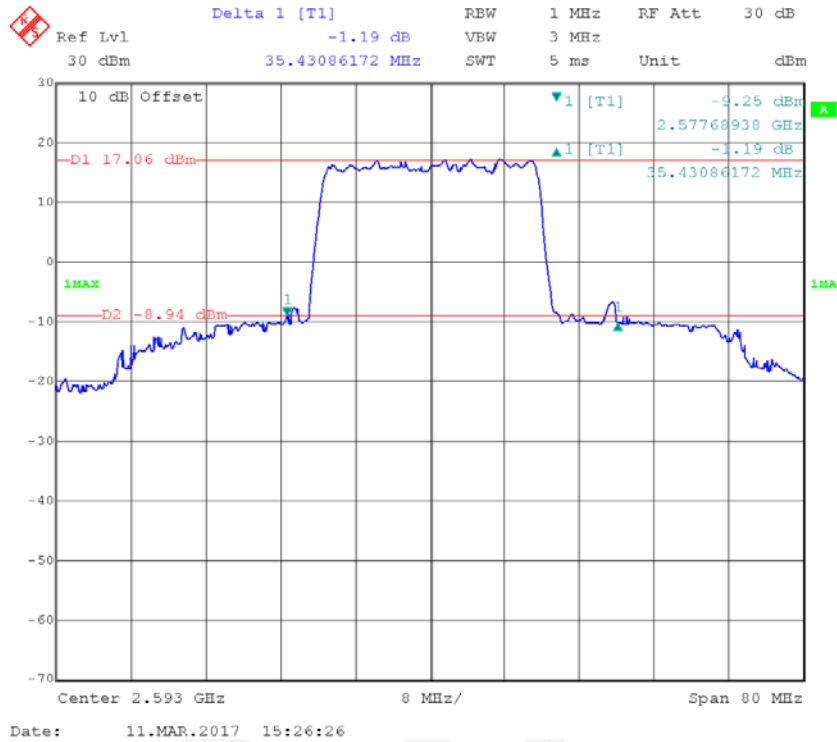

**Band 41\_20&5MHz\_16QAM\_P100#0&S25#0**

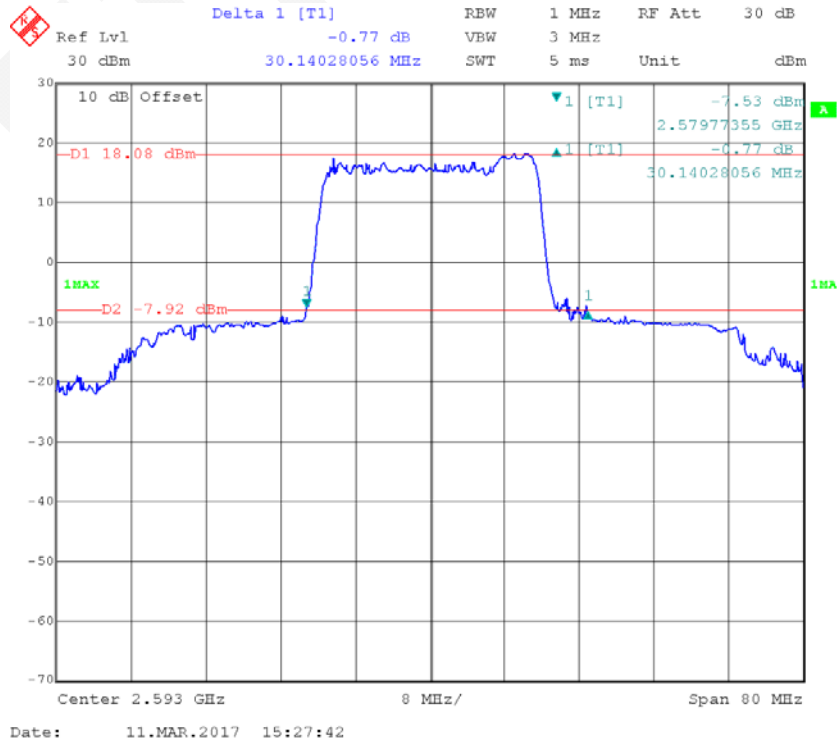

**Band 41\_20&10MHz\_QPSK\_P100#0&S50#0**

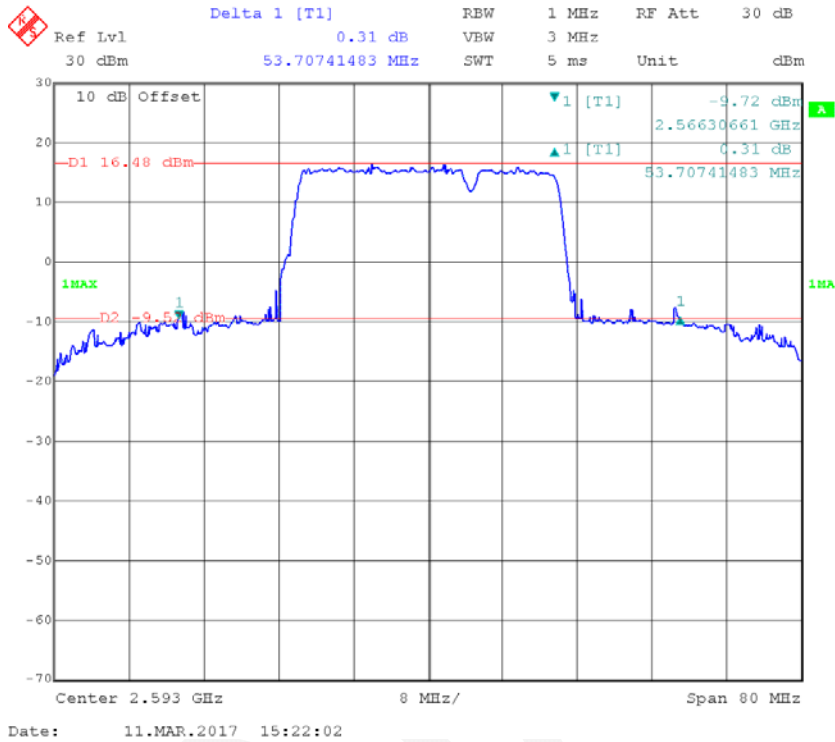

**Band 41\_20&10MHz\_16QAM\_P100#0&S50#0**

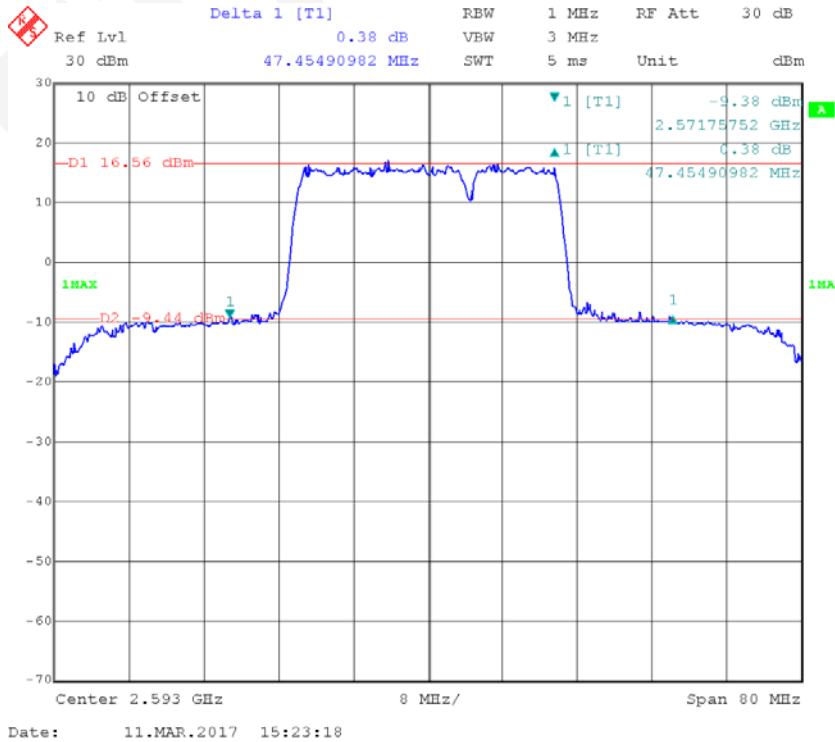

**Band 41\_20&15MHz\_QPSK\_P100#0&S75#0**

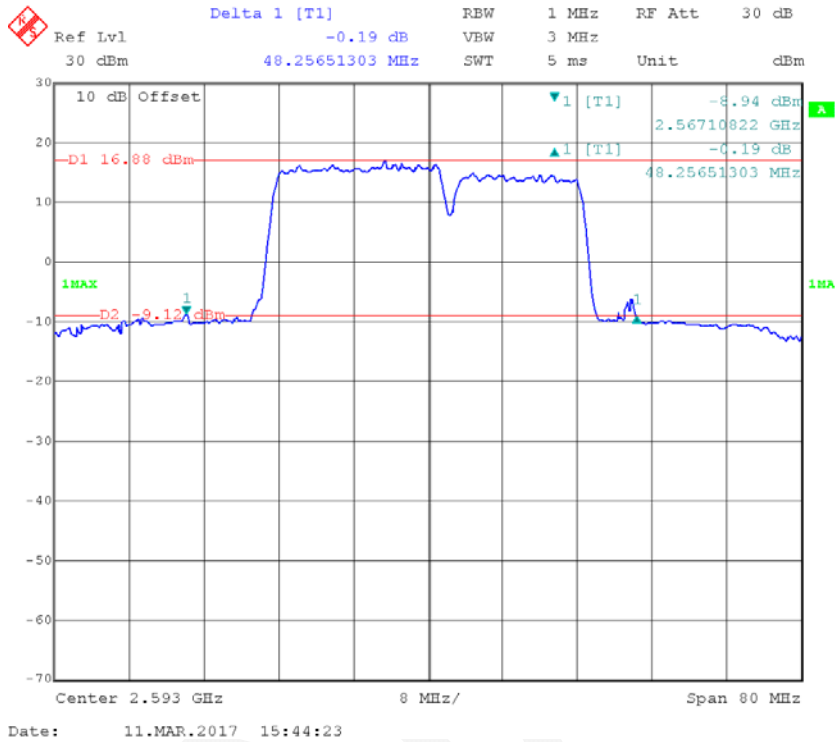

**Band 41\_20&15MHz\_16QAM\_P100#0&S75#0**

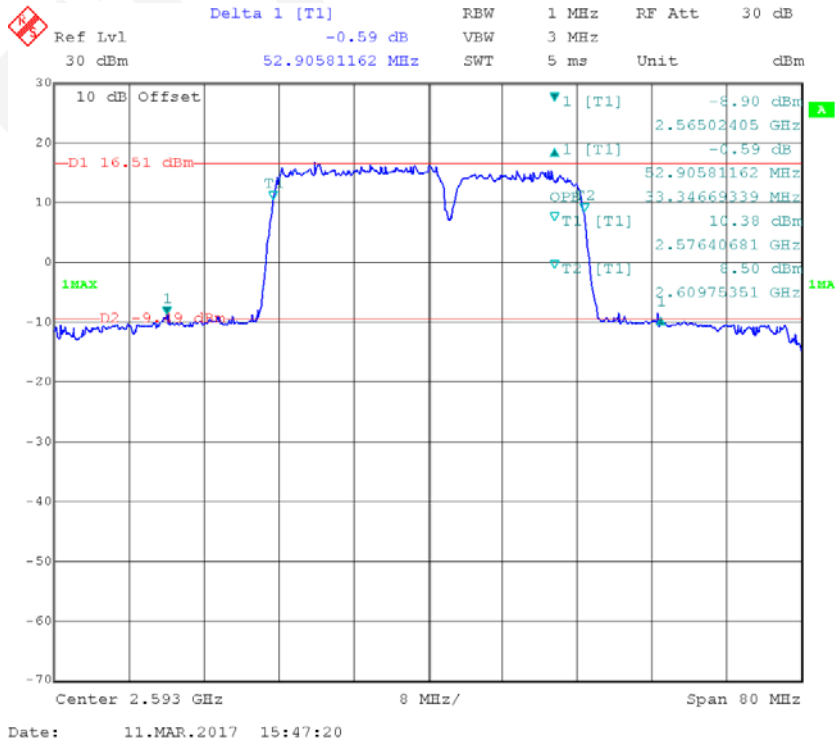

**Band 41\_20&20MHz\_QPSK\_P100#0&S100#0**

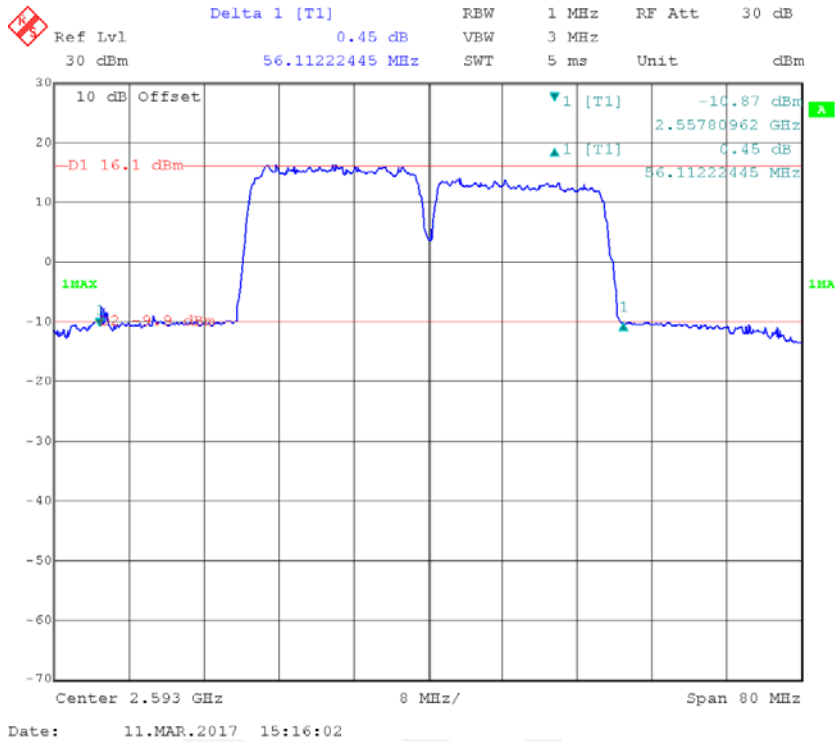

**Band 41\_20&20MHz\_16QAM\_P100#0&S100#0**

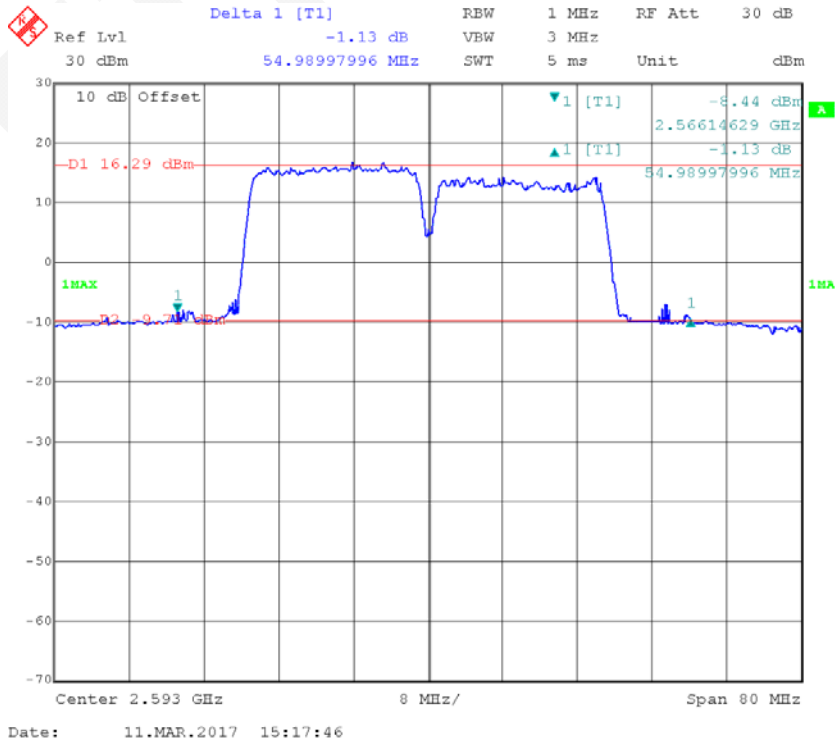

### Band 41\_20MHz\_QPSK\_RB1

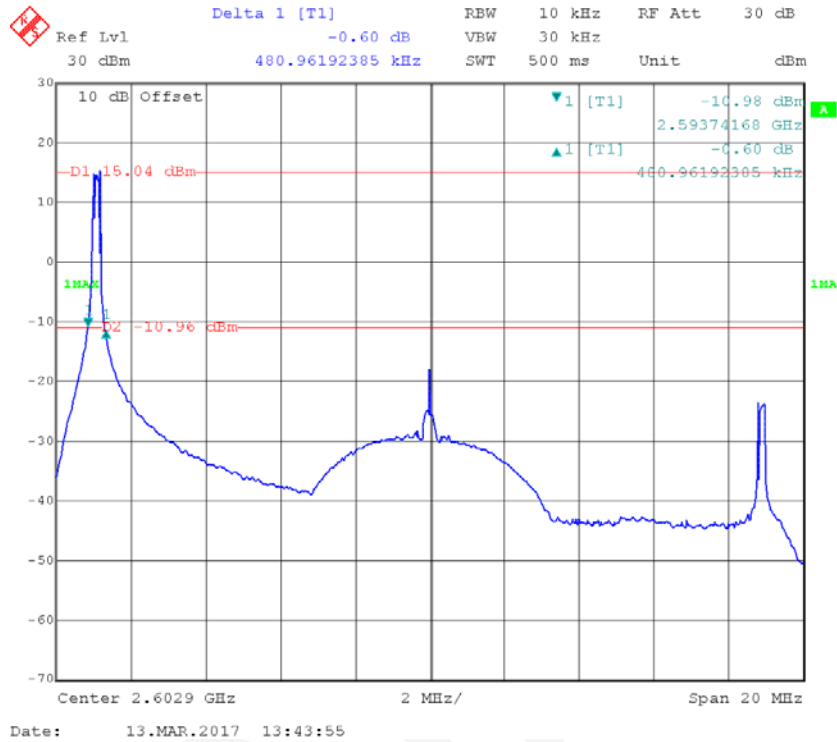

### Band 41\_20MHz\_QPSK\_RB100

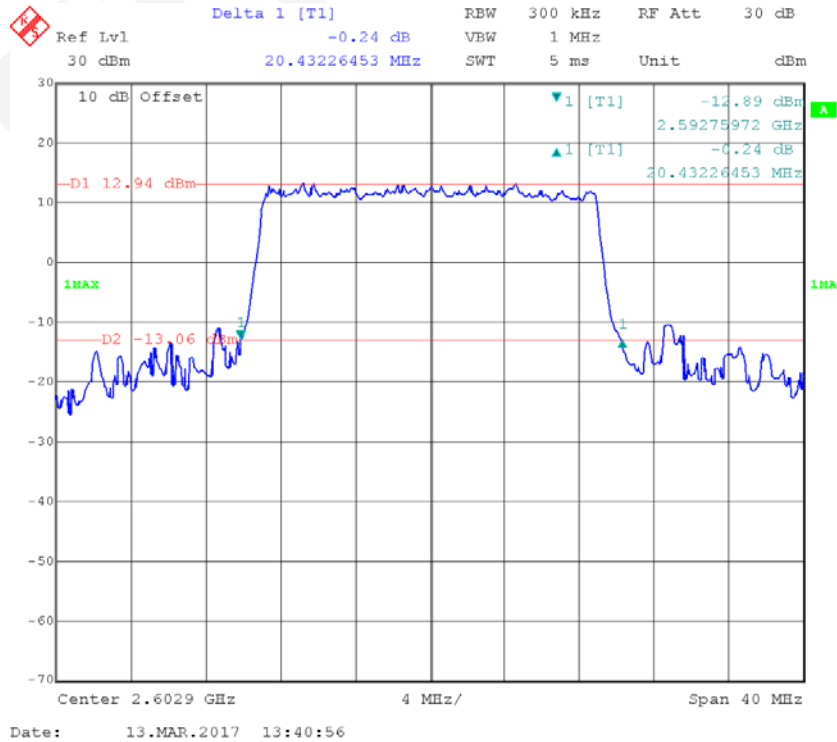



### Band 41\_20MHz\_16QAM\_RB1

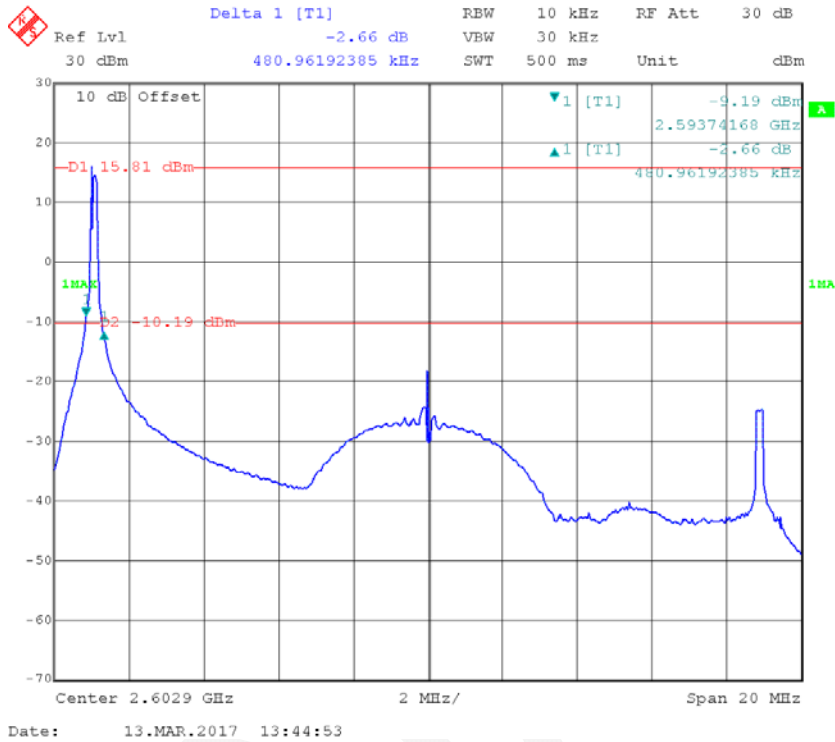

### Band 41\_20MHz\_16QAM\_RB100

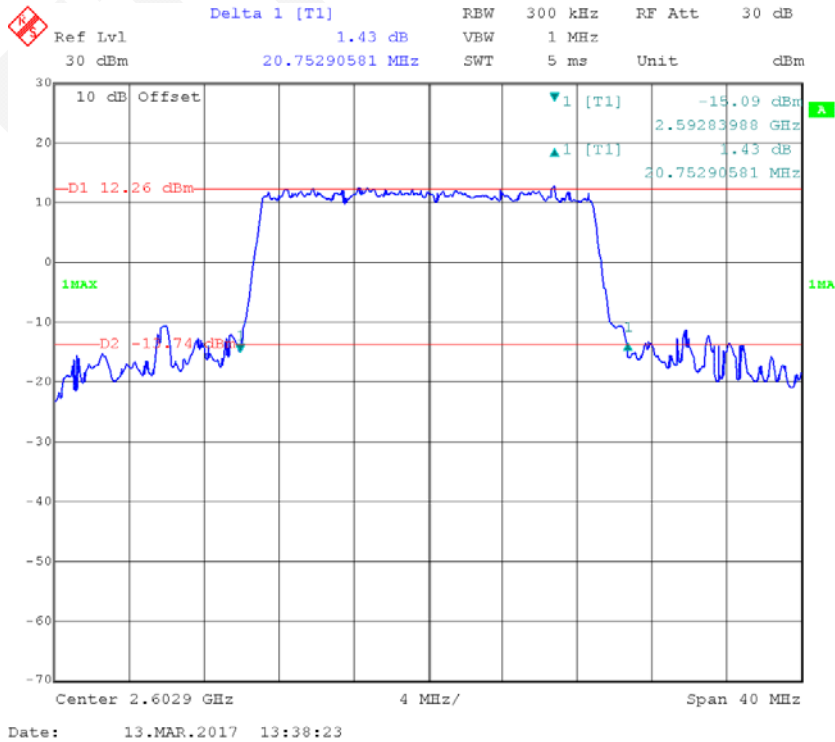

**99% Occupied Bandwidth:**

**Band 7\_5&20MHz\_QPSK\_P25#0&S100#0**

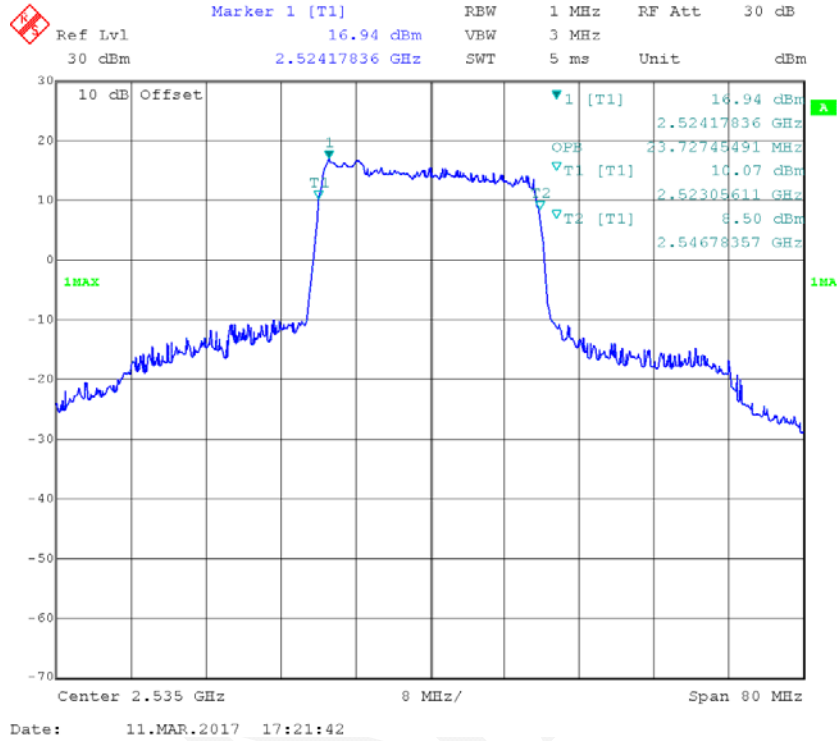

Date: 11.MAR.2017 17:21:42

**Band 7\_5&20MHz\_16QAM\_P25#0&S100#0**

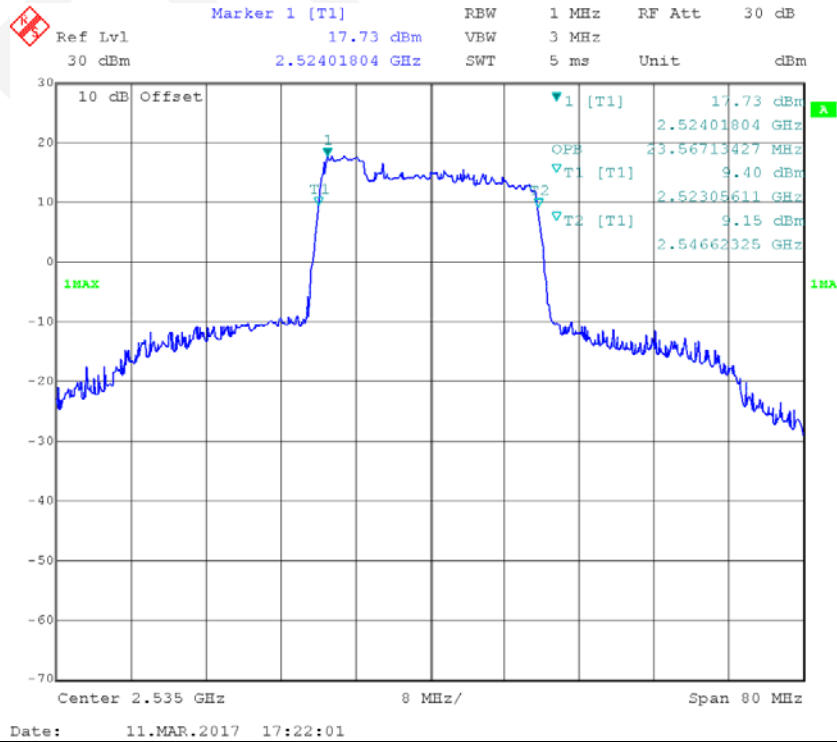

Date: 11.MAR.2017 17:22:01

### Band 7\_5MHz\_QPSK\_RB1

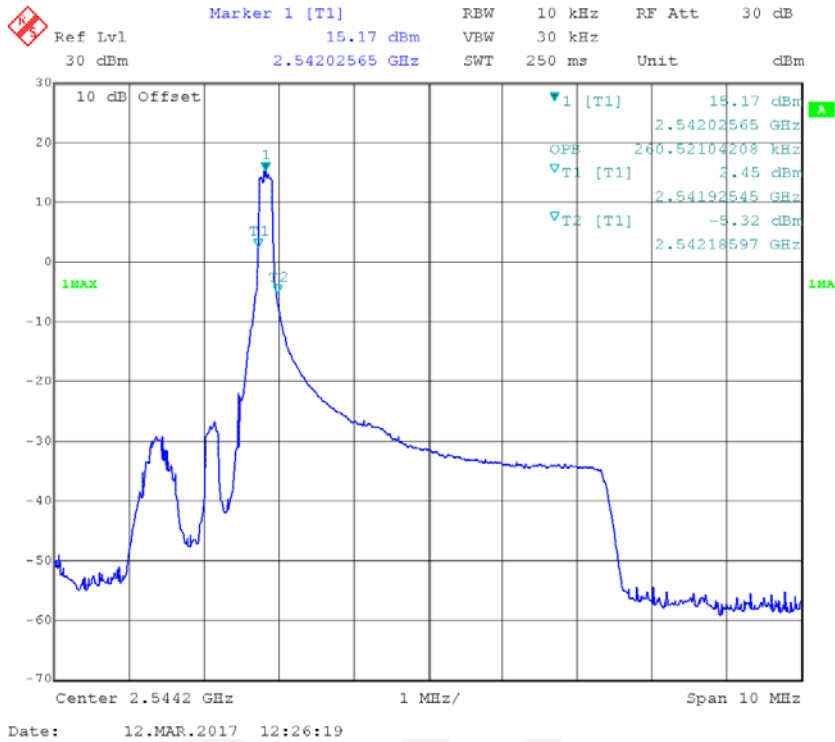

### Band 7\_5MHz\_QPSK\_RB25

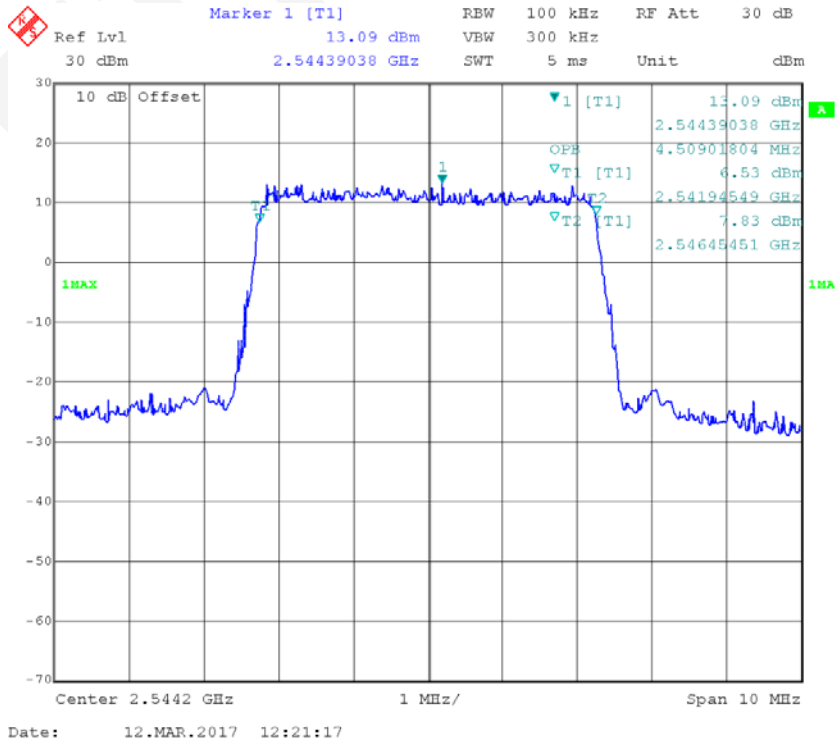

**Band 7\_5MHz\_16QAM\_RB1**

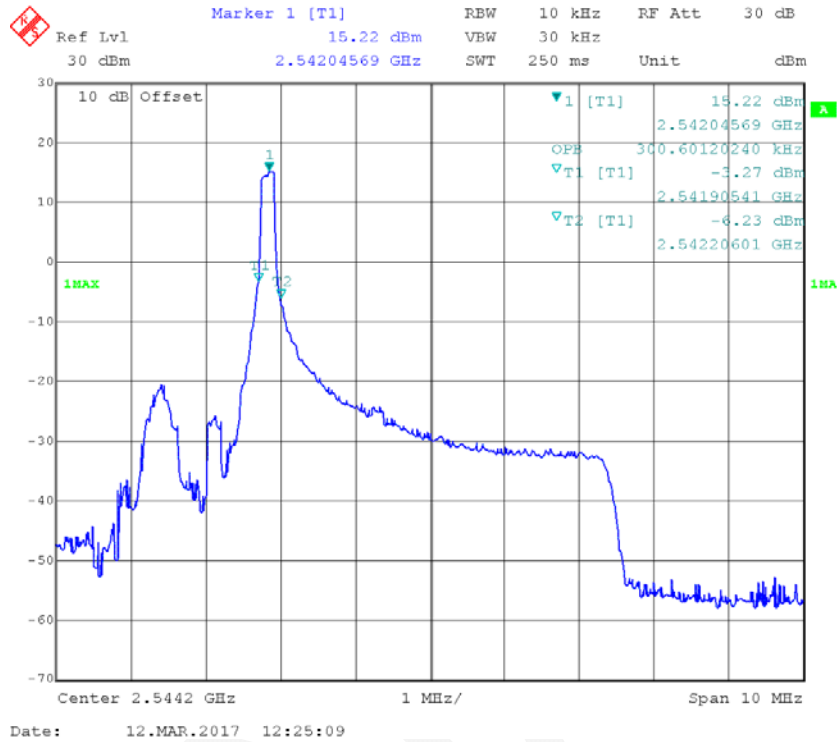

**Band 7\_5MHz\_16QAM\_RB25**

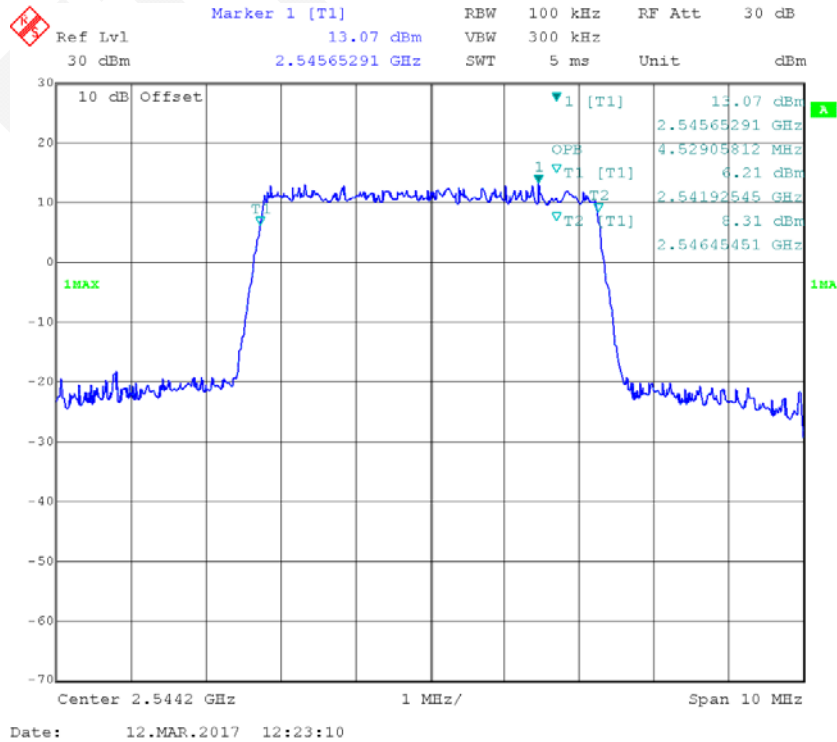

### Band 7\_10&20MHz\_QPSK\_P50#0&S100#0

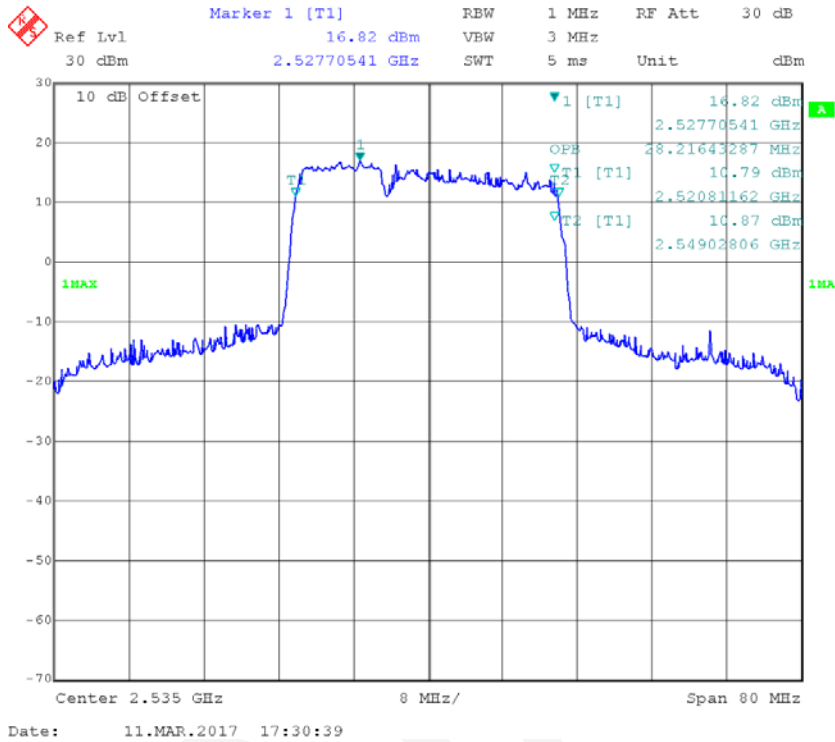

### Band 7\_10&20MHz\_16QAM\_P50#0&S100#0

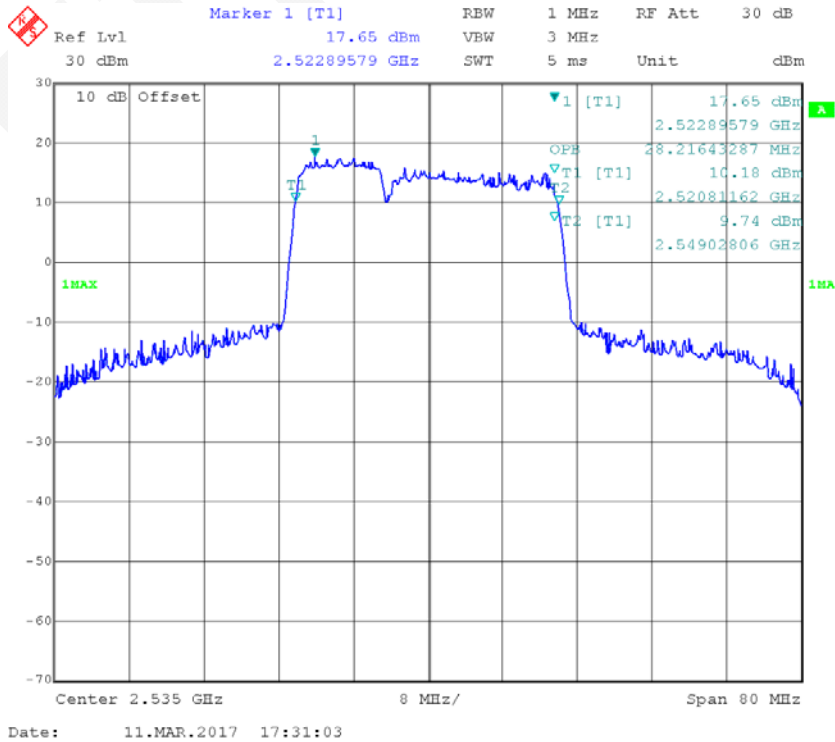

**Band 7\_15&15MHz\_QPSK\_P75#0&S75#0**

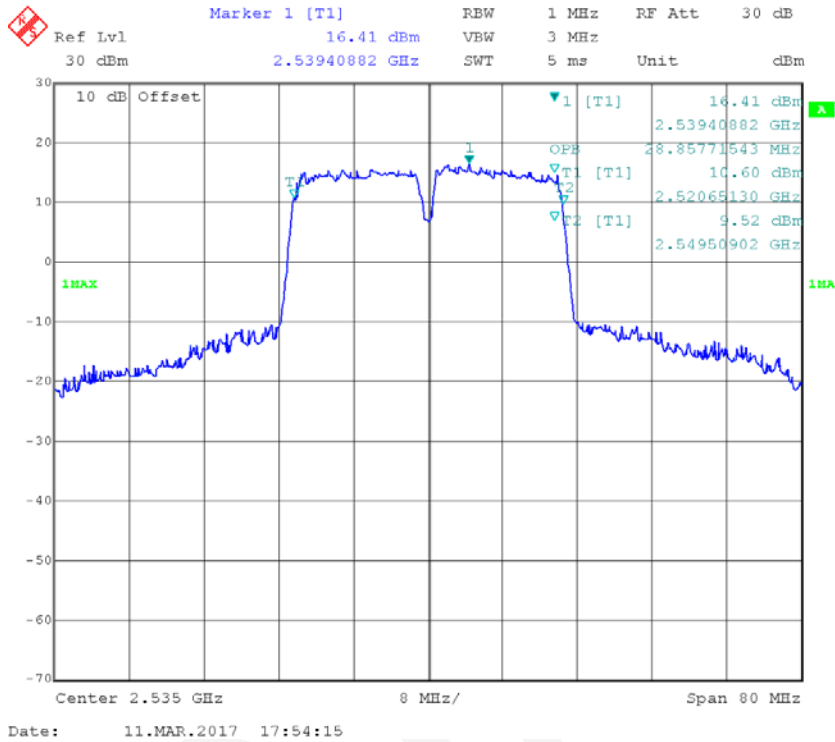

**Band 7\_15&20MHz\_QPSK\_P75#0&S100#0**

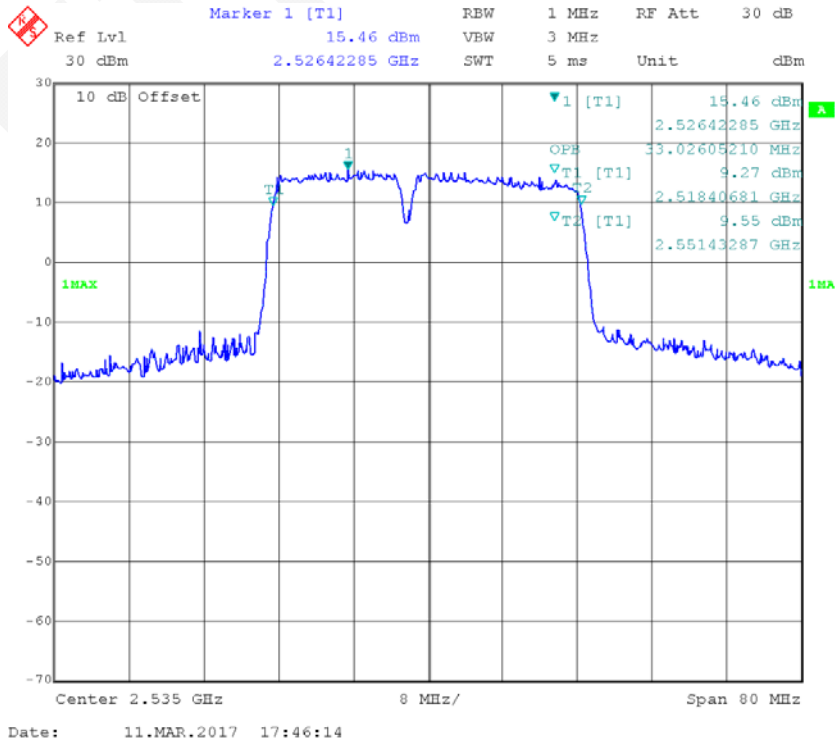

**Band 7\_15&20MHz\_16QAM\_P75#0&S100#0**

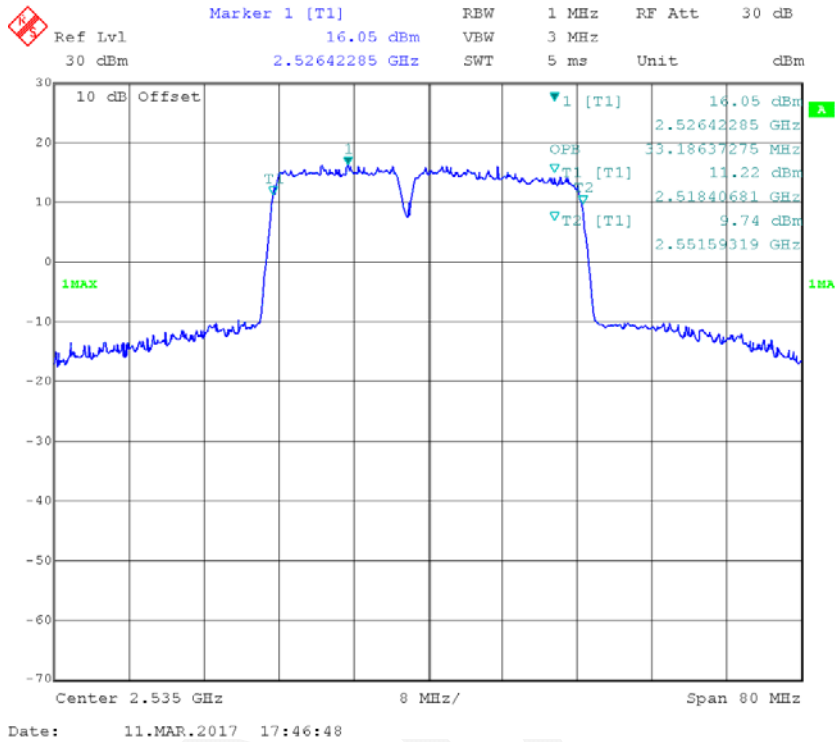

**Band 7\_20&5MHz\_QPSK\_P100#0&S25#0**

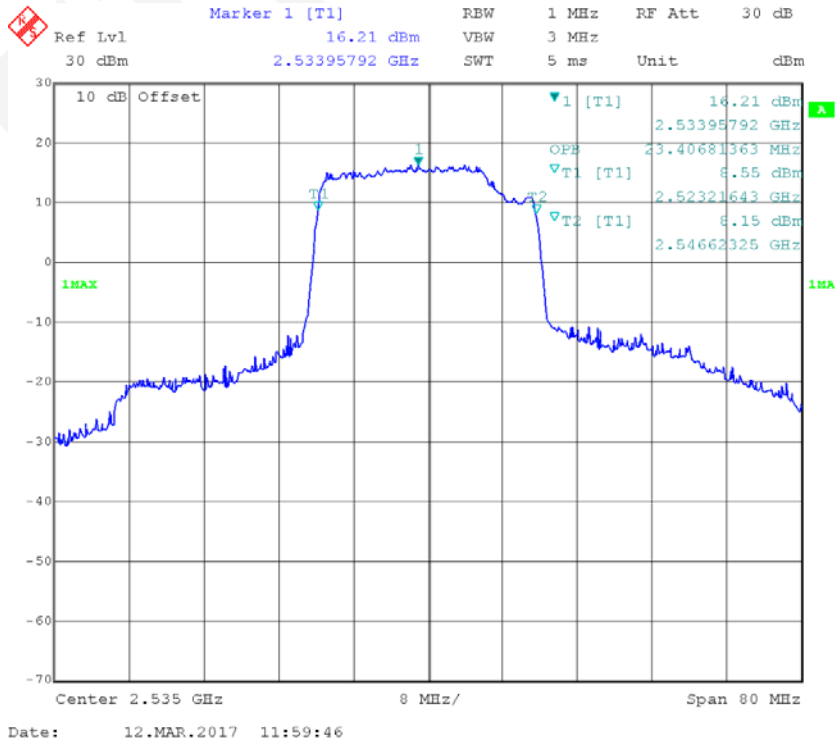

**Band 7\_20&5MHz\_16QAM\_P100#0&S25#0**

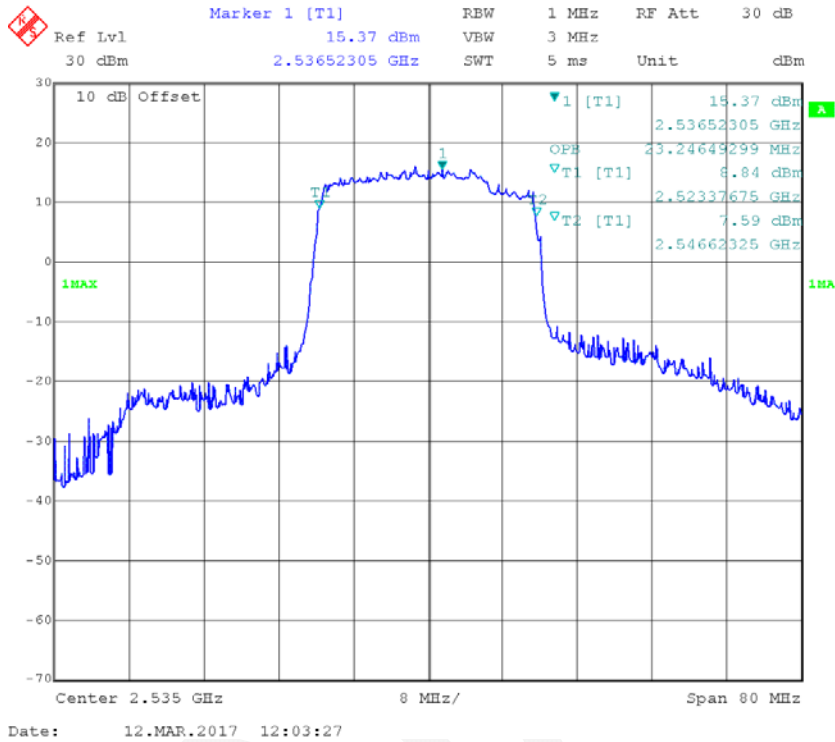

**Band 7\_20&10MHz\_QPSK\_P100#0&S50#0**

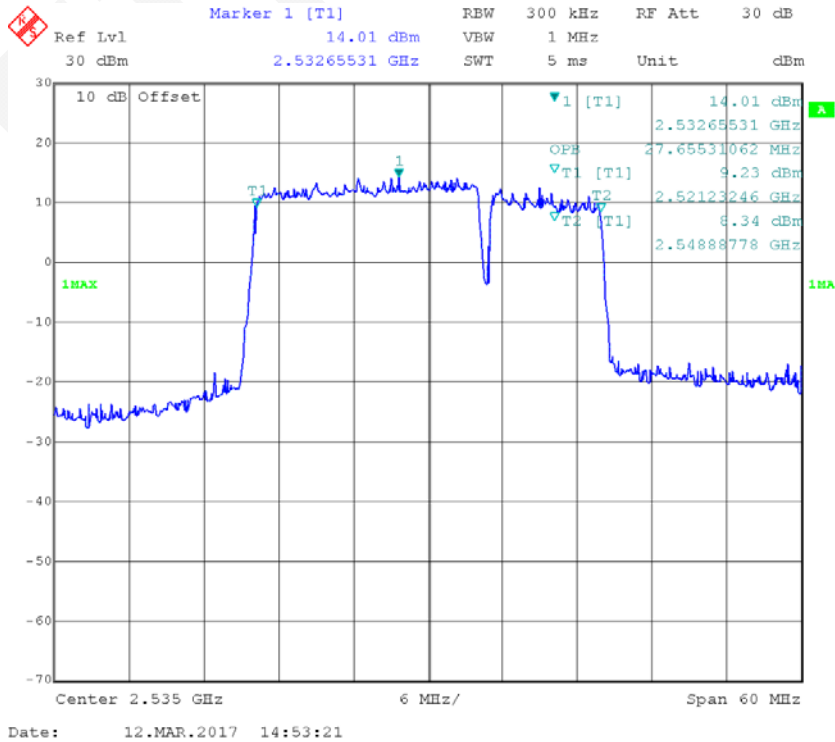



**Band 7\_20&10MHz\_16QAM\_P100#0&S50#0**

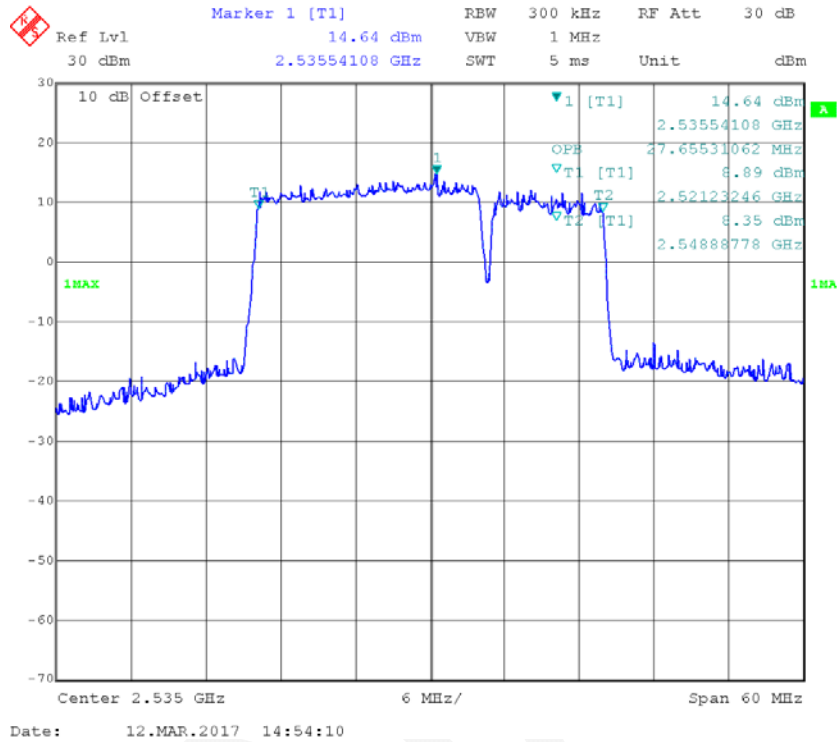

**Band 7\_15&15MHz\_16QM\_P75#0&S75#0**

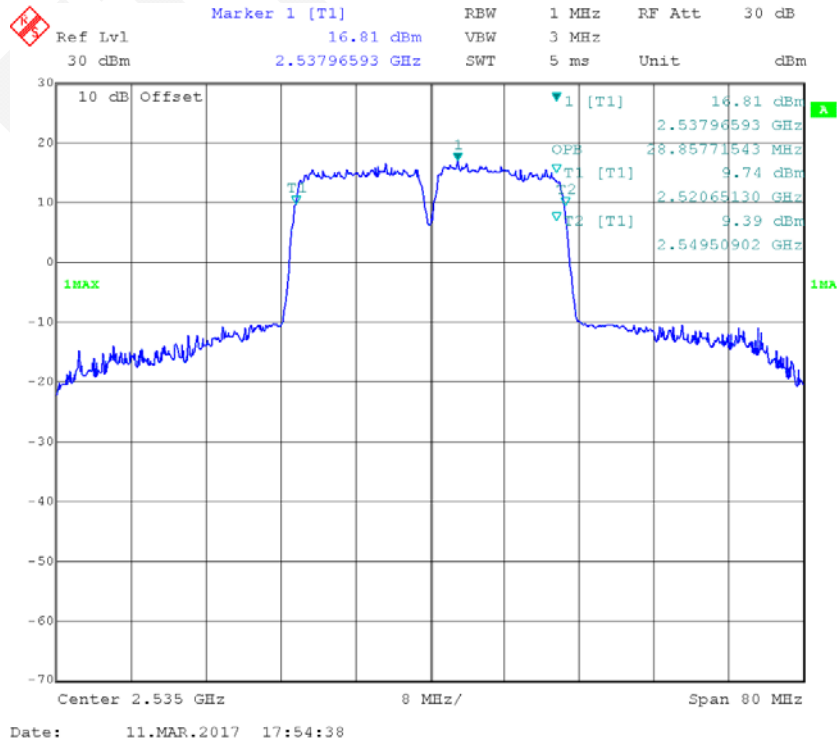

**Band 7\_20&15MHz\_QPSK\_P100#0&S75#0**

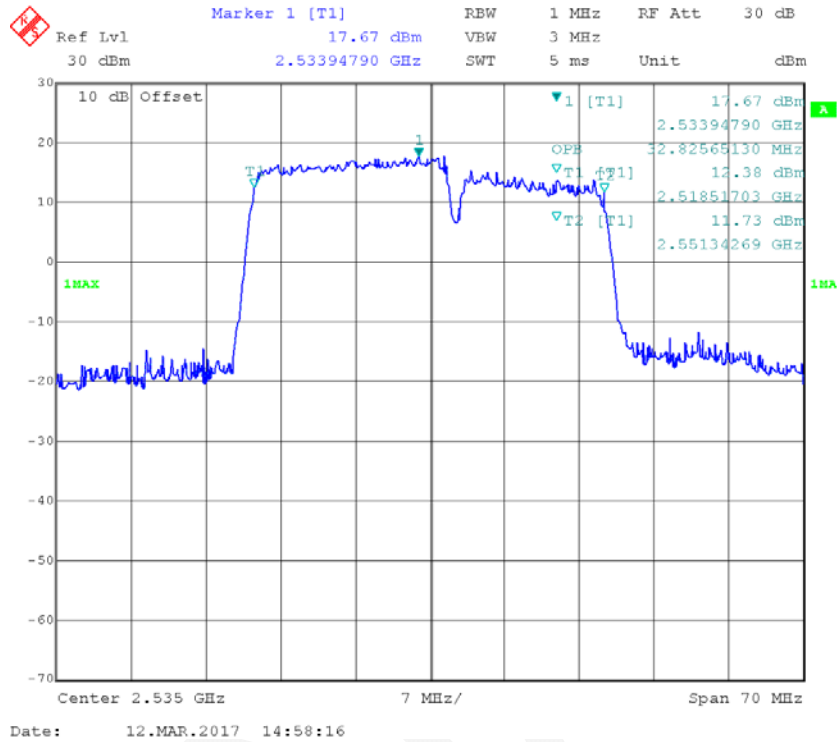

**Band 7\_20&15MHz\_16QAM\_P100#0&S75#0**

