

**ELECTROMAGNETIC EMISSIONS COMPLIANCE REPORT**  
**INTENTIONAL RADIATOR CERTIFICATION TO**  
**FCC PART 22 SUBPART H, PART 24 SUBPART E and PART 27 SUBPART**  
**M & SUBPART L REQUIREMENT**

OF

**Product Name:** Mobile WiFi  
**Brand Name:** HUAWEI  
**Model No.:** E5788u-96a  
**Model Difference:** N/A  
**FCC ID:** QISE5788U-96A  
**Report No.:** E2/2017/70076  
**Issue Date:** Nov. 03, 2017  
**FCC Rule Part:** 2 , 22H & 24E & 27M & L  
**Prepared for:** Huawei Technologies Co., Ltd.  
Administration Building, Headquarters of Huawei Technologies Co., Ltd., Bantian, Longgang District, Shenzhen, 518129, P.R.C  
**Prepared by:** SGS Taiwan Ltd.  
Electronics & Communication Laboratory  
No.2, Keji 1st Rd., Guishan District, Taoyuan City, Taiwan 333



**Note:** This report shall not be reproduced except in full, without the written approval of SGS Taiwan Ltd. This document may be altered or revised by SGS Taiwan Ltd. personnel only, and shall be noted in the revision section of the document.

Unless otherwise stated the results shown in this test report refer only to the sample(s) tested and such sample(s) are retained for 90 days only.

除非另有說明，此報告結果僅對測試之樣品負責，同時此樣品僅保留90天。本報告未經本公司書面許可，不可部份複製。

This document is issued by the Company subject to its General Conditions of Service printed overleaf, available on request or accessible at [www.sgs.com/terms\\_and\\_conditions.htm](http://www.sgs.com/terms_and_conditions.htm) and, for electronic format documents, subject to Terms and Conditions for Electronic Documents at [www.sgs.com/terms\\_e-document.htm](http://www.sgs.com/terms_e-document.htm). Attention is drawn to the limitation of liability, indemnification and jurisdiction issues defined therein. Any holder of this document is advised that information contained hereon reflects the Company's findings at the time of its intervention only and within the limits of Client's instructions, if any. The Company's sole responsibility is to its Client and this document does not exonerate parties to a transaction from exercising all their rights and obligations under the transaction documents. This document cannot be reproduced except in full, without prior written approval of the Company. Any unauthorized alteration, forgery or falsification of the content or appearance of this document is unlawful and offenders may be prosecuted to the fullest extent of the law.

SGS Taiwan Ltd.

No.134,WuKungRoad,NewTaipeiIndustrialPark,WukuDistrict,NewTaipeiCity,Taiwan24803/新北市五股區新北產業園區五工路 134 號

台灣檢驗科技股份有限公司

t (886-2) 2299-3279

f (886-2) 2298-0488

[www.tw.sgs.com](http://www.tw.sgs.com)

Member of SGS Group

## VERIFICATION OF COMPLIANCE

**Applicant:** Huawei Technologies Co., Ltd.  
Administration Building, Headquarters of Huawei Technologies Co., Ltd., Bantian, Longgang District, Shenzhen, 518129, P.R.C

**Product Name:** Mobile WiFi

**Brand Name:** HUAWEI

**Model No.:** E5788u-96a

**Model Difference:** N/A

**FCC ID:** QISE5788U-96A

**File Number:** E2/2017/70076

**Date of test:** Jul. 19, 2017 ~ Aug. 24, 2017

**Date of EUT Received:** Jul. 19, 2017

### We hereby certify that:

The above equipment was tested by SGS Taiwan Ltd. Electronics & Communication Laboratory. The test data, data evaluation, test procedures, and equipment configurations shown in this report were made in accordance with the procedures given in TIA/EIA-603-D-2010 and the energy emitted by the sample EUT tested as described in this report is in compliance with conducted and radiated emission limits.

The test results of this report relate only to the tested sample identified in this report.

**Test By:**

*Aken Huang*

**Date:**

Nov. 03, 2017

**Aken Huang / Engineer**

**Prepared By:**

*Karen Huang*

**Date:**

Nov. 03, 2017

**Karen Huang / Clerk**

**Approved By:**

*Jim Chang*

**Date:**

Nov. 03, 2017

**Jim Chang / Asst. Manager**

Unless otherwise stated the results shown in this test report refer only to the sample(s) tested and such sample(s) are retained for 90 days only.

除非另有說明，此報告結果僅對測試之樣品負責，同時此樣品僅保留90天。本報告未經本公司書面許可，不可部份複製。

This document is issued by the Company subject to its General Conditions of Service printed overleaf, available on request or accessible at [www.sgs.com/terms\\_and\\_conditions.htm](http://www.sgs.com/terms_and_conditions.htm) and, for electronic format documents, subject to Terms and Conditions for Electronic Documents at [www.sgs.com/terms\\_e-document.htm](http://www.sgs.com/terms_e-document.htm). Attention is drawn to the limitation of liability, indemnification and jurisdiction issues defined therein. Any holder of this document is advised that information contained hereon reflects the Company's findings at the time of its intervention only and within the limits of Client's instructions, if any. The Company's sole responsibility is to its Client and this document does not exonerate parties to a transaction from exercising all their rights and obligations under the transaction documents. This document cannot be reproduced except in full, without prior written approval of the Company. Any unauthorized alteration, forgery or falsification of the content or appearance of this document is unlawful and offenders may be prosecuted to the fullest extent of the law.

SGS Taiwan Ltd.

No.134,WuKungRoad,NewTaipeiIndustrialPark,WukuDistrict,NewTaipeiCity,Taiwan24803/新北市五股區新北產業園區五工路134號

台灣檢驗科技股份有限公司

t (886-2) 2299-3279

f (886-2) 2298-0488

[www.tw.sgs.com](http://www.tw.sgs.com)

Member of SGS Group

## Revision History

Report Number	Revision	Description	Issue Date
E2/2017/70076	Rev.00	Initial creation of document	Nov. 03, 2017

Unless otherwise stated the results shown in this test report refer only to the sample(s) tested and such sample(s) are retained for 90 days only.

除非另有說明，此報告結果僅對測試之樣品負責，同時此樣品僅保留90天。本報告未經本公司書面許可，不可部份複製。

This document is issued by the Company subject to its General Conditions of Service printed overleaf, available on request or accessible at [www.sgs.com/terms\\_and\\_conditions.htm](http://www.sgs.com/terms_and_conditions.htm) and, for electronic format documents, subject to Terms and Conditions for Electronic Documents at [www.sgs.com/terms\\_e-document.htm](http://www.sgs.com/terms_e-document.htm). Attention is drawn to the limitation of liability, indemnification and jurisdiction issues defined therein. Any holder of this document is advised that information contained hereon reflects the Company's findings at the time of its intervention only and within the limits of Client's instructions, if any. The Company's sole responsibility is to its Client and this document does not exonerate parties to a transaction from exercising all their rights and obligations under the transaction documents. This document cannot be reproduced except in full, without prior written approval of the Company. Any unauthorized alteration, forgery or falsification of the content or appearance of this document is unlawful and offenders may be prosecuted to the fullest extent of the law.

SGS Taiwan Ltd.

No.134,WuKungRoad,NewTaipeiIndustrialPark,WukuDistrict,NewTaipeiCity,Taiwan24803/新北市五股區新北產業園區五工路 134 號

台灣檢驗科技股份有限公司

t (886-2) 2299-3279

f (886-2) 2298-0488

[www.tw.sgs.com](http://www.tw.sgs.com)

Member of SGS Group

## Contents

1. GENERAL PRODUCT INFORMATION .....	5
2. SYSTEM TEST CONFIGURATION .....	16
3. SUMMARY OF TEST RESULTS .....	21
4. DESCRIPTION OF TEST MODES .....	22
5. MEASUREMENT UNCERTAINTY .....	30
6. RF CONDUCTED OUTPUT POWER MEASUREMENT .....	31
7. EFFECTIVE RADIATED POWER AND EQUIVALENT ISOTROPIC RADIATED POWER MEASUREMENT .....	61
8. OCCUPIED BANDWIDTH MEASUREMENT .....	126
9. OUT OF BAND EMISSION AT ANTENNA TERMINALS .....	186
10. FIELD STRENGTH OF SPURIOUS RADIATION MEASUREMENT .....	309
11. FREQUENCY STABILITY MEASUREMENT .....	379
12. PEAK TO AVERAGE RATIO .....	391

Unless otherwise stated the results shown in this test report refer only to the sample(s) tested and such sample(s) are retained for 90 days only.

除非另有說明，此報告結果僅對測試之樣品負責，同時此樣品僅保留90天。本報告未經本公司書面許可，不可部份複製。

This document is issued by the Company subject to its General Conditions of Service printed overleaf, available on request or accessible at [www.sgs.com/terms\\_and\\_conditions.htm](http://www.sgs.com/terms_and_conditions.htm) and, for electronic format documents, subject to Terms and Conditions for Electronic Documents at [www.sgs.com/terms\\_e-document.htm](http://www.sgs.com/terms_e-document.htm). Attention is drawn to the limitation of liability, indemnification and jurisdiction issues defined therein. Any holder of this document is advised that information contained hereon reflects the Company's findings at the time of its intervention only and within the limits of Client's instructions, if any. The Company's sole responsibility is to its Client and this document does not exonerate parties to a transaction from exercising all their rights and obligations under the transaction documents. This document cannot be reproduced except in full, without prior written approval of the Company. Any unauthorized alteration, forgery or falsification of the content or appearance of this document is unlawful and offenders may be prosecuted to the fullest extent of the law.

SGS Taiwan Ltd.

No.134,WuKungRoad,NewTaipeiIndustrialPark,WukuDistrict,NewTaipeiCity,Taiwan24803/新北市五股區新北產業園區五工路 134 號

台灣檢驗科技股份有限公司

t (886-2) 2299-3279

f (886-2) 2298-0488

[www.tw.sgs.com](http://www.tw.sgs.com)

Member of SGS Group

## 1. GENERAL PRODUCT INFORMATION

### 1.1. Product Description

General:

Product Name:	Mobile WiFi	
Brand Name:	HUAWEI	
Model No.:	E5788u-96a	
Model difference:	N/A	
Hardware Version:	N/A	
Software Version:	N/A	
USB Cable:	Model No.: N/A, Supplier: N/A	
Power Supply:	3.8Vdc from Rechargeable Li-ion Battery or 100-240V from AC/DC Power Adapter	
	Battery:	Model No.: HB494590EBC-B, Supplier: HUAWEI
	Adapter:	Model No.: HW-050200U01, Supplier: HUAWEI

Unless otherwise stated the results shown in this test report refer only to the sample(s) tested and such sample(s) are retained for 90 days only.

除非另有說明，此報告結果僅對測試之樣品負責，同時此樣品僅保留90天。本報告未經本公司書面許可，不可部份複製。

This document is issued by the Company subject to its General Conditions of Service printed overleaf, available on request or accessible at [www.sgs.com/terms\\_and\\_conditions.htm](http://www.sgs.com/terms_and_conditions.htm) and, for electronic format documents, subject to Terms and Conditions for Electronic Documents at [www.sgs.com/terms\\_e-document.htm](http://www.sgs.com/terms_e-document.htm). Attention is drawn to the limitation of liability, indemnification and jurisdiction issues defined therein. Any holder of this document is advised that information contained hereon reflects the Company's findings at the time of its intervention only and within the limits of Client's instructions, if any. The Company's sole responsibility is to its Client and this document does not exonerate parties to a transaction from exercising all their rights and obligations under the transaction documents. This document cannot be reproduced except in full, without prior written approval of the Company. Any unauthorized alteration, forgery or falsification of the content or appearance of this document is unlawful and offenders may be prosecuted to the fullest extent of the law.

SGS Taiwan Ltd.

No.134,WuKungRoad,NewTaipeiIndustrialPark,WukuDistrict,NewTaipeiCity,Taiwan24803/新北市五股區新北產業園區五工路 134 號

台灣檢驗科技股份有限公司

t (886-2) 2299-3279

f (886-2) 2298-0488

[www.tw.sgs.com](http://www.tw.sgs.com)

Member of SGS Group

**GSM / WCDMA / LTE:**

Cellular Phone Standards Frequency Range and Power	Operating Frequency		Rated Power
		GPRS 850	824.2 MHz– 848.8 MHz
	EDGE 850	824.2 MHz– 848.8 MHz	33dBm
	GPRS 1900	1850.2MHz – 1909.8MHz	30dBm
	EDGE 1900	1850.2MHz – 1909.8MHz	30dBm
	WCDMA / HSPA+ Band II	1852.4MHz – 1907.6MHz	24dBm
	WCDMA / HSPA+ Band IV	1712.4MHz – 1752.6MHz	24dBm
	WCDMA / HSPA+ Band V	826.4MHz - 846.6MHz	24dBm
	LTE-Band 2 (1.4MHz)	1850.7MHz– 1909.3MHz	24dBm
	LTE-Band 2 (3MHz)	1851.5MHz – 1908.5MHz	24dBm
	LTE-Band 2 (5MHz)	1852.5MHz – 1907.5MHz	24dBm
	LTE-Band 2 (10MHz)	1855.0MHz – 1905.0MHz	24dBm
	LTE-Band 2 (15MHz)	1857.5MHz – 1902.5MHz	24dBm
	LTE-Band 2 (20MHz)	1860.0MHz – 1900.0MHz	24dBm
	LTE-Band 4 (1.4MHz)	1710.7MHz– 1754.3MHz	24dBm
	LTE-Band 4 (3MHz)	1711.5MHz – 1753.5MHz	24dBm
	LTE-Band 4 (5MHz)	1712.5MHz – 1752.5MHz	24dBm
	LTE-Band 4 (10MHz)	1715MHz – 1750MHz	24dBm
	LTE-Band 4 (15MHz)	1717.5MHz – 1747.5MHz	24dBm
	LTE-Band 4 (20MHz)	1720MHz – 1745MHz	24dBm
	LTE-Band 5 (1.4MHz)	824.7MHz – 848.3MHz	24.5dBm
	LTE-Band 5 (3MHz)	825.5MHz – 847.5MHz	24.5dBm
	LTE-Band 5 (5MHz)	826.5MHz – 846.5MHz	24.5dBm
	LTE-Band 5 (10MHz)	829.0MHz – 844.0MHz	24.5dBm
	LTE-Band 7 (5MHz)	2502.5MHz – 2567.5MHz	23dBm
	LTE-Band 7 (10MHz)	2505.0MHz – 2565.0MHz	23dBm
	LTE-Band 7 (15MHz)	2507.5MHz – 2562.5MHz	23dBm
	LTE-Band 7 (20MHz)	2510.0MHz – 2560MHz	23dBm
	LTE-Band 38 (5MHz)	2572.5MHz – 2617.5MHz	23.5dBm
	LTE-Band 38 (10MHz)	2575MHz – 2615MHz	23.5dBm
	LTE-Band 38 (15MHz)	2577.5MHz – 2612.5MHz	23.5dBm
	LTE-Band 38 (20MHz)	2580MHz – 2610MHz	23.5dBm

Unless otherwise stated the results shown in this test report refer only to the sample(s) tested and such sample(s) are retained for 90 days only.

除非另有說明，此報告結果僅對測試之樣品負責，同時此樣品僅保留90天。本報告未經本公司書面許可，不可部份複製。

This document is issued by the Company subject to its General Conditions of Service printed overleaf, available on request or accessible at [www.sgs.com/terms\\_and\\_conditions.htm](http://www.sgs.com/terms_and_conditions.htm) and, for electronic format documents, subject to Terms and Conditions for Electronic Documents at [www.sgs.com/terms\\_e-document.htm](http://www.sgs.com/terms_e-document.htm). Attention is drawn to the limitation of liability, indemnification and jurisdiction issues defined therein. Any holder of this document is advised that information contained hereon reflects the Company's findings at the time of its intervention only and within the limits of Client's instructions, if any. The Company's sole responsibility is to its Client and this document does not exonerate parties to a transaction from exercising all their rights and obligations under the transaction documents. This document cannot be reproduced except in full, without prior written approval of the Company. Any unauthorized alteration, forgery or falsification of the content or appearance of this document is unlawful and offenders may be prosecuted to the fullest extent of the law.

SGS Taiwan Ltd.

No.134,WuKungRoad,NewTaipeiIndustrialPark,WukuDistrict,NewTaipeiCity,Taiwan24803/新北市五股區新北產業園區五工路 134 號

台灣檢驗科技股份有限公司

t (886-2) 2299-3279

f (886-2) 2298-0488

[www.tw.sgs.com](http://www.tw.sgs.com)

Member of SGS Group

Cellular Phone Standards Frequency Range and Power	Operating Frequency		Rated Power
	LTE-Band 41 (5MHz)	2498.5MHz – 2687.5MHz	23.5dBm
	LTE-Band 41 (10MHz)	2501.0MHz – 2685.0MHz	23.5dBm
	LTE-Band 41 (15MHz)	2503.5MHz – 2682.5MHz	23.5dBm
	LTE-Band 41 (20MHz)	2506.0MHz – 2680.0MHz	23.5dBm
IMEI:	351908090000364		

**Type of Emission:**

Frequency Band	Type of Emission:
GPRS 850	250KGXW
EDGE 850	246KG7W
GPRS 1900	248KGXW
EDGE 1900	248KG7W
WCDMA Band II	4M13F9W
HSDPA Band II	4M13F9W
HSUPA Band II	4M12F9W
WCDMA Band IV	4M13F9W
HSDPA Band IV	4M12F9W
HSUPA Band IV	4M12F9W
WCDMA Band V	4M12F9W
HSDPA Band V	4M12F9W
HSUPA Band V	4M13F9W

Unless otherwise stated the results shown in this test report refer only to the sample(s) tested and such sample(s) are retained for 90 days only.

除非另有說明，此報告結果僅對測試之樣品負責，同時此樣品僅保留90天。本報告未經本公司書面許可，不可部份複製。

This document is issued by the Company subject to its General Conditions of Service printed overleaf, available on request or accessible at [www.sgs.com/terms\\_and\\_conditions.htm](http://www.sgs.com/terms_and_conditions.htm) and, for electronic format documents, subject to Terms and Conditions for Electronic Documents at [www.sgs.com/terms\\_e-document.htm](http://www.sgs.com/terms_e-document.htm). Attention is drawn to the limitation of liability, indemnification and jurisdiction issues defined therein. Any holder of this document is advised that information contained hereon reflects the Company's findings at the time of its intervention only and within the limits of Client's instructions, if any. The Company's sole responsibility is to its Client and this document does not exonerate parties to a transaction from exercising all their rights and obligations under the transaction documents. This document cannot be reproduced except in full, without prior written approval of the Company. Any unauthorized alteration, forgery or falsification of the content or appearance of this document is unlawful and offenders may be prosecuted to the fullest extent of the law.

SGS Taiwan Ltd.

No.134,WuKungRoad,NewTaipeiIndustrialPark,WukuDistrict,NewTaipeiCity,Taiwan24803/新北市五股區新北產業園區五工路 134 號

台灣檢驗科技股份有限公司

t (886-2) 2299-3279

f (886-2) 2298-0488

www.tw.sgs.com

Member of SGS Group

LTE Band	BW (MHz)	Modulation	Type of Emission
LTE Band 2	1.4MHz	QPSK	1M09G7D
LTE Band 2	1.4MHz	16QAM	1M09D7W
LTE Band 2	1.4MHz	64QAM	1M09D7W
LTE Band 2	3MHz	QPSK	2M70G7D
LTE Band 2	3MHz	16QAM	2M70D7W
LTE Band 2	3MHz	64QAM	2M70D7W
LTE Band 2	5MHz	QPSK	4M50G7D
LTE Band 2	5MHz	16QAM	4M50D7W
LTE Band 2	5MHz	64QAM	4M49D7W
LTE Band 2	10MHz	QPSK	9M00G7D
LTE Band 2	10MHz	16QAM	8M97D7W
LTE Band 2	10MHz	64QAM	8M97D7W
LTE Band 2	15MHz	QPSK	13M5G7D
LTE Band 2	15MHz	16QAM	13M5D7W
LTE Band 2	15MHz	64QAM	13M5D7W
LTE Band 2	20MHz	QPSK	17M9G7D
LTE Band 2	20MHz	16QAM	17M9D7W
LTE Band 2	20MHz	64QAM	17M9D7W

LTE Band	BW (MHz)	Modulation	Type of Emission
LTE Band 4	1.4MHz	QPSK	1M09G7D
LTE Band 4	1.4MHz	16QAM	1M10D7W
LTE Band 4	1.4MHz	64QAM	1M09D7W
LTE Band 4	3MHz	QPSK	2M70G7D
LTE Band 4	3MHz	16QAM	2M70D7W
LTE Band 4	3MHz	64QAM	2M71D7W
LTE Band 4	5MHz	QPSK	4M50G7D
LTE Band 4	5MHz	16QAM	4M49D7W
LTE Band 4	5MHz	64QAM	4M49D7W
LTE Band 4	10MHz	QPSK	9M00G7D
LTE Band 4	10MHz	16QAM	8M96D7W
LTE Band 4	10MHz	64QAM	8M98D7W
LTE Band 4	15MHz	QPSK	13M5G7D
LTE Band 4	15MHz	16QAM	13M5D7W
LTE Band 4	15MHz	64QAM	13M5D7W
LTE Band 4	20MHz	QPSK	17M9G7D
LTE Band 4	20MHz	16QAM	18M0D7W
LTE Band 4	20MHz	64QAM	17M9D7W

Unless otherwise stated the results shown in this test report refer only to the sample(s) tested and such sample(s) are retained for 90 days only.

除非另有說明，此報告結果僅對測試之樣品負責，同時此樣品僅保留90天。本報告未經本公司書面許可，不可部份複製。

This document is issued by the Company subject to its General Conditions of Service printed overleaf, available on request or accessible at [www.sgs.com/terms\\_and\\_conditions.htm](http://www.sgs.com/terms_and_conditions.htm) and, for electronic format documents, subject to Terms and Conditions for Electronic Documents at [www.sgs.com/terms\\_e-document.htm](http://www.sgs.com/terms_e-document.htm). Attention is drawn to the limitation of liability, indemnification and jurisdiction issues defined therein. Any holder of this document is advised that information contained hereon reflects the Company's findings at the time of its intervention only and within the limits of Client's instructions, if any. The Company's sole responsibility is to its Client and this document does not exonerate parties to a transaction from exercising all their rights and obligations under the transaction documents. This document cannot be reproduced except in full, without prior written approval of the Company. Any unauthorized alteration, forgery or falsification of the content or appearance of this document is unlawful and offenders may be prosecuted to the fullest extent of the law.

SGS Taiwan Ltd.

No.134,WuKungRoad,NewTaipeiIndustrialPark,WukuDistrict,NewTaipeiCity,Taiwan24803/新北市五股區新北產業園區五工路 134 號

台灣檢驗科技股份有限公司

t (886-2) 2299-3279

f (886-2) 2298-0488

www.tw.sgs.com

Member of SGS Group



LTE Band	BW (MHz)	Modulation	Type of Emission
LTE Band 5	1.4MHz	QPSK	1M09G7D
LTE Band 5	1.4MHz	16QAM	1M09D7W
LTE Band 5	1.4MHz	64QAM	1M09D7W
LTE Band 5	3MHz	QPSK	2M70G7D
LTE Band 5	3MHz	16QAM	2M70D7W
LTE Band 5	3MHz	64QAM	2M71D7W
LTE Band 5	5MHz	QPSK	4M50G7D
LTE Band 5	5MHz	16QAM	4M50D7W
LTE Band 5	5MHz	64QAM	4M49D7W
LTE Band 5	10MHz	QPSK	9M01G7D
LTE Band 5	10MHz	16QAM	8M96D7W
LTE Band 5	10MHz	64QAM	8M99D7W
LTE Band 7	5MHz	QPSK	4M50G7D
LTE Band 7	5MHz	16QAM	4M50D7W
LTE Band 7	5MHz	64QAM	4M49D7W
LTE Band 7	10MHz	QPSK	9M00G7D
LTE Band 7	10MHz	16QAM	8M97D7W
LTE Band 7	10MHz	64QAM	8M98D7W
LTE Band 7	15MHz	QPSK	13M5G7D
LTE Band 7	15MHz	16QAM	13M5D7W
LTE Band 7	15MHz	64QAM	13M5D7W
LTE Band 7	20MHz	QPSK	17M9G7D
LTE Band 7	20MHz	16QAM	17M9D7W
LTE Band 7	20MHz	64QAM	17M9D7W

Unless otherwise stated the results shown in this test report refer only to the sample(s) tested and such sample(s) are retained for 90 days only.

除非另有說明，此報告結果僅對測試之樣品負責，同時此樣品僅保留90天。本報告未經本公司書面許可，不可部份複製。

This document is issued by the Company subject to its General Conditions of Service printed overleaf, available on request or accessible at [www.sgs.com/terms\\_and\\_conditions.htm](http://www.sgs.com/terms_and_conditions.htm) and, for electronic format documents, subject to Terms and Conditions for Electronic Documents at [www.sgs.com/terms\\_e-document.htm](http://www.sgs.com/terms_e-document.htm). Attention is drawn to the limitation of liability, indemnification and jurisdiction issues defined therein. Any holder of this document is advised that information contained hereon reflects the Company's findings at the time of its intervention only and within the limits of Client's instructions, if any. The Company's sole responsibility is to its Client and this document does not exonerate parties to a transaction from exercising all their rights and obligations under the transaction documents. This document cannot be reproduced except in full, without prior written approval of the Company. Any unauthorized alteration, forgery or falsification of the content or appearance of this document is unlawful and offenders may be prosecuted to the fullest extent of the law.

SGS Taiwan Ltd.

No.134,WuKungRoad,NewTaipeiIndustrialPark,WukuDistrict,NewTaipeiCity,Taiwan24803/新北市五股區新北產業園區五工路 134 號

台灣檢驗科技股份有限公司

t (886-2) 2299-3279

f (886-2) 2298-0488

www.tw.sgs.com

Member of SGS Group

LTE Band	BW (MHz)	Modulation	Type of Emission
LTE Band 38	5MHz	QPSK	4M51G7D
LTE Band 38	5MHz	16QAM	4M50D7W
LTE Band 38	5MHz	64QAM	4M49D7W
LTE Band 38	10MHz	QPSK	8M98G7D
LTE Band 38	10MHz	16QAM	8M97D7W
LTE Band 38	10MHz	64QAM	8M98D7W
LTE Band 38	15MHz	QPSK	13M5G7D
LTE Band 38	15MHz	16QAM	13M5D7W
LTE Band 38	15MHz	64QAM	13M5D7W
LTE Band 38	20MHz	QPSK	18M0G7D
LTE Band 38	20MHz	16QAM	18M0D7W
LTE Band 38	20MHz	64QAM	17M9D7W
LTE Band 41	5MHz	QPSK	4M51G7D
LTE Band 41	5MHz	16QAM	4M50D7W
LTE Band 41	5MHz	64QAM	4M51D7W
LTE Band 41	10MHz	QPSK	8M97G7D
LTE Band 41	10MHz	16QAM	8M98D7W
LTE Band 41	10MHz	64QAM	8M97D7W
LTE Band 41	15MHz	QPSK	13M5G7D
LTE Band 41	15MHz	16QAM	13M5D7W
LTE Band 41	15MHz	64QAM	13M4D7W
LTE Band 41	20MHz	QPSK	17M9G7D
LTE Band 41	20MHz	16QAM	17M9D7W
LTE Band 41	20MHz	16QAM	17M9D7W

Unless otherwise stated the results shown in this test report refer only to the sample(s) tested and such sample(s) are retained for 90 days only.

除非另有說明，此報告結果僅對測試之樣品負責，同時此樣品僅保留90天。本報告未經本公司書面許可，不可部份複製。

This document is issued by the Company subject to its General Conditions of Service printed overleaf, available on request or accessible at [www.sgs.com/terms\\_and\\_conditions.htm](http://www.sgs.com/terms_and_conditions.htm) and, for electronic format documents, subject to Terms and Conditions for Electronic Documents at [www.sgs.com/terms\\_e-document.htm](http://www.sgs.com/terms_e-document.htm). Attention is drawn to the limitation of liability, indemnification and jurisdiction issues defined therein. Any holder of this document is advised that information contained hereon reflects the Company's findings at the time of its intervention only and within the limits of Client's instructions, if any. The Company's sole responsibility is to its Client and this document does not exonerate parties to a transaction from exercising all their rights and obligations under the transaction documents. This document cannot be reproduced except in full, without prior written approval of the Company. Any unauthorized alteration, forgery or falsification of the content or appearance of this document is unlawful and offenders may be prosecuted to the fullest extent of the law.

SGS Taiwan Ltd.

No.134, WuKungRoad, NewTaipeiIndustrialPark, WukuDistrict, NewTaipeiCity, Taiwan24803/新北市五股區新北產業園區五工路 134 號

台灣檢驗科技股份有限公司

t (886-2) 2299-3279

f (886-2) 2298-0488

www.tw.sgs.com

Member of SGS Group

**Max ERP/EIRP Power Measurement Result:**

	<b>dBm</b>		<b>W</b>
GPRS 850	<b>28.68</b>	ERP	0.738
EDGE 850	<b>25.49</b>	ERP	0.354
GPRS 1900	<b>29.76</b>	EIRP	0.946
EDGE 1900	<b>28.86</b>	EIRP	0.769
WCDMA Band II	<b>26.77</b>	EIRP	0.475
HSDPA Band II	<b>24.02</b>	EIRP	0.252
HSUPA Band II	<b>24.08</b>	EIRP	0.256
WCDMA Band IV	<b>21.76</b>	EIRP	0.150
HSDPA Band IV	<b>21.75</b>	EIRP	0.150
HSUPA Band IV	<b>18.73</b>	EIRP	0.075
WCDMA Band V	<b>22.65</b>	ERP	0.184
HSDPA Band V	<b>20.77</b>	ERP	0.119
HSUPA Band V	<b>21.71</b>	ERP	0.148

Unless otherwise stated the results shown in this test report refer only to the sample(s) tested and such sample(s) are retained for 90 days only.

除非另有說明，此報告結果僅對測試之樣品負責，同時此樣品僅保留90天。本報告未經本公司書面許可，不可部份複製。

This document is issued by the Company subject to its General Conditions of Service printed overleaf, available on request or accessible at [www.sgs.com/terms\\_and\\_conditions.htm](http://www.sgs.com/terms_and_conditions.htm) and, for electronic format documents, subject to Terms and Conditions for Electronic Documents at [www.sgs.com/terms\\_e-document.htm](http://www.sgs.com/terms_e-document.htm). Attention is drawn to the limitation of liability, indemnification and jurisdiction issues defined therein. Any holder of this document is advised that information contained hereon reflects the Company's findings at the time of its intervention only and within the limits of Client's instructions, if any. The Company's sole responsibility is to its Client and this document does not exonerate parties to a transaction from exercising all their rights and obligations under the transaction documents. This document cannot be reproduced except in full, without prior written approval of the Company. Any unauthorized alteration, forgery or falsification of the content or appearance of this document is unlawful and offenders may be prosecuted to the fullest extent of the law.

SGS Taiwan Ltd.

No.134,WuKungRoad,NewTaipeiIndustrialPark,WukuDistrict,NewTaipeiCity,Taiwan24803/新北市五股區新北產業園區五工路 134 號

台灣檢驗科技股份有限公司

t (886-2) 2299-3279

f (886-2) 2298-0488

[www.tw.sgs.com](http://www.tw.sgs.com)

Member of SGS Group

	dBm		W
LTE-Band 2 (Bandwidth 1.4MHz) QPSK	24.40	EIRP	0.275
LTE-Band 2 (Bandwidth 1.4MHz) 16QAM	24.02	EIRP	0.252
LTE-Band 2 (Bandwidth 1.4MHz) 64QAM	24.87	EIRP	0.307
LTE-Band 2 (Bandwidth 3MHz) QPSK	24.16	EIRP	0.261
LTE-Band 2 (Bandwidth 3MHz) 16QAM	24.22	EIRP	0.264
LTE-Band 2 (Bandwidth 3MHz) 64QAM	24.37	EIRP	0.274
LTE-Band 2 (Bandwidth 5MHz) QPSK	24.50	EIRP	0.282
LTE-Band 2 (Bandwidth 5MHz) 16QAM	24.32	EIRP	0.270
LTE-Band 2 (Bandwidth 5MHz) 64QAM	24.50	EIRP	0.282
LTE-Band 2 (Bandwidth 10MHz) QPSK	23.72	EIRP	0.236
LTE-Band 2 (Bandwidth 10MHz) 16QAM	23.40	EIRP	0.219
LTE-Band 2 (Bandwidth 10MHz) 64QAM	23.40	EIRP	0.219
LTE-Band 2 (Bandwidth 15MHz) QPSK	26.21	EIRP	0.418
LTE-Band 2 (Bandwidth 15MHz) 16QAM	25.54	EIRP	0.358
LTE-Band 2 (Bandwidth 15MHz) 64QAM	25.59	EIRP	0.362
LTE-Band 2 (Bandwidth 20MHz) QPSK	26.05	EIRP	0.403
LTE-Band 2 (Bandwidth 20MHz) 16QAM	25.86	EIRP	0.385
LTE-Band 2 (Bandwidth 20MHz) 64QAM	25.47	EIRP	0.352
LTE-Band 4 (Bandwidth 1.4MHz) QPSK	25.32	EIRP	0.340
LTE-Band 4 (Bandwidth 1.4MHz) 16QAM	25.45	EIRP	0.351
LTE-Band 4 (Bandwidth 1.4MHz) 64QAM	26.03	EIRP	0.401
LTE-Band 4 (Bandwidth 3MHz) QPSK	25.64	EIRP	0.366
LTE-Band 4 (Bandwidth 3MHz) 16QAM	25.26	EIRP	0.336
LTE-Band 4 (Bandwidth 3MHz) 64QAM	26.18	EIRP	0.415
LTE-Band 4 (Bandwidth 5MHz) QPSK	23.84	EIRP	0.242
LTE-Band 4 (Bandwidth 5MHz) 16QAM	25.37	EIRP	0.344
LTE-Band 4 (Bandwidth 5MHz) 64QAM	26.29	EIRP	0.426
LTE-Band 4 (Bandwidth 10MHz) QPSK	23.87	EIRP	0.244
LTE-Band 4 (Bandwidth 10MHz) 16QAM	25.40	EIRP	0.347
LTE-Band 4 (Bandwidth 10MHz) 64QAM	26.32	EIRP	0.429
LTE-Band 4 (Bandwidth 15MHz) QPSK	24.43	EIRP	0.277
LTE-Band 4 (Bandwidth 15MHz) 16QAM	25.39	EIRP	0.346
LTE-Band 4 (Bandwidth 15MHz) 64QAM	26.25	EIRP	0.422
LTE-Band 4 (Bandwidth 20MHz) QPSK	24.33	EIRP	0.271
LTE-Band 4 (Bandwidth 20MHz) 16QAM	26.02	EIRP	0.400
LTE-Band 4 (Bandwidth 20MHz) 64QAM	25.91	EIRP	0.390

Unless otherwise stated the results shown in this test report refer only to the sample(s) tested and such sample(s) are retained for 90 days only.

除非另有說明，此報告結果僅對測試之樣品負責，同時此樣品僅保留90天。本報告未經本公司書面許可，不可部份複製。

This document is issued by the Company subject to its General Conditions of Service printed overleaf, available on request or accessible at [www.sgs.com/terms\\_and\\_conditions.htm](http://www.sgs.com/terms_and_conditions.htm) and, for electronic format documents, subject to Terms and Conditions for Electronic Documents at [www.sgs.com/terms\\_e-document.htm](http://www.sgs.com/terms_e-document.htm). Attention is drawn to the limitation of liability, indemnification and jurisdiction issues defined therein. Any holder of this document is advised that information contained hereon reflects the Company's findings at the time of its intervention only and within the limits of Client's instructions, if any. The Company's sole responsibility is to its Client and this document does not exonerate parties to a transaction from exercising all their rights and obligations under the transaction documents. This document cannot be reproduced except in full, without prior written approval of the Company. Any unauthorized alteration, forgery or falsification of the content or appearance of this document is unlawful and offenders may be prosecuted to the fullest extent of the law.

SGS Taiwan Ltd.

No.134,WuKungRoad,NewTaipeiIndustrialPark,WukuDistrict,NewTaipeiCity,Taiwan24803/新北市五股區新北產業園區五工路 134 號

台灣檢驗科技股份有限公司

t (886-2) 2299-3279

f (886-2) 2298-0488

www.tw.sgs.com

Member of SGS Group

	dBm		W
LTE-Band 5 (Bandwidth 1.4MHz) QPSK	26.96	ERP	0.497
LTE-Band 5 (Bandwidth 1.4MHz) 16QAM	26.96	ERP	0.497
LTE-Band 5 (Bandwidth 1.4MHz) 64QAM	26.98	ERP	0.499
LTE-Band 5 (Bandwidth 3MHz) QPSK	26.95	ERP	0.495
LTE-Band 5 (Bandwidth 3MHz) 16QAM	27.05	ERP	0.507
LTE-Band 5 (Bandwidth 3MHz) 64QAM	27.03	ERP	0.505
LTE-Band 5 (Bandwidth 5MHz) QPSK	25.29	ERP	0.338
LTE-Band 5 (Bandwidth 5MHz) 16QAM	26.51	ERP	0.448
LTE-Band 5 (Bandwidth 5MHz) 64QAM	27.29	ERP	0.536
LTE-Band 5 (Bandwidth 10MHz) QPSK	25.10	ERP	0.324
LTE-Band 5 (Bandwidth 10MHz) 16QAM	26.27	ERP	0.424
LTE-Band 5 (Bandwidth 10MHz) 64QAM	27.19	ERP	0.524
LTE-Band 7 (Bandwidth 5MHz) QPSK	21.04	EIRP	0.127
LTE-Band 7 (Bandwidth 5MHz) 16QAM	21.52	EIRP	0.142
LTE-Band 7 (Bandwidth 5MHz) 64QAM	22.85	EIRP	0.193
LTE-Band 7 (Bandwidth 10MHz) QPSK	21.02	EIRP	0.126
LTE-Band 7 (Bandwidth 10MHz) 16QAM	21.99	EIRP	0.158
LTE-Band 7 (Bandwidth 10MHz) 64QAM	22.66	EIRP	0.185
LTE-Band 7 (Bandwidth 15MHz) QPSK	21.58	EIRP	0.144
LTE-Band 7 (Bandwidth 15MHz) 16QAM	21.86	EIRP	0.153
LTE-Band 7 (Bandwidth 15MHz) 64QAM	23.28	EIRP	0.213
LTE-Band 7 (Bandwidth 20MHz) QPSK	21.50	EIRP	0.141
LTE-Band 7 (Bandwidth 20MHz) 16QAM	22.34	EIRP	0.171
LTE-Band 7 (Bandwidth 20MHz) 64QAM	23.06	EIRP	0.202
LTE-Band 38 (Bandwidth 5MHz) QPSK	24.33	EIRP	0.271
LTE-Band 38 (Bandwidth 5MHz) 16QAM	23.30	EIRP	0.214
LTE-Band 38 (Bandwidth 5MHz) 64QAM	23.21	EIRP	0.209
LTE-Band 38 (Bandwidth 10MHz) QPSK	21.26	EIRP	0.134
LTE-Band 38 (Bandwidth 10MHz) 16QAM	21.33	EIRP	0.136
LTE-Band 38 (Bandwidth 10MHz) 64QAM	21.38	EIRP	0.137
LTE-Band 38 (Bandwidth 15MHz) QPSK	21.32	EIRP	0.136
LTE-Band 38 (Bandwidth 15MHz) 16QAM	21.64	EIRP	0.146
LTE-Band 38 (Bandwidth 15MHz) 64QAM	21.63	EIRP	0.146
LTE-Band 38 (Bandwidth 20MHz) QPSK	21.60	EIRP	0.145
LTE-Band 38 (Bandwidth 20MHz) 16QAM	21.70	EIRP	0.148
LTE-Band 38 (Bandwidth 20MHz) 64QAM	21.61	EIRP	0.145

Unless otherwise stated the results shown in this test report refer only to the sample(s) tested and such sample(s) are retained for 90 days only.

除非另有說明，此報告結果僅對測試之樣品負責，同時此樣品僅保留90天。本報告未經本公司書面許可，不可部份複製。

This document is issued by the Company subject to its General Conditions of Service printed overleaf, available on request or accessible at [www.sgs.com/terms\\_and\\_conditions.htm](http://www.sgs.com/terms_and_conditions.htm) and, for electronic format documents, subject to Terms and Conditions for Electronic Documents at [www.sgs.com/terms\\_e-document.htm](http://www.sgs.com/terms_e-document.htm). Attention is drawn to the limitation of liability, indemnification and jurisdiction issues defined therein. Any holder of this document is advised that information contained hereon reflects the Company's findings at the time of its intervention only and within the limits of Client's instructions, if any. The Company's sole responsibility is to its Client and this document does not exonerate parties to a transaction from exercising all their rights and obligations under the transaction documents. This document cannot be reproduced except in full, without prior written approval of the Company. Any unauthorized alteration, forgery or falsification of the content or appearance of this document is unlawful and offenders may be prosecuted to the fullest extent of the law.

SGS Taiwan Ltd.

No.134,WuKungRoad,NewTaipeiIndustrialPark,WukuDistrict,NewTaipeiCity,Taiwan24803/新北市五股區新北產業園區五工路 134 號

台灣檢驗科技股份有限公司

t (886-2) 2299-3279

f (886-2) 2298-0488

www.tw.sgs.com

Member of SGS Group

	<b>dBm</b>		<b>W</b>
LTE-Band 41 (Bandwidth 5MHz) QPSK	<b>20.44</b>	EIRP	0.111
LTE-Band 41 (Bandwidth 5MHz) 16QAM	<b>19.96</b>	EIRP	0.099
LTE-Band 41 (Bandwidth 5MHz) 64QAM	<b>19.94</b>	EIRP	0.099
LTE-Band 41 (Bandwidth 10MHz) QPSK	<b>20.18</b>	EIRP	0.104
LTE-Band 41 (Bandwidth 10MHz) 16QAM	<b>19.64</b>	EIRP	0.092
LTE-Band 41 (Bandwidth 10MHz) 64QAM	<b>19.81</b>	EIRP	0.096
LTE-Band 41 (Bandwidth 15MHz) QPSK	<b>20.33</b>	EIRP	0.108
LTE-Band 41 (Bandwidth 15MHz) 16QAM	<b>20.02</b>	EIRP	0.100
LTE-Band 41 (Bandwidth 15MHz) 64QAM	<b>19.82</b>	EIRP	0.096
LTE-Band 41 (Bandwidth 20MHz) QPSK	<b>21.22</b>	EIRP	0.132
LTE-Band 41 (Bandwidth 20MHz) 16QAM	<b>20.24</b>	EIRP	0.106
LTE-Band 41 (Bandwidth 20MHz) 64QAM	<b>20.58</b>	EIRP	0.114

Unless otherwise stated the results shown in this test report refer only to the sample(s) tested and such sample(s) are retained for 90 days only.

除非另有說明，此報告結果僅對測試之樣品負責，同時此樣品僅保留90天。本報告未經本公司書面許可，不可部份複製。

This document is issued by the Company subject to its General Conditions of Service printed overleaf, available on request or accessible at [www.sgs.com/terms\\_and\\_conditions.htm](http://www.sgs.com/terms_and_conditions.htm) and, for electronic format documents, subject to Terms and Conditions for Electronic Documents at [www.sgs.com/terms\\_e-document.htm](http://www.sgs.com/terms_e-document.htm). Attention is drawn to the limitation of liability, indemnification and jurisdiction issues defined therein. Any holder of this document is advised that information contained hereon reflects the Company's findings at the time of its intervention only and within the limits of Client's instructions, if any. The Company's sole responsibility is to its Client and this document does not exonerate parties to a transaction from exercising all their rights and obligations under the transaction documents. This document cannot be reproduced except in full, without prior written approval of the Company. Any unauthorized alteration, forgery or falsification of the content or appearance of this document is unlawful and offenders may be prosecuted to the fullest extent of the law.

SGS Taiwan Ltd.

No.134,WuKungRoad,NewTaipeiIndustrialPark,WukuDistrict,NewTaipeiCity,Taiwan24803/新北市五股區新北產業園區五工路 134 號

台灣檢驗科技股份有限公司

t (886-2) 2299-3279

f (886-2) 2298-0488

[www.tw.sgs.com](http://www.tw.sgs.com)

Member of SGS Group

## 1.2. Test Methodology of Applied Standards

FCC 47 CFR Part 2, 22, 24, 27

ANSI / TIA / EIA 603-D-2010

KDB971168 D01 Power Meas license Digital System

KDB941225 of the Output power Procedure of (SAR Measurement Procedures for 3G Devices, WCDMA / HSPA) was used for EUT and Base station setting.

TS 151 010-1 is used to set, and measure the output power.

Note: All test items have been performed and record as per the above standards.

## 1.3. Test Facility

SGS Taiwan Ltd. Electronics & Communication Laboratory No.2, Keji 1st Rd.,  
Guishan District, Taoyuan City, Taiwan 333 (TAF code 0513)

FCC Registration Numbers are: 735305

## 1.4. Special Accessories

No special accessories were used during testing.

## 1.5. Equipment Modifications

There were no modifications incorporated into the EUT.

Unless otherwise stated the results shown in this test report refer only to the sample(s) tested and such sample(s) are retained for 90 days only.

除非另有說明，此報告結果僅對測試之樣品負責，同時此樣品僅保留90天。本報告未經本公司書面許可，不可部份複製。

This document is issued by the Company subject to its General Conditions of Service printed overleaf, available on request or accessible at [www.sgs.com/terms\\_and\\_conditions.htm](http://www.sgs.com/terms_and_conditions.htm) and, for electronic format documents, subject to Terms and Conditions for Electronic Documents at [www.sgs.com/terms\\_e-document.htm](http://www.sgs.com/terms_e-document.htm). Attention is drawn to the limitation of liability, indemnification and jurisdiction issues defined therein. Any holder of this document is advised that information contained hereon reflects the Company's findings at the time of its intervention only and within the limits of Client's instructions, if any. The Company's sole responsibility is to its Client and this document does not exonerate parties to a transaction from exercising all their rights and obligations under the transaction documents. This document cannot be reproduced except in full, without prior written approval of the Company. Any unauthorized alteration, forgery or falsification of the content or appearance of this document is unlawful and offenders may be prosecuted to the fullest extent of the law.

SGS Taiwan Ltd.

No.134,WuKungRoad,NewTaipeiIndustrialPark,WukuDistrict,NewTaipeiCity,Taiwan24803/新北市五股區新北產業園區五工路 134 號

台灣檢驗科技股份有限公司

t (886-2) 2299-3279

f (886-2) 2298-0488

[www.tw.sgs.com](http://www.tw.sgs.com)

Member of SGS Group

## 2. SYSTEM TEST CONFIGURATION

### 2.1. EUT Configuration

The EUT configuration for testing is installed on RF field strength measurement to meet the Commissions requirement and operating in a manner which intends to maximize its emission characteristics in a continuous normal application.

### 2.2. EUT Exercise

The EUT (Transmitter) was operated in the continuous transmission mode employed with the simulator of the Base Station that fixates at test default channels to fix the Tx frequency which was for the purpose of the measurements.

### 2.3. Test Procedure

#### 2.3.1 Conducted Measurement at Antenna Port

According to measurement procured TIA/EIA 603C, the EUT is placed on a turn table which is 0.8 m above ground plane. A low loss of RF cable was used to connect the antenna port of EUT to measurement equipment.

#### 2.3.2 Radiated Emissions (ERP/EIRP)

According to measurement procured TIA/EIA 603C, The EUT is a placed on as turn table which is 0.8 m above ground plane. The turn table shall rotate 360 degrees to determine the position of maximum emission level. EUT is set 3m away from the receiving antenna which varied from 1m to 4m to find out the highest emission. And also, each emission was to be maximized by changing the polarization of receiving antenna both Horizontal and Vertical. In order to find out the max. emission, the relative positions of this hand-held transmitter (EUT) was rotated through three orthogonal axes and measurement procedures for electric field radiated emissions above 1 GHz the EUT measurement is to be made "while keeping the antenna in the 'cone of radiation' from that area and pointed at the area both in azimuth and elevation, with polarization oriented for maximum response." is still within the 3dB illumination BW of the measurement antenna according to the requirements in Section 8 and 13.

Unless otherwise stated the results shown in this test report refer only to the sample(s) tested and such sample(s) are retained for 90 days only.

除非另有說明，此報告結果僅對測試之樣品負責，同時此樣品僅保留90天。本報告未經本公司書面許可，不可部份複製。

This document is issued by the Company subject to its General Conditions of Service printed overleaf, available on request or accessible at [www.sgs.com/terms\\_and\\_conditions.htm](http://www.sgs.com/terms_and_conditions.htm) and, for electronic format documents, subject to Terms and Conditions for Electronic Documents at [www.sgs.com/terms\\_e-document.htm](http://www.sgs.com/terms_e-document.htm). Attention is drawn to the limitation of liability, indemnification and jurisdiction issues defined therein. Any holder of this document is advised that information contained hereon reflects the Company's findings at the time of its intervention only and within the limits of Client's instructions, if any. The Company's sole responsibility is to its Client and this document does not exonerate parties to a transaction from exercising all their rights and obligations under the transaction documents. This document cannot be reproduced except in full, without prior written approval of the Company. Any unauthorized alteration, forgery or falsification of the content or appearance of this document is unlawful and offenders may be prosecuted to the fullest extent of the law.



## 2.4. Measurement Results Explanation Example

### For all conducted test items:

The offset level is set in the spectrum analyzer to compensate the RF cable loss and attenuation factor between EUT conducted port and spectrum analyzer. With the offset compensation, the spectrum analyzer reading level is exactly EUT RF output level.

### Note:

The spectrum analyzer offset is derived from RF cable loss and attenuator factor.

Low Band: Offset = RF cable loss (dB) + attenuation factor(dB) =24.1(dB)

High Band: Offset = RF cable loss (dB) + attenuation factor(dB) =24.6(dB)

## 2.5. Final Amplifier Voltage and Current Information:

Test mode	DC voltage (V)	DC current (mA)
GPRS 850	3.8	334
GPRS 1900	3.8	301
EDGE 850	3.8	287
EDGE 1900	3.8	267
WCDMA B2	3.8	446
WCDMA B4	3.8	435
WCDMA B5	3.8	471
HSUPA B2	3.8	417
HSUPA B4	3.8	405
HSUPA B5	3.8	401
HSDPA B2	3.8	392
HSDPA B4	3.8	399
HSDPA B5	3.8	401

Unless otherwise stated the results shown in this test report refer only to the sample(s) tested and such sample(s) are retained for 90 days only.

除非另有說明，此報告結果僅對測試之樣品負責，同時此樣品僅保留90天。本報告未經本公司書面許可，不可部份複製。

This document is issued by the Company subject to its General Conditions of Service printed overleaf, available on request or accessible at [www.sgs.com/terms\\_and\\_conditions.htm](http://www.sgs.com/terms_and_conditions.htm) and, for electronic format documents, subject to Terms and Conditions for Electronic Documents at [www.sgs.com/terms\\_e-document.htm](http://www.sgs.com/terms_e-document.htm). Attention is drawn to the limitation of liability, indemnification and jurisdiction issues defined therein. Any holder of this document is advised that information contained hereon reflects the Company's findings at the time of its intervention only and within the limits of Client's instructions, if any. The Company's sole responsibility is to its Client and this document does not exonerate parties to a transaction from exercising all their rights and obligations under the transaction documents. This document cannot be reproduced except in full, without prior written approval of the Company. Any unauthorized alteration, forgery or falsification of the content or appearance of this document is unlawful and offenders may be prosecuted to the fullest extent of the law.

SGS Taiwan Ltd.

No.134,WuKungRoad,NewTaipeiIndustrialPark,WukuDistrict,NewTaipeiCity,Taiwan24803/新北市五股區新北產業園區五工路 134 號

台灣檢驗科技股份有限公司

t (886-2) 2299-3279

f (886-2) 2298-0488

www.tw.sgs.com

Member of SGS Group

### LTE Band 2

Test mode	DC voltage	DC current
LTE Band 2_1.4M QPSK	3.8	419
LTE Band 2_1.4M 16QAM	3.8	311
LTE Band 2_3M QPSK	3.8	428
LTE Band 2_3M 16QAM	3.8	336
LTE Band 2_5M QPSK	3.8	438
LTE Band 2_5M 16QAM	3.8	333
LTE Band 2_10M QPSK	3.8	423
LTE Band 2_10M 16QAM	3.8	316
LTE Band 2_15M QPSK	3.8	426
LTE Band 2_15M 16QAM	3.8	322
LTE Band 2_20M QPSK	3.8	420
LTE Band 2_20M 16QAM	3.8	320

### LTE Band 4

Test mode	DC voltage	DC current
LTE Band 4_1.4M QPSK	3.8	419
LTE Band 4_1.4M 16QAM	3.8	308
LTE Band 4_3M QPSK	3.8	427
LTE Band 4_3M 16QAM	3.8	331
LTE Band 4_5M QPSK	3.8	431
LTE Band 4_5M 16QAM	3.8	307
LTE Band 4_10M QPSK	3.8	440
LTE Band 4_10M 16QAM	3.8	312
LTE Band 4_15M QPSK	3.8	421
LTE Band 4_15M 16QAM	3.8	312
LTE Band 4_20M QPSK	3.8	423
LTE Band 4_20M 16QAM	3.8	319

### LTE Band 2

Test mode	DC voltage (V)	DC current (mA)
LTE Band 2_1.4M 64QAM	3.8	261
LTE Band 2_3M 64QAM	3.8	286
LTE Band 2_5M 64QAM	3.8	283
LTE Band 2_10M 64QAM	3.8	266
LTE Band 2_15M 64QAM	3.8	272
LTE Band 2_20M 64QAM	3.8	270

### LTE Band 4

Test mode	DC voltage (V)	DC current (mA)
LTE Band 4_1.4M 64QAM	3.8	261
LTE Band 4_3M 64QAM	3.8	286
LTE Band 4_5M 64QAM	3.8	283
LTE Band 4_10M 64QAM	3.8	266
LTE Band 4_15M 64QAM	3.8	272
LTE Band 4_20M 64QAM	3.8	270

Unless otherwise stated the results shown in this test report refer only to the sample(s) tested and such sample(s) are retained for 90 days only.

除非另有說明，此報告結果僅對測試之樣品負責，同時此樣品僅保留90天。本報告未經本公司書面許可，不可部份複製。

This document is issued by the Company subject to its General Conditions of Service printed overleaf, available on request or accessible at [www.sgs.com/terms\\_and\\_conditions.htm](http://www.sgs.com/terms_and_conditions.htm) and, for electronic format documents, subject to Terms and Conditions for Electronic Documents at [www.sgs.com/terms\\_e-document.htm](http://www.sgs.com/terms_e-document.htm). Attention is drawn to the limitation of liability, indemnification and jurisdiction issues defined therein. Any holder of this document is advised that information contained hereon reflects the Company's findings at the time of its intervention only and within the limits of Client's instructions, if any. The Company's sole responsibility is to its Client and this document does not exonerate parties to a transaction from exercising all their rights and obligations under the transaction documents. This document cannot be reproduced except in full, without prior written approval of the Company. Any unauthorized alteration, forgery or falsification of the content or appearance of this document is unlawful and offenders may be prosecuted to the fullest extent of the law.

SGS Taiwan Ltd.

No.134,WuKungRoad,NewTaipeiIndustrialPark,WukuDistrict,NewTaipeiCity,Taiwan24803/新北市五股區新北產業園區五工路 134 號

台灣檢驗科技股份有限公司

t (886-2) 2299-3279

f (886-2) 2298-0488

www.tw.sgs.com

Member of SGS Group

### LTE Band 5

Test mode	DC voltage	DC current
LTE Band 5_1.4M QPSK	3.8	527
LTE Band 5_1.4M 16QAM	3.8	419
LTE Band 5_3M QPSK	3.8	545
LTE Band 5_3M 16QAM	3.8	425
LTE Band 5_5M QPSK	3.8	526
LTE Band 5_5M 16QAM	3.8	409
LTE Band 5_10M QPSK	3.8	542
LTE Band 5_10M 16QAM	3.8	429

### LTE Band 38

Test mode	DC voltage	DC current
LTE Band 38_5M QPSK	3.8	440
LTE Band 38_5M 16QAM	3.8	312
LTE Band 38_10M QPSK	3.8	438
LTE Band 38_10M 16QAM	3.8	317
LTE Band 38_15M QPSK	3.8	427
LTE Band 38_15M 16QAM	3.8	335
LTE Band 38_20M QPSK	3.8	417
LTE Band 38_20M 16QAM	3.8	313

### LTE Band 5

Test mode	DC voltage (V)	DC current (mA)
LTE Band 5_1.4M 64QAM	3.8	261
LTE Band 5_3M 64QAM	3.8	286
LTE Band 5_5M 64QAM	3.8	283
LTE Band 5_10M 64QAM	3.8	266

### LTE Band 38

Test mode	DC voltage (V)	DC current (mA)
LTE Band 38_5M 64QAM	3.8	261
LTE Band 38_10M 64QAM	3.8	286
LTE Band 38_15M 64QAM	3.8	283
LTE Band 38_20M 64QAM	3.8	266

### LTE Band 7

Test mode	DC voltage	DC current
LTE Band 7_5M QPSK	3.8	622
LTE Band 7_5M 16QAM	3.8	511
LTE Band 7_10M QPSK	3.8	646
LTE Band 7_10M 16QAM	3.8	533
LTE Band 7_15M QPSK	3.8	638
LTE Band 7_15M 16QAM	3.8	516
LTE Band 7_20M QPSK	3.8	631
LTE Band 7_20M 16QAM	3.8	518

### LTE Band 41

Test Mode	DC voltage	DC current
LTE Band 41_5M QPSK	3.8	493
LTE Band 41_5M 16QAM	3.8	383
LTE Band 41_10M QPSK	3.8	468
LTE Band 41_10M 16QAM	3.8	373
LTE Band 41_15M QPSK	3.8	472
LTE Band 41_15M 16QAM	3.8	382
LTE Band 41_20M QPSK	3.8	483
LTE Band 41_20M 16QAM	3.8	375

### LTE Band 7

Test mode	DC voltage (V)	DC current (mA)
LTE Band 7_5M 64QAM	3.8	261
LTE Band 7_10M 64QAM	3.8	286
LTE Band 7_15M 64QAM	3.8	283
LTE Band 7_20M 64QAM	3.8	266

### LTE Band 41

Test Mode	DC voltage (V)	DC current (mA)
LTE Band 41_5M 64QAM	3.8	261
LTE Band 41_10M 64QAM	3.8	286
LTE Band 41_15M 64QAM	3.8	283
LTE Band 41_20M 64QAM	3.8	266

Unless otherwise stated the results shown in this test report refer only to the sample(s) tested and such sample(s) are retained for 90 days only.

除非另有說明，此報告結果僅對測試之樣品負責，同時此樣品僅保留90天。本報告未經本公司書面許可，不可部份複製。

This document is issued by the Company subject to its General Conditions of Service printed overleaf, available on request or accessible at [www.sgs.com/terms\\_and\\_conditions.htm](http://www.sgs.com/terms_and_conditions.htm) and, for electronic format documents, subject to Terms and Conditions for Electronic Documents at [www.sgs.com/terms\\_e-document.htm](http://www.sgs.com/terms_e-document.htm). Attention is drawn to the limitation of liability, indemnification and jurisdiction issues defined therein. Any holder of this document is advised that information contained hereon reflects the Company's findings at the time of its intervention only and within the limits of Client's instructions, if any. The Company's sole responsibility is to its Client and this document does not exonerate parties to a transaction from exercising all their rights and obligations under the transaction documents. This document cannot be reproduced except in full, without prior written approval of the Company. Any unauthorized alteration, forgery or falsification of the content or appearance of this document is unlawful and offenders may be prosecuted to the fullest extent of the law.

## 2.6. Configuration of Tested System

**Fig. 2-1 Configuration of Tested System (Fixed Channel-Conducted)**

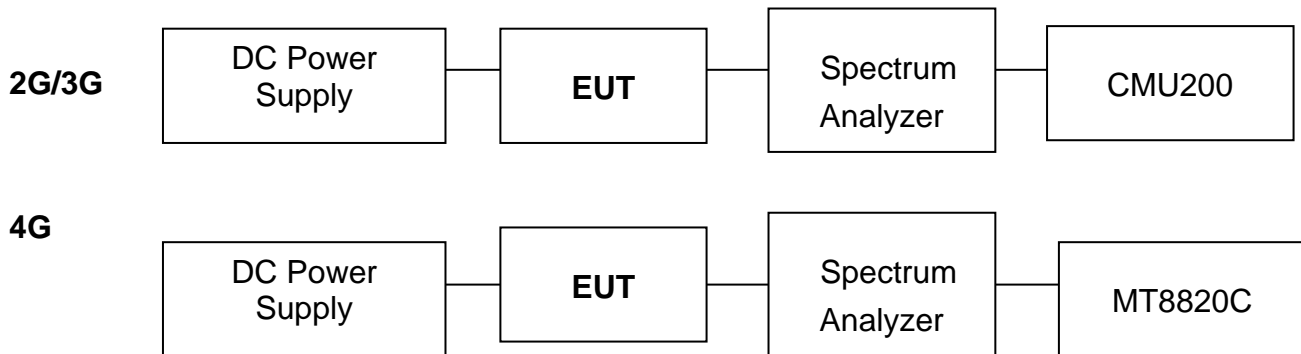

**Fig. 2-2 Configuration of Tested System (Fixed Channel-Radiated)**

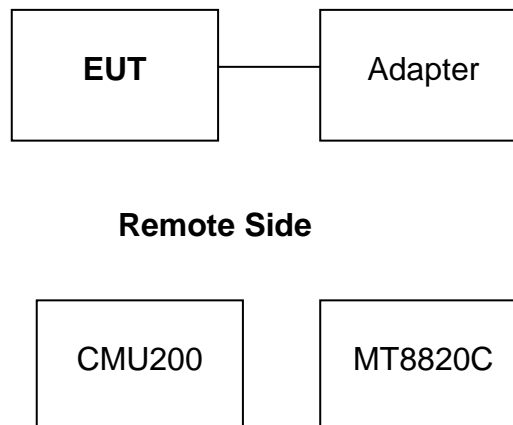

**Table 2-1 Equipment Used in**

Item	Equipment	Mfr/Brand	Model/ Type No.	Series No.	Data Cable	Power Cord
1.	Universal Radio Communication Tester	R&S	CMU200	102189	shielded	Un-shielded
2.	Universal Radio Communication Tester	Anritsu	MT8820C	6200307563	shielded	Un-shielded

Unless otherwise stated the results shown in this test report refer only to the sample(s) tested and such sample(s) are retained for 90 days only.

除非另有說明，此報告結果僅對測試之樣品負責，同時此樣品僅保留90天。本報告未經本公司書面許可，不可部份複製。

This document is issued by the Company subject to its General Conditions of Service printed overleaf, available on request or accessible at [www.sgs.com/terms\\_and\\_conditions.htm](http://www.sgs.com/terms_and_conditions.htm) and, for electronic format documents, subject to Terms and Conditions for Electronic Documents at [www.sgs.com/terms\\_e-document.htm](http://www.sgs.com/terms_e-document.htm). Attention is drawn to the limitation of liability, indemnification and jurisdiction issues defined therein. Any holder of this document is advised that information contained hereon reflects the Company's findings at the time of its intervention only and within the limits of Client's instructions, if any. The Company's sole responsibility is to its Client and this document does not exonerate parties to a transaction from exercising all their rights and obligations under the transaction documents. This document cannot be reproduced except in full, without prior written approval of the Company. Any unauthorized alteration, forgery or falsification of the content or appearance of this document is unlawful and offenders may be prosecuted to the fullest extent of the law.

SGS Taiwan Ltd.

No.134,WuKungRoad,NewTaipeiIndustrialPark,WukuDistrict,NewTaipeiCity,Taiwan24803/新北市五股區新北產業園區五工路 134 號

台灣檢驗科技股份有限公司

t (886-2) 2299-3279

f (886-2) 2298-0488

[www.tw.sgs.com](http://www.tw.sgs.com)

Member of SGS Group

### 3. SUMMARY OF TEST RESULTS

FCC Rules	Description Of Test	Result
§2.1046	RF Power Output	Compliant
§2.1046(a) §22.913(a)(5) §24.232(c) §27.50(d)(4) §27.50(h)(2)	ERP/ EIRP measurement	Compliant
§2.1049(h)	99% & 26dB Occupied Bandwidth	Compliant
§2.1051 §22.917(a) §24.238(a) §27.53(g) §27.53(h) §27.53(m)(4)(6)	Out of Band Emissions at Antenna Terminals and Band Edge / Emission mask requirements	Compliant
§2.1053 §22.917(a) §24.238(a) §27.53(h) §27.53(m)	Field Strength of Spurious Radiation	Compliant
§24.232(d) §27.50(b)	Peak to Average Ratio	Compliant
§2.1055(a)(1) §22.355 §24.235 §27.54	Frequency Stability	Compliant

Unless otherwise stated the results shown in this test report refer only to the sample(s) tested and such sample(s) are retained for 90 days only.

除非另有說明，此報告結果僅對測試之樣品負責，同時此樣品僅保留90天。本報告未經本公司書面許可，不可部份複製。

This document is issued by the Company subject to its General Conditions of Service printed overleaf, available on request or accessible at [www.sgs.com/terms\\_and\\_conditions.htm](http://www.sgs.com/terms_and_conditions.htm) and, for electronic format documents, subject to Terms and Conditions for Electronic Documents at [www.sgs.com/terms\\_e-document.htm](http://www.sgs.com/terms_e-document.htm). Attention is drawn to the limitation of liability, indemnification and jurisdiction issues defined therein. Any holder of this document is advised that information contained hereon reflects the Company's findings at the time of its intervention only and within the limits of Client's instructions, if any. The Company's sole responsibility is to its Client and this document does not exonerate parties to a transaction from exercising all their rights and obligations under the transaction documents. This document cannot be reproduced except in full, without prior written approval of the Company. Any unauthorized alteration, forgery or falsification of the content or appearance of this document is unlawful and offenders may be prosecuted to the fullest extent of the law.

SGS Taiwan Ltd.

No.134,WuKungRoad,NewTaipeiIndustrialPark,WukuDistrict,NewTaipeiCity,Taiwan24803/新北市五股區新北產業園區五工路 134 號

台灣檢驗科技股份有限公司

t (886-2) 2299-3279

f (886-2) 2298-0488

www.tw.sgs.com

Member of SGS Group

## 4. DESCRIPTION OF TEST MODES

### 4.1. The Worst Test Modes and Channel Details

1. The EUT has been tested under operating condition.
2. Pre-Scan has been conducted to determine the worst-case mode from all possible combinations between available modulations, data rates, X(E1)Y(E2)Z(H) axis and antenna ports. The worst case was found as listed below. Following channel(s) was (were) selected for the final test as listed below:

BAND	ERP/EIRP	RADIATED EMISSION and Wireless charging Cover
GPRS/EDGE 850	H-plan	H-plan
GPRS/EDGE 1900	E1-plan	E1-plan
WCDMA/HSPA Band II	E1-plan	E1-plan
WCDMA/HSPA Band IV	E1-plan	E1-plan
WCDMA/HSPA Band V	H-plan	H-plan
LTE Band 2	E1-plan	E1-plan
LTE Band 4	E1-plan	E1-plan
LTE Band 5	H-plan	H-plan
LTE Band 7	E1-plan	E1-plan
LTE Band 38	E1-plan	E1-plan
LTE Band 41	E1-plan	E1-plan

Unless otherwise stated the results shown in this test report refer only to the sample(s) tested and such sample(s) are retained for 90 days only.

除非另有說明，此報告結果僅對測試之樣品負責，同時此樣品僅保留90天。本報告未經本公司書面許可，不可部份複製。

This document is issued by the Company subject to its General Conditions of Service printed overleaf, available on request or accessible at [www.sgs.com/terms\\_and\\_conditions.htm](http://www.sgs.com/terms_and_conditions.htm) and, for electronic format documents, subject to Terms and Conditions for Electronic Documents at [www.sgs.com/terms\\_e-document.htm](http://www.sgs.com/terms_e-document.htm). Attention is drawn to the limitation of liability, indemnification and jurisdiction issues defined therein. Any holder of this document is advised that information contained hereon reflects the Company's findings at the time of its intervention only and within the limits of Client's instructions, if any. The Company's sole responsibility is to its Client and this document does not exonerate parties to a transaction from exercising all their rights and obligations under the transaction documents. This document cannot be reproduced except in full, without prior written approval of the Company. Any unauthorized alteration, forgery or falsification of the content or appearance of this document is unlawful and offenders may be prosecuted to the fullest extent of the law.

SGS Taiwan Ltd.

No.134,WuKungRoad,NewTaipeiIndustrialPark,WukuDistrict,NewTaipeiCity,Taiwan24803/新北市五股區新北產業園區五工路 134 號

台灣檢驗科技股份有限公司

t (886-2) 2299-3279

f (886-2) 2298-0488

[www.tw.sgs.com](http://www.tw.sgs.com)

Member of SGS Group

GPRS/EDGE MODE

TEST ITEM	AVAILABLE CHANNEL	TESTED CHANNEL	MODE
ERP	128 to 251	128, 190, 251	GPRS/EDGE 850
EIRP	512 to 810	512, 661, 810	GPRS/EDGE 1900
FREQUENCY STABILITY	128 to 251 512 to 810	190 661	GPRS 850 GPRS 1900
OCCUPIED BANDWIDTH	128 to 251 512 to 810	190 661	GPRS/EDGE 850 GPRS/EDGE 1900
PEAK TO AVERAGE RATIO	128 to 251 512 to 810	128, 190, 251 512, 661, 810	GPRS/EDGE 850 GPRS/EDGE 1900
BAND EDGE	128 to 251 512 to 810	128, 251 512, 810	GPRS/EDGE 850 GPRS/EDGE 1900
CONDCUDED EMISSION	128 to 251 512 to 810	128, 190, 251 512, 661, 810	GPRS/EDGE 850 GPRS/EDGE 1900
RADIATED EMISSION	128 to 251 512 to 810	128, 190, 251 512, 661, 810	GPRS 850 GPRS 1900

WCDMA/HSPA MODE

TEST ITEM	AVAILABLE CHANNEL	TESTED CHANNEL	MODE
ERP	4132 to 4233	4132, 4183, 4233	WCDMA/HSPA Band V
EIRP	9262 to 9538 1312 to 1513	9262, 9400, 9583 1312, 1413, 1513	WCDMA/HSPA Band II WCDMA/HSPA Band IV
FREQUENCY STABILITY	4132 to 4233 1312 to 1513 9262 to 9538	4183 1413 9400	WCDMA Band II WCDMA Band IV WCDMA Band V
OCCUPIED BANDWIDTH	4132 to 4233 1312 to 1513 9262 to 9538	4132, 4183, 4233 1312, 1413, 1513 9262, 9400, 9583	WCDMA/HSPA Band II WCDMA/HSPA Band IV WCDMA/HSPA Band V
PEAK TO AVERAGE RATIO	4132 to 4233 1312 to 1513 9262 to 9538	4132, 4183, 4233 1312, 1413, 1513 9262, 9400, 9583	WCDMA/HSPA Band II WCDMA/HSPA Band IV WCDMA/HSPA Band V
BAND EDGE	4132 to 4233 1312 to 1513 9262 to 9538	4132, 4233 1312, 1513 9262, 9583	WCDMA Band II WCDMA Band IV WCDMA Band V
CONDCUDED EMISSION	4132 to 4233 1312 to 1513 9262 to 9538	4132, 4183, 4233 1312, 1413, 1513 9262, 9400, 9583	WCDMA Band II WCDMA Band IV WCDMA Band V
RADIATED EMISSION	4132 to 4233 1312 to 1513 9262 to 9538	4132, 4183, 4233 1312, 1413, 1513 9262, 9400, 9583	HSDPA Band II HSUPA Band IV WCDMA Band V

Unless otherwise stated the results shown in this test report refer only to the sample(s) tested and such sample(s) are retained for 90 days only.

除非另有說明，此報告結果僅對測試之樣品負責，同時此樣品僅保留90天。本報告未經本公司書面許可，不可部份複製。

This document is issued by the Company subject to its General Conditions of Service printed overleaf, available on request or accessible at [www.sgs.com/terms\\_and\\_conditions.htm](http://www.sgs.com/terms_and_conditions.htm) and, for electronic format documents, subject to Terms and Conditions for Electronic Documents at [www.sgs.com/terms\\_e-document.htm](http://www.sgs.com/terms_e-document.htm). Attention is drawn to the limitation of liability, indemnification and jurisdiction issues defined therein. Any holder of this document is advised that information contained hereon reflects the Company's findings at the time of its intervention only and within the limits of Client's instructions, if any. The Company's sole responsibility is to its Client and this document does not exonerate parties to a transaction from exercising all their rights and obligations under the transaction documents. This document cannot be reproduced except in full, without prior written approval of the Company. Any unauthorized alteration, forgery or falsification of the content or appearance of this document is unlawful and offenders may be prosecuted to the fullest extent of the law.

**LTE Band 2 MODE**

TEST ITEM	AVAILABLE CHANNEL	TESTED CHANNEL	CHANNEL BANDWIDTH	MODULATION	MODE
EIRP	18607 to 19193	18607, 18900, 19193	1.4MHz	QPSK, 16QAM 64QAM	1 RB/ 0,5 RB Offest
	18615 to 19185	18615, 18900, 19185	3MHz	QPSK, 16QAM 64QAM	1 RB/ 0,14 RB Offest
	18625 to 19175	18625, 18900, 19175	5MHz	QPSK, 16QAM 64QAM	1 RB/ 0,24 RB Offest
	18650 to 19150	18650, 18900, 19150	10MHz	QPSK, 16QAM 64QAM	1 RB/ 0,49 RB Offest
	18675 to 19125	18675, 18900, 19125	15MHz	QPSK, 16QAM 64QAM	1 RB/ 0,74 RB Offest
	18700 to 19100	18700, 18900, 19100	20MHz	QPSK, 16QAM 64QAM	1 RB/ 0,99 RB Offest
FREQUENCY STABILITY	18650 to 19150	18900	10MHz	QPSK,	Full RB
OCCUPIED BANDWIDTH	18607 to 19193	18607, 18900, 19193	1.4MHz	QPSK, 16QAM 64QAM	Full RB
	18615 to 19185	18615, 18900, 19185	3MHz	QPSK, 16QAM 64QAM	Full RB
	18625 to 19175	18625, 18900, 19175	5MHz	QPSK, 16QAM 64QAM	Full RB
	18650 to 19150	18650, 18900, 19150	10MHz	QPSK, 16QAM 64QAM	Full RB
	18675 to 19125	18675, 18900, 19125	15MHz	QPSK, 16QAM 64QAM	Full RB
	18700 to 19100	18700, 18900, 19100	20MHz	QPSK, 16QAM 64QAM	Full RB
PEAK TO AVERAGE RATIO	18607 to 19193	18607, 18900, 19193	1.4MHz	64QAM	Full RB
	18615 to 19185	18615, 18900, 19185	3MHz	64QAM	Full RB
	18625 to 19175	18625, 18900, 19175	5MHz	64QAM	Full RB
	18650 to 19150	18650, 18900, 19150	10MHz	64QAM	Full RB
	18675 to 19125	18675, 18900, 19125	15MHz	64QAM	Full RB
	18700 to 19100	18700, 18900, 19100	20MHz	64QAM	Full RB
BAND EDGE	18607 to 19193	18607, 19193	1.4MHz	QPSK,	1 RB/ 0,5 RB Offes Full RB
	18615 to 19185	18615, 19185	3MHz	QPSK,	1 RB/ 0,14 RB Offest Full RB
	18625 to 19175	18625, 19175	5MHz	QPSK,	1 RB/ 0,24 RB Offest Full RB
	18650 to 19150	18650, 19150	10MHz	QPSK,	1 RB/ 0,49 RB Offest Full RB
	18675 to 19125	18675, 19125	15MHz	QPSK,	1 RB/ 0,74 RB Offest Full RB
	18700 to 19100	18700, 19100	20MHz	QPSK,	1 RB/ 0,99 RB Offest Full RB
CONDCUDED EMISSION	18607 to 19193	18607, 18900, 19193	1.4MHz	QPSK,	1 RB, 0 RB Offest
	18615 to 19185	18615, 18900, 19185	3MHz	QPSK,	1 RB, 0 RB Offest
	18625 to 19175	18625, 18900, 19175	5MHz	QPSK,	1 RB, 0 RB Offest
	18650 to 19150	18650, 18900, 19150	10MHz	QPSK,	1 RB, 0 RB Offest
	18675 to 19125	18675, 18900, 19125	15MHz	QPSK,	1 RB, 0 RB Offest
	18700 to 19100	18700, 18900, 19100	20MHz	QPSK,	1 RB, 0 RB Offest
RADIATED EMISSION	18625 to 19175	18625, 18900, 19175	5MHz	QPSK	1 RB, 0 RB Offest

Unless otherwise stated the results shown in this test report refer only to the sample(s) tested and such sample(s) are retained for 90 days only.

除非另有說明，此報告結果僅對測試之樣品負責，同時此樣品僅保留90天。本報告未經本公司書面許可，不可部份複製。

This document is issued by the Company subject to its General Conditions of Service printed overleaf, available on request or accessible at [www.sgs.com/terms\\_and\\_conditions.htm](http://www.sgs.com/terms_and_conditions.htm) and, for electronic format documents, subject to Terms and Conditions for Electronic Documents at [www.sgs.com/terms\\_e-document.htm](http://www.sgs.com/terms_e-document.htm). Attention is drawn to the limitation of liability, indemnification and jurisdiction issues defined therein. Any holder of this document is advised that information contained hereon reflects the Company's findings at the time of its intervention only and within the limits of Client's instructions, if any. The Company's sole responsibility is to its Client and this document does not exonerate parties to a transaction from exercising all their rights and obligations under the transaction documents. This document cannot be reproduced except in full, without prior written approval of the Company. Any unauthorized alteration, forgery or falsification of the content or appearance of this document is unlawful and offenders may be prosecuted to the fullest extent of the law.

SGS Taiwan Ltd.

No.134,WuKungRoad,NewTaipeiIndustrialPark,WukuDistrict,NewTaipeiCity,Taiwan24803/新北市五股區新北產業園區五工路 134 號

台灣檢驗科技股份有限公司

t (886-2) 2299-3279

f (886-2) 2298-0488

www.tw.sgs.com

Member of SGS Group



**LTE Band 4 MODE**

TEST ITEM	AVAILABLE CHANNEL	TESTED CHANNEL	CHANNEL BANDWIDTH	MODULATION	MODE
EIRP	19957 to 19393	19957, 20175, 19393	1.4MHz	QPSK, 16QAM 64QAM	1 RB/ 0,5 RB Offest
	19965 to 22385	19965, 20175, 22385	3MHz	QPSK, 16QAM 64QAM	1 RB/ 0,14 RB Offest
	19975 to 20375	19975, 20175, 20375	5MHz	QPSK, 16QAM 64QAM	1 RB/ 0,24 RB Offest
	20000 to 20350	20000, 20175, 20350	10MHz	QPSK, 16QAM 64QAM	1 RB/ 0,49 RB Offest
	20025 to 20325	20025, 20175, 20325	15MHz	QPSK, 16QAM 64QAM	1 RB/ 0,74 RB Offest
	20050 to 20300	20050, 20175, 20300	20MHz	QPSK, 16QAM 64QAM	1 RB/ 0,99 RB Offest
FREQUENCY STABILITY	20000 to 20350	20175	10MHz	QPSK,	Full RB
OCCUPIED BANDWIDTH	19957 to 19393	19957, 20175, 19393	1.4MHz	QPSK, 16QAM 64QAM	Full RB
	19965 to 22385	19965, 20175, 22385	3MHz	QPSK, 16QAM 64QAM	Full RB
	19975 to 20375	19975, 20175, 20375	5MHz	QPSK, 16QAM 64QAM	Full RB
	20000 to 20350	20000, 20175, 20350	10MHz	QPSK, 16QAM 64QAM	Full RB
	20025 to 20325	20025, 20175, 20325	15MHz	QPSK, 16QAM 64QAM	Full RB
	20050 to 20300	20050, 20175, 20300	20MHz	QPSK, 16QAM 64QAM	Full RB
PEAK TO AVERAGE RATIO	19957 to 19393	19957, 20175, 19393	1.4MHz	64QAM	Full RB
	19965 to 22385	19965, 20175, 22385	3MHz	64QAM	Full RB
	19975 to 20375	19975, 20175, 20375	5MHz	64QAM	Full RB
	20000 to 20350	20000, 20175, 20350	10MHz	64QAM	Full RB
	20025 to 20325	20025, 20175, 20325	15MHz	64QAM	Full RB
	20050 to 20300	20050, 20175, 20300	20MHz	64QAM	Full RB
BAND EDGE	19957 to 19393	19957, 19393	1.4MHz	QPSK,	1 RB/ 0,5 RB Offes Full RB
	19965 to 22385	19965, 22385	3MHz	QPSK,	1 RB/ 0,14 RB Offest Full RB
	19975 to 20375	19975, 20375	5MHz	QPSK,	1 RB/ 0,24 RB Offest Full RB
	20000 to 20350	20000, 20350	10MHz	QPSK,	1 RB/ 0,49 RB Offest Full RB
	20025 to 20325	20025, 20325	15MHz	QPSK,	1 RB/ 0,74 RB Offest Full RB
	20050 to 20300	20050, 20300	20MHz	QPSK,	1 RB/ 0,99 RB Offest Full RB
CONDCUETED EMISSION	19957 to 19393	19957, 20175, 19393	1.4MHz	QPSK,	1 RB, 0 RB Offest
	19965 to 22385	19965, 20175, 22385	3MHz	QPSK,	1 RB, 0 RB Offest
	19975 to 20375	19975, 20175, 20375	5MHz	QPSK,	1 RB, 0 RB Offest
	20000 to 20350	20000, 20175, 20350	10MHz	QPSK,	1 RB, 0 RB Offest
	20025 to 20325	20025, 20175, 20325	15MHz	QPSK,	1 RB, 0 RB Offest
	20050 to 20300	20050, 20175, 20300	20MHz	QPSK,	1 RB, 0 RB Offest
RADIATED EMISSION	19965 to 22385	19965, 20175, 22385	3MHz	QPSK	1 RB, 0 RB Offest

Unless otherwise stated the results shown in this test report refer only to the sample(s) tested and such sample(s) are retained for 90 days only.

除非另有說明，此報告結果僅對測試之樣品負責，同時此樣品僅保留90天。本報告未經本公司書面許可，不可部份複製。

This document is issued by the Company subject to its General Conditions of Service printed overleaf, available on request or accessible at [www.sgs.com/terms\\_and\\_conditions.htm](http://www.sgs.com/terms_and_conditions.htm) and, for electronic format documents, subject to Terms and Conditions for Electronic Documents at [www.sgs.com/terms\\_e-document.htm](http://www.sgs.com/terms_e-document.htm). Attention is drawn to the limitation of liability, indemnification and jurisdiction issues defined therein. Any holder of this document is advised that information contained hereon reflects the Company's findings at the time of its intervention only and within the limits of Client's instructions, if any. The Company's sole responsibility is to its Client and this document does not exonerate parties to a transaction from exercising all their rights and obligations under the transaction documents. This document cannot be reproduced except in full, without prior written approval of the Company. Any unauthorized alteration, forgery or falsification of the content or appearance of this document is unlawful and offenders may be prosecuted to the fullest extent of the law.

SGS Taiwan Ltd.

No.134,WuKungRoad,NewTaipeiIndustrialPark,WukuDistrict,NewTaipeiCity,Taiwan24803/新北市五股區新北產業園區五工路 134 號

台灣檢驗科技股份有限公司

t (886-2) 2299-3279

f (886-2) 2298-0488

www.tw.sgs.com

Member of SGS Group

**LTE Band 5 MODE**

TEST ITEM	AVAILABLE CHANNEL	TESTED CHANNEL	CHANNEL BANDWIDTH	MODULATION	MODE
ERP	20470 to 20643	20470, 20525, 20643	1.4MHz	QPSK, 16QAM 64QAM	1 RB/ 0,5 RB Offest
	20415 to 20635	20415, 20525, 20635	3MHz	QPSK, 16QAM 64QAM	1 RB/ 0,14 RB Offest
	20425 to 20625	20425, 20525, 20625	5MHz	QPSK, 16QAM 64QAM	1 RB/ 0,24 RB Offest
	20450 to 20600	20450, 20525, 20600	10MHz	QPSK, 16QAM 64QAM	1 RB/ 0,49 RB Offest
FREQUENCY STABILITY	20450 to 20600	20525	10MHz	QPSK,	Full RB
OCCUPIED BANDWIDTH	20470 to 20643	20470, 20525, 20643	1.4MHz	QPSK, 16QAM 64QAM	Full RB
	20415 to 20635	20415, 20525, 20635	3MHz	QPSK, 16QAM 64QAM	Full RB
	20425 to 20625	20425, 20525, 20625	5MHz	QPSK, 16QAM 64QAM	Full RB
	20450 to 20600	20450, 20525, 20600	10MHz	QPSK, 16QAM 64QAM	Full RB
PEAK TO AVERAGE RATIO	20470 to 20643	20470, 20525, 20643	1.4MHz	16QAM	Full RB
	20415 to 20635	20415, 20525, 20635	3MHz	16QAM	Full RB
	20425 to 20625	20425, 20525, 20625	5MHz	16QAM	Full RB
	20450 to 20600	20450, 20525, 20600	10MHz	16QAM	Full RB
BAND EDGE	20470 to 20643	20470, 20643	1.4MHz	QPSK,	1 RB/ 0,5 RB Offes Full RB
	20415 to 20635	20415, 20635	3MHz	QPSK,	1 RB/ 0,14 RB Offest Full RB
	20425 to 20625	20425, 20625	5MHz	QPSK,	1 RB/ 0,24 RB Offest Full RB
	20450 to 20600	20450, 20600	10MHz	QPSK,	1 RB/ 0,49 RB Offest Full RB
CONDCUDED EMISSION	20470 to 20643	20470, 20525, 20643	1.4MHz	QPSK,	1 RB, 0 RB Offest
	20415 to 20635	20415, 20525, 20635	3MHz	QPSK,	1 RB, 0 RB Offest
	20425 to 20625	20425, 20525, 20625	5MHz	QPSK,	1 RB, 0 RB Offest
	20450 to 20600	20450, 20525, 20600	10MHz	QPSK,	1 RB, 0 RB Offest
RADIATED EMISSION	20450 to 20600	20450, 20525, 20600	1.4MHz	QPSK	1 RB, 0 RB Offest

Unless otherwise stated the results shown in this test report refer only to the sample(s) tested and such sample(s) are retained for 90 days only.

除非另有說明，此報告結果僅對測試之樣品負責，同時此樣品僅保留90天。本報告未經本公司書面許可，不可部份複製。

This document is issued by the Company subject to its General Conditions of Service printed overleaf, available on request or accessible at [www.sgs.com/terms\\_and\\_conditions.htm](http://www.sgs.com/terms_and_conditions.htm) and, for electronic format documents, subject to Terms and Conditions for Electronic Documents at [www.sgs.com/terms\\_e-document.htm](http://www.sgs.com/terms_e-document.htm). Attention is drawn to the limitation of liability, indemnification and jurisdiction issues defined therein. Any holder of this document is advised that information contained hereon reflects the Company's findings at the time of its intervention only and within the limits of Client's instructions, if any. The Company's sole responsibility is to its Client and this document does not exonerate parties to a transaction from exercising all their rights and obligations under the transaction documents. This document cannot be reproduced except in full, without prior written approval of the Company. Any unauthorized alteration, forgery or falsification of the content or appearance of this document is unlawful and offenders may be prosecuted to the fullest extent of the law.

SGS Taiwan Ltd.

No.134,WuKungRoad,NewTaipeiIndustrialPark,WukuDistrict,NewTaipeiCity,Taiwan24803/新北市五股區新北產業園區五工路 134 號

台灣檢驗科技股份有限公司

t (886-2) 2299-3279

f (886-2) 2298-0488

www.tw.sgs.com

Member of SGS Group

**LTE Band 7 MODE**

TEST ITEM	AVAILABLE CHANNEL	TESTED CHANNEL	CHANNEL BANDWIDTH	MODULATION	MODE
EIRP	20775 to 21425	20775, 21100, 21425	5MHz	QPSK, 16QAM 64QAM	1 RB/ 0,24 RB Offest
	20800 to 21400	20800, 21100, 21400	10MHz	QPSK, 16QAM 64QAM	1 RB/ 0,49 RB Offest
	20850 to 21375	20850, 21100, 21375	15MHz	QPSK, 16QAM 64QAM	1 RB/ 0,74 RB Offest
	20850 to 21350	20850, 21100, 21350	20MHz	QPSK, 16QAM 64QAM	1 RB/ 0,99 RB Offest
FREQUENCY STABILITY	20800 to 21400	21100	10MHz	QPSK,	Full RB
OCCUPIED BANDWIDTH	20775 to 21425	20775, 21100, 21425	5MHz	QPSK, 16QAM 64QAM	Full RB
	20800 to 21400	20800, 21100, 21400	10MHz	QPSK, 16QAM 64QAM	Full RB
	20850 to 21375	20850, 21100, 21375	15MHz	QPSK, 16QAM 64QAM	Full RB
	20850 to 21350	20850, 21100, 21350	20MHz	QPSK, 16QAM 64QAM	Full RB
PEAK TO AVERAGE RATIO	20775 to 21425	20775, 21100, 21425	5MHz	16QAM	Full RB
	20800 to 21400	20800, 21100, 21400	10MHz	16QAM	Full RB
	20850 to 21375	20850, 21100, 21375	15MHz	16QAM	Full RB
	20850 to 21350	20850, 21100, 21350	20MHz	16QAM	Full RB
BAND EDGE	20775 to 21425	20775, 21100, 21425	5MHz	QPSK,	1 RB/ 0,24 RB Offest Full RB
	20800 to 21400	20800, 21100, 21400	10MHz	QPSK,	1 RB/ 0,49 RB Offest Full RB
	20850 to 21375	20850, 21100, 21375	15MHz	QPSK,	1 RB/ 0,74 RB Offest Full RB
	20850 to 21350	20850, 21100, 21350	20MHz	QPSK,	1 RB/ 0,99 RB Offest Full RB
CONDCUDED EMISSION	20775 to 21425	20775, 21100, 21425	5MHz	QPSK,	1 RB, 0 RB Offest
	20800 to 21400	20800, 21100, 21400	10MHz	QPSK,	1 RB, 0 RB Offest
	20850 to 21375	20850, 21100, 21375	15MHz	QPSK,	1 RB, 0 RB Offest
	20850 to 21350	20850, 21100, 21350	20MHz	QPSK,	1 RB, 0 RB Offest
RADIATED EMISSION	20775 to 21425	20775, 21100, 21425	5MHz	QPSK,	1 RB, 0 RB Offest
EMISSION MASK	20775 to 21425	20775, 21100, 21425	5MHz	QPSK,	1 RB/ 0,24 RB Offest 25 RB/ 0 Offset
	20800 to 21400	20800, 21100, 21400	10MHz	QPSK,	1 RB/ 0,49 RB Offest 50 RB/ 0 Offset
	20850 to 21375	20850, 21100, 21375	15MHz	QPSK,	1 RB/ 0,74 RB Offest 75 RB/ 0 Offset
	20850 to 21350	20850, 21100, 21350	20MHz	QPSK,	1 RB/ 0,99 RB Offest 100 RB/ 0 Offset

Unless otherwise stated the results shown in this test report refer only to the sample(s) tested and such sample(s) are retained for 90 days only.

除非另有說明，此報告結果僅對測試之樣品負責，同時此樣品僅保留90天。本報告未經本公司書面許可，不可部份複製。

This document is issued by the Company subject to its General Conditions of Service printed overleaf, available on request or accessible at [www.sgs.com/terms\\_and\\_conditions.htm](http://www.sgs.com/terms_and_conditions.htm) and, for electronic format documents, subject to Terms and Conditions for Electronic Documents at [www.sgs.com/terms\\_e-document.htm](http://www.sgs.com/terms_e-document.htm). Attention is drawn to the limitation of liability, indemnification and jurisdiction issues defined therein. Any holder of this document is advised that information contained hereon reflects the Company's findings at the time of its intervention only and within the limits of Client's instructions, if any. The Company's sole responsibility is to its Client and this document does not exonerate parties to a transaction from exercising all their rights and obligations under the transaction documents. This document cannot be reproduced except in full, without prior written approval of the Company. Any unauthorized alteration, forgery or falsification of the content or appearance of this document is unlawful and offenders may be prosecuted to the fullest extent of the law.

SGS Taiwan Ltd.

No.134,WuKungRoad,NewTaipeiIndustrialPark,WukuDistrict,NewTaipeiCity,Taiwan24803/新北市五股區新北產業園區五工路 134 號

台灣檢驗科技股份有限公司

t (886-2) 2299-3279

f (886-2) 2298-0488

www.tw.sgs.com

Member of SGS Group

**LTE Band 38 MODE**

TEST ITEM	AVAILABLE CHANNEL	TESTED CHANNEL	CHANNEL BANDWIDTH	MODULATION	MODE
EIRP	37775 to 38225	37775, 38000, 38225	5MHz	QPSK, 16QAM 64QAM	1 RB/ 0,24 RB Offest
	37800 to 38200	37800 , 38000, 38200	10MHz	QPSK, 16QAM 64QAM	1 RB/ 0,49 RB Offest
	37825 to 38175	37825 , 38000, 38175	15MHz	QPSK, 16QAM 64QAM	1 RB/ 0,74 RB Offest
	37850 to 38150	37850 , 38000, 38150	20MHz	QPSK, 16QAM 64QAM	1 RB/ 0,99 RB Offest
FREQUENCY STABILITY	37800 to 38200	37800 , 38000, 38200	10MHz	QPSK,	Full RB
OCCUPIED BANDWIDTH	37775 to 38225	37775, 38000, 38225	5MHz	QPSK, 16QAM 64QAM	Full RB
	37800 to 38200	37800 , 38000, 38200	10MHz	QPSK, 16QAM 64QAM	Full RB
	37825 to 38175	37825 , 38000, 38175	15MHz	QPSK, 16QAM 64QAM	Full RB
	37850 to 38150	37850 , 38000, 38150	20MHz	QPSK, 16QAM 64QAM	Full RB
PEAK TO AVERAGE RATIO	37775 to 38225	37775, 38000, 38225	5MHz	16QAM	Full RB
	37800 to 38200	37800 , 38000, 38200	10MHz	16QAM	Full RB
	37825 to 38175	37825 , 38000, 38175	15MHz	16QAM	Full RB
	37850 to 38150	37850 , 38000, 38150	20MHz	16QAM	Full RB
BAND EDGE	37775 to 38225	37775, 38000, 38225	5MHz	QPSK,	1 RB/ 0,24 RB Offest Full RB
	37800 to 38200	37800 , 38000, 38200	10MHz	QPSK,	1 RB/ 0,49 RB Offest Full RB
	37825 to 38175	37825 , 38000, 38175	15MHz	QPSK,	1 RB/ 0,74 RB Offest Full RB
	37850 to 38150	37850 , 38000, 38150	20MHz	QPSK,	1 RB/ 0,99 RB Offest Full RB
CONDCUDED EMISSION	37775 to 38225	37775, 38000, 38225	5MHz	QPSK,	1 RB, 0 RB Offest
	37800 to 38200	37800 , 38000, 38200	10MHz	QPSK,	1 RB, 0 RB Offest
	37825 to 38175	37825 , 38000, 38175	15MHz	QPSK,	1 RB, 0 RB Offest
	37850 to 38150	37850 , 38000, 38150	20MHz	QPSK,	1 RB, 0 RB Offest
RADIATED EMISSION	37775 to 38225	37775, 38000, 38225	5MHz	QPSK,	1 RB, 0 RB Offest
EMISSION MASK	37775 to 38225	37775, 38000, 38225	5MHz	QPSK,	1 RB/ 0,24 RB Offest 25 RB/ 0 Offset
	37800 to 38200	37800 , 38000, 38200	10MHz	QPSK,	1 RB/ 0,49 RB Offest 50 RB/ 0 Offset
	37825 to 38175	37825 , 38000, 38175	15MHz	QPSK,	1 RB/ 0,74 RB Offest 75 RB/ 0 Offset
	37850 to 38150	37850 , 38000, 38150	20MHz	QPSK,	1 RB/ 0,99 RB Offest 100 RB/ 0 Offset

Unless otherwise stated the results shown in this test report refer only to the sample(s) tested and such sample(s) are retained for 90 days only.

除非另有說明，此報告結果僅對測試之樣品負責，同時此樣品僅保留90天。本報告未經本公司書面許可，不可部份複製。

This document is issued by the Company subject to its General Conditions of Service printed overleaf, available on request or accessible at [www.sgs.com/terms\\_and\\_conditions.htm](http://www.sgs.com/terms_and_conditions.htm) and, for electronic format documents, subject to Terms and Conditions for Electronic Documents at [www.sgs.com/terms\\_e-document.htm](http://www.sgs.com/terms_e-document.htm). Attention is drawn to the limitation of liability, indemnification and jurisdiction issues defined therein. Any holder of this document is advised that information contained hereon reflects the Company's findings at the time of its intervention only and within the limits of Client's instructions, if any. The Company's sole responsibility is to its Client and this document does not exonerate parties to a transaction from exercising all their rights and obligations under the transaction documents. This document cannot be reproduced except in full, without prior written approval of the Company. Any unauthorized alteration, forgery or falsification of the content or appearance of this document is unlawful and offenders may be prosecuted to the fullest extent of the law.

SGS Taiwan Ltd.

No.134,WuKungRoad,NewTaipeiIndustrialPark,WukuDistrict,NewTaipeiCity,Taiwan24803/新北市五股區新北產業園區五工路 134 號

台灣檢驗科技股份有限公司

t (886-2) 2299-3279

f (886-2) 2298-0488

www.tw.sgs.com

Member of SGS Group

**LTE Band 41 MODE**

TEST ITEM	AVAILABLE CHANNEL	TESTED CHANNEL	CHANNEL BANDWIDTH	MODULATION	MODE
EIRP	40165 to 41215	40165, 40690, 41215	5MHz	QPSK, 16QAM 64QAM	1 RB/ 0,24 RB Offest
	40190 to 41190	40190 , 40690, 41190	10MHz	QPSK, 16QAM 64QAM	1 RB/ 0,49 RB Offest
	40215 to 41165	40215 , 40690, 41165	15MHz	QPSK, 16QAM 64QAM	1 RB/ 0,74 RB Offest
	40240 to 41140	40240 , 40690, 41140	20MHz	QPSK, 16QAM 64QAM	1 RB/ 0,99 RB Offest
FREQUENCY STABILITY	40240 to 41140	40340 , 40690, 41140	20MHz	QPSK,	Full RB
OCCUPIED BANDWIDTH	40165 to 41215	40165, 40690, 41215	5MHz	QPSK, 16QAM 64QAM	Full RB
	40190 to 41190	40190 , 40690, 41190	10MHz	QPSK, 16QAM 64QAM	Full RB
	40215 to 41165	40215 , 40690, 41165	15MHz	QPSK, 16QAM 64QAM	Full RB
	40240 to 41140	40240 , 40690, 41140	20MHz	QPSK, 16QAM 64QAM	Full RB
PEAK TO AVERAGE RATIO	40165 to 41215	40165, 40690, 41215	5MHz	16QAM	Full RB
	40190 to 41190	40190 , 40690, 41190	10MHz	16QAM	Full RB
	40215 to 41165	40215 , 40690, 41165	15MHz	16QAM	Full RB
	40240 to 41140	40240 , 40690, 41140	20MHz	16QAM	Full RB
BAND EDGE	40165 to 41215	40165, 40690, 41215	5MHz	QPSK,	1 RB/ 0,24 RB Offest Full RB
	40190 to 41190	40190 , 40690, 41190	10MHz	QPSK,	1 RB/ 0,49 RB Offest Full RB
	40215 to 41165	40215 , 40690, 41165	15MHz	QPSK,	1 RB/ 0,74 RB Offest Full RB
	40240 to 41140	40240 , 40690, 41140	20MHz	QPSK,	1 RB/ 0,99 RB Offest Full RB
CONDCUDED EMISSION	40165 to 41215	40165, 40690, 41215	5MHz	QPSK,	1 RB, 0 RB Offest
	40190 to 41190	40190 , 40690, 41190	10MHz	QPSK,	1 RB, 0 RB Offest
	40215 to 41165	40215 , 40690, 41165	15MHz	QPSK,	1 RB, 0 RB Offest
	40240 to 41140	40240 , 40690, 41140	20MHz	QPSK,	1 RB, 0 RB Offest
RADIATED EMISSION	40165 to 41215	40165, 40690, 41215	5MHz	QPSK,	1 RB, 0 RB Offest
EMISSION MASK	40165 to 41215	40165, 40690, 41215	5MHz	QPSK,	1 RB/ 0,24 RB Offest 25 RB/ 0 Offset
	40190 to 41190	40190 , 40690, 41190	10MHz	QPSK,	1 RB/ 0,49 RB Offest 50 RB/ 0 Offset
	40215 to 41165	40215 , 40690, 41165	15MHz	QPSK,	1 RB/ 0,74 RB Offest 75 RB/ 0 Offset
	40240 to 41140	40240 , 40690, 41140	20MHz	QPSK,	1 RB/ 0,99 RB Offest 100 RB/ 0 Offset

Unless otherwise stated the results shown in this test report refer only to the sample(s) tested and such sample(s) are retained for 90 days only.

除非另有說明，此報告結果僅對測試之樣品負責，同時此樣品僅保留90天。本報告未經本公司書面許可，不可部份複製。

This document is issued by the Company subject to its General Conditions of Service printed overleaf, available on request or accessible at [www.sgs.com/terms\\_and\\_conditions.htm](http://www.sgs.com/terms_and_conditions.htm) and, for electronic format documents, subject to Terms and Conditions for Electronic Documents at [www.sgs.com/terms\\_e-document.htm](http://www.sgs.com/terms_e-document.htm). Attention is drawn to the limitation of liability, indemnification and jurisdiction issues defined therein. Any holder of this document is advised that information contained hereon reflects the Company's findings at the time of its intervention only and within the limits of Client's instructions, if any. The Company's sole responsibility is to its Client and this document does not exonerate parties to a transaction from exercising all their rights and obligations under the transaction documents. This document cannot be reproduced except in full, without prior written approval of the Company. Any unauthorized alteration, forgery or falsification of the content or appearance of this document is unlawful and offenders may be prosecuted to the fullest extent of the law.

SGS Taiwan Ltd.

No.134,WuKungRoad,NewTaipeiIndustrialPark,WukuDistrict,NewTaipeiCity,Taiwan24803/新北市五股區新北產業園區五工路 134 號

台灣檢驗科技股份有限公司

t (886-2) 2299-3279

f (886-2) 2298-0488

www.tw.sgs.com

Member of SGS Group

## 5. MEASUREMENT UNCERTAINTY

Test Items	Uncertainty
RF Power Output	+/- 1.10 dB
ERP/ EIRP measurement	Vertical Polarization = +/- 4.74dB Horizontal Polarization = +/- 4.62dB
99% Occupied Bandwidth	+/- 5.19 Hz
Out of Band Emissions at Antenna Terminals and Band Edge	+/- 0.70 dB
Peak to Average Ratio	+/- 0.70 dB
Frequency Stability vs. Temperature	+/- 5.19 Hz
Frequency Stability vs. Voltage	+/- 5.19 Hz
Temperature	+/- 0.65 °C
Humidity	+/- 4.6 %
DC / AC Power Source	DC= +/- 0.13%, AC= +/- 0.2%

### Radiated Spurious Emission:

Measurement uncertainty (Polarization : <b>Vertical</b> )	9kHz – 30MHz: +/- 2.87 dB
	30MHz - 180MHz: +/- 3.37dB
	180MHz -417MHz: +/- 3.19dB
	0.417GHz-1GHz: +/- 3.19dB
	1GHz - 18GHz: +/- 4.04dB
	18GHz - 40GHz: +/- 4.04dB

Measurement uncertainty (Polarization : <b>Horizontal</b> )	9kHz – 30MHz: +/- 2.87 dB
	30MHz - 167MHz: +/- 4.22dB
	167MHz -500MHz: +/- 3.44dB
	0.5GHz-1GHz: +/- 3.39dB
	1GHz - 18GHz: +/- 4.08dB
	18GHz - 40GHz: +/- 4.08dB

This uncertainty represents an expanded uncertainty expressed at approximately the 95% confidence level using a coverage factor of k=2.

Unless otherwise stated the results shown in this test report refer only to the sample(s) tested and such sample(s) are retained for 90 days only.

除非另有說明，此報告結果僅對測試之樣品負責，同時此樣品僅保留90天。本報告未經本公司書面許可，不可部份複製。

This document is issued by the Company subject to its General Conditions of Service printed overleaf, available on request or accessible at [www.sgs.com/terms\\_and\\_conditions.htm](http://www.sgs.com/terms_and_conditions.htm) and, for electronic format documents, subject to Terms and Conditions for Electronic Documents at [www.sgs.com/terms\\_e-document.htm](http://www.sgs.com/terms_e-document.htm). Attention is drawn to the limitation of liability, indemnification and jurisdiction issues defined therein. Any holder of this document is advised that information contained hereon reflects the Company's findings at the time of its intervention only and within the limits of Client's instructions, if any. The Company's sole responsibility is to its Client and this document does not exonerate parties to a transaction from exercising all their rights and obligations under the transaction documents. This document cannot be reproduced except in full, without prior written approval of the Company. Any unauthorized alteration, forgery or falsification of the content or appearance of this document is unlawful and offenders may be prosecuted to the fullest extent of the law.

## 6. RF CONDUCTED OUTPUT POWER MEASUREMENT

### 6.1. Standard Applicable

A base station simulator was used to establish communication with the EUT. Its parameters were set to transmit the maximum power on the EUT. The measured power in the radio frequency on the transmitter output terminals.

### 6.2. Test Set-up

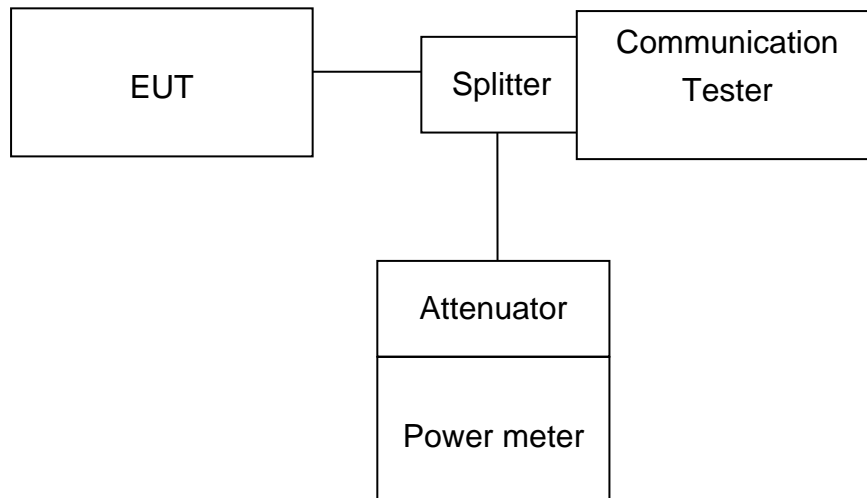

**Note:** Measurement setup for testing on Antenna connector

### 6.3. Measurement Procedure

The transmitter output was connected to a calibrated attenuator, the other end of which was connected to a power meter. Transmitter output was read off the power meter in dBm. The power output at the transmitter antenna port was determined by adding the value of the attenuator to the power meter reading. TS 151 010-1 is reference to conduct the test measurement of output power.

The Procedure of KDB941225 (SAR Measurement Procedures for 3G devices, (WCD-MA/HSPA) was used for EUT and Base station setting. RMC 12.2kps is used for this testing, and KDB 971168 D01 Power Meas License Digital System as the supplemental test methodology to adjust the proper setting obtaining the measurement results

Unless otherwise stated the results shown in this test report refer only to the sample(s) tested and such sample(s) are retained for 90 days only.

除非另有說明，此報告結果僅對測試之樣品負責，同時此樣品僅保留90天。本報告未經本公司書面許可，不可部份複製。

This document is issued by the Company subject to its General Conditions of Service printed overleaf, available on request or accessible at [www.sgs.com/terms\\_and\\_conditions.htm](http://www.sgs.com/terms_and_conditions.htm) and, for electronic format documents, subject to Terms and Conditions for Electronic Documents at [www.sgs.com/terms\\_e-document.htm](http://www.sgs.com/terms_e-document.htm). Attention is drawn to the limitation of liability, indemnification and jurisdiction issues defined therein. Any holder of this document is advised that information contained hereon reflects the Company's findings at the time of its intervention only and within the limits of Client's instructions, if any. The Company's sole responsibility is to its Client and this document does not exonerate parties to a transaction from exercising all their rights and obligations under the transaction documents. This document cannot be reproduced except in full, without prior written approval of the Company. Any unauthorized alteration, forgery or falsification of the content or appearance of this document is unlawful and offenders may be prosecuted to the fullest extent of the law.

SGS Taiwan Ltd.

No.134,WuKungRoad,NewTaipeiIndustrialPark,WukuDistrict,NewTaipeiCity,Taiwan24803/新北市五股區新北產業園區五工路 134 號

台灣檢驗科技股份有限公司

t (886-2) 2299-3279

f (886-2) 2298-0488

www.tw.sgs.com

Member of SGS Group

#### 6.4. Measurement Equipment Used

Conducted Emission (measured at antenna port) Test Site					
EQUIPMENT TYPE	MFR	MODEL NUMBER	SERIAL NUMBER	LAST CAL.	CAL DUE.
Spectrum Analyzer	KEYSIGHT	N9010A	MY51440113	06/20/2017	06/19/2018
Communication Tester	Anritsu	MT8820C	6201107337	05/25/2017	05/24/2018
Coaxial Cable 30cm	WOKEN	00100A1F1A19 5C	RF01	12/12/2016	12/11/2017
Temperature Chamber	TERCHY	MHK-120LK	1020582	06/13/2017	06/12/2018
DC Block	PASTERNAK	PE8210	RF29	12/12/2016	12/11/2017
Splitter	RF-LAMBAD	RFLT2W1G18G	RF35	12/12/2016	12/11/2017
Attenuator	WOKEN	218FS-10	RF23	12/12/2016	12/11/2017
DC Power Supply	Agilent	E3640A	MY53140006	05/02/2017	05/01/2018

#### 6.5. Measurement Result

##### RF Conducted Output Power

GPRS/EDGE (GMSK; 8-PSK) Result:

EUT Mode	Frequency (MHz)	CH	Average Burst Power (1DN 1UP) Class 8 (dBm)	Average Burst Power (1DN 2UP) Class 10 (dBm)	Average Burst Power (1DN 3UP) Class 12 (dBm)	Average Burst Power (1DN 4UP) Class 12 (dBm)
GPRS 850	824.2	128	32.09	30.17	29.26	27.32
	836.6	190	32.07	30.06	29.33	27.66
	848.8	251	32.26	30.34	29.31	27.4
GPRS 1900	1850.2	512	29.51	27.86	25.08	24.03
	1880.0	661	29.57	27.83	25.13	24.05
	1909.8	810	29.88	27.79	25.31	24.01
EDGE 850	824.2	128	26.98	23.63	21.09	19.84
	836.6	190	26.91	23.57	21.36	19.88
	848.8	251	26.75	23.47	21.14	19.83
EDGE 1900	1850.2	512	25.94	22.43	20.15	19.01
	1880.0	661	25.92	22.76	20.24	19.12
	1909.8	810	25.91	22.39	20.13	19.06

Unless otherwise stated the results shown in this test report refer only to the sample(s) tested and such sample(s) are retained for 90 days only.

除非另有說明，此報告結果僅對測試之樣品負責，同時此樣品僅保留90天。本報告未經本公司書面許可，不可部份複製。

This document is issued by the Company subject to its General Conditions of Service printed overleaf, available on request or accessible at [www.sgs.com/terms\\_and\\_conditions.htm](http://www.sgs.com/terms_and_conditions.htm) and, for electronic format documents, subject to Terms and Conditions for Electronic Documents at [www.sgs.com/terms\\_e-document.htm](http://www.sgs.com/terms_e-document.htm). Attention is drawn to the limitation of liability, indemnification and jurisdiction issues defined therein. Any holder of this document is advised that information contained hereon reflects the Company's findings at the time of its intervention only and within the limits of Client's instructions, if any. The Company's sole responsibility is to its Client and this document does not exonerate parties to a transaction from exercising all their rights and obligations under the transaction documents. This document cannot be reproduced except in full, without prior written approval of the Company. Any unauthorized alteration, forgery or falsification of the content or appearance of this document is unlawful and offenders may be prosecuted to the fullest extent of the law.

SGS Taiwan Ltd.

No.134,WuKungRoad,NewTaipeiIndustrialPark,WukuDistrict,NewTaipeiCity,Taiwan24803/新北市五股區新北產業園區五工路 134 號

台灣檢驗科技股份有限公司

t (886-2) 2299-3279

f (886-2) 2298-0488

www.tw.sgs.com

Member of SGS Group



**WCDMA MODE:**

The following tests were completed according to the test requirements outlined in section 5.2 of the 3GPP TS34.121-1 V8.4.0 specification. The EUT supports power Class 3, which has a nominal maximum output power of 24 dBm (+1.7/-3.7). RMC 12.2kps is used for this testing.

**Results:**

EUT Mode		WCDMA Band II	HSDPA Band II	HSUPA Band II
Frequency (MHz)	CH	Avg. Power (dBm)	Avg. Power (dBm)	Avg. Power (dBm)
1852.4	9262	<b>23.25</b>	23.01	22.84
1880.0	9400	23.28	22.98	22.79
1907.6	9538	23.24	22.97	22.75

EUT Mode		WCDMA Band IV	HSDPA Band IV	HSUPA Band IV
Frequency (MHz)	CH	Avg. Power (dBm)	Avg. Power (dBm)	Avg. Power (dBm)
1712.4	1312	<b>23.31</b>	22.96	22.81
1732.6	1412	23.33	23.01	22.73
1752.6	1513	23.19	22.73	22.68

EUT Mode		WCDMA Band V	HSDPA Band V	HSUPA Band V
Frequency (MHz)	CH	Avg. Power (dBm)	Avg. Power (dBm)	Avg. Power (dBm)
826.4	4132	<b>22.84</b>	22.64	22.48
836.6	4183	22.83	22.58	22.41
846.6	4233	22.76	22.49	22.37

Unless otherwise stated the results shown in this test report refer only to the sample(s) tested and such sample(s) are retained for 90 days only.

除非另有說明，此報告結果僅對測試之樣品負責，同時此樣品僅保留90天。本報告未經本公司書面許可，不可部份複製。

This document is issued by the Company subject to its General Conditions of Service printed overleaf, available on request or accessible at [www.sgs.com/terms\\_and\\_conditions.htm](http://www.sgs.com/terms_and_conditions.htm) and, for electronic format documents, subject to Terms and Conditions for Electronic Documents at [www.sgs.com/terms\\_e-document.htm](http://www.sgs.com/terms_e-document.htm). Attention is drawn to the limitation of liability, indemnification and jurisdiction issues defined therein. Any holder of this document is advised that information contained hereon reflects the Company's findings at the time of its intervention only and within the limits of Client's instructions, if any. The Company's sole responsibility is to its Client and this document does not exonerate parties to a transaction from exercising all their rights and obligations under the transaction documents. This document cannot be reproduced except in full, without prior written approval of the Company. Any unauthorized alteration, forgery or falsification of the content or appearance of this document is unlawful and offenders may be prosecuted to the fullest extent of the law.

LTE Result

LTE Band 2

LTE Band 2_Uplink frequency band : 1850 to 1910 MHz								
BW (MHz)	RB Size	RB Offset	Conducted power (dBm)					
			QPSK			16QAM		
			CH (Low) 18607	CH (Mid) 18900	CH (High) 19193	CH (Low) 18607	CH (Mid) 18900	CH (High) 19193
1.4	1	0	22.54	22.21	22.27	21.36	21.29	21.52
	1	5	22.23	22.52	22.31	21.41	21.76	21.31
	3	2	22.45	22.43	22.38	21.69	21.8	21.25
	6	0	21.22	21.26	21.24	20.45	20.36	20.5

LTE Band 2_Uplink frequency band : 1850 to 1910 MHz								
BW (MHz)	RB Size	RB Offset	Conducted power (dBm)					
			QPSK			16QAM		
			CH (Low) 18615	CH (Mid) 18900	CH (High) 19185	CH (Low) 18615	CH (Mid) 18900	CH (High) 19185
3	1	0	22.5	22.52	22.4	21.65	21.67	21.37
	1	14	22.33	22.38	22.33	21.58	21.41	21.64
	8	4	21.34	21.42	21.63	20.29	20.49	20.25
	15	0	21.28	21.69	21.38	20.44	20.4	20.25

LTE Band 2_Uplink frequency band : 1850 to 1910 MHz								
BW (MHz)	RB Size	RB Offset	Conducted power (dBm)					
			QPSK			16QAM		
			CH (Low) 18625	CH (Mid) 18900	CH (High) 19175	CH (Low) 18625	CH (Mid) 18900	CH (High) 19175
5	1	0	22.77	22.71	22.35	21.63	21.12	21.85
	1	24	22.5	22.44	22.91	21.77	21.41	21.82
	12	6	21.15	21.2	21.71	20.89	20.47	20.34
	25	0	21.91	21.23	21.16	20.32	20.51	20.75

Unless otherwise stated the results shown in this test report refer only to the sample(s) tested and such sample(s) are retained for 90 days only.

除非另有說明，此報告結果僅對測試之樣品負責，同時此樣品僅保留90天。本報告未經本公司書面許可，不可部份複製。

This document is issued by the Company subject to its General Conditions of Service printed overleaf, available on request or accessible at [www.sgs.com/terms\\_and\\_conditions.htm](http://www.sgs.com/terms_and_conditions.htm) and, for electronic format documents, subject to Terms and Conditions for Electronic Documents at [www.sgs.com/terms\\_e-document.htm](http://www.sgs.com/terms_e-document.htm). Attention is drawn to the limitation of liability, indemnification and jurisdiction issues defined therein. Any holder of this document is advised that information contained hereon reflects the Company's findings at the time of its intervention only and within the limits of Client's instructions, if any. The Company's sole responsibility is to its Client and this document does not exonerate parties to a transaction from exercising all their rights and obligations under the transaction documents. This document cannot be reproduced except in full, without prior written approval of the Company. Any unauthorized alteration, forgery or falsification of the content or appearance of this document is unlawful and offenders may be prosecuted to the fullest extent of the law.

LTE Band 2_Uplink frequency band : 1850 to 1910 MHz								
BW (MHz)	RB Size	RB Offset	Conducted power (dBm)					
			QPSK			16QAM		
			CH (Low) 18650	CH (Mid) 18900	CH (High) 19150	CH (Low) 18650	CH (Mid) 18900	CH (High) 19150
10	1	0	22.65	22.65	22.33	21.3	21.75	21.68
	1	49	22.71	22.54	22.44	21.25	21.7	21.34
	25	12	21.47	21.56	21.43	20.56	20.75	20.78
	50	0	21.29	21.52	21.62	20.56	20.3	20.63

LTE Band 2_Uplink frequency band : 1850 to 1910 MHz								
BW (MHz)	RB Size	RB Offset	Conducted power (dBm)					
			QPSK			16QAM		
			CH (Low) 18675	CH (Mid) 18900	CH (High) 19125	CH (Low) 18675	CH (Mid) 18900	CH (High) 19125
15	1	0	22.66	22.85	22.04	21.08	21.45	21.85
	1	74	22.97	22.92	22.29	21.26	21.98	21.02
	36	19	21.31	21.45	21.61	20.66	20.69	20.71
	75	0	21.71	21.47	22.28	20.07	20.17	20.91

LTE Band 2_Uplink frequency band : 1850 to 1910 MHz								
BW (MHz)	RB Size	RB Offset	Conducted power (dBm)					
			QPSK			16QAM		
			CH (Low) 18700	CH (Mid) 18900	CH (High) 19100	CH (Low) 18700	CH (Mid) 18900	CH (High) 19100
20	1	0	22.28	22.65	22.56	21.92	21.22	21.39
	1	99	22.56	22.13	22.29	21.54	21.64	21.73
	50	25	21.24	21.09	21.36	20.65	20.47	20.34
	100	0	21.86	21.41	22.39	20.29	20.71	20.2

Unless otherwise stated the results shown in this test report refer only to the sample(s) tested and such sample(s) are retained for 90 days only.

除非另有說明，此報告結果僅對測試之樣品負責，同時此樣品僅保留90天。本報告未經本公司書面許可，不可部份複製。

This document is issued by the Company subject to its General Conditions of Service printed overleaf, available on request or accessible at [www.sgs.com/terms\\_and\\_conditions.htm](http://www.sgs.com/terms_and_conditions.htm) and, for electronic format documents, subject to Terms and Conditions for Electronic Documents at [www.sgs.com/terms\\_e-document.htm](http://www.sgs.com/terms_e-document.htm). Attention is drawn to the limitation of liability, indemnification and jurisdiction issues defined therein. Any holder of this document is advised that information contained hereon reflects the Company's findings at the time of its intervention only and within the limits of Client's instructions, if any. The Company's sole responsibility is to its Client and this document does not exonerate parties to a transaction from exercising all their rights and obligations under the transaction documents. This document cannot be reproduced except in full, without prior written approval of the Company. Any unauthorized alteration, forgery or falsification of the content or appearance of this document is unlawful and offenders may be prosecuted to the fullest extent of the law.

LTE Band 2

LTE Band 2_Uplink frequency band : 1850 to 1910 MHz					
BW (MHz)	RB Size	RB Offset	Conducted power (dBm)		
			64QAM		
			CH (Low)	CH (Mid)	CH (High)
			18607	18900	19193
1.4	1	0	20.75	20.71	20.49
	1	5	20.58	20.76	20.45
	3	2	20.69	20.39	19.59
	6	0	19.75	19.38	19.33

LTE Band 2_Uplink frequency band : 1850 to 1910 MHz					
BW (MHz)	RB Size	RB Offset	Conducted power (dBm)		
			64QAM		
			CH (Low)	CH (Mid)	CH (High)
			18615	18900	19185
3	1	0	20.34	20.44	20.51
	1	14	20.44	20.37	20.5
	8	4	19.35	19.25	19.63
	15	0	19.33	19.37	19.66

Unless otherwise stated the results shown in this test report refer only to the sample(s) tested and such sample(s) are retained for 90 days only.  
除非另有說明，此報告結果僅對測試之樣品負責，同時此樣品僅保留90天。本報告未經本公司書面許可，不可部份複製。

This document is issued by the Company subject to its General Conditions of Service printed overleaf, available on request or accessible at [www.sgs.com/terms\\_and\\_conditions.htm](http://www.sgs.com/terms_and_conditions.htm) and, for electronic format documents, subject to Terms and Conditions for Electronic Documents at [www.sgs.com/terms\\_e-document.htm](http://www.sgs.com/terms_e-document.htm). Attention is drawn to the limitation of liability, indemnification and jurisdiction issues defined therein. Any holder of this document is advised that information contained hereon reflects the Company's findings at the time of its intervention only and within the limits of Client's instructions, if any. The Company's sole responsibility is to its Client and this document does not exonerate parties to a transaction from exercising all their rights and obligations under the transaction documents. This document cannot be reproduced except in full, without prior written approval of the Company. Any unauthorized alteration, forgery or falsification of the content or appearance of this document is unlawful and offenders may be prosecuted to the fullest extent of the law.

SGS Taiwan Ltd.

No.134,WuKungRoad,NewTaipeiIndustrialPark,WukuDistrict,NewTaipeiCity,Taiwan24803/新北市五股區新北產業園區五工路 134 號

台灣檢驗科技股份有限公司

t (886-2) 2299-3279

f (886-2) 2298-0488

[www.tw.sgs.com](http://www.tw.sgs.com)

Member of SGS Group

LTE Band 2_Uplink frequency band : 1850 to 1910 MHz					
BW (MHz)	RB Size	RB Offset	Conducted power (dBm)		
			64QAM		
			CH (Low) 18625	CH (Mid) 18900	CH (High) 19175
5	1	0	20.38	20.76	20.45
	1	24	20.41	20.35	20.38
	12	6	19.95	19.31	19.73
	25	0	19.25	19.57	19.39

LTE Band 2_Uplink frequency band : 1850 to 1910 MHz					
BW (MHz)	RB Size	RB Offset	Conducted power (dBm)		
			64QAM		
			CH (Low) 18650	CH (Mid) 18900	CH (High) 19150
10	1	0	20.64	20.75	20.6
	1	49	20.74	20.46	20.38
	25	12	19.63	19.7	19.56
	50	0	19.41	19.72	19.41

LTE Band 2_Uplink frequency band : 1850 to 1910 MHz					
BW (MHz)	RB Size	RB Offset	Conducted power (dBm)		
			64QAM		
			CH (Low) 18675	CH (Mid) 18900	CH (High) 19125
15	1	0	20.53	20.29	20.01
	1	74	20.54	20.46	20.87
	36	19	19.32	19.24	19.56
	75	0	19.1	19.61	19.44

Unless otherwise stated the results shown in this test report refer only to the sample(s) tested and such sample(s) are retained for 90 days only.  
除非另有說明，此報告結果僅對測試之樣品負責，同時此樣品僅保留90天。本報告未經本公司書面許可，不可部份複製。

This document is issued by the Company subject to its General Conditions of Service printed overleaf, available on request or accessible at [www.sgs.com/terms\\_and\\_conditions.htm](http://www.sgs.com/terms_and_conditions.htm) and, for electronic format documents, subject to Terms and Conditions for Electronic Documents at [www.sgs.com/terms\\_e-document.htm](http://www.sgs.com/terms_e-document.htm). Attention is drawn to the limitation of liability, indemnification and jurisdiction issues defined therein. Any holder of this document is advised that information contained hereon reflects the Company's findings at the time of its intervention only and within the limits of Client's instructions, if any. The Company's sole responsibility is to its Client and this document does not exonerate parties to a transaction from exercising all their rights and obligations under the transaction documents. This document cannot be reproduced except in full, without prior written approval of the Company. Any unauthorized alteration, forgery or falsification of the content or appearance of this document is unlawful and offenders may be prosecuted to the fullest extent of the law.

LTE Band 2_Uplink frequency band : 1850 to 1910 MHz					
BW (MHz)	RB Size	RB Offset	Conducted power (dBm)		
			(dBm)		
			64QAM		
			CH (Low)	CH (Mid)	CH (High)
			18700	18900	19100
20	1	0	20.47	20.73	20.93
	1	99	19.9	19.55	20.58
	50	25	19.24	19.13	19.74
	100	0	20.13	20.64	19.69

Unless otherwise stated the results shown in this test report refer only to the sample(s) tested and such sample(s) are retained for 90 days only.

除非另有說明，此報告結果僅對測試之樣品負責，同時此樣品僅保留90天。本報告未經本公司書面許可，不可部份複製。

This document is issued by the Company subject to its General Conditions of Service printed overleaf, available on request or accessible at [www.sgs.com/terms\\_and\\_conditions.htm](http://www.sgs.com/terms_and_conditions.htm) and, for electronic format documents, subject to Terms and Conditions for Electronic Documents at [www.sgs.com/terms\\_e-document.htm](http://www.sgs.com/terms_e-document.htm). Attention is drawn to the limitation of liability, indemnification and jurisdiction issues defined therein. Any holder of this document is advised that information contained hereon reflects the Company's findings at the time of its intervention only and within the limits of Client's instructions, if any. The Company's sole responsibility is to its Client and this document does not exonerate parties to a transaction from exercising all their rights and obligations under the transaction documents. This document cannot be reproduced except in full, without prior written approval of the Company. Any unauthorized alteration, forgery or falsification of the content or appearance of this document is unlawful and offenders may be prosecuted to the fullest extent of the law.

SGS Taiwan Ltd.

No.134,WuKungRoad,NewTaipeiIndustrialPark,WukuDistrict,NewTaipeiCity,Taiwan24803/新北市五股區新北產業園區五工路 134 號

台灣檢驗科技股份有限公司

t (886-2) 2299-3279

f (886-2) 2298-0488

[www.tw.sgs.com](http://www.tw.sgs.com)

Member of SGS Group

LTE Band 4

LTE Band 4_Uplink frequency band : 1710 to 1755 MHz								
BW (MHz)	RB Size	RB Offset	Conducted power (dBm)					
			QPSK			16QAM		
			CH (Low) 19957	CH (Mid) 20175	CH (High) 20393	CH (Low) 19957	CH (Mid) 20175	CH (High) 20393
1.4	1	0	22.38	22.25	22.65	21.48	21.22	21.6
	1	5	22.36	22.35	22.29	21.71	21.61	21.6
	3	2	22.22	22.43	22.69	21.53	21.68	21.22
	6	0	21.58	21.34	21.25	20.4	20.45	20.39

LTE Band 4_Uplink frequency band : 1710 to 1755 MHz								
BW (MHz)	RB Size	RB Offset	Conducted power (dBm)					
			QPSK			16QAM		
			CH (Low) 19965	CH (Mid) 20175	CH (High) 20385	CH (Low) 19965	CH (Mid) 20175	CH (High) 20385
3	1	0	22.21	22.2	22.83	21.69	21.16	21.44
	1	14	22.84	22.83	22.42	21.75	21.52	21.73
	8	4	21.23	21.54	21.51	20.46	20.62	20.78
	15	0	21.16	21.37	21.62	20.52	20.33	20.76

LTE Band 4_Uplink frequency band : 1710 to 1755 MHz								
BW (MHz)	RB Size	RB Offset	Conducted power (dBm)					
			QPSK			16QAM		
			CH (Low) 19975	CH (Mid) 20175	CH (High) 20375	CH (Low) 19975	CH (Mid) 20175	CH (High) 20375
5	1	0	22.38	22.52	22.71	21.23	21.4	21.52
	1	24	22.2	22.32	22.7	21.43	21.54	21.19
	12	6	21.45	21.54	21.87	20.08	20.23	20.91
	25	0	21.54	21.76	21.44	20.29	20.17	20.54

Unless otherwise stated the results shown in this test report refer only to the sample(s) tested and such sample(s) are retained for 90 days only.

除非另有說明，此報告結果僅對測試之樣品負責，同時此樣品僅保留90天。本報告未經本公司書面許可，不可部份複製。

This document is issued by the Company subject to its General Conditions of Service printed overleaf, available on request or accessible at [www.sgs.com/terms\\_and\\_conditions.htm](http://www.sgs.com/terms_and_conditions.htm) and, for electronic format documents, subject to Terms and Conditions for Electronic Documents at [www.sgs.com/terms\\_e-document.htm](http://www.sgs.com/terms_e-document.htm). Attention is drawn to the limitation of liability, indemnification and jurisdiction issues defined therein. Any holder of this document is advised that information contained hereon reflects the Company's findings at the time of its intervention only and within the limits of Client's instructions, if any. The Company's sole responsibility is to its Client and this document does not exonerate parties to a transaction from exercising all their rights and obligations under the transaction documents. This document cannot be reproduced except in full, without prior written approval of the Company. Any unauthorized alteration, forgery or falsification of the content or appearance of this document is unlawful and offenders may be prosecuted to the fullest extent of the law.

LTE Band 4_Uplink frequency band : 1710 to 1755 MHz								
BW (MHz)	RB Size	RB Offset	Conducted power (dBm)					
			QPSK			16QAM		
			CH (Low) 20000	CH (Mid) 20175	CH (High) 20350	CH (Low) 20000	CH (Mid) 20175	CH (High) 20350
10	1	0	22.8	22.79	22.76	21.72	21.37	21.63
	1	49	22.6	22.4	22.34	21.72	21.48	21.31
	25	12	21.38	21.78	21.51	20.37	20.22	20.2
	50	0	21.32	21.51	21.74	20.26	20.18	20.45

LTE Band 4_Uplink frequency band : 1710 to 1755 MHz								
BW (MHz)	RB Size	RB Offset	Conducted power (dBm)					
			QPSK			16QAM		
			CH (Low) 20025	CH (Mid) 20175	CH (High) 20325	CH (Low) 20025	CH (Mid) 20175	CH (High) 20325
15	1	0	22.09	22.71	22.6	21.41	21.92	21.32
	1	74	22.33	22.3	22.41	21.6	21.25	21.78
	36	19	21.82	21.65	21.72	20.58	20.87	20.14
	75	0	21.26	21.11	21.07	20.34	20.23	20.36

LTE Band 4_Uplink frequency band : 1710 to 1755 MHz								
BW (MHz)	RB Size	RB Offset	Conducted power (dBm)					
			QPSK			16QAM		
			CH (Low) 20050	CH (Mid) 20175	CH (High) 20300	CH (Low) 20050	CH (Mid) 20175	CH (High) 20300
20	1	0	22.72	22.46	22.41	21.74	21.47	21.47
	1	99	22.68	22.58	22.29	21.34	21.71	21.39
	50	25	21.21	21.34	21.39	20.59	20.21	20.42
	100	0	21.5	21.75	21.49	20.2	20.69	20.4

Unless otherwise stated the results shown in this test report refer only to the sample(s) tested and such sample(s) are retained for 90 days only.

除非另有說明，此報告結果僅對測試之樣品負責，同時此樣品僅保留90天。本報告未經本公司書面許可，不可部份複製。

This document is issued by the Company subject to its General Conditions of Service printed overleaf, available on request or accessible at [www.sgs.com/terms\\_and\\_conditions.htm](http://www.sgs.com/terms_and_conditions.htm) and, for electronic format documents, subject to Terms and Conditions for Electronic Documents at [www.sgs.com/terms\\_e-document.htm](http://www.sgs.com/terms_e-document.htm). Attention is drawn to the limitation of liability, indemnification and jurisdiction issues defined therein. Any holder of this document is advised that information contained hereon reflects the Company's findings at the time of its intervention only and within the limits of Client's instructions, if any. The Company's sole responsibility is to its Client and this document does not exonerate parties to a transaction from exercising all their rights and obligations under the transaction documents. This document cannot be reproduced except in full, without prior written approval of the Company. Any unauthorized alteration, forgery or falsification of the content or appearance of this document is unlawful and offenders may be prosecuted to the fullest extent of the law.



LTE Band 4

LTE Band 4_Uplink frequency band : 1710 to 1755 MHz					
BW (MHz)	RB Size	RB Offset	Conducted power (dBm)		
			64QAM		
			CH (Low)	CH (Mid)	CH (High)
			19957	20175	20393
1.4	1	0	20.52	20.58	20.16
	1	5	20.5	20.47	20.45
	3	2	20.26	20.79	20.17
	6	0	19.66	19.58	19.26

LTE Band 4_Uplink frequency band : 1710 to 1755 MHz					
BW (MHz)	RB Size	RB Offset	Conducted power (dBm)		
			64QAM		
			CH (Low)	CH (Mid)	CH (High)
			19965	20175	20385
3	1	0	20.63	20.15	20.83
	1	14	20.45	20.72	20.58
	8	4	19.16	19.26	19.39
	15	0	19.47	19.21	19.32

LTE Band 4_Uplink frequency band : 1710 to 1755 MHz					
BW (MHz)	RB Size	RB Offset	Conducted power (dBm)		
			64QAM		
			CH (Low)	CH (Mid)	CH (High)
			19975	20175	20375
5	1	0	20.58	20.78	20.62
	1	24	20.88	20.14	20.1
	12	6	19.81	19.39	19.94
	25	0	19.22	19.95	19.89

Unless otherwise stated the results shown in this test report refer only to the sample(s) tested and such sample(s) are retained for 90 days only. 除非另有說明，此報告結果僅對測試之樣品負責，同時此樣品僅保留90天。本報告未經本公司書面許可，不可部份複製。

This document is issued by the Company subject to its General Conditions of Service printed overleaf, available on request or accessible at [www.sgs.com/terms\\_and\\_conditions.htm](http://www.sgs.com/terms_and_conditions.htm) and, for electronic format documents, subject to Terms and Conditions for Electronic Documents at [www.sgs.com/terms\\_e-document.htm](http://www.sgs.com/terms_e-document.htm). Attention is drawn to the limitation of liability, indemnification and jurisdiction issues defined therein. Any holder of this document is advised that information contained hereon reflects the Company's findings at the time of its intervention only and within the limits of Client's instructions, if any. The Company's sole responsibility is to its Client and this document does not exonerate parties to a transaction from exercising all their rights and obligations under the transaction documents. This document cannot be reproduced except in full, without prior written approval of the Company. Any unauthorized alteration, forgery or falsification of the content or appearance of this document is unlawful and offenders may be prosecuted to the fullest extent of the law.

LTE Band 4_Uplink frequency band : 1710 to 1755 MHz					
BW (MHz)	RB Size	RB Offset	Conducted power (dBm)		
			64QAM		
			CH (Low) 20000	CH (Mid) 20175	CH (High) 20350
10	1	0	20.7	20.35	20.59
	1	49	20.77	20.61	20.44
	25	12	19.69	19.19	19.3
	50	0	19.74	19.57	19.48

LTE Band 4_Uplink frequency band : 1710 to 1755 MHz					
BW (MHz)	RB Size	RB Offset	Conducted power (dBm)		
			64QAM		
			CH (Low) 20025	CH (Mid) 20175	CH (High) 20325
15	1	0	20.11	20.87	20.14
	1	74	20.49	20.56	20.57
	36	19	19.28	19.34	19.2
	75	0	19.6	19.8	19.8

LTE Band 4_Uplink frequency band : 1710 to 1755 MHz					
BW (MHz)	RB Size	RB Offset	Conducted power (dBm)		
			(dBm)		
			64QAM		
CH (Low) 20050	CH (Mid) 20175	CH (High) 20300			
20	1	0	20.47	20.55	20.56
	1	99	20.72	20.36	20.22
	50	25	19.4	19.3	19.47
	100	0	19.41	19.36	19.21

Unless otherwise stated the results shown in this test report refer only to the sample(s) tested and such sample(s) are retained for 90 days only.  
除非另有說明，此報告結果僅對測試之樣品負責，同時此樣品僅保留90天。本報告未經本公司書面許可，不可部份複製。

This document is issued by the Company subject to its General Conditions of Service printed overleaf, available on request or accessible at [www.sgs.com/terms\\_and\\_conditions.htm](http://www.sgs.com/terms_and_conditions.htm) and, for electronic format documents, subject to Terms and Conditions for Electronic Documents at [www.sgs.com/terms\\_e-document.htm](http://www.sgs.com/terms_e-document.htm). Attention is drawn to the limitation of liability, indemnification and jurisdiction issues defined therein. Any holder of this document is advised that information contained hereon reflects the Company's findings at the time of its intervention only and within the limits of Client's instructions, if any. The Company's sole responsibility is to its Client and this document does not exonerate parties to a transaction from exercising all their rights and obligations under the transaction documents. This document cannot be reproduced except in full, without prior written approval of the Company. Any unauthorized alteration, forgery or falsification of the content or appearance of this document is unlawful and offenders may be prosecuted to the fullest extent of the law.

LTE Band 5

LTE Band 5_Uplink frequency band : 824 to 849 MHz								
BW (MHz)	RB Size	RB Offset	Conducted power (dBm)					
			QPSK			16QAM		
			CH (Low) 20407	CH (Mid) 20525	CH (High) 20643	CH (Low) 20407	CH (Mid) 20525	CH (High) 20643
1.4	1	0	23.75	23.19	23.51	22.75	22.36	22.42
	1	5	23.58	23.29	23.73	22.21	22.62	22.69
	3	2	23.25	23.11	23.31	22.21	22.5	22.85
	6	0	22.14	22.35	22.74	21.58	21.57	21.71

LTE Band 5_Uplink frequency band : 824 to 849 MHz								
BW (MHz)	RB Size	RB Offset	Conducted power (dBm)					
			QPSK			16QAM		
			CH (Low) 20415	CH (Mid) 20525	CH (High) 20635	CH (Low) 20415	CH (Mid) 20525	CH (High) 20635
3	1	0	23.28	23.6	23.18	22.6	22.87	22.61
	1	14	23.44	23.28	23.25	22.87	22.45	22.73
	8	4	22.52	22.79	22.31	21.76	21.28	21.58
	15	0	22.46	22.83	22.71	21.75	21.3	21.48

LTE Band 5_Uplink frequency band : 824 to 849 MHz								
BW (MHz)	RB Size	RB Offset	Conducted power (dBm)					
			QPSK			16QAM		
			CH (Low) 20425	CH (Mid) 20525	CH (High) 20625	CH (Low) 20425	CH (Mid) 20525	CH (High) 20625
5	1	0	23.47	23.29	23.76	22.7	22.32	22.4
	1	24	23.32	23.55	23.29	22.8	22.73	22.26
	12	6	22.7	22.34	22.29	21.27	21.27	21.33
	25	0	22.76	22.63	22.58	21.73	21.7	21.67

Unless otherwise stated the results shown in this test report refer only to the sample(s) tested and such sample(s) are retained for 90 days only.

除非另有說明，此報告結果僅對測試之樣品負責，同時此樣品僅保留90天。本報告未經本公司書面許可，不可部份複製。

This document is issued by the Company subject to its General Conditions of Service printed overleaf, available on request or accessible at [www.sgs.com/terms\\_and\\_conditions.htm](http://www.sgs.com/terms_and_conditions.htm) and, for electronic format documents, subject to Terms and Conditions for Electronic Documents at [www.sgs.com/terms\\_e-document.htm](http://www.sgs.com/terms_e-document.htm). Attention is drawn to the limitation of liability, indemnification and jurisdiction issues defined therein. Any holder of this document is advised that information contained hereon reflects the Company's findings at the time of its intervention only and within the limits of Client's instructions, if any. The Company's sole responsibility is to its Client and this document does not exonerate parties to a transaction from exercising all their rights and obligations under the transaction documents. This document cannot be reproduced except in full, without prior written approval of the Company. Any unauthorized alteration, forgery or falsification of the content or appearance of this document is unlawful and offenders may be prosecuted to the fullest extent of the law.

LTE Band 5_Uplink frequency band : 824 to 849 MHz								
BW (MHz)	RB Size	RB Offset	Conducted power (dBm)					
			QPSK			16QAM		
			CH (Low) 20450	CH (Mid) 20525	CH (High) 20600	CH (Low) 20450	CH (Mid) 20525	CH (High) 20600
10	1	0	23.78	23.62	23.37	22.61	22.7	22.4
	1	49	23.75	23.33	23.69	22.74	22.39	22.45
	25	12	22.75	22.7	22.36	21.48	21.75	21.38
	50	0	22.66	22.73	22.78	21.27	21.41	21.67

LTE Band 5

LTE Band 5_Uplink frequency band : 824 to 849 MHz					
BW (MHz)	RB Size	RB Offset	Conducted power (dBm)		
			64QAM		
			CH (Low) 20407	CH (Mid) 20525	CH (High) 20643
1.4	1	0	21.16	21.29	21.1
	1	5	21.16	21.21	21.67
	3	2	21.84	21.17	21.32
	6	0	20.67	20.26	20.23

LTE Band 5_Uplink frequency band : 824 to 849 MHz					
BW (MHz)	RB Size	RB Offset	Conducted power (dBm)		
			64QAM		
			CH (Low) 20415	CH (Mid) 20525	CH (High) 20635
3	1	0	21.8	21.56	21.81
	1	14	21.89	21.31	21.69
	8	4	20.4	20.68	20.2
	15	0	20.52	20.1	20.47

Unless otherwise stated the results shown in this test report refer only to the sample(s) tested and such sample(s) are retained for 90 days only.  
除非另有說明，此報告結果僅對測試之樣品負責，同時此樣品僅保留90天。本報告未經本公司書面許可，不可部份複製。

This document is issued by the Company subject to its General Conditions of Service printed overleaf, available on request or accessible at [www.sgs.com/terms\\_and\\_conditions.htm](http://www.sgs.com/terms_and_conditions.htm) and, for electronic format documents, subject to Terms and Conditions for Electronic Documents at [www.sgs.com/terms\\_e-document.htm](http://www.sgs.com/terms_e-document.htm). Attention is drawn to the limitation of liability, indemnification and jurisdiction issues defined therein. Any holder of this document is advised that information contained hereon reflects the Company's findings at the time of its intervention only and within the limits of Client's instructions, if any. The Company's sole responsibility is to its Client and this document does not exonerate parties to a transaction from exercising all their rights and obligations under the transaction documents. This document cannot be reproduced except in full, without prior written approval of the Company. Any unauthorized alteration, forgery or falsification of the content or appearance of this document is unlawful and offenders may be prosecuted to the fullest extent of the law.

LTE Band 5_Uplink frequency band : 824 to 849 MHz					
BW (MHz)	RB Size	RB Offset	Conducted power (dBm)		
			64QAM		
			CH (Low) 20425	CH (Mid) 20525	CH (High) 20625
5	1	0	21.38	21.31	21.33
	1	24	21.54	21.39	21.46
	12	6	20.54	20.35	20.75
	25	0	20.4	20.47	20.55

LTE Band 5_Uplink frequency band : 824 to 849 MHz					
BW (MHz)	RB Size	RB Offset	Conducted power (dBm)		
			64QAM		
			CH (Low) 20450	CH (Mid) 20525	CH (High) 20600
10	1	0	21.76	21.59	21.38
	1	49	21.78	21.76	21.55
	25	12	20.76	20.72	20.37
	50	0	20.44	20.62	20.3

Unless otherwise stated the results shown in this test report refer only to the sample(s) tested and such sample(s) are retained for 90 days only.  
除非另有說明，此報告結果僅對測試之樣品負責，同時此樣品僅保留90天。本報告未經本公司書面許可，不可部份複製。

This document is issued by the Company subject to its General Conditions of Service printed overleaf, available on request or accessible at [www.sgs.com/terms\\_and\\_conditions.htm](http://www.sgs.com/terms_and_conditions.htm) and, for electronic format documents, subject to Terms and Conditions for Electronic Documents at [www.sgs.com/terms\\_e-document.htm](http://www.sgs.com/terms_e-document.htm). Attention is drawn to the limitation of liability, indemnification and jurisdiction issues defined therein. Any holder of this document is advised that information contained hereon reflects the Company's findings at the time of its intervention only and within the limits of Client's instructions, if any. The Company's sole responsibility is to its Client and this document does not exonerate parties to a transaction from exercising all their rights and obligations under the transaction documents. This document cannot be reproduced except in full, without prior written approval of the Company. Any unauthorized alteration, forgery or falsification of the content or appearance of this document is unlawful and offenders may be prosecuted to the fullest extent of the law.

SGS Taiwan Ltd.

No.134,WuKungRoad,NewTaipeiIndustrialPark,WukuDistrict,NewTaipeiCity,Taiwan24803/新北市五股區新北產業園區五工路 134 號

台灣檢驗科技股份有限公司

t (886-2) 2299-3279

f (886-2) 2298-0488

www.tw.sgs.com

Member of SGS Group

LTE Band 7

LTE Band 7_Uplink frequency band : 2500 to 2570 MHz								
BW (MHz)	RB Size	RB Offset	Conducted power (dBm)					
			QPSK			16QAM		
			CH (Low) 20775	CH (Mid) 21100	CH (High) 21425	CH (Low) 20775	CH (Mid) 21100	CH (High) 21425
5	1	0	21.78	21.57	22.8	21.48	21.26	21.66
	1	24	21.85	21.62	22.65	21.35	21.26	21.69
	12	6	21.58	21.75	21.19	20.08	20.72	20.05
	25	0	21.24	21.07	21.4	20.73	20.32	20.63

LTE Band 7_Uplink frequency band : 2500 to 2570 MHz								
BW (MHz)	RB Size	RB Offset	Conducted power (dBm)					
			QPSK			16QAM		
			CH (Low) 20800	CH (Mid) 21100	CH (High) 21400	CH (Low) 20800	CH (Mid) 21100	CH (High) 21400
10	1	0	22.15	21.79	22.43	21.26	21.27	21.02
	1	49	22.19	21.61	22.42	21.82	21.01	21.9
	25	12	21.55	21.77	21.71	20.42	20.14	20.44
	50	0	21.82	21.19	21.35	20.01	20.85	20.25

LTE Band 7_Uplink frequency band : 2500 to 2570 MHz								
BW (MHz)	RB Size	RB Offset	Conducted power (dBm)					
			QPSK			16QAM		
			CH (Low) 20825	CH (Mid) 21100	CH (High) 21375	CH (Low) 20825	CH (Mid) 21100	CH (High) 21375
15	1	0	22.16	22.74	22.37	21.2	21.78	21.08
	1	74	22.01	22.26	22.05	21.73	21.7	21.43
	36	19	21.26	21.89	21.6	20.21	20.93	20.77
	75	0	21.01	21.82	21.27	20.94	20.85	20.3

Unless otherwise stated the results shown in this test report refer only to the sample(s) tested and such sample(s) are retained for 90 days only.

除非另有說明，此報告結果僅對測試之樣品負責，同時此樣品僅保留90天。本報告未經本公司書面許可，不可部份複製。

This document is issued by the Company subject to its General Conditions of Service printed overleaf, available on request or accessible at [www.sgs.com/terms\\_and\\_conditions.htm](http://www.sgs.com/terms_and_conditions.htm) and, for electronic format documents, subject to Terms and Conditions for Electronic Documents at [www.sgs.com/terms\\_e-document.htm](http://www.sgs.com/terms_e-document.htm). Attention is drawn to the limitation of liability, indemnification and jurisdiction issues defined therein. Any holder of this document is advised that information contained hereon reflects the Company's findings at the time of its intervention only and within the limits of Client's instructions, if any. The Company's sole responsibility is to its Client and this document does not exonerate parties to a transaction from exercising all their rights and obligations under the transaction documents. This document cannot be reproduced except in full, without prior written approval of the Company. Any unauthorized alteration, forgery or falsification of the content or appearance of this document is unlawful and offenders may be prosecuted to the fullest extent of the law.

LTE Band 7_Uplink frequency band : 2500 to 2570 MHz								
BW (MHz)	RB Size	RB Offset	Conducted power (dBm)					
			QPSK			16QAM		
			CH (Low) 20850	CH (Mid) 21100	CH (High) 21350	CH (Low) 20850	CH (Mid) 21100	CH (High) 21350
20	1	0	22.62	22.6	22.63	21.39	21.09	21.41
	1	99	22.43	22.5	22.25	21.87	21.41	21.73
	50	25	21.97	21.92	21.42	20.31	20.51	20.92
	100	0	21.14	21.51	21.62	20.45	20.58	20.86

LTE Band 7

LTE Band 7_Uplink frequency band : 2500 to 2570 MHz					
BW (MHz)	RB Size	RB Offset	Conducted power (dBm)		
			64QAM		
			CH (Low) 20775	CH (Mid) 21100	CH (High) 21425
5	1	0	20.68	20.67	20.28
	1	24	20.41	20.12	20.65
	12	6	19.5	19.83	19.21
	25	0	19.2	19.09	19.61

Unless otherwise stated the results shown in this test report refer only to the sample(s) tested and such sample(s) are retained for 90 days only.

除非另有說明，此報告結果僅對測試之樣品負責，同時此樣品僅保留90天。本報告未經本公司書面許可，不可部份複製。

This document is issued by the Company subject to its General Conditions of Service printed overleaf, available on request or accessible at [www.sgs.com/terms\\_and\\_conditions.htm](http://www.sgs.com/terms_and_conditions.htm) and, for electronic format documents, subject to Terms and Conditions for Electronic Documents at [www.sgs.com/terms\\_e-document.htm](http://www.sgs.com/terms_e-document.htm). Attention is drawn to the limitation of liability, indemnification and jurisdiction issues defined therein. Any holder of this document is advised that information contained hereon reflects the Company's findings at the time of its intervention only and within the limits of Client's instructions, if any. The Company's sole responsibility is to its Client and this document does not exonerate parties to a transaction from exercising all their rights and obligations under the transaction documents. This document cannot be reproduced except in full, without prior written approval of the Company. Any unauthorized alteration, forgery or falsification of the content or appearance of this document is unlawful and offenders may be prosecuted to the fullest extent of the law.

SGS Taiwan Ltd.

No.134,WuKungRoad,NewTaipeiIndustrialPark,WukuDistrict,NewTaipeiCity,Taiwan24803/新北市五股區新北產業園區五工路 134 號

台灣檢驗科技股份有限公司

t (886-2) 2299-3279

f (886-2) 2298-0488

www.tw.sgs.com

Member of SGS Group

LTE Band 7_Uplink frequency band : 2500 to 2570 MHz					
BW (MHz)	RB Size	RB Offset	Conducted power (dBm)		
			64QAM		
			CH (Low) 20800	CH (Mid) 21100	CH (High) 21400
10	1	0	20.85	20.76	20.59
	1	49	20.42	20.51	20.37
	25	12	19.49	19.8	19.62
	50	0	19.49	19.07	19.1

LTE Band 7_Uplink frequency band : 2500 to 2570 MHz					
BW (MHz)	RB Size	RB Offset	Conducted power (dBm)		
			64QAM		
			CH (Low) 20825	CH (Mid) 21100	CH (High) 21375
15	1	0	20.33	20.5	20.32
	1	74	20.76	20.28	20.76
	36	19	19.59	19.02	19.57
	75	0	19.43	19.58	19.74

Unless otherwise stated the results shown in this test report refer only to the sample(s) tested and such sample(s) are retained for 90 days only.  
除非另有說明，此報告結果僅對測試之樣品負責，同時此樣品僅保留90天。本報告未經本公司書面許可，不可部份複製。

This document is issued by the Company subject to its General Conditions of Service printed overleaf, available on request or accessible at [www.sgs.com/terms\\_and\\_conditions.htm](http://www.sgs.com/terms_and_conditions.htm) and, for electronic format documents, subject to Terms and Conditions for Electronic Documents at [www.sgs.com/terms\\_e-document.htm](http://www.sgs.com/terms_e-document.htm). Attention is drawn to the limitation of liability, indemnification and jurisdiction issues defined therein. Any holder of this document is advised that information contained hereon reflects the Company's findings at the time of its intervention only and within the limits of Client's instructions, if any. The Company's sole responsibility is to its Client and this document does not exonerate parties to a transaction from exercising all their rights and obligations under the transaction documents. This document cannot be reproduced except in full, without prior written approval of the Company. Any unauthorized alteration, forgery or falsification of the content or appearance of this document is unlawful and offenders may be prosecuted to the fullest extent of the law.



LTE Band 7_Uplink frequency band : 2500 to 2570 MHz					
BW (MHz)	RB Size	RB Offset	Conducted power (dBm)		
			64QAM		
			CH (Low)	CH (Mid)	CH (High)
			20850	21100	21350
20	1	0	20.22	20.82	20.33
	1	99	20.26	20.4	20.45
	50	25	19.13	19.3	19.51
	100	0	19.95	19.19	19.5

Unless otherwise stated the results shown in this test report refer only to the sample(s) tested and such sample(s) are retained for 90 days only.

除非另有說明，此報告結果僅對測試之樣品負責，同時此樣品僅保留90天。本報告未經本公司書面許可，不可部份複製。

This document is issued by the Company subject to its General Conditions of Service printed overleaf, available on request or accessible at [www.sgs.com/terms\\_and\\_conditions.htm](http://www.sgs.com/terms_and_conditions.htm) and, for electronic format documents, subject to Terms and Conditions for Electronic Documents at [www.sgs.com/terms\\_e-document.htm](http://www.sgs.com/terms_e-document.htm). Attention is drawn to the limitation of liability, indemnification and jurisdiction issues defined therein. Any holder of this document is advised that information contained hereon reflects the Company's findings at the time of its intervention only and within the limits of Client's instructions, if any. The Company's sole responsibility is to its Client and this document does not exonerate parties to a transaction from exercising all their rights and obligations under the transaction documents. This document cannot be reproduced except in full, without prior written approval of the Company. Any unauthorized alteration, forgery or falsification of the content or appearance of this document is unlawful and offenders may be prosecuted to the fullest extent of the law.

SGS Taiwan Ltd.

No.134,WuKungRoad,NewTaipeiIndustrialPark,WukuDistrict,NewTaipeiCity,Taiwan24803/新北市五股區新北產業園區五工路 134 號

台灣檢驗科技股份有限公司

t (886-2) 2299-3279

f (886-2) 2298-0488

www.tw.sgs.com

Member of SGS Group

LTE Band 38

LTE Band 38_Uplink frequency band : 2570 to 2620 MHz								
BW (MHz)	RB Size	RB Offset	Conducted power (dBm)					
			QPSK			16QAM		
			CH (Low)	CH (Mid)	CH (High)	CH (Low)	CH (Mid)	CH (High)
			37775	38000	38225	37775	38000	38225
5	1	0	22.52	22.42	22.39	21.85	21.8	21.66
	1	24	22.69	22.08	22.26	21.17	21.94	21.43
	12	6	21.71	21.58	21.64	20.27	20.41	20.88
	25	0	21.48	21.25	21.56	20.35	20.84	20.2

LTE Band 38_Uplink frequency band : 2570 to 2620 MHz								
BW (MHz)	RB Size	RB Offset	Conducted power (dBm)					
			QPSK			16QAM		
			CH (Low)	CH (Mid)	CH (High)	CH (Low)	CH (Mid)	CH (High)
			37800	38000	38200	37800	38000	38200
10	1	0	22.68	22.33	22.74	21.26	21.51	21.38
	1	49	22.67	22.7	22.73	21.71	21.34	21.25
	25	12	21.63	21.48	21.39	20.95	20.35	20.34
	50	0	21.6	21.33	21.44	20.22	20.18	20.4

LTE Band 38_Uplink frequency band : 2570 to 2620 MHz								
BW (MHz)	RB Size	RB Offset	Conducted power (dBm)					
			QPSK			16QAM		
			CH (Low)	CH (Mid)	CH (High)	CH (Low)	CH (Mid)	CH (High)
			37825	38000	38175	37825	38000	38175
15	1	0	22.11	22.66	22.45	21.68	21.95	21.38
	1	74	22.21	22.73	22.76	21.71	21.3	21.67
	36	19	21.92	21.47	21.77	20.2	20.16	20.57
	75	0	21.8	21.4	21.8	20.87	20.97	20.37

Unless otherwise stated the results shown in this test report refer only to the sample(s) tested and such sample(s) are retained for 90 days only.

除非另有說明，此報告結果僅對測試之樣品負責，同時此樣品僅保留90天。本報告未經本公司書面許可，不可部份複製。

This document is issued by the Company subject to its General Conditions of Service printed overleaf, available on request or accessible at [www.sgs.com/terms\\_and\\_conditions.htm](http://www.sgs.com/terms_and_conditions.htm) and, for electronic format documents, subject to Terms and Conditions for Electronic Documents at [www.sgs.com/terms\\_e-document.htm](http://www.sgs.com/terms_e-document.htm). Attention is drawn to the limitation of liability, indemnification and jurisdiction issues defined therein. Any holder of this document is advised that information contained hereon reflects the Company's findings at the time of its intervention only and within the limits of Client's instructions, if any. The Company's sole responsibility is to its Client and this document does not exonerate parties to a transaction from exercising all their rights and obligations under the transaction documents. This document cannot be reproduced except in full, without prior written approval of the Company. Any unauthorized alteration, forgery or falsification of the content or appearance of this document is unlawful and offenders may be prosecuted to the fullest extent of the law.

LTE Band 38_Uplink frequency band : 2570 to 2620 MHz								
BW (MHz)	RB Size	RB Offset	Conducted power (dBm)					
			QPSK			16QAM		
			CH (Low) 37850	CH (Mid) 38000	CH (High) 38150	CH (Low) 37850	CH (Mid) 38000	CH (High) 38150
20	1	0	22.78	22.79	22.02	21.62	21.41	21.61
	1	99	22.04	22.9	22.73	21.27	21.81	21.18
	50	25	21.07	21.41	21.59	20.4	20.28	20.78
	100	0	21.83	21.67	21.28	20.34	20.77	20.9

LTE Band 38

LTE Band 38_Uplink frequency band : 2570 to 2620 MHz					
BW (MHz)	RB Size	RB Offset	Conducted power (dBm)		
			64QAM		
			CH (Low) 37775	CH (Mid) 38000	CH (High) 38225
5	1	0	20.79	20.93	20.42
	1	24	20.89	20.73	20.44
	12	6	19.53	19.78	19.78
	25	0	19.58	19.83	19.95

LTE Band 38_Uplink frequency band : 2570 to 2620 MHz					
BW (MHz)	RB Size	RB Offset	Conducted power (dBm)		
			64QAM		
			CH (Low) 37800	CH (Mid) 38000	CH (High) 38200
10	1	0	20.33	20.35	20.66
	1	49	20.84	20.55	20.69
	25	12	19.86	19.66	19.56
	50	0	19.62	19.94	19.29

Unless otherwise stated the results shown in this test report refer only to the sample(s) tested and such sample(s) are retained for 90 days only. 除非另有說明，此報告結果僅對測試之樣品負責，同時此樣品僅保留90天。本報告未經本公司書面許可，不可部份複製。

This document is issued by the Company subject to its General Conditions of Service printed overleaf, available on request or accessible at [www.sgs.com/terms\\_and\\_conditions.htm](http://www.sgs.com/terms_and_conditions.htm) and, for electronic format documents, subject to Terms and Conditions for Electronic Documents at [www.sgs.com/terms\\_e-document.htm](http://www.sgs.com/terms_e-document.htm). Attention is drawn to the limitation of liability, indemnification and jurisdiction issues defined therein. Any holder of this document is advised that information contained hereon reflects the Company's findings at the time of its intervention only and within the limits of Client's instructions, if any. The Company's sole responsibility is to its Client and this document does not exonerate parties to a transaction from exercising all their rights and obligations under the transaction documents. This document cannot be reproduced except in full, without prior written approval of the Company. Any unauthorized alteration, forgery or falsification of the content or appearance of this document is unlawful and offenders may be prosecuted to the fullest extent of the law.

LTE Band 38_Uplink frequency band : 2570 to 2620 MHz					
BW (MHz)	RB Size	RB Offset	Conducted power (dBm)		
			64QAM		
			CH (Low)	CH (Mid)	CH (High)
			37825	38000	38175
15	1	0	20.47	20.26	20.52
	1	74	20.83	20.14	20.14
	36	19	19.74	19.23	19.55
	75	0	19.21	19.52	19.31

LTE Band 38_Uplink frequency band : 2570 to 2620 MHz					
BW (MHz)	RB Size	RB Offset	Conducted power (dBm)		
			64QAM		
			CH (Low)	CH (Mid)	CH (High)
			37850	38000	38150
20	1	0	20.15	20.86	20.54
	1	99	20.49	20.12	20.73
	50	25	19.39	19.09	19.5
	100	0	19.25	19.2	19.36

Unless otherwise stated the results shown in this test report refer only to the sample(s) tested and such sample(s) are retained for 90 days only.  
除非另有說明，此報告結果僅對測試之樣品負責，同時此樣品僅保留90天。本報告未經本公司書面許可，不可部份複製。

This document is issued by the Company subject to its General Conditions of Service printed overleaf, available on request or accessible at [www.sgs.com/terms\\_and\\_conditions.htm](http://www.sgs.com/terms_and_conditions.htm) and, for electronic format documents, subject to Terms and Conditions for Electronic Documents at [www.sgs.com/terms\\_e-document.htm](http://www.sgs.com/terms_e-document.htm). Attention is drawn to the limitation of liability, indemnification and jurisdiction issues defined therein. Any holder of this document is advised that information contained hereon reflects the Company's findings at the time of its intervention only and within the limits of Client's instructions, if any. The Company's sole responsibility is to its Client and this document does not exonerate parties to a transaction from exercising all their rights and obligations under the transaction documents. This document cannot be reproduced except in full, without prior written approval of the Company. Any unauthorized alteration, forgery or falsification of the content or appearance of this document is unlawful and offenders may be prosecuted to the fullest extent of the law.

SGS Taiwan Ltd.

No.134,WuKungRoad,NewTaipeiIndustrialPark,WukuDistrict,NewTaipeiCity,Taiwan24803/新北市五股區新北產業園區五工路 134 號

台灣檢驗科技股份有限公司

t (886-2) 2299-3279

f (886-2) 2298-0488

[www.tw.sgs.com](http://www.tw.sgs.com)

Member of SGS Group

LTE Band 41

LTE Band 41_Uplink frequency band : 2496 to 2690 MHz								
BW (MHz)	RB Size	RB Offset	Conducted power (dBm)					
			QPSK			16QAM		
			CH (Low) 39675	CH (Mid) 40620	CH (High) 41565	CH (Low) 39675	CH (Mid) 40620	CH (High) 41565
5	1	0	22.4	22.98	22.94	21.12	21.81	21.68
	1	24	22.47	22.64	22.76	21.13	21.93	21.7
	12	6	21.36	21.49	21.3	20.99	20.91	20.58
	25	0	21.85	21.19	21.17	20.44	20.29	20.97

LTE Band 41_Uplink frequency band : 2496 to 2690 MHz								
BW (MHz)	RB Size	RB Offset	Conducted power (dBm)					
			QPSK			16QAM		
			CH (Low) 39700	CH (Mid) 40620	CH (High) 41540	CH (Low) 39700	CH (Mid) 40620	CH (High) 41540
10	1	0	22.75	22.56	22.67	21.03	21.8	21.8
	1	49	22.46	22.29	22.15	21.93	21.65	21.41
	25	12	21.54	21.8	21.52	20.48	20.77	20.74
	50	0	21.1	21.06	21.54	20.8	20.52	20.84

LTE Band 41_Uplink frequency band : 2496 to 2690 MHz								
BW (MHz)	RB Size	RB Offset	Conducted power (dBm)					
			QPSK			16QAM		
			CH (Low) 39725	CH (Mid) 40620	CH (High) 41515	CH (Low) 39725	CH (Mid) 40620	CH (High) 41515
15	1	0	21.28	22.89	20.85	21.73	21.09	21.4
	1	74	19.89	22.18	21.97	21.74	21.28	21.4
	36	19	20.76	21.7	21.05	20.38	20.66	20.85
	75	0	19.87	21.57	19.74	20.4	20.29	20.44

Unless otherwise stated the results shown in this test report refer only to the sample(s) tested and such sample(s) are retained for 90 days only.

除非另有說明，此報告結果僅對測試之樣品負責，同時此樣品僅保留90天。本報告未經本公司書面許可，不可部份複製。

This document is issued by the Company subject to its General Conditions of Service printed overleaf, available on request or accessible at [www.sgs.com/terms\\_and\\_conditions.htm](http://www.sgs.com/terms_and_conditions.htm) and, for electronic format documents, subject to Terms and Conditions for Electronic Documents at [www.sgs.com/terms\\_e-document.htm](http://www.sgs.com/terms_e-document.htm). Attention is drawn to the limitation of liability, indemnification and jurisdiction issues defined therein. Any holder of this document is advised that information contained hereon reflects the Company's findings at the time of its intervention only and within the limits of Client's instructions, if any. The Company's sole responsibility is to its Client and this document does not exonerate parties to a transaction from exercising all their rights and obligations under the transaction documents. This document cannot be reproduced except in full, without prior written approval of the Company. Any unauthorized alteration, forgery or falsification of the content or appearance of this document is unlawful and offenders may be prosecuted to the fullest extent of the law.

LTE Band 41_Uplink frequency band : 2496 to 2690 MHz								
BW (MHz)	RB Size	RB Offset	Conducted power (dBm)					
			QPSK			16QAM		
			CH (Low) 39750	CH (Mid) 40620	CH (High) 41490	CH (Low) 39750	CH (Mid) 40620	CH (High) 41490
20	1	0	21.16	22.33	20.69	21.53	21.43	21.24
	1	99	19.77	22.4	21.86	21.47	21.05	21.97
	50	25	20.74	21.25	21.16	20.66	20.38	20.31
	100	0	19.81	21.81	19.71	20.79	20.77	20.05

LTE Band 41

LTE Band 41_Uplink frequency band : 2496 to 2690 MHz					
BW (MHz)	RB Size	RB Offset	Conducted power (dBm)		
			64QAM		
			CH (Low) 39675	CH (Mid) 40620	CH (High) 41565
5	1	0	20.96	20.23	20.36
	1	24	20.97	20.1	20.08
	12	6	19.6	19.49	19.15
	25	0	19.82	19.4	19.87

LTE Band 41_Uplink frequency band : 2496 to 2690 MHz					
BW (MHz)	RB Size	RB Offset	Conducted power (dBm)		
			64QAM		
			CH (Low) 39700	CH (Mid) 40620	CH (High) 41540
10	1	0	20.18	20.48	20.64
	1	49	20.7	20.19	20.55
	25	12	19.27	19.22	19.8
	50	0	19.36	19.26	19.7

Unless otherwise stated the results shown in this test report refer only to the sample(s) tested and such sample(s) are retained for 90 days only.  
除非另有說明，此報告結果僅對測試之樣品負責，同時此樣品僅保留90天。本報告未經本公司書面許可，不可部份複製。

This document is issued by the Company subject to its General Conditions of Service printed overleaf, available on request or accessible at [www.sgs.com/terms\\_and\\_conditions.htm](http://www.sgs.com/terms_and_conditions.htm) and, for electronic format documents, subject to Terms and Conditions for Electronic Documents at [www.sgs.com/terms\\_e-document.htm](http://www.sgs.com/terms_e-document.htm). Attention is drawn to the limitation of liability, indemnification and jurisdiction issues defined therein. Any holder of this document is advised that information contained hereon reflects the Company's findings at the time of its intervention only and within the limits of Client's instructions, if any. The Company's sole responsibility is to its Client and this document does not exonerate parties to a transaction from exercising all their rights and obligations under the transaction documents. This document cannot be reproduced except in full, without prior written approval of the Company. Any unauthorized alteration, forgery or falsification of the content or appearance of this document is unlawful and offenders may be prosecuted to the fullest extent of the law.

LTE Band 41_Uplink frequency band : 2496 to 2690 MHz					
BW (MHz)	RB Size	RB Offset	Conducted power (dBm)		
			64QAM		
			CH (Low) 39725	CH (Mid) 40620	CH (High) 41515
15	1	0	20.31	20.91	20.59
	1	74	20.07	20.29	20.72
	36	19	19.22	19.42	19.83
	75	0	19.89	19.37	19.55

LTE Band 41_Uplink frequency band : 2496 to 2690 MHz					
BW (MHz)	RB Size	RB Offset	Conducted power (dBm)		
			64QAM		
			CH (Low) 39750	CH (Mid) 40620	CH (High) 41490
20	1	0	20.07	20.14	20.65
	1	99	20.28	20.45	20.36
	50	25	19.6	19.98	19.17
	100	0	19.16	19.32	19.02

Unless otherwise stated the results shown in this test report refer only to the sample(s) tested and such sample(s) are retained for 90 days only.  
除非另有說明，此報告結果僅對測試之樣品負責，同時此樣品僅保留90天。本報告未經本公司書面許可，不可部份複製。

This document is issued by the Company subject to its General Conditions of Service printed overleaf, available on request or accessible at [www.sgs.com/terms\\_and\\_conditions.htm](http://www.sgs.com/terms_and_conditions.htm) and, for electronic format documents, subject to Terms and Conditions for Electronic Documents at [www.sgs.com/terms\\_e-document.htm](http://www.sgs.com/terms_e-document.htm). Attention is drawn to the limitation of liability, indemnification and jurisdiction issues defined therein. Any holder of this document is advised that information contained hereon reflects the Company's findings at the time of its intervention only and within the limits of Client's instructions, if any. The Company's sole responsibility is to its Client and this document does not exonerate parties to a transaction from exercising all their rights and obligations under the transaction documents. This document cannot be reproduced except in full, without prior written approval of the Company. Any unauthorized alteration, forgery or falsification of the content or appearance of this document is unlawful and offenders may be prosecuted to the fullest extent of the law.

SGS Taiwan Ltd.

No.134,WuKungRoad,NewTaipeiIndustrialPark,WukuDistrict,NewTaipeiCity,Taiwan24803/新北市五股區新北產業園區五工路 134 號

台灣檢驗科技股份有限公司

t (886-2) 2299-3279

f (886-2) 2298-0488

www.tw.sgs.com

Member of SGS Group

**HSDPA Release 6 MODE:**

The following 4 Sub-Tests were completed according to the test requirements outlined in section 5.2A of the 3GPP TS34.121-1 V8.4.0 specification. All TX RMS power requirements for Power Class 3 were met according to table 5.2AA.5 and 5.2B.5 All UE channels and power ratio's are set according to table C10.1.4 & C11.1.3 in the 3GPP TS34.121-1 V8.4.0. RMC 12.2kps is used for this testing.

**HSDPA SUB-TEST Setting**

Table C.10.1.4:  $\beta$  values for transmitter characteristics tests with HS-DPCCH(FOR HSDPA)

Sub-test	$\beta_c$	$\beta_d$	$\beta_d$ (SF)	$\beta_c/\beta_d$	$\beta_{HS}$ (Note 1, Note 2)	CM (dB) (Note 3)	MPR (dB) (Note 3)	RMC (Kbps)
1	2/15	15/15	64	2/15	4/15	0.0	0.0	12.2
2	12/15 (Note 4)	15/15 (Note 4)	64	12/15 (Note 4)	24/15	1.0	0.0	12.2
3	15/15	8/15	64	15/8	30/15	1.5	0.5	12.2
4	15/15	4/15	64	15/4	30/15	1.5	0.5	12.2

**Note: The recommended HSDPA MPRs are implemented as per following sub-tests.**

**Results:**

Unless otherwise stated the results shown in this test report refer only to the sample(s) tested and such sample(s) are retained for 90 days only.

除非另有說明，此報告結果僅對測試之樣品負責，同時此樣品僅保留90天。本報告未經本公司書面許可，不可部份複製。

This document is issued by the Company subject to its General Conditions of Service printed overleaf, available on request or accessible at [www.sgs.com/terms\\_and\\_conditions.htm](http://www.sgs.com/terms_and_conditions.htm) and, for electronic format documents, subject to Terms and Conditions for Electronic Documents at [www.sgs.com/terms\\_e-document.htm](http://www.sgs.com/terms_e-document.htm). Attention is drawn to the limitation of liability, indemnification and jurisdiction issues defined therein. Any holder of this document is advised that information contained hereon reflects the Company's findings at the time of its intervention only and within the limits of Client's instructions, if any. The Company's sole responsibility is to its Client and this document does not exonerate parties to a transaction from exercising all their rights and obligations under the transaction documents. This document cannot be reproduced except in full, without prior written approval of the Company. Any unauthorized alteration, forgery or falsification of the content or appearance of this document is unlawful and offenders may be prosecuted to the fullest extent of the law.

SGS Taiwan Ltd.

No.134,WuKungRoad,NewTaipeiIndustrialPark,WukuDistrict,NewTaipeiCity,Taiwan24803/新北市五股區新北產業園區五工路 134 號

台灣檢驗科技股份有限公司

t (886-2) 2299-3279

f (886-2) 2298-0488

www.tw.sgs.com

Member of SGS Group



Mode	Sub test	Avg. Power (dBm) Channel			Power Class 3 Limitation (dBm)	Result
		9262	9400	9538		
HSDPA II	1	<b>22.2</b>	22.67	22.15	20.3 ~ 25.7	Pass
	2	22	22.34	22.1	20.3 ~ 25.7	Pass
	3	21.45	21.74	21.51	19.8 ~ 25.7	Pass
	4	21.4	21.62	21.42	19.8 ~ 25.7	Pass

Mode	Sub test	Avg. Power (dBm) Channel			Power Class 3 Limitation (dBm)	Result
		1312	1413	1513		
HSDPA IV	1	22.15	<b>22.49</b>	22.45	20.3 ~ 25.7	Pass
	2	21.94	22.24	22.16	20.3 ~ 25.7	Pass
	3	21.54	21.51	21.68	19.8 ~ 25.7	Pass
	4	21.48	21.45	21.56	19.8 ~ 25.7	Pass

Mode	Sub test	Avg. Power (dBm) Channel			Power Class 3 Limitation (dBm)	Result
		4132	4183	4233		
HSDPA V	1	22.87	22.74	<b>22.74</b>	20.3 ~ 25.7	Pass
	2	22.67	22.61	21.70	20.3 ~ 25.7	Pass
	3	22.16	22.16	21.46	19.8 ~ 25.7	Pass
	4	22.07	22.09	21.35	19.8 ~ 25.7	Pass

Unless otherwise stated the results shown in this test report refer only to the sample(s) tested and such sample(s) are retained for 90 days only.

除非另有說明，此報告結果僅對測試之樣品負責，同時此樣品僅保留90天。本報告未經本公司書面許可，不可部份複製。

This document is issued by the Company subject to its General Conditions of Service printed overleaf, available on request or accessible at [www.sgs.com/terms\\_and\\_conditions.htm](http://www.sgs.com/terms_and_conditions.htm) and, for electronic format documents, subject to Terms and Conditions for Electronic Documents at [www.sgs.com/terms\\_e-document.htm](http://www.sgs.com/terms_e-document.htm). Attention is drawn to the limitation of liability, indemnification and jurisdiction issues defined therein. Any holder of this document is advised that information contained hereon reflects the Company's findings at the time of its intervention only and within the limits of Client's instructions, if any. The Company's sole responsibility is to its Client and this document does not exonerate parties to a transaction from exercising all their rights and obligations under the transaction documents. This document cannot be reproduced except in full, without prior written approval of the Company. Any unauthorized alteration, forgery or falsification of the content or appearance of this document is unlawful and offenders may be prosecuted to the fullest extent of the law.

### HSPA (HSDPA & HSUPA) Release 6 MODE

The following 5 Sub-Tests were completed according to the test requirements outlined in section 5.2A of the 3GPP TS34.121-1 V8.4.0 specification. All TX RMS power requirements for Power Class 3 were met according to table 5.2AA.5 and 5.2B.5 All UE channels and power ratio's are set according to table C11.1.3 in the 3GPP TS34.121-1 V8.4.0. RMC 12.2kps is used for this testing

### HSPA SUB-TEST Setting

Table C.11.1.3:  $\beta$  values for transmitter characteristics tests with HS-DPCCH and E-DCH(FOR HSUPA)

Sub-test	$\beta_c$	$\beta_d$	$\beta_d$ (SF)	$\beta_c/\beta_d$	$\beta_{HS}$	$\beta_{ec}$	$\beta_{ed}$	$\beta_{ed}$ (SF)	$\beta_{ed}$ (Code s)	CM (dB)	MPR (dB)	AG Index	E-TFCI	RMC (Kbps)
1	11/15 (Note 3)	15/15 (Note 3)	64	11/15 (Note 3)	22/15	209/225	1309/225	4	1	1.0	0.0	20	75	12.2
2	6/15	15/15	64	6/15	12/15	12/15	94/75	4	1	3.0	2.0	12	67	12.2
3	15/15	9/15	64	15/9	30/15	30/15	$\beta_{ed1}: 47/15$ $\beta_{ed2}: 47/15$	4 4	2	2.0	1.0	15	92	12.2
4	2/15	15/15	64	2/15	4/15	2/15	56/75	4	1	3.0	2.0	17	71	12.2
5	15/15 (Note 4)	15/15 (Note 4)	64	15/15 (Note 4)	30/15	24/15	134/15	4	1	1.0	0.0	21	81	12.2

**Note: The recommended HSUPA MPRs are implemented as per following sub-tests.**

### Results:

Unless otherwise stated the results shown in this test report refer only to the sample(s) tested and such sample(s) are retained for 90 days only.

除非另有說明，此報告結果僅對測試之樣品負責，同時此樣品僅保留90天。本報告未經本公司書面許可，不可部份複製。

This document is issued by the Company subject to its General Conditions of Service printed overleaf, available on request or accessible at [www.sgs.com/terms\\_and\\_conditions.htm](http://www.sgs.com/terms_and_conditions.htm) and, for electronic format documents, subject to Terms and Conditions for Electronic Documents at [www.sgs.com/terms\\_e-document.htm](http://www.sgs.com/terms_e-document.htm). Attention is drawn to the limitation of liability, indemnification and jurisdiction issues defined therein. Any holder of this document is advised that information contained hereon reflects the Company's findings at the time of its intervention only and within the limits of Client's instructions, if any. The Company's sole responsibility is to its Client and this document does not exonerate parties to a transaction from exercising all their rights and obligations under the transaction documents. This document cannot be reproduced except in full, without prior written approval of the Company. Any unauthorized alteration, forgery or falsification of the content or appearance of this document is unlawful and offenders may be prosecuted to the fullest extent of the law.

SGS Taiwan Ltd.

No.134,WuKungRoad,NewTaipeiIndustrialPark,WukuDistrict,NewTaipeiCity,Taiwan24803/新北市五股區新北產業園區五工路 134 號

台灣檢驗科技股份有限公司

t (886-2) 2299-3279

f (886-2) 2298-0488

[www.tw.sgs.com](http://www.tw.sgs.com)

Member of SGS Group

Mode	Sub test	Avg. Power (dBm) Channel			Power Class 3 Limitation (dBm)	Result
		9262	9400	9538		
HSUPA II	1	21.95	<b>22.01</b>	21.48	18.8 ~ 25.7	Pass
	2	21.21	21.40	21.08	16.8 ~ 25.7	Pass
	3	21.91	21.81	21.04	17.8 ~ 25.7	Pass
	4	21.43	21.34	21.37	16.8 ~ 25.7	Pass
	5	21.85	21.79	21.48	18.8 ~ 25.7	Pass

Mode	Sub test	Avg. Power (dBm) Channel			Power Class 3 Limitation (dBm)	Result
		1312	1413	1513		
HSDPA IV	1	21.75	22.30	<b>22.37</b>	20.3 ~ 25.7	Pass
	2	21.48	21.39	21.34	20.3 ~ 25.7	Pass
	3	21.34	21.90	22.21	19.8 ~ 25.7	Pass
	4	21.43	21.39	21.36	19.8 ~ 25.7	Pass
	5	21.67	22.10	22.30	19.8 ~ 25.7	Pass

Mode	Sub test	Avg. Power (dBm) Channel			Power Class 3 Limitation (dBm)	Result
		4132	4183	4233		
HSUPA V	1	22.45	<b>22.46</b>	22.15	18.8 ~ 25.7	Pass
	2	20.89	20.75	20.77	16.8 ~ 25.7	Pass
	3	21.78	21.78	21.74	17.8 ~ 25.7	Pass
	4	20.84	20.79	20.75	16.8 ~ 25.7	Pass
	5	22.35	22.31	21.98	16.8 ~ 25.7	Pass

Unless otherwise stated the results shown in this test report refer only to the sample(s) tested and such sample(s) are retained for 90 days only.

除非另有說明，此報告結果僅對測試之樣品負責，同時此樣品僅保留90天。本報告未經本公司書面許可，不可部份複製。

This document is issued by the Company subject to its General Conditions of Service printed overleaf, available on request or accessible at [www.sgs.com/terms\\_and\\_conditions.htm](http://www.sgs.com/terms_and_conditions.htm) and, for electronic format documents, subject to Terms and Conditions for Electronic Documents at [www.sgs.com/terms\\_e-document.htm](http://www.sgs.com/terms_e-document.htm). Attention is drawn to the limitation of liability, indemnification and jurisdiction issues defined therein. Any holder of this document is advised that information contained hereon reflects the Company's findings at the time of its intervention only and within the limits of Client's instructions, if any. The Company's sole responsibility is to its Client and this document does not exonerate parties to a transaction from exercising all their rights and obligations under the transaction documents. This document cannot be reproduced except in full, without prior written approval of the Company. Any unauthorized alteration, forgery or falsification of the content or appearance of this document is unlawful and offenders may be prosecuted to the fullest extent of the law.

SGS Taiwan Ltd.

No.134,WuKungRoad,NewTaipeiIndustrialPark,WukuDistrict,NewTaipeiCity,Taiwan24803/新北市五股區新北產業園區五工路 134 號

台灣檢驗科技股份有限公司

t (886-2) 2299-3279

f (886-2) 2298-0488

www.tw.sgs.com

Member of SGS Group

**Minimum Communications Power Measurement**  
**PCS 1900 band**

PCL	0	1	2	3	4	5	6	7	8
Output power (dBm)	29.51	28.2	25.77	23.91	21.98	19.92	17.81	15.77	13.85

PCL	9	10	11	12	13	14	15
Output power (dBm)	12.41	10.47	8.51	6.53	4.62	2.47	1.01

Note: The EUT output power was controlled by simulator. Set Communication Tester MT8820C PCL as above, and get the mobile phone output power reading

**WCDMA/HSDPA/HSUPA band II, IV, V**

The EUT output power was controlled by simulator. Set Communication Tester MT8820C function key “UE Power Control” and enter max rated power 24dBm. The EUT is going to be set to max output power to 24dBm. Then record the read (see page 15 for measurement data). The min. power was measures by a function key “minimum power” then record the read. It is -52.3dBm. The power variation can be 0.1dB step by setting.

Unless otherwise stated the results shown in this test report refer only to the sample(s) tested and such sample(s) are retained for 90 days only.

除非另有說明，此報告結果僅對測試之樣品負責，同時此樣品僅保留90天。本報告未經本公司書面許可，不可部份複製。

This document is issued by the Company subject to its General Conditions of Service printed overleaf, available on request or accessible at [www.sgs.com/terms\\_and\\_conditions.htm](http://www.sgs.com/terms_and_conditions.htm) and, for electronic format documents, subject to Terms and Conditions for Electronic Documents at [www.sgs.com/terms\\_e-document.htm](http://www.sgs.com/terms_e-document.htm). Attention is drawn to the limitation of liability, indemnification and jurisdiction issues defined therein. Any holder of this document is advised that information contained hereon reflects the Company's findings at the time of its intervention only and within the limits of Client's instructions, if any. The Company's sole responsibility is to its Client and this document does not exonerate parties to a transaction from exercising all their rights and obligations under the transaction documents. This document cannot be reproduced except in full, without prior written approval of the Company. Any unauthorized alteration, forgery or falsification of the content or appearance of this document is unlawful and offenders may be prosecuted to the fullest extent of the law.

SGS Taiwan Ltd.

No.134,WuKungRoad,NewTaipeiIndustrialPark,WukuDistrict,NewTaipeiCity,Taiwan24803/新北市五股區新北產業園區五工路 134 號

台灣檢驗科技股份有限公司

t (886-2) 2299-3279

f (886-2) 2298-0488

[www.tw.sgs.com](http://www.tw.sgs.com)

Member of SGS Group

## 7. EFFECTIVE RADIATED POWER AND EQUIVALENT ISOTROPIC RADIATED POWER MEASUREMENT

### 7.1. Standard Applicable

According to FCC §2.1046

FCC 22.913(a) Mobile station is limited to 7W ERP.

FCC 24.232(c) Mobile and portable stations are limited to 2 W EIRP.

FCC 27.50(c) (10) Control stations and mobile stations are limited to 3 W ERP.

FCC 27.50(d)(4) Fixed, mobile, and portable (hand-held) stations are limited to 1W EIRP.

FCC 27, 50(h)(2) Mobile and other user stations. Mobile stations are limited to 2 W EIRP

### 7.2. Test SET-UP

(A) Radiated Power Test Set-Up, Frequency Below 1000MHz

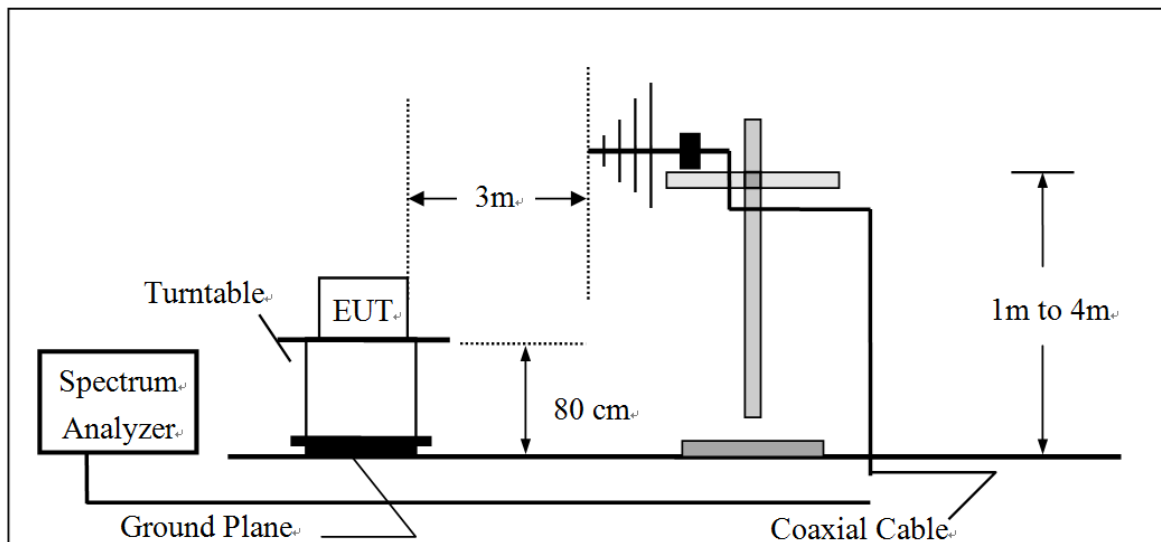

Unless otherwise stated the results shown in this test report refer only to the sample(s) tested and such sample(s) are retained for 90 days only.

除非另有說明，此報告結果僅對測試之樣品負責，同時此樣品僅保留90天。本報告未經本公司書面許可，不可部份複製。

This document is issued by the Company subject to its General Conditions of Service printed overleaf, available on request or accessible at [www.sgs.com/terms\\_and\\_conditions.htm](http://www.sgs.com/terms_and_conditions.htm) and, for electronic format documents, subject to Terms and Conditions for Electronic Documents at [www.sgs.com/terms\\_e-document.htm](http://www.sgs.com/terms_e-document.htm). Attention is drawn to the limitation of liability, indemnification and jurisdiction issues defined therein. Any holder of this document is advised that information contained hereon reflects the Company's findings at the time of its intervention only and within the limits of Client's instructions, if any. The Company's sole responsibility is to its Client and this document does not exonerate parties to a transaction from exercising all their rights and obligations under the transaction documents. This document cannot be reproduced except in full, without prior written approval of the Company. Any unauthorized alteration, forgery or falsification of the content or appearance of this document is unlawful and offenders may be prosecuted to the fullest extent of the law.

SGS Taiwan Ltd.

No.134,WuKungRoad,NewTaipeiIndustrialPark,WukuDistrict,NewTaipeiCity,Taiwan24803/新北市五股區新北產業園區五工路 134 號

台灣檢驗科技股份有限公司

t (886-2) 2299-3279

f (886-2) 2298-0488

www.tw.sgs.com

Member of SGS Group

(B) Radiated Power Test Set-UP Frequency Over 1 GHz

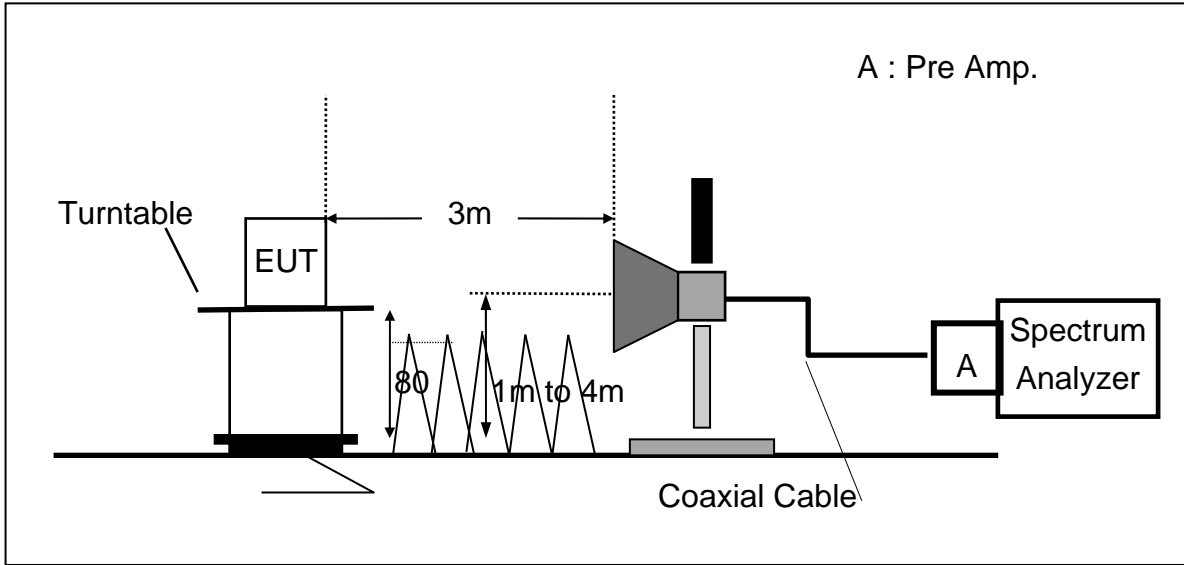

(C) Substituted Method Test Set-UP

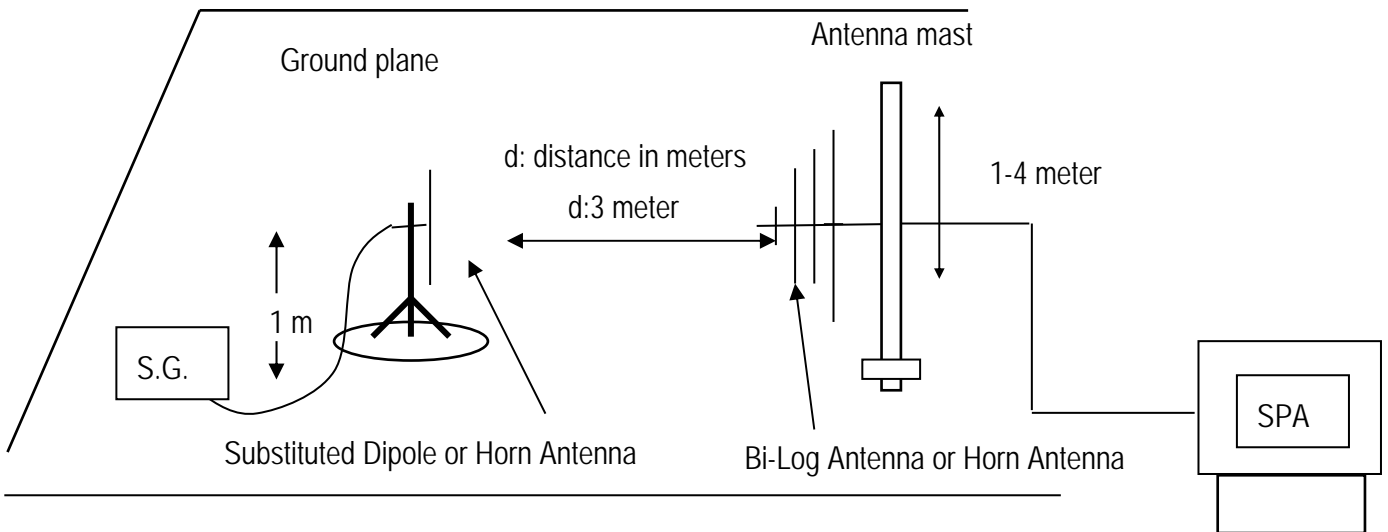

Unless otherwise stated the results shown in this test report refer only to the sample(s) tested and such sample(s) are retained for 90 days only.  
除非另有說明，此報告結果僅對測試之樣品負責，同時此樣品僅保留90天。本報告未經本公司書面許可，不可部份複製。

This document is issued by the Company subject to its General Conditions of Service printed overleaf, available on request or accessible at [www.sgs.com/terms\\_and\\_conditions.htm](http://www.sgs.com/terms_and_conditions.htm) and, for electronic format documents, subject to Terms and Conditions for Electronic Documents at [www.sgs.com/terms\\_e-document.htm](http://www.sgs.com/terms_e-document.htm). Attention is drawn to the limitation of liability, indemnification and jurisdiction issues defined therein. Any holder of this document is advised that information contained hereon reflects the Company's findings at the time of its intervention only and within the limits of Client's instructions, if any. The Company's sole responsibility is to its Client and this document does not exonerate parties to a transaction from exercising all their rights and obligations under the transaction documents. This document cannot be reproduced except in full, without prior written approval of the Company. Any unauthorized alteration, forgery or falsification of the content or appearance of this document is unlawful and offenders may be prosecuted to the fullest extent of the law.

### 7.3. Measurement Procedure

1. The testing follows the Measurement Procedure of FCC KDB 971168 D01
2. The EUT was placed on a non-conductive turntable using a non-conductive support. The radiated emission at the fundamental frequency was measured at 3 m with a test antenna and EMI spectrum analyzer.
3. During the measurement, the EUT was communication with the station. The highest emission was recorded with the rotation of the turntable and the lowering of the test antenna from 4m to 1m. The reading was recorded and the field strength (E in dBuV/m) was calculated
4. The testing follows the Measurement Procedure of FCC KDB 971168 D01
5. The substitution horn antenna is substituted for EUT at the same position and signals generator export the CW signal to the substitution antenna via a tx cable. Rotated the Turn Table and moved receiving antenna to find the maximum radiation power. Adjust output power level of S.G to get a Value of spectrum reading equal to "Read Value" of step b. Record the power level of S.G.
6.  $ERP = S.G. \text{ output (dBm)} + \text{Antenna Gain (dBd)} - \text{Cable Loss (dB)}$
7.  $ERP = S.G. \text{ output (dBm)} + \text{Antenna Gain (dBd)} - \text{Cable Loss (dB)}$
8. Spectrum setting:
  - (1) Detector = Peak, marker the highest value of the detector by maximum hold, set RBW wide enough to capture the entire signal of emission, and  $VBW \geq 3 \times RBW$ .
  - (2) KDB 971168 D01 is adopted, and the procedure as lists under item 4, Measurement of the Average Power over the Fundamental Signal Bandwidth, is followed to set correspondingly for the acquisition of proper measurement data.

Set frequency = nominal signal center frequency;  
 Set span = 2 X occupied BW;  
 Set RBW  $\approx$  1~5% of the span, not to exceed 1 MHz  
 Set VBW = 3 x RBW;  
 Select average power (RMS) detector  
 Set sweep time and number of measurement points to achieve a minimum of 1 millisecond/pt integration time (ex. Point = 601points, then sweep time =  $601 \times 10^{-3} = 6s$ .)

Activate trace averaging routine over a minimum of 10 sweeps;

Activate marker/span pair and set span = signal or channel bandwidth;

Activate the band/interval power marker function;

Record the band power level;

Record adjusted value as the average signal power level. Then activate the occupied bandwidth measurement function.

The proper adjustment due to limitation of spectrum capability is given compensated to spectrum with conversion factor of  $10 \times \log(TBW/RBW)$ , where TBW is the transmission of UE exceeding the maximum BW UE can extends, and RBW is the resolution BW in UE.

Unless otherwise stated the results shown in this test report refer only to the sample(s) tested and such sample(s) are retained for 90 days only.

除非另有說明，此報告結果僅對測試之樣品負責，同時此樣品僅保留90天。本報告未經本公司書面許可，不可部份複製。

This document is issued by the Company subject to its General Conditions of Service printed overleaf, available on request or accessible at [www.sgs.com/terms\\_and\\_conditions.htm](http://www.sgs.com/terms_and_conditions.htm) and, for electronic format documents, subject to Terms and Conditions for Electronic Documents at [www.sgs.com/terms\\_e-document.htm](http://www.sgs.com/terms_e-document.htm). Attention is drawn to the limitation of liability, indemnification and jurisdiction issues defined therein. Any holder of this document is advised that information contained hereon reflects the Company's findings at the time of its intervention only and within the limits of Client's instructions, if any. The Company's sole responsibility is to its Client and this document does not exonerate parties to a transaction from exercising all their rights and obligations under the transaction documents. This document cannot be reproduced except in full, without prior written approval of the Company. Any unauthorized alteration, forgery or falsification of the content or appearance of this document is unlawful and offenders may be prosecuted to the fullest extent of the law.

#### 7.4. Measurement Equipment Used

ERP, EIRP MEASUREMENT EQUIPMENT List 966 Chamber					
EQUIPMENT TYPE	MFR	MODEL NUMBER	SERIAL NUMBER	LAST CAL.	CAL DUE.
EMI Test Receiver	R&S	ESU 40	100363	04/18/2017	04/17/2018
Broadband Antenna	TESEQ	CBL 6112D	35240	11/03/2016	11/02/2017
Broadband Antenna	TESEQ	CBL 6112D	35243	11/09/2016	11/08/2017
Horn Antenna	ETS-Lindgren	3117	00143272	12/15/2016	12/16/2017
Horn Antenna	ETS-Lindgren	3117	143279	11/14/2016	11/13/2017
Horn Antenna	Schwarzbeck	BBHA9170	184	12/11/2016	12/10/2017
Horn Antenna	Schwarzbeck	BBHA9170	185	08/01/2017	07/31/2018
Pre Amplifier	EMC Instruments	EMC330	980096	12/12/2016	12/11/2017
Pre Amplifier	EMC Instruments	EMC0011830	980199	12/12/2016	12/11/2017
Pre Amplifier	R&S	SCU-18	10204	12/12/2016	12/11/2017
Pre Amplifier	R&S	SCU-26	100780	12/12/2016	12/11/2017
Pre Amplifier	EMC Instruments	EMC184045B	980135	12/12/2016	12/11/2017
Coaxial Cable	Huber+Suhner	RG 214/U	966Rx 9K-30M	12/12/2016	12/11/2017
Coaxial Cable	Huber+Suhner	RG 214/U SUCOFLEX 104	966Rx 30M-3G	12/12/2016	12/11/2017
Coaxial Cable	Huber+Suhner	SUCOFLEX 104	966Rx 1G-18G	12/12/2016	12/11/2017
Coaxial Cable	Huber+Suhner	mini 141-12 SUCOFLEX 104	966Rx 18G-40G	12/12/2016	12/11/2017
Coaxial Cable	Huber+Suhner	SUCOFLEX 104	966Tx 30M-18G	12/12/2016	12/11/2017
Coaxial Cable	Huber+Suhner	SUCOFLEX 102	966Tx 18G-40G	12/12/2016	12/11/2017
Attenuator	WOKEN	218FS-10	RF27	12/12/2016	12/11/2017
Communication Tester	Anritsu	MT8820C	6201107337	05/25/2017	05/24/2018
Site NSA	SGS	966 Chamber C	SAC-C	03/02/2017	03/01/2018
Site VSWR	SGS	966 Chamber C	SAC-C	03/02/2017	03/01/2018
DC Power Supply	HOLA	DP-3003	D7070035	05/04/2017	05/03/2018
Controller	MF	MF-7802	N/A	N.C.R.	N.C.R.
Antenna Master	MF	N/A	N/A	N.C.R.	N.C.R.
Turn Table	MF	N/A	N/A	N.C.R.	N.C.R.
Test Software	World-Pallas	Dr. E	V 3.0 Lite	N.C.R.	N.C.R.

Unless otherwise stated the results shown in this test report refer only to the sample(s) tested and such sample(s) are retained for 90 days only.

除非另有說明，此報告結果僅對測試之樣品負責，同時此樣品僅保留90天。本報告未經本公司書面許可，不可部份複製。

This document is issued by the Company subject to its General Conditions of Service printed overleaf, available on request or accessible at [www.sgs.com/terms\\_and\\_conditions.htm](http://www.sgs.com/terms_and_conditions.htm) and, for electronic format documents, subject to Terms and Conditions for Electronic Documents at [www.sgs.com/terms\\_e-document.htm](http://www.sgs.com/terms_e-document.htm). Attention is drawn to the limitation of liability, indemnification and jurisdiction issues defined therein. Any holder of this document is advised that information contained hereon reflects the Company's findings at the time of its intervention only and within the limits of Client's instructions, if any. The Company's sole responsibility is to its Client and this document does not exonerate parties to a transaction from exercising all their rights and obligations under the transaction documents. This document cannot be reproduced except in full, without prior written approval of the Company. Any unauthorized alteration, forgery or falsification of the content or appearance of this document is unlawful and offenders may be prosecuted to the fullest extent of the law.

SGS Taiwan Ltd.

No. 134, WuKungRoad, NewTaipeiIndustrialPark, WukuDistrict, NewTaipeiCity, Taiwan24803/新北市五股區新北產業園區五工路 134 號

台灣檢驗科技股份有限公司

t (886-2) 2299-3279

f (886-2) 2298-0488

www.tw.sgs.com

Member of SGS Group



**7.5. Measurement Result: (Peak) –using option of peak measurement**

EUT			Measurement					
Operation Band	Fundamental Frequency	CH	Antenna Pol.	S.G. Output	Antenna Gain	Cable Loss	ERP	Limit
	MHz		V/H	dBm	dBd	dB	dBm	dBm
GPRS 850	824.2	128	V	18.45	5.14	-4.18	19.41	38.45
			H	27.72	5.14	-4.18	<b>28.68</b>	38.45
	836.6	190	V	19.12	5.09	-4.23	19.98	38.45
			H	26.45	5.09	-4.23	27.31	38.45
	848.8	251	V	18	5.05	-4.27	18.78	38.45
			H	27.02	5.05	-4.27	27.8	38.45
EDGE 850	824.2	128	V	16	5.05	-4.27	16.78	38.45
			H	24.71	5.05	-4.27	<b>25.49</b>	38.45
	836.6	190	V	16.86	5.14	-4.18	17.82	38.45
			H	24	5.14	-4.18	24.96	38.45
	848.8	251	V	16.84	5.1	-4.23	17.71	38.45
			H	24.57	5.1	-4.23	25.44	38.45

**Remark: The RBW,VBW of SPA for frequency RBW=300 KHz, VBW=1MHz**

Unless otherwise stated the results shown in this test report refer only to the sample(s) tested and such sample(s) are retained for 90 days only.  
除非另有說明，此報告結果僅對測試之樣品負責，同時此樣品僅保留90天。本報告未經本公司書面許可，不可部份複製。

This document is issued by the Company subject to its General Conditions of Service printed overleaf, available on request or accessible at [www.sgs.com/terms\\_and\\_conditions.htm](http://www.sgs.com/terms_and_conditions.htm) and, for electronic format documents, subject to Terms and Conditions for Electronic Documents at [www.sgs.com/terms\\_e-document.htm](http://www.sgs.com/terms_e-document.htm). Attention is drawn to the limitation of liability, indemnification and jurisdiction issues defined therein. Any holder of this document is advised that information contained hereon reflects the Company's findings at the time of its intervention only and within the limits of Client's instructions, if any. The Company's sole responsibility is to its Client and this document does not exonerate parties to a transaction from exercising all their rights and obligations under the transaction documents. This document cannot be reproduced except in full, without prior written approval of the Company. Any unauthorized alteration, forgery or falsification of the content or appearance of this document is unlawful and offenders may be prosecuted to the fullest extent of the law.

EUT			Measurement					
Operation Band	Fundamental Frequency	CH	Antenna Pol.	S.G. Output	Antenna Gain	Cable Loss	ERP	Limit
	MHz		V/H	dBm	dBd	dB	dBm	dBm
GPRS 1900	1850.2	512	V	14.70	9.57	-6.86	17.42	33.00
			H	26.50	9.57	-6.86	29.21	33.00
	1880.0	661	V	26.91	9.70	-6.91	29.70	33.00
			H	16.90	9.70	-6.91	19.68	33.00
	1909.8	810	V	13.04	9.82	-6.97	15.89	33.00
			H	26.91	9.82	-6.97	<b>29.76</b>	33.00
EDGE 1900	1850.2	512	V	13.12	9.57	-6.86	15.83	33.00
			H	25.56	9.57	-6.86	28.27	33.00
	1880.0	661	V	15.91	9.70	-6.91	18.69	33.00
			H	25.71	9.70	-6.91	28.49	33.00
	1909.8	810	V	11.86	9.82	-6.97	14.71	33.00
			H	26.01	9.82	-6.97	<b>28.86</b>	33.00

**Remark: The RBW,VBW of SPA for frequency RBW=300 KHz, VBW=1MHz**

Unless otherwise stated the results shown in this test report refer only to the sample(s) tested and such sample(s) are retained for 90 days only.

除非另有說明，此報告結果僅對測試之樣品負責，同時此樣品僅保留90天。本報告未經本公司書面許可，不可部份複製。

This document is issued by the Company subject to its General Conditions of Service printed overleaf, available on request or accessible at [www.sgs.com/terms\\_and\\_conditions.htm](http://www.sgs.com/terms_and_conditions.htm) and, for electronic format documents, subject to Terms and Conditions for Electronic Documents at [www.sgs.com/terms\\_e-document.htm](http://www.sgs.com/terms_e-document.htm). Attention is drawn to the limitation of liability, indemnification and jurisdiction issues defined therein. Any holder of this document is advised that information contained hereon reflects the Company's findings at the time of its intervention only and within the limits of Client's instructions, if any. The Company's sole responsibility is to its Client and this document does not exonerate parties to a transaction from exercising all their rights and obligations under the transaction documents. This document cannot be reproduced except in full, without prior written approval of the Company. Any unauthorized alteration, forgery or falsification of the content or appearance of this document is unlawful and offenders may be prosecuted to the fullest extent of the law.

SGS Taiwan Ltd.

No.134,WuKungRoad,NewTaipeiIndustrialPark,WukuDistrict,NewTaipeiCity,Taiwan24803/新北市五股區新北產業園區五工路 134 號

台灣檢驗科技股份有限公司

t (886-2) 2299-3279

f (886-2) 2298-0488

[www.tw.sgs.com](http://www.tw.sgs.com)

Member of SGS Group

EUT			Measurement					
Operation Band	Fundamental Frequency	CH	Antenna Pol.	S.G. Output	Antenna Gain	Cable Loss	EIRP	Limit
	MHz		V/H	dBm	dBd	dB	dBm	dBm
WCDMA Band II	1852.4	9262	V	12.96	9.58	-6.86	15.68	33.00
			H	22.33	9.58	-6.86	25.05	33.00
	1880.0	9400	V	8.62	9.7	-6.91	11.41	33.00
			H	17.04	9.7	-6.91	19.83	33.00
	1907.6	9538	V	6.8	9.81	-6.96	9.65	33.00
			H	23.92	9.81	-6.96	26.77	33.00
HSDPA Band II	1852.4	9262	V	13.65	9.58	-6.86	16.37	33.00
			H	21.3	9.58	-6.86	24.02	33.00
	1880.0	9400	V	14.95	9.7	-6.91	17.74	33.00
			H	21.09	9.7	-6.91	23.88	33.00
	1907.6	9538	V	14.22	9.81	-6.96	17.07	33.00
			H	20.46	9.81	-6.96	23.31	33.00
HSUPA Band II	1852.4	9262	V	13.49	9.58	-6.86	16.21	33.00
			H	21.36	9.58	-6.86	24.08	33.00
	1880.0	9400	V	9.82	9.69	-6.91	12.6	33.00
			H	16.51	9.69	-6.91	19.29	33.00
	1907.6	9538	V	11.76	9.81	-6.96	14.61	33.00
			H	18.38	9.81	-6.96	21.23	33.00

**Remark: The RBW,VBW of SPA for frequency RBW=5 MHz, VBW=8 MHz**

Unless otherwise stated the results shown in this test report refer only to the sample(s) tested and such sample(s) are retained for 90 days only.

除非另有說明，此報告結果僅對測試之樣品負責，同時此樣品僅保留90天。本報告未經本公司書面許可，不可部份複製。

This document is issued by the Company subject to its General Conditions of Service printed overleaf, available on request or accessible at [www.sgs.com/terms\\_and\\_conditions.htm](http://www.sgs.com/terms_and_conditions.htm) and, for electronic format documents, subject to Terms and Conditions for Electronic Documents at [www.sgs.com/terms\\_e-document.htm](http://www.sgs.com/terms_e-document.htm). Attention is drawn to the limitation of liability, indemnification and jurisdiction issues defined therein. Any holder of this document is advised that information contained hereon reflects the Company's findings at the time of its intervention only and within the limits of Client's instructions, if any. The Company's sole responsibility is to its Client and this document does not exonerate parties to a transaction from exercising all their rights and obligations under the transaction documents. This document cannot be reproduced except in full, without prior written approval of the Company. Any unauthorized alteration, forgery or falsification of the content or appearance of this document is unlawful and offenders may be prosecuted to the fullest extent of the law.

SGS Taiwan Ltd.

No.134,WuKungRoad,NewTaipeiIndustrialPark,WukuDistrict,NewTaipeiCity,Taiwan24803/新北市五股區新北產業園區五工路 134 號

台灣檢驗科技股份有限公司

t (886-2) 2299-3279

f (886-2) 2298-0488

www.tw.sgs.com

Member of SGS Group

EUT			Measurement					
Operation Band	Fundamental Frequency	CH	Antenna Pol.	S.G. Output	Antenna Gain	Cable Loss	EIRP	Limit
	MHz		V/H	dBm	dBd	dB	dBm	dBm
WCDMA Band IV	1712.4	1312	V	9.05	8.99	-6.58	11.46	30.00
			H	19.09	8.99	-6.58	21.5	30.00
	1732.6	1413	V	6.08	9.07	-6.62	8.53	30.00
			H	19.31	9.07	-6.62	21.76	30.00
	1752.6	1513	V	8.97	9.16	-6.67	11.46	30.00
			H	17.55	9.16	-6.67	20.04	30.00
HSDPA Band IV	1712.4	1312	V	9.03	8.99	-6.86	11.16	30.00
			H	19.07	8.99	-6.86	21.2	30.00
	1732.6	1413	V	5.83	9.08	-6.63	8.28	30.00
			H	19.3	9.08	-6.63	21.75	30.00
	1752.6	1513	V	10.31	9.16	-6.67	12.8	30.00
			H	18.68	9.16	-6.67	21.17	30.00
HSUPA Band IV	1712.4	1312	V	2.12	8.99	-6.58	4.53	30.00
			H	15.25	8.99	-6.58	17.66	30.00
	1732.6	1413	V	0.26	9.07	-6.62	2.71	30.00
			H	16.28	9.07	-6.62	18.73	30.00
	1752.6	1513	V	8.42	9.16	-6.67	10.91	30.00
			H	14.8	9.16	-6.67	17.29	30.00

**Remark: The RBW,VBW of SPA for frequency RBW=5 MHz, VBW=8 MHz**

Unless otherwise stated the results shown in this test report refer only to the sample(s) tested and such sample(s) are retained for 90 days only.

除非另有說明，此報告結果僅對測試之樣品負責，同時此樣品僅保留90天。本報告未經本公司書面許可，不可部份複製。

This document is issued by the Company subject to its General Conditions of Service printed overleaf, available on request or accessible at [www.sgs.com/terms\\_and\\_conditions.htm](http://www.sgs.com/terms_and_conditions.htm) and, for electronic format documents, subject to Terms and Conditions for Electronic Documents at [www.sgs.com/terms\\_e-document.htm](http://www.sgs.com/terms_e-document.htm). Attention is drawn to the limitation of liability, indemnification and jurisdiction issues defined therein. Any holder of this document is advised that information contained hereon reflects the Company's findings at the time of its intervention only and within the limits of Client's instructions, if any. The Company's sole responsibility is to its Client and this document does not exonerate parties to a transaction from exercising all their rights and obligations under the transaction documents. This document cannot be reproduced except in full, without prior written approval of the Company. Any unauthorized alteration, forgery or falsification of the content or appearance of this document is unlawful and offenders may be prosecuted to the fullest extent of the law.

SGS Taiwan Ltd.

No.134,WuKungRoad,NewTaipeiIndustrialPark,WukuDistrict,NewTaipeiCity,Taiwan24803/新北市五股區新北產業園區五工路 134 號

台灣檢驗科技股份有限公司

t (886-2) 2299-3279

f (886-2) 2298-0488

www.tw.sgs.com

Member of SGS Group

EUT			Measurement					
Operation Band	Fundamental Frequency	CH	Antenna Pol.	S.G. Output	Antenna Gain	Cable Loss	ERP	Limit
	MHz		V/H	dBm	dBd	dB	dBm	dBm
WCDMA Band V	826.4	4132	V	4.52	5.13	-4.19	5.46	38.45
			H	21.71	5.13	-4.19	22.65	38.45
	836.6	4183	V	4.74	5.1	-4.23	5.61	38.45
			H	21.46	5.1	-4.23	22.33	38.45
	846.6	4233	V	3.61	5.06	-4.26	4.41	38.45
			H	20	5.06	-4.26	20.8	38.45
HSDPA Band V	826.4	4132	V	9.07	5.13	-4.19	10.01	38.45
			H	19.83	5.13	-4.19	20.77	38.45
	836.6	4183	V	9.65	5.1	-4.22	10.53	38.45
			H	19.52	5.1	-4.22	20.4	38.45
	846.6	4233	V	8.71	5.06	-4.25	9.52	38.45
			H	19.51	5.06	-4.25	20.32	38.45
HSUPA Band V	826.4	4132	V	11.33	5.13	-4.19	12.27	38.45
			H	20.77	5.13	-4.19	21.71	38.45
	836.6	4183	V	14.39	5.1	-4.23	15.26	38.45
			H	19.14	5.1	-4.23	20.01	38.45
	846.6	4233	V	13.19	5.06	-4.26	13.99	38.45
			H	17.98	5.06	-4.26	18.78	38.45

**Remark: The RBW,VBW of SPA for frequency RBW=5 MHz, VBW=8 MHz**

Unless otherwise stated the results shown in this test report refer only to the sample(s) tested and such sample(s) are retained for 90 days only.

除非另有說明，此報告結果僅對測試之樣品負責，同時此樣品僅保留90天。本報告未經本公司書面許可，不可部份複製。

This document is issued by the Company subject to its General Conditions of Service printed overleaf, available on request or accessible at [www.sgs.com/terms\\_and\\_conditions.htm](http://www.sgs.com/terms_and_conditions.htm) and, for electronic format documents, subject to Terms and Conditions for Electronic Documents at [www.sgs.com/terms\\_e-document.htm](http://www.sgs.com/terms_e-document.htm). Attention is drawn to the limitation of liability, indemnification and jurisdiction issues defined therein. Any holder of this document is advised that information contained hereon reflects the Company's findings at the time of its intervention only and within the limits of Client's instructions, if any. The Company's sole responsibility is to its Client and this document does not exonerate parties to a transaction from exercising all their rights and obligations under the transaction documents. This document cannot be reproduced except in full, without prior written approval of the Company. Any unauthorized alteration, forgery or falsification of the content or appearance of this document is unlawful and offenders may be prosecuted to the fullest extent of the law.

SGS Taiwan Ltd.

No.134,WuKungRoad,NewTaipeiIndustrialPark,WukuDistrict,NewTaipeiCity,Taiwan24803/新北市五股區新北產業園區五工路 134 號

台灣檢驗科技股份有限公司

t (886-2) 2299-3279

f (886-2) 2298-0488

www.tw.sgs.com

Member of SGS Group

EUT			Measurement					
Operation Band	Fundamental Frequency MHz	CH	Antenna Pol. V/H	S.G. Output dBm	Antenna Gain dBi	Cable Loss dB	EIRP dBm	Limit dBm
<b>BAND 2 BW: 1.4M QPSK RB: 1,0</b>	1850.7	18607	V	17.71	9.57	-8.42	18.86	33.01
			H	23.25	9.57	-8.42	24.4	33.01
	1880.0	18900	V	17.1	9.7	-8.53	18.27	33.01
			H	21.88	9.7	-8.53	23.05	33.01
	1909.3	19193	V	17.52	9.81	-8.63	18.7	33.01
			H	20.82	9.81	-8.63	22	33.01
<b>BAND 2 BW: 1.4M QPSK RB: 1,5</b>	1850.7	18607	V	18.03	9.58	-8.42	19.19	33.01
			H	18.41	9.58	-8.42	19.57	33.01
	1880.0	18900	V	17.11	9.70	-8.53	18.28	33.01
			H	21.83	9.70	-8.53	23.00	33.01
	1909.3	19193	V	17.03	9.82	-8.63	18.22	33.01
			H	20.70	9.82	-8.63	21.89	33.01
<b>BAND 2 BW: 1.4M 16QAM RB: 1,0</b>	1850.7	18607	V	19.97	9.57	-8.42	21.12	33.01
			H	20.48	9.57	-8.42	21.63	33.01
	1880.0	18900	V	18.09	9.70	-8.53	19.26	33.01
			H	22.61	9.70	-8.53	23.78	33.01
	1909.3	19193	V	18.08	9.81	-8.63	19.26	33.01
			H	21.48	9.81	-8.63	22.66	33.01
<b>BAND 2 BW: 1.4M 16QAM RB: 1,5</b>	1850.7	18607	V	19.61	9.57	-8.43	20.75	33.01
			H	22.88	9.57	-8.43	24.02	33.01
	1880.0	18900	V	18.23	9.70	-8.53	19.40	33.01
			H	22.74	9.70	-8.53	23.91	33.01
	1909.3	19193	V	17.79	9.82	-8.63	18.98	33.01
			H	21.31	9.82	-8.63	22.50	33.01

The RBW,VBW of SPA for frequency RBW= 8MHz , VBW= 8MHz

Unless otherwise stated the results shown in this test report refer only to the sample(s) tested and such sample(s) are retained for 90 days only.

除非另有說明，此報告結果僅對測試之樣品負責，同時此樣品僅保留90天。本報告未經本公司書面許可，不可部份複製。

This document is issued by the Company subject to its General Conditions of Service printed overleaf, available on request or accessible at [www.sgs.com/terms\\_and\\_conditions.htm](http://www.sgs.com/terms_and_conditions.htm) and, for electronic format documents, subject to Terms and Conditions for Electronic Documents at [www.sgs.com/terms\\_e-document.htm](http://www.sgs.com/terms_e-document.htm). Attention is drawn to the limitation of liability, indemnification and jurisdiction issues defined therein. Any holder of this document is advised that information contained hereon reflects the Company's findings at the time of its intervention only and within the limits of Client's instructions, if any. The Company's sole responsibility is to its Client and this document does not exonerate parties to a transaction from exercising all their rights and obligations under the transaction documents. This document cannot be reproduced except in full, without prior written approval of the Company. Any unauthorized alteration, forgery or falsification of the content or appearance of this document is unlawful and offenders may be prosecuted to the fullest extent of the law.

SGS Taiwan Ltd.

No.134,WuKungRoad,NewTaipeiIndustrialPark,WukuDistrict,NewTaipeiCity,Taiwan24803/新北市五股區新北產業園區五工路 134 號

台灣檢驗科技股份有限公司

t (886-2) 2299-3279

f (886-2) 2298-0488

www.tw.sgs.com

Member of SGS Group

EUT			Measurement					
Operation Band	Fundamental Frequency MHz	CH	Antenna Pol. V/H	S.G. Output dBm	Antenna Gain dBi	Cable Loss dB	EIRP dBm	Limit dBm
<b>BAND 2 BW: 1.4M 64QAM RB: 1,0</b>	1850.7	18607	V	18.65	9.57	-8.42	19.8	33.01
			H	23.72	9.57	-8.42	24.87	33.01
	1880.0	18900	V	18.09	-0.69	-8.52	8.88	33.01
			H	22.87	-0.69	-8.52	13.66	33.01
	1909.3	19193	V	18.15	9.82	-8.63	19.34	33.01
			H	21.6	9.82	-8.63	22.79	33.01
<b>BAND 2 BW: 1.4M 64QAM RB: 1,5</b>	1850.7	18607	V	18.58	9.58	-8.43	19.73	33.01
			H	23.67	9.58	-8.43	24.82	33.01
	1880.0	18900	V	18.12	9.7	-8.53	19.29	33.01
			H	22.81	9.7	-8.53	23.98	33.01
	1909.3	19193	V	19.08	9.82	-8.63	20.27	33.01
			H	22.7	9.82	-8.63	23.89	33.01

The RBW,VBW of SPA for frequency RBW= 8MHz , VBW= 8MHz

Unless otherwise stated the results shown in this test report refer only to the sample(s) tested and such sample(s) are retained for 90 days only.

除非另有說明，此報告結果僅對測試之樣品負責，同時此樣品僅保留90天。本報告未經本公司書面許可，不可部份複製。

This document is issued by the Company subject to its General Conditions of Service printed overleaf, available on request or accessible at [www.sgs.com/terms\\_and\\_conditions.htm](http://www.sgs.com/terms_and_conditions.htm) and, for electronic format documents, subject to Terms and Conditions for Electronic Documents at [www.sgs.com/terms\\_e-document.htm](http://www.sgs.com/terms_e-document.htm). Attention is drawn to the limitation of liability, indemnification and jurisdiction issues defined therein. Any holder of this document is advised that information contained hereon reflects the Company's findings at the time of its intervention only and within the limits of Client's instructions, if any. The Company's sole responsibility is to its Client and this document does not exonerate parties to a transaction from exercising all their rights and obligations under the transaction documents. This document cannot be reproduced except in full, without prior written approval of the Company. Any unauthorized alteration, forgery or falsification of the content or appearance of this document is unlawful and offenders may be prosecuted to the fullest extent of the law.

SGS Taiwan Ltd.

No.134,WuKungRoad,NewTaipeiIndustrialPark,WukuDistrict,NewTaipeiCity,Taiwan24803/新北市五股區新北產業園區五工路 134 號

台灣檢驗科技股份有限公司

t (886-2) 2299-3279

f (886-2) 2298-0488

www.tw.sgs.com

Member of SGS Group

EUT			Measurement					
Operation Band	Fundamental Frequency MHz	CH	Antenna Pol. V/H	S.G. Output dBm	Antenna Gain dBi	Cable Loss dB	EIRP dBm	Limit dBm
<b>BAND 2 BW: 3M QPSK RB: 1,0</b>	1851.5	18615	V	18.79	9.58	-8.43	19.94	33.01
			H	22.87	9.58	-8.43	24.02	33.01
	1880.0	18900	V	19.10	9.69	-8.52	20.27	33.01
			H	22.95	9.69	-8.52	<b>24.12</b>	33.01
	1908.5	19185	V	20.16	9.81	-8.62	21.35	33.01
			H	21.51	9.81	-8.62	22.70	33.01
<b>BAND 2 BW: 3M QPSK RB: 1,14</b>	1851.5	18615	V	18.57	9.59	-8.43	19.73	33.01
			H	22.82	9.59	-8.43	23.98	33.01
	1880.0	18900	V	19.55	9.70	-8.53	20.72	33.01
			H	22.99	9.70	-8.53	<b>24.16</b>	33.01
	1908.5	19185	V	19.34	9.82	-8.63	20.53	33.01
			H	21.21	9.82	-8.63	22.40	33.01
<b>BAND 2 BW: 3M 16QAM RB: 1,0</b>	1851.5	18615	V	18.81	9.58	-8.43	19.96	33.01
			H	22.88	9.58	-8.43	24.03	33.01
	1880.0	18900	V	19.27	9.69	-8.52	20.44	33.01
			H	23.05	9.69	-8.52	<b>24.22</b>	33.01
	1908.5	19185	V	20.23	9.81	-8.62	21.42	33.01
			H	21.52	9.81	-8.62	22.71	33.01
<b>BAND 2 BW: 3M 16QAM RB: 1,14</b>	1851.5	18615	V	18.74	9.58	-8.43	19.89	33.01
			H	22.93	9.58	-8.43	24.08	33.01
	1880.0	18900	V	19.69	9.69	-8.52	20.86	33.01
			H	22.97	9.69	-8.52	<b>24.14</b>	33.01
	1908.5	19185	V	20.14	9.81	-8.63	21.32	33.01
			H	21.57	9.81	-8.63	22.75	33.01

The RBW,VBW of SPA for frequency RBW= 8MHz , VBW= 8MHz

Unless otherwise stated the results shown in this test report refer only to the sample(s) tested and such sample(s) are retained for 90 days only.

除非另有說明，此報告結果僅對測試之樣品負責，同時此樣品僅保留90天。本報告未經本公司書面許可，不可部份複製。

This document is issued by the Company subject to its General Conditions of Service printed overleaf, available on request or accessible at [www.sgs.com/terms\\_and\\_conditions.htm](http://www.sgs.com/terms_and_conditions.htm) and, for electronic format documents, subject to Terms and Conditions for Electronic Documents at [www.sgs.com/terms\\_e-document.htm](http://www.sgs.com/terms_e-document.htm). Attention is drawn to the limitation of liability, indemnification and jurisdiction issues defined therein. Any holder of this document is advised that information contained hereon reflects the Company's findings at the time of its intervention only and within the limits of Client's instructions, if any. The Company's sole responsibility is to its Client and this document does not exonerate parties to a transaction from exercising all their rights and obligations under the transaction documents. This document cannot be reproduced except in full, without prior written approval of the Company. Any unauthorized alteration, forgery or falsification of the content or appearance of this document is unlawful and offenders may be prosecuted to the fullest extent of the law.

SGS Taiwan Ltd.

No.134,WuKungRoad,NewTaipeiIndustrialPark,WukuDistrict,NewTaipeiCity,Taiwan24803/新北市五股區新北產業園區五工路 134 號

台灣檢驗科技股份有限公司

t (886-2) 2299-3279

f (886-2) 2298-0488

www.tw.sgs.com

Member of SGS Group



EUT			Measurement					
Operation Band	Fundamental Frequency MHz	CH	Antenna Pol. V/H	S.G. Output dBm	Antenna Gain dBi	Cable Loss dB	EIRP dBm	Limit dBm
<b>BAND 2 BW: 3M 64QAM RB: 1,0</b>	1851.5	18615	V	18.64	9.58	-8.42	19.8	33.01
			H	22.86	9.58	-8.42	24.02	33.01
	1880.0	18900	V	19.17	9.69	-8.53	20.33	33.01
			H	23.15	9.69	-8.53	24.31	33.01
	1908.5	19185	V	20.24	9.81	-8.62	<b>21.43</b>	33.01
			H	21.61	9.81	-8.62	22.8	33.01
<b>BAND 2 BW: 3M 64QAM RB: 1,14</b>	1851.5	18615	V	18.7	9.59	-8.44	19.85	33.01
			H	22.74	9.59	-8.44	23.89	33.01
	1880.0	18900	V	19.78	9.7	-8.53	20.95	33.01
			H	23.2	9.7	-8.53	<b>24.37</b>	33.01
	1908.5	19185	V	19.49	9.82	-8.63	20.68	33.01
			H	21.5	9.82	-8.63	22.69	33.01

The RBW,VBW of SPA for frequency RBW= 8MHz , VBW= 8MHz

Unless otherwise stated the results shown in this test report refer only to the sample(s) tested and such sample(s) are retained for 90 days only.

除非另有說明，此報告結果僅對測試之樣品負責，同時此樣品僅保留90天。本報告未經本公司書面許可，不可部份複製。

This document is issued by the Company subject to its General Conditions of Service printed overleaf, available on request or accessible at [www.sgs.com/terms\\_and\\_conditions.htm](http://www.sgs.com/terms_and_conditions.htm) and, for electronic format documents, subject to Terms and Conditions for Electronic Documents at [www.sgs.com/terms\\_e-document.htm](http://www.sgs.com/terms_e-document.htm). Attention is drawn to the limitation of liability, indemnification and jurisdiction issues defined therein. Any holder of this document is advised that information contained hereon reflects the Company's findings at the time of its intervention only and within the limits of Client's instructions, if any. The Company's sole responsibility is to its Client and this document does not exonerate parties to a transaction from exercising all their rights and obligations under the transaction documents. This document cannot be reproduced except in full, without prior written approval of the Company. Any unauthorized alteration, forgery or falsification of the content or appearance of this document is unlawful and offenders may be prosecuted to the fullest extent of the law.

SGS Taiwan Ltd.

No.134,WuKungRoad,NewTaipeiIndustrialPark,WukuDistrict,NewTaipeiCity,Taiwan24803/新北市五股區新北產業園區五工路 134 號

台灣檢驗科技股份有限公司

t (886-2) 2299-3279

f (886-2) 2298-0488

www.tw.sgs.com

Member of SGS Group

EUT			Measurement					
Operation Band	Fundamental Frequency MHz	CH	Antenna Pol. V/H	S.G. Output dBm	Antenna Gain dBi	Cable Loss dB	EIRP dBm	Limit dBm
<b>BAND 2 BW: 5M QPSK RB: 1,0</b>	1852.5	18625	V	18.69	9.57	-8.42	19.84	33.01
			H	22.82	9.57	-8.42	23.97	33.01
	1880.0	18900	V	19.14	9.69	-8.52	20.31	33.01
			H	23.33	9.69	-8.52	<b>24.50</b>	33.01
	1907.5	19175	V	20.23	9.80	-8.62	21.41	33.01
			H	21.56	9.80	-8.62	22.74	33.01
<b>BAND 2 BW: 5M QPSK RB: 1,24</b>	1852.5	18625	V	18.47	9.59	-8.44	19.62	33.01
			H	22.74	9.59	-8.44	23.89	33.01
	1880.0	18900	V	19.89	9.71	-8.53	21.07	33.01
			H	23.10	9.71	-8.53	<b>24.28</b>	33.01
	1907.5	19175	V	19.05	9.82	-8.63	20.24	33.01
			H	21.14	9.82	-8.63	22.33	33.01
<b>BAND 2 BW: 5M 16QAM RB: 1,0</b>	1852.5	18625	V	18.69	9.57	-8.42	19.84	33.01
			H	22.93	9.57	-8.42	24.08	33.01
	1880.0	18900	V	19.25	9.69	-8.52	20.42	33.01
			H	23.15	9.69	-8.52	<b>24.32</b>	33.01
	1907.5	19175	V	20.43	9.80	-8.62	21.61	33.01
			H	21.62	9.80	-8.62	22.80	33.01
<b>BAND 2 BW: 5M 16QAM RB: 1,24</b>	1852.5	18625	V	18.49	9.58	-8.44	19.63	33.01
			H	22.79	9.58	-8.44	23.93	33.01
	1880.0	18900	V	19.84	9.71	-8.54	21.01	33.01
			H	23.05	9.71	-8.54	<b>24.22</b>	33.01
	1907.5	19175	V	19.19	9.82	-8.63	20.38	33.01
			H	21.26	9.82	-8.63	22.45	33.01

The RBW,VBW of SPA for frequency RBW= 8MHz , VBW= 8MHz

Unless otherwise stated the results shown in this test report refer only to the sample(s) tested and such sample(s) are retained for 90 days only.

除非另有說明，此報告結果僅對測試之樣品負責，同時此樣品僅保留90天。本報告未經本公司書面許可，不可部份複製。

This document is issued by the Company subject to its General Conditions of Service printed overleaf, available on request or accessible at [www.sgs.com/terms\\_and\\_conditions.htm](http://www.sgs.com/terms_and_conditions.htm) and, for electronic format documents, subject to Terms and Conditions for Electronic Documents at [www.sgs.com/terms\\_e-document.htm](http://www.sgs.com/terms_e-document.htm). Attention is drawn to the limitation of liability, indemnification and jurisdiction issues defined therein. Any holder of this document is advised that information contained hereon reflects the Company's findings at the time of its intervention only and within the limits of Client's instructions, if any. The Company's sole responsibility is to its Client and this document does not exonerate parties to a transaction from exercising all their rights and obligations under the transaction documents. This document cannot be reproduced except in full, without prior written approval of the Company. Any unauthorized alteration, forgery or falsification of the content or appearance of this document is unlawful and offenders may be prosecuted to the fullest extent of the law.

SGS Taiwan Ltd.

No.134,WuKungRoad,NewTaipeiIndustrialPark,WukuDistrict,NewTaipeiCity,Taiwan24803/新北市五股區新北產業園區五工路 134 號

台灣檢驗科技股份有限公司

t (886-2) 2299-3279

f (886-2) 2298-0488

www.tw.sgs.com

Member of SGS Group

EUT			Measurement					
Operation Band	Fundamental Frequency MHz	CH	Antenna Pol. V/H	S.G. Output dBm	Antenna Gain dBi	Cable Loss dB	EIRP dBm	Limit dBm
<b>BAND 2 BW: 5M 64QAM RB: 1,0</b>	1852.5	18625	V	18.80	9.57	-8.42	19.95	33.01
			H	22.89	9.57	-8.42	24.04	33.01
	1880.0	18900	V	19.12	9.69	-8.52	20.29	33.01
			H	23.22	9.69	-8.52	24.39	33.01
	1907.5	19175	V	20.45	9.80	-8.62	21.63	33.01
			H	21.70	9.80	-8.62	22.88	33.01
<b>BAND 2 BW: 5M 64QAM RB: 1,24</b>	1852.5	18625	V	18.57	9.59	-8.44	19.72	33.01
			H	23.35	9.59	-8.44	24.50	33.01
	1880.0	18900	V	19.87	9.71	-8.53	21.05	33.01
			H	23.28	9.71	-8.53	24.46	33.01
	1907.5	19175	V	19.27	9.82	-8.64	20.45	33.01
			H	21.28	9.82	-8.64	22.46	33.01

The RBW,VBW of SPA for frequency RBW= 8MHz , VBW= 8MHz

Unless otherwise stated the results shown in this test report refer only to the sample(s) tested and such sample(s) are retained for 90 days only.

除非另有說明，此報告結果僅對測試之樣品負責，同時此樣品僅保留90天。本報告未經本公司書面許可，不可部份複製。

This document is issued by the Company subject to its General Conditions of Service printed overleaf, available on request or accessible at [www.sgs.com/terms\\_and\\_conditions.htm](http://www.sgs.com/terms_and_conditions.htm) and, for electronic format documents, subject to Terms and Conditions for Electronic Documents at [www.sgs.com/terms\\_e-document.htm](http://www.sgs.com/terms_e-document.htm). Attention is drawn to the limitation of liability, indemnification and jurisdiction issues defined therein. Any holder of this document is advised that information contained hereon reflects the Company's findings at the time of its intervention only and within the limits of Client's instructions, if any. The Company's sole responsibility is to its Client and this document does not exonerate parties to a transaction from exercising all their rights and obligations under the transaction documents. This document cannot be reproduced except in full, without prior written approval of the Company. Any unauthorized alteration, forgery or falsification of the content or appearance of this document is unlawful and offenders may be prosecuted to the fullest extent of the law.

SGS Taiwan Ltd.

No.134,WuKungRoad,NewTaipeiIndustrialPark,WukuDistrict,NewTaipeiCity,Taiwan24803/新北市五股區新北產業園區五工路 134 號

台灣檢驗科技股份有限公司

t (886-2) 2299-3279

f (886-2) 2298-0488

www.tw.sgs.com

Member of SGS Group

EUT			Measurement					
Operation Band	Fundamental Frequency MHz	CH	Antenna Pol. V/H	S.G. Output dBm	Antenna Gain dBi	Cable Loss dB	EIRP dBm	Limit dBm
<b>BAND 2 BW: 10M QPSK RB: 1,0</b>	1855.0	18650	V	19.87	9.57	-8.42	21.02	33.01
			H	22.57	9.57	-8.42	<b>23.72</b>	33.01
	1880.0	18900	V	19.77	9.68	-8.51	20.94	33.01
			H	22.32	9.68	-8.51	23.49	33.01
	1905.0	19150	V	20.59	9.79	-8.60	21.78	33.01
			H	21.90	9.79	-8.60	23.09	33.01
<b>BAND 2 BW: 10M QPSK RB: 1,49</b>	1855.0	18650	V	19.79	9.61	-8.46	20.94	33.01
			H	21.91	9.61	-8.46	23.06	33.01
	1880.0	18900	V	20.89	9.72	-8.54	22.07	33.01
			H	22.10	9.72	-8.54	<b>23.28</b>	33.01
	1905.0	19150	V	20.14	9.82	-8.63	21.33	33.01
			H	19.62	9.82	-8.63	20.81	33.01
<b>BAND 2 BW: 10M 16QAM RB: 1,0</b>	1855.0	18650	V	19.94	9.57	-8.42	21.09	33.01
			H	22.25	9.57	-8.42	<b>23.40</b>	33.01
	1880.0	18900	V	19.89	9.68	-8.51	21.06	33.01
			H	22.20	9.68	-8.51	23.37	33.01
	1905.0	19150	V	20.63	9.78	-8.60	21.81	33.01
			H	21.62	9.78	-8.60	22.80	33.01
<b>BAND 2 BW: 10M 16QAM RB: 1,49</b>	1855.0	18650	V	19.55	9.61	-8.46	20.70	33.01
			H	21.95	9.61	-8.46	23.10	33.01
	1880.0	18900	V	20.94	9.71	-8.54	22.11	33.01
			H	21.97	9.71	-8.54	<b>23.14</b>	33.01
	1905.0	19150	V	19.73	9.82	-8.63	20.92	33.01
			H	20.17	9.82	-8.63	21.36	33.01

The RBW,VBW of SPA for frequency RBW= 8MHz , VBW= 8MHz

Unless otherwise stated the results shown in this test report refer only to the sample(s) tested and such sample(s) are retained for 90 days only.

除非另有說明，此報告結果僅對測試之樣品負責，同時此樣品僅保留90天。本報告未經本公司書面許可，不可部份複製。

This document is issued by the Company subject to its General Conditions of Service printed overleaf, available on request or accessible at [www.sgs.com/terms\\_and\\_conditions.htm](http://www.sgs.com/terms_and_conditions.htm) and, for electronic format documents, subject to Terms and Conditions for Electronic Documents at [www.sgs.com/terms\\_e-document.htm](http://www.sgs.com/terms_e-document.htm). Attention is drawn to the limitation of liability, indemnification and jurisdiction issues defined therein. Any holder of this document is advised that information contained hereon reflects the Company's findings at the time of its intervention only and within the limits of Client's instructions, if any. The Company's sole responsibility is to its Client and this document does not exonerate parties to a transaction from exercising all their rights and obligations under the transaction documents. This document cannot be reproduced except in full, without prior written approval of the Company. Any unauthorized alteration, forgery or falsification of the content or appearance of this document is unlawful and offenders may be prosecuted to the fullest extent of the law.

SGS Taiwan Ltd.

No.134,WuKungRoad,NewTaipeiIndustrialPark,WukuDistrict,NewTaipeiCity,Taiwan24803/新北市五股區新北產業園區五工路 134 號

台灣檢驗科技股份有限公司

t (886-2) 2299-3279

f (886-2) 2298-0488

www.tw.sgs.com

Member of SGS Group

EUT			Measurement					
Operation Band	Fundamental Frequency MHz	CH	Antenna Pol. V/H	S.G. Output dBm	Antenna Gain dBi	Cable Loss dB	EIRP dBm	Limit dBm
<b>BAND 2 BW: 10M 64QAM RB: 1,0</b>	1855.0	18650	V	19.92	9.57	-8.42	21.07	33.01
			H	22.25	9.57	-8.42	<b>23.40</b>	33.01
	1880.0	18900	V	19.79	9.68	-8.51	20.96	33.01
			H	22.23	9.68	-8.51	<b>23.40</b>	33.01
	1905.0	19150	V	20.68	9.79	-8.60	21.87	33.01
			H	21.75	9.79	-8.60	22.94	33.01
<b>BAND 2 BW: 10M 64QAM RB: 1,49</b>	1855.0	18650	V	19.62	9.61	-8.45	20.78	33.01
			H	22.04	9.61	-8.45	23.20	33.01
	1880.0	18900	V	20.98	9.72	-8.55	22.15	33.01
			H	22.20	9.72	-8.55	<b>23.37</b>	33.01
	1905.0	19150	V	19.78	9.82	-8.63	20.97	33.01
			H	20.37	9.82	-8.63	21.56	33.01

The RBW,VBW of SPA for frequency RBW= 8MHz , VBW= 8MHz

Unless otherwise stated the results shown in this test report refer only to the sample(s) tested and such sample(s) are retained for 90 days only.

除非另有說明，此報告結果僅對測試之樣品負責，同時此樣品僅保留90天。本報告未經本公司書面許可，不可部份複製。

This document is issued by the Company subject to its General Conditions of Service printed overleaf, available on request or accessible at [www.sgs.com/terms\\_and\\_conditions.htm](http://www.sgs.com/terms_and_conditions.htm) and, for electronic format documents, subject to Terms and Conditions for Electronic Documents at [www.sgs.com/terms\\_e-document.htm](http://www.sgs.com/terms_e-document.htm). Attention is drawn to the limitation of liability, indemnification and jurisdiction issues defined therein. Any holder of this document is advised that information contained hereon reflects the Company's findings at the time of its intervention only and within the limits of Client's instructions, if any. The Company's sole responsibility is to its Client and this document does not exonerate parties to a transaction from exercising all their rights and obligations under the transaction documents. This document cannot be reproduced except in full, without prior written approval of the Company. Any unauthorized alteration, forgery or falsification of the content or appearance of this document is unlawful and offenders may be prosecuted to the fullest extent of the law.

SGS Taiwan Ltd.

No.134,WuKungRoad,NewTaipeiIndustrialPark,WukuDistrict,NewTaipeiCity,Taiwan24803/新北市五股區新北產業園區五工路 134 號

台灣檢驗科技股份有限公司

t (886-2) 2299-3279

f (886-2) 2298-0488

www.tw.sgs.com

Member of SGS Group

EUT			Measurement					
Operation Band	Fundamental Frequency MHz	CH	Antenna Pol. V/H	S.G. Output dBm	Antenna Gain dBi	Cable Loss dB	EIRP dBm	Limit dBm
<b>BAND 2 BW: 15M QPSK RB: 1,0</b>	1857.5	18675	V	19.84	9.57	-8.42	20.99	33.01
			H	25.06	9.57	-8.42	<b>26.21</b>	33.01
	1880.0	18900	V	19.66	9.67	-8.50	20.83	33.01
			H	24.25	9.67	-8.50	25.42	33.01
	1902.5	19125	V	21.96	9.76	-8.58	23.14	33.01
			H	23.70	9.76	-8.58	24.88	33.01
<b>BAND 2 BW: 15M QPSK RB: 1,74</b>	1857.5	18675	V	19.95	9.63	-8.47	21.11	33.01
			H	24.25	9.63	-8.47	25.41	33.01
	1880.0	18900	V	21.33	9.73	-8.55	22.51	33.01
			H	24.33	9.73	-8.55	<b>25.51</b>	33.01
	1902.5	19125	V	20.12	9.82	-8.63	21.31	33.01
			H	22.48	9.82	-8.63	23.67	33.01
<b>BAND 2 BW: 15M 16QAM RB: 1,0</b>	1857.5	18675	V	19.86	9.57	-8.42	21.01	33.01
			H	23.70	9.57	-8.42	24.85	33.01
	1880.0	18900	V	19.41	9.67	-8.50	20.58	33.01
			H	24.37	9.67	-8.50	<b>25.54</b>	33.01
	1902.5	19125	V	22.06	9.76	-8.59	23.23	33.01
			H	23.77	9.76	-8.59	24.94	33.01
<b>BAND 2 BW: 15M 16QAM RB: 1,74</b>	1857.5	18675	V	19.94	9.63	-8.48	21.09	33.01
			H	23.21	9.63	-8.48	24.36	33.01
	1880.0	18900	V	21.28	9.72	-8.55	22.45	33.01
			H	24.29	9.72	-8.55	<b>25.46</b>	33.01
	1902.5	19125	V	20.28	9.82	-8.63	21.47	33.01
			H	22.63	9.82	-8.63	23.82	33.01

The RBW,VBW of SPA for frequency RBW= 8MHz , VBW= 8MHz

Unless otherwise stated the results shown in this test report refer only to the sample(s) tested and such sample(s) are retained for 90 days only.

除非另有說明，此報告結果僅對測試之樣品負責，同時此樣品僅保留90天。本報告未經本公司書面許可，不可部份複製。

This document is issued by the Company subject to its General Conditions of Service printed overleaf, available on request or accessible at [www.sgs.com/terms\\_and\\_conditions.htm](http://www.sgs.com/terms_and_conditions.htm) and, for electronic format documents, subject to Terms and Conditions for Electronic Documents at [www.sgs.com/terms\\_e-document.htm](http://www.sgs.com/terms_e-document.htm). Attention is drawn to the limitation of liability, indemnification and jurisdiction issues defined therein. Any holder of this document is advised that information contained hereon reflects the Company's findings at the time of its intervention only and within the limits of Client's instructions, if any. The Company's sole responsibility is to its Client and this document does not exonerate parties to a transaction from exercising all their rights and obligations under the transaction documents. This document cannot be reproduced except in full, without prior written approval of the Company. Any unauthorized alteration, forgery or falsification of the content or appearance of this document is unlawful and offenders may be prosecuted to the fullest extent of the law.

SGS Taiwan Ltd.

No.134,WuKungRoad,NewTaipeiIndustrialPark,WukuDistrict,NewTaipeiCity,Taiwan24803/新北市五股區新北產業園區五工路 134 號

台灣檢驗科技股份有限公司

t (886-2) 2299-3279

f (886-2) 2298-0488

www.tw.sgs.com

Member of SGS Group

EUT			Measurement					
Operation Band	Fundamental Frequency MHz	CH	Antenna Pol. V/H	S.G. Output dBm	Antenna Gain dBi	Cable Loss dB	EIRP dBm	Limit dBm
<b>BAND 2 BW: 15M 64QAM RB: 1,0</b>	1857.5	18675	V	20.05	9.57	-8.42	21.20	33.01
			H	23.77	9.57	-8.42	24.92	33.01
	1880.0	18900	V	19.16	9.67	-8.51	20.32	33.01
			H	24.33	9.67	-8.51	<b>25.49</b>	33.01
	1902.5	19125	V	22.07	9.76	-8.59	23.24	33.01
			H	23.87	9.76	-8.59	25.04	33.01
<b>BAND 2 BW: 15M 64QAM RB: 1,74</b>	1857.5	18675	V	18.96	9.63	-8.47	20.12	33.01
			H	23.58	9.63	-8.47	24.74	33.01
	1880.0	18900	V	21.34	9.72	-8.55	22.51	33.01
			H	24.42	9.72	-8.55	<b>25.59</b>	33.01
	1902.5	19125	V	20.40	9.82	-8.63	21.59	33.01
			H	23.80	9.82	-8.63	24.99	33.01

The RBW,VBW of SPA for frequency RBW= 8MHz , VBW= 8MHz

Unless otherwise stated the results shown in this test report refer only to the sample(s) tested and such sample(s) are retained for 90 days only.

除非另有說明，此報告結果僅對測試之樣品負責，同時此樣品僅保留90天。本報告未經本公司書面許可，不可部份複製。

This document is issued by the Company subject to its General Conditions of Service printed overleaf, available on request or accessible at [www.sgs.com/terms\\_and\\_conditions.htm](http://www.sgs.com/terms_and_conditions.htm) and, for electronic format documents, subject to Terms and Conditions for Electronic Documents at [www.sgs.com/terms\\_e-document.htm](http://www.sgs.com/terms_e-document.htm). Attention is drawn to the limitation of liability, indemnification and jurisdiction issues defined therein. Any holder of this document is advised that information contained hereon reflects the Company's findings at the time of its intervention only and within the limits of Client's instructions, if any. The Company's sole responsibility is to its Client and this document does not exonerate parties to a transaction from exercising all their rights and obligations under the transaction documents. This document cannot be reproduced except in full, without prior written approval of the Company. Any unauthorized alteration, forgery or falsification of the content or appearance of this document is unlawful and offenders may be prosecuted to the fullest extent of the law.

SGS Taiwan Ltd.

No.134,WuKungRoad,NewTaipeiIndustrialPark,WukuDistrict,NewTaipeiCity,Taiwan24803/新北市五股區新北產業園區五工路 134 號

台灣檢驗科技股份有限公司

t (886-2) 2299-3279

f (886-2) 2298-0488

www.tw.sgs.com

Member of SGS Group

EUT			Measurement					
Operation Band	Fundamental Frequency MHz	CH	Antenna Pol. V/H	S.G. Output dBm	Antenna Gain dBi	Cable Loss dB	EIRP dBm	Limit dBm
<b>BAND 2 BW: 20M QPSK RB: 1,0</b>	1860.0	18700	V	20.20	9.58	-8.43	21.35	33.01
			H	24.90	9.58	-8.43	<b>26.05</b>	33.01
	1880.0	18900	V	19.06	9.66	-8.50	20.22	33.01
			H	24.34	9.66	-8.50	25.50	33.01
	1900.0	19100	V	21.75	9.74	-8.57	22.92	33.01
			H	24.25	9.74	-8.57	25.42	33.01
<b>BAND 2 BW: 20M QPSK RB: 1,99</b>	1860.0	18700	V	18.81	9.65	-8.49	19.97	33.01
			H	24.13	9.65	-8.49	25.29	33.01
	1880.0	18900	V	21.55	9.74	-8.56	22.73	33.01
			H	24.12	9.74	-8.56	<b>25.30</b>	33.01
	1900.0	19100	V	20.37	9.82	-8.63	21.56	33.01
			H	22.50	9.82	-8.63	23.69	33.01
<b>BAND 2 BW: 20M 16QAM RB: 1,0</b>	1860.0	18700	V	19.38	9.58	-8.42	20.54	33.01
			H	23.76	9.58	-8.42	24.92	33.01
	1880.0	18900	V	18.91	9.66	-8.50	20.07	33.01
			H	24.30	9.66	-8.50	25.46	33.01
	1900.0	19100	V	21.73	9.74	-8.57	22.90	33.01
			H	24.69	9.74	-8.57	<b>25.86</b>	33.01
<b>BAND 2 BW: 20M 16QAM RB: 1,99</b>	1860.0	18700	V	18.67	9.65	-8.49	19.83	33.01
			H	24.15	9.65	-8.49	25.31	33.01
	1880.0	18900	V	21.62	9.74	-8.56	22.80	33.01
			H	24.14	9.74	-8.56	<b>25.32</b>	33.01
	1900.0	19100	V	20.24	9.82	-8.63	21.43	33.01
			H	22.62	9.82	-8.63	23.81	33.01

The RBW,VBW of SPA for frequency RBW= 8MHz , VBW= 8MHz

Unless otherwise stated the results shown in this test report refer only to the sample(s) tested and such sample(s) are retained for 90 days only.

除非另有說明，此報告結果僅對測試之樣品負責，同時此樣品僅保留90天。本報告未經本公司書面許可，不可部份複製。

This document is issued by the Company subject to its General Conditions of Service printed overleaf, available on request or accessible at [www.sgs.com/terms\\_and\\_conditions.htm](http://www.sgs.com/terms_and_conditions.htm) and, for electronic format documents, subject to Terms and Conditions for Electronic Documents at [www.sgs.com/terms\\_e-document.htm](http://www.sgs.com/terms_e-document.htm). Attention is drawn to the limitation of liability, indemnification and jurisdiction issues defined therein. Any holder of this document is advised that information contained hereon reflects the Company's findings at the time of its intervention only and within the limits of Client's instructions, if any. The Company's sole responsibility is to its Client and this document does not exonerate parties to a transaction from exercising all their rights and obligations under the transaction documents. This document cannot be reproduced except in full, without prior written approval of the Company. Any unauthorized alteration, forgery or falsification of the content or appearance of this document is unlawful and offenders may be prosecuted to the fullest extent of the law.

SGS Taiwan Ltd.

No.134,WuKungRoad,NewTaipeiIndustrialPark,WukuDistrict,NewTaipeiCity,Taiwan24803/新北市五股區新北產業園區五工路 134 號

台灣檢驗科技股份有限公司

t (886-2) 2299-3279

f (886-2) 2298-0488

www.tw.sgs.com

Member of SGS Group



EUT			Measurement					
Operation Band	Fundamental Frequency MHz	CH	Antenna Pol. V/H	S.G. Output dBm	Antenna Gain dBi	Cable Loss dB	EIRP dBm	Limit dBm
<b>BAND 2 BW: 20M 64QAM RB: 1,0</b>	1860.0	18700	V	19.50	9.57	-8.42	20.65	33.01
			H	23.92	9.57	-8.42	25.07	33.01
	1880.0	18900	V	18.96	9.66	-8.50	20.12	33.01
			H	24.31	9.66	-8.50	25.47	33.01
	1900.0	19100	V	21.85	9.74	-8.57	23.02	33.01
			H	24.17	9.74	-8.57	25.34	33.01
<b>BAND 2 BW: 20M 64QAM RB: 1,99</b>	1860.0	18700	V	18.65	9.65	-8.49	19.81	33.01
			H	24.21	9.65	-8.49	25.37	33.01
	1880.0	18900	V	21.61	9.74	-8.56	22.79	33.01
			H	24.12	9.74	-8.56	25.30	33.01
	1900.0	19100	V	20.38	9.82	-8.63	21.57	33.01
			H	22.72	9.82	-8.63	23.91	33.01

The RBW,VBW of SPA for frequency RBW= 8MHz , VBW= 8MHz

Unless otherwise stated the results shown in this test report refer only to the sample(s) tested and such sample(s) are retained for 90 days only.

除非另有說明，此報告結果僅對測試之樣品負責，同時此樣品僅保留90天。本報告未經本公司書面許可，不可部份複製。

This document is issued by the Company subject to its General Conditions of Service printed overleaf, available on request or accessible at [www.sgs.com/terms\\_and\\_conditions.htm](http://www.sgs.com/terms_and_conditions.htm) and, for electronic format documents, subject to Terms and Conditions for Electronic Documents at [www.sgs.com/terms\\_e-document.htm](http://www.sgs.com/terms_e-document.htm). Attention is drawn to the limitation of liability, indemnification and jurisdiction issues defined therein. Any holder of this document is advised that information contained hereon reflects the Company's findings at the time of its intervention only and within the limits of Client's instructions, if any. The Company's sole responsibility is to its Client and this document does not exonerate parties to a transaction from exercising all their rights and obligations under the transaction documents. This document cannot be reproduced except in full, without prior written approval of the Company. Any unauthorized alteration, forgery or falsification of the content or appearance of this document is unlawful and offenders may be prosecuted to the fullest extent of the law.

SGS Taiwan Ltd.

No.134,WuKungRoad,NewTaipeiIndustrialPark,WukuDistrict,NewTaipeiCity,Taiwan24803/新北市五股區新北產業園區五工路 134 號

台灣檢驗科技股份有限公司

t (886-2) 2299-3279

f (886-2) 2298-0488

www.tw.sgs.com

Member of SGS Group

EUT			Measurement					
Operation Band	Fundamental Frequency MHz	CH	Antenna Pol. V/H	S.G. Output dBm	Antenna Gain dBi	Cable Loss dB	EIRP dBm	Limit dBm
<b>BAND 4 BW: 1.4M QPSK RB: 1,0</b>	1710.7	19957	V	14.79	8.98	-7.91	15.86	30.00
			H	24.25	8.98	-7.91	<b>25.32</b>	30.00
	1732.5	20175	V	11.08	9.07	-7.99	12.16	30.00
			H	22.58	9.07	-7.99	23.66	30.00
	1754.3	20393	V	14.91	9.17	-8.07	16.01	30.00
			H	22.10	9.17	-8.07	23.20	30.00
<b>BAND 4 BW: 1.4M QPSK RB: 1,5</b>	1710.7	19957	V	14.59	8.99	-7.91	15.67	30.00
			H	24.23	8.99	-7.91	<b>25.31</b>	30.00
	1732.5	20175	V	10.85	9.08	-7.99	11.94	30.00
			H	22.28	9.08	-7.99	23.37	30.00
	1754.3	20393	V	15.14	9.17	-8.07	16.24	30.00
			H	21.91	9.17	-8.07	23.01	30.00
<b>BAND 4 BW: 1.4M 16QAM RB: 1,0</b>	1710.7	19957	V	14.57	8.98	-7.91	15.64	30.00
			H	24.30	8.98	-7.91	25.37	30.00
	1732.5	20175	V	12.73	9.07	-7.99	13.81	30.00
			H	24.37	9.07	-7.99	<b>25.45</b>	30.00
	1754.3	20393	V	15.97	9.17	-8.07	17.07	30.00
			H	22.92	9.17	-8.07	24.02	30.00
<b>BAND 4 BW: 1.4M 16QAM RB: 1,5</b>	1710.7	19957	V	14.63	8.99	-7.91	15.71	30.00
			H	24.28	8.99	-7.91	<b>25.36</b>	30.00
	1732.5	20175	V	12.68	9.08	-7.99	13.77	30.00
			H	24.11	9.08	-7.99	25.20	30.00
	1754.3	20393	V	16.15	9.17	-8.07	17.25	30.00
			H	22.98	9.17	-8.07	24.08	30.00

The RBW,VBW of SPA for frequency RBW= 8MHz , VBW= 8MHz

Unless otherwise stated the results shown in this test report refer only to the sample(s) tested and such sample(s) are retained for 90 days only.

除非另有說明，此報告結果僅對測試之樣品負責，同時此樣品僅保留90天。本報告未經本公司書面許可，不可部份複製。

This document is issued by the Company subject to its General Conditions of Service printed overleaf, available on request or accessible at [www.sgs.com/terms\\_and\\_conditions.htm](http://www.sgs.com/terms_and_conditions.htm) and, for electronic format documents, subject to Terms and Conditions for Electronic Documents at [www.sgs.com/terms\\_e-document.htm](http://www.sgs.com/terms_e-document.htm). Attention is drawn to the limitation of liability, indemnification and jurisdiction issues defined therein. Any holder of this document is advised that information contained hereon reflects the Company's findings at the time of its intervention only and within the limits of Client's instructions, if any. The Company's sole responsibility is to its Client and this document does not exonerate parties to a transaction from exercising all their rights and obligations under the transaction documents. This document cannot be reproduced except in full, without prior written approval of the Company. Any unauthorized alteration, forgery or falsification of the content or appearance of this document is unlawful and offenders may be prosecuted to the fullest extent of the law.

SGS Taiwan Ltd.

No.134,WuKungRoad,NewTaipeiIndustrialPark,WukuDistrict,NewTaipeiCity,Taiwan24803/新北市五股區新北產業園區五工路 134 號

台灣檢驗科技股份有限公司

t (886-2) 2299-3279

f (886-2) 2298-0488

www.tw.sgs.com

Member of SGS Group

EUT			Measurement					
Operation Band	Fundamental Frequency MHz	CH	Antenna Pol. V/H	S.G. Output dBm	Antenna Gain dBi	Cable Loss dB	EIRP dBm	Limit dBm
<b>BAND 4 BW: 1.4M 64QAM RB: 1,0</b>	1710.7	19957	V	14.58	8.98	-7.91	15.65	30.00
			H	24.41	8.98	-7.91	25.48	30.00
	1732.5	20175	V	13.30	9.07	-7.99	14.38	30.00
			H	24.95	9.07	-7.99	<b>26.03</b>	30.00
	1754.3	20393	V	16.57	9.17	-8.07	17.67	30.00
			H	23.46	9.17	-8.07	24.56	30.00
<b>BAND 4 BW: 1.4M 64QAM RB: 1,5</b>	1710.7	19957	V	14.63	8.98	-7.91	15.7	30.00
			H	24.42	8.98	-7.91	25.49	30.00
	1732.5	20175	V	13.32	9.08	-7.99	14.41	30.00
			H	24.71	9.08	-7.99	<b>25.8</b>	30.00
	1754.3	20393	V	16.81	9.17	-8.07	17.91	30.00
			H	23.63	9.17	-8.07	24.73	30.00

The RBW,VBW of SPA for frequency RBW= 8MHz , VBW= 8MHz

Unless otherwise stated the results shown in this test report refer only to the sample(s) tested and such sample(s) are retained for 90 days only.

除非另有說明，此報告結果僅對測試之樣品負責，同時此樣品僅保留90天。本報告未經本公司書面許可，不可部份複製。

This document is issued by the Company subject to its General Conditions of Service printed overleaf, available on request or accessible at [www.sgs.com/terms\\_and\\_conditions.htm](http://www.sgs.com/terms_and_conditions.htm) and, for electronic format documents, subject to Terms and Conditions for Electronic Documents at [www.sgs.com/terms\\_e-document.htm](http://www.sgs.com/terms_e-document.htm). Attention is drawn to the limitation of liability, indemnification and jurisdiction issues defined therein. Any holder of this document is advised that information contained hereon reflects the Company's findings at the time of its intervention only and within the limits of Client's instructions, if any. The Company's sole responsibility is to its Client and this document does not exonerate parties to a transaction from exercising all their rights and obligations under the transaction documents. This document cannot be reproduced except in full, without prior written approval of the Company. Any unauthorized alteration, forgery or falsification of the content or appearance of this document is unlawful and offenders may be prosecuted to the fullest extent of the law.

SGS Taiwan Ltd.

No.134,WuKungRoad,NewTaipeiIndustrialPark,WukuDistrict,NewTaipeiCity,Taiwan24803/新北市五股區新北產業園區五工路 134 號

台灣檢驗科技股份有限公司

t (886-2) 2299-3279

f (886-2) 2298-0488

www.tw.sgs.com

Member of SGS Group

EUT			Measurement					
Operation Band	Fundamental Frequency MHz	CH	Antenna Pol. V/H	S.G. Output dBm	Antenna Gain dBi	Cable Loss dB	EIRP dBm	Limit dBm
<b>BAND 4 BW: 3M QPSK RB: 1,0</b>	1711.5	19965	V	11.21	8.98	-6.58	13.61	30.00
			H	23.24	8.98	-6.58	<b>25.64</b>	30.00
	1732.5	20175	V	5.13	9.07	-6.62	7.58	30.00
			H	21.25	9.07	-6.62	23.70	30.00
	1753.5	20385	V	10.20	9.16	-6.66	12.70	30.00
			H	20.75	9.16	-6.66	23.25	30.00
<b>BAND 4 BW: 3M QPSK RB: 1,14</b>	1711.5	19965	V	11.17	8.99	-6.59	13.57	30.00
			H	22.68	8.99	-6.59	<b>25.08</b>	30.00
	1732.5	20175	V	6.18	9.08	-6.63	8.63	30.00
			H	20.60	9.08	-6.63	23.05	30.00
	1753.5	20385	V	10.40	9.17	-6.67	12.90	30.00
			H	20.69	9.17	-6.67	23.19	30.00
<b>BAND 4 BW: 3M 16QAM RB: 1,0</b>	1711.5	19965	V	11.08	8.98	-6.58	13.48	30.00
			H	22.86	8.98	-6.58	<b>25.26</b>	30.00
	1732.5	20175	V	6.76	9.07	-6.62	9.21	30.00
			H	22.76	9.07	-6.62	25.21	30.00
	1753.5	20385	V	11.78	9.16	-6.66	14.28	30.00
			H	21.69	9.16	-6.66	24.19	30.00
<b>BAND 4 BW: 3M 16QAM RB: 1,14</b>	1711.5	19965	V	11.17	8.99	-6.58	13.58	30.00
			H	22.64	8.99	-6.58	<b>25.05</b>	30.00
	1732.5	20175	V	7.64	9.08	-6.63	10.09	30.00
			H	22.46	9.08	-6.63	24.91	30.00
	1753.5	20385	V	11.38	9.17	-6.67	13.88	30.00
			H	21.69	9.17	-6.67	24.19	30.00

The RBW,VBW of SPA for frequency RBW= 8MHz , VBW= 8MHz

Unless otherwise stated the results shown in this test report refer only to the sample(s) tested and such sample(s) are retained for 90 days only.

除非另有說明，此報告結果僅對測試之樣品負責，同時此樣品僅保留90天。本報告未經本公司書面許可，不可部份複製。

This document is issued by the Company subject to its General Conditions of Service printed overleaf, available on request or accessible at [www.sgs.com/terms\\_and\\_conditions.htm](http://www.sgs.com/terms_and_conditions.htm) and, for electronic format documents, subject to Terms and Conditions for Electronic Documents at [www.sgs.com/terms\\_e-document.htm](http://www.sgs.com/terms_e-document.htm). Attention is drawn to the limitation of liability, indemnification and jurisdiction issues defined therein. Any holder of this document is advised that information contained hereon reflects the Company's findings at the time of its intervention only and within the limits of Client's instructions, if any. The Company's sole responsibility is to its Client and this document does not exonerate parties to a transaction from exercising all their rights and obligations under the transaction documents. This document cannot be reproduced except in full, without prior written approval of the Company. Any unauthorized alteration, forgery or falsification of the content or appearance of this document is unlawful and offenders may be prosecuted to the fullest extent of the law.

SGS Taiwan Ltd.

No.134,WuKungRoad,NewTaipeiIndustrialPark,WukuDistrict,NewTaipeiCity,Taiwan24803/新北市五股區新北產業園區五工路 134 號

台灣檢驗科技股份有限公司

t (886-2) 2299-3279

f (886-2) 2298-0488

www.tw.sgs.com

Member of SGS Group

EUT			Measurement					
Operation Band	Fundamental Frequency MHz	CH	Antenna Pol. V/H	S.G. Output dBm	Antenna Gain dBi	Cable Loss dB	EIRP dBm	Limit dBm
<b>BAND 4 BW: 3M 64QAM RB: 1,0</b>	1711.5	19965	V	11.16	8.98	-6.58	13.56	30.00
			H	22.77	8.98	-6.58	25.17	30.00
	1732.5	20175	V	7.71	9.07	-6.62	10.16	30.00
			H	23.73	9.07	-6.62	26.18	30.00
	1753.5	20385	V	11.66	9.16	-6.66	14.16	30.00
			H	22.22	9.16	-6.66	24.72	30.00
<b>BAND 4 BW: 3M 64QAM RB: 1,14</b>	1711.5	19965	V	11.22	8.99	-6.58	13.63	30.00
			H	22.70	8.99	-6.58	25.11	30.00
	1732.5	20175	V	8.53	9.08	-6.63	10.98	30.00
			H	23.38	9.08	-6.63	25.83	30.00
	1753.5	20385	V	12.22	9.17	-6.67	14.72	30.00
			H	22.50	9.17	-6.67	25.00	30.00

The RBW,VBW of SPA for frequency RBW= 8MHz , VBW= 8MHz

Unless otherwise stated the results shown in this test report refer only to the sample(s) tested and such sample(s) are retained for 90 days only.

除非另有說明，此報告結果僅對測試之樣品負責，同時此樣品僅保留90天。本報告未經本公司書面許可，不可部份複製。

This document is issued by the Company subject to its General Conditions of Service printed overleaf, available on request or accessible at [www.sgs.com/terms\\_and\\_conditions.htm](http://www.sgs.com/terms_and_conditions.htm) and, for electronic format documents, subject to Terms and Conditions for Electronic Documents at [www.sgs.com/terms\\_e-document.htm](http://www.sgs.com/terms_e-document.htm). Attention is drawn to the limitation of liability, indemnification and jurisdiction issues defined therein. Any holder of this document is advised that information contained hereon reflects the Company's findings at the time of its intervention only and within the limits of Client's instructions, if any. The Company's sole responsibility is to its Client and this document does not exonerate parties to a transaction from exercising all their rights and obligations under the transaction documents. This document cannot be reproduced except in full, without prior written approval of the Company. Any unauthorized alteration, forgery or falsification of the content or appearance of this document is unlawful and offenders may be prosecuted to the fullest extent of the law.

SGS Taiwan Ltd.

No.134,WuKungRoad,NewTaipeiIndustrialPark,WukuDistrict,NewTaipeiCity,Taiwan24803/新北市五股區新北產業園區五工路 134 號

台灣檢驗科技股份有限公司

t (886-2) 2299-3279

f (886-2) 2298-0488

www.tw.sgs.com

Member of SGS Group

EUT			Measurement					
Operation Band	Fundamental Frequency MHz	CH	Antenna Pol. V/H	S.G. Output dBm	Antenna Gain dBi	Cable Loss dB	EIRP dBm	Limit dBm
<b>BAND 4 BW: 5M QPSK RB: 1,0</b>	1712.5	19975	V	9.80	8.98	-6.58	12.20	30.00
			H	21.44	8.98	-6.58	<b>23.84</b>	30.00
	1732.5	20175	V	5.10	9.07	-6.62	7.55	30.00
			H	21.33	9.07	-6.62	23.78	30.00
	1752.5	20375	V	9.94	9.15	-6.66	12.43	30.00
			H	20.88	9.15	-6.66	23.37	30.00
<b>BAND 4 BW: 5M QPSK RB: 1,24</b>	1712.5	19975	V	9.68	9.00	-6.59	12.09	30.00
			H	21.28	9.00	-6.59	<b>23.69</b>	30.00
	1732.5	20175	V	6.17	9.09	-6.63	8.63	30.00
			H	20.57	9.09	-6.63	23.03	30.00
	1752.5	20375	V	10.47	9.17	-6.67	12.97	30.00
			H	20.79	9.17	-6.67	23.29	30.00
<b>BAND 4 BW: 5M 16QAM RB: 1,0</b>	1712.5	19975	V	11.17	8.98	-6.58	13.57	30.00
			H	22.73	8.98	-6.58	25.13	30.00
	1732.5	20175	V	6.60	9.07	-6.62	9.05	30.00
			H	22.92	9.07	-6.62	<b>25.37</b>	30.00
	1752.5	20375	V	9.56	9.00	-6.59	11.97	30.00
			H	21.41	9.00	-6.59	23.82	30.00
<b>BAND 4 BW: 5M 16QAM RB: 1,24</b>	1712.5	19975	V	11.10	9.15	-6.66	13.59	30.00
			H	21.82	9.15	-6.66	24.31	30.00
	1732.5	20175	V	11.55	0.00	0.00	11.55	30.00
			H	21.69	9.16	-6.67	24.18	30.00
	1752.5	20375	V	11.23	8.98	-6.58	13.63	30.00
			H	22.78	8.98	-6.58	<b>25.18</b>	30.00

The RBW,VBW of SPA for frequency RBW= 8MHz , VBW= 8MHz

Unless otherwise stated the results shown in this test report refer only to the sample(s) tested and such sample(s) are retained for 90 days only.

除非另有說明，此報告結果僅對測試之樣品負責，同時此樣品僅保留90天。本報告未經本公司書面許可，不可部份複製。

This document is issued by the Company subject to its General Conditions of Service printed overleaf, available on request or accessible at [www.sgs.com/terms\\_and\\_conditions.htm](http://www.sgs.com/terms_and_conditions.htm) and, for electronic format documents, subject to Terms and Conditions for Electronic Documents at [www.sgs.com/terms\\_e-document.htm](http://www.sgs.com/terms_e-document.htm). Attention is drawn to the limitation of liability, indemnification and jurisdiction issues defined therein. Any holder of this document is advised that information contained hereon reflects the Company's findings at the time of its intervention only and within the limits of Client's instructions, if any. The Company's sole responsibility is to its Client and this document does not exonerate parties to a transaction from exercising all their rights and obligations under the transaction documents. This document cannot be reproduced except in full, without prior written approval of the Company. Any unauthorized alteration, forgery or falsification of the content or appearance of this document is unlawful and offenders may be prosecuted to the fullest extent of the law.

SGS Taiwan Ltd.

No.134,WuKungRoad,NewTaipeiIndustrialPark,WukuDistrict,NewTaipeiCity,Taiwan24803/新北市五股區新北產業園區五工路 134 號

台灣檢驗科技股份有限公司

t (886-2) 2299-3279

f (886-2) 2298-0488

www.tw.sgs.com

Member of SGS Group

EUT			Measurement					
Operation Band	Fundamental Frequency MHz	CH	Antenna Pol. V/H	S.G. Output dBm	Antenna Gain dBi	Cable Loss dB	EIRP dBm	Limit dBm
<b>BAND 4 BW: 5M 64QAM RB: 1,0</b>	1712.5	19975	V	7.51	9.07	-6.62	9.96	30.00
			H	23.84	9.07	-6.62	<b>26.29</b>	30.00
	1732.5	20175	V	11.26	9.15	-6.66	13.75	30.00
			H	21.99	9.15	-6.66	24.48	30.00
	1752.5	20375	V	11.06	9.00	-6.59	13.47	30.00
			H	22.86	9.00	-6.59	25.27	30.00
<b>BAND 4 BW: 5M 64QAM RB: 1,24</b>	1712.5	19975	V	8.74	9.08	-6.66	11.16	30.00
			H	23.37	9.08	-6.66	<b>25.79</b>	30.00
	1732.5	20175	V	12.20	9.17	-6.67	14.70	30.00
			H	22.53	9.17	-6.67	25.03	30.00
	1752.5	20375	V	9.76	8.98	-6.58	12.16	30.00
			H	21.47	8.98	-6.58	23.87	30.00

The RBW,VBW of SPA for frequency RBW= 8MHz , VBW= 8MHz

Unless otherwise stated the results shown in this test report refer only to the sample(s) tested and such sample(s) are retained for 90 days only.

除非另有說明，此報告結果僅對測試之樣品負責，同時此樣品僅保留90天。本報告未經本公司書面許可，不可部份複製。

This document is issued by the Company subject to its General Conditions of Service printed overleaf, available on request or accessible at [www.sgs.com/terms\\_and\\_conditions.htm](http://www.sgs.com/terms_and_conditions.htm) and, for electronic format documents, subject to Terms and Conditions for Electronic Documents at [www.sgs.com/terms\\_e-document.htm](http://www.sgs.com/terms_e-document.htm). Attention is drawn to the limitation of liability, indemnification and jurisdiction issues defined therein. Any holder of this document is advised that information contained hereon reflects the Company's findings at the time of its intervention only and within the limits of Client's instructions, if any. The Company's sole responsibility is to its Client and this document does not exonerate parties to a transaction from exercising all their rights and obligations under the transaction documents. This document cannot be reproduced except in full, without prior written approval of the Company. Any unauthorized alteration, forgery or falsification of the content or appearance of this document is unlawful and offenders may be prosecuted to the fullest extent of the law.

SGS Taiwan Ltd.

No.134,WuKungRoad,NewTaipeiIndustrialPark,WukuDistrict,NewTaipeiCity,Taiwan24803/新北市五股區新北產業園區五工路 134 號

台灣檢驗科技股份有限公司

t (886-2) 2299-3279

f (886-2) 2298-0488

www.tw.sgs.com

Member of SGS Group

EUT			Measurement					
Operation Band	Fundamental Frequency MHz	CH	Antenna Pol. V/H	S.G. Output dBm	Antenna Gain dBi	Cable Loss dB	EIRP dBm	Limit dBm
<b>BAND 4 BW: 10M QPSK RB: 1,0</b>	1715.0	20000	V	9.76	8.99	-6.58	12.16	30.00
			H	21.47	8.98	-6.58	<b>23.87</b>	30.00
	1732.5	20175	V	5.14	9.06	-6.62	7.59	30.00
			H	21.14	9.06	-6.62	23.59	30.00
	1750.0	20350	V	9.28	9.13	-6.65	11.76	30.00
			H	21.10	9.13	-6.65	23.58	30.00
<b>BAND 4 BW: 10M QPSK RB: 1,49</b>	1715.0	20000	V	9.15	9.02	-6.60	11.57	30.00
			H	21.24	9.02	-6.60	<b>23.67</b>	30.00
	1732.5	20175	V	6.29	9.09	-6.63	8.75	30.00
			H	20.14	9.09	-6.63	22.60	30.00
	1750.0	20350	V	10.38	9.17	-6.67	12.88	30.00
			H	20.73	9.17	-6.67	23.23	30.00
<b>BAND 4 BW: 10M 16QAM RB: 1,0</b>	1715.0	20000	V	11.29	8.98	-6.58	13.69	30.00
			H	22.65	8.98	-6.58	25.06	30.00
	1732.5	20175	V	6.95	9.06	-6.62	9.39	30.00
			H	22.95	9.06	-6.62	<b>25.40</b>	30.00
	1750.0	20350	V	10.32	9.13	-6.65	12.80	30.00
			H	22.05	9.13	-6.65	24.53	30.00
<b>BAND 4 BW: 10M 16QAM RB: 1,49</b>	1715.0	20000	V	9.86	9.02	-6.60	12.28	30.00
			H	22.15	9.02	-6.60	24.58	30.00
	1732.5	20175	V	8.29	9.09	-6.63	10.75	30.00
			H	22.16	9.09	-6.63	<b>24.62</b>	30.00
	1750.0	20350	V	11.43	9.17	-6.67	13.93	30.00
			H	21.70	9.17	-6.67	24.20	30.00

The RBW,VBW of SPA for frequency RBW= 8MHz , VBW= 8MHz

Unless otherwise stated the results shown in this test report refer only to the sample(s) tested and such sample(s) are retained for 90 days only.

除非另有說明，此報告結果僅對測試之樣品負責，同時此樣品僅保留90天。本報告未經本公司書面許可，不可部份複製。

This document is issued by the Company subject to its General Conditions of Service printed overleaf, available on request or accessible at [www.sgs.com/terms\\_and\\_conditions.htm](http://www.sgs.com/terms_and_conditions.htm) and, for electronic format documents, subject to Terms and Conditions for Electronic Documents at [www.sgs.com/terms\\_e-document.htm](http://www.sgs.com/terms_e-document.htm). Attention is drawn to the limitation of liability, indemnification and jurisdiction issues defined therein. Any holder of this document is advised that information contained hereon reflects the Company's findings at the time of its intervention only and within the limits of Client's instructions, if any. The Company's sole responsibility is to its Client and this document does not exonerate parties to a transaction from exercising all their rights and obligations under the transaction documents. This document cannot be reproduced except in full, without prior written approval of the Company. Any unauthorized alteration, forgery or falsification of the content or appearance of this document is unlawful and offenders may be prosecuted to the fullest extent of the law.

SGS Taiwan Ltd.

No.134,WuKungRoad,NewTaipeiIndustrialPark,WukuDistrict,NewTaipeiCity,Taiwan24803/新北市五股區新北產業園區五工路 134 號

台灣檢驗科技股份有限公司

t (886-2) 2299-3279

f (886-2) 2298-0488

www.tw.sgs.com

Member of SGS Group



EUT			Measurement					
Operation Band	Fundamental Frequency MHz	CH	Antenna Pol. V/H	S.G. Output dBm	Antenna Gain dBi	Cable Loss dB	EIRP dBm	Limit dBm
<b>BAND 4 BW: 10M 64QAM RB: 1,0</b>	1715.0	20000	V	11.36	8.98	-6.58	13.76	30.00
			H	22.80	8.98	-6.58	25.21	30.00
	1732.5	20175	V	8.01	9.06	-6.62	10.45	30.00
			H	23.88	9.06	-6.62	<b>26.32</b>	30.00
	1750.0	20350	V	11.49	9.13	-6.65	13.98	30.00
			H	22.07	9.13	-6.65	24.55	30.00
<b>BAND 4 BW: 10M 64QAM RB: 1,49</b>	1715.0	20000	V	10.94	9.02	-6.60	13.36	30.00
			H	23.28	9.02	-6.60	<b>25.71</b>	30.00
	1732.5	20175	V	9.29	9.09	-6.63	11.75	30.00
			H	23.08	9.10	-6.63	25.54	30.00
	1750.0	20350	V	12.22	9.17	-6.67	14.72	30.00
			H	22.40	9.17	-6.67	24.90	30.00

The RBW,VBW of SPA for frequency RBW= 8MHz , VBW= 8MHz

Unless otherwise stated the results shown in this test report refer only to the sample(s) tested and such sample(s) are retained for 90 days only.

除非另有說明，此報告結果僅對測試之樣品負責，同時此樣品僅保留90天。本報告未經本公司書面許可，不可部份複製。

This document is issued by the Company subject to its General Conditions of Service printed overleaf, available on request or accessible at [www.sgs.com/terms\\_and\\_conditions.htm](http://www.sgs.com/terms_and_conditions.htm) and, for electronic format documents, subject to Terms and Conditions for Electronic Documents at [www.sgs.com/terms\\_e-document.htm](http://www.sgs.com/terms_e-document.htm). Attention is drawn to the limitation of liability, indemnification and jurisdiction issues defined therein. Any holder of this document is advised that information contained hereon reflects the Company's findings at the time of its intervention only and within the limits of Client's instructions, if any. The Company's sole responsibility is to its Client and this document does not exonerate parties to a transaction from exercising all their rights and obligations under the transaction documents. This document cannot be reproduced except in full, without prior written approval of the Company. Any unauthorized alteration, forgery or falsification of the content or appearance of this document is unlawful and offenders may be prosecuted to the fullest extent of the law.

SGS Taiwan Ltd.

No.134,WuKungRoad,NewTaipeiIndustrialPark,WukuDistrict,NewTaipeiCity,Taiwan24803/新北市五股區新北產業園區五工路 134 號

台灣檢驗科技股份有限公司

t (886-2) 2299-3279

f (886-2) 2298-0488

www.tw.sgs.com

Member of SGS Group

EUT			Measurement					
Operation Band	Fundamental Frequency MHz	CH	Antenna Pol. V/H	S.G. Output dBm	Antenna Gain dBi	Cable Loss dB	EIRP dBm	Limit dBm
<b>BAND 4 BW: 15M QPSK RB: 1,0</b>	1717.5	20025	V	9.91	8.99	-6.58	12.31	30.00
			H	21.43	8.99	-6.58	23.83	30.00
	1732.5	20175	V	7.16	9.05	-6.61	9.59	30.00
			H	22.00	9.05	-6.61	<b>24.43</b>	30.00
	1747.5	20325	V	8.11	9.11	-6.64	10.58	30.00
			H	21.32	9.11	-6.64	23.79	30.00
<b>BAND 4 BW: 15M QPSK RB: 1,74</b>	1717.5	20025	V	7.93	9.04	-6.61	10.36	30.00
			H	21.57	9.04	-6.61	<b>24.00</b>	30.00
	1732.5	20175	V	7.76	9.10	-6.64	10.23	30.00
			H	21.14	9.10	-6.64	23.61	30.00
	1747.5	20325	V	10.40	9.17	-6.67	12.90	30.00
			H	20.71	9.17	-6.67	23.21	30.00
<b>BAND 4 BW: 15M 16QAM RB: 1,0</b>	1717.5	20025	V	11.20	8.99	-6.58	13.60	30.00
			H	22.64	8.99	-6.58	25.05	30.00
	1732.5	20175	V	8.06	9.05	-6.61	10.50	30.00
			H	22.96	9.05	-6.61	<b>25.39</b>	30.00
	1747.5	20325	V	8.99	9.11	-6.64	11.46	30.00
			H	22.37	9.11	-6.64	24.84	30.00
<b>BAND 4 BW: 15M 16QAM RB: 1,74</b>	1717.5	20025	V	8.83	9.04	-6.61	11.27	30.00
			H	22.63	9.04	-6.61	<b>25.06</b>	30.00
	1732.5	20175	V	8.68	9.10	-6.64	11.15	30.00
			H	22.17	9.10	-6.64	24.64	30.00
	1747.5	20325	V	11.37	9.17	-6.67	13.87	30.00
			H	21.45	9.17	-6.67	23.95	30.00

The RBW,VBW of SPA for frequency RBW= 8MHz , VBW= 8MHz

Unless otherwise stated the results shown in this test report refer only to the sample(s) tested and such sample(s) are retained for 90 days only.

除非另有說明，此報告結果僅對測試之樣品負責，同時此樣品僅保留90天。本報告未經本公司書面許可，不可部份複製。

This document is issued by the Company subject to its General Conditions of Service printed overleaf, available on request or accessible at [www.sgs.com/terms\\_and\\_conditions.htm](http://www.sgs.com/terms_and_conditions.htm) and, for electronic format documents, subject to Terms and Conditions for Electronic Documents at [www.sgs.com/terms\\_e-document.htm](http://www.sgs.com/terms_e-document.htm). Attention is drawn to the limitation of liability, indemnification and jurisdiction issues defined therein. Any holder of this document is advised that information contained hereon reflects the Company's findings at the time of its intervention only and within the limits of Client's instructions, if any. The Company's sole responsibility is to its Client and this document does not exonerate parties to a transaction from exercising all their rights and obligations under the transaction documents. This document cannot be reproduced except in full, without prior written approval of the Company. Any unauthorized alteration, forgery or falsification of the content or appearance of this document is unlawful and offenders may be prosecuted to the fullest extent of the law.

SGS Taiwan Ltd.

No.134,WuKungRoad,NewTaipeiIndustrialPark,WukuDistrict,NewTaipeiCity,Taiwan24803/新北市五股區新北產業園區五工路 134 號

台灣檢驗科技股份有限公司

t (886-2) 2299-3279

f (886-2) 2298-0488

www.tw.sgs.com

Member of SGS Group

EUT			Measurement					
Operation Band	Fundamental Frequency MHz	CH	Antenna Pol. V/H	S.G. Output dBm	Antenna Gain dBi	Cable Loss dB	EIRP dBm	Limit dBm
<b>BAND 4 BW: 15M 64QAM RB: 1,0</b>	1717.5	20025	V	11.31	8.99	-6.58	13.72	30.00
			H	22.83	8.99	-6.58	25.24	30.00
	1732.5	20175	V	8.91	9.05	-6.61	11.35	30.00
			H	23.82	9.05	-6.61	<b>26.25</b>	30.00
	1747.5	20325	V	9.55	9.11	-6.64	12.02	30.00
			H	22.72	9.11	-6.64	25.19	30.00
<b>BAND 4 BW: 15M 64QAM RB: 1,74</b>	1717.5	20025	V	9.66	9.04	-6.61	12.10	30.00
			H	23.56	9.04	-6.61	<b>25.99</b>	30.00
	1732.5	20175	V	9.47	9.11	-6.64	11.93	30.00
			H	22.87	9.10	-6.64	25.33	30.00
	1747.5	20325	V	12.11	9.17	-6.67	14.61	30.00
			H	22.40	9.17	-6.67	24.90	30.00

The RBW,VBW of SPA for frequency RBW= 8MHz , VBW= 8MHz

Unless otherwise stated the results shown in this test report refer only to the sample(s) tested and such sample(s) are retained for 90 days only.

除非另有說明，此報告結果僅對測試之樣品負責，同時此樣品僅保留90天。本報告未經本公司書面許可，不可部份複製。

This document is issued by the Company subject to its General Conditions of Service printed overleaf, available on request or accessible at [www.sgs.com/terms\\_and\\_conditions.htm](http://www.sgs.com/terms_and_conditions.htm) and, for electronic format documents, subject to Terms and Conditions for Electronic Documents at [www.sgs.com/terms\\_e-document.htm](http://www.sgs.com/terms_e-document.htm). Attention is drawn to the limitation of liability, indemnification and jurisdiction issues defined therein. Any holder of this document is advised that information contained hereon reflects the Company's findings at the time of its intervention only and within the limits of Client's instructions, if any. The Company's sole responsibility is to its Client and this document does not exonerate parties to a transaction from exercising all their rights and obligations under the transaction documents. This document cannot be reproduced except in full, without prior written approval of the Company. Any unauthorized alteration, forgery or falsification of the content or appearance of this document is unlawful and offenders may be prosecuted to the fullest extent of the law.

SGS Taiwan Ltd.

No.134,WuKungRoad,NewTaipeiIndustrialPark,WukuDistrict,NewTaipeiCity,Taiwan24803/新北市五股區新北產業園區五工路 134 號

台灣檢驗科技股份有限公司

t (886-2) 2299-3279

f (886-2) 2298-0488

www.tw.sgs.com

Member of SGS Group

EUT			Measurement					
Operation Band	Fundamental Frequency MHz	CH	Antenna Pol. V/H	S.G. Output dBm	Antenna Gain dBi	Cable Loss dB	EIRP dBm	Limit dBm
<b>BAND 4 BW: 20M QPSK RB: 1,0</b>	1720.0	20050	V	9.70	8.99	-6.58	12.10	30.00
			H	21.35	8.99	-6.58	23.76	30.00
	1732.5	20175	V	8.10	9.04	-6.61	10.53	30.00
			H	21.90	9.04	-6.61	<b>24.33</b>	30.00
	1745.0	20300	V	6.29	9.09	-6.63	8.75	30.00
			H	20.41	9.09	-6.63	22.87	30.00
<b>BAND 4 BW: 20M QPSK RB: 1,99</b>	1720.0	20050	V	5.00	9.06	-6.62	7.44	30.00
			H	21.00	9.06	-6.62	23.45	30.00
	1732.5	20175	V	8.18	9.11	-6.64	10.65	30.00
			H	21.01	9.11	-6.64	<b>23.48</b>	30.00
	1745.0	20300	V	10.23	9.17	-6.67	12.73	30.00
			H	20.46	9.17	-6.67	22.96	30.00
<b>BAND 4 BW: 20M 16QAM RB: 1,0</b>	1720.0	20050	V	11.15	8.99	-6.58	13.55	30.00
			H	22.66	8.99	-6.58	25.06	30.00
	1732.5	20175	V	9.02	9.04	-6.61	11.45	30.00
			H	22.80	9.04	-6.61	<b>25.23</b>	30.00
	1745.0	20300	V	8.29	9.09	-6.63	10.75	30.00
			H	22.27	9.09	-6.63	24.72	30.00
<b>BAND 4 BW: 20M 16QAM RB: 1,99</b>	1720.0	20050	V	6.78	9.06	-6.62	9.23	30.00
			H	22.62	9.06	-6.62	25.06	30.00
	1732.5	20175	V	9.39	9.12	-6.64	11.86	30.00
			H	22.06	9.11	-6.64	24.53	30.00
	1745.0	20300	V	7.70	9.06	-6.62	10.14	30.00
			H	23.57	9.06	-6.62	<b>26.02</b>	30.00

The RBW,VBW of SPA for frequency RBW= 8MHz , VBW= 8MHz

Unless otherwise stated the results shown in this test report refer only to the sample(s) tested and such sample(s) are retained for 90 days only.

除非另有說明，此報告結果僅對測試之樣品負責，同時此樣品僅保留90天。本報告未經本公司書面許可，不可部份複製。

This document is issued by the Company subject to its General Conditions of Service printed overleaf, available on request or accessible at [www.sgs.com/terms\\_and\\_conditions.htm](http://www.sgs.com/terms_and_conditions.htm) and, for electronic format documents, subject to Terms and Conditions for Electronic Documents at [www.sgs.com/terms\\_e-document.htm](http://www.sgs.com/terms_e-document.htm). Attention is drawn to the limitation of liability, indemnification and jurisdiction issues defined therein. Any holder of this document is advised that information contained hereon reflects the Company's findings at the time of its intervention only and within the limits of Client's instructions, if any. The Company's sole responsibility is to its Client and this document does not exonerate parties to a transaction from exercising all their rights and obligations under the transaction documents. This document cannot be reproduced except in full, without prior written approval of the Company. Any unauthorized alteration, forgery or falsification of the content or appearance of this document is unlawful and offenders may be prosecuted to the fullest extent of the law.

SGS Taiwan Ltd.

No.134,WuKungRoad,NewTaipeiIndustrialPark,WukuDistrict,NewTaipeiCity,Taiwan24803/新北市五股區新北產業園區五工路 134 號

台灣檢驗科技股份有限公司

t (886-2) 2299-3279

f (886-2) 2298-0488

www.tw.sgs.com

Member of SGS Group

EUT			Measurement					
Operation Band	Fundamental Frequency MHz	CH	Antenna Pol. V/H	S.G. Output dBm	Antenna Gain dBi	Cable Loss dB	EIRP dBm	Limit dBm
<b>BAND 4 BW: 20M 64QAM RB: 1,0</b>	1720.0	20050	V	11.27	9.17	-6.67	13.77	30.00
			H	21.48	9.17	-6.67	23.98	30.00
	1732.5	20175	V	11.17	8.99	-6.58	13.57	30.00
			H	22.72	8.99	-6.58	25.13	30.00
	1745.0	20300	V	9.75	9.04	-6.61	12.19	30.00
			H	23.48	9.04	-6.61	25.91	30.00
<b>BAND 4 BW: 20M 64QAM RB: 1,99</b>	1720.0	20050	V	9.02	9.09	-6.63	11.48	30.00
			H	23.30	9.09	-6.63	25.76	30.00
	1732.5	20175	V	9.76	9.12	-6.64	12.23	30.00
			H	22.50	9.11	-6.64	24.97	30.00
	1745.0	20300	V	12.11	9.16	-6.67	14.61	30.00
			H	22.32	9.16	-6.67	24.82	30.00

The RBW,VBW of SPA for frequency RBW= 8MHz , VBW= 8MHz

Unless otherwise stated the results shown in this test report refer only to the sample(s) tested and such sample(s) are retained for 90 days only.

除非另有說明，此報告結果僅對測試之樣品負責，同時此樣品僅保留90天。本報告未經本公司書面許可，不可部份複製。

This document is issued by the Company subject to its General Conditions of Service printed overleaf, available on request or accessible at [www.sgs.com/terms\\_and\\_conditions.htm](http://www.sgs.com/terms_and_conditions.htm) and, for electronic format documents, subject to Terms and Conditions for Electronic Documents at [www.sgs.com/terms\\_e-document.htm](http://www.sgs.com/terms_e-document.htm). Attention is drawn to the limitation of liability, indemnification and jurisdiction issues defined therein. Any holder of this document is advised that information contained hereon reflects the Company's findings at the time of its intervention only and within the limits of Client's instructions, if any. The Company's sole responsibility is to its Client and this document does not exonerate parties to a transaction from exercising all their rights and obligations under the transaction documents. This document cannot be reproduced except in full, without prior written approval of the Company. Any unauthorized alteration, forgery or falsification of the content or appearance of this document is unlawful and offenders may be prosecuted to the fullest extent of the law.

SGS Taiwan Ltd.

No.134,WuKungRoad,NewTaipeiIndustrialPark,WukuDistrict,NewTaipeiCity,Taiwan24803/新北市五股區新北產業園區五工路 134 號

台灣檢驗科技股份有限公司

t (886-2) 2299-3279

f (886-2) 2298-0488

www.tw.sgs.com

Member of SGS Group

EUT			Measurement					
Operation Band	Fundamental Frequency	CH	Antenna Pol.	S.G. Output	Antenna Gain	Cable Loss	ERP	Limit
	MHz		V/H	dBm	dBd	dB	dBm	dBm
<b>BAND 5 BW: 1.4M QPSK RB: 1,0</b>	824.7	20407	V	13.14	5.14	-4.18	14.10	38.45
			H	25.15	5.14	-4.18	26.11	38.45
	836.5	20525	V	7.57	5.10	-4.22	8.44	38.45
			H	26.08	5.10	-4.22	26.96	38.45
	848.3	20643	V	9.93	5.06	-4.26	10.73	38.45
			H	25.82	5.06	-4.26	26.62	38.45
<b>BAND 5 BW: 1.4M QPSK RB: 1,5</b>	824.7	20407	V	6.01	5.13	-4.18	6.96	38.45
			H	25.21	5.13	-4.18	26.16	38.45
	836.5	20525	V	7.37	5.10	-4.23	8.24	38.45
			H	26.05	5.10	-4.23	26.91	38.45
	848.3	20643	V	9.63	5.05	-4.27	10.42	38.45
			H	25.87	5.05	-4.27	26.66	38.45
<b>BAND 5 BW: 1.4M 16QAM RB: 1,0</b>	824.7	20407	V	5.79	5.14	-4.18	6.75	38.45
			H	24.86	5.14	-4.18	25.83	38.45
	836.5	20525	V	7.15	5.10	-4.22	8.03	38.45
			H	26.09	5.10	-4.22	26.96	38.45
	848.3	20643	V	9.55	5.06	-4.26	10.35	38.45
			H	25.86	5.06	-4.26	26.65	38.45
<b>BAND 5 BW: 1.4M 16QAM RB: 1,5</b>	824.7	20407	V	6.11	5.13	-4.18	7.06	38.45
			H	25.24	5.13	-4.18	26.19	38.45
	836.5	20525	V	7.30	5.09	-4.23	8.16	38.45
			H	26.05	5.09	-4.23	26.92	38.45
	848.3	20643	V	9.68	5.06	-4.26	10.47	38.45
			H	25.95	5.06	-4.26	26.74	38.45

The RBW,VBW of SPA for frequency RBW= 8MHz , VBW= 8MHz

Unless otherwise stated the results shown in this test report refer only to the sample(s) tested and such sample(s) are retained for 90 days only.

除非另有說明，此報告結果僅對測試之樣品負責，同時此樣品僅保留90天。本報告未經本公司書面許可，不可部份複製。

This document is issued by the Company subject to its General Conditions of Service printed overleaf, available on request or accessible at [www.sgs.com/terms\\_and\\_conditions.htm](http://www.sgs.com/terms_and_conditions.htm) and, for electronic format documents, subject to Terms and Conditions for Electronic Documents at [www.sgs.com/terms\\_e-document.htm](http://www.sgs.com/terms_e-document.htm). Attention is drawn to the limitation of liability, indemnification and jurisdiction issues defined therein. Any holder of this document is advised that information contained hereon reflects the Company's findings at the time of its intervention only and within the limits of Client's instructions, if any. The Company's sole responsibility is to its Client and this document does not exonerate parties to a transaction from exercising all their rights and obligations under the transaction documents. This document cannot be reproduced except in full, without prior written approval of the Company. Any unauthorized alteration, forgery or falsification of the content or appearance of this document is unlawful and offenders may be prosecuted to the fullest extent of the law.

SGS Taiwan Ltd.

No.134,WuKungRoad,NewTaipeiIndustrialPark,WukuDistrict,NewTaipeiCity,Taiwan24803/新北市五股區新北產業園區五工路 134 號

台灣檢驗科技股份有限公司

t (886-2) 2299-3279

f (886-2) 2298-0488

www.tw.sgs.com

Member of SGS Group

EUT			Measurement					
Operation Band	Fundamental Frequency	CH	Antenna Pol.	S.G. Output	Antenna Gain	Cable Loss	ERP	Limit
	MHz		V/H	dBm	dBd	dB	dBm	dBm
<b>BAND 5 BW: 1.4M 64QAM RB: 1,0</b>	824.7	20407	V	5.88	5.14	-4.18	6.84	38.45
			H	24.85	5.14	-4.18	25.81	38.45
	836.5	20525	V	7.10	5.10	-4.22	7.98	38.45
			H	26.11	5.10	-4.22	<b>26.98</b>	38.45
	848.3	20643	V	9.55	5.06	-4.26	10.35	38.45
			H	25.85	5.06	-4.26	26.65	38.45
<b>BAND 5 BW: 1.4M 64QAM RB: 1,5</b>	824.7	20407	V	5.80	5.13	-4.18	6.75	38.45
			H	25.21	5.13	-4.18	26.17	38.45
	836.5	20525	V	7.13	5.09	-4.23	8.00	38.45
			H	26.06	5.09	-4.23	<b>26.93</b>	38.45
	848.3	20643	V	9.47	5.06	-4.26	10.26	38.45
			H	26.02	5.06	-4.26	26.81	38.45

The RBW,VBW of SPA for frequency RBW= 8MHz , VBW= 8MHz

Unless otherwise stated the results shown in this test report refer only to the sample(s) tested and such sample(s) are retained for 90 days only.

除非另有說明，此報告結果僅對測試之樣品負責，同時此樣品僅保留90天。本報告未經本公司書面許可，不可部份複製。

This document is issued by the Company subject to its General Conditions of Service printed overleaf, available on request or accessible at [www.sgs.com/terms\\_and\\_conditions.htm](http://www.sgs.com/terms_and_conditions.htm) and, for electronic format documents, subject to Terms and Conditions for Electronic Documents at [www.sgs.com/terms\\_e-document.htm](http://www.sgs.com/terms_e-document.htm). Attention is drawn to the limitation of liability, indemnification and jurisdiction issues defined therein. Any holder of this document is advised that information contained hereon reflects the Company's findings at the time of its intervention only and within the limits of Client's instructions, if any. The Company's sole responsibility is to its Client and this document does not exonerate parties to a transaction from exercising all their rights and obligations under the transaction documents. This document cannot be reproduced except in full, without prior written approval of the Company. Any unauthorized alteration, forgery or falsification of the content or appearance of this document is unlawful and offenders may be prosecuted to the fullest extent of the law.

SGS Taiwan Ltd.

No.134,WuKungRoad,NewTaipeiIndustrialPark,WukuDistrict,NewTaipeiCity,Taiwan24803/新北市五股區新北產業園區五工路 134 號

台灣檢驗科技股份有限公司

t (886-2) 2299-3279

f (886-2) 2298-0488

www.tw.sgs.com

Member of SGS Group

EUT			Measurement					
Operation Band	Fundamental Frequency	CH	Antenna Pol.	S.G. Output	Antenna Gain	Cable Loss	EIRP	Limit
	MHz		V/H	dBm	dBd	dB	dBm	dBm
<b>BAND 5 BW: 3M QPSK RB: 1,0</b>	825.5	20415	V	5.55	5.14	-4.18	6.51	38.45
			H	24.85	5.14	-4.18	25.81	38.45
	836.5	20525	V	5.91	5.10	-4.22	6.79	38.45
			H	26.07	5.10	-4.22	<b>26.95</b>	38.45
	847.5	20635	V	9.67	5.06	-4.26	10.48	38.45
			H	26.04	5.06	-4.26	26.84	38.45
<b>BAND 5 BW: 3M QPSK RB: 1,14</b>	825.5	20415	V	5.21	5.13	-4.18	6.16	38.45
			H	25.14	5.13	-4.18	26.09	38.45
	836.5	20525	V	7.47	5.10	-4.22	8.34	38.45
			H	25.98	5.10	-4.22	<b>26.86</b>	38.45
	847.5	20635	V	9.32	5.06	-4.26	10.11	38.45
			H	25.85	5.06	-4.26	26.64	38.45
<b>BAND 5 BW: 3M 16QAM RB: 1,0</b>	825.5	20415	V	5.03	5.14	-4.18	5.99	38.45
			H	24.81	5.14	-4.18	25.77	38.45
	836.5	20525	V	7.54	5.10	-4.22	8.42	38.45
			H	26.17	5.10	-4.22	<b>27.05</b>	38.45
	847.5	20635	V	9.14	5.06	-4.26	9.95	38.45
			H	26.07	5.06	-4.26	26.87	38.45
<b>BAND 5 BW: 3M 16QAM RB: 1,14</b>	825.5	20415	V	4.96	5.14	-4.18	5.92	38.45
			H	25.22	5.14	-4.18	26.18	38.45
	836.5	20525	V	7.70	5.10	-4.22	8.58	38.45
			H	26.03	5.10	-4.22	<b>26.90</b>	38.45
	847.5	20635	V	9.31	5.06	-4.27	10.10	38.45
			H	25.94	5.06	-4.27	26.73	38.45

The RBW,VBW of SPA for frequency RBW= 8MHz , VBW= 8MHz

Unless otherwise stated the results shown in this test report refer only to the sample(s) tested and such sample(s) are retained for 90 days only.

除非另有說明，此報告結果僅對測試之樣品負責，同時此樣品僅保留90天。本報告未經本公司書面許可，不可部份複製。

This document is issued by the Company subject to its General Conditions of Service printed overleaf, available on request or accessible at [www.sgs.com/terms\\_and\\_conditions.htm](http://www.sgs.com/terms_and_conditions.htm) and, for electronic format documents, subject to Terms and Conditions for Electronic Documents at [www.sgs.com/terms\\_e-document.htm](http://www.sgs.com/terms_e-document.htm). Attention is drawn to the limitation of liability, indemnification and jurisdiction issues defined therein. Any holder of this document is advised that information contained hereon reflects the Company's findings at the time of its intervention only and within the limits of Client's instructions, if any. The Company's sole responsibility is to its Client and this document does not exonerate parties to a transaction from exercising all their rights and obligations under the transaction documents. This document cannot be reproduced except in full, without prior written approval of the Company. Any unauthorized alteration, forgery or falsification of the content or appearance of this document is unlawful and offenders may be prosecuted to the fullest extent of the law.

SGS Taiwan Ltd.

No.134,WuKungRoad,NewTaipeiIndustrialPark,WukuDistrict,NewTaipeiCity,Taiwan24803/新北市五股區新北產業園區五工路 134 號

台灣檢驗科技股份有限公司

t (886-2) 2299-3279

f (886-2) 2298-0488

www.tw.sgs.com

Member of SGS Group



EUT			Measurement					
Operation Band	Fundamental Frequency	CH	Antenna Pol.	S.G. Output	Antenna Gain	Cable Loss	EIRP	Limit
	MHz		V/H	dBm	dBd	dB	dBm	dBm
<b>BAND 5 BW: 3M 64QAM RB: 1,0</b>	825.5	20415	V	4.81	5.14	-4.18	5.77	38.45
			H	24.85	5.14	-4.18	25.81	38.45
	836.5	20525	V	7.79	5.10	-4.22	8.67	38.45
			H	26.15	5.10	-4.22	<b>27.03</b>	38.45
	847.5	20635	V	9.18	5.06	-4.26	9.98	38.45
			H	26.17	5.06	-4.26	26.97	38.45
<b>BAND 5 BW: 3M 64QAM RB: 1,14</b>	825.5	20415	V	4.91	5.13	-4.18	5.86	38.45
			H	25.21	5.13	-4.18	26.15	38.45
	836.5	20525	V	8.10	5.09	-4.23	8.96	38.45
			H	26.07	5.09	-4.23	<b>26.93</b>	38.45
	847.5	20635	V	10.72	5.05	-4.27	11.51	38.45
			H	26.03	5.05	-4.27	26.82	38.45

The RBW,VBW of SPA for frequency RBW= 8MHz , VBW= 8MHz

Unless otherwise stated the results shown in this test report refer only to the sample(s) tested and such sample(s) are retained for 90 days only.

除非另有說明，此報告結果僅對測試之樣品負責，同時此樣品僅保留90天。本報告未經本公司書面許可，不可部份複製。

This document is issued by the Company subject to its General Conditions of Service printed overleaf, available on request or accessible at [www.sgs.com/terms\\_and\\_conditions.htm](http://www.sgs.com/terms_and_conditions.htm) and, for electronic format documents, subject to Terms and Conditions for Electronic Documents at [www.sgs.com/terms\\_e-document.htm](http://www.sgs.com/terms_e-document.htm). Attention is drawn to the limitation of liability, indemnification and jurisdiction issues defined therein. Any holder of this document is advised that information contained hereon reflects the Company's findings at the time of its intervention only and within the limits of Client's instructions, if any. The Company's sole responsibility is to its Client and this document does not exonerate parties to a transaction from exercising all their rights and obligations under the transaction documents. This document cannot be reproduced except in full, without prior written approval of the Company. Any unauthorized alteration, forgery or falsification of the content or appearance of this document is unlawful and offenders may be prosecuted to the fullest extent of the law.

SGS Taiwan Ltd.

No.134,WuKungRoad,NewTaipeiIndustrialPark,WukuDistrict,NewTaipeiCity,Taiwan24803/新北市五股區新北產業園區五工路 134 號

台灣檢驗科技股份有限公司

t (886-2) 2299-3279

f (886-2) 2298-0488

www.tw.sgs.com

Member of SGS Group

EUT			Measurement					
Operation Band	Fundamental Frequency	CH	Antenna Pol.	S.G. Output	Antenna Gain	Cable Loss	ERP	Limit
	MHz		V/H	dBm	dBd	dB	dBm	dBm
<b>BAND 5 BW: 5M QPSK RB: 1,0</b>	826.5	20425	V	2.62	5.14	-4.18	3.57	38.45
			H	23.50	5.14	-4.18	24.45	38.45
	836.5	20525	V	0.04	5.10	-4.22	0.93	38.45
			H	23.57	5.10	-4.22	24.46	38.45
	846.5	20625	V	3.11	5.07	-4.25	3.93	38.45
			H	24.29	5.07	-4.25	25.11	38.45
<b>BAND 5 BW: 5M QPSK RB: 1,24</b>	826.5	20425	V	1.16	5.12	-4.19	2.08	38.45
			H	23.69	5.12	-4.19	24.62	38.45
	836.5	20525	V	0.81	5.09	-4.23	1.67	38.45
			H	23.30	5.09	-4.23	24.16	38.45
	846.5	20625	V	4.62	5.05	-4.27	5.40	38.45
			H	24.50	5.05	-4.27	25.29	38.45
<b>BAND 5 BW: 5M 16QAM RB: 1,0</b>	826.5	20425	V	3.14	5.14	-4.18	4.10	38.45
			H	24.56	5.14	-4.18	25.52	38.45
	836.5	20525	V	1.50	5.10	-4.22	2.38	38.45
			H	25.38	5.10	-4.22	26.26	38.45
	846.5	20625	V	5.27	5.07	-4.25	6.09	38.45
			H	25.54	5.07	-4.25	26.36	38.45
<b>BAND 5 BW: 5M 16QAM RB: 1,24</b>	826.5	20425	V	1.14	5.12	-4.19	2.07	38.45
			H	23.64	5.12	-4.19	24.57	38.45
	836.5	20525	V	2.65	5.09	-4.23	3.50	38.45
			H	25.38	5.09	-4.23	26.24	38.45
	846.5	20625	V	7.47	5.05	-4.27	8.26	38.45
			H	25.72	5.05	-4.27	26.51	38.45

The RBW,VBW of SPA for frequency RBW= 8MHz , VBW= 8MHz

Unless otherwise stated the results shown in this test report refer only to the sample(s) tested and such sample(s) are retained for 90 days only.

除非另有說明，此報告結果僅對測試之樣品負責，同時此樣品僅保留90天。本報告未經本公司書面許可，不可部份複製。

This document is issued by the Company subject to its General Conditions of Service printed overleaf, available on request or accessible at [www.sgs.com/terms\\_and\\_conditions.htm](http://www.sgs.com/terms_and_conditions.htm) and, for electronic format documents, subject to Terms and Conditions for Electronic Documents at [www.sgs.com/terms\\_e-document.htm](http://www.sgs.com/terms_e-document.htm). Attention is drawn to the limitation of liability, indemnification and jurisdiction issues defined therein. Any holder of this document is advised that information contained hereon reflects the Company's findings at the time of its intervention only and within the limits of Client's instructions, if any. The Company's sole responsibility is to its Client and this document does not exonerate parties to a transaction from exercising all their rights and obligations under the transaction documents. This document cannot be reproduced except in full, without prior written approval of the Company. Any unauthorized alteration, forgery or falsification of the content or appearance of this document is unlawful and offenders may be prosecuted to the fullest extent of the law.

SGS Taiwan Ltd.

No.134,WuKungRoad,NewTaipeiIndustrialPark,WukuDistrict,NewTaipeiCity,Taiwan24803/新北市五股區新北產業園區五工路 134 號

台灣檢驗科技股份有限公司

t (886-2) 2299-3279

f (886-2) 2298-0488

www.tw.sgs.com

Member of SGS Group

EUT			Measurement					
Operation Band	Fundamental Frequency	CH	Antenna Pol.	S.G. Output	Antenna Gain	Cable Loss	ERP	Limit
	MHz		V/H	dBm	dBd	dB	dBm	dBm
<b>BAND 5 BW: 5M 64QAM RB: 1,0</b>	826.5	20425	V	1.72	5.14	-4.18	2.67	38.45
			H	23.51	5.14	-4.18	24.46	38.45
	836.5	20525	V	2.12	5.10	-4.22	3.01	38.45
			H	26.32	5.10	-4.22	27.21	38.45
	846.5	20625	V	4.91	5.07	-4.25	5.72	38.45
			H	26.48	5.07	-4.25	<b>27.29</b>	38.45
<b>BAND 5 BW: 5M 64QAM RB: 1,24</b>	826.5	20425	V	3.03	5.12	-4.19	3.96	38.45
			H	25.79	5.12	-4.19	26.72	38.45
	836.5	20525	V	3.18	5.09	-4.24	4.03	38.45
			H	26.32	5.09	-4.24	27.17	38.45
	846.5	20625	V	5.67	5.06	-4.27	6.46	38.45
			H	26.39	5.06	-4.27	<b>27.18</b>	38.45

The RBW,VBW of SPA for frequency RBW= 8MHz , VBW= 8MHz

Unless otherwise stated the results shown in this test report refer only to the sample(s) tested and such sample(s) are retained for 90 days only.

除非另有說明，此報告結果僅對測試之樣品負責，同時此樣品僅保留90天。本報告未經本公司書面許可，不可部份複製。

This document is issued by the Company subject to its General Conditions of Service printed overleaf, available on request or accessible at [www.sgs.com/terms\\_and\\_conditions.htm](http://www.sgs.com/terms_and_conditions.htm) and, for electronic format documents, subject to Terms and Conditions for Electronic Documents at [www.sgs.com/terms\\_e-document.htm](http://www.sgs.com/terms_e-document.htm). Attention is drawn to the limitation of liability, indemnification and jurisdiction issues defined therein. Any holder of this document is advised that information contained hereon reflects the Company's findings at the time of its intervention only and within the limits of Client's instructions, if any. The Company's sole responsibility is to its Client and this document does not exonerate parties to a transaction from exercising all their rights and obligations under the transaction documents. This document cannot be reproduced except in full, without prior written approval of the Company. Any unauthorized alteration, forgery or falsification of the content or appearance of this document is unlawful and offenders may be prosecuted to the fullest extent of the law.

SGS Taiwan Ltd.

No.134,WuKungRoad,NewTaipeiIndustrialPark,WukuDistrict,NewTaipeiCity,Taiwan24803/新北市五股區新北產業園區五工路 134 號

台灣檢驗科技股份有限公司

t (886-2) 2299-3279

f (886-2) 2298-0488

www.tw.sgs.com

Member of SGS Group

EUT			Measurement					
Operation Band	Fundamental Frequency	CH	Antenna Pol.	S.G. Output	Antenna Gain	Cable Loss	ERP	Limit
	MHz		V/H	dBm	dBd	dB	dBm	dBm
<b>BAND 5 BW: 10M QPSK RB: 1,0</b>	829.0	20450	V	1.39	5.14	-4.18	2.35	38.45
			H	23.54	5.14	-4.18	24.50	38.45
	836.5	20525	V	-0.58	5.11	-4.21	0.33	38.45
			H	24.04	5.11	-4.21	<b>24.95</b>	38.45
	844.0	20600	V	2.56	5.09	-4.24	3.41	38.45
			H	23.61	5.09	-4.24	24.46	38.45
<b>BAND 5 BW: 10M QPSK RB: 1,49</b>	829.0	20450	V	0.39	5.11	-4.21	1.28	38.45
			H	23.89	5.11	-4.21	24.78	38.45
	836.5	20525	V	-1.49	5.08	-4.24	-0.65	38.45
			H	24.06	5.08	-4.24	24.91	38.45
	844.0	20600	V	5.60	5.06	-4.27	6.39	38.45
			H	24.31	5.06	-4.27	<b>25.10</b>	38.45
<b>BAND 5 BW: 5M 16QAM RB: 1,0</b>	829.0	20450	V	2.31	5.14	-4.18	3.26	38.45
			H	24.68	5.14	-4.18	25.63	38.45
	836.5	20525	V	1.32	5.11	-4.21	2.22	38.45
			H	24.05	5.11	-4.21	24.95	38.45
	844.0	20600	V	3.69	5.09	-4.23	4.54	38.45
			H	25.42	5.09	-4.23	<b>26.27</b>	38.45
<b>BAND 5 BW: 10M 16QAM RB: 1,49</b>	829.0	20450	V	0.98	5.11	-4.21	1.87	38.45
			H	25.20	5.11	-4.21	26.10	38.45
	836.5	20525	V	5.15	5.08	-4.24	5.99	38.45
			H	25.19	5.08	-4.24	26.04	38.45
	844.0	20600	V	6.50	5.06	-4.26	7.30	38.45
			H	25.31	5.06	-4.26	<b>26.10</b>	38.45

The RBW,VBW of SPA for frequency RBW= 8MHz , VBW= 8MHz

Unless otherwise stated the results shown in this test report refer only to the sample(s) tested and such sample(s) are retained for 90 days only.

除非另有說明，此報告結果僅對測試之樣品負責，同時此樣品僅保留90天。本報告未經本公司書面許可，不可部份複製。

This document is issued by the Company subject to its General Conditions of Service printed overleaf, available on request or accessible at [www.sgs.com/terms\\_and\\_conditions.htm](http://www.sgs.com/terms_and_conditions.htm) and, for electronic format documents, subject to Terms and Conditions for Electronic Documents at [www.sgs.com/terms\\_e-document.htm](http://www.sgs.com/terms_e-document.htm). Attention is drawn to the limitation of liability, indemnification and jurisdiction issues defined therein. Any holder of this document is advised that information contained hereon reflects the Company's findings at the time of its intervention only and within the limits of Client's instructions, if any. The Company's sole responsibility is to its Client and this document does not exonerate parties to a transaction from exercising all their rights and obligations under the transaction documents. This document cannot be reproduced except in full, without prior written approval of the Company. Any unauthorized alteration, forgery or falsification of the content or appearance of this document is unlawful and offenders may be prosecuted to the fullest extent of the law.

SGS Taiwan Ltd.

No.134,WuKungRoad,NewTaipeiIndustrialPark,WukuDistrict,NewTaipeiCity,Taiwan24803/新北市五股區新北產業園區五工路 134 號

台灣檢驗科技股份有限公司

t (886-2) 2299-3279

f (886-2) 2298-0488

www.tw.sgs.com

Member of SGS Group

EUT			Measurement					
Operation Band	Fundamental Frequency	CH	Antenna Pol.	S.G. Output	Antenna Gain	Cable Loss	ERP	Limit
	MHz		V/H	dBm	dBd	dB	dBm	dBm
<b>BAND 5 BW: 10M 64QAM RB: 1,0</b>	829.0	20450	V	2.43	5.14	-4.18	3.38	38.45
			H	25.21	5.14	-4.18	26.17	38.45
	836.5	20525	V	4.14	5.11	-4.21	5.05	38.45
			H	26.10	5.11	-4.21	27.01	38.45
	844.0	20600	V	4.44	5.09	-4.24	5.29	38.45
			H	26.34	5.09	-4.24	<b>27.19</b>	38.45
<b>BAND 5 BW: 10M 64QAM RB: 1,49</b>	829.0	20450	V	1.29	5.11	-4.21	2.19	38.45
			H	26.04	5.11	-4.21	26.93	38.45
	836.5	20525	V	5.73	5.08	-4.24	6.57	38.45
			H	26.11	5.08	-4.24	26.94	38.45
	844.0	20600	V	4.15	5.06	-4.26	4.94	38.45
			H	26.37	5.06	-4.26	<b>27.16</b>	38.45

The RBW,VBW of SPA for frequency RBW= 8MHz , VBW= 8MHz

Unless otherwise stated the results shown in this test report refer only to the sample(s) tested and such sample(s) are retained for 90 days only.

除非另有說明，此報告結果僅對測試之樣品負責，同時此樣品僅保留90天。本報告未經本公司書面許可，不可部份複製。

This document is issued by the Company subject to its General Conditions of Service printed overleaf, available on request or accessible at [www.sgs.com/terms\\_and\\_conditions.htm](http://www.sgs.com/terms_and_conditions.htm) and, for electronic format documents, subject to Terms and Conditions for Electronic Documents at [www.sgs.com/terms\\_e-document.htm](http://www.sgs.com/terms_e-document.htm). Attention is drawn to the limitation of liability, indemnification and jurisdiction issues defined therein. Any holder of this document is advised that information contained hereon reflects the Company's findings at the time of its intervention only and within the limits of Client's instructions, if any. The Company's sole responsibility is to its Client and this document does not exonerate parties to a transaction from exercising all their rights and obligations under the transaction documents. This document cannot be reproduced except in full, without prior written approval of the Company. Any unauthorized alteration, forgery or falsification of the content or appearance of this document is unlawful and offenders may be prosecuted to the fullest extent of the law.

SGS Taiwan Ltd.

No.134,WuKungRoad,NewTaipeiIndustrialPark,WukuDistrict,NewTaipeiCity,Taiwan24803/新北市五股區新北產業園區五工路 134 號

台灣檢驗科技股份有限公司

t (886-2) 2299-3279

f (886-2) 2298-0488

www.tw.sgs.com

Member of SGS Group

EUT			Measurement					
Operation Band	Fundamental Frequency MHz	CH	Antenna Pol. V/H	S.G. Output dBm	Antenna Gain dBi	Cable Loss dB	EIRP dBm	Limit dBm
<b>BAND 7 BW: 5M QPSK RB: 1,0</b>	2502.5	20775	V	9.62	10.70	-7.83	12.49	33.01
			H	17.62	10.70	-7.83	20.49	33.01
	2535.0	21100	V	8.98	10.74	-7.87	11.85	33.01
			H	17.79	10.74	-7.87	20.66	33.01
	2567.5	21425	V	9.38	10.78	-7.90	12.25	33.01
			H	18.17	10.78	-7.90	21.04	33.01
<b>BAND 7 BW: 5M QPSK RB: 1,24</b>	2502.5	20775	V	10.01	10.71	-7.84	12.88	33.01
			H	17.48	10.71	-7.84	20.35	33.01
	2535.0	21100	V	8.72	10.74	-7.87	11.59	33.01
			H	17.66	10.75	-7.87	20.53	33.01
	2567.5	21425	V	9.58	10.78	-7.91	12.46	33.01
			H	17.56	10.78	-7.91	20.44	33.01
<b>BAND 7 BW: 5M 16QAM RB: 1,0</b>	2502.5	20775	V	10.67	10.70	-7.83	13.54	33.01
			H	18.40	10.70	-7.83	21.27	33.01
	2535.0	21100	V	9.76	10.74	-7.87	12.64	33.01
			H	18.44	10.74	-7.87	21.31	33.01
	2567.5	21425	V	9.67	10.78	-7.90	12.54	33.01
			H	18.29	10.78	-7.90	21.17	33.01
<b>BAND 7 BW: 5M 16QAM RB: 1,24</b>	2502.5	20775	V	11.10	10.71	-7.84	13.97	33.01
			H	18.65	10.70	-7.83	21.52	33.01
	2535.0	21100	V	9.21	10.74	-7.87	12.08	33.01
			H	18.22	10.74	-7.87	21.09	33.01
	2567.5	21425	V	9.73	10.78	-7.91	12.61	33.01
			H	17.78	10.78	-7.91	20.65	33.01

The RBW,VBW of SPA for frequency RBW= 8MHz , VBW= 8MHz

Unless otherwise stated the results shown in this test report refer only to the sample(s) tested and such sample(s) are retained for 90 days only.

除非另有說明，此報告結果僅對測試之樣品負責，同時此樣品僅保留90天。本報告未經本公司書面許可，不可部份複製。

This document is issued by the Company subject to its General Conditions of Service printed overleaf, available on request or accessible at [www.sgs.com/terms\\_and\\_conditions.htm](http://www.sgs.com/terms_and_conditions.htm) and, for electronic format documents, subject to Terms and Conditions for Electronic Documents at [www.sgs.com/terms\\_e-document.htm](http://www.sgs.com/terms_e-document.htm). Attention is drawn to the limitation of liability, indemnification and jurisdiction issues defined therein. Any holder of this document is advised that information contained hereon reflects the Company's findings at the time of its intervention only and within the limits of Client's instructions, if any. The Company's sole responsibility is to its Client and this document does not exonerate parties to a transaction from exercising all their rights and obligations under the transaction documents. This document cannot be reproduced except in full, without prior written approval of the Company. Any unauthorized alteration, forgery or falsification of the content or appearance of this document is unlawful and offenders may be prosecuted to the fullest extent of the law.

SGS Taiwan Ltd.

No.134,WuKungRoad,NewTaipeiIndustrialPark,WukuDistrict,NewTaipeiCity,Taiwan24803/新北市五股區新北產業園區五工路 134 號

台灣檢驗科技股份有限公司

t (886-2) 2299-3279

f (886-2) 2298-0488

www.tw.sgs.com

Member of SGS Group

EUT			Measurement					
Operation Band	Fundamental Frequency MHz	CH	Antenna Pol. V/H	S.G. Output dBm	Antenna Gain dBi	Cable Loss dB	EIRP dBm	Limit dBm
<b>BAND 7 BW: 5M 64QAM RB: 1,0</b>	2502.5	20775	V	11.31	10.70	-7.83	14.18	33.01
			H	18.99	10.70	-7.83	21.86	33.01
	2535.0	21100	V	10.89	10.74	-7.87	13.77	33.01
			H	19.28	10.74	-7.87	22.16	33.01
	2567.5	21425	V	11.43	10.78	-7.90	14.30	33.01
			H	19.97	10.78	-7.90	<b>22.85</b>	33.01
<b>BAND 7 BW: 5M 64QAM RB: 1,24</b>	2502.5	20775	V	11.43	10.71	-7.84	14.30	33.01
			H	19.16	10.71	-7.84	22.03	33.01
	2535.0	21100	V	10.71	10.74	-7.87	13.58	33.01
			H	19.64	10.74	-7.87	<b>22.52</b>	33.01
	2567.5	21425	V	11.53	10.78	-7.91	14.41	33.01
			H	19.56	10.78	-7.91	22.44	33.01

The RBW,VBW of SPA for frequency RBW= 8MHz , VBW= 8MHz

Unless otherwise stated the results shown in this test report refer only to the sample(s) tested and such sample(s) are retained for 90 days only.

除非另有說明，此報告結果僅對測試之樣品負責，同時此樣品僅保留90天。本報告未經本公司書面許可，不可部份複製。

This document is issued by the Company subject to its General Conditions of Service printed overleaf, available on request or accessible at [www.sgs.com/terms\\_and\\_conditions.htm](http://www.sgs.com/terms_and_conditions.htm) and, for electronic format documents, subject to Terms and Conditions for Electronic Documents at [www.sgs.com/terms\\_e-document.htm](http://www.sgs.com/terms_e-document.htm). Attention is drawn to the limitation of liability, indemnification and jurisdiction issues defined therein. Any holder of this document is advised that information contained hereon reflects the Company's findings at the time of its intervention only and within the limits of Client's instructions, if any. The Company's sole responsibility is to its Client and this document does not exonerate parties to a transaction from exercising all their rights and obligations under the transaction documents. This document cannot be reproduced except in full, without prior written approval of the Company. Any unauthorized alteration, forgery or falsification of the content or appearance of this document is unlawful and offenders may be prosecuted to the fullest extent of the law.

SGS Taiwan Ltd.

No.134,WuKungRoad,NewTaipeiIndustrialPark,WukuDistrict,NewTaipeiCity,Taiwan24803/新北市五股區新北產業園區五工路 134 號

台灣檢驗科技股份有限公司

t (886-2) 2299-3279

f (886-2) 2298-0488

www.tw.sgs.com

Member of SGS Group

EUT			Measurement					
Operation Band	Fundamental Frequency MHz	CH	Antenna Pol. V/H	S.G. Output dBm	Antenna Gain dBi	Cable Loss dB	EIRP dBm	Limit dBm
<b>BAND 7 BW: 10M QPSK RB: 1,0</b>	2505.0	20800	V	9.43	10.70	-7.83	12.30	33.01
			H	17.54	10.70	-7.83	20.41	33.01
	2535.0	21100	V	9.00	10.74	-7.86	11.87	33.01
			H	17.50	10.74	-7.86	20.37	33.01
	2565.0	21400	V	9.80	10.77	-7.90	12.68	33.01
			H	18.14	10.77	-7.90	<b>21.02</b>	33.01
<b>BAND 7 BW: 10M QPSK RB: 1,49</b>	2505.0	20800	V	10.26	10.71	-7.84	13.13	33.01
			H	17.87	10.71	-7.84	<b>20.75</b>	33.01
	2535.0	21100	V	8.39	10.75	-7.87	11.27	33.01
			H	17.53	10.75	-7.87	20.40	33.01
	2565.0	21400	V	9.52	10.78	-7.91	12.40	33.01
			H	17.57	10.78	-7.91	20.44	33.01
<b>BAND 7 BW: 10M 16QAM RB: 1,0</b>	2505.0	20800	V	10.48	10.70	-7.83	13.35	33.01
			H	18.26	10.70	-7.83	21.13	33.01
	2535.0	21100	V	9.96	10.74	-7.86	12.84	33.01
			H	18.37	10.74	-7.86	21.24	33.01
	2565.0	21400	V	10.86	10.77	-7.90	13.74	33.01
			H	19.12	10.77	-7.90	<b>21.99</b>	33.01
<b>BAND 7 BW: 10M 16QAM RB: 1,49</b>	2505.0	20800	V	11.16	10.71	-7.84	14.03	33.01
			H	18.84	10.71	-7.84	<b>21.71</b>	33.01
	2535.0	21100	V	8.96	10.75	-7.87	11.83	33.01
			H	18.27	10.75	-7.87	21.14	33.01
	2565.0	21400	V	9.79	10.78	-7.91	12.66	33.01
			H	17.51	10.78	-7.91	20.38	33.01

The RBW,VBW of SPA for frequency RBW= 8MHz , VBW= 8MHz

Unless otherwise stated the results shown in this test report refer only to the sample(s) tested and such sample(s) are retained for 90 days only.

除非另有說明，此報告結果僅對測試之樣品負責，同時此樣品僅保留90天。本報告未經本公司書面許可，不可部份複製。

This document is issued by the Company subject to its General Conditions of Service printed overleaf, available on request or accessible at [www.sgs.com/terms\\_and\\_conditions.htm](http://www.sgs.com/terms_and_conditions.htm) and, for electronic format documents, subject to Terms and Conditions for Electronic Documents at [www.sgs.com/terms\\_e-document.htm](http://www.sgs.com/terms_e-document.htm). Attention is drawn to the limitation of liability, indemnification and jurisdiction issues defined therein. Any holder of this document is advised that information contained hereon reflects the Company's findings at the time of its intervention only and within the limits of Client's instructions, if any. The Company's sole responsibility is to its Client and this document does not exonerate parties to a transaction from exercising all their rights and obligations under the transaction documents. This document cannot be reproduced except in full, without prior written approval of the Company. Any unauthorized alteration, forgery or falsification of the content or appearance of this document is unlawful and offenders may be prosecuted to the fullest extent of the law.

SGS Taiwan Ltd.

No.134,WuKungRoad,NewTaipeiIndustrialPark,WukuDistrict,NewTaipeiCity,Taiwan24803/新北市五股區新北產業園區五工路 134 號

台灣檢驗科技股份有限公司

t (886-2) 2299-3279

f (886-2) 2298-0488

www.tw.sgs.com

Member of SGS Group



EUT			Measurement					
Operation Band	Fundamental Frequency MHz	CH	Antenna Pol. V/H	S.G. Output dBm	Antenna Gain dBi	Cable Loss dB	EIRP dBm	Limit dBm
<b>BAND 7 BW: 10M 16QAM RB: 1,0</b>	2505.0	20800	V	11.19	10.70	-7.83	14.06	33.01
			H	18.97	10.70	-7.83	21.84	33.01
	2535.0	21100	V	10.10	10.74	-7.86	12.98	33.01
			H	18.46	10.74	-7.86	21.33	33.01
	2565.0	21400	V	11.42	10.77	-7.90	14.30	33.01
			H	19.79	10.77	-7.90	22.66	33.01
<b>BAND 7 BW: 10M 16QAM RB: 1,49</b>	2505.0	20800	V	11.45	10.71	-7.84	14.32	33.01
			H	19.02	10.71	-7.84	21.89	33.01
	2535.0	21100	V	10.34	10.75	-7.87	13.21	33.01
			H	19.50	10.75	-7.87	22.37	33.01
	2565.0	21400	V	11.58	10.78	-7.91	14.46	33.01
			H	19.51	10.78	-7.91	22.39	33.01

The RBW,VBW of SPA for frequency RBW= 8MHz , VBW= 8MHz

Unless otherwise stated the results shown in this test report refer only to the sample(s) tested and such sample(s) are retained for 90 days only.

除非另有說明，此報告結果僅對測試之樣品負責，同時此樣品僅保留90天。本報告未經本公司書面許可，不可部份複製。

This document is issued by the Company subject to its General Conditions of Service printed overleaf, available on request or accessible at [www.sgs.com/terms\\_and\\_conditions.htm](http://www.sgs.com/terms_and_conditions.htm) and, for electronic format documents, subject to Terms and Conditions for Electronic Documents at [www.sgs.com/terms\\_e-document.htm](http://www.sgs.com/terms_e-document.htm). Attention is drawn to the limitation of liability, indemnification and jurisdiction issues defined therein. Any holder of this document is advised that information contained hereon reflects the Company's findings at the time of its intervention only and within the limits of Client's instructions, if any. The Company's sole responsibility is to its Client and this document does not exonerate parties to a transaction from exercising all their rights and obligations under the transaction documents. This document cannot be reproduced except in full, without prior written approval of the Company. Any unauthorized alteration, forgery or falsification of the content or appearance of this document is unlawful and offenders may be prosecuted to the fullest extent of the law.

SGS Taiwan Ltd.

No.134,WuKungRoad,NewTaipeiIndustrialPark,WukuDistrict,NewTaipeiCity,Taiwan24803/新北市五股區新北產業園區五工路 134 號

台灣檢驗科技股份有限公司

t (886-2) 2299-3279

f (886-2) 2298-0488

www.tw.sgs.com

Member of SGS Group

EUT			Measurement					
Operation Band	Fundamental Frequency MHz	CH	Antenna Pol. V/H	S.G. Output dBm	Antenna Gain dBi	Cable Loss dB	EIRP dBm	Limit dBm
<b>BAND 7 BW: 15M QPSK RB: 1,0</b>	2507.5	20825	V	9.52	10.70	-7.83	12.39	33.01
			H	17.46	10.70	-7.83	20.33	33.01
	2535.0	21100	V	8.93	10.73	-7.86	11.80	33.01
			H	17.39	10.73	-7.86	20.27	33.01
	2562.5	21375	V	9.85	10.77	-7.89	12.72	33.01
			H	18.71	10.77	-7.89	<b>21.58</b>	33.01
<b>BAND 7 BW: 15M QPSK RB: 1,74</b>	2507.5	20825	V	9.87	10.72	-7.85	12.74	33.01
			H	17.88	10.72	-7.85	<b>20.75</b>	33.01
	2535.0	21100	V	8.29	10.75	-7.88	11.16	33.01
			H	17.74	10.75	-7.88	20.61	33.01
	2562.5	21375	V	9.67	10.78	-7.91	12.55	33.01
			H	17.62	10.78	-7.91	20.50	33.01
<b>BAND 7 BW: 15M 16QAM RB: 1,0</b>	2507.5	20825	V	10.62	10.70	-7.83	13.49	33.01
			H	18.29	10.70	-7.83	21.16	33.01
	2535.0	21100	V	10.00	10.73	-7.86	12.87	33.01
			H	18.37	10.73	-7.86	21.24	33.01
	2562.5	21375	V	9.68	10.77	-7.89	2.88	33.01
			H	18.45	10.77	-7.89	<b>21.33</b>	33.01
<b>BAND 7 BW: 15M 16QAM RB: 1,74</b>	2507.5	20825	V	10.96	10.72	-7.85	13.84	33.01
			H	18.99	10.72	-7.85	<b>21.86</b>	33.01
	2535.0	21100	V	9.21	10.75	-7.88	12.08	33.01
			H	18.43	10.75	-7.88	21.30	33.01
	2562.5	21375	V	9.69	10.78	-7.91	12.56	33.01
			H	17.75	10.78	-7.91	20.63	33.01

The RBW,VBW of SPA for frequency RBW= 8MHz , VBW= 8MHz

Unless otherwise stated the results shown in this test report refer only to the sample(s) tested and such sample(s) are retained for 90 days only.

除非另有說明，此報告結果僅對測試之樣品負責，同時此樣品僅保留90天。本報告未經本公司書面許可，不可部份複製。

This document is issued by the Company subject to its General Conditions of Service printed overleaf, available on request or accessible at [www.sgs.com/terms\\_and\\_conditions.htm](http://www.sgs.com/terms_and_conditions.htm) and, for electronic format documents, subject to Terms and Conditions for Electronic Documents at [www.sgs.com/terms\\_e-document.htm](http://www.sgs.com/terms_e-document.htm). Attention is drawn to the limitation of liability, indemnification and jurisdiction issues defined therein. Any holder of this document is advised that information contained hereon reflects the Company's findings at the time of its intervention only and within the limits of Client's instructions, if any. The Company's sole responsibility is to its Client and this document does not exonerate parties to a transaction from exercising all their rights and obligations under the transaction documents. This document cannot be reproduced except in full, without prior written approval of the Company. Any unauthorized alteration, forgery or falsification of the content or appearance of this document is unlawful and offenders may be prosecuted to the fullest extent of the law.

SGS Taiwan Ltd.

No.134,WuKungRoad,NewTaipeiIndustrialPark,WukuDistrict,NewTaipeiCity,Taiwan24803/新北市五股區新北產業園區五工路 134 號

台灣檢驗科技股份有限公司

t (886-2) 2299-3279

f (886-2) 2298-0488

www.tw.sgs.com

Member of SGS Group

EUT			Measurement					
Operation Band	Fundamental Frequency MHz	CH	Antenna Pol. V/H	S.G. Output dBm	Antenna Gain dBi	Cable Loss dB	EIRP dBm	Limit dBm
<b>BAND 7 BW: 15M 16QAM RB: 1,0</b>	2507.5	20825	V	11.16	10.70	-7.83	14.03	33.01
			H	18.87	10.70	-7.83	21.74	33.01
	2535.0	21100	V	10.38	10.73	-7.86	13.25	33.01
			H	18.60	10.73	-7.86	21.47	33.01
	2562.5	21375	V	11.86	10.77	-7.89	14.74	33.01
			H	20.41	10.77	-7.89	<b>23.28</b>	33.01
<b>BAND 7 BW: 15M 16QAM RB: 1,74</b>	2507.5	20825	V	11.40	10.72	-7.85	14.27	33.01
			H	19.36	10.72	-7.85	<b>22.23</b>	33.01
	2535.0	21100	V	10.24	10.75	-7.88	13.11	33.01
			H	18.38	10.75	-7.88	21.25	33.01
	2562.5	21375	V	11.44	10.78	-7.91	14.31	33.01
			H	19.34	10.78	-7.91	22.22	33.01

The RBW,VBW of SPA for frequency RBW= 8MHz , VBW= 8MHz

Unless otherwise stated the results shown in this test report refer only to the sample(s) tested and such sample(s) are retained for 90 days only.

除非另有說明，此報告結果僅對測試之樣品負責，同時此樣品僅保留90天。本報告未經本公司書面許可，不可部份複製。

This document is issued by the Company subject to its General Conditions of Service printed overleaf, available on request or accessible at [www.sgs.com/terms\\_and\\_conditions.htm](http://www.sgs.com/terms_and_conditions.htm) and, for electronic format documents, subject to Terms and Conditions for Electronic Documents at [www.sgs.com/terms\\_e-document.htm](http://www.sgs.com/terms_e-document.htm). Attention is drawn to the limitation of liability, indemnification and jurisdiction issues defined therein. Any holder of this document is advised that information contained hereon reflects the Company's findings at the time of its intervention only and within the limits of Client's instructions, if any. The Company's sole responsibility is to its Client and this document does not exonerate parties to a transaction from exercising all their rights and obligations under the transaction documents. This document cannot be reproduced except in full, without prior written approval of the Company. Any unauthorized alteration, forgery or falsification of the content or appearance of this document is unlawful and offenders may be prosecuted to the fullest extent of the law.

SGS Taiwan Ltd.

No.134,WuKungRoad,NewTaipeiIndustrialPark,WukuDistrict,NewTaipeiCity,Taiwan24803/新北市五股區新北產業園區五工路 134 號

台灣檢驗科技股份有限公司

t (886-2) 2299-3279

f (886-2) 2298-0488

www.tw.sgs.com

Member of SGS Group

EUT			Measurement					
Operation Band	Fundamental Frequency MHz	CH	Antenna Pol. V/H	S.G. Output dBm	Antenna Gain dBi	Cable Loss dB	EIRP dBm	Limit dBm
<b>BAND 7 BW: 20M QPSK RB: 1,0</b>	2510.0	20850	V	9.65	10.70	-7.83	12.52	33.01
			H	17.74	10.70	-7.83	20.61	33.01
	2535.0	21100	V	9.06	10.73	-7.86	11.93	33.01
			H	17.71	10.73	-7.86	20.59	33.01
	2560.0	21350	V	9.22	10.76	-7.89	12.10	33.01
			H	18.03	10.76	-7.89	<b>20.90</b>	33.01
<b>BAND 7 BW: 20M QPSK RB: 1,99</b>	2510.0	20850	V	8.33	10.72	-7.85	11.20	33.01
			H	17.29	10.72	-7.85	20.16	33.01
	2535.0	21100	V	8.78	10.75	-7.88	11.66	33.01
			H	17.66	10.75	-7.88	20.54	33.01
	2560.0	21350	V	9.57	10.78	-7.91	12.45	33.01
			H	18.63	10.70	-7.83	<b>21.50</b>	33.01
<b>BAND 7 BW: 20M 16QAM RB: 1,0</b>	2510.0	20850	V	10.85	10.70	-7.83	13.72	33.01
			H	18.64	10.73	-7.86	21.51	33.01
	2535.0	21100	V	9.96	10.73	-7.86	12.84	33.01
			H	19.47	10.76	-7.89	<b>22.34</b>	33.01
	2560.0	21350	V	10.66	10.76	-7.89	13.53	33.01
			H	10.31	10.72	-7.85	13.18	33.01
<b>BAND 7 BW: 20M 16QAM RB: 1,99</b>	2510.0	20850	V	10.31	10.72	-7.85	13.18	33.01
			H	18.93	10.72	-7.85	<b>21.80</b>	33.01
	2535.0	21100	V	9.73	10.75	-7.88	12.60	33.01
			H	18.80	10.75	-7.88	21.68	33.01
	2560.0	21350	V	9.63	10.78	-7.91	12.50	33.01
			H	17.68	10.78	-7.91	20.56	33.01

The RBW,VBW of SPA for frequency RBW= 8MHz , VBW= 8MHz

Unless otherwise stated the results shown in this test report refer only to the sample(s) tested and such sample(s) are retained for 90 days only.

除非另有說明，此報告結果僅對測試之樣品負責，同時此樣品僅保留90天。本報告未經本公司書面許可，不可部份複製。

This document is issued by the Company subject to its General Conditions of Service printed overleaf, available on request or accessible at [www.sgs.com/terms\\_and\\_conditions.htm](http://www.sgs.com/terms_and_conditions.htm) and, for electronic format documents, subject to Terms and Conditions for Electronic Documents at [www.sgs.com/terms\\_e-document.htm](http://www.sgs.com/terms_e-document.htm). Attention is drawn to the limitation of liability, indemnification and jurisdiction issues defined therein. Any holder of this document is advised that information contained hereon reflects the Company's findings at the time of its intervention only and within the limits of Client's instructions, if any. The Company's sole responsibility is to its Client and this document does not exonerate parties to a transaction from exercising all their rights and obligations under the transaction documents. This document cannot be reproduced except in full, without prior written approval of the Company. Any unauthorized alteration, forgery or falsification of the content or appearance of this document is unlawful and offenders may be prosecuted to the fullest extent of the law.

SGS Taiwan Ltd.

No.134,WuKungRoad,NewTaipeiIndustrialPark,WukuDistrict,NewTaipeiCity,Taiwan24803/新北市五股區新北產業園區五工路 134 號

台灣檢驗科技股份有限公司

t (886-2) 2299-3279

f (886-2) 2298-0488

www.tw.sgs.com

Member of SGS Group

EUT			Measurement					
Operation Band	Fundamental Frequency MHz	CH	Antenna Pol. V/H	S.G. Output dBm	Antenna Gain dBi	Cable Loss dB	EIRP dBm	Limit dBm
<b>BAND 7 BW: 20M 64QAM RB: 1,0</b>	2510.0	20850	V	11.24	10.70	-7.83	14.11	33.01
			H	19.03	10.70	-7.83	21.90	33.01
	2535.0	21100	V	10.58	10.73	-7.86	13.46	33.01
			H	19.10	10.73	-7.86	21.97	33.01
	2560.0	21350	V	11.68	10.76	-7.89	14.56	33.01
			H	20.19	10.76	-7.89	<b>23.06</b>	33.01
<b>BAND 7 BW: 20M 64QAM RB: 1,99</b>	2510.0	20850	V	11.12	10.72	-7.85	13.99	33.01
			H	19.96	10.72	-7.85	<b>22.83</b>	33.01
	2535.0	21100	V	9.93	10.75	-7.88	12.81	33.01
			H	19.00	10.75	-7.88	21.88	33.01
	2560.0	21350	V	11.53	10.78	-7.91	14.41	33.01
			H	19.50	10.78	-7.91	22.37	33.01

The RBW,VBW of SPA for frequency RBW= 8MHz , VBW= 8MHz

Unless otherwise stated the results shown in this test report refer only to the sample(s) tested and such sample(s) are retained for 90 days only.

除非另有說明，此報告結果僅對測試之樣品負責，同時此樣品僅保留90天。本報告未經本公司書面許可，不可部份複製。

This document is issued by the Company subject to its General Conditions of Service printed overleaf, available on request or accessible at [www.sgs.com/terms\\_and\\_conditions.htm](http://www.sgs.com/terms_and_conditions.htm) and, for electronic format documents, subject to Terms and Conditions for Electronic Documents at [www.sgs.com/terms\\_e-document.htm](http://www.sgs.com/terms_e-document.htm). Attention is drawn to the limitation of liability, indemnification and jurisdiction issues defined therein. Any holder of this document is advised that information contained hereon reflects the Company's findings at the time of its intervention only and within the limits of Client's instructions, if any. The Company's sole responsibility is to its Client and this document does not exonerate parties to a transaction from exercising all their rights and obligations under the transaction documents. This document cannot be reproduced except in full, without prior written approval of the Company. Any unauthorized alteration, forgery or falsification of the content or appearance of this document is unlawful and offenders may be prosecuted to the fullest extent of the law.

SGS Taiwan Ltd.

No.134,WuKungRoad,NewTaipeiIndustrialPark,WukuDistrict,NewTaipeiCity,Taiwan24803/新北市五股區新北產業園區五工路 134 號

台灣檢驗科技股份有限公司

t (886-2) 2299-3279

f (886-2) 2298-0488

www.tw.sgs.com

Member of SGS Group

EUT			Measurement					
Operation Band	Fundamental Frequency MHz	CH	Antenna Pol. V/H	S.G. Output dBm	Antenna Gain dBi	Cable Loss dB	EIRP dBm	Limit dBm
<b>BAND 38 BW: 5M QPSK RB: 1,0</b>	2572.5	37775	V	13.55	10.78	-7.91	16.43	33.00
			H	21.46	10.79	-7.91	<b>24.33</b>	33.00
	2595.0	38000	V	13.34	10.81	-7.93	16.22	33.00
			H	19.43	10.81	-7.93	22.31	33.00
	2617.5	38225	V	15.26	10.84	-7.96	18.14	33.00
			H	20.14	10.84	-7.96	23.02	33.00
<b>BAND 38 BW: 5M QPSK RB: 1,24</b>	2572.5	37775	V	14.06	10.79	-7.91	16.94	33.00
			H	19.64	10.79	-7.91	22.52	33.00
	2595.0	38000	V	13.52	10.82	-7.94	16.40	33.00
			H	20.02	10.82	-7.94	22.90	33.00
	2617.5	38225	V	14.79	10.84	-7.96	17.67	33.00
			H	20.26	10.84	-7.96	<b>23.14</b>	33.00
<b>BAND 38 BW: 5M 16QAM RB: 1,0</b>	2572.5	37775	V	13.26	10.78	-7.91	16.13	33.00
			H	20.34	10.78	-7.90	<b>23.21</b>	33.00
	2595.0	38000	V	13.25	10.81	-7.93	16.13	33.00
			H	14.95	10.84	-7.96	17.83	33.00
	2617.5	38225	V	20.27	10.84	-7.96	23.15	33.00
			H	13.32	10.79	-7.91	16.20	33.00
<b>BAND 38 BW: 5M 16QAM RB: 1,24</b>	2572.5	37775	V	13.32	10.79	-7.91	16.20	33.00
			H	20.03	10.79	-7.91	22.91	33.00
	2595.0	38000	V	13.38	10.82	-7.94	16.26	33.00
			H	20.06	10.82	-7.94	22.94	33.00
	2617.5	38225	V	14.83	10.84	-7.96	17.71	33.00
			H	20.42	10.84	-7.96	<b>23.30</b>	33.00

The RBW,VBW of SPA for frequency RBW= 8MHz , VBW= 8MHz

Unless otherwise stated the results shown in this test report refer only to the sample(s) tested and such sample(s) are retained for 90 days only.

除非另有說明，此報告結果僅對測試之樣品負責，同時此樣品僅保留90天。本報告未經本公司書面許可，不可部份複製。

This document is issued by the Company subject to its General Conditions of Service printed overleaf, available on request or accessible at [www.sgs.com/terms\\_and\\_conditions.htm](http://www.sgs.com/terms_and_conditions.htm) and, for electronic format documents, subject to Terms and Conditions for Electronic Documents at [www.sgs.com/terms\\_e-document.htm](http://www.sgs.com/terms_e-document.htm). Attention is drawn to the limitation of liability, indemnification and jurisdiction issues defined therein. Any holder of this document is advised that information contained hereon reflects the Company's findings at the time of its intervention only and within the limits of Client's instructions, if any. The Company's sole responsibility is to its Client and this document does not exonerate parties to a transaction from exercising all their rights and obligations under the transaction documents. This document cannot be reproduced except in full, without prior written approval of the Company. Any unauthorized alteration, forgery or falsification of the content or appearance of this document is unlawful and offenders may be prosecuted to the fullest extent of the law.

SGS Taiwan Ltd.

No.134,WuKungRoad,NewTaipeiIndustrialPark,WukuDistrict,NewTaipeiCity,Taiwan24803/新北市五股區新北產業園區五工路 134 號

台灣檢驗科技股份有限公司

t (886-2) 2299-3279

f (886-2) 2298-0488

www.tw.sgs.com

Member of SGS Group

EUT			Measurement					
Operation Band	Fundamental Frequency MHz	CH	Antenna Pol. V/H	S.G. Output dBm	Antenna Gain dBi	Cable Loss dB	EIRP dBm	Limit dBm
<b>BAND 38 BW: 5M 64QAM RB: 1,0</b>	2572.5	37775	V	13.61	10.79	-7.91	16.49	33.00
			H	20.17	10.78	-7.91	23.04	33.00
	2595.0	38000	V	13.28	10.81	-7.93	16.16	33.00
			H	19.62	10.81	-7.93	22.50	33.00
	2617.5	38225	V	15.06	10.84	-7.96	17.95	33.00
			H	20.33	10.84	-7.96	<b>23.21</b>	33.00
<b>BAND 38 BW: 5M 64QAM RB: 1,24</b>	2572.5	37775	V	13.61	10.79	-7.91	16.49	33.00
			H	20.17	10.78	-7.91	23.04	33.00
	2595.0	38000	V	13.28	10.81	-7.93	16.16	33.00
			H	19.62	10.81	-7.93	22.50	33.00
	2617.5	38225	V	15.06	10.84	-7.96	17.95	33.00
			H	20.33	10.84	-7.96	<b>23.21</b>	33.00

The RBW,VBW of SPA for frequency RBW= 8MHz , VBW= 8MHz

Unless otherwise stated the results shown in this test report refer only to the sample(s) tested and such sample(s) are retained for 90 days only.

除非另有說明，此報告結果僅對測試之樣品負責，同時此樣品僅保留90天。本報告未經本公司書面許可，不可部份複製。

This document is issued by the Company subject to its General Conditions of Service printed overleaf, available on request or accessible at [www.sgs.com/terms\\_and\\_conditions.htm](http://www.sgs.com/terms_and_conditions.htm) and, for electronic format documents, subject to Terms and Conditions for Electronic Documents at [www.sgs.com/terms\\_e-document.htm](http://www.sgs.com/terms_e-document.htm). Attention is drawn to the limitation of liability, indemnification and jurisdiction issues defined therein. Any holder of this document is advised that information contained hereon reflects the Company's findings at the time of its intervention only and within the limits of Client's instructions, if any. The Company's sole responsibility is to its Client and this document does not exonerate parties to a transaction from exercising all their rights and obligations under the transaction documents. This document cannot be reproduced except in full, without prior written approval of the Company. Any unauthorized alteration, forgery or falsification of the content or appearance of this document is unlawful and offenders may be prosecuted to the fullest extent of the law.

SGS Taiwan Ltd.

No.134,WuKungRoad,NewTaipeiIndustrialPark,WukuDistrict,NewTaipeiCity,Taiwan24803/新北市五股區新北產業園區五工路 134 號

台灣檢驗科技股份有限公司

t (886-2) 2299-3279

f (886-2) 2298-0488

www.tw.sgs.com

Member of SGS Group

EUT			Measurement					
Operation Band	Fundamental Frequency MHz	CH	Antenna Pol. V/H	S.G. Output dBm	Antenna Gain dBi	Cable Loss dB	EIRP dBm	Limit dBm
<b>BAND 38 BW: 10M QPSK RB: 1,0</b>	2575.0	37800	V	8.43	10.78	-7.91	11.31	33.00
			H	18.10	10.78	-7.91	20.98	33.00
	2595.0	38000	V	7.86	10.81	-7.93	10.74	33.00
			H	16.93	10.81	-7.93	19.81	33.00
	2615.0	38200	V	9.93	10.83	-7.95	12.81	33.00
			H	18.24	10.83	-7.95	21.12	33.00
<b>BAND 38 BW: 10M QPSK RB: 1,49</b>	2575.0	37800	V	7.96	10.80	-7.92	10.84	33.00
			H	17.40	10.80	-7.92	20.28	33.00
	2595.0	38000	V	7.99	10.82	-7.94	10.87	33.00
			H	17.77	10.82	-7.94	20.65	33.00
	2615.0	38200	V	9.63	10.84	-7.96	12.51	33.00
			H	18.37	10.84	-7.96	21.26	33.00
<b>BAND 38 BW: 10M 16QAM RB: 1,0</b>	2575.0	37800	V	7.95	10.78	-7.91	10.83	33.00
			H	18.19	10.78	-7.91	21.07	33.00
	2595.0	38000	V	7.79	10.81	-7.93	10.67	33.00
			H	17.04	10.81	-7.93	19.92	33.00
	2615.0	38200	V	9.69	10.83	-7.95	12.58	33.00
			H	18.30	10.83	-7.95	21.18	33.00
<b>BAND 38 BW: 10M 16QAM RB: 1,49</b>	2575.0	37800	V	8.33	10.80	-7.92	11.21	33.00
			H	17.30	10.80	-7.92	20.18	33.00
	2595.0	38000	V	8.06	10.82	-7.94	10.94	33.00
			H	17.82	10.82	-7.94	20.70	33.00
	2615.0	38200	V	9.50	10.84	-7.96	12.38	33.00
			H	18.45	10.84	-7.96	21.33	33.00

The RBW,VBW of SPA for frequency RBW= 8MHz , VBW= 8MHz

Unless otherwise stated the results shown in this test report refer only to the sample(s) tested and such sample(s) are retained for 90 days only.

除非另有說明，此報告結果僅對測試之樣品負責，同時此樣品僅保留90天。本報告未經本公司書面許可，不可部份複製。

This document is issued by the Company subject to its General Conditions of Service printed overleaf, available on request or accessible at [www.sgs.com/terms\\_and\\_conditions.htm](http://www.sgs.com/terms_and_conditions.htm) and, for electronic format documents, subject to Terms and Conditions for Electronic Documents at [www.sgs.com/terms\\_e-document.htm](http://www.sgs.com/terms_e-document.htm). Attention is drawn to the limitation of liability, indemnification and jurisdiction issues defined therein. Any holder of this document is advised that information contained hereon reflects the Company's findings at the time of its intervention only and within the limits of Client's instructions, if any. The Company's sole responsibility is to its Client and this document does not exonerate parties to a transaction from exercising all their rights and obligations under the transaction documents. This document cannot be reproduced except in full, without prior written approval of the Company. Any unauthorized alteration, forgery or falsification of the content or appearance of this document is unlawful and offenders may be prosecuted to the fullest extent of the law.

SGS Taiwan Ltd.

No.134,WuKungRoad,NewTaipeiIndustrialPark,WukuDistrict,NewTaipeiCity,Taiwan24803/新北市五股區新北產業園區五工路 134 號

台灣檢驗科技股份有限公司

t (886-2) 2299-3279

f (886-2) 2298-0488

www.tw.sgs.com

Member of SGS Group



EUT			Measurement					
Operation Band	Fundamental Frequency MHz	CH	Antenna Pol. V/H	S.G. Output dBm	Antenna Gain dBi	Cable Loss dB	EIRP dBm	Limit dBm
<b>BAND 38 BW: 10M 64QAM RB: 1,0</b>	2575.0	37800	V	7.80	10.79	-7.91	10.68	33.00
			H	18.36	10.78	-7.91	21.24	33.00
	2595.0	38000	V	7.82	10.81	-7.93	10.69	33.00
			H	17.17	10.81	-7.93	20.05	33.00
	2615.0	38200	V	9.74	10.83	-7.95	12.62	33.00
			H	18.37	10.83	-7.95	21.25	33.00
<b>BAND 38 BW: 10M 64QAM RB: 1,49</b>	2575.0	37800	V	8.02	10.80	-7.92	10.90	33.00
			H	17.44	10.80	-7.92	20.32	33.00
	2595.0	38000	V	8.20	10.82	-7.94	11.08	33.00
			H	17.81	10.82	-7.94	20.69	33.00
	2615.0	38200	V	9.72	10.84	-7.96	12.60	33.00
			H	18.50	10.84	-7.96	21.38	33.00

The RBW,VBW of SPA for frequency RBW= 8MHz , VBW= 8MHz

Unless otherwise stated the results shown in this test report refer only to the sample(s) tested and such sample(s) are retained for 90 days only.

除非另有說明，此報告結果僅對測試之樣品負責，同時此樣品僅保留90天。本報告未經本公司書面許可，不可部份複製。

This document is issued by the Company subject to its General Conditions of Service printed overleaf, available on request or accessible at [www.sgs.com/terms\\_and\\_conditions.htm](http://www.sgs.com/terms_and_conditions.htm) and, for electronic format documents, subject to Terms and Conditions for Electronic Documents at [www.sgs.com/terms\\_e-document.htm](http://www.sgs.com/terms_e-document.htm). Attention is drawn to the limitation of liability, indemnification and jurisdiction issues defined therein. Any holder of this document is advised that information contained hereon reflects the Company's findings at the time of its intervention only and within the limits of Client's instructions, if any. The Company's sole responsibility is to its Client and this document does not exonerate parties to a transaction from exercising all their rights and obligations under the transaction documents. This document cannot be reproduced except in full, without prior written approval of the Company. Any unauthorized alteration, forgery or falsification of the content or appearance of this document is unlawful and offenders may be prosecuted to the fullest extent of the law.

SGS Taiwan Ltd.

No.134,WuKungRoad,NewTaipeiIndustrialPark,WukuDistrict,NewTaipeiCity,Taiwan24803/新北市五股區新北產業園區五工路 134 號

台灣檢驗科技股份有限公司

t (886-2) 2299-3279

f (886-2) 2298-0488

www.tw.sgs.com

Member of SGS Group

EUT			Measurement					
Operation Band	Fundamental Frequency MHz	CH	Antenna Pol. V/H	S.G. Output dBm	Antenna Gain dBi	Cable Loss dB	EIRP dBm	Limit dBm
<b>BAND 38 BW: 15M QPSK RB: 1,0</b>	2577.5	37825	V	10.76	10.78	-7.91	13.63	33.00
			H	17.56	10.79	-7.91	20.44	33.00
	2595.0	38000	V	10.54	10.81	-7.93	13.42	33.00
			H	16.68	10.81	-7.93	19.56	33.00
	2612.5	38175	V	11.42	10.83	-7.95	14.30	33.00
			H	17.98	10.83	-7.95	<b>20.86</b>	33.00
<b>BAND 38 BW: 15M QPSK RB: 1,74</b>	2577.5	37825	V	10.12	10.80	-7.92	13.00	33.00
			H	17.11	10.80	-7.92	19.99	33.00
	2595.0	38000	V	10.97	10.82	-7.94	13.85	33.00
			H	17.18	10.82	-7.94	20.06	33.00
	2612.5	38175	V	12.19	10.84	-7.96	15.08	33.00
			H	18.44	10.84	-7.96	<b>21.32</b>	33.00
<b>BAND 38 BW: 15M 16QAM RB: 1,0</b>	2577.5	37825	V	10.50	10.79	-7.91	13.38	33.00
			H	17.44	10.78	-7.91	<b>20.32</b>	33.00
	2595.0	38000	V	10.31	10.81	-7.93	13.19	33.00
			H	16.72	10.81	-7.93	19.60	33.00
	2612.5	38175	V	11.43	10.83	-7.95	14.31	33.00
			H	17.33	10.83	-7.95	20.22	33.00
<b>BAND 38 BW: 15M 16QAM RB: 1,74</b>	2577.5	37825	V	10.14	10.80	-7.92	13.02	33.00
			H	16.96	10.80	-7.92	19.84	33.00
	2595.0	38000	V	11.11	10.82	-7.94	13.99	33.00
			H	17.16	10.82	-7.94	20.04	33.00
	2612.5	38175	V	18.75	10.84	-7.96	<b>21.64</b>	33.00
			H	11.93	10.84	-7.96	14.82	33.00

The RBW,VBW of SPA for frequency RBW= 8MHz , VBW= 8MHz

Unless otherwise stated the results shown in this test report refer only to the sample(s) tested and such sample(s) are retained for 90 days only.

除非另有說明，此報告結果僅對測試之樣品負責，同時此樣品僅保留90天。本報告未經本公司書面許可，不可部份複製。

This document is issued by the Company subject to its General Conditions of Service printed overleaf, available on request or accessible at [www.sgs.com/terms\\_and\\_conditions.htm](http://www.sgs.com/terms_and_conditions.htm) and, for electronic format documents, subject to Terms and Conditions for Electronic Documents at [www.sgs.com/terms\\_e-document.htm](http://www.sgs.com/terms_e-document.htm). Attention is drawn to the limitation of liability, indemnification and jurisdiction issues defined therein. Any holder of this document is advised that information contained hereon reflects the Company's findings at the time of its intervention only and within the limits of Client's instructions, if any. The Company's sole responsibility is to its Client and this document does not exonerate parties to a transaction from exercising all their rights and obligations under the transaction documents. This document cannot be reproduced except in full, without prior written approval of the Company. Any unauthorized alteration, forgery or falsification of the content or appearance of this document is unlawful and offenders may be prosecuted to the fullest extent of the law.

SGS Taiwan Ltd.

No.134,WuKungRoad,NewTaipeiIndustrialPark,WukuDistrict,NewTaipeiCity,Taiwan24803/新北市五股區新北產業園區五工路 134 號

台灣檢驗科技股份有限公司

t (886-2) 2299-3279

f (886-2) 2298-0488

www.tw.sgs.com

Member of SGS Group

EUT			Measurement					
Operation Band	Fundamental Frequency MHz	CH	Antenna Pol. V/H	S.G. Output dBm	Antenna Gain dBi	Cable Loss dB	EIRP dBm	Limit dBm
<b>BAND 38 BW: 15M 64QAM RB: 1,0</b>	2577.5	37825	V	10.48	10.79	-7.91	13.36	33.00
			H	17.48	10.78	-7.91	<b>20.36</b>	33.00
	2595.0	38000	V	10.33	10.81	-7.93	13.21	33.00
			H	16.65	10.81	-7.93	19.53	33.00
	2612.5	38175	V	11.81	10.83	-7.95	14.69	33.00
			H	17.40	10.83	-7.95	20.28	33.00
<b>BAND 38 BW: 15M 64QAM RB: 1,74</b>	2577.5	37825	V	10.12	10.80	-7.92	13.00	33.00
			H	16.98	10.80	-7.92	19.86	33.00
	2595.0	38000	V	14.14	11.26	-7.94	17.47	33.00
			H	17.05	10.82	-7.94	19.93	33.00
	2612.5	38175	V	11.94	10.84	-7.96	14.83	33.00
			H	18.75	10.84	-7.96	<b>21.63</b>	33.00

The RBW,VBW of SPA for frequency RBW= 8MHz , VBW= 8MHz

Unless otherwise stated the results shown in this test report refer only to the sample(s) tested and such sample(s) are retained for 90 days only.

除非另有說明，此報告結果僅對測試之樣品負責，同時此樣品僅保留90天。本報告未經本公司書面許可，不可部份複製。

This document is issued by the Company subject to its General Conditions of Service printed overleaf, available on request or accessible at [www.sgs.com/terms\\_and\\_conditions.htm](http://www.sgs.com/terms_and_conditions.htm) and, for electronic format documents, subject to Terms and Conditions for Electronic Documents at [www.sgs.com/terms\\_e-document.htm](http://www.sgs.com/terms_e-document.htm). Attention is drawn to the limitation of liability, indemnification and jurisdiction issues defined therein. Any holder of this document is advised that information contained hereon reflects the Company's findings at the time of its intervention only and within the limits of Client's instructions, if any. The Company's sole responsibility is to its Client and this document does not exonerate parties to a transaction from exercising all their rights and obligations under the transaction documents. This document cannot be reproduced except in full, without prior written approval of the Company. Any unauthorized alteration, forgery or falsification of the content or appearance of this document is unlawful and offenders may be prosecuted to the fullest extent of the law.

SGS Taiwan Ltd.

No.134,WuKungRoad,NewTaipeiIndustrialPark,WukuDistrict,NewTaipeiCity,Taiwan24803/新北市五股區新北產業園區五工路 134 號

台灣檢驗科技股份有限公司

t (886-2) 2299-3279

f (886-2) 2298-0488

www.tw.sgs.com

Member of SGS Group

EUT			Measurement					
Operation Band	Fundamental Frequency MHz	CH	Antenna Pol. V/H	S.G. Output dBm	Antenna Gain dBi	Cable Loss dB	EIRP dBm	Limit dBm
<b>BAND 38 BW: 20M QPSK RB: 1,0</b>	2580.0	37850	V	10.72	10.79	-7.91	13.60	33.00
			H	17.60	10.79	-7.91	<b>20.48</b>	33.00
	2595.0	38000	V	10.54	10.80	-7.92	13.42	33.00
			H	17.15	10.80	-7.93	20.03	33.00
	2610.0	38150	V	11.64	10.82	-7.94	14.52	33.00
			H	17.15	10.82	-7.94	20.03	33.00
<b>BAND 38 BW: 20M QPSK RB: 1,99</b>	2580.0	37850	V	10.80	-7.92	-7.92	12.89	33.00
			H	17.16	10.80	-7.92	20.04	33.00
	2595.0	38000	V	17.45	10.83	-7.94	20.33	33.00
			H	11.23	10.82	-7.94	14.11	33.00
	2610.0	38150	V	11.80	10.84	-7.96	14.69	33.00
			H	18.72	10.84	-7.96	<b>21.60</b>	33.00
<b>BAND 38 BW: 20M 16QAM RB: 1,0</b>	2580.0	37850	V	10.55	10.79	-7.91	13.43	33.00
			H	17.40	10.79	-7.91	<b>20.28</b>	33.00
	2595.0	38000	V	10.55	10.80	-7.93	13.42	33.00
			H	16.88	10.80	-7.93	19.76	33.00
	2610.0	38150	V	11.47	10.82	-7.94	14.35	33.00
			H	17.15	10.82	-7.94	20.03	33.00
<b>BAND 38 BW: 20M 16QAM RB: 1,74</b>	2580.0	37850	V	10.00	10.80	-7.92	12.88	33.00
			H	17.00	10.80	-7.92	19.88	33.00
	2595.0	38000	V	11.31	10.83	-7.94	14.19	33.00
			H	17.43	10.83	-7.94	20.32	33.00
	2610.0	38150	V	11.85	10.84	-7.96	14.73	33.00
			H	18.81	10.84	-7.96	<b>21.70</b>	33.00

The RBW,VBW of SPA for frequency RBW= 8MHz , VBW= 8MHz

Unless otherwise stated the results shown in this test report refer only to the sample(s) tested and such sample(s) are retained for 90 days only.

除非另有說明，此報告結果僅對測試之樣品負責，同時此樣品僅保留90天。本報告未經本公司書面許可，不可部份複製。

This document is issued by the Company subject to its General Conditions of Service printed overleaf, available on request or accessible at [www.sgs.com/terms\\_and\\_conditions.htm](http://www.sgs.com/terms_and_conditions.htm) and, for electronic format documents, subject to Terms and Conditions for Electronic Documents at [www.sgs.com/terms\\_e-document.htm](http://www.sgs.com/terms_e-document.htm). Attention is drawn to the limitation of liability, indemnification and jurisdiction issues defined therein. Any holder of this document is advised that information contained hereon reflects the Company's findings at the time of its intervention only and within the limits of Client's instructions, if any. The Company's sole responsibility is to its Client and this document does not exonerate parties to a transaction from exercising all their rights and obligations under the transaction documents. This document cannot be reproduced except in full, without prior written approval of the Company. Any unauthorized alteration, forgery or falsification of the content or appearance of this document is unlawful and offenders may be prosecuted to the fullest extent of the law.

SGS Taiwan Ltd.

No.134,WuKungRoad,NewTaipeiIndustrialPark,WukuDistrict,NewTaipeiCity,Taiwan24803/新北市五股區新北產業園區五工路 134 號

台灣檢驗科技股份有限公司

t (886-2) 2299-3279

f (886-2) 2298-0488

www.tw.sgs.com

Member of SGS Group

EUT			Measurement					
Operation Band	Fundamental Frequency MHz	CH	Antenna Pol. V/H	S.G. Output dBm	Antenna Gain dBi	Cable Loss dB	EIRP dBm	Limit dBm
<b>BAND 38 BW: 20M 64QAM RB: 1,0</b>	2580.0	37850	V	10.45	10.79	-7.91	13.32	33.00
			H	17.56	10.79	-7.91	<b>20.44</b>	33.00
	2595.0	38000	V	10.52	10.80	-7.92	13.40	33.00
			H	17.01	10.80	-7.92	19.89	33.00
	2610.0	38150	V	11.53	10.82	-7.94	14.41	33.00
			H	17.19	10.82	-7.94	20.07	33.00
<b>BAND 38 BW: 20M 64QAM RB: 1,99</b>	2580.0	37850	V	10.00	10.81	-7.93	12.88	33.00
			H	16.78	10.81	-7.93	19.66	33.00
	2595.0	38000	V	11.42	10.82	-7.94	14.30	33.00
			H	17.49	10.82	-7.94	20.37	33.00
	2610.0	38150	V	12.01	10.84	-7.96	14.90	33.00
			H	18.73	10.84	-7.96	<b>21.61</b>	33.00

The RBW,VBW of SPA for frequency RBW= 8MHz , VBW= 8MHz

Unless otherwise stated the results shown in this test report refer only to the sample(s) tested and such sample(s) are retained for 90 days only.

除非另有說明，此報告結果僅對測試之樣品負責，同時此樣品僅保留90天。本報告未經本公司書面許可，不可部份複製。

This document is issued by the Company subject to its General Conditions of Service printed overleaf, available on request or accessible at [www.sgs.com/terms\\_and\\_conditions.htm](http://www.sgs.com/terms_and_conditions.htm) and, for electronic format documents, subject to Terms and Conditions for Electronic Documents at [www.sgs.com/terms\\_e-document.htm](http://www.sgs.com/terms_e-document.htm). Attention is drawn to the limitation of liability, indemnification and jurisdiction issues defined therein. Any holder of this document is advised that information contained hereon reflects the Company's findings at the time of its intervention only and within the limits of Client's instructions, if any. The Company's sole responsibility is to its Client and this document does not exonerate parties to a transaction from exercising all their rights and obligations under the transaction documents. This document cannot be reproduced except in full, without prior written approval of the Company. Any unauthorized alteration, forgery or falsification of the content or appearance of this document is unlawful and offenders may be prosecuted to the fullest extent of the law.

SGS Taiwan Ltd.

No.134,WuKungRoad,NewTaipeiIndustrialPark,WukuDistrict,NewTaipeiCity,Taiwan24803/新北市五股區新北產業園區五工路 134 號

台灣檢驗科技股份有限公司

t (886-2) 2299-3279

f (886-2) 2298-0488

www.tw.sgs.com

Member of SGS Group

EUT			Measurement					
Operation Band	Fundamental Frequency	CH	Antenna Pol.	S.G. Output	Antenna Gain	Cable Loss	EIRP	Limit
	MHz		V/H	dBm	dBi	dB	dBm	dBm
<b>BAND 41 BW: 5M QPSK RB: 1,0</b>	2498.5	39675	V	10.25	10.70	-7.83	13.12	33.01
			H	14.77	10.70	-7.83	17.64	33.01
	2593.0	40620	V	9.51	10.81	-7.93	12.39	33.01
			H	16.24	10.81	-7.93	19.12	33.01
	2687.5	41565	V	10.86	10.92	-8.03	13.76	33.01
			H	17.17	10.92	-8.03	<b>20.07</b>	33.01
<b>BAND 41 BW: 5M QPSK RB: 1,24</b>	2498.5	39675	V	8.70	10.70	-7.83	11.57	33.01
			H	15.23	10.70	-7.83	18.10	33.01
	2593.0	40620	V	9.43	10.81	-7.93	12.31	33.01
			H	16.37	10.81	-7.93	19.24	33.01
	2687.5	41565	V	9.14	10.93	-8.03	12.04	33.01
			H	17.54	10.93	-8.03	<b>20.44</b>	33.01
<b>BAND 41 BW: 5M 16QAM RB: 1,0</b>	2498.5	39675	V	9.85	10.70	-7.83	12.72	33.01
			H	14.26	10.70	-7.83	17.13	33.01
	2593.0	40620	V	9.13	10.81	-7.93	12.01	33.01
			H	16.29	10.81	-7.93	19.17	33.01
	2687.5	41565	V	10.42	10.92	-8.03	13.32	33.01
			H	16.89	10.92	-8.03	<b>19.78</b>	33.01
<b>BAND 41 BW: 5M 16QAM RB: 1,24</b>	2498.5	39675	V	8.35	10.70	-7.83	11.22	33.01
			H	14.85	10.70	-7.83	17.72	33.01
	2593.0	40620	V	9.23	10.81	-7.94	12.11	33.01
			H	16.38	10.81	-7.94	19.26	33.01
	2687.5	41565	V	8.76	10.93	-8.03	11.66	33.01
			H	17.06	10.93	-8.03	<b>19.96</b>	33.01

The RBW,VBW of SPA for frequency RBW= 8MHz , VBW= 8MHz

Unless otherwise stated the results shown in this test report refer only to the sample(s) tested and such sample(s) are retained for 90 days only.

除非另有說明，此報告結果僅對測試之樣品負責，同時此樣品僅保留90天。本報告未經本公司書面許可，不可部份複製。

This document is issued by the Company subject to its General Conditions of Service printed overleaf, available on request or accessible at [www.sgs.com/terms\\_and\\_conditions.htm](http://www.sgs.com/terms_and_conditions.htm) and, for electronic format documents, subject to Terms and Conditions for Electronic Documents at [www.sgs.com/terms\\_e-document.htm](http://www.sgs.com/terms_e-document.htm). Attention is drawn to the limitation of liability, indemnification and jurisdiction issues defined therein. Any holder of this document is advised that information contained hereon reflects the Company's findings at the time of its intervention only and within the limits of Client's instructions, if any. The Company's sole responsibility is to its Client and this document does not exonerate parties to a transaction from exercising all their rights and obligations under the transaction documents. This document cannot be reproduced except in full, without prior written approval of the Company. Any unauthorized alteration, forgery or falsification of the content or appearance of this document is unlawful and offenders may be prosecuted to the fullest extent of the law.

SGS Taiwan Ltd.

No.134,WuKungRoad,NewTaipeiIndustrialPark,WukuDistrict,NewTaipeiCity,Taiwan24803/新北市五股區新北產業園區五工路 134 號

台灣檢驗科技股份有限公司

t (886-2) 2299-3279

f (886-2) 2298-0488

www.tw.sgs.com

Member of SGS Group

EUT			Measurement					
Operation Band	Fundamental Frequency	CH	Antenna Pol.	S.G. Output	Antenna Gain	Cable Loss	EIRP	Limit
	MHz		V/H	dBm	dBi	dB	dBm	dBm
<b>BAND 41 BW: 5M 64QAM RB: 1,0</b>	2498.5	39675	V	9.90	10.70	-7.83	12.77	33.01
			H	14.59	10.70	-7.83	17.46	33.01
	2593.0	40620	V	9.20	10.81	-7.93	12.08	33.01
			H	16.45	10.81	-7.93	19.33	33.01
	2687.5	41565	V	10.45	10.92	-8.03	13.34	33.01
			H	16.80	10.92	-8.03	<b>19.70</b>	33.01
<b>BAND 41 BW: 5M 64QAM RB: 1,24</b>	2498.5	39675	V	8.47	10.70	-7.83	11.34	33.01
			H	14.96	10.70	-7.83	17.83	33.01
	2593.0	40620	V	9.38	10.81	-7.93	12.26	33.01
			H	16.42	10.81	-7.93	19.30	33.01
	2687.5	41565	V	8.89	10.93	-8.03	11.79	33.01
			H	17.04	10.93	-8.03	<b>19.94</b>	33.01

The RBW,VBW of SPA for frequency RBW= 8MHz , VBW= 8MHz

Unless otherwise stated the results shown in this test report refer only to the sample(s) tested and such sample(s) are retained for 90 days only.

除非另有說明，此報告結果僅對測試之樣品負責，同時此樣品僅保留90天。本報告未經本公司書面許可，不可部份複製。

This document is issued by the Company subject to its General Conditions of Service printed overleaf, available on request or accessible at [www.sgs.com/terms\\_and\\_conditions.htm](http://www.sgs.com/terms_and_conditions.htm) and, for electronic format documents, subject to Terms and Conditions for Electronic Documents at [www.sgs.com/terms\\_e-document.htm](http://www.sgs.com/terms_e-document.htm). Attention is drawn to the limitation of liability, indemnification and jurisdiction issues defined therein. Any holder of this document is advised that information contained hereon reflects the Company's findings at the time of its intervention only and within the limits of Client's instructions, if any. The Company's sole responsibility is to its Client and this document does not exonerate parties to a transaction from exercising all their rights and obligations under the transaction documents. This document cannot be reproduced except in full, without prior written approval of the Company. Any unauthorized alteration, forgery or falsification of the content or appearance of this document is unlawful and offenders may be prosecuted to the fullest extent of the law.

SGS Taiwan Ltd.

No.134,WuKungRoad,NewTaipeiIndustrialPark,WukuDistrict,NewTaipeiCity,Taiwan24803/新北市五股區新北產業園區五工路 134 號

台灣檢驗科技股份有限公司

t (886-2) 2299-3279

f (886-2) 2298-0488

[www.tw.sgs.com](http://www.tw.sgs.com)

Member of SGS Group

EUT			Measurement					
Operation Band	Fundamental Frequency	CH	Antenna Pol.	S.G. Output	Antenna Gain	Cable Loss	EIRP	Limit
	MHz		V/H	dBm	dBi	dB	dBm	dBm
<b>BAND 41 BW: 10M QPSK RB: 1,0</b>	2501.0	39700	V	9.68	10.70	-7.83	12.55	33.01
			H	14.46	10.70	-7.83	17.33	33.01
	2593.0	40620	V	9.56	10.81	-7.93	12.43	33.01
			H	16.56	10.81	-7.93	19.44	33.01
	2685.0	41540	V	12.07	10.92	-8.02	14.96	33.01
			H	16.24	10.92	-8.02	19.14	33.01
<b>BAND 41 BW: 10M QPSK RB: 1,49</b>	2501.0	39700	V	7.69	10.71	-7.84	10.56	33.01
			H	15.57	10.71	-7.84	18.44	33.01
	2593.0	40620	V	9.72	10.82	-7.94	12.60	33.01
			H	16.53	10.82	-7.94	19.41	33.01
	2685.0	41540	V	9.31	10.93	-8.03	12.21	33.01
			H	17.28	10.93	-8.03	20.18	33.01
<b>BAND 41 BW: 10M 16QAM RB: 1,0</b>	2501.0	39700	V	9.66	10.70	-7.83	12.54	33.01
			H	14.48	10.70	-7.83	17.35	33.01
	2593.0	40620	V	9.15	10.81	-7.93	12.03	33.01
			H	16.09	10.81	-7.93	18.97	33.01
	2685.0	41540	V	11.37	10.92	-8.02	14.27	33.01
			H	15.81	10.92	-8.02	18.71	33.01
<b>BAND 41 BW: 10M 16QAM RB: 1,49</b>	2501.0	39700	V	7.60	10.71	-7.84	10.47	33.01
			H	15.53	10.71	-7.84	18.40	33.01
	2593.0	40620	V	9.52	10.82	-7.94	12.40	33.01
			H	16.18	10.82	-7.94	19.06	33.01
	2685.0	41540	V	8.91	10.93	-8.03	11.81	33.01
			H	16.75	10.93	-8.03	19.64	33.01

The RBW,VBW of SPA for frequency RBW= 8MHz , VBW= 8MHz

Unless otherwise stated the results shown in this test report refer only to the sample(s) tested and such sample(s) are retained for 90 days only.

除非另有說明，此報告結果僅對測試之樣品負責，同時此樣品僅保留90天。本報告未經本公司書面許可，不可部份複製。

This document is issued by the Company subject to its General Conditions of Service printed overleaf, available on request or accessible at [www.sgs.com/terms\\_and\\_conditions.htm](http://www.sgs.com/terms_and_conditions.htm) and, for electronic format documents, subject to Terms and Conditions for Electronic Documents at [www.sgs.com/terms\\_e-document.htm](http://www.sgs.com/terms_e-document.htm). Attention is drawn to the limitation of liability, indemnification and jurisdiction issues defined therein. Any holder of this document is advised that information contained hereon reflects the Company's findings at the time of its intervention only and within the limits of Client's instructions, if any. The Company's sole responsibility is to its Client and this document does not exonerate parties to a transaction from exercising all their rights and obligations under the transaction documents. This document cannot be reproduced except in full, without prior written approval of the Company. Any unauthorized alteration, forgery or falsification of the content or appearance of this document is unlawful and offenders may be prosecuted to the fullest extent of the law.

SGS Taiwan Ltd.

No.134,WuKungRoad,NewTaipeiIndustrialPark,WukuDistrict,NewTaipeiCity,Taiwan24803/新北市五股區新北產業園區五工路 134 號

台灣檢驗科技股份有限公司

t (886-2) 2299-3279

f (886-2) 2298-0488

www.tw.sgs.com

Member of SGS Group



EUT			Measurement					
Operation Band	Fundamental Frequency	CH	Antenna Pol.	S.G. Output	Antenna Gain	Cable Loss	EIRP	Limit
	MHz		V/H	dBm	dBi	dB	dBm	dBm
<b>BAND 41 BW: 10M 64QAM RB: 1,0</b>	2501.0	39700	V	9.82	10.70	-7.83	12.69	33.01
			H	14.51	10.70	-7.83	17.38	33.01
	2593.0	40620	V	9.22	10.81	-7.93	12.10	33.01
			H	16.93	10.81	-7.93	<b>19.81</b>	33.01
	2685.0	41540	V	11.39	10.92	-8.02	14.29	33.01
			H	15.86	10.92	-8.02	18.75	33.01
<b>BAND 41 BW: 10M 64QAM RB: 1,49</b>	2501.0	39700	V	7.73	10.71	-7.84	10.60	33.01
			H	15.68	10.71	-7.84	18.55	33.01
	2593.0	40620	V	9.64	10.82	-7.94	12.52	33.01
			H	16.84	10.82	-7.94	<b>19.72</b>	33.01
	2685.0	41540	V	8.92	10.93	-8.03	11.82	33.01
			H	16.81	10.93	-8.03	19.70	33.01

The RBW,VBW of SPA for frequency RBW= 8MHz , VBW= 8MHz

Unless otherwise stated the results shown in this test report refer only to the sample(s) tested and such sample(s) are retained for 90 days only.

除非另有說明，此報告結果僅對測試之樣品負責，同時此樣品僅保留90天。本報告未經本公司書面許可，不可部份複製。

This document is issued by the Company subject to its General Conditions of Service printed overleaf, available on request or accessible at [www.sgs.com/terms\\_and\\_conditions.htm](http://www.sgs.com/terms_and_conditions.htm) and, for electronic format documents, subject to Terms and Conditions for Electronic Documents at [www.sgs.com/terms\\_e-document.htm](http://www.sgs.com/terms_e-document.htm). Attention is drawn to the limitation of liability, indemnification and jurisdiction issues defined therein. Any holder of this document is advised that information contained hereon reflects the Company's findings at the time of its intervention only and within the limits of Client's instructions, if any. The Company's sole responsibility is to its Client and this document does not exonerate parties to a transaction from exercising all their rights and obligations under the transaction documents. This document cannot be reproduced except in full, without prior written approval of the Company. Any unauthorized alteration, forgery or falsification of the content or appearance of this document is unlawful and offenders may be prosecuted to the fullest extent of the law.

SGS Taiwan Ltd.

No.134,WuKungRoad,NewTaipeiIndustrialPark,WukuDistrict,NewTaipeiCity,Taiwan24803/新北市五股區新北產業園區五工路 134 號

台灣檢驗科技股份有限公司

t (886-2) 2299-3279

f (886-2) 2298-0488

[www.tw.sgs.com](http://www.tw.sgs.com)

Member of SGS Group

EUT			Measurement					
Operation Band	Fundamental Frequency	CH	Antenna Pol.	S.G. Output	Antenna Gain	Cable Loss	EIRP	Limit
	MHz		V/H	dBm	dBi	dB	dBm	dBm
<b>BAND 41 BW: 15M QPSK RB: 1,0</b>	2503.5	39725	V	10.28	10.70	-7.83	13.15	33.01
			H	14.82	10.70	-7.83	17.69	33.01
	2593.0	40620	V	9.67	10.80	-7.92	12.55	33.01
			H	16.84	10.80	-7.92	19.72	33.01
	2682.5	41515	V	12.45	10.91	-8.02	15.34	33.01
			H	16.68	10.91	-8.02	19.58	33.01
<b>BAND 41 BW: 15M QPSK RB: 1,74</b>	2503.5	39725	V	8.04	10.71	-7.84	10.91	33.01
			H	17.03	10.71	-7.84	19.90	33.01
	2593.0	40620	V	9.95	10.82	-7.94	12.83	33.01
			H	16.99	10.82	-7.94	19.87	33.01
	2682.5	41515	V	9.42	10.93	-8.03	12.32	33.01
			H	17.43	10.93	-8.03	20.33	33.01
<b>BAND 41 BW: 15M 16QAM RB: 1,0</b>	2503.5	39725	V	9.74	10.70	-7.83	12.61	33.01
			H	14.45	10.70	-7.83	17.32	33.01
	2593.0	40620	V	9.23	10.80	-7.92	12.10	33.01
			H	16.32	10.80	-7.92	19.19	33.01
	2682.5	41515	V	12.21	10.91	-8.02	15.10	33.01
			H	16.19	10.91	-8.02	19.09	33.01
<b>BAND 41 BW: 15M 16QAM RB: 1,74</b>	2503.5	39725	V	7.83	10.71	-7.84	10.70	33.01
			H	16.61	10.71	-7.84	19.48	33.01
	2593.0	40620	V	9.64	10.82	-7.94	12.52	33.01
			H	16.50	10.82	-7.94	19.38	33.01
	2682.5	41515	V	9.12	10.93	-8.03	12.02	33.01
			H	17.12	10.93	-8.03	20.02	33.01

The RBW,VBW of SPA for frequency RBW= 8MHz , VBW= 8MHz

Unless otherwise stated the results shown in this test report refer only to the sample(s) tested and such sample(s) are retained for 90 days only.

除非另有說明，此報告結果僅對測試之樣品負責，同時此樣品僅保留90天。本報告未經本公司書面許可，不可部份複製。

This document is issued by the Company subject to its General Conditions of Service printed overleaf, available on request or accessible at [www.sgs.com/terms\\_and\\_conditions.htm](http://www.sgs.com/terms_and_conditions.htm) and, for electronic format documents, subject to Terms and Conditions for Electronic Documents at [www.sgs.com/terms\\_e-document.htm](http://www.sgs.com/terms_e-document.htm). Attention is drawn to the limitation of liability, indemnification and jurisdiction issues defined therein. Any holder of this document is advised that information contained hereon reflects the Company's findings at the time of its intervention only and within the limits of Client's instructions, if any. The Company's sole responsibility is to its Client and this document does not exonerate parties to a transaction from exercising all their rights and obligations under the transaction documents. This document cannot be reproduced except in full, without prior written approval of the Company. Any unauthorized alteration, forgery or falsification of the content or appearance of this document is unlawful and offenders may be prosecuted to the fullest extent of the law.

SGS Taiwan Ltd.

No.134,WuKungRoad,NewTaipeiIndustrialPark,WukuDistrict,NewTaipeiCity,Taiwan24803/新北市五股區新北產業園區五工路 134 號

台灣檢驗科技股份有限公司

t (886-2) 2299-3279

f (886-2) 2298-0488

www.tw.sgs.com

Member of SGS Group

EUT			Measurement					
Operation Band	Fundamental Frequency	CH	Antenna Pol.	S.G. Output	Antenna Gain	Cable Loss	EIRP	Limit
	MHz		V/H	dBm	dBi	dB	dBm	dBm
<b>BAND 41 BW: 15M 64QAM RB: 1,0</b>	2503.5	39725	V	9.83	10.70	-7.83	12.70	33.01
			H	14.58	10.70	-7.83	17.46	33.01
	2593.0	40620	V	9.28	10.80	-7.93	12.16	33.01
			H	16.74	10.80	-7.93	19.62	33.01
	2682.5	41515	V	12.00	10.91	-8.02	14.90	33.01
			H	16.36	10.91	-8.02	19.25	33.01
<b>BAND 41 BW: 15M 64QAM RB: 1,74</b>	2503.5	39725	V	7.80	10.71	-7.84	10.67	33.01
			H	16.52	10.71	-7.84	19.39	33.01
	2593.0	40620	V	9.86	10.82	-7.94	12.74	33.01
			H	16.75	10.82	-7.94	19.63	33.01
	2682.5	41515	V	9.09	10.93	-8.03	11.99	33.01
			H	16.92	10.93	-8.03	19.82	33.01

The RBW,VBW of SPA for frequency RBW= 8MHz , VBW= 8MHz

Unless otherwise stated the results shown in this test report refer only to the sample(s) tested and such sample(s) are retained for 90 days only.

除非另有說明，此報告結果僅對測試之樣品負責，同時此樣品僅保留90天。本報告未經本公司書面許可，不可部份複製。

This document is issued by the Company subject to its General Conditions of Service printed overleaf, available on request or accessible at [www.sgs.com/terms\\_and\\_conditions.htm](http://www.sgs.com/terms_and_conditions.htm) and, for electronic format documents, subject to Terms and Conditions for Electronic Documents at [www.sgs.com/terms\\_e-document.htm](http://www.sgs.com/terms_e-document.htm). Attention is drawn to the limitation of liability, indemnification and jurisdiction issues defined therein. Any holder of this document is advised that information contained hereon reflects the Company's findings at the time of its intervention only and within the limits of Client's instructions, if any. The Company's sole responsibility is to its Client and this document does not exonerate parties to a transaction from exercising all their rights and obligations under the transaction documents. This document cannot be reproduced except in full, without prior written approval of the Company. Any unauthorized alteration, forgery or falsification of the content or appearance of this document is unlawful and offenders may be prosecuted to the fullest extent of the law.

SGS Taiwan Ltd.

No.134,WuKungRoad,NewTaipeiIndustrialPark,WukuDistrict,NewTaipeiCity,Taiwan24803/新北市五股區新北產業園區五工路 134 號

台灣檢驗科技股份有限公司

t (886-2) 2299-3279

f (886-2) 2298-0488

www.tw.sgs.com

Member of SGS Group

EUT			Measurement					
Operation Band	Fundamental Frequency	CH	Antenna Pol.	S.G. Output	Antenna Gain	Cable Loss	EIRP	Limit
	MHz		V/H	dBm	dBi	dB	dBm	dBm
<b>BAND 41 BW: 20M QPSK RB: 1,0</b>	2506.0	39750	V	11.13	10.70	-7.83	14.00	33.01
			H	15.42	10.70	-7.83	18.29	33.01
	2593.0	40620	V	9.92	10.80	-7.92	12.80	33.01
			H	16.45	10.80	-7.92	19.33	33.01
	2680.0	41490	V	12.02	10.91	-8.01	14.92	33.01
			H	16.66	10.91	-8.01	19.56	33.01
<b>BAND 41 BW: 20M QPSK RB: 1,99</b>	2506.0	39750	V	7.17	10.72	-7.85	10.04	33.01
			H	18.35	10.72	-7.85	21.22	33.01
	2593.0	40620	V	10.13	10.82	-7.94	13.01	33.01
			H	16.82	10.82	-7.94	19.71	33.01
	2680.0	41490	V	9.30	10.93	-8.03	12.19	33.01
			H	17.27	10.93	-8.03	20.16	33.01
<b>BAND 41 BW: 20M 16QAM RB: 1,0</b>	2506.0	39750	V	10.10	10.70	-7.83	12.97	33.01
			H	14.62	10.70	-7.83	17.50	33.01
	2593.0	40620	V	10.10	10.80	-7.92	12.98	33.01
			H	16.76	10.80	-7.92	19.64	33.01
	2680.0	41490	V	11.82	10.90	-8.01	14.71	33.01
			H	16.53	10.90	-8.01	19.42	33.01
<b>BAND 41 BW: 20M 16QAM RB: 1,99</b>	2506.0	39750	V	7.34	10.72	-7.85	10.21	33.01
			H	17.36	10.72	-7.85	20.24	33.01
	2593.0	40620	V	9.99	10.82	-7.94	12.87	33.01
			H	17.30	10.82	-7.94	20.18	33.01
	2680.0	41490	V	9.21	10.93	-8.03	12.11	33.01
			H	17.08	10.93	-8.03	19.97	33.01

The RBW,VBW of SPA for frequency RBW= 8MHz , VBW= 8MHz

Unless otherwise stated the results shown in this test report refer only to the sample(s) tested and such sample(s) are retained for 90 days only.

除非另有說明，此報告結果僅對測試之樣品負責，同時此樣品僅保留90天。本報告未經本公司書面許可，不可部份複製。

This document is issued by the Company subject to its General Conditions of Service printed overleaf, available on request or accessible at [www.sgs.com/terms\\_and\\_conditions.htm](http://www.sgs.com/terms_and_conditions.htm) and, for electronic format documents, subject to Terms and Conditions for Electronic Documents at [www.sgs.com/terms\\_e-document.htm](http://www.sgs.com/terms_e-document.htm). Attention is drawn to the limitation of liability, indemnification and jurisdiction issues defined therein. Any holder of this document is advised that information contained hereon reflects the Company's findings at the time of its intervention only and within the limits of Client's instructions, if any. The Company's sole responsibility is to its Client and this document does not exonerate parties to a transaction from exercising all their rights and obligations under the transaction documents. This document cannot be reproduced except in full, without prior written approval of the Company. Any unauthorized alteration, forgery or falsification of the content or appearance of this document is unlawful and offenders may be prosecuted to the fullest extent of the law.

SGS Taiwan Ltd.

No.134,WuKungRoad,NewTaipeiIndustrialPark,WukuDistrict,NewTaipeiCity,Taiwan24803/新北市五股區新北產業園區五工路 134 號

台灣檢驗科技股份有限公司

t (886-2) 2299-3279

f (886-2) 2298-0488

www.tw.sgs.com

Member of SGS Group

EUT			Measurement					
Operation Band	Fundamental Frequency	CH	Antenna Pol.	S.G. Output	Antenna Gain	Cable Loss	EIRP	Limit
	MHz		V/H	dBm	dBi	dB	dBm	dBm
<b>BAND 41</b>	2506.0	39750	V	9.92	10.70	-7.83	12.79	33.01
			H	14.77	10.70	-7.83	17.64	33.01
<b>BW: 20M</b>	2593.0	40620	V	9.69	10.80	-7.92	12.57	33.01
			H	16.73	10.80	-7.92	19.60	33.01
<b>QPSK</b>	2680.0	41490	V	11.61	10.91	-8.01	14.50	33.01
			H	17.10	10.91	-8.01	<b>20.00</b>	33.01
<b>RB: 1,0</b>	2506.0	39750	V	7.16	10.72	-7.85	10.03	33.01
			H	17.46	10.72	-7.85	20.33	33.01
<b>BAND 41</b>	2593.0	40620	V	9.97	10.82	-7.94	12.85	33.01
			H	17.04	10.82	-7.94	19.92	33.01
<b>BW: 20M</b>	2680.0	41490	V	8.86	10.93	-8.03	11.76	33.01
			H	17.68	10.93	-8.03	<b>20.58</b>	33.01
<b>QPSK</b>			V					
			H					
<b>RB: 1,99</b>			V					
			H					
The RBW,VBW of SPA for frequency RBW= 8MHz , VBW= 8MHz								

Unless otherwise stated the results shown in this test report refer only to the sample(s) tested and such sample(s) are retained for 90 days only.

除非另有說明，此報告結果僅對測試之樣品負責，同時此樣品僅保留90天。本報告未經本公司書面許可，不可部份複製。

This document is issued by the Company subject to its General Conditions of Service printed overleaf, available on request or accessible at [www.sgs.com/terms\\_and\\_conditions.htm](http://www.sgs.com/terms_and_conditions.htm) and, for electronic format documents, subject to Terms and Conditions for Electronic Documents at [www.sgs.com/terms\\_e-document.htm](http://www.sgs.com/terms_e-document.htm). Attention is drawn to the limitation of liability, indemnification and jurisdiction issues defined therein. Any holder of this document is advised that information contained hereon reflects the Company's findings at the time of its intervention only and within the limits of Client's instructions, if any. The Company's sole responsibility is to its Client and this document does not exonerate parties to a transaction from exercising all their rights and obligations under the transaction documents. This document cannot be reproduced except in full, without prior written approval of the Company. Any unauthorized alteration, forgery or falsification of the content or appearance of this document is unlawful and offenders may be prosecuted to the fullest extent of the law.

SGS Taiwan Ltd.

No.134,WuKungRoad,NewTaipeiIndustrialPark,WukuDistrict,NewTaipeiCity,Taiwan24803/新北市五股區新北產業園區五工路 134 號

台灣檢驗科技股份有限公司

t (886-2) 2299-3279

f (886-2) 2298-0488

www.tw.sgs.com

Member of SGS Group

## 8. OCCUPIED BANDWIDTH MEASUREMENT

### 8.1. Standard Applicable

The occupied bandwidth is the frequency bandwidth such that, below its lower and above its upper frequency limits, the mean powers radiated are each equal to 0.5 percent of the total mean power.

### 8.2. Test Set-up

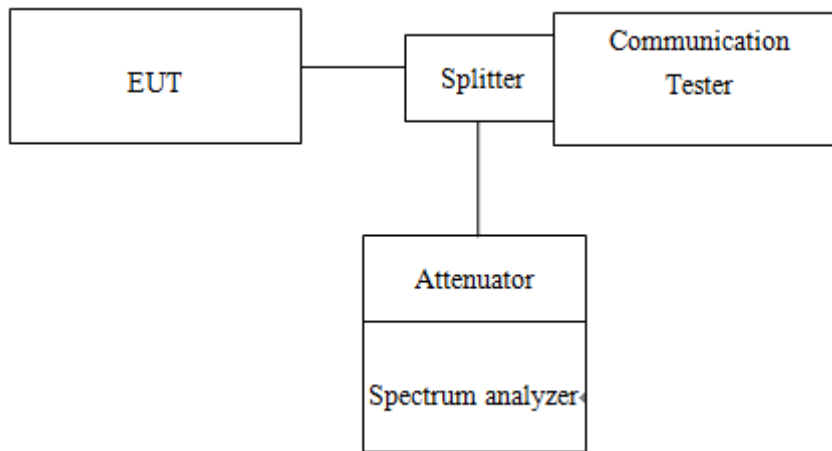

### 8.3. Measurement Procedure

#### **99% & 26dB Bandwidth with detector peak**

The EUT's output RF connector was connected with a short cable to the spectrum analyzer, RBW was set to about 1% of emission BW, VBW= 3 times RBW, -26dBc display line was placed on the screen (or 26dB bandwidth), the occupied bandwidth is the delta frequency between the two points where the display line intersects the signal trace. Then set RBW to 99% bandwidth, RBW= 1%, VBW= 3 RBW, with span > 2 \* Signal BW, set % Power = 99%.

#### **99% Bandwidth with detector sample**

The EUT's output RF connector was connected with a short cable to the spectrum analyzer, RBW was set to about 1% ~ 5% of emission BW, VBW= 3 times RBW, -20dBc display line was placed on the screen (or 20dB bandwidth). Set RBW to 99% bandwidth, RBW= 1% ~ 5%, VBW= 3 RBW, with span > 2 \* Signal BW, set % Power = 99%.

Unless otherwise stated the results shown in this test report refer only to the sample(s) tested and such sample(s) are retained for 90 days only.

除非另有說明，此報告結果僅對測試之樣品負責，同時此樣品僅保留90天。本報告未經本公司書面許可，不可部份複製。

This document is issued by the Company subject to its General Conditions of Service printed overleaf, available on request or accessible at [www.sgs.com/terms\\_and\\_conditions.htm](http://www.sgs.com/terms_and_conditions.htm) and, for electronic format documents, subject to Terms and Conditions for Electronic Documents at [www.sgs.com/terms\\_e-document.htm](http://www.sgs.com/terms_e-document.htm). Attention is drawn to the limitation of liability, indemnification and jurisdiction issues defined therein. Any holder of this document is advised that information contained hereon reflects the Company's findings at the time of its intervention only and within the limits of Client's instructions, if any. The Company's sole responsibility is to its Client and this document does not exonerate parties to a transaction from exercising all their rights and obligations under the transaction documents. This document cannot be reproduced except in full, without prior written approval of the Company. Any unauthorized alteration, forgery or falsification of the content or appearance of this document is unlawful and offenders may be prosecuted to the fullest extent of the law.

#### 8.4. Measurement Equipment Used

Conducted Emission (measured at antenna port) Test Site					
EQUIPMENT TYPE	MFR	MODEL NUMBER	SERIAL NUMBER	LAST CAL.	CAL DUE.
Spectrum Analyzer	KEYSIGHT	N9010A	MY51440113	06/20/2017	06/19/2018
Communication Tester	Anritsu	MT8820C	6201107337	05/25/2017	05/24/2018
Coaxial Cable 30cm	WOKEN	00100A1F1A 195C	RF01	12/12/2016	12/11/2017
Temperature Chamber	TERCHY	MHK-120LK	1020582	06/13/2017	06/12/2018
DC Block	PASTERNAK	PE8210	RF29	12/12/2016	12/11/2017
Splitter	RF-LAMBAD	RFLT2W1G1 8G	RF35	12/12/2016	12/11/2017
Attenuator	WOKEN	218FS-10	RF23	12/12/2016	12/11/2017
DC Power Supply	Agilent	E3640A	MY53140006	05/02/2017	05/01/2018

Unless otherwise stated the results shown in this test report refer only to the sample(s) tested and such sample(s) are retained for 90 days only.

除非另有說明，此報告結果僅對測試之樣品負責，同時此樣品僅保留90天。本報告未經本公司書面許可，不可部份複製。

This document is issued by the Company subject to its General Conditions of Service printed overleaf, available on request or accessible at [www.sgs.com/terms\\_and\\_conditions.htm](http://www.sgs.com/terms_and_conditions.htm) and, for electronic format documents, subject to Terms and Conditions for Electronic Documents at [www.sgs.com/terms\\_e-document.htm](http://www.sgs.com/terms_e-document.htm). Attention is drawn to the limitation of liability, indemnification and jurisdiction issues defined therein. Any holder of this document is advised that information contained hereon reflects the Company's findings at the time of its intervention only and within the limits of Client's instructions, if any. The Company's sole responsibility is to its Client and this document does not exonerate parties to a transaction from exercising all their rights and obligations under the transaction documents. This document cannot be reproduced except in full, without prior written approval of the Company. Any unauthorized alteration, forgery or falsification of the content or appearance of this document is unlawful and offenders may be prosecuted to the fullest extent of the law.

SGS Taiwan Ltd.

No.134,WuKungRoad,NewTaipeiIndustrialPark,WukuDistrict,NewTaipeiCity,Taiwan24803/新北市五股區新北產業園區五工路 134 號

台灣檢驗科技股份有限公司

t (886-2) 2299-3279

f (886-2) 2298-0488

www.tw.sgs.com

Member of SGS Group

### 8.5. Measurement Result

Freq. (MHz)	CH	99% BW (MHz)			26 dB BW (MHz)		
		GSM 850	GPRS 850	EDGE 850	GSM 850	GPRS 850	EDGE 850
824.2	128	-	0.24517	0.24005	-	0.31410	0.31770
836.6	190	-	0.25020	0.24622	-	0.31310	0.31810
848.8	251	-	0.24781	0.23910	-	0.31240	0.30720

Freq. (MHz)	CH	99% BW (MHz)			26 dB BW (MHz)		
		GSM 1900	GPRS 1900	EDGE 1900	GSM 1900	GPRS 1900	EDGE 1900
1850.2	512	-	0.24659	0.24837	-	0.31840	0.32130
1880.0	661	-	0.24642	0.24497	-	0.31620	0.31390
1909.8	810	-	0.24769	0.24267	-	0.31850	0.31490

Freq. (MHz)	CH	99% BW (MHz)			26 dB BW (MHz)		
		WCDMA II	HSDPA II	HSUPA II	WCDMA II	HSDPA II	HSUPA II
1850.20	9262	4.1149	4.1179	4.1160	4.6570	4.6670	4.6740
1880.00	9400	4.1305	4.1079	4.1122	4.6850	4.6910	4.6690
1909.80	9538	4.1276	4.1253	4.1205	4.6840	4.6540	4.6780

Freq. (MHz)	CH	99% BW (MHz)			26 dB BW (MHz)		
		WCDMA IV	HSDPA IV	HSUPA IV	WCDMA IV	HSDPA IV	HSUPA IV
1712.40	1312	4.1332	4.1219	4.1154	4.6720	4.6710	4.6740
1732.60	1413	4.1172	4.1173	4.1177	4.6870	4.6790	4.6950
1752.60	1513	4.1156	4.1121	4.1091	4.6730	4.6670	4.6440

Freq. (MHz)	CH	99% BW (MHz)			26 dB BW (MHz)		
		WCDMA V	HSDPA V	HSUPA V	WCDMA V	HSDPA V	HSUPA V
826.40	4132	4.1215	4.1247	4.1237	4.6750	4.6630	4.6690
836.60	4183	4.1247	4.1062	4.1125	4.6780	4.6850	4.6630
846.60	4233	4.1162	4.1108	4.1342	4.6810	4.6590	4.6970

Unless otherwise stated the results shown in this test report refer only to the sample(s) tested and such sample(s) are retained for 90 days only.

除非另有說明，此報告結果僅對測試之樣品負責，同時此樣品僅保留90天。本報告未經本公司書面許可，不可部份複製。

This document is issued by the Company subject to its General Conditions of Service printed overleaf, available on request or accessible at [www.sgs.com/terms\\_and\\_conditions.htm](http://www.sgs.com/terms_and_conditions.htm) and, for electronic format documents, subject to Terms and Conditions for Electronic Documents at [www.sgs.com/terms\\_e-document.htm](http://www.sgs.com/terms_e-document.htm). Attention is drawn to the limitation of liability, indemnification and jurisdiction issues defined therein. Any holder of this document is advised that information contained hereon reflects the Company's findings at the time of its intervention only and within the limits of Client's instructions, if any. The Company's sole responsibility is to its Client and this document does not exonerate parties to a transaction from exercising all their rights and obligations under the transaction documents. This document cannot be reproduced except in full, without prior written approval of the Company. Any unauthorized alteration, forgery or falsification of the content or appearance of this document is unlawful and offenders may be prosecuted to the fullest extent of the law.



LTE BAND 2 Channel bandwidth: 1.4MHz					
Freq. (MHz)	CH	99% BW (MHz)	99% BW (MHz)	26 dB BW (MHz)	26 dB BW (MHz)
		QPSK	16QAM	QPSK	16QAM
1850.7	18607	1.0914	1.0927	1.241	1.231
1880.0	18900	1.0905	1.0905	1.238	1.233
1909.3	19193	1.0929	1.0929	1.236	1.243

LTE BAND 2 Channel bandwidth: 3MHz					
Freq. (MHz)	CH	99% BW (MHz)	99% BW (MHz)	26 dB BW (MHz)	26 dB BW (MHz)
		QPSK	16QAM	QPSK	16QAM
1851.5	18615	2.6938	2.6980	2.957	3.004
1880.0	18900	2.6993	2.6968	2.982	3.009
1908.5	19185	2.6994	2.6941	2.999	3.003

LTE BAND 2 Channel bandwidth: 5MHz					
Freq. (MHz)	CH	99% BW (MHz)	99% BW (MHz)	26 dB BW (MHz)	26 dB BW (MHz)
		QPSK	16QAM	QPSK	16QAM
1852.5	18625	4.4870	4.4944	4.999	4.937
1880.0	18900	4.4982	4.4937	4.989	4.940
1907.5	19175	4.5002	4.4972	4.978	4.936

LTE BAND 2 Channel bandwidth: 10MHz					
Freq. (MHz)	CH	99% BW (MHz)	99% BW (MHz)	26 dB BW (MHz)	26 dB BW (MHz)
		QPSK	16QAM	QPSK	16QAM
1855.0	18650	9.0024	8.9666	9.723	9.710
1880.0	18900	8.9975	8.9536	9.748	9.749
1905.0	19150	8.9940	8.9612	9.801	9.776

LTE BAND 2 Channel bandwidth: 15MHz					
Freq. (MHz)	CH	99% BW (MHz)	99% BW (MHz)	26 dB BW (MHz)	26 dB BW (MHz)
		QPSK	16QAM	QPSK	16QAM
1857.5	18675	13.476	13.469	14.59	14.64
1880.0	18900	13.426	13.457	14.64	14.61
1902.5	19125	13.448	13.447	14.63	14.72

LTE BAND 2 Channel bandwidth: 20MHz					
Freq. (MHz)	CH	99% BW (MHz)	99% BW (MHz)	26 dB BW (MHz)	26 dB BW (MHz)
		QPSK	16QAM	QPSK	16QAM
1860.0	18700	17.935	17.935	19.52	19.39
1880.0	18900	17.930	17.939	19.49	19.35
1900.0	19100	17.926	17.948	19.50	19.54

Unless otherwise stated the results shown in this test report refer only to the sample(s) tested and such sample(s) are retained for 90 days only.

除非另有說明，此報告結果僅對測試之樣品負責，同時此樣品僅保留90天。本報告未經本公司書面許可，不可部份複製。

This document is issued by the Company subject to its General Conditions of Service printed overleaf, available on request or accessible at [www.sgs.com/terms\\_and\\_conditions.htm](http://www.sgs.com/terms_and_conditions.htm) and, for electronic format documents, subject to Terms and Conditions for Electronic Documents at [www.sgs.com/terms\\_e-document.htm](http://www.sgs.com/terms_e-document.htm). Attention is drawn to the limitation of liability, indemnification and jurisdiction issues defined therein. Any holder of this document is advised that information contained hereon reflects the Company's findings at the time of its intervention only and within the limits of Client's instructions, if any. The Company's sole responsibility is to its Client and this document does not exonerate parties to a transaction from exercising all their rights and obligations under the transaction documents. This document cannot be reproduced except in full, without prior written approval of the Company. Any unauthorized alteration, forgery or falsification of the content or appearance of this document is unlawful and offenders may be prosecuted to the fullest extent of the law.

SGS Taiwan Ltd.

No.134,WuKungRoad,NewTaipeiIndustrialPark,WukuDistrict,NewTaipeiCity,Taiwan24803/新北市五股區新北產業園區五工路 134 號

台灣檢驗科技股份有限公司

t (886-2) 2299-3279

f (886-2) 2298-0488

www.tw.sgs.com

Member of SGS Group

LTE BAND 2 Channel bandwidth: 1.4MHz			
Freq. (MHz)	CH	99% BW (MHz)	26 dB BW (MHz)
		64QAM	64QAM
1850.7	18607	1.0890	1.244
1880.0	18900	1.0920	1.235
1909.3	19193	1.0910	1.238

LTE BAND 2 Channel bandwidth: 3MHz			
Freq. (MHz)	CH	99% BW (MHz)	26 dB BW (MHz)
		64QAM	64QAM
1851.5	18615	2.7018	3.010
1880.0	18900	2.7070	3.009
1908.5	19185	2.7048	2.993

LTE BAND 2 Channel bandwidth: 5MHz			
Freq. (MHz)	CH	99% BW (MHz)	26 dB BW (MHz)
		64QAM	64QAM
1852.5	18625	4.4863	4.935
1880.0	18900	4.4914	4.937
1907.5	19175	4.4894	4.916

LTE BAND 2 Channel bandwidth: 10MHz			
Freq. (MHz)	CH	99% BW (MHz)	26 dB BW (MHz)
		64QAM	64QAM
1855.0	18650	8.9692	9.797
1880.0	18900	8.9689	9.789
1905.0	19150	8.9663	9.834

LTE BAND 2 Channel bandwidth: 15MHz			
Freq. (MHz)	CH	99% BW (MHz)	26 dB BW (MHz)
		64QAM	64QAM
1857.5	18675	13.452	14.59
1880.0	18900	13.447	14.58
1902.5	19125	13.444	14.72

LTE BAND 2 Channel bandwidth: 20MHz			
Freq. (MHz)	CH	99% BW (MHz)	26 dB BW (MHz)
		64QAM	64QAM
1860.0	18700	17.923	19.41
1880.0	18900	17.933	19.54
1900.0	19100	17.918	19.38

Unless otherwise stated the results shown in this test report refer only to the sample(s) tested and such sample(s) are retained for 90 days only.

除非另有說明，此報告結果僅對測試之樣品負責，同時此樣品僅保留90天。本報告未經本公司書面許可，不可部份複製。

This document is issued by the Company subject to its General Conditions of Service printed overleaf, available on request or accessible at [www.sgs.com/terms\\_and\\_conditions.htm](http://www.sgs.com/terms_and_conditions.htm) and, for electronic format documents, subject to Terms and Conditions for Electronic Documents at [www.sgs.com/terms\\_e-document.htm](http://www.sgs.com/terms_e-document.htm). Attention is drawn to the limitation of liability, indemnification and jurisdiction issues defined therein. Any holder of this document is advised that information contained hereon reflects the Company's findings at the time of its intervention only and within the limits of Client's instructions, if any. The Company's sole responsibility is to its Client and this document does not exonerate parties to a transaction from exercising all their rights and obligations under the transaction documents. This document cannot be reproduced except in full, without prior written approval of the Company. Any unauthorized alteration, forgery or falsification of the content or appearance of this document is unlawful and offenders may be prosecuted to the fullest extent of the law.

LTE BAND 4 Channel bandwidth: 1.4MHz					
Freq. (MHz)	CH	99% BW (MHz)	99% BW (MHz)	26 dB BW (MHz)	26 dB BW (MHz)
		QPSK	16QAM	QPSK	16QAM
1710.7	19957	1.0921	1.0940	1.235	1.235
1732.5	20175	1.0918	1.0951	1.233	1.236
1754.3	20393	1.0894	1.0938	1.238	1.235

LTE BAND 4 Channel bandwidth: 3MHz					
Freq. (MHz)	CH	99% BW (MHz)	99% BW (MHz)	26 dB BW (MHz)	26 dB BW (MHz)
		QPSK	16QAM	QPSK	16QAM
1711.5	19965	2.6953	2.6961	3.009	3.008
1732.5	20175	2.6967	2.6964	2.998	2.984
1753.5	20385	2.6992	2.6956	2.998	3.006

LTE BAND 4 Channel bandwidth: 5MHz					
Freq. (MHz)	CH	99% BW (MHz)	99% BW (MHz)	26 dB BW (MHz)	26 dB BW (MHz)
		QPSK	16QAM	QPSK	16QAM
1712.5	19957	4.4973	4.4904	4.984	4.938
1732.5	20175	4.4926	4.4920	4.988	4.948
1752.5	20375	4.5005	4.4848	4.990	4.917

LTE BAND 4 Channel bandwidth: 10MHz					
Freq. (MHz)	CH	99% BW (MHz)	99% BW (MHz)	26 dB BW (MHz)	26 dB BW (MHz)
		QPSK	16QAM	QPSK	16QAM
1715.0	20000	8.9823	8.9605	9.830	9.784
1732.5	20175	9.0043	8.9628	9.776	9.731
1750.0	20350	8.9829	8.9630	9.805	9.732

LTE BAND 4 Channel bandwidth: 15MHz					
Freq. (MHz)	CH	99% BW (MHz)	99% BW (MHz)	26 dB BW (MHz)	26 dB BW (MHz)
		QPSK	16QAM	QPSK	16QAM
1717.5	20025	13.469	13.469	14.65	14.72
1732.5	20175	13.455	13.470	14.66	14.60
1747.5	20325	13.471	13.436	14.69	14.69

LTE BAND 4 Channel bandwidth: 20MHz					
Freq. (MHz)	CH	99% BW (MHz)	99% BW (MHz)	26 dB BW (MHz)	26 dB BW (MHz)
		QPSK	16QAM	QPSK	16QAM
1720.0	20050	17.908	17.931	19.39	19.37
1732.5	20175	17.940	17.966	19.40	19.54
1745.0	20300	17.913	17.927	19.46	19.49

Unless otherwise stated the results shown in this test report refer only to the sample(s) tested and such sample(s) are retained for 90 days only.

除非另有說明，此報告結果僅對測試之樣品負責，同時此樣品僅保留90天。本報告未經本公司書面許可，不可部份複製。

This document is issued by the Company subject to its General Conditions of Service printed overleaf, available on request or accessible at [www.sgs.com/terms\\_and\\_conditions.htm](http://www.sgs.com/terms_and_conditions.htm) and, for electronic format documents, subject to Terms and Conditions for Electronic Documents at [www.sgs.com/terms\\_e-document.htm](http://www.sgs.com/terms_e-document.htm). Attention is drawn to the limitation of liability, indemnification and jurisdiction issues defined therein. Any holder of this document is advised that information contained hereon reflects the Company's findings at the time of its intervention only and within the limits of Client's instructions, if any. The Company's sole responsibility is to its Client and this document does not exonerate parties to a transaction from exercising all their rights and obligations under the transaction documents. This document cannot be reproduced except in full, without prior written approval of the Company. Any unauthorized alteration, forgery or falsification of the content or appearance of this document is unlawful and offenders may be prosecuted to the fullest extent of the law.

SGS Taiwan Ltd.

No.134,WuKungRoad,NewTaipeiIndustrialPark,WukuDistrict,NewTaipeiCity,Taiwan24803/新北市五股區新北產業園區五工路 134 號

台灣檢驗科技股份有限公司

t (886-2) 2299-3279

f (886-2) 2298-0488

www.tw.sgs.com

Member of SGS Group

LTE BAND 4 Channel bandwidth: 1.4MHz			
Freq. (MHz)	CH	99% BW (MHz)	26 dB BW (MHz)
		64QAM	64QAM
1710.7	19957	1.0922	1.244
1732.5	20175	1.0881	1.239
1754.3	20393	1.0922	1.237

LTE BAND 4 Channel bandwidth: 3MHz			
Freq. (MHz)	CH	99% BW (MHz)	26 dB BW (MHz)
		64QAM	64QAM
1711.5	19965	2.7017	2.992
1732.5	20175	2.7072	3.009
1753.5	20385	2.7058	2.990

LTE BAND 4 Channel bandwidth: 5MHz			
Freq. (MHz)	CH	99% BW (MHz)	26 dB BW (MHz)
		64QAM	64QAM
1712.5	19957	4.4823	4.927
1732.5	20175	4.4944	4.952
1752.5	20375	4.4946	4.931

LTE BAND 4 Channel bandwidth: 10MHz			
Freq. (MHz)	CH	99% BW (MHz)	26 dB BW (MHz)
		64QAM	64QAM
1715.0	20000	8.9833	9.830
1732.5	20175	8.9583	9.758
1750.0	20350	8.9785	9.798

LTE BAND 4 Channel bandwidth: 15MHz			
Freq. (MHz)	CH	99% BW (MHz)	26 dB BW (MHz)
		64QAM	64QAM
1717.5	20025	13.472	14.70
1732.5	20175	13.464	14.64
1747.5	20325	13.463	14.63

LTE BAND 4 Channel bandwidth: 20MHz			
Freq. (MHz)	CH	99% BW (MHz)	26 dB BW (MHz)
		64QAM	64QAM
1720.0	20050	17.928	19.55
1732.5	20175	17.929	19.42
1745.0	20300	17.919	19.39

Unless otherwise stated the results shown in this test report refer only to the sample(s) tested and such sample(s) are retained for 90 days only.

除非另有說明，此報告結果僅對測試之樣品負責，同時此樣品僅保留90天。本報告未經本公司書面許可，不可部份複製。

This document is issued by the Company subject to its General Conditions of Service printed overleaf, available on request or accessible at [www.sgs.com/terms\\_and\\_conditions.htm](http://www.sgs.com/terms_and_conditions.htm) and, for electronic format documents, subject to Terms and Conditions for Electronic Documents at [www.sgs.com/terms\\_e-document.htm](http://www.sgs.com/terms_e-document.htm). Attention is drawn to the limitation of liability, indemnification and jurisdiction issues defined therein. Any holder of this document is advised that information contained hereon reflects the Company's findings at the time of its intervention only and within the limits of Client's instructions, if any. The Company's sole responsibility is to its Client and this document does not exonerate parties to a transaction from exercising all their rights and obligations under the transaction documents. This document cannot be reproduced except in full, without prior written approval of the Company. Any unauthorized alteration, forgery or falsification of the content or appearance of this document is unlawful and offenders may be prosecuted to the fullest extent of the law.

LTE BAND 5 Channel bandwidth: 1.4MHz					
Freq. (MHz)	CH	99% BW (MHz)	99% BW (MHz)	26 dB BW (MHz)	26 dB BW (MHz)
		QPSK	16QAM	QPSK	16QAM
824.7	20407	1.0928	1.0929	1.237	1.240
836.5	20525	1.0929	1.0935	1.243	1.240
848.3	20643	1.0939	1.0938	1.232	1.239

LTE BAND 5 Channel bandwidth: 3MHz					
Freq. (MHz)	CH	99% BW (MHz)	99% BW (MHz)	26 dB BW (MHz)	26 dB BW (MHz)
		QPSK	16QAM	QPSK	16QAM
825.5	20415	2.7004	2.6970	2.990	3.009
836.5	20525	2.6972	2.6971	2.985	3.016
847.5	20635	2.6924	2.6931	2.983	2.996

LTE BAND 5 Channel bandwidth: 5MHz					
Freq. (MHz)	CH	99% BW (MHz)	99% BW (MHz)	26 dB BW (MHz)	26 dB BW (MHz)
		QPSK	16QAM	QPSK	16QAM
826.5	20425	4.4969	4.4946	4.994	4.978
836.5	20525	4.4942	4.4998	4.962	4.993
846.5	20625	4.4870	4.4889	4.938	4.917

LTE BAND 5 Channel bandwidth: 10MHz					
Freq. (MHz)	CH	99% BW (MHz)	99% BW (MHz)	26 dB BW (MHz)	26 dB BW (MHz)
		QPSK	16QAM	QPSK	16QAM
829.0	20450	9.0122	8.9499	9.744	9.781
836.5	20525	8.9814	8.9609	9.804	9.761
844.0	20600	8.9917	8.9603	9.812	9.750

LTE BAND 5 Channel bandwidth: 1.4MHz			
Freq. (MHz)	CH	99% BW (MHz)	26 dB BW (MHz)
		64QAM	64QAM
824.7	20407	1.0902	1.244
836.5	20525	1.0905	1.236
848.3	20643	1.0910	1.238

LTE BAND 5 Channel bandwidth: 3MHz			
Freq. (MHz)	CH	99% BW (MHz)	26 dB BW (MHz)
		64QAM	64QAM
825.5	20415	2.7027	3.009
836.5	20525	2.7042	3.016
847.5	20635	2.7056	3.011

LTE BAND 5 Channel bandwidth: 5MHz			
Freq. (MHz)	CH	99% BW (MHz)	26 dB BW (MHz)
		64QAM	64QAM
826.5	20425	4.4900	4.951
836.5	20525	4.4922	4.949
846.5	20625	4.4947	4.920

LTE BAND 5 Channel bandwidth: 10MHz			
Freq. (MHz)	CH	99% BW (MHz)	26 dB BW (MHz)
		64QAM	64QAM
829.0	20450	8.9913	9.821
836.5	20525	8.9714	9.809
844.0	20600	8.9822	9.790

Unless otherwise stated the results shown in this test report refer only to the sample(s) tested and such sample(s) are retained for 90 days only.

除非另有說明，此報告結果僅對測試之樣品負責，同時此樣品僅保留90天。本報告未經本公司書面許可，不可部份複製。

This document is issued by the Company subject to its General Conditions of Service printed overleaf, available on request or accessible at [www.sgs.com/terms\\_and\\_conditions.htm](http://www.sgs.com/terms_and_conditions.htm) and, for electronic format documents, subject to Terms and Conditions for Electronic Documents at [www.sgs.com/terms\\_e-document.htm](http://www.sgs.com/terms_e-document.htm). Attention is drawn to the limitation of liability, indemnification and jurisdiction issues defined therein. Any holder of this document is advised that information contained hereon reflects the Company's findings at the time of its intervention only and within the limits of Client's instructions, if any. The Company's sole responsibility is to its Client and this document does not exonerate parties to a transaction from exercising all their rights and obligations under the transaction documents. This document cannot be reproduced except in full, without prior written approval of the Company. Any unauthorized alteration, forgery or falsification of the content or appearance of this document is unlawful and offenders may be prosecuted to the fullest extent of the law.

SGS Taiwan Ltd.

No.134,WuKungRoad,NewTaipeiIndustrialPark,WukuDistrict,NewTaipeiCity,Taiwan24803/新北市五股區新北產業園區五工路 134 號

台灣檢驗科技股份有限公司

t (886-2) 2299-3279

f (886-2) 2298-0488

www.tw.sgs.com

Member of SGS Group

LTE BAND 7 Channel bandwidth: 5MHz					
Freq. (MHz)	CH	99% BW (MHz)	99% BW (MHz)	26 dB BW (MHz)	26 dB BW (MHz)
		QPSK	16QAM	QPSK	16QAM
2502.5	20775	4.4986	4.5012	4.955	4.985
2535.0	21100	4.4955	4.4910	4.983	4.992
2567.5	21425	4.4967	4.4892	4.978	4.951

LTE BAND 7 Channel bandwidth: 10MHz					
Freq. (MHz)	CH	99% BW (MHz)	99% BW (MHz)	26 dB BW (MHz)	26 dB BW (MHz)
		QPSK	16QAM	QPSK	16QAM
2505.0	20800	9.0042	8.9727	9.823	9.720
2535.0	21100	8.9934	8.9574	9.754	9.716
2565.0	21400	8.9802	8.9561	9.780	9.704

LTE BAND 7 Channel bandwidth: 15MHz					
Freq. (MHz)	CH	99% BW (MHz)	99% BW (MHz)	26 dB BW (MHz)	26 dB BW (MHz)
		QPSK	16QAM	QPSK	16QAM
2507.5	20825	13.454	13.457	14.60	14.56
2535.0	21100	13.447	13.444	14.63	14.67
2562.5	21375	13.454	13.431	14.67	14.62

LTE BAND 7 Channel bandwidth: 20MHz					
Freq. (MHz)	CH	99% BW (MHz)	99% BW (MHz)	26 dB BW (MHz)	26 dB BW (MHz)
		QPSK	16QAM	QPSK	16QAM
2510.0	20850	17.916	17.911	19.41	19.41
2535.0	21100	17.879	17.875	19.41	19.44
2560.0	21350	17.892	17.927	19.37	19.40

LTE BAND 7 Channel bandwidth: 5MHz			
Freq. (MHz)	CH	99% BW (MHz)	26 dB BW (MHz)
		64QAM	64QAM
2502.5	20775	4.4937	4.943
2535.0	21100	4.4883	4.952
2567.5	21425	4.4813	4.938

LTE BAND 7 Channel bandwidth: 10MHz			
Freq. (MHz)	CH	99% BW (MHz)	26 dB BW (MHz)
		64QAM	64QAM
2505.0	20800	8.9846	9.797
2535.0	21100	8.9823	9.782
2565.0	21400	8.9703	9.823

LTE BAND 7 Channel bandwidth: 15MHz			
Freq. (MHz)	CH	99% BW (MHz)	26 dB BW (MHz)
		64QAM	64QAM
2507.5	20825	13.470	14.59
2535.0	21100	13.445	14.56
2562.5	21375	13.448	14.61

LTE BAND 7 Channel bandwidth: 20MHz			
Freq. (MHz)	CH	99% BW (MHz)	26 dB BW (MHz)
		64QAM	64QAM
2510.0	20850	17.912	19.41
2535.0	21100	17.914	19.37
2560.0	21350	17.918	19.24

Unless otherwise stated the results shown in this test report refer only to the sample(s) tested and such sample(s) are retained for 90 days only.

除非另有說明，此報告結果僅對測試之樣品負責，同時此樣品僅保留90天。本報告未經本公司書面許可，不可部份複製。

This document is issued by the Company subject to its General Conditions of Service printed overleaf, available on request or accessible at [www.sgs.com/terms\\_and\\_conditions.htm](http://www.sgs.com/terms_and_conditions.htm) and, for electronic format documents, subject to Terms and Conditions for Electronic Documents at [www.sgs.com/terms\\_e-document.htm](http://www.sgs.com/terms_e-document.htm). Attention is drawn to the limitation of liability, indemnification and jurisdiction issues defined therein. Any holder of this document is advised that information contained hereon reflects the Company's findings at the time of its intervention only and within the limits of Client's instructions, if any. The Company's sole responsibility is to its Client and this document does not exonerate parties to a transaction from exercising all their rights and obligations under the transaction documents. This document cannot be reproduced except in full, without prior written approval of the Company. Any unauthorized alteration, forgery or falsification of the content or appearance of this document is unlawful and offenders may be prosecuted to the fullest extent of the law.

SGS Taiwan Ltd.

No.134,WuKungRoad,NewTaipeiIndustrialPark,WukuDistrict,NewTaipeiCity,Taiwan24803/新北市五股區新北產業園區五工路 134 號

台灣檢驗科技股份有限公司

t (886-2) 2299-3279

f (886-2) 2298-0488

www.tw.sgs.com

Member of SGS Group

LTE BAND 38 Channel bandwidth: 5MHz					
Freq. (MHz)	CH	99% BW (MHz)	99% BW (MHz)	26 dB BW (MHz)	26 dB BW (MHz)
		QPSK	16QAM	QPSK	16QAM
2572.5	37775	4.5055	4.4931	4.953	4.942
2595.0	38000	4.4995	4.4979	4.977	4.952
2617.5	38225	4.5004	4.4914	4.962	4.963

LTE BAND 38 Channel bandwidth: 10MHz					
Freq. (MHz)	CH	99% BW (MHz)	99% BW (MHz)	26 dB BW (MHz)	26 dB BW (MHz)
		QPSK	16QAM	QPSK	16QAM
2575.0	37800	8.9744	8.9470	9.804	9.662
2595.0	38000	8.9796	8.9634	9.746	9.746
2615.0	38200	8.9576	8.9699	9.742	9.720

LTE BAND 38 Channel bandwidth: 15MHz					
Freq. (MHz)	CH	99% BW (MHz)	99% BW (MHz)	26 dB BW (MHz)	26 dB BW (MHz)
		QPSK	16QAM	QPSK	16QAM
2577.5	37825	13.432	13.453	14.59	14.54
2595.0	38000	13.426	13.484	14.54	14.78
2612.5	38175	13.453	13.453	14.59	14.71

LTE BAND 38 Channel bandwidth: 20MHz					
Freq. (MHz)	CH	99% BW (MHz)	99% BW (MHz)	26 dB BW (MHz)	26 dB BW (MHz)
		QPSK	16QAM	QPSK	16QAM
2580.0	37850	17.914	17.873	19.39	19.29
2595.0	38000	17.911	17.931	19.42	19.33
2610.0	38150	17.954	17.878	19.45	19.43

LTE BAND 38 Channel bandwidth: 5MHz			
Freq. (MHz)	CH	99% BW (MHz)	26 dB BW (MHz)
		64QAM	64QAM
2572.5	37775	4.4821	4.903
2595.0	38000	4.4874	4.894
2617.5	38225	4.4775	4.935

LTE BAND 38 Channel bandwidth: 10MHz			
Freq. (MHz)	CH	99% BW (MHz)	26 dB BW (MHz)
		64QAM	64QAM
2575.0	37800	8.9511	9.669
2595.0	38000	8.9719	9.741
2615.0	38200	8.9776	9.911

LTE BAND 38 Channel bandwidth: 15MHz			
Freq. (MHz)	CH	99% BW (MHz)	26 dB BW (MHz)
		64QAM	64QAM
2577.5	37825	13.469	14.75
2595.0	38000	13.462	14.51
2612.5	38175	13.421	14.54

LTE BAND 38 Channel bandwidth: 20MHz			
Freq. (MHz)	CH	99% BW (MHz)	26 dB BW (MHz)
		64QAM	64QAM
2580.0	37850	17.867	19.33
2595.0	38000	17.883	19.43
2610.0	38150	17.895	19.38

Unless otherwise stated the results shown in this test report refer only to the sample(s) tested and such sample(s) are retained for 90 days only.

除非另有說明，此報告結果僅對測試之樣品負責，同時此樣品僅保留90天。本報告未經本公司書面許可，不可部份複製。

This document is issued by the Company subject to its General Conditions of Service printed overleaf, available on request or accessible at [www.sgs.com/terms\\_and\\_conditions.htm](http://www.sgs.com/terms_and_conditions.htm) and, for electronic format documents, subject to Terms and Conditions for Electronic Documents at [www.sgs.com/terms\\_e-document.htm](http://www.sgs.com/terms_e-document.htm). Attention is drawn to the limitation of liability, indemnification and jurisdiction issues defined therein. Any holder of this document is advised that information contained hereon reflects the Company's findings at the time of its intervention only and within the limits of Client's instructions, if any. The Company's sole responsibility is to its Client and this document does not exonerate parties to a transaction from exercising all their rights and obligations under the transaction documents. This document cannot be reproduced except in full, without prior written approval of the Company. Any unauthorized alteration, forgery or falsification of the content or appearance of this document is unlawful and offenders may be prosecuted to the fullest extent of the law.

SGS Taiwan Ltd.

No.134,WuKungRoad,NewTaipeiIndustrialPark,WukuDistrict,NewTaipeiCity,Taiwan24803/新北市五股區新北產業園區五工路 134 號

台灣檢驗科技股份有限公司

t (886-2) 2299-3279

f (886-2) 2298-0488

www.tw.sgs.com

Member of SGS Group

LTE BAND 41 Channel bandwidth: 5MHz					
Freq. (MHz)	CH	99% BW (MHz)	99% BW (MHz)	26 dB BW (MHz)	26 dB BW (MHz)
		QPSK	16QAM	QPSK	16QAM
2498.5	39675	4.5012	4.5013	4.991	4.923
2593.0	40620	4.5068	4.4997	4.922	4.875
2687.5	41565	4.4938	4.4939	4.919	4.985

LTE BAND 41 Channel bandwidth: 10MHz					
Freq. (MHz)	CH	99% BW (MHz)	99% BW (MHz)	26 dB BW (MHz)	26 dB BW (MHz)
		QPSK	16QAM	QPSK	16QAM
2501.0	39700	8.9470	8.9644	9.756	9.717
2593.0	40620	8.9634	8.9752	9.724	9.774
2685.0	41540	8.9699	8.9671	9.744	9.737

LTE BAND 41 Channel bandwidth: 15MHz					
Freq. (MHz)	CH	99% BW (MHz)	99% BW (MHz)	26 dB BW (MHz)	26 dB BW (MHz)
		QPSK	16QAM	QPSK	16QAM
2503.5	39725	13.449	13.466	14.56	14.69
2593.0	40620	13.464	13.464	14.52	14.77
2682.5	41515	13.475	13.466	14.68	14.59

LTE BAND 41 Channel bandwidth: 20MHz					
Freq. (MHz)	CH	99% BW (MHz)	99% BW (MHz)	26 dB BW (MHz)	26 dB BW (MHz)
		QPSK	16QAM	QPSK	16QAM
2506.0	39750	17.885	17.868	19.39	19.44
2593.0	40620	17.921	17.872	19.44	19.47
2680.0	41490	17.893	17.911	19.45	19.31

LTE BAND 41 Channel bandwidth: 5MHz			
Freq. (MHz)	CH	99% BW (MHz)	26 dB BW (MHz)
		64QAM	64QAM
2498.5	39675	4.5061	4.952
2593.0	40620	4.5069	4.923
2687.5	41565	4.5052	4.944

LTE BAND 41 Channel bandwidth: 10MHz			
Freq. (MHz)	CH	99% BW (MHz)	26 dB BW (MHz)
		64QAM	64QAM
2501.0	39700	8.9705	9.805
2593.0	40620	8.9666	9.786
2685.0	41540	8.9724	9.745

LTE BAND 41 Channel bandwidth: 15MHz			
Freq. (MHz)	CH	99% BW (MHz)	26 dB BW (MHz)
		64QAM	64QAM
2503.5	39725	13.427	14.72
2593.0	40620	13.435	14.61
2682.5	41515	13.425	14.68

LTE BAND 41 Channel bandwidth: 20MHz			
Freq. (MHz)	CH	99% BW (MHz)	26 dB BW (MHz)
		64QAM	64QAM
2506.0	39750	17.878	19.33
2593.0	40620	17.890	19.42
2680.0	41490	17.912	19.28

Unless otherwise stated the results shown in this test report refer only to the sample(s) tested and such sample(s) are retained for 90 days only.

除非另有說明，此報告結果僅對測試之樣品負責，同時此樣品僅保留90天。本報告未經本公司書面許可，不可部份複製。

This document is issued by the Company subject to its General Conditions of Service printed overleaf, available on request or accessible at [www.sgs.com/terms\\_and\\_conditions.htm](http://www.sgs.com/terms_and_conditions.htm) and, for electronic format documents, subject to Terms and Conditions for Electronic Documents at [www.sgs.com/terms\\_e-document.htm](http://www.sgs.com/terms_e-document.htm). Attention is drawn to the limitation of liability, indemnification and jurisdiction issues defined therein. Any holder of this document is advised that information contained hereon reflects the Company's findings at the time of its intervention only and within the limits of Client's instructions, if any. The Company's sole responsibility is to its Client and this document does not exonerate parties to a transaction from exercising all their rights and obligations under the transaction documents. This document cannot be reproduced except in full, without prior written approval of the Company. Any unauthorized alteration, forgery or falsification of the content or appearance of this document is unlawful and offenders may be prosecuted to the fullest extent of the law.

SGS Taiwan Ltd.

No.134,WuKungRoad,NewTaipeiIndustrialPark,WukuDistrict,NewTaipeiCity,Taiwan24803/新北市五股區新北產業園區五工路 134 號

台灣檢驗科技股份有限公司

t (886-2) 2299-3279

f (886-2) 2298-0488

www.tw.sgs.com

Member of SGS Group



GRPS\_850MHz\_LowCH128-824.2

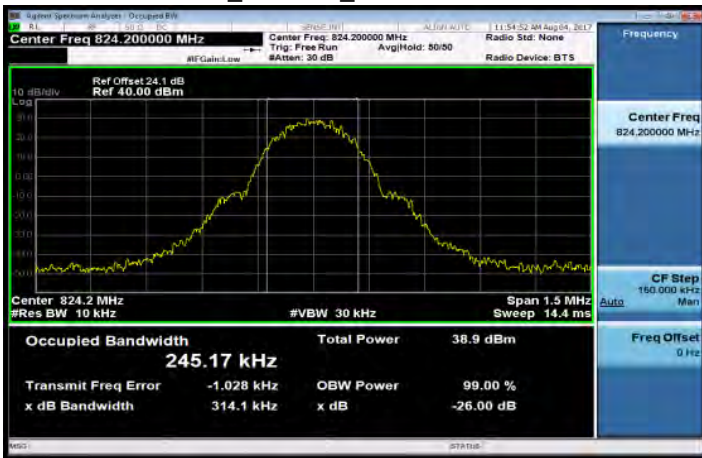

EDGE\_850MHz\_LowCH128-824.2

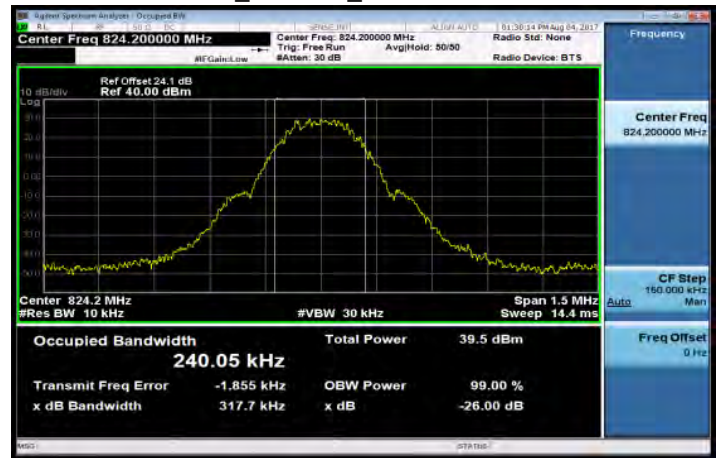

GRPS\_850MHz\_MidCH190-836.6

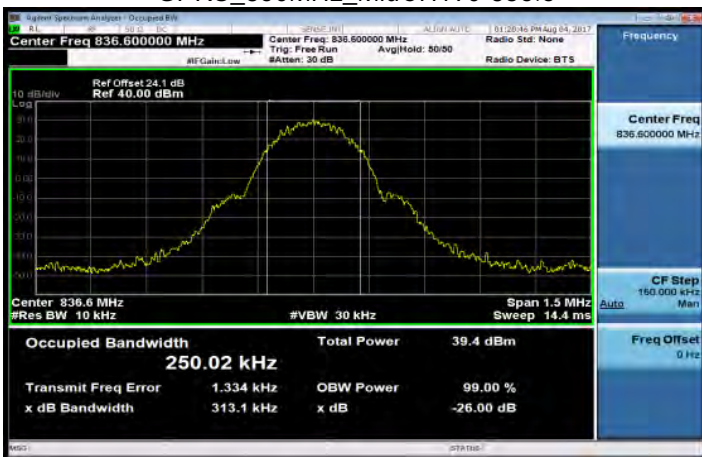

EDGE\_850MHz\_MidCH190-836.6

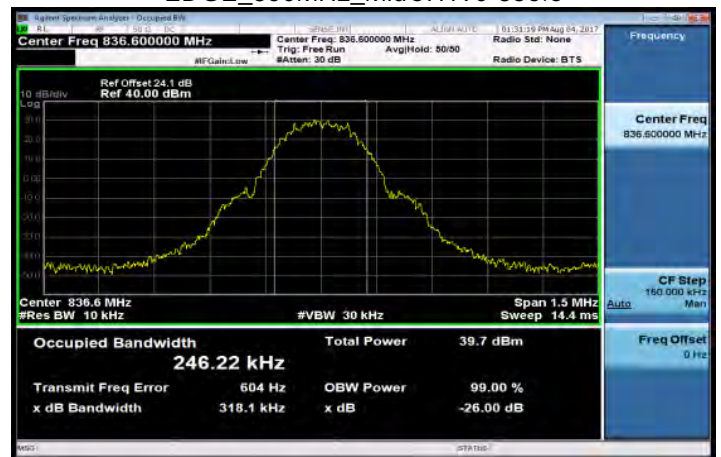

GRPS\_850MHz\_HighCH251-848.8

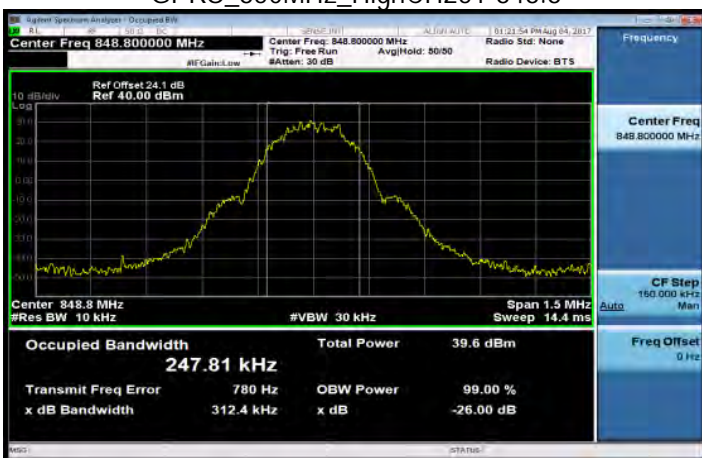

EDGE\_850MHz\_HighCH251-848.8

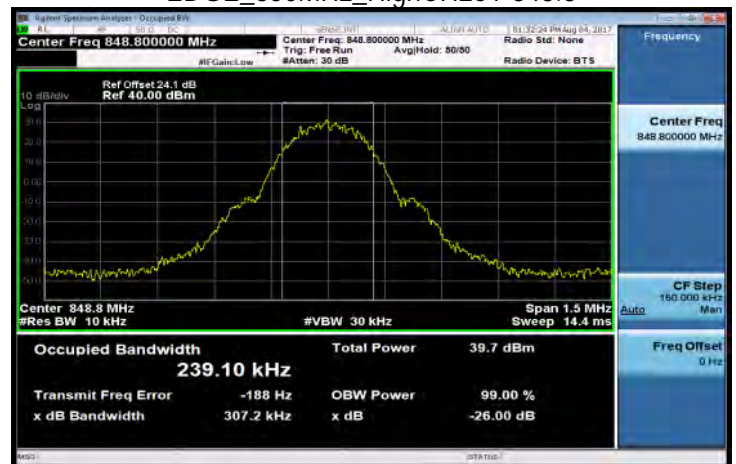

Unless otherwise stated the results shown in this test report refer only to the sample(s) tested and such sample(s) are retained for 90 days only.

除非另有說明，此報告結果僅對測試之樣品負責，同時此樣品僅保留90天。本報告未經本公司書面許可，不可部份複製。

This document is issued by the Company subject to its General Conditions of Service printed overleaf, available on request or accessible at [www.sgs.com/terms\\_and\\_conditions.htm](http://www.sgs.com/terms_and_conditions.htm) and, for electronic format documents, subject to Terms and Conditions for Electronic Documents at [www.sgs.com/terms\\_e-document.htm](http://www.sgs.com/terms_e-document.htm). Attention is drawn to the limitation of liability, indemnification and jurisdiction issues defined therein. Any holder of this document is advised that information contained hereon reflects the Company's findings at the time of its intervention only and within the limits of Client's instructions, if any. The Company's sole responsibility is to its Client and this document does not exonerate parties to a transaction from exercising all their rights and obligations under the transaction documents. This document cannot be reproduced except in full, without prior written approval of the Company. Any unauthorized alteration, forgery or falsification of the content or appearance of this document is unlawful and offenders may be prosecuted to the fullest extent of the law.

GPRS\_1900MHz\_LowCH512-1850.2

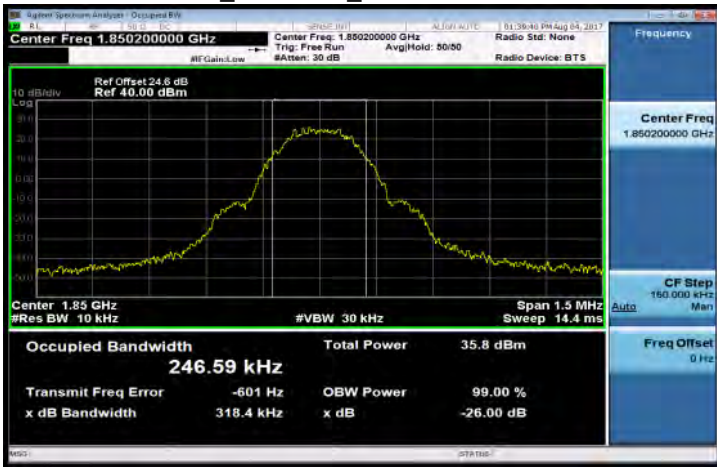

EDGE\_1900MHz\_LowCH512-1850.2

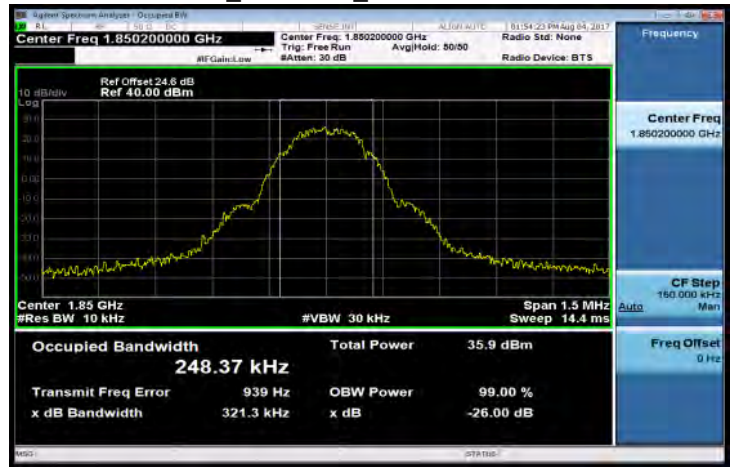

GPRS\_1900MHz\_MidCH661-1880

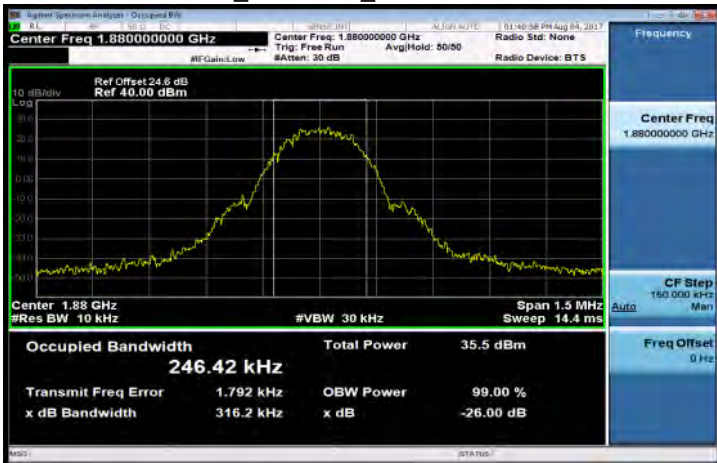

EDGE\_1900MHz\_MidCH661-1880

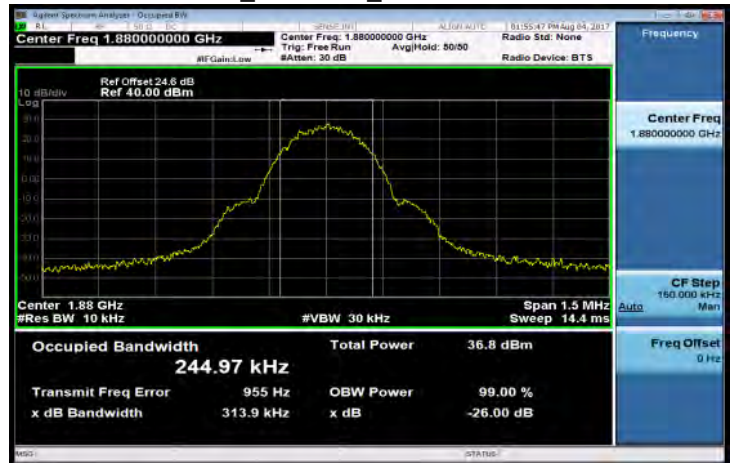

GPRS\_1900MHz\_HighCH810-1909.8

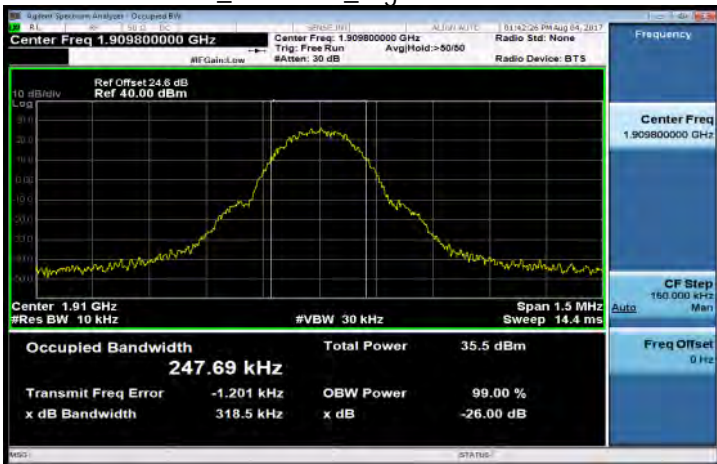

EDGE\_1900MHz\_HighCH810-1909.8

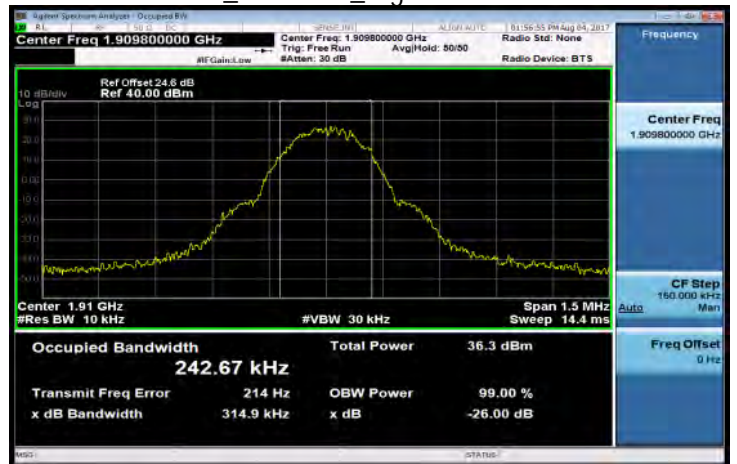

Unless otherwise stated the results shown in this test report refer only to the sample(s) tested and such sample(s) are retained for 90 days only.

除非另有說明，此報告結果僅對測試之樣品負責，同時此樣品僅保留90天。本報告未經本公司書面許可，不可部份複製。

This document is issued by the Company subject to its General Conditions of Service printed overleaf, available on request or accessible at [www.sgs.com/terms\\_and\\_conditions.htm](http://www.sgs.com/terms_and_conditions.htm) and, for electronic format documents, subject to Terms and Conditions for Electronic Documents at [www.sgs.com/terms\\_e-document.htm](http://www.sgs.com/terms_e-document.htm). Attention is drawn to the limitation of liability, indemnification and jurisdiction issues defined therein. Any holder of this document is advised that information contained hereon reflects the Company's findings at the time of its intervention only and within the limits of Client's instructions, if any. The Company's sole responsibility is to its Client and this document does not exonerate parties to a transaction from exercising all their rights and obligations under the transaction documents. This document cannot be reproduced except in full, without prior written approval of the Company. Any unauthorized alteration, forgery or falsification of the content or appearance of this document is unlawful and offenders may be prosecuted to the fullest extent of the law.

WCDMA\_B2\_LowCH9262-1852.4

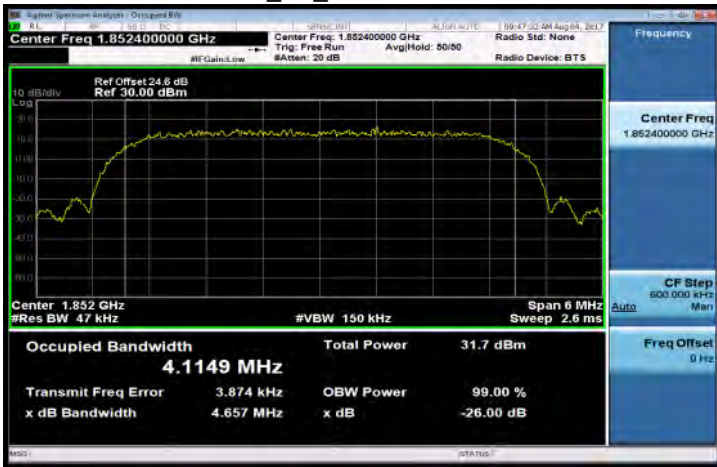

HSDPA\_B2\_LowCH9262-1852.4

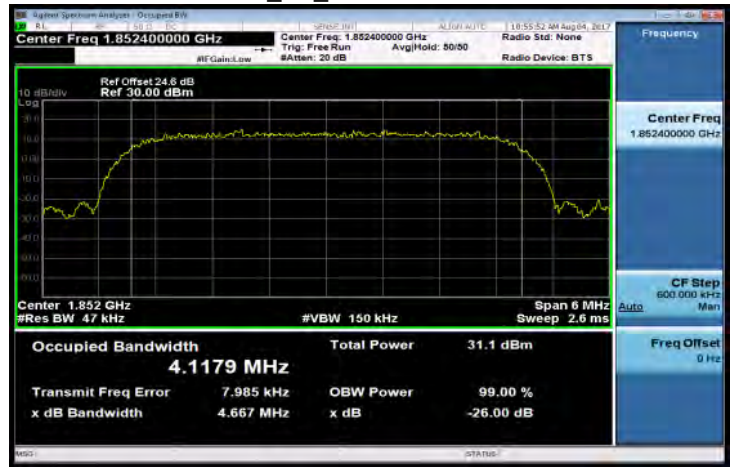

WCDMA\_B2\_MidCH9400-1880



HSDPA\_B2\_MidCH9400-1880

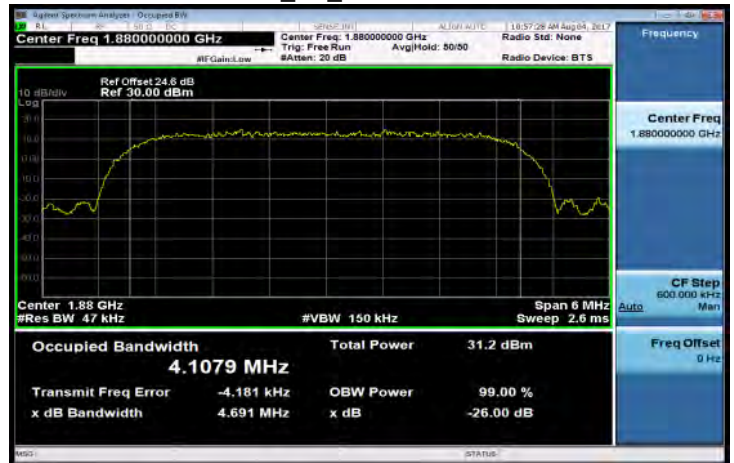

WCDMA\_B2\_HighCH9538-1907.6

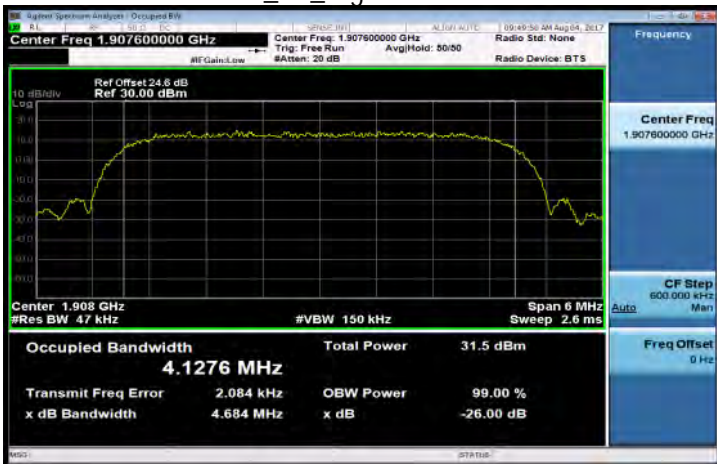

HSDPA\_B2\_HighCH9538-1907.6

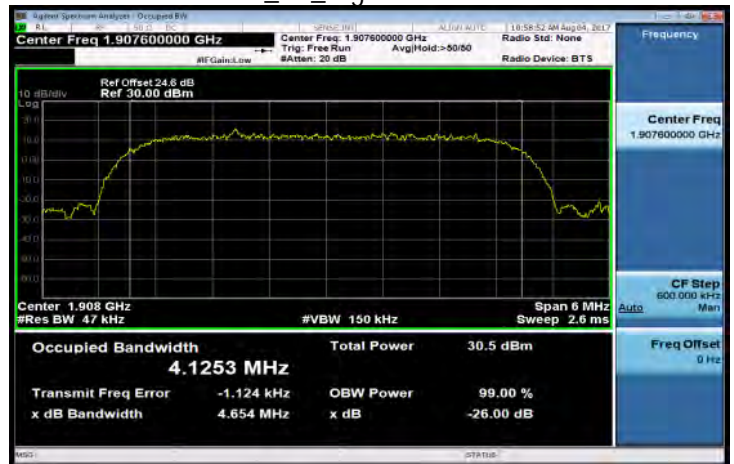

Unless otherwise stated the results shown in this test report refer only to the sample(s) tested and such sample(s) are retained for 90 days only.

除非另有說明，此報告結果僅對測試之樣品負責，同時此樣品僅保留90天。本報告未經本公司書面許可，不可部份複製。

This document is issued by the Company subject to its General Conditions of Service printed overleaf, available on request or accessible at [www.sgs.com/terms\\_and\\_conditions.htm](http://www.sgs.com/terms_and_conditions.htm) and, for electronic format documents, subject to Terms and Conditions for Electronic Documents at [www.sgs.com/terms\\_e-document.htm](http://www.sgs.com/terms_e-document.htm). Attention is drawn to the limitation of liability, indemnification and jurisdiction issues defined therein. Any holder of this document is advised that information contained hereon reflects the Company's findings at the time of its intervention only and within the limits of Client's instructions, if any. The Company's sole responsibility is to its Client and this document does not exonerate parties to a transaction from exercising all their rights and obligations under the transaction documents. This document cannot be reproduced except in full, without prior written approval of the Company. Any unauthorized alteration, forgery or falsification of the content or appearance of this document is unlawful and offenders may be prosecuted to the fullest extent of the law.

HSUPA\_B2\_LowCH9262-1852.4

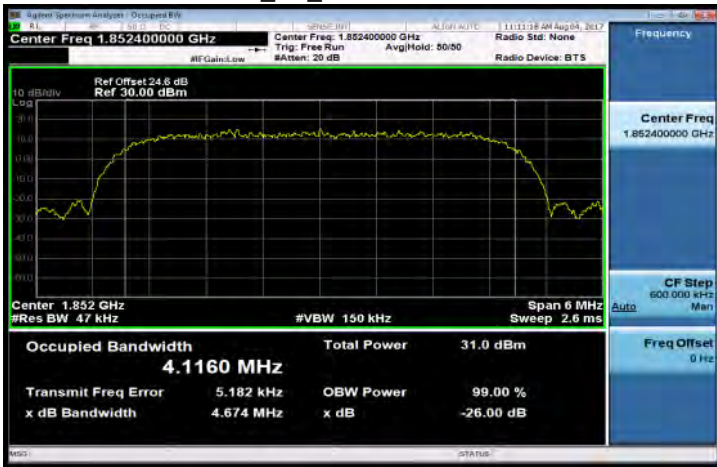

WCDMA\_B4\_LowCH1312-1712.4



HSUPA\_B2\_MidCH9400-1880

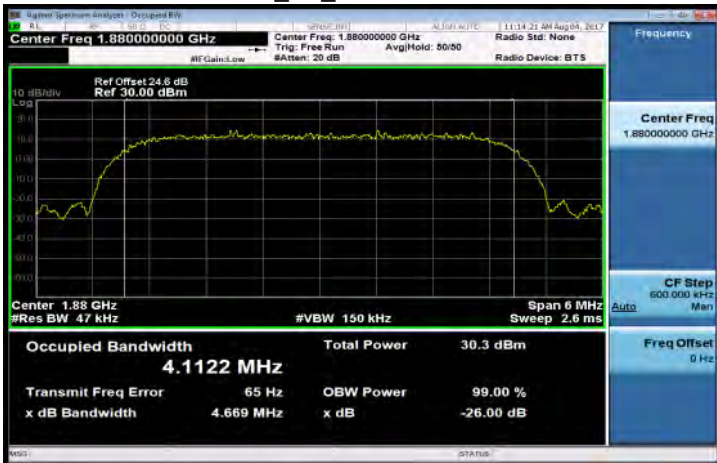

WCDMA\_B4\_MidCH1413-1732.6

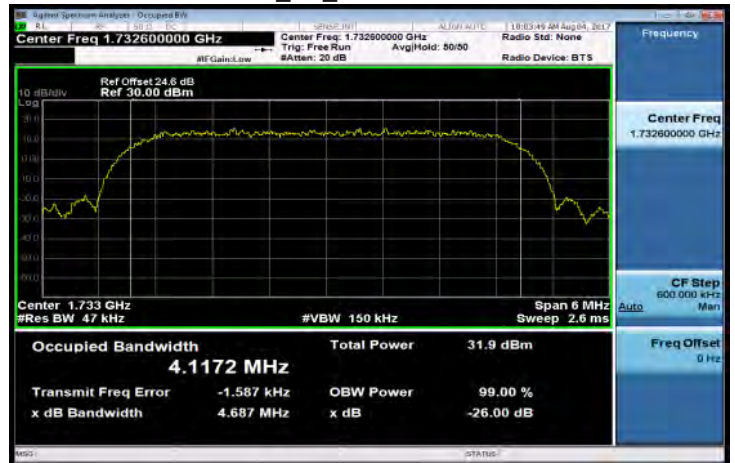

HSUPA\_B2\_HighCH9538-1907.6

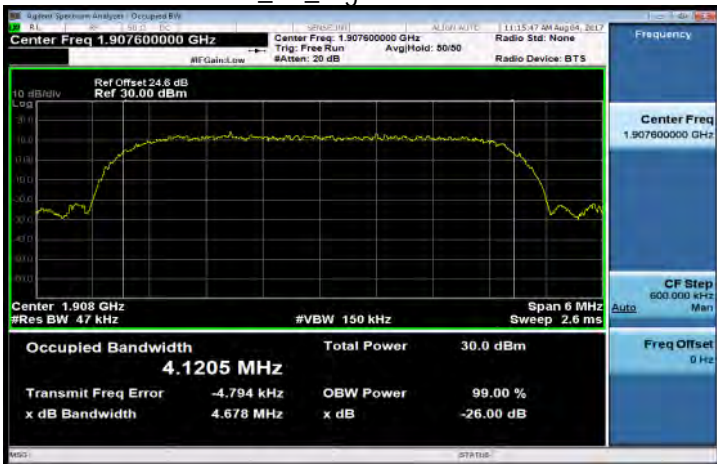

WCDMA\_B4\_HighCH1513-1752.6



Unless otherwise stated the results shown in this test report refer only to the sample(s) tested and such sample(s) are retained for 90 days only.

除非另有說明，此報告結果僅對測試之樣品負責，同時此樣品僅保留90天。本報告未經本公司書面許可，不可部份複製。

This document is issued by the Company subject to its General Conditions of Service printed overleaf, available on request or accessible at [www.sgs.com/terms\\_and\\_conditions.htm](http://www.sgs.com/terms_and_conditions.htm) and, for electronic format documents, subject to Terms and Conditions for Electronic Documents at [www.sgs.com/terms\\_e-document.htm](http://www.sgs.com/terms_e-document.htm). Attention is drawn to the limitation of liability, indemnification and jurisdiction issues defined therein. Any holder of this document is advised that information contained hereon reflects the Company's findings at the time of its intervention only and within the limits of Client's instructions, if any. The Company's sole responsibility is to its Client and this document does not exonerate parties to a transaction from exercising all their rights and obligations under the transaction documents. This document cannot be reproduced except in full, without prior written approval of the Company. Any unauthorized alteration, forgery or falsification of the content or appearance of this document is unlawful and offenders may be prosecuted to the fullest extent of the law.

HSDPA\_B4\_LowCH1312-1712.4

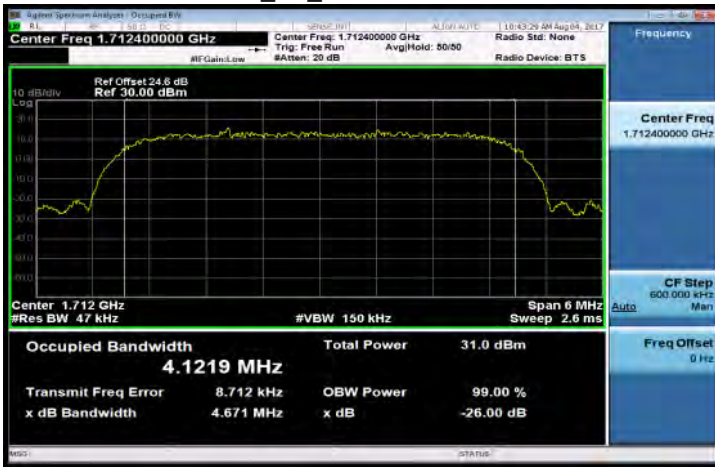

HSUPA\_B4\_LowCH1312-1712.4

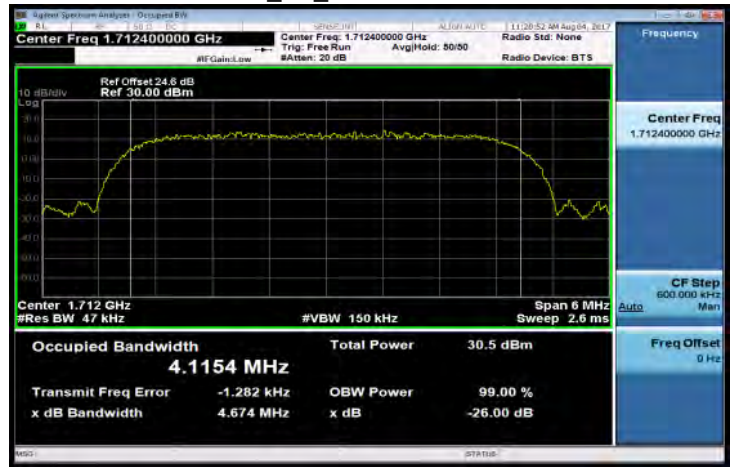

HSDPA\_B4\_MidCH1413-1732.6

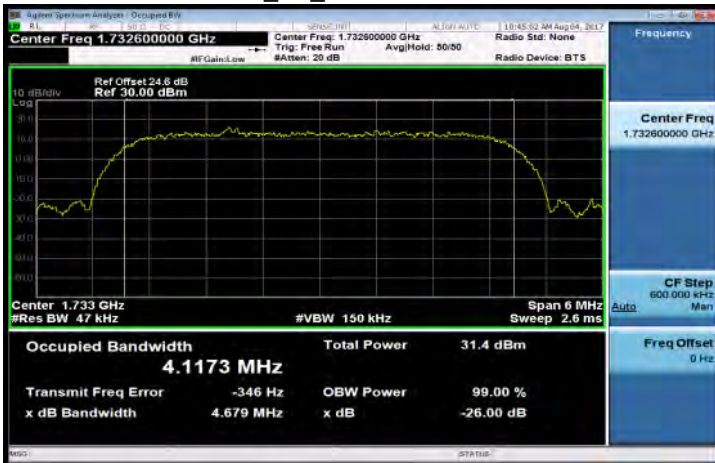

HSUPA\_B4\_MidCH1413-1732.6

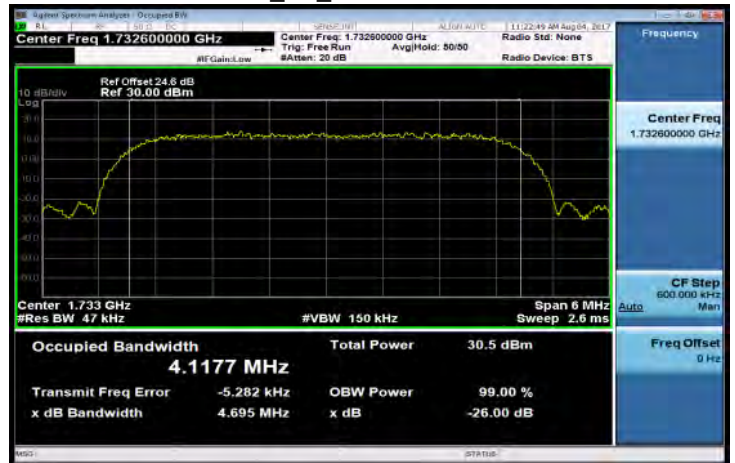

HSDPA\_B4\_HighCH1513-1752.6

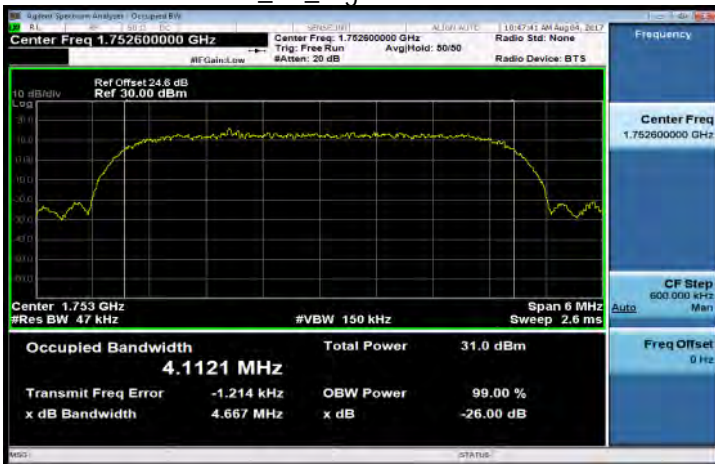

HSUPA\_B4\_HighCH1513-1752.6

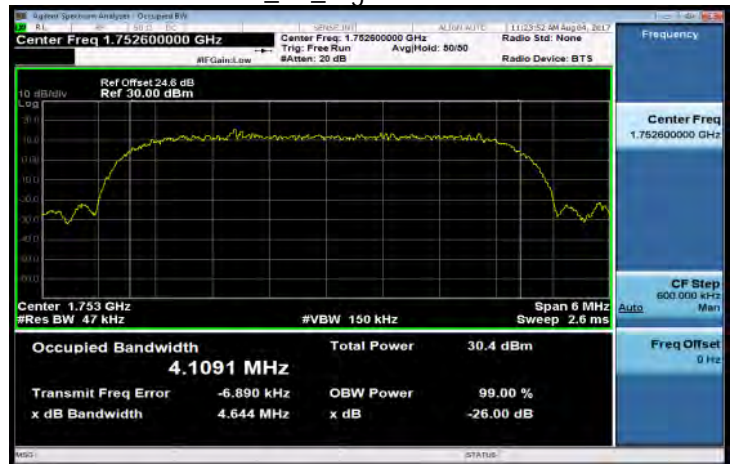

Unless otherwise stated the results shown in this test report refer only to the sample(s) tested and such sample(s) are retained for 90 days only.

除非另有說明，此報告結果僅對測試之樣品負責，同時此樣品僅保留90天。本報告未經本公司書面許可，不可部份複製。

This document is issued by the Company subject to its General Conditions of Service printed overleaf, available on request or accessible at [www.sgs.com/terms\\_and\\_conditions.htm](http://www.sgs.com/terms_and_conditions.htm) and, for electronic format documents, subject to Terms and Conditions for Electronic Documents at [www.sgs.com/terms\\_e-document.htm](http://www.sgs.com/terms_e-document.htm). Attention is drawn to the limitation of liability, indemnification and jurisdiction issues defined therein. Any holder of this document is advised that information contained hereon reflects the Company's findings at the time of its intervention only and within the limits of Client's instructions, if any. The Company's sole responsibility is to its Client and this document does not exonerate parties to a transaction from exercising all their rights and obligations under the transaction documents. This document cannot be reproduced except in full, without prior written approval of the Company. Any unauthorized alteration, forgery or falsification of the content or appearance of this document is unlawful and offenders may be prosecuted to the fullest extent of the law.

WCDMA\_B5\_LowCH4132-826.4

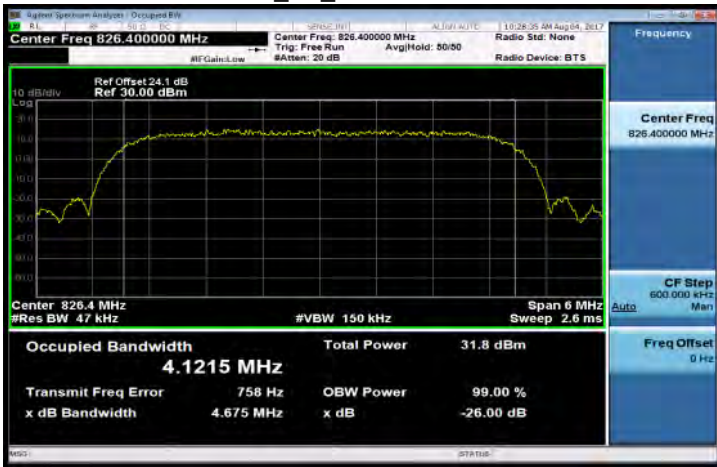

HSDPA\_B5\_LowCH4132-826.4



WCDMA\_B5\_MidCH4183-836.6

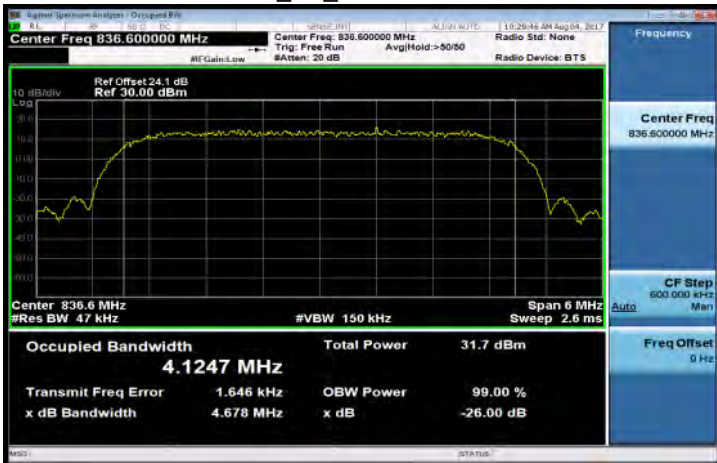

HSDPA\_B5\_MidCH4183-836.6

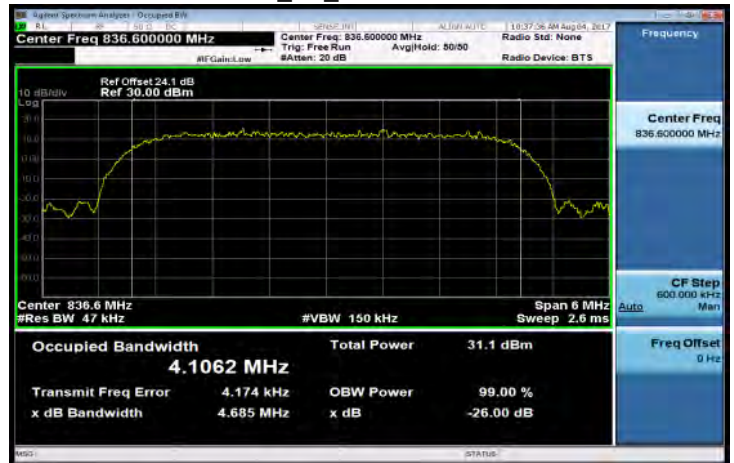

WCDMA\_B5\_HighCH4233-846.6



HSDPA\_B5\_HighCH4233-846.6

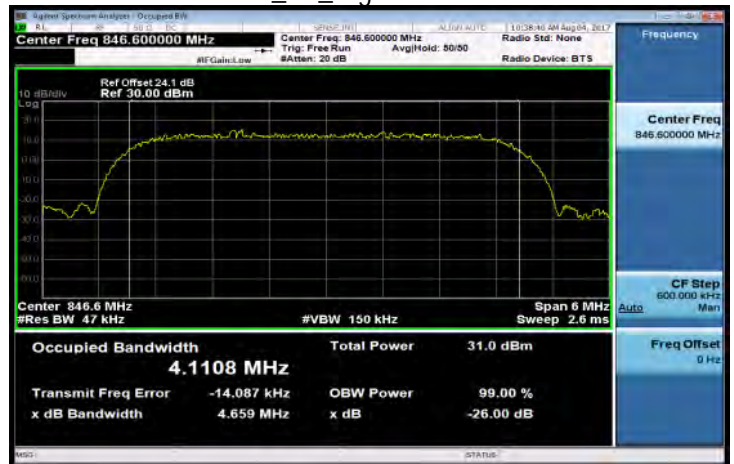

Unless otherwise stated the results shown in this test report refer only to the sample(s) tested and such sample(s) are retained for 90 days only.

除非另有說明，此報告結果僅對測試之樣品負責，同時此樣品僅保留90天。本報告未經本公司書面許可，不可部份複製。

This document is issued by the Company subject to its General Conditions of Service printed overleaf, available on request or accessible at [www.sgs.com/terms\\_and\\_conditions.htm](http://www.sgs.com/terms_and_conditions.htm) and, for electronic format documents, subject to Terms and Conditions for Electronic Documents at [www.sgs.com/terms\\_e-document.htm](http://www.sgs.com/terms_e-document.htm). Attention is drawn to the limitation of liability, indemnification and jurisdiction issues defined therein. Any holder of this document is advised that information contained hereon reflects the Company's findings at the time of its intervention only and within the limits of Client's instructions, if any. The Company's sole responsibility is to its Client and this document does not exonerate parties to a transaction from exercising all their rights and obligations under the transaction documents. This document cannot be reproduced except in full, without prior written approval of the Company. Any unauthorized alteration, forgery or falsification of the content or appearance of this document is unlawful and offenders may be prosecuted to the fullest extent of the law.

HSUPA\_B5\_LowCH4132-826.4

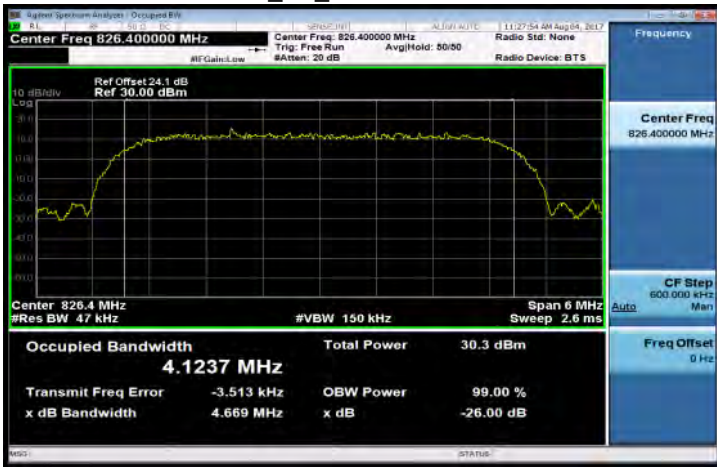

Band2\_1\_4MHz\_QPSK\_6\_0\_LowCH18607-1850.7

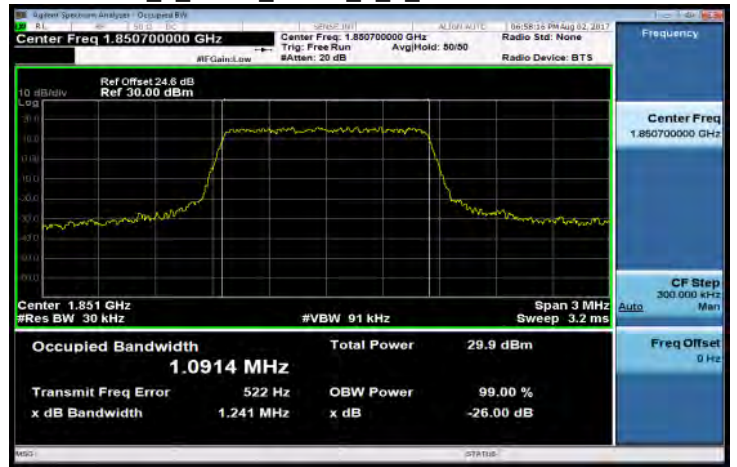

HSUPA\_B5\_MidCH4183-836.6



Band2\_1\_4MHz\_QPSK\_6\_0\_MidCH18900-1880

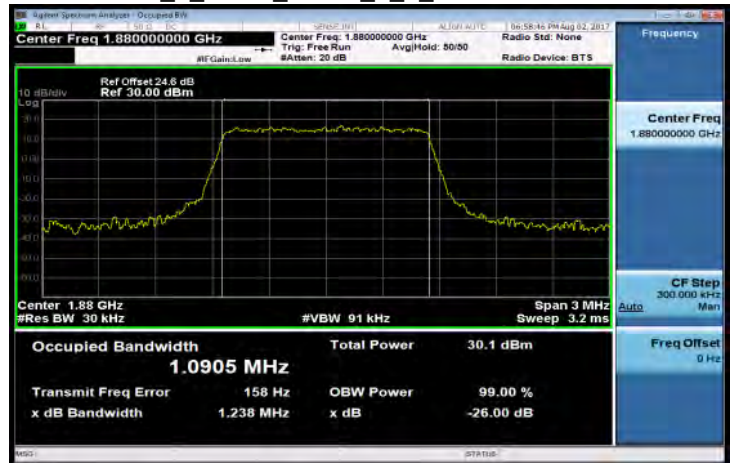

HSUPA\_B5\_HighCH4233-846.6



Band2\_1\_4MHz\_QPSK\_6\_0\_HighCH19193-1909.3

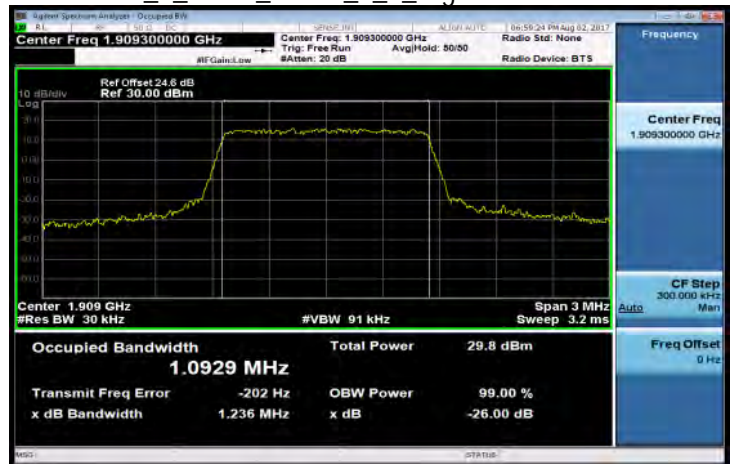

Unless otherwise stated the results shown in this test report refer only to the sample(s) tested and such sample(s) are retained for 90 days only.

除非另有說明，此報告結果僅對測試之樣品負責，同時此樣品僅保留90天。本報告未經本公司書面許可，不可部份複製。

This document is issued by the Company subject to its General Conditions of Service printed overleaf, available on request or accessible at [www.sgs.com/terms\\_and\\_conditions.htm](http://www.sgs.com/terms_and_conditions.htm) and, for electronic format documents, subject to Terms and Conditions for Electronic Documents at [www.sgs.com/terms\\_e-document.htm](http://www.sgs.com/terms_e-document.htm). Attention is drawn to the limitation of liability, indemnification and jurisdiction issues defined therein. Any holder of this document is advised that information contained hereon reflects the Company's findings at the time of its intervention only and within the limits of Client's instructions, if any. The Company's sole responsibility is to its Client and this document does not exonerate parties to a transaction from exercising all their rights and obligations under the transaction documents. This document cannot be reproduced except in full, without prior written approval of the Company. Any unauthorized alteration, forgery or falsification of the content or appearance of this document is unlawful and offenders may be prosecuted to the fullest extent of the law.

Band2\_1\_4MHz\_16QAM\_6\_0\_LowCH18607-1850.7

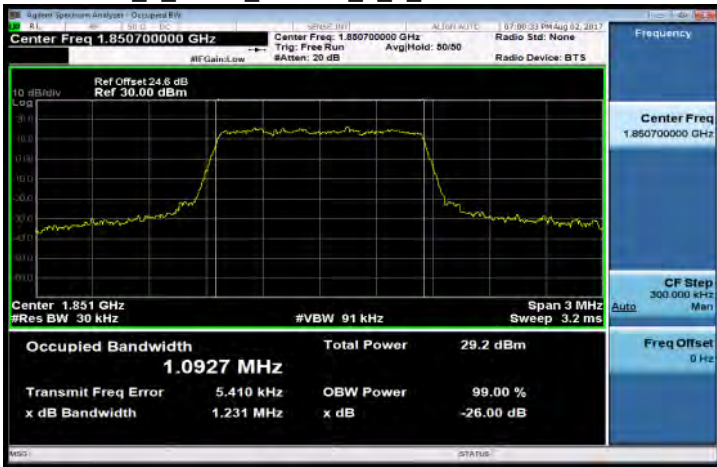

Band2\_1\_4MHz\_64QAM\_6\_0\_LowCH18607-1850.7

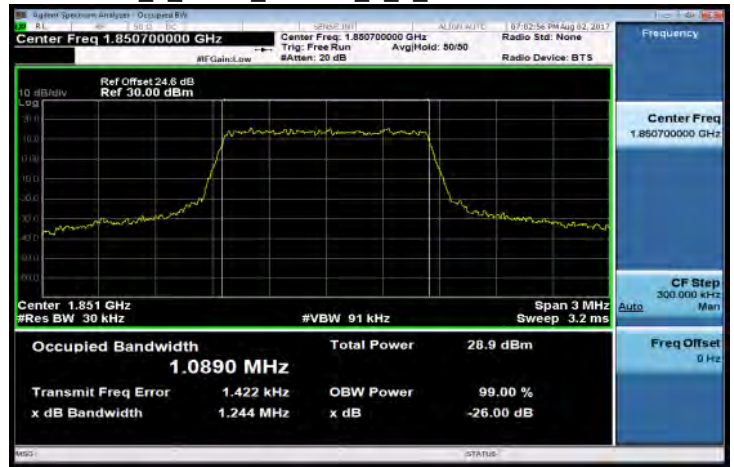

Band2\_1\_4MHz\_16QAM\_6\_0\_MidCH18900-1880

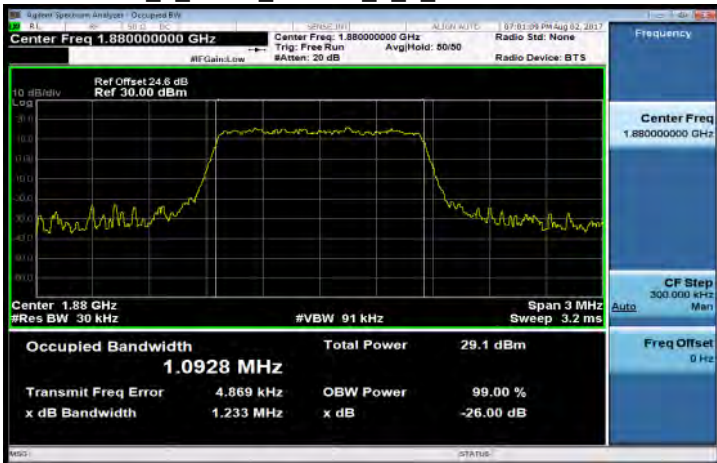

Band2\_1\_4MHz\_64QAM\_6\_0\_MidCH18900-1880

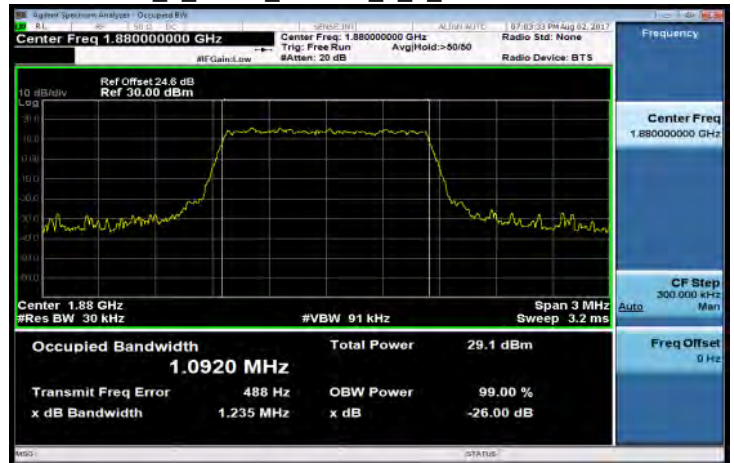

Band2\_1\_4MHz\_16QAM\_6\_0\_HighCH19193-1909.3



Band2\_1\_4MHz\_64QAM\_6\_0\_HighCH19193-1909.3

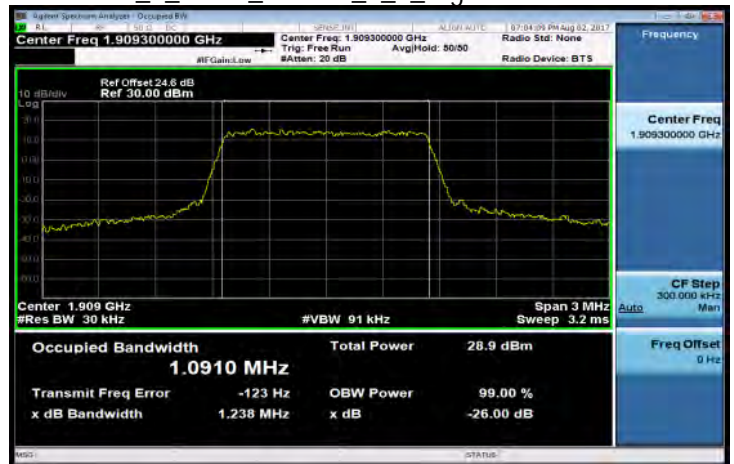

Unless otherwise stated the results shown in this test report refer only to the sample(s) tested and such sample(s) are retained for 90 days only.

除非另有說明，此報告結果僅對測試之樣品負責，同時此樣品僅保留90天。本報告未經本公司書面許可，不可部份複製。

This document is issued by the Company subject to its General Conditions of Service printed overleaf, available on request or accessible at [www.sgs.com/terms\\_and\\_conditions.htm](http://www.sgs.com/terms_and_conditions.htm) and, for electronic format documents, subject to Terms and Conditions for Electronic Documents at [www.sgs.com/terms\\_e-document.htm](http://www.sgs.com/terms_e-document.htm). Attention is drawn to the limitation of liability, indemnification and jurisdiction issues defined therein. Any holder of this document is advised that information contained hereon reflects the Company's findings at the time of its intervention only and within the limits of Client's instructions, if any. The Company's sole responsibility is to its Client and this document does not exonerate parties to a transaction from exercising all their rights and obligations under the transaction documents. This document cannot be reproduced except in full, without prior written approval of the Company. Any unauthorized alteration, forgery or falsification of the content or appearance of this document is unlawful and offenders may be prosecuted to the fullest extent of the law.



Band2\_3MHz\_QPSK\_15\_0\_LowCH18615-1851.5

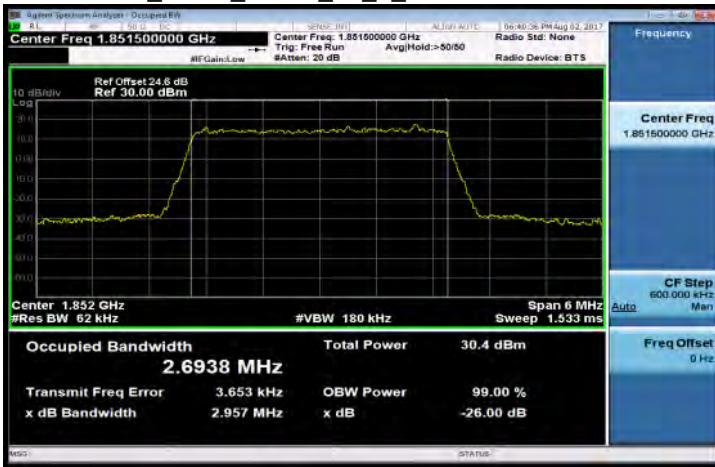

Band2\_3MHz\_16QAM\_15\_0\_LowCH18615-1851.5

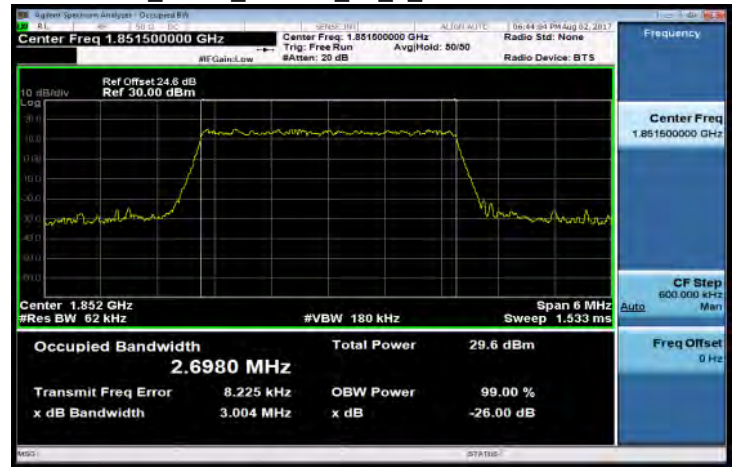

Band2\_3MHz\_QPSK\_15\_0\_MidCH18900-1880

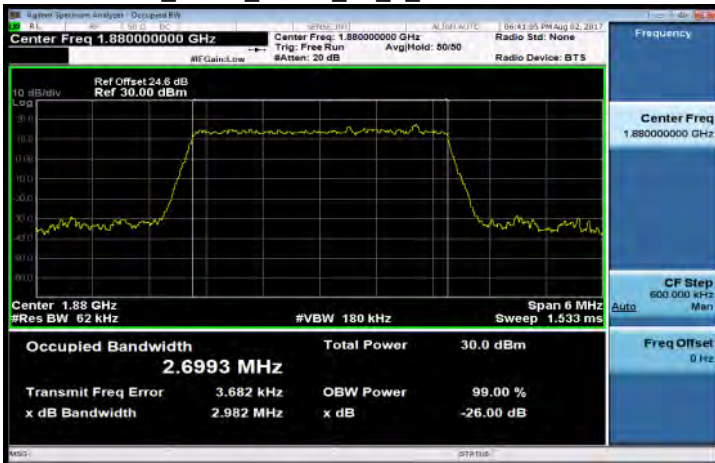

Band2\_3MHz\_16QAM\_15\_0\_MidCH18900-1880

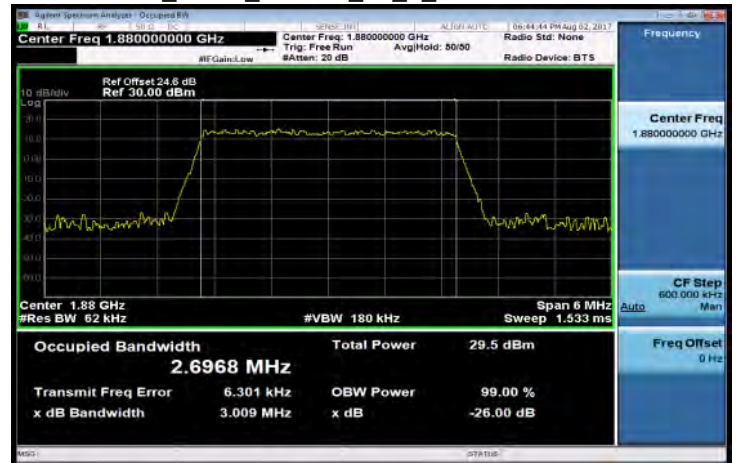

Band2\_3MHz\_QPSK\_15\_0\_HighCH19185-1908.5

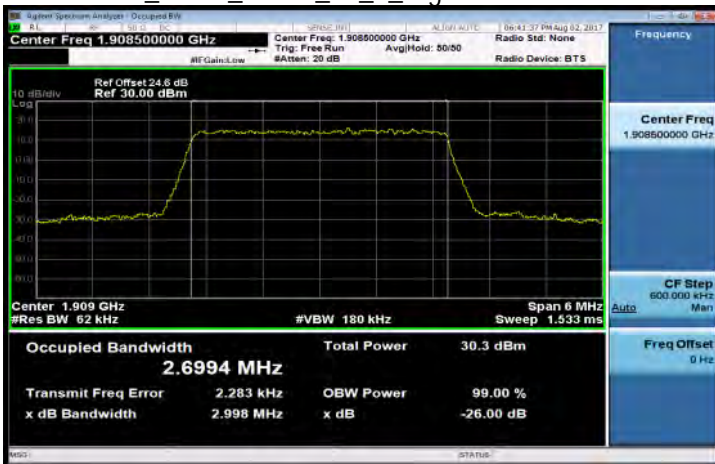

Band2\_3MHz\_16QAM\_15\_0\_HighCH19185-1908.5

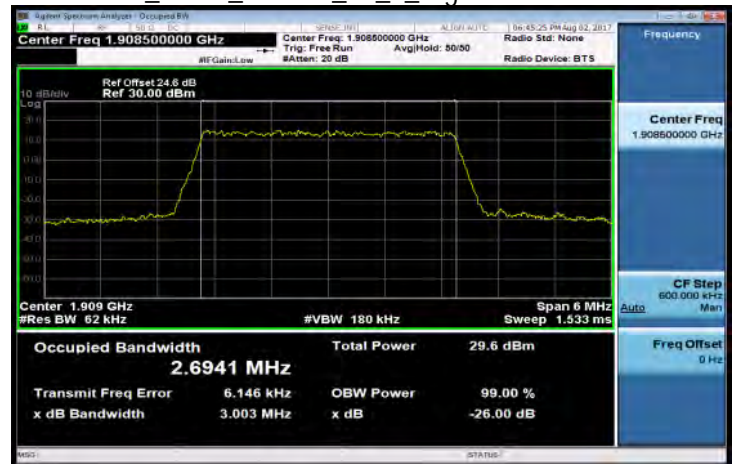

Unless otherwise stated the results shown in this test report refer only to the sample(s) tested and such sample(s) are retained for 90 days only.

除非另有說明，此報告結果僅對測試之樣品負責，同時此樣品僅保留90天。本報告未經本公司書面許可，不可部份複製。

This document is issued by the Company subject to its General Conditions of Service printed overleaf, available on request or accessible at [www.sgs.com/terms\\_and\\_conditions.htm](http://www.sgs.com/terms_and_conditions.htm) and, for electronic format documents, subject to Terms and Conditions for Electronic Documents at [www.sgs.com/terms\\_e-document.htm](http://www.sgs.com/terms_e-document.htm). Attention is drawn to the limitation of liability, indemnification and jurisdiction issues defined therein. Any holder of this document is advised that information contained hereon reflects the Company's findings at the time of its intervention only and within the limits of Client's instructions, if any. The Company's sole responsibility is to its Client and this document does not exonerate parties to a transaction from exercising all their rights and obligations under the transaction documents. This document cannot be reproduced except in full, without prior written approval of the Company. Any unauthorized alteration, forgery or falsification of the content or appearance of this document is unlawful and offenders may be prosecuted to the fullest extent of the law.

Band2\_3MHz\_64QAM\_15\_0\_LowCH18615-1851.5

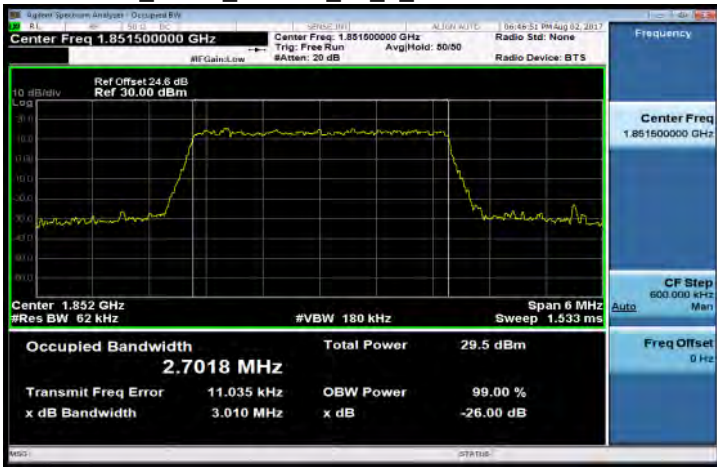

Band2\_5MHz\_QPSK\_25\_0\_LowCH18625-1852.5

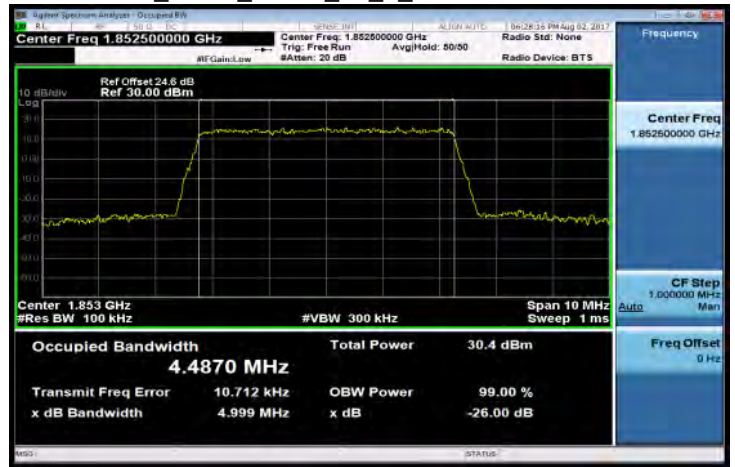

Band2\_3MHz\_64QAM\_15\_0\_MidCH18900-1880

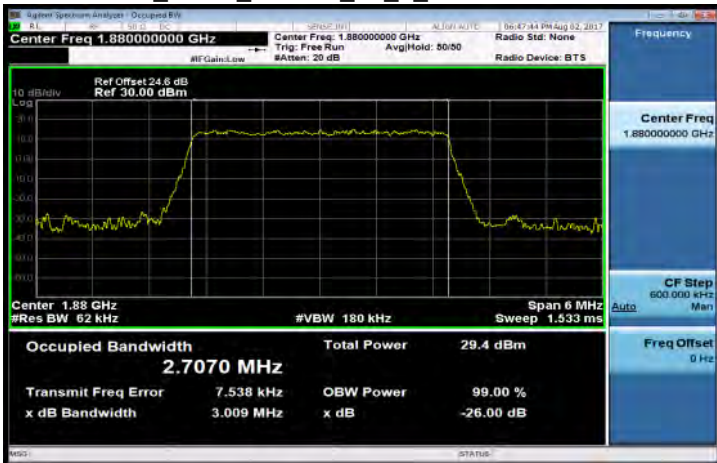

Band2\_5MHz\_QPSK\_25\_0\_MidCH18900-1880

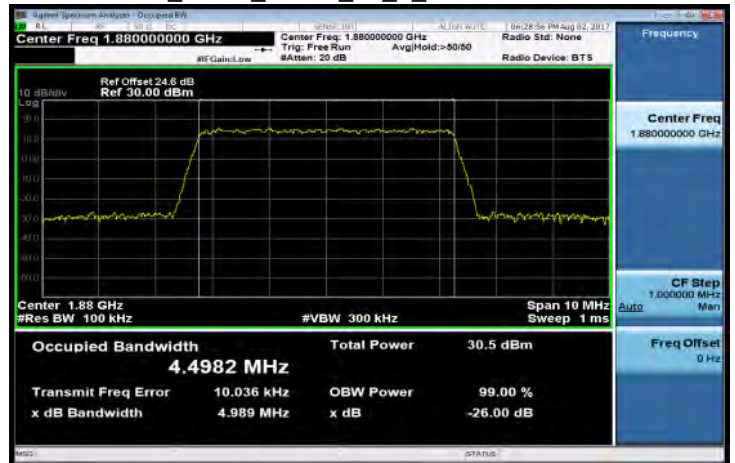

Band2\_3MHz\_64QAM\_15\_0\_HighCH19185-1908.5

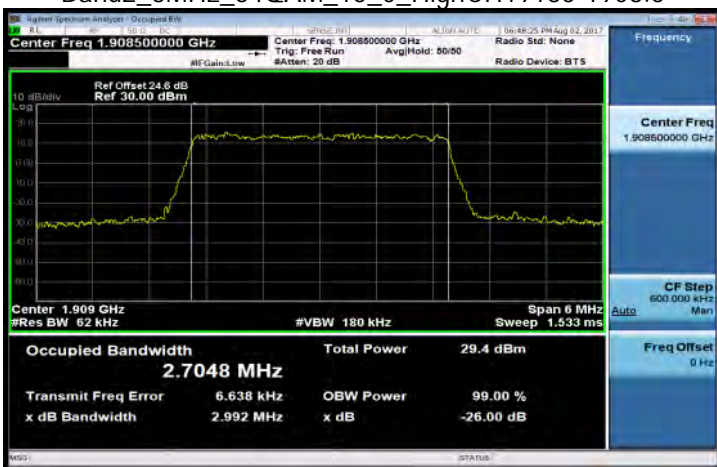

Band2\_5MHz\_QPSK\_25\_0\_HighCH19175-1907.5

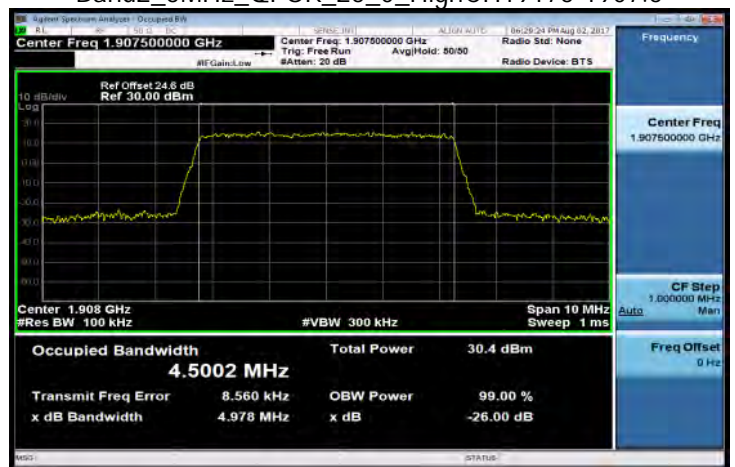

Unless otherwise stated the results shown in this test report refer only to the sample(s) tested and such sample(s) are retained for 90 days only.

除非另有說明，此報告結果僅對測試之樣品負責，同時此樣品僅保留90天。本報告未經本公司書面許可，不可部份複製。

This document is issued by the Company subject to its General Conditions of Service printed overleaf, available on request or accessible at [www.sgs.com/terms\\_and\\_conditions.htm](http://www.sgs.com/terms_and_conditions.htm) and, for electronic format documents, subject to Terms and Conditions for Electronic Documents at [www.sgs.com/terms\\_e-document.htm](http://www.sgs.com/terms_e-document.htm). Attention is drawn to the limitation of liability, indemnification and jurisdiction issues defined therein. Any holder of this document is advised that information contained hereon reflects the Company's findings at the time of its intervention only and within the limits of Client's instructions, if any. The Company's sole responsibility is to its Client and this document does not exonerate parties to a transaction from exercising all their rights and obligations under the transaction documents. This document cannot be reproduced except in full, without prior written approval of the Company. Any unauthorized alteration, forgery or falsification of the content or appearance of this document is unlawful and offenders may be prosecuted to the fullest extent of the law.

Band2\_5MHz\_16QAM\_25\_0\_LowCH18625-1852.5

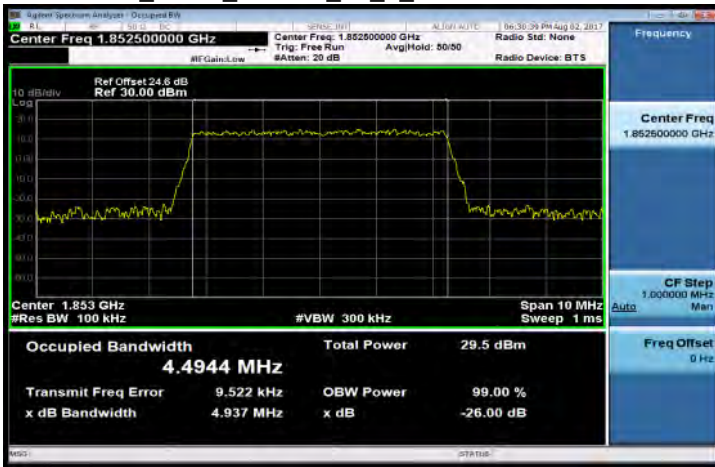

Band2\_5MHz\_64QAM\_25\_0\_LowCH18625-1852.5



Band2\_5MHz\_16QAM\_25\_0\_MidCH18900-1880

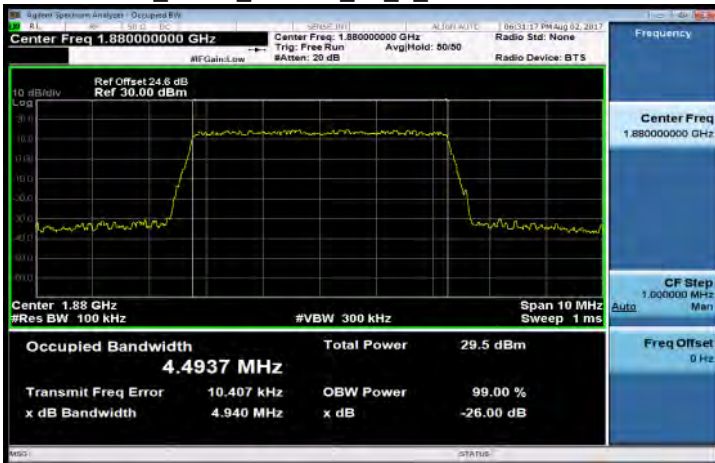

Band2\_5MHz\_64QAM\_25\_0\_MidCH18900-1880

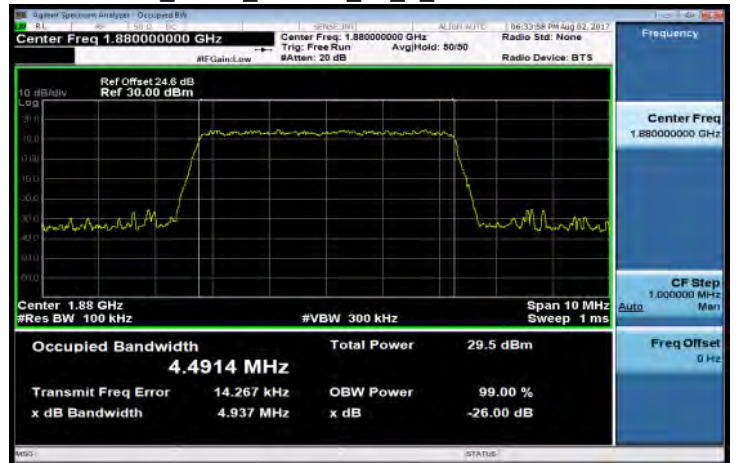

Band2\_5MHz\_16QAM\_25\_0\_HighCH19175-1907.5

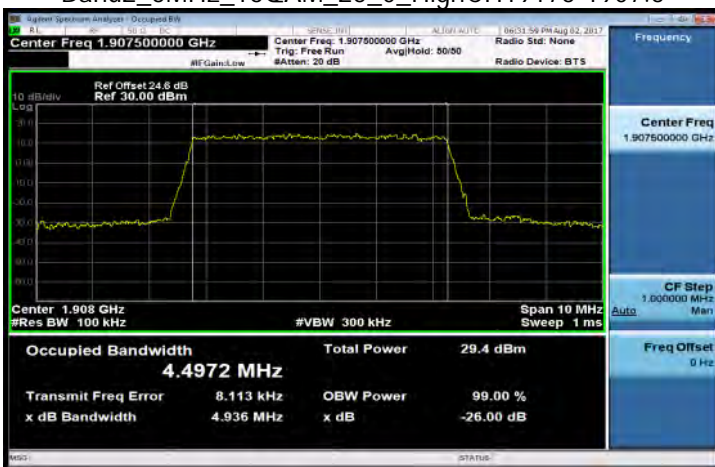

Band2\_5MHz\_64QAM\_25\_0\_HighCH19175-1907.5

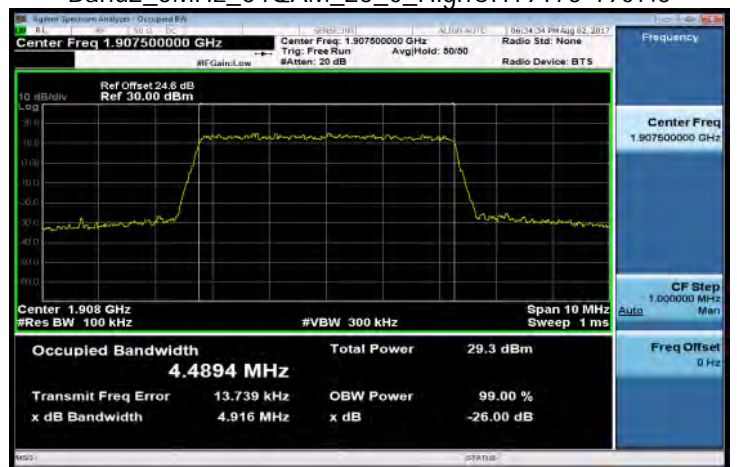

Unless otherwise stated the results shown in this test report refer only to the sample(s) tested and such sample(s) are retained for 90 days only.

除非另有說明，此報告結果僅對測試之樣品負責，同時此樣品僅保留90天。本報告未經本公司書面許可，不可部份複製。

This document is issued by the Company subject to its General Conditions of Service printed overleaf, available on request or accessible at [www.sgs.com/terms\\_and\\_conditions.htm](http://www.sgs.com/terms_and_conditions.htm) and, for electronic format documents, subject to Terms and Conditions for Electronic Documents at [www.sgs.com/terms\\_e-document.htm](http://www.sgs.com/terms_e-document.htm). Attention is drawn to the limitation of liability, indemnification and jurisdiction issues defined therein. Any holder of this document is advised that information contained hereon reflects the Company's findings at the time of its intervention only and within the limits of Client's instructions, if any. The Company's sole responsibility is to its Client and this document does not exonerate parties to a transaction from exercising all their rights and obligations under the transaction documents. This document cannot be reproduced except in full, without prior written approval of the Company. Any unauthorized alteration, forgery or falsification of the content or appearance of this document is unlawful and offenders may be prosecuted to the fullest extent of the law.

Band2\_10MHz\_QPSK\_50\_0\_LowCH18650-1855

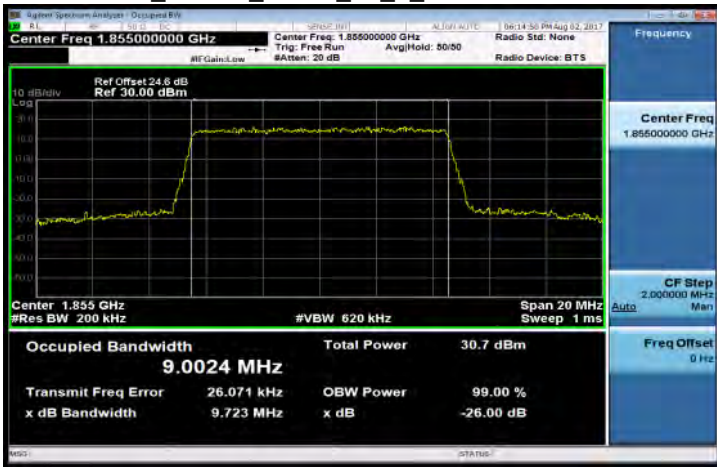

Band2\_10MHz\_16QAM\_50\_0\_LowCH18650-1855

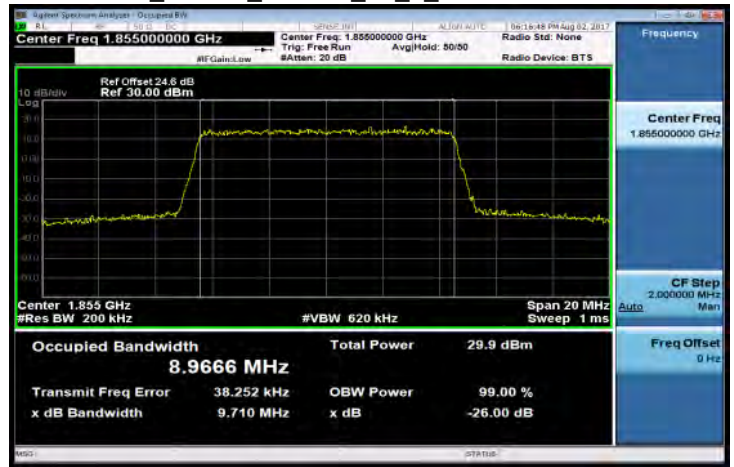

Band2\_10MHz\_QPSK\_50\_0\_MidCH18900-1880

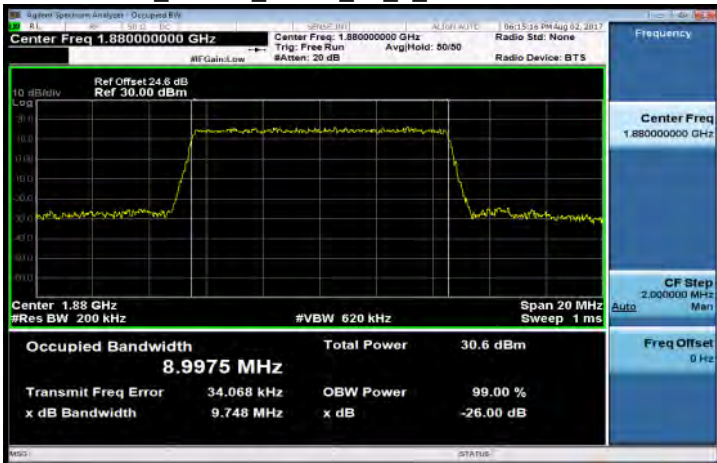

Band2\_10MHz\_16QAM\_50\_0\_MidCH18900-1880

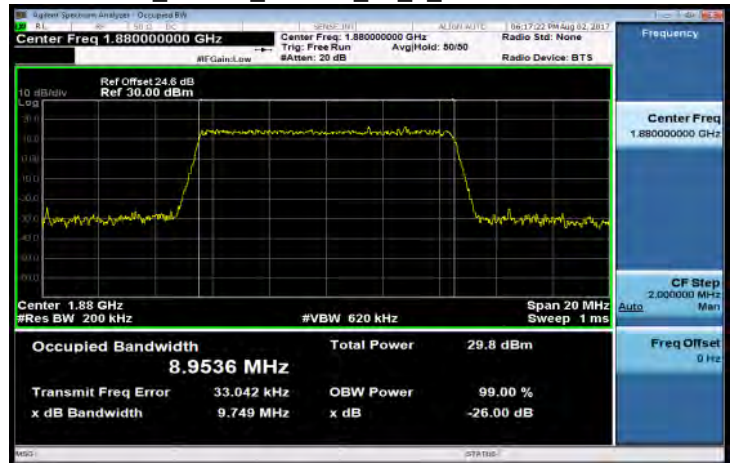

Band2\_10MHz\_QPSK\_50\_0\_HighCH19150-1905

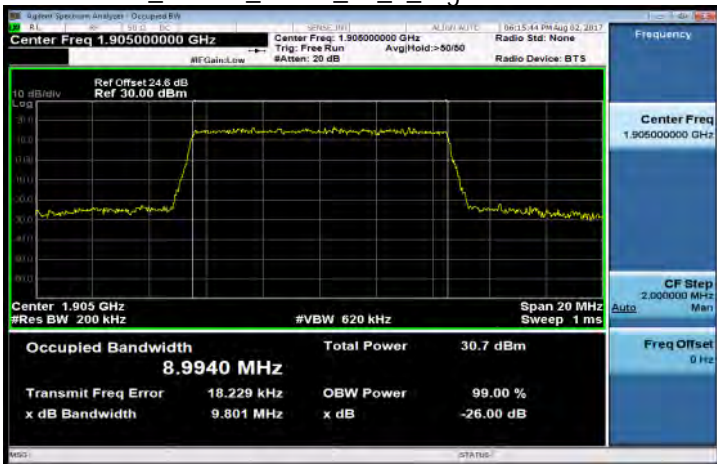

Band2\_10MHz\_16QAM\_50\_0\_HighCH19150-1905

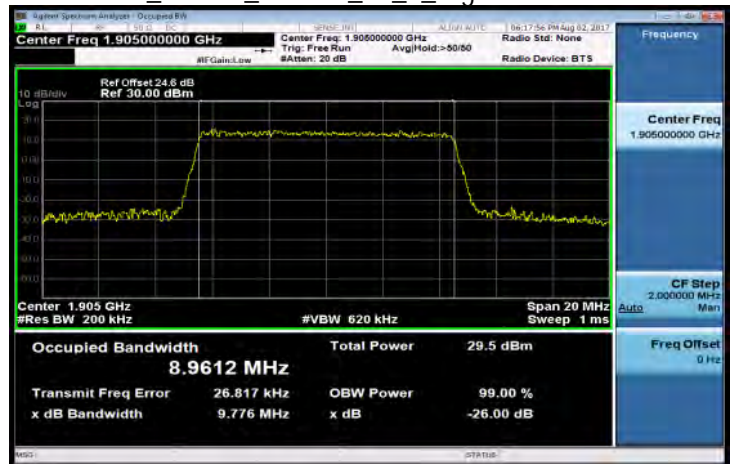

Unless otherwise stated the results shown in this test report refer only to the sample(s) tested and such sample(s) are retained for 90 days only.

除非另有說明，此報告結果僅對測試之樣品負責，同時此樣品僅保留90天。本報告未經本公司書面許可，不可部份複製。

This document is issued by the Company subject to its General Conditions of Service printed overleaf, available on request or accessible at [www.sgs.com/terms\\_and\\_conditions.htm](http://www.sgs.com/terms_and_conditions.htm) and, for electronic format documents, subject to Terms and Conditions for Electronic Documents at [www.sgs.com/terms\\_e-document.htm](http://www.sgs.com/terms_e-document.htm). Attention is drawn to the limitation of liability, indemnification and jurisdiction issues defined therein. Any holder of this document is advised that information contained hereon reflects the Company's findings at the time of its intervention only and within the limits of Client's instructions, if any. The Company's sole responsibility is to its Client and this document does not exonerate parties to a transaction from exercising all their rights and obligations under the transaction documents. This document cannot be reproduced except in full, without prior written approval of the Company. Any unauthorized alteration, forgery or falsification of the content or appearance of this document is unlawful and offenders may be prosecuted to the fullest extent of the law.

Band2\_10MHz\_64QAM\_50\_0\_LowCH18650-1855

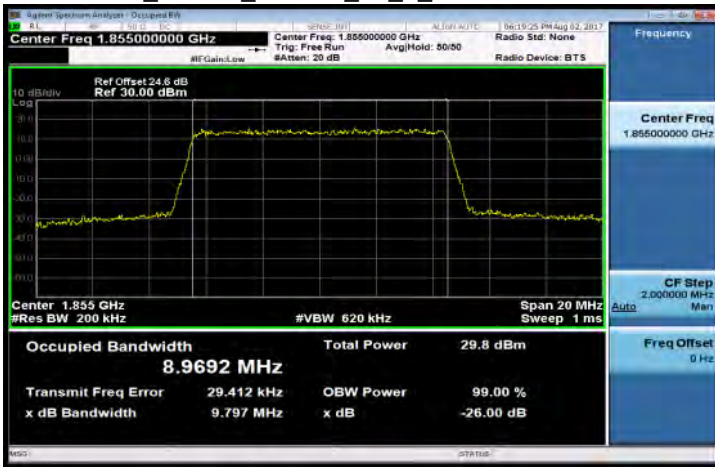

Band2\_15MHz\_QPSK\_75\_0\_LowCH18675-1857.5

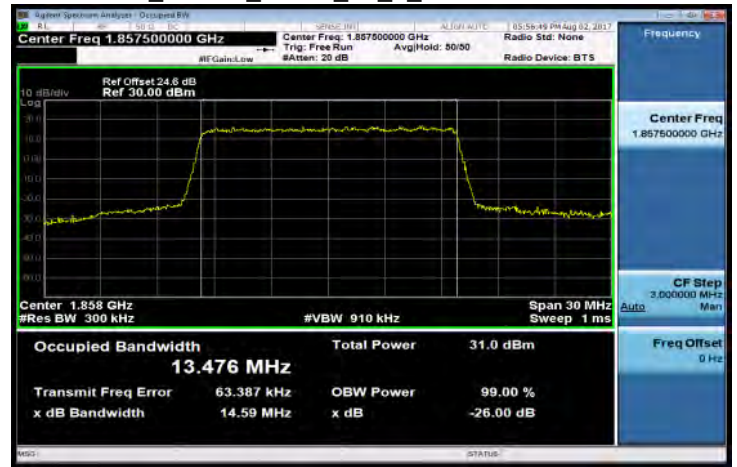

Band2\_10MHz\_64QAM\_50\_0\_MidCH18900-1880

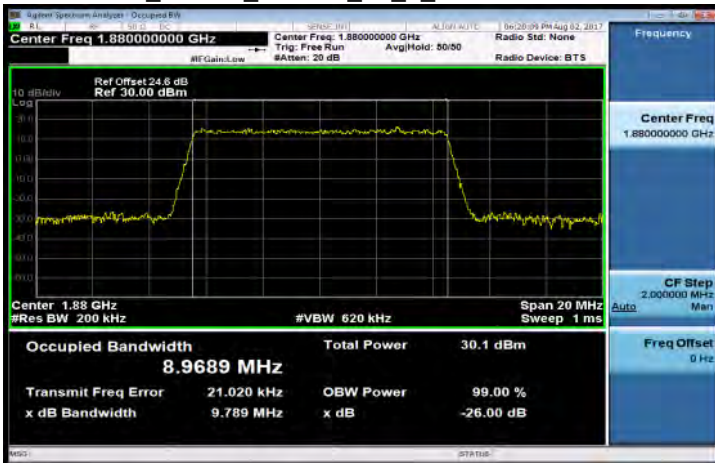

Band2\_15MHz\_QPSK\_75\_0\_MidCH18900-1880

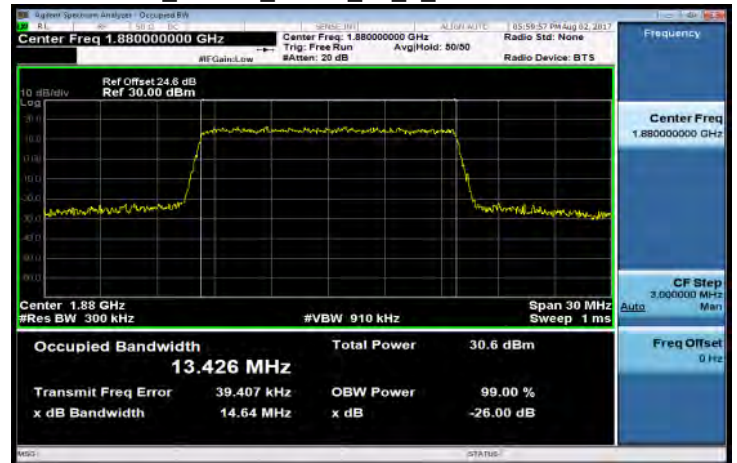

Band2\_10MHz\_64QAM\_50\_0\_HighCH19150-1905

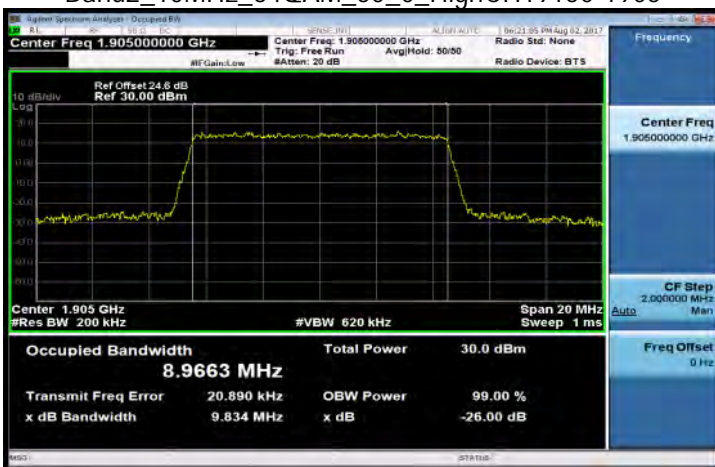

Band2\_15MHz\_QPSK\_75\_0\_HighCH19125-1902.5

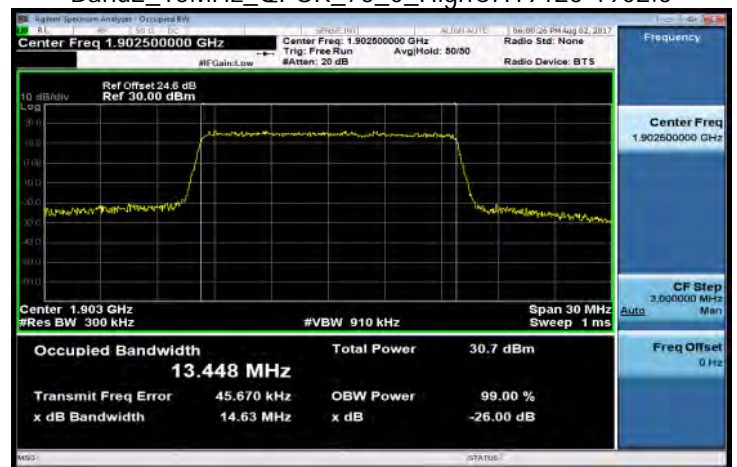

Unless otherwise stated the results shown in this test report refer only to the sample(s) tested and such sample(s) are retained for 90 days only.

除非另有說明，此報告結果僅對測試之樣品負責，同時此樣品僅保留90天。本報告未經本公司書面許可，不可部份複製。

This document is issued by the Company subject to its General Conditions of Service printed overleaf, available on request or accessible at [www.sgs.com/terms\\_and\\_conditions.htm](http://www.sgs.com/terms_and_conditions.htm) and, for electronic format documents, subject to Terms and Conditions for Electronic Documents at [www.sgs.com/terms\\_e-document.htm](http://www.sgs.com/terms_e-document.htm). Attention is drawn to the limitation of liability, indemnification and jurisdiction issues defined therein. Any holder of this document is advised that information contained hereon reflects the Company's findings at the time of its intervention only and within the limits of Client's instructions, if any. The Company's sole responsibility is to its Client and this document does not exonerate parties to a transaction from exercising all their rights and obligations under the transaction documents. This document cannot be reproduced except in full, without prior written approval of the Company. Any unauthorized alteration, forgery or falsification of the content or appearance of this document is unlawful and offenders may be prosecuted to the fullest extent of the law.

Band2\_15MHz\_16QAM\_75\_0\_LowCH18675-1857.5



Band2\_15MHz\_64QAM\_75\_0\_LowCH18675-1857.5



Band2\_15MHz\_16QAM\_75\_0\_MidCH18900-1880

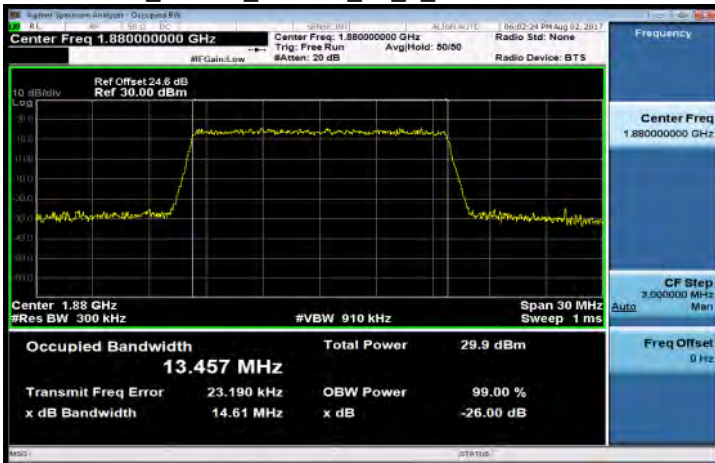

Band2\_15MHz\_64QAM\_75\_0\_MidCH18900-1880

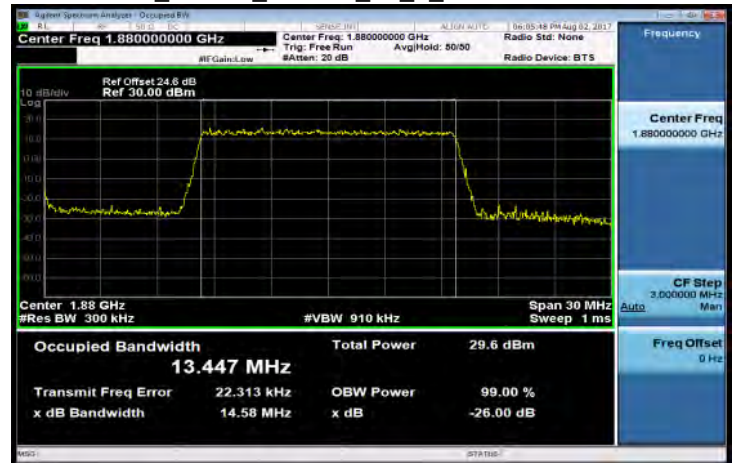

Band2\_15MHz\_16QAM\_75\_0\_HighCH19125-1902.5

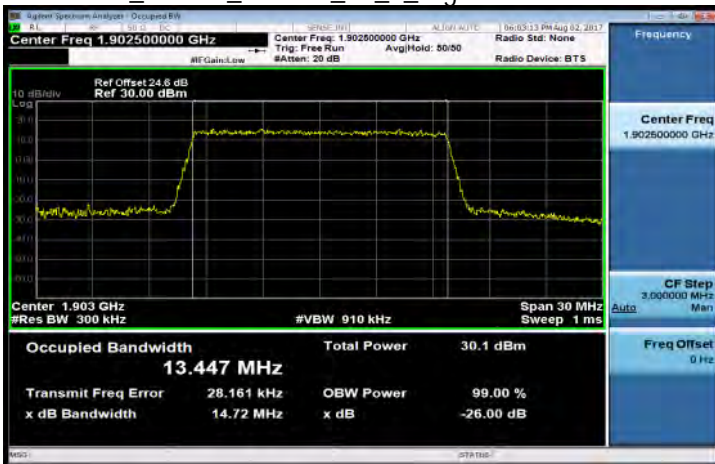

Band2\_15MHz\_64QAM\_75\_0\_HighCH19125-1902.5



Unless otherwise stated the results shown in this test report refer only to the sample(s) tested and such sample(s) are retained for 90 days only.

除非另有說明，此報告結果僅對測試之樣品負責，同時此樣品僅保留90天。本報告未經本公司書面許可，不可部份複製。

This document is issued by the Company subject to its General Conditions of Service printed overleaf, available on request or accessible at [www.sgs.com/terms\\_and\\_conditions.htm](http://www.sgs.com/terms_and_conditions.htm) and, for electronic format documents, subject to Terms and Conditions for Electronic Documents at [www.sgs.com/terms\\_e-document.htm](http://www.sgs.com/terms_e-document.htm). Attention is drawn to the limitation of liability, indemnification and jurisdiction issues defined therein. Any holder of this document is advised that information contained hereon reflects the Company's findings at the time of its intervention only and within the limits of Client's instructions, if any. The Company's sole responsibility is to its Client and this document does not exonerate parties to a transaction from exercising all their rights and obligations under the transaction documents. This document cannot be reproduced except in full, without prior written approval of the Company. Any unauthorized alteration, forgery or falsification of the content or appearance of this document is unlawful and offenders may be prosecuted to the fullest extent of the law.

Band2\_20MHz\_QPSK\_100\_0\_LowCH18700-1860

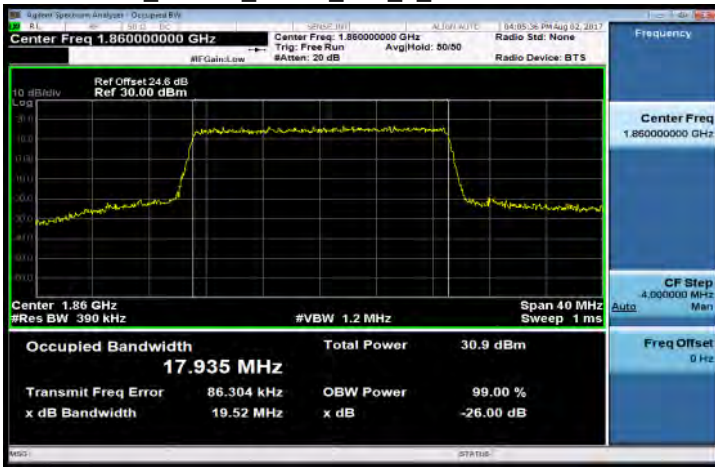

Band2\_20MHz\_16QAM\_100\_0\_LowCH18700-1860

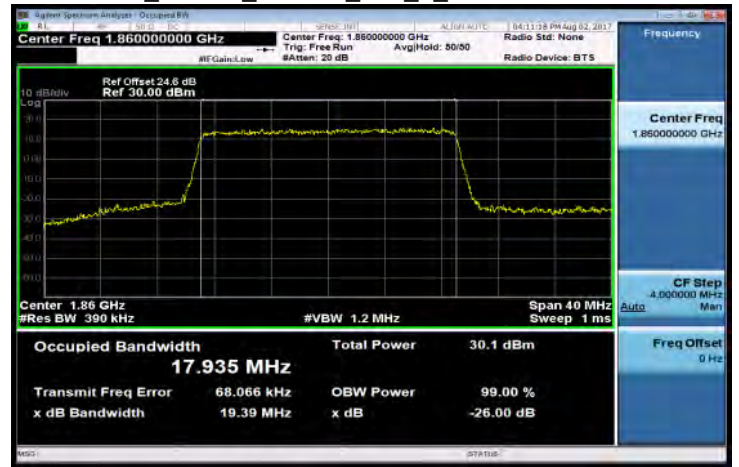

Band2\_20MHz\_QPSK\_100\_0\_MidCH18900-1880

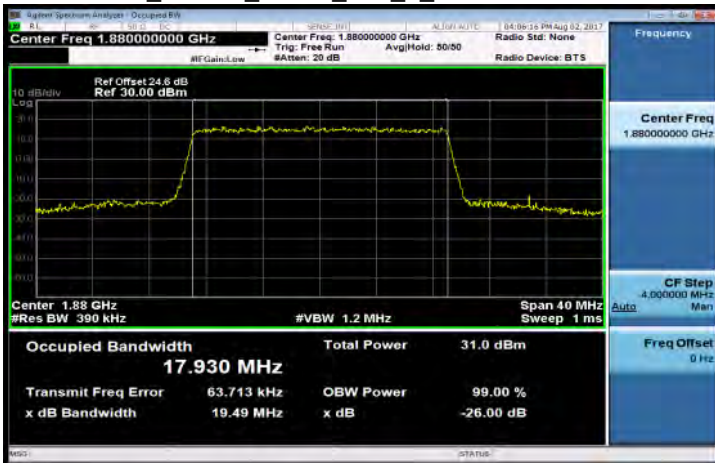

Band2\_20MHz\_16QAM\_100\_0\_MidCH18900-1880

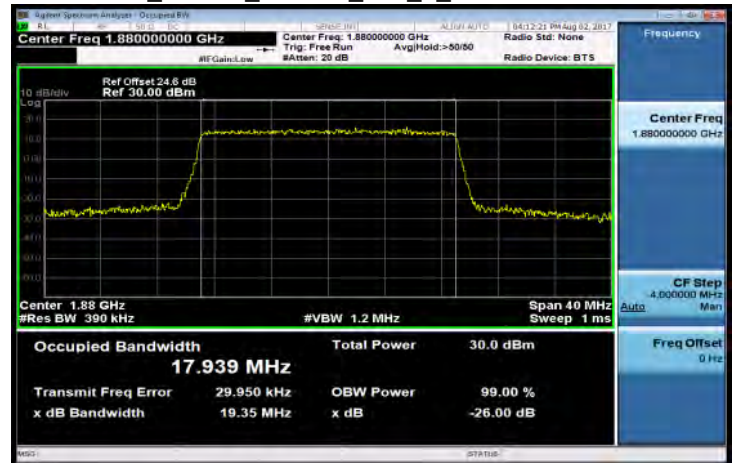

Band2\_20MHz\_QPSK\_100\_0\_HighCH19100-1900



Band2\_20MHz\_16QAM\_100\_0\_HighCH19100-1900



Unless otherwise stated the results shown in this test report refer only to the sample(s) tested and such sample(s) are retained for 90 days only.

除非另有說明，此報告結果僅對測試之樣品負責，同時此樣品僅保留90天。本報告未經本公司書面許可，不可部份複製。

This document is issued by the Company subject to its General Conditions of Service printed overleaf, available on request or accessible at [www.sgs.com/terms\\_and\\_conditions.htm](http://www.sgs.com/terms_and_conditions.htm) and, for electronic format documents, subject to Terms and Conditions for Electronic Documents at [www.sgs.com/terms\\_e-document.htm](http://www.sgs.com/terms_e-document.htm). Attention is drawn to the limitation of liability, indemnification and jurisdiction issues defined therein. Any holder of this document is advised that information contained hereon reflects the Company's findings at the time of its intervention only and within the limits of Client's instructions, if any. The Company's sole responsibility is to its Client and this document does not exonerate parties to a transaction from exercising all their rights and obligations under the transaction documents. This document cannot be reproduced except in full, without prior written approval of the Company. Any unauthorized alteration, forgery or falsification of the content or appearance of this document is unlawful and offenders may be prosecuted to the fullest extent of the law.

Band2\_20MHz\_64QAM\_100\_0\_LowCH18700-1860

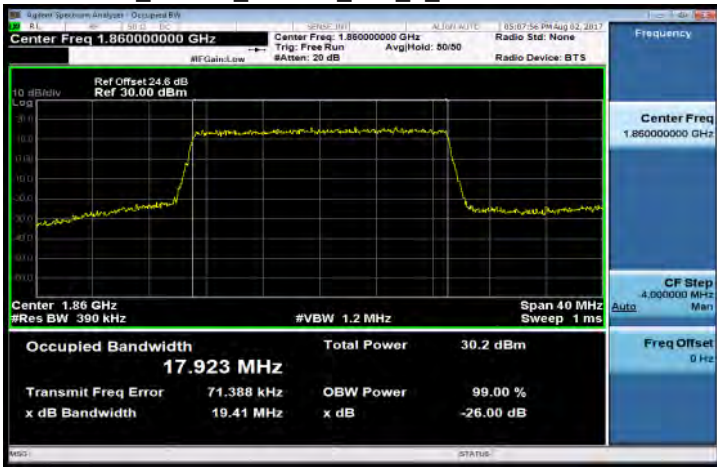

Band4\_1\_4MHz\_QPSK\_6\_0\_LowCH19957-1710.7

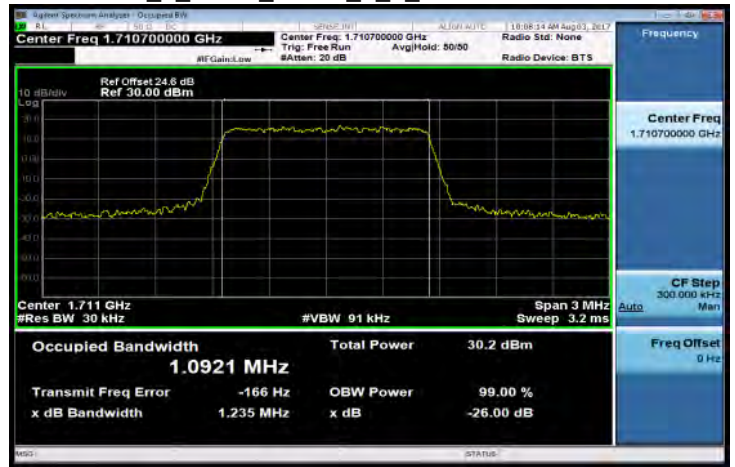

Band2\_20MHz\_64QAM\_100\_0\_MidCH18900-1880

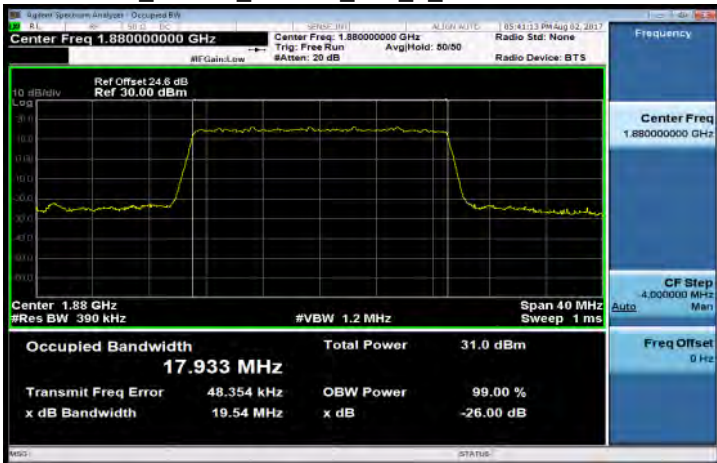

Band4\_1\_4MHz\_QPSK\_6\_0\_MidCH20175-1732.5

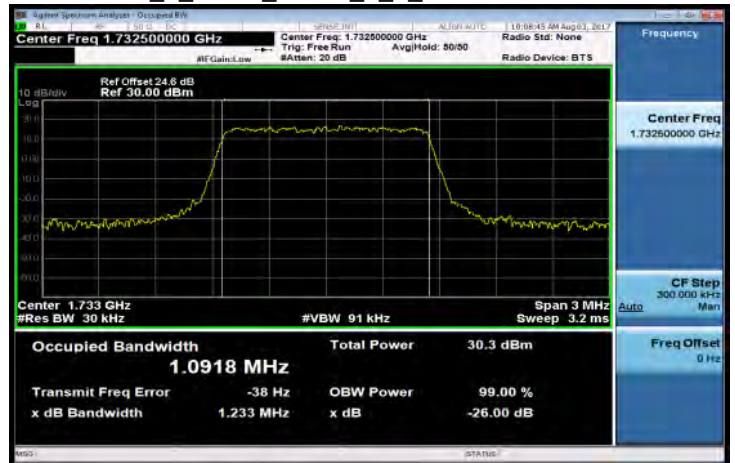

Band2\_20MHz\_64QAM\_100\_0\_HighCH19100-1900



Band4\_1\_4MHz\_QPSK\_6\_0\_HighCH20393-1754.3

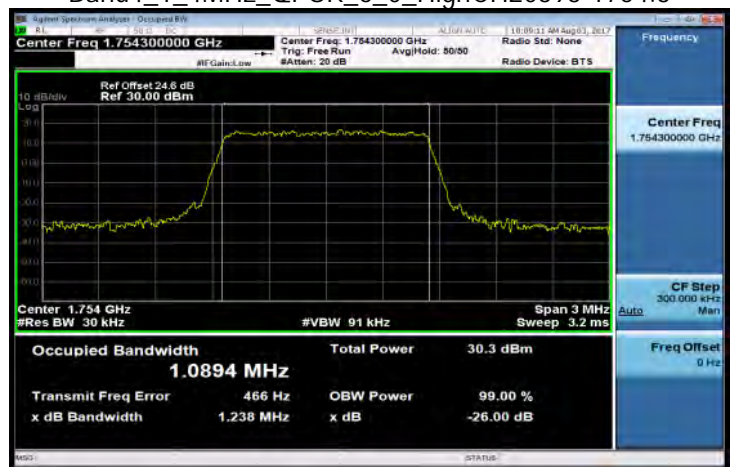

Unless otherwise stated the results shown in this test report refer only to the sample(s) tested and such sample(s) are retained for 90 days only.

除非另有說明，此報告結果僅對測試之樣品負責，同時此樣品僅保留90天。本報告未經本公司書面許可，不可部份複製。

This document is issued by the Company subject to its General Conditions of Service printed overleaf, available on request or accessible at [www.sgs.com/terms\\_and\\_conditions.htm](http://www.sgs.com/terms_and_conditions.htm) and, for electronic format documents, subject to Terms and Conditions for Electronic Documents at [www.sgs.com/terms\\_e-document.htm](http://www.sgs.com/terms_e-document.htm). Attention is drawn to the limitation of liability, indemnification and jurisdiction issues defined therein. Any holder of this document is advised that information contained hereon reflects the Company's findings at the time of its intervention only and within the limits of Client's instructions, if any. The Company's sole responsibility is to its Client and this document does not exonerate parties to a transaction from exercising all their rights and obligations under the transaction documents. This document cannot be reproduced except in full, without prior written approval of the Company. Any unauthorized alteration, forgery or falsification of the content or appearance of this document is unlawful and offenders may be prosecuted to the fullest extent of the law.



Band4\_1\_4MHz\_16QAM\_6\_0\_LowCH19957-1710.7

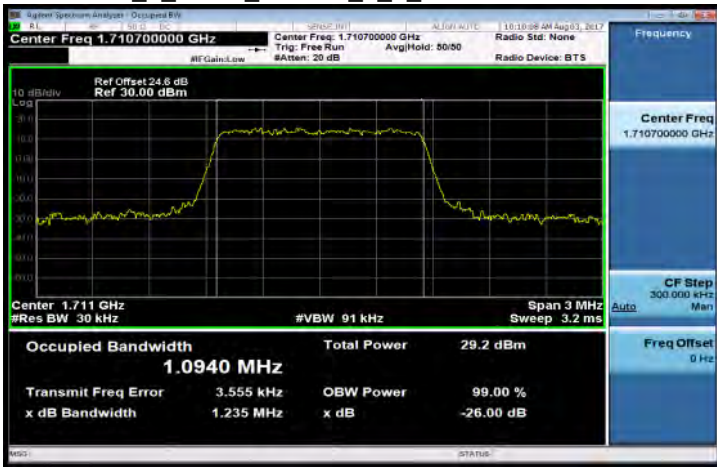

Band4\_1\_4MHz\_64QAM\_6\_0\_LowCH19957-1710.7



Band4\_1\_4MHz\_16QAM\_6\_0\_MidCH20175-1732.5

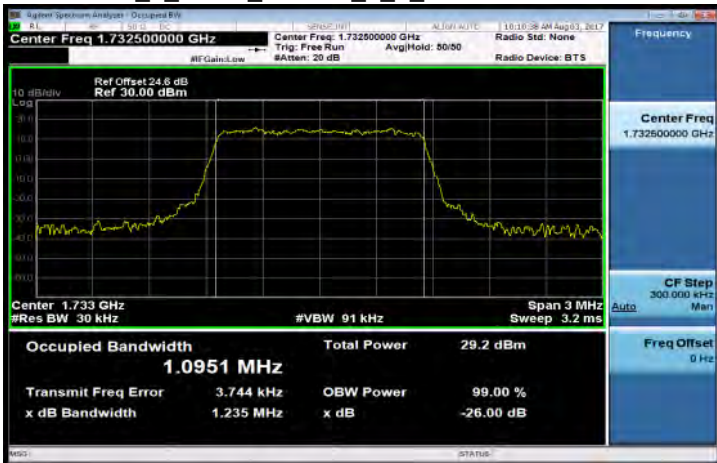

Band4\_1\_4MHz\_64QAM\_6\_0\_MidCH20175-1732.5

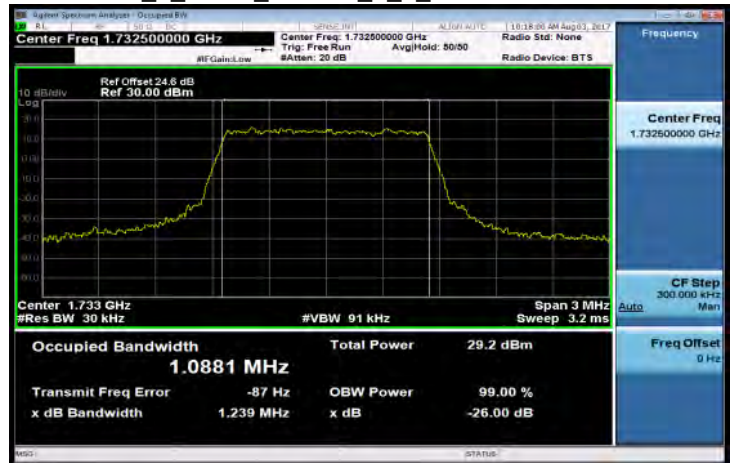

Band4\_1\_4MHz\_16QAM\_6\_0\_HighCH20393-1754.3

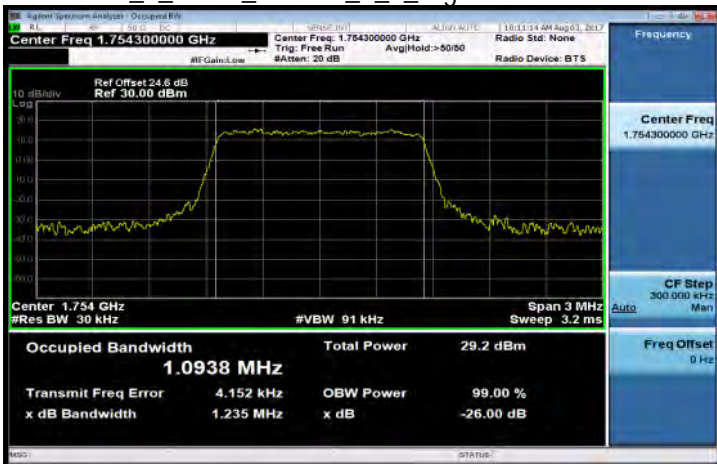

Band4\_1\_4MHz\_64QAM\_6\_0\_HighCH20393-1754.3

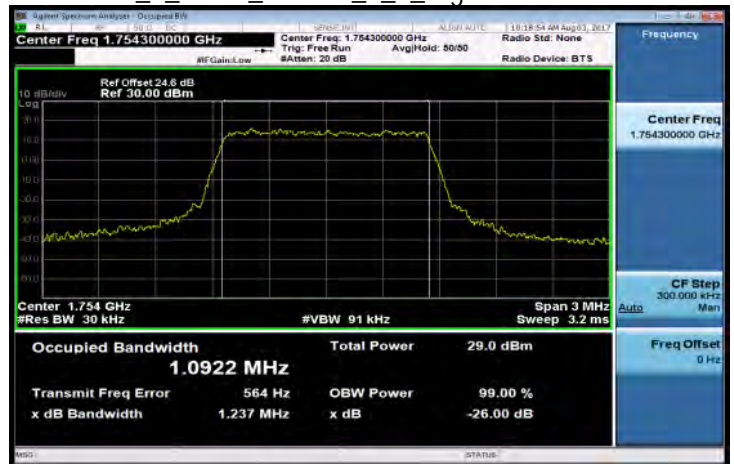

Unless otherwise stated the results shown in this test report refer only to the sample(s) tested and such sample(s) are retained for 90 days only.

除非另有說明，此報告結果僅對測試之樣品負責，同時此樣品僅保留90天。本報告未經本公司書面許可，不可部份複製。

This document is issued by the Company subject to its General Conditions of Service printed overleaf, available on request or accessible at [www.sgs.com/terms\\_and\\_conditions.htm](http://www.sgs.com/terms_and_conditions.htm) and, for electronic format documents, subject to Terms and Conditions for Electronic Documents at [www.sgs.com/terms\\_e-document.htm](http://www.sgs.com/terms_e-document.htm). Attention is drawn to the limitation of liability, indemnification and jurisdiction issues defined therein. Any holder of this document is advised that information contained hereon reflects the Company's findings at the time of its intervention only and within the limits of Client's instructions, if any. The Company's sole responsibility is to its Client and this document does not exonerate parties to a transaction from exercising all their rights and obligations under the transaction documents. This document cannot be reproduced except in full, without prior written approval of the Company. Any unauthorized alteration, forgery or falsification of the content or appearance of this document is unlawful and offenders may be prosecuted to the fullest extent of the law.

Band4\_3MHz\_QPSK\_15\_0\_LowCH19965-1711.5

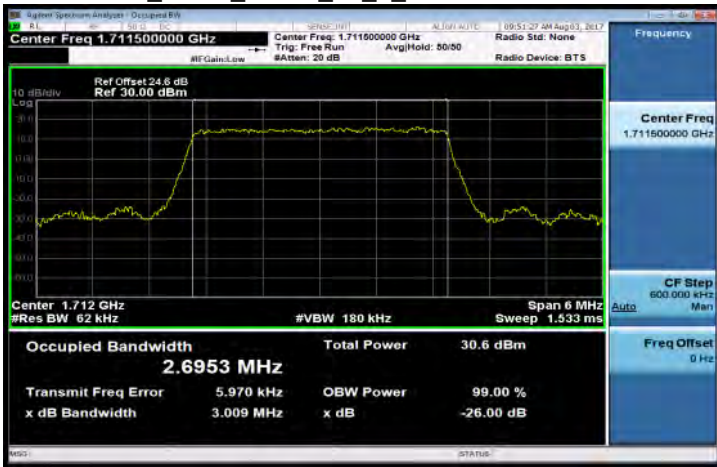

Band4\_3MHz\_16QAM\_15\_0\_LowCH19965-1711.5

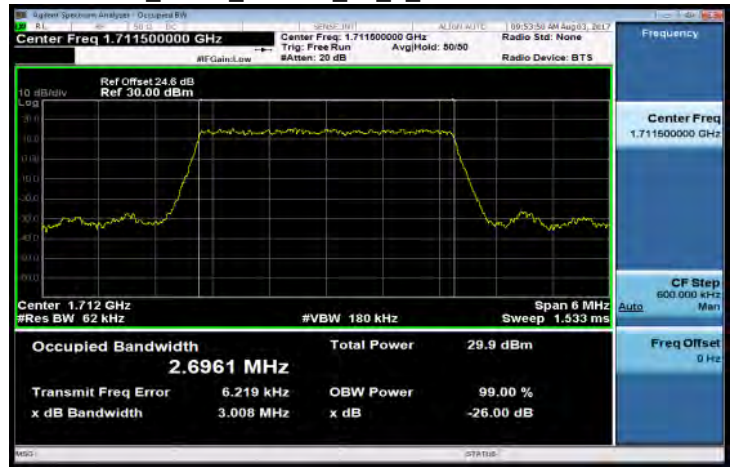

Band4\_3MHz\_QPSK\_15\_0\_MidCH20175-1732.5

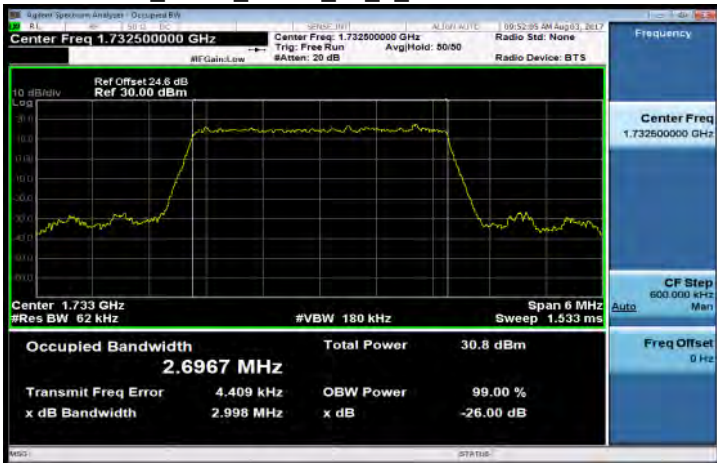

Band4\_3MHz\_16QAM\_15\_0\_MidCH20175-1732.5

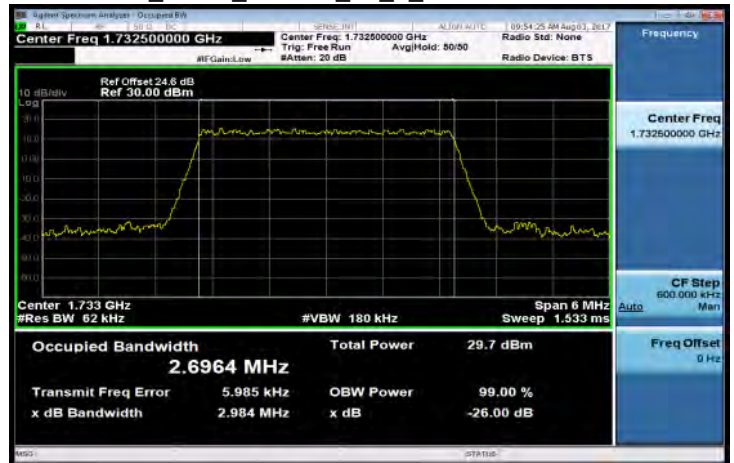

Band4\_3MHz\_QPSK\_15\_0\_HighCH20385-1753.5

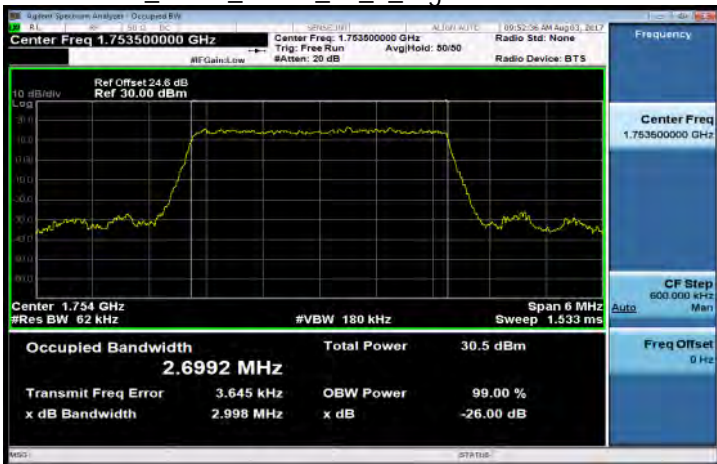

Band4\_3MHz\_16QAM\_15\_0\_HighCH20385-1753.5



Unless otherwise stated the results shown in this test report refer only to the sample(s) tested and such sample(s) are retained for 90 days only.

除非另有說明，此報告結果僅對測試之樣品負責，同時此樣品僅保留90天。本報告未經本公司書面許可，不可部份複製。

This document is issued by the Company subject to its General Conditions of Service printed overleaf, available on request or accessible at [www.sgs.com/terms\\_and\\_conditions.htm](http://www.sgs.com/terms_and_conditions.htm) and, for electronic format documents, subject to Terms and Conditions for Electronic Documents at [www.sgs.com/terms\\_e-document.htm](http://www.sgs.com/terms_e-document.htm). Attention is drawn to the limitation of liability, indemnification and jurisdiction issues defined therein. Any holder of this document is advised that information contained hereon reflects the Company's findings at the time of its intervention only and within the limits of Client's instructions, if any. The Company's sole responsibility is to its Client and this document does not exonerate parties to a transaction from exercising all their rights and obligations under the transaction documents. This document cannot be reproduced except in full, without prior written approval of the Company. Any unauthorized alteration, forgery or falsification of the content or appearance of this document is unlawful and offenders may be prosecuted to the fullest extent of the law.

Band4\_3MHz\_64QAM\_15\_0\_LowCH1965-1711.5

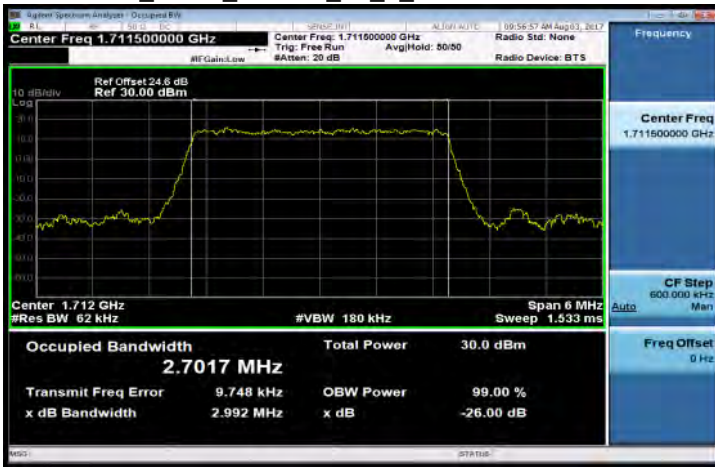

Band4\_5MHz\_QPSK\_25\_0\_LowCH1975-1712.5

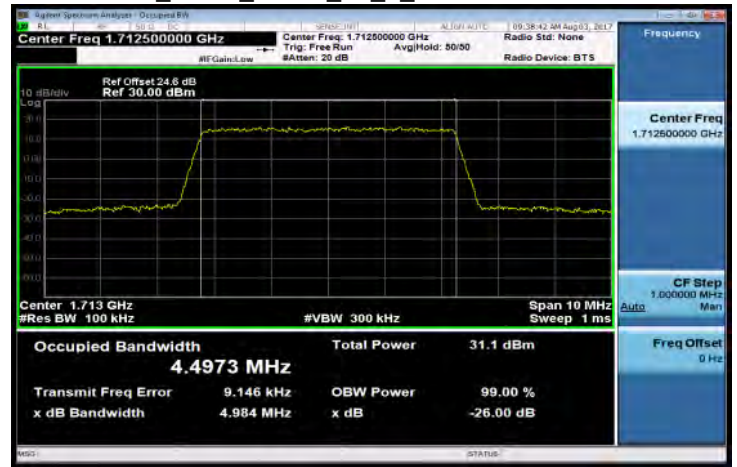

Band4\_3MHz\_64QAM\_15\_0\_MidCH20175-1732.5

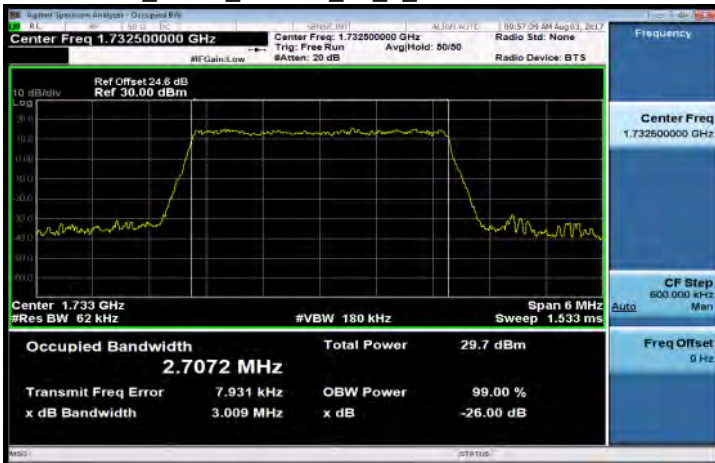

Band4\_5MHz\_QPSK\_25\_0\_MidCH20175-1732.5



Band4\_3MHz\_64QAM\_15\_0\_HighCH20385-1753.5

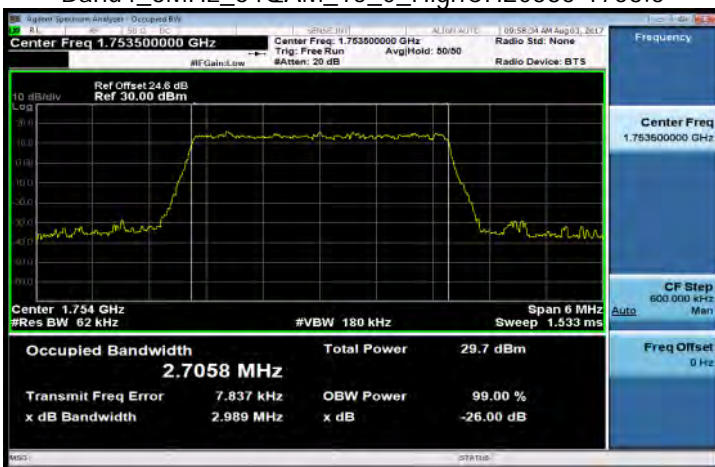

Band4\_5MHz\_QPSK\_25\_0\_HighCH20375-1752.5

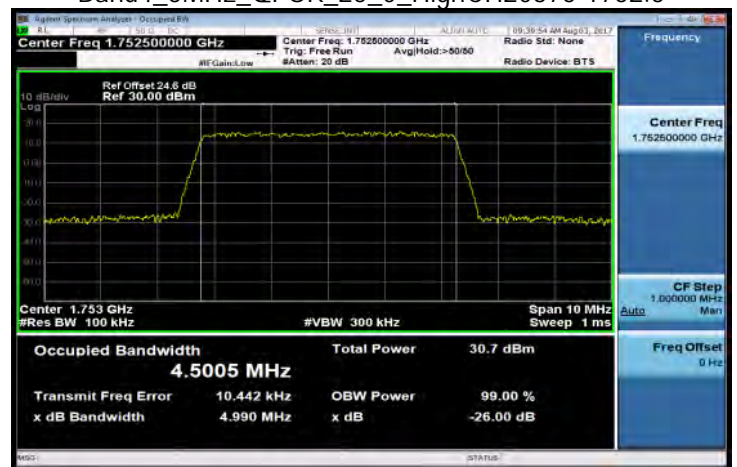

Unless otherwise stated the results shown in this test report refer only to the sample(s) tested and such sample(s) are retained for 90 days only.

除非另有說明，此報告結果僅對測試之樣品負責，同時此樣品僅保留90天。本報告未經本公司書面許可，不可部份複製。

This document is issued by the Company subject to its General Conditions of Service printed overleaf, available on request or accessible at [www.sgs.com/terms\\_and\\_conditions.htm](http://www.sgs.com/terms_and_conditions.htm) and, for electronic format documents, subject to Terms and Conditions for Electronic Documents at [www.sgs.com/terms\\_e-document.htm](http://www.sgs.com/terms_e-document.htm). Attention is drawn to the limitation of liability, indemnification and jurisdiction issues defined therein. Any holder of this document is advised that information contained hereon reflects the Company's findings at the time of its intervention only and within the limits of Client's instructions, if any. The Company's sole responsibility is to its Client and this document does not exonerate parties to a transaction from exercising all their rights and obligations under the transaction documents. This document cannot be reproduced except in full, without prior written approval of the Company. Any unauthorized alteration, forgery or falsification of the content or appearance of this document is unlawful and offenders may be prosecuted to the fullest extent of the law.

Band4\_5MHz\_16QAM\_25\_0\_LowCH1975-1712.5

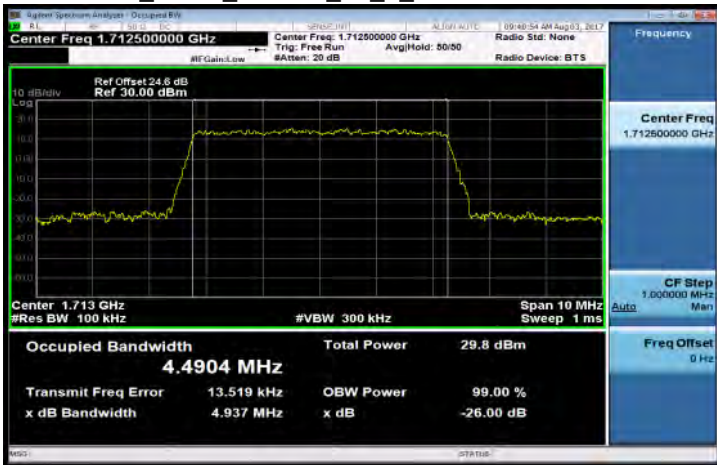

Band4\_5MHz\_64QAM\_25\_0\_LowCH1975-1712.5



Band4\_5MHz\_16QAM\_25\_0\_MidCH20175-1732.5

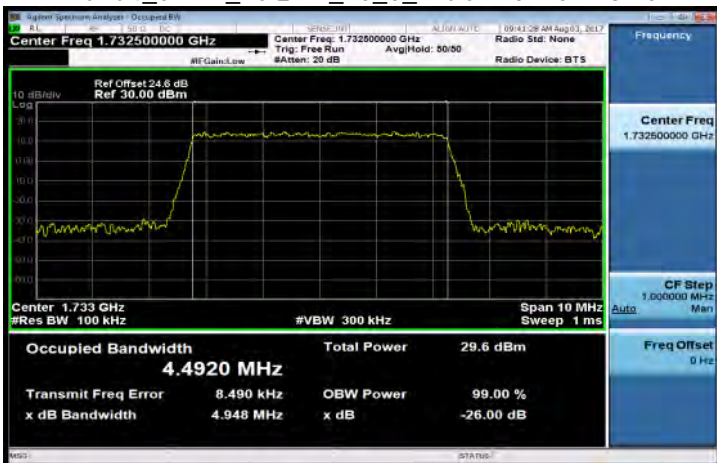

Band4\_5MHz\_64QAM\_25\_0\_MidCH20175-1732.5

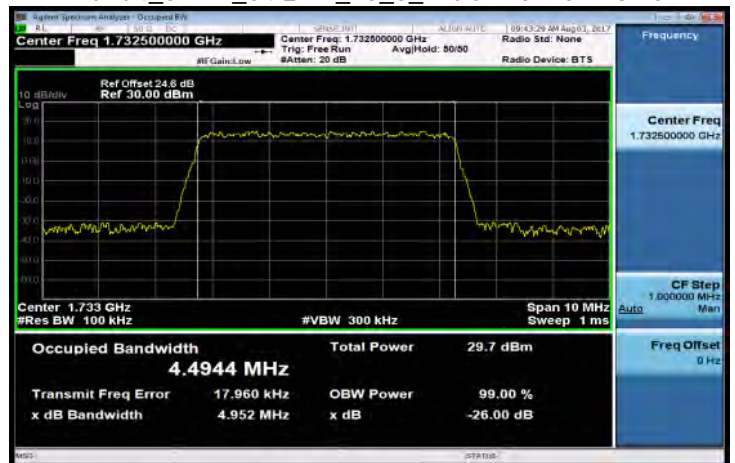

Band4\_5MHz\_16QAM\_25\_0\_HighCH20375-1752.5

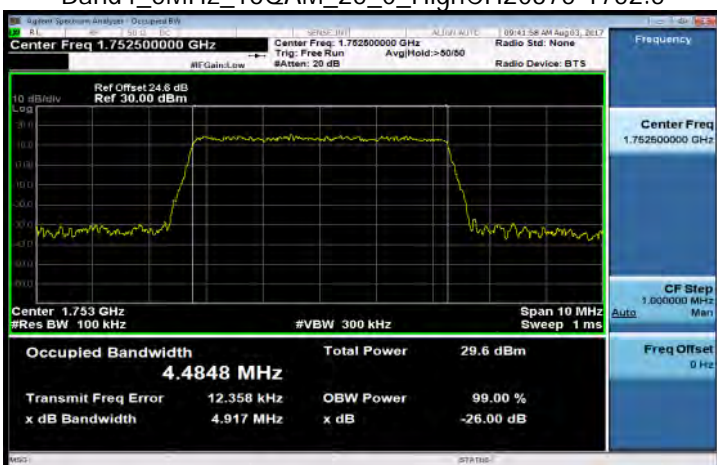

Band4\_5MHz\_64QAM\_25\_0\_HighCH20375-1752.5

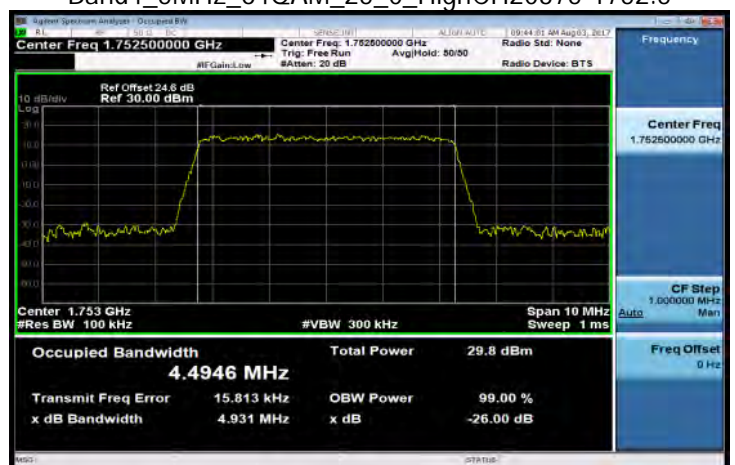

Unless otherwise stated the results shown in this test report refer only to the sample(s) tested and such sample(s) are retained for 90 days only.

除非另有說明，此報告結果僅對測試之樣品負責，同時此樣品僅保留90天。本報告未經本公司書面許可，不可部份複製。

This document is issued by the Company subject to its General Conditions of Service printed overleaf, available on request or accessible at [www.sgs.com/terms\\_and\\_conditions.htm](http://www.sgs.com/terms_and_conditions.htm) and, for electronic format documents, subject to Terms and Conditions for Electronic Documents at [www.sgs.com/terms\\_e-document.htm](http://www.sgs.com/terms_e-document.htm). Attention is drawn to the limitation of liability, indemnification and jurisdiction issues defined therein. Any holder of this document is advised that information contained hereon reflects the Company's findings at the time of its intervention only and within the limits of Client's instructions, if any. The Company's sole responsibility is to its Client and this document does not exonerate parties to a transaction from exercising all their rights and obligations under the transaction documents. This document cannot be reproduced except in full, without prior written approval of the Company. Any unauthorized alteration, forgery or falsification of the content or appearance of this document is unlawful and offenders may be prosecuted to the fullest extent of the law.

Band4\_10MHz\_QPSK\_50\_0\_LowCH20000-1715



Band4\_10MHz\_16QAM\_50\_0\_LowCH20000-1715



Band4\_10MHz\_QPSK\_50\_0\_MidCH20175-1732.5

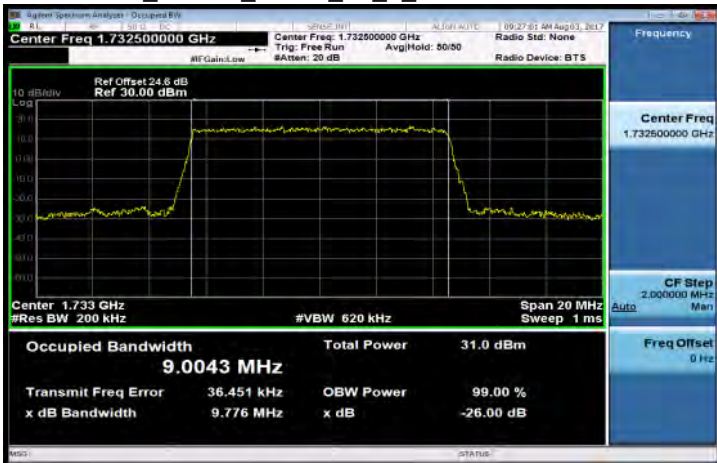

Band4\_10MHz\_16QAM\_50\_0\_MidCH20175-1732.5

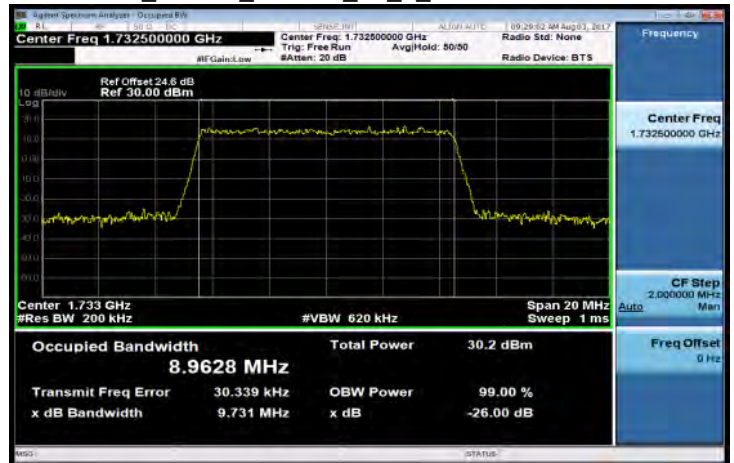

Band4\_10MHz\_QPSK\_50\_0\_HighCH20350-1750



Band4\_10MHz\_16QAM\_50\_0\_HighCH20350-1750

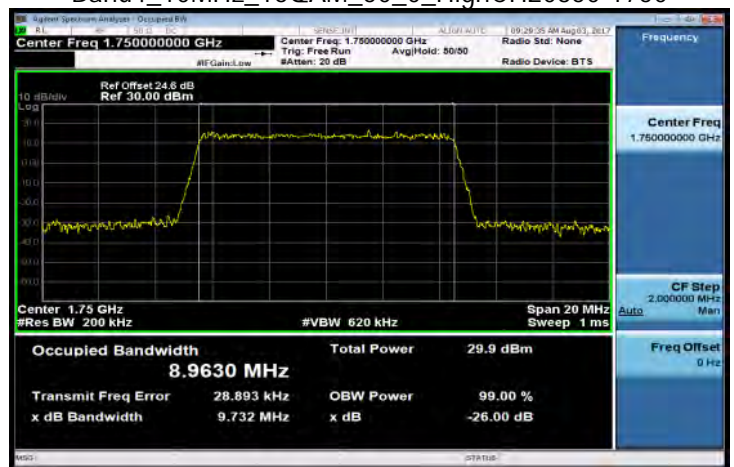

Unless otherwise stated the results shown in this test report refer only to the sample(s) tested and such sample(s) are retained for 90 days only.

除非另有說明，此報告結果僅對測試之樣品負責，同時此樣品僅保留90天。本報告未經本公司書面許可，不可部份複製。

This document is issued by the Company subject to its General Conditions of Service printed overleaf, available on request or accessible at [www.sgs.com/terms\\_and\\_conditions.htm](http://www.sgs.com/terms_and_conditions.htm) and, for electronic format documents, subject to Terms and Conditions for Electronic Documents at [www.sgs.com/terms\\_e-document.htm](http://www.sgs.com/terms_e-document.htm). Attention is drawn to the limitation of liability, indemnification and jurisdiction issues defined therein. Any holder of this document is advised that information contained hereon reflects the Company's findings at the time of its intervention only and within the limits of Client's instructions, if any. The Company's sole responsibility is to its Client and this document does not exonerate parties to a transaction from exercising all their rights and obligations under the transaction documents. This document cannot be reproduced except in full, without prior written approval of the Company. Any unauthorized alteration, forgery or falsification of the content or appearance of this document is unlawful and offenders may be prosecuted to the fullest extent of the law.

Band4\_10MHz\_64QAM\_50\_0\_LowCH20000-1715

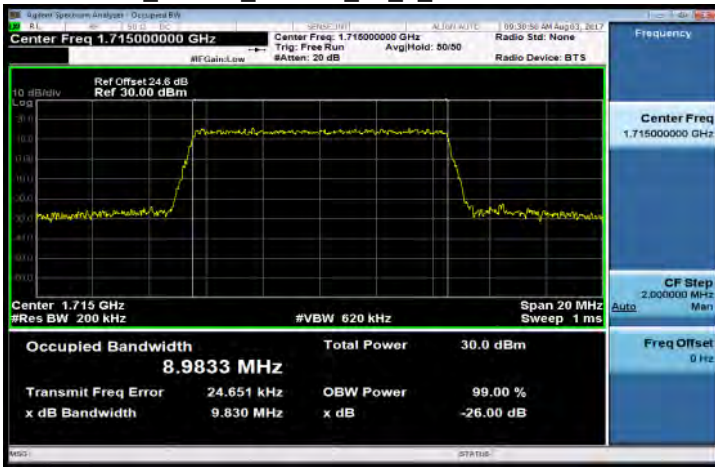

Band4\_15MHz\_QPSK\_75\_0\_LowCH20025-1717.5

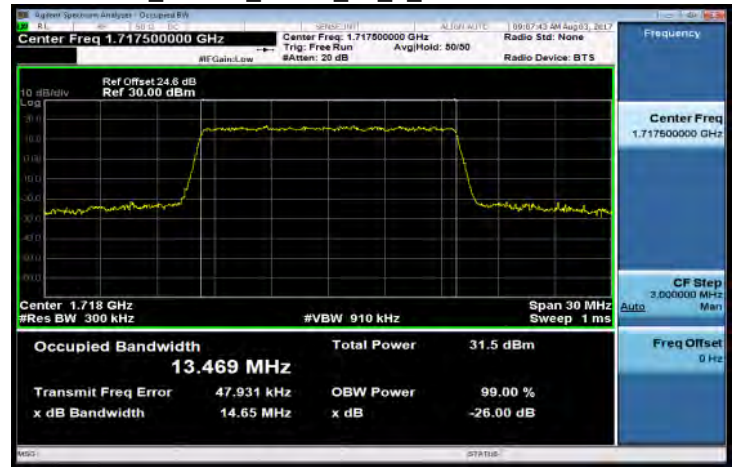

Band4\_10MHz\_64QAM\_50\_0\_MidCH20175-1732.5

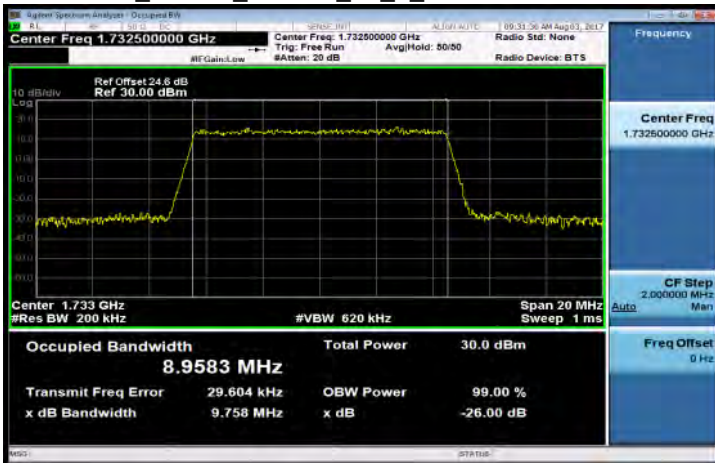

Band4\_15MHz\_QPSK\_75\_0\_MidCH20175-1732.5

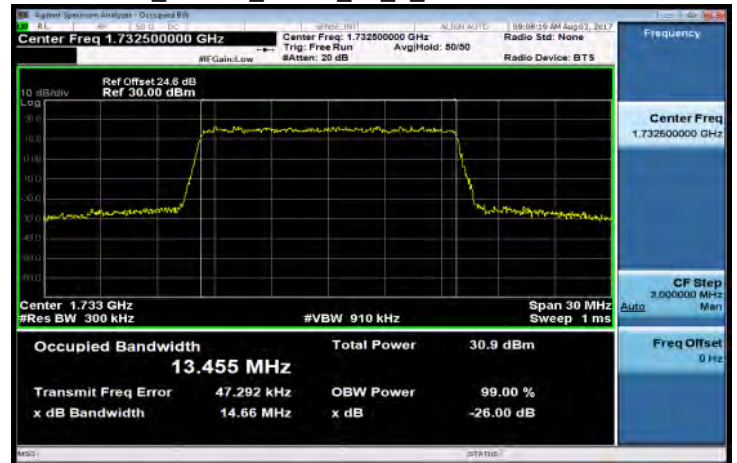

Band4\_10MHz\_64QAM\_50\_0\_HighCH20350-1750

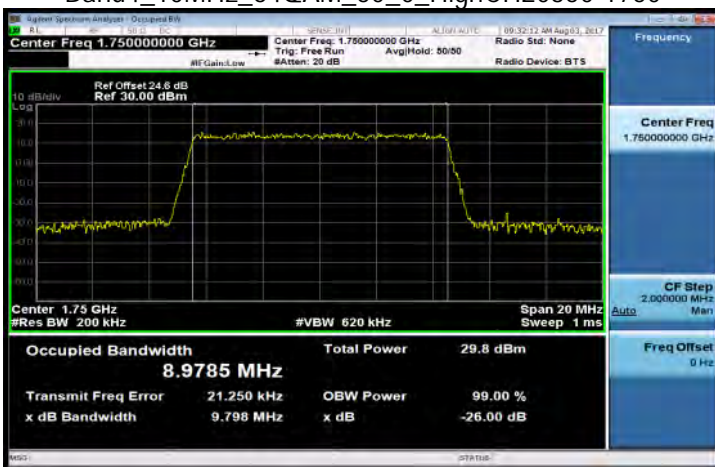

Band4\_15MHz\_QPSK\_75\_0\_HighCH20325-1747.5

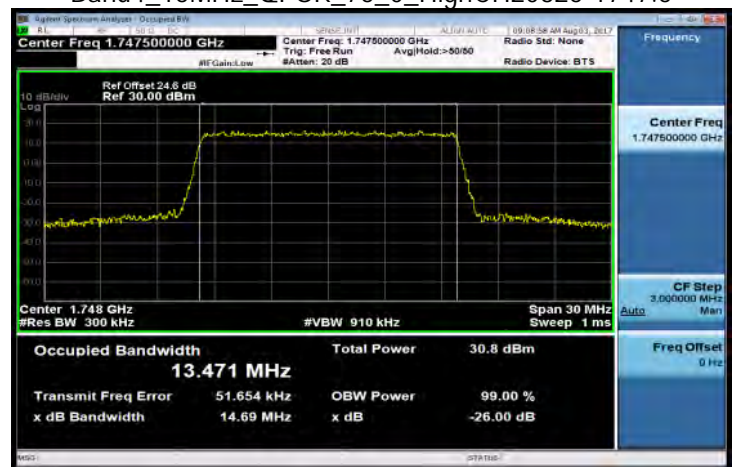

Unless otherwise stated the results shown in this test report refer only to the sample(s) tested and such sample(s) are retained for 90 days only.

除非另有說明，此報告結果僅對測試之樣品負責，同時此樣品僅保留90天。本報告未經本公司書面許可，不可部份複製。

This document is issued by the Company subject to its General Conditions of Service printed overleaf, available on request or accessible at [www.sgs.com/terms\\_and\\_conditions.htm](http://www.sgs.com/terms_and_conditions.htm) and, for electronic format documents, subject to Terms and Conditions for Electronic Documents at [www.sgs.com/terms\\_e-document.htm](http://www.sgs.com/terms_e-document.htm). Attention is drawn to the limitation of liability, indemnification and jurisdiction issues defined therein. Any holder of this document is advised that information contained hereon reflects the Company's findings at the time of its intervention only and within the limits of Client's instructions, if any. The Company's sole responsibility is to its Client and this document does not exonerate parties to a transaction from exercising all their rights and obligations under the transaction documents. This document cannot be reproduced except in full, without prior written approval of the Company. Any unauthorized alteration, forgery or falsification of the content or appearance of this document is unlawful and offenders may be prosecuted to the fullest extent of the law.

Band4\_15MHz\_16QAM\_75\_0\_LowCH20025-1717.5

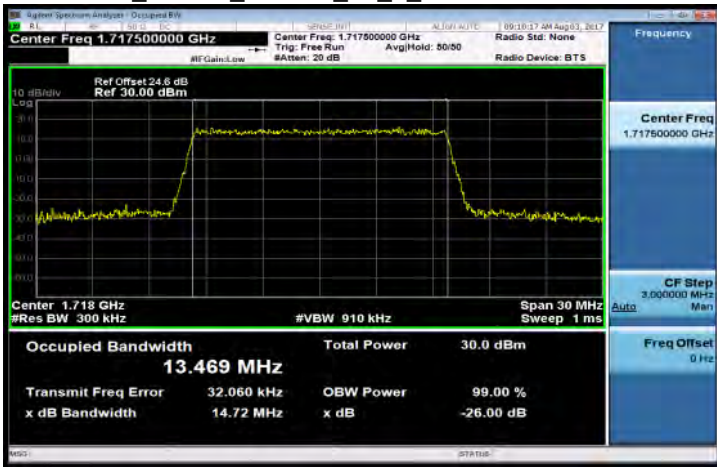

Band4\_15MHz\_64QAM\_75\_0\_LowCH20025-1717.5

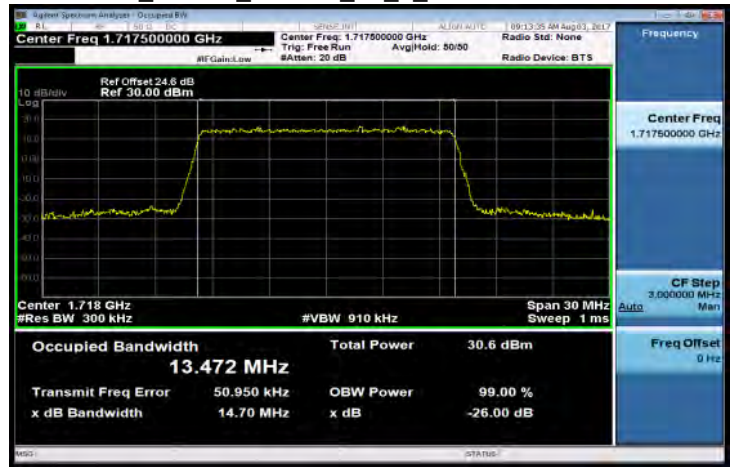

Band4\_15MHz\_16QAM\_75\_0\_MidCH20175-1732.5

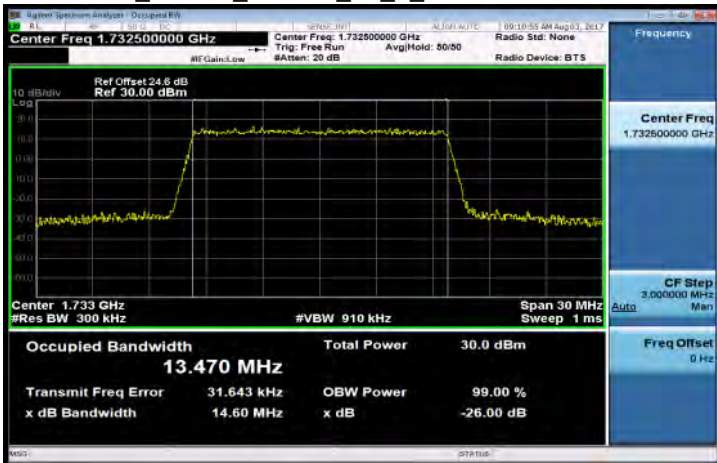

Band4\_15MHz\_64QAM\_75\_0\_MidCH20175-1732.5

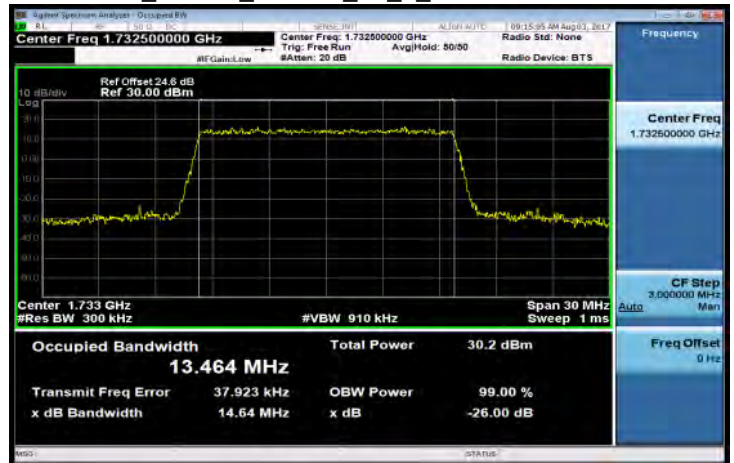

Band4\_15MHz\_16QAM\_75\_0\_HighCH20325-1747.5

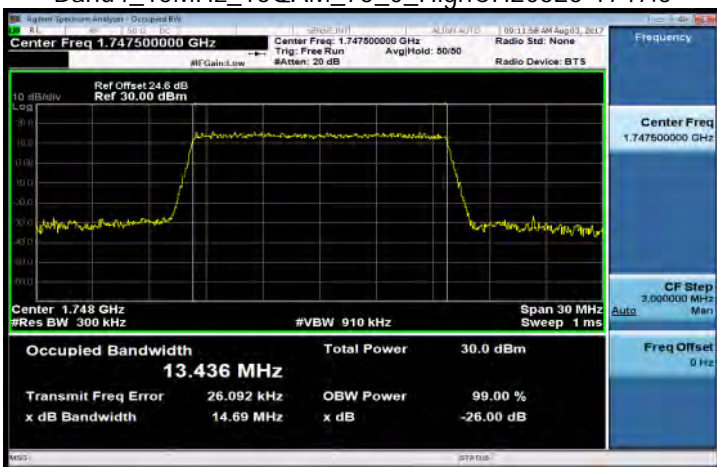

Band4\_15MHz\_64QAM\_75\_0\_HighCH20325-1747.5



Unless otherwise stated the results shown in this test report refer only to the sample(s) tested and such sample(s) are retained for 90 days only.

除非另有說明，此報告結果僅對測試之樣品負責，同時此樣品僅保留90天。本報告未經本公司書面許可，不可部份複製。

This document is issued by the Company subject to its General Conditions of Service printed overleaf, available on request or accessible at [www.sgs.com/terms\\_and\\_conditions.htm](http://www.sgs.com/terms_and_conditions.htm) and, for electronic format documents, subject to Terms and Conditions for Electronic Documents at [www.sgs.com/terms\\_e-document.htm](http://www.sgs.com/terms_e-document.htm). Attention is drawn to the limitation of liability, indemnification and jurisdiction issues defined therein. Any holder of this document is advised that information contained hereon reflects the Company's findings at the time of its intervention only and within the limits of Client's instructions, if any. The Company's sole responsibility is to its Client and this document does not exonerate parties to a transaction from exercising all their rights and obligations under the transaction documents. This document cannot be reproduced except in full, without prior written approval of the Company. Any unauthorized alteration, forgery or falsification of the content or appearance of this document is unlawful and offenders may be prosecuted to the fullest extent of the law.

Band4\_20MHz\_QPSK\_100\_0\_LowCH20050-1720

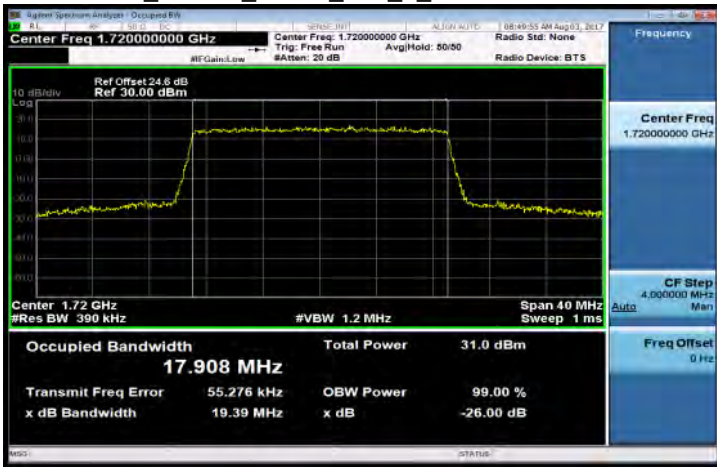

Band4\_20MHz\_16QAM\_100\_0\_LowCH20050-1720

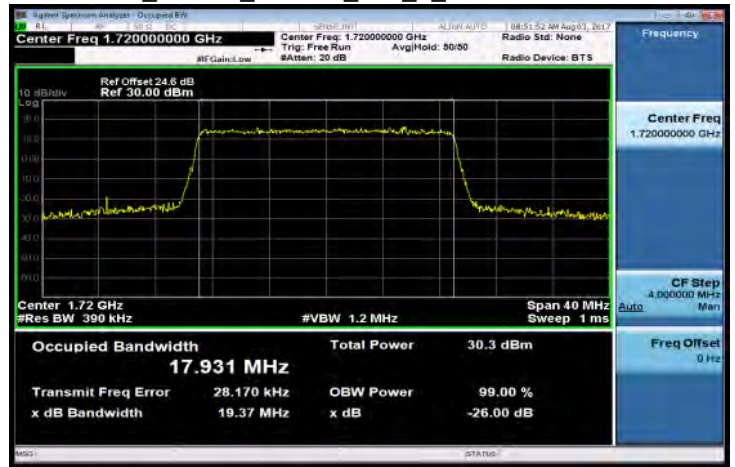

Band4\_20MHz\_QPSK\_100\_0\_MidCH20175-1732.5

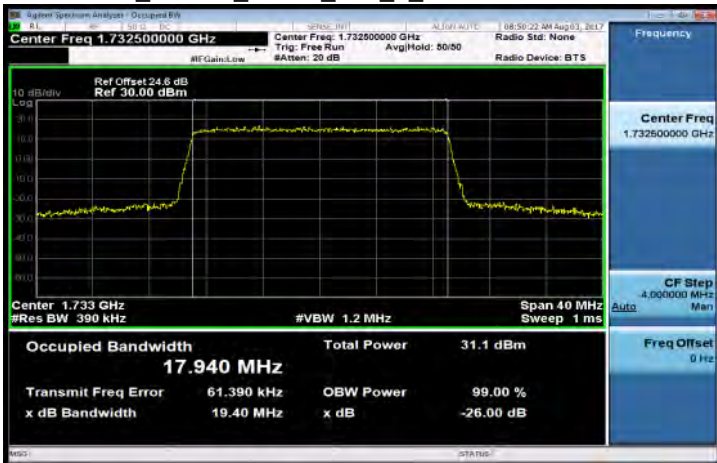

Band4\_20MHz\_16QAM\_100\_0\_MidCH20175-1732.5



Band4\_20MHz\_QPSK\_100\_0\_HighCH20300-1745

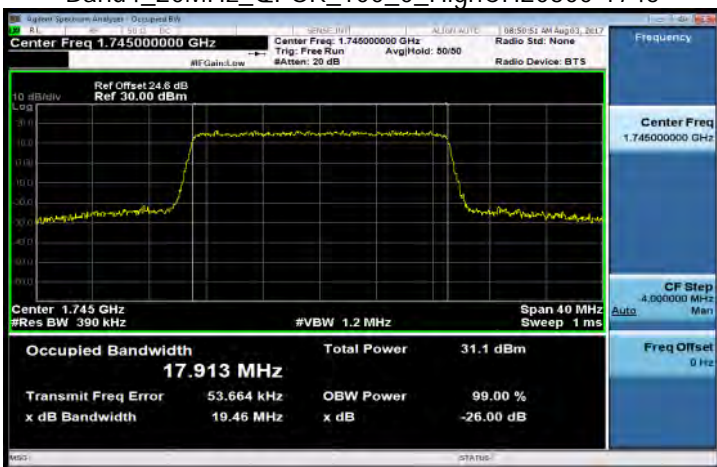

Band4\_20MHz\_16QAM\_100\_0\_HighCH20300-1745

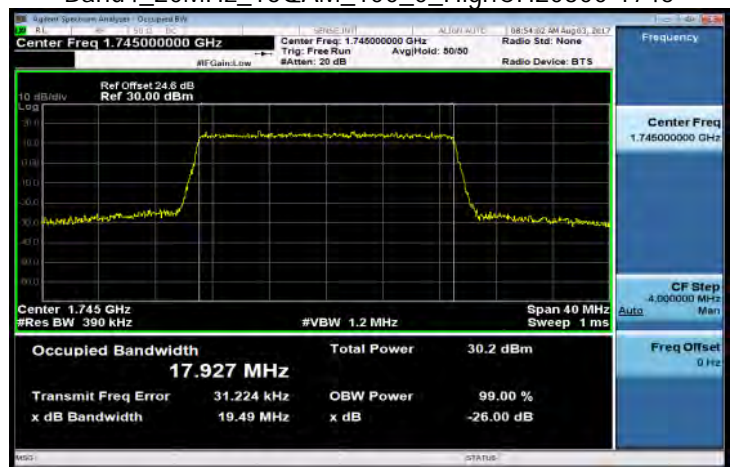

Unless otherwise stated the results shown in this test report refer only to the sample(s) tested and such sample(s) are retained for 90 days only.

除非另有說明，此報告結果僅對測試之樣品負責，同時此樣品僅保留90天。本報告未經本公司書面許可，不可部份複製。

This document is issued by the Company subject to its General Conditions of Service printed overleaf, available on request or accessible at [www.sgs.com/terms\\_and\\_conditions.htm](http://www.sgs.com/terms_and_conditions.htm) and, for electronic format documents, subject to Terms and Conditions for Electronic Documents at [www.sgs.com/terms\\_e-document.htm](http://www.sgs.com/terms_e-document.htm). Attention is drawn to the limitation of liability, indemnification and jurisdiction issues defined therein. Any holder of this document is advised that information contained hereon reflects the Company's findings at the time of its intervention only and within the limits of Client's instructions, if any. The Company's sole responsibility is to its Client and this document does not exonerate parties to a transaction from exercising all their rights and obligations under the transaction documents. This document cannot be reproduced except in full, without prior written approval of the Company. Any unauthorized alteration, forgery or falsification of the content or appearance of this document is unlawful and offenders may be prosecuted to the fullest extent of the law.



Band4\_20MHz\_64QAM\_100\_0\_LowCH20050-1720

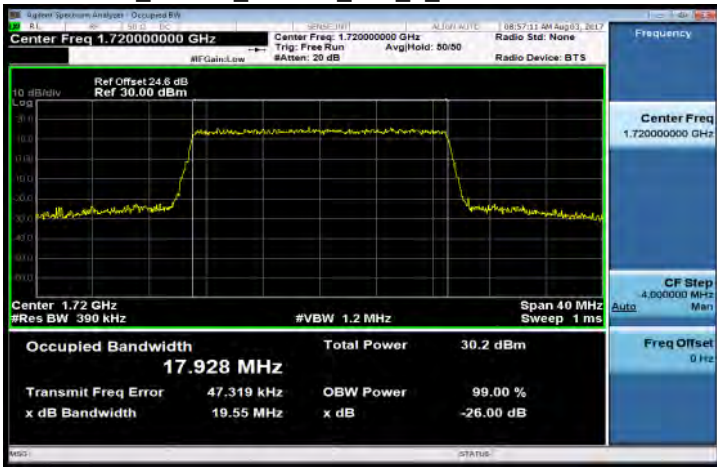

Band5\_1\_4MHz\_QPSK\_6\_0\_LowCH20407-824.7

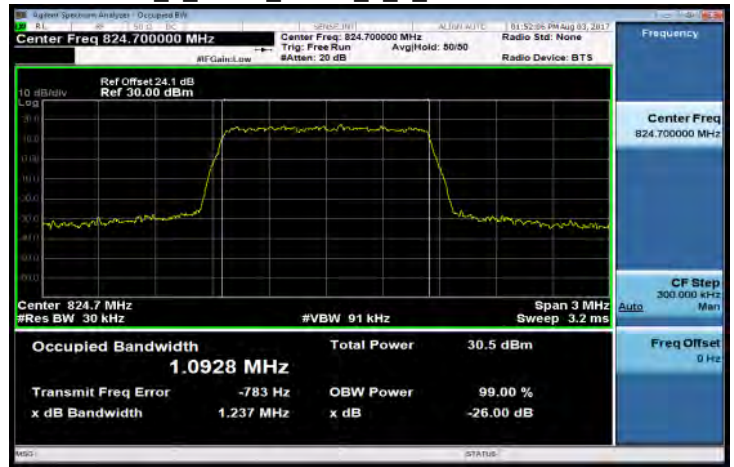

Band4\_20MHz\_64QAM\_100\_0\_MidCH20175-1732.5

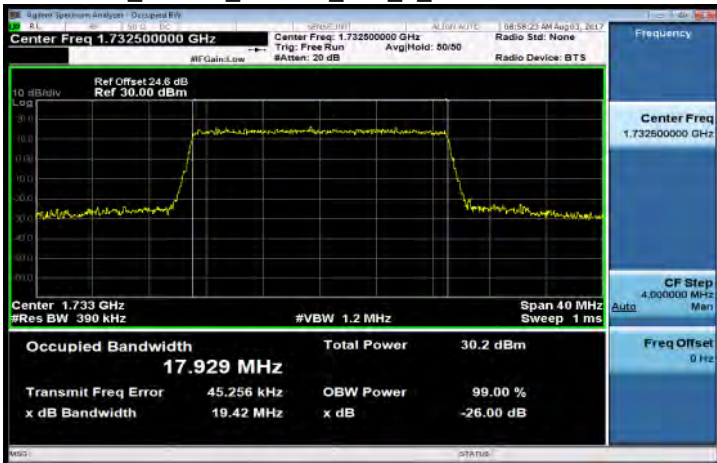

Band5\_1\_4MHz\_QPSK\_6\_0\_MidCH20525-836.5

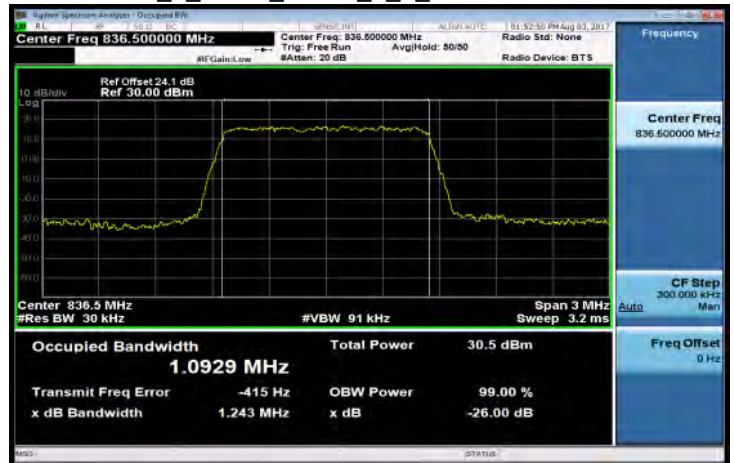

Band4\_20MHz\_64QAM\_100\_0\_HighCH20300-1745



Band5\_1\_4MHz\_QPSK\_6\_0\_HighCH20643-848.3

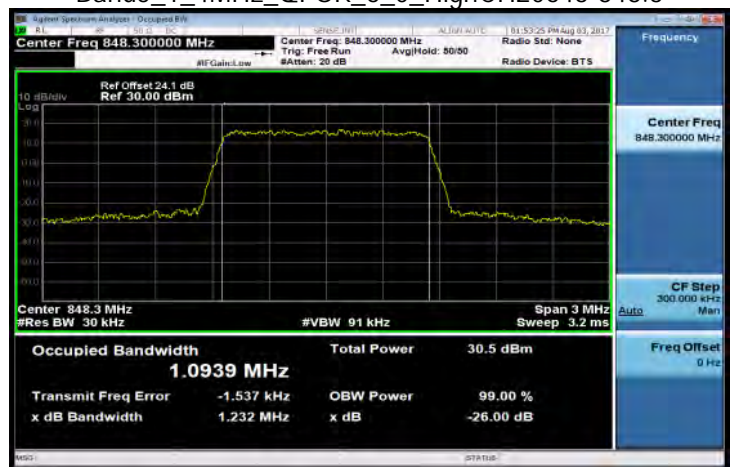

Unless otherwise stated the results shown in this test report refer only to the sample(s) tested and such sample(s) are retained for 90 days only.

除非另有說明，此報告結果僅對測試之樣品負責，同時此樣品僅保留90天。本報告未經本公司書面許可，不可部份複製。

This document is issued by the Company subject to its General Conditions of Service printed overleaf, available on request or accessible at [www.sgs.com/terms\\_and\\_conditions.htm](http://www.sgs.com/terms_and_conditions.htm) and, for electronic format documents, subject to Terms and Conditions for Electronic Documents at [www.sgs.com/terms\\_e-document.htm](http://www.sgs.com/terms_e-document.htm). Attention is drawn to the limitation of liability, indemnification and jurisdiction issues defined therein. Any holder of this document is advised that information contained hereon reflects the Company's findings at the time of its intervention only and within the limits of Client's instructions, if any. The Company's sole responsibility is to its Client and this document does not exonerate parties to a transaction from exercising all their rights and obligations under the transaction documents. This document cannot be reproduced except in full, without prior written approval of the Company. Any unauthorized alteration, forgery or falsification of the content or appearance of this document is unlawful and offenders may be prosecuted to the fullest extent of the law.

Band5\_1\_4MHz\_16QAM\_6\_0\_LowCH20407-824.7

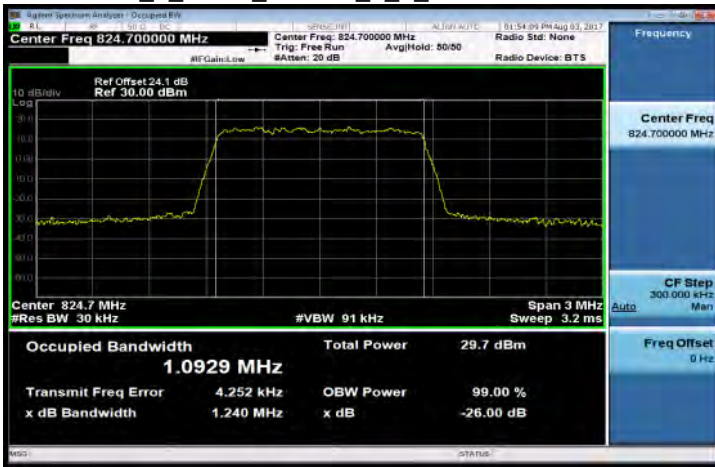

Band5\_1\_4MHz\_64QAM\_6\_0\_LowCH20407-824.7

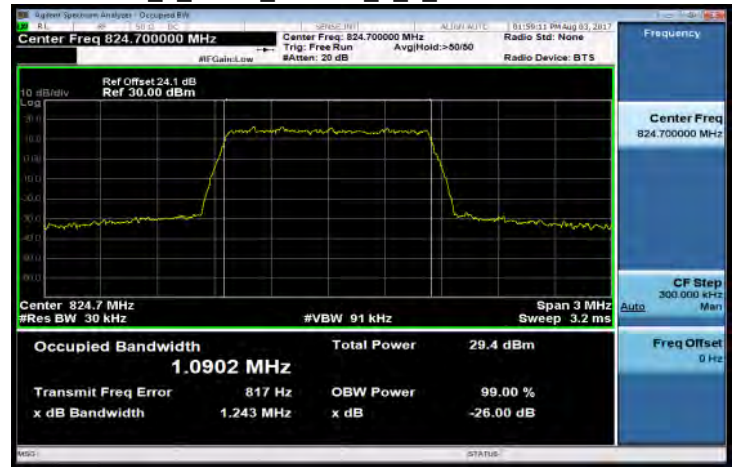

Band5\_1\_4MHz\_16QAM\_6\_0\_MidCH20525-836.5

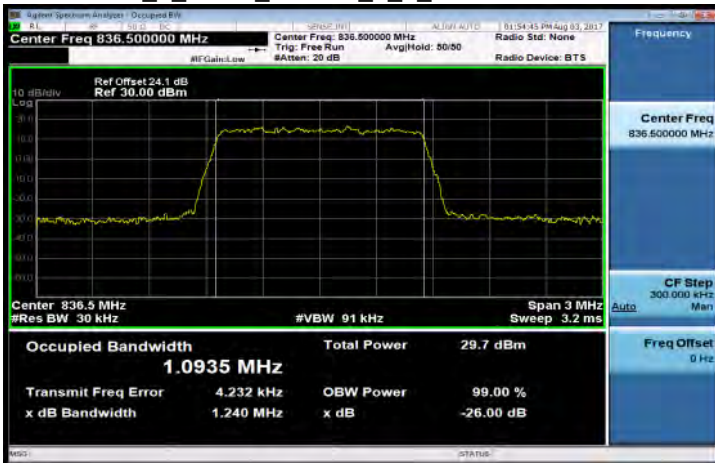

Band5\_1\_4MHz\_64QAM\_6\_0\_MidCH20525-836.5

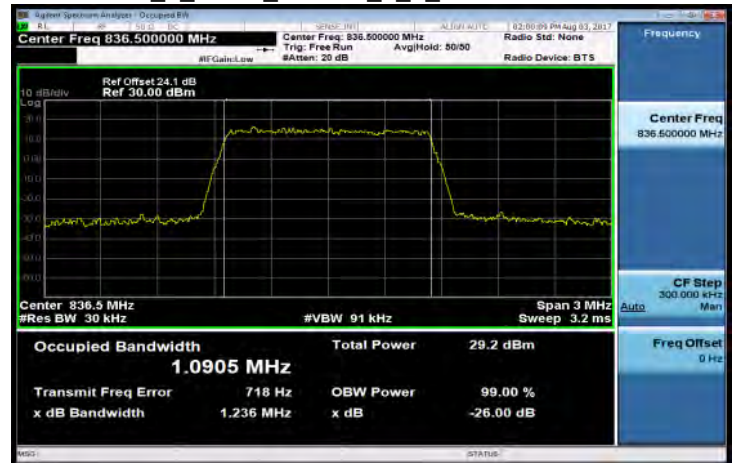

Band5\_1\_4MHz\_16QAM\_6\_0\_HighCH20643-848.3

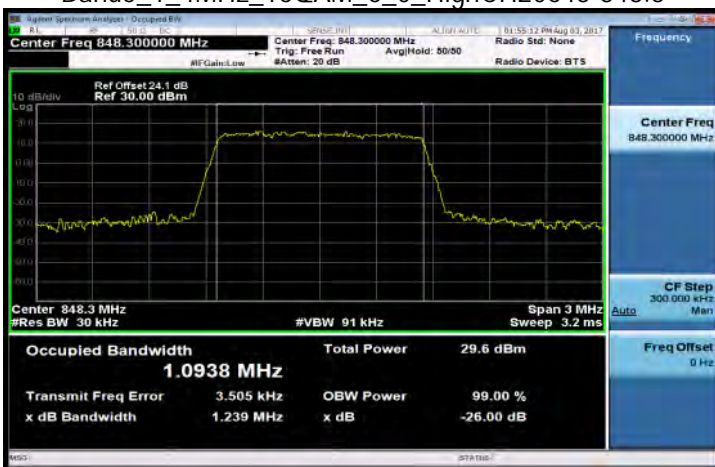

Band5\_1\_4MHz\_64QAM\_6\_0\_HighCH20643-848.3

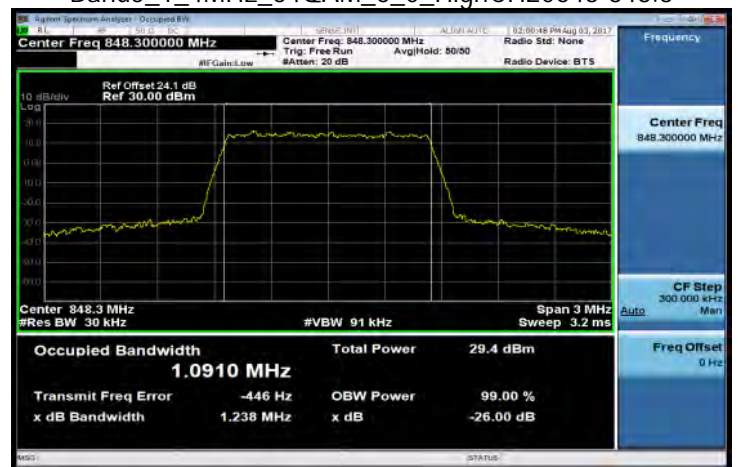

Unless otherwise stated the results shown in this test report refer only to the sample(s) tested and such sample(s) are retained for 90 days only.

除非另有說明，此報告結果僅對測試之樣品負責，同時此樣品僅保留90天。本報告未經本公司書面許可，不可部份複製。

This document is issued by the Company subject to its General Conditions of Service printed overleaf, available on request or accessible at [www.sgs.com/terms\\_and\\_conditions.htm](http://www.sgs.com/terms_and_conditions.htm) and, for electronic format documents, subject to Terms and Conditions for Electronic Documents at [www.sgs.com/terms\\_e-document.htm](http://www.sgs.com/terms_e-document.htm). Attention is drawn to the limitation of liability, indemnification and jurisdiction issues defined therein. Any holder of this document is advised that information contained hereon reflects the Company's findings at the time of its intervention only and within the limits of Client's instructions, if any. The Company's sole responsibility is to its Client and this document does not exonerate parties to a transaction from exercising all their rights and obligations under the transaction documents. This document cannot be reproduced except in full, without prior written approval of the Company. Any unauthorized alteration, forgery or falsification of the content or appearance of this document is unlawful and offenders may be prosecuted to the fullest extent of the law.

Band5\_3MHz\_QPSK\_15\_0\_LowCH20415-825.5



Band5\_3MHz\_16QAM\_15\_0\_LowCH20415-825.5

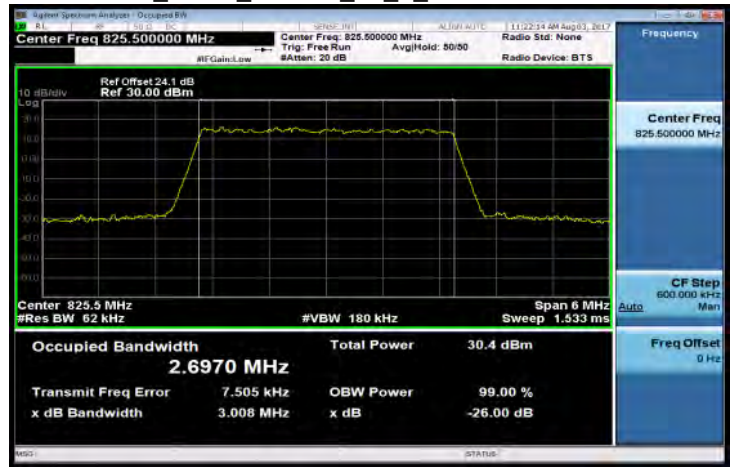

Band5\_3MHz\_QPSK\_15\_0\_MidCH20525-836.5

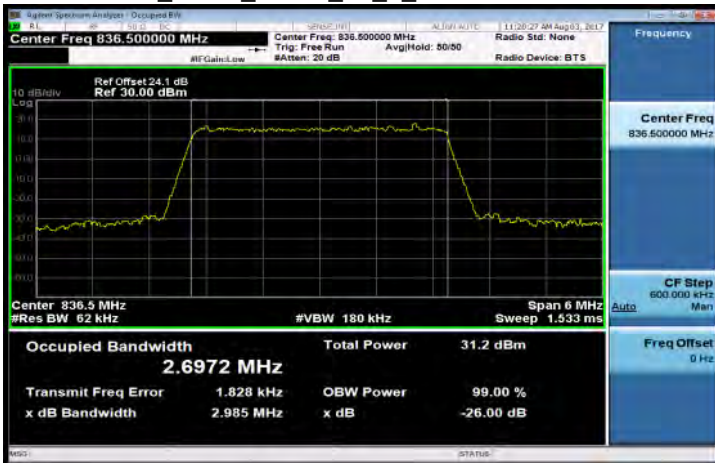

Band5\_3MHz\_16QAM\_15\_0\_MidCH20525-836.5

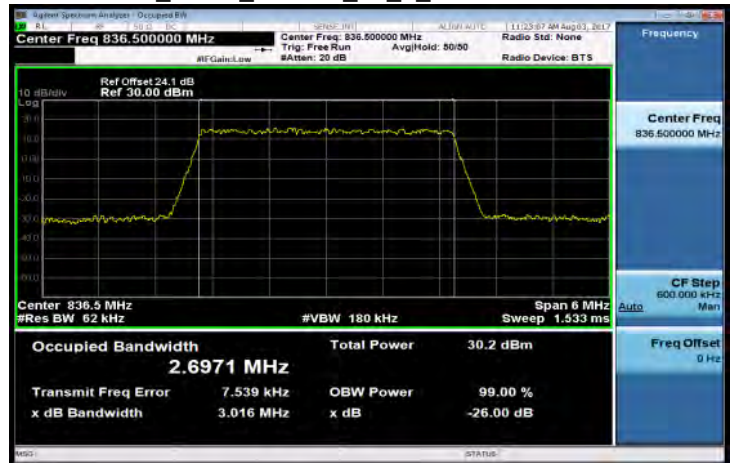

Band5\_3MHz\_QPSK\_15\_0\_HighCH20635-847.5

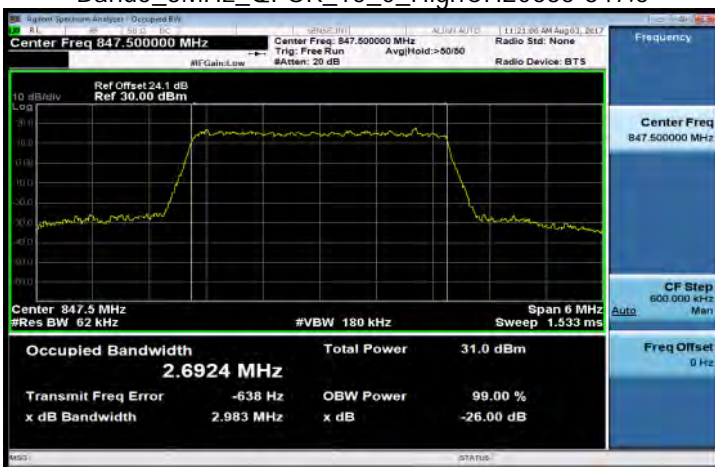

Band5\_3MHz\_16QAM\_15\_0\_HighCH20635-847.5

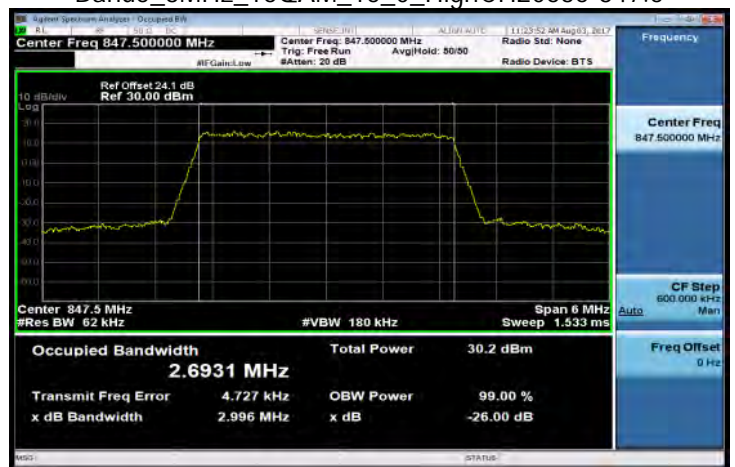

Unless otherwise stated the results shown in this test report refer only to the sample(s) tested and such sample(s) are retained for 90 days only.

除非另有說明，此報告結果僅對測試之樣品負責，同時此樣品僅保留90天。本報告未經本公司書面許可，不可部份複製。

This document is issued by the Company subject to its General Conditions of Service printed overleaf, available on request or accessible at [www.sgs.com/terms\\_and\\_conditions.htm](http://www.sgs.com/terms_and_conditions.htm) and, for electronic format documents, subject to Terms and Conditions for Electronic Documents at [www.sgs.com/terms\\_e-document.htm](http://www.sgs.com/terms_e-document.htm). Attention is drawn to the limitation of liability, indemnification and jurisdiction issues defined therein. Any holder of this document is advised that information contained hereon reflects the Company's findings at the time of its intervention only and within the limits of Client's instructions, if any. The Company's sole responsibility is to its Client and this document does not exonerate parties to a transaction from exercising all their rights and obligations under the transaction documents. This document cannot be reproduced except in full, without prior written approval of the Company. Any unauthorized alteration, forgery or falsification of the content or appearance of this document is unlawful and offenders may be prosecuted to the fullest extent of the law.

Band5\_3MHz\_64QAM\_15\_0\_LowCH20415-825.5

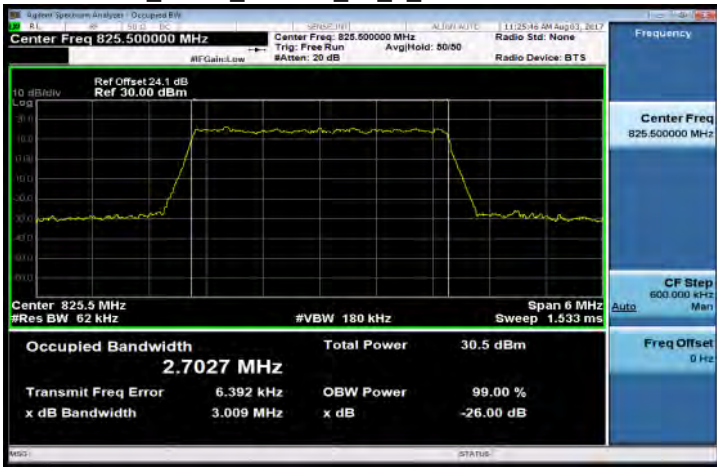

Band5\_5MHz\_QPSK\_25\_0\_LowCH20425-826.5

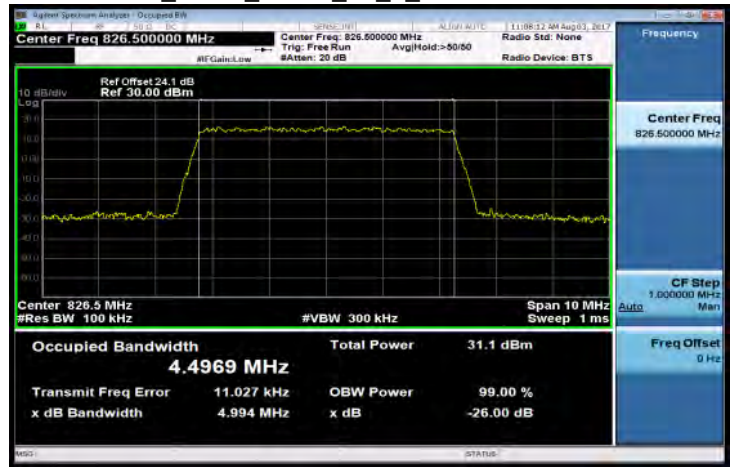

Band5\_3MHz\_64QAM\_15\_0\_MidCH20525-836.5

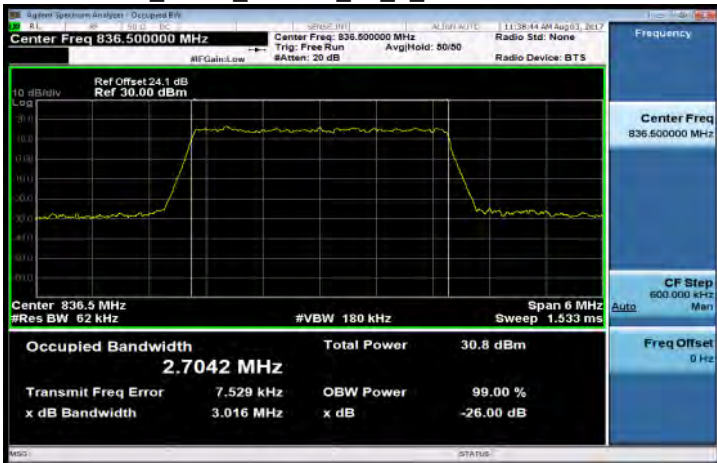

Band5\_5MHz\_QPSK\_25\_0\_MidCH20525-836.5

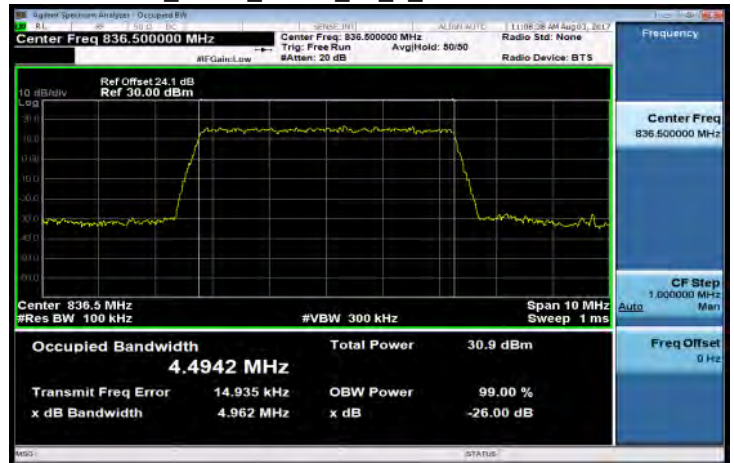

Band5\_3MHz\_64QAM\_15\_0\_HighCH20635-847.5

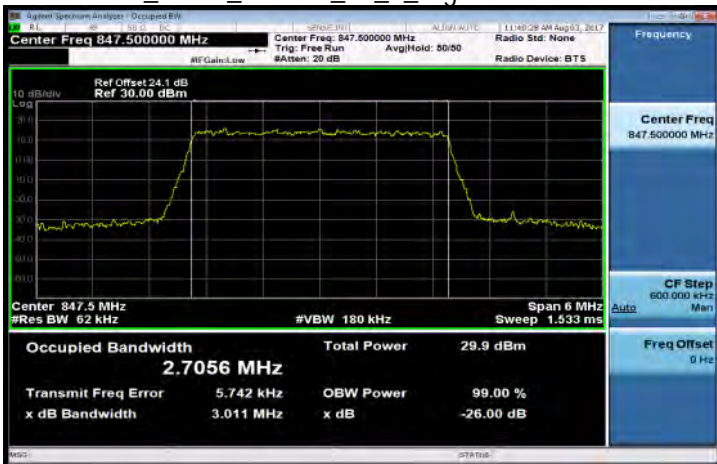

Band5\_5MHz\_QPSK\_25\_0\_HighCH20625-846.5

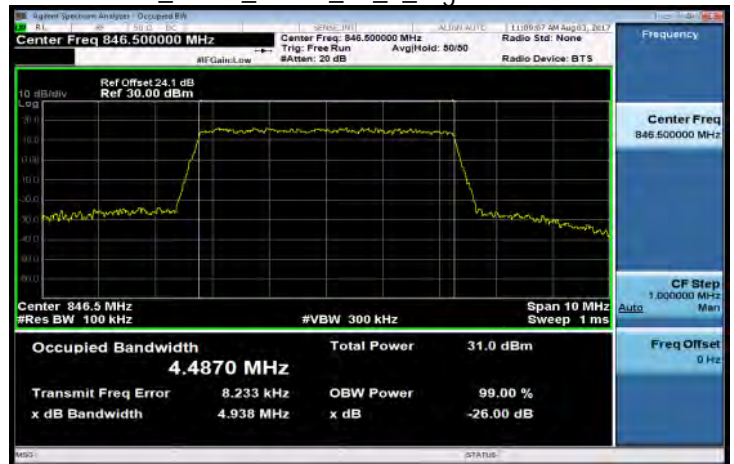

Unless otherwise stated the results shown in this test report refer only to the sample(s) tested and such sample(s) are retained for 90 days only.

除非另有說明，此報告結果僅對測試之樣品負責，同時此樣品僅保留90天。本報告未經本公司書面許可，不可部份複製。

This document is issued by the Company subject to its General Conditions of Service printed overleaf, available on request or accessible at [www.sgs.com/terms\\_and\\_conditions.htm](http://www.sgs.com/terms_and_conditions.htm) and, for electronic format documents, subject to Terms and Conditions for Electronic Documents at [www.sgs.com/terms\\_e-document.htm](http://www.sgs.com/terms_e-document.htm). Attention is drawn to the limitation of liability, indemnification and jurisdiction issues defined therein. Any holder of this document is advised that information contained hereon reflects the Company's findings at the time of its intervention only and within the limits of Client's instructions, if any. The Company's sole responsibility is to its Client and this document does not exonerate parties to a transaction from exercising all their rights and obligations under the transaction documents. This document cannot be reproduced except in full, without prior written approval of the Company. Any unauthorized alteration, forgery or falsification of the content or appearance of this document is unlawful and offenders may be prosecuted to the fullest extent of the law.

Band5\_5MHz\_16QAM\_25\_0\_LowCH20425-826.5

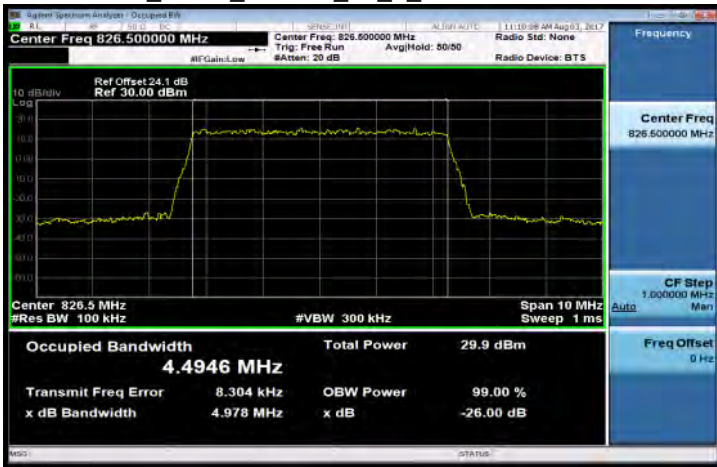

Band5\_5MHz\_64QAM\_25\_0\_LowCH20425-826.5

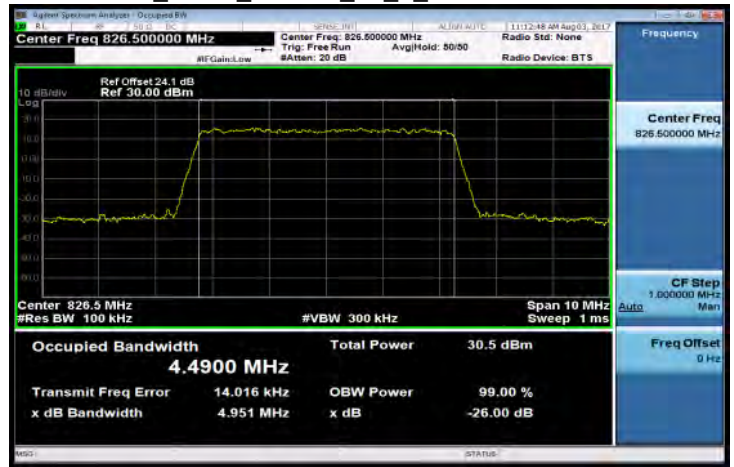

Band5\_5MHz\_16QAM\_25\_0\_MidCH20525-836.5



Band5\_5MHz\_64QAM\_25\_0\_MidCH20525-836.5

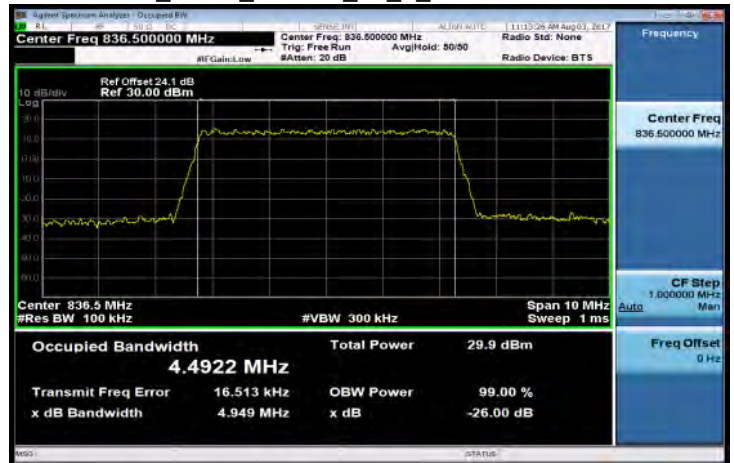

Band5\_5MHz\_16QAM\_25\_0\_HighCH20625-846.5



Band5\_5MHz\_64QAM\_25\_0\_HighCH20625-846.5



Unless otherwise stated the results shown in this test report refer only to the sample(s) tested and such sample(s) are retained for 90 days only.

除非另有說明，此報告結果僅對測試之樣品負責，同時此樣品僅保留90天。本報告未經本公司書面許可，不可部份複製。

This document is issued by the Company subject to its General Conditions of Service printed overleaf, available on request or accessible at [www.sgs.com/terms\\_and\\_conditions.htm](http://www.sgs.com/terms_and_conditions.htm) and, for electronic format documents, subject to Terms and Conditions for Electronic Documents at [www.sgs.com/terms\\_e-document.htm](http://www.sgs.com/terms_e-document.htm). Attention is drawn to the limitation of liability, indemnification and jurisdiction issues defined therein. Any holder of this document is advised that information contained hereon reflects the Company's findings at the time of its intervention only and within the limits of Client's instructions, if any. The Company's sole responsibility is to its Client and this document does not exonerate parties to a transaction from exercising all their rights and obligations under the transaction documents. This document cannot be reproduced except in full, without prior written approval of the Company. Any unauthorized alteration, forgery or falsification of the content or appearance of this document is unlawful and offenders may be prosecuted to the fullest extent of the law.

Band5\_10MHz\_QPSK\_50\_0\_LowCH20450-829



Band5\_10MHz\_16QAM\_50\_0\_LowCH20450-829



Band5\_10MHz\_QPSK\_50\_0\_MidCH20525-836.5

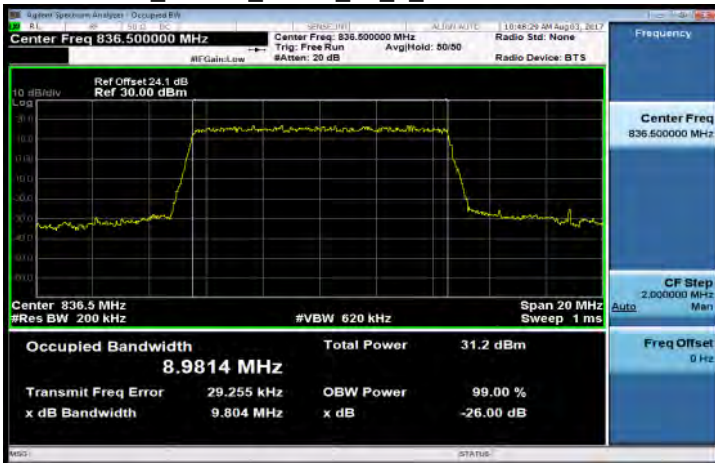

Band5\_10MHz\_16QAM\_50\_0\_MidCH20525-836.5



Band5\_10MHz\_QPSK\_50\_0\_HighCH20600-844

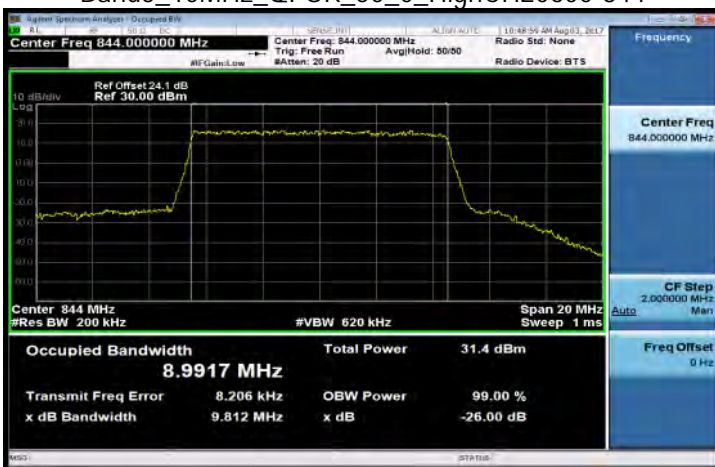

Band5\_10MHz\_16QAM\_50\_0\_HighCH20600-844

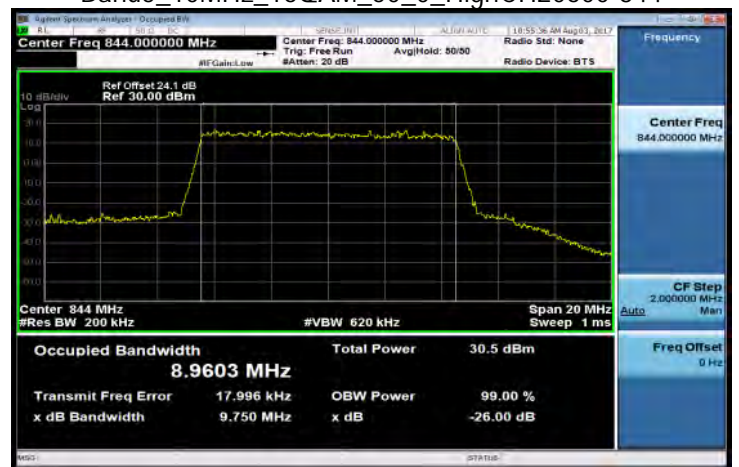

Unless otherwise stated the results shown in this test report refer only to the sample(s) tested and such sample(s) are retained for 90 days only.

除非另有說明，此報告結果僅對測試之樣品負責，同時此樣品僅保留90天。本報告未經本公司書面許可，不可部份複製。

This document is issued by the Company subject to its General Conditions of Service printed overleaf, available on request or accessible at [www.sgs.com/terms\\_and\\_conditions.htm](http://www.sgs.com/terms_and_conditions.htm) and, for electronic format documents, subject to Terms and Conditions for Electronic Documents at [www.sgs.com/terms\\_e-document.htm](http://www.sgs.com/terms_e-document.htm). Attention is drawn to the limitation of liability, indemnification and jurisdiction issues defined therein. Any holder of this document is advised that information contained hereon reflects the Company's findings at the time of its intervention only and within the limits of Client's instructions, if any. The Company's sole responsibility is to its Client and this document does not exonerate parties to a transaction from exercising all their rights and obligations under the transaction documents. This document cannot be reproduced except in full, without prior written approval of the Company. Any unauthorized alteration, forgery or falsification of the content or appearance of this document is unlawful and offenders may be prosecuted to the fullest extent of the law.

Band5\_10MHz\_64QAM\_50\_0\_LowCH20450-829

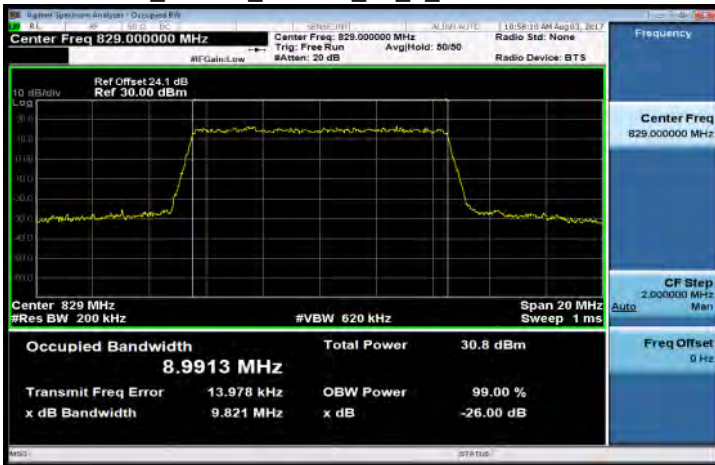

Band7\_5MHz\_QPSK\_25\_0\_LowCH20775-2502.5



Band5\_10MHz\_64QAM\_50\_0\_MidCH20525-836.5

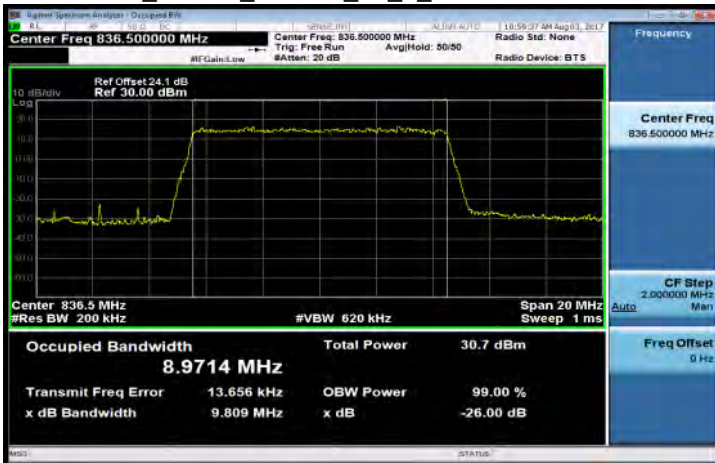

Band7\_5MHz\_QPSK\_25\_0\_MidCH21100-2535

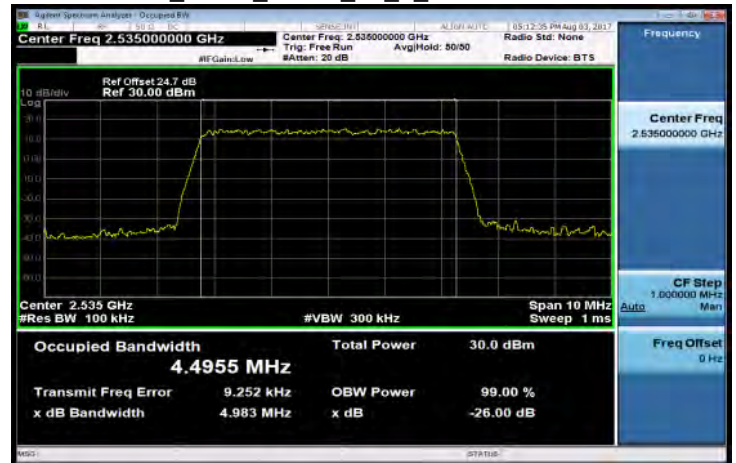

Band5\_10MHz\_64QAM\_50\_0\_HighCH20600-844

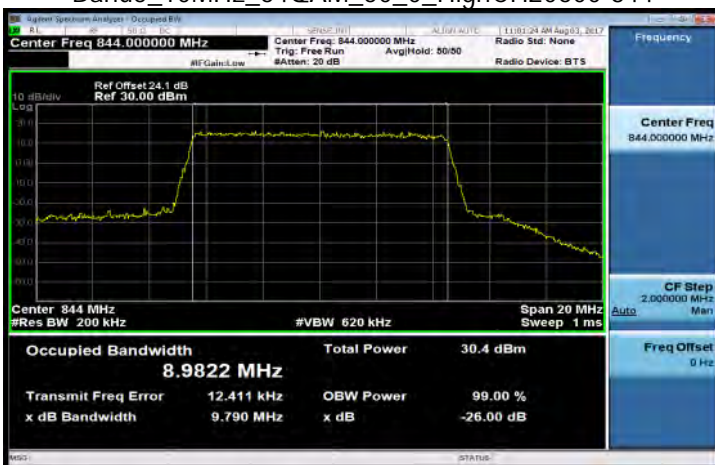

Band7\_5MHz\_QPSK\_25\_0\_HighCH21425-2567.5

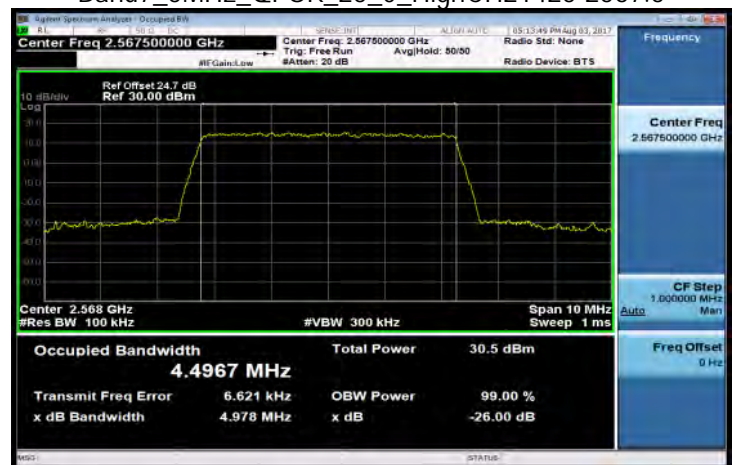

Unless otherwise stated the results shown in this test report refer only to the sample(s) tested and such sample(s) are retained for 90 days only.

除非另有說明，此報告結果僅對測試之樣品負責，同時此樣品僅保留90天。本報告未經本公司書面許可，不可部份複製。

This document is issued by the Company subject to its General Conditions of Service printed overleaf, available on request or accessible at [www.sgs.com/terms\\_and\\_conditions.htm](http://www.sgs.com/terms_and_conditions.htm) and, for electronic format documents, subject to Terms and Conditions for Electronic Documents at [www.sgs.com/terms\\_e-document.htm](http://www.sgs.com/terms_e-document.htm). Attention is drawn to the limitation of liability, indemnification and jurisdiction issues defined therein. Any holder of this document is advised that information contained hereon reflects the Company's findings at the time of its intervention only and within the limits of Client's instructions, if any. The Company's sole responsibility is to its Client and this document does not exonerate parties to a transaction from exercising all their rights and obligations under the transaction documents. This document cannot be reproduced except in full, without prior written approval of the Company. Any unauthorized alteration, forgery or falsification of the content or appearance of this document is unlawful and offenders may be prosecuted to the fullest extent of the law.

Band7\_5MHz\_16QAM\_25\_0\_LowCH20775-2502.5

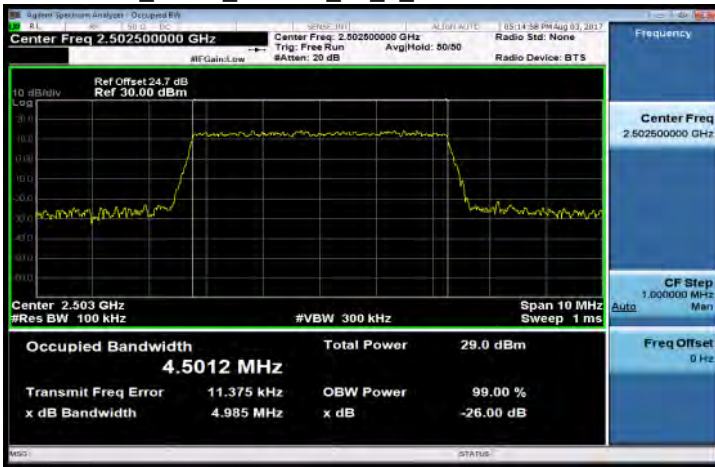

Band7\_5MHz\_64QAM\_25\_0\_LowCH20775-2502.5



Band7\_5MHz\_16QAM\_25\_0\_MidCH21100-2535

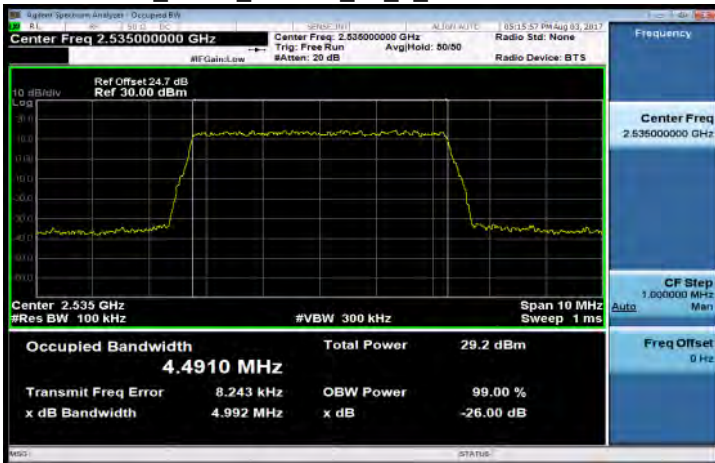

Band7\_5MHz\_64QAM\_25\_0\_MidCH21100-2535



Band7\_5MHz\_16QAM\_25\_0\_HighCH21425-2567.5

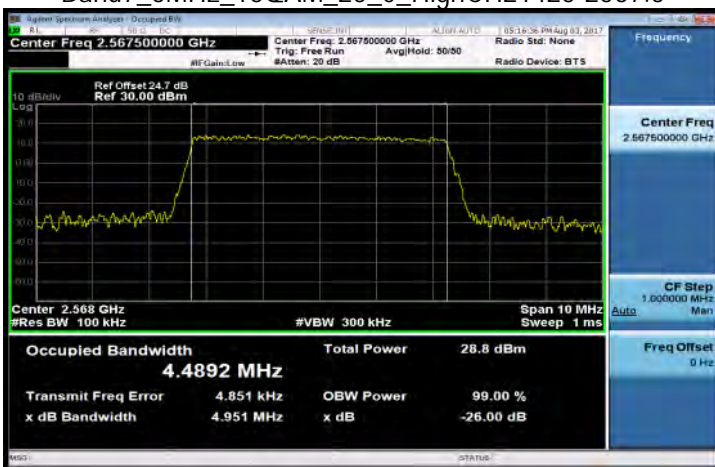

Band7\_5MHz\_64QAM\_25\_0\_HighCH21425-2567.5

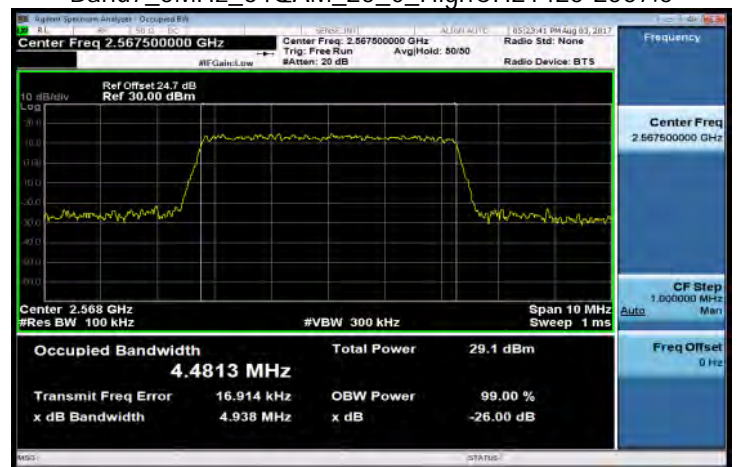

Unless otherwise stated the results shown in this test report refer only to the sample(s) tested and such sample(s) are retained for 90 days only.

除非另有說明，此報告結果僅對測試之樣品負責，同時此樣品僅保留90天。本報告未經本公司書面許可，不可部份複製。

This document is issued by the Company subject to its General Conditions of Service printed overleaf, available on request or accessible at [www.sgs.com/terms\\_and\\_conditions.htm](http://www.sgs.com/terms_and_conditions.htm) and, for electronic format documents, subject to Terms and Conditions for Electronic Documents at [www.sgs.com/terms\\_e-document.htm](http://www.sgs.com/terms_e-document.htm). Attention is drawn to the limitation of liability, indemnification and jurisdiction issues defined therein. Any holder of this document is advised that information contained hereon reflects the Company's findings at the time of its intervention only and within the limits of Client's instructions, if any. The Company's sole responsibility is to its Client and this document does not exonerate parties to a transaction from exercising all their rights and obligations under the transaction documents. This document cannot be reproduced except in full, without prior written approval of the Company. Any unauthorized alteration, forgery or falsification of the content or appearance of this document is unlawful and offenders may be prosecuted to the fullest extent of the law.



Band7\_10MHz\_QPSK\_50\_0\_LowCH20800-2505

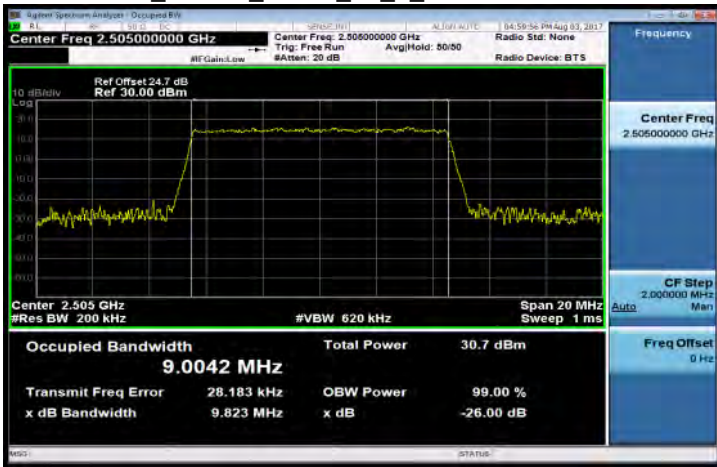

Band7\_10MHz\_16QAM\_50\_0\_LowCH20800-2505

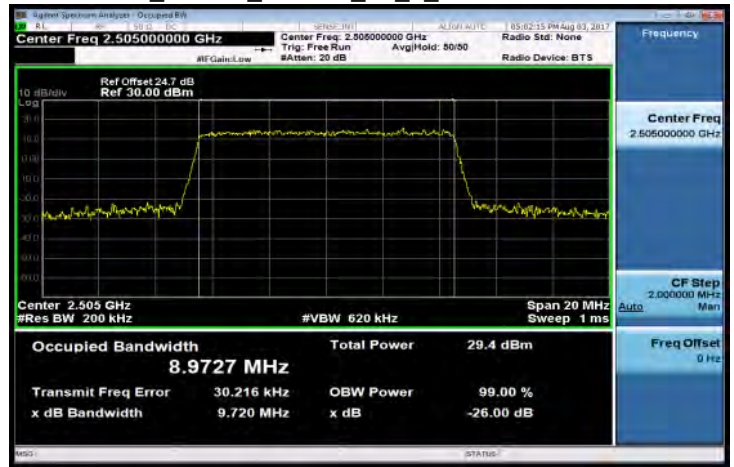

Band7\_10MHz\_QPSK\_50\_0\_MidCH21100-2535

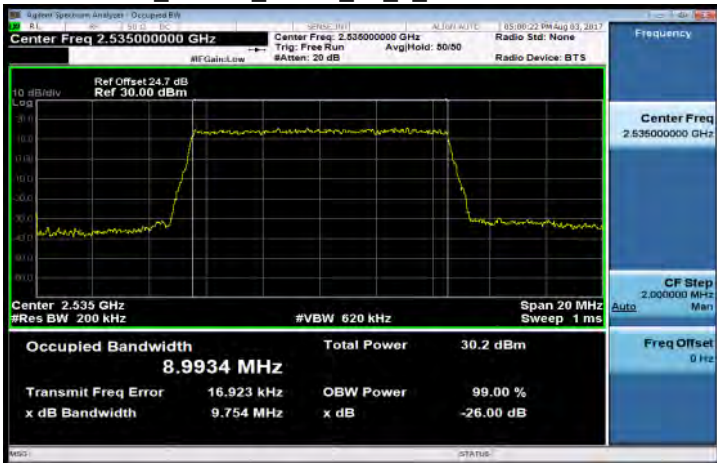

Band7\_10MHz\_16QAM\_50\_0\_MidCH21100-2535

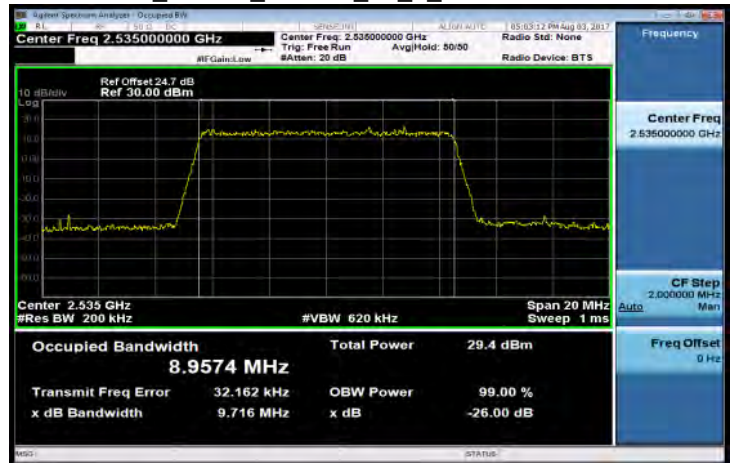

Band7\_10MHz\_QPSK\_50\_0\_HighCH21400-2565



Band7\_10MHz\_16QAM\_50\_0\_HighCH21400-2565

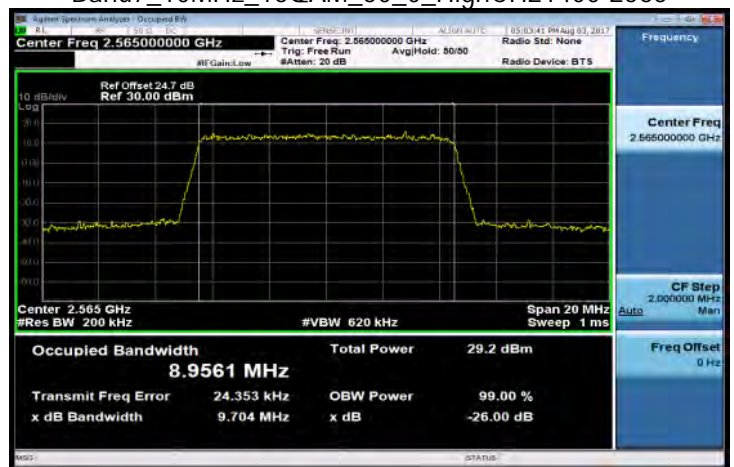

Unless otherwise stated the results shown in this test report refer only to the sample(s) tested and such sample(s) are retained for 90 days only.

除非另有說明，此報告結果僅對測試之樣品負責，同時此樣品僅保留90天。本報告未經本公司書面許可，不可部份複製。

This document is issued by the Company subject to its General Conditions of Service printed overleaf, available on request or accessible at [www.sgs.com/terms\\_and\\_conditions.htm](http://www.sgs.com/terms_and_conditions.htm) and, for electronic format documents, subject to Terms and Conditions for Electronic Documents at [www.sgs.com/terms\\_e-document.htm](http://www.sgs.com/terms_e-document.htm). Attention is drawn to the limitation of liability, indemnification and jurisdiction issues defined therein. Any holder of this document is advised that information contained hereon reflects the Company's findings at the time of its intervention only and within the limits of Client's instructions, if any. The Company's sole responsibility is to its Client and this document does not exonerate parties to a transaction from exercising all their rights and obligations under the transaction documents. This document cannot be reproduced except in full, without prior written approval of the Company. Any unauthorized alteration, forgery or falsification of the content or appearance of this document is unlawful and offenders may be prosecuted to the fullest extent of the law.

Band7\_10MHz\_64QAM\_50\_0\_LowCH20800-2505

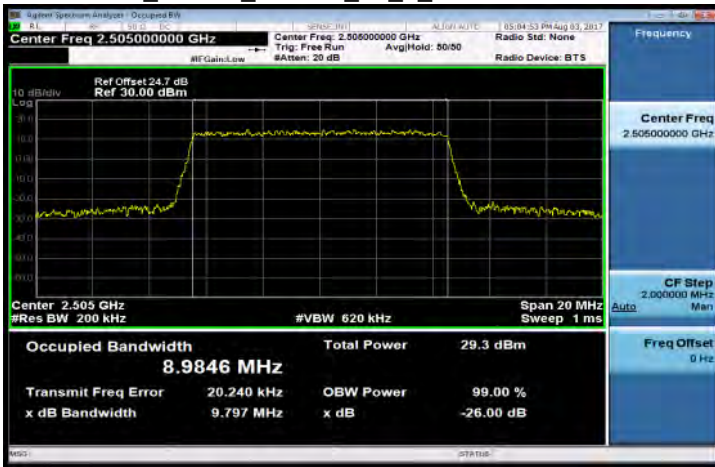

Band7\_15MHz\_QPSK\_75\_0\_LowCH20825-2507.5

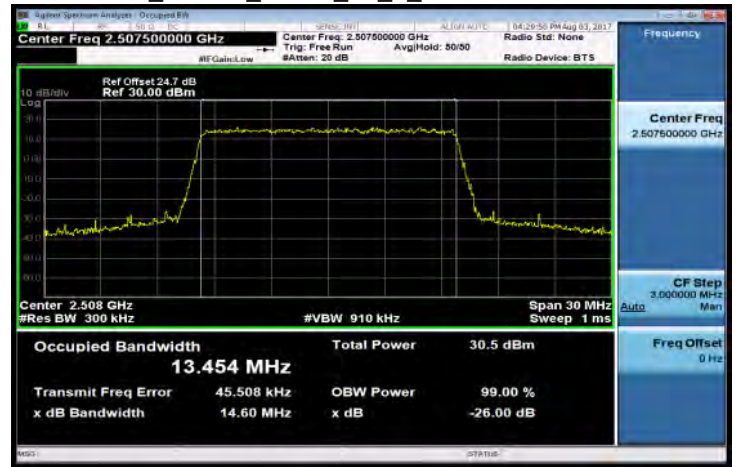

Band7\_10MHz\_64QAM\_50\_0\_MidCH21100-2535

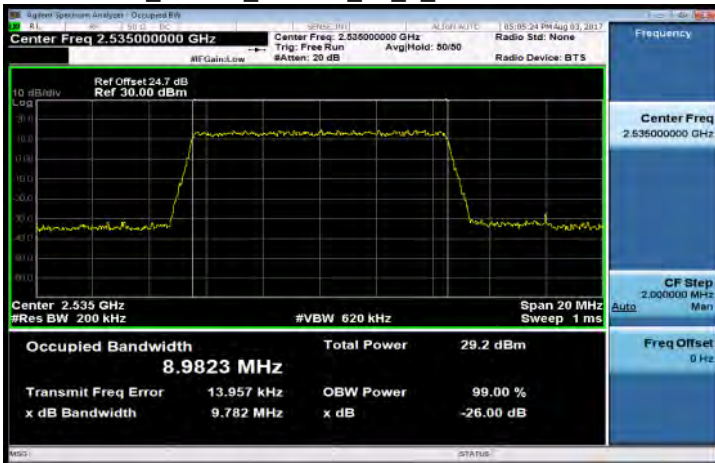

Band7\_15MHz\_QPSK\_75\_0\_MidCH21100-2535

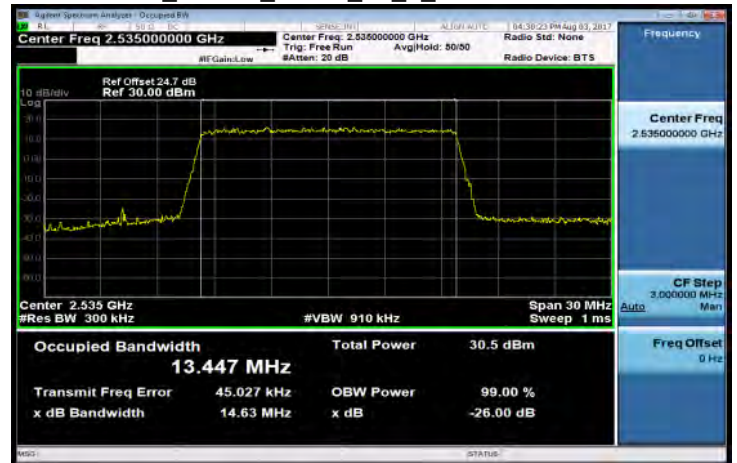

Band7\_10MHz\_64QAM\_50\_0\_HighCH21400-2565

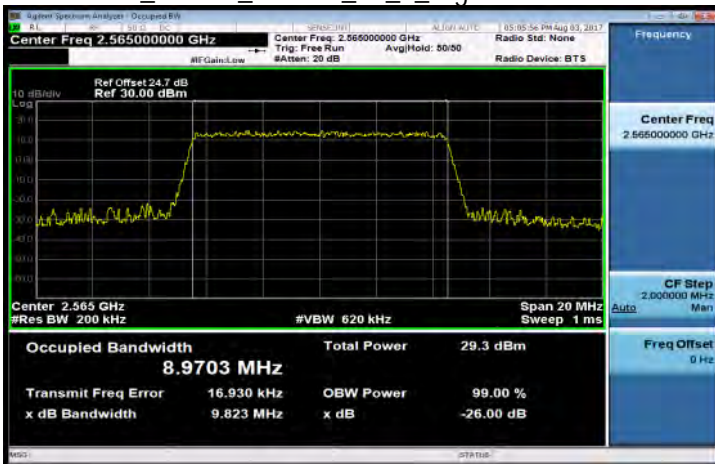

Band7\_15MHz\_QPSK\_75\_0\_HighCH21375-2562.5



Unless otherwise stated the results shown in this test report refer only to the sample(s) tested and such sample(s) are retained for 90 days only.

除非另有說明，此報告結果僅對測試之樣品負責，同時此樣品僅保留90天。本報告未經本公司書面許可，不可部份複製。

This document is issued by the Company subject to its General Conditions of Service printed overleaf, available on request or accessible at [www.sgs.com/terms\\_and\\_conditions.htm](http://www.sgs.com/terms_and_conditions.htm) and, for electronic format documents, subject to Terms and Conditions for Electronic Documents at [www.sgs.com/terms\\_e-document.htm](http://www.sgs.com/terms_e-document.htm). Attention is drawn to the limitation of liability, indemnification and jurisdiction issues defined therein. Any holder of this document is advised that information contained hereon reflects the Company's findings at the time of its intervention only and within the limits of Client's instructions, if any. The Company's sole responsibility is to its Client and this document does not exonerate parties to a transaction from exercising all their rights and obligations under the transaction documents. This document cannot be reproduced except in full, without prior written approval of the Company. Any unauthorized alteration, forgery or falsification of the content or appearance of this document is unlawful and offenders may be prosecuted to the fullest extent of the law.

Band7\_15MHz\_16QAM\_75\_0\_LowCH20825-2507.5



Band7\_15MHz\_64QAM\_75\_0\_LowCH20825-2507.5

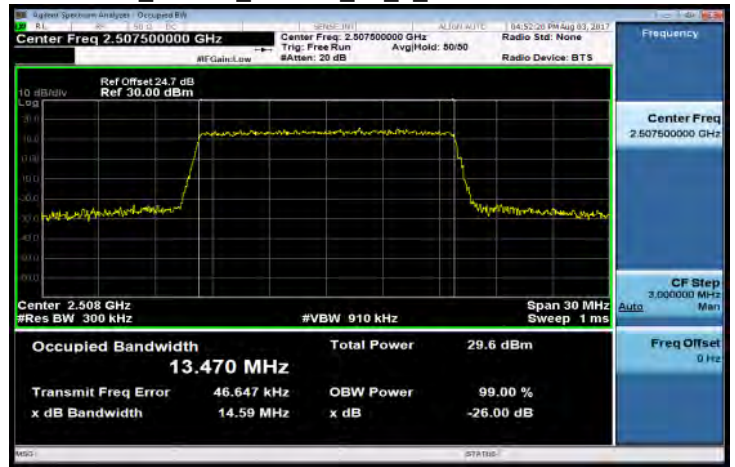

Band7\_15MHz\_16QAM\_75\_0\_MidCH21100-2535

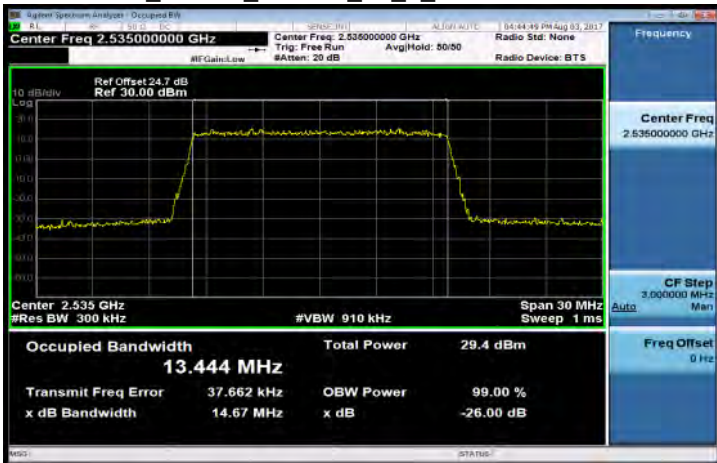

Band7\_15MHz\_64QAM\_75\_0\_MidCH21100-2535

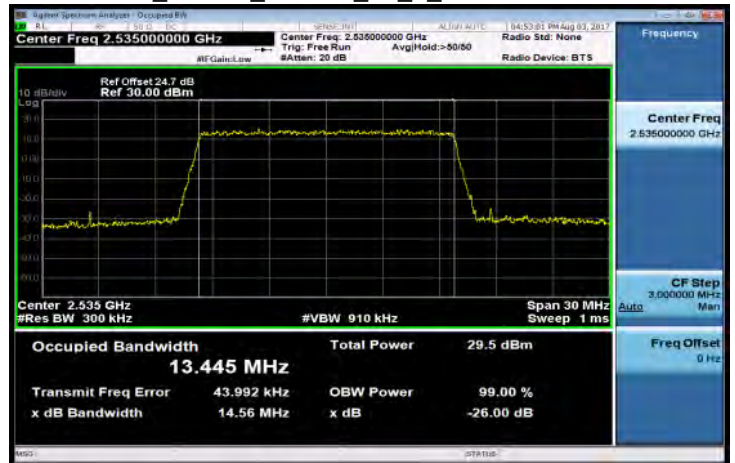

Band7\_15MHz\_16QAM\_75\_0\_HighCH21375-2562.5

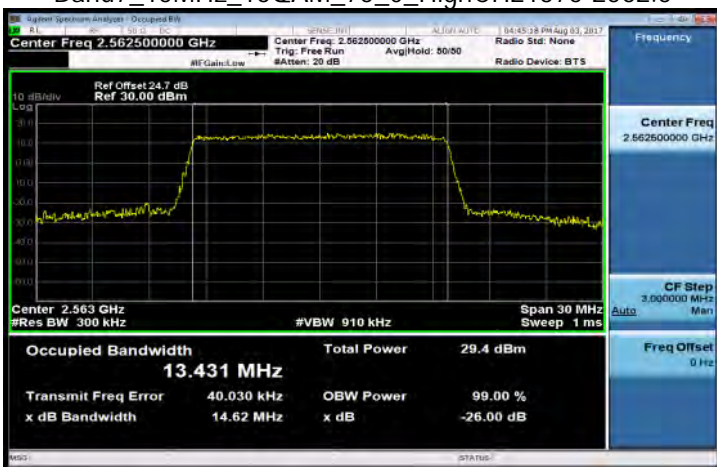

Band7\_15MHz\_64QAM\_75\_0\_HighCH21375-2562.5

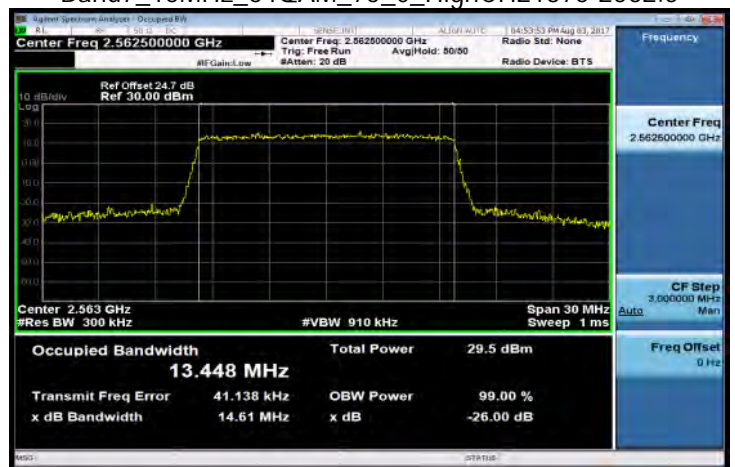

Unless otherwise stated the results shown in this test report refer only to the sample(s) tested and such sample(s) are retained for 90 days only.

除非另有說明，此報告結果僅對測試之樣品負責，同時此樣品僅保留90天。本報告未經本公司書面許可，不可部份複製。

This document is issued by the Company subject to its General Conditions of Service printed overleaf, available on request or accessible at [www.sgs.com/terms\\_and\\_conditions.htm](http://www.sgs.com/terms_and_conditions.htm) and, for electronic format documents, subject to Terms and Conditions for Electronic Documents at [www.sgs.com/terms\\_e-document.htm](http://www.sgs.com/terms_e-document.htm). Attention is drawn to the limitation of liability, indemnification and jurisdiction issues defined therein. Any holder of this document is advised that information contained hereon reflects the Company's findings at the time of its intervention only and within the limits of Client's instructions, if any. The Company's sole responsibility is to its Client and this document does not exonerate parties to a transaction from exercising all their rights and obligations under the transaction documents. This document cannot be reproduced except in full, without prior written approval of the Company. Any unauthorized alteration, forgery or falsification of the content or appearance of this document is unlawful and offenders may be prosecuted to the fullest extent of the law.

Band7\_20MHz\_QPSK\_100\_0\_LowCH20850-2510

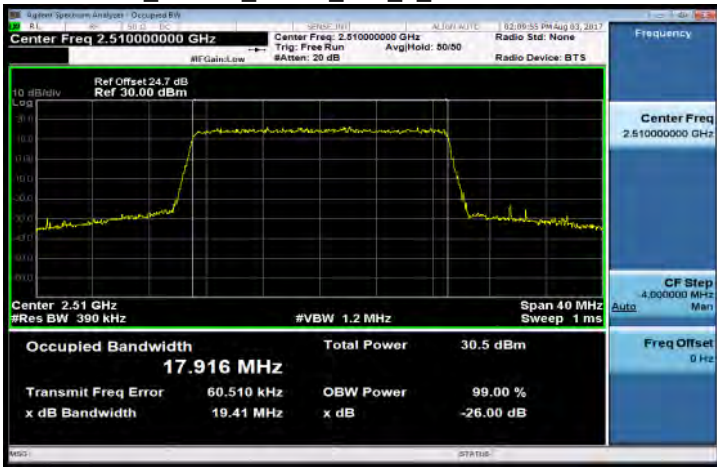

Band7\_20MHz\_16QAM\_100\_0\_LowCH20850-2510

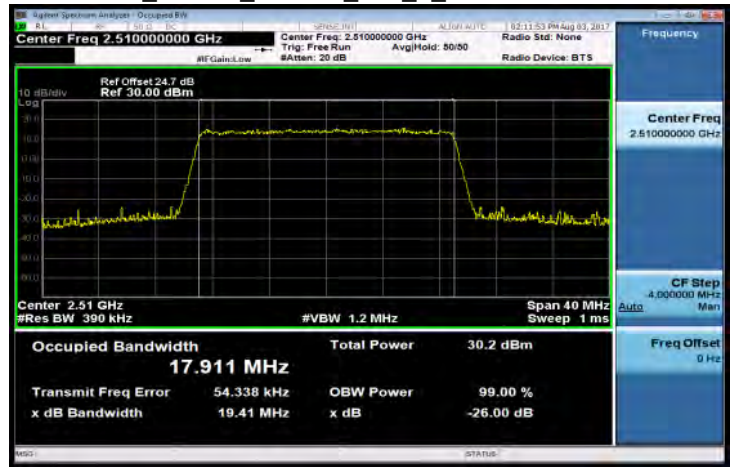

Band7\_20MHz\_QPSK\_100\_0\_MidCH21100-2535

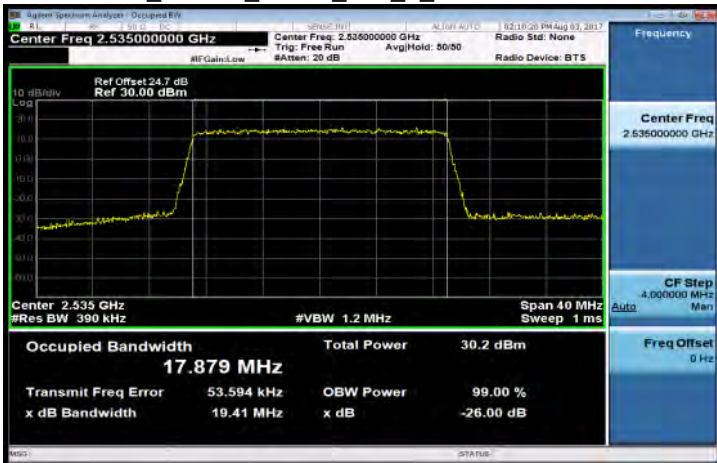

Band7\_20MHz\_16QAM\_100\_0\_MidCH21100-2535

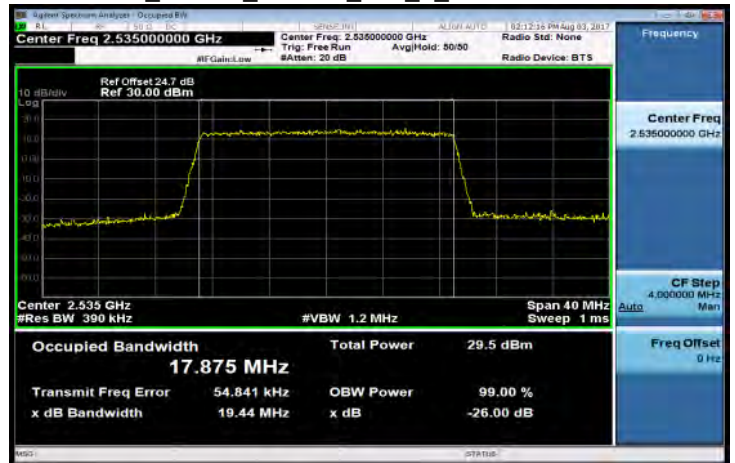

Band7\_20MHz\_QPSK\_100\_0\_HighCH21350-2560



Band7\_20MHz\_16QAM\_100\_0\_HighCH21350-2560



Unless otherwise stated the results shown in this test report refer only to the sample(s) tested and such sample(s) are retained for 90 days only.

除非另有說明，此報告結果僅對測試之樣品負責，同時此樣品僅保留90天。本報告未經本公司書面許可，不可部份複製。

This document is issued by the Company subject to its General Conditions of Service printed overleaf, available on request or accessible at [www.sgs.com/terms\\_and\\_conditions.htm](http://www.sgs.com/terms_and_conditions.htm) and, for electronic format documents, subject to Terms and Conditions for Electronic Documents at [www.sgs.com/terms\\_e-document.htm](http://www.sgs.com/terms_e-document.htm). Attention is drawn to the limitation of liability, indemnification and jurisdiction issues defined therein. Any holder of this document is advised that information contained hereon reflects the Company's findings at the time of its intervention only and within the limits of Client's instructions, if any. The Company's sole responsibility is to its Client and this document does not exonerate parties to a transaction from exercising all their rights and obligations under the transaction documents. This document cannot be reproduced except in full, without prior written approval of the Company. Any unauthorized alteration, forgery or falsification of the content or appearance of this document is unlawful and offenders may be prosecuted to the fullest extent of the law.