



RF TEST REPORT

Applicant Huawei Technologies Co., Ltd.
FCC ID QISE3619U-828
Product Huawei Locator
Model E3619U-828
Report No. R1812H0172-R7
Issue Date January 18, 2019

TA Technology (Shanghai) Co., Ltd. tested the above equipment in accordance with the requirements in **FCC CFR47 Part 2 (2018)/ FCC CFR47 Part 27C (2018)**. The test results show that the equipment tested is capable of demonstrating compliance with the requirements as documented in this report.

Jiang peng Lan

Performed by: Jiangpeng Lan

Kai Xu

Approved by: Kai Xu

TA Technology (Shanghai) Co., Ltd.

No.145, Jintang Rd, Tangzhen Industry Park, Pudong Shanghai, China

TEL: +86-021-50791141/2/3

FAX: +86-021-50791141/2/3-8000

Table of Contents

1	Test Laboratory	4
1.1	Notes of the Test Report	4
1.2	Test facility	4
1.3	Testing Location	5
2	General Description of Equipment under Test	6
3	Applied Standards	8
4	Test Configuration	9
5	Test Case Results	10
5.1	RF Power Output	10
5.2	Effective Isotropic Radiated Power	12
5.3	Occupied Bandwidth	16
5.4	Band Edge Compliance	21
5.5	Peak-to-Average Power Ratio (PAPR)	24
5.6	Frequency Stability	26
5.7	Spurious Emissions at Antenna Terminals	28
5.8	Radiates Spurious Emission	32
6	Main Test Instruments	36

Summary of Measurement Results

Number	Test Case	Clause in FCC rules	Verdict
1	RF power output	2.1046	PASS
2	Effective Isotropic Radiated power	27.50(d)(4)	PASS
3	Occupied Bandwidth	2.1049	PASS
4	Band Edge Compliance	27.53(h)	PASS
5	Peak-to-Average Power Ratio	27.50(d)/KDB971168 D01(5.7)	PASS
6	Frequency Stability	2.1055 / 27.54	PASS
7	Spurious Emissions at Antenna Terminals	2.1051 /27.53(h)	PASS
8	Radiates Spurious Emission	2.1053 /27.53(h)	PASS
Date of Testing: January 8, 2019 ~ January 15, 2019			
Note: PASS: The EUT complies with the essential requirements in the standard. FAIL: The EUT does not comply with the essential requirements in the standard.			

1 Test Laboratory

1.1 Notes of the Test Report

This report shall not be reproduced in full or partial, without the written approval of **TA technology (shanghai) co., Ltd.** The results documented in this report apply only to the tested sample, under the conditions and modes of operation as described herein .Measurement Uncertainties were not taken into account and are published for informational purposes only. This report is written to support regulatory compliance of the applicable standards stated above.

1.2 Test facility

CNAS (accreditation number: L2264)

TA Technology (Shanghai) Co., Ltd. has obtained the accreditation of China National Accreditation Service for Conformity Assessment (CNAS).

FCC (Designation number: CN1179, Test Firm Registration Number: 446626)

TA Technology (Shanghai) Co., Ltd. has been listed on the US Federal Communications Commission list of test facilities recognized to perform electromagnetic emissions measurements.

IC (recognition number is 8510A)

TA Technology (Shanghai) Co., Ltd. has been listed by industry Canada to perform electromagnetic emission measurement.

VCCI (recognition number is C-4595, T-2154, R-4113, G-10766)

TA Technology (Shanghai) Co., Ltd. has been listed by industry Japan to perform electromagnetic emission measurement.

A2LA (Certificate Number: 3857.01)

TA Technology (Shanghai) Co., Ltd. has been listed by American Association for Laboratory Accreditation to perform electromagnetic emission measurement.

1.3 Testing Location

Company: TA Technology (Shanghai) Co., Ltd.
Address: No.145, Jintang Rd, Tangzhen Industry Park, Pudong Shanghai, China
City: Shanghai
Post code: 201201
Country: P. R. China
Contact: Xu Kai
Telephone: +86-021-50791141/2/3
Fax: +86-021-50791141/2/3-8000
Website: <http://www.ta-shanghai.com>
E-mail: xukai@ta-shanghai.com

2 General Description of Equipment under Test

Client Information

Applicant	Huawei Technologies Co., Ltd.
Applicant address	Administration Building, Headquarters of Huawei Technologies Co., Ltd., Bantian, Longgang District, Shenzhen, 518129, P.R.China.
Manufacturer	Huawei Technologies Co., Ltd.
Manufacturer address	Administration Building, Headquarters of Huawei Technologies Co., Ltd., Bantian, Longgang District, Shenzhen, 518129, P.R.China.

General information

EUT Description			
Model	E3619U-828		
IMEI	/		
Hardware Version	IM1E3619UM VER.E		
Software Version	1.0.0.35(H126SP9C00)		
Power Supply	Battery		
Antenna Type	Internal Antenna		
Antenna Gain	NB-IOT Band 4: -1.6dBi		
Test Mode(s)	NB-IOT Band 4		
LTE Category	NB1		
Test Modulation	BPSK, QPSK		
Category	NB1		
Deployment	stand-alone		
Sub-carrier spacing	3.75KHz, 15KHz		
Ntones	single, multi-tone		
Maximum E.I.R.P./ E.R.P.	NB-IOT Band 4:	19.47dBm	
Rated Power Supply Voltage:	3.82V		
Extreme Voltage	Minimum: 3.45V Maximum: 4.4V		
Extreme Temperature	Lowest: -15°C Highest: +55°C		
Operating Frequency Range(s)	Mode	Tx (MHz)	Rx (MHz)
	NB-IOT Band 4	1710 ~ 1755	2110 ~ 2155
EUT Accessory			
Battery 1	Manufacturer: AmpereX Technology Limited Model: HB642735ECW		
Battery 2	Manufacturer: Tianjin Lishen Battery Joint-Stock Co., Ltd Model: HB642735ECW		
USB Cable 1	Manufacturer: HUIZHOU DEHONG TECHNOLOGY CO., LTD		

	17cm, shielded
USB Cable 2	Manufacturer: NINGBO BROAD TELECOMMUNICATION CO.,LTD 17cm, shielded
USB Cable 3	Manufacturer: Luxshare Precision Industry Co., Ltd. 17cm, shielded
EMI suppression Ferrite core	Manufacturer: Prosperity Electronic Co., Limited. Model: A2 RC 103B
<p>Note: 1. The information of the EUT is declared by the manufacturer.</p> <p>2. There is more than one USB cable, one Battery, each one should be applied throughout the compliance test respectively, and however, only the worst case (USB cable 1 and Battery 1) will be recorded in this report.</p>	

3 Applied Standards

According to the specifications of the manufacturer, it must comply with the requirements of the following standards:

Test standards

FCC CFR47 Part 2 (2018)

FCC CFR47 Part 27C (2018)

ANSI C63.26 (2015)

KDB 971168 D01 Power Meas License Digital Systems v03r01

4 Test Configuration

Radiated measurements are performed by rotating the EUT in three different orthogonal test planes. EUT stand-up position (Z axis), lie-down position (X, Y axis). Receiver antenna polarization (horizontal and vertical), the worst emission was found in position (Z axis, vertical polarization) and the worst case was recorded.

All modes as Subcarrier Spacing, modulations, Channel were investigated.

Subsequently, only the worst case emissions are reported.

The following testing in NB-IOT is set based on the maximum RF Output Power.

The following testing in different mode is set to detail in the following table:

Test modes are chosen to be reported as the worst case configuration below for NB-IOT Band 4:

Test items	Deployment mode	Subcarrier Spacing (kHz)		Modulation		Test Channel		
	Stand-alone	3.75	15	BPSK	QPSK	L	M	H
RF power output	O	O	O	O	O	O	O	O
Effective Isotropic Radiated power	O	O	O	O	O	O	O	O
Occupied Bandwidth	O	O	O	O	O	O	O	O
Band Edge Compliance	O	O	O	O	O	O	-	O
Peak-to-Average Power Ratio	O	O	O	O	O	-	O	-
Frequency Stability	O	O	O	O	O	O	O	O
Conducted Spurious Emissions	O	-	O	-	O	O	O	O
Radiates Spurious Emission	O	-	O	-	O	-	O	-
Note 1. The mark "O" means that this configuration is chosen for testing. 2. The mark "-" means that this configuration is not testing.								

5 Test Case Results

5.1 RF Power Output

Ambient condition

Temperature	Relative humidity	Pressure
23°C ~25°C	45%~50%	101.5kPa

Methods of Measurement

During the process of the testing, The EUT is controlled by the Base Station Simulator to ensure max power transmission and proper modulation.

Test Setup

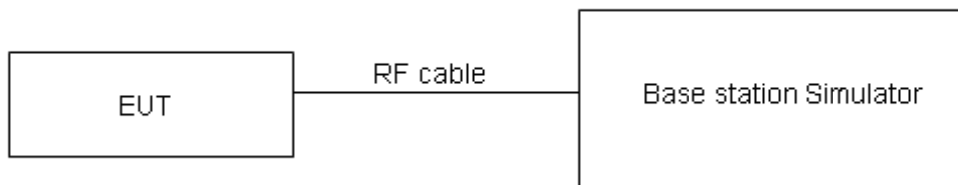

The loss between RF output port of the EUT and the input port of the tester has been taken into consideration.

Limits

No specific RF power output requirements in part 2.1046.

Measurement Uncertainty

The assessed measurement uncertainty to ensure 95% confidence level for the normal distribution is with the coverage factor $k = 2$, $U=0.4$ dB.

Test Results

Mode	Modulation	Sub-carrier spacing (KHz)	Ntones	Conducted Power (dBm) for low/mid/high Channel/Frequency(MHz)		
				19951/1710.1	20175/1732.5	20399/1754.9
Band 4 Standalone	BPSK	3.75	1@0	23.33	23.01	22.73
			1@47	23.26	22.99	22.64
		15	1@0	23.36	23.12	22.83
			1@11	23.31	23.05	22.77
	QPSK	3.75	1@0	23.03	23.07	22.78
			1@47	22.95	23.02	22.75
		15	1@0	23.44	23.18	22.90
			1@11	23.37	23.13	22.94
		15	12@0	21.64	21.42	21.09

5.2 Effective Isotropic Radiated Power

Ambient condition

Temperature	Relative humidity	Pressure
23°C ~25°C	45%~50%	101.5kPa

Methods of Measurement

1. The testing follows FCC KDB 971168 D01 v03r01 Section 5.8 and ANSI C63.26 (2015).

a) Connect the equipment as illustrated. Mount the equipment with the manufacturer specified antenna in a vertical orientation on a manufacturer specified mounting surface located on a non-conducting rotating platform of a RF anechoic chamber (preferred) or a standard radiation site.

b) Key the transmitter, then rotate the EUT 360° azimuthally and record spectrum analyzer power level (LVL) measurements at angular increments that are sufficiently small to permit resolution of all peaks. If a standard radiation test site is used, raise and lower the test antenna to obtain a maximum reading at each angular increment. (Note: several batteries may be needed to offset the effect of battery voltage droop, which should not exceed 5% of the manufactured specified battery voltage during transmission).

c) Replace the transmitter under test with a vertically polarized half-wave dipole (or an antenna whose gain is known relative to an ideal half-wave dipole). The center of the antenna should be at the same location as the center of the antenna under test.

d) Connect the antenna to a signal generator with a known output power and record the path loss (in dB) as LOSS. If a standard radiation test site is used, raise and lower the test antenna to obtain a maximum reading. $LOSS = \text{Generator Output Power (dBm)} - \text{Analyzer reading (dBm)}$

e) Determine the effective radiated output power at each angular position from the readings in steps b) and d) using the following equation: $ERP \text{ (dBm)} = \text{LVL (dBm)} + \text{LOSS (dB)}$

f) The maximum ERP is the maximum value determined in the preceding step.

g) When calculating ERP, in addition to knowing the antenna radiation and matching characteristics, it is necessary to know the loss values of all elements (e.g. transmission line attenuation, mismatches, filters, combiners) interposed between the point where transmitter output power is measured, and the point where power is applied to the antenna. ERP can then be calculated as follows:

$$EIRP \text{ (dBm)} = \text{Output Power (dBm)} - \text{Losses (dB)} + \text{Antenna Gain (dBi)}$$

where: dBd refers to gain relative to an ideal dipole.

$$EIRP \text{ (dBm)} = ERP \text{ (dBm)} + 2.15 \text{ (dB.)}$$

The RB allocation refers to section 5.1, using the maximum output power configuration.

Test setup

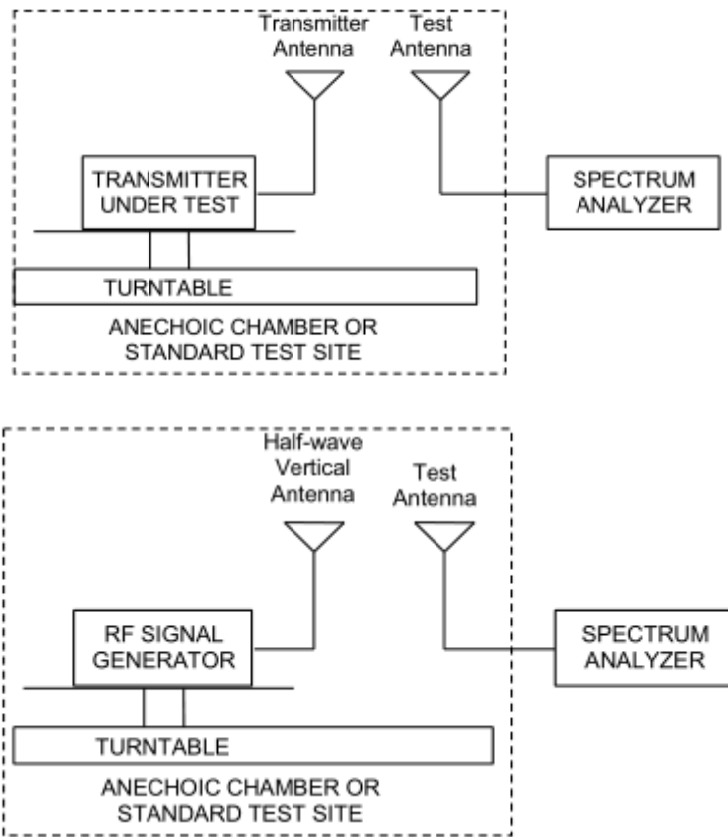

Note: Area side:2.4mX3.6m

The radiated emission was measured in the following position: EUT stand-up position (Z axis), lie-down position (X, Y axis). The worst emission was found in stand-up position (Z axis) and the worst case was recorded.

Limits

Rule Part 27.50(d) (4) specifies that “Fixed, mobile and portable (hand-held) stations operating in the 1710–1755 MHz band are limited to 1 watt EIRP”

Part 27.50(d)(4)Limit	$\leq 1 \text{ W}$ (30 dBm)
-----------------------	-----------------------------

Measurement Uncertainty

The assessed measurement uncertainty to ensure 95% confidence level for the normal distribution is with the coverage factor $k = 2$, $U = 1.19 \text{ dB}$

Test Results

The measurement is performed for both of horizontal and vertical antenna Polarization, and only the data of worst mode is recorded in this report.

Mode	Channel	Frequency (MHz)	Modulation	Polarization	Sub-carrier spacing (KHz)	Ntones	EIRP (dBm)	Limit (dBm)	Conclusion
Band4 Standalone	19951	1710.1	BPSK	vertical	3.75	1@0	17.96	30	Pass
			QPSK	vertical	3.75	1@0	18.05	30	Pass
			BPSK	vertical	15	1@0	18.43	30	Pass
			QPSK	vertical	15	1@0	18.55	30	Pass
	20175	1732.5	BPSK	vertical	3.75	1@0	19.19	30	Pass
			QPSK	vertical	3.75	1@0	19.36	30	Pass
			BPSK	vertical	15	1@0	19.43	30	Pass
			QPSK	vertical	15	1@0	19.47	30	Pass
	20399	1754.9	BPSK	vertical	3.75	1@0	17.93	30	Pass
			QPSK	vertical	3.75	1@0	17.99	30	Pass
			BPSK	vertical	15	1@0	18.83	30	Pass
			QPSK	vertical	15	1@0	18.97	30	Pass

5.3 Occupied Bandwidth

Ambient condition

Temperature	Relative humidity	Pressure
23°C ~25°C	45%~50%	101.5kPa

Method of Measurement

The EUT was connected to Spectrum Analyzer and Base Station Simulator via power Splitter. The occupied bandwidth is measured using spectrum analyzer.

RBW is set to 2kHz, VBW is set to 6.2kHz for NB-IOT Band 4

99% power and -26dBc occupied bandwidths are recorded. Spectrum analyzer plots are included on the following pages.

Test Setup

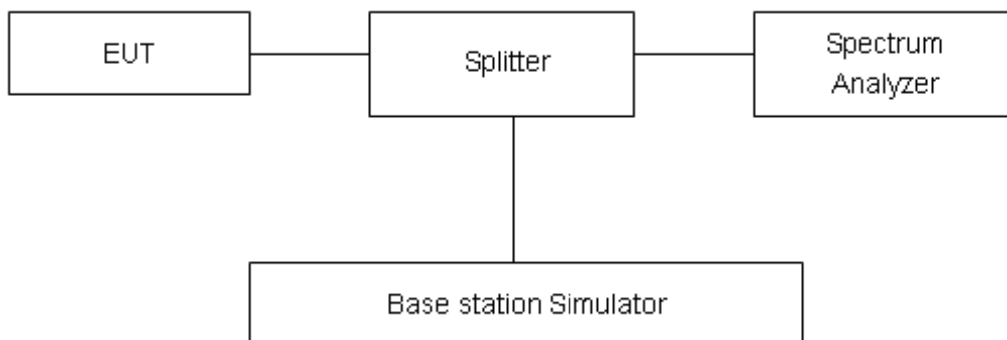

Limits

No specific occupied bandwidth requirements in part 2.1049.

Measurement Uncertainty

The assessed measurement uncertainty to ensure 95% confidence level for the normal distribution is with the coverage factor $k = 2$, $U=624\text{Hz}$.

Test Result

Mode	Modulation	Sub-carrier spacing (KHz)	Ntones	Bandwidth(KHz) Channel/Frequency(MHz)					
				19951/1710.1		20175/1732.5		20399/1754.9	
				99% Power	26dBc	99% Power	-26dBc	99% Power	-26dBc
Band 4 Standalone	BPSK	3.75	1@0	54.080	37.920	52.212	37.340	53.169	37.870
	QPSK	3.75	1@0	60.287	39.68	61.638	39.300	60.010	39.000
	BPSK	15	1@0	116.340	101.800	127.030	117.200	127.520	115.000
	QPSK	15	1@0	120.600	118.900	132.040	131.300	125.410	117.200
	QPSK	15	12@0	182.840	238.400	184.270	240.500	183.620	251.500

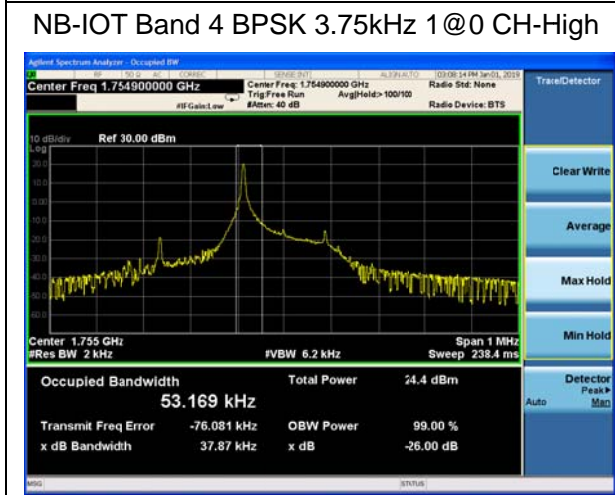
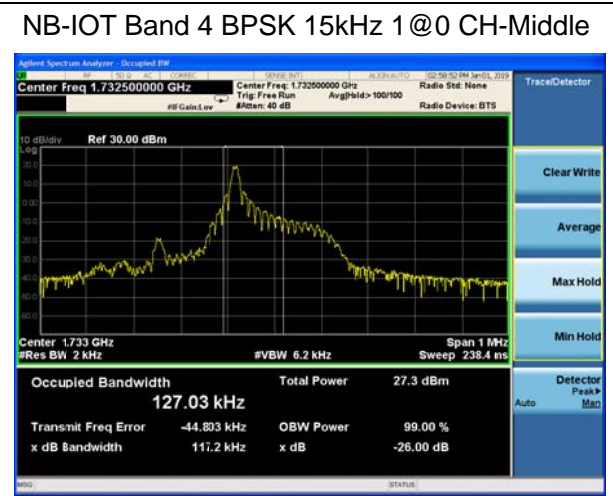
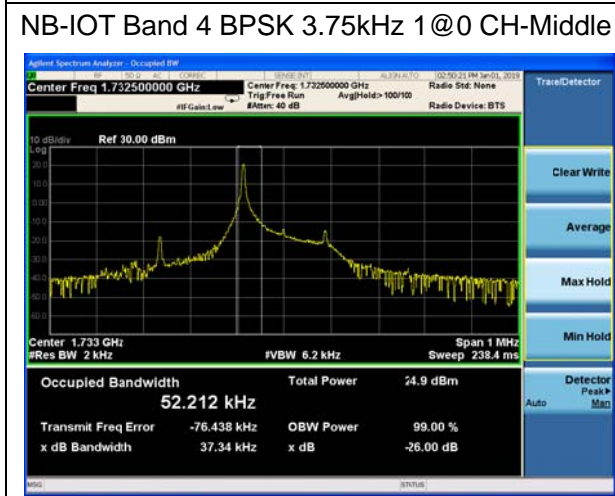
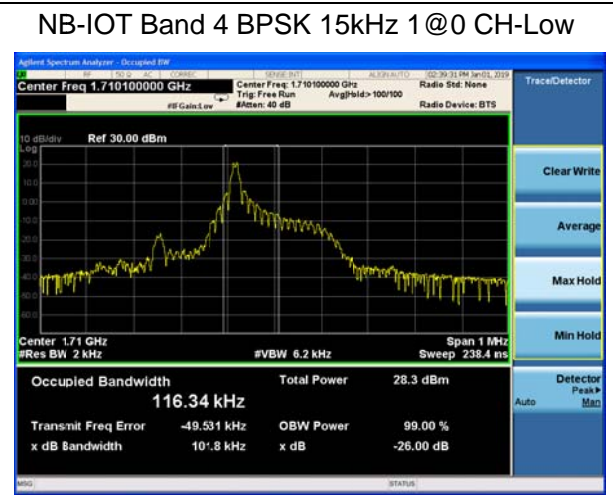
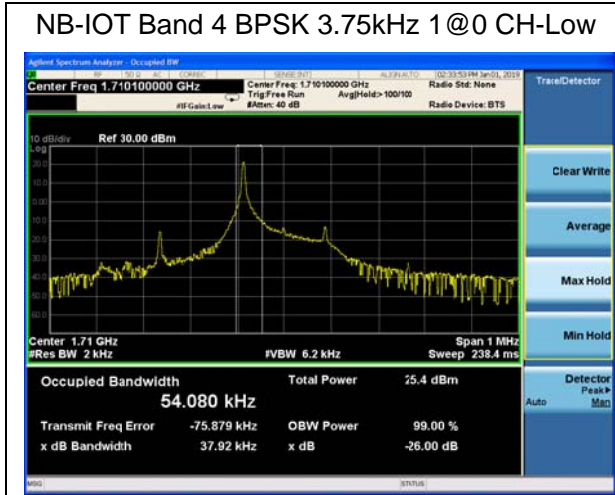

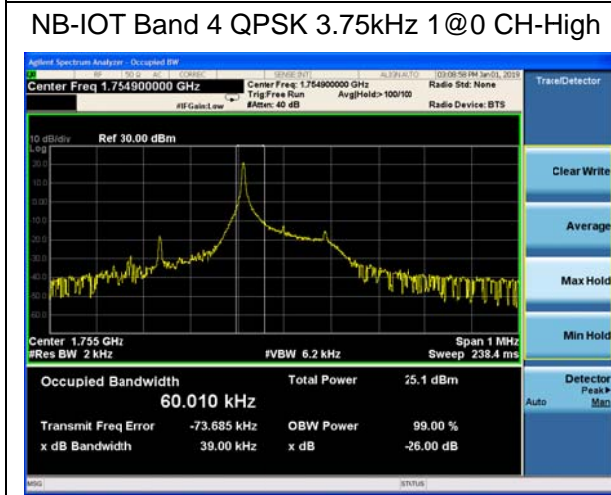
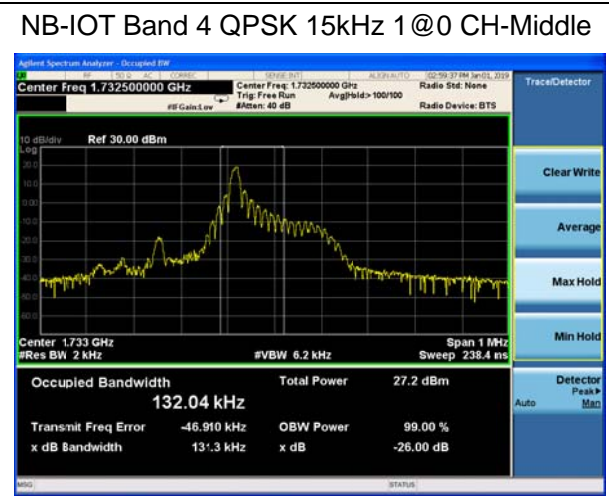
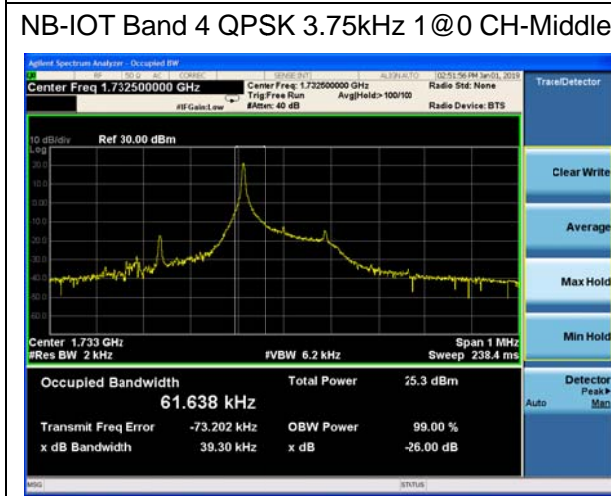
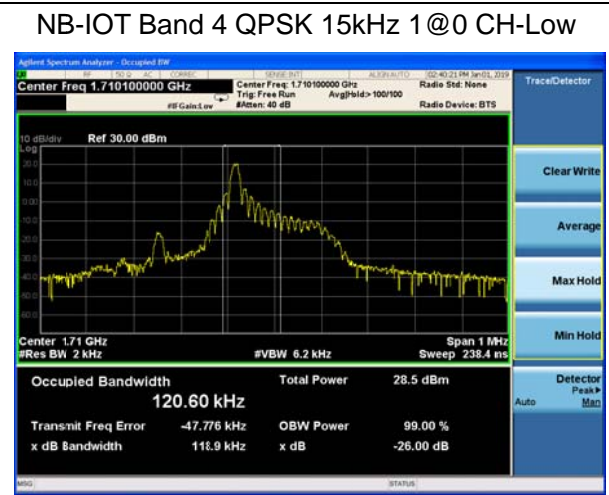
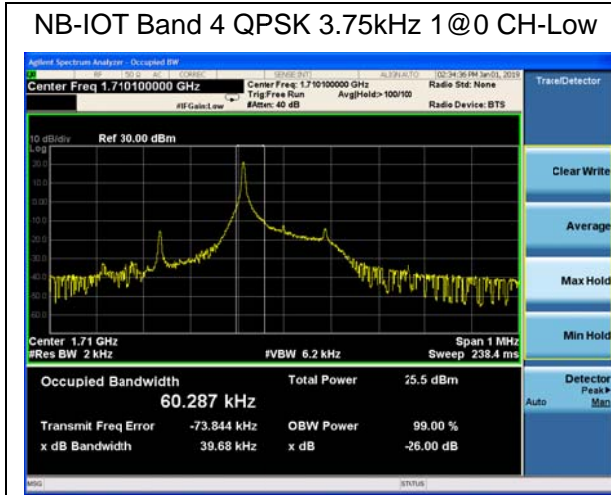

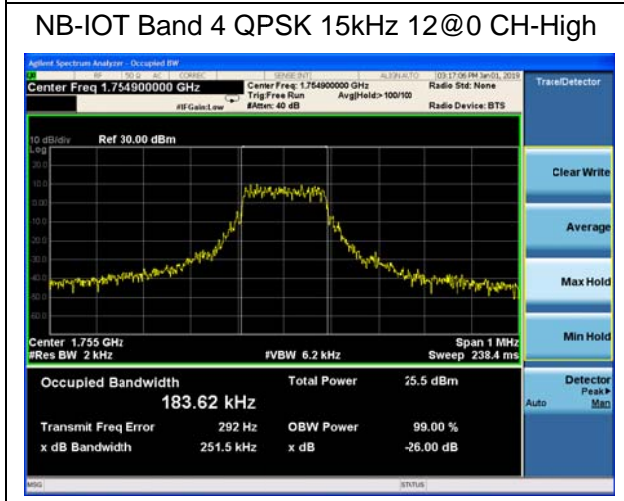
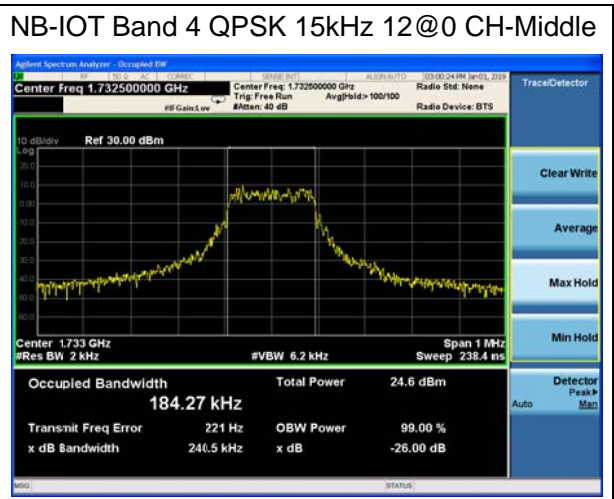
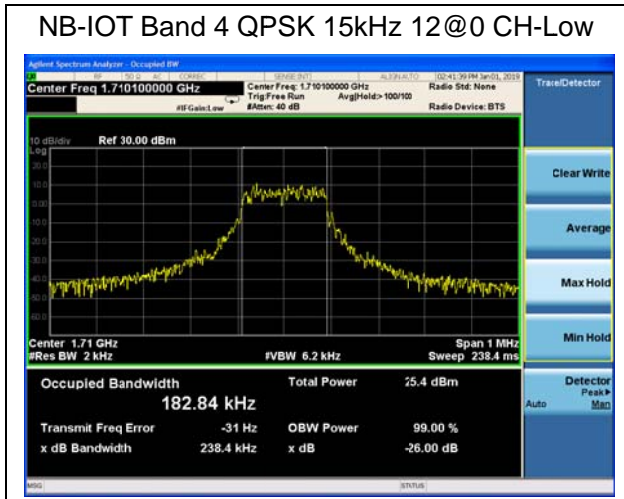

5.4 Band Edge Compliance

Ambient condition

Temperature	Relative humidity	Pressure
23°C ~25°C	45%~50%	101.5kPa

Method of Measurement

The EUT was connected to Spectrum Analyzer and Base Station Simulator via power Splitter. The band edge of the lowest and highest channels were measured.

The testing follows KDB 971168 D01 v03r01 Section 6.0

1. The EUT was connected to spectrum analyzer and system simulator via a power divider.
2. The band edges of low and high channels for the highest RF powers were measured.
3. RBW is set to 2kHz, VBW is set to 6.2kHz for NB-IOT Band 4, on spectrum analyzer.
4. Set spectrum analyzer with RMS detector.
5. The RF fundamental frequency should be excluded against the limit line in the operating frequency band.
6. Checked that all the results comply with the emission limit line.

Test Setup

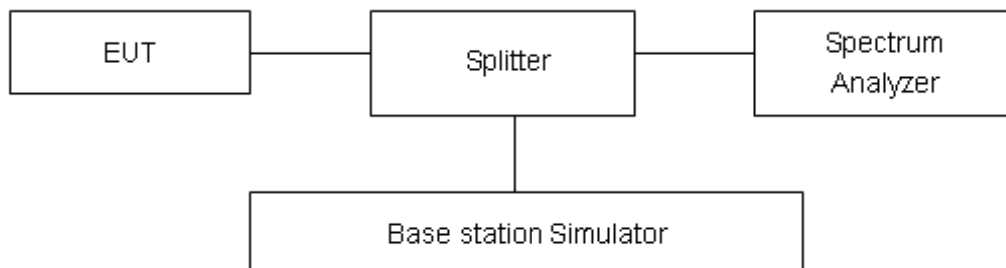

Limits

Rule Part 27.53(h) specifies that “ for operations in the 1695-1710 MHz, 1710-1755 MHz, 1755-1780 MHz, 1915-1920 MHz, 1995-2000 MHz, 2000-2020 MHz, 2110-2155 MHz, 2155-2180 MHz, and 2180-2200 bands, the power of any emission outside a licensee's frequency block shall be attenuated below the transmitter power (P) in watts by at least $43 + 10 \log_{10} (P)$ dB”

Measurement Uncertainty

The assessed measurement uncertainty to ensure 95% confidence level for the normal distribution is with the coverage factor $k = 1.96$, $U=0.684$ dB.

Test Result

All the test traces in the plots shows the test results clearly.

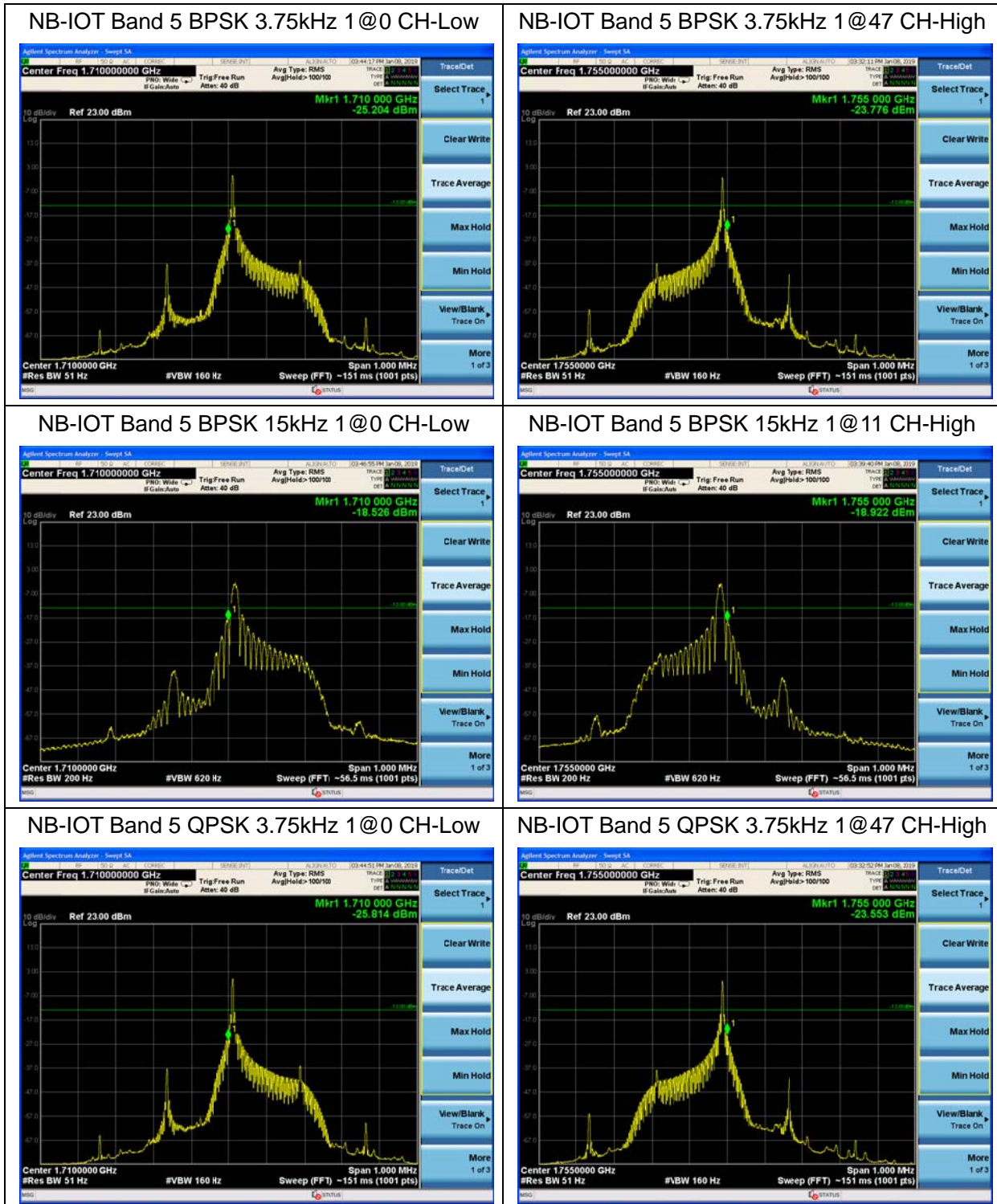

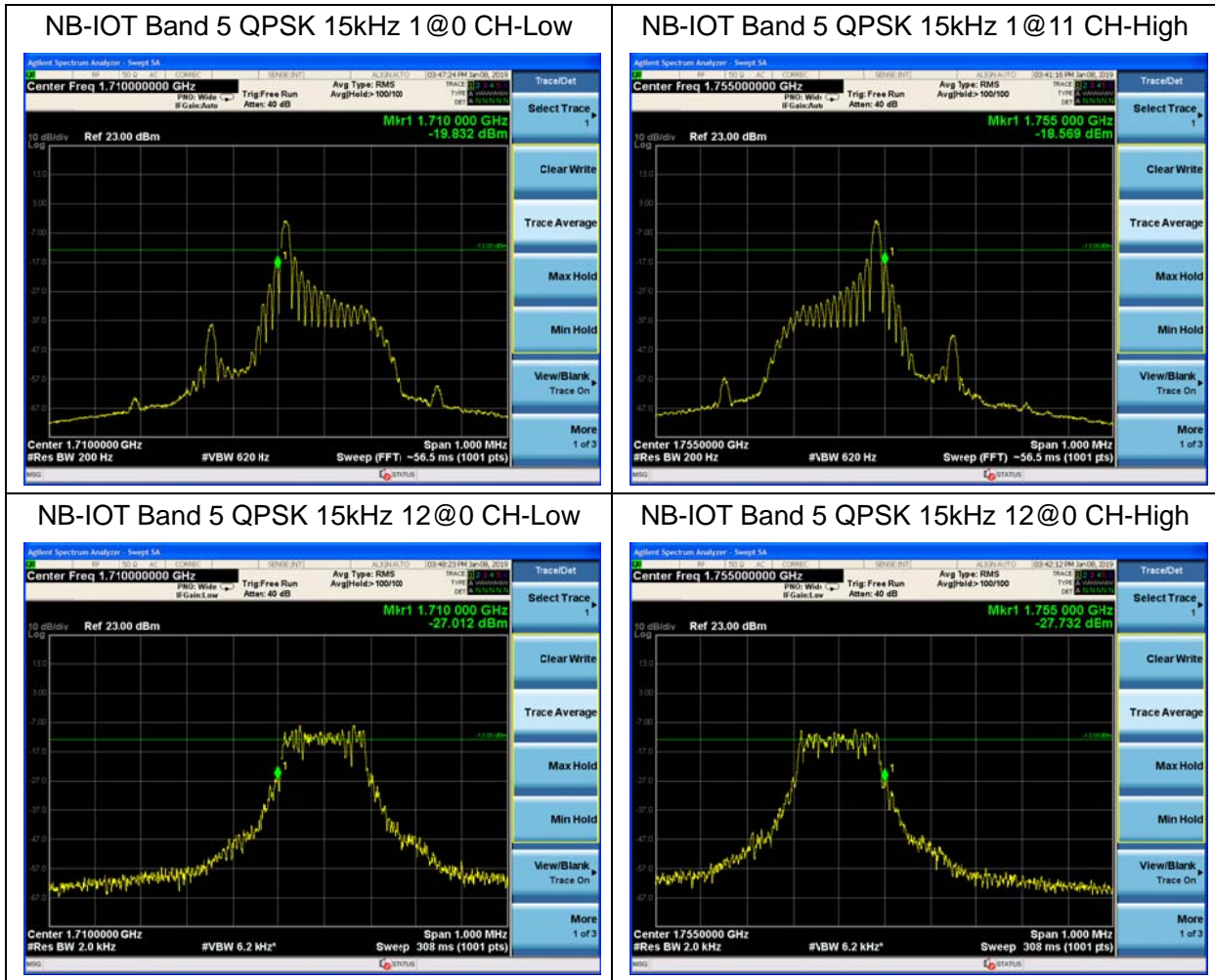

5.5 Peak-to-Average Power Ratio (PAPR)

Ambient condition

Temperature	Relative humidity	Pressure
23°C ~25°C	45%~50%	101.5kPa

Methods of Measurement

Measure the total peak power and record as PPk. And measure the total average power and record as PAvg. Both the peak and average power levels must be expressed in the same logarithmic units (e.g., dBm). Determine the PAPR from:

$$PAPR (dB) = PPk (dBm) - PAvg (dBm).$$

Test Setup

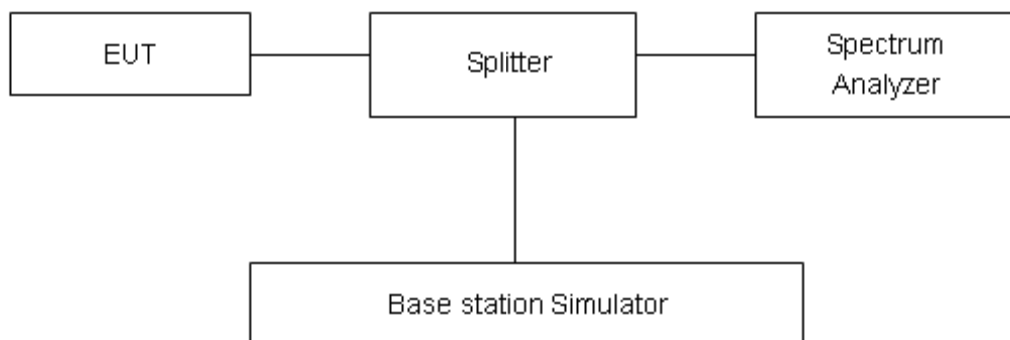

Limits

Rule Part 27.50(d)(5) Equipment employed must be authorized in accordance with the provisions of 24.51. Power measurements for transmissions by stations authorized under this section may be made either in accordance with a Commission-approved average power technique or in compliance with paragraph (d)(6) of this section. In measuring transmissions in this band using an average power technique, the peak-to-average ratio (PAR) of the transmission may not exceed 13 dB.

Measurement Uncertainty

The assessed measurement uncertainty to ensure 95% confidence level for the normal distribution is with the coverage factor $k = 2$, $U = 0.4$ dB.

Test Results

Mode	Modulation	Sub-carrier spacing (KHz)	Channel/ Frequency(MHz)	Peak-to-Average Power Ratio (PAPR)		
				Peak(dBm)	Avg(dBm)	PAPR(dB)
Band 4 Standalone	BPSK	3.75	20175/1732.5	23.50	19.63	3.87
	QPSK	3.75	20175/1732.5	23.09	19.67	3.42
	BPSK	15	20175/1732.5	23.68	17.13	6.55
	QPSK	15	20175/1732.5	23.65	17.18	6.47

5.6 Frequency Stability

Ambient condition

Temperature	Relative humidity	Pressure
23°C ~25°C	45%~50%	101.5kPa

Method of Measurement

Frequency Stability (Temperature Variation)

The temperature inside the climate chamber is varied from -30°C to +55°C in 10°C step size.

(1)With all power removed, the temperature was decreased to -10°C and permitted to stabilize for three hours.

(2)Measure the carrier frequency with the test equipment in a “call mode”. These measurements should be made within 1 minute of powering up the mobile station, to prevent significant self warming.

(3) Repeat the above measurements at 10°C increments from -30°C to +55°C. Allow at least 1.5 hours at each temperature, un-powered, before making measurements.

Frequency Stability (Voltage Variation)

The frequency stability shall be measured with variation of primary supply voltage as follows:

(1) Vary primary supply voltage from 85 to 115 percent of the nominal value for other than hand carried battery equipment.

(2) For hand carried, battery powered equipment, reduce primary supply voltage to the battery-operating end point which shall be specified by the manufacturer.

This transceiver is specified to operate with an input voltage of between 3.45 V and 4.4 V, with a nominal voltage of 3.82V.

Test setup

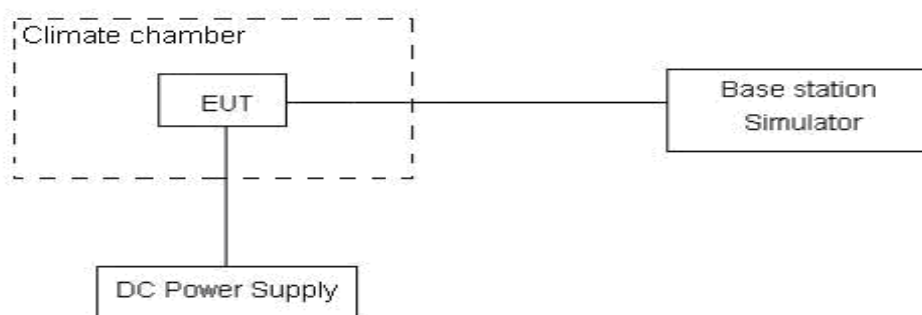

Limits

The frequency stability shall be sufficient to ensure that the fundamental emissions stay within the authorized bands of operation.

Measurement Uncertainty

The assessed measurement uncertainty to ensure 99.75% confidence level for the normal distribution is with the coverage factor $k = 3$, $U=0.01$ ppm.

Test Result

NB-IOT Band 4						
BPSK,(15KHz)						
Condition		1710	1755	Delta(Hz)	Frequency Stability(ppm)	
Temperature	Voltage	F low@-13dBm(MHz)	F high@-13dBm(MHz)			
Normal (25°C)	Normal	1710.0973	1754.0679	2.65	0.00317	
Extreme (55°C)		1710.0932	1754.0631	13.54	0.01619	
Extreme (50°C)		1710.0961	1754.0665	25.11	0.03002	
Extreme (40°C)		1710.0919	1754.0694	23.01	0.02751	
Extreme (30°C)		1710.0948	1754.0676	18.41	0.02201	
Extreme (20°C)		1710.0925	1754.0684	7.22	0.00863	
Extreme (10C)		1710.0939	1754.0659	19.64	0.02348	
Extreme (0°C)		1710.0967	1754.0662	17.43	0.02084	
Extreme (-10°C)		1710.0958	1754.0671	28.65	0.03425	
Extreme (-20°C)		1710.0939	1754.0652	30.42	0.03637	
Extreme (-30°C)		1710.0942	1754.0684	4.65	0.00556	
25°C		LV	1710.0963	1754.0637	7.95	0.00950
		HV	1710.0924	1754.0659	18.46	0.02207
QPSK,(15KHZ)						
Condition		1710	1755	Delta(Hz)	Frequency Stability(ppm)	
Temperature	Voltage	F low@-13dBm(MHz)	F high@-13dBm(MHz)			
Normal (25°C)	Normal	1710.0764	1754.0223	2.84	0.00340	
Extreme (55°C)		1710.0728	1754.0258	25.03	0.02992	
Extreme (50°C)		1710.0796	1754.0252	27.63	0.03303	
Extreme (40°C)		1710.0774	1754.0247	21.45	0.02564	
Extreme (30°C)		1710.0768	1754.0286	13.58	0.01623	
Extreme (20°C)		1710.0756	1754.0253	9.64	0.01152	
Extreme (10C)		1710.0743	1754.0241	3.78	0.00452	
Extreme (0°C)		1710.0791	1754.0268	6.95	0.00831	
Extreme (-10°C)		1710.0772	1754.0228	18.34	0.02192	
Extreme (-20°C)		1710.0758	1754.0236	2.44	0.00292	
Extreme (-30°C)		1710.0794	1754.0274	15.73	0.01880	
25°C		LV	1710.0737	1754.0254	15.39	0.01840
		HV	1710.0749	1754.0236	29.37	0.03511

5.7 Spurious Emissions at Antenna Terminals

Ambient condition

Temperature	Relative humidity	Pressure
23°C ~25°C	45%~50%	101.5kPa

Method of Measurement

The EUT was connected to Spectrum Analyzer and Base Station Simulator via power Splitter. The measurement is carried out using a spectrum analyzer. The spectrum analyzer scans from 9kHz to the 10th harmonic of the carrier. The peak detector is used.

RBW is set to 100kHz, VBW is set to 300kHz for 30MHz~1GHz

RBW is set to 1MHz, VBW is set to 3MHz for above 1GHz, Sweep is set to ATUO.

Of those disturbances below (limit – 20 dB), the mark is not required for the EUT.

The modulation mode and RB allocation refer to section 5.1, using the maximum output power configuration.

Test setup

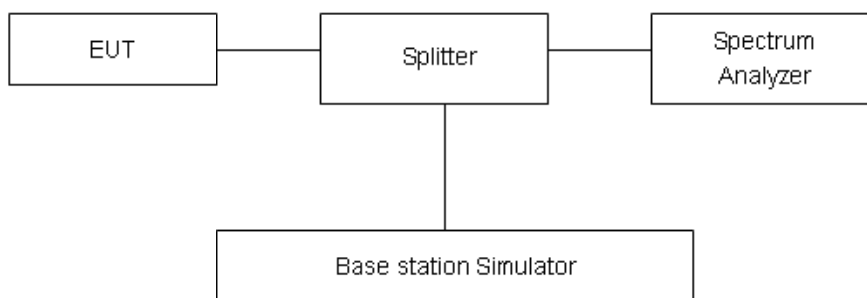

Limits

Rule Part 27.53(h) specifies that “for operations in the 1695-1710 MHz, 1710-1755 MHz, 1755-1780 MHz, 1915-1920 MHz, 1995-2000 MHz, 2000-2020 MHz, 2110-2155 MHz, 2155-2180 MHz, and 2180-2200 bands, the power of any emission outside a licensee's frequency block shall be attenuated below the transmitter power (P) in watts by at least 43 + 10 log₁₀ (P) dB..”

Part 27.53 (h) Limit	-13 dBm
----------------------	---------

Measurement Uncertainty

The assessed measurement uncertainty to ensure 99.75% confidence level for the normal distribution is with the coverage factor $k = 1.96$.

Frequency	Uncertainty
-----------	-------------



9kHz-1GHz	0.684 dB
1GHz-27GHz	1.407 dB

Test Result

Sweep the whole frequency band through the range from 9kHz to the 10th harmonic of the carrier, the emissions more than 20 dB below the limit are not reported.

For Spurious Emissions at Antenna Terminals test, the worst mode (15KHz+QPSK) should be reflected in the report.

The signal beyond the limit is carrier.

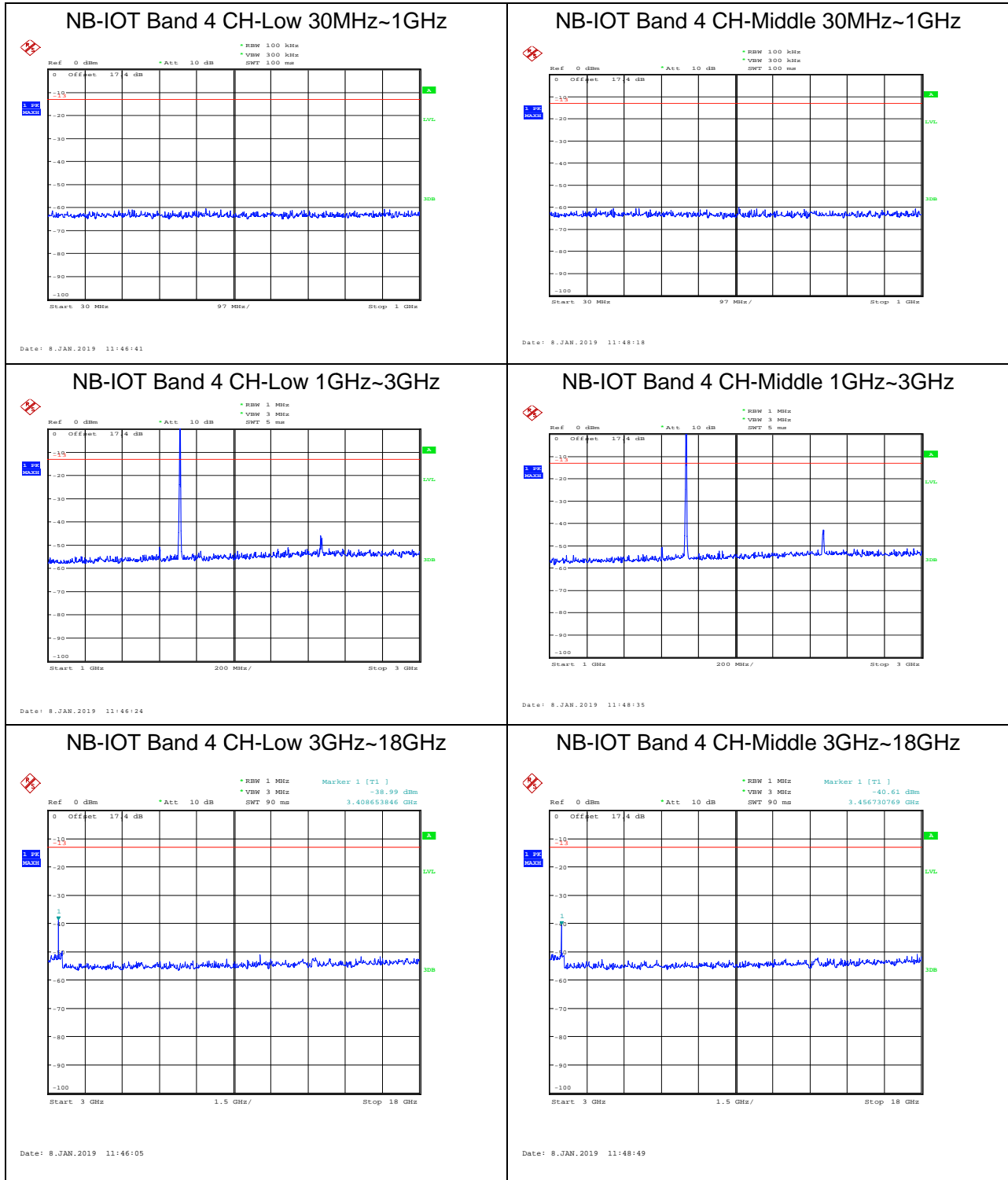

NB-IOT Band 4 CH-High 30MHz~1GHz

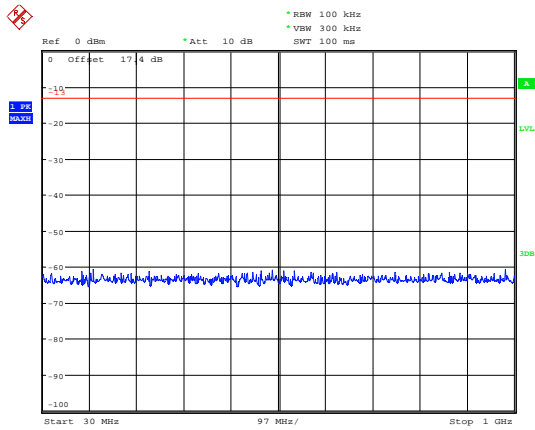

Date: 8.JAN.2019 11:54:14

NB-IOT Band 4 CH-High 1GHz~3GHz

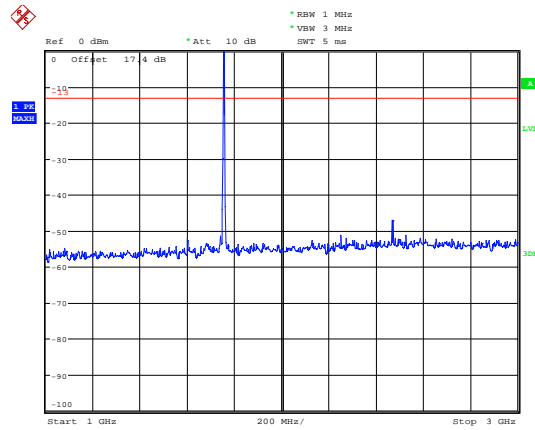

Date: 8.JAN.2019 11:53:16

NB-IOT Band 4 CH-High 3GHz~18GHz

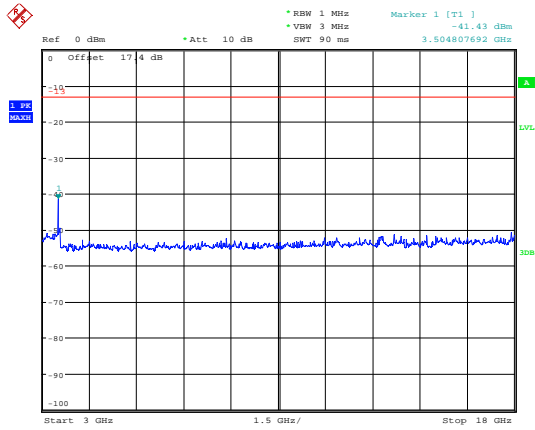

Date: 8.JAN.2019 11:53:01

5.8 Radiates Spurious Emission

Ambient condition

Temperature	Relative humidity	Pressure
23°C ~25°C	45%~50%	101.5kPa

Method of Measurement

- The testing follows FCC KDB 971168 D01 v03r01 Section 5.8 and ANSI C63.26 (2015).
- Below 1GHz: The EUT is placed on a turntable 0.8 meters above the ground in the chamber, 3 meter away from the antenna. The maximal emission value is acquired by adjusting the antenna height, polarisation and turntable azimuth. Normally, the height range of antenna is 1 m to 4 m, the azimuth range of turntable is 0° to 360°, and the receive antenna has two polarizations Vertical (V) and Horizontal (H). Above 1GHz: (Note: the FCC's permission to use 1.5m as an alternative per TCBC Conf call of Dec. 2, 2014.) The EUT is placed on a turntable 1.5 meters above the ground in the chamber, 3 meter away from the antenna. The maximal emission value is acquired by adjusting the antenna height, polarisation and turntable azimuth. Normally, the height range of antenna is 1 m to 4 m, the azimuth range of turntable is 0° to 360°, and the receive antenna has two polarizations Vertical (V) and Horizontal (H).
- A loop antenna, A log-periodic antenna or horn antenna shall be substituted in place of the EUT. The log-periodic antenna will be driven by a signal generator and the level will be adjusted till the same power value on the spectrum analyzer or receiver. The level of the spurious emissions can be calculated through the level of the signal generator, cable loss, the gain of the substitution antenna and the reading of the spectrum analyzer or receiver.
- The EUT is then put into continuously transmitting mode at its maximum power level during the test. Set Test Receiver or Spectrum RBW=200Hz,VBW=600Hz for 9kHz150kHz , RBW=10kHz, VBW=30kHz 150kHz-30MHz ,RBW=100kHz,VBW=300kHz for 30MHz to 1GHz and RBW=1MHz, VBW=3MHz for above 1GHz And the maximum value of the receiver should be recorded as (Pr).
- The EUT shall be replaced by a substitution antenna. In the chamber, an substitution antenna for the frequency band of interest is placed at the reference point of the chamber. An RF Signal source for the frequency band of interest is connected to the substitution antenna with a cable that has been constructed to not interfere with the radiation pattern of the antenna. A power (PMea) is applied to the input of the substitution antenna, and adjust the level of the signal generator output until the value of the receiver reach the previously recorded (Pr). The power of signal source (PMea) is recorded. The test should be performed by rotating the test item and adjusting the receiving antenna polarization.
- A amplifier should be connected to the Signal Source output port. And the cable should be connect between the Amplifier and the Substitution Antenna. The cable loss (Pcl) ,the Substitution Antenna Gain (Ga) and the Amplifier Gain (PAg) should be recorded after test.
- The measurement results are obtained as described below:
 $Power(EIRP)=PMea- PAg - Pcl + Ga$
 The measurement results are amend as described below:
 $Power(EIRP)=PMea- Pcl + Ga$
- This value is EIRP since the measurement is calibrated using an antenna of known gain (2.15 dBi)

and known input power. ERP can be calculated from EIRP by subtracting the gain of the dipole, $ERP = EIRP - 2.15\text{dBi}$.

The modulation mode and RB allocation refer to section 5.1, using the maximum output power configuration.

Test setup

9KHz ~ 30MHz

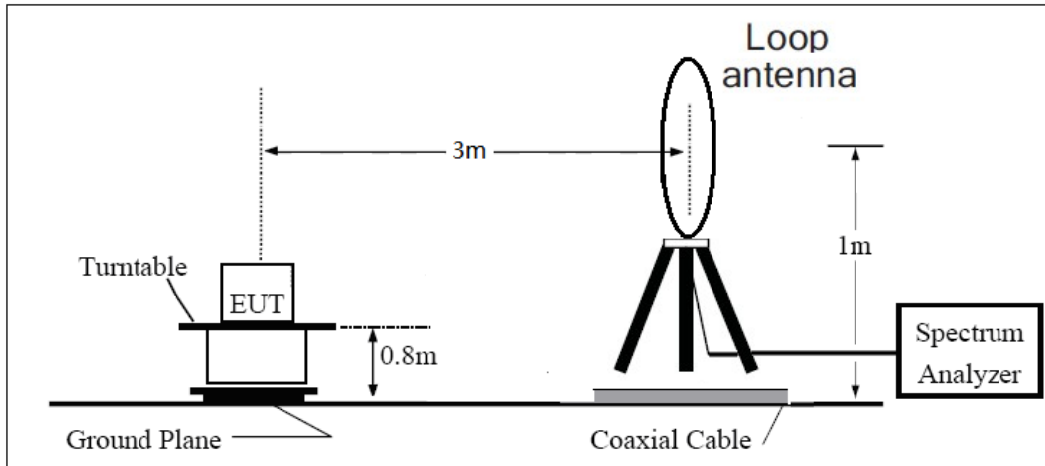

30MHz ~ 1GHz

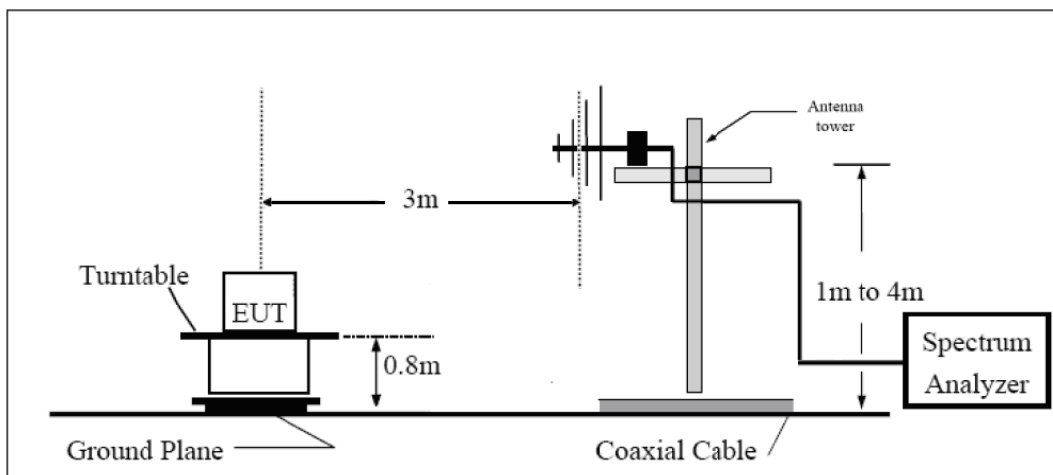

Above 1GHz

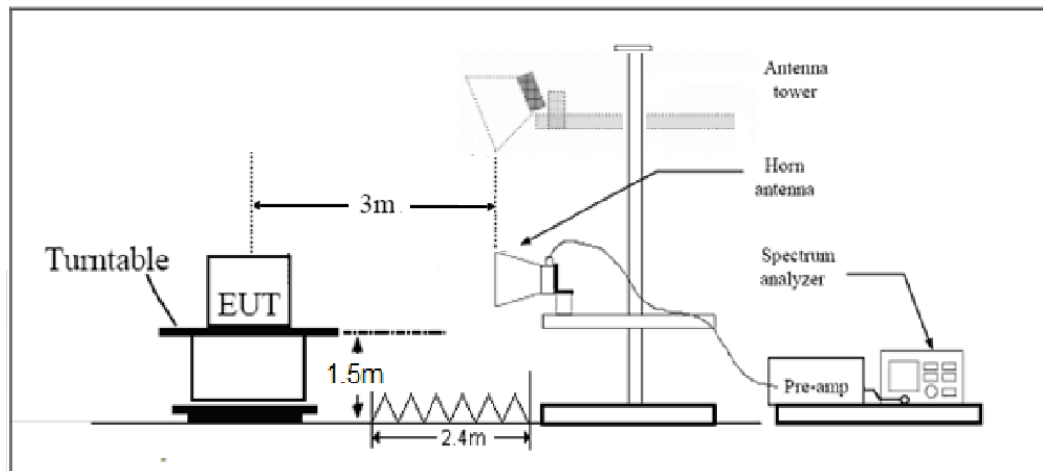

Note: Area side:2.4mX3.6m

Limits

Rule Part 27.53(h) specifies that “for operations in the 1695-1710 MHz, 1710-1755 MHz, 1755-1780 MHz, 1915-1920 MHz, 1995-2000 MHz, 2000-2020 MHz, 2110-2155 MHz, 2155-2180 MHz, and 2180-2200 bands, the power of any emission outside a licensee's frequency block shall be attenuated below the transmitter power (P) in watts by at least $43 + 10 \log_{10} (P)$ dB.”

Part 27.53 (h) Limit	-13 dBm
----------------------	---------

Measurement Uncertainty

The assessed measurement uncertainty to ensure 95% confidence level for the normal distribution is with the coverage factor $k = \pm 1.96$, $U = \pm 3.55$ dB.

Test Result

Sweep the whole frequency band through the range from 9kHz to the 10th harmonic of the carrier, the emissions below the noise floor will not be recorded in the report.

For radiated spurious emissions test, the worst mode (15KHz+QPSK) should be reflected in the report.

NB-IOT Band 4 15KHz+QPSK CH-Middle

Harmonic	Frequency (MHz)	SG (dBm)	Cable Loss (dB)	Gain (dBi)	Antenna Polarization	EIRP Level (dBm)	Limit (dBm)	Margin (dB)	Azimuth (deg)
2	3465.0	-61.92	2.6	10.75	Vertical	-53.77	-13.00	40.77	225
3	5197.5	-61.29	2.4	11.05	Vertical	-52.64	-13.00	39.64	90
4	6930.0	-56.49	4.5	11.15	Vertical	-49.84	-13.00	36.84	45
5	8662.5	-54.99	5.1	11.35	Vertical	-48.74	-13.00	35.74	180
6	10395.0	-53.05	5.3	11.95	Vertical	-46.40	-13.00	33.40	225
7	12127.5	-52.15	5.5	13.55	Vertical	-44.10	-13.00	31.10	0
8	13860.0	-51.92	6.3	13.75	Vertical	-44.47	-13.00	31.47	180
9	15592.5	-50.82	6.7	13.85	Vertical	-43.67	-13.00	30.67	225
10	17325.0	-50.20	6.8	14.25	Vertical	-42.75	-13.00	29.75	180

Note: 1. The other Spurious RF Radiated emissions level is no more than noise floor.

2. The worst emission was found in the antenna is Vertical position.

6 Main Test Instruments

Name	Manufacturer	Type	Serial Number	Calibration Date	Expiration Date
Base Station Simulator	R&S	CMW500	113824	2018-05-20	2019-05-19
Power Splitter	Hua Xiang	SHX-GF2-2-13	10120101	/	/
Spectrum Analyzer	Key sight	N9010A	MY50210259	2018-05-20	2019-05-19
Signal Analyzer	R&S	FSV30	100815	2018-12-16	2019-12-15
EMI Test Receiver	R&S	ESCI	100948	2018-05-20	2019-05-19
Loop Antenna	SCHWARZBECK	FMZB1519	1519-047	2017-09-26	2019-09-25
Trilog Antenna	SCHWARZBECK	VUBL 9163	9163-201	2017-11-18	2019-11-17
Horn Antenna	R&S	HF907	100126	2018-07-07	2020-07-06
Signal generator	R&S	SMB 100A	102594	2018-05-20	2019-05-19
Climatic Chamber	ESPEC	SU-242	93000506	2017-12-17	2020-12-16
Preamplifier	R&S	SCU18	102327	2018-05-20	2019-05-19
MOB COMMS DC SUPPLY	Keysight	66319D	MY43004105	2018-05-21	2019-05-20
RF Cable	Agilent	SMA 15cm	0001	/	/
Software	R&S	EMC32	9.26.0	/	/

*****END OF REPORT *****