



中国认可
国际互认
检测
TESTING
CNAS L0310



FCC RF Test Report

Product Name: Smart Phone

Model Number: DRA-LX3

Report No.: SYBH(Z-RF)20180207022001-2001

FCC ID: QISDRA-LX3

Reliability Laboratory of Huawei Technologies Co., Ltd.

(Global Compliance and Testing Center of Huawei Technologies Co., Ltd)

Administration Building, Headquarters of Huawei Technologies Co., Ltd., Bantian, Longgang District,
Shenzhen, 518129, P.R.C

Tel: +86 755 28780808 Fax: +86 755 89652518



Notice

1. The laboratory has passed the accreditation by China National Accreditation Service for Conformity Assessment (CNAS). The accreditation number is L0310.
2. The laboratory has passed the accreditation by The American Association for Laboratory Accreditation (A2LA). The accreditation number is 2174.01
3. The laboratory has been recognized by the US Federal Communications Commission (FCC) to perform compliance testing subject to the Commission's Certification rules. The Designation Number is CN1173, and the Test Firm Registration Number is 294140.
4. The laboratory has been listed by Industry Canada to perform electromagnetic emission measurements. The recognition numbers of test site are 6369A-1.
5. The laboratory (Reliability Lab of Huawei Technologies Co., Ltd) is also named "Global Compliance and Testing Center of Huawei Technologies Co., Ltd", the both names have coexisted since 2009.
6. The test report is invalid if not marked with the signatures of the persons responsible for preparing and approving the test report.
7. The test report is invalid if there is any evidence of erasure and/or falsification.
8. The test report is only valid for the test samples.
9. Content of the test report, in part or in full, cannot be used for publicity and/or promotional purposes without prior written approval from the laboratory.



Applicant: Huawei Technologies Co., Ltd.
Address: Administration Building, Headquarters of Huawei Technologies Co., Ltd.,
Bantian, Longgang District, Shenzhen, 518129, P.R.C

Date of Receipt Sample: 2018-02-28
Start Date of Test: 2018-02-28
End Date of Test: 2018-04-04

Test Result: Pass

| | | | |
|-------------------------------------|------------|-------------|--------------------|
| Approved by Senior Engineer: | 2018-04-04 | Roger zhang | <i>Roger Zhang</i> |
| | Date | Name | Signature |

| | | | |
|---------------------|------------|---------|---------------|
| Prepared by: | 2018-04-04 | Pan Man | <i>Panman</i> |
| | Date | Name | Signature |



CONTENT

1 General Information.....5

1.1 Applied Standard.....5

1.2 Test Location5

1.3 Test Environment Condition.....5

2 Test Summary6

2.1 Cellular Band (824-849 MHz paired with 869-894 MHz)6

2.2 PCS Band (1850-1910 MHz paired with 1930-1990 MHz).....7

2.3 AWS Band (1710-1755 MHz paired with 2110-2155 MHz)8

2.4 BRS&EBS Band (2500-2570 MHz paired with 2620-2690 MHz)9

3 Description of the Equipment under Test (EUT)10

3.1 General Description10

3.2 EUT Identity10

3.3 Technical Specification11

4 General Test Conditions / Configurations.....13

4.1 Test Modes13

4.2 Test Environment.....13

4.3 Test Frequency14

4.4 DESCRIPTION OF TESTS20

4.5 Test Setups.....26

4.6 Test Conditions29

5 Main Test Instruments31

6 Measurement Uncertainty.....33

7 Appendixes.....33



2 Test Summary

2.1 Cellular Band (824-849 MHz paired with 869-894 MHz)

| Test Item | FCC Rule No. | Requirements | Test Result | Verdict (Note1) |
|--|------------------|--|-------------|-----------------|
| Effective (Isotropic) Radiated Power Output Data | §2.1046, §22.913 | FCC: ERP \leq 7 W. | Appendix A | Pass |
| Peak-Average Ratio | --- | Limit \leq 13 dB | Appendix B | Pass |
| Modulation Characteristics | §2.1047 | Digital modulation | Appendix C | Pass |
| Bandwidth | §2.1049 | OBW: No limit. EBW: No limit. | Appendix D | Pass |
| Band Edges Compliance | §2.1051, §22.917 | \leq -13 dBm/1%*EBW, in 1 MHz bands immediately outside and adjacent to the frequency block. | Appendix E | Pass |
| Spurious Emission at Antenna Terminals | §2.1051, §22.917 | FCC: \leq -13 dBm/100 kHz, from 9 kHz to 10 th harmonics but outside authorized operating frequency ranges. | Appendix F | Pass |
| Field Strength of Spurious Radiation | §2.1053, §22.917 | FCC: \leq -13 dBm/100 kHz. | Appendix G | Pass |
| Frequency Stability | §2.1055, §22.355 | \leq \pm 2.5ppm. | Appendix H | Pass |

NOTE: For the verdict, the "N/A" denotes "not applicable", the "N/T" denotes "not tested".

**2.2 PCS Band (1850-1910 MHz paired with 1930-1990 MHz)**

| Test Item | FCC Rule No. | Requirements | Test Result | Verdict (Note1) |
|--|------------------|--|-------------|-----------------|
| Effective (Isotropic) Radiated Power Output Data | §2.1046, §24.232 | $EIRP \leq 2\text{ W}$ | Appendix A | Pass |
| Peak-Average Ratio | §2.1046, §24.232 | Limit \leq 13 dB | Appendix B | Pass |
| Modulation Characteristics | §2.1047 | Digital modulation | Appendix C | Pass |
| Bandwidth | §2.1049 | OBW: No limit. EBW: No limit. | Appendix D | Pass |
| Band Edges Compliance | §2.1051, §24.238 | $\leq -13\text{ dBm}/1\%*EBW$, in 1 MHz bands immediately outside and adjacent to the frequency block. | Appendix E | Pass |
| Spurious Emission at Antenna Terminals | §2.1051, §24.238 | $\leq -13\text{ dBm}/1\text{ MHz}$, from 9 kHz to 10 th harmonics but outside authorized operating frequency ranges. | Appendix F | Pass |
| Field Strength of Spurious Radiation | §2.1053, §24.238 | $\leq -13\text{ dBm}/1\text{ MHz}$. | Appendix G | Pass |
| Frequency Stability | §2.1055, §24.235 | $\leq \pm 2.5\text{ ppm}$. | Appendix H | Pass |
| NOTE: For the verdict, the "N/A" denotes "not applicable", the "N/T" denotes "not tested". | | | | |

**2.3 AWS Band (1710-1755 MHz paired with 2110-2155 MHz)**

| Test Item | FCC Rule No. | Requirements | Test Result | Verdict (Note1) |
|--|--------------------|--|-------------|-----------------|
| Effective (Isotropic) Radiated Power Output Data | §2.1046, §27.50(d) | $EIRP \leq 1\text{ W}$ | Appendix A | Pass |
| Peak-Average Ratio | §2.1046, §27.50(d) | Limits $\leq 13\text{ dB}$ | Appendix B | Pass |
| Modulation Characteristics | §2.1047 | Digital modulation | Appendix C | Pass |
| Bandwidth | §2.1049 | OBW: No limit. EBW: No limit. | Appendix D | Pass |
| Band Edges Compliance | §2.1051, §27.53(h) | $\leq -13\text{ dBm}/1\%*EBW$, in 1 MHz bands immediately outside and adjacent to the frequency block. | Appendix E | Pass |
| Spurious Emission at Antenna Terminals | §2.1051, §27.53(h) | $\leq -13\text{ dBm}/1\text{ MHz}$, from 9 kHz to 10 th harmonics but outside authorized operating frequency ranges. | Appendix F | Pass |
| Field Strength of Spurious Radiation | §2.1053, §27.53(h) | $\leq -13\text{ dBm}/1\text{ MHz}$. | Appendix G | Pass |
| Frequency Stability | §2.1055, §27.54 | $\leq \pm 2.5\text{ ppm}$. | Appendix H | Pass |
| NOTE: For the verdict, the "N/A" denotes "not applicable", the "N/T" denotes "not tested". | | | | |

2.4 BRS&EBS Band (2500-2570 MHz paired with 2620-2690 MHz)

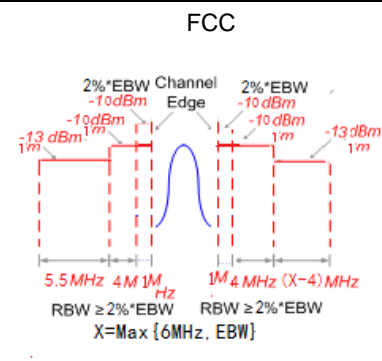
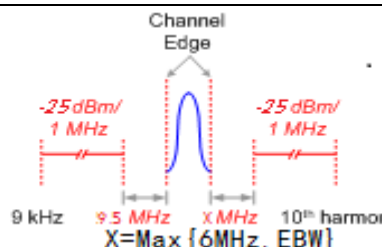
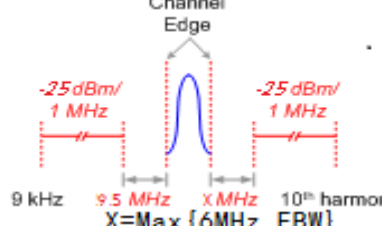
| Test Item | FCC Rule No. | Requirements | Test Result | Verdict (Note1) |
|--|---------------------|--|-------------|-----------------|
| Effective (Isotropic) Radiated Power Output Data | §2.1046, §27.50(h) | $EIRP \leq 2W$ | Appendix A | Pass |
| Peak-Average Ratio | §27.50(a) | Limit ≤ 13 dB | Appendix B | Pass |
| Modulation Characteristics | §2.1047 | Digital modulation | Appendix C | Pass |
| Bandwidth | §2.1049 | OBW: No limit. EBW: No limit. | Appendix D | Pass |
| Band Edges Compliance | §2.1051, §27.53(m4) | <p style="text-align: center;">FCC</p>  <p style="text-align: center;"> $2\% \cdot EBW$ Channel Edge $2\% \cdot EBW$ $-10dBm$ $-10dBm$ $-13dBm$ $-13dBm$ $5.5MHz$ $4MHz$ $1MHz$ $1MHz$ $1MHz$ $1MHz$ $RBW \geq 2\% \cdot EBW$ $RBW \geq 2\% \cdot EBW$ $X = \text{Max} \{6MHz, EBW\}$ </p> | Appendix E | Pass |
| Spurious Emission at Antenna Terminals | §2.1051, §27.53(m) |  <p style="text-align: center;"> Channel Edge $-25dBm/1MHz$ $-25dBm/1MHz$ $9kHz$ $5MHz$ $XMHz$ 10^{th} harmonics $X = \text{Max} \{6MHz, EBW\}$ </p> | Appendix F | Pass |
| Field Strength of Spurious Radiation | §2.1053, §27.53(m) |  <p style="text-align: center;"> Channel Edge $-25dBm/1MHz$ $-25dBm/1MHz$ $9kHz$ $5MHz$ $XMHz$ 10^{th} harmonics $X = \text{Max} \{6MHz, EBW\}$ </p> | Appendix G | Pass |
| Frequency Stability | §2.1055, §27.54 | Within authorized bands of operation/frequency block. | Appendix H | Pass |

NOTE 1: For the verdict, the "N/A" denotes "not applicable", the "N/T" denotes "not tested".



3 Description of the Equipment under Test (EUT)

3.1 General Description

DRA-LX3 is subscriber equipment in the GSM/UMTS/LTE system, including single SIM and double SIM two different versions of card. The GSM frequency band includes GSM850 and GSM900 and DCS1800 and PCS1900. The UMTS frequency band is band 1/2/4/5/8. The LTE frequency band is band 2/4/5/7/8/28. The Mobile Phone implements such functions as RF signal receiving/transmitting, LTE/UMTS and GSM/GPRS/EDGE protocol processing, voice, video MMS service, GPS and WIFI etc. Externally it provides micro SD card interface, earphone port (to provide voice service) . It also provides bluetooth module to synchronize data between a PC and the phone, or to use the built-in modem of the phone to access the Internet with a PC, or to exchange data with other bluetooth devices.

Note: Only GSM850/1900&WCDMA850/1700/1900<E B2/B4/B5/7 test data included in this report.



3.2 EUT Identity

NOTE: Unless otherwise noted in the report, the functional boards installed in the units shall be selected from the below list, but not means all the functional boards listed below shall be installed in one unit.

3.2.1 Board

| Board | | |
|-------------|------------------|------------------------|
| Description | Hardware Version | Software Version |
| Main Board | HL1DURAM | DRA-LX3 1.0.0.51(C900) |

3.2.2 Sub-Assembly

| Sub-Assembly | | | |
|--------------------|--------------|-------------------------------|--|
| Sub-Assembly Name | Model | Manufacturer | Description |
| Adapter | HW-050100U01 | Huawei Technologies Co., Ltd. | Input Voltage: 100-240V ~50/60Hz 0.2A Output Voltage: 5V  1A |
| Li-Polymer Battery | HB405979ECW | Huawei Technologies Co., Ltd. | Rated capacity: 2920mAh Nominal Voltage:3.82 V Charging Voltage:  +4.4V |



3.3 Technical Specification

| Characteristics | Description | |
|---|---|---|
| Radio System Type | <input checked="" type="checkbox"/> GSM <input checked="" type="checkbox"/> UMTS <input checked="" type="checkbox"/> LTE | |
| Supported Frequency Range | GSM850/ WCDMA850 | Transmission (TX): 824 to 849 MHz |
| | | Receiving (RX): 869 to 894 MHz |
| | GSM1900/ WCDMA1900 | Transmission (TX): 1850 to 1910 MHz |
| | | Receiving (RX): 1930 to 1990 MHz |
| | WCDMA1700 | Transmission (TX): 1710 to 1755 MHz |
| | | Receiving (RX): 2110 to 2155 MHz |
| | LTE BAND2 | Transmission (TX): 1850 to 1910 MHz |
| | | Receiving (RX): 1930 to 1990 MHz |
| LTE BAND4 | Transmission (TX): 1710 to 1755 MHz | |
| | Receiving (RX): 2110 to 2155 MHz | |
| LTE BAND5 | Transmission (TX): 824 to 849 MHz | |
| | Receiving (RX): 869 to 894 MHz | |
| LTE BAND7 | Transmission (TX): 2500 to 2570 MHz | |
| | Receiving (RX): 2620 to 2690 MHz | |
| TX and RX Antenna Ports | TX & RX port: | 1 |
| | TX-only port: | 0 |
| | RX-only port: | 1 |
| Target TX Output Power | GSM850: 33dBm GSM1900 30dBm UMTS850 24dBm UMTS1700: 23.5dBm UMTS1900: 23.5dBm LTE Band 2: 23dBm LTE Band 4: 23dBm LTE Band 5: 23.5dBm LTE Band 7: 23dBm | |
| Supported Channel Bandwidth | GSM system: | <input checked="" type="checkbox"/> 200 kHz |
| | UMTS system: | <input checked="" type="checkbox"/> 5 MHz |
| | LTE band 2 | <input checked="" type="checkbox"/> 1.4MHz, <input checked="" type="checkbox"/> 3MHz <input checked="" type="checkbox"/> 5MHz, <input checked="" type="checkbox"/> 10MHz , <input checked="" type="checkbox"/> 15MHz , <input checked="" type="checkbox"/> 20MHz |
| | LTE band 4 | <input checked="" type="checkbox"/> 1.4MHz, <input checked="" type="checkbox"/> 3MHz <input checked="" type="checkbox"/> 5MHz, <input checked="" type="checkbox"/> 10MHz , <input checked="" type="checkbox"/> 15MHz , <input checked="" type="checkbox"/> 20MHz |
| | LTE band 5 | <input checked="" type="checkbox"/> 1.4MHz, <input checked="" type="checkbox"/> 3MHz <input checked="" type="checkbox"/> 5MHz, <input checked="" type="checkbox"/> 10MHz , |
| | LTE band 7 | <input checked="" type="checkbox"/> 5MHz, <input checked="" type="checkbox"/> 10MHz , <input checked="" type="checkbox"/> 15MHz , <input checked="" type="checkbox"/> 20MHz |
| Designation of Emissions (Note: the necessary bandwidth of | GSM850: | 248KGXW, 252KG7W |
| | GSM1900: | 245KGXW, 247KG7W |



| Characteristics | Description | |
|---|--|--|
| which is the worst value from the measured occupied bandwidths for each type of channel bandwidth configuration.) | UMTS850: | 4M17F9W |
| | UMTS1900: | 4M18F9W |
| | UMTS1700: | 4M17F9W |
| | LTE BAND2: | 1M09G7D (1.4 MHz QPSK modulation), 1M10W7D (1.4 MHz 16QAM modulation) 2M70G7D (3 MHz QPSK modulation), 2M69W7D (3 MHz 16QAM modulation) 4M53G7D (5 MHz QPSK modulation), 4M53W7D (5 MHz 16QAM modulation) 9M02G7D (10 MHz QPSK modulation), 9M03W7D (10 MHz 16QAM modulation) 13M6G7D (15 MHz QPSK modulation), 13M5W7D (15 MHz 16QAM modulation) 18M0G7D (20 MHz QPSK modulation), 18M0W7D (20 MHz 16QAM modulation) |
| | LTE BAND4: | 1M09G7D (1.4 MHz QPSK modulation), 1M10W7D (1.4 MHz 16QAM modulation) 2M70G7D (3 MHz QPSK modulation), 2M70W7D (3 MHz 16QAM modulation) 4M53G7D (5 MHz QPSK modulation), 4M52W7D (5 MHz 16QAM modulation) 9M01G7D (10 MHz QPSK modulation), 9M01W7D (10 MHz 16QAM modulation) 13M5G7D (15 MHz QPSK modulation), 13M5W7D (15 MHz 16QAM modulation) 18M0G7D (20 MHz QPSK modulation), 18M0W7D (20 MHz 16QAM modulation) |
| LTE BAND5: | 1M09G7D (1.4 MHz QPSK modulation), 1M10W7D (1.4 MHz 16QAM modulation) 2M70G7D (3 MHz QPSK modulation), 2M70W7D (3 MHz 16QAM modulation) 4M54G7D (5 MHz QPSK modulation), 4M53W7D (5 MHz 16QAM modulation) 9M02G7D (10 MHz QPSK modulation), 9M037D (10 MHz 16QAM modulation) | |
| LTE BAND7: | 4M53G7D (5 MHz QPSK modulation), 4M52W7D (5 MHz 16QAM modulation) 9M02G7D (10 MHz QPSK modulation), 9M02W7D (10 MHz 16QAM modulation) 13M5G7D (15 MHz QPSK modulation), 13M5W7D (15 MHz 16QAM modulation) 18M0G7D (20 MHz QPSK modulation), 18M0W7D (20 MHz 16QAM modulation) | |



4 General Test Conditions / Configurations

4.1 Test Modes

NOTE: The test mode(s) are selected according to relevant radio technology specifications.

| Test Mode | Test Modes Description |
|-----------|---------------------------------------|
| GSM/TM1 | GSM system, GSM/GPRS, GMSK modulation |
| GSM/TM2 | GSM system, EDGE, 8PSK modulation |
| UMTS/TM1 | WCDMA system, QPSK modulation |
| LTE/TM1 | LTE system, QPSK modulation |
| LTE/TM2 | LTE system, 16QAM modulation |

4.2 Test Environment

| Environment Parameter | Selected Values During Tests | |
|-----------------------|------------------------------|---------|
| Relative Humidity | Ambient | |
| Temperature | TN | Ambient |
| Voltage | VL | 3.6V |
| | VN | 3.82V |
| | VH | 4.4V |

NOTE: VL= lower extreme test voltage
VN= nominal voltage
VH= upper extreme test voltage
TN= normal temperature



4.3 Test Frequency

| Test Mode | TX / RX | RF Channel | | |
|-----------|---------|--------------|--------------|--------------|
| | | Low (L) | Middle (M) | High (H) |
| GSM850 | TX | Channel 128 | Channel 190 | Channel 251 |
| | | 824.2MHz | 836.6MHz | 848.8MHz |
| | RX | Channel 128 | Channel 190 | Channel 251 |
| | | 869.2MHz | 881.6MHz | 893.8MHz |
| WCDMA850 | TX | Channel 4132 | Channel 4182 | Channel 4233 |
| | | 826.4MHz | 836.4MHz | 846.6MHz |
| | RX | Channel 4357 | Channel 4407 | Channel 4458 |
| | | 871.4MHz | 881.4MHz | 891.6MHz |
| Test Mode | TX / RX | RF Channel | | |
| | | Low (L) | Middle (M) | High (H) |
| GSM1900 | TX | Channel 512 | Channel 661 | Channel 810 |
| | | 1850.2MHz | 1880.0MHz | 1909.8MHz |
| | RX | Channel 512 | Channel 661 | Channel 810 |
| | | 1930.2 MHz | 1960.0 MHz | 1989.8 MHz |
| WCDMA1900 | TX | Channel 9262 | Channel9400 | Channel9538 |
| | | 1852.4MHz | 1880.0MHz | 1907.6MHz |
| | RX | Channel 9662 | Channel 9800 | Channel 9938 |
| | | 1932.4 MHz | 1960.0 MHz | 1987.6 MHz |
| Test Mode | TX / RX | RF Channel | | |
| | | Low (L) | Middle (M) | High (H) |
| WCDMA1700 | TX | Channel1312 | Channel1413 | Channel1513 |
| | | 1712.4MHz | 1732.6MHz | 1752.6MHz |



| Test Mode | TX / RX | RF Channel | | |
|-----------|---------|--------------|--------------|--------------|
| | | Low (L) | Middle (M) | High (H) |
| | RX | Channel 1537 | Channel 1638 | Channel 1738 |
| | | 2112.4 MHz | 2132.6 MHz | 2152.6 MHz |

| Test Mode | TX / RX | RF Channel | | |
|------------|----------|---------------|---------------|---------------|
| | | Low (B) | Middle (M) | High (T) |
| LTE Band 2 | TX(1.4M) | Channel 18607 | Channel 18900 | Channel 19193 |
| | | 1850.7 MHz | 1880 MHz | 1909.3 MHz |
| | TX(3M) | Channel 18615 | Channel 18900 | Channel 19185 |
| | | 1851.5 MHz | 1880 MHz | 1908.5 MHz |
| | TX(5M) | Channel 18625 | Channel 18900 | Channel 19175 |
| | | 1852.5 MHz | 1880 MHz | 1907.5 MHz |
| | TX(10M) | Channel 18650 | Channel 18900 | Channel 19150 |
| | | 1855 MHz | 1880 MHz | 1905 MHz |
| | TX(15M) | Channel 18675 | Channel 18900 | Channel 19125 |
| | | 1857.5 MHz | 1880 MHz | 1902.5 MHz |
| | TX(20M) | Channel 18700 | Channel 18900 | Channel 19100 |
| | | 1860 MHz | 1880 MHz | 1900 MHz |
| | RX(1.4M) | Channel 607 | Channel 900 | Channel 1193 |
| | | 1930.7 MHz | 1960 MHz | 1989.3 MHz |
| | RX(3M) | Channel 615 | Channel 900 | Channel 1185 |
| | | 1931.5 MHz | 1960 MHz | 1988.5 MHz |
| | RX(5M) | Channel 625 | Channel 900 | Channel 1175 |
| | | 1932.5 MHz | 1960 MHz | 1987.5 MHz |



| Test Mode | TX / RX | RF Channel | | |
|-----------|---------|-------------|-------------|--------------|
| | | Low (B) | Middle (M) | High (T) |
| | RX(10M) | Channel 650 | Channel 900 | Channel 1150 |
| | | 1935 MHz | 1960 MHz | 1985 MHz |
| | RX(15M) | Channel 675 | Channel 900 | Channel 1125 |
| | | 1937.5 MHz | 1960 MHz | 1982.5 MHz |
| | RX(20M) | Channel 700 | Channel 900 | Channel 1100 |
| | | 1940 MHz | 1960 MHz | 1980 MHz |

| Test Mode | TX / RX | RF Channel | | |
|------------|----------|---------------|---------------|---------------|
| | | Low (B) | Middle (M) | High (T) |
| LTE Band 4 | TX(1.4M) | Channel 19957 | Channel 20175 | Channel 20393 |
| | | 1710.7 MHz | 1732.5 MHz | 1754.3 MHz |
| | TX(3M) | Channel 19965 | Channel 20175 | Channel 20385 |
| | | 1711.5 MHz | 1732.5 MHz | 1753.5 MHz |
| | TX(5M) | Channel 19975 | Channel 20175 | Channel 20375 |
| | | 1712.5 MHz | 1732.5 MHz | 1752.5 MHz |
| | TX(10M) | Channel 20000 | Channel 20175 | Channel 20350 |
| | | 1715 MHz | 1732.5 MHz | 1750 MHz |
| | TX(15M) | Channel 20025 | Channel 20175 | Channel 20325 |
| | | 1717.5 MHz | 1732.5 MHz | 1747.5 MHz |
| | TX(20M) | Channel 20050 | Channel 20175 | Channel 20300 |
| | | 1720 MHz | 1732.5 MHz | 1745 MHz |
| | RX(1.4M) | Channel 1975 | Channel 2175 | Channel 2375 |
| | | 2112.5 MHz | 2132.5MHz | 2152.5 MHz |



| Test Mode | TX / RX | RF Channel | | |
|-----------|---------|--------------|--------------|--------------|
| | | Low (B) | Middle (M) | High (T) |
| | RX(3M) | Channel 2000 | Channel 2175 | Channel 2350 |
| | | 2115 MHz | 2132.5MHz | 2150 MHz |
| | RX(5M) | Channel 1975 | Channel 2175 | Channel 2375 |
| | | 2112.5 MHz | 2132.5MHz | 2152.5 MHz |
| | RX(10M) | Channel 2000 | Channel 2175 | Channel 2350 |
| | | 2115 MHz | 2132.5MHz | 2150 MHz |
| | RX(15M) | Channel 2025 | Channel 2175 | Channel 2325 |
| | | 2117.5 MHz | 2132.5MHz | 2147.5 MHz |
| | RX(20M) | Channel 2050 | Channel 2175 | Channel 2300 |
| | | 2120 MHz | 2132.5MHz | 2145 MHz |

| Test Mode | TX / RX | RF Channel | | |
|------------|----------|---------------|---------------|---------------|
| | | Low (B) | Middle (M) | High (T) |
| LTE Band 5 | TX(1.4M) | Channel 20407 | Channel 20525 | Channel 20643 |
| | | 824.7 MHz | 836.5 MHz | 848.3 MHz |
| | TX(3M) | Channel 20415 | Channel 20525 | Channel 20635 |
| | | 825.5 MHz | 836.5 MHz | 847.5 MHz |
| | TX(5M) | Channel 20425 | Channel 20525 | Channel 20625 |
| | | 826.5 MHz | 836.5 MHz | 846.5 MHz |
| | TX(10M) | Channel 20450 | Channel 20525 | Channel 20600 |
| | | 829 MHz | 836.5 MHz | 844 MHz |
| | RX(1.4M) | Channel 2407 | Channel 2525 | Channel 2643 |
| | | 869.7 MHz | 881.5 MHz | 893.3 MHz |
| | RX (3M) | Channel 2415 | Channel 2525 | Channel 2635 |



| Test Mode | TX / RX | RF Channel | | |
|-----------|----------|--------------|--------------|--------------|
| | | Low (B) | Middle (M) | High (T) |
| | | 870.5 MHz | 881.5 MHz | 892.5 MHz |
| | | Channel 2425 | Channel 2525 | Channel 2625 |
| | RX(5M) | 871.5 MHz | 881.5 MHz | 891.5 MHz |
| | | Channel 2450 | Channel 2525 | Channel 2600 |
| | RX (10M) | 874 MHz | 881.5 MHz | 889 MHz |
| | | | | |

| Test Mode | TX / RX | RF Channel | | |
|------------|----------|---------------|---------------|---------------|
| | | Low (B) | Middle (M) | High (T) |
| LTE Band 7 | TX (5M) | Channel 20775 | Channel 21100 | Channel 21425 |
| | | 2502.5 MHz | 2535 MHz | 2567.5 MHz |
| | TX (10M) | Channel 20800 | Channel 21100 | Channel 21400 |
| | | 2505 MHz | 2535 MHz | 2565 MHz |
| | TX (15M) | Channel 20825 | Channel 21100 | Channel 21375 |
| | | 2507.5 MHz | 2535 MHz | 2562.5 MHz |
| | TX (20M) | Channel 20850 | Channel 21100 | Channel 21350 |
| | | 2510 MHz | 2535 MHz | 2560 MHz |
| | RX (5M) | Channel 2775 | Channel 3100 | Channel 3425 |
| | | 2622.5 MHz | 2655 MHz | 2687.5 MHz |
| | RX (10M) | Channel 2800 | Channel 3100 | Channel 3400 |
| | | 2625 MHz | 2655 MHz | 2685 MHz |
| | RX (15M) | Channel 2825 | Channel 3100 | Channel 3375 |
| | | 2627.5 MHz | 2655 MHz | 2682.5 MHz |
| | RX (20M) | Channel 2850 | Channel 3100 | Channel 3350 |



| Test Mode | TX / RX | RF Channel | | |
|-----------|---------|------------|------------|----------|
| | | Low (B) | Middle (M) | High (T) |
| | | 2630 MHz | 2655 MHz | 2680 MHz |



4.4 DESCRIPTION OF TESTS

4.4.1 Radiated Power and Radiated Spurious Emissions

Radiated spurious emissions are investigated indoors in a semi-anechoic chamber to determine the frequencies producing the worst case emissions. Final measurements for radiated power and radiated spurious emissions are performed on the 3 meter OATS per the guidelines of ANSI/TIA-603-D-2010. The equipment under test was transmitting while connected to its integral antenna and is placed on a wooden turntable 80cm above the ground plane and 3 meters from the receive antenna. The spectrum is scanned from the lowest frequency generated in the equipment up to a frequency including its 10th harmonic. The receive antenna height is adjusted between 1 and 4 meter height, the turntable is rotated through 360 degrees, and the EUT is manipulated through all orthogonal planes representative of its typical use to achieve the highest reading on the receive spectrum analyzer. Emissions are also investigated with the receive antenna horizontally and vertically polarized.

A portable or small unlicensed wireless device shall be placed on a non-metallic test fixture or other non-metallic support during testing. The supporting fixture shall permit orientation of the EUT in each of three orthogonal (x, y, z) axis positions such that emissions from the EUT are maximized. Measure the EUT maximum RF power and record the result.

A half-wave dipole is then substituted in place of the EUT. For emissions above 3GHz, a horn antenna is substituted in place of the EUT. The substitute antenna is driven by a signal generator with the level of the signal generator being adjusted to obtain the same receive spectrum analyzer level previously recorded from the spurious emission from the EUT.

The power of the emission is calculated using the following formula:

$$P_d [\text{dBm}] = P_g [\text{dBm}] - \text{cable loss} [\text{dB}] + \text{antenna gain} [\text{dBd/dBi}]$$

Where, P_d is the dipole equivalent power, P_g is the generator output into the substitution antenna, and the antenna gain is the gain of the substitute antenna used relative to either a half-wave dipole (dBd) or an isotropic source (dBi). The substitute level is equal to $P_g [\text{dBm}] - \text{cable loss} [\text{dB}]$.

The calculated P_d levels are then compared to the absolute spurious emission limit of -13dBm which is equivalent to the required minimum attenuation of $43 + 10\log_{10}(\text{Power} [\text{Watts}])$.

Test Procedures Used

KDB 971168 D01 v03-Section 5.2.2 / KDB 971168 D01 v03-Section 5.8

ANSI/TIA-603-D-2010-Section 2.2.17 / ANSI/TIA-603-D-2010-Section 2.2.12

Note: Reference test setup 3



4.4.2 Peak-Average Ratio

A peak to average ratio measurement is performed at the conducted port of the EUT. For WCDMA signals, the spectrum analyzers Complementary Cumulative Distribution Function (CCDF) measurement profile is used to determine the largest deviation between the average and the peak power of the EUT in a given bandwidth. The CCDF curve shows how much time the peak waveform spends at or above a given average power level. The percent of time the signal spends at or above the level defines the probability for that particular power level. For GSM signals, an average and a peak trace are used on a spectrum analyzer to determine the largest deviation between the average and the peak power of the EUT in a bandwidth greater than the emission bandwidth. The traces are generated with the spectrum analyzer set to zero span mode.

Test Procedures Used

KDB 971168 D01 v03-Section 5.7.2

Test Settings

- 1、 The signal analyzer's CCDF measurement profile enabled
- 2、 Frequency= carrier center frequency
- 3、 Measurement BW > EBW of signal
- 4、 for continuous transmissions, set to 1ms
- 5、 Record the maximum PAPR level associated with a probability of 0.1%.

Note: Reference test setup 1



4.4.3 Occupied Bandwidth

The occupied bandwidth, that is the frequency bandwidth such that, below its lower and above its upper frequency limits, the mean powers radiated are each equal to 0.5 percent of the total mean power radiated by a given emission shall be measured. The span of the analyzer shall be set to capture all products of the modulation process, including the emission skirts. The resolution bandwidth shall be set to as close to 1 percent of the selected span as is possible without being below 1 percent. The video bandwidth shall be set to 3 times the resolution bandwidth. Video averaging is not permitted. Where practical, a sampling detector shall be used since a peak or, peak hold, may produce a wider bandwidth than actual. The trace data points are recovered and are directly summed in linear terms. The recovered amplitude data points, beginning at the lowest frequency, are placed in a running sum until 0.5 percent of the total is reached and that frequency recorded. The process is repeated for the highest frequency data points. This frequency is recorded. The span between the two recorded frequencies is the occupied bandwidth.

Test Procedures Used

KDB 971168 D01 v03-Section 4.3

Test Settings

- 1、 SET RBW=1-5% of OBW
- 2、 SET VBW \geq 3*RBW
- 3、 Detector: Peak
- 4、 Trace mode= max hold.
- 5、 Sweep= auto couple
- 6、 Steps 1-5 were repeated after it is stable

Note: Reference test setup 1.



4.4.4 Band Edge Compliance

The 1 MHz bands immediately outside and adjacent to the frequency block a resolution bandwidth of at least one percent of the emission bandwidth of the fundamental emission of the transmitter may be employed. The emission power must be attenuated below the transmitting power (P) by a factor of at least $43+10\log_{10}P$ dB.

Test Procedures Used

KDB 971168 D01 v03-Section 6

Test Settings

- 1、 SET RBW \geq 1% of Emission BW.
- 2、 SET VBW about three times of RBW
- 3、 Detector: RMS
- 4、 Trace mode= max hold.
- 5、 Span= 2MHz

Note: Reference test setup 1.



4.4.5 Spurious and Harmonic Emissions at Antenna Terminal

The level of the carrier and the various conducted spurious and harmonic frequencies is measured by means of a calibrated spectrum analyzer. The spectrum is scanned from the lowest frequency generated in the equipment up to a frequency including its 10th harmonic. On any frequency outside a licensee's frequency block, the power of any emission shall be attenuated below the transmitter power (P) by at least $43 + 10 \log(P)$ dB. Compliance with these provisions is based on the use of measurement instrumentation employing a resolution bandwidth of 1 MHz or greater. However, in the 1 MHz bands immediately outside and adjacent to the frequency block a resolution bandwidth of at least one percent of the emission bandwidth of the fundamental emission of the transmitter may be employed. The emission bandwidth is defined as the width of the signal between two points, one below the carrier center frequency and one above the carrier center frequency, outside of which all emission are attenuated at least 26 dB below the transmitter power.

Test Procedures Used

KDB 971168 D01 v03-Section 6

Test Settings

- 1、 9kHz~150kHz, $RBW = 1\text{KHz}$, $VBW \geq 3 \times RBW$,
150kHz~30MHz, $RBW = 10\text{KHz}$, $VBW \geq 3 \times RBW$,
30MHz~1GHz, $RBW = 100\text{ kHz}$, $VBW = 300\text{ kHz}$.
Above 1GHz, $RBW = 1\text{ MHz}$, $VBW = 3\text{ MHz}$.

2、 Detector: Peak

3、 Trace mode= max hold.

Note: Reference test setup 1.



4.4.6 Frequency Stability / Temperature Variation

Frequency stability testing is performed in accordance with the guidelines of ANSI/TIA-603-D-2010. The frequency stability of the transmitter is measured by:

- a.) **Temperature:** The temperature is varied from -30°C to +50°C in 10°C increments using an environmental chamber.
- b.) **Primary Supply Voltage:** The primary supply voltage is varied from 85% to 115% of the nominal value for non hand-carried battery and AC powered equipment. For hand-carried, battery-powered equipment, primary supply voltage is reduced to the battery operating end point which shall be specified by the manufacturer.

Specification – The frequency stability shall be sufficient to ensure that the fundamental emission stays within the authorized frequency block. The frequency stability of the transmitter shall be maintained within $\pm 0.00025\%$ (± 2.5 ppm) of the center frequency.

Time Period and Procedure:

1. The carrier frequency of the transmitter is measured at room temperature (20°C to provide a reference).
2. The equipment is turned on in a “standby” condition for fifteen minutes before applying power to the transmitter. Measurement of the carrier frequency of the transmitter is made within one minute after applying power to the transmitter.
3. Frequency measurements are made at 10°C intervals ranging from -30°C to +50°C. A period of at least one half-hour is provided to allow stabilization of the equipment at each temperature level.

Test Procedures Used

ANSI/TIA-603-D-2010

Note: Reference test setup 2.

4.5 Test Setups

4.5.1 Test Setup 1

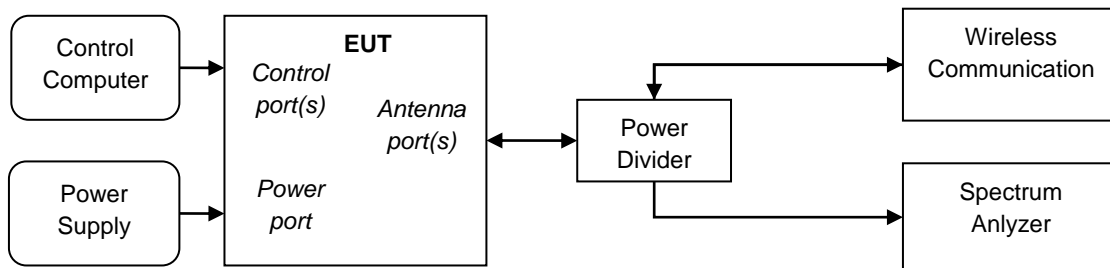

4.5.2 Test Setup 2

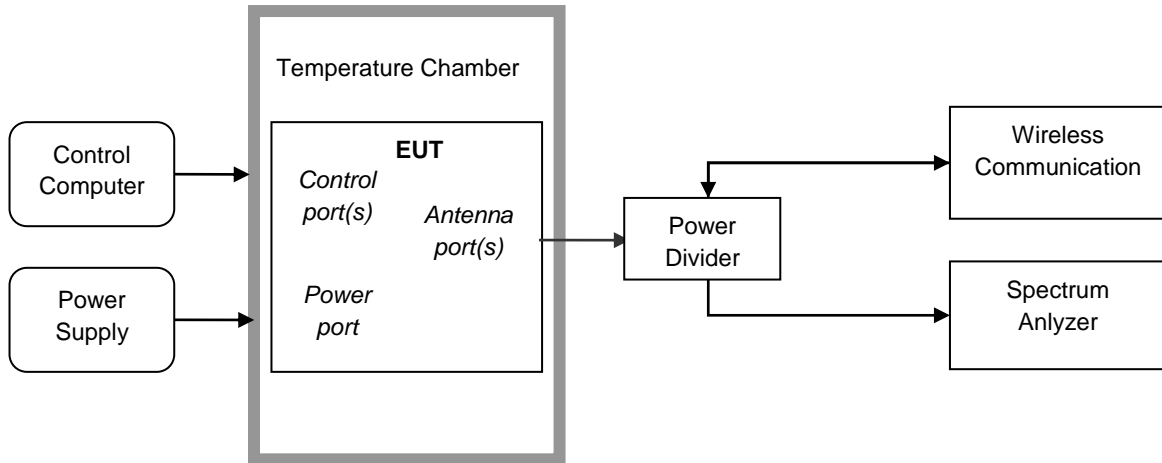

4.5.3 Test Setup 3

NOTE: Effective radiated power (ERP) and Equivalent Isotropic Radiated Power(EIRP) refers to the radiation power output of the EUT, assuming all emissions are radiated from half-wave dipole antennas.

4.5.3.1 Step 1: Pre-test

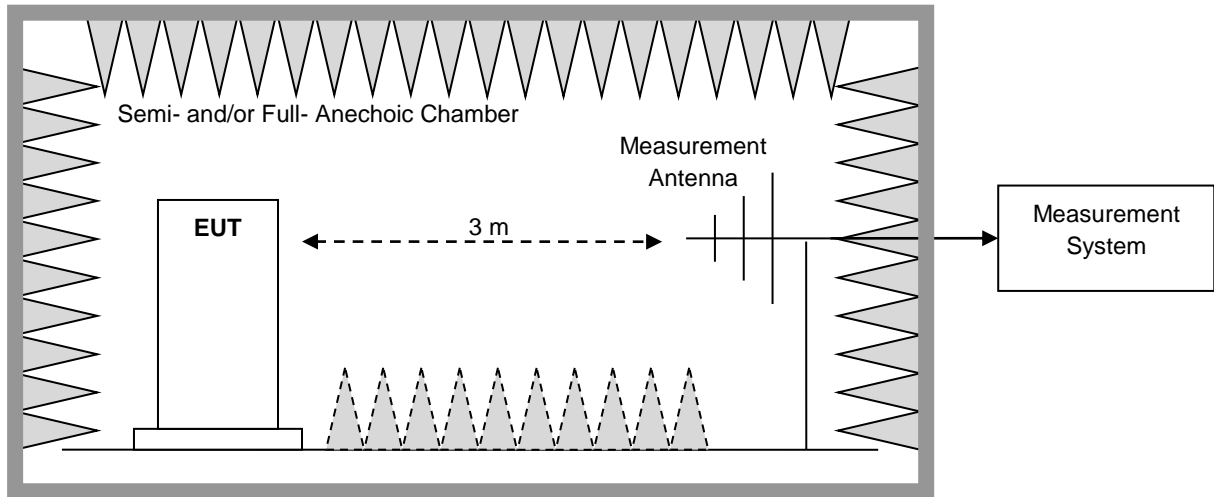

4.5.3.2 Step 2: Substitution method to verify the maximum ERP/EIRP

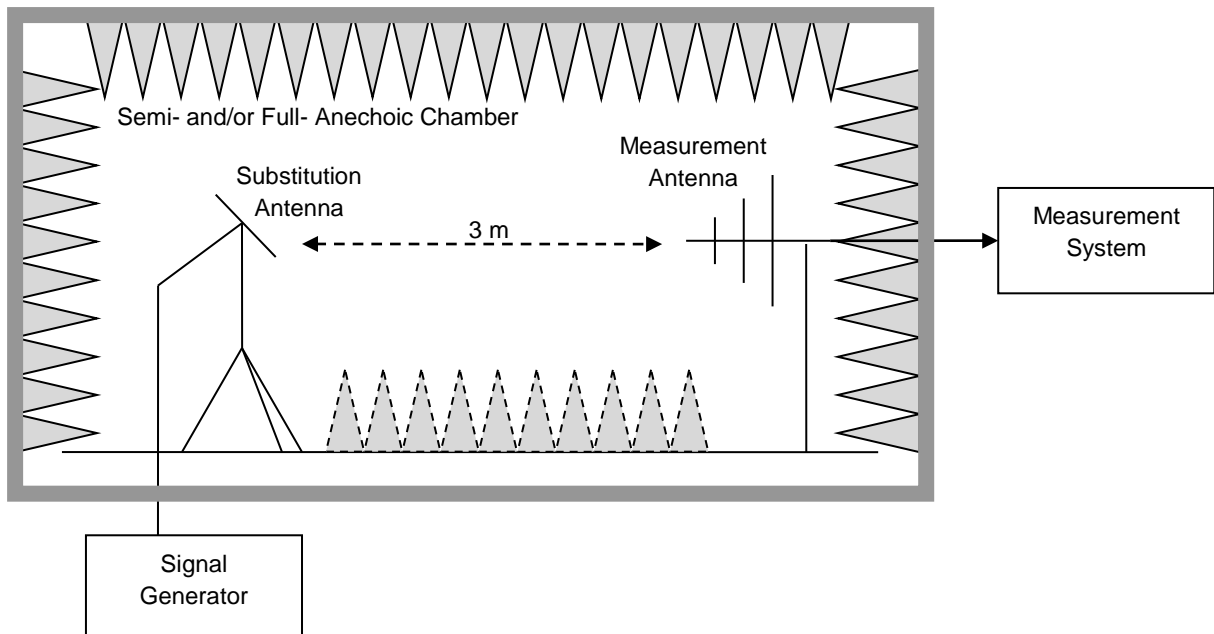



4.6 Test Conditions

| Test Case | | Test Conditions | |
|---|---|---------------------|--|
| Transmit Output Power Data | Average Power, Total | Test Env. | Ambient Climate & Rated Voltage |
| | | Test Setup | Test Setup 1 |
| | | RF Channels (TX) | L, M, H (L= low channel, M= middle channel, H= high channel) |
| | | Test Mode | GSM/TM1,GSM/TM2,UMTS/TM1,LTE/TM1,LTE/TM2 |
| | Average Power, Spectral Density (if required) | Test Env. | Ambient Climate & Rated Voltage |
| | | Test Setup | Test Setup 1 |
| | | RF Channels (TX) | L, M, H (L= low channel, M= middle channel, H= high channel) |
| | | Test Mode | GSM/TM1,GSM/TM2,UMTS/TM1,LTE/TM1,LTE/TM2 |
| Peak-to-Average Ratio (if required) | | Test Env. | Ambient Climate & Rated Voltage |
| | | Test Setup | Test Setup 1 |
| | | RF Channels (TX) | L, M, H (L= low channel, M= middle channel, H= high channel) |
| | | Test Mode | GSM/TM1,GSM/TM2,UMTS/TM1,LTE/TM1,LTE/TM2 |
| Modulation Characteristics | | Test Env. | Ambient Climate & Rated Voltage |
| | | Test Setup | Test Setup 1 |
| | | RF Channels (TX) | M (L= low channel, M= middle channel, H= high channel) |
| | | Test Mode | GSM/TM1,GSM/TM2,UMTS/TM1,LTE/TM1,LTE/TM2 |
| Bandwidth | Occupied Bandwidth | Test Env. | Ambient Climate & Rated Voltage |
| | | Test Setup | Test Setup 1 |
| | | RF Channels (TX) | L, M, H (L= low channel, M= middle channel, H= high channel) |
| | | Test Mode | GSM/TM1,GSM/TM2,UMTS/TM1,LTE/TM1,LTE/TM2 |
| | Emission Bandwidth (if required) | Test Env. | Ambient Climate & Rated Voltage |
| | | Test Setup | Test Setup 1 |
| | | RF Channels (TX) | L, M, H (L= low channel, M= middle channel, H= high channel) |
| | | Test Mode | GSM/TM1,GSM/TM2,UMTS/TM1,LTE/TM1,LTE/TM2 |
| Band Edges Compliance | | Test Env. | Ambient Climate & Rated Voltage |
| | | Test Setup | Test Setup 1 |
| | | RF Channels (TX) | L, H (L= low channel, M= middle channel, H= high channel) |
| | | Test Mode | GSM/TM1,GSM/TM2,UMTS/TM1,LTE/TM1,LTE/TM2 |
| Spurious Emission at Antenna Terminals | | Test Env. | Ambient Climate & Rated Voltage |
| | | Test Setup | Test Setup 1 |
| | | RF Channels (TX) | L, M, H (L= low channel, M= middle channel, H= high channel) |



| Test Case | Test Conditions | |
|--------------------------------------|------------------|--|
| | Test Mode | GSM/TM1,GSM/TM2,UMTS/TM1,LTE/TM1,LTE/TM2 |
| Field Strength of Spurious Radiation | Test Env. | Ambient Climate & Rated Voltage |
| | Test Setup | Test Setup 3 |
| | Test Mode | GSM/TM1,GSM/TM2,UMTS/TM1/TM2/TM3,LTE/TM1,LTE/TM2 NOTE: If applicable, the EUT conf. that has maximum power density (based on the equivalent power level) is selected. |
| | RF Channels (TX) | L, M, H (L= low channel, M= middle channel, H= high channel) |
| Frequency Stability | Test Env. | (1) -30 °C to +50 °C with step 10 °C at Rated Voltage; (2) VL, VN and VH of Rated Voltage at Ambient Climate. |
| | Test Setup | Test Setup 2 |
| | RF Channels (TX) | L, M, H (L= low channel, M= middle channel, H= high channel) |
| | Test Mode | GSM/TM1,GSM/TM2,UMTS/TM1,LTE/TM1,LTE/TM2 |

**5 Main Test Instruments**

| Main Test Equipments | | | | | |
|---|--------------|-----------|----------------|------------|------------|
| Equipment Name | Manufacturer | Model | Serial Number | Cal Date | Cal- Due |
| Power supply | KEITHLEY | 2303 | 000500E | 2017/5/31 | 2018/5/30 |
| Wireless Communication Test set | Agilent | N4010A | MY49081592 | 2017/7/31 | 2018/7/30 |
| Universal Radio Communication Tester | R&S | CMU200 | 110932 | 2017/5/2 | 2018/5/1 |
| Spectrum Analyzer | Agilent | N9020A | MY52090652 | 2017/7/10 | 2018/7/9 |
| Universal Radio Communication Tester | R & S | CMW500 | 126854 | 2017/10/19 | 2018/10/18 |
| Signal Analyzer | R&S | FSQ31 | 200021 | 2017/7/31 | 2018/7/30 |
| Spectrum Analyzer | Agilent | N9030A | MY49431698 | 2017/7/31 | 2018/7/30 |
| Temperature Chamber | WEISS | WKL64 | 56246002940010 | 2017/12/13 | 2018/12/12 |
| Signal generator | Agilent | E8257D | MY49281095 | 2017/7/31 | 2018/7/30 |
| Vector Signal Generator | R&S | SMU200A | 104162 | 2017/7/31 | 2018/7/30 |
| Test receiver | R&S | ESU26 | 100387 | 2018/1/20 | 2019/1/19 |
| Test receiver | R&S | ESCI | 101163 | 2018/1/20 | 2019/1/19 |
| Spectrum analyzer | R&S | FSU3 | 200474 | 2018/1/20 | 2019/1/19 |
| Spectrum analyzer | R&S | FSU43 | 100144 | 2018/1/20 | 2019/1/19 |
| LOOP Antennas(9kHz-30MHz) | R&S | HFH2-Z2 | 100262 | 2017/4/25 | 2019/4/25 |
| LOOP Antennas(9kHz-30MHz) | R&S | HFH2-Z2 | 100263 | 2017/4/25 | 2019/4/25 |
| Trilog Broadband Antenna (30M~3GHz) | SCHWARZ BECK | VULB 9163 | 9163-490 | 2017/3/29 | 2019/3/29 |
| Trilog Broadband Antenna (30M~3GHz) | SCHWARZ BECK | VULB 9163 | 9163-521 | 2017/4/9 | 2019/4/9 |
| Double-Ridged Waveguide Horn Antenna (1G~18GHz) | R&S | HF907 | 100304 | 2017/5/27 | 2019/5/27 |
| Pyramidal Horn Antenna(18GHz-26.5GHz) | ETS-Lindgren | 3160-09 | 5140299 | 2017/7/20 | 2019/7/19 |
| Artificial Main Network | R&S | ENV4200 | 100134 | 2017/5/15 | 2018/5/14 |
| Line Impedance Stabilization Network | R&S | ENV216 | 100382 | 2017/5/15 | 2018/5/14 |
| Power Detecting & Sampling Unit | R&S | OSP-B157 | 100914 | 2017/7/31 | 2018/7/30 |
| Power supply | KEITHLEY | 2303 | 000500E | 2017/5/31 | 2018/5/30 |
| Wireless Communication Test set | Agilent | N4010A | MY49081592 | 2017/7/31 | 2018/7/30 |



| Software Information | | | |
|----------------------|---------------|--------------|---------|
| Test Item | Software Name | Manufacturer | Version |
| RSE | EMC32 | R&S | V8.40.0 |



6 Measurement Uncertainty

For a 95% confidence level ($k = 2$), the measurement expanded uncertainties for defined systems, in accordance with the recommendations of ISO 17025 as following:

| Test Item | | Extended Uncertainty |
|--------------------------------------|--------------------------|--|
| Transmit Output Power Data | Power [dBm] | U = 0.42 dB |
| Bandwidth | Magnitude [%] | U = 0.2% |
| Band Edge Compliance | Disturbance Power [dBm] | U = 1.24 dB |
| Spurious Emissions, Conducted | Disturbance Power [dBm] | U = 1.62 dB |
| Field Strength of Spurious Radiation | ERP [dBm] | For 3 m Chamber: U = 4.9 dB (30 MHz to 26.5GHz) |
| Frequency Stability | Frequency Accuracy [ppm] | U = 0.017 ppm |

7 Appendixes

| Appendix No. | Description |
|---------------------------------|------------------------|
| SYBH(Z-RF)20180207022001-2001-A | Appendix_for_GSM |
| SYBH(Z-RF)20180207022001-2001-B | Appendix_for_WCDMA |
| SYBH(Z-RF)20180207022001-2001-C | Appendix_for_LTE Band2 |
| SYBH(Z-RF)20180207022001-2001-D | Appendix_for_LTE Band4 |
| SYBH(Z-RF)20180207022001-2001-E | Appendix_for_LTE Band5 |
| SYBH(Z-RF)20180207022001-2001-F | Appendix_for_LTE Band7 |

| Appendix | Description |
|------------|--|
| Appendix A | Effective (Isotropic) Radiated Power Output Data |
| Appendix B | Peak-Average Ratio |
| Appendix C | Modulation Characteristics |
| Appendix D | Bandwidth |
| Appendix E | Band Edges Compliance |
| Appendix F | Spurious Emission at Antenna Terminals |
| Appendix G | Field Strength of Spurious Radiation |
| Appendix H | Frequency Stability |

END