

FCC Radio Test Report

FCC ID: QISDG8045

This report concerns (check one): Original Grant Class I Change Class II Change

Project No. : 1707C303
Equipment : VDSL Home Gateway
Test Model : EchoLife DG8045
Series Model : N/A
Applicant : Huawei Technologies Co.,Ltd.
Address : Administration Building, Headquarters of Huawei Technologies Co., Ltd., Bantian, Longgang District, Shenzhen, 518129, P.R.C

Date of Receipt : Jul. 28, 2017
Date of Test : Jul. 28, 2017 ~ Aug. 18, 2017
Issued Date : Aug. 21, 2017
Tested by : BTL Inc.

Testing Engineer : Paul Li
(Paul Li)

Technical Manager : David Mao
(David Mao)

Authorized Signatory : Steven Lu
(Steven Lu)

B T L I N C .

No.3, Jinshagang 1st Road, Shixia, Dalang Town, Dongguan,
Guangdong, China.

TEL: +86-769-8318-3000 FAX: +86-769-8319-6000

Declaration

BTL represents to the client that testing is done in accordance with standard procedures as applicable and that test instruments used has been calibrated with standards traceable to international standard(s) and/or national standard(s).

BTL's reports apply only to the specific samples tested under conditions. It is manufacture's responsibility to ensure that additional production units of this model are manufactured with the identical electrical and mechanical components. **BTL** shall have no liability for any declarations, inferences or generalizations drawn by the client or others from **BTL** issued reports.

BTL's report must not be used by the client to claim product certification, approval, or endorsement by NVLAP, NIST, or any agency of the Federal Government.

This report is the confidential property of the client. As a mutual protection to the clients, the public and **BTL-self**, extracts from the test report shall not be reproduced except in full with **BTL's** authorized written approval.

BTL's laboratory quality assurance procedures are in compliance with the **ISO Guide 17025** requirements, and accredited by the conformity assessment authorities listed in this test report.

Limitation

For the use of the authority's logo is limited unless the Test Standard(s)/Scope(s)/Item(s) mentioned in this test report is (are) included in the conformity assessment authorities acceptance respective.

Table of Contents	Page
1 . CERTIFICATION	6
2 . SUMMARY OF TEST RESULTS	7
2.1 TEST FACILITY	8
2.2 MEASUREMENT UNCERTAINTY	8
3 . GENERAL INFORMATION	9
3.1 GENERAL DESCRIPTION OF EUT	9
3.2 DESCRIPTION OF TEST MODES	11
3.3 TABLE OF PARAMETERS OF TEXT SOFTWARE SETTING	13
3.4 BLOCK DIAGRAM SHOWING THE CONFIGURATION OF SYSTEM TESTED	14
3.5 DESCRIPTION OF SUPPORT UNITS	14
4 . EMC EMISSION TEST	15
4.1 CONDUCTED EMISSION MEASUREMENT	15
4.1.1 POWER LINE CONDUCTED EMISSION LIMITS	15
4.1.2 TEST PROCEDURE	15
4.1.3 DEVIATION FROM TEST STANDARD	15
4.1.4 TEST SETUP	16
4.1.5 EUT OPERATING CONDITIONS	16
4.1.6 EUT TEST CONDITIONS	16
4.1.7 TEST RESULTS	16
4.2 RADIATED EMISSION MEASUREMENT	17
4.2.1 RADIATED EMISSION LIMITS	17
4.2.2 TEST PROCEDURE	18
4.2.3 DEVIATION FROM TEST STANDARD	18
4.2.4 TEST SETUP	19
4.2.5 EUT OPERATING CONDITIONS	20
4.2.6 EUT TEST CONDITIONS	20
4.2.7 TEST RESULTS (9KHZ TO 30MHZ)	20
4.2.8 TEST RESULTS (30MHZ TO 1000MHZ)	20
4.2.9 TEST RESULTS (ABOVE 1000MHZ)	20
5 . BANDWIDTH TEST	21
5.1 APPLIED PROCEDURES	21
5.1.1 TEST PROCEDURE	21
5.1.2 DEVIATION FROM STANDARD	21
5.1.3 TEST SETUP	21
5.1.4 EUT OPERATION CONDITIONS	21
5.1.5 EUT TEST CONDITIONS	21
5.1.6 TEST RESULTS	21
6 . MAXIMUM PEAK CONDUCTED OUTPUT POWER TEST	22

Table of Contents	Page
6.1 APPLIED PROCEDURES / LIMIT	22
6.1.1 TEST PROCEDURE	22
6.1.2 DEVIATION FROM STANDARD	22
6.1.3 TEST SETUP	22
6.1.4 EUT OPERATION CONDITIONS	22
6.1.5 EUT TEST CONDITIONS	22
6.1.6 TEST RESULTS	22
7 . ANTENNA CONDUCTED SPURIOUS EMISSION	23
7.1 APPLIED PROCEDURES / LIMIT	23
7.1.1 TEST PROCEDURE	23
7.1.2 DEVIATION FROM STANDARD	23
7.1.3 TEST SETUP	23
7.1.4 EUT OPERATION CONDITIONS	23
7.1.5 EUT TEST CONDITIONS	23
7.1.6 TEST RESULTS	23
8 . POWER SPECTRAL DENSITY TEST	24
8.1 APPLIED PROCEDURES / LIMIT	24
8.1.1 TEST PROCEDURE	24
8.1.2 DEVIATION FROM STANDARD	24
8.1.3 TEST SETUP	24
8.1.4 EUT OPERATION CONDITIONS	24
8.1.5 EUT TEST CONDITIONS	24
8.1.6 TEST RESULTS	24
9 . MEASUREMENT INSTRUMENTS LIST	25
10 . EUT TEST PHOTO	27
APPENDIX A - CONDUCTED EMISSION	31
APPENDIX B - RADIATED EMISSION (9KHZ TO 30MHZ)	36
APPENDIX D - RADIATED EMISSION (ABOVE 1000MHZ)	58
APPENDIX E - BANDWIDTH	107
APPENDIX F - MAXIMUM PEAK CONDUCTED OUTPUT POWER	116
APPENDIX G - ANTENNA CONDUCTED SPURIOUS EMISSION	120
APPENDIX H - POWER SPECTRAL DENSITY	157

REPORT ISSUED HISTORY

Issued No.	Description	Issued Date
BTL-FCCP-1-1707C303	Original Issue.	Aug. 21, 2017

1. CERTIFICATION

Equipment : VDSL Home Gateway
Brand Name : HUAWEI
Test Model : EchoLife DG8045
Series Model : N/A
Applicant : Huawei Technologies Co.,Ltd.
Manufacturer : Huawei Technologies Co.,Ltd.
Address : Administration Building, Headquarters of Huawei Technologies Co., Ltd.,
Bantian, Longgang District, Shenzhen, 518129, P.R.C
Factory : Shenzhen Zowee Smart Manufacturing Co., Ltd
Address : No. 149, Second Industrial Road, TangXiachong, SongGang, Baoan District,
Shenzhen, Guangdong , China
Date of Test : Jul. 28, 2017 ~ Aug. 18, 2017
Test Sample : Engineering Sample
Standard(s) : FCC Part15, Subpart C:(15.247) / ANSI C63.10-2013

The above equipment has been tested and found compliance with the requirement of the relative standards by BTL Inc.

The test data, data evaluation, and equipment configuration contained in our test report (Ref No. BTL-FCCP-1-1707C303) were obtained utilizing the test procedures, test instruments, test sites that has been accredited by the Authority of TAF according to the ISO-17025 quality assessment standard and technical standard(s).

2. SUMMARY OF TEST RESULTS

Test procedures according to the technical standard(s):

Applied Standard(s): FCC Part15 (15.247) , Subpart C			
Standard(s) Section	Test Item	Judgment	Remark
15.207	Conducted Emission	PASS	
15.247(d)	Antenna conducted Spurious Emission	PASS	
15.247(a)(2)	6dB Bandwidth	PASS	
15.247(b)(3)	Peak Output Power	PASS	
15.247(e)	Power Spectral Density	PASS	
15.203	Antenna Requirement	PASS	
15.247(d)/ 15.205/ 15.209	Transmitter Radiated Emissions	PASS	

Note:

(1) "N/A" denotes test is not applicable in this test report.

2.1 TEST FACILITY

The test facilities used to collect the test data in this report is at the location of No.3,Jinshagang 1st Road, Shixia, Dalang Town, Dongguan, Guangdong, China.

BTL's test firm number for FCC: 319330

2.2 MEASUREMENT UNCERTAINTY

Where relevant, the following measurement uncertainty levels have been estimated for tests performed on the EUT as specified in CISPR 16-4-2. The BTL measurement uncertainty is less than the CISPR 16-4-2 U_{CISPR} requirement.

The reported uncertainty of measurement $y \pm U$, where expanded uncertainty U is based on a standard uncertainty multiplied by a coverage factor of $k=2$, providing a level of confidence of approximately 95 %.

A. Conducted Measurement:

Test Site	Method	Measurement Frequency Range	U, (dB)
DG-C02	CISPR	150 KHz ~ 30MHz	2.32

B. Radiated Measurement:

Test Site	Method	Measurement Frequency Range	Ant. H / V	U, (dB)
DG-CB03	CISPR	9KHz~30MHz	V	3.79
		9KHz~30MHz	H	3.57
		30MHz ~ 200MHz	V	3.82
		30MHz ~ 200MHz	H	3.78
		200MHz ~ 1,000MHz	V	4.10
		200MHz ~ 1,000MHz	H	4.06
		1GHz~18GHz	V	3.12
		1GHz~18GHz	H	3.68
		18GHz~40GHz	V	4.15
		18GHz~40GHz	H	4.14

Note: Unless specifically mentioned, the uncertainty of measurement has not been taken into account to declare the compliance or non-compliance to the specification.

3. GENERAL INFORMATION

3.1 GENERAL DESCRIPTION OF EUT

Equipment	VDSL Home Gateway	
Brand Name	HUAWEI	
Test Model	EchoLife DG8045	
Series Model	N/A	
Model Difference	N/A	
Product Description	Operation Frequency	2412~2462 MHz
	Modulation Technology	802.11b:DSSS 802.11g:OFDM 802.11n:OFDM
	Bit Rate of Transmitter	802.11b: 11/5.5/2/1 Mbps 802.11g: 54/48/36/24/18/12/9/6 Mbps 802.11n up to 300 Mbps
	Output Power (Max.)	802.11b: 20.05dBm 802.11g: 27.31dBm 802.11n(20MHz): 28.64dBm 802.11n(40MHz): 25.66dBm
Power Source	DC voltage supplied from adapter. Brand/Model:HUAWEI / HW-120100U6W(Huntkey) Brand/Model:HUAWEI / HW-120100U6W(XinQiao)	
Power Rating	Input: 100-240V~50/60Hz, 0.5A Output: 12.0V --- 1.0A	

Note:



1. For a more detailed features description, please refer to the manufacturer's specifications or the user's manual.

2. Channel List:



CH01 - CH11 for 802.11b, 802.11g, 802.11n(20MHz) CH03 - CH09 for 802.11n(40MHz)							
Channel	Frequency (MHz)	Channel	Frequency (MHz)	Channel	Frequency (MHz)	Channel	Frequency (MHz)
01	2412	04	2427	07	2442	10	2457
02	2417	05	2432	08	2447	11	2462
03	2422	06	2437	09	2452		

3. Table for Filed Antenna

Group 1

Ant.	Brand	Model Name	Antenna Type	Connector	Gain (dBi)	Note
1		81800T384	PCB	N/A	2	TX/RX
2		81800T385	PCB	N/A	2	TX/RX
3		81800T385	PCB	N/A	2	RX

Group 2

Ant.	Brand	Model Name	Antenna Type	Connector	Gain (dBi)	Note
1		G009-20655-A	PCB	N/A	2	TX/RX
2		G009-20656-A	PCB	N/A	2	TX/RX
3		G009-20656-A	PCB	N/A	2	RX

1. The EUT incorporates a MIMO function. Physically, the EUT provides two transmitters and three receivers (2T3R).
2. Only different for brand name for these two group antennas.

3.2 DESCRIPTION OF TEST MODES

To investigate the maximum EMI emission characteristics generated from EUT, the test system was pre-scanning tested based on the consideration of following EUT operation mode or test configuration mode which possibly have effect on EMI emission level. Each of these EUT operation mode(s) or test configuration mode(s) mentioned above was evaluated respectively.

Pretest Mode	Description
Mode 1	TX B MODE CHANNEL 01/06/11
Mode 2	TX G MODE CHANNEL 01/06/11
Mode 3	TX N-20MHZ MODE CHANNEL 01/06/11
Mode 4	TX N-40MHZ MODE CHANNEL 03/06/09
Mode 5	Normal Link

The EUT system operated these modes were found to be the worst case during the pre-scanning test as following:

For Conducted Test	
Final Test Mode	Description
Mode 5	Normal Link

For Radiated Test	
Final Test Mode	Description
Mode 1	TX B MODE CHANNEL 01/06/11
Mode 2	TX G MODE CHANNEL 01/06/11
Mode 3	TX N-20MHZ MODE CHANNEL 01/06/11
Mode 4	TX N-40MHZ MODE CHANNEL 03/06/09

For Band Edge Test	
Final Test Mode	Description
Mode 1	TX B MODE CHANNEL 01/06/11
Mode 2	TX G MODE CHANNEL 01/06/11
Mode 3	TX N-20MHZ MODE CHANNEL 01/06/11
Mode 4	TX N-40MHZ MODE CHANNEL 03/06/09

6dB Spectrum Bandwidth	
Final Test Mode	Description
Mode 1	TX B MODE CHANNEL 01/06/11
Mode 2	TX G MODE CHANNEL 01/06/11
Mode 3	TX N-20MHZ MODE CHANNEL 01/06/11
Mode 4	TX N-40MHZ MODE CHANNEL 03/06/09

Maximum Conducted Output Power	
Final Test Mode	Description
Mode 1	TX B MODE CHANNEL 01/06/11
Mode 2	TX G MODE CHANNEL 01/06/11
Mode 3	TX N-20MHZ MODE CHANNEL 01/06/11
Mode 4	TX N-40MHZ MODE CHANNEL 03/06/09

Power Spectral Density	
Final Test Mode	Description
Mode 1	TX B MODE CHANNEL 01/06/11
Mode 2	TX G MODE CHANNEL 01/06/11
Mode 3	TX N-20MHZ MODE CHANNEL 01/06/11
Mode 4	TX N-40MHZ MODE CHANNEL 03/06/09

Note:

- (1) The measurements are performed at the high, middle, low available channels.
- (2) 802.11b mode: DBPSK (1Mbps)
 802.11g mode: OFDM (6Mbps)
 802.11n HT20 mode : BPSK (13Mbps)
 802.11n HT40 mode : BPSK (27Mbps)
 For radiated emission tests, the highest output powers were set for final test.
- (3) For radiated below 1G test, the 802.11b is found to be the worst case and recorded.
- (4) The EUT was programmed to be in continuously transmitting mode and the transmit duty cycle is not less than 98%.

3.3 TABLE OF PARAMETERS OF TEXT SOFTWARE SETTING

During testing, channel & power controlling software provided by the customer was used to control the operating channel as well as the output power level. The RF output power selection is for the setting of RF output power expected by the customer and is going to be fixed on the firmware of the final end product power parameters of WLAN.

Test software version	CMD		
Frequency (MHz)	2412	2437	2462
802.11b	38	38	38
802.11g	49	47	47
802.11n (20MHz)	46/48	41/46	41/43
Frequency (MHz)	2422	2437	2452
802.11n (40MHz)	42/44	42/43	43/44

3.4 BLOCK DIAGRAM SHOWING THE CONFIGURATION OF SYSTEM TESTED

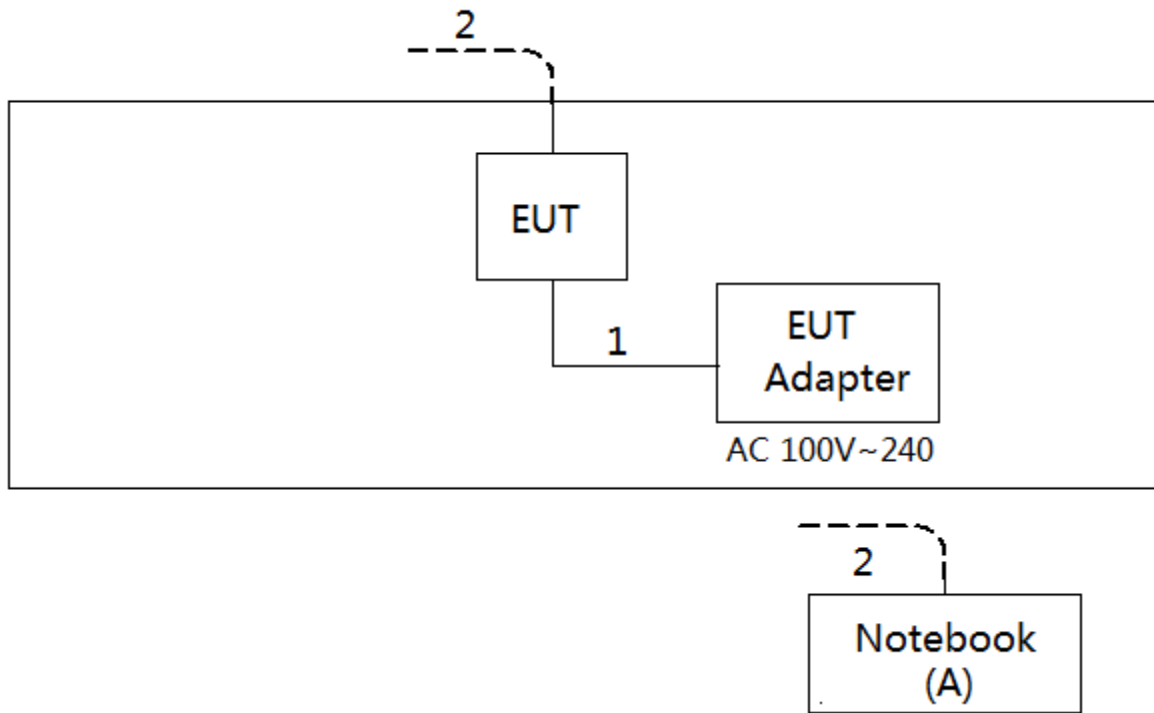

3.5 DESCRIPTION OF SUPPORT UNITS

The EUT has been tested as an independent unit together with other necessary accessories or support units. The following support units or accessories were used to form a representative test configuration during the tests.

Item	Equipment	Mfr/Brand	Model/Type No.	FCC ID	Series No.
A	Notebook	Dell	DCSM 745	DOC	G7K832X

Item	Shielded Type	Ferrite Core	Length	Note
1	NO	NO	1.5M	DC Cable
2	NO	NO	10M	RJ45 Cable

4. EMC EMISSION TEST

4.1 CONDUCTED EMISSION MEASUREMENT

4.1.1 POWER LINE CONDUCTED EMISSION LIMITS (Frequency Range 150KHz-30MHz)

Frequency of Emission (MHz)	Conducted Limit (dBμV)	
	Quasi-peak	Average
0.15 -0.50	66 to 56*	56 to 46*
0.50 -5.0	56	46
5.0 -30.0	60	50

Note:

- (1) The limit of " * " decreases with the logarithm of the frequency
- (2) The test result calculated as following:
 Measurement Value = Reading Level + Correct Factor
 Correct Factor = Insertion Loss + Cable Loss + Attenuator Factor(if use)
 Margin Level = Measurement Value - Limit Value

The following table is the setting of the receiver

Receiver Parameters	Setting
Attenuation	10 dB
Start Frequency	0.15 MHz
Stop Frequency	30 MHz
IF Bandwidth	9 KHz

4.1.2 TEST PROCEDURE

- a. The EUT was placed 0.8 meters from the horizontal ground plane with EUT being connected to the power mains through a line impedance stabilization network (LISN). All other support equipment powered from additional LISN(s). The LISN provide 50 Ohm/ 50uH of coupling impedance for the measuring instrument.
- b. Interconnecting cables that hang closer than 40 cm to the ground plane shall be folded back and forth in the center forming a bundle 30 to 40 cm long.
- c. I/O cables that are not connected to a peripheral shall be bundled in the center. The end of the cable may be terminated, if required, using the correct terminating impedance. The overall length shall not exceed 1 m.
- d. LISN at least 80 cm from nearest part of EUT chassis.
- e. For the actual test configuration, please refer to the related Item -EUT Test Photos.

4.1.3 DEVIATION FROM TEST STANDARD

No deviation

4.1.4 TEST SETUP

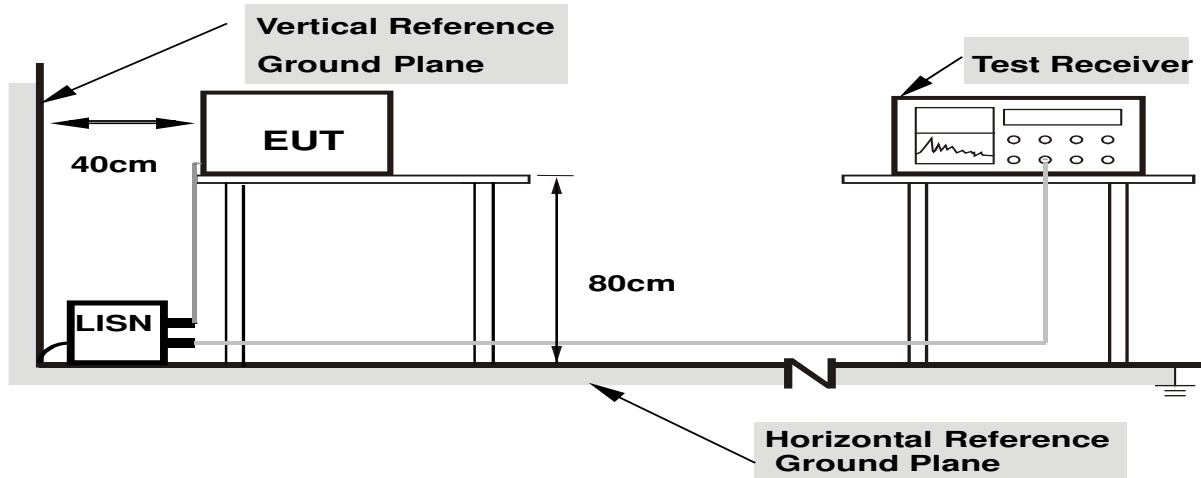

- Note:**
1. Support units were connected to second LISN.
 2. Both of LISNs (AMN) are 80 cm from EUT and at least 80 from other units and other metal planes

4.1.5 EUT OPERATING CONDITIONS

The EUT was placed on the test table and programmed in normal function.

4.1.6 EUT TEST CONDITIONS

Temperature: 25°C Relative Humidity: 55% Test Voltage: AC 120V/60Hz

4.1.7 TEST RESULTS

Please refer to the Appendix A.

4.2 RADIATED EMISSION MEASUREMENT

4.2.1 RADIATED EMISSION LIMITS

In case the emission fall within the restricted band specified on 15.205(a), then the 15.209(a) limit in the table below has to be followed.

LIMITS OF RADIATED EMISSION MEASUREMENT (9KHz-1000MHz)

Frequency (MHz)	Field Strength (microvolts/meter)	Measurement Distance (meters)
0.009~0.490	2400/F(KHz)	300
0.490~1.705	24000/F(KHz)	30
1.705~30.0	30	30
30~88	100	3
88~216	150	3
216~960	200	3
960~1000	500	3

LIMITS OF RADIATED EMISSION MEASUREMENT (Above 1000MHz)

Frequency (MHz)	(dBuV/m) (at 3 meters)	
	PEAK	AVERAGE
Above 1000	74	54

Notes:

- (1) The limit for radiated test was performed according to FCC PART 15C.
- (2) The tighter limit applies at the band edges.
- (3) Emission level (dBuV/m)=20log Emission level (uV/m).
- (4) The test result calculated as following:
 Measurement Value = Reading Level + Correct Factor
 Correct Factor = Antenna Factor + Cable Loss - Amplifier Gain(if use)
 Margin Level = Measurement Value - Limit Value

Spectrum Parameter	Setting
Attenuation	Auto
Start Frequency	1000 MHz
Stop Frequency	10th carrier harmonic
RBW / VBW (Emission in restricted band)	1MHz / 3MHz for Peak, 1MHz / 1/T for Average

Receiver Parameter	Setting
Attenuation	Auto
Start ~ Stop Frequency	9KHz~90KHz for PK/AVG detector
Start ~ Stop Frequency	90KHz~110KHz for QP detector
Start ~ Stop Frequency	110KHz~490KHz for PK/AVG detector
Start ~ Stop Frequency	490KHz~30MHz for QP detector
Start ~ Stop Frequency	30MHz~1000MHz for QP detector

4.2.2 TEST PROCEDURE

- a. The measuring distance of 3 m shall be used for measurements. The EUT was placed on the top of a rotating table 0.8 meter above the ground at a 3 meter semi-anechoic chamber. The table was rotated 360 degrees to determine the position of the highest radiation.(below 1GHz)
- b. The measuring distance of 3 m shall be used for measurements. The EUT was placed on the top of a rotating table 1.5 meter above the ground at a 3 meter semi-anechoic chamber. The table was rotated 360 degrees to determine the position of the highest radiation.(above 1GHz)
- c. The height of the equipment or of the substitution antenna shall be 0.8m or 1.5m; the height of the test antenna shall vary between 1 m to 4 m. Both horizontal and vertical polarizations of the antenna are set to make the measurement.
- d. For each suspected emission, the EUT was arranged to its worst case and then the antenna was tuned to heights find the maximum reading (used Bore sight function).
- e. The receiver system was set to peak and average detect function and specified bandwidth with maximum hold mode when the test frequency is above 1GHz.
- f. The initial step in collecting radiated emission data is a receiver peak detector mode pre-scanning the measurement frequency range. Significant peaks are then marked and then Quasi Peak detector mode re-measured.
- g. All readings are Peak unless otherwise stated QP in column of Note. Peak denotes that the Peak reading compliance with the QP Limits and then QP Mode measurement didn't perform. (below 1GHz)
- h. All readings are Peak Mode value unless otherwise stated AVG in column of Note. If the Peak Mode Measured value compliance with the Peak Limits and lower than AVG Limits, the EUT shall be deemed to meet both Peak & AVG Limits and then only Peak Mode was measured, but AVG Mode didn't perform. (above 1GHz)
- i. For the actual test configuration, please refer to the related Item -EUT Test Photos.

4.2.3 DEVIATION FROM TEST STANDARD

No deviation

4.2.4 TEST SETUP

(A) Radiated Emission Test Set-Up Frequency Below 1 GHz

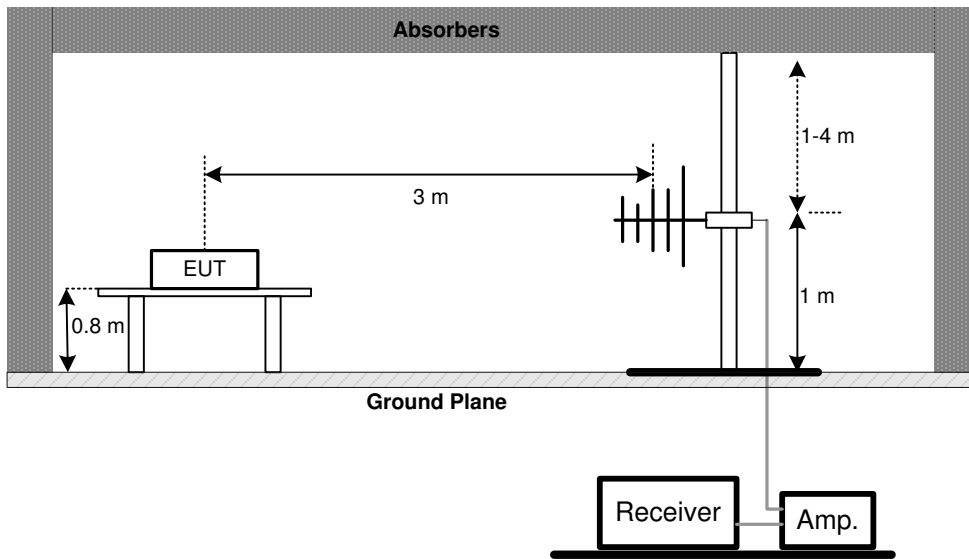

(B) Radiated Emission Test Set-Up Frequency Above 1 GHz

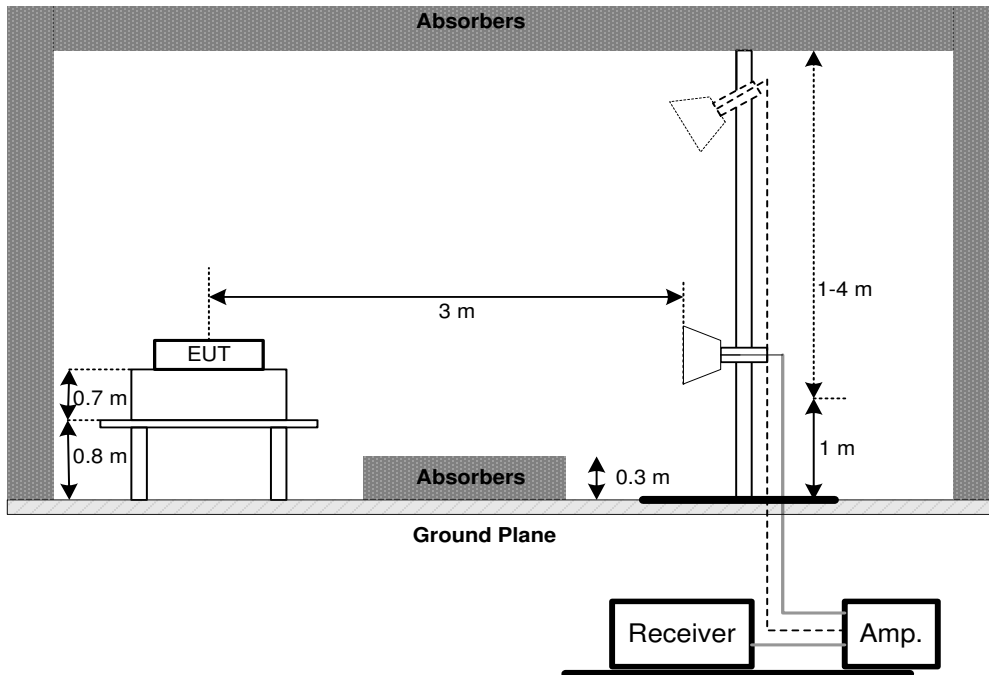

(C) For Radiated Emissions Below 30MHz

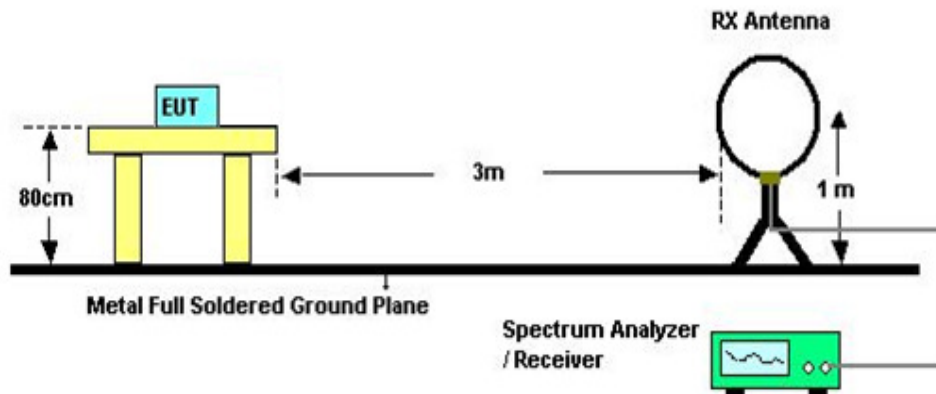

4.2.5 EUT OPERATING CONDITIONS

The EUT was programmed to be in continuously transmitting mode.

4.2.6 EUT TEST CONDITIONS

Temperature: 25°C Relative Humidity: 55% Test Voltage: AC 120V/60Hz

4.2.7 TEST RESULTS (9KHZ TO 30MHZ)

Please refer to the Appendix B

Remark:

- (1) The amplitude of spurious emissions which are attenuated by more than 20 dB below the permissible value has no need to be reported.
- (2) Distance extrapolation factor = $40 \log (\text{specific distance} / \text{test distance})$ (dB).
- (3) Limit line = specific limits (dBuV) + distance extrapolation factor.

4.2.8 TEST RESULTS (30MHZ TO 1000MHZ)

Please refer to the Appendix C.

4.2.9 TEST RESULTS (ABOVE 1000MHZ)

Please refer to the Appendix D.

Remark:

- (1) No limit: This is fundamental signal, the judgment is not applicable.
For fundamental signal judgment was referred to Peak output test.

5. BANDWIDTH TEST

5.1 APPLIED PROCEDURES

FCC Part15 (15.247) , Subpart C			
Section	Test Item	Frequency Range (MHz)	Result
15.247(a)(2)	Bandwidth	2400-2483.5	PASS

5.1.1 TEST PROCEDURE

- a. The EUT was directly connected to the spectrum analyzer and antenna output port as show in the block diagram below,
- b. Spectrum Setting: RBW= 100KHz, VBW=300KHz, Sweep time = 2.5 ms.

5.1.2 DEVIATION FROM STANDARD

No deviation.

5.1.3 TEST SETUP



5.1.4 EUT OPERATION CONDITIONS

The EUT was programmed to be in continuously transmitting mode.

5.1.5 EUT TEST CONDITIONS

Temperature: 25°C Relative Humidity: 55% Test Voltage: AC 120V/60Hz

5.1.6 TEST RESULTS

Please refer to the Appendix E.

6. MAXIMUM PEAK CONDUCTED OUTPUT POWER TEST

6.1 APPLIED PROCEDURES / LIMIT

FCC Part15 (15.247) , Subpart C				
Section	Test Item	Limit	Frequency Range (MHz)	Result
15.247(b)(3)	Maximum Output Power	1 Watt or 30dBm	2400-2483.5	PASS

6.1.1 TEST PROCEDURE

- a. The EUT was directly connected to the power meter and antenna output port as show in the block diagram below,
- b. The maximum peak conducted output power was performed in accordance with method 9.1.2 of FCC KDB 558074 D01 DTS Meas Guidance and FCC KDB 662911 D01 Multiple Transmitter Output.

6.1.2 DEVIATION FROM STANDARD

No deviation.

6.1.3 TEST SETUP

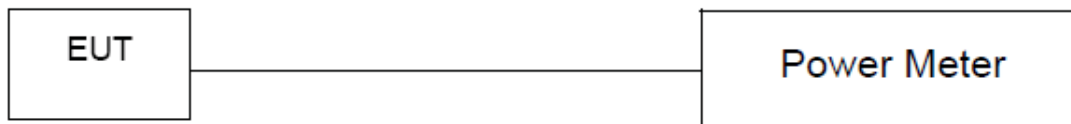

6.1.4 EUT OPERATION CONDITIONS

The EUT was programmed to be in continuously transmitting mode.

6.1.5 EUT TEST CONDITIONS

Temperature: 25°C Relative Humidity: 55% Test Voltage: AC 120V/60Hz

6.1.6 TEST RESULTS

Please refer to the Appendix F.

7. ANTENNA CONDUCTED SPURIOUS EMISSION

7.1 APPLIED PROCEDURES / LIMIT

In any 100 kHz bandwidth outside the frequency band in which the spread spectrum or digitally modulated device is operating, the RF power that is produced shall be at least 20 dB below that in the 100 kHz bandwidth within the band that contains the highest level of the desired power, based on either an RF conducted or a radiated measurement, provided that the transmitter demonstrates compliance with the peak conducted power limits.

7.1.1 TEST PROCEDURE

- a. The EUT was directly connected to the spectrum analyzer and antenna output port as show in the block diagram below,
- b. Spectrum Setting: RBW= 100KHz, VBW=300KHz, Sweep time = Auto.
- c. Offset=antenna gain+cable loss

7.1.2 DEVIATION FROM STANDARD

No deviation.

7.1.3 TEST SETUP



7.1.4 EUT OPERATION CONDITIONS

The EUT was programmed to be in continuously transmitting mode.

7.1.5 EUT TEST CONDITIONS

Temperature: 25°C Relative Humidity: 55% Test Voltage: AC 120V/60Hz

7.1.6 TEST RESULTS

Please refer to the Appendix G.

8. POWER SPECTRAL DENSITY TEST

8.1 APPLIED PROCEDURES / LIMIT

FCC Part15 (15.247) , Subpart C				
Section	Test Item	Limit	Frequency Range (MHz)	Result
15.247(e)	Power Spectral Density	8 dBm (in any 3KHz)	2400-2483.5	PASS

8.1.1 TEST PROCEDURE

- a. The EUT was directly connected to the spectrum analyzer and antenna output port as show in the block diagram below,
- b. Spectrum Setting: RBW=3KHz, VBW=10KHz, Sweep time = Auto.

8.1.2 DEVIATION FROM STANDARD

No deviation.

8.1.3 TEST SETUP

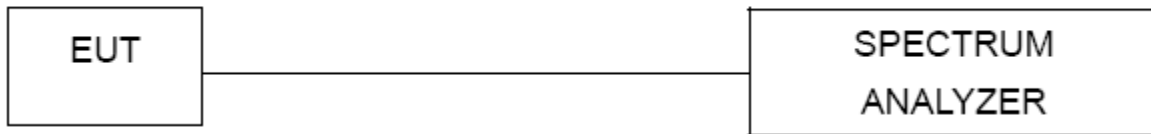

8.1.4 EUT OPERATION CONDITIONS

The EUT was programmed to be in continuously transmitting mode.

8.1.5 EUT TEST CONDITIONS

Temperature: 25°C Relative Humidity: 55% Test Voltage: AC 120V/60Hz

8.1.6 TEST RESULTS

Please refer to the Appendix H.

9. MEASUREMENT INSTRUMENTS LIST

Conducted Emission					
Item	Kind of Equipment	Manufacturer	Type No.	Serial No.	Calibrated until
1	EMI Test Receiver	R&S	ESCI	100382	Mar. 26, 2018
2	LISN	EMCO	3816/2	52765	Mar. 26, 2018
3	50Ω Terminator	SHX	TF2-3G-A	8122901	Mar. 26, 2018
4	TWO-LINE V-NETWORK	R&S	ENV216	101447	Mar. 26, 2018
5	Cable	N/A	RG223	12m	Oct. 20, 2017
6	Measurement Software	Farad	EZ-EMC Ver.NB-03A1-01	N/A	N/A

Radiated Emission Below 1GHz					
Item	Kind of Equipment	Manufacturer	Type No.	Serial No.	Calibrated until
1	Antenna	Schwarzbeck	VULB9160	9160-3232	Mar. 26, 2018
2	Amplifier	HP	8447D	2944A09673	Oct. 20, 2017
3	Receiver	Agilent	N9038A	MY52130039	Sep. 04, 2017
4	Cable	emci	LMR-400(30MHz-1 GHz)(8m+5m)	N/A	Jun. 26, 2018
5	Controller	CT	SC100	N/A	N/A
6	Controller	MF	MF-7802	MF780208416	N/A
7	Measurement Software	Farad	EZ-EMC Ver.NB-03A1-01	N/A	N/A

Radiated Emission Above 1GHz					
Item	Kind of Equipment	Manufacturer	Type No.	Serial No.	Calibrated until
1	Double Ridged Guide Antenna	ETS	3115	75789	Mar. 26, 2018
2	Broad-Band Horn Antenna	Schwarzbeck	BBHA 9170	9170319	Jun. 08, 2018
3	Amplifier	Agilent	8449B	3008A02274	May. 16, 2018
4	Microwave Preamplifier With Adaptor	EMC INSTRUMENT	EMC2654045	980039 & HA01	Mar. 26, 2018
5	Receiver	Agilent	N9038A	MY52130039	Sep. 04, 2017
6	Antenna	EM	EM-6876-1	230	Jul. 07, 2018
7	Controller	CT	SC100	N/A	N/A
8	Controller	MF	MF-7802	MF780208416	N/A
9	Cable	emci	EMC104-SM-SM-1 2000(12m)	N/A	Jun. 26, 2018
10	Measurement Software	Farad	EZ-EMC Ver.NB-03A1-01	N/A	N/A

6dB Bandwidth					
Item	Kind of Equipment	Manufacturer	Type No.	Serial No.	Calibrated until
1	Spectrum Analyzer	R&S	FSP40	100185	Sep. 04, 2017

Peak Output Power					
Item	Kind of Equipment	Manufacturer	Type No.	Serial No.	Calibrated until
1	Power Meter	ANRITSU	ML2495A	1128009	Mar. 26, 2018
2	Pulse Power Sensor	ANRITSU	MA 2411B	1027500	Mar. 26, 2018

Antenna Conducted Spurious Emission					
Item	Kind of Equipment	Manufacturer	Type No.	Serial No.	Calibrated until
1	Spectrum Analyzer	R&S	FSP40	100185	Sep. 04, 2017

Power Spectral Density					
Item	Kind of Equipment	Manufacturer	Type No.	Serial No.	Calibrated until
1	Spectrum Analyzer	R&S	FSP40	100185	Sep. 04, 2017

Remark: "N/A" denotes no model name, serial no. or calibration specified.
 All calibration period of equipment list is one year.

APPENDIX A - CONDUCTED EMISSION

Test Mode : Normal Link (Adapter:Huntkey)

Line

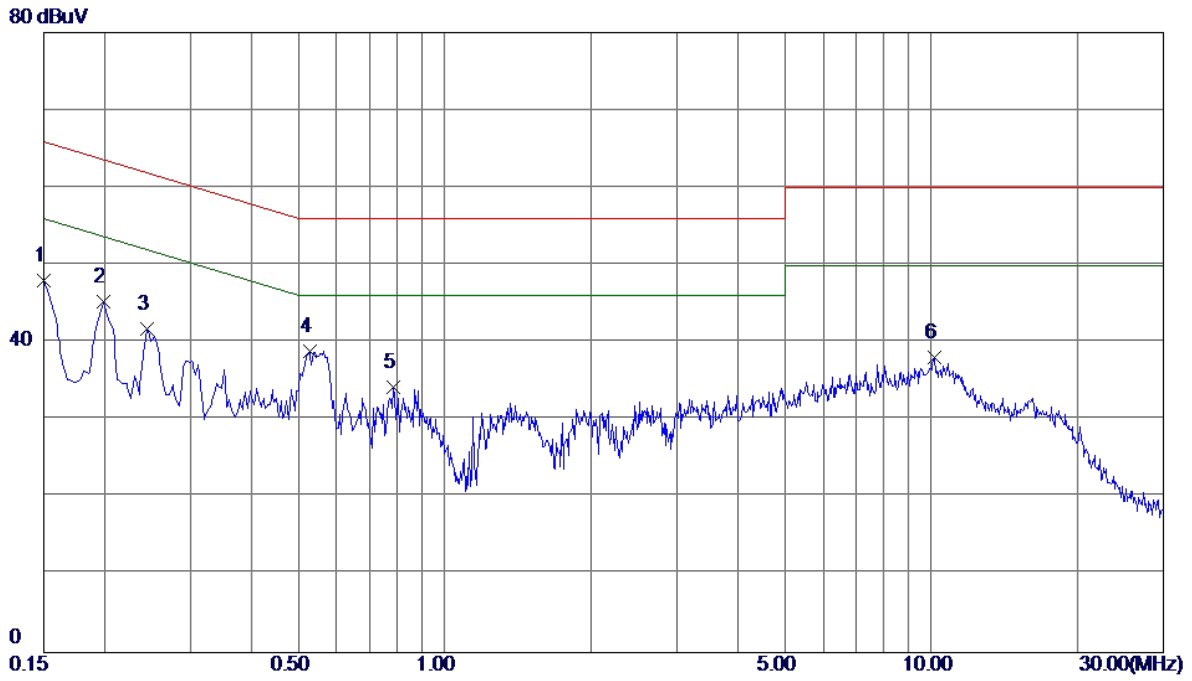

No.	Freq. MHz	Reading Level dBuV	Correct Factor dB	Measure ment dBuV	Limit dBuV	Margin dB	Detector	Comment
1	0.1500	38.17	9.79	47.96	66.00	-18.04	Peak	
2	0.1995	35.54	9.76	45.30	63.63	-18.33	Peak	
3	0.2445	32.03	9.76	41.79	61.94	-20.15	Peak	
4 *	0.5280	29.04	9.80	38.84	56.00	-17.16	Peak	
5	0.7845	24.37	9.82	34.19	56.00	-21.81	Peak	
6	10.1670	27.75	10.33	38.08	60.00	-21.92	Peak	

Test Mode : Normal Link (Adapter:Huntkey)

Neutral

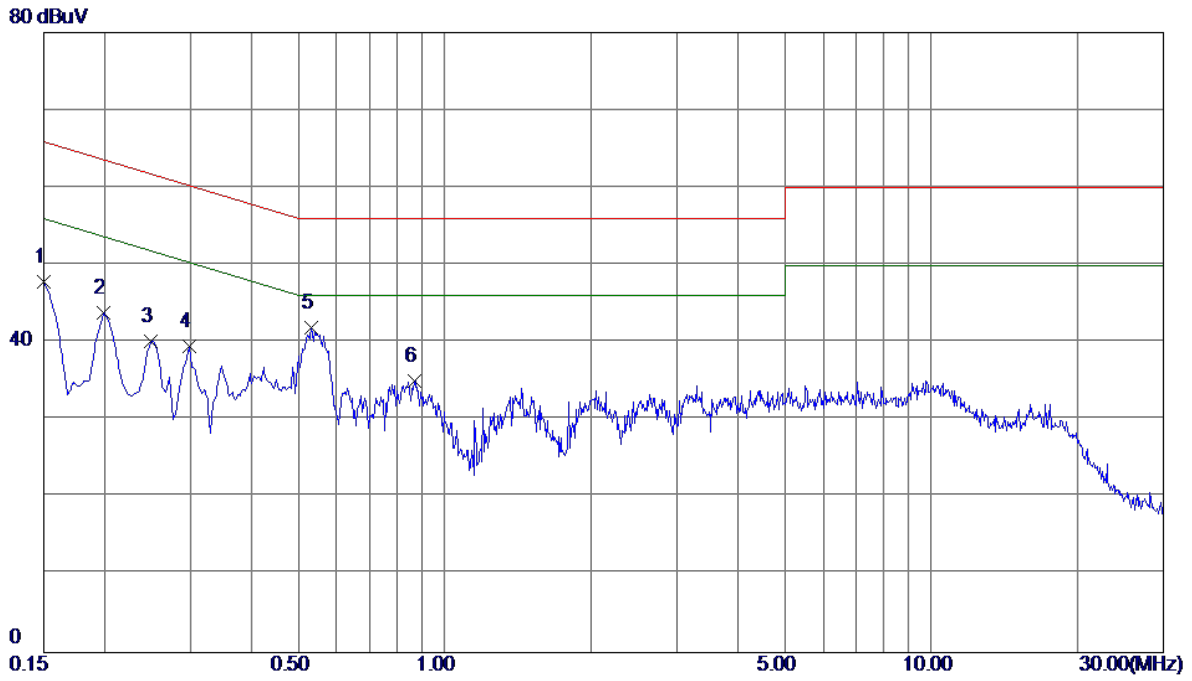

No.	Freq. MHz	Reading Level dBuV	Correct Factor dB	Measure ment dBuV	Limit dBuV	Margin dB	Detector	Comment
1	0.1500	38.24	9.68	47.92	66.00	-18.08	Peak	
2	0.1995	34.22	9.69	43.91	63.63	-19.72	Peak	
3	0.2490	30.44	9.67	40.11	61.79	-21.68	Peak	
4	0.2985	29.81	9.68	39.49	60.28	-20.79	Peak	
5 *	0.5325	32.20	9.70	41.90	56.00	-14.10	Peak	
6	0.8655	25.27	9.73	35.00	56.00	-21.00	Peak	

Test Mode : Normal Link (Adapter:XinQiao)

Line

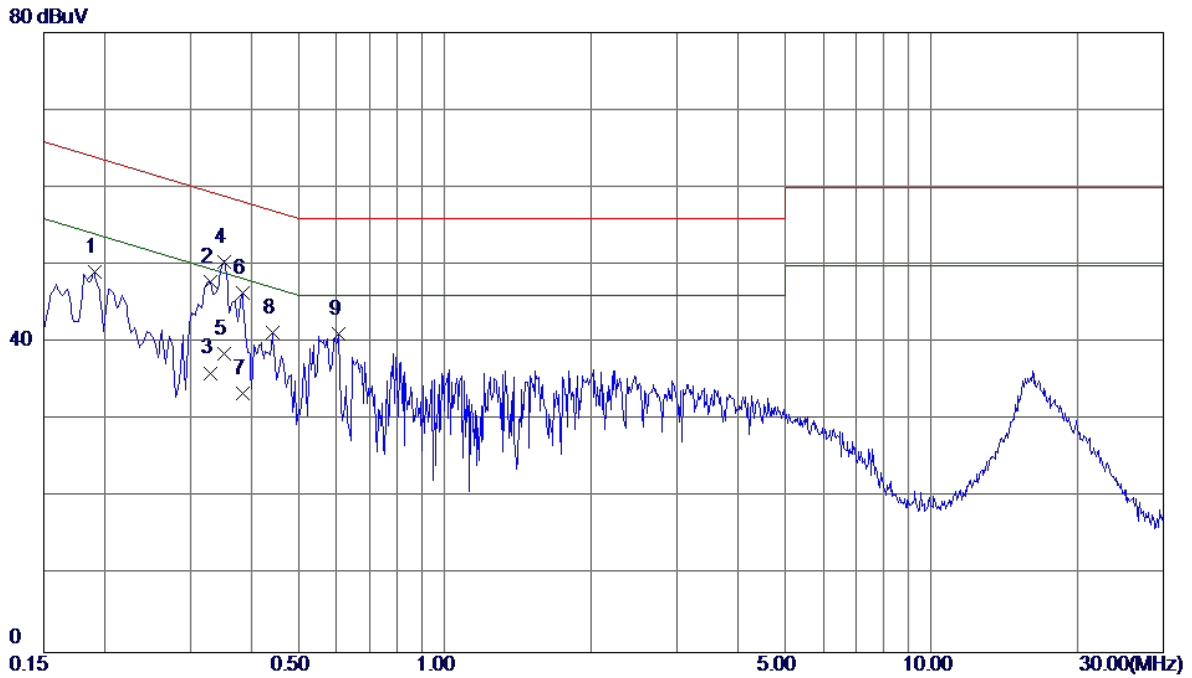

No.	Freq. MHz	Reading Level dBuV	Correct Factor dB	Measure ment dBuV	Limit dBuV	Margin dB	Detector	Comment
1	0.1905	39.29	9.77	49.06	64.01	-14.95	Peak	
2	0.3300	38.12	9.78	47.90	59.45	-11.55	Peak	
3	0.3300	26.30	9.78	36.08	49.45	-13.37	AVG	
4 *	0.3525	40.69	9.79	50.48	58.90	-8.42	Peak	
5	0.3525	28.80	9.79	38.59	48.90	-10.31	AVG	
6	0.3840	36.66	9.79	46.45	58.19	-11.74	Peak	
7	0.3840	23.60	9.79	33.39	48.19	-14.80	AVG	
8	0.4425	31.54	9.80	41.34	57.01	-15.67	Peak	
9	0.6044	31.24	9.81	41.05	56.00	-14.95	Peak	

Test Mode : Normal Link (Adapter:XinQiao)

Neutral

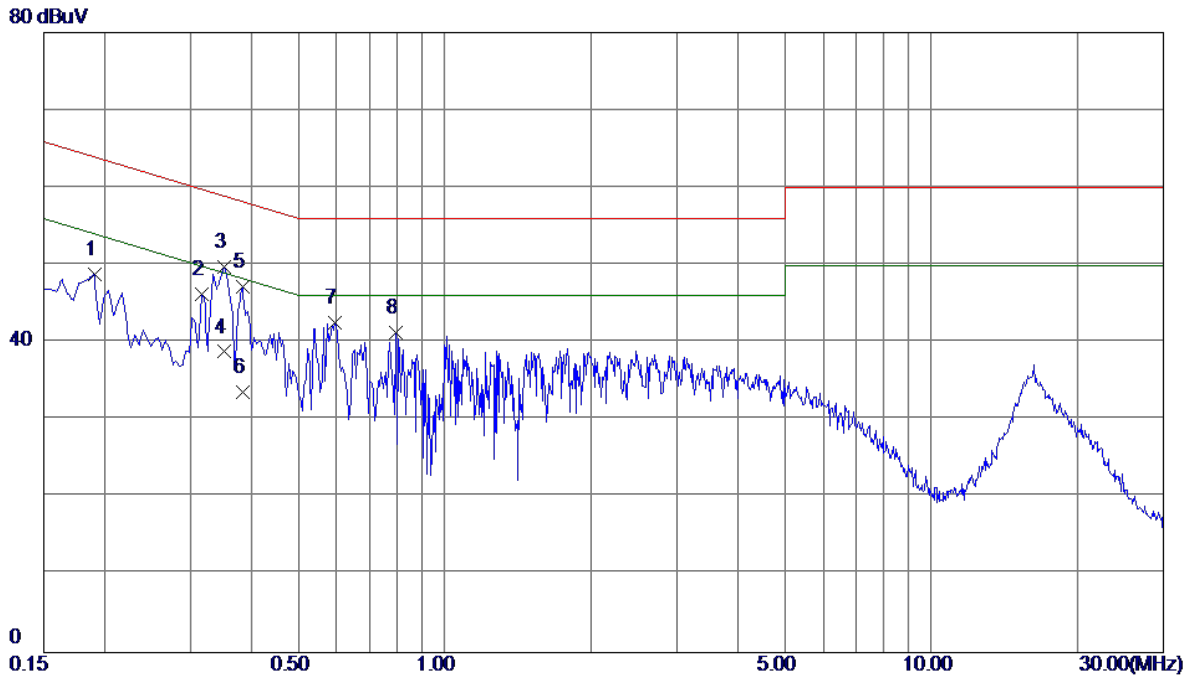

No.	Freq. MHz	Reading Level dBuV	Correct Factor dB	Measure ment dBuV	Limit dBuV	Margin dB	Detector	Comment
1	0.1905	39.16	9.69	48.85	64.01	-15.16	Peak	
2	0.3165	36.54	9.68	46.22	59.80	-13.58	Peak	
3 *	0.3525	40.10	9.70	49.80	58.90	-9.10	Peak	
4	0.3525	29.10	9.70	38.80	48.90	-10.10	AVG	
5	0.3840	37.48	9.69	47.17	58.19	-11.02	Peak	
6	0.3840	23.90	9.69	33.59	48.19	-14.60	AVG	
7	0.5955	32.83	9.71	42.54	56.00	-13.46	Peak	
8	0.7935	31.61	9.72	41.33	56.00	-14.67	Peak	

APPENDIX B - RADIATED EMISSION (9KHZ TO 30MHZ)

Test Mode: TX B MODE CHANNEL 01 (Adapter:Huntkey)

Ant 0°

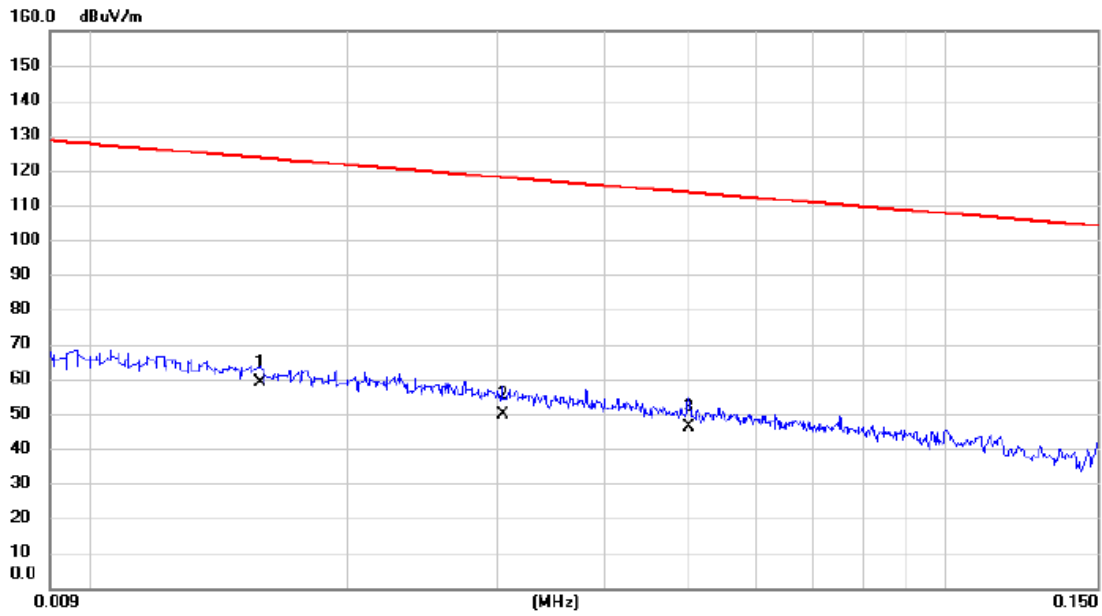

No.	Mk.	Freq. MHz	Reading Level dBuV	Correct Factor dB	Measure- ment dBuV/m	Limit dBuV/m	Margin dB	Detector	Comment
1	*	0.016	38.64	20.17	58.81	123.63	-64.82	AVG	
2		0.030	30.46	19.31	49.77	117.95	-68.18	AVG	
3		0.050	27.68	18.72	46.40	113.61	-67.21	AVG	

Test Mode: TX B MODE CHANNEL 01 (Adapter:Huntkey)

Ant 0°

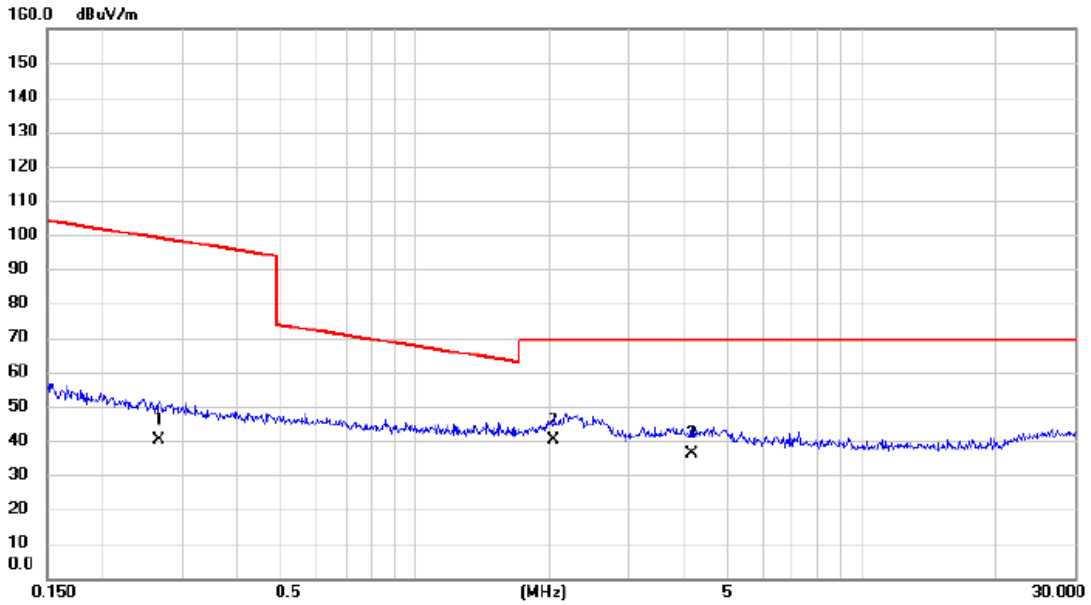

No.	Mk.	Freq. MHz	Reading Level dBuV	Correct Factor dB	Measure- ment dBuV/m	Limit dBuV/m	Margin dB	Detector	Comment
1		0.267	23.68	16.65	40.33	99.07	-58.74	AVG	
2	*	2.044	24.86	15.50	40.36	69.54	-29.18	QP	
3		4.157	21.49	14.86	36.35	69.54	-33.19	QP	

Test Mode: TX B MODE CHANNEL 01 (Adapter:Huntkey)

Ant 90°

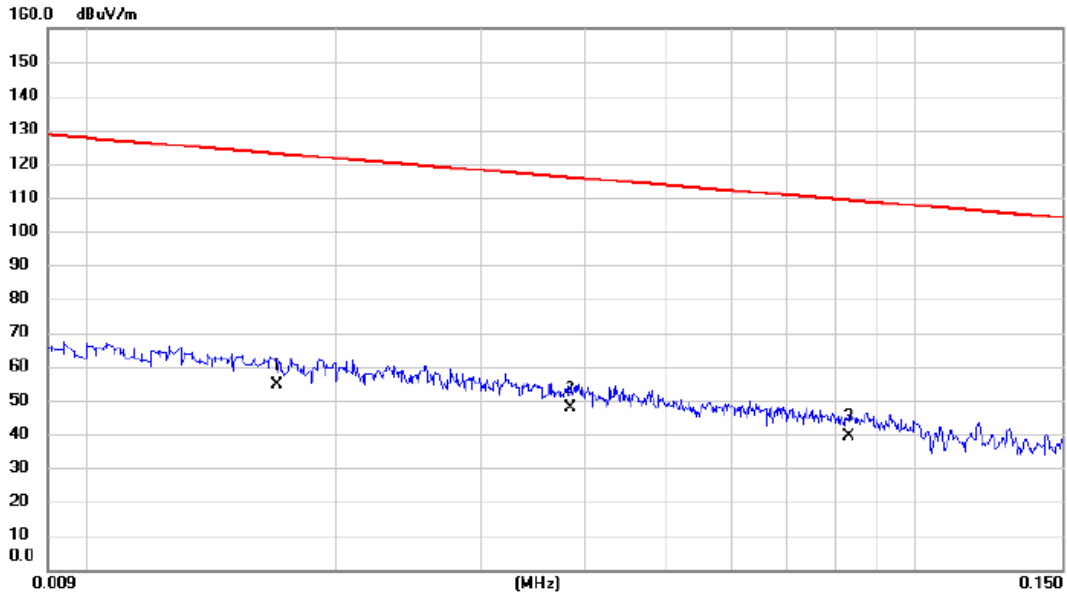

No. Mk.	Freq. MHz	Reading Level dBuV	Correct Factor dB	Measurement dBuV/m	Limit dBuV/m	Margin dB	Detector	Comment
1	0.017	34.65	20.01	54.66	123.00	-68.34	AVG	
2 *	0.038	28.64	19.07	47.71	115.92	-68.21	AVG	
3	0.083	21.40	18.04	39.44	109.22	-69.78	AVG	

Test Mode: TX B MODE CHANNEL 01 (Adapter:Huntkey)

Ant 90°

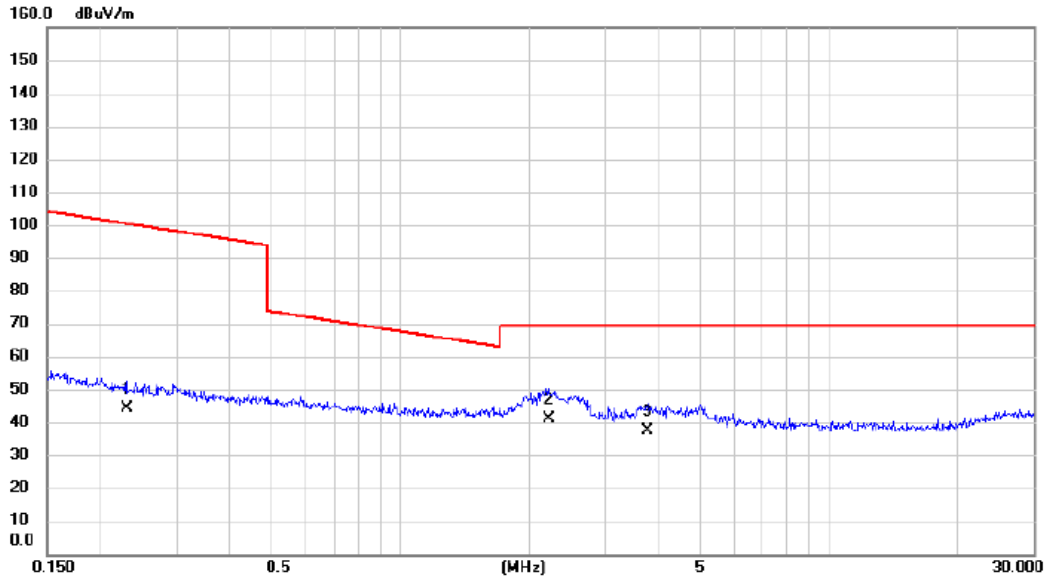

No.	Mk.	Freq.	Reading Level	Correct Factor	Measurement	Limit	Margin	Detector	Comment
		MHz	dBuV	dB	dBuV/m	dBuV/m	dB		
1		0.230	27.49	16.71	44.20	100.36	-56.16	AVG	
2	*	2.213	25.61	15.45	41.06	69.54	-28.48	QP	
3		3.779	22.43	15.02	37.45	69.54	-32.09	QP	

Test Mode: TX B MODE CHANNEL 01 (Adapter:XinQiao)

Ant 0°

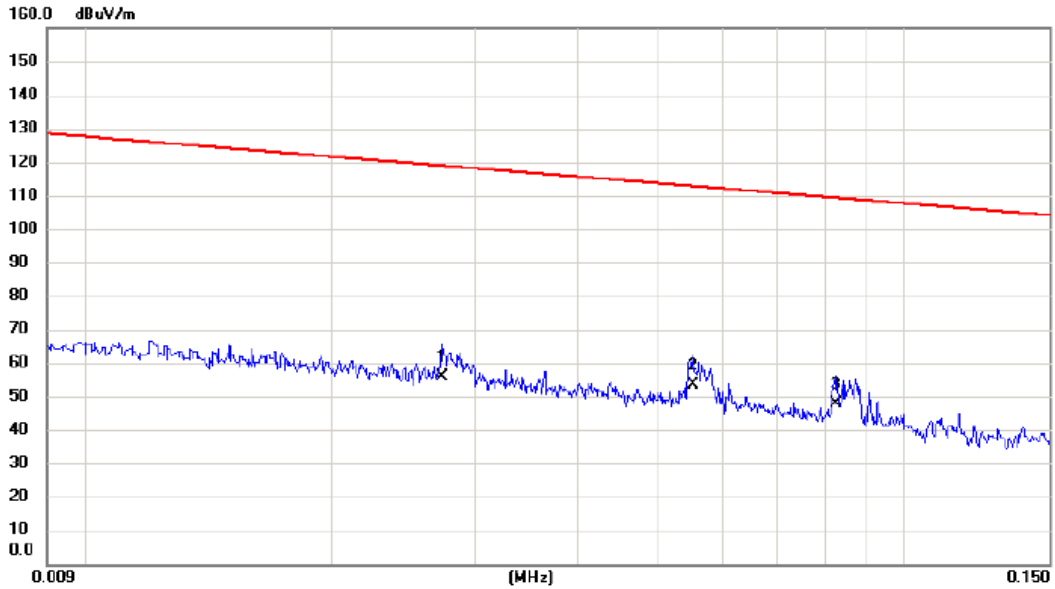

No. Mk.	Freq. MHz	Reading Level dBuV	Correct Factor dB	Measurement dBuV/m	Limit dBuV/m	Margin dB	Detector	Comment
1	0.0273	36.57	19.40	55.97	118.88	-62.91	AVG	
2 *	0.0553	34.59	18.62	53.21	112.75	-59.54	AVG	
3	0.0824	29.67	18.05	47.72	109.29	-61.57	AVG	

Test Mode: TX B MODE CHANNEL 01 (Adapter:XinQiao)

Ant 0°

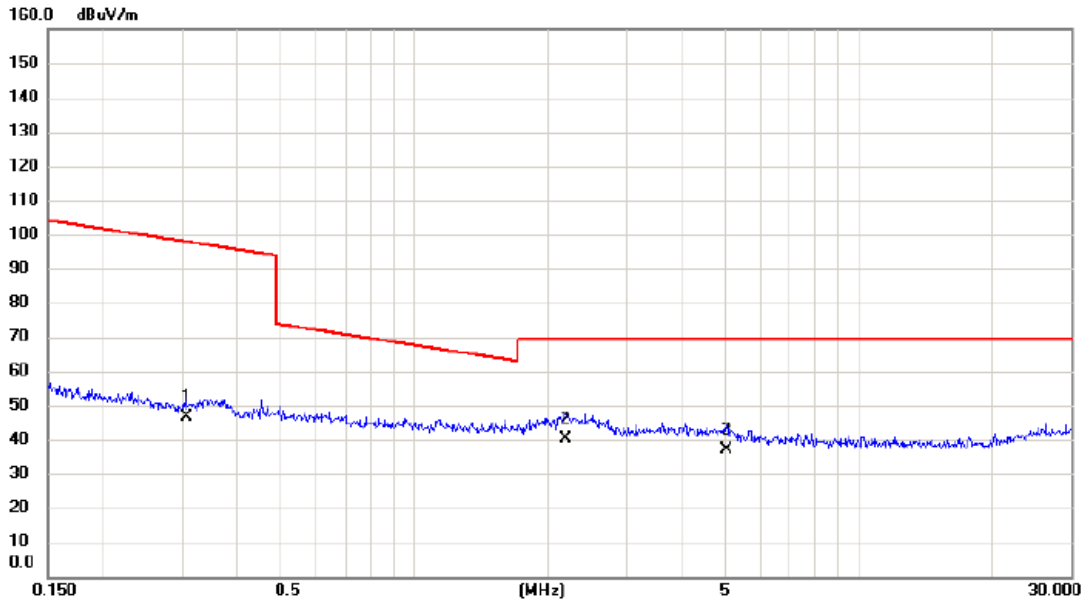

No.	Mk.	Freq. MHz	Reading Level dBuV	Correct Factor dB	Measure- ment dBuV/m	Limit dBuV/m	Margin dB	Detector	Comment
1		0.3067	29.84	16.61	46.45	97.87	-51.42	AVG	
2	*	2.1898	24.57	15.45	40.02	69.54	-29.52	QP	
3		5.0312	22.61	14.37	36.98	69.54	-32.56	QP	

Test Mode: TX B MODE CHANNEL 01(Adapter:XinQiao)

Ant 90°

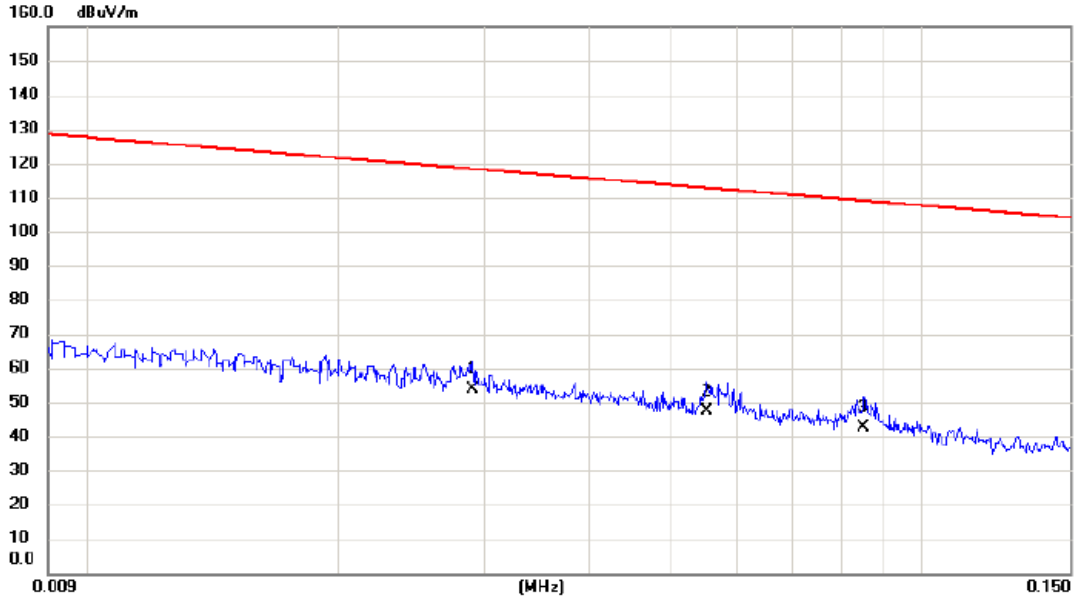

No.	Mk.	Freq. MHz	Reading Level dBuV	Correct Factor dB	Measure- ment dBuV/m	Limit dBuV/m	Margin dB	Detector	Comment
1	*	0.0290	34.59	19.35	53.94	118.36	-64.42	AVG	
2		0.0553	28.67	18.62	47.29	112.75	-65.46	AVG	
3		0.0851	24.63	17.99	42.62	109.01	-66.39	AVG	

Test Mode: TX B MODE CHANNEL 01(Adapter:XinQiao)

Ant 90°

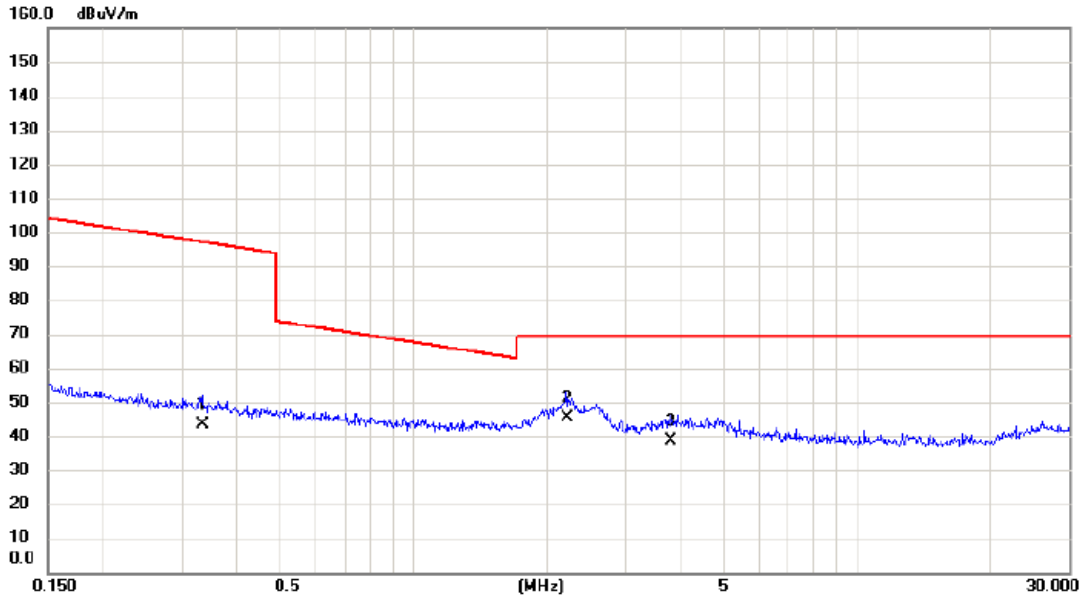

No.	Mk.	Freq. MHz	Reading Level dBuV	Correct Factor dB	Measure- ment dBuV/m	Limit dBuV/m	Margin dB	Detector	Comment
1		0.3338	26.94	16.59	43.53	97.14	-53.61	AVG	
2	*	2.2132	29.84	15.45	45.29	69.54	-24.25	QP	
3		3.7994	23.68	15.01	38.69	69.54	-30.85	QP	

APPENDIX C - RADIATED EMISSION (30MHZ TO 1000MHZ)

Test Mode: TX B MODE CHANNEL 01 (Adapter:Huntkey)

Vertical

80 dBuV/m

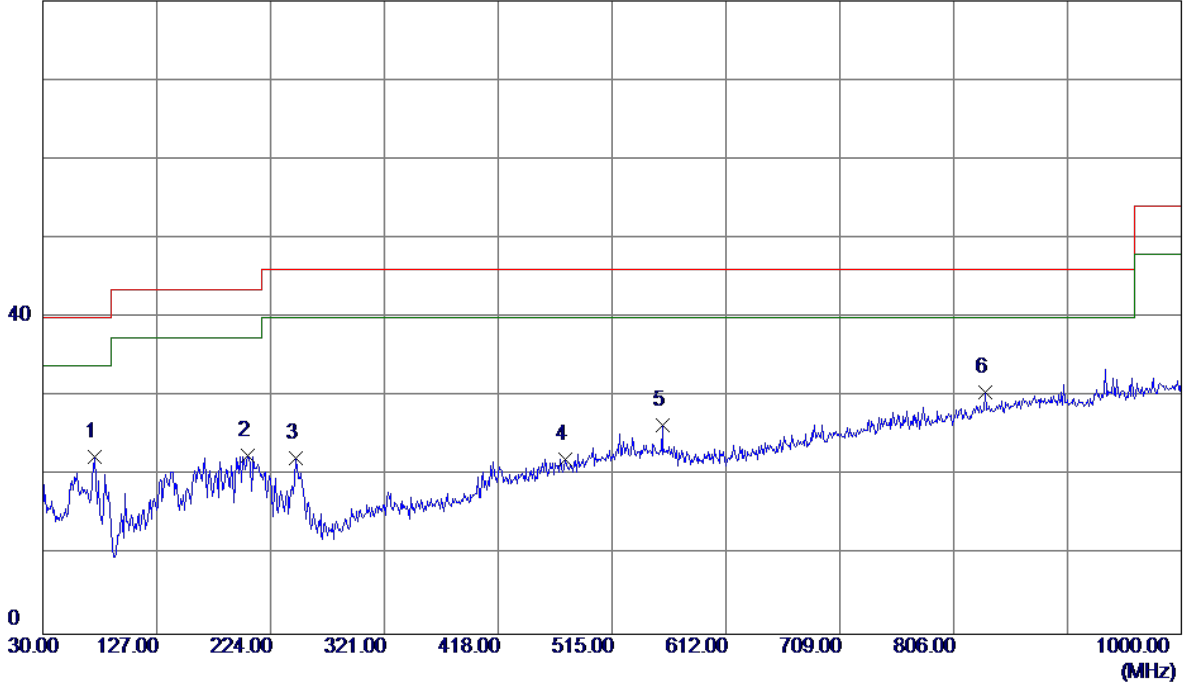

No.	Freq. MHz	Reading Level dBuV/m	Correct Factor dB	Measure ment dBuV/m	Limit dBuV/m	Margin dB	Detector	Comment
1	74.6200	39.42	-17.04	22.38	40.00	-17.62	Peak	
2	204.6000	36.46	-13.85	22.61	43.50	-20.89	Peak	
3	245.3400	36.83	-14.64	22.19	46.00	-23.81	Peak	
4	475.2300	31.42	-9.32	22.10	46.00	-23.90	Peak	
5	557.6800	33.92	-7.52	26.40	46.00	-19.60	Peak	
6 *	833.1599	30.97	-0.46	30.51	46.00	-15.49	Peak	

Test Mode: TX B MODE CHANNEL 01 (Adapter:Huntkey)

Horizontal

80 dBuV/m

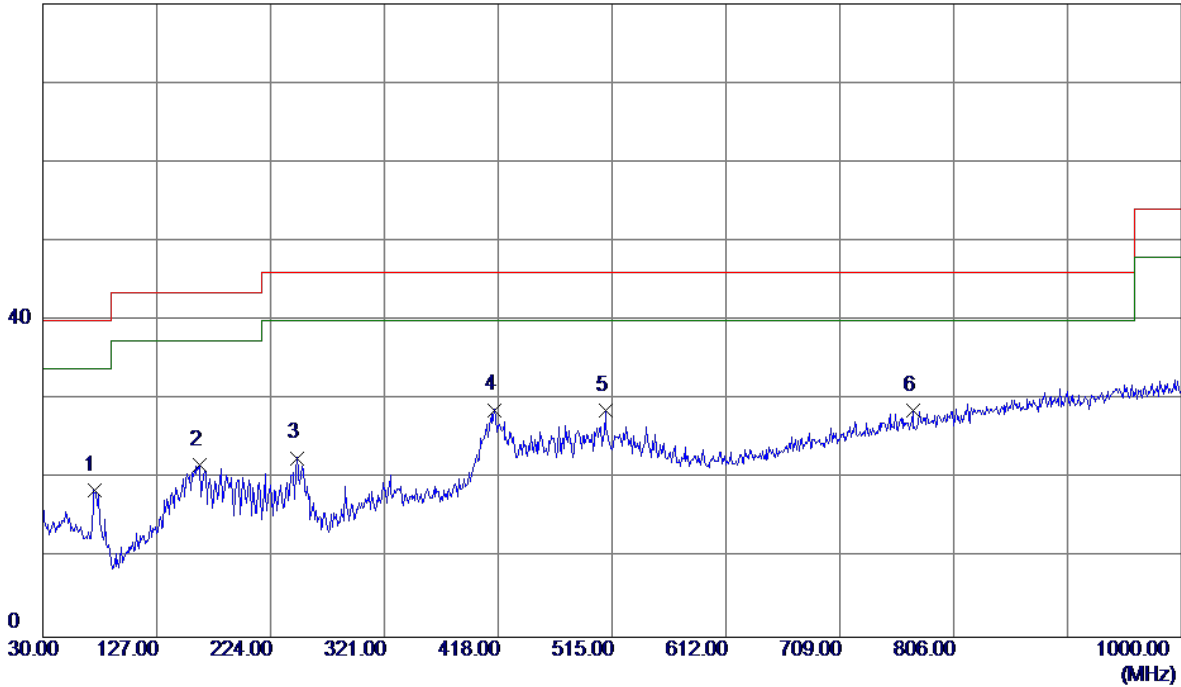

No.	Freq. MHz	Reading Level dBuV/m	Correct Factor dB	Measure ment dBuV/m	Limit dBuV/m	Margin dB	Detector	Comment
1	73.6500	35.44	-16.93	18.51	40.00	-21.49	Peak	
2	163.8600	34.46	-12.70	21.76	43.50	-21.74	Peak	
3	246.3100	37.33	-14.69	22.64	46.00	-23.36	Peak	
4 *	415.0900	39.65	-10.93	28.72	46.00	-17.28	Peak	
5	509.1800	37.16	-8.54	28.62	46.00	-17.38	Peak	
6	771.0800	30.57	-1.99	28.58	46.00	-17.42	Peak	

Test Mode: TX B MODE CHANNEL 06 (Adapter:Huntkey)

Vertical

80 dBuV/m

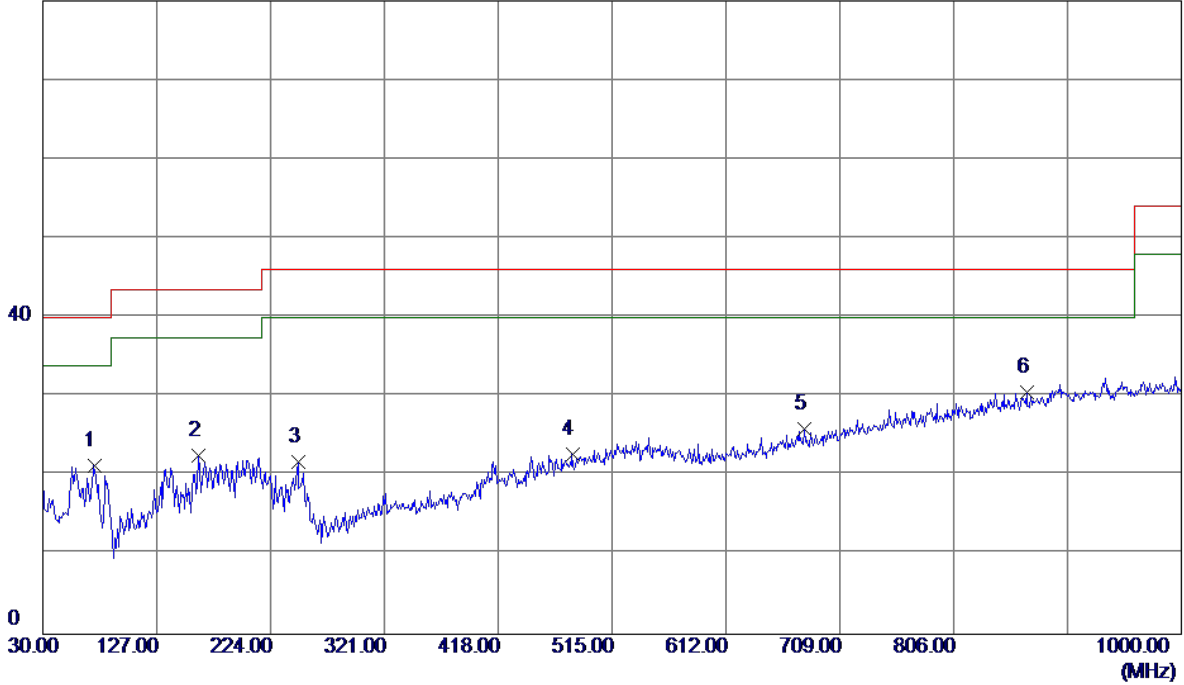

No.	Freq. MHz	Reading Level dBuV/m	Correct Factor dB	Measure ment dBuV/m	Limit dBuV/m	Margin dB	Detector	Comment
1	73.6500	38.25	-16.93	21.32	40.00	-18.68	Peak	
2	162.8900	35.36	-12.76	22.60	43.50	-20.90	Peak	
3	247.2800	36.47	-14.74	21.73	46.00	-24.27	Peak	
4	481.0500	31.84	-9.18	22.66	46.00	-23.34	Peak	
5	678.9300	30.56	-4.59	25.97	46.00	-20.03	Peak	
6 *	868.0800	30.25	0.37	30.62	46.00	-15.38	Peak	

Test Mode: TX B MODE CHANNEL 06 (Adapter:Huntkey)

Horizontal

80 dBuV/m

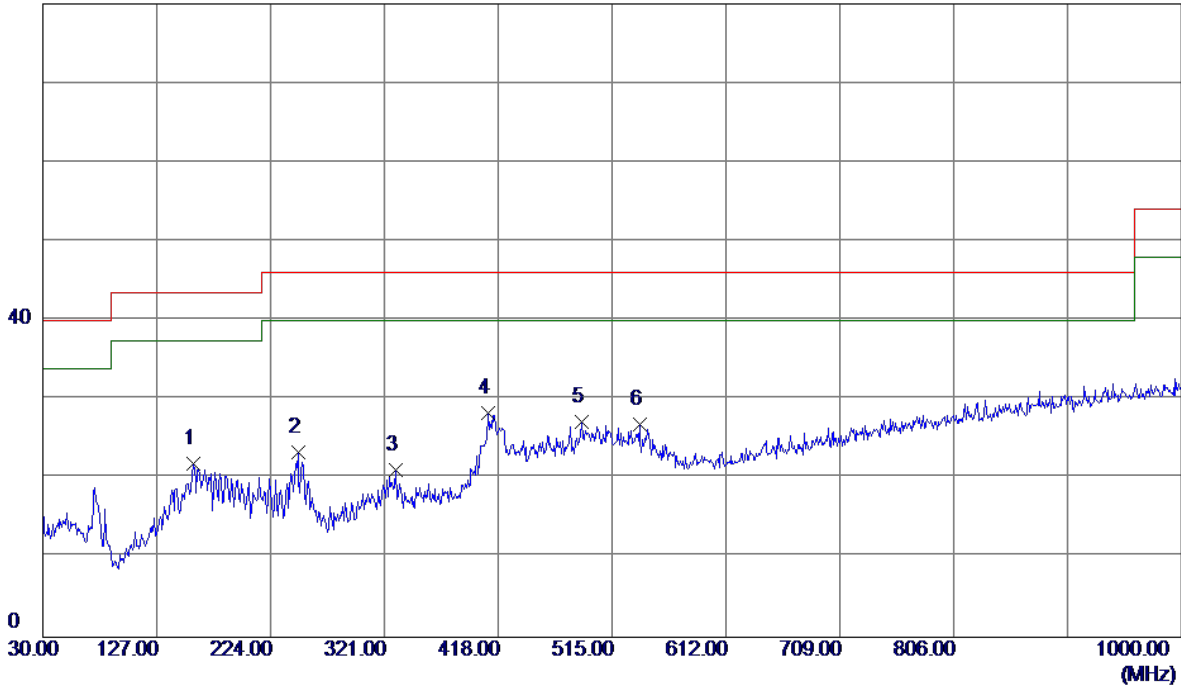

No.	Freq. MHz	Reading Level dBuV/m	Correct Factor dB	Measure ment dBuV/m	Limit dBuV/m	Margin dB	Detector	Comment
1	158.0399	35.01	-13.05	21.96	43.50	-21.54	Peak	
2	247.2800	38.06	-14.74	23.32	46.00	-22.68	Peak	
3	330.7000	33.44	-12.29	21.15	46.00	-24.85	Peak	
4 *	409.2700	39.49	-11.10	28.39	46.00	-17.61	Peak	
5	488.8100	36.12	-8.99	27.13	46.00	-18.87	Peak	
6	538.2800	34.90	-7.95	26.95	46.00	-19.05	Peak	

Test Mode: TX B MODE CHANNEL 11 (Adapter:Huntkey)

Vertical

80 dBuV/m

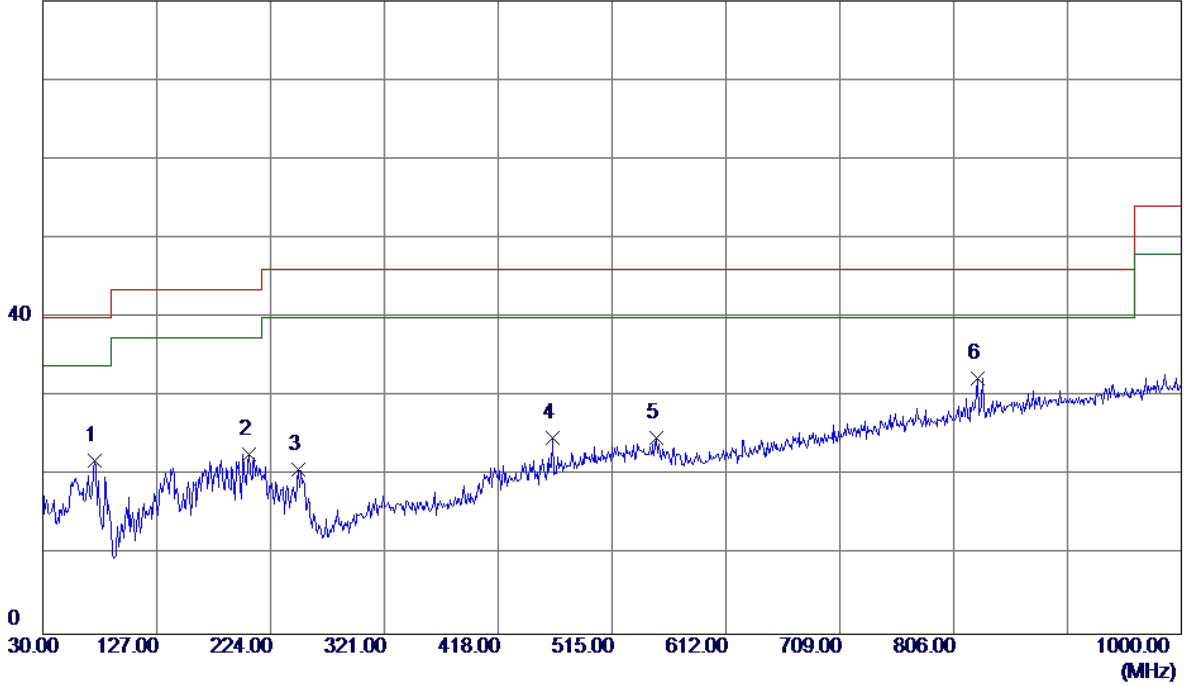

No.	Freq. MHz	Reading Level dBuV/m	Correct Factor dB	Measure ment dBuV/m	Limit dBuV/m	Margin dB	Detector	Comment
1	74.6200	38.96	-17.04	21.92	40.00	-18.08	Peak	
2	205.5700	36.66	-13.88	22.78	43.50	-20.72	Peak	
3	247.2800	35.58	-14.74	20.84	46.00	-25.16	Peak	
4	464.5600	34.31	-9.58	24.73	46.00	-21.27	Peak	
5	552.8300	32.51	-7.64	24.87	46.00	-21.13	Peak	
6 *	826.3700	32.91	-0.64	32.27	46.00	-13.73	Peak	

Test Mode: TX B MODE CHANNEL 11 (Adapter:Huntkey)

Horizontal

80 dBuV/m

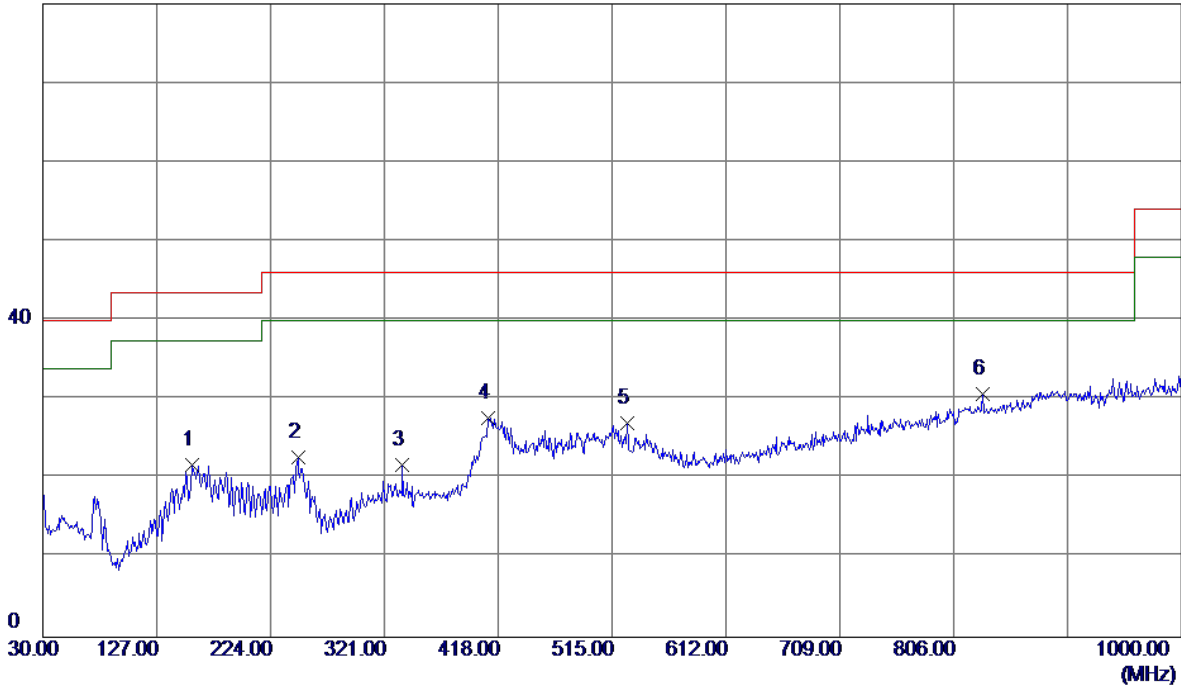

No.	Freq. MHz	Reading Level dBuV/m	Correct Factor dB	Measure ment dBuV/m	Limit dBuV/m	Margin dB	Detector	Comment
1	157.0700	34.84	-13.10	21.74	43.50	-21.76	Peak	
2	247.2800	37.53	-14.74	22.79	46.00	-23.21	Peak	
3	336.5200	33.89	-12.19	21.70	46.00	-24.30	Peak	
4	409.2700	38.79	-11.10	27.69	46.00	-18.31	Peak	
5	527.6100	35.17	-8.17	27.00	46.00	-19.00	Peak	
6 *	831.2199	31.28	-0.51	30.77	46.00	-15.23	Peak	

Test Mode: TX B MODE CHANNEL 01 (Adapter:XinQiao)

Vertical

80 dBuV/m

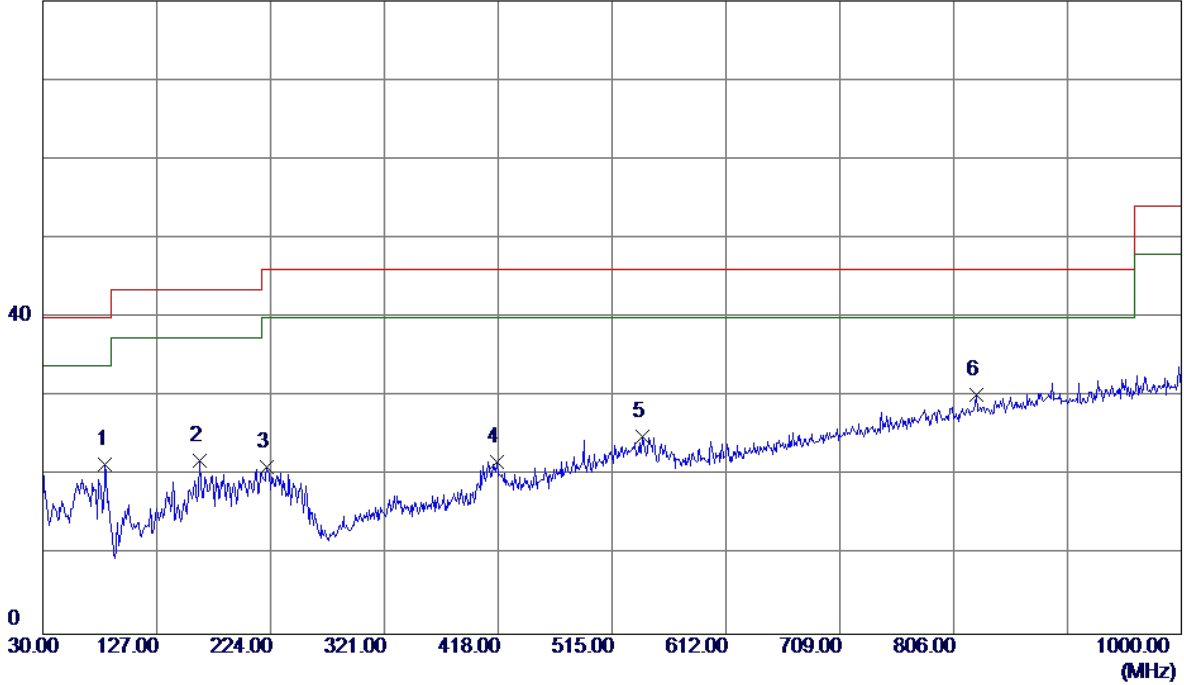

No.	Freq. MHz	Reading Level dBuV/m	Correct Factor dB	Measure ment dBuV/m	Limit dBuV/m	Margin dB	Detector	Comment
1	83.3500	39.76	-18.34	21.42	40.00	-18.58	Peak	
2	163.8600	34.64	-12.70	21.94	43.50	-21.56	Peak	
3	221.0900	35.00	-13.93	21.07	46.00	-24.93	Peak	
4	417.0300	32.59	-10.88	21.71	46.00	-24.29	Peak	
5	541.1900	32.90	-7.89	25.01	46.00	-20.99	Peak	
6 *	825.4000	30.97	-0.67	30.30	46.00	-15.70	Peak	

Test Mode: TX B MODE CHANNEL 01 (Adapter:XinQiao)

Horizontal

80 dBuV/m

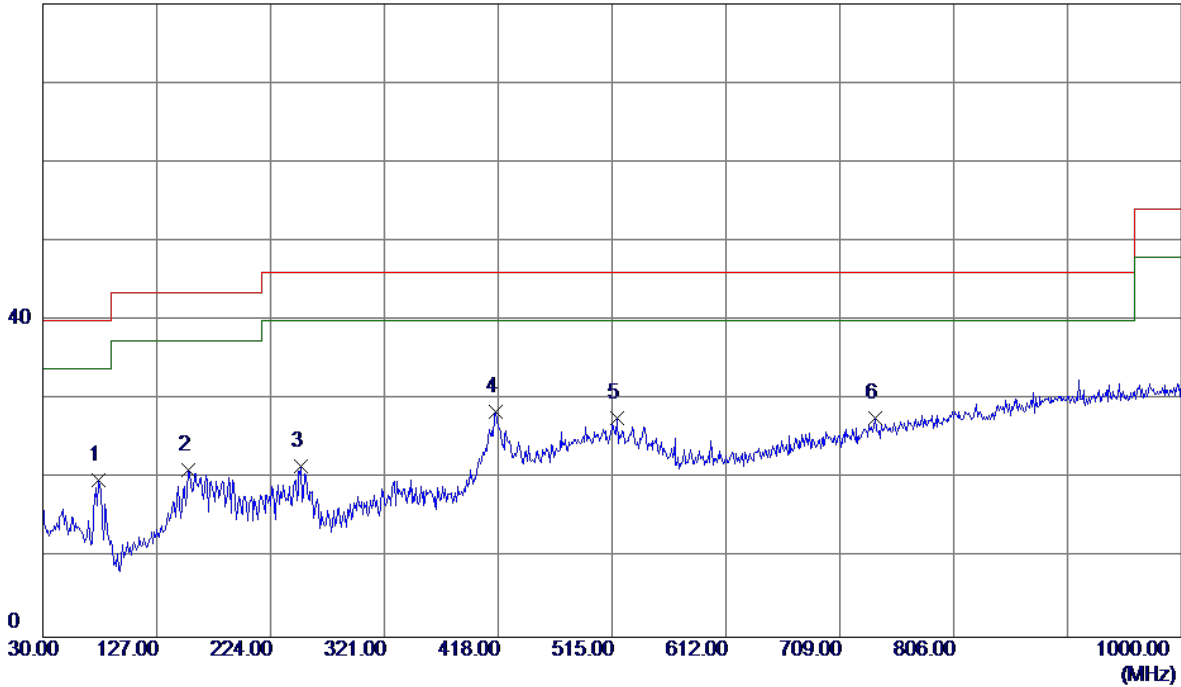

No.	Freq. MHz	Reading Level dBuV/m	Correct Factor dB	Measure ment dBuV/m	Limit dBuV/m	Margin dB	Detector	Comment
1	77.5300	37.54	-17.67	19.87	40.00	-20.13	Peak	
2	154.1600	34.35	-13.28	21.07	43.50	-22.43	Peak	
3	250.1900	36.47	-14.90	21.57	46.00	-24.43	Peak	
4 *	416.0600	39.42	-10.90	28.52	46.00	-17.48	Peak	
5	518.8800	36.08	-8.34	27.74	46.00	-18.26	Peak	
6	739.0700	30.41	-2.77	27.64	46.00	-18.36	Peak	

Test Mode: TX B MODE CHANNEL 06 (Adapter:XinQiao)

Vertical

80 dBuV/m

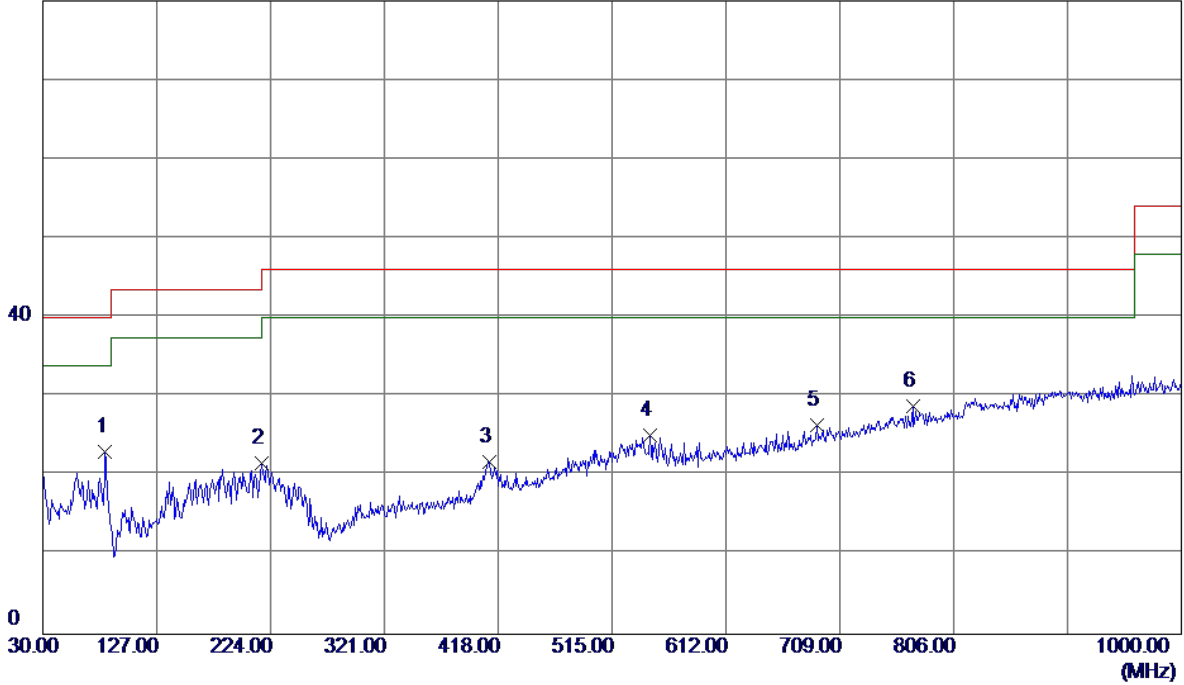

No.	Freq. MHz	Reading Level dBuV/m	Correct Factor dB	Measure ment dBuV/m	Limit dBuV/m	Margin dB	Detector	Comment
1 *	83.3500	41.36	-18.34	23.02	40.00	-16.98	Peak	
2	216.2400	35.57	-13.93	21.64	46.00	-24.36	Peak	
3	410.2400	32.87	-11.07	21.80	46.00	-24.20	Peak	
4	547.0100	32.93	-7.78	25.15	46.00	-20.85	Peak	
5	689.6000	30.62	-4.26	26.36	46.00	-19.64	Peak	
6	771.0800	30.83	-1.99	28.84	46.00	-17.16	Peak	

Test Mode: TX B MODE CHANNEL 06 (Adapter:XinQiao)

Horizontal

80 dBuV/m

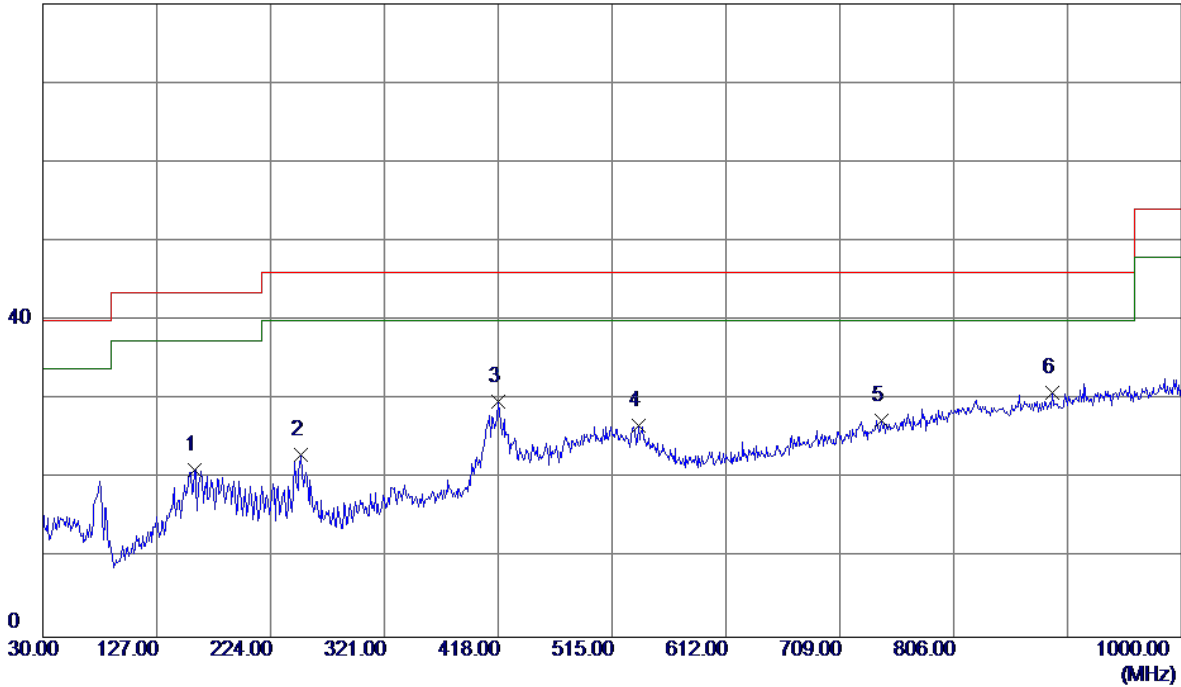

No.	Freq. MHz	Reading Level dBuV/m	Correct Factor dB	Measure ment dBuV/m	Limit dBuV/m	Margin dB	Detector	Comment
1	159.0100	34.16	-12.99	21.17	43.50	-22.33	Peak	
2	250.1900	37.91	-14.90	23.01	46.00	-22.99	Peak	
3	418.0000	40.60	-10.85	29.75	46.00	-16.25	Peak	
4	537.3100	34.69	-7.97	26.72	46.00	-19.28	Peak	
5	744.8900	30.02	-2.60	27.42	46.00	-18.58	Peak	
6 *	890.3900	30.12	0.83	30.95	46.00	-15.05	Peak	

Test Mode: TX B MODE CHANNEL 11 (Adapter:XinQiao)

Vertical

80 dBuV/m

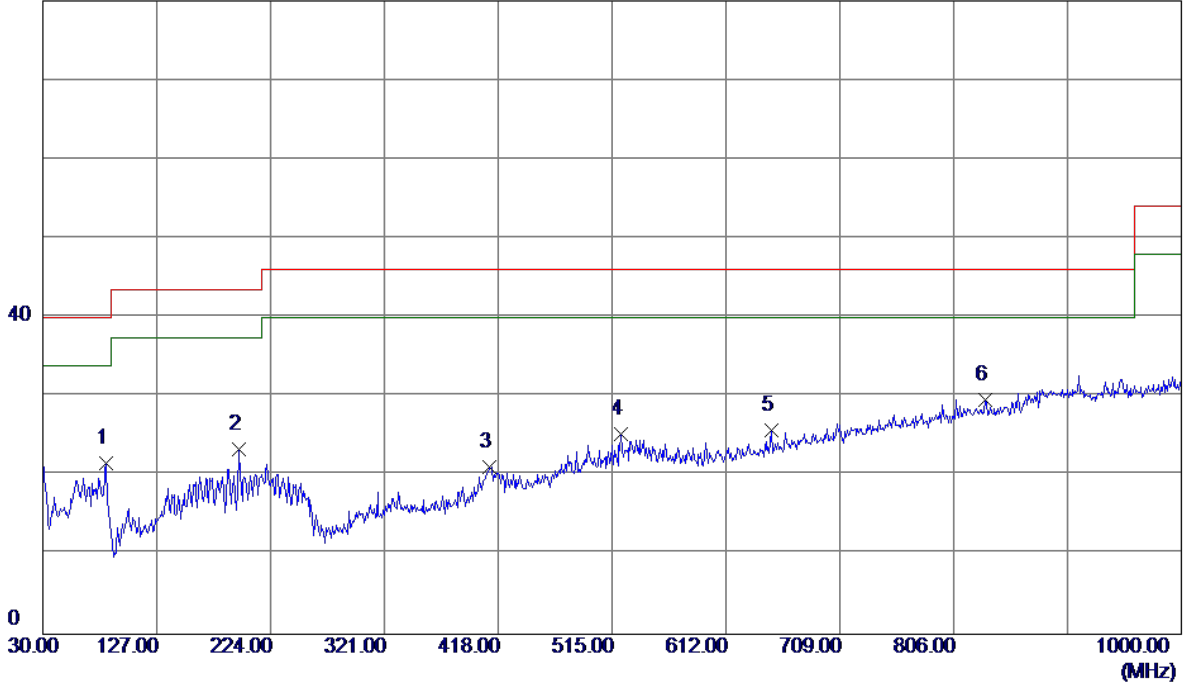

No.	Freq. MHz	Reading Level dBuV/m	Correct Factor dB	Measure ment dBuV/m	Limit dBuV/m	Margin dB	Detector	Comment
1	84.3200	39.90	-18.37	21.53	40.00	-18.47	Peak	
2	196.8400	36.80	-13.46	23.34	43.50	-20.16	Peak	
3	410.2400	32.25	-11.07	21.18	46.00	-24.82	Peak	
4	522.7600	33.49	-8.26	25.23	46.00	-20.77	Peak	
5	650.8000	31.22	-5.45	25.77	46.00	-20.23	Peak	
6 *	833.1599	30.04	-0.46	29.58	46.00	-16.42	Peak	

Test Mode: TX B MODE CHANNEL 11 (Adapter:XinQiao)

Horizontal

80 dBuV/m

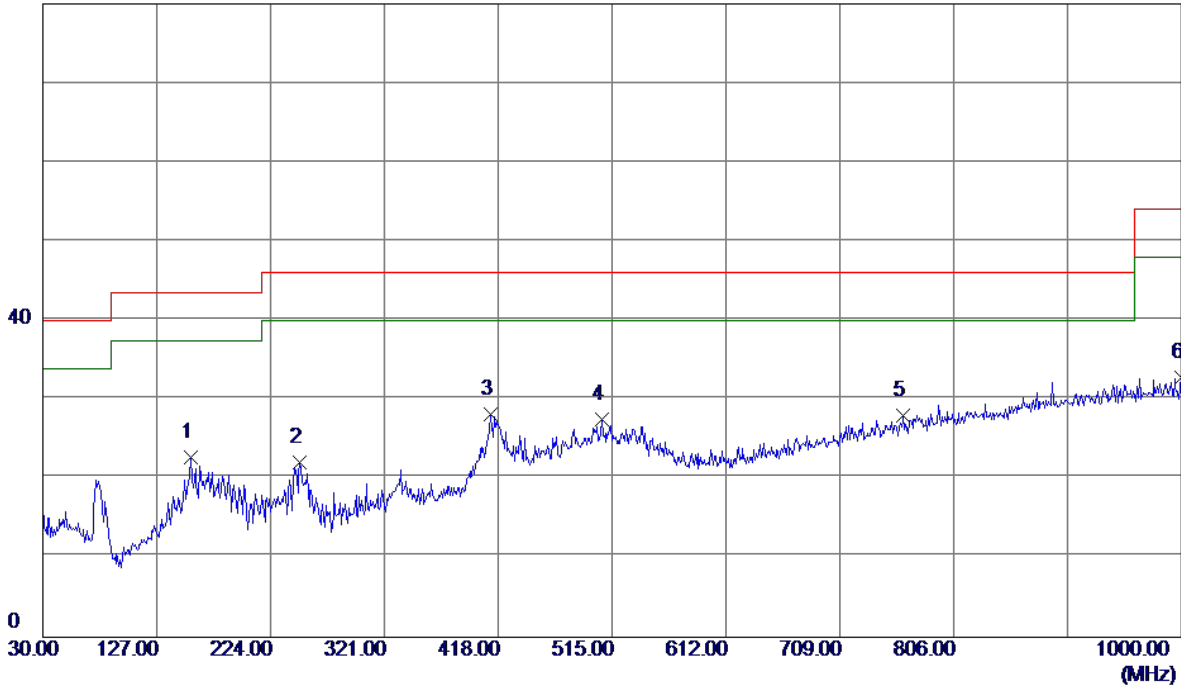

No.	Freq. MHz	Reading Level dBuV/m	Correct Factor dB	Measure ment dBuV/m	Limit dBuV/m	Margin dB	Detector	Comment
1	156.1000	35.93	-13.16	22.77	43.50	-20.73	Peak	
2	249.2200	36.92	-14.84	22.08	46.00	-23.92	Peak	
3 *	411.2100	39.17	-11.04	28.13	46.00	-17.87	Peak	
4	506.2700	36.14	-8.59	27.55	46.00	-18.45	Peak	
5	763.3200	30.10	-2.16	27.94	46.00	-18.06	Peak	
6	1000.0000	29.82	2.96	32.78	54.00	-21.22	Peak	

APPENDIX D - RADIATED EMISSION (ABOVE 1000MHZ)

Orthogonal Axis :	X
Test Mode :	TX B MODE 2412MHz

Vertical

120 dBuV/m

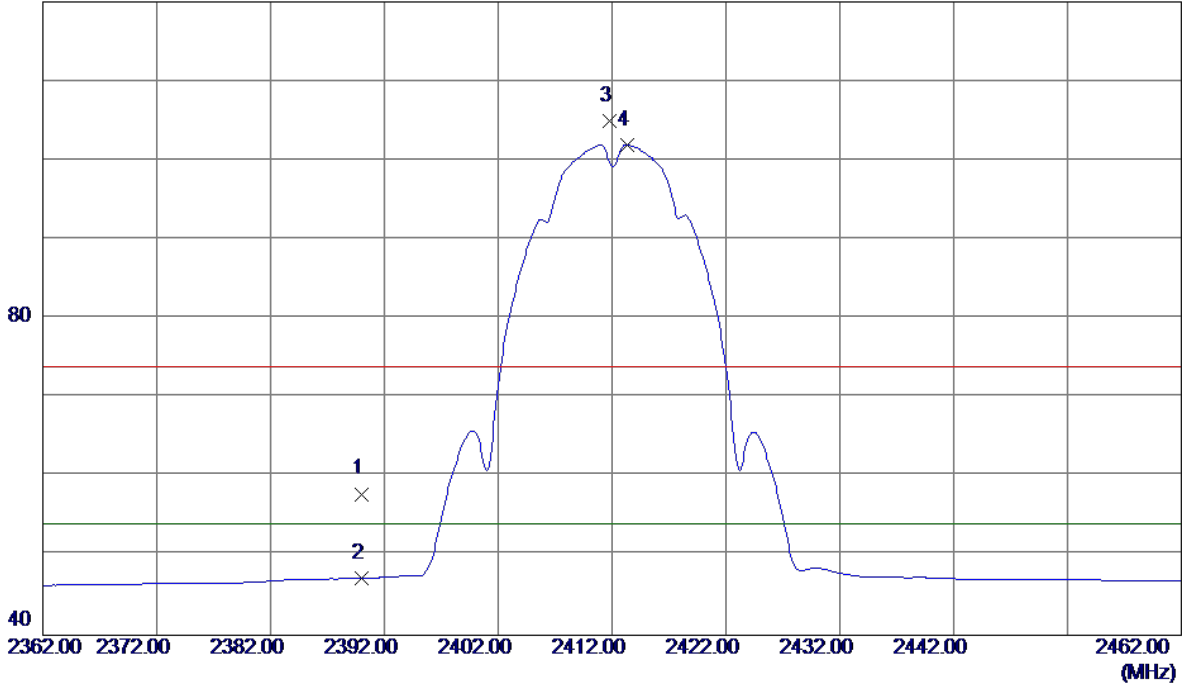

No.	Freq. MHz	Reading Level dBuV/m	Correct Factor dB	Measure ment dBuV/m	Limit dBuV/m	Margin dB	Detector	Comment
1	2390.0000	24.78	33.06	57.84	74.00	-16.16	Peak	
2	2390.0000	14.09	33.06	47.15	54.00	-6.85	AVG	
3	2411.8000	71.82	33.14	104.96	74.00	30.96	Peak	No Limit
4 *	2413.3000	68.84	33.14	101.98	54.00	47.98	AVG	No Limit

Orthogonal Axis :	X
Test Mode :	TX B MODE 2412MHz

Vertical

80 dBuV/m

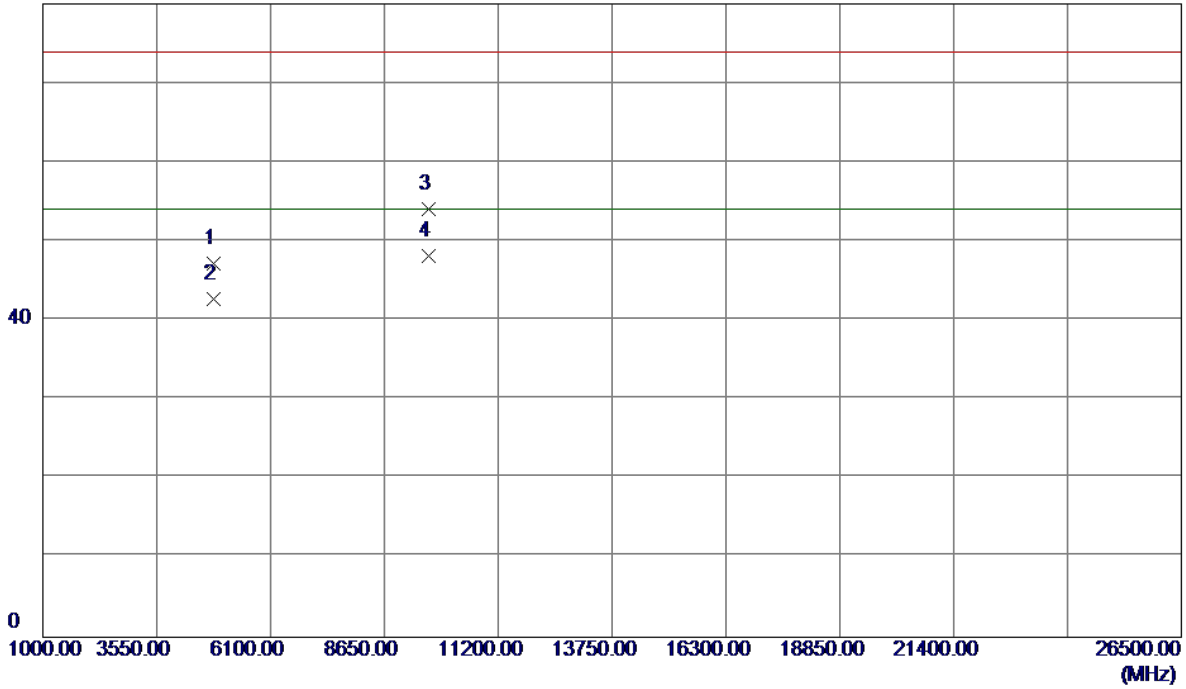

No.	Freq. MHz	Reading Level dBuV/m	Correct Factor dB	Measure ment dBuV/m	Limit dBuV/m	Margin dB	Detector	Comment
1	4824.0219	40.92	6.32	47.24	74.00	-26.76	Peak	
2	4824.0400	36.45	6.32	42.77	54.00	-11.23	AVG	
3	9648.0730	38.29	15.83	54.12	74.00	-19.88	Peak	
4 *	9648.0890	32.27	15.83	48.10	54.00	-5.90	AVG	

Orthogonal Axis :	X
Test Mode :	TX B MODE 2412MHz

Horizontal

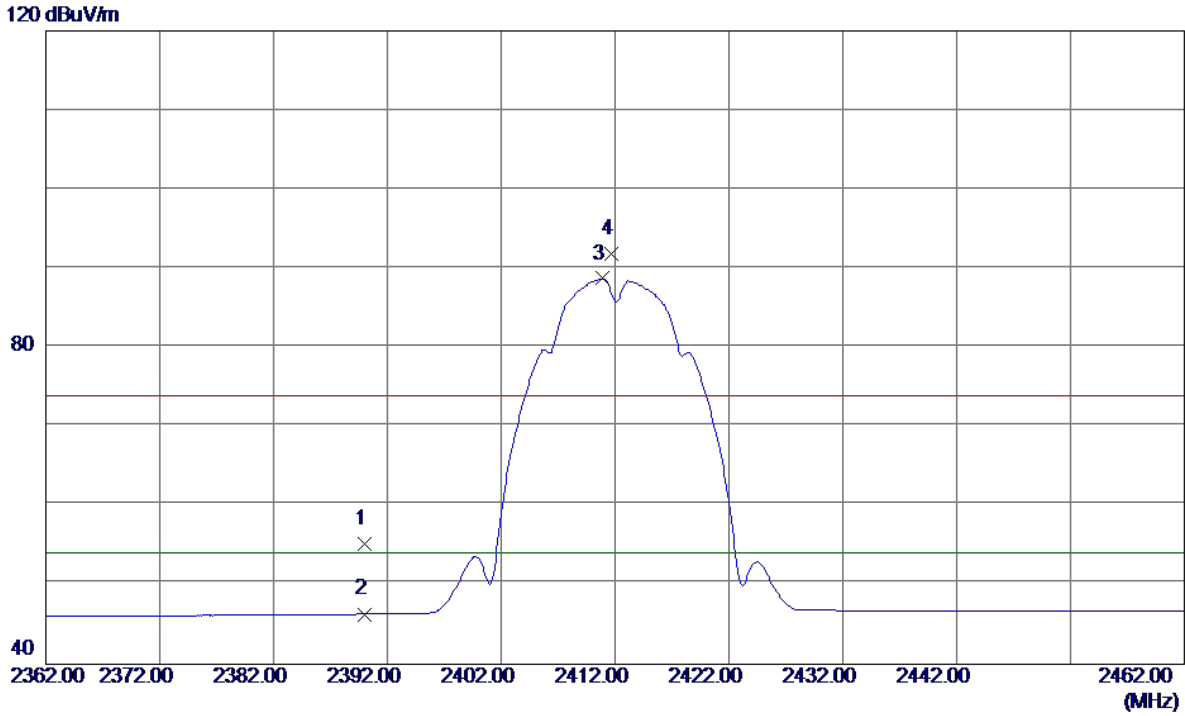

No.	Freq. MHz	Reading Level dBuV/m	Correct Factor dB	Measure ment dBuV/m	Limit dBuV/m	Margin dB	Detector	Comment
1	2390.0000	22.17	33.06	55.23	74.00	-18.77	Peak	
2	2390.0000	13.26	33.06	46.32	54.00	-7.68	AVG	
3 *	2410.9000	55.59	33.13	88.72	54.00	34.72	AVG	No Limit
4	2411.7000	58.67	33.14	91.81	74.00	17.81	Peak	No Limit

Orthogonal Axis :	X
Test Mode :	TX B MODE 2412MHz

Horizontal

80 dBuV/m

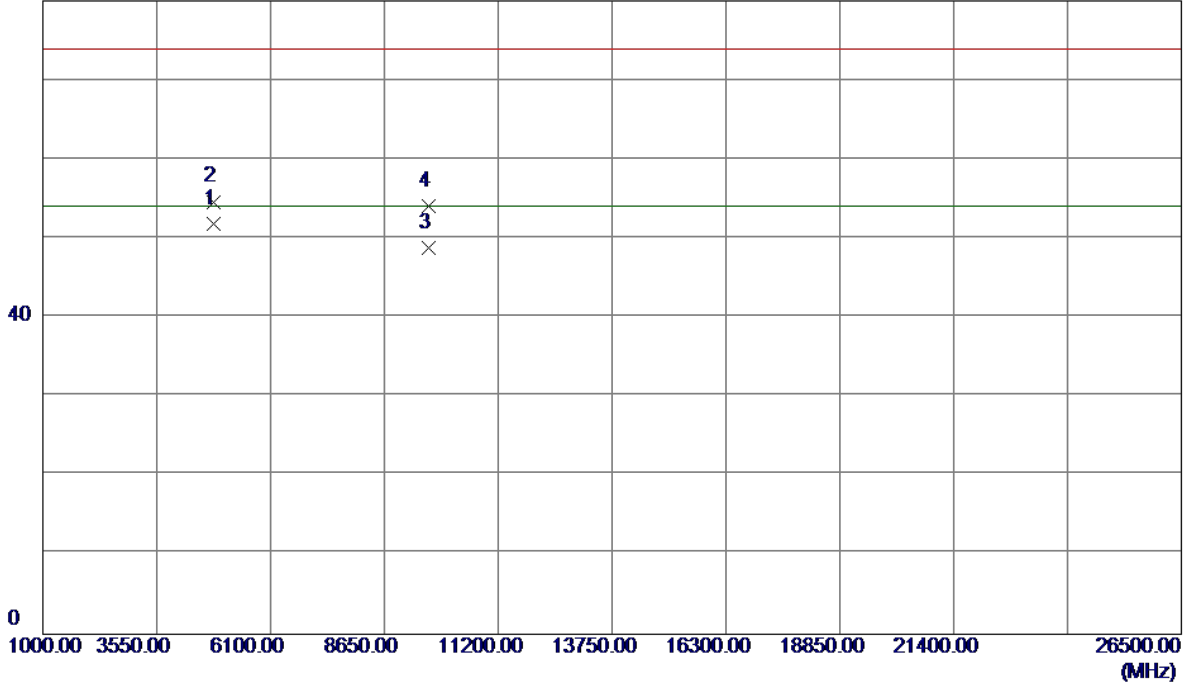

No.	Freq. MHz	Reading Level dBuV/m	Correct Factor dB	Measure ment dBuV/m	Limit dBuV/m	Margin dB	Detector	Comment
1 *	4824.0540	45.60	6.32	51.92	54.00	-2.08	AVG	
2	4824.0750	48.32	6.32	54.64	74.00	-19.36	Peak	
3	9648.1030	33.01	15.83	48.84	54.00	-5.16	AVG	
4	9648.1150	38.30	15.83	54.13	74.00	-19.87	Peak	

Orthogonal Axis :	X
Test Mode :	TX B MODE 2437MHz

Vertical

120 dBuV/m

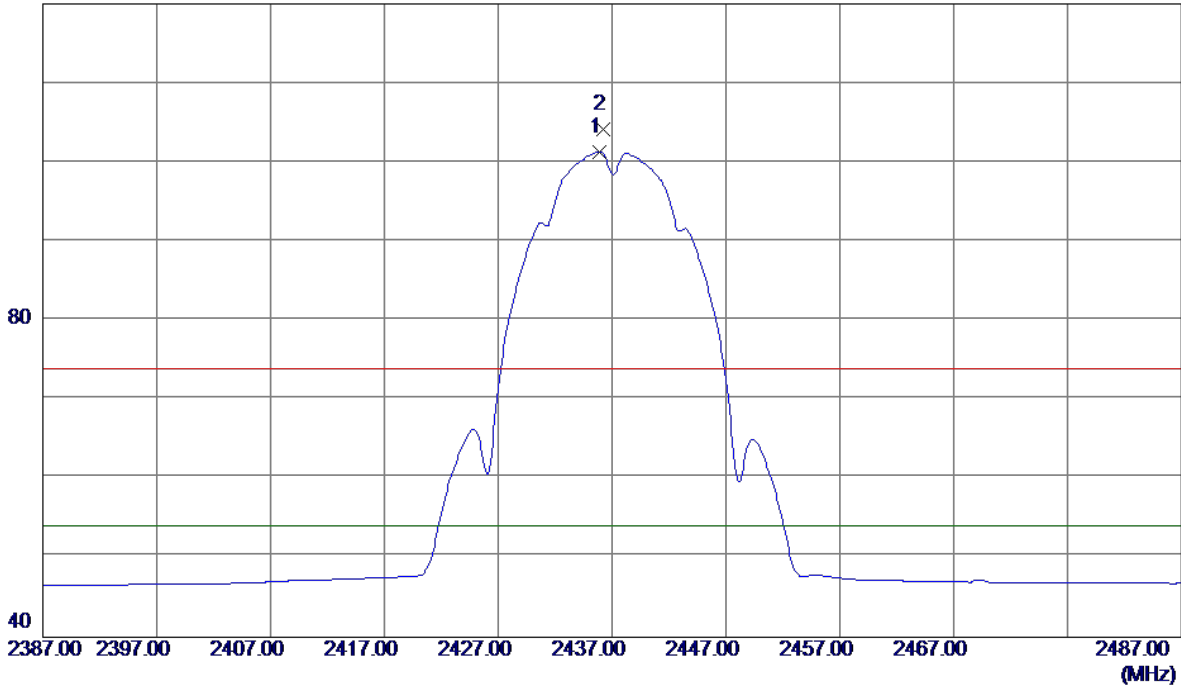

No.	Freq. MHz	Reading Level dBuV/m	Correct Factor dB	Measure ment dBuV/m	Limit dBuV/m	Margin dB	Detector	Comment
1 *	2435.9000	68.08	33.23	101.31	54.00	47.31	AVG	No Limit
2	2436.2000	70.91	33.23	104.14	74.00	30.14	Peak	No Limit

Orthogonal Axis :	X
Test Mode :	TX B MODE 2437MHz

Vertical

80 dBuV/m

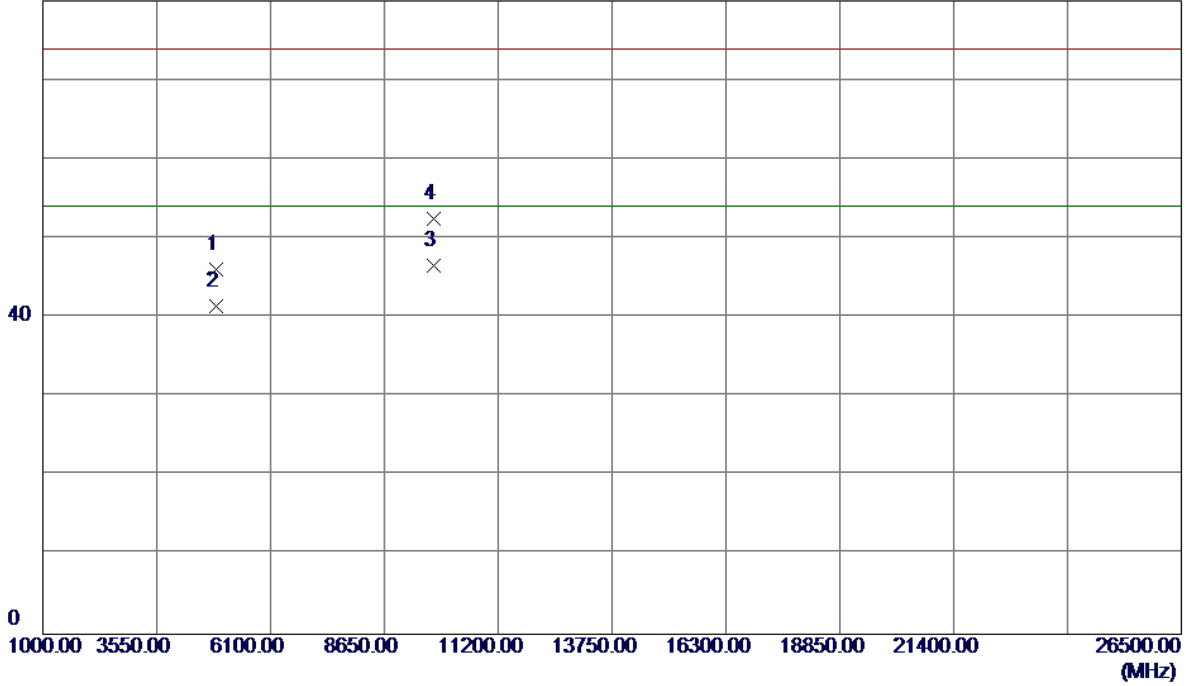

No.	Freq. MHz	Reading Level dBuV/m	Correct Factor dB	Measure ment dBuV/m	Limit dBuV/m	Margin dB	Detector	Comment
1	4873.8900	39.71	6.44	46.15	74.00	-27.85	Peak	
2	4874.0200	34.93	6.44	41.37	54.00	-12.63	AVG	
3 *	9748.1060	30.61	15.90	46.51	54.00	-7.49	AVG	
4	9748.1460	36.52	15.90	52.42	74.00	-21.58	Peak	

Orthogonal Axis :	X
Test Mode :	TX B MODE 2437MHz

Horizontal

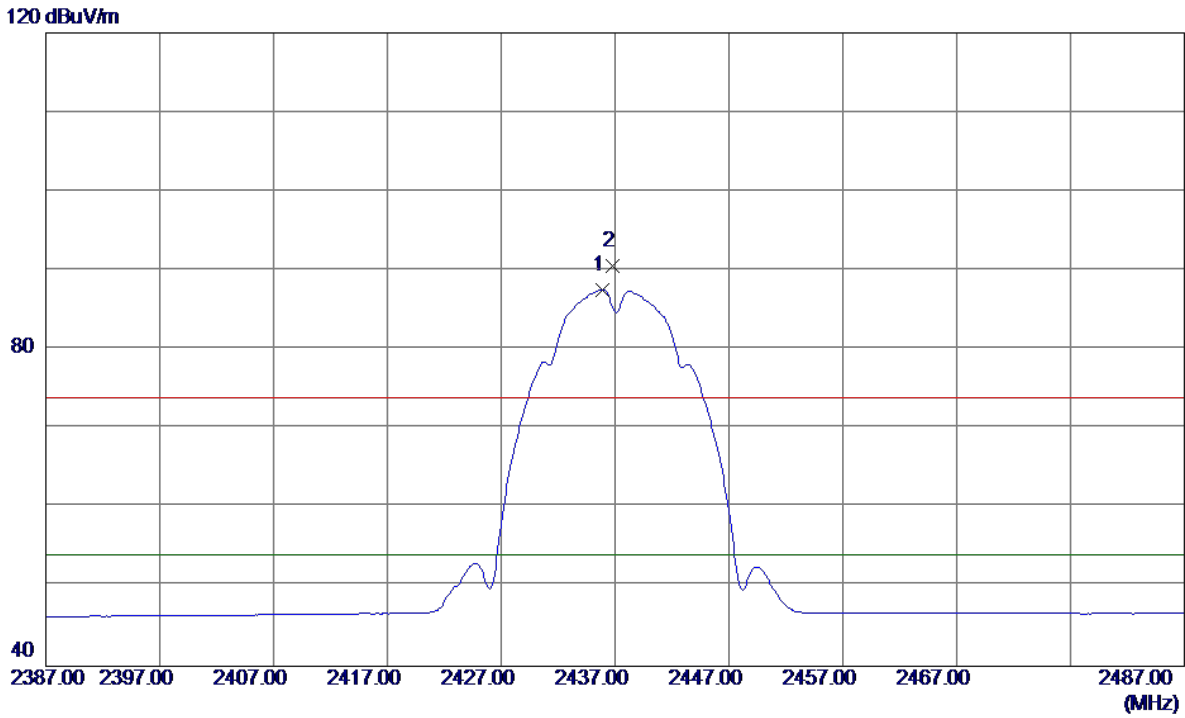

No.	Freq. MHz	Reading Level dBuV/m	Correct Factor dB	Measure ment dBuV/m	Limit dBuV/m	Margin dB	Detector	Comment
1 *	2435.9000	54.35	33.23	87.58	54.00	33.58	AVG	No Limit
2	2436.8000	57.30	33.23	90.53	74.00	16.53	Peak	No Limit

Orthogonal Axis :	X
Test Mode :	TX B MODE 2437MHz

Horizontal

80 dBuV/m

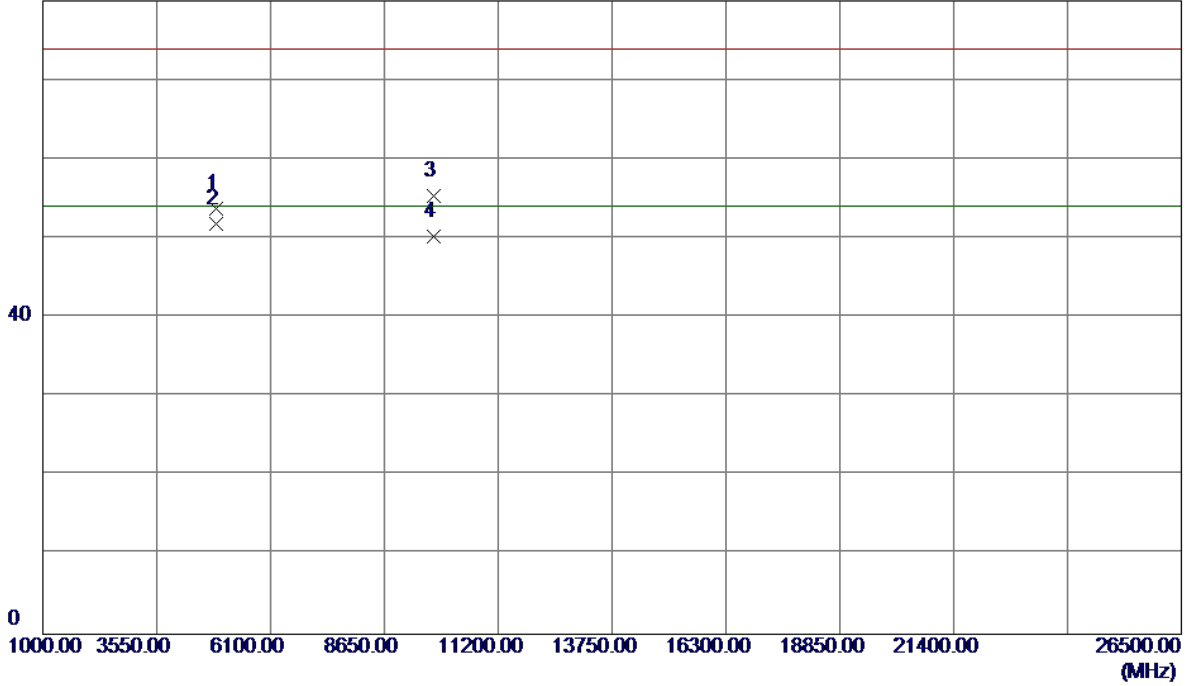

No.	Freq. MHz	Reading Level dBuV/m	Correct Factor dB	Measure ment dBuV/m	Limit dBuV/m	Margin dB	Detector	Comment
1	4874.0160	47.37	6.44	53.81	74.00	-20.19	Peak	
2 *	4874.0400	45.42	6.44	51.86	54.00	-2.14	AVG	
3	9748.0900	39.40	15.90	55.30	74.00	-18.70	Peak	
4	9748.0980	34.39	15.90	50.29	54.00	-3.71	AVG	

Orthogonal Axis :	X
Test Mode :	TX B MODE 2462MHz

Vertical

120 dBuV/m

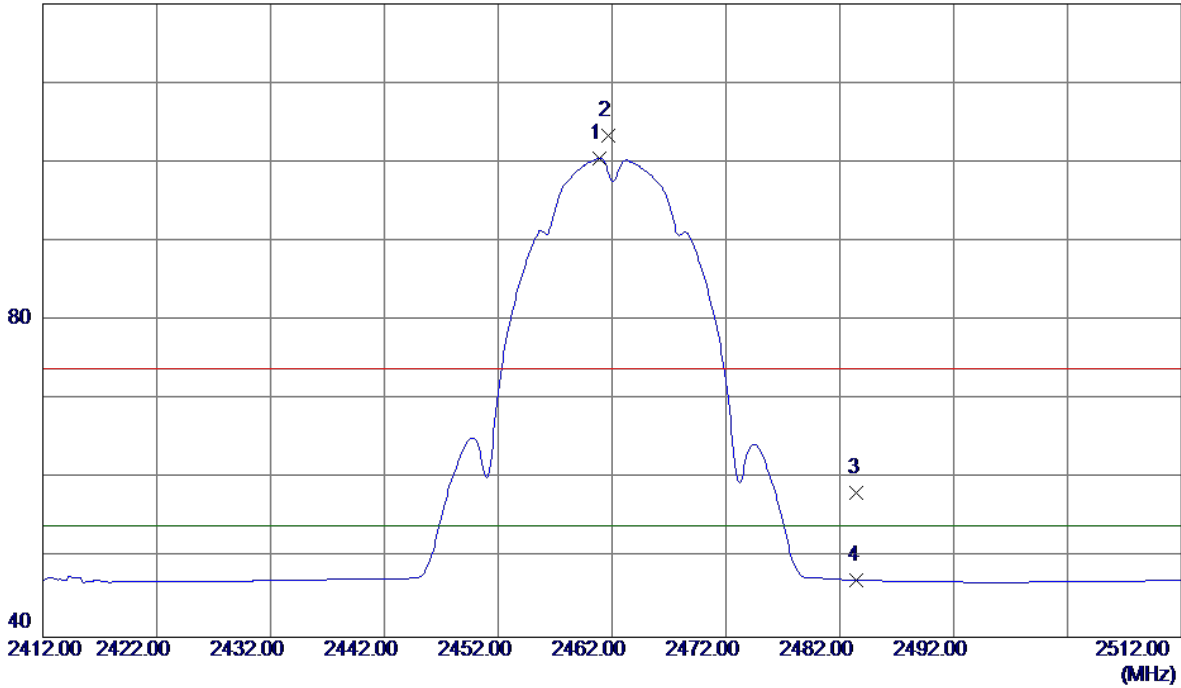

No.	Freq. MHz	Reading Level dBuV/m	Correct Factor dB	Measure ment dBuV/m	Limit dBuV/m	Margin dB	Detector	Comment
1 *	2460.9000	67.17	33.32	100.49	54.00	46.49	AVG	No Limit
2	2461.7000	70.07	33.33	103.40	74.00	29.40	Peak	No Limit
3	2483.5000	24.82	33.41	58.23	74.00	-15.77	Peak	
4	2483.5000	13.74	33.41	47.15	54.00	-6.85	AVG	

Orthogonal Axis :	X
Test Mode :	TX B MODE 2462MHz

Vertical

80 dBuV/m

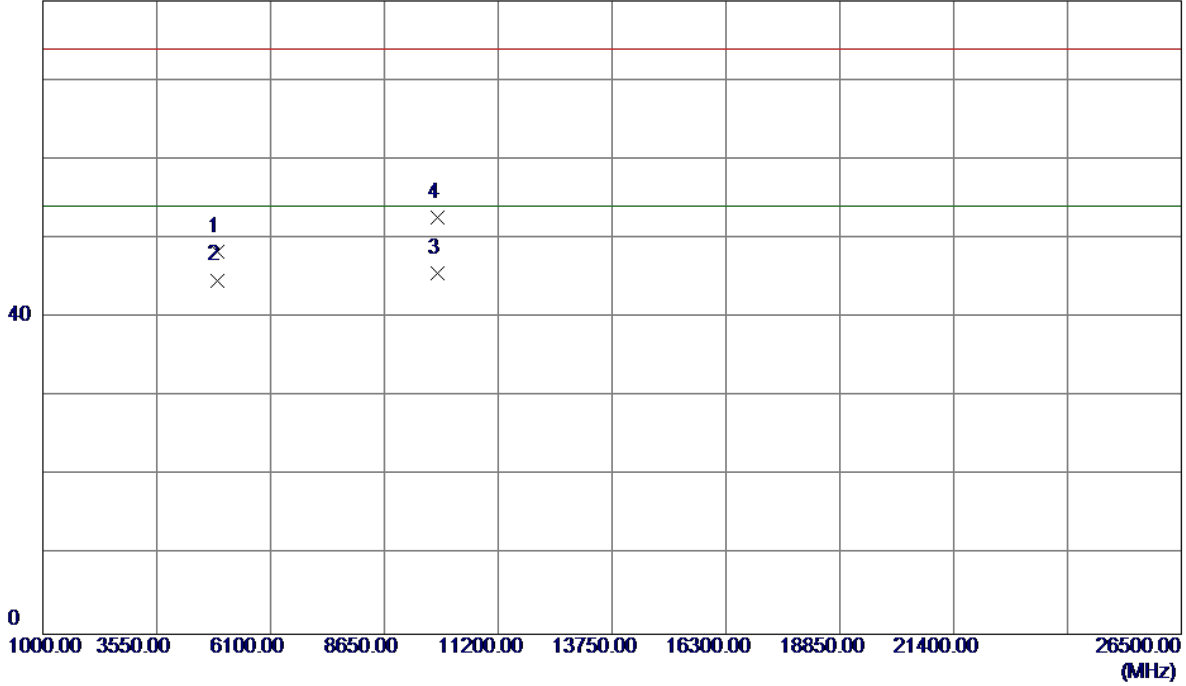

No.	Freq. MHz	Reading Level dBuV/m	Correct Factor dB	Measure ment dBuV/m	Limit dBuV/m	Margin dB	Detector	Comment
1	4924.0139	41.74	6.57	48.31	74.00	-25.69	Peak	
2	4924.0379	38.15	6.57	44.72	54.00	-9.28	AVG	
3 *	9848.1100	29.59	15.98	45.57	54.00	-8.43	AVG	
4	9848.1800	36.71	15.98	52.69	74.00	-21.31	Peak	

Orthogonal Axis :	X
Test Mode :	TX B MODE 2462MHz

Horizontal

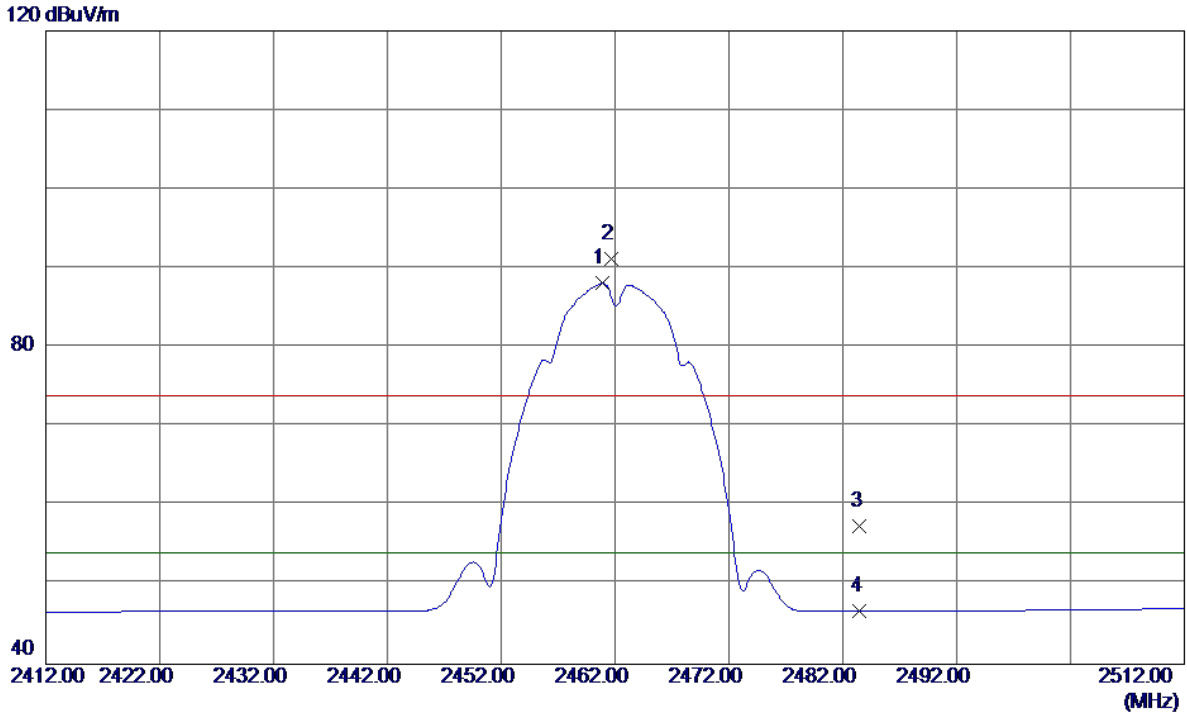

No.	Freq. MHz	Reading Level dBuV/m	Correct Factor dB	Measure ment dBuV/m	Limit dBuV/m	Margin dB	Detector	Comment
1 *	2460.9000	54.77	33.32	88.09	54.00	34.09	AVG	No Limit
2	2461.7000	57.81	33.33	91.14	74.00	17.14	Peak	No Limit
3	2483.5000	24.03	33.41	57.44	74.00	-16.56	Peak	
4	2483.5000	13.28	33.41	46.69	54.00	-7.31	AVG	

Orthogonal Axis :	X
Test Mode :	TX B MODE 2462MHz

Horizontal

80 dBuV/m

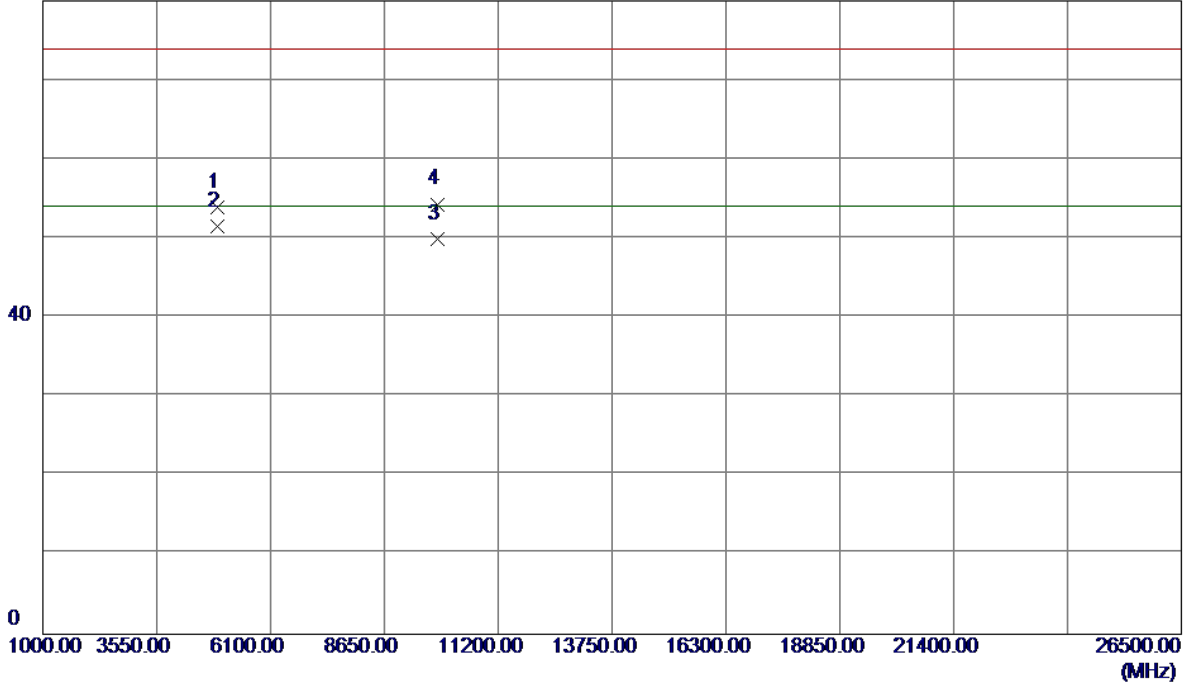

No.	Freq. MHz	Reading Level dBuV/m	Correct Factor dB	Measure ment dBuV/m	Limit dBuV/m	Margin dB	Detector	Comment
1	4924.0390	47.42	6.57	53.99	74.00	-20.01	Peak	
2 *	4924.0500	45.00	6.57	51.57	54.00	-2.43	AVG	
3	9848.0980	33.93	15.98	49.91	54.00	-4.09	AVG	
4	9848.1140	38.34	15.98	54.32	74.00	-19.68	Peak	

Orthogonal Axis :	X
Test Mode :	TX G MODE 2412MHz

Vertical

120 dBuV/m

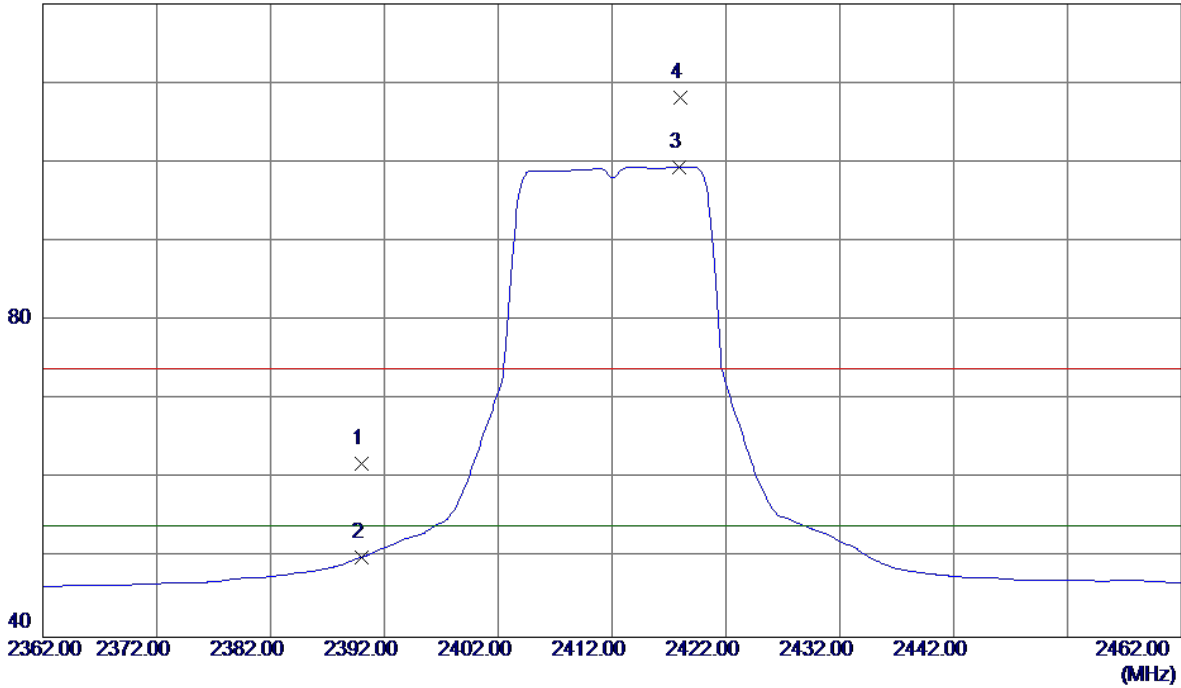

No.	Freq. MHz	Reading Level dBuV/m	Correct Factor dB	Measure ment dBuV/m	Limit dBuV/m	Margin dB	Detector	Comment
1	2390.0000	28.79	33.06	61.85	74.00	-12.15	Peak	
2	2390.0000	17.06	33.06	50.12	54.00	-3.88	AVG	
3 *	2417.9000	66.26	33.16	99.42	54.00	45.42	AVG	No Limit
4	2418.0000	74.98	33.16	108.14	74.00	34.14	Peak	No Limit

Orthogonal Axis :	X
Test Mode :	TX G MODE 2412MHz

Vertical

80 dBuV/m

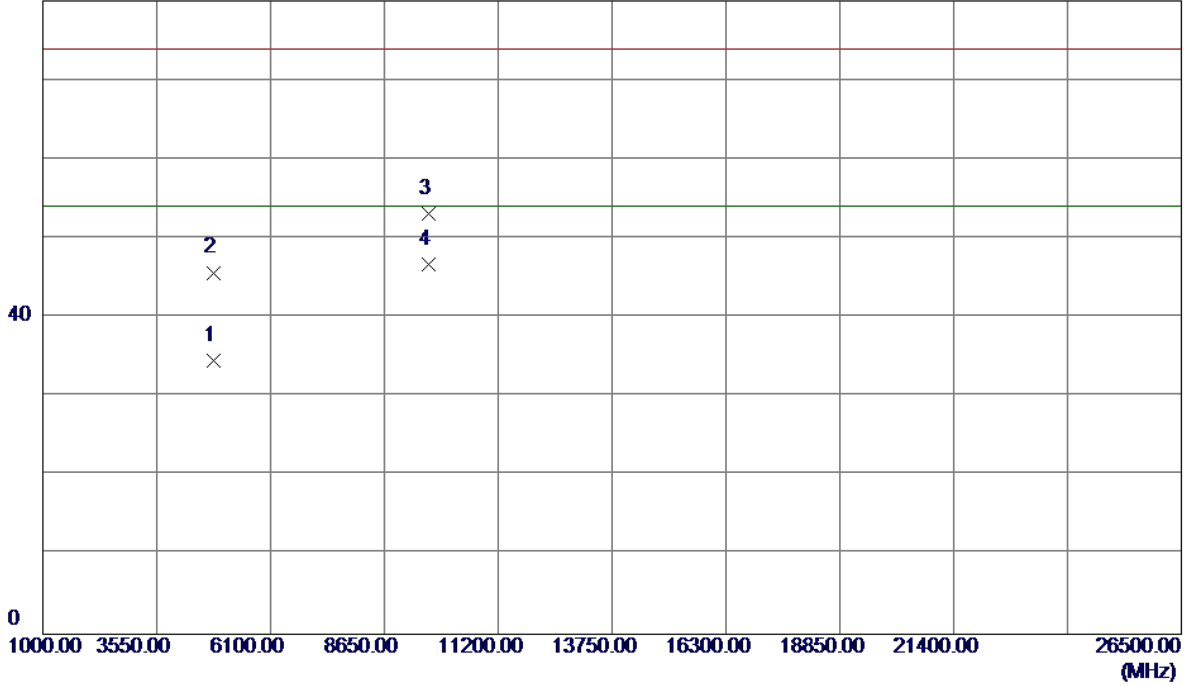

No.	Freq. MHz	Reading Level dBuV/m	Correct Factor dB	Measure ment dBuV/m	Limit dBuV/m	Margin dB	Detector	Comment
1	4824.0460	28.28	6.32	34.60	54.00	-19.40	AVG	
2	4824.3400	39.36	6.32	45.68	74.00	-28.32	Peak	
3	9647.9320	37.33	15.83	53.16	74.00	-20.84	Peak	
4 *	9648.0940	30.86	15.83	46.69	54.00	-7.31	AVG	

Orthogonal Axis :	X
Test Mode :	TX G MODE 2412MHz

Horizontal

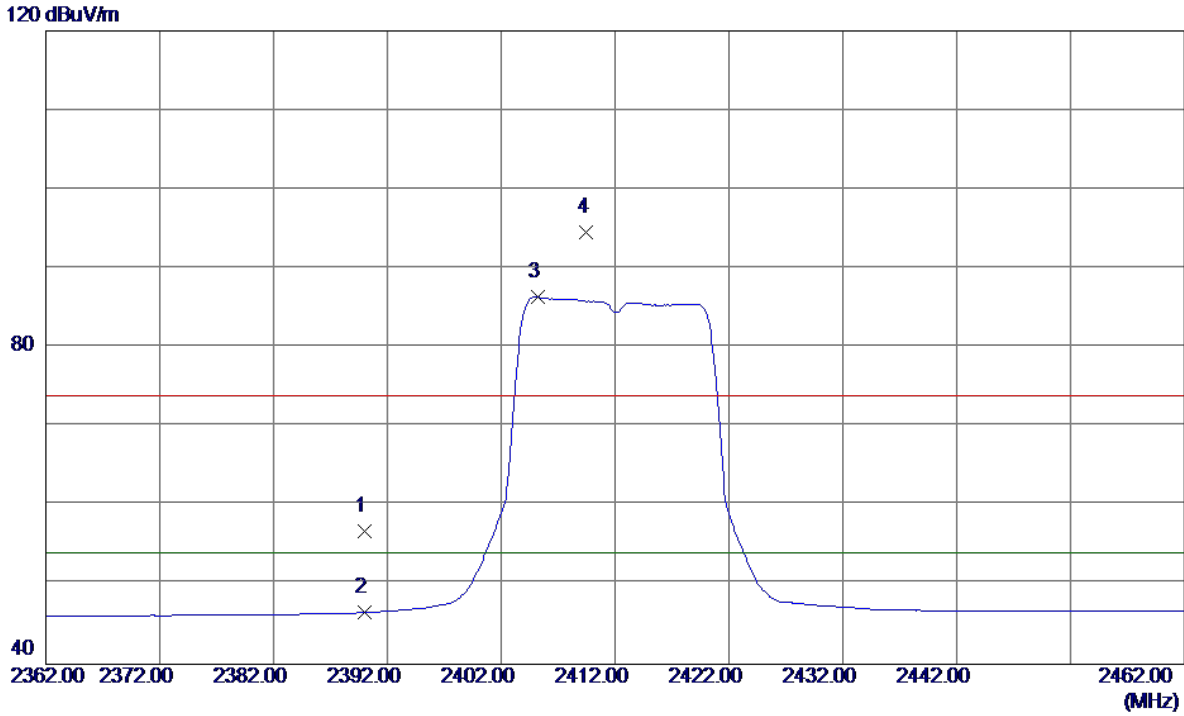

No.	Freq. MHz	Reading Level dBuV/m	Correct Factor dB	Measure ment dBuV/m	Limit dBuV/m	Margin dB	Detector	Comment
1	2390.0000	23.73	33.06	56.79	74.00	-17.21	Peak	
2	2390.0000	13.46	33.06	46.52	54.00	-7.48	AVG	
3 *	2405.2000	53.27	33.11	86.38	54.00	32.38	AVG	No Limit
4	2409.5000	61.44	33.13	94.57	74.00	20.57	Peak	No Limit

Orthogonal Axis :	X
Test Mode :	TX G MODE 2412MHz

Horizontal

80 dBuV/m

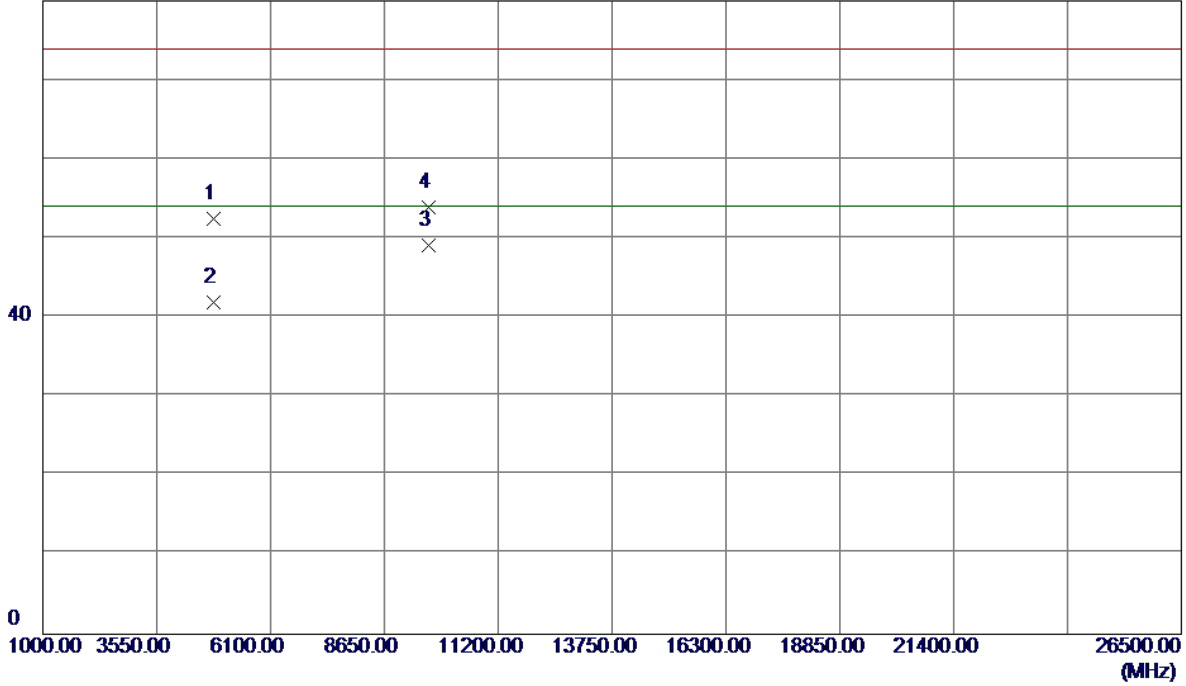

No.	Freq. MHz	Reading Level dBuV/m	Correct Factor dB	Measure ment dBuV/m	Limit dBuV/m	Margin dB	Detector	Comment
1	4824.0600	46.21	6.32	52.53	74.00	-21.47	Peak	
2	4824.0600	35.64	6.32	41.96	54.00	-12.04	AVG	
3 *	9648.1000	33.23	15.83	49.06	54.00	-4.94	AVG	
4	9648.1380	38.08	15.83	53.91	74.00	-20.09	Peak	

Orthogonal Axis :	X
Test Mode :	TX G MODE 2437MHz

Vertical

120 dBuV/m

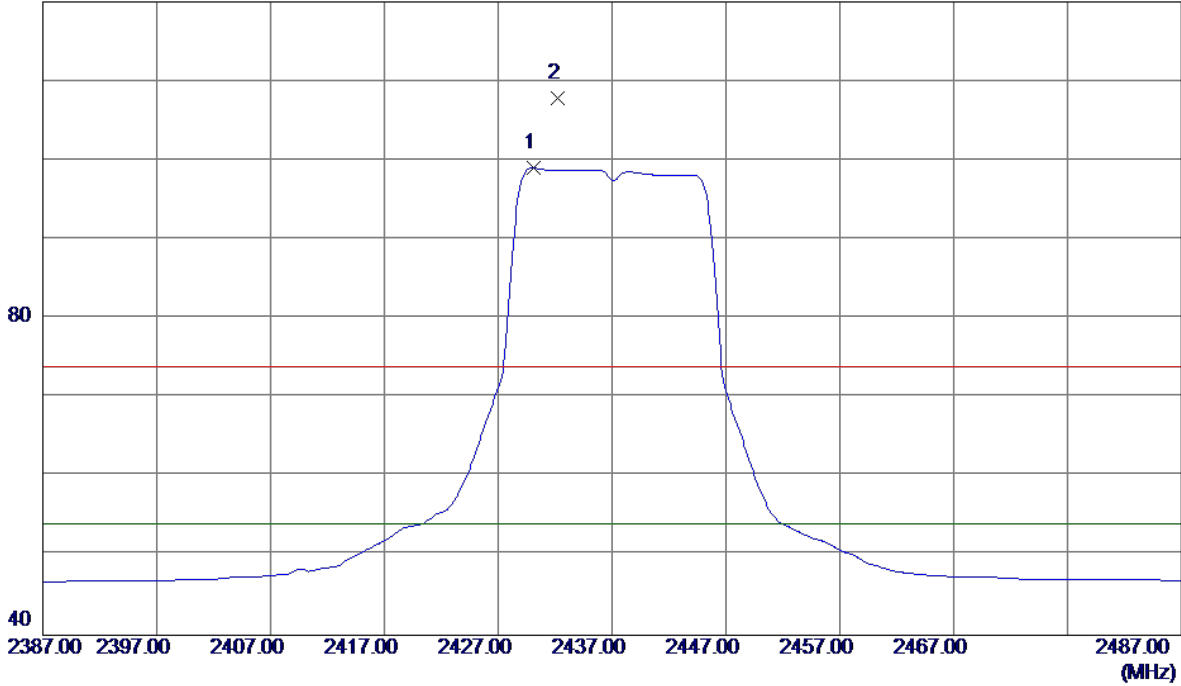

No.	Freq. MHz	Reading Level dBuV/m	Correct Factor dB	Measure ment dBuV/m	Limit dBuV/m	Margin dB	Detector	Comment
1 *	2430.1000	65.77	33.21	98.98	54.00	44.98	AVG	No Limit
2	2432.2000	74.61	33.21	107.82	74.00	33.82	Peak	No Limit

Orthogonal Axis :	X
Test Mode :	TX G MODE 2437MHz

Vertical

80 dBuV/m

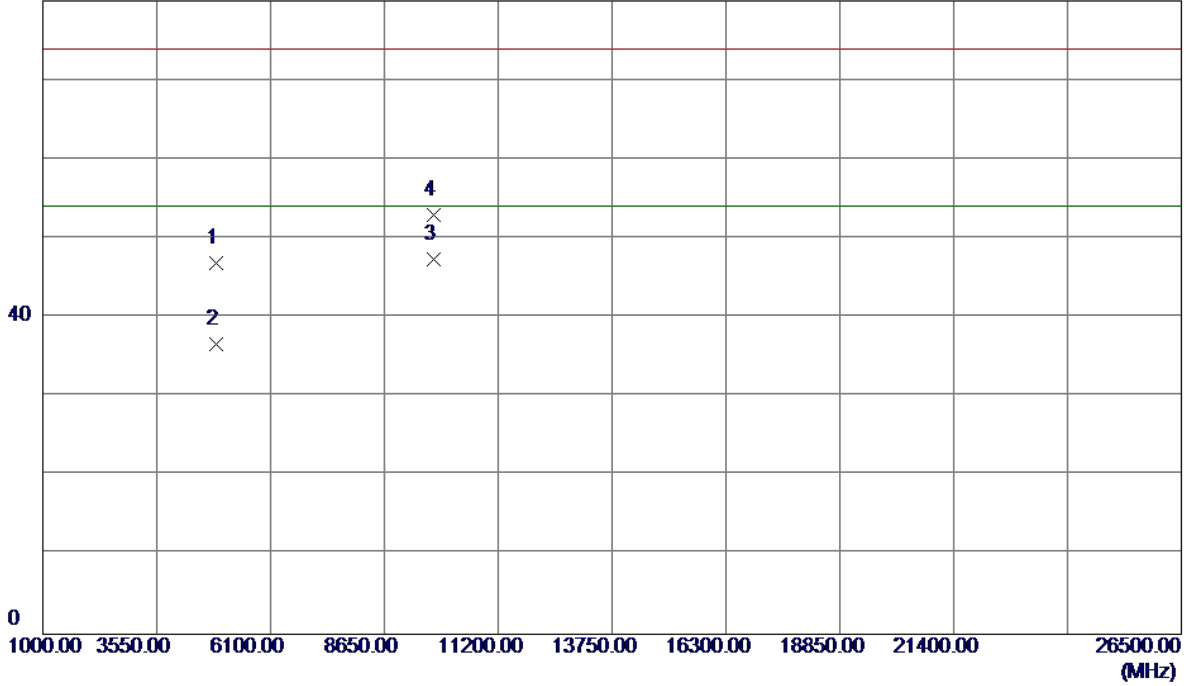

No.	Freq. MHz	Reading Level dBuV/m	Correct Factor dB	Measure ment dBuV/m	Limit dBuV/m	Margin dB	Detector	Comment
1	4873.8350	40.51	6.44	46.95	74.00	-27.05	Peak	
2	4874.1050	30.20	6.44	36.64	54.00	-17.36	AVG	
3 *	9748.0900	31.44	15.90	47.34	54.00	-6.66	AVG	
4	9748.1960	37.01	15.90	52.91	74.00	-21.09	Peak	

Orthogonal Axis :	X
Test Mode :	TX G MODE 2437MHz

Horizontal

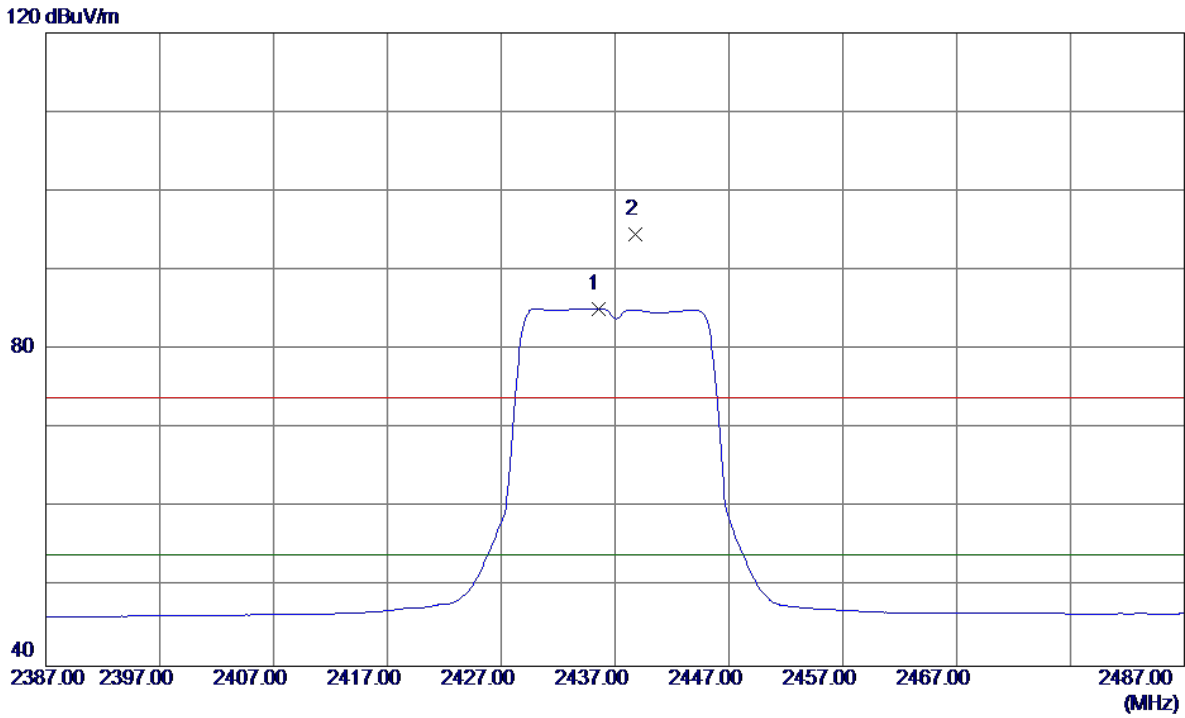

No.	Freq. MHz	Reading Level dBuV/m	Correct Factor dB	Measure ment dBuV/m	Limit dBuV/m	Margin dB	Detector	Comment
1 *	2435.5000	51.93	33.23	85.16	54.00	31.16	AVG	No Limit
2	2438.8000	61.34	33.24	94.58	74.00	20.58	Peak	No Limit

Orthogonal Axis :	X
Test Mode :	TX G MODE 2437MHz

Horizontal

80 dBuV/m

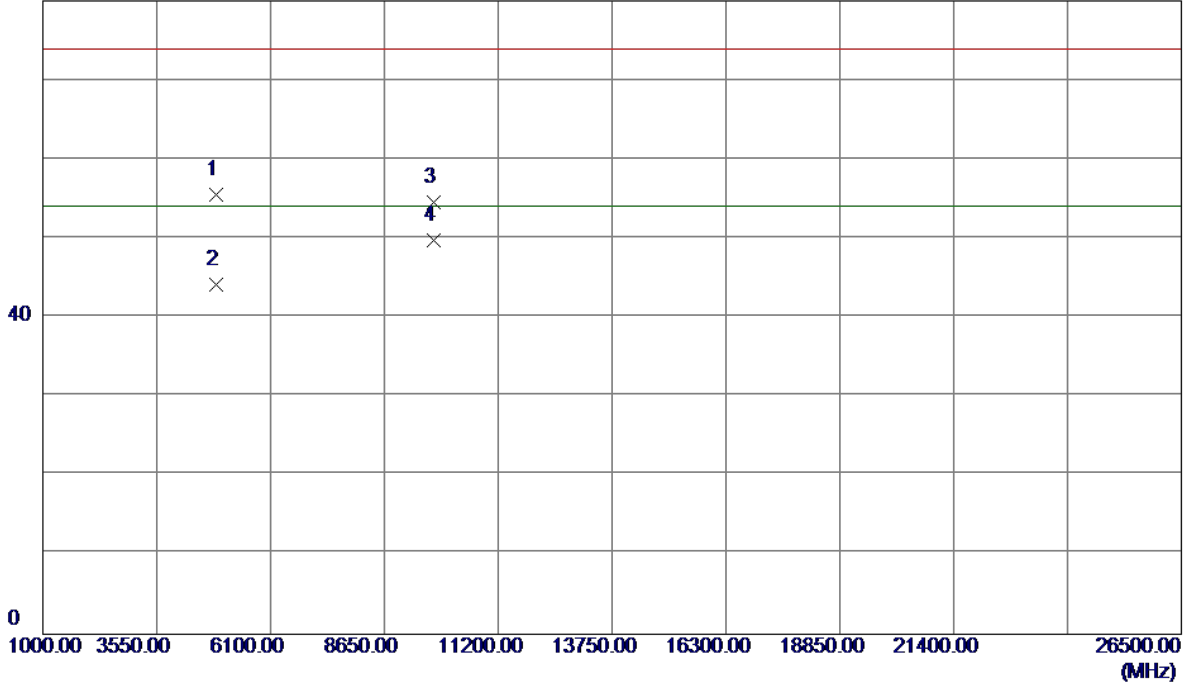

No.	Freq. MHz	Reading Level dBuV/m	Correct Factor dB	Measure ment dBuV/m	Limit dBuV/m	Margin dB	Detector	Comment
1	4873.9420	49.14	6.44	55.58	74.00	-18.42	Peak	
2	4874.0440	37.69	6.44	44.13	54.00	-9.87	AVG	
3	9748.0320	38.69	15.90	54.59	74.00	-19.41	Peak	
4 *	9748.1020	33.81	15.90	49.71	54.00	-4.29	AVG	

Orthogonal Axis :	X
Test Mode :	TX G MODE 2462MHz

Vertical

120 dBuV/m

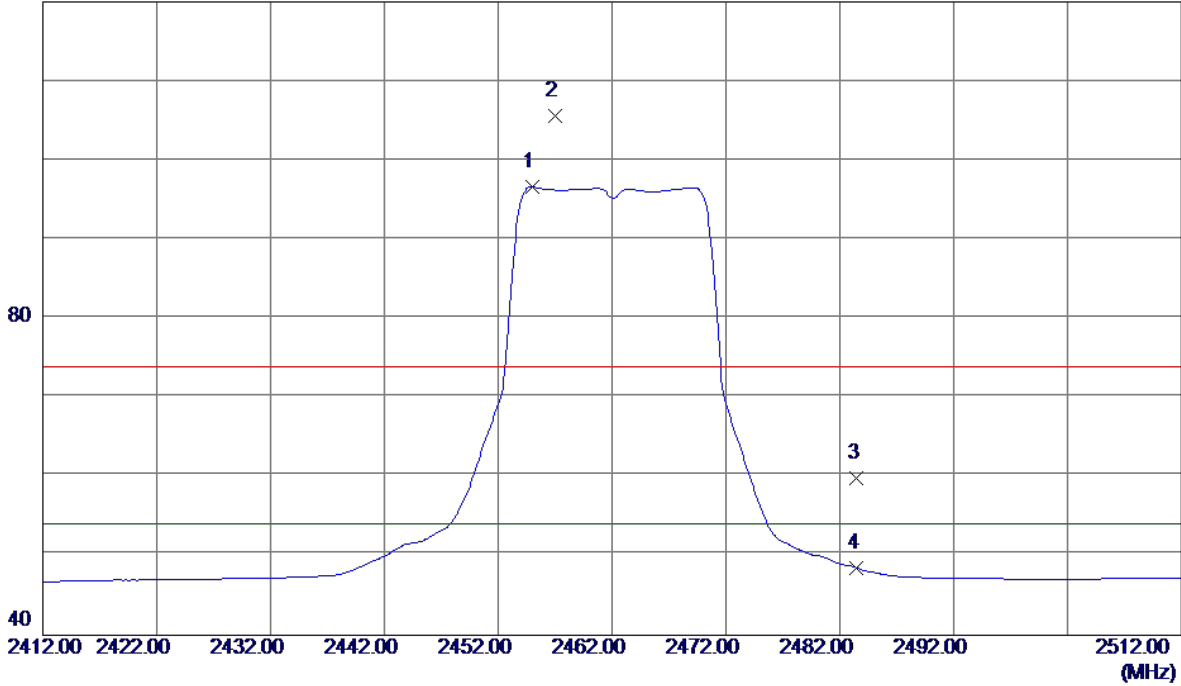

No.	Freq. MHz	Reading Level dBuV/m	Correct Factor dB	Measure ment dBuV/m	Limit dBuV/m	Margin dB	Detector	Comment
1 *	2455.0000	63.30	33.30	96.60	54.00	42.60	AVG	No Limit
2	2457.0000	72.32	33.31	105.63	74.00	31.63	Peak	No Limit
3	2483.5000	26.44	33.41	59.85	74.00	-14.15	Peak	
4	2483.5000	15.10	33.41	48.51	54.00	-5.49	AVG	

Orthogonal Axis :	X
Test Mode :	TX G MODE 2462MHz

Vertical

80 dBuV/m

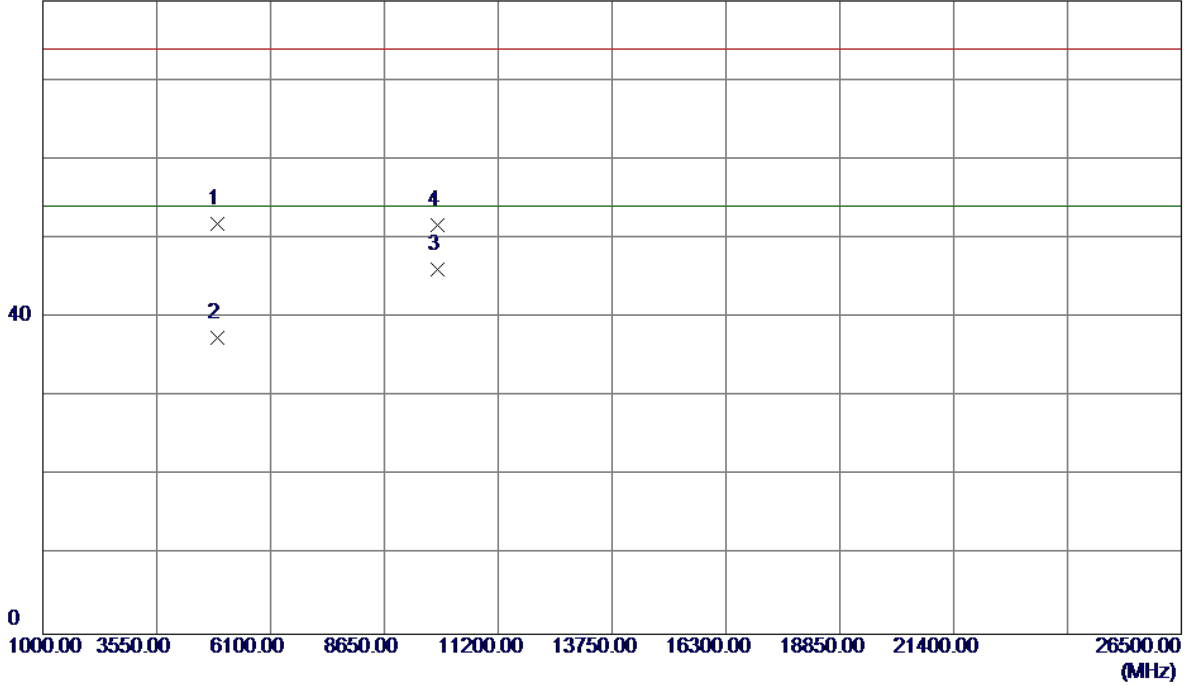

No.	Freq. MHz	Reading Level dBuV/m	Correct Factor dB	Measure ment dBuV/m	Limit dBuV/m	Margin dB	Detector	Comment
1	4923.1360	45.28	6.57	51.85	74.00	-22.15	Peak	
2	4924.0580	30.81	6.57	37.38	54.00	-16.62	AVG	
3 *	9848.1240	30.11	15.98	46.09	54.00	-7.91	AVG	
4	9848.1940	35.78	15.98	51.76	74.00	-22.24	Peak	

Orthogonal Axis :	X
Test Mode :	TX G MODE 2462MHz

Horizontal

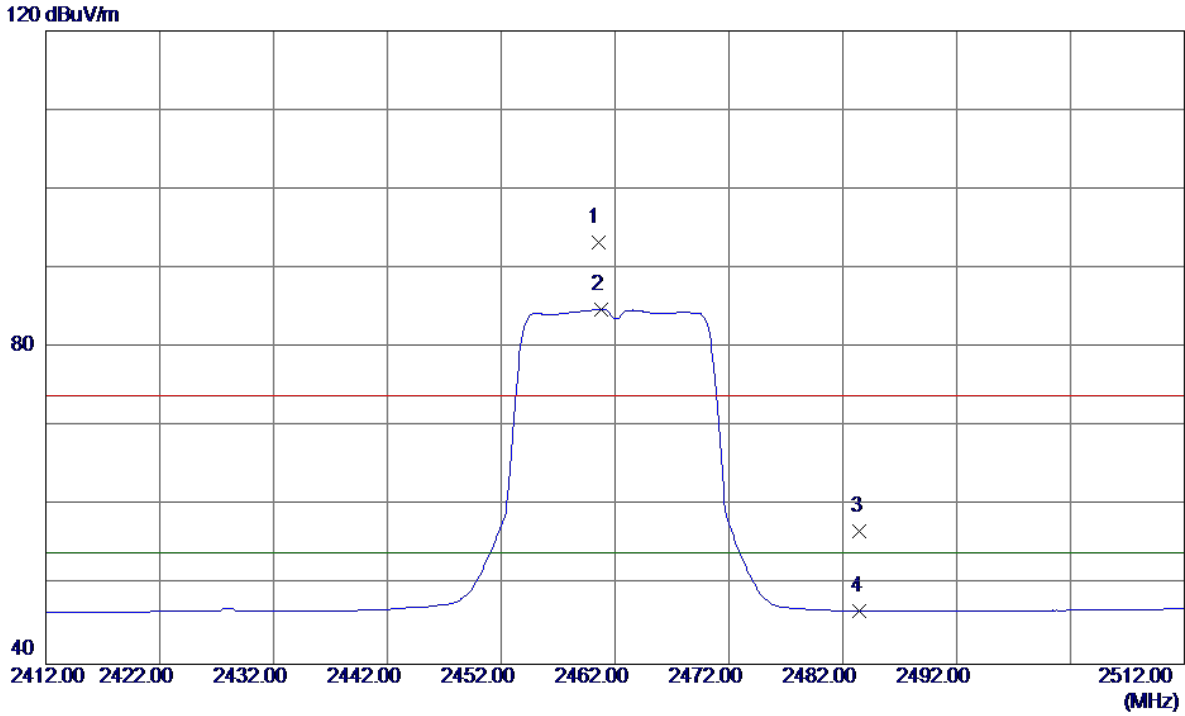

No.	Freq. MHz	Reading Level dBuV/m	Correct Factor dB	Measure ment dBuV/m	Limit dBuV/m	Margin dB	Detector	Comment
1	2460.5000	60.01	33.32	93.33	74.00	19.33	Peak	No Limit
2 *	2460.8000	51.52	33.32	84.84	54.00	30.84	AVG	No Limit
3	2483.5000	23.46	33.41	56.87	74.00	-17.13	Peak	
4	2483.5000	13.30	33.41	46.71	54.00	-7.29	AVG	

Orthogonal Axis :	X
Test Mode :	TX G MODE 2462MHz

Horizontal

80 dBuV/m

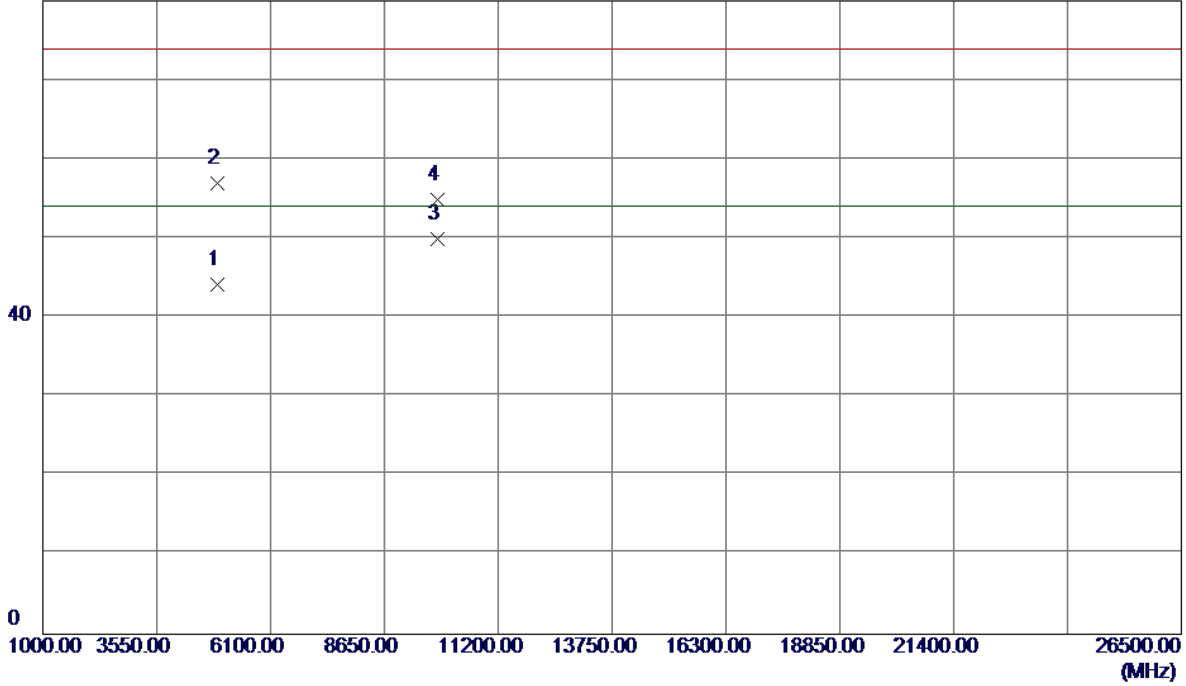

No.	Freq. MHz	Reading Level dBuV/m	Correct Factor dB	Measure ment dBuV/m	Limit dBuV/m	Margin dB	Detector	Comment
1	4924.0600	37.66	6.57	44.23	54.00	-9.77	AVG	
2	4924.1040	50.31	6.57	56.88	74.00	-17.12	Peak	
3 *	9848.1060	33.99	15.98	49.97	54.00	-4.03	AVG	
4	9848.1260	38.85	15.98	54.83	74.00	-19.17	Peak	

Orthogonal Axis :	X
Test Mode :	TX N-20M MODE 2412MHz

Vertical

120 dBuV/m

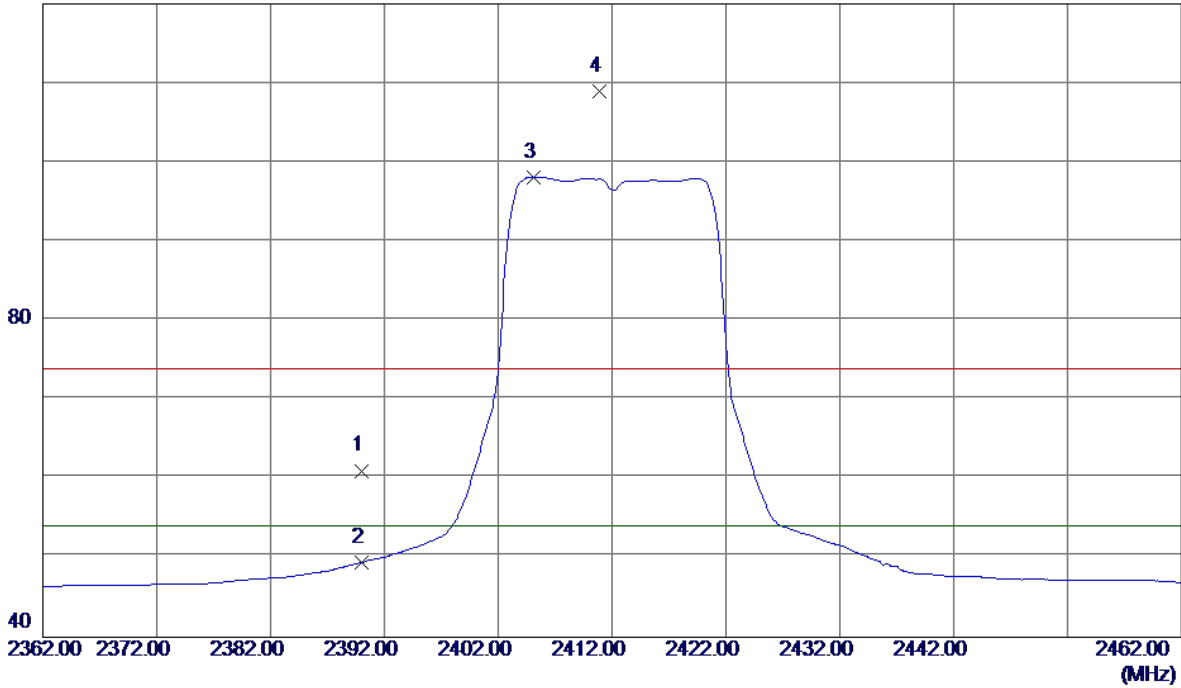

No.	Freq. MHz	Reading Level dBuV/m	Correct Factor dB	Measure ment dBuV/m	Limit dBuV/m	Margin dB	Detector	Comment
1	2390.0000	27.98	33.06	61.04	74.00	-12.96	Peak	
2	2390.0000	16.40	33.06	49.46	54.00	-4.54	AVG	
3 *	2405.1000	65.02	33.11	98.13	54.00	44.13	AVG	No Limit
4	2410.9000	75.76	33.13	108.89	74.00	34.89	Peak	No Limit

Orthogonal Axis :	X
Test Mode :	TX N-20M MODE 2412MHz

Vertical

80 dBuV/m

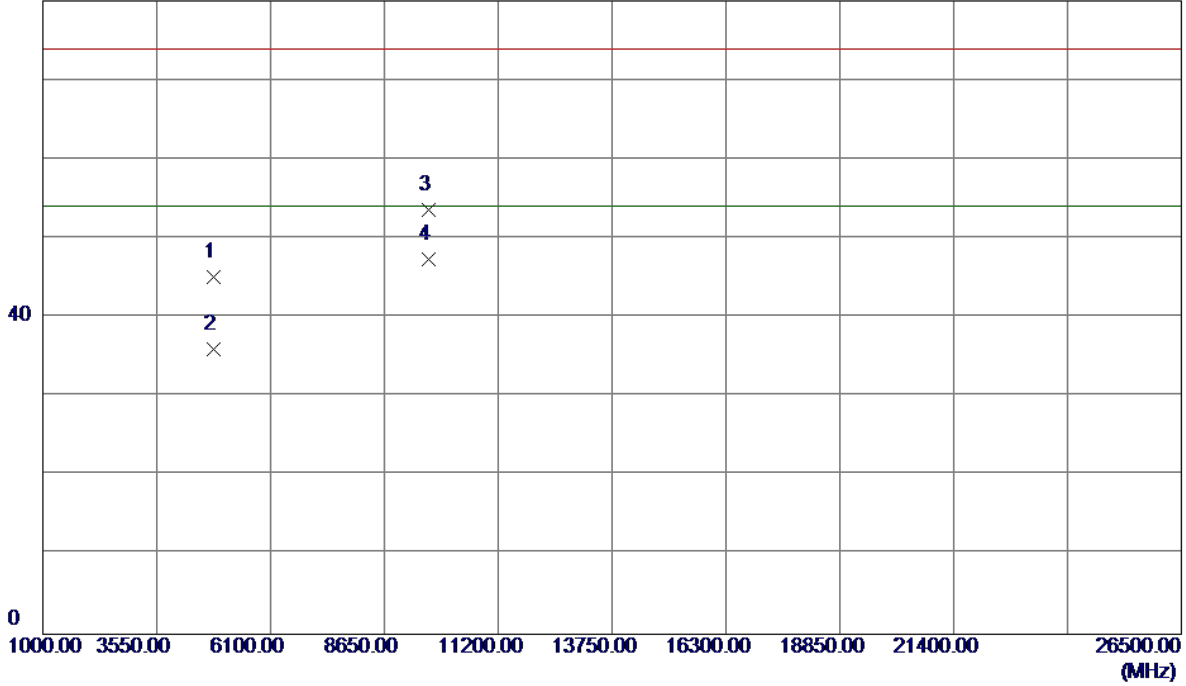

No.	Freq. MHz	Reading Level dBuV/m	Correct Factor dB	Measure ment dBuV/m	Limit dBuV/m	Margin dB	Detector	Comment
1	4823.9350	38.79	6.32	45.11	74.00	-28.89	Peak	
2	4824.1100	29.66	6.32	35.98	54.00	-18.02	AVG	
3	9648.0000	37.83	15.83	53.66	74.00	-20.34	Peak	
4 *	9648.0000	31.53	15.83	47.36	54.00	-6.64	AVG	

Orthogonal Axis :	X
Test Mode :	TX N-20M MODE 2412MHz

Horizontal

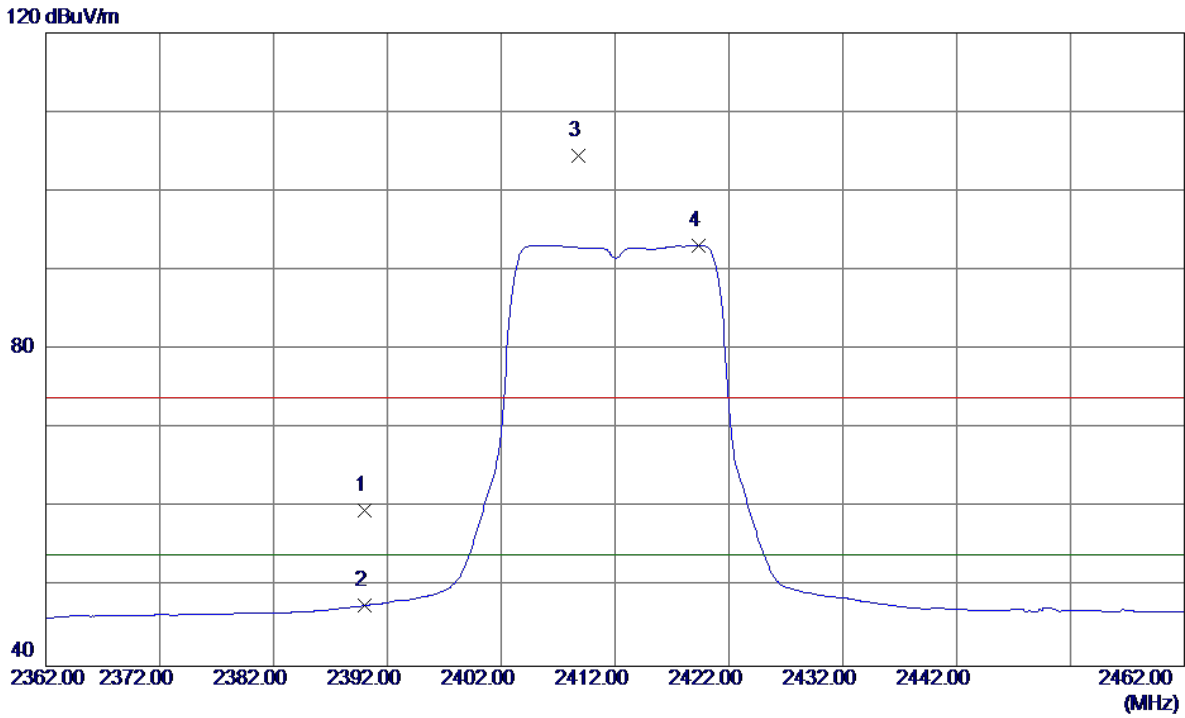

No.	Freq. MHz	Reading Level dBuV/m	Correct Factor dB	Measure ment dBuV/m	Limit dBuV/m	Margin dB	Detector	Comment
1	2390.0000	26.66	33.06	59.72	74.00	-14.28	Peak	
2	2390.0000	14.59	33.06	47.65	54.00	-6.35	AVG	
3	2408.8000	71.27	33.13	104.40	74.00	30.40	Peak	No Limit
4 *	2419.3000	60.02	33.17	93.19	54.00	39.19	AVG	No Limit

Orthogonal Axis :	X
Test Mode :	TX N-20M MODE 2412MHz

Horizontal

80 dBuV/m

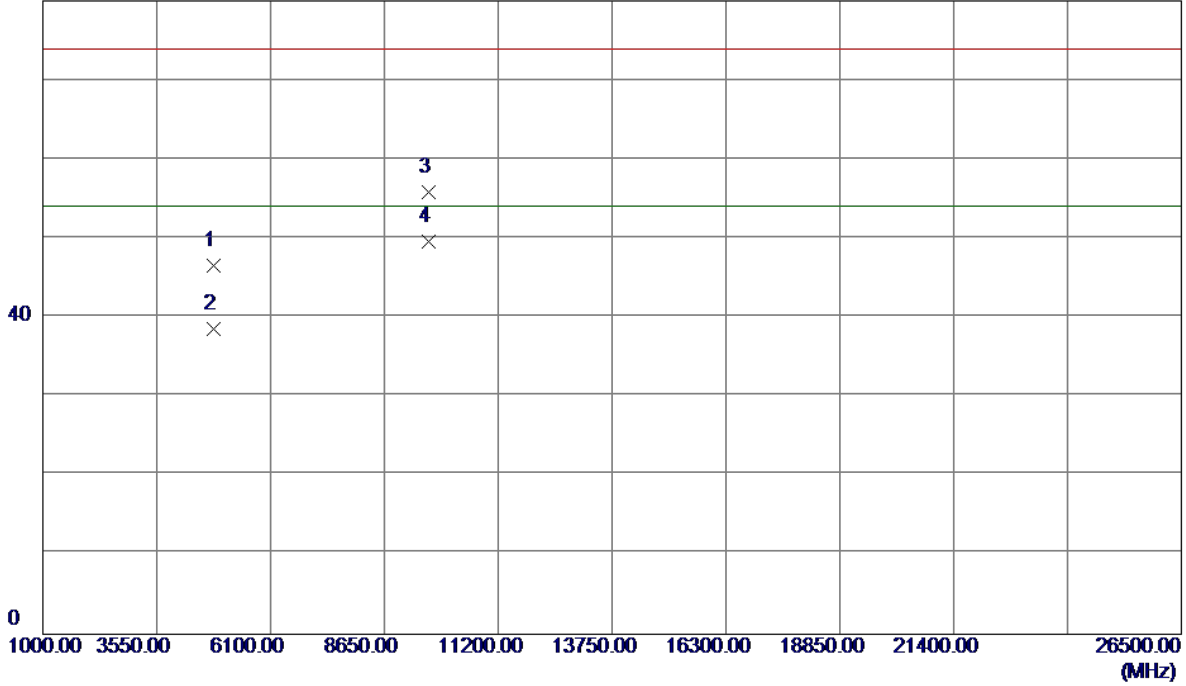

No.	Freq. MHz	Reading Level dBuV/m	Correct Factor dB	Measure ment dBuV/m	Limit dBuV/m	Margin dB	Detector	Comment
1	4823.5570	40.31	6.32	46.63	74.00	-27.37	Peak	
2	4824.3680	32.23	6.32	38.55	54.00	-15.45	AVG	
3	9648.0279	39.97	15.83	55.80	74.00	-18.20	Peak	
4 *	9648.2020	33.82	15.83	49.65	54.00	-4.35	AVG	

Orthogonal Axis :	X
Test Mode :	TX N-20M MODE 2437MHz

Vertical

120 dBuV/m

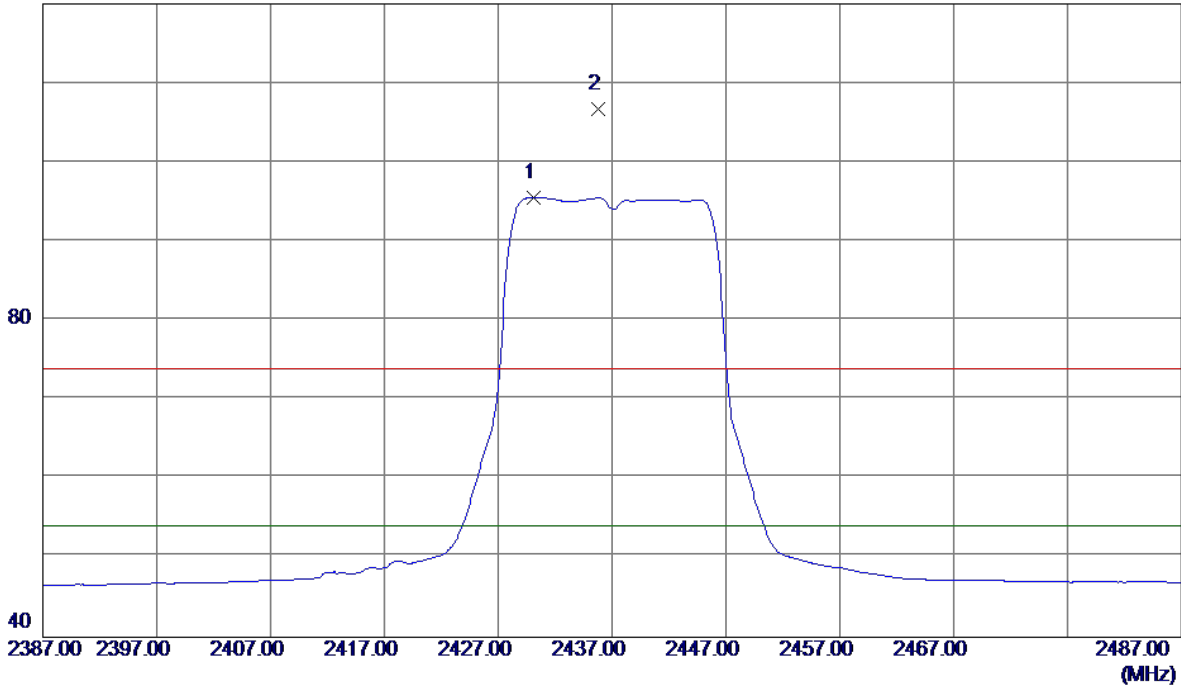

No.	Freq. MHz	Reading Level dBuV/m	Correct Factor dB	Measure ment dBuV/m	Limit dBuV/m	Margin dB	Detector	Comment
1 *	2430.1000	62.32	33.21	95.53	54.00	41.53	AVG	No Limit
2	2435.8000	73.53	33.23	106.76	74.00	32.76	Peak	No Limit

Orthogonal Axis :	X
Test Mode :	TX N-20M MODE 2437MHz

Vertical

80 dBuV/m

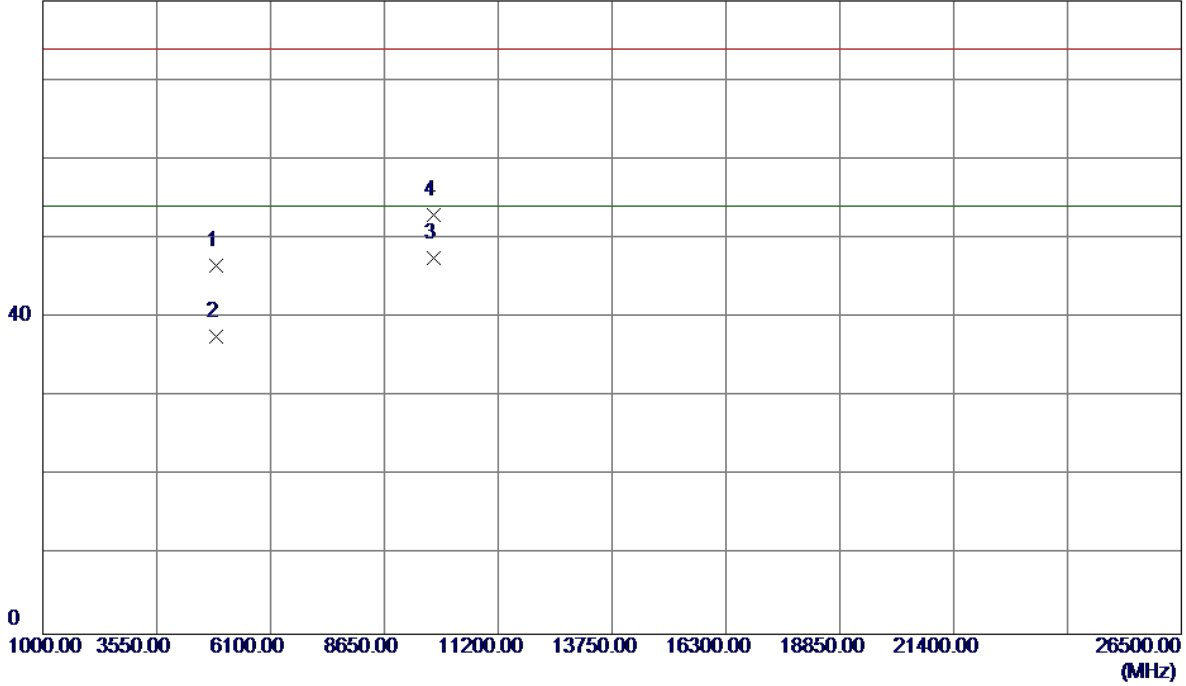

No.	Freq. MHz	Reading Level dBuV/m	Correct Factor dB	Measure ment dBuV/m	Limit dBuV/m	Margin dB	Detector	Comment
1	4873.8950	40.10	6.44	46.54	74.00	-27.46	Peak	
2	4874.1600	31.20	6.44	37.64	54.00	-16.36	AVG	
3 *	9748.1240	31.69	15.90	47.59	54.00	-6.41	AVG	
4	9748.1440	37.12	15.90	53.02	74.00	-20.98	Peak	

Orthogonal Axis :	X
Test Mode :	TX N-20M MODE 2437MHz

Horizontal

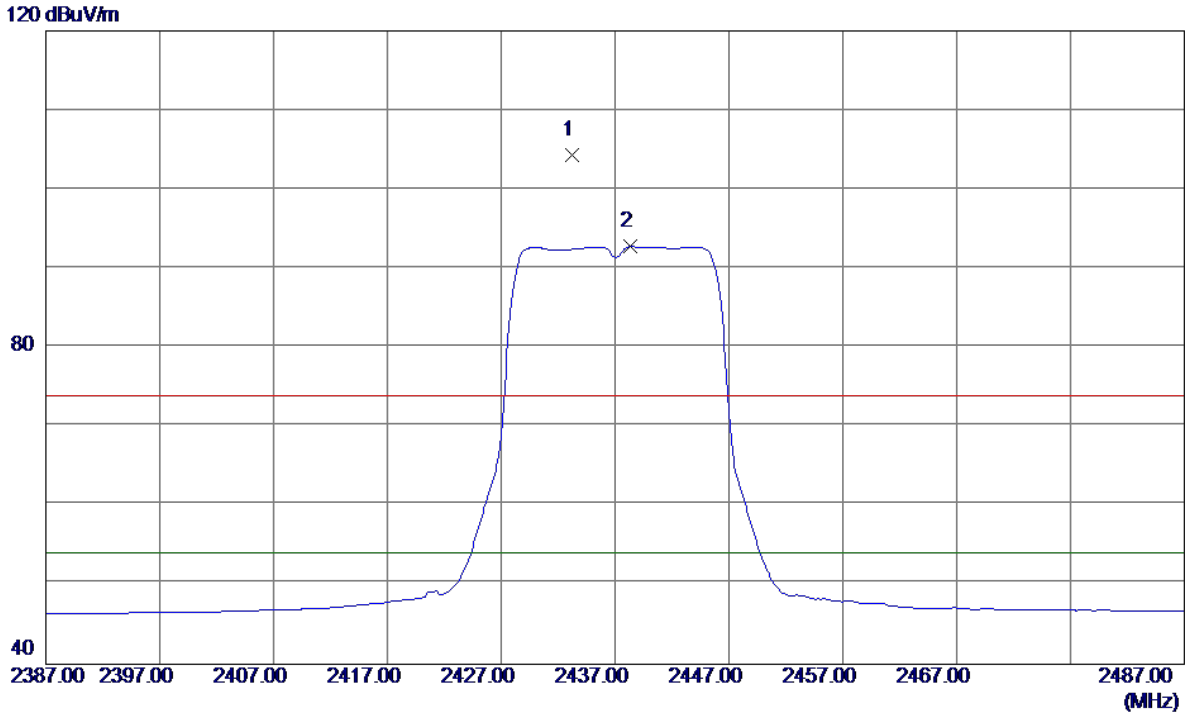

No.	Freq. MHz	Reading Level dBuV/m	Correct Factor dB	Measure ment dBuV/m	Limit dBuV/m	Margin dB	Detector	Comment
1	2433.2000	71.15	33.22	104.37	74.00	30.37	Peak	No Limit
2 *	2438.3000	59.51	33.24	92.75	54.00	38.75	AVG	No Limit

Orthogonal Axis :	X
Test Mode :	TX N-20M MODE 2437MHz

Horizontal

80 dBuV/m

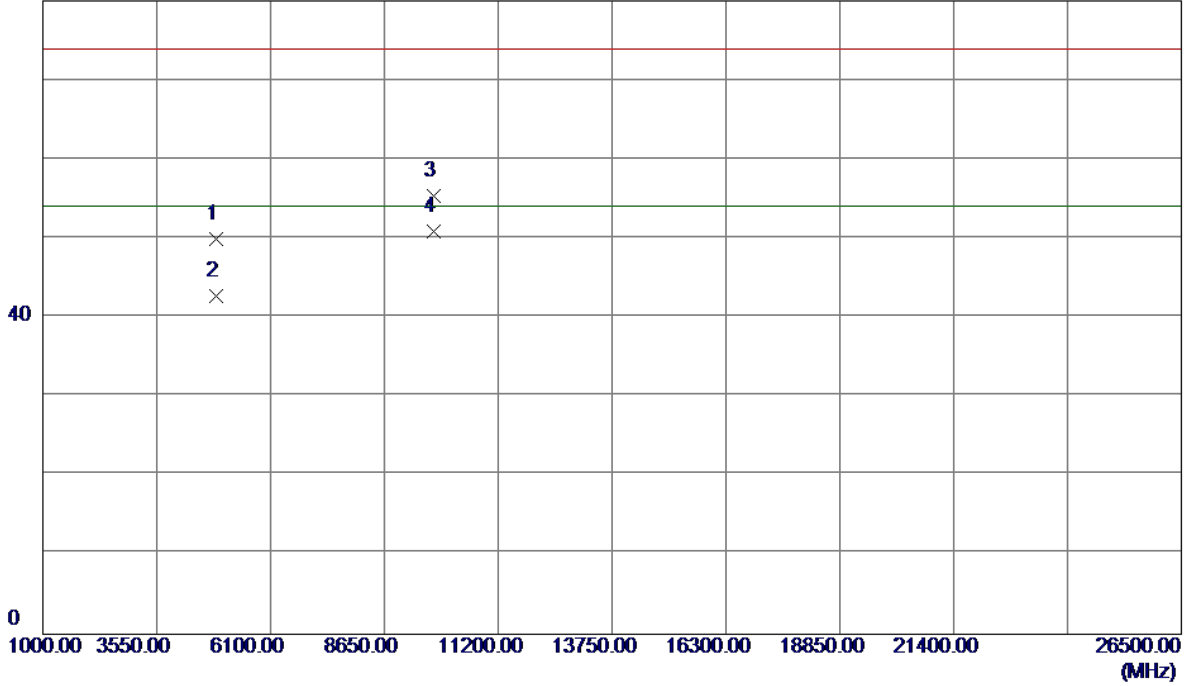

No.	Freq. MHz	Reading Level dBuV/m	Correct Factor dB	Measure ment dBuV/m	Limit dBuV/m	Margin dB	Detector	Comment
1	4874.0350	43.43	6.44	49.87	74.00	-24.13	Peak	
2	4874.0500	36.30	6.44	42.74	54.00	-11.26	AVG	
3	9748.0780	39.50	15.90	55.40	74.00	-18.60	Peak	
4 *	9748.1140	34.91	15.90	50.81	54.00	-3.19	AVG	

Orthogonal Axis :	X
Test Mode :	TX N-20M MODE 2462MHz

Vertical

120 dBuV/m

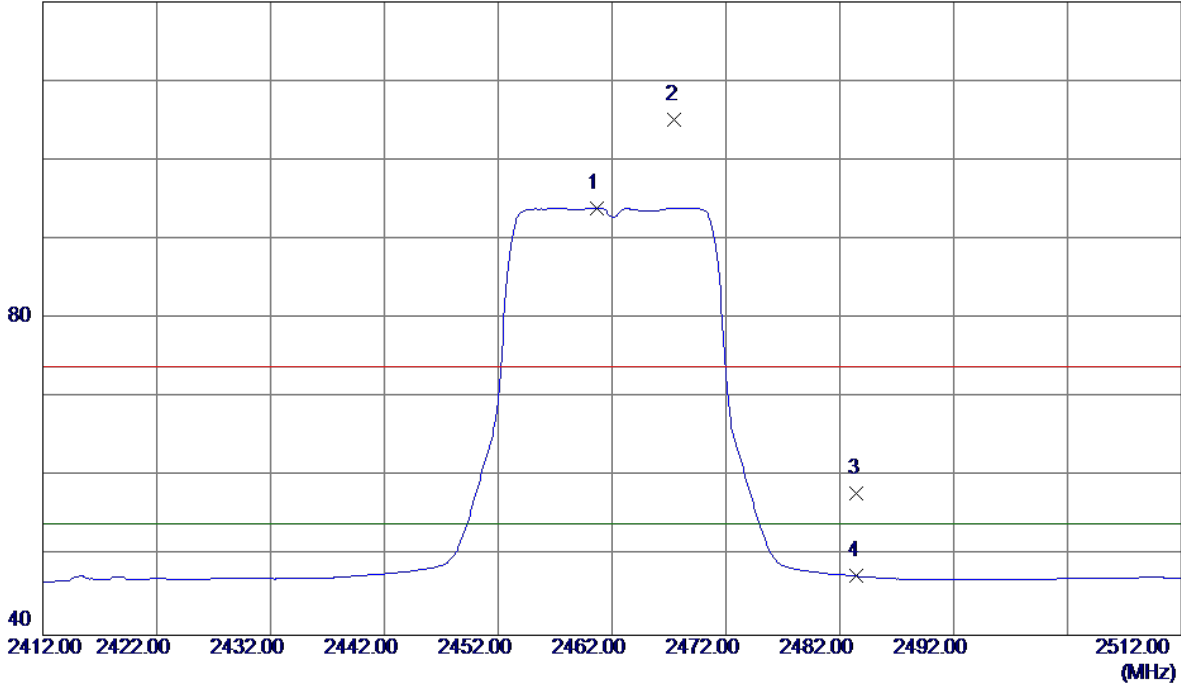

No.	Freq. MHz	Reading Level dBuV/m	Correct Factor dB	Measure ment dBuV/m	Limit dBuV/m	Margin dB	Detector	Comment
1 *	2460.7000	60.67	33.32	93.99	54.00	39.99	AVG	No Limit
2	2467.5000	71.72	33.35	105.07	74.00	31.07	Peak	No Limit
3	2483.5000	24.53	33.41	57.94	74.00	-16.06	Peak	
4	2483.5000	14.05	33.41	47.46	54.00	-6.54	AVG	

Orthogonal Axis :	X
Test Mode :	TX N-20M MODE 2462MHz

Vertical

80 dBuV/m

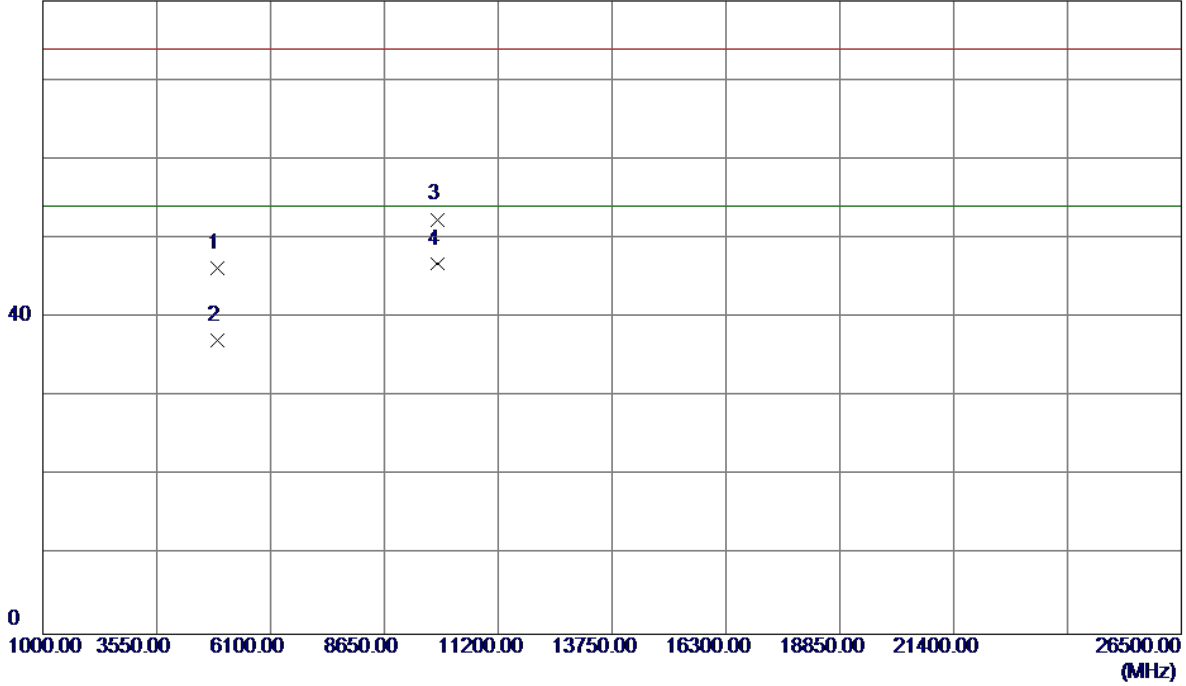

No.	Freq. MHz	Reading Level dBuV/m	Correct Factor dB	Measure ment dBuV/m	Limit dBuV/m	Margin dB	Detector	Comment
1	4923.4850	39.65	6.57	46.22	74.00	-27.78	Peak	
2	4924.0000	30.48	6.57	37.05	54.00	-16.95	AVG	
3	9848.0000	36.42	15.98	52.40	74.00	-21.60	Peak	
4 *	9848.0000	30.82	15.98	46.80	54.00	-7.20	AVG	

Orthogonal Axis :	X
Test Mode :	TX N-20M MODE 2462MHz

Horizontal

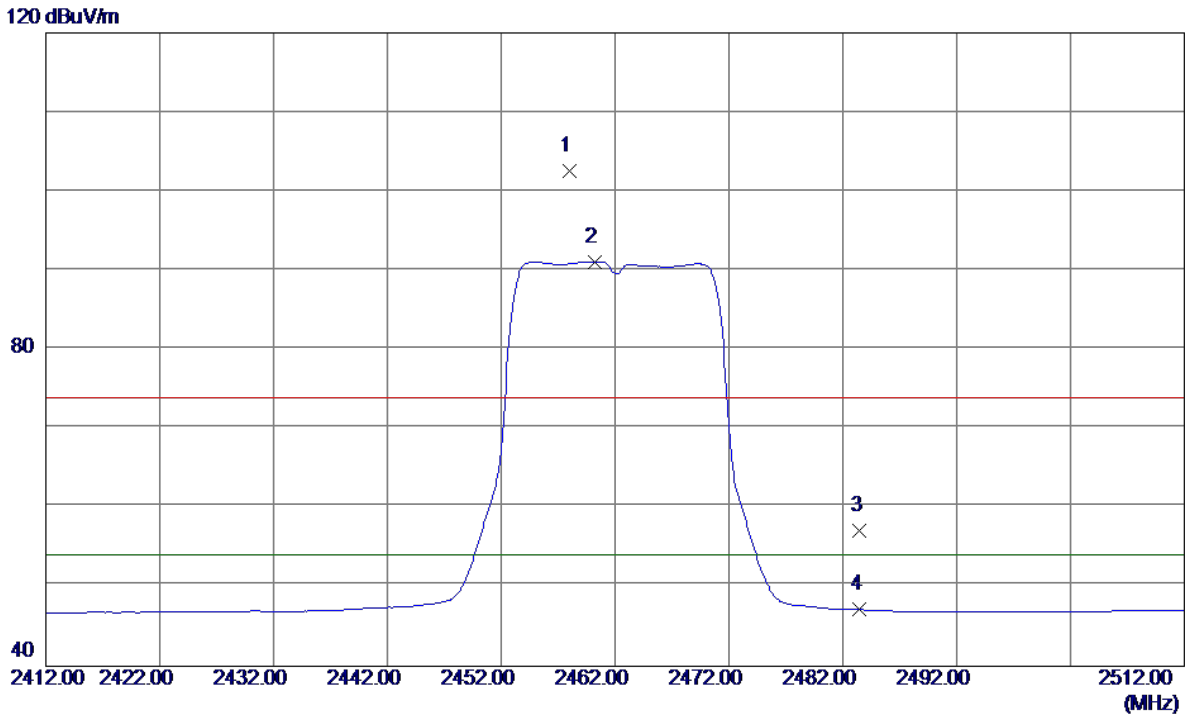

No.	Freq. MHz	Reading Level dBuV/m	Correct Factor dB	Measure ment dBuV/m	Limit dBuV/m	Margin dB	Detector	Comment
1	2458.0000	69.29	33.31	102.60	74.00	28.60	Peak	No Limit
2 *	2460.2000	57.76	33.32	91.08	54.00	37.08	AVG	No Limit
3	2483.5000	23.78	33.41	57.19	74.00	-16.81	Peak	
4	2483.5000	13.73	33.41	47.14	54.00	-6.86	AVG	

Orthogonal Axis :	X
Test Mode :	TX N-20M MODE 2462MHz

Horizontal

80 dBuV/m

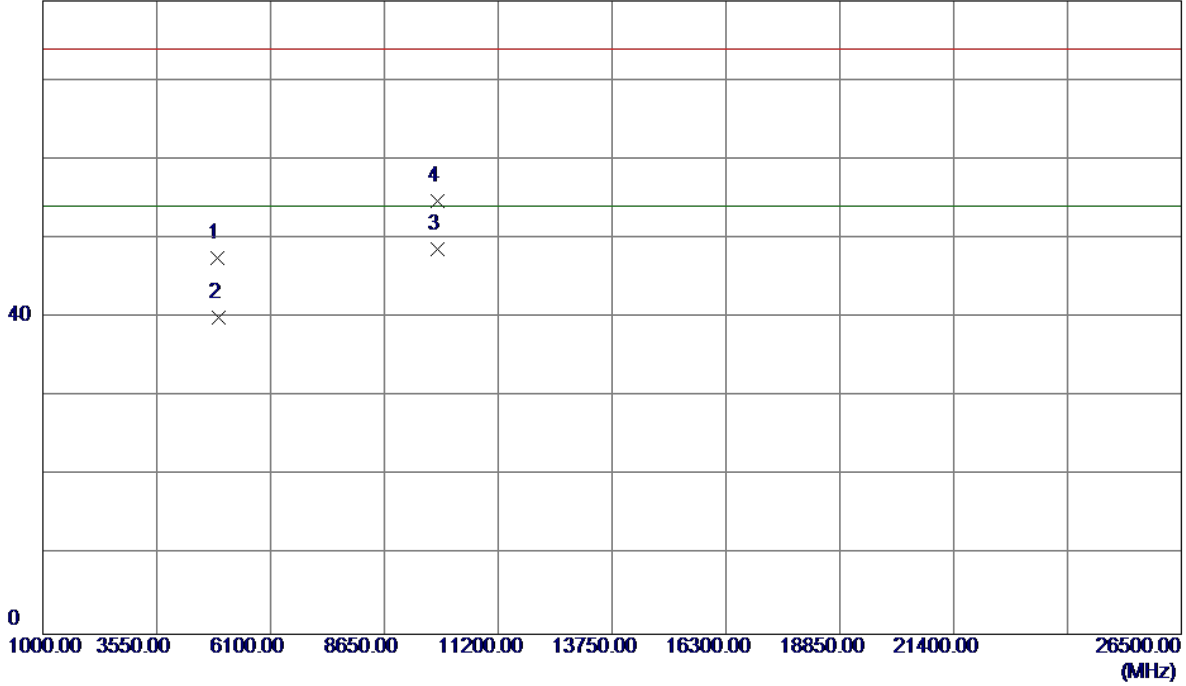

No.	Freq. MHz	Reading Level dBuV/m	Correct Factor dB	Measure ment dBuV/m	Limit dBuV/m	Margin dB	Detector	Comment
1	4923.8040	41.02	6.57	47.59	74.00	-26.41	Peak	
2	4924.2480	33.50	6.57	40.07	54.00	-13.93	AVG	
3 *	9848.0010	32.67	15.98	48.65	54.00	-5.35	AVG	
4	9848.2250	38.73	15.98	54.71	74.00	-19.29	Peak	

Orthogonal Axis :	X
Test Mode :	TX N-40M MODE 2422MHz

Vertical

120 dBuV/m

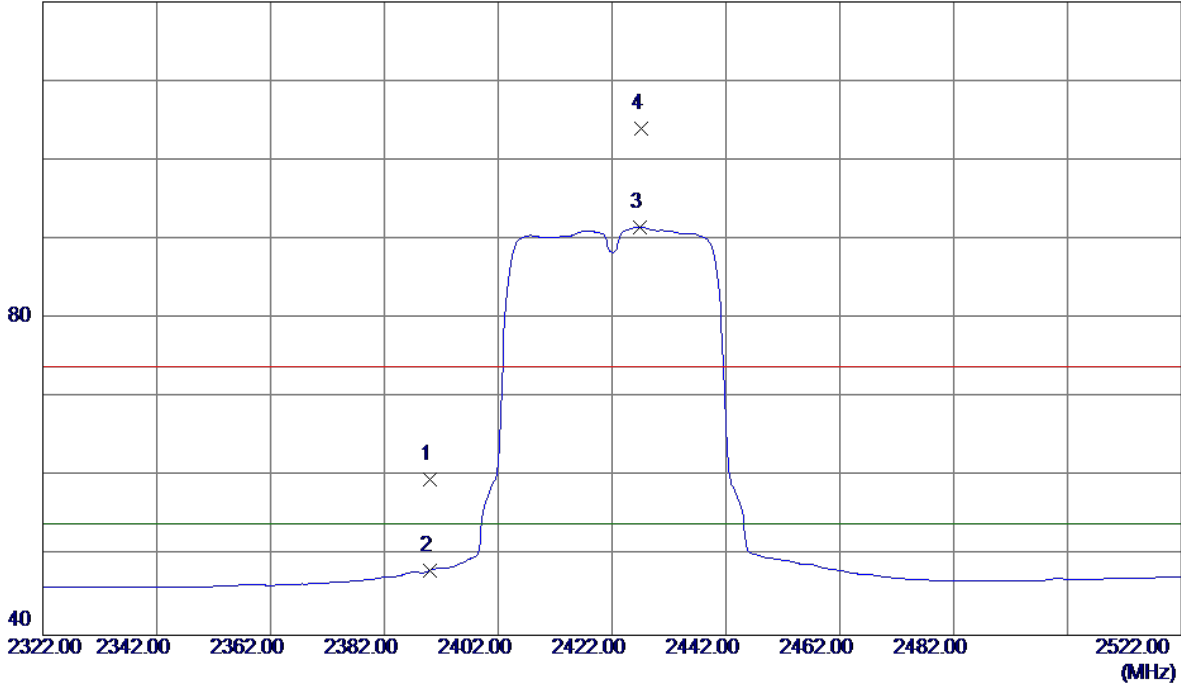

No.	Freq. MHz	Reading Level dBuV/m	Correct Factor dB	Measure ment dBuV/m	Limit dBuV/m	Margin dB	Detector	Comment
1	2390.0000	26.56	33.06	59.62	74.00	-14.38	Peak	
2	2390.0000	15.13	33.06	48.19	54.00	-5.81	AVG	
3 *	2426.8000	58.39	33.19	91.58	54.00	37.58	AVG	No Limit
4	2427.2000	70.83	33.20	104.03	74.00	30.03	Peak	No Limit

Orthogonal Axis :	X
Test Mode :	TX N-40M MODE 2422MHz

Vertical

80 dBuV/m

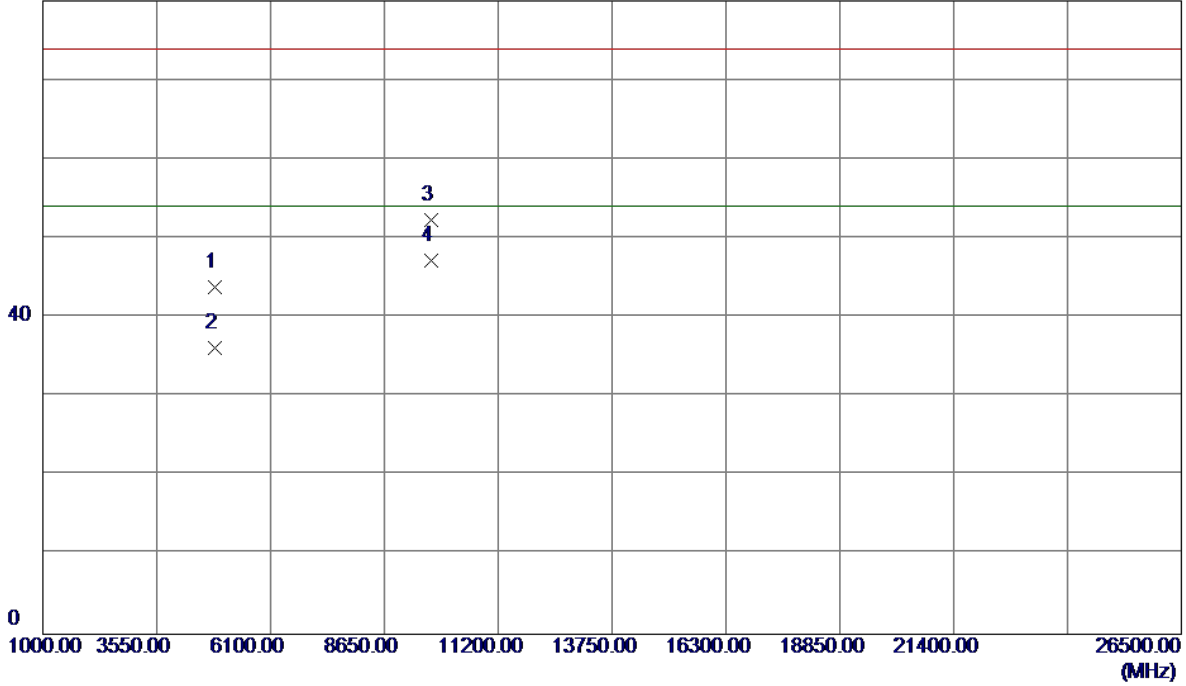

No.	Freq. MHz	Reading Level dBuV/m	Correct Factor dB	Measure ment dBuV/m	Limit dBuV/m	Margin dB	Detector	Comment
1	4843.9600	37.48	6.37	43.85	74.00	-30.15	Peak	
2	4844.0500	29.86	6.37	36.23	54.00	-17.77	AVG	
3	9688.0350	36.48	15.86	52.34	74.00	-21.66	Peak	
4 *	9688.0450	31.38	15.86	47.24	54.00	-6.76	AVG	

Orthogonal Axis :	X
Test Mode :	TX N-40M MODE 2422MHz

Horizontal

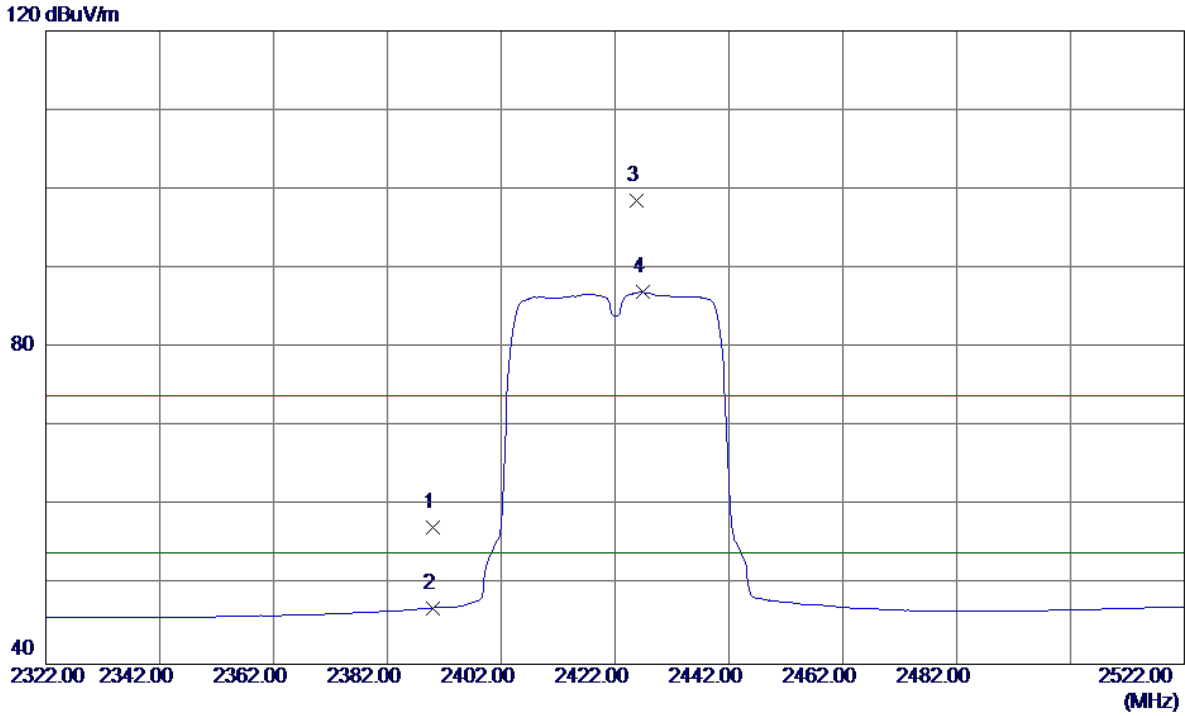

No.	Freq. MHz	Reading Level dBuV/m	Correct Factor dB	Measure ment dBuV/m	Limit dBuV/m	Margin dB	Detector	Comment
1	2390.0000	24.21	33.06	57.27	74.00	-16.73	Peak	
2	2390.0000	14.05	33.06	47.11	54.00	-6.89	AVG	
3	2425.8000	65.33	33.19	98.52	74.00	24.52	Peak	No Limit
4 *	2426.8000	53.83	33.19	87.02	54.00	33.02	AVG	No Limit

Orthogonal Axis :	X
Test Mode :	TX N-40M MODE 2422MHz

Horizontal

80 dBuV/m

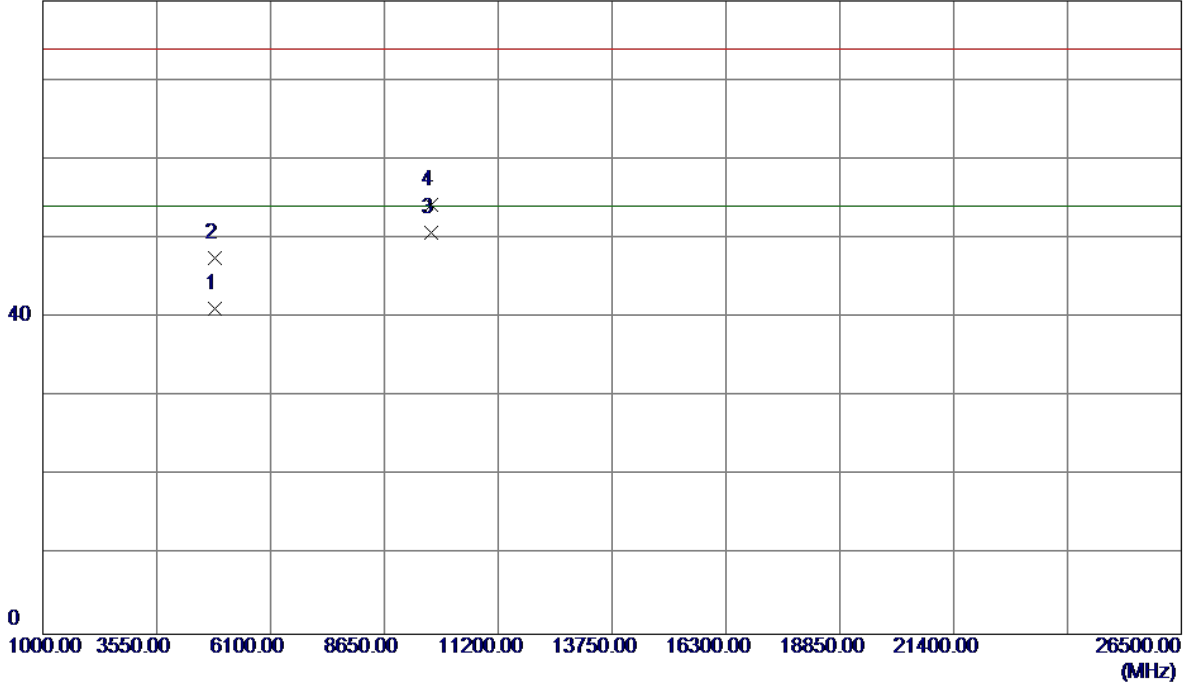

No.	Freq. MHz	Reading Level dBuV/m	Correct Factor dB	Measure ment dBuV/m	Limit dBuV/m	Margin dB	Detector	Comment
1	4844.0750	34.72	6.37	41.09	54.00	-12.91	AVG	
2	4844.3200	41.09	6.37	47.46	74.00	-26.54	Peak	
3 *	9688.0900	34.82	15.86	50.68	54.00	-3.32	AVG	
4	9688.0950	38.38	15.86	54.24	74.00	-19.76	Peak	

Orthogonal Axis :	X
Test Mode :	TX N-40M MODE 2437MHz

Vertical

120 dBuV/m

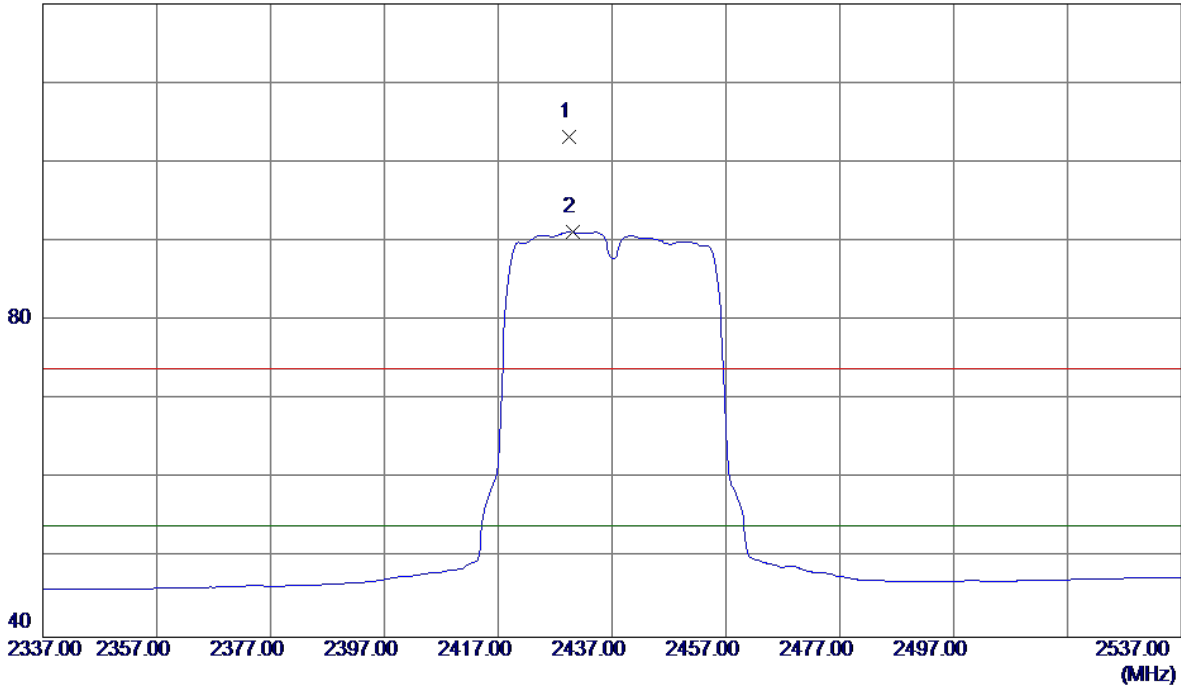

No.	Freq. MHz	Reading Level dBuV/m	Correct Factor dB	Measure ment dBuV/m	Limit dBuV/m	Margin dB	Detector	Comment
1	2429.4000	70.04	33.20	103.24	74.00	29.24	Peak	No Limit
2 *	2430.2000	57.92	33.21	91.13	54.00	37.13	AVG	No Limit

Orthogonal Axis :	X
Test Mode :	TX N-40M MODE 2437MHz

Vertical

80 dBuV/m

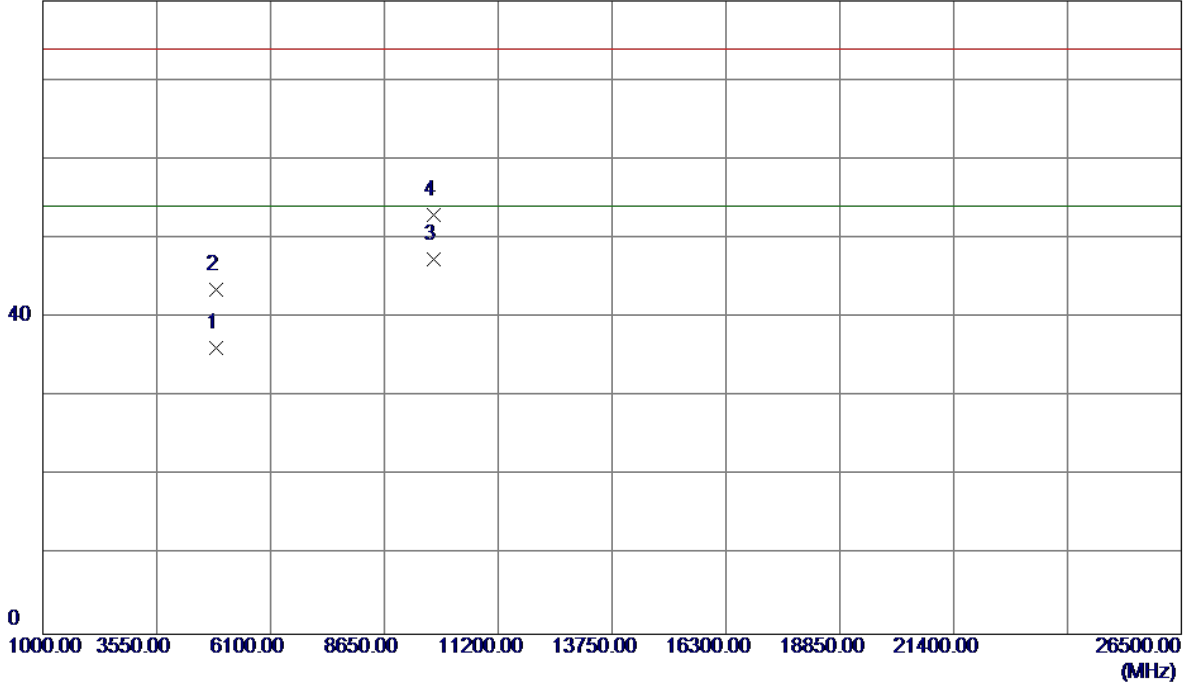

No.	Freq. MHz	Reading Level dBuV/m	Correct Factor dB	Measure ment dBuV/m	Limit dBuV/m	Margin dB	Detector	Comment
1	4873.9750	29.70	6.44	36.14	54.00	-17.86	AVG	
2	4874.4400	37.09	6.44	43.53	74.00	-30.47	Peak	
3 *	9748.1100	31.48	15.90	47.38	54.00	-6.62	AVG	
4	9748.2200	37.11	15.90	53.01	74.00	-20.99	Peak	

Orthogonal Axis :	X
Test Mode :	TX N-40M MODE 2437MHz

Horizontal

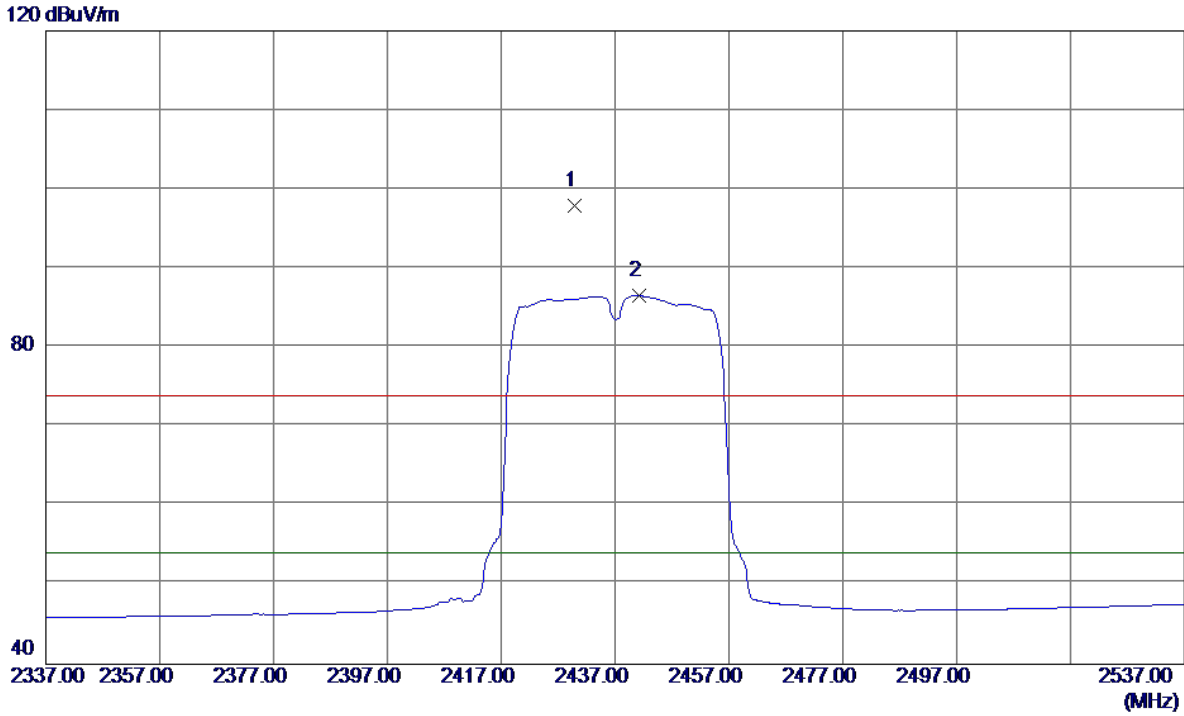

No.	Freq. MHz	Reading Level dBuV/m	Correct Factor dB	Measure ment dBuV/m	Limit dBuV/m	Margin dB	Detector	Comment
1	2429.8000	64.72	33.21	97.93	74.00	23.93	Peak	No Limit
2 *	2441.2000	53.31	33.25	86.56	54.00	32.56	AVG	No Limit

Orthogonal Axis :	X
Test Mode :	TX N-40M MODE 2437MHz

Horizontal

80 dBuV/m

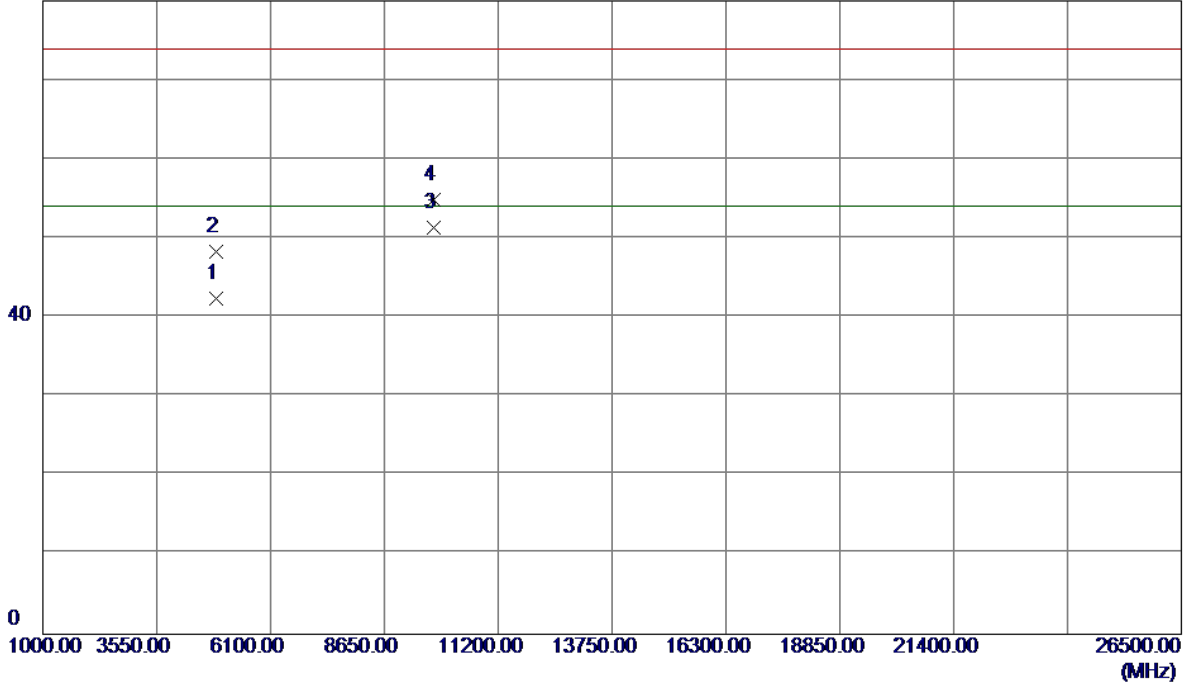

No.	Freq. MHz	Reading Level dBuV/m	Correct Factor dB	Measure ment dBuV/m	Limit dBuV/m	Margin dB	Detector	Comment
1	4874.0900	35.90	6.44	42.34	54.00	-11.66	AVG	
2	4874.3450	41.83	6.44	48.27	74.00	-25.73	Peak	
3 *	9748.1250	35.45	15.90	51.35	54.00	-2.65	AVG	
4	9748.1350	38.93	15.90	54.83	74.00	-19.17	Peak	

Orthogonal Axis :	X
Test Mode :	TX N-40M MODE 2452MHz

Vertical

120 dBuV/m

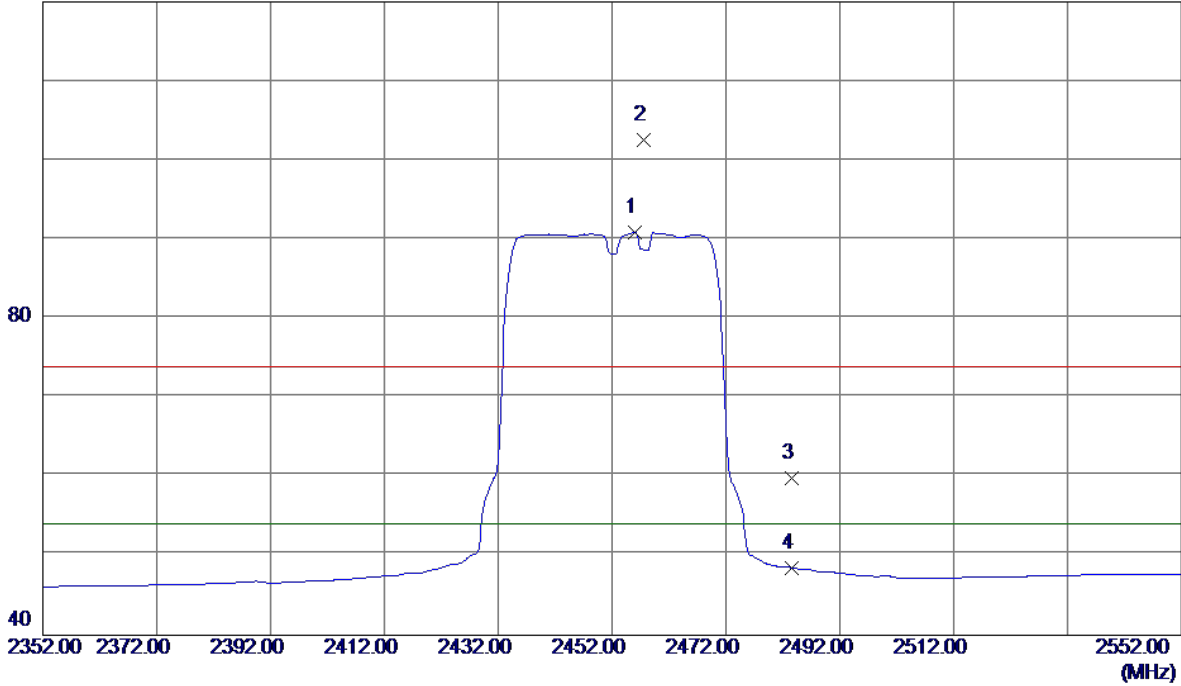

No.	Freq. MHz	Reading Level dBuV/m	Correct Factor dB	Measure ment dBuV/m	Limit dBuV/m	Margin dB	Detector	Comment
1 *	2456.0000	57.66	33.30	90.96	54.00	36.96	AVG	No Limit
2	2457.6000	69.28	33.31	102.59	74.00	28.59	Peak	No Limit
3	2483.5000	26.41	33.41	59.82	74.00	-14.18	Peak	
4	2483.5000	15.11	33.41	48.52	54.00	-5.48	AVG	

Orthogonal Axis :	X
Test Mode :	TX N-40M MODE 2452MHz

Vertical

80 dBuV/m

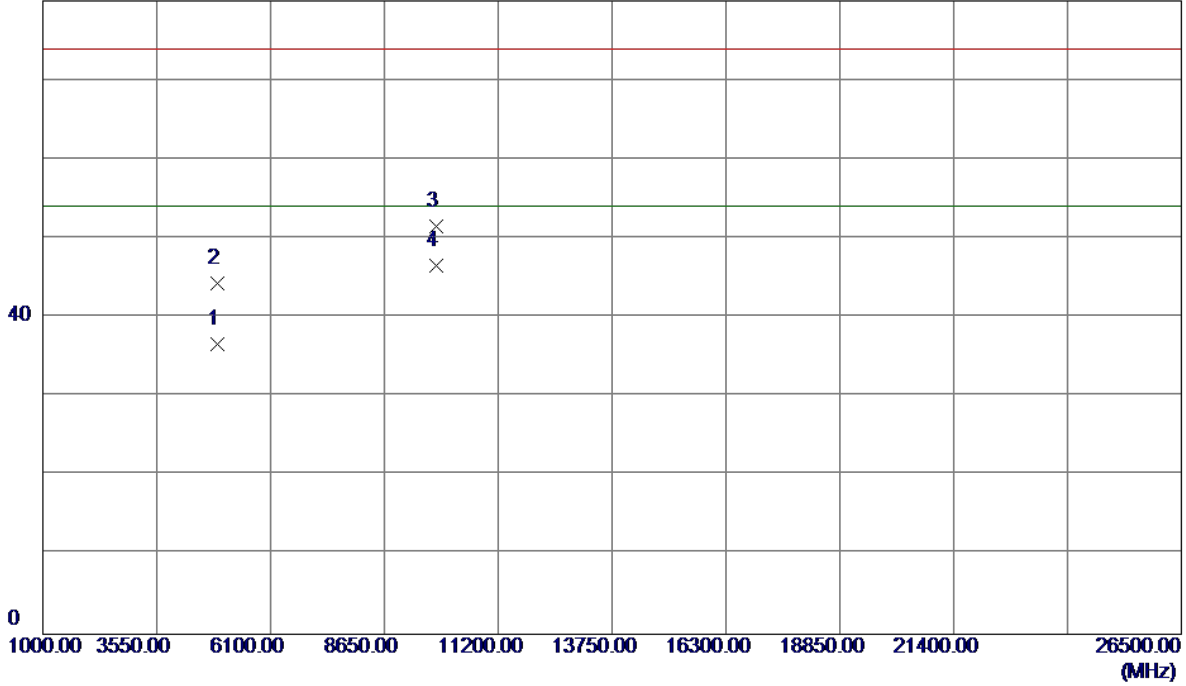

No.	Freq. MHz	Reading Level dBuV/m	Correct Factor dB	Measure ment dBuV/m	Limit dBuV/m	Margin dB	Detector	Comment
1	4904.0750	30.13	6.52	36.65	54.00	-17.35	AVG	
2	4904.1900	37.84	6.52	44.36	74.00	-29.64	Peak	
3	9808.0150	35.52	15.95	51.47	74.00	-22.53	Peak	
4 *	9808.0950	30.57	15.95	46.52	54.00	-7.48	AVG	

Orthogonal Axis :	X
Test Mode :	TX N-40M MODE 2452MHz

Horizontal

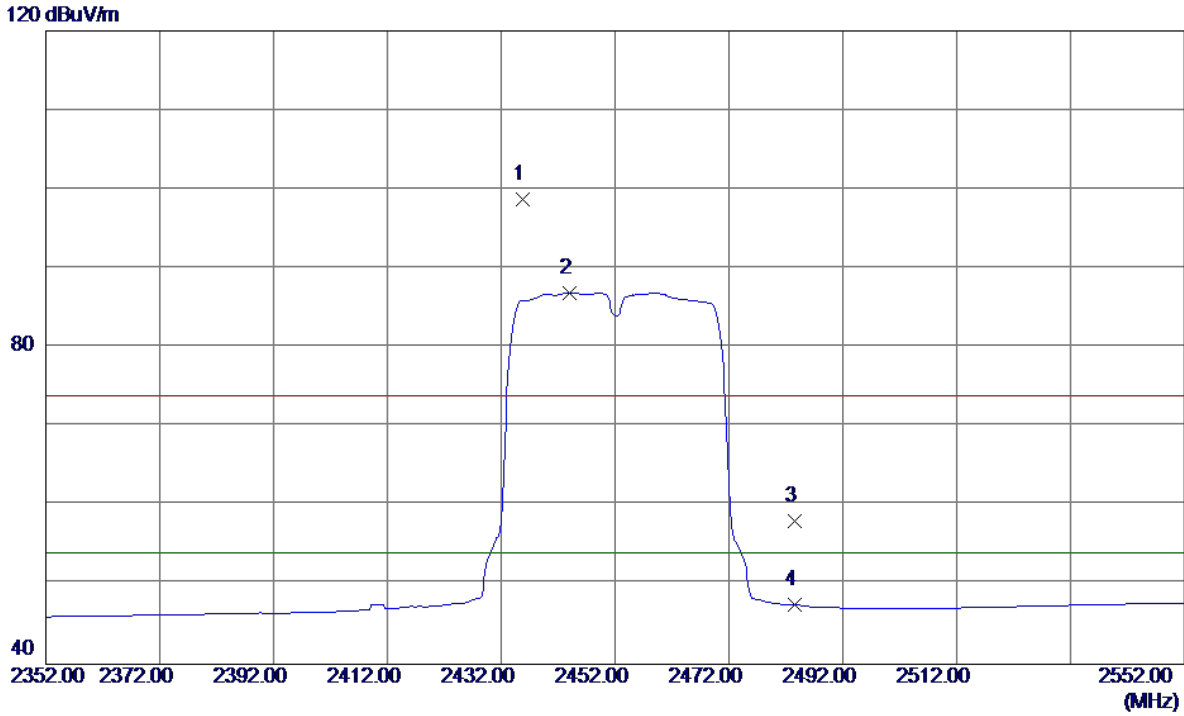

No.	Freq. MHz	Reading Level dBuV/m	Correct Factor dB	Measure ment dBuV/m	Limit dBuV/m	Margin dB	Detector	Comment
1	2435.8000	65.56	33.23	98.79	74.00	24.79	Peak	No Limit
2 *	2444.0000	53.67	33.26	86.93	54.00	32.93	AVG	No Limit
3	2483.5000	24.66	33.41	58.07	74.00	-15.93	Peak	
4	2483.5000	14.06	33.41	47.47	54.00	-6.53	AVG	

Orthogonal Axis :	X
Test Mode :	TX N-40M MODE 2452MHz

Horizontal

80 dBuV/m

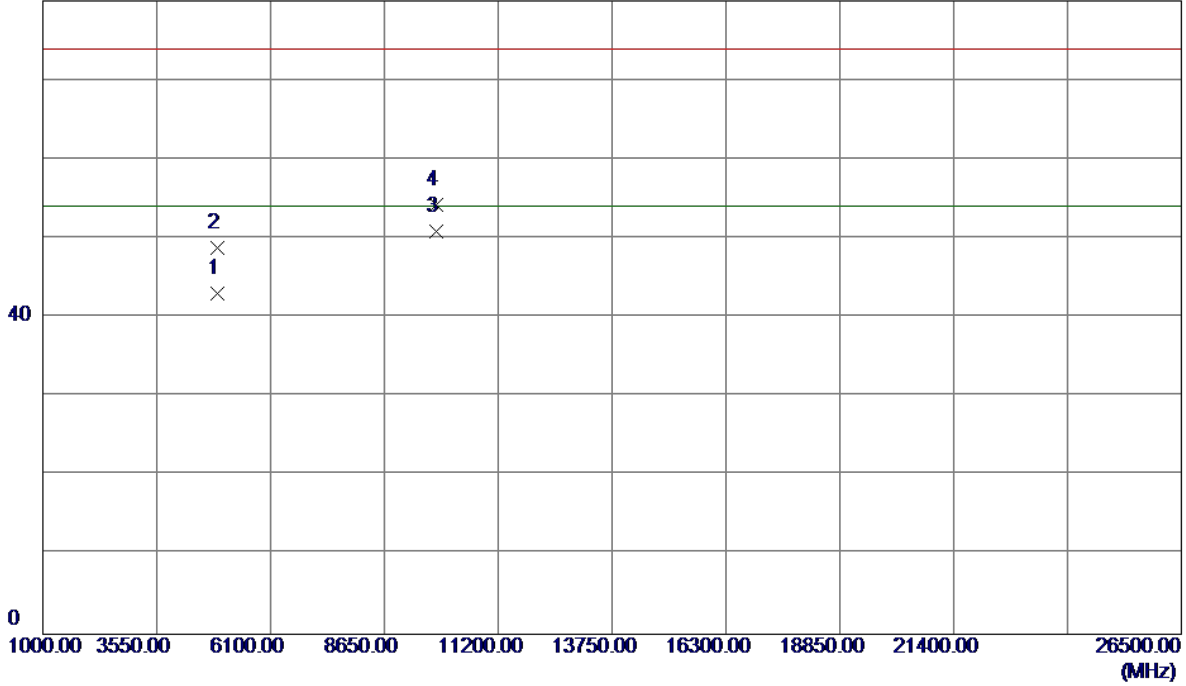

No.	Freq. MHz	Reading Level dBuV/m	Correct Factor dB	Measure ment dBuV/m	Limit dBuV/m	Margin dB	Detector	Comment
1	4904.0500	36.56	6.52	43.08	54.00	-10.92	AVG	
2	4904.0750	42.23	6.52	48.75	74.00	-25.25	Peak	
3 *	9808.0850	34.96	15.95	50.91	54.00	-3.09	AVG	
4	9808.1700	38.30	15.95	54.25	74.00	-19.75	Peak	

APPENDIX E - BANDWIDTH

Test Mode : TX B Mode_CH01/06/11

Frequency (MHz)	6dB Bandwidth (MHz)	99% Occupied BW (MHz)	Min. Limit (kHz)	Test Result
2412	10.03	15.04	500	Complies
2437	10.04	15.08	500	Complies
2462	10.04	15.08	500	Complies

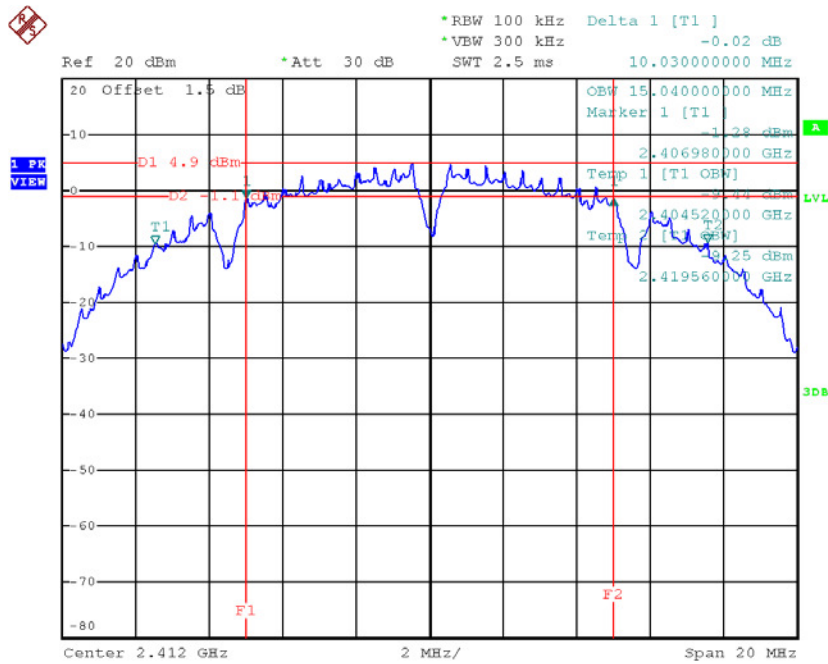
TX CH01

Date: 18.AUG.2017 09:18:05

TX CH06

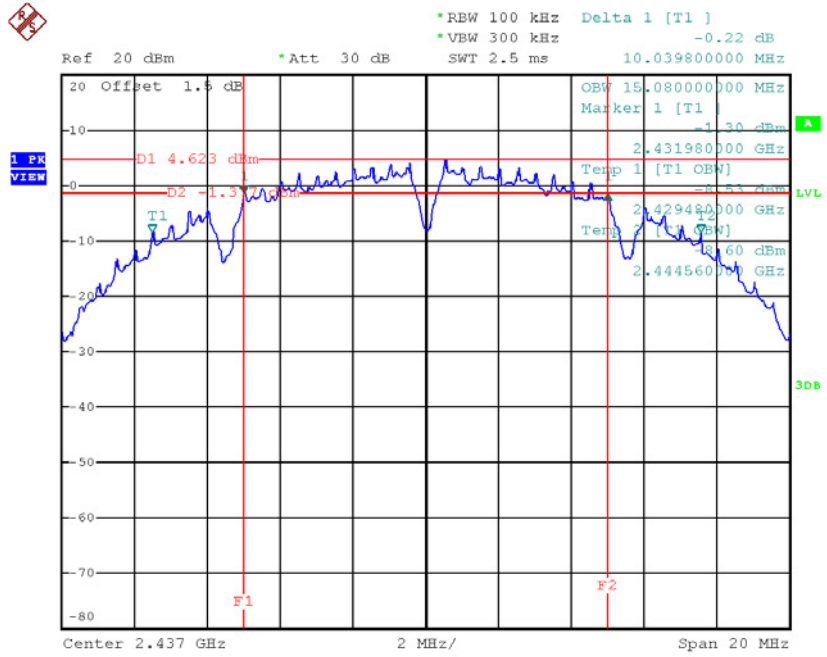

Date: 18.AUG.2017 09:15:55

TX CH11

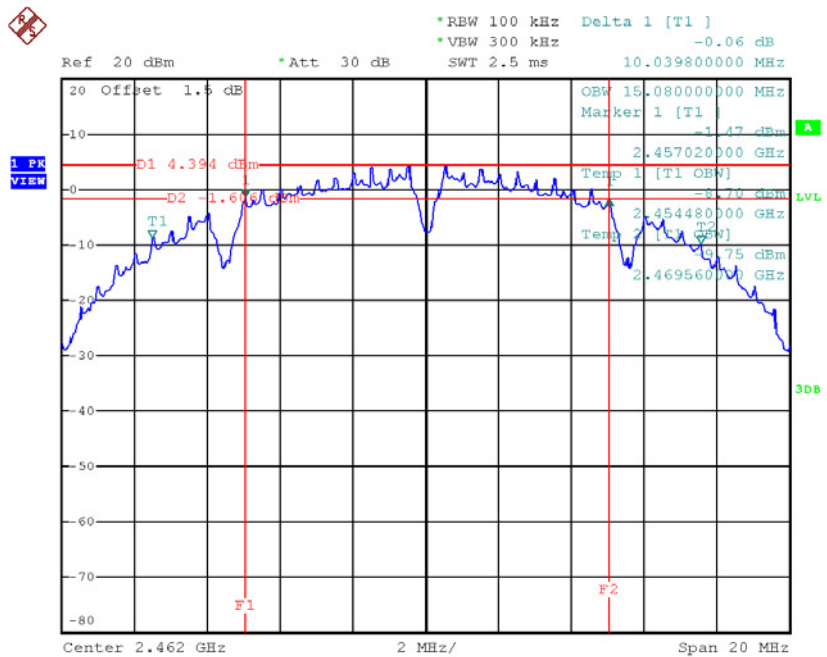

Date: 18.AUG.2017 09:20:02

Test Mode: TX G Mode_CH01/06/11

Frequency (MHz)	6dB Bandwidth (MHz)	99% Occupied BW (MHz)	Min. Limit (kHz)	Test Result
2412	16.42	16.52	500	Complies
2437	16.4	16.52	500	Complies
2462	16.42	16.52	500	Complies

TX CH01

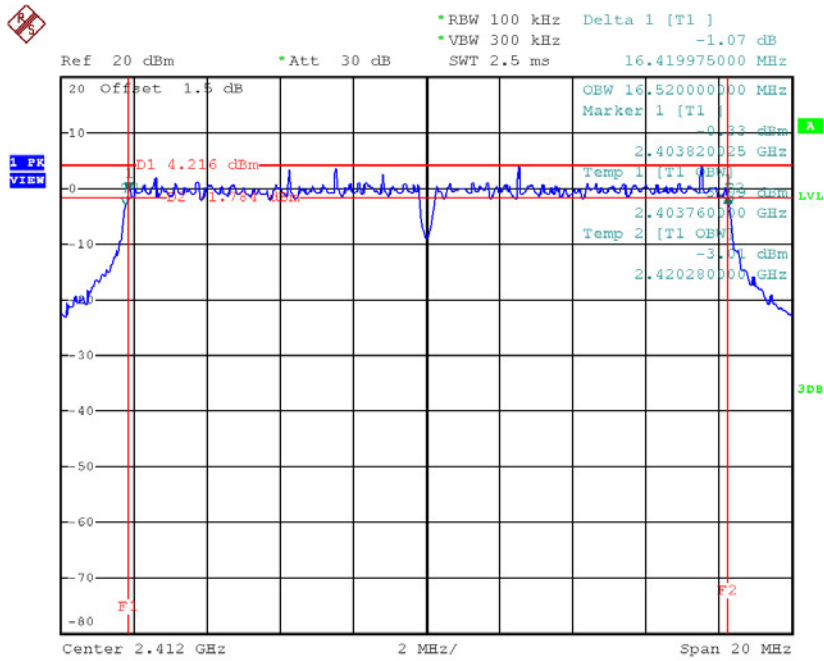

Date: 18.AUG.2017 09:30:15

TX CH06

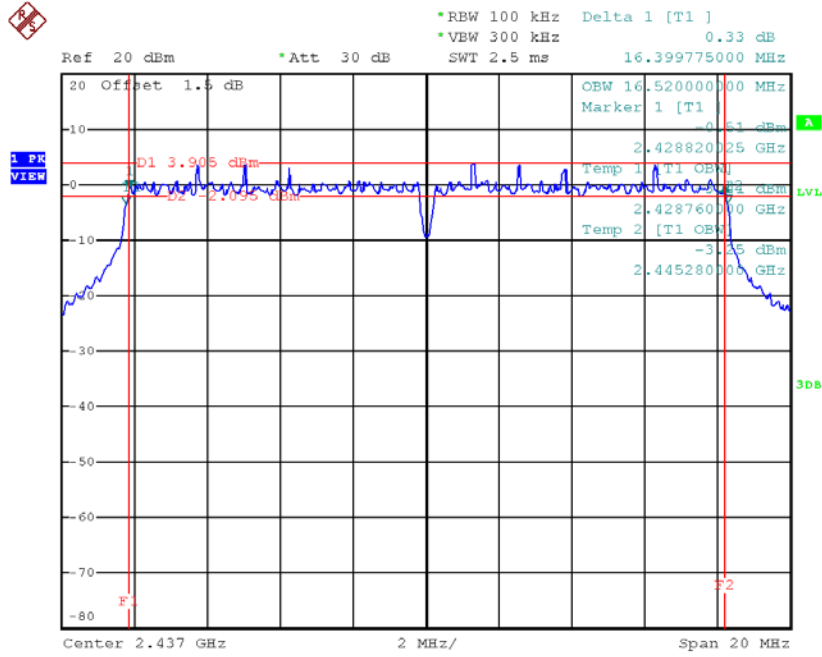

Date: 18.AUG.2017 09:31:43

TX CH11

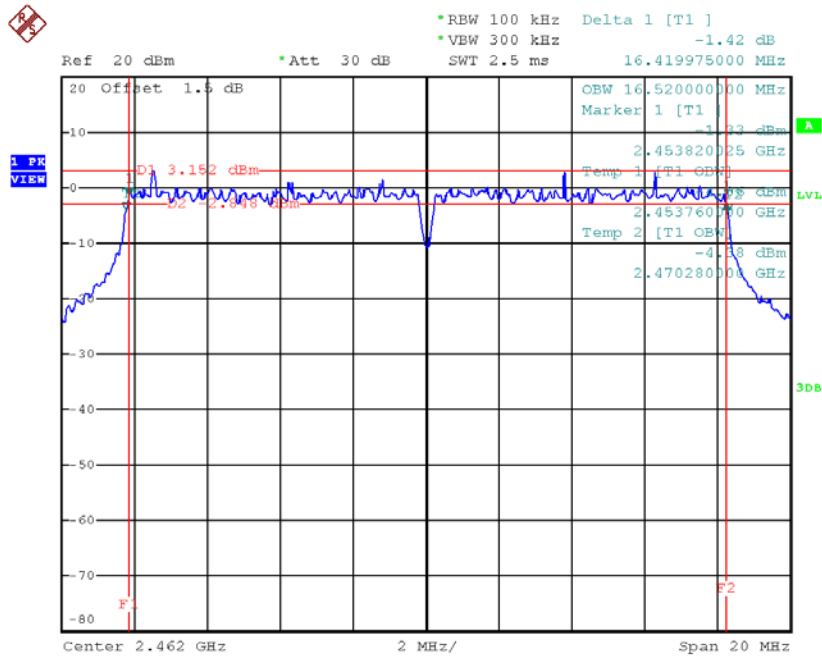

Date: 18.AUG.2017 09:33:01

Test Mode : TX N-20MHz Mode_CH01/06/11

Frequency (MHz)	6dB Bandwidth (MHz)	99% Occupied BW (MHz)	Min. Limit (kHz)	Test Result
2412	17.62	17.72	500	Complies
2437	17.66	17.68	500	Complies
2462	17.66	17.68	500	Complies

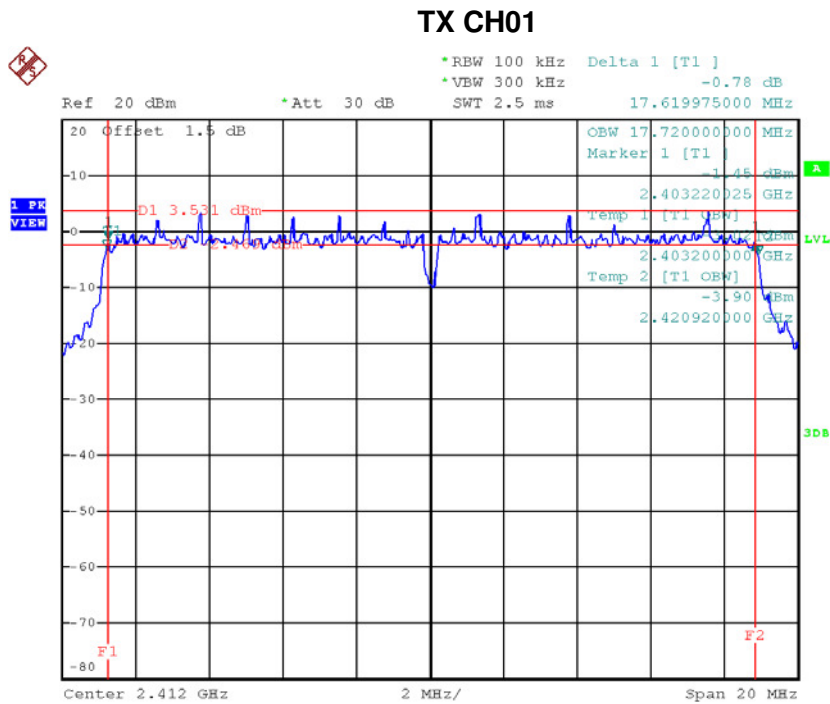

Date: 18.AUG.2017 09:35:27

TX CH06

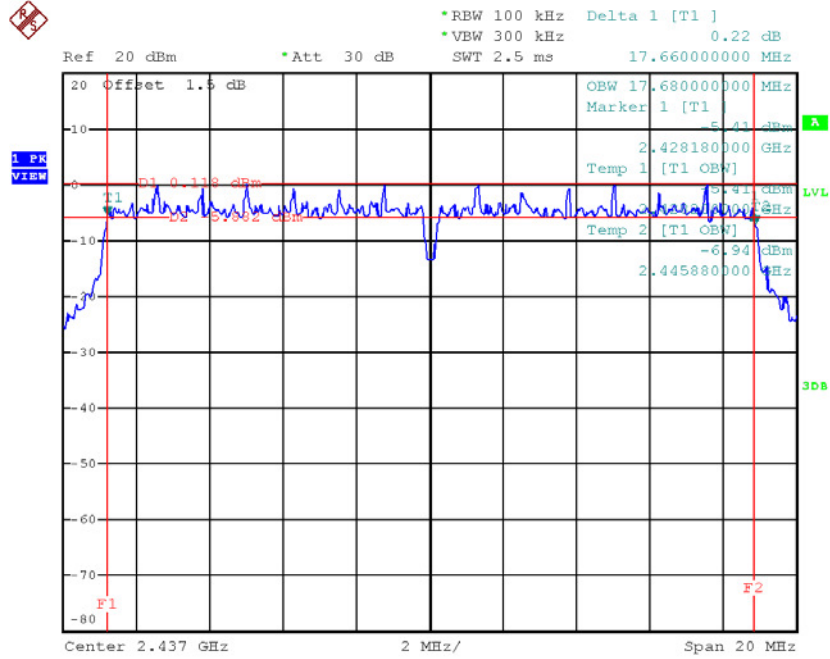

Date: 18.AUG.2017 09:36:32

TX CH11

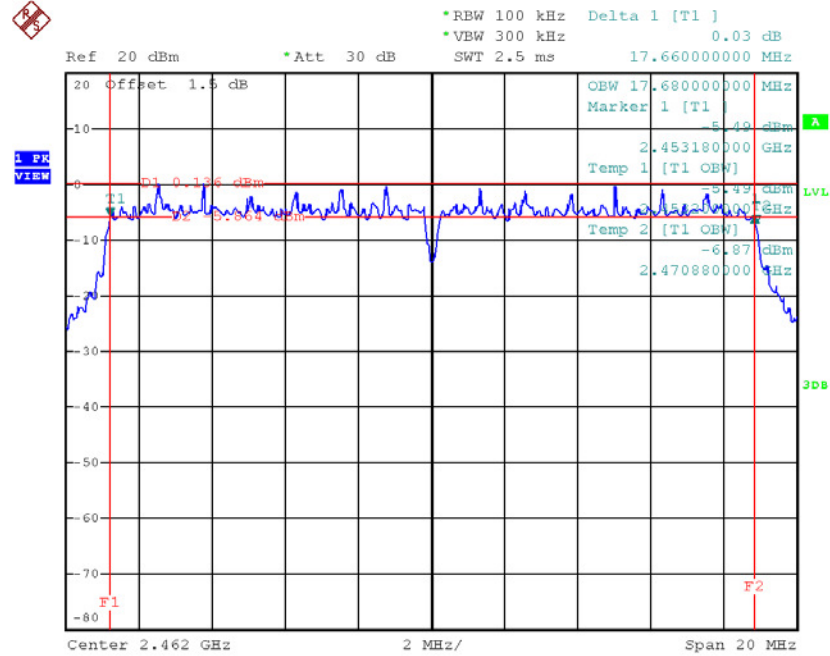

Date: 18.AUG.2017 09:37:32

Test Mode : TX N-40MHz Mode_CH03/06/09

Frequency (MHz)	6dB Bandwidth (MHz)	99% Occupied BW (MHz)	Min. Limit (kHz)	Test Result
2422	35.59	36.08	500	Complies
2437	35.91	36.08	500	Complies
2452	35.76	36.08	500	Complies

TX CH03

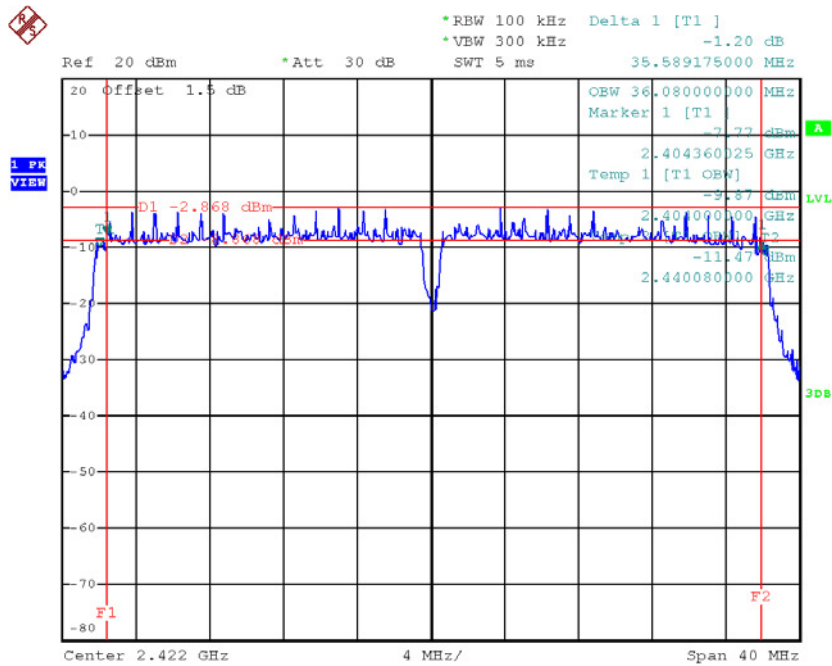

Date: 18.AUG.2017 09:40:11

TX CH06

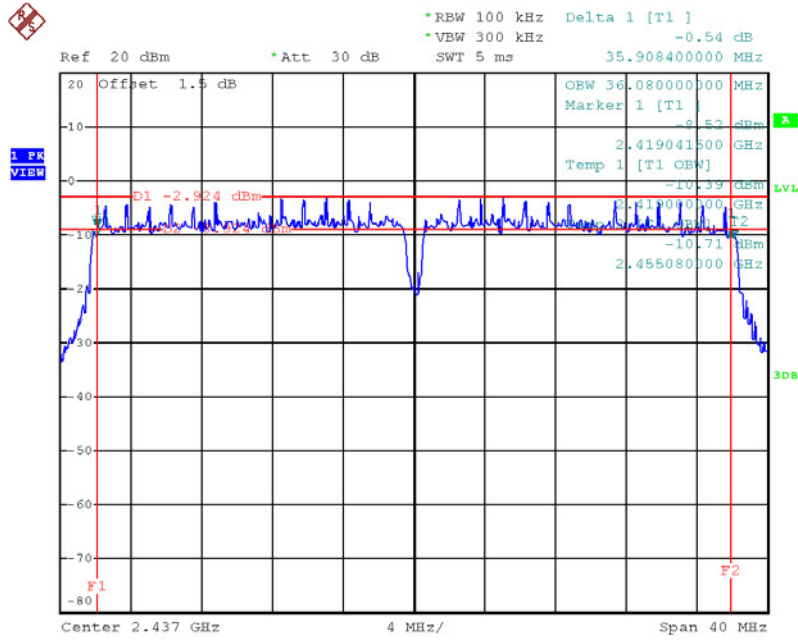

Date: 18.AUG.2017 09:41:36

TX CH09

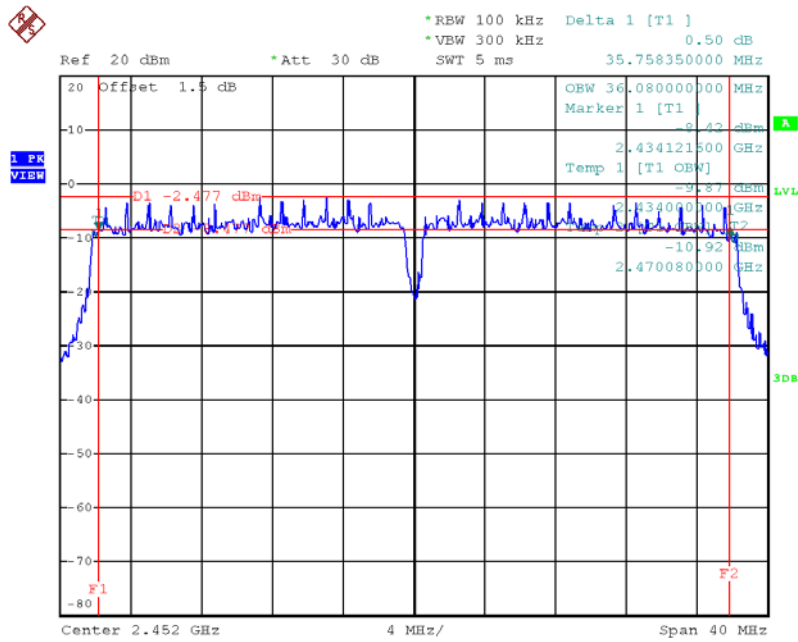

Date: 18.AUG.2017 09:42:55

APPENDIX F - MAXIMUM PEAK CONDUCTED OUTPUT POWER

Test Mode :TX B Mode_CH01/06/11					
Frequency (MHz)	Conducted Power (dBm)	Conducted Power (W)	Max. Limit (dBm)	Max. Limit (W)	Result
2412	20.05	0.10	30.00	1.00	Complies
2437	19.94	0.10	30.00	1.00	Complies
2462	19.93	0.10	30.00	1.00	Complies

Test Mode :TX G Mode_CH01/06/11					
Frequency (MHz)	Conducted Power (dBm)	Conducted Power (W)	Max. Limit (dBm)	Max. Limit (W)	Result
2412	27.31	0.54	30.00	1.00	Complies
2437	26.87	0.49	30.00	1.00	Complies
2462	26.88	0.49	30.00	1.00	Complies

Test Mode :TX N20 Mode_CH01/06/11_ANT 1					
Frequency (MHz)	Conducted Power (dBm)	Conducted Power (W)	Max. Limit (dBm)	Max. Limit (W)	Result
2412	25.18	0.33	30.00	1.00	Complies
2437	22.91	0.20	30.00	1.00	Complies
2462	22.51	0.18	30.00	1.00	Complies

Test Mode :TX N20 Mode_CH01/06/11_ANT 2					
Frequency (MHz)	Conducted Power (dBm)	Conducted Power (W)	Max. Limit (dBm)	Max. Limit (W)	Result
2412	26.03	0.40	30.00	1.00	Complies
2437	25.58	0.36	30.00	1.00	Complies
2462	24.24	0.27	30.00	1.00	Complies

Test Mode :TX N20 Mode_CH01/06/11_Total					
Frequency (MHz)	Conducted Power (dBm)	Conducted Power (W)	Max. Limit (dBm)	Max. Limit (W)	Result
2412	28.64	0.73	30.00	1.00	Complies
2437	27.46	0.56	30.00	1.00	Complies
2462	26.47	0.44	30.00	1.00	Complies

Test Mode :TX N40 Mode_CH03/06/09_ANT 1					
Frequency (MHz)	Conducted Power (dBm)	Conducted Power (W)	Max. Limit (dBm)	Max. Limit (W)	Result
2422	21.66	0.15	30.00	1.00	Complies
2437	21.48	0.14	30.00	1.00	Complies
2452	21.73	0.15	30.00	1.00	Complies

Test Mode :TX N40 Mode_CH03/06/09_ANT 2					
Frequency (MHz)	Conducted Power (dBm)	Conducted Power (W)	Max. Limit (dBm)	Max. Limit (W)	Result
2422	23.24	0.21	30.00	1.00	Complies
2437	22.86	0.19	30.00	1.00	Complies
2452	23.41	0.22	30.00	1.00	Complies

Test Mode :TX N40 Mode_CH03/06/09_Total					
Frequency (MHz)	Conducted Power (dBm)	Conducted Power (W)	Max. Limit (dBm)	Max. Limit (W)	Result
2422	25.53	0.36	30.00	1.00	Complies
2437	25.23	0.33	30.00	1.00	Complies
2452	25.66	0.37	30.00	1.00	Complies

APPENDIX G - ANTENNA CONDUCTED SPURIOUS EMISSION

Test Mode : TX B Mode

TX B mode CH01

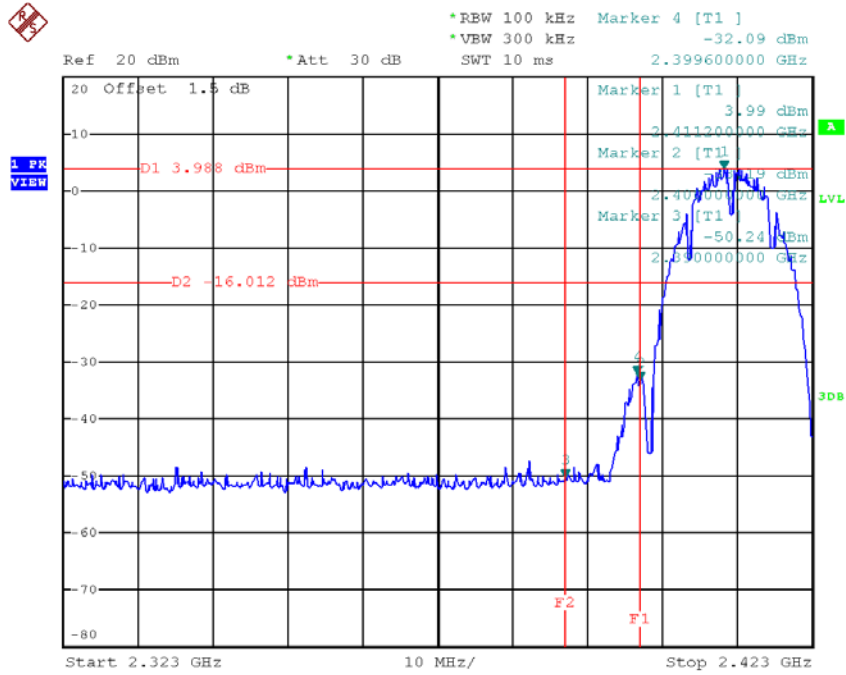

Date: 18.AUG.2017 09:18:41

TX B mode CH11

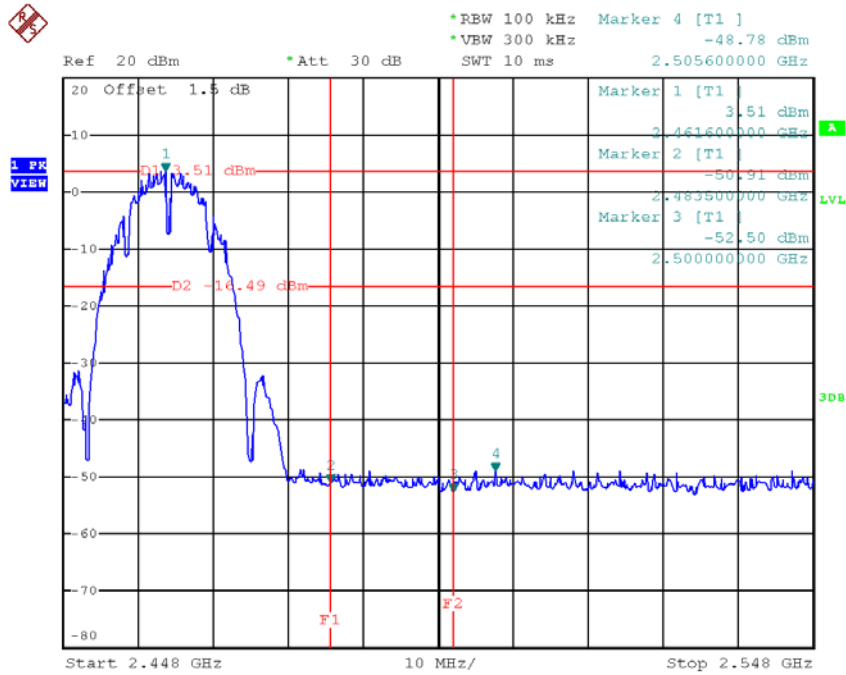

Date: 18.AUG.2017 09:20:36

TX B mode CH01 (10 Harmonic of the frequency)

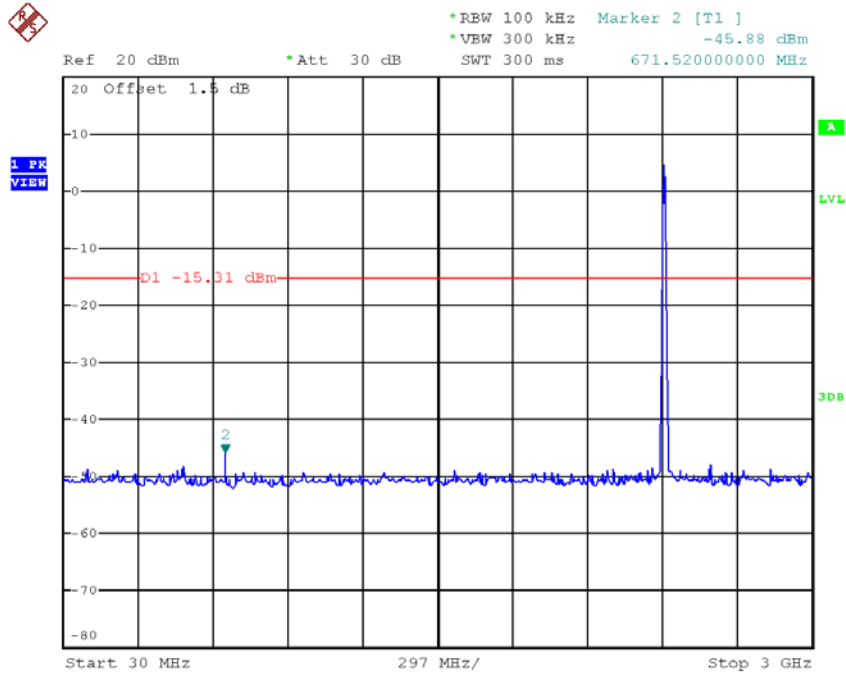

Date: 18.AUG.2017 09:18:19

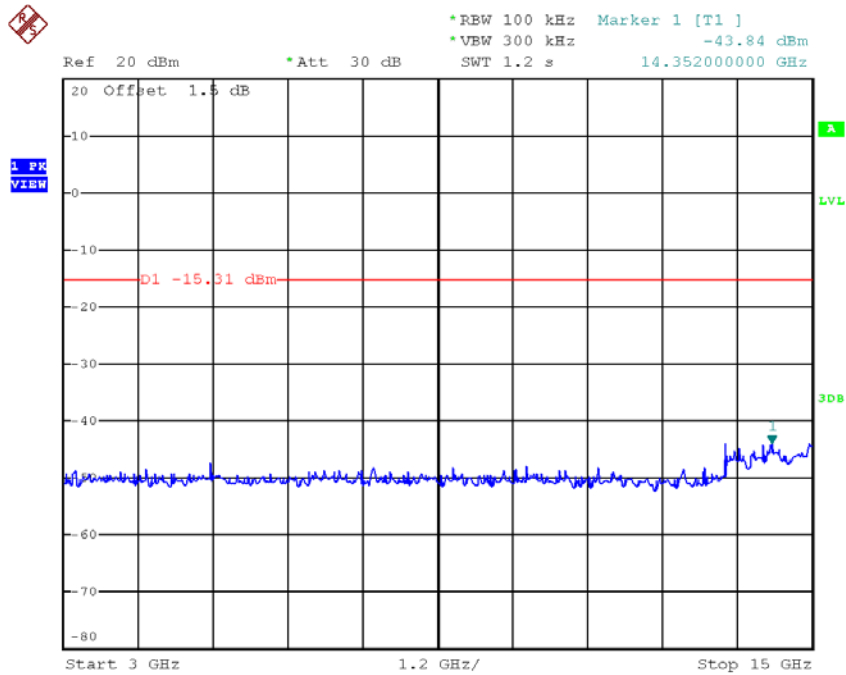

Date: 18.AUG.2017 09:18:26

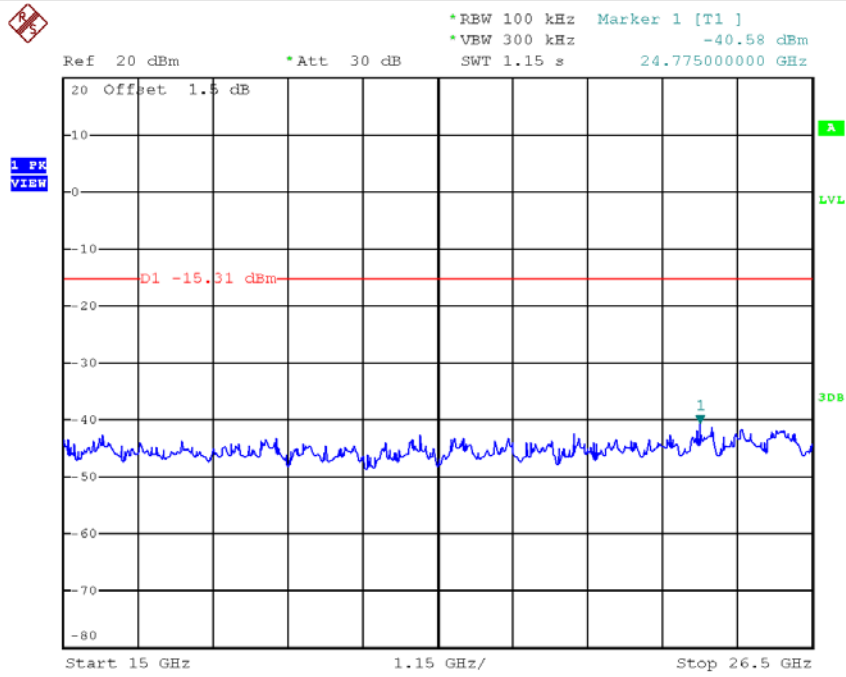

Date: 18.AUG.2017 09:18:33

TX B mode CH06 (10 Harmonic of the frequency)

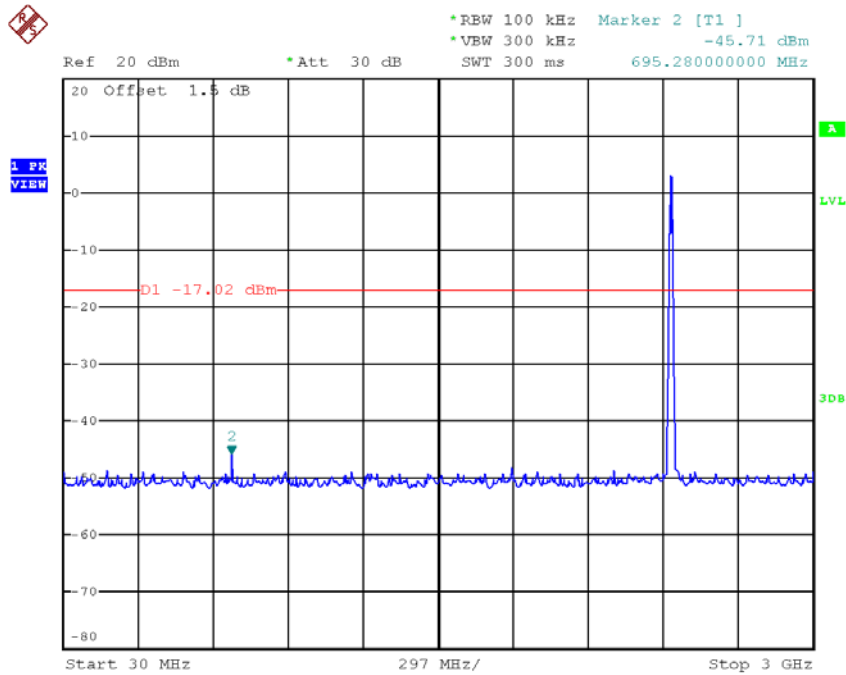

Date: 18.AUG.2017 09:14:21

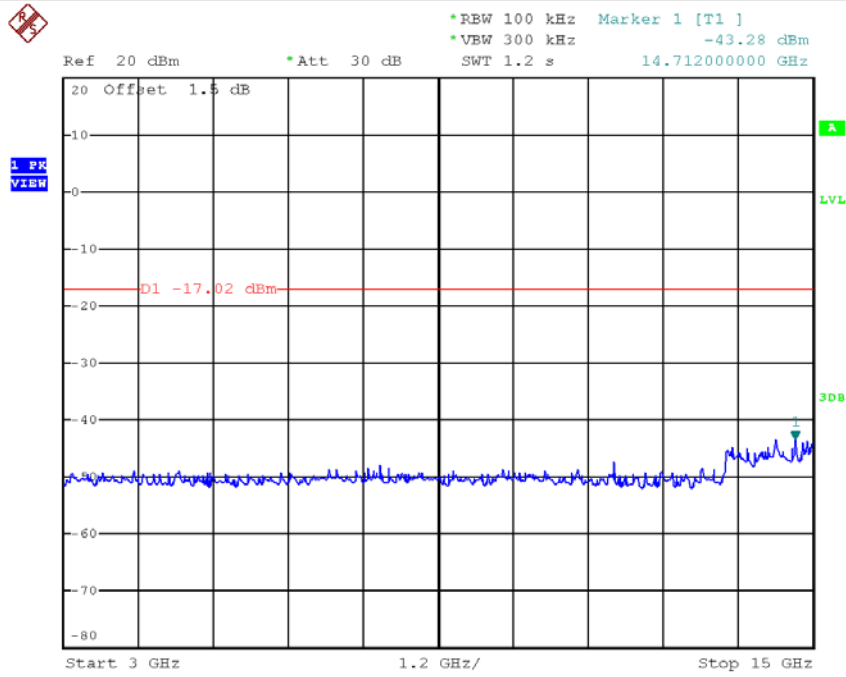

Date: 18.AUG.2017 09:14:28

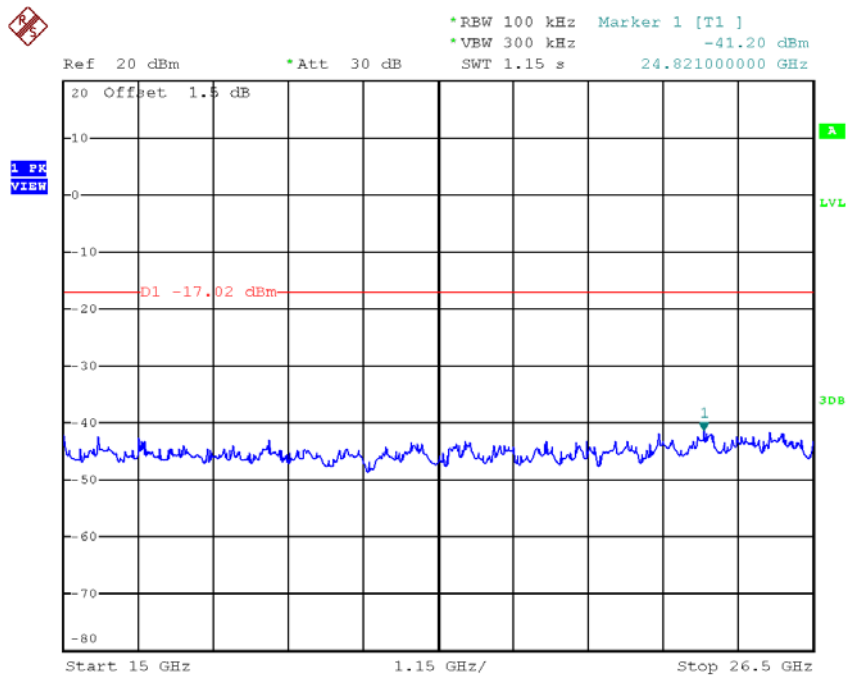

Date: 18.AUG.2017 09:14:35

TX B mode CH11 (10 Harmonic of the frequency)

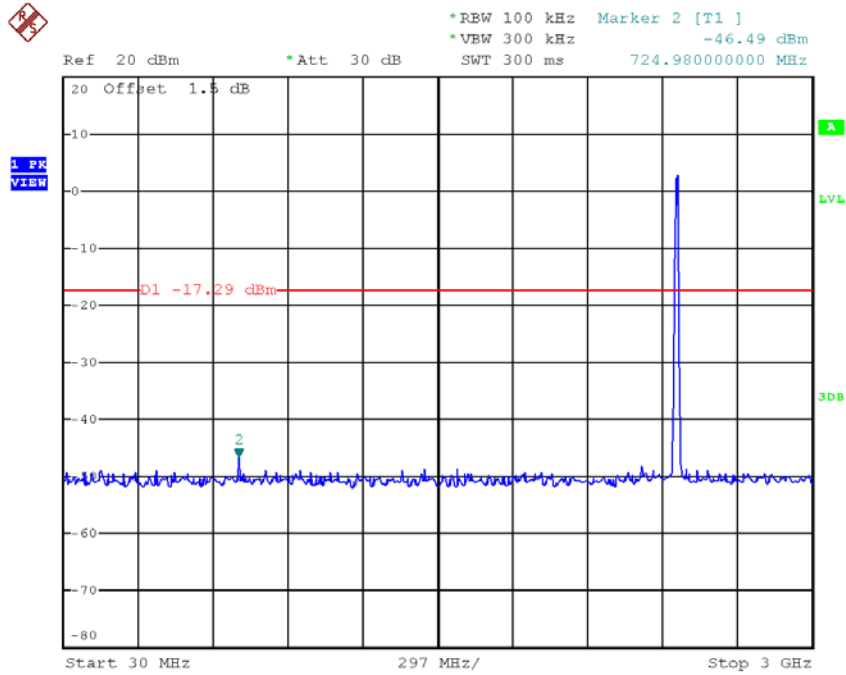

Date: 18.AUG.2017 09:20:15

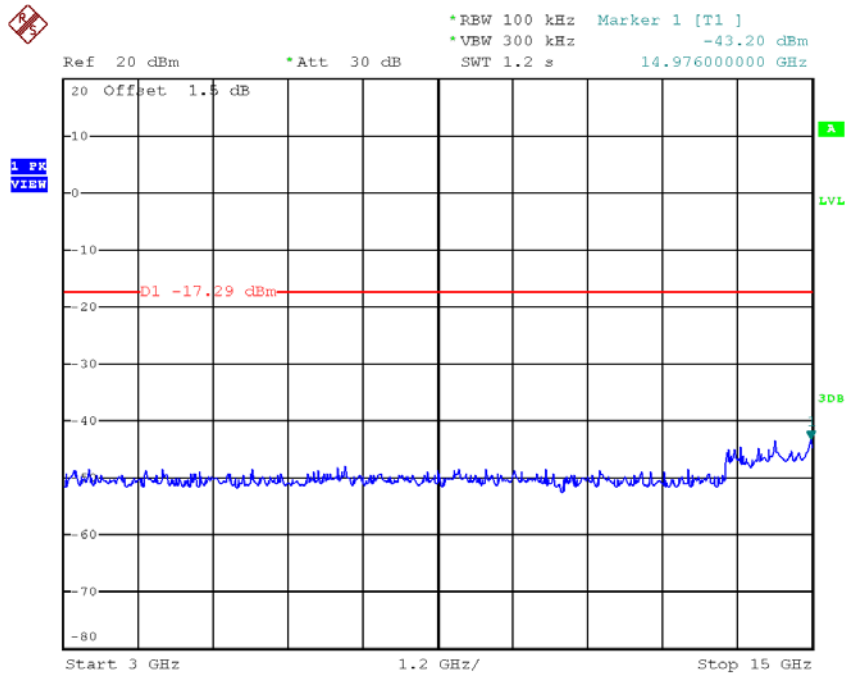

Date: 18.AUG.2017 09:20:22

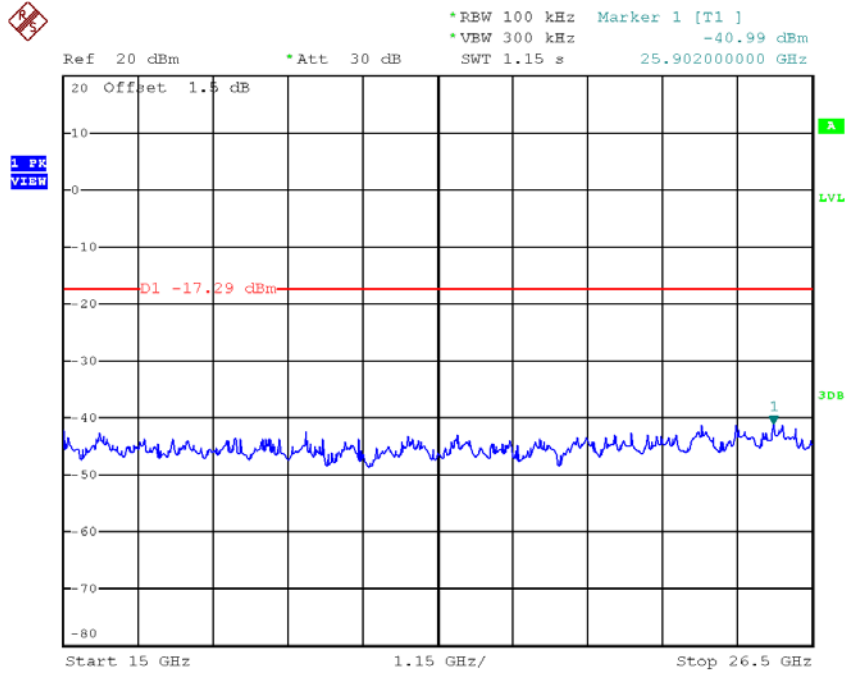

Date: 18.AUG.2017 09:20:29

Test Mode : TX G Mode

TX G mode CH01

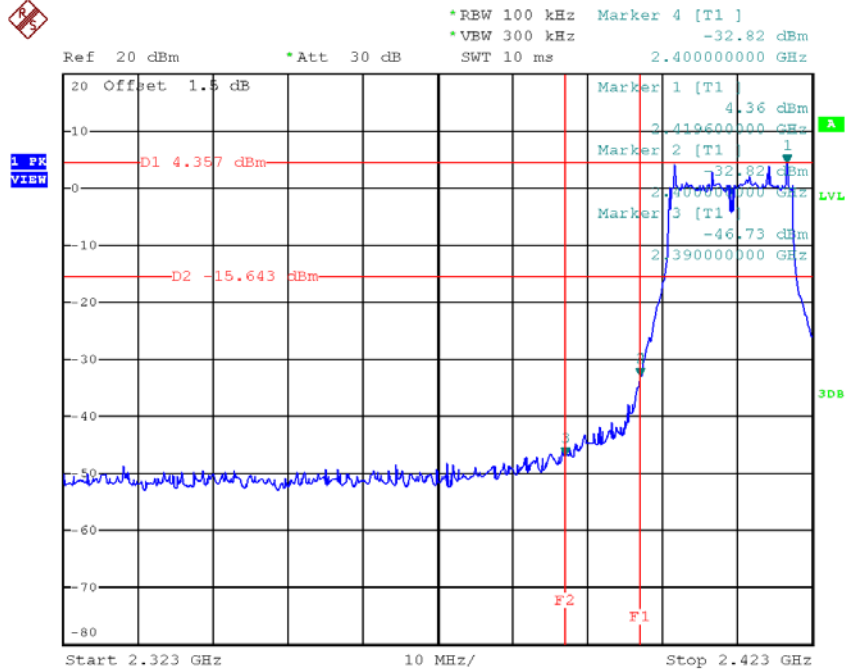

Date: 18.AUG.2017 09:30:49

TX G mode CH11

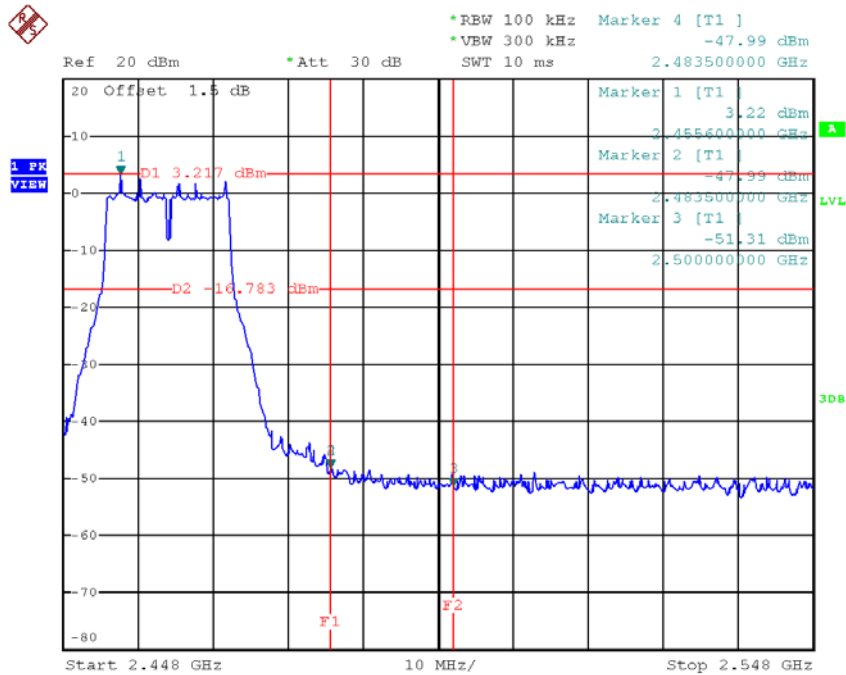

Date: 18.AUG.2017 09:33:35

TX G mode CH01 (10 Harmonic of the frequency)

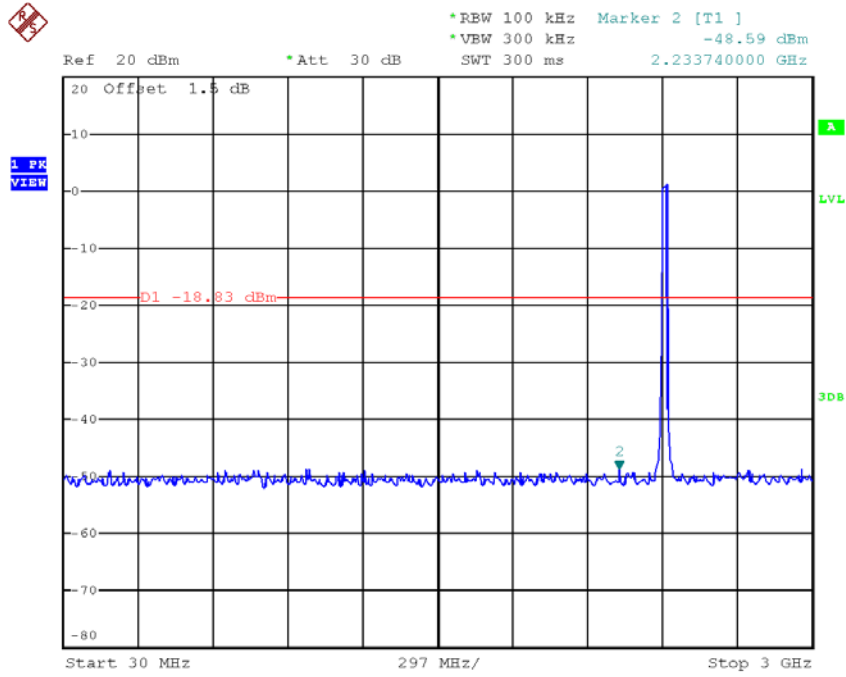

Date: 18.AUG.2017 09:30:28

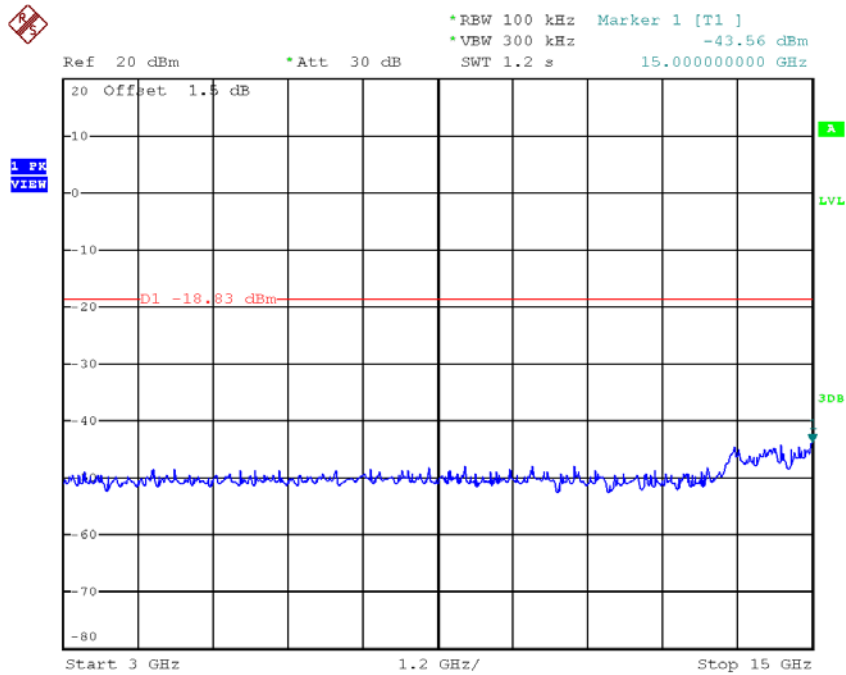

Date: 18.AUG.2017 09:30:35

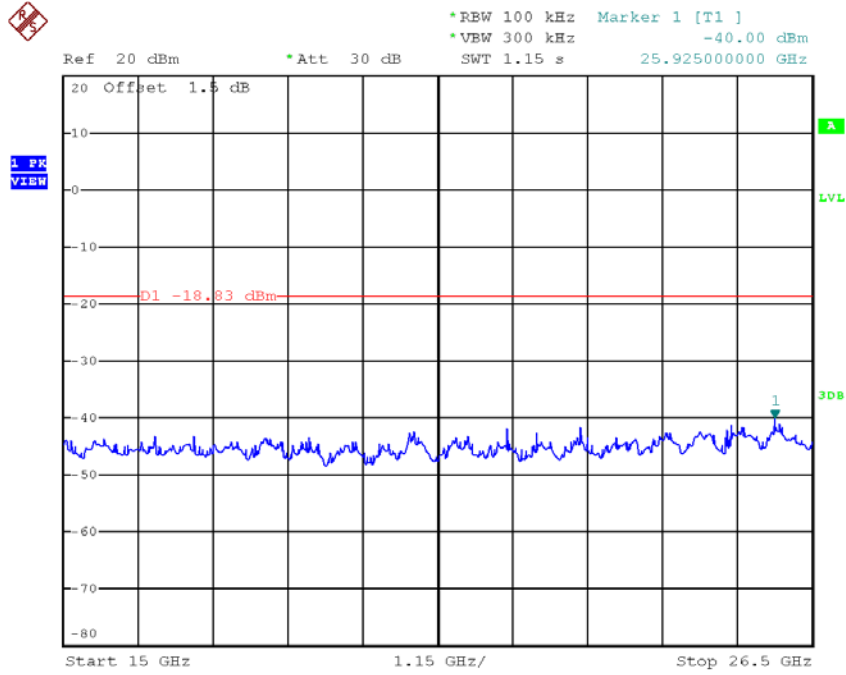

Date: 18.AUG.2017 09:30:42

TX G mode CH06 (10 Harmonic of the frequency)

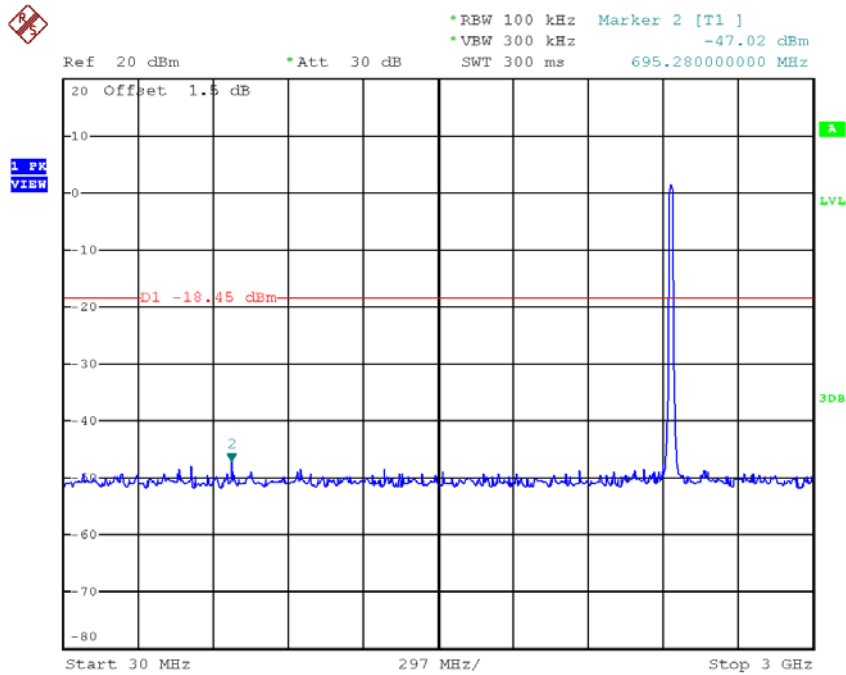

Date: 18.AUG.2017 09:31:56

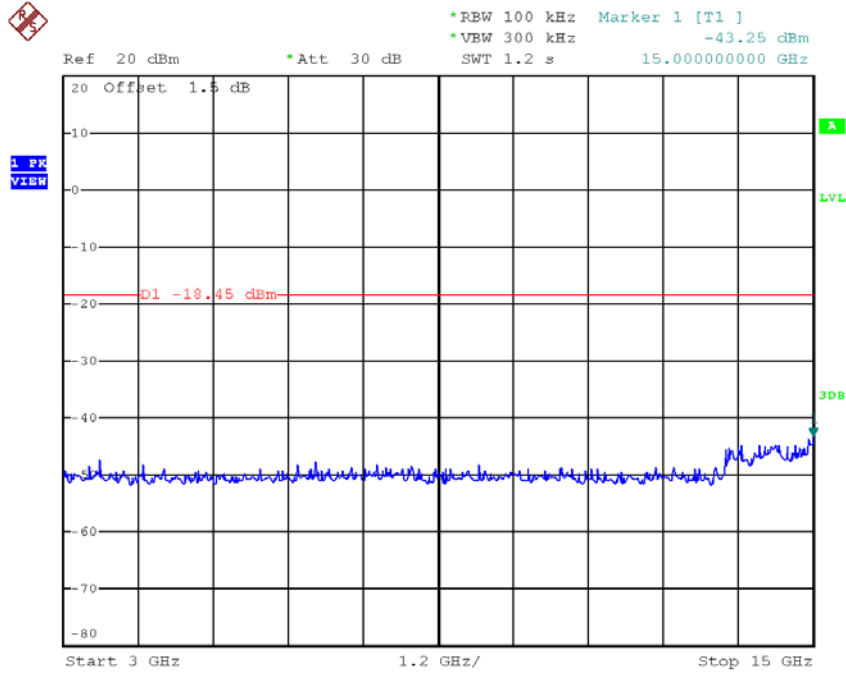

Date: 18.AUG.2017 09:32:03

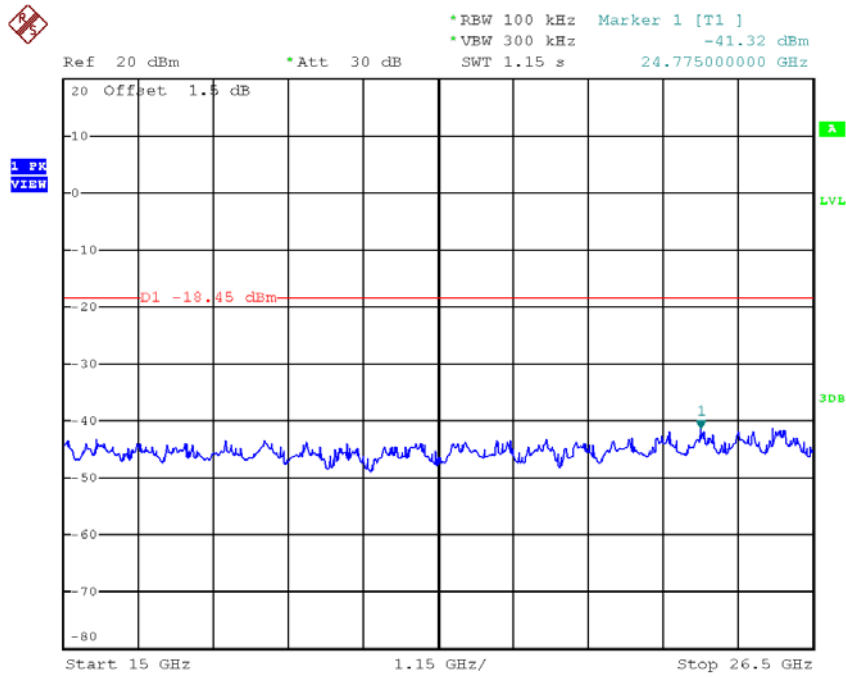

Date: 18.AUG.2017 09:32:10

TX G mode CH11 (10 Harmonic of the frequency)

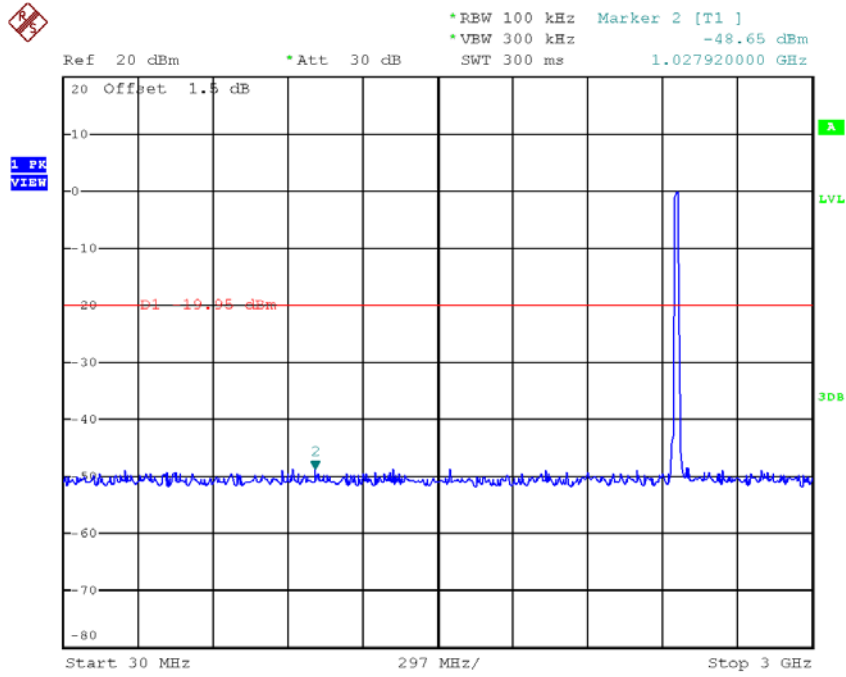

Date: 18.AUG.2017 09:33:14

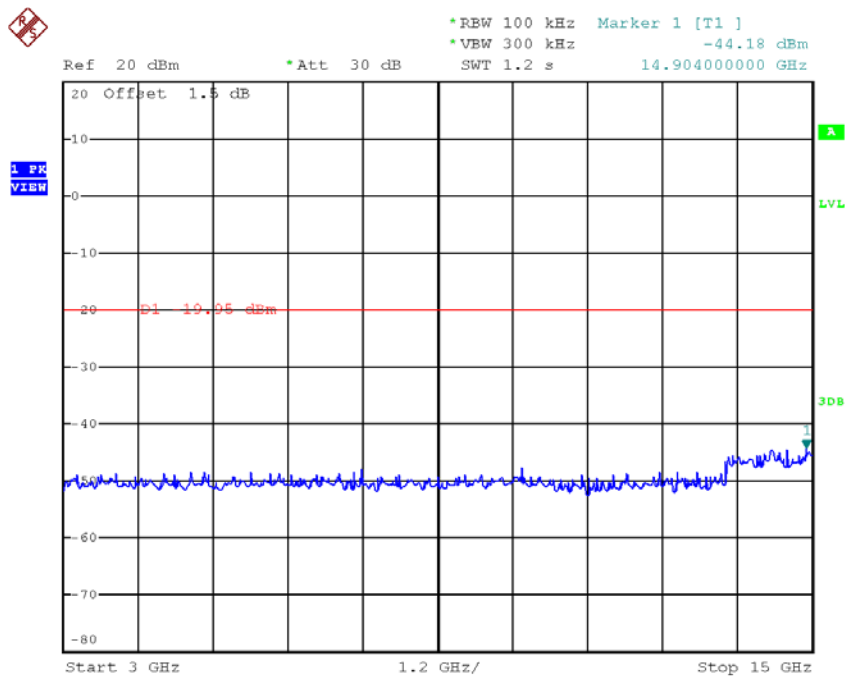

Date: 18.AUG.2017 09:33:21

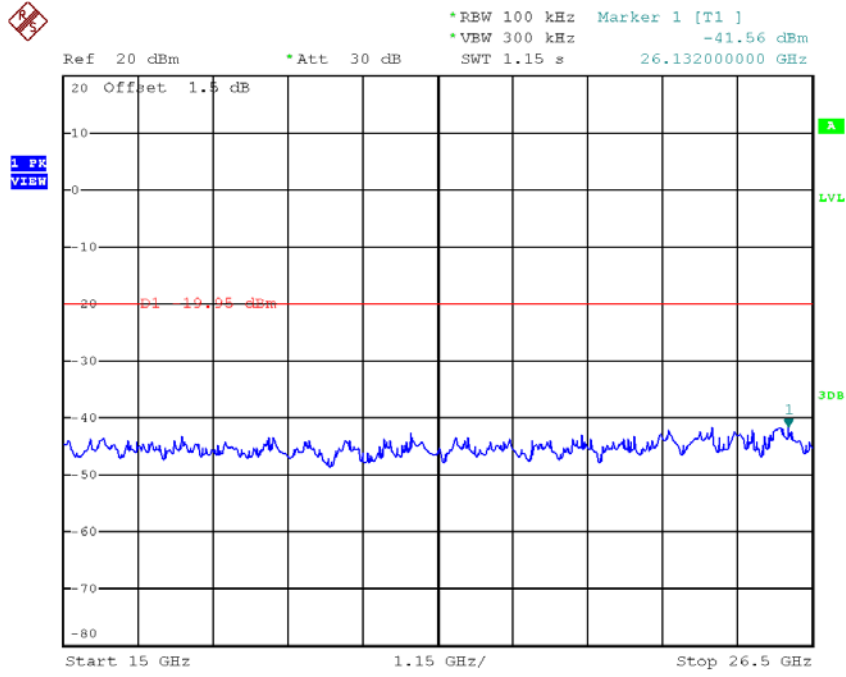

Date: 18.AUG.2017 09:33:28

Test Mode : TX N-20M Mode_ANT 1

TX HT20 mode CH01

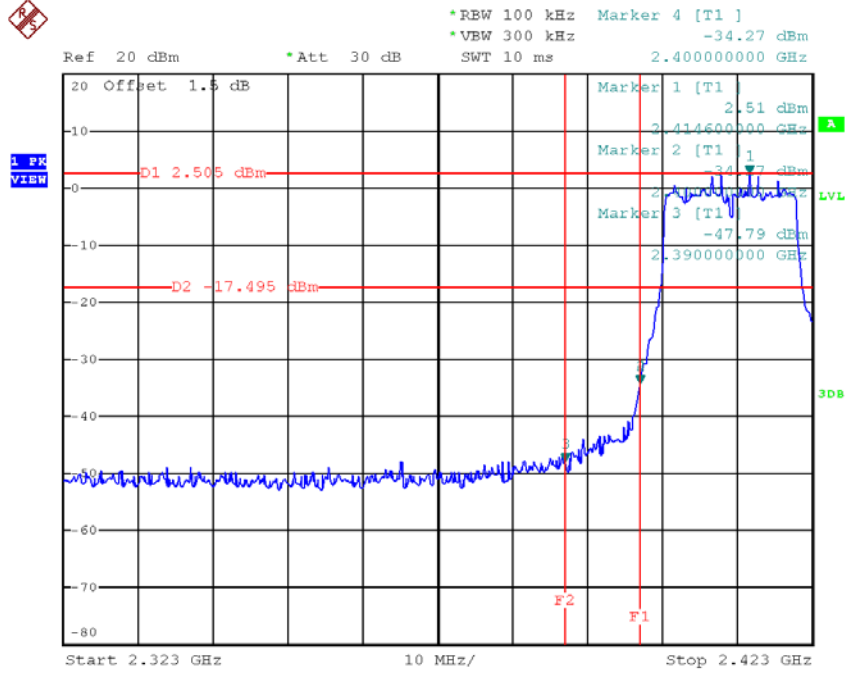

Date: 18.AUG.2017 09:36:00

TX HT20 mode CH11

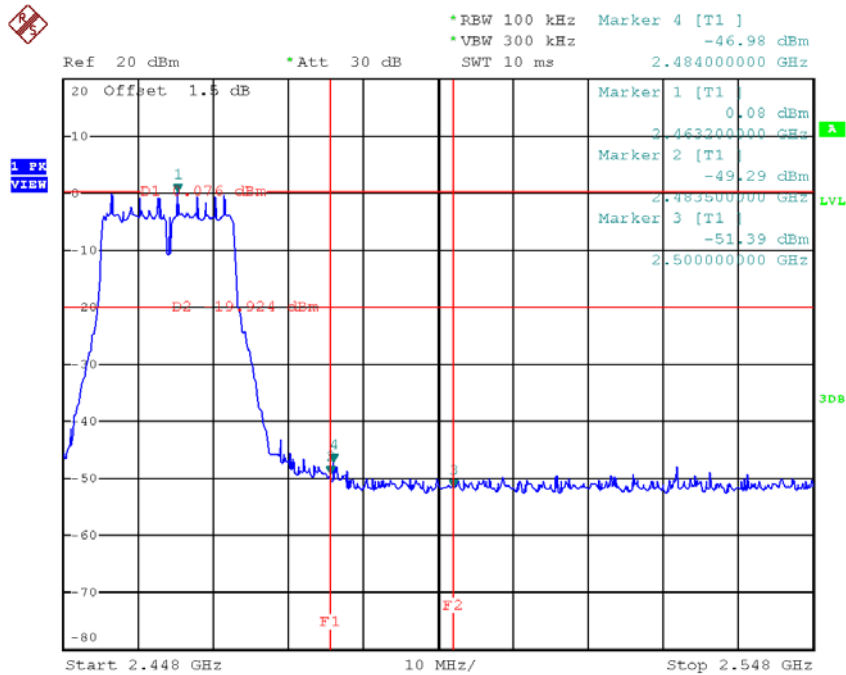

Date: 18.AUG.2017 09:38:05

TX HT20 mode CH01 (10 Harmonic of the frequency)

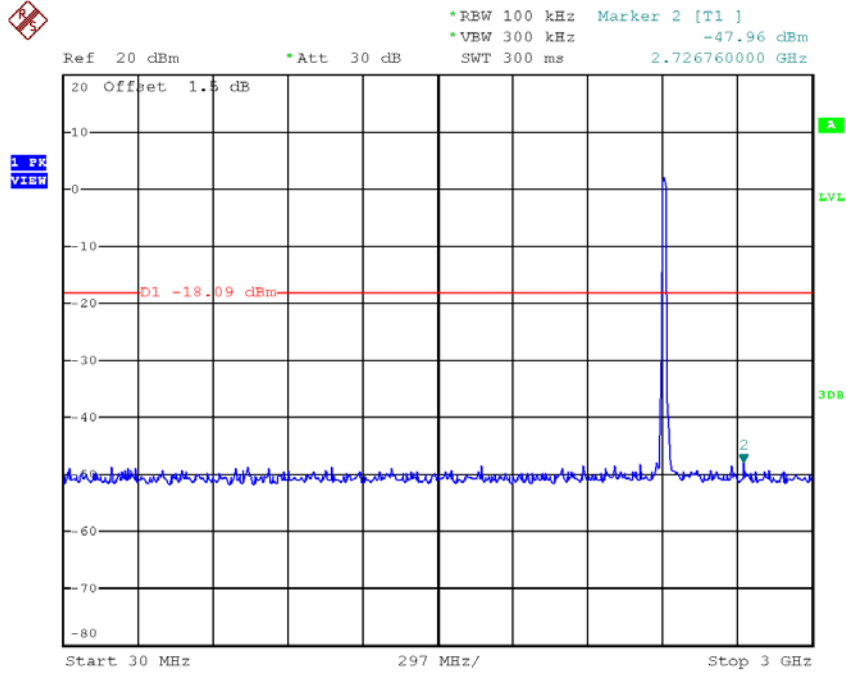

Date: 18.AUG.2017 09:35:40

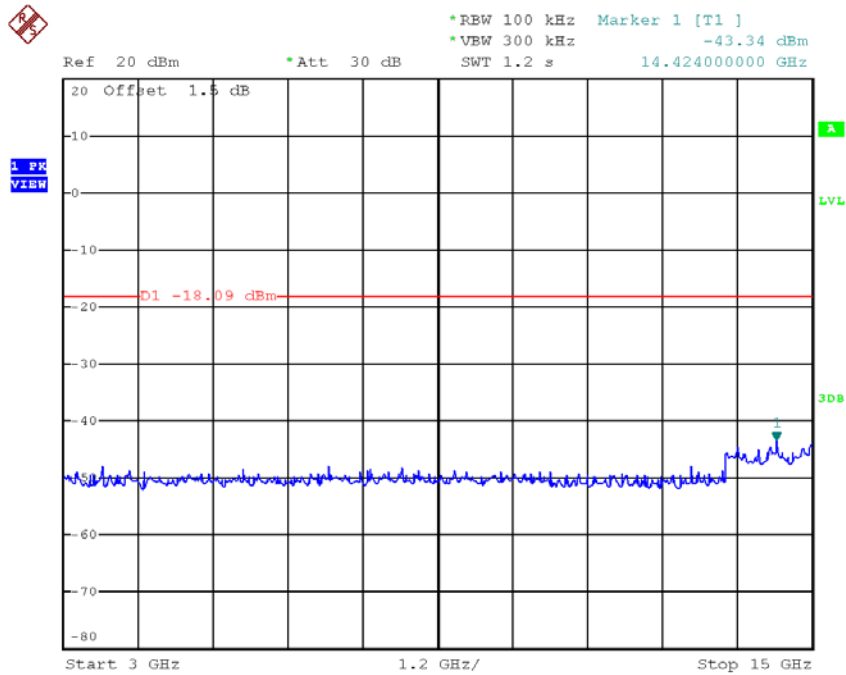

Date: 18.AUG.2017 09:35:47

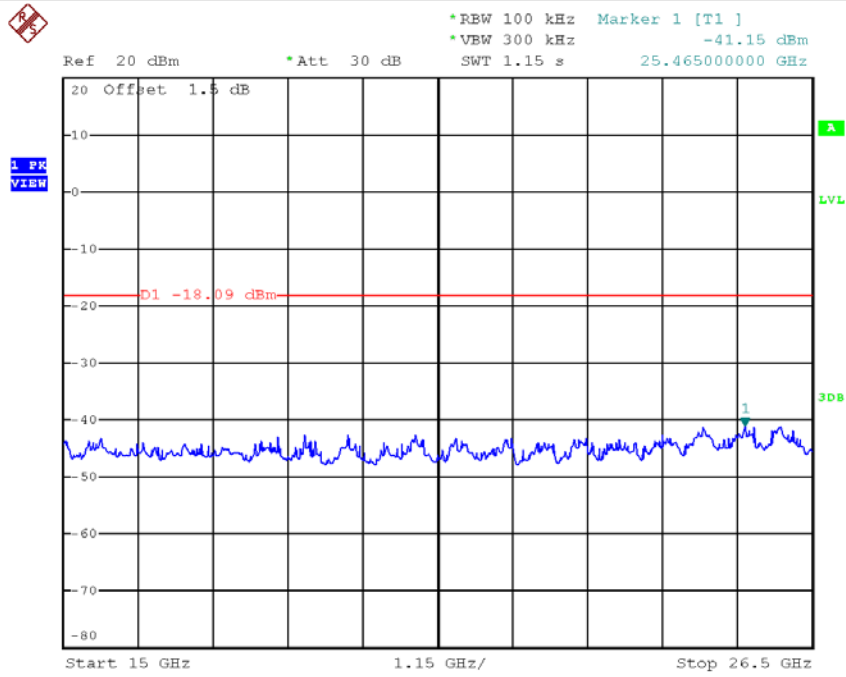

Date: 18.AUG.2017 09:35:54

TX HT20 mode CH06 (10 Harmonic of the frequency)

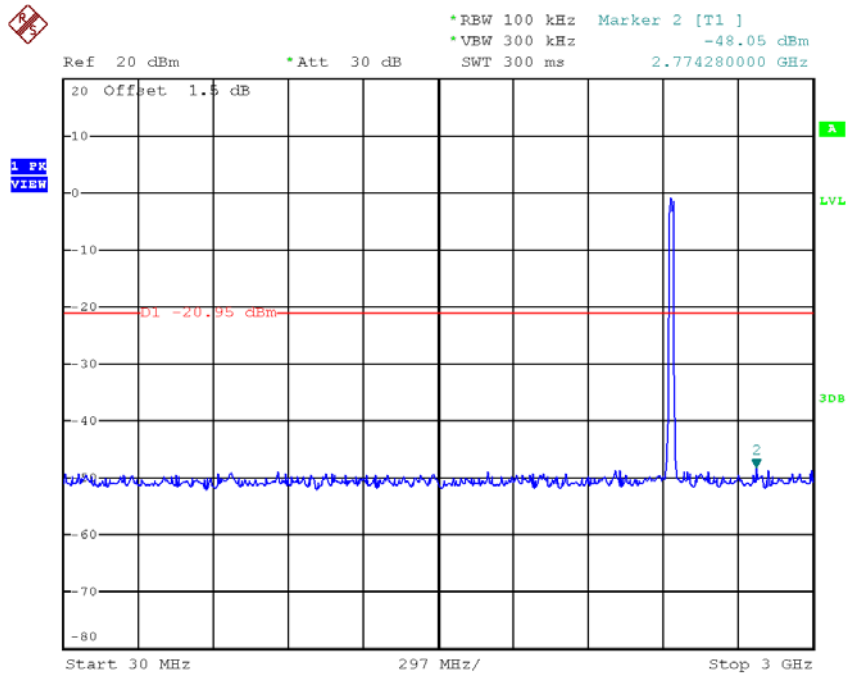

Date: 18.AUG.2017 09:36:45

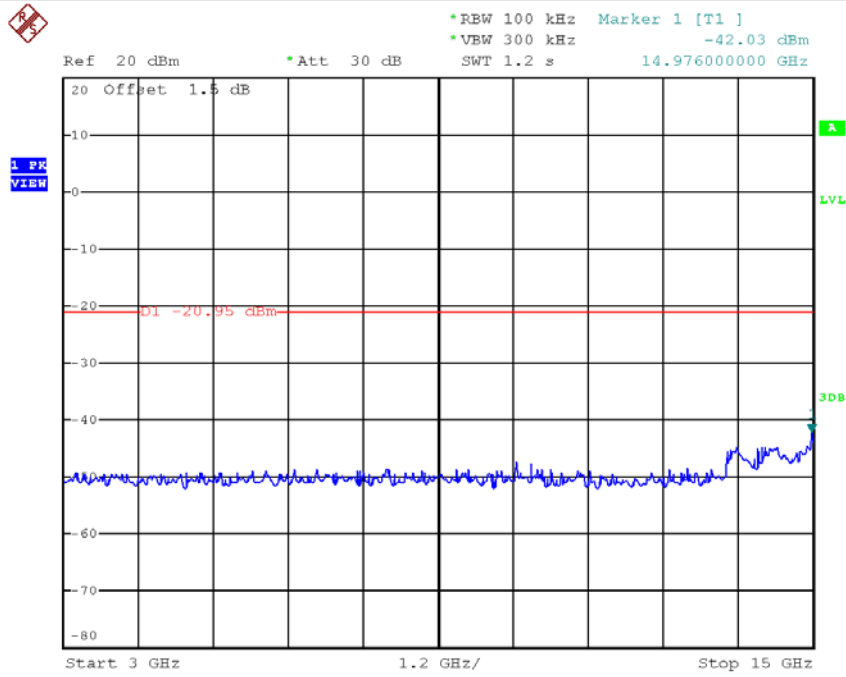

Date: 18.AUG.2017 09:36:52

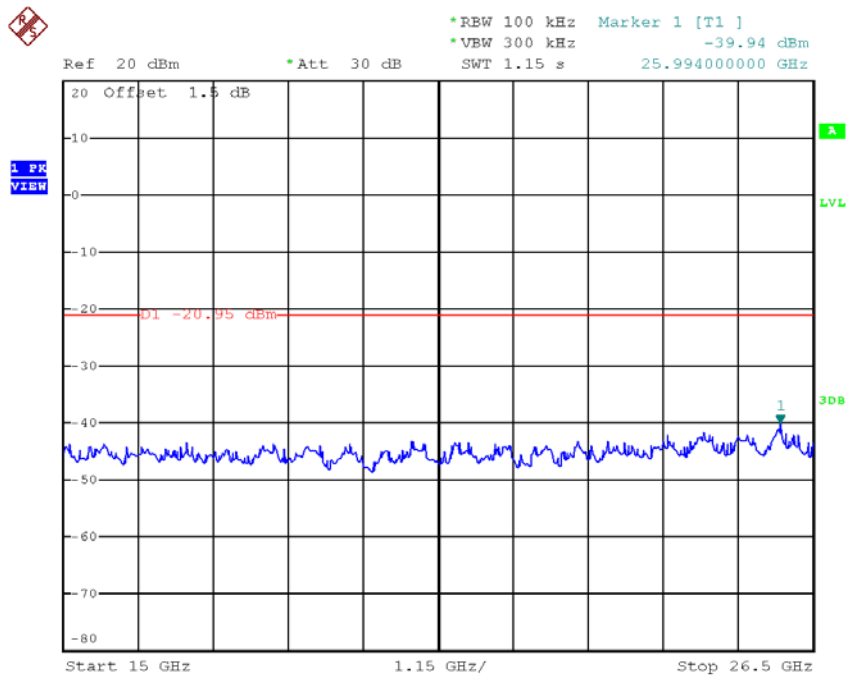

Date: 18.AUG.2017 09:36:59

TX HT20 mode CH11 (10 Harmonic of the frequency)

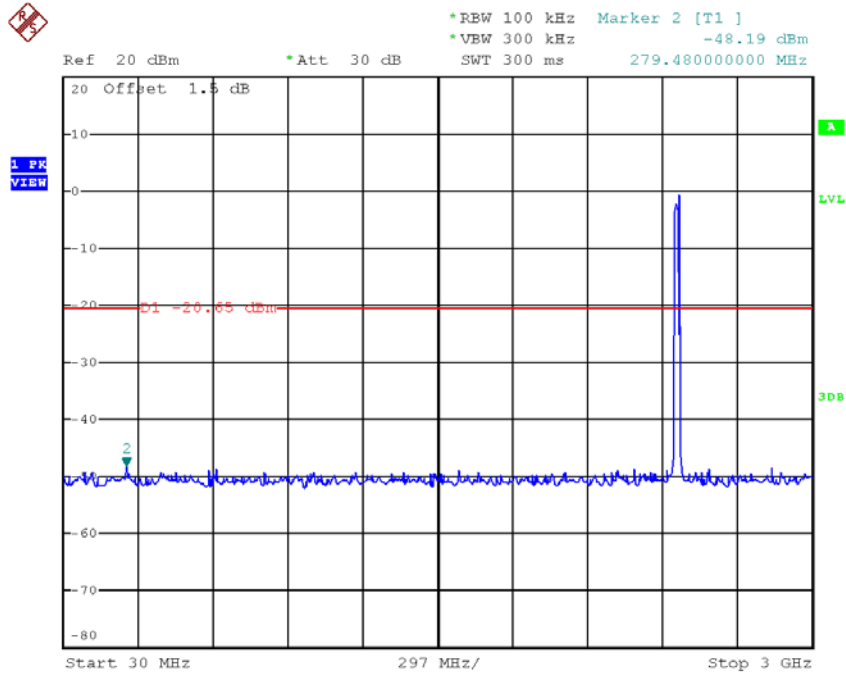

Date: 18.AUG.2017 09:37:44

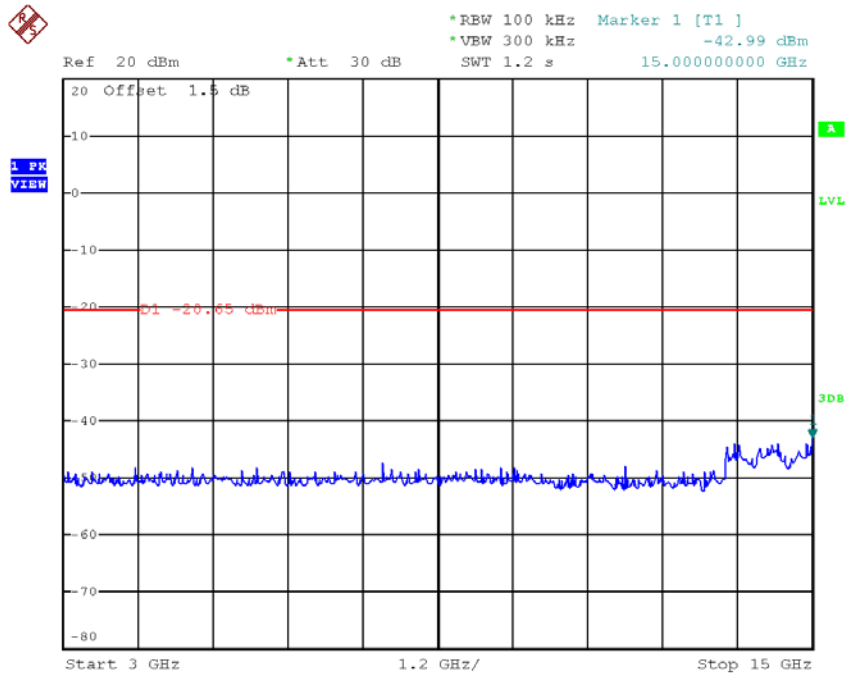

Date: 18.AUG.2017 09:37:52

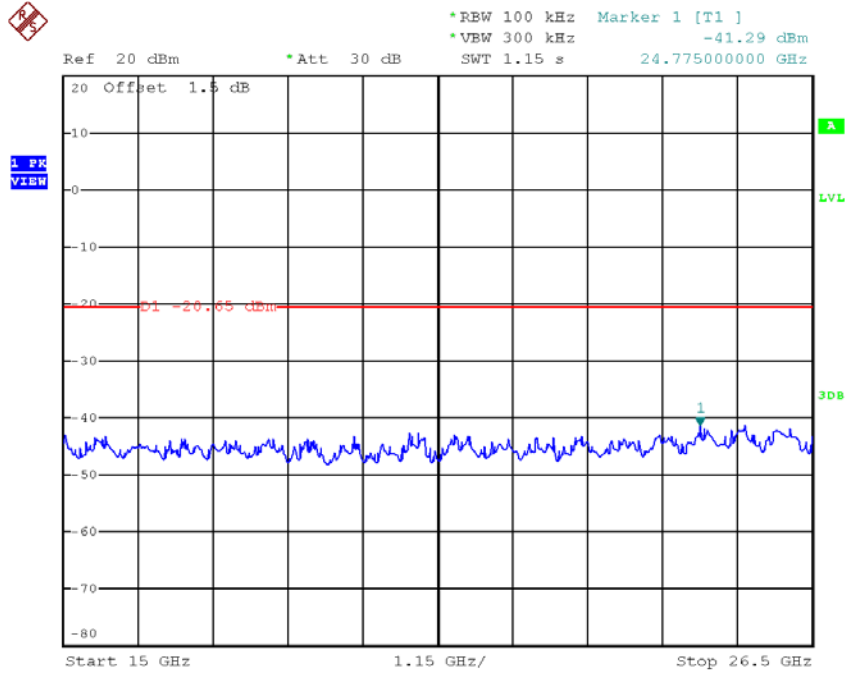

Date: 18.AUG.2017 09:37:59

Test Mode : TX N-20M Mode_ANT 2

TX HT20 mode CH01

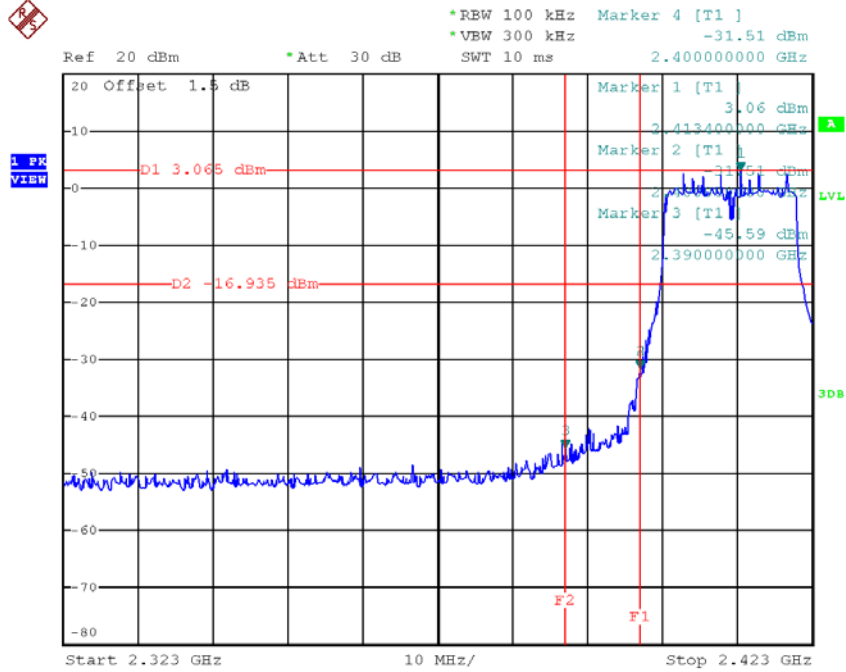

Date: 18.AUG.2017 09:46:38

TX HT20 mode CH11

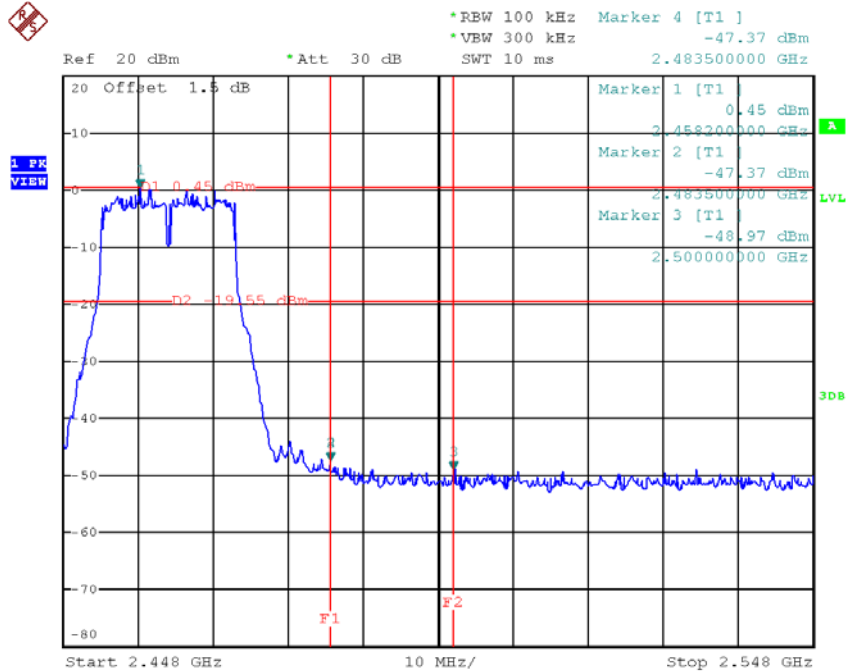

Date: 18.AUG.2017 09:49:57