

FCC Radio Test Report

FCC ID: QISCRO-LX3

This report concerns (check one): Original Grant Class II Change

Project No. : 1701C155E
Equipment : Smart Phone
Model Name : CRO-L03,CRO-L23
Applicant : Huawei Technologies Co.,Ltd.
Address : Administration Building, Headquarters of Huawei Technologies Co., Ltd., Bantian, Longgang District Shenzhen China

Date of Receipt : Jan. 18, 2017(CRO-L03)
Mar. 15, 2017(CRO-L23)
May 09, 2017
Date of Test : Jan. 18, 2017 ~ Feb. 27, 2017(CRO-L03)
Mar. 15, 2017 ~ Mar. 22, 2017(CRO-L23)
May 14, 2017 ~ Jun, 05, 2017
Issued Date : Jun, 06 2017
Tested by : BTL Inc.

Technical Engineer :

(Shawn Xiao)

Authorized Signatory :

(Steven Lu)

B T L I N C .

No.3,Jinshagang 1st Road, Shixia,Dalang Town, Dongguan,
Guangdong, China.

TEL: +86-769-8318-3000 FAX: +86-769-8319-6000

Declaration

BTL represents to the client that testing is done in accordance with standard procedures as applicable and that test instruments used has been calibrated with standards traceable to international standard(s) and/or national standard(s).

BTL's reports apply only to the specific samples tested under conditions. It is manufacture's responsibility to ensure that additional production units of this model are manufactured with the identical electrical and mechanical components. **BTL** shall have no liability for any declarations, inferences or generalizations drawn by the client or others from **BTL** issued reports.

BTL's report must not be used by the client to claim product certification, approval, or endorsement by NVLAP, NIST, or any agency of the Federal Government.

This report is the confidential property of the client. As a mutual protection to the clients, the public and **BTL-self**, extracts from the test report shall not be reproduced except in full with **BTL's** authorized written approval.

BTL's laboratory quality assurance procedures are in compliance with the **ISO Guide17025** requirements, and accredited by the conformity assessment authorities listed in this test report.

Limitation

For the use of the authority's logo is limited unless the Test Standard(s)/Scope(s)/Item(s) mentioned in this test report is (are) included in the conformity assessment authorities acceptance respective.

Table of Contents

Page

REPORT ISSUED HISTORY	5
1 . CERTIFICATION	6
2 . SUMMARY OF TEST RESULTS	7
2.1 TEST FACILITY	8
2.2 MEASUREMENT UNCERTAINTY	8
3 . GENERAL INFORMATION	9
3.1 GENERAL DESCRIPTION OF EUT	9
3.2 DESCRIPTION OF TEST MODES AND TEST CONDITION	11
3.3 BLOCKDIAGRAMSHOWINGTHECONFIGURATIONOFSYSTEMTESTED FOR RADIATED	14
3.4 DESCRIPTION OF SUPPORT UNITS	14
4 . TEST RESULT	15
4.1 OUTPUT POWER MEASUREMENT	15
4.1.1 LIMIT	15
4.1.2 TEST PROCEDURE	15
4.1.3 TESTSETUP LAYOUT	15
4.1.4 TEST DEVIATION	15
4.1.5 TEST RESULTS	15
4.2 OCCUPIED BANDWIDTH MEASUREMENT	16
4.2.1 TEST PROCEDURE	16
4.2.2 TEST SETUP LAYOUT	16
4.2.3 TEST DEVIATION	16
4.2.4 TEST RESULTS	16
4.3 CONDUCTED EMISSIONS MEASUREMENT	17
4.3.1 LIMIT	17
4.3.2 TEST PROCEDURES	17
4.3.3 TESTSETUP LAYOUT	17
4.3.4 TESTDEVIATION	17
4.3.5 TEST RESULTS	17
4.4 RADIATED EMISSIONS MEASUREMENT	18
4.4.1 LIMIT	18
4.4.2 TEST PROCEDURES	18
4.4.3 TESTSETUP LAYOUT	18
4.4.4 TESTDEVIATION	18
4.4.5 TEST RESULTS	18
4.5 BAND EDGE MEASUREMENT	19
4.5.1 LIMIT	19

Table of Contents	Page
4.5.2 TEST PROCEDURES	19
4.5.3 TESTSETUP LAYOUT	19
4.5.4 TESTDEVIATION	19
4.5.5 TEST RESULTS	19
4.6 PEAK TO AVERAGE RATIO MEASUREMENT	20
4.6.1 LIMIT	20
4.6.2 TEST PROCEDURES	20
4.6.3 TESTSETUP LAYOUT	20
4.6.4 TESTDEVIATION	20
4.6.5 TEST RESULTS	20
4.7 FREQUENCY STABILITY MEASUREMENT	21
4.7.1 LIMIT	21
4.7.2 TEST PROCEDURES	21
4.7.3 TESTSETUP LAYOUT	21
4.7.4 TESTDEVIATION	21
4.7.5 TEST RESULTS	21
5. LIST OF MEASUREMENT EQUIPMENTS	22
ATTACHMENT A - OUTPUT POWER	24
ATTACHMENT B - OCCUPIED BANDWIDTH	31
ATTACHMENT C - CONDUCTED EMISSIONS	49
ATTACHMENT D - RADIATED EMISSION	60
ATTACHMENT E - BAND EDGE	145
ATTACHMENT F - PEAK TO AVERAGE RATIO	154
ATTACHMENT G - FREQUENCY STABILITY	165

REPORT ISSUED HISTORY

Issued No.	Description	Issued Date
BTL-FCCP-5-1701C155	Original Report.	Feb. 28, 2017
BTL-FCCP-5-1701C155A	Compared with the original report (BTL-FCCP-5-1701C155), the differences please see the below table. According to the differences description below table, CRO-L23 shares the same test data of CRO-L03 of the same bands. Only the Radiated Spurious Emissions in DCS1900 band of SIM 2 add evaluated and recorded in the test report, the rest are the same.	Mar. 23, 2017
BTL-FCCP-5-1701C155E	Compared with the original report (BTL-FCCP-5-1701C155A), the antenna is changed and battery, earphone are added. The Radiated Spurious Emissions had been evaluated and recorded in the test report, the rest are the same.	Jun.06, 2017

Model	CRO-L03	CRO-L23
Brand	HUAWEI	HUAWEI
2G Frequency	GSM/GPRS/EDEG 850//1900	GSM/GPRS/EDEG 850//1900
3G Frequency	UMTS: B2/B4/B5	UMTS: B2/B4/B5
4G Frequency	FDD-LTE:B2/B4/B5/B7	FDD-LTE:B2/B4/B5/B7
Hardware version	The same	The same
Software version	The difference	The difference
SIM Card	Single (Hardware GPIO level is tested by software to identify odd and even cards.)	Double Hardware GPIO level is tested by software to identify odd and even cards. The dual-slot is added through the hardware, others are the same; The only difference between CRO-L03 and CRO-L23 is: CRO-L03 is single SIM point, and the CRO-L23 is double SIM points.
Dimensions	The same	The same
Appearance	The same	The same
main antenna	The same	The same
BT/Wi-Fi antenna	The same	The same
GPS antenna	The same	The same
PA(GSM)	The same	The same
PA(UMTS/FDD)	The same	The same

1. CERTIFICATION

Equipment : Smart Phone
Brand Name : HUAWEI
Model Name : CRO-L03,CRO-L23
Applicant : Huawei Technologies Co.,Ltd.
Manufacturer : Huawei Technologies Co.,Ltd.
Address : Administration Building, Headquarters of Huawei Technologies Co., Ltd.,
Bantian, Longgang District Shenzhen China
Factory : Huawei Technologies Co.,Ltd.
Address : Administration Building, Headquarters of Huawei Technologies Co., Ltd.,
Bantian, Longgang District Shenzhen China
Date of Test : Jan. 18, 2017 ~ Feb. 27, 2017(CRO-L03)
Mar. 15, 2017 ~ Mar. 22, 2017(CRO-L23)
May 14, 2017 ~ Jun, 05, 2017
Test Sample : Engineering Sample
Standard(s) : 47 CFR FCC Part 24 Subpart E
47 CFR FCC Part 2
ANSI/TIA-603-D-2010
KDB 971168 D01 Power Meas License Digital Systems v02r02

The above equipment has been tested and found compliance with the requirement of the relative standards by BTL Inc.

The test data, data evaluation, and equipment configuration contained in our test report (Ref No. BTL-FCCP-5-1701C155E) were obtained utilizing the test procedures, test instruments, test sites that has been accredited by the Authority of TAF according to the ISO-17025 quality assessment standard and technical standard(s).

Test results included in this report is only for the DCS1900, WCDMA Band 2 and LTE Band 2 part.

2. SUMMARY OF TEST RESULTS

Test procedures according to the technical standard(s):

FCC Part 22 Subpart H& Part 2			
Standard(s) Section	Test Item	Judgment	Tested By
2.1046 24.232(c)	Radiated power	PASS	Paul Li
2.1046 24.232(c)	Conducted Output Power	PASS	Paul Li
2.1049 24.238(a)	Occupied Bandwidth	PASS	Paul Li
2.1051 24.238(a)	Conducted Spurious Emissions	PASS	Paul Li
2.1053 24.238(a)	Radiated Spurious Emissions	PASS	Paul Li
24.238(a)	Band Edge Measurements	PASS	Paul Li
24.232(d)	Peak To Average Ratio	PASS	Paul Li
2.1055 24.235	Frequency Stability	PASS	Paul Li

NOTE:

(1) "N/A" denotes test is not applicable to this device.

2.1 TEST FACILITY

The test facilities used to collect the test data in this report is at the location of No.3,Jinshagang 1st Road, Shixia, Dalang Town, Dongguan, Guangdong, China.

BTL's test firm number for FCC: 319330

2.2 MEASUREMENT UNCERTAINTY

Where relevant, the following measurement uncertainty levels have been estimated for tests performed on the EUT as specified in CISPR 16-4-2. The BTL measurement uncertainty is less than the CISPR 16-4-2 U_{CISPR} requirement.

The reported uncertainty of measurement $y \pm U$, where expanded uncertainty U is based on a standard uncertainty multiplied by a coverage factor of $k=2$, providing a level of confidence of approximately 95 %.

Test Site	Method	Measurement Frequency Range	Ant. H / V	U_1 (dB)
DG-CB03 (3m)	CISPR	9KHz ~ 30MHz	V	3.79
		9KHz ~ 30MHz	H	3.57
		30MHz ~ 200MHz	V	3.82
		30MHz ~ 200MHz	H	3.78
		200MHz ~ 1,000MHz	V	4.10
		200MHz ~ 1,000MHz	H	4.06

Test Site	Method	Measurement Frequency Range	Ant. H / V	U_1 (dB)
DG-CB03 (3m)	CISPR	1GHz ~ 18GHz	V	3.12
		1GHz ~ 18GHz	H	3.68

Test Site	Method	Measurement Frequency Range	Ant. H / V	U_1 (dB)
DG-CB03 (1m)	CISPR	18GHz ~ 40GHz	V	4.15
		18GHz ~ 40GHz	H	4.14

Note: Unless specifically mentioned, the uncertainty of measurement has not been taken into account to declare the compliance or non-compliance to the specification.

3. GENERAL INFORMATION

3.1 GENERAL DESCRIPTION OF EUT

Equipment	Smart Phone		
Brand Name	HUAWEI		
Model Name	CRO-L03,CRO-L23		
Model Difference	Please refer to page 5.		
Modulation Type	GSM/GPRS	GMSK	
	EDGE	GMSK, 8PSK	
	WCDMA	Uplink: BPSK Downlink: QPSK	
	WCDMA(HSDPA/HSUPA/HSPA+/DC-HSDPA/DC-HSUPA)	16QAM	
	LTE	QPSK, 16QAM	
Operation Frequency	GSM /EDGE/GPRS	1850.2 ~ 1909.8 MHz	
	WCDMA Band 2	1852.4 ~ 1907.6 MHz	
	LTE 2 (Channel Bandwidth: 1.4MHz)	1850.7 ~ 1909.3 MHz	
	LTE 2 (Channel Bandwidth: 3MHz)	1851.5 ~ 1908.5 MHz	
	LTE 2 (Channel Bandwidth: 5MHz)	1852.5 ~ 1907.5 MHz	
	LTE 2 (Channel Bandwidth: 10MHz)	1855.0 ~ 1905.0 MHz	
	LTE 2 (Channel Bandwidth: 15MHz)	1857.5 ~ 1902.5 MHz	
	LTE 2 (Channel Bandwidth: 20MHz)	1860.0 ~ 1900.0 MHz	
Max. EIRP Power	GSM/GPRS	GMSK	27.14 dBm
	EDGE	8PSK	23.45 dBm
	WCDMA	BPSK	20.32 dBm
	WCDMA_HSDPA	16QAM	19.34 dBm
	WCDMA_HSUPA	16QAM	18.85 dBm
	LTE 2 (Channel Bandwidth: 1.4MHz)	QPSK	22.51 dBm
		16QAM	21.61 dBm
	LTE 2 (Channel Bandwidth: 3MHz)	QPSK	20.29 dBm
		16QAM	19.62 dBm
	LTE 2 (Channel Bandwidth: 5MHz)	QPSK	20.30 dBm
		16QAM	19.82 dBm
	LTE 2 (Channel Bandwidth: 10MHz)	QPSK	20.36 dBm
		16QAM	19.68 dBm
	LTE 2 (Channel Bandwidth: 15MHz)	QPSK	20.54 dBm
		16QAM	19.66 dBm
	LTE 2 (Channel Bandwidth: 20MHz)	QPSK	20.55 dBm
16QAM		19.82 dBm	

Antenna Type	Internal Antenna		
Antenna Gain	2.40 dBi for GSM, 2.4 dBi for WCDMA, 1.57 dBi for LTE		
Hardware Version	HL1CROM		
Software Version	CRO-L03:Cairo-L03C469B015 CRO-L23:Cairo-L23C469B022		
IMEI No.	CRO-L03	Radiated	862555030018808
		Conducted	862555030018808
	CRO-L23	Radiated	SIM 1:862556030020463
			SIM 2:862556030520462
Power Source	#1 DC Voltage supplied from AC/DC adapter. #2 Battery Supplied.		
Power Rating	#1:AC 100–240V 50/60Hz DC 5V 1A #2:DC 3.82V 2200mAh		

Note:

1. For a more detailed features description, please refer to the manufacturer's specifications or the user's manual.

2.

Item	Mfr/Brand	Model.
Battery	SCUD (FUJIAN) Electronics Co., Ltd	HB3742A0EZC+
	Shenzhen Desay Battery Tech Co., Ltd.	
	Sunwoda Electronic Co.,LTD.	
USB Cable	FOXCONN INTERCONNECT TECHNOLOGY LIMITED	CUBB01M-HC208-DH
	HONGLIN TECHNOLOGY CO.,LTD	130-26654
	Luxshare Precision Industry Co., Ltd.	L99U2013-CS-H
Earphone	Jiangxi Lianchuang Hongsheng Electronic Co.,LTD	MEMD1632B580C00
	BOLUO COUNTY QUANCHENG ELECTRONIC CO.,LTD	1311-3291-3.5mm-229
	MERRY ELECTRONICS CO., LTD.	EMC309-001
	Jiangxi Lianchuang Hongsheng Electronic Co.,LTD (Black)	MEMD1532B528000
	BOLUO COUNTY QUANCHENG ELECTRONIC CO.,LTD (Black)	1293#+3283# 3.5MM-150
	GoerTek (Black),	HA1-3
	GoerTek (White)	NA12
Adapter	HUIZHOU BYD ELECTRONIC CO., LTD.	HW-050100U01
	Shenzhen Huntkey Electric Co., Ltd.	
	DONG GUAN PHITEK ELECTRONICS CO., LTD.	

3.2 DESCRIPTION OF TEST MODES AND TEST CONDITION

Following channel(s) was (were) selected for the final test as listed below:

GSM MODE			
Test Item	Available Channel	Tested Channel	Mode
EIRP	512 to 810	512, 661, 810	GSM, EDGE
Conducted Output Power	512 to 810	512, 661, 810	GSM, EDGE
Occupied Bandwidth	512 to 810	512, 661, 810	GSM, EDGE
Condcudeted Emission	512 to 810	661	GSM, EDGE
Radiated Emission	512 to 810	661	GSM, EDGE
Band Edge	512 to 810	512, 810	GSM, EDGE
Peak to Average Ratio	512 to 810	512, 661, 810	GSM, EDGE
Frequency Stability	512 to 810	661	GSM, EDGE

WCDMA MODE			
Test Item	Available Channel	Tested Channel	Mode
EIRP	9262 to 9538	9262, 9400, 9538	WCDMA, HSDPA, HSUPA
Conducted Output Power	9262 to 9538	9262, 9400, 9538	WCDMA, HSDPA, HSUPA
Condcudeted Emission	9262 to 9538	9400	WCDMA, HSDPA, HSUPA
Radiated Emission	9262 to 9538	9400	WCDMA, HSDPA, HSUPA
Band Edge	9262 to 9538	9262, 9538	WCDMA, HSDPA, HSUPA
Peak to Average Ratio	9262 to 9538	9262, 9400, 9538	WCDMA, HSDPA, HSUPA
Frequency Stability	9262 to 9538	9262	WCDMA, HSDPA, HSUPA

Note: This device was tested under all bandwidths, RB configurations and modulations. The worst case was found in **QPSK** modulation.

LTE BAND 2 MODE					
Test Item	Available Channel	Tested Channel	Channel Bandwidth	Modulation	Mode
EIRP	18607 to 19193	18607, 18900, 19193	1.4MHz	QPSK, 16QAM	1 RB / 0 RB Offset
	18615 to 19185	18615, 18900, 19185	3MHz	QPSK, 16QAM	1 RB / 0 RB Offset
	18625 to 19175	18625, 18900, 19175	5MHz	QPSK, 16QAM	1 RB / 0 RB Offset
	18650 to 19150	18650, 18900, 19150	10MHz	QPSK, 16QAM	1 RB / 0 RB Offset
	18675 to 19125	18675, 18900, 19125	15MHz	QPSK, 16QAM	1 RB / 0 RB Offset
	18700 to 19100	18700, 18900, 19100	20MHz	QPSK, 16QAM	1 RB / 0 RB Offset
Occupied Bandwidth	18607 to 19193	18607, 18900, 19193	1.4MHz	QPSK, 16QAM	6 RB / 0 RB Offset
	18615 to 19185	18615, 18900, 19185	3MHz	QPSK, 16QAM	15 RB / 0 RB Offset
	18625 to 19175	18625, 18900, 19175	5MHz	QPSK, 16QAM	25 RB / 0 RB Offset
	18650 to 19150	18650, 18900, 19150	10MHz	QPSK, 16QAM	50 RB / 0 RB Offset
	18675 to 19125	18675, 18900, 19125	15MHz	QPSK, 16QAM	75 RB / 0 RB Offset
	18700 to 19100	18700, 18900, 19100	20MHz	QPSK, 16QAM	100 RB / 0 RB Offset
Conducted Emission	18607 to 19193	18900	1.4MHz	QPSK	1 RB / 0 RB Offset
	18615 to 19185	18900	3MHz	QPSK	1 RB / 0 RB Offset
	18625 to 19175	18900	5MHz	QPSK	1 RB / 0 RB Offset
	18650 to 19150	18900	10MHz	QPSK	1 RB / 0 RB Offset
	18675 to 19125	18900	15MHz	QPSK	1 RB / 0 RB Offset
	18700 to 19100	18900	20MHz	QPSK	1 RB / 0 RB Offset
Radiated Emission	18607 to 19193	18900	1.4MHz	QPSK	1 RB / 0 RB Offset
	18700 to 19100	18900	20MHz	QPSK	1 RB / 0 RB Offset

LTE BAND 2 MODE						
Test Item	Available Channel	Tested Channel	Channel Bandwidth	Modulation	Mode	
Band Edge	18607 to 19193	18607	1.4MHz	QPSK	1 RB / 0 RB Offset 6 RB / 0 RB Offset	
		19193	1.4MHz	QPSK	1 RB / 5 RB Offset 6 RB / 0 RB Offset	
	18615 to 19185	18615	3MHz	QPSK	1 RB / 0 RB Offset 15 RB / 0 RB Offset	
		19185	3MHz	QPSK	1 RB / 14 RB Offset 15 RB / 0 RB Offset	
	18625 to 19175	18625	5MHz	QPSK	1 RB / 0 RB Offset 25 RB / 0 RB Offset	
		19175	5MHz	QPSK	1 RB / 24 RB Offset 25 RB / 0 RB Offset	
	18650 to 19150	18650	10MHz	QPSK	1 RB / 0 RB Offset 50 RB / 0 RB Offset	
		19150	10MHz	QPSK	1 RB / 49 RB Offset 50 RB / 0 RB Offset	
	18675 to 19125	18675	15MHz	QPSK	1 RB / 0 RB Offset 75 RB / 0 RB Offset	
		19125	15MHz	QPSK	1 RB / 74 RB Offset 75 RB / 0 RB Offset	
	18700 to 19100	18700	20MHz	QPSK	1 RB / 0 RB Offset 100 RB / 0 RB Offset	
		19100	20MHz	QPSK	1 RB / 99 RB Offset 100 RB / 0 RB Offset	
	Peak To Average Ratio	18607 to 19193	18607, 18900, 19193	1.4MHz	QPSK, 16QAM	1 RB / 0 RB Offset
		18615 to 19185	18615, 18900, 19185	3MHz	QPSK, 16QAM	1 RB / 0 RB Offset
		18625 to 19175	18625, 18900, 19175	5MHz	QPSK, 16QAM	1 RB / 0 RB Offset
		18650 to 19150	18650, 18900, 19150	10MHz	QPSK, 16QAM	1 RB / 0 RB Offset
		18675 to 19125	18675, 18900, 19125	15MHz	QPSK, 16QAM	1 RB / 0 RB Offset
		18700 to 19100	18700, 18900, 19100	20MHz	QPSK, 16QAM	1 RB / 0 RB Offset
Frequency Stability	18607 to 19193	18900	1.4MHz	QPSK	1 RB / 0 RB Offset	
	18615 to 19185	18900	3MHz	QPSK	1 RB / 0 RB Offset	
	18625 to 19175	18900	5MHz	QPSK	1 RB / 0 RB Offset	
	18650 to 19150	18900	10MHz	QPSK	1 RB / 0 RB Offset	
	18675 to 19125	18900	15MHz	QPSK	1 RB / 0 RB Offset	
	18700 to 19100	18900	20MHz	QPSK	1 RB / 0 RB Offset	

EUT TEST CONDITIONS:

Test Item	Environmental Conditions	Test Voltage
EIRP	25°C, 60%RH	DC 3.82V
Conducted Output Power	25°C, 65%RH	DC 3.82V
Occupied Bandwidth	25°C, 65%RH	DC 3.82V
Conducted Emission	25°C, 65%RH	DC 3.82V
Radiated Emission	25°C, 60%RH	AC 120V/60Hz
Band Edge	25°C, 65%RH	DC 3.82V
Peak to Average Ratio	25°C, 65%RH	DC 3.82V
Frequency Stability	25°C, 65%RH	DC 3.82V

3.3 BLOCK DIAGRAM SHOWING THE CONFIGURATION OF SYSTEM TESTED FOR RADIATED

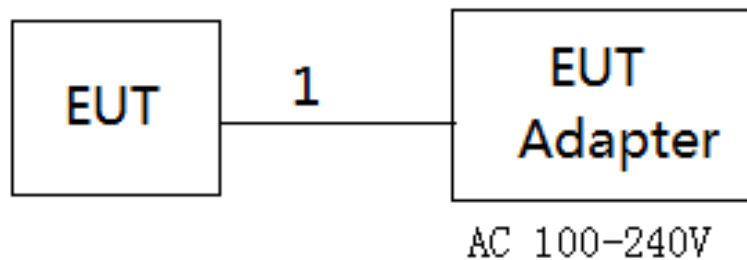

3.4 DESCRIPTION OF SUPPORT UNITS

The EUT has been tested as an independent unit together with other necessary accessories or support units. The following support units or accessories were used to form a representative test configuration during the tests.

Item	Equipment	Mfr/Brand	Model/Type No.	FCC ID	Series No.
-	-	-	-	-	-

Item	Shielded Type	Ferrite Core	Length	Note
1	NO	NO	1.2m	USB Cable

4. TEST RESULT

4.1 OUTPUT POWER MEASUREMENT

4.1.1 LIMIT

Mobile / Portable station are limited to 2 watts e.i.r.p.

4.1.2 TEST PROCEDURE

EIRP/ERP:

EIRP= Conducted Power +Antenan gain

ERP power=EIPR power-2.15dBi.

Conducted Power:

The EUT was set up for the maximum power with GSM, GPRS, EDGE, WCDMA, CDMA, and LTE link data modulation and link up with simulator. Set the EUT to transmit under low, middle and high channel and record the power level shown on simulator.

4.1.3 TESTSETUP LAYOUT

Conducted Power Measurement

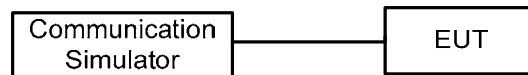

4.1.4 TEST DEVIATION

No deviation

4.1.5 TEST RESULTS

Please refer to the Attachment A.

4.2 OCCUPIED BANDWIDTH MEASUREMENT

4.2.1 TEST PROCEDURE

The EUT makes a call to the communication simulator. All measurements were done at low, middle and high operational frequency range. The communication simulator station system controlled a EUT to export maximum output power under transmission mode and specific channel frequency. Use OBW measurement function of Spectrum analyzer to measure 99 % occupied bandwidth and 26dB bandwidth.

4.2.2 TEST SETUP LAYOUT

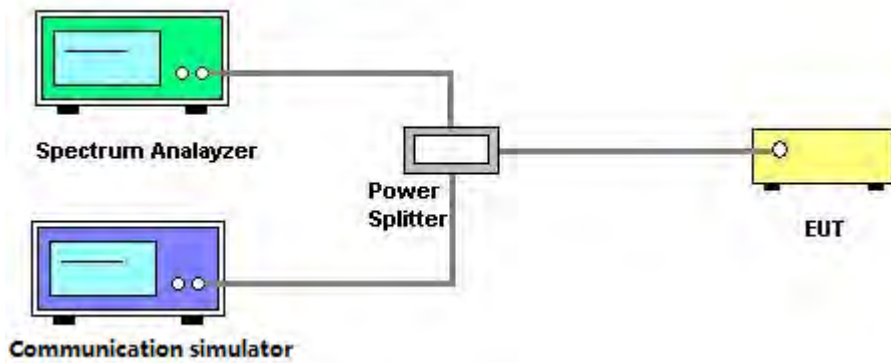

4.2.3 TEST DEVIATION

No deviation

4.2.4 TEST RESULTS

Please refer to the Attachment B.

4.3 CONDUCTED EMISSIONS MEASUREMENT

4.3.1 LIMIT

The power of any emission outside of the authorized operating frequency ranges must be attenuated below the transmitting power (P) by a factor of at least $43 + 10 \log(P)$ dB. The emission limit equal to -13dBm .

4.3.2 TEST PROCEDURES

1. The testing follows FCC KDB 971168 v02r02 Section 6.0.
2. The EUT was connected to spectrum analyzer and system simulator via a power divider.
3. The band edges of low and high channels for the highest RF powers were measured. Set $\text{RBW} \geq 1\%$ EBW in the 1MHz band immediately outside and adjacent to the band edge.
4. Set spectrum analyzer with RMS detector.
5. The RF fundamental frequency should be excluded against the limit line in the operating frequency band.
6. The limit line is derived from $43+10\log(P)\text{dB}$ below the transmitter power P(Watts)

$$= P(\text{W}) - [43 + 10\log(P)](\text{dB})$$

$$= [30 + 10\log(P)](\text{dBm}) - [43 + 10\log(P)](\text{dB})$$

$$= -13\text{dBm}$$

4.3.3 TESTSETUP LAYOUT

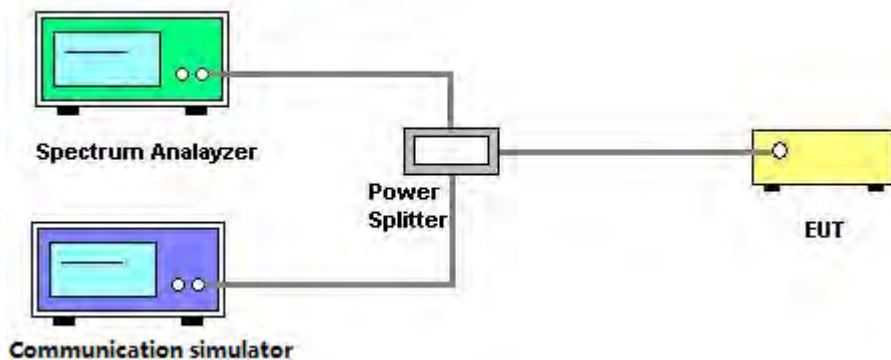

4.3.4 TESTDEVIATION

No deviation

4.3.5 TEST RESULTS

Please refer to the Attachment C.

4.4 RADIATED EMISSIONS MEASUREMENT

4.4.1 LIMIT

The power of any emission outside of the authorized operating frequency ranges must be attenuated below the transmitting power (P) by a factor of at least $43 + 10 \log(P)$ dB. The emission limit equal to -13dBm.

4.4.2 TEST PROCEDURES

1. Substitution method is used for E.I.R.P measurement. In the semi-anechoic chamber, EUT placed on the 0.8m height of Turn Table, rotated the table around 360 degrees to search the maximum radiation power and receiver antenna shall be rotated vertical and horizontal polarization and moved height from 1m to 4m to find the maximum polar radiated power. The "Read Value" is the spectrum reading the maximum power value.
2. The substitution horn antenna is substituted for EUT at the same position and signals generator export the CW signal to the substitution antenna via a TX cable. Rotated the Turn Table and moved receiving antenna to find the maximum radiation power. Adjust output power level of S.G to get a Value of spectrum reading equal to "Read Value " of step a. Record the power level of S.G
3. EIRP = Output power level of S.G – TX cable loss + Antenna gain of substitution horn.
4. E.R.P power can be calculated form E.I.R.P power by subtracting the gain of dipole, E.R.P power = E.I.P.R power - 2.15dBi.
5. The resolution bandwidth and video bandwidth of test receiver/spectrum analyzer is 1MHz/3MHz.

4.4.3 TESTSETUP LAYOUT

This test setup layout is the same as that shown in **section 4.1.3**.

4.4.4 TESTDEVIATION

No deviation

4.4.5 TEST RESULTS

Please refer to the Attachment D.

4.5 BAND EDGE MEASUREMENT

4.5.1 LIMIT

A Power of any emission outside of the authorized operating frequency ranges must be attenuated below the transmitting power (P) by a factor of at least $43 + 10 \log(P)$ dB. In the 1 MHz bands immediately outside and adjacent to the frequency block a resolution bandwidth of at least one percent of the emission bandwidth of the fundamental emission of the transmitter may be employed.

4.5.2 TEST PROCEDURES

1. All measurements were done at low and high operational frequency range.
2. The center frequency of spectrum is the band edge frequency and span is 1MHz. RB of the spectrum is 3kHz and VB of the spectrum is 10kHz (GSM/GPRS/EDGE).
3. The center frequency of spectrum is the band edge frequency and span is 5MHz. RB of the spectrum is 100kHz and VB of the spectrum is 300kHz (WCDMA).
4. The center frequency of spectrum is the band edge frequency and span is 1MHz. RB of the spectrum is 13kHz and VB of the spectrum is 51kHz (LTE Bandwidth 1.4MHz).
5. The center frequency of spectrum is the band edge frequency and span is 1MHz. RB of the spectrum is 30kHz and VB of the spectrum is 100kHz (LTE Bandwidth 3MHz).
6. The center frequency of spectrum is the band edge frequency and span is 1MHz. RB of the spectrum is 100kHz and VB of the spectrum is 300kHz (LTE Bandwidth 5MHz/10MHz).
7. Record the max trace plot into the test report.

4.5.3 TESTSETUP LAYOUT

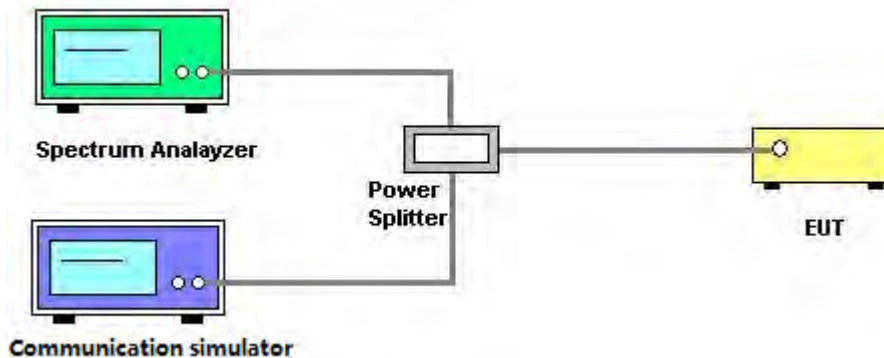

4.5.4 TESTDEVIATION

No deviation

4.5.5 TEST RESULTS

Please refer to the Attachment E.

4.6 PEAK TO AVERAGE RATIO MEASUREMENT

4.6.1 LIMIT

In measuring transmissions in this band using an average power technique, the peak to-average ratio (PAR) of the transmission may not exceed 13 dB.

4.6.2 TEST PROCEDURES

1. Set resolution/measurement bandwidth \geq signal's occupied bandwidth;
2. Set the number of counts to a value that stabilizes the measured CCDF curve;
3. Record the maximum PAPR level associated with a probability of 0.1%.

4.6.3 TESTSETUP LAYOUT

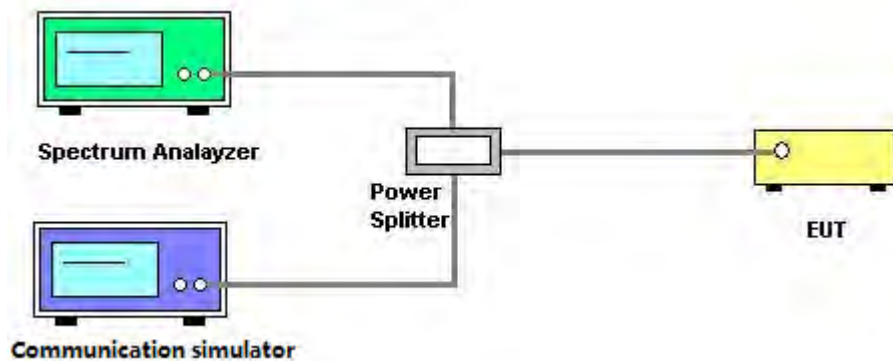

4.6.4 TESTDEVIATION

No deviation

4.6.5 TEST RESULTS

Please refer to the Attachment F.

4.7 FREQUENCY STABILITY MEASUREMENT

4.7.1 LIMIT

1.5 ppm is for base and fixed station. 2.5 ppm is for mobile station.

4.7.2 TEST PROCEDURES

1. Device is placed at the oven room. The oven room could control the temperatures and humidity. Power warm up is at least 15 min and power applied should perform before recording frequency error.
2. EUT is connected the external power supply to control the DC input power. The test voltage range is from minimum to maximum working voltage. Each step shall be record the frequency error rate.
3. The temperature range step is 10 degrees in this test items. All temperature levels shall be hold the $\pm 0.5^{\circ}\text{C}$ during the measurement testing. The each temperature step shall be at least 0.5 hours, consider the EUT could be test under the stability condition.
4. The frequency error was recorded frequency error from the communication simulator.

4.7.3 TESTSETUP LAYOUT

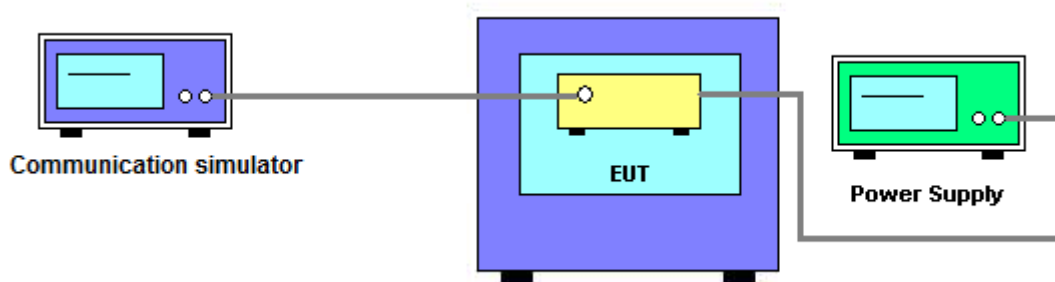

4.7.4 TESTDEVIATION

No deviation

4.7.5 TEST RESULTS

Please refer to the Attachment G.

5. LIST OF MEASUREMENT EQUIPMENTS

Radiated Emission & ERP or EIRP Measurement					
Item	Kind of Equipment	Manufacturer	Type No.	Serial No.	Calibrated until
1	Antenna	Schwarbeck	VULB9160	9160-3232	Mar. 26, 2018
2	Double Ridged Guide Antenna	ETS	3115	75789	Mar. 26, 2018
3	Broad-Band Horn Antenna	Schwarzbeck	BBHA 9170	9170319	Apr. 22, 2018
4	Amplifier	Agilent	8449B	3008A02274	Mar. 09, 2018
5	Amplifier	HP	8447D	2944A09673	Oct. 20, 2017
6	HighPass Filter	Wairwright Instruments Gmbh	WHK 1.5/15G-10ST	11	Mar. 09, 2018
7	Band Reject Filter	Wairwright Instruments Gmbh	WRCG 1710/1785-1690/180 5-60/12SS	38	Feb. 22, 2018
8	Band Reject Filter	Wairwright Instruments Gmbh	WRCG 824/849-810/863-60/ 9SS	7	Feb. 22, 2018
9	Band Reject Filter	Wairwright Instruments Gmbh	WRCG 880/915-860/935-60/ 9SS	14	Feb. 22, 2018
10	Band Reject Filter	Wairwright Instruments Gmbh	WRCG 1850/1910-1830/193 0-60/10SS	17	Feb. 22, 2018
11	HighPass Filter	Wairwright Instruments Gmbh	WHK3.1/18G-10SS	24	Mar. 09, 2018
12	Wireless Communication Test SET	Agilent	E5515C	MY48364183	Mar. 26, 2018
13	Microwave Preamplifier With Adaptor	EMC INSTRUMENT	EMC2654045	980039 & HA01	Mar. 26, 2018
14	Receiver	Agilent	N9038A	MY52130039	Sep. 04, 2017
15	wideband radio communication tester	R&S	CMW500	152372	Mar. 26, 2018
16	High pass filter	ZHPF-M1000-4000-1	ZHPF-M3-12.75G-3869	B2015073763	Aug. 04, 2017
17	High pass filter	ZHPF-M3-12.75G-3869	ZHPF-M1000-4000-1	B2015073762	Aug. 04, 2017
18	High pass filter	ZHPF-M6-18G-1727	ZHPF-M6-186-1727	B2015073764	Aug. 04, 2017
19	Cable	emci	LMR-400(30MHz-1GHz)(8m+5m)	N/A	Jun. 27, 2017
20	Cable	emci	EMC104-SM-SM-12000(12m)	N/A	Jul. 06, 2017
21	Controller	ETS-Lindgren	2090	N/A	N/A
22	Measurement Software	Farad	EZ-EMC Ver.NB-03A1-01	N/A	N/A

Conducted Emission & Band Edge & Occupied Bandwidth Measurement					
Item	Kind of Equipment	Manufacturer	Type No.	Serial No.	Calibrated until
1	Wireless Communication Test SET	Agilent	E5515C	MY48364183	Mar. 26, 2018
2	EXA Spectrum Analyzer	Agilent	N9010A	MY50520044	Mar. 26, 2018
3	POWER SPLITTER	Mini-Circuits	ZFRSC-123-S+	331000910-1	Feb. 25, 2018
4	wideband radio communication tester	R&S	CMW500	152372	Mar. 26, 2018
5	Cable	N/A	RG316(0.3m)	N/A	Jul. 06, 2017
6	Cable	N/A	RG316(0.3m)	N/A	Jul. 06, 2017

Frequency Stability Measurement					
Item	Kind of Equipment	Manufacturer	Type No.	Serial No.	Calibrated until
1	Wireless Communication Test SET	Agilent	E5515C	MY48364183	Mar. 26, 2018
2	DC power supply	GW Instek	GPC-3030DN	EK880675	Oct. 13, 2017
3	POWER SPLITTER	Mini-Circuits	ZFRSC-123-S+	331000910-1	Feb. 25, 2018
4	wideband radio communication tester	R&S	CMW500	152372	Mar. 26, 2018
5	Const Temp, & Humidity Chamber	Giant?Force	ITH-225-20-S	IAB0309-001	Sep. 04, 2017
6	Cable	N/A	RG316(0.3m)	N/A	Jul. 06, 2017

Remark: "N/A" denotes no model name, serial no. or calibration specified.
All calibration period of equipment list is one year.

ATTACHMENT A - OUTPUT POWER

Conducted Power:

DCS1900 (Capsensor Off)	Burst Conducted Power (dBm)		
	512CH	661CH	810CH
	1850.2MHz	1880MHz	1909.8MHz
GSM (CS)	29.25	29.29	29.03
GPRS/EDGE (GMSK)	29.25	29.29	29.03
	28.27	28.30	28.05
	26.29	26.34	26.08
	25.22	25.26	24.97
EDGE (8PSK)	25.17	25.60	25.00
	24.01	24.42	23.92
	21.94	22.25	21.71
	20.82	21.13	20.80

Modulation	Band	WCDMA Band 2(Capsensor Off)		
	Tx Channel	9262CH	9400CH	9538CH
	Rx Channel	9662CH	9800CH	9938CH
	Frequency	1852.4MHz	1880MHz	1907.6MHz
BPSK	RMC 12.2K	21.98	22.34	22.47
	RMC 64K	21.93	22.37	22.47
	RMC 144K	21.98	22.37	22.46
	RMC 384K	21.99	22.36	22.42
16QAM	HSDPA Subtest-1	20.95	21.30	21.46
	HSDPA Subtest-2	20.94	21.32	21.49
	HSDPA Subtest-3	20.45	20.80	21.01
	HSDPA Subtest-4	20.39	20.77	21.02
16QAM	HSUPA Subtest-1	19.04	19.38	19.51
	HSUPA Subtest-2	19.03	19.35	19.47
	HSUPA Subtest-3	20.18	20.55	20.56
	HSUPA Subtest-4	19.58	19.14	19.07
	HSUPA Subtest-5	20.60	20.86	21.00

LTE Band / BW	Modulation	RB Sizing	RB Offset	Low CH	Mid CH	High CH
				18607 CH	18900 CH	19193 CH
				1850.7 MHz	1880 MHz	1909.3 MHz
2 / 1.4M	QPSK	1	0	21.58	22.46	22.07
		1	2	21.64	22.51	22.13
		1	5	21.60	22.44	22.09
		3	0	21.70	22.45	22.08
		3	1	21.64	22.34	22.02
		3	3	21.70	22.44	22.09
	16QAM	6	0	20.63	21.39	21.07
		1	0	20.59	21.61	20.85
		1	2	20.65	21.61	20.87
		1	5	20.61	21.55	20.87
		3	0	20.61	21.40	21.07
		3	1	20.54	21.11	21.04
		3	3	20.60	21.50	21.08
		6	0	19.63	20.51	20.05

LTE Band / BW	Modulation	RB Sizing	RB Offset	Low CH	Mid CH	High CH
				18615 CH	18900 CH	19185 CH
				1851.5 MHz	1880 MHz	1908.5 MHz
2 / 3M	QPSK	1	0	21.51	22.41	21.98
		1	7	21.59	22.44	22.03
		1	14	21.55	22.39	21.96
		8	0	20.69	21.49	21.12
		8	3	20.69	21.48	21.12
		8	7	20.67	21.47	21.12
		15	0	20.65	21.42	21.07
	16QAM	1	0	20.51	21.72	20.92
		1	7	20.71	21.77	20.87
		1	14	20.57	21.69	20.77
		8	0	19.78	20.52	20.00
		8	3	19.81	20.53	20.00
		8	7	19.78	20.52	19.97
		15	0	19.71	20.46	19.90

LTE Band / BW	Modulation	RB Sizing	RB Offset	Low CH	Mid CH	High CH
				18625 CH	18900 CH	19175 CH
				1852.5 MHz	1880 MHz	1907.5 MHz
2 / 5M	QPSK	1	0	21.74	22.45	22.13
		1	12	21.76	22.43	22.10
		1	24	21.72	22.41	22.07
		12	0	20.69	21.50	21.12
		12	6	20.71	21.46	21.13
		12	13	20.71	21.47	21.11
		25	0	20.63	21.43	21.07
	16QAM	1	0	20.84	21.97	21.21
		1	12	20.89	21.91	21.03
		1	24	20.84	21.91	20.94
		12	0	19.80	20.63	20.00
		12	6	19.80	20.60	20.04
		12	13	19.82	20.61	19.95
		25	0	19.69	20.48	19.87

LTE Band / BW	Modulation	RB Siset	RB Offset	Low CH	Mid CH	High CH
				18650 CH	18900 CH	19150 CH
				1855 MHz	1880 MHz	1905 MHz
2 / 10M	QPSK	1	0	21.68	22.51	22.07
		1	24	21.70	22.49	22.05
		1	49	21.70	22.51	22.05
		25	0	20.70	21.45	21.09
		25	12	20.69	21.42	21.07
		25	25	20.71	21.43	21.08
	16QAM	50	0	20.72	21.44	21.07
		1	0	20.63	21.82	21.07
		1	24	20.64	21.76	21.00
		1	49	20.62	21.83	20.81
		25	0	19.72	20.48	19.86
		25	12	19.71	20.45	20.29
		25	25	19.74	20.45	20.25
		50	0	19.72	20.46	20.00

LTE Band / BW	Modulation	RB Siset	RB Offset	Low CH	Mid CH	High CH
				18675 CH	18900 CH	19125 CH
				1857.5 MHz	1880 MHz	1902.5 MHz
2 / 15M	QPSK	1	0	21.82	22.47	22.61
		1	37	21.82	22.44	22.53
		1	74	21.82	22.47	22.69
		36	0	20.86	21.77	21.67
		36	19	20.89	21.49	21.73
		36	39	20.89	21.51	21.74
		75	0	20.91	21.54	21.55
	16QAM	1	0	20.74	21.81	21.66
		1	37	20.77	21.71	21.41
		1	74	20.78	21.65	21.48
		36	0	19.86	20.85	20.35
		36	19	19.88	20.48	20.37
		36	39	19.88	20.47	20.32
		75	0	19.90	20.49	20.38

LTE Band / BW	Modulation	RB Siset	RB Offset	Low CH	Mid CH	High CH
				18700 CH	18900 CH	19100 CH
				1860 MHz	1880 MHz	1900 MHz
2 / 20M	QPSK	1	0	22.03	22.65	22.70
		1	50	21.97	21.89	22.60
		1	99	21.98	22.64	22.51
		50	0	20.96	21.57	21.38
		50	25	20.96	21.53	21.29
		50	50	20.99	21.56	21.39
		100	0	20.95	21.53	21.47
	16QAM	1	0	21.46	21.97	21.93
		1	50	21.49	20.05	21.75
		1	99	21.13	21.75	21.66
		50	0	20.01	20.57	20.45
		50	25	20.02	20.53	20.42
		50	50	20.05	20.56	20.45
		100	0	20.00	20.51	20.46

EIRP Power

DCS1900 (Capsensor Off)	EIRP Power (dBm)		
	512CH	661CH	810CH
	1850.2MHz	1880MHz	1909.8MHz
GSM (CS)	27.10	27.14	26.88
GPRS/EDGE (GMSK)	27.10	27.14	26.88
	26.12	26.15	25.90
	24.14	24.19	23.93
	23.07	23.11	22.82
EDGE (8PSK)	23.02	23.45	22.85
	21.86	22.27	21.77
	19.79	20.10	19.56
	18.67	18.98	18.65

Modulation	Band	WCDMA Band 2(Capsensor Off)		
	Tx Channel	9262CH	9400CH	9538CH
	Rx Channel	9662CH	9800CH	9938CH
	Frequency	1852.4MHz	1880MHz	1907.6MHz
BPSK	RMC 12.2K	19.83	20.19	20.32
	RMC 64K	19.78	20.22	20.32
	RMC 144K	19.83	20.22	20.31
	RMC 384K	19.84	20.21	20.27
16QAM	HSDPA Subtest-1	18.80	19.15	19.31
	HSDPA Subtest-2	18.79	19.17	19.34
	HSDPA Subtest-3	18.30	18.65	18.86
	HSDPA Subtest-4	18.24	18.62	18.87
16QAM	HSUPA Subtest-1	16.89	17.23	17.36
	HSUPA Subtest-2	16.88	17.20	17.32
	HSUPA Subtest-3	18.03	18.40	18.41
	HSUPA Subtest-4	17.43	16.99	16.92
	HSUPA Subtest-5	18.45	18.71	18.85

LTE Band / BW	Modulation	RB Sizing	RB Offset	Low CH	Mid CH	High CH
				18607 CH	18900 CH	19193 CH
				1850.7 MHz	1880 MHz	1909.3 MHz
2 / 1.4M	QPSK	1	0	21.58	22.46	22.07
		1	2	21.64	22.51	22.13
		1	5	21.60	22.44	22.09
		3	0	21.70	22.45	22.08
		3	1	21.64	22.34	22.02
		3	3	21.70	22.44	22.09
	16QAM	6	0	20.63	21.39	21.07
		1	0	20.59	21.61	20.85
		1	2	20.65	21.61	20.87
		1	5	20.61	21.55	20.87
		3	0	20.61	21.40	21.07
		3	1	20.54	21.11	21.04
		3	3	20.60	21.50	21.08
		6	0	19.63	20.51	20.05

LTE Band / BW	Modulation	RB Sizing	RB Offset	Low CH	Mid CH	High CH
				18615 CH	18900 CH	19185 CH
				1851.5 MHz	1880 MHz	1908.5 MHz
2 / 3M	QPSK	1	0	19.36	20.26	19.83
		1	7	19.44	20.29	19.88
		1	14	19.40	20.24	19.81
		8	0	18.54	19.34	18.97
		8	3	18.54	19.33	18.97
		8	7	18.52	19.32	18.97
		15	0	18.50	19.27	18.92
	16QAM	1	0	18.36	19.57	18.77
		1	7	18.56	19.62	18.72
		1	14	18.42	19.54	18.62
		8	0	17.63	18.37	17.85
		8	3	17.66	18.38	17.85
		8	7	17.63	18.37	17.82
		15	0	17.56	18.31	17.75

LTE Band / BW	Modulation	RB Sizing	RB Offset	Low CH	Mid CH	High CH
				18625 CH	18900 CH	19175 CH
				1852.5 MHz	1880 MHz	1907.5 MHz
2 / 5M	QPSK	1	0	19.59	20.30	19.98
		1	12	19.61	20.28	19.95
		1	24	19.57	20.26	19.92
		12	0	18.54	19.35	18.97
		12	6	18.56	19.31	18.98
		12	13	18.56	19.32	18.96
		25	0	18.48	19.28	18.92
	16QAM	1	0	18.69	19.82	19.06
		1	12	18.74	19.76	18.88
		1	24	18.69	19.76	18.79
		12	0	17.65	18.48	17.85
		12	6	17.65	18.45	17.89
		12	13	17.67	18.46	17.80
		25	0	17.54	18.33	17.72

LTE Band / BW	Modulation	RB Sizing	RB Offset	Low CH	Mid CH	High CH
				18650 CH	18900 CH	19150 CH
				1855 MHz	1880 MHz	1905 MHz
2 / 10M	QPSK	1	0	19.53	20.36	19.92
		1	24	19.55	20.34	19.90
		1	49	19.55	20.36	19.90
		25	0	18.55	19.30	18.94
		25	12	18.54	19.27	18.92
		25	25	18.56	19.28	18.93
	16QAM	50	0	18.57	19.29	18.92
		1	0	18.48	19.67	18.92
		1	24	18.49	19.61	18.85
		1	49	18.47	19.68	18.66
		25	0	17.57	18.33	17.71
		25	12	17.56	18.30	18.14
		25	25	17.59	18.30	18.10
		50	0	17.57	18.31	17.85

LTE Band / BW	Modulation	RB Sizing	RB Offset	Low CH	Mid CH	High CH
				18675 CH	18900 CH	19125 CH
				1857.5 MHz	1880 MHz	1902.5 MHz
2 / 15M	QPSK	1	0	19.67	20.32	20.46
		1	37	19.67	20.29	20.38
		1	74	19.67	20.32	20.54
		36	0	18.71	19.62	19.52
		36	19	18.74	19.34	19.58
		36	39	18.74	19.36	19.59
		75	0	18.76	19.39	19.40
	16QAM	1	0	18.59	19.66	19.51
		1	37	18.62	19.56	19.26
		1	74	18.63	19.50	19.33
		36	0	17.71	18.70	18.20
		36	19	17.73	18.33	18.22
		36	39	17.73	18.32	18.17
		75	0	17.75	18.34	18.23

LTE Band / BW	Modulation	RB Sizing	RB Offset	Low CH	Mid CH	High CH
				18700 CH	18900 CH	19100 CH
				1860 MHz	1880 MHz	1900 MHz
2 / 20M	QPSK	1	0	19.88	20.50	20.55
		1	50	19.82	19.74	20.45
		1	99	19.83	20.49	20.36
		50	0	18.81	19.42	19.23
		50	25	18.81	19.38	19.14
		50	50	18.84	19.41	19.24
		100	0	18.80	19.38	19.32
	16QAM	1	0	19.31	19.82	19.78
		1	50	19.34	17.90	19.60
		1	99	18.98	19.60	19.51
		50	0	17.86	18.42	18.30
		50	25	17.87	18.38	18.27
		50	50	17.90	18.41	18.30
		100	0	17.85	18.36	18.31

ATTACHMENT B - OCCUPIED BANDWIDTH

DCS1900					
GSM			EDGE		
CS			8PSK		
Channel	Frequency (MHz)	99% Occupied Bandwidth (MHz)	Channel	Frequency (MHz)	99% Occupied Bandwidth (MHz)
512	1850.2	0.242	512	1850.2	0.250
661	1880	0.246	661	1880	0.252
810	1909.8	0.246	810	1909.8	0.246
Channel	Frequency (MHz)	26dB Bandwidth (MHz)	Channel	Frequency (MHz)	26dB Bandwidth (MHz)
512	1850.2	1.851	512	1850.2	1.851
661	1880	1.880	661	1880	1.881
810	1909.8	1.909	810	1909.8	1.909

Spectrum Plot

GSM -512

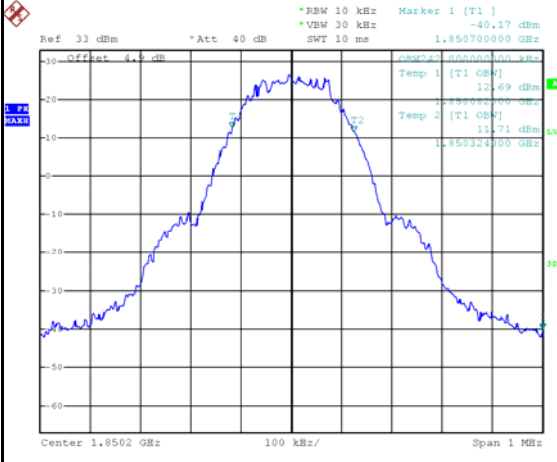

GSM-661

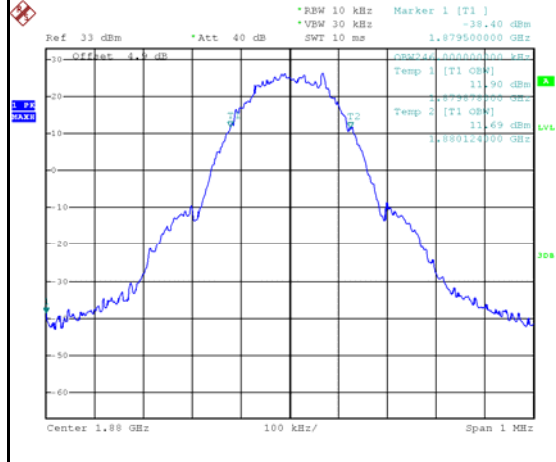

GSM-810

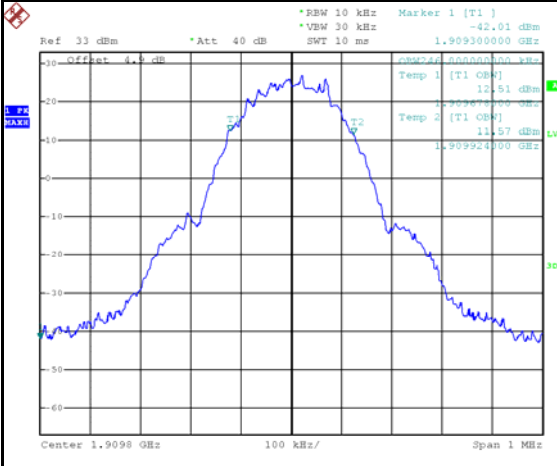

EDGE-512

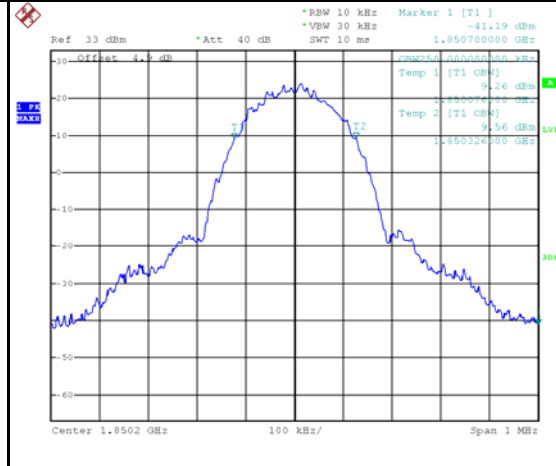

EDGE-661

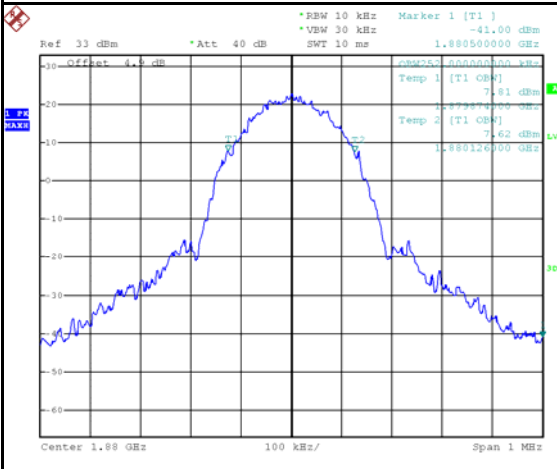

EDGE-810

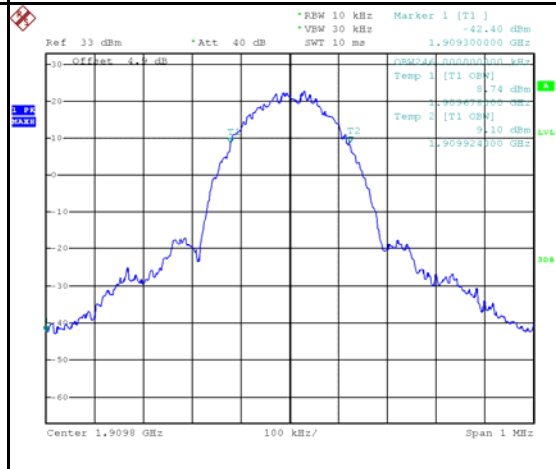

WCDMA Band 2					
BPSK					
Channel	Frequency (MHz)	99% Occupied Bandwidth (MHz)	Channel	Frequency (MHz)	26dB Bandwidth (MHz)
9262	1852.4	4.220	9262	1852.4	1.857
9400	1880	4.220	9400	1880	1.875
9538	1907.6	4.220	9538	1907.6	1.903

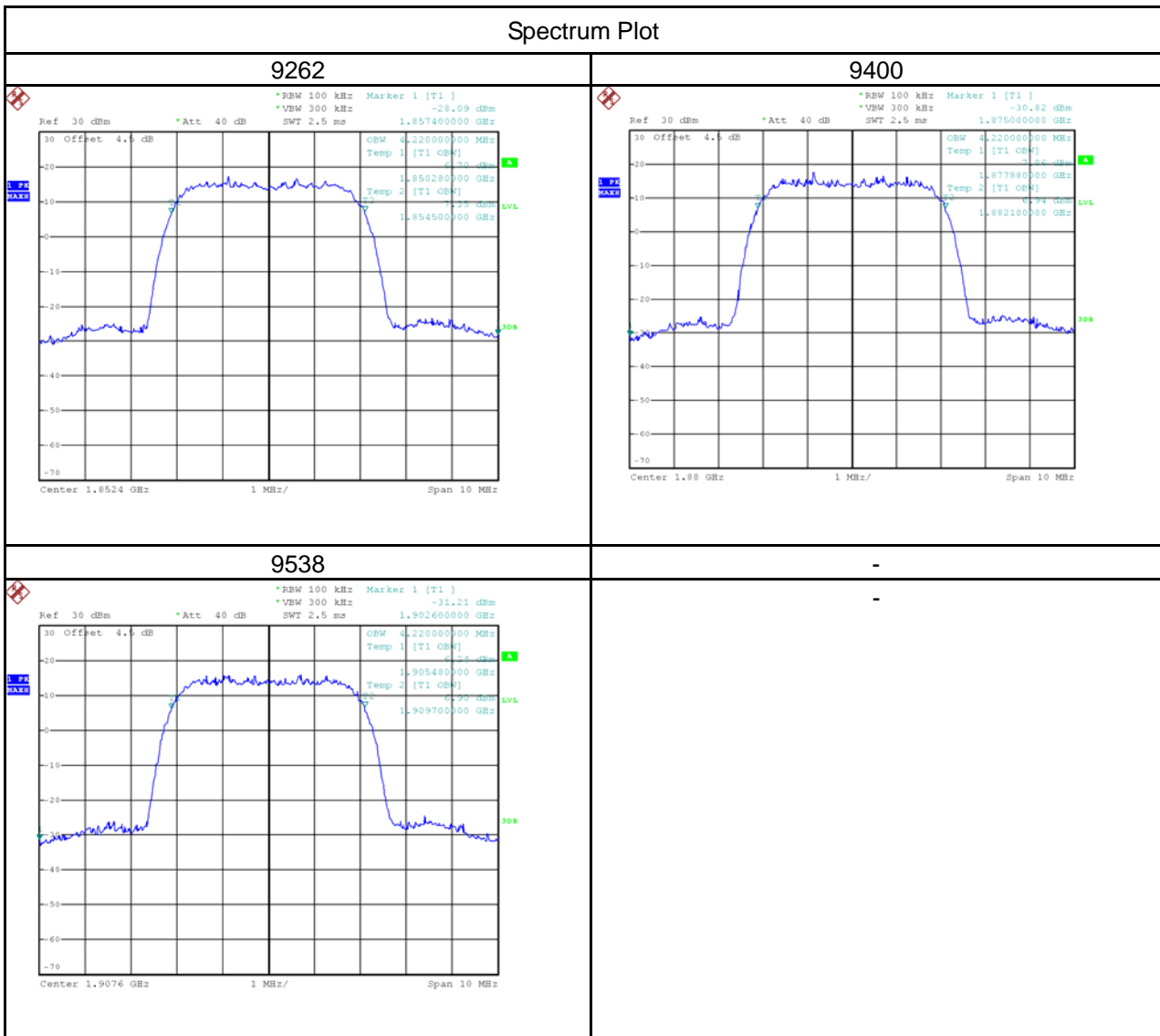

WCDMA_HSDPA Band 2					
Channel	Frequency (MHz)	99% Occupied Bandwidth (MHz)	Channel	Frequency (MHz)	26dB Bandwidth (MHz)
9262	1852.4	4.240	9262	1852.4	1.857
9400	1880	4.240	9400	1880	1.885
9538	1907.6	4.220	9538	1907.6	1.903

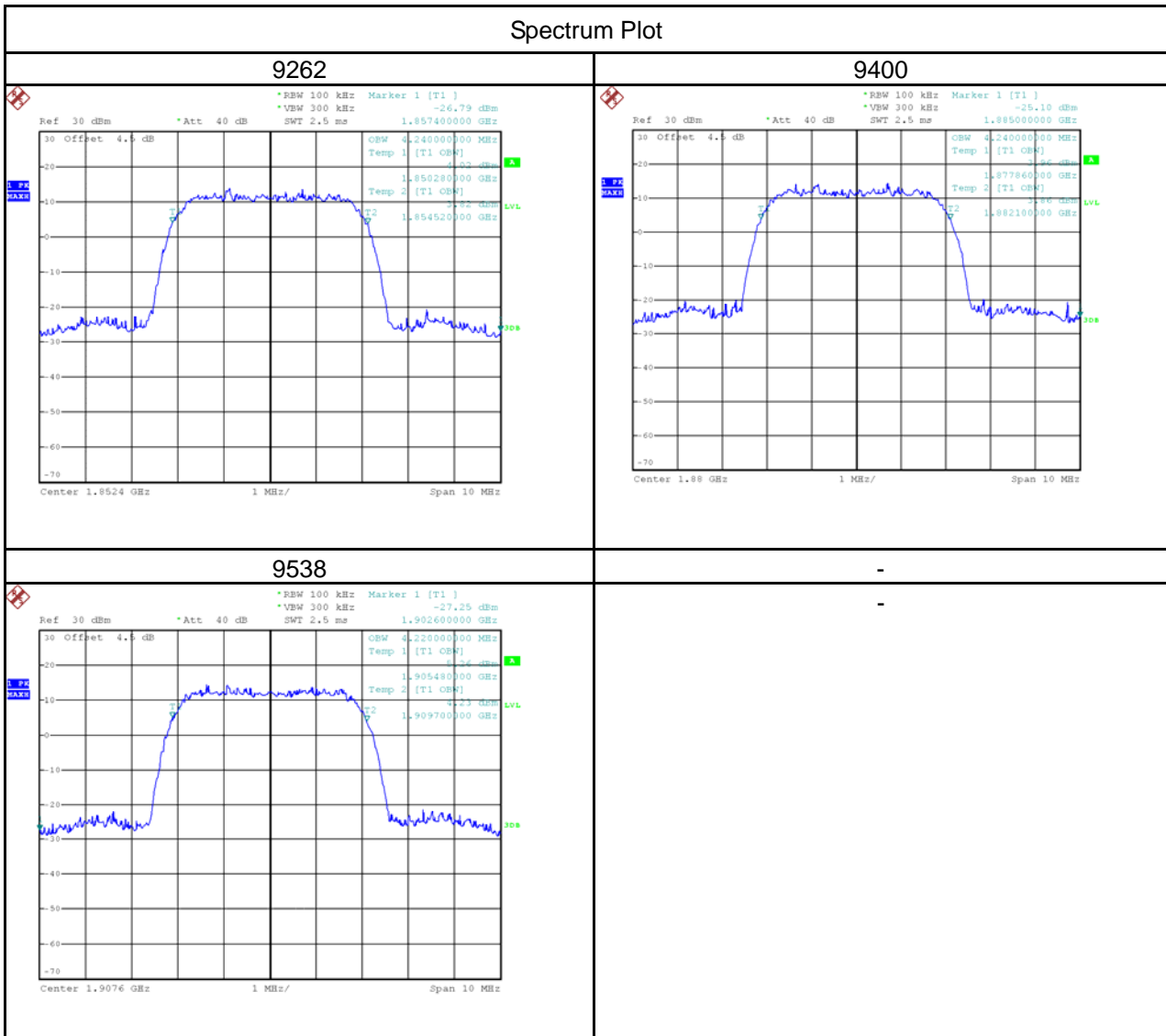

LTE Band 2_1.4M					
QPSK			16QAM		
Channel	Frequency (MHz)	99% Occupied Bandwidth (MHz)	Channel	Frequency (MHz)	99% Occupied Bandwidth (MHz)
18607	1850.7	1.087	18607	1850.7	1.093
18900	1880	1.094	18900	1880	1.092
19193	1909.3	1.096	19193	1909.3	1.090
Channel	Frequency (MHz)	26dB Bandwidth (MHz)	Channel	Frequency (MHz)	26dB Bandwidth (MHz)
18607	1850.7	1.265	18607	1850.7	1.255
18900	1880	1.274	18900	1880	1.269
19193	1909.3	1.267	19193	1909.3	1.265

Spectrum Plot

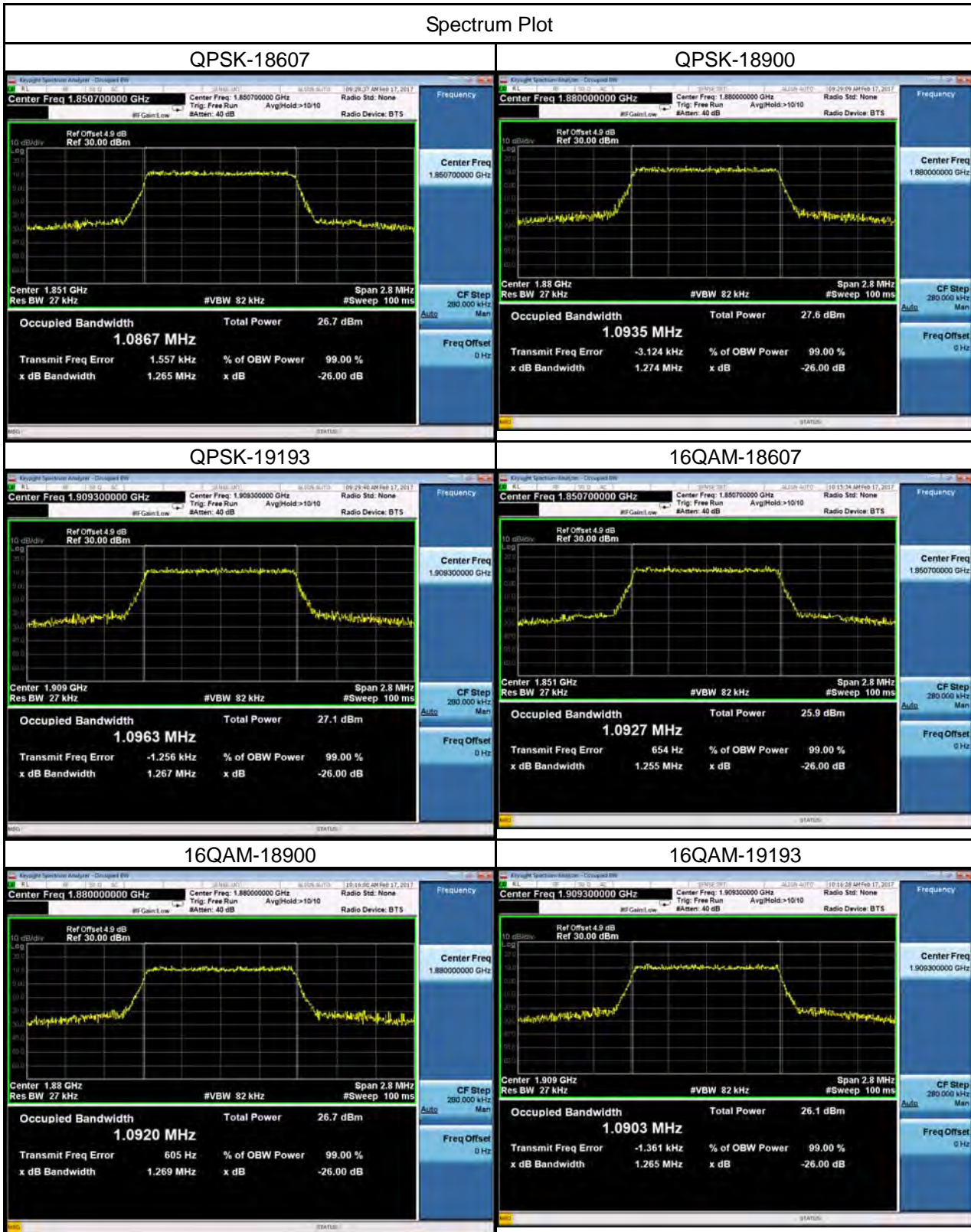

LTE Band 2_3M					
QPSK			16QAM		
Channel	Frequency (MHz)	99% Occupied Bandwidth (MHz)	Channel	Frequency (MHz)	99% Occupied Bandwidth (MHz)
18615	1851.5	2.692	18615	1851.5	2.695
18900	1880	2.697	18900	1880	2.697
19185	1908.5	2.696	19185	1908.5	2.694
Channel	Frequency (MHz)	26dB Bandwidth (MHz)	Channel	Frequency (MHz)	26dB Bandwidth (MHz)
18615	1851.5	2.973	18615	1851.5	2.953
18900	1880	2.952	18900	1880	2.972
19185	1908.5	2.954	19185	1908.5	2.982

Spectrum Plot

QPSK-18615

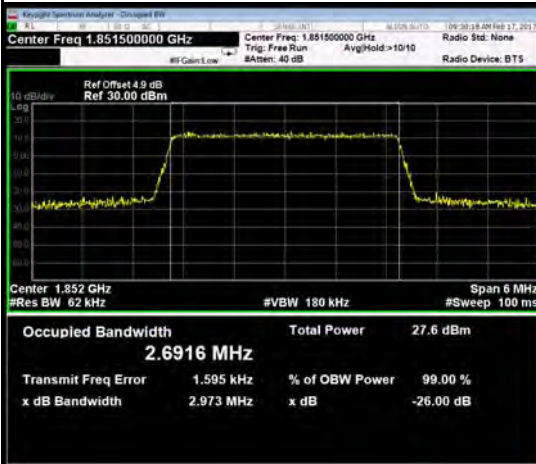

QPSK-18900

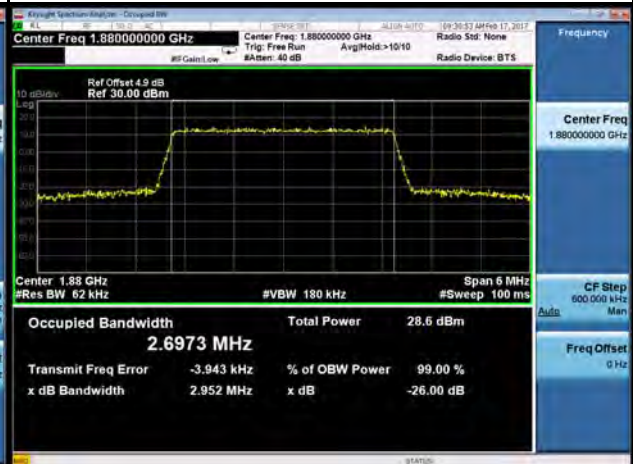

QPSK-19185

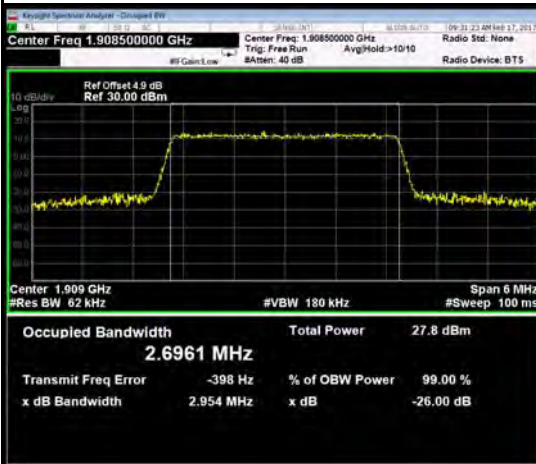

16QAM-18615



16QAM-18900

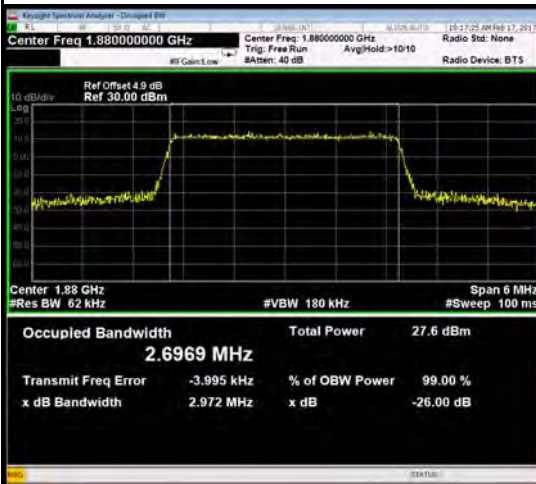

16QAM-19185



LTE Band 2_5M					
QPSK			16QAM		
Channel	Frequency (MHz)	99% Occupied Bandwidth (MHz)	Channel	Frequency (MHz)	99% Occupied Bandwidth (MHz)
18625	1852.5	4.531	18625	1852.5	4.513
18900	1880	4.520	18900	1880	4.514
19175	1907.5	4.519	19175	1907.5	4.514
Channel	Frequency (MHz)	26dB Bandwidth (MHz)	Channel	Frequency (MHz)	26dB Bandwidth (MHz)
18625	1852.5	5.025	18625	1852.5	5.053
18900	1880	5.076	18900	1880	5.025
19175	1907.5	5.016	19175	1907.5	4.992

LTE Band 2_10M					
QPSK			16QAM		
Channel	Frequency (MHz)	99% Occupied Bandwidth (MHz)	Channel	Frequency (MHz)	99% Occupied Bandwidth (MHz)
18650	1855	8.982	18650	1855	8.986
18900	1880	8.966	18900	1880	8.962
19150	1905	9.002	19150	1905	8.981
Channel	Frequency (MHz)	26dB Bandwidth (MHz)	Channel	Frequency (MHz)	26dB Bandwidth (MHz)
18650	1855	10.040	18650	1855	9.895
18900	1880	9.899	18900	1880	9.889
19150	1905	9.934	19150	1905	9.898

Spectrum Plot

QPSK-18650

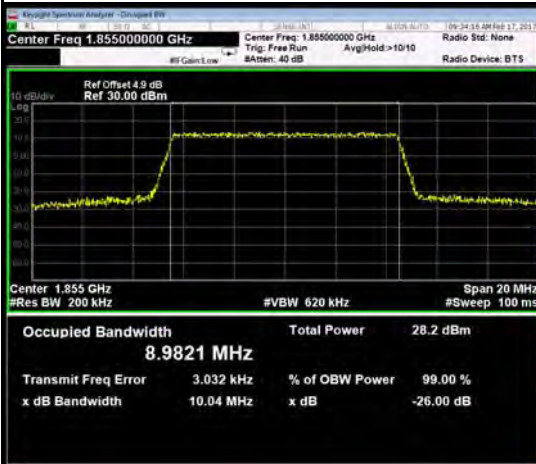

QPSK-18900

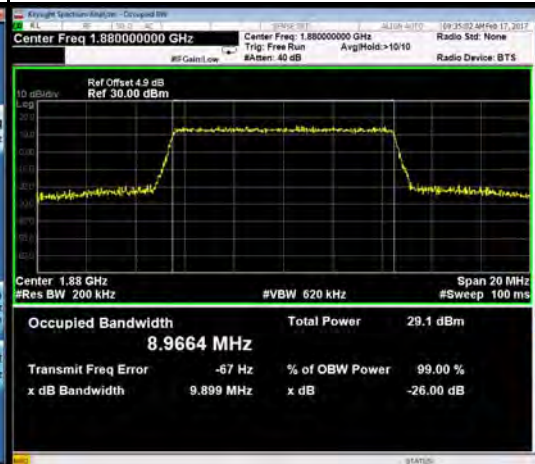

QPSK-19150

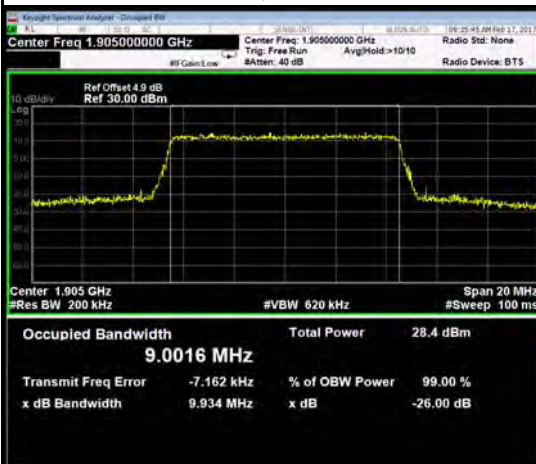

16QAM-18650

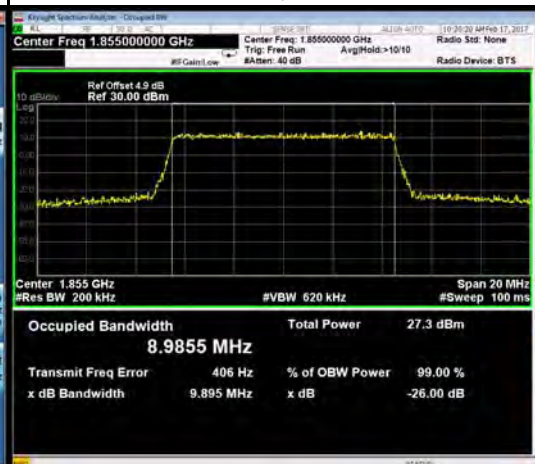

16QAM-18900

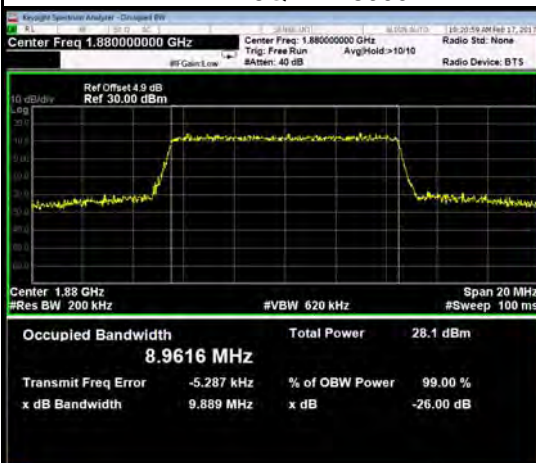

16QAM-19150

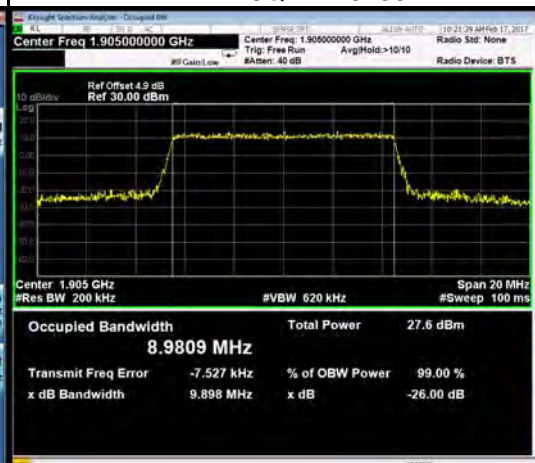

LTE Band 2_15M					
QPSK			16QAM		
Channel	Frequency (MHz)	99% Occupied Bandwidth (MHz)	Channel	Frequency (MHz)	99% Occupied Bandwidth (MHz)
18675	1857.5	13.484	18675	1857.5	13.472
18900	1880	13.447	18900	1880	13.447
19125	1902.5	13.481	19125	1902.5	13.489
Channel	Frequency (MHz)	26dB Bandwidth (MHz)	Channel	Frequency (MHz)	26dB Bandwidth (MHz)
18675	1857.5	14.790	18675	1857.5	14.830
18900	1880	14.770	18900	1880	14.780
19125	1902.5	14.680	19125	1902.5	14.750

Spectrum Plot

QPSK-18675

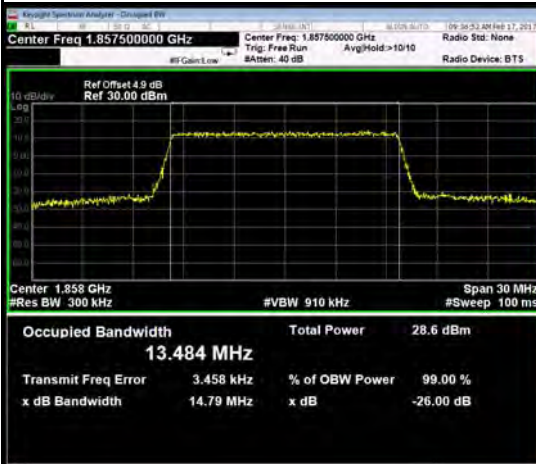

QPSK-18900

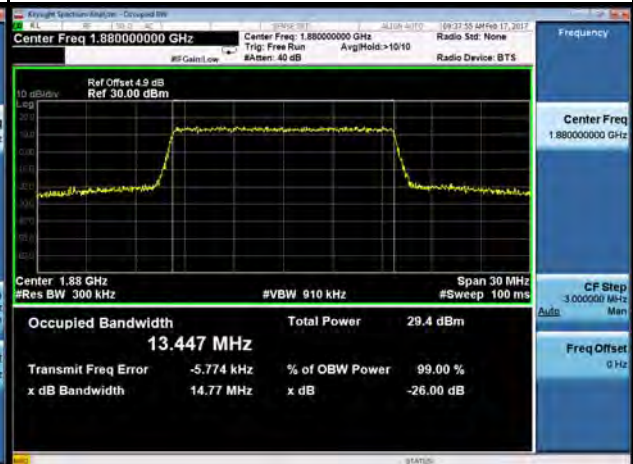

QPSK-19125

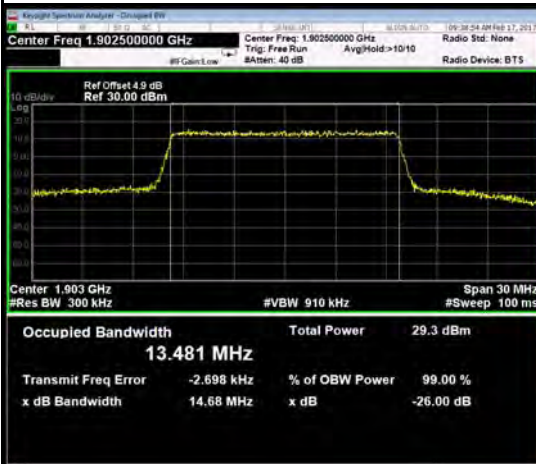

16QAM-18675



16QAM-18900

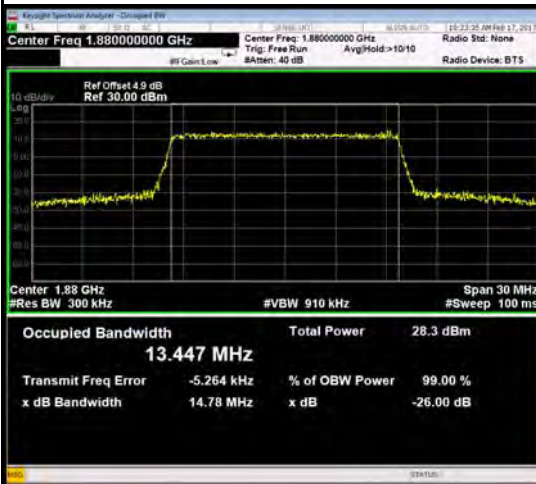

16QAM-19125



LTE Band 2_20M					
QPSK			16QAM		
Channel	Frequency (MHz)	99% Occupied Bandwidth (MHz)	Channel	Frequency (MHz)	99% Occupied Bandwidth (MHz)
18700	1860	17.970	18700	1860	17.951
18900	1880	17.955	18900	1880	17.928
19100	1900	17.968	19100	1900	17.971
Channel	Frequency (MHz)	26dB Bandwidth (MHz)	Channel	Frequency (MHz)	26dB Bandwidth (MHz)
18700	1860	19.580	18700	1860	19.590
18900	1880	19.370	18900	1880	19.600
19100	1900	19.66	19100	1900	19.650

Spectrum Plot

QPSK-18700

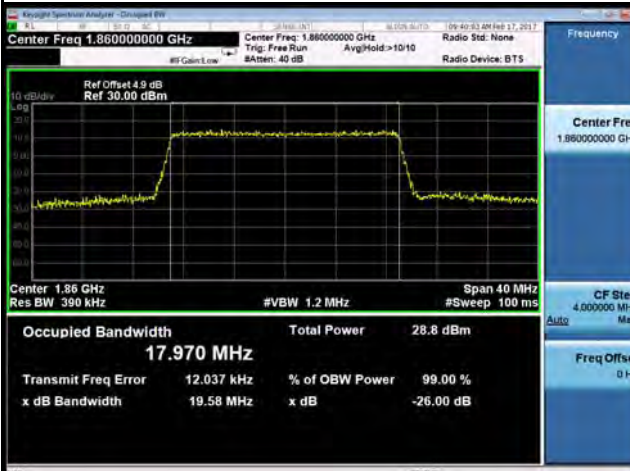

QPSK-18900

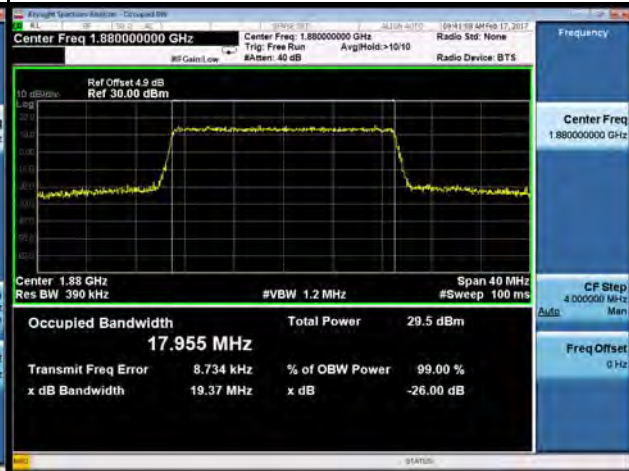

QPSK-19100



16QAM-18700

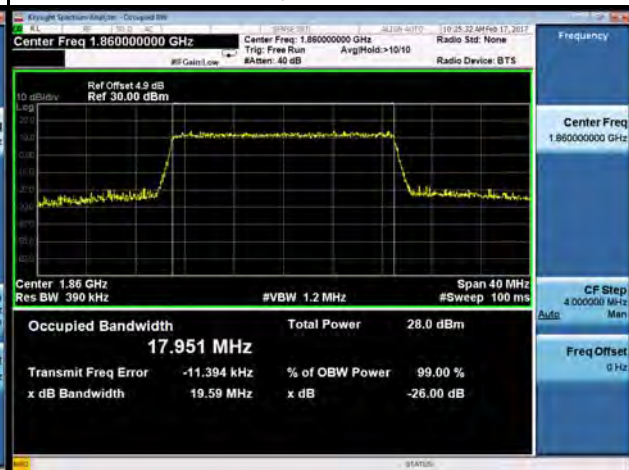

16QAM-18900

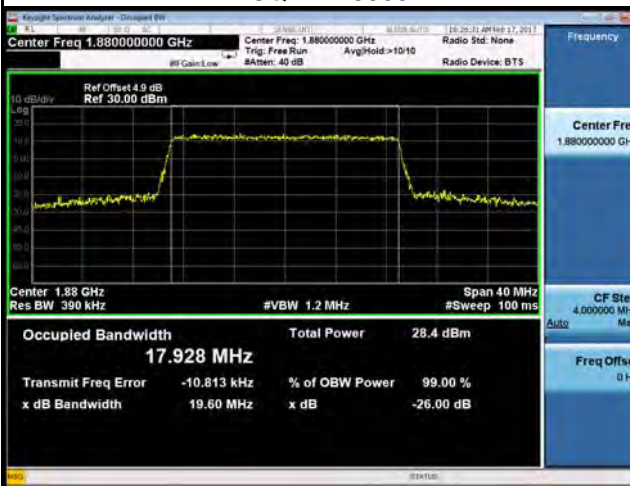

16QAM-19100



ATTACHMENT C - CONDUCTED EMISSIONS

DCS1900			
GSM		GSM	
Channel	Frequency(MHz)	Channel	Frequency(MHz)
661	1880	661	1880
GSM		EDGE	
Channel	Frequency(MHz)	Channel	Frequency(MHz)
661	1880	661	1880
EDGE		EDGE	
Channel	Frequency(MHz)	Channel	Frequency(MHz)
661	1880	661	1880

WCDMA Band 2

Channel	Frequency(MHz)	Channel	Frequency(MHz)
9400	1880	9400	1880
Channel	Frequency(MHz)	-	-
9400	1880	-	-
		-	

WCDMA_HSDPA Band 2

Channel	Frequency(MHz)	Channel	Frequency(MHz)
9400	1880	9400	1880
Channel	Frequency(MHz)	-	-
9400	1880	-	-
		-	

WCDMA_HSUPA Band 2

Channel	Frequency(MHz)	Channel	Frequency(MHz)
9400	1880	9400	1880
Channel	Frequency(MHz)	-	-
9400	1880	-	-
		-	

LTE Band 2_1.4M

Channel	Frequency(MHz)	Channel	Frequency(MHz)
18900	1880	18900	1880
Channel	Frequency(MHz)	-	-
18900	1880	-	-

LTE Band 2_3M

Channel	Frequency(MHz)	Channel	Frequency(MHz)
18900	1880	18900	1880
Channel	Frequency(MHz)	-	-
18900	1880	-	-

LTE Band 2_5M

Channel	Frequency(MHz)	Channel	Frequency(MHz)
18900	1880	18900	1880

Ref: 0 dBm, Att: 30 dB, SWF: 145 ms, Marker 1 (T1): 9.600000000 kHz, -51.46 dBm

Ref: 0 dBm, Att: 30 dB, SWF: 100 ms, Marker 1 (T1): 249.600000000 kHz, -54.00 dBm

Channel	Frequency(MHz)	-	-
18900	1880	-	-

Center Freq: 9.415000000 GHz
Mkr1: 5.642 GHz, -38.60 dBm

Auto Tune

Center Freq: 9.415000000 GHz

Start Freq: 30.000000000 MHz

Stop Freq: 18.800000000 GHz

CF Step: 1.977000000 GHz

Freq Offset: 0 Hz

Scale Type: Log

LTE Band 2_10M

Channel	Frequency(MHz)	Channel	Frequency(MHz)
18900	1880	18900	1880
Channel	Frequency(MHz)	-	-
18900	1880	-	-

LTE Band 2_15M

Channel	Frequency(MHz)	Channel	Frequency(MHz)
18900	1880	18900	1880
Channel	Frequency(MHz)	-	-
18900	1880	-	-

LTE Band 2_20M

Channel	Frequency(MHz)	Channel	Frequency(MHz)
18900	1880	18900	1880
Channel	Frequency(MHz)	-	-
18900	1880	-	-

ATTACHMENT D - RADIATED EMISSION

Test Mode: TX Mode_Adapter: BYD

Ant 0°

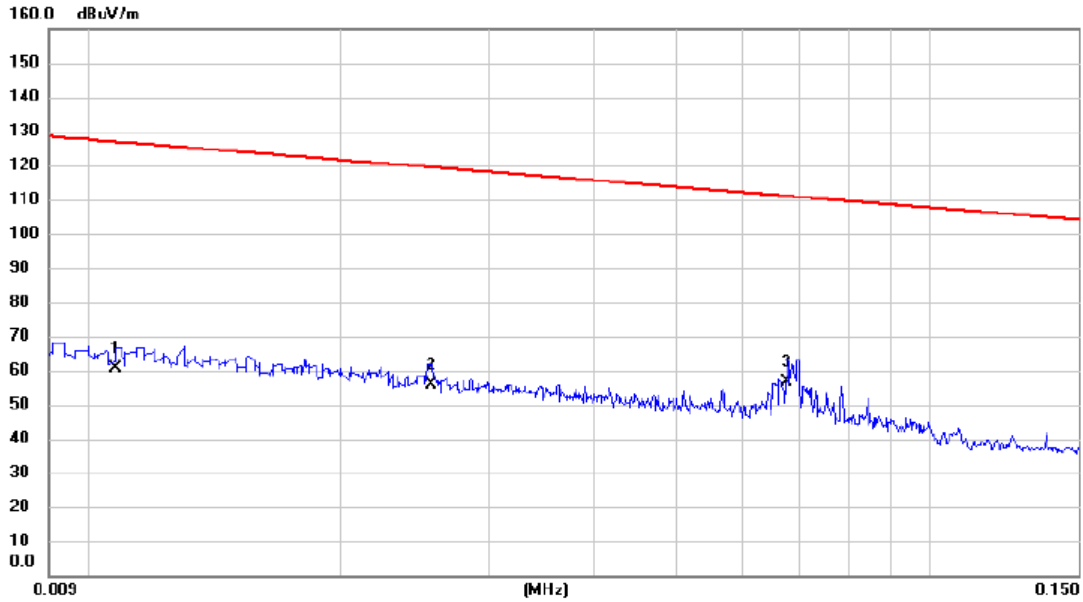

No.	Mk.	Freq. MHz	Reading Level dBuV	Correct Factor dB	Measure- ment dBuV/m	Limit dBuV/m	Margin dB	Detector	Comment
1		0.011	39.85	20.82	60.67	126.94	-66.27	AVG	
2		0.026	36.51	19.45	55.96	119.44	-63.48	AVG	
3	*	0.068	38.28	18.38	56.66	110.99	-54.33	AVG	

Test Mode: TX Mode_Adapter: BYD

Ant 0°

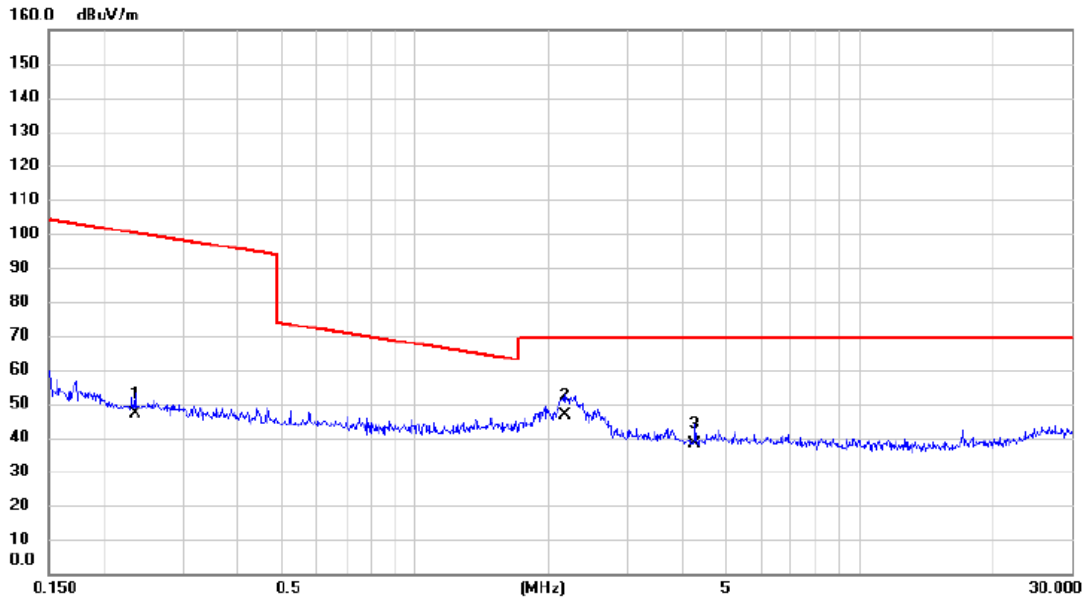

No.	Mk.	Freq. MHz	Reading Level dBuV	Correct Factor dB	Measure- ment dBuV/m	Limit dBuV/m	Margin dB	Detector	Comment
1		0.234	30.11	16.70	46.81	100.22	-53.41	AVG	
2	*	2.178	31.15	15.46	46.61	69.54	-22.93	QP	
3		4.269	23.36	14.80	38.16	69.54	-31.38	QP	

Test Mode: TX Mode_Adapter: BYD

Ant 90°

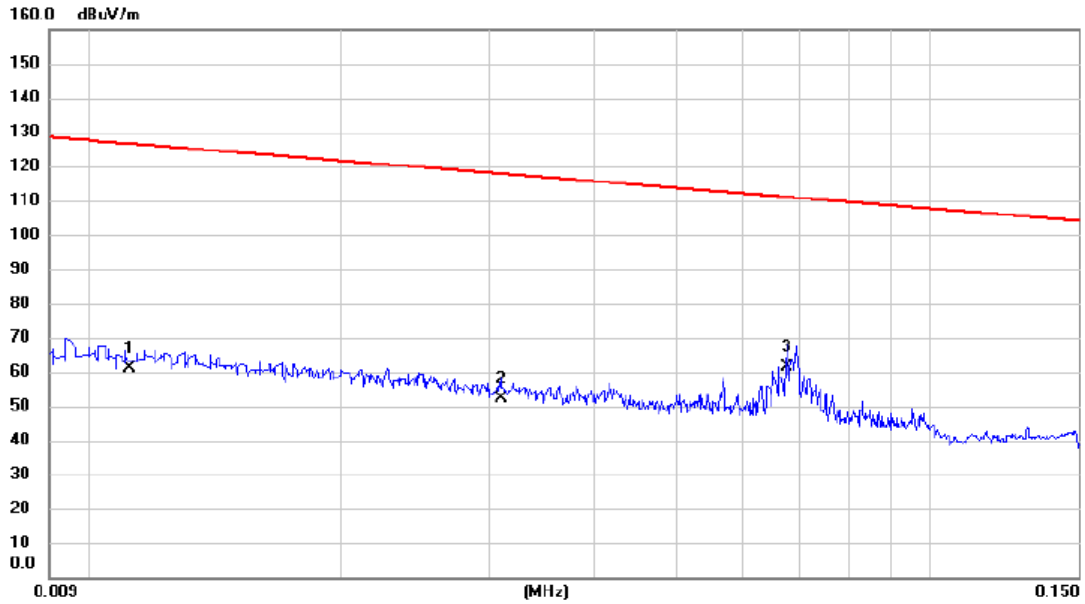

No.	Mk.	Freq. MHz	Reading Level dBuV	Correct Factor dB	Measure- ment dBuV/m	Limit dBuV/m	Margin dB	Detector	Comment
1		0.011	40.42	20.76	61.18	126.62	-65.44	AVG	
2		0.031	32.94	19.29	52.23	117.78	-65.55	AVG	
3	*	0.068	42.88	18.38	61.26	111.01	-49.75	AVG	

Test Mode: TX Mode_ Adapter: BYD

Ant 90°

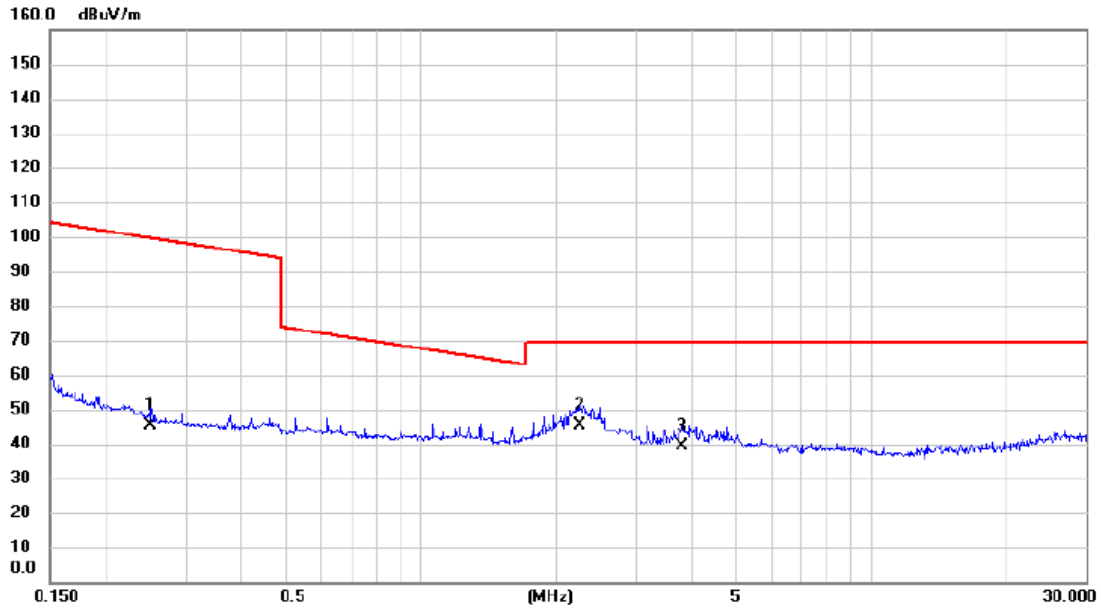

No.	Mk.	Freq. MHz	Reading Level dBuV	Correct Factor dB	Measure- ment dBuV/m	Limit dBuV/m	Margin dB	Detector	Comment
1		0.251	28.91	16.65	45.56	99.62	-54.06	AVG	
2	*	2.249	29.77	15.44	45.21	69.54	-24.33	QP	
3		3.799	24.28	15.01	39.29	69.54	-30.25	QP	

Test Mode: TX Mode_Adapter: PHITEK

Ant 0°

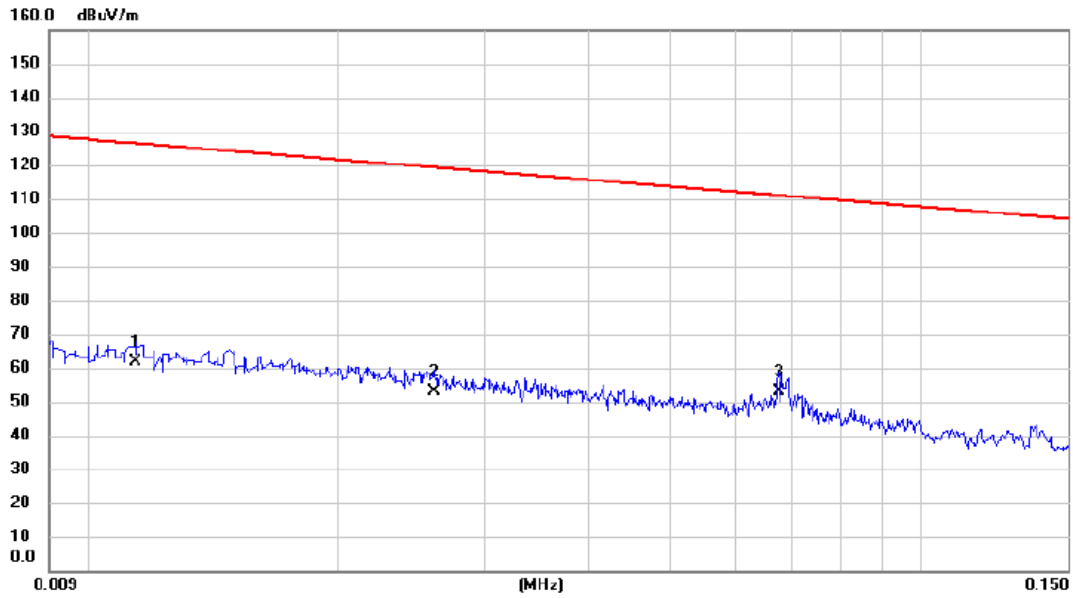

No. Mk.	Freq. MHz	Reading Level dBuV	Correct Factor dB	Measure- ment dBuV/m	Limit dBuV/m	Margin dB	Detector	Comment
1	0.011	41.14	20.74	61.88	126.47	-64.59	AVG	
2	0.026	33.54	19.44	52.98	119.27	-66.29	AVG	
3 *	0.068	34.64	18.38	53.02	111.02	-58.00	AVG	

Test Mode: TX Mode_Adapter: PHITEK

Ant 0°

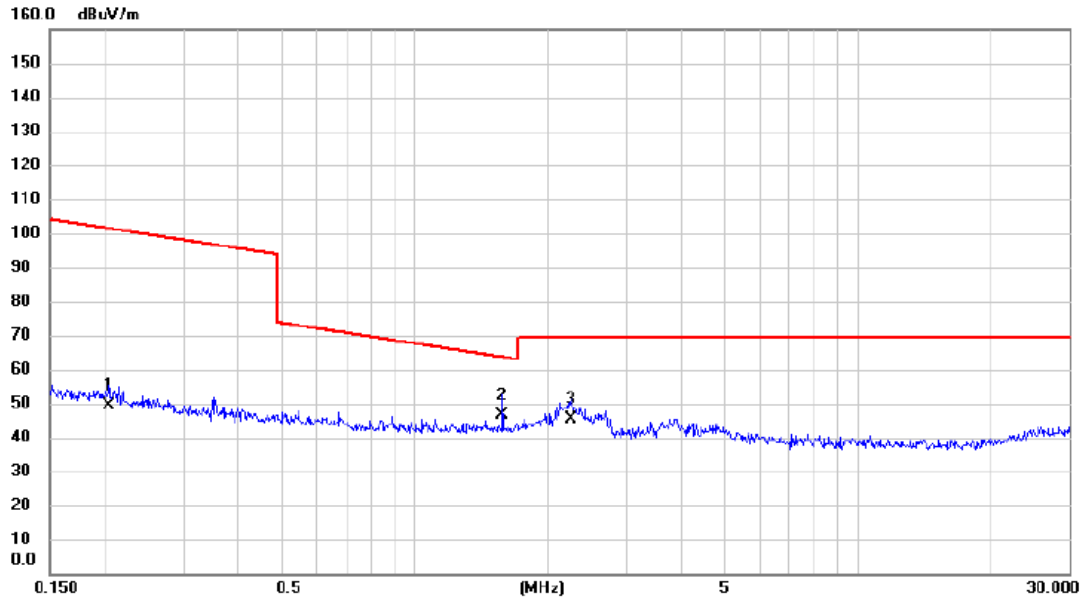

No.	Mk.	Freq. MHz	Reading Level dBuV	Correct Factor dB	Measure- ment dBuV/m	Limit dBuV/m	Margin dB	Detector	Comment
1		0.204	32.63	16.78	49.41	101.41	-52.00	AVG	
2	*	1.577	31.10	15.66	46.76	63.65	-16.89	QP	
3		2.249	29.92	15.44	45.36	69.54	-24.18	QP	

Test Mode: TX Mode_ Adapter: PHITEK

Ant 90°

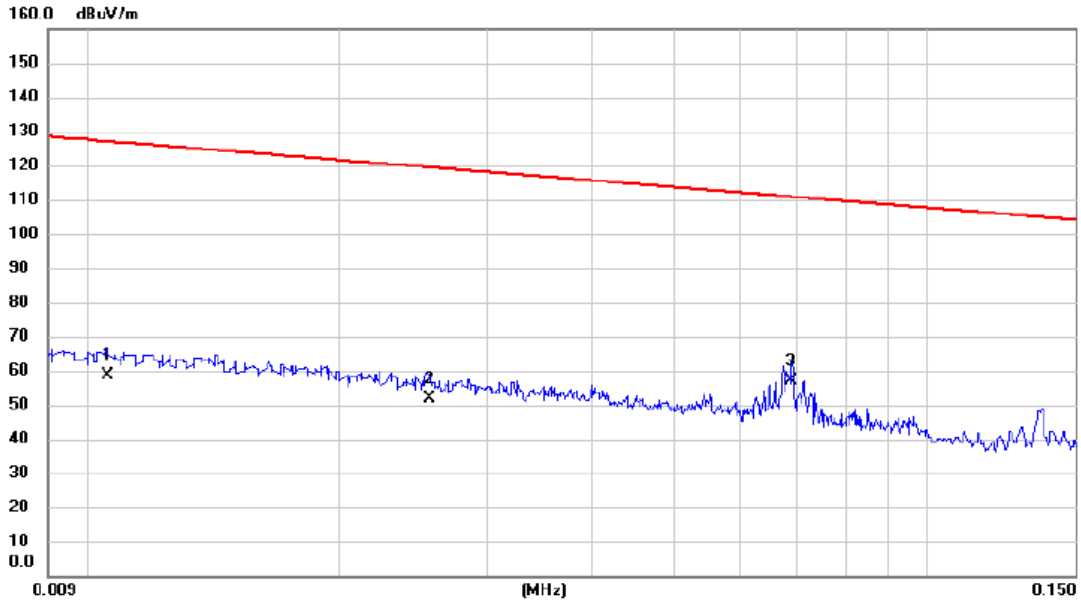

No.	Mk.	Freq. MHz	Reading Level dBuV	Correct Factor dB	Measure- ment dBuV/m	Limit dBuV/m	Margin dB	Detector	Comment
1		0.011	37.66	20.84	58.50	127.10	-68.60	AVG	
2		0.026	32.46	19.45	51.91	119.44	-67.53	AVG	
3	*	0.069	38.68	18.35	57.03	110.83	-53.80	AVG	

Test Mode: TX Mode_Adapter: PHITEK

Ant 90°

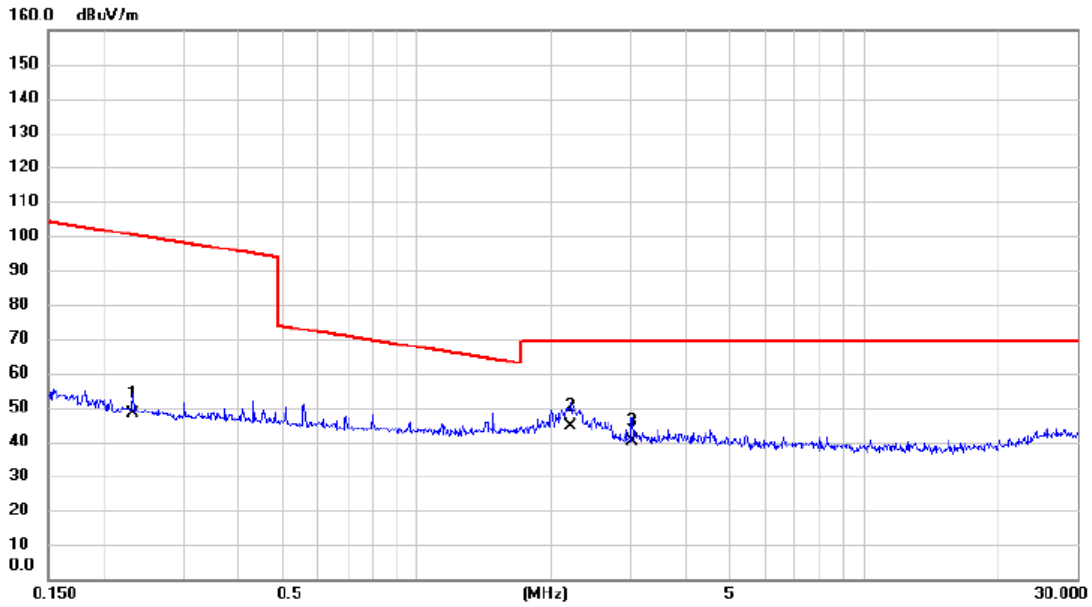

No.	Mk.	Freq. MHz	Reading Level dBuV	Correct Factor dB	Measure- ment dBuV/m	Limit dBuV/m	Margin dB	Detector	Comment
1		0.232	31.58	16.71	48.29	100.31	-52.02	AVG	
2	*	2.213	28.97	15.45	44.42	69.54	-25.12	QP	
3		3.025	24.90	15.22	40.12	69.54	-29.42	QP	

Test Mode: TX Mode_Adapter: Huntkey

Ant 0°

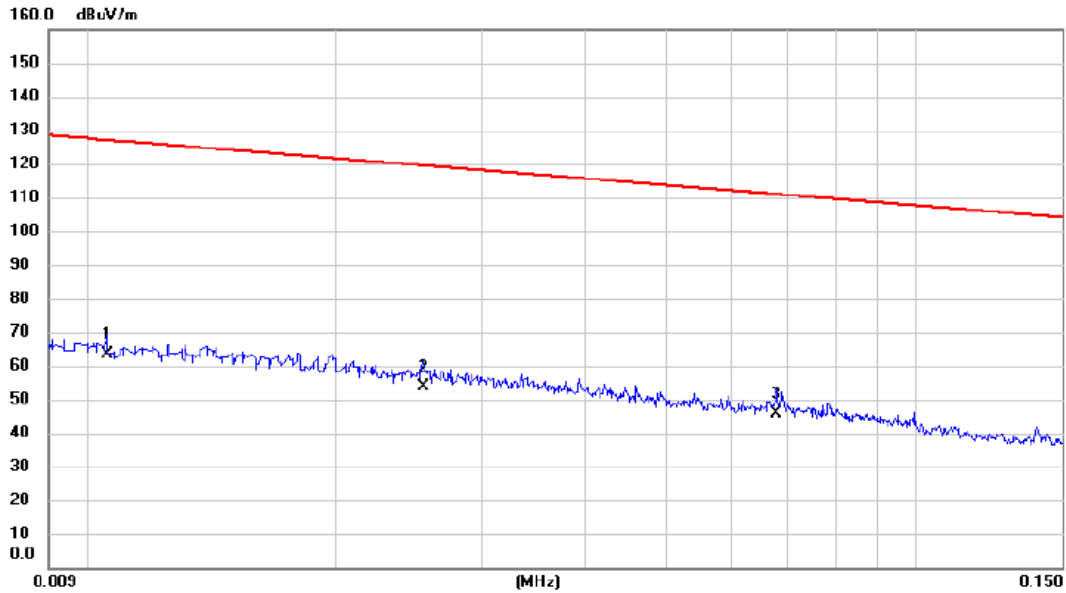

No.	Mk.	Freq. MHz	Reading Level dBuV	Correct Factor dB	Measure- ment dBuV/m	Limit dBuV/m	Margin dB	Detector	Comment
1	*	0.011	42.76	20.84	63.60	127.10	-63.50	AVG	
2		0.025	34.27	19.46	53.73	119.47	-65.74	AVG	
3		0.068	27.27	18.37	45.64	110.98	-65.34	AVG	

Test Mode: TX Mode_ Adapter: Huntkey

Ant 0°

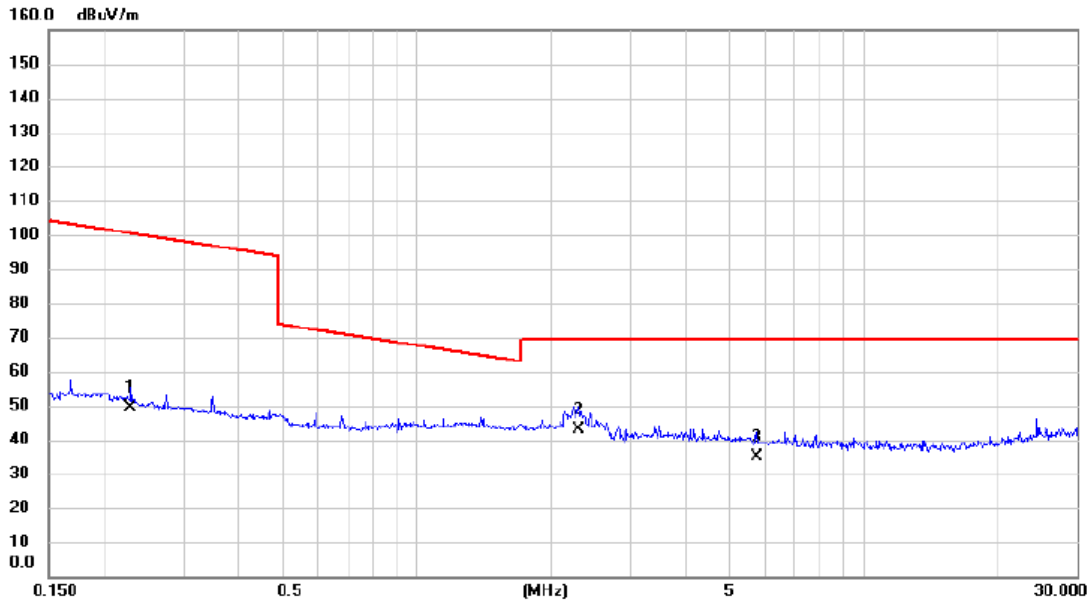

No.	Mk.	Freq. MHz	Reading Level dBuV	Correct Factor dB	Measure- ment dBuV/m	Limit dBuV/m	Margin dB	Detector	Comment
1		0.229	32.83	16.71	49.54	100.41	-50.87	AVG	
2	*	2.297	27.52	15.42	42.94	69.54	-26.60	QP	
3		5.774	20.81	14.28	35.09	69.54	-34.45	QP	

Test Mode: TX Mode_Adapter: Huntkey

Ant 90°

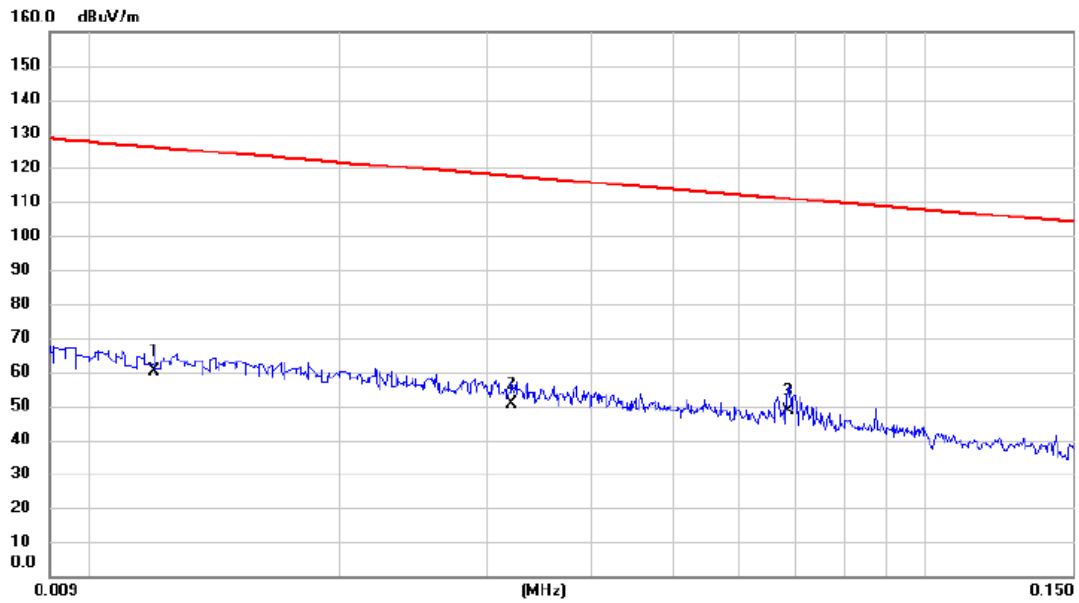

No.	Mk.	Freq. MHz	Reading Level dBuV	Correct Factor dB	Measure- ment dBuV/m	Limit dBuV/m	Margin dB	Detector	Comment
1		0.012	39.57	20.66	60.23	126.02	-65.79	AVG	
2		0.032	31.45	19.26	50.71	117.47	-66.76	AVG	
3	*	0.069	30.26	18.36	48.62	110.87	-62.25	AVG	

Test Mode: TX Mode_ Adapter: Huntkey

Ant 90°

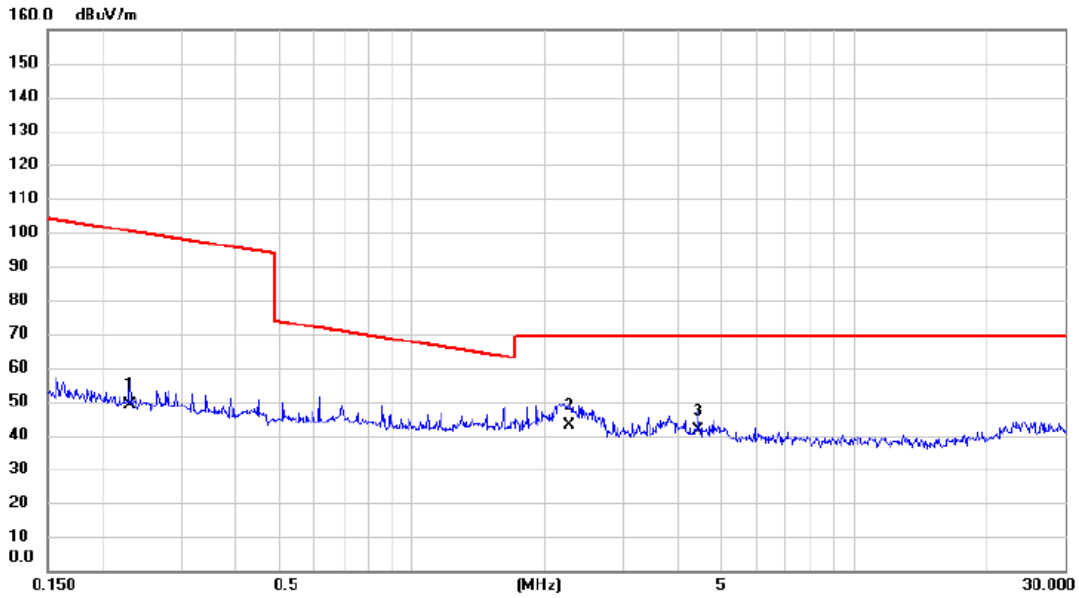

No.	Mk.	Freq.	Reading Level	Correct Factor	Measurement	Limit	Margin	Detector	Comment
		MHz	dBuV	dB	dBuV/m	dBuV/m	dB		
1		0.230	32.41	16.71	49.12	100.36	-51.24	AVG	
2	*	2.272	27.49	15.43	42.92	69.54	-26.62	QP	
3		4.431	26.68	14.71	41.39	69.54	-28.15	QP	

SIM Card 1

Test Mode: DCS1900_TX CH661_GSM

Vertical

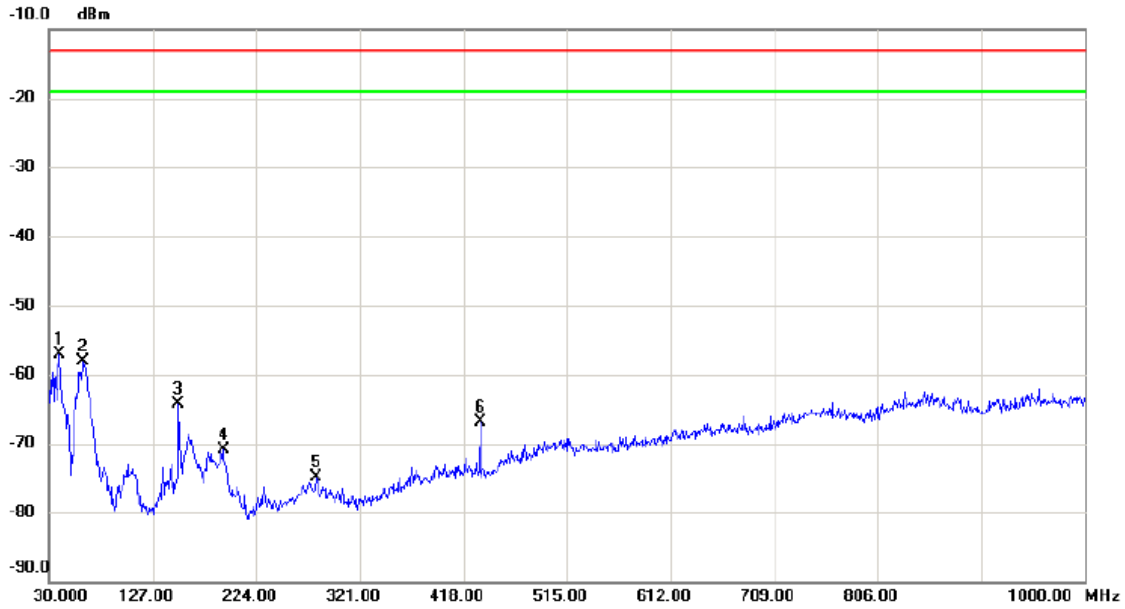

No.	Mk.	Freq. MHz	Reading Level dBm	Correct Factor dB	Measure- ment dBm	Limit dBm	Margin dB	Detector	Comment
1	*	39.700	-59.07	1.90	-57.17	-13.00	-44.17	peak	
2		62.010	-58.87	0.73	-58.14	-13.00	-45.14	peak	
3		151.250	-67.51	3.15	-64.36	-13.00	-51.36	peak	
4		192.960	-68.89	-1.95	-70.84	-13.00	-57.84	peak	
5		280.260	-77.49	2.64	-74.85	-13.00	-61.85	peak	
6		433.520	-71.28	4.45	-66.83	-13.00	-53.83	peak	

Test Mode: DCS1900_TX CH661_GSM

Horizontal

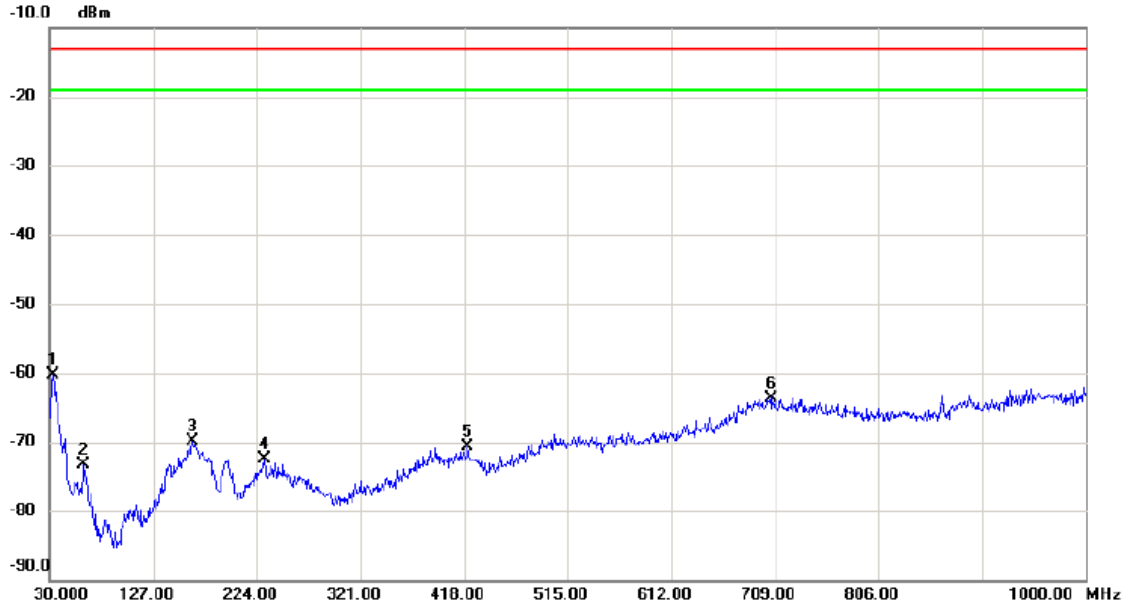

No.	Mk.	Freq. MHz	Reading Level dBm	Correct Factor dB	Measure- ment dBm	Limit dBm	Margin dB	Detector	Comment
1	*	32.910	-61.18	0.96	-60.22	-13.00	-47.22	peak	
2		62.010	-72.31	-0.97	-73.28	-13.00	-60.28	peak	
3		163.860	-71.08	1.14	-69.94	-13.00	-56.94	peak	
4		230.790	-75.73	3.18	-72.55	-13.00	-59.55	peak	
5		420.910	-77.54	6.78	-70.76	-13.00	-57.76	peak	
6		705.120	-77.46	13.86	-63.60	-13.00	-50.60	peak	

Test Mode: DCS1900_TX CH661_GSM

Vertical

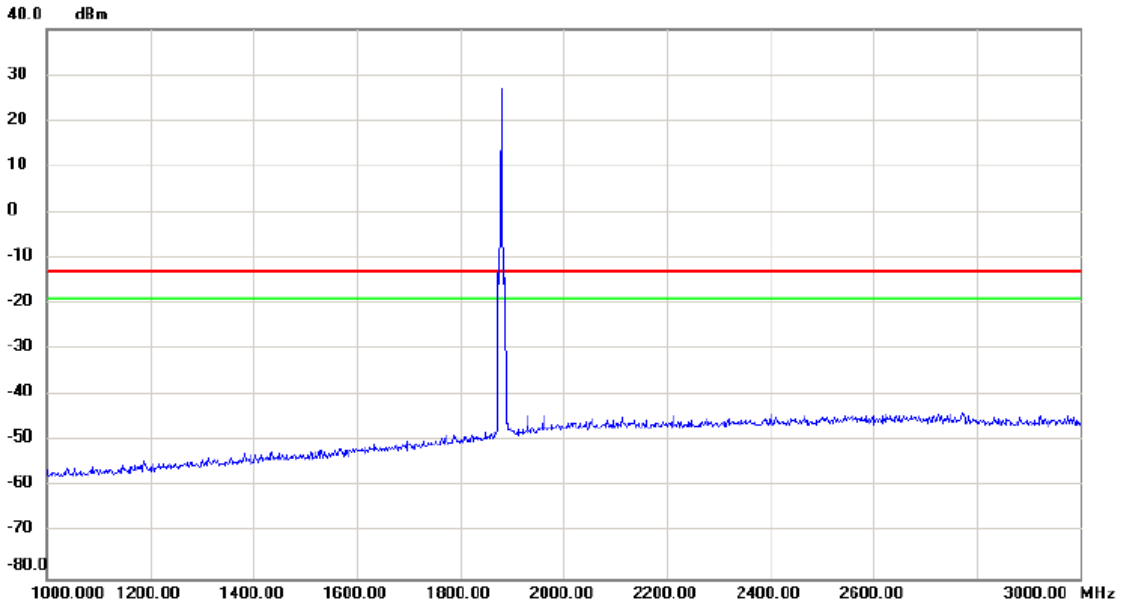

No.	Mk.	Freq.	Reading Level	Correct Factor	Measurement	Limit	Margin	Detector	Comment
		MHz	dBm	dB	dBm	dBm	dB		
		1900.00	25.00	0.00	25.00	-15.00	40.00		

Test Mode: DCS1900_TX CH661_GSM

Horizontal

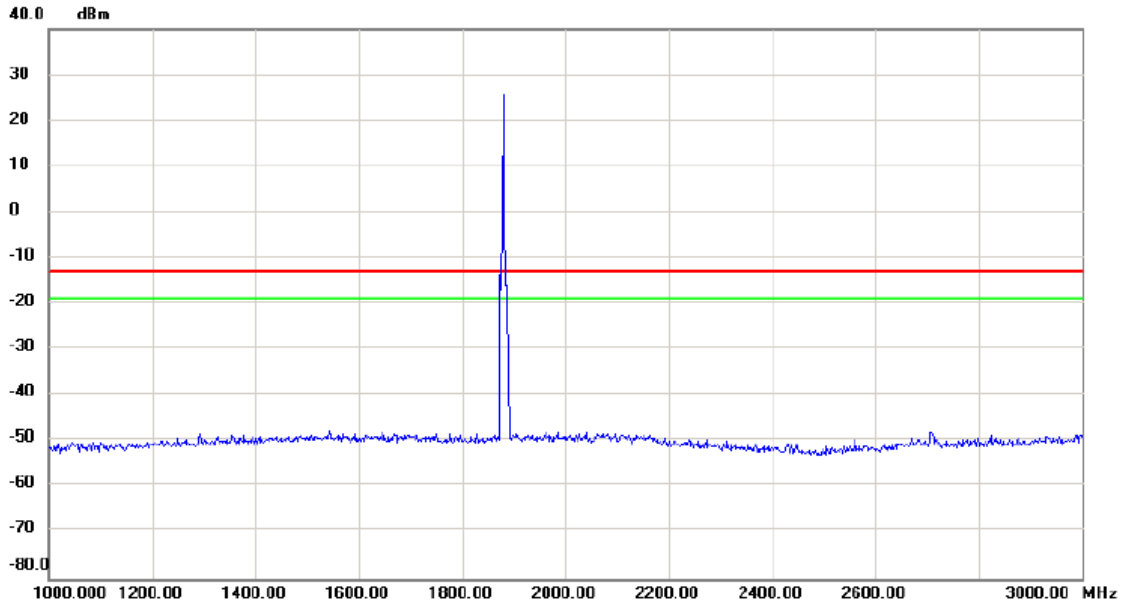

No.	Mk.	Freq. MHz	Reading Level dBm	Correct Factor dB	Measure- ment dBm	Limit dBm	Margin dB	Detector	Comment
		1880.00	25.00	0.00	25.00	-15.00	40.00		

Test Mode: DCS1900_TX CH661_GSM

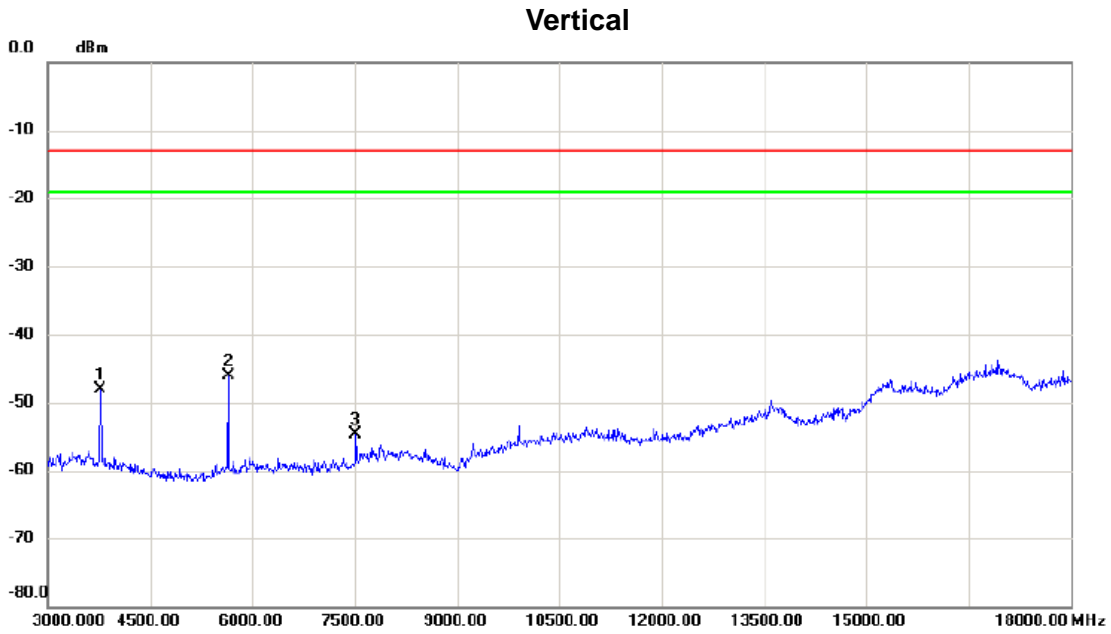

No.	Mk.	Freq. MHz	Reading Level dBm	Correct Factor dB	Measure- ment dBm	Limit dBm	Margin dB	Detector	Comment
1		3765.000	-62.58	14.51	-48.07	-13.00	-35.07	peak	
2	*	5640.000	-62.41	16.31	-46.10	-13.00	-33.10	peak	
3		7515.000	-72.61	17.92	-54.69	-13.00	-41.69	peak	

Test Mode: DCS1900_TX CH661_GSM

Horizontal

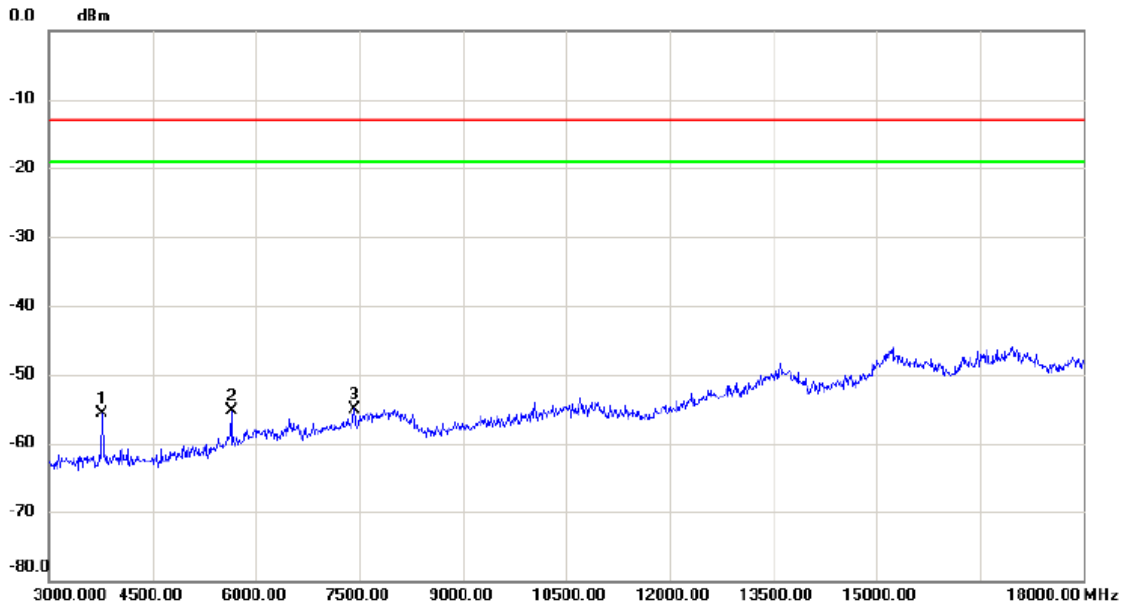

No.	Mk.	Freq. MHz	Reading Level dBm	Correct Factor dB	Measure- ment dBm	Limit dBm	Margin dB	Detector	Comment
1		3765.000	-67.06	11.36	-55.70	-13.00	-42.70	peak	
2		5640.000	-72.43	17.04	-55.39	-13.00	-42.39	peak	
3	*	7425.000	-75.39	20.39	-55.00	-13.00	-42.00	peak	

Test Mode: DCS1900_TX CH661_GSM

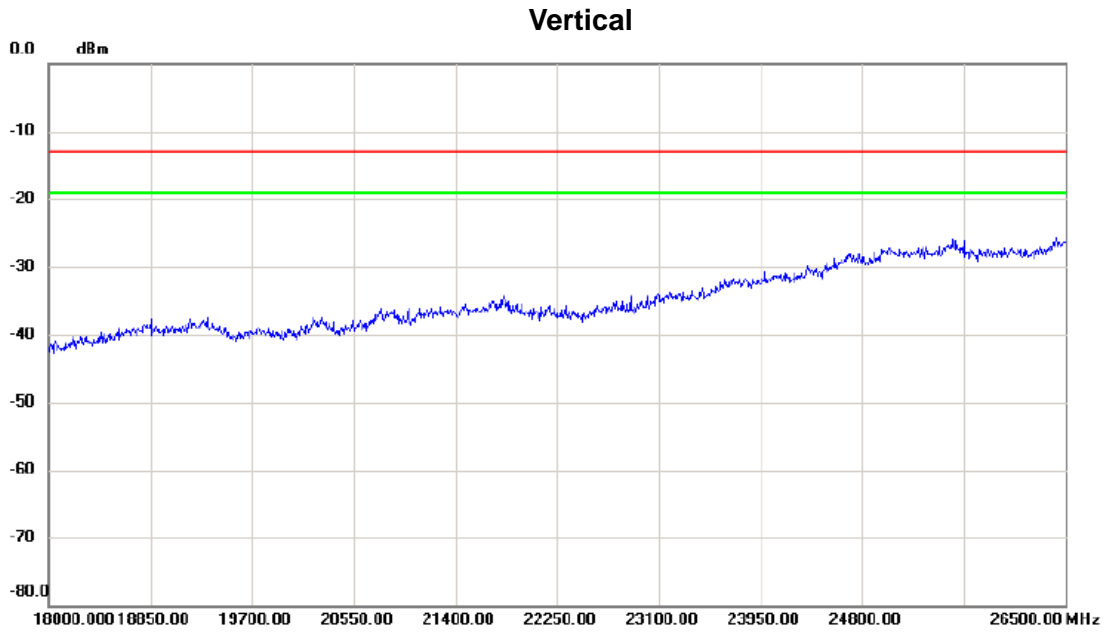

No.	Mk.	Freq. MHz	Reading Level dBm	Correct Factor dB	Measure- ment dBm	Limit dBm	Margin dB	Detector	Comment
-----	-----	--------------	-------------------------	-------------------------	-------------------------	--------------	--------------	----------	---------

Test Mode: DCS1900_TX CH661_GSM

Horizontal

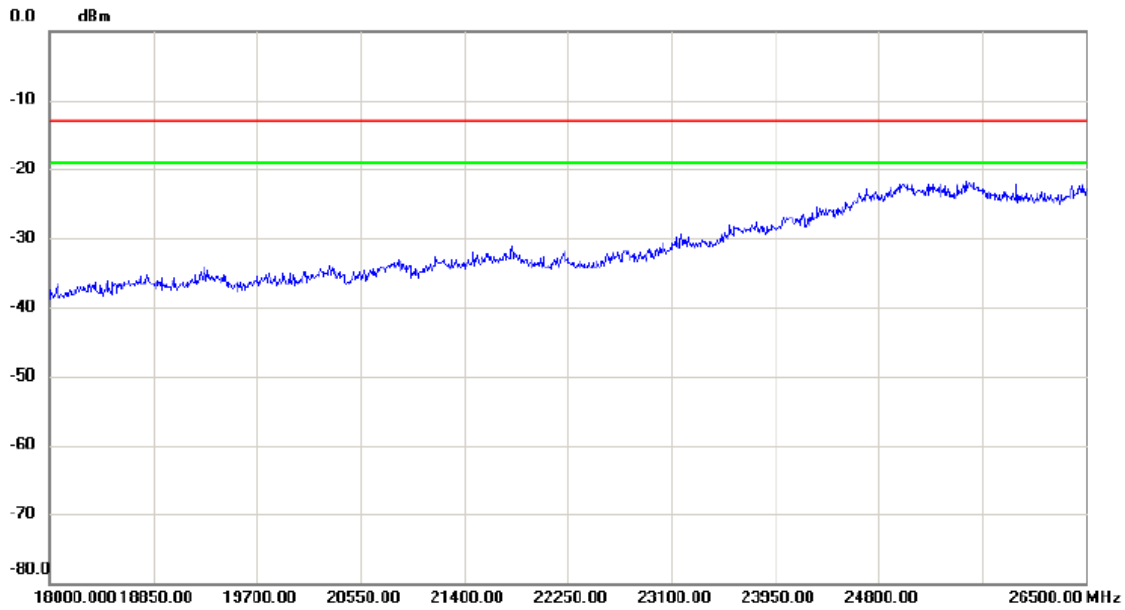

No.	Mk.	Freq. MHz	Reading Level dBm	Correct Factor dB	Measure- ment dBm	Limit dBm	Margin dB	Detector	Comment
-----	-----	--------------	-------------------------	-------------------------	-------------------------	--------------	--------------	----------	---------

Test Mode: DCS1900_TX CH661_EDGE

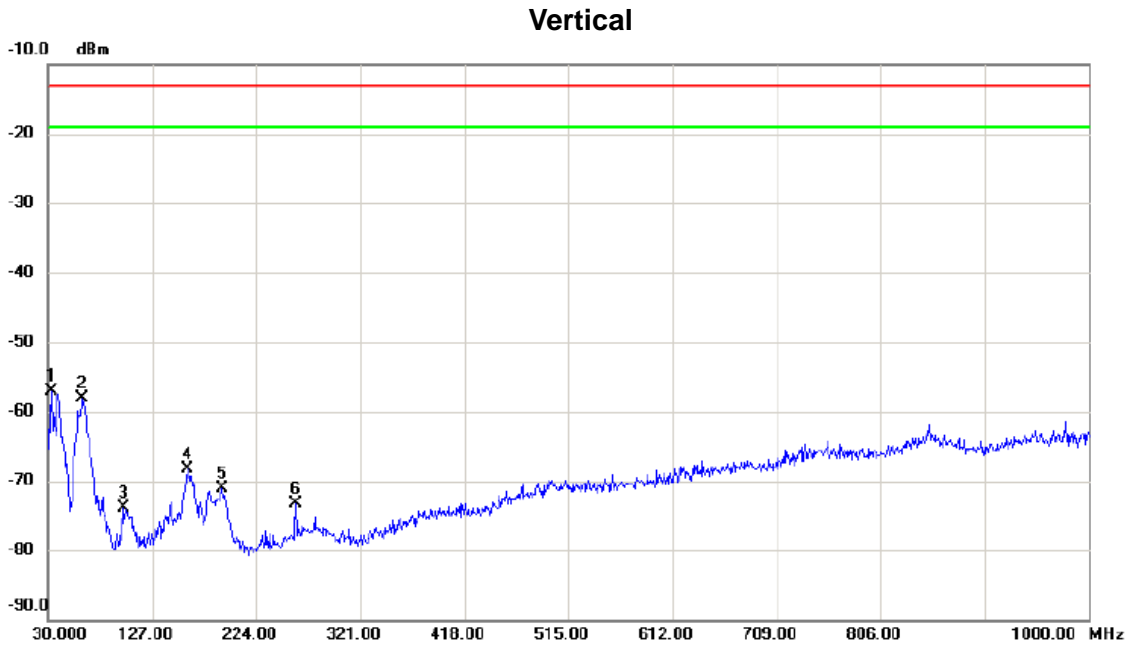

No.	Mk.	Freq. MHz	Reading Level dBm	Correct Factor dB	Measure- ment dBm	Limit dBm	Margin dB	Detector	Comment
1	*	32.910	-56.19	-0.96	-57.15	-13.00	-44.15	peak	
2		62.010	-58.80	0.73	-58.07	-13.00	-45.07	peak	
3		99.840	-72.48	-1.45	-73.93	-13.00	-60.93	peak	
4		159.980	-71.49	3.18	-68.31	-13.00	-55.31	peak	
5		191.990	-69.23	-1.90	-71.13	-13.00	-58.13	peak	
6		260.860	-74.20	0.86	-73.34	-13.00	-60.34	peak	

Test Mode: DCS1900_TX CH661_EDGE

Horizontal

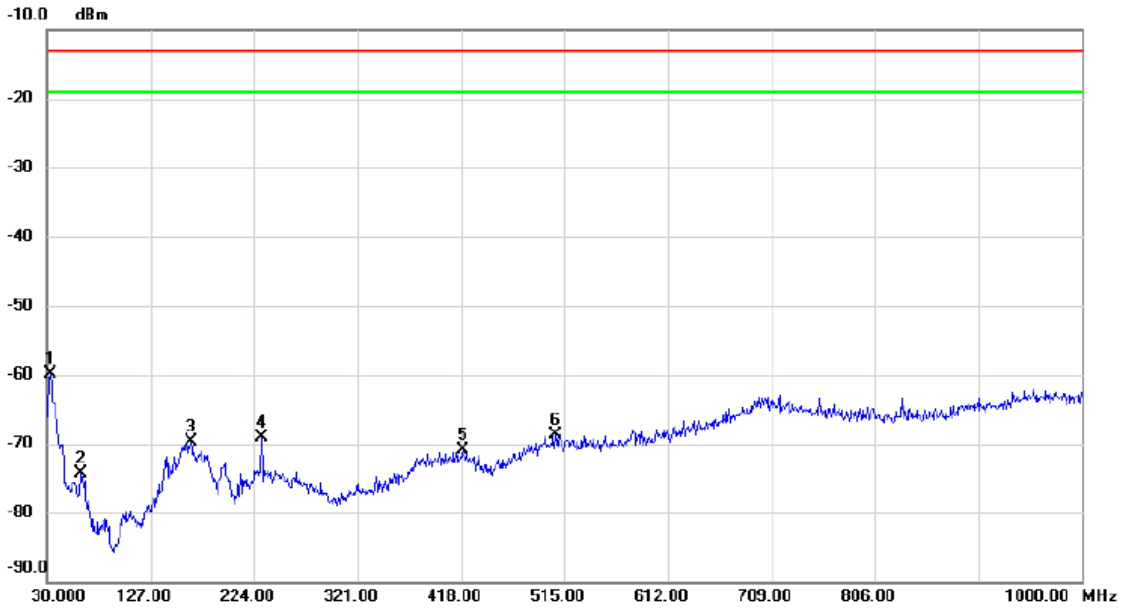

No.	Mk.	Freq. MHz	Reading Level dBm	Correct Factor dB	Measure- ment dBm	Limit dBm	Margin dB	Detector	Comment
1	*	32.910	-60.78	0.96	-59.82	-13.00	-46.82	peak	
2		62.010	-73.27	-0.97	-74.24	-13.00	-61.24	peak	
3		164.830	-70.52	0.74	-69.78	-13.00	-56.78	peak	
4		230.790	-72.32	3.18	-69.14	-13.00	-56.14	peak	
5		419.940	-77.81	6.88	-70.93	-13.00	-57.93	peak	
6		506.270	-76.70	8.07	-68.63	-13.00	-55.63	peak	

Test Mode: DCS1900_TX CH661_EDGE

Vertical

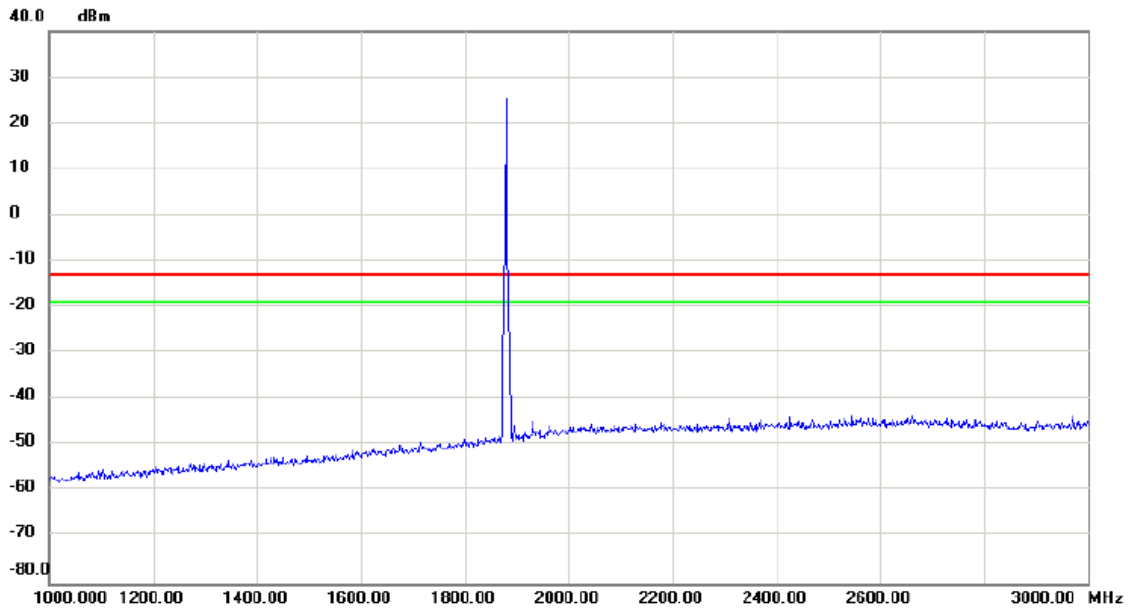

No.	Mk.	Freq. MHz	Reading Level dBm	Correct Factor dB	Measure- ment dBm	Limit dBm	Margin dB	Detector	Comment
-----	-----	--------------	-------------------------	-------------------------	-------------------------	--------------	--------------	----------	---------

Test Mode: DCS1900_TX CH661_EDGE

Horizontal

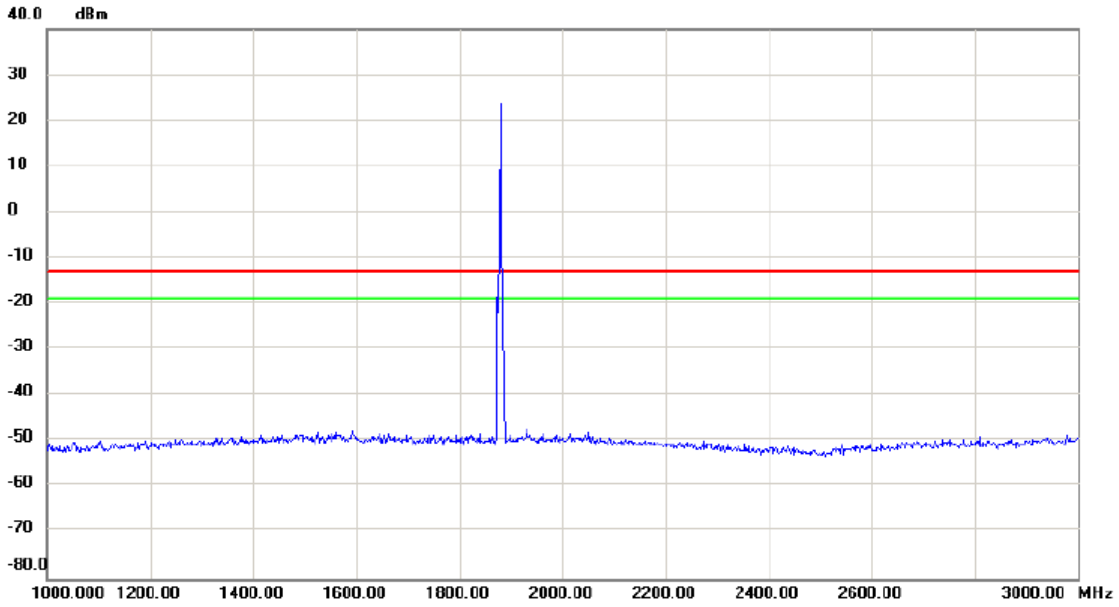

No.	Mk.	Freq.	Reading Level	Correct Factor	Measurement	Limit	Margin	Detector	Comment
		MHz	dBm	dB	dBm	dBm	dB		
		1900.000	25.0	0.0	25.0	-15.0	40.0		

Test Mode: DCS1900_TX CH661_EDGE

Vertical

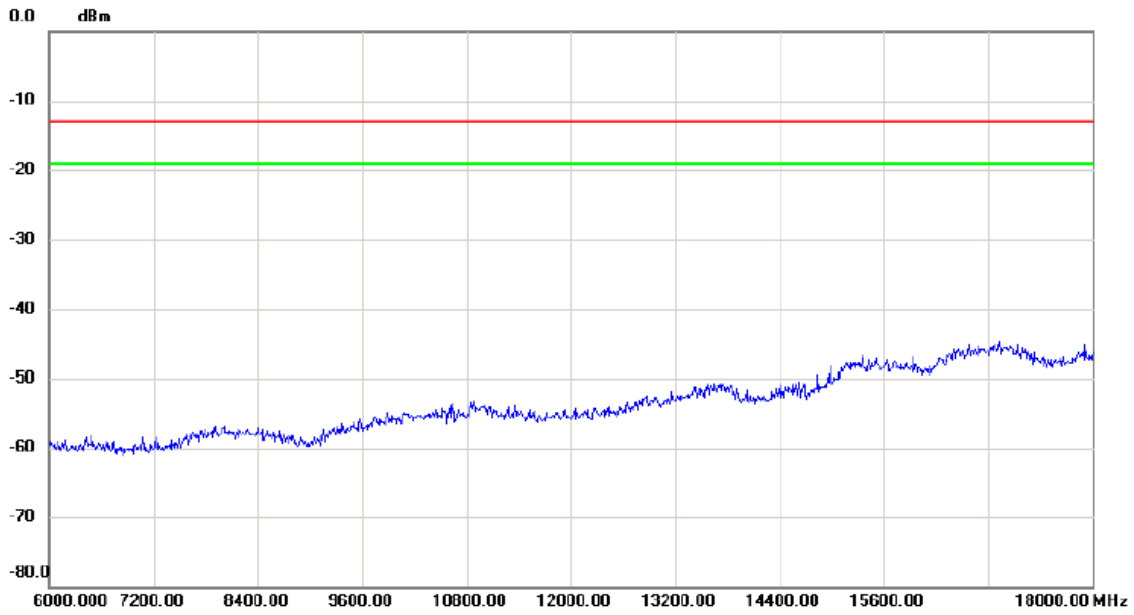

No.	Mk.	Freq.	Reading Level	Correct Factor	Measurement	Limit	Margin	Detector	Comment
		MHz	dBm	dB	dBm	dBm	dB		

Test Mode: DCS1900_TX CH661_EDGE

Horizontal

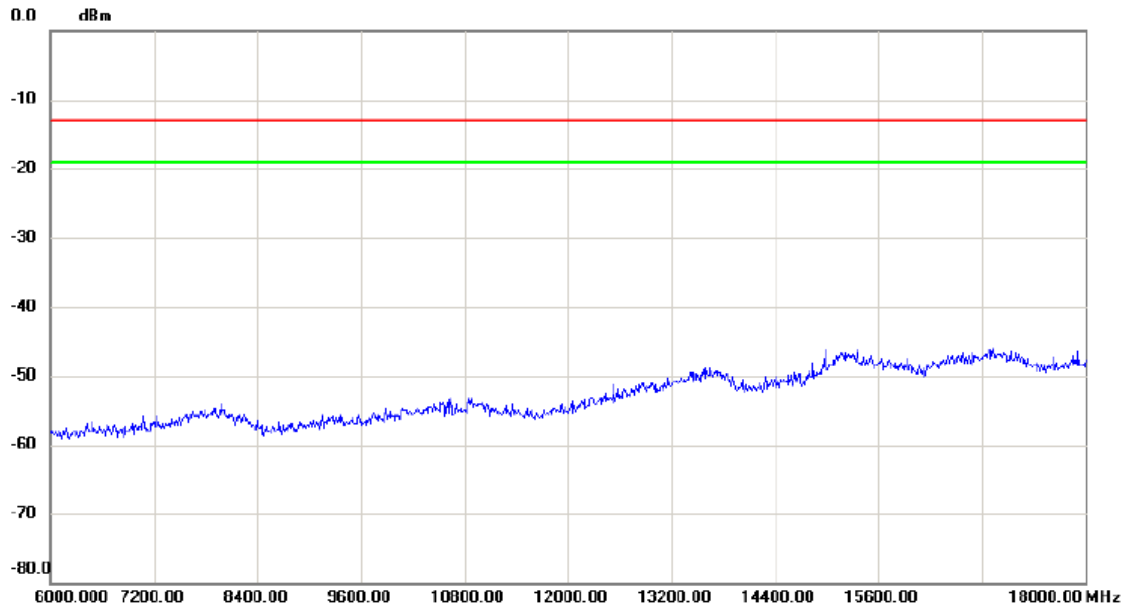

No.	Mk.	Freq. MHz	Reading Level dBm	Correct Factor dB	Measure- ment dBm	Limit dBm	Margin dB	Detector	Comment
-----	-----	--------------	-------------------------	-------------------------	-------------------------	--------------	--------------	----------	---------

Test Mode: DCS1900_TX CH661_EDGE

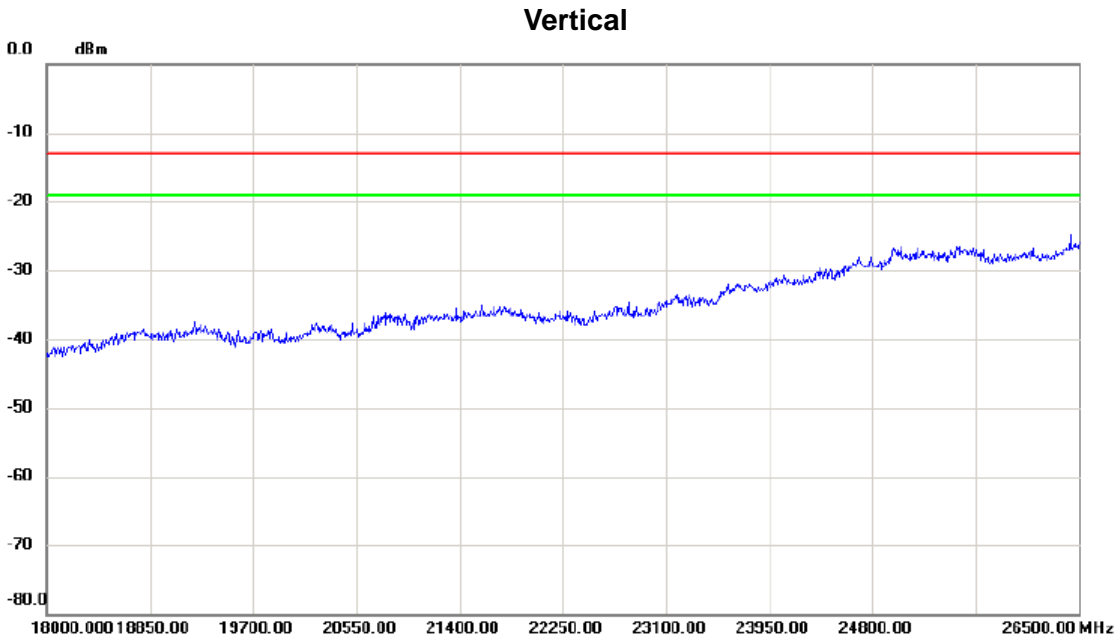

No.	Mk.	Freq.	Reading Level	Correct Factor	Measurement	Limit	Margin	Detector	Comment
		MHz	dBm	dB	dBm	dBm	dB		

Test Mode: DCS1900_TX CH661_EDGE

Horizontal

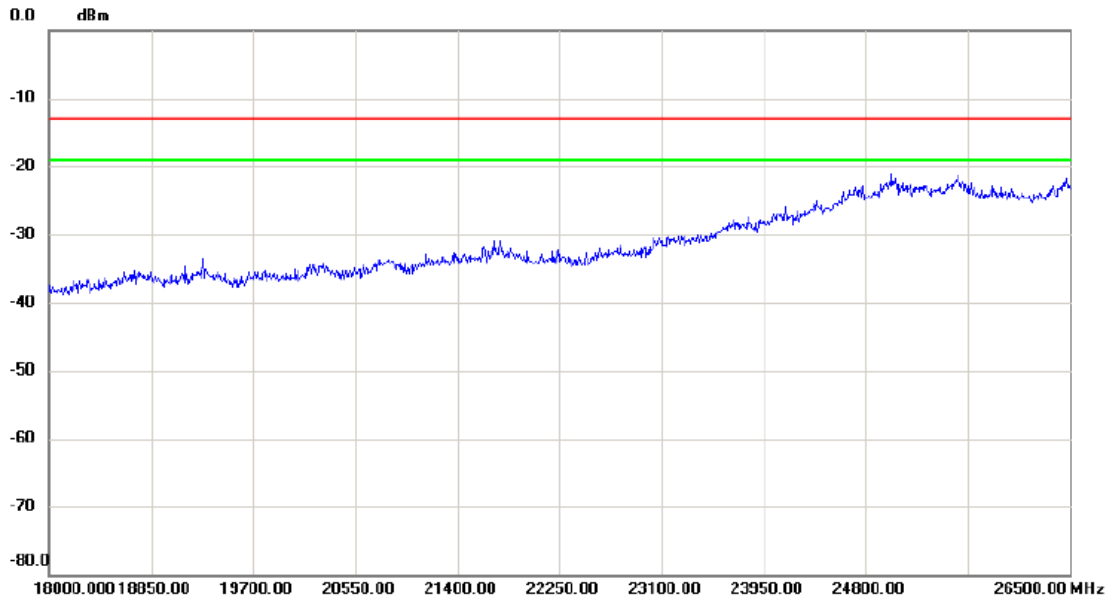

No.	Mk.	Freq.	Reading Level	Correct Factor	Measurement	Limit	Margin	Detector	Comment
		MHz	dBm	dB	dBm	dBm	dB		
		18000.000	-38		-38	-13	-25		
		18950.000	-38		-38	-13	-25		
		19700.000	-38		-38	-13	-25		
		20550.000	-38		-38	-13	-25		
		21400.000	-38		-38	-13	-25		
		22250.000	-38		-38	-13	-25		
		23100.000	-38		-38	-13	-25		
		23950.000	-38		-38	-13	-25		
		24800.000	-38		-38	-13	-25		
		26500.000	-38		-38	-13	-25		

SIM Card 2

Test Mode: DCS1900_TX CH661_GSM

Vertical

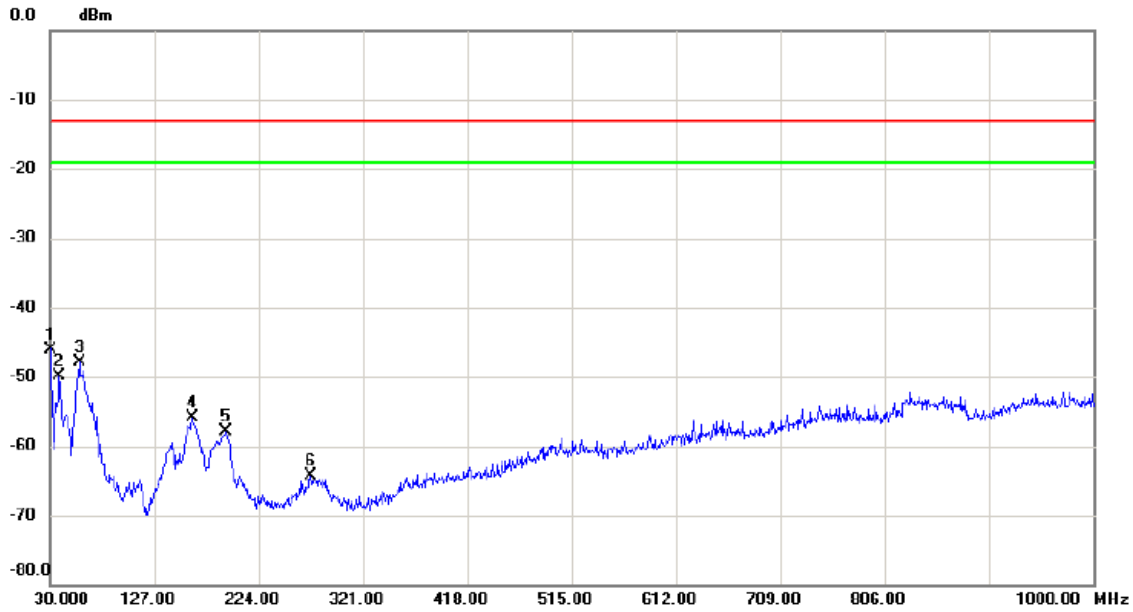

No.	Mk.	Freq. MHz	Reading Level dBm	Correct Factor dB	Measure- ment dBm	Limit dBm	Margin dB	Detector	Comment
1	*	30.000	-55.74	9.74	-46.00	-13.00	-33.00	peak	
2		38.730	-61.16	11.21	-49.95	-13.00	-36.95	peak	
3		57.160	-59.57	11.74	-47.83	-13.00	-34.83	peak	
4		161.920	-68.48	12.55	-55.93	-13.00	-42.93	peak	
5		193.930	-65.92	8.00	-57.92	-13.00	-44.92	peak	
6		272.500	-76.50	12.30	-64.20	-13.00	-51.20	peak	

Test Mode: DCS1900_TX CH661_GSM

Horizontal

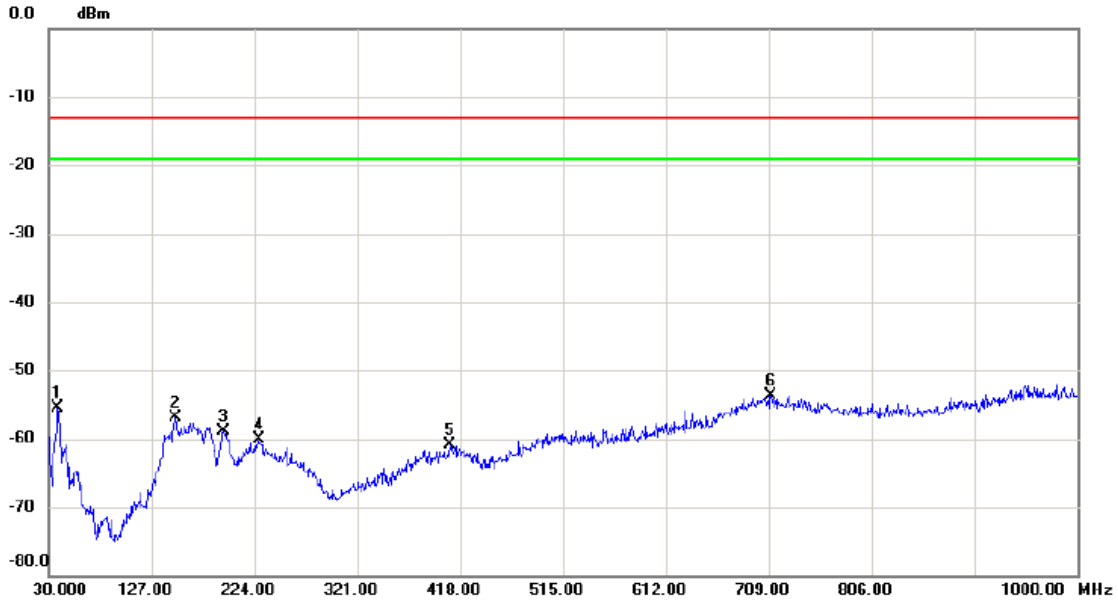

No.	Mk.	Freq. MHz	Reading Level dBm	Correct Factor dB	Measure- ment dBm	Limit dBm	Margin dB	Detector	Comment
1		38.730	-67.17	11.63	-55.54	-13.00	-42.54	peak	
2		149.310	-71.08	14.16	-56.92	-13.00	-43.92	peak	
3		194.900	-67.07	8.26	-58.81	-13.00	-45.81	peak	
4		227.880	-72.86	12.68	-60.18	-13.00	-47.18	peak	
5		408.300	-77.23	16.30	-60.93	-13.00	-47.93	peak	
6	*	710.940	-77.35	23.72	-53.63	-13.00	-40.63	peak	

Test Mode: DCS1900_TX CH661_GSM

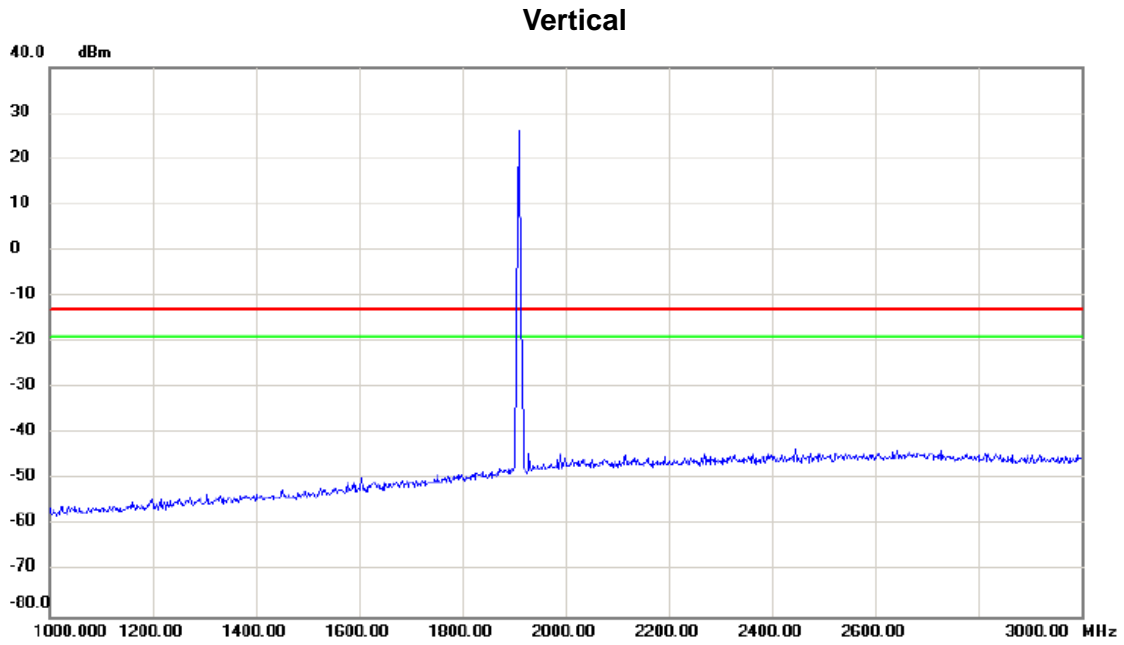

No.	Mk.	Freq. MHz	Reading Level dBm	Correct Factor dB	Measure- ment dBm	Limit dBm	Margin dB	Detector	Comment
		1900.00	25.00	0.00	25.00	-15.00	40.00		

Test Mode: DCS1900_TX CH661_GSM

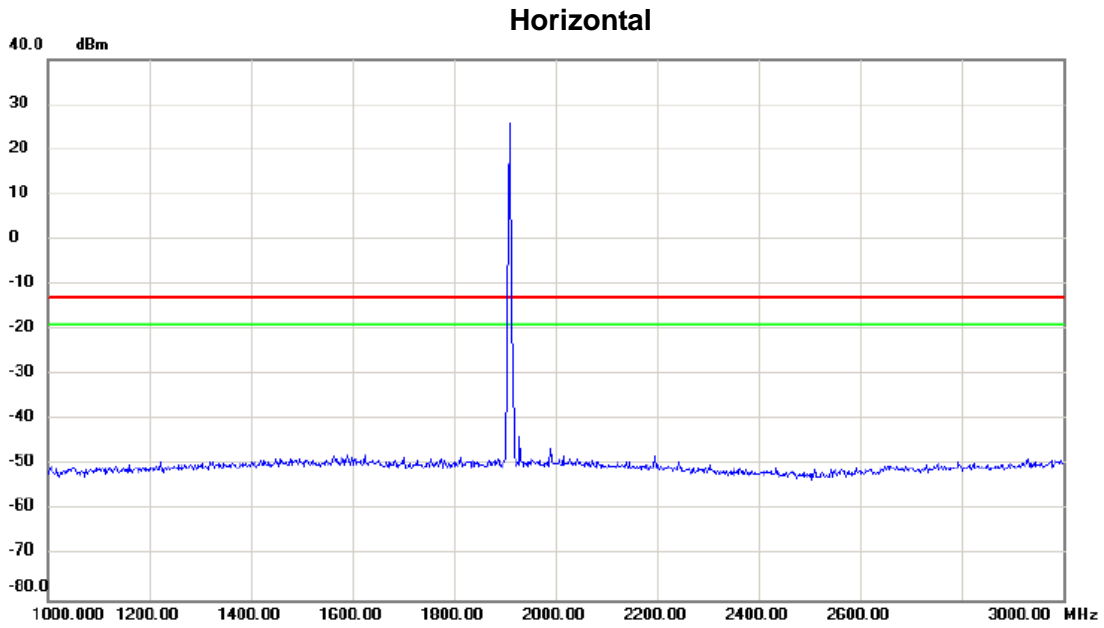

No.	Mk.	Freq.	Reading Level	Correct Factor	Measurement	Limit	Margin	Detector	Comment
		MHz	dBm	dB	dBm	dBm	dB		
		1930.00	25.00	0.00	25.00	-15.00	40.00		

Test Mode: DCS1900_TX CH661_GSM

Vertical

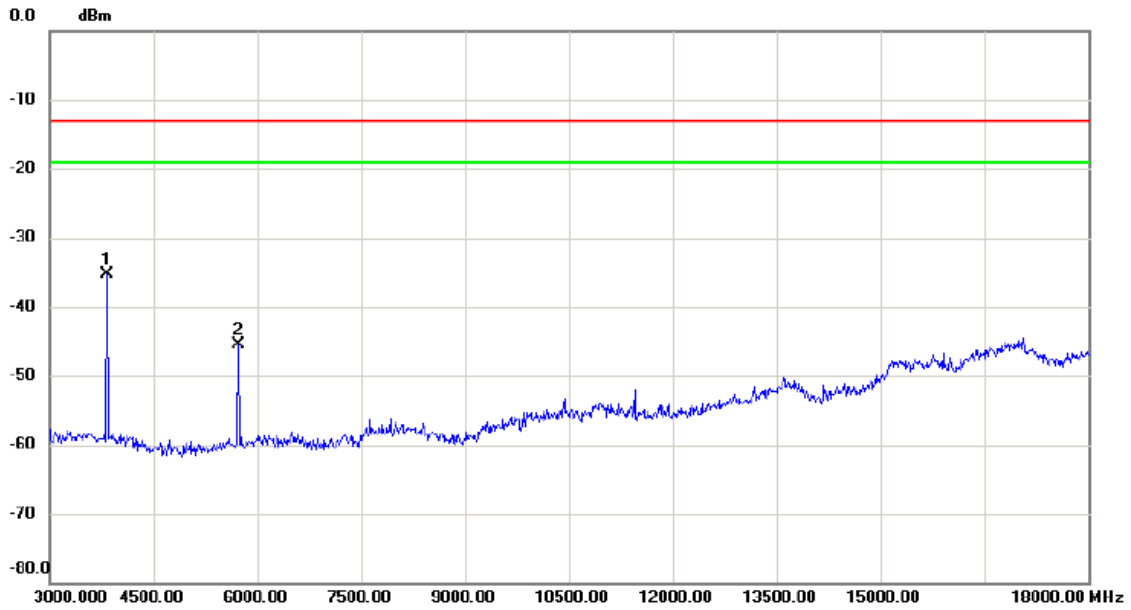

No.	Mk.	Freq. MHz	Reading Level dBm	Correct Factor dB	Measure- ment dBm	Limit dBm	Margin dB	Detector	Comment
1	*	3825.000	-49.83	14.57	-35.26	-13.00	-22.26	peak	
2		5730.000	-61.90	16.46	-45.44	-13.00	-32.44	peak	

Test Mode: DCS1900_TX CH661_GSM

Horizontal

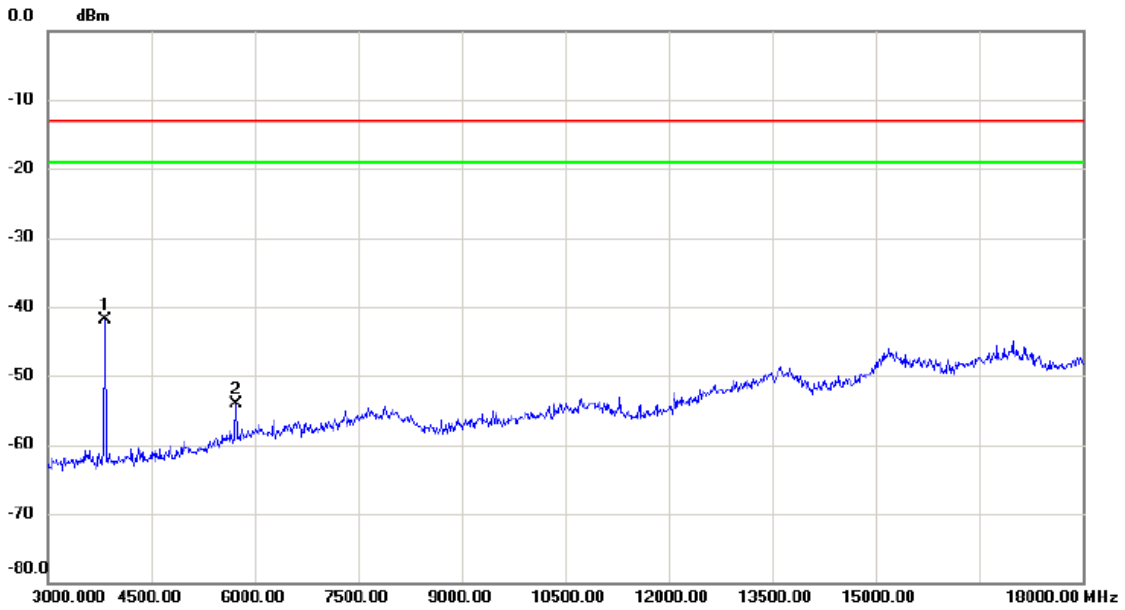

No.	Mk.	Freq. MHz	Reading Level dBm	Correct Factor dB	Measure- ment dBm	Limit dBm	Margin dB	Detector	Comment
1	*	3825.000	-53.42	11.52	-41.90	-13.00	-28.90	peak	
2		5730.000	-71.51	17.33	-54.18	-13.00	-41.18	peak	

Test Mode: DCS1900_TX CH661_GSM

Vertical

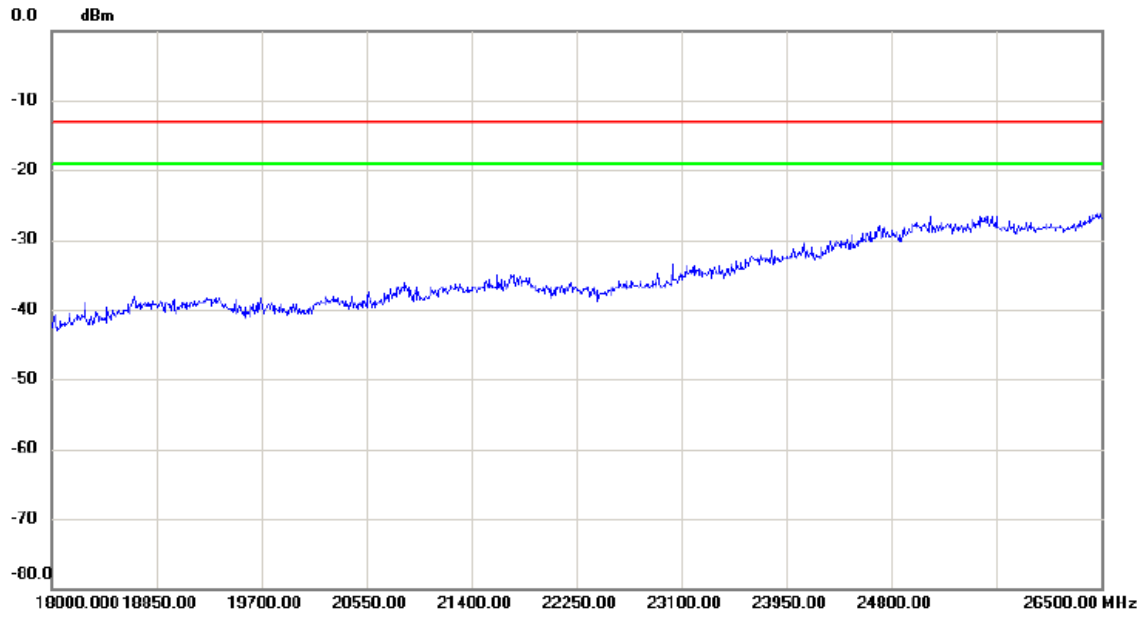

No.	Mk.	Freq.	Reading Level	Correct Factor	Measurement	Limit	Margin	Detector	Comment
		MHz	dBm	dB	dBm	dBm	dB		

Test Mode: DCS1900_TX CH661_GSM

Horizontal

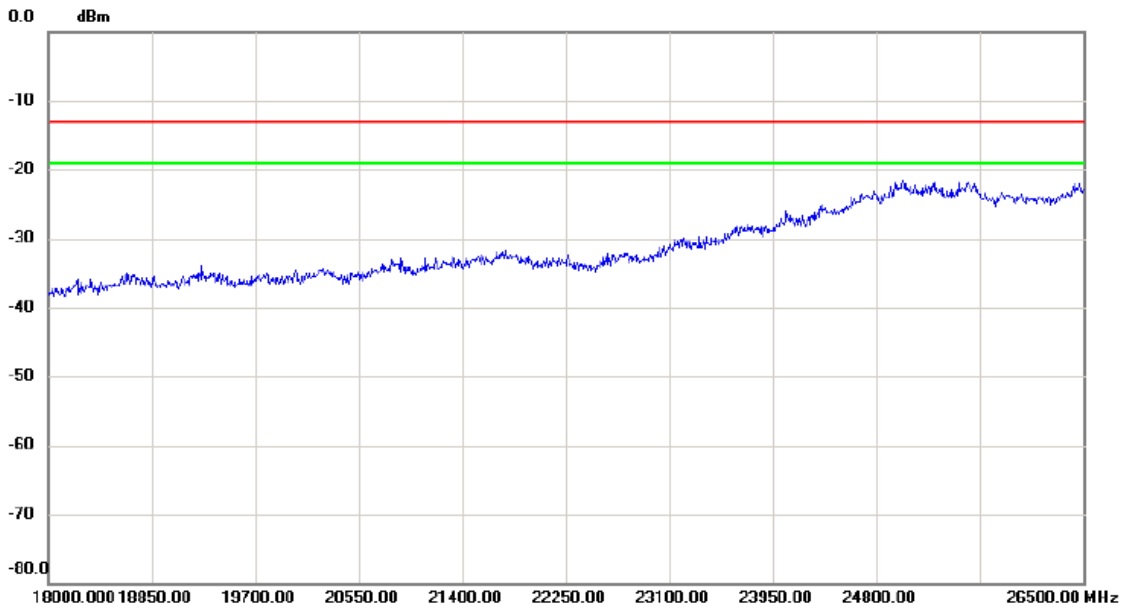

No.	Mk.	Freq.	Reading Level	Correct Factor	Measurement	Limit	Margin	Detector	Comment
		MHz	dBm	dB	dBm	dBm	dB		

Test Mode: DCS1900_TX CH661_EDGE

Vertical



No.	Mk.	Freq. MHz	Reading Level dBm	Correct Factor dB	Measure- ment dBm	Limit dBm	Margin dB	Detector	Comment
1		30.000	-57.64	9.74	-47.90	-13.00	-34.90	peak	
2		38.730	-61.20	11.21	-49.99	-13.00	-36.99	peak	
3	*	61.040	-58.35	10.60	-47.75	-13.00	-34.75	peak	
4		143.490	-71.74	12.50	-59.24	-13.00	-46.24	peak	
5		160.950	-69.01	12.87	-56.14	-13.00	-43.14	peak	
6		192.960	-65.51	8.05	-57.46	-13.00	-44.46	peak	

Test Mode: DCS1900_TX CH661_EDGE

Horizontal



No.	Mk.	Freq. MHz	Reading Level dBm	Correct Factor dB	Measure- ment dBm	Limit dBm	Margin dB	Detector	Comment
1	*	39.700	-68.10	11.97	-56.13	-13.00	-43.13	peak	
2		158.040	-70.32	13.04	-57.28	-13.00	-44.28	peak	
3		195.870	-67.68	8.23	-59.45	-13.00	-46.45	peak	
4		233.700	-73.18	12.94	-60.24	-13.00	-47.24	peak	
5		429.640	-76.95	15.79	-61.16	-13.00	-48.16	peak	
6		512.090	-76.52	18.07	-58.45	-13.00	-45.45	peak	

Test Mode: DCS1900_TX CH661_EDGE

Vertical

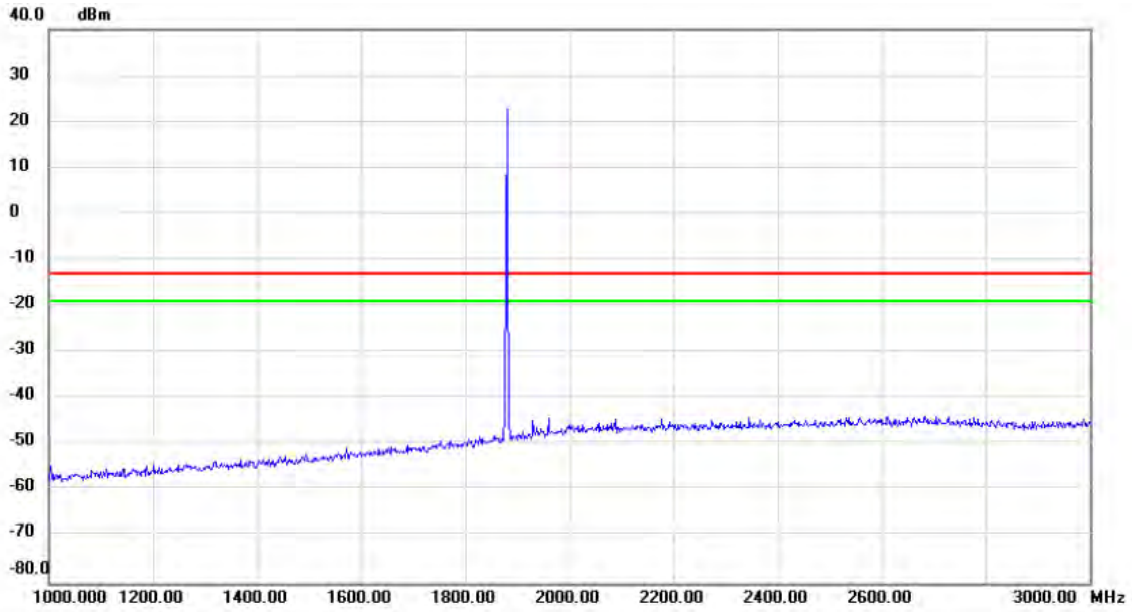

No.	Mk.	Freq. MHz	Reading Level dBm	Correct Factor dB	Measure- ment dBm	Limit dBm	Margin dB	Detector	Comment
		1900.000	25.0	0.0	25.0	-15.0	40.0		

Test Mode: DCS1900_TX CH661_EDGE

Horizontal

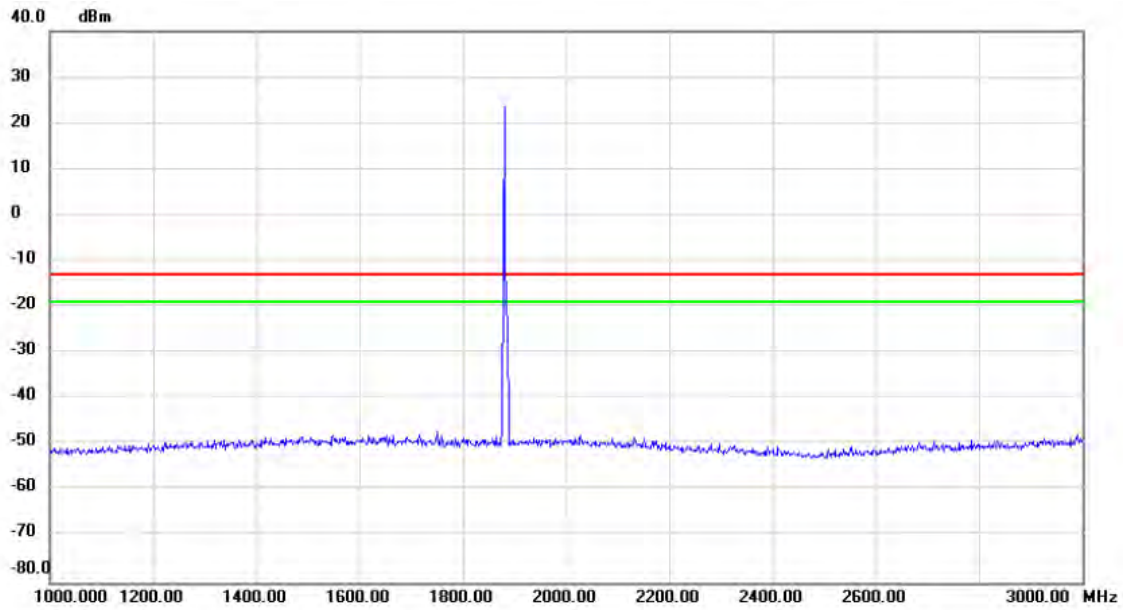

No.	Mk.	Freq. MHz	Reading Level dBm	Correct Factor dB	Measure- ment dBm	Limit dBm	Margin dB	Detector	Comment
		1900.00	25.00	0.00	25.00	-15.00	40.00		

Test Mode: DCS1900_TX CH661_EDGE

Vertical



No.	Mk.	Freq. MHz	Reading Level dBm	Correct Factor dB	Measure- ment dBm	Limit dBm	Margin dB	Detector	Comment
1	*	3765.000	-56.99	14.51	-42.48	-13.00	-29.48	peak	
2		5640.000	-66.55	16.31	-50.24	-13.00	-37.24	peak	

Test Mode: DCS1900_TX CH661_EDGE

Horizontal

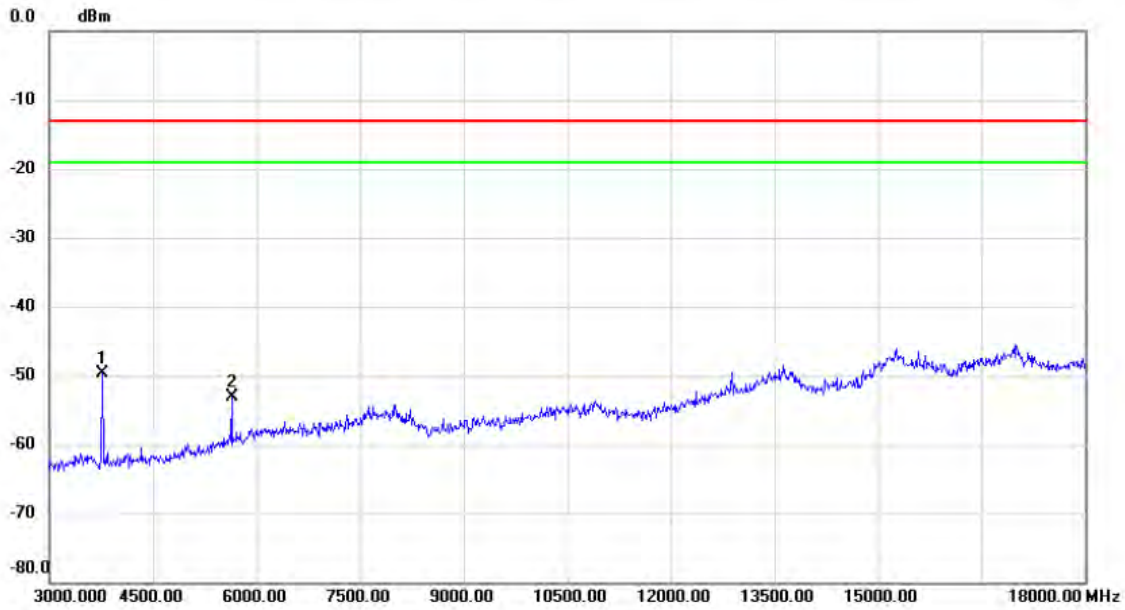

No.	Mk.	Freq. MHz	Reading Level dBm	Correct Factor dB	Measure- ment dBm	Limit dBm	Margin dB	Detector	Comment
1	*	3765.000	-61.04	11.36	-49.68	-13.00	-36.68	peak	
2		5640.000	-70.12	17.04	-53.08	-13.00	-40.08	peak	

Test Mode: DCS1900_TX CH661_EDGE

Vertical

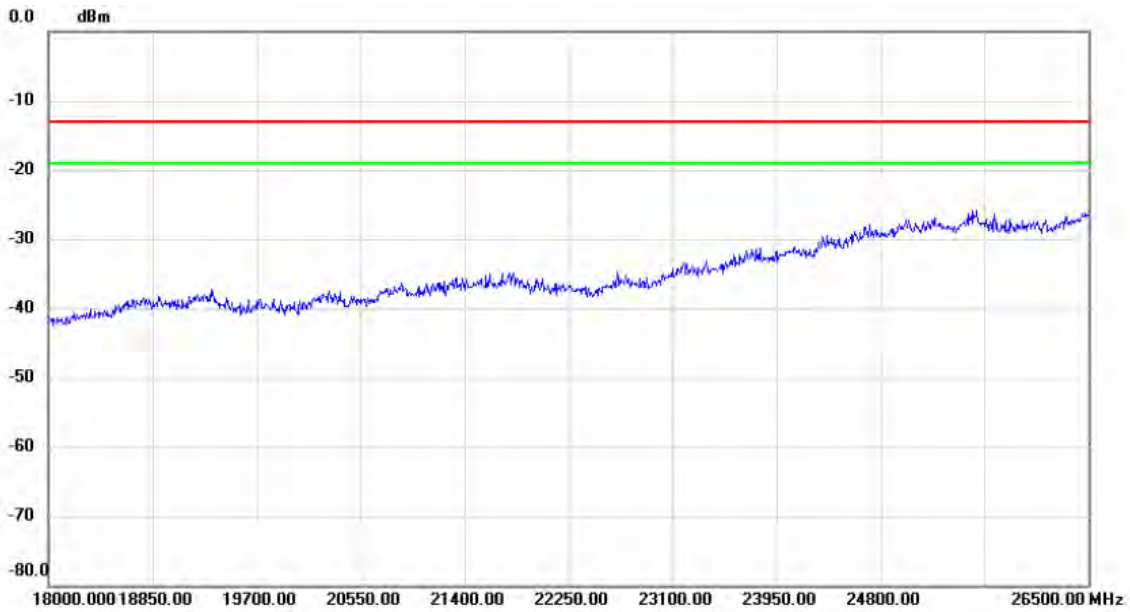

No.	Mk.	Freq.	Reading Level	Correct Factor	Measurement	Limit	Margin	Detector	Comment
		MHz	dBm	dB	dBm	dBm	dB		

Test Mode: DCS1900_TX CH661_EDGE

Horizontal

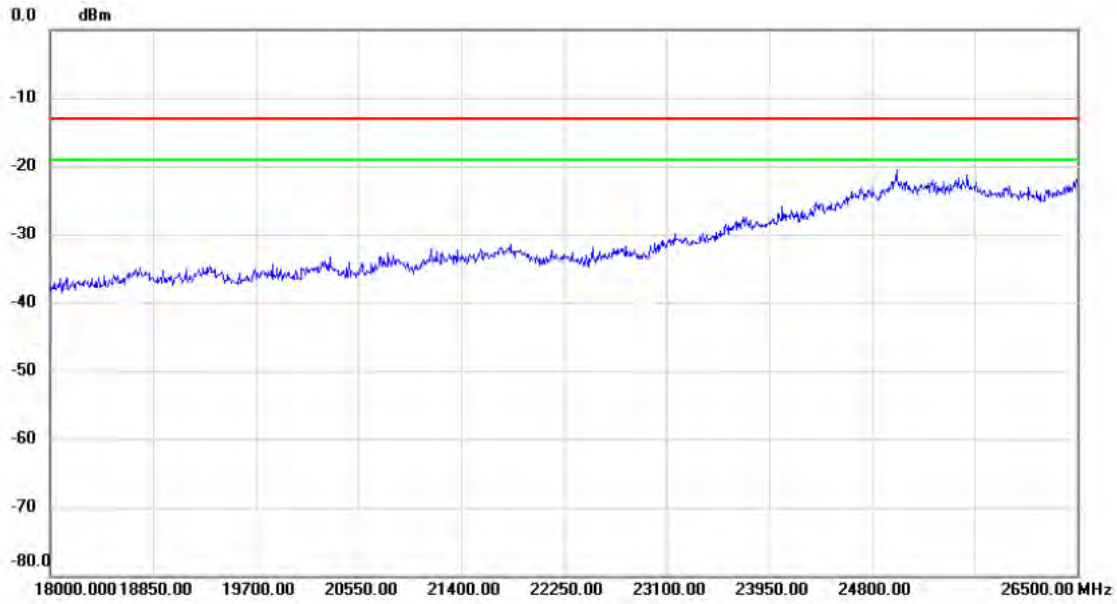

No.	Mk.	Freq.	Reading Level	Correct Factor	Measurement	Limit	Margin	Detector	Comment
		MHz	dBm	dB	dBm	dBm	dB		
		18000.000	-38		-38	-15	-23		
		18850.00	-37		-37	-15	-22		
		19700.00	-36		-36	-15	-21		
		20550.00	-35		-35	-15	-20		
		21400.00	-34		-34	-15	-19		
		22250.00	-33		-33	-15	-18		
		23100.00	-32		-32	-15	-17		
		23950.00	-31		-31	-15	-16		
		24800.00	-30		-30	-15	-15		
		26500.00	-25		-25	-15	-10		

Test Mode: WCDMA Band 2_TX CH9400

Vertical

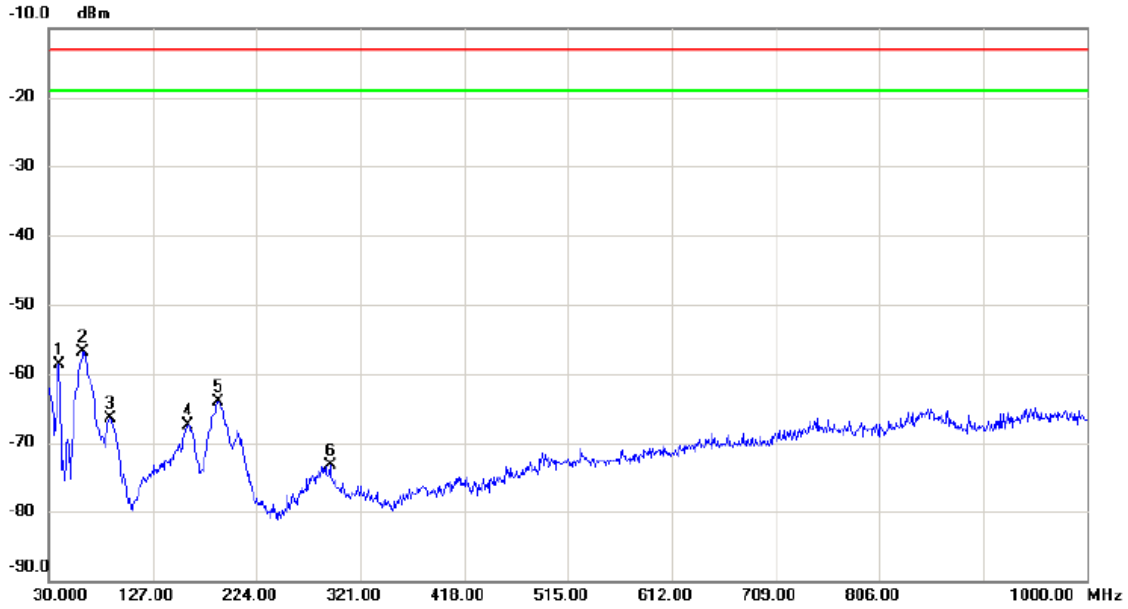

No.	Mk.	Freq. MHz	Reading Level dBm	Correct Factor dB	Measure- ment dBm	Limit dBm	Margin dB	Detector	Comment
1		39.700	-60.69	1.90	-58.79	-13.00	-45.79	peak	
2	*	62.010	-57.61	0.73	-56.88	-13.00	-43.88	peak	
3		87.230	-60.99	-5.46	-66.45	-13.00	-53.45	peak	
4		159.980	-70.58	3.18	-67.40	-13.00	-54.40	peak	
5		188.110	-62.74	-1.31	-64.05	-13.00	-51.05	peak	
6		292.870	-75.19	1.86	-73.33	-13.00	-60.33	peak	

Test Mode: WCDMA Band 2_TX CH9400

Horizontal

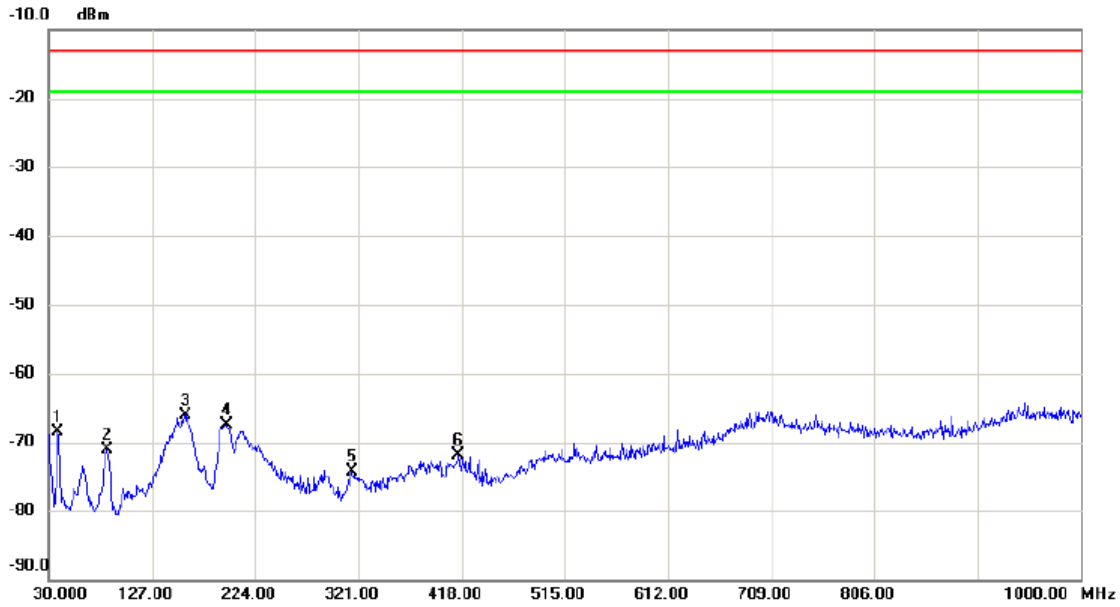

No.	Mk.	Freq. MHz	Reading Level dBm	Correct Factor dB	Measure- ment dBm	Limit dBm	Margin dB	Detector	Comment
1		38.730	-70.08	1.63	-68.45	-13.00	-55.45	peak	
2		85.290	-63.17	-7.88	-71.05	-13.00	-58.05	peak	
3	*	159.010	-68.90	2.90	-66.00	-13.00	-53.00	peak	
4		196.840	-65.74	-1.81	-67.55	-13.00	-54.55	peak	
5		315.180	-76.20	1.86	-74.34	-13.00	-61.34	peak	
6		415.090	-78.62	6.63	-71.99	-13.00	-58.99	peak	

Test Mode: WCDMA Band 2_TX CH9400

Vertical

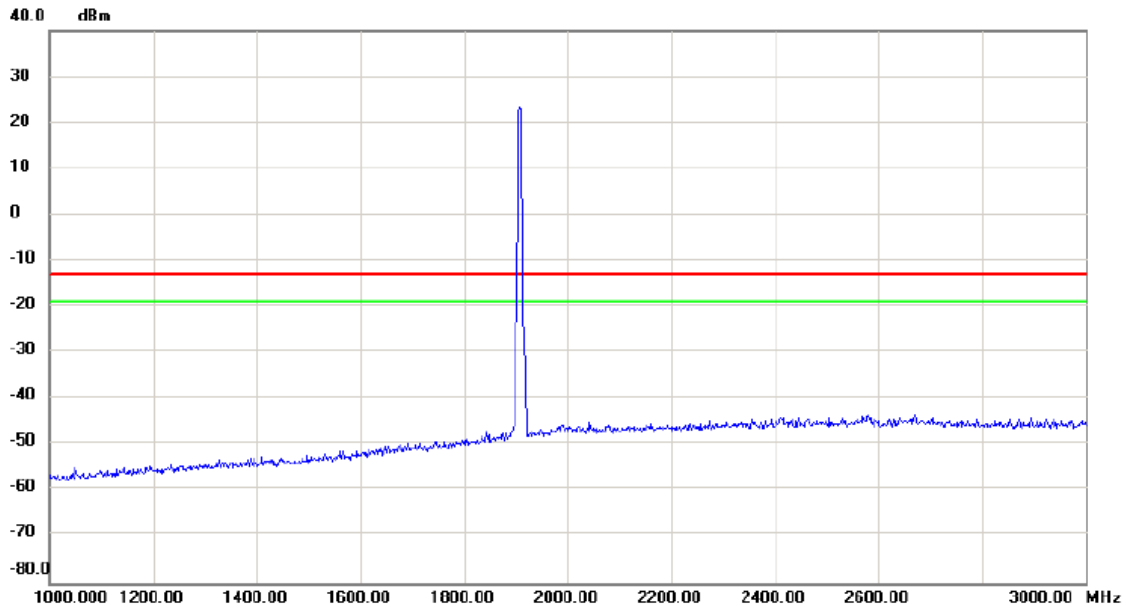

No.	Mk.	Freq. MHz	Reading Level dBm	Correct Factor dB	Measure- ment dBm	Limit dBm	Margin dB	Detector	Comment
-----	-----	--------------	-------------------------	-------------------------	-------------------------	--------------	--------------	----------	---------

Test Mode: WCDMA Band 2_TX CH9400

Horizontal

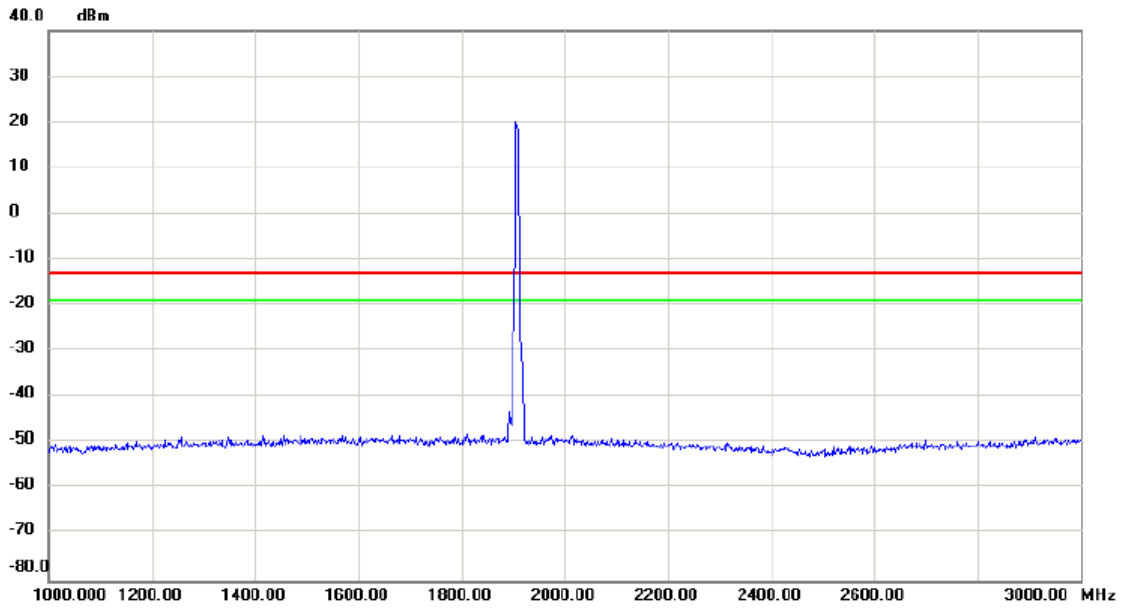

No.	Mk.	Freq. MHz	Reading Level dBm	Correct Factor dB	Measure- ment dBm	Limit dBm	Margin dB	Detector	Comment
		1920.00	20.00	0.00	20.00	-15.00	5.00		

Test Mode: WCDMA Band 2_TX CH9400

Vertical

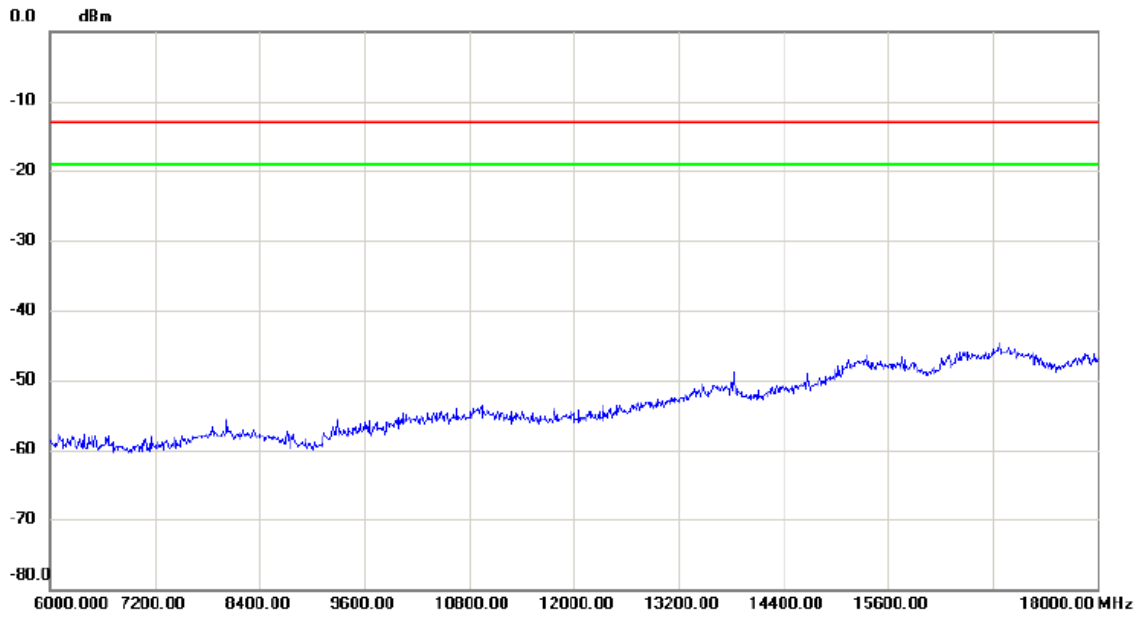

No.	Mk.	Freq.	Reading Level	Correct Factor	Measurement	Limit	Margin	Detector	Comment
		MHz	dBm	dB	dBm	dBm	dB		

Test Mode: WCDMA Band 2_TX CH9400

Horizontal

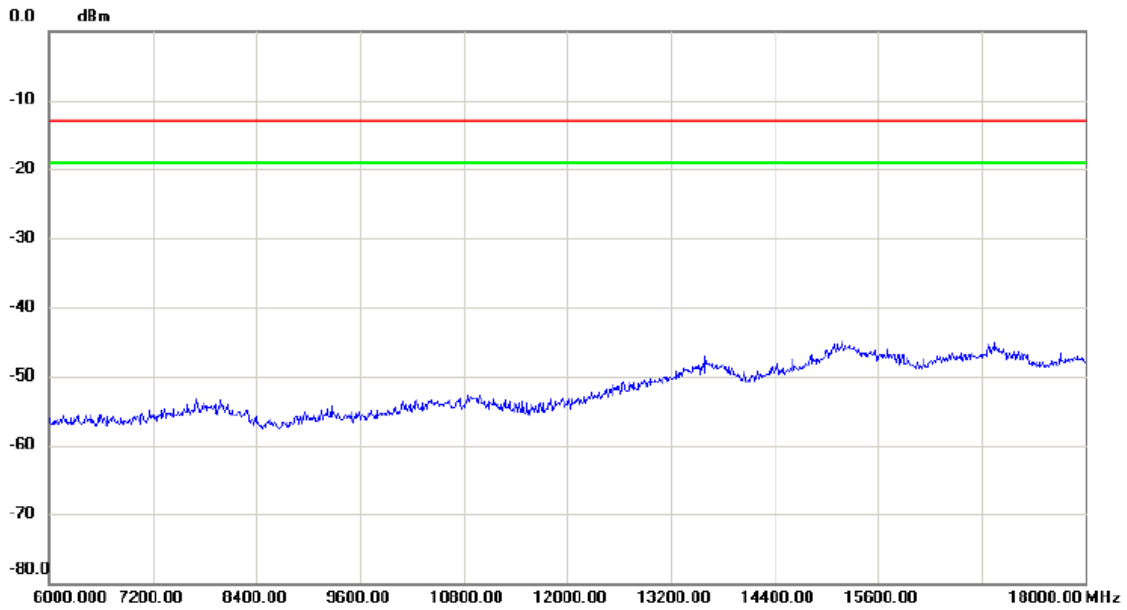

No.	Mk.	Freq. MHz	Reading Level dBm	Correct Factor dB	Measure- ment dBm	Limit dBm	Margin dB	Detector	Comment
-----	-----	--------------	-------------------------	-------------------------	-------------------------	--------------	--------------	----------	---------

Test Mode: WCDMA Band 2_TX CH9400

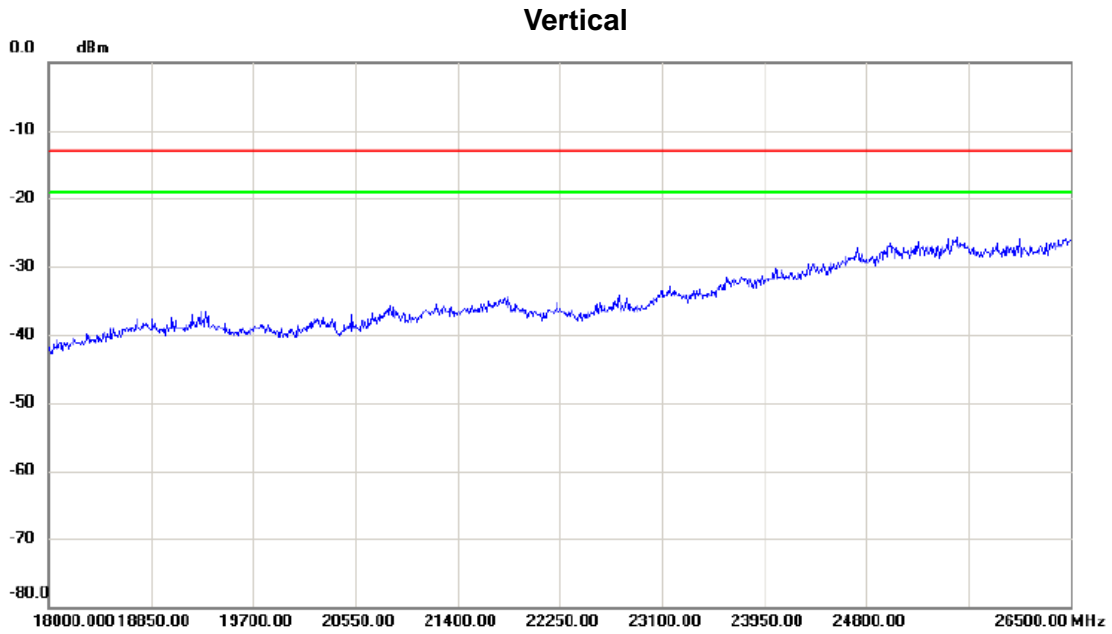

No.	Mk.	Freq.	Reading Level	Correct Factor	Measurement	Limit	Margin	Detector	Comment
		MHz	dBm	dB	dBm	dBm	dB		

Test Mode: WCDMA Band 2_TX CH9400

Horizontal

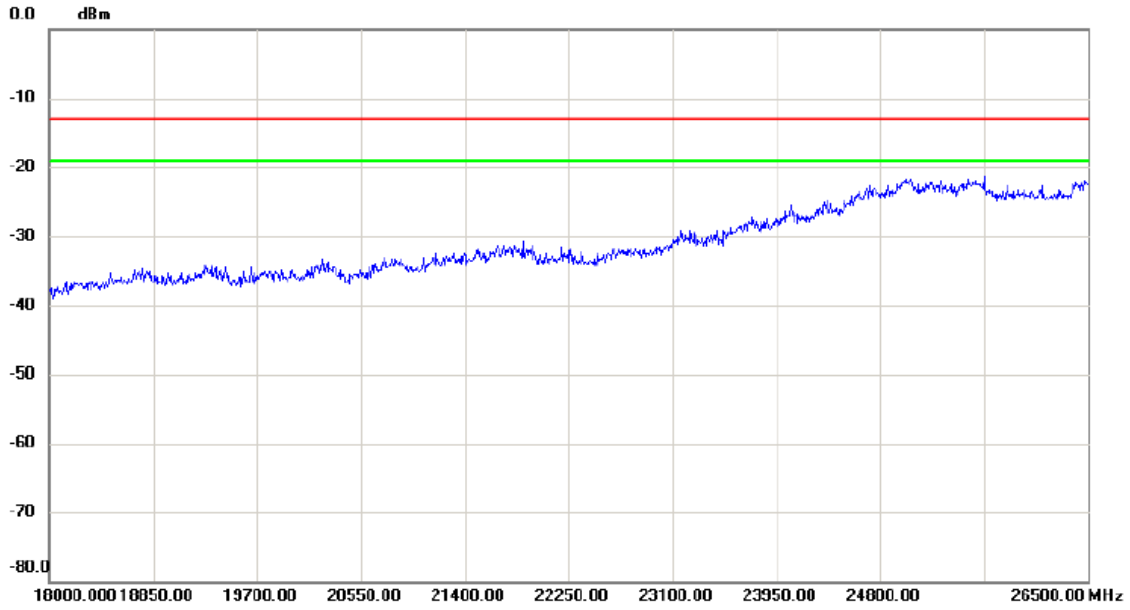

No.	Mk.	Freq. MHz	Reading Level dBm	Correct Factor dB	Measure- ment dBm	Limit dBm	Margin dB	Detector	Comment
-----	-----	--------------	-------------------------	-------------------------	-------------------------	--------------	--------------	----------	---------

Test Mode: WCDMA Band 2_HSDPA_TX CH9400

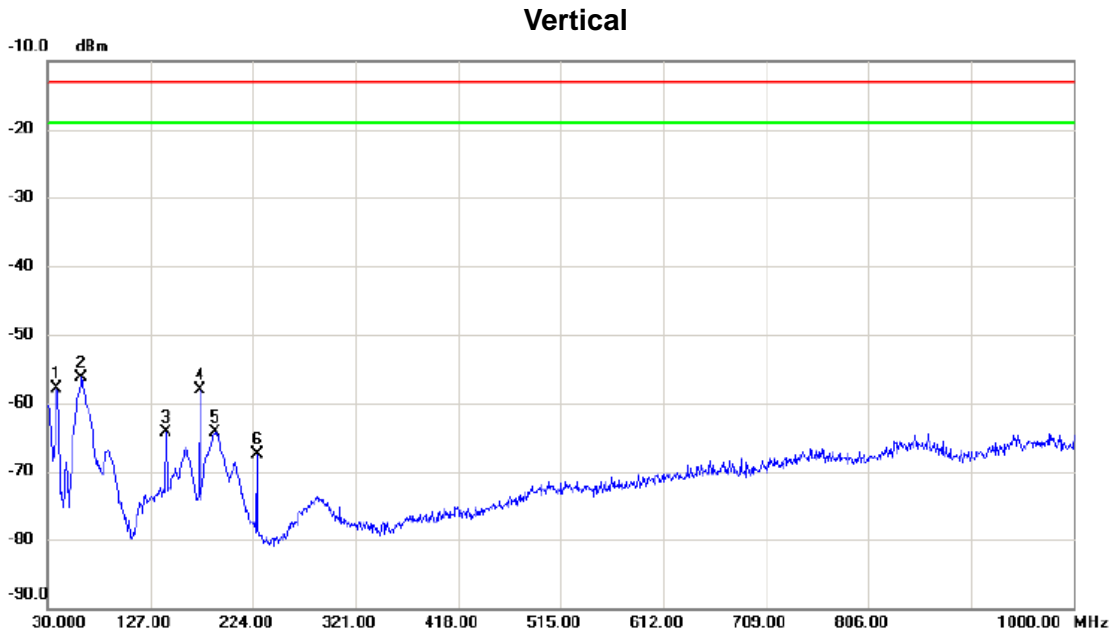

No.	Mk.	Freq. MHz	Reading Level dBm	Correct Factor dB	Measure- ment dBm	Limit dBm	Margin dB	Detector	Comment
1		38.730	-59.16	1.21	-57.95	-13.00	-44.95	peak	
2	*	62.010	-57.10	0.73	-56.37	-13.00	-43.37	peak	
3		141.550	-66.67	2.31	-64.36	-13.00	-51.36	peak	
4		173.560	-58.23	0.20	-58.03	-13.00	-45.03	peak	
5		188.110	-62.90	-1.31	-64.21	-13.00	-51.21	peak	
6		227.880	-67.58	0.08	-67.50	-13.00	-54.50	peak	

Test Mode: WCDMA Band 2_HSDPA_TX CH9400

Horizontal

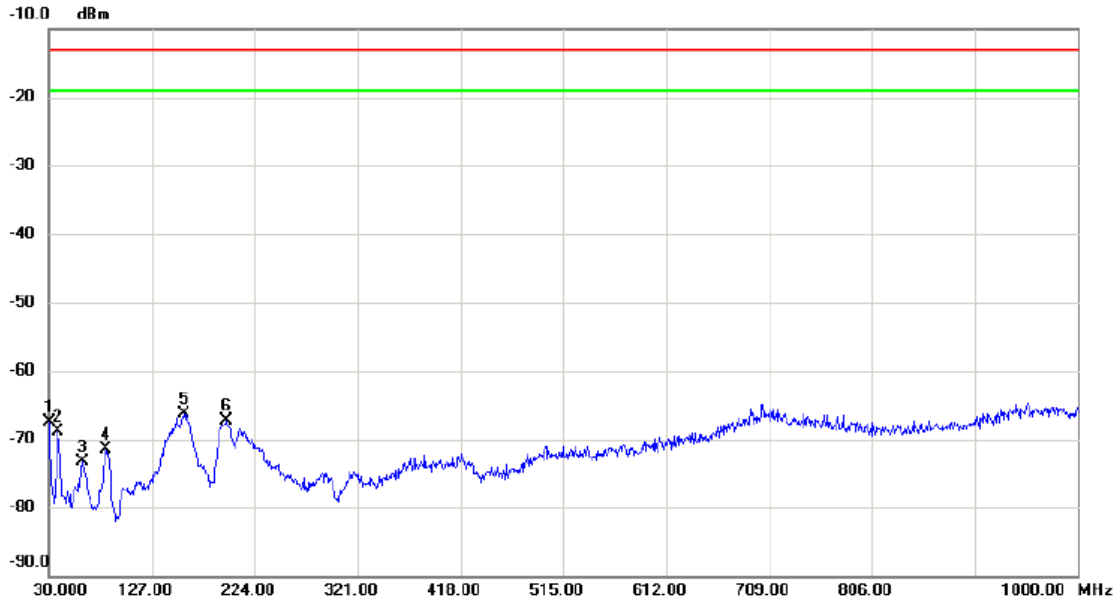

No. Mk.	Freq. MHz	Reading Level dBm	Correct Factor dB	Measurement dBm	Limit dBm	Margin dB	Detector	Comment
1	30.000	-69.30	1.88	-67.42	-13.00	-54.42	peak	
2	38.730	-70.56	1.63	-68.93	-13.00	-55.93	peak	
3	62.010	-72.28	-0.97	-73.25	-13.00	-60.25	peak	
4	83.350	-63.64	-7.76	-71.40	-13.00	-58.40	peak	
5 *	157.070	-69.54	3.19	-66.35	-13.00	-53.35	peak	
6	197.810	-65.38	-1.84	-67.22	-13.00	-54.22	peak	

Test Mode: WCDMA Band 2_HSDPA_TX CH9400

Vertical

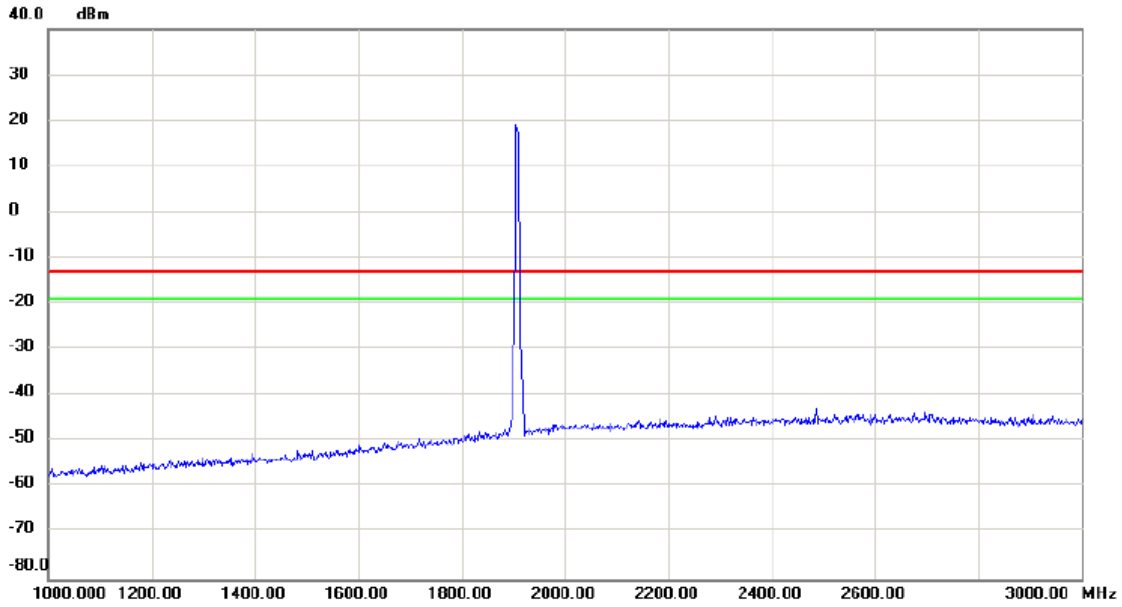

No.	Mk.	Freq. MHz	Reading Level dBm	Correct Factor dB	Measure- ment dBm	Limit dBm	Margin dB	Detector	Comment
		1920.00	18.0	0.0	18.0	-15.0	3.0		

Test Mode: WCDMA Band 2_HSDPA_TX CH9400

Horizontal

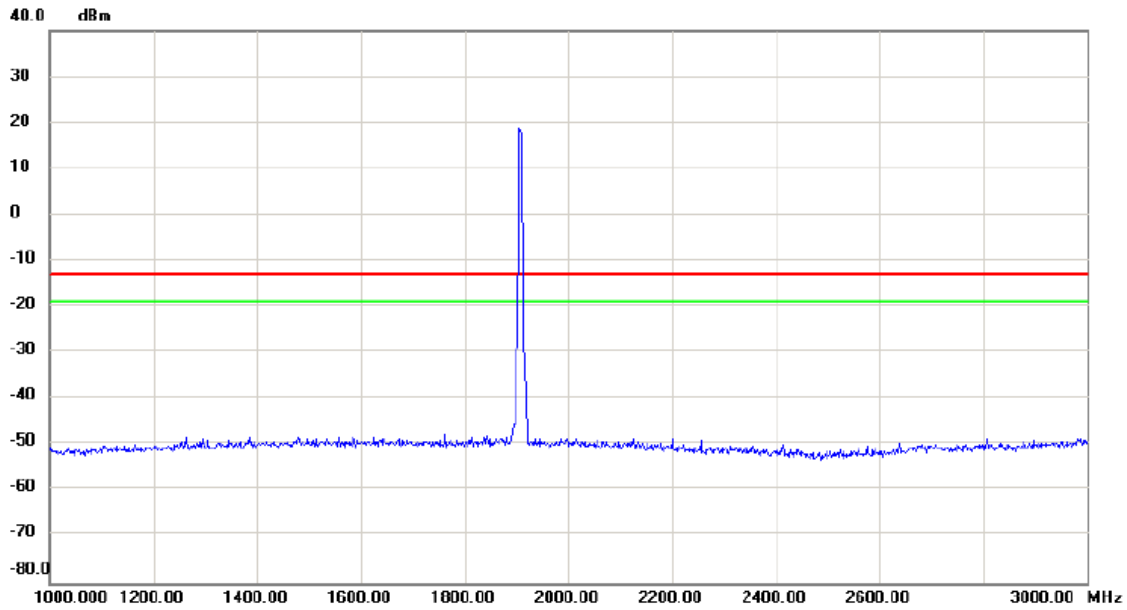

No.	Mk.	Freq. MHz	Reading Level dBm	Correct Factor dB	Measure- ment dBm	Limit dBm	Margin dB	Detector	Comment
		1920.00	18.00	0.00	18.00	-10.00	28.00		

Test Mode: WCDMA Band 2_HSDPA_TX CH9400

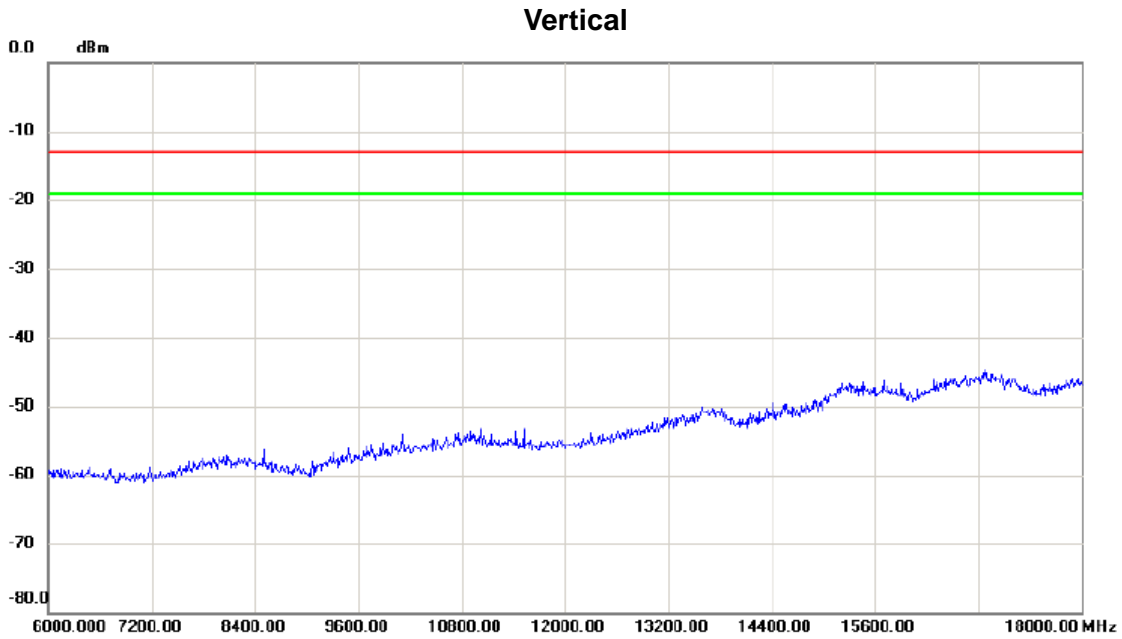

No.	Mk.	Freq.	Reading Level	Correct Factor	Measurement	Limit	Margin	Detector	Comment
		MHz	dBm	dB	dBm	dBm	dB		

Test Mode: WCDMA Band 2_HSDPA_TX CH9400

Horizontal

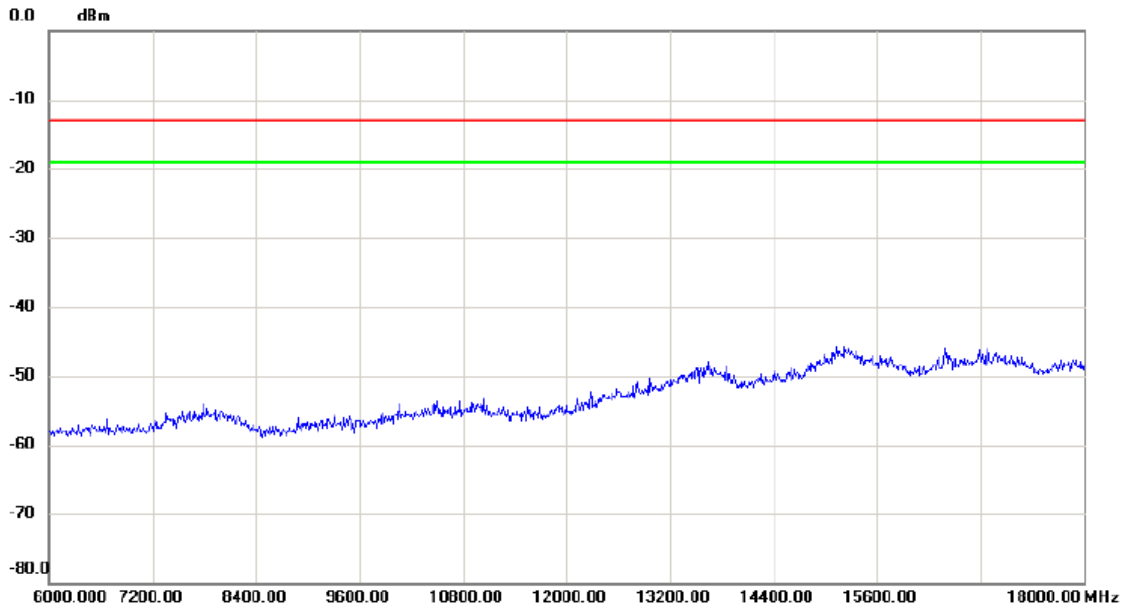

No.	Mk.	Freq.	Reading Level	Correct Factor	Measurement	Limit	Margin	Detector	Comment
		MHz	dBm	dB	dBm	dBm	dB		

Test Mode: WCDMA Band 2_HSDPA_TX CH9400

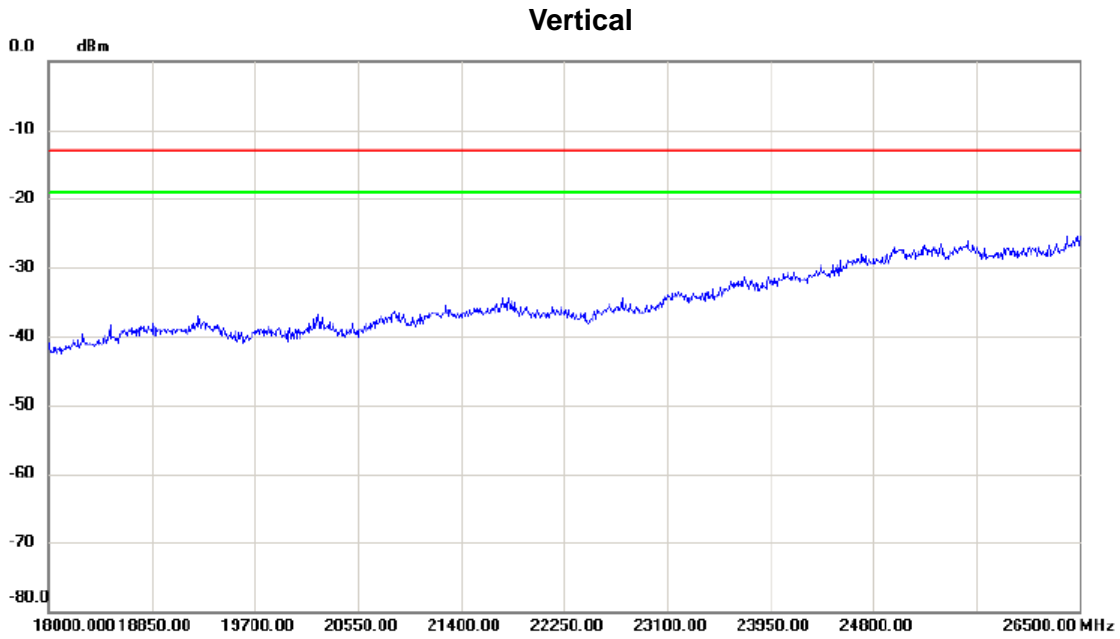

No.	Mk.	Freq.	Reading Level	Correct Factor	Measurement	Limit	Margin	Detector	Comment
		MHz	dBm	dB	dBm	dBm	dB		

Test Mode: WCDMA Band 2_HSDPA_TX CH9400

Horizontal

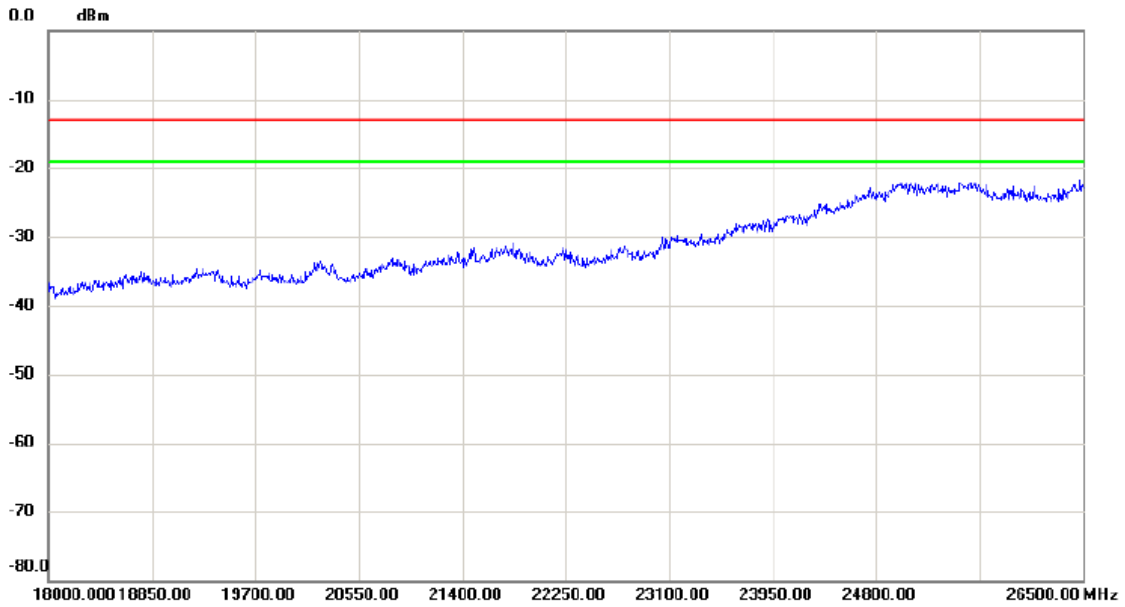

No.	Mk.	Freq.	Reading Level	Correct Factor	Measurement	Limit	Margin	Detector	Comment
		MHz	dBm	dB	dBm	dBm	dB		

Test Mode: WCDMA Band 2_HSUPA_TX CH9400

Vertical

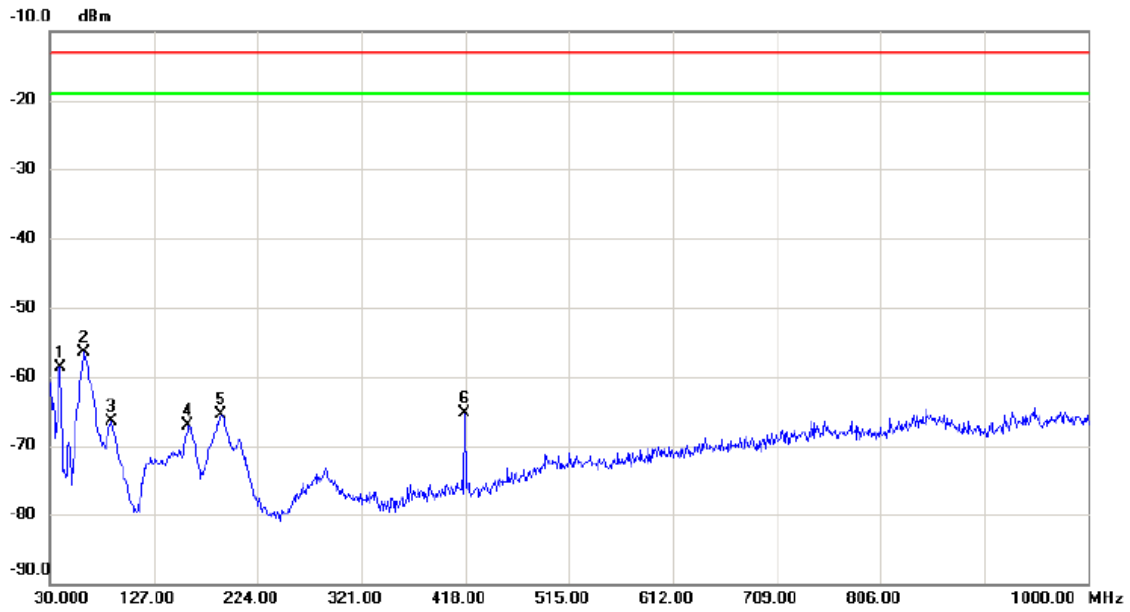

No.	Mk.	Freq. MHz	Reading Level dBm	Correct Factor dB	Measure- ment dBm	Limit dBm	Margin dB	Detector	Comment
1		39.700	-60.61	1.90	-58.71	-13.00	-45.71	peak	
2	*	61.040	-57.04	0.60	-56.44	-13.00	-43.44	peak	
3		87.230	-61.13	-5.46	-66.59	-13.00	-53.59	peak	
4		159.010	-70.19	3.18	-67.01	-13.00	-54.01	peak	
5		189.080	-63.96	-1.56	-65.52	-13.00	-52.52	peak	
6		417.030	-69.77	4.57	-65.20	-13.00	-52.20	peak	

Test Mode: WCDMA Band 2_HSUPA_TX CH9400

Horizontal

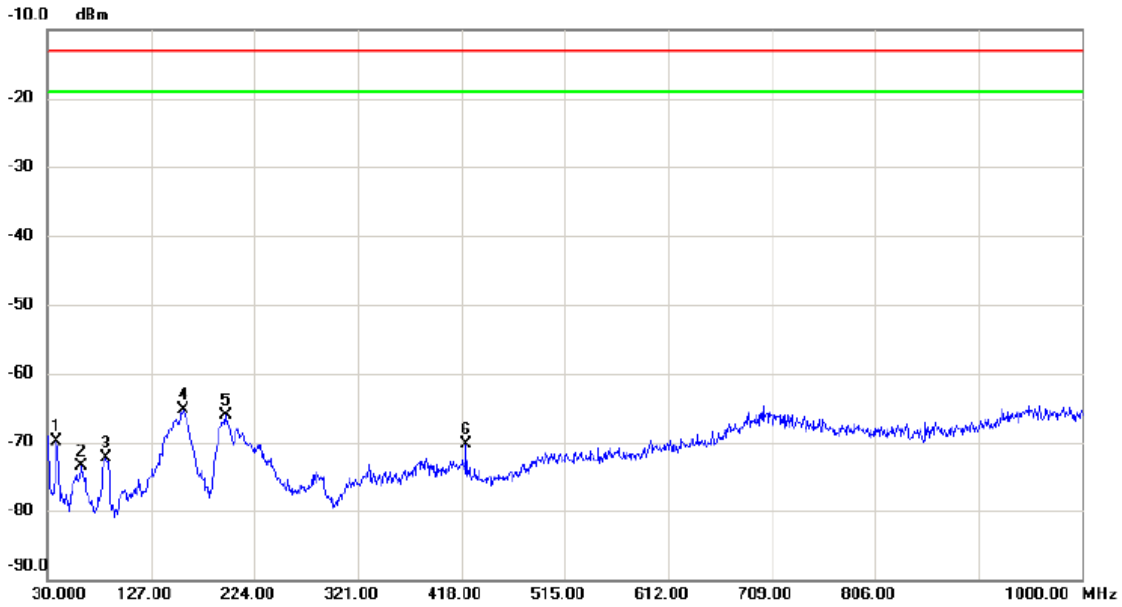

No.	Mk.	Freq. MHz	Reading Level dBm	Correct Factor dB	Measure- ment dBm	Limit dBm	Margin dB	Detector	Comment
1		38.730	-71.57	1.63	-69.94	-13.00	-56.94	peak	
2		62.010	-72.56	-0.97	-73.53	-13.00	-60.53	peak	
3		84.320	-64.33	-7.87	-72.20	-13.00	-59.20	peak	
4	*	157.070	-68.52	3.19	-65.33	-13.00	-52.33	peak	
5		196.840	-64.23	-1.81	-66.04	-13.00	-53.04	peak	
6		422.850	-76.84	6.56	-70.28	-13.00	-57.28	peak	

Test Mode: WCDMA Band 2_HSUPA_TX CH9400

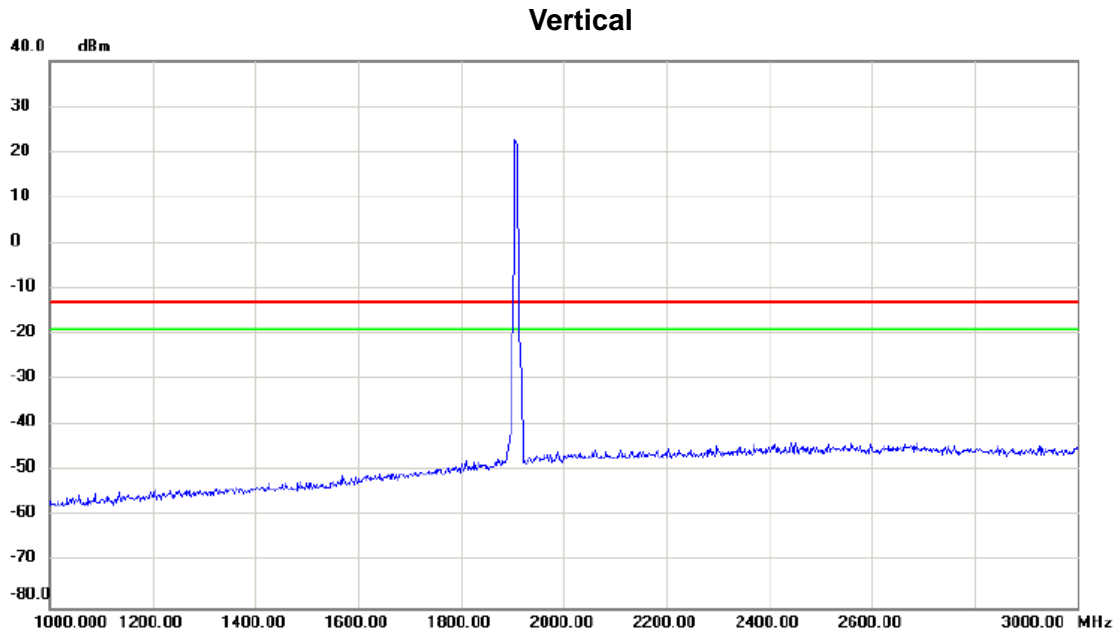

No.	Mk.	Freq.	Reading Level	Correct Factor	Measurement	Limit	Margin	Detector	Comment
		MHz	dBm	dB	dBm	dBm	dB		

Test Mode: WCDMA Band 2_HSUPA_TX CH9400

Horizontal

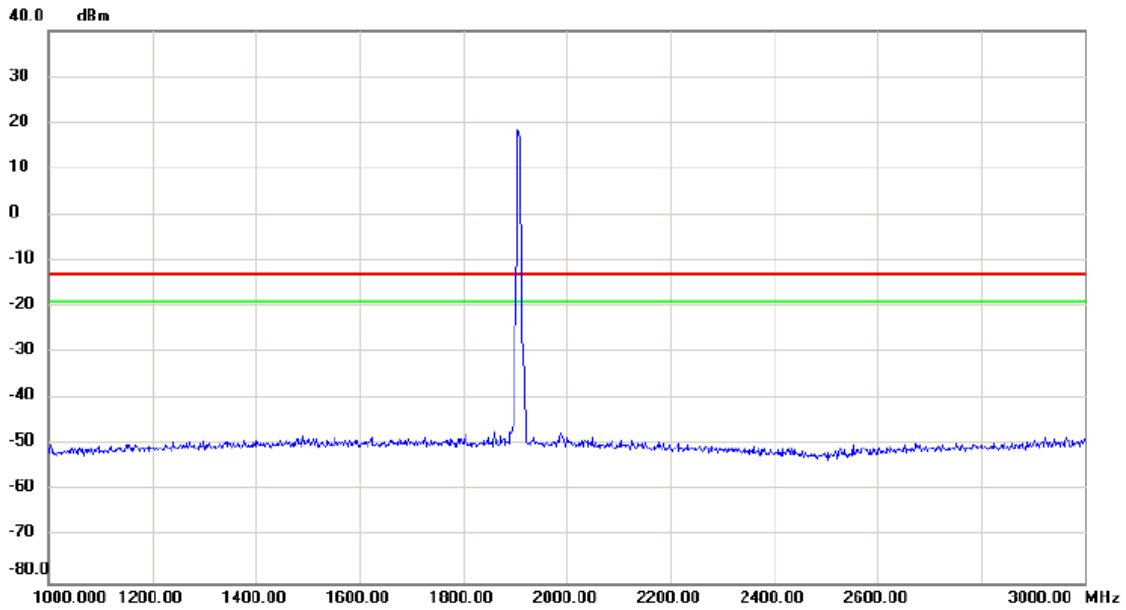

No.	Mk.	Freq.	Reading Level	Correct Factor	Measurement	Limit	Margin	Detector	Comment
		MHz	dBm	dB	dBm	dBm	dB		
		1920.00	18.00	0.00	18.00	-15.00	3.00		

Test Mode: WCDMA Band 2_HSUPA_TX CH9400

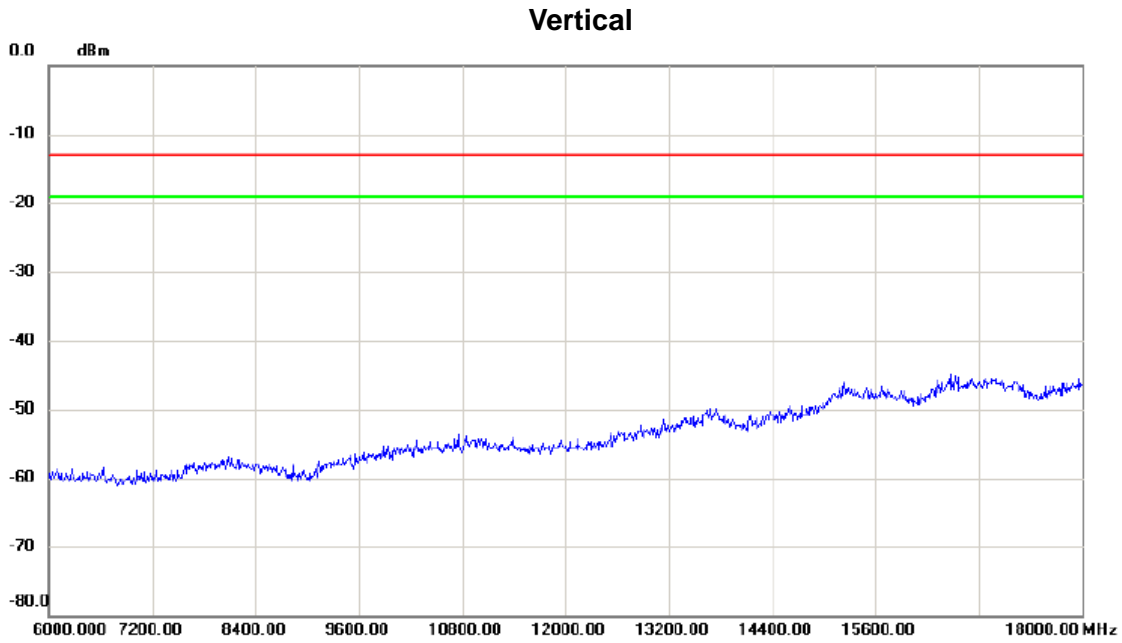

No.	Mk.	Freq.	Reading Level	Correct Factor	Measurement	Limit	Margin	Detector	Comment
		MHz	dBm	dB	dBm	dBm	dB		

Test Mode: WCDMA Band 2_HSUPA_TX CH9400

Horizontal

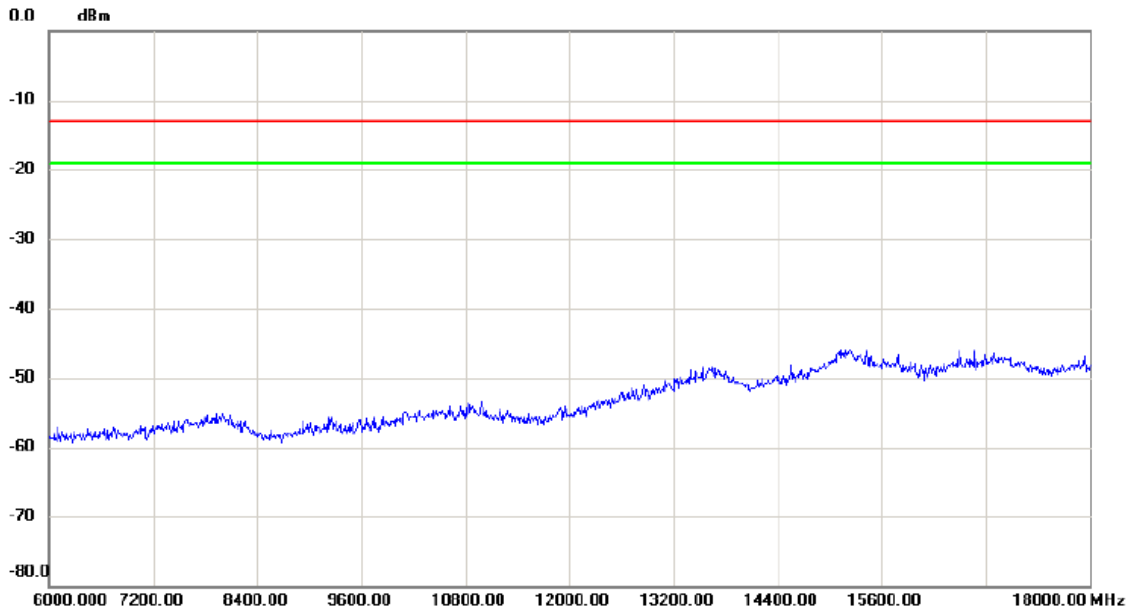

No.	Mk.	Freq.	Reading Level	Correct Factor	Measurement	Limit	Margin	Detector	Comment
		MHz	dBm	dB	dBm	dBm	dB		

Test Mode: WCDMA Band 2_HSUPA_TX CH9400

Vertical

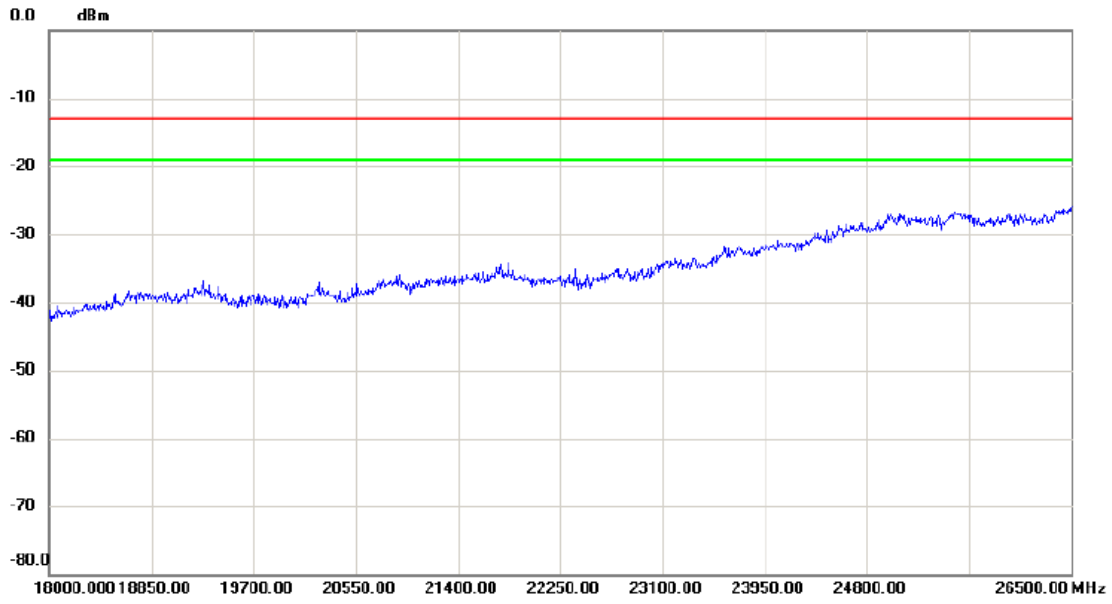

No.	Mk.	Freq.	Reading Level	Correct Factor	Measurement	Limit	Margin	Detector	Comment
		MHz	dBm	dB	dBm	dBm	dB		

Test Mode: WCDMA Band 2_HSUPA_TX CH9400

Horizontal

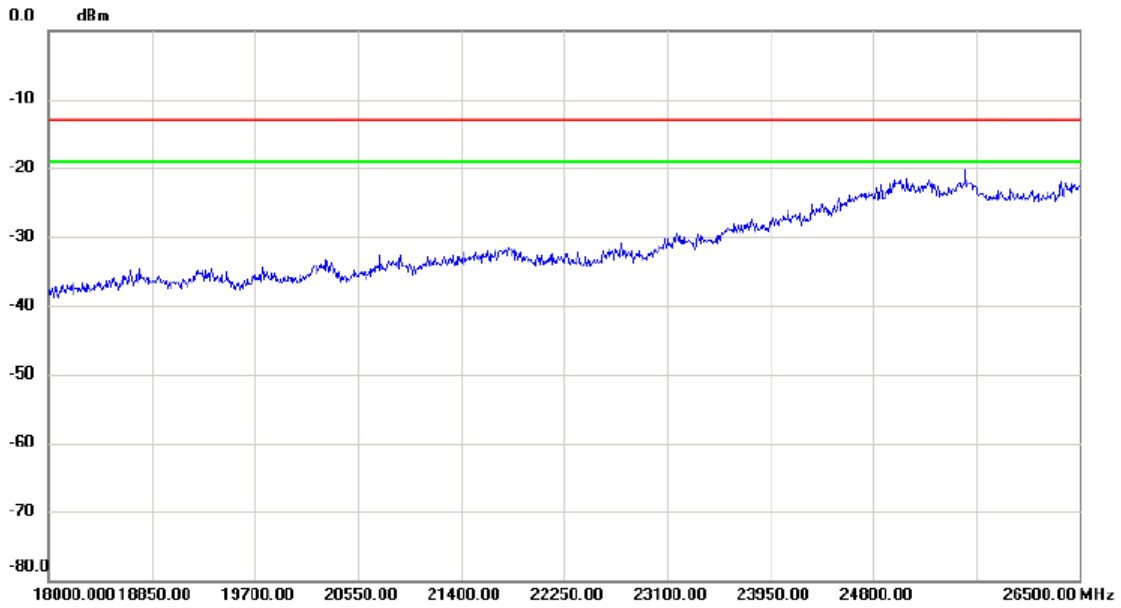

No.	Mk.	Freq.	Reading Level	Correct Factor	Measurement	Limit	Margin	Detector	Comment
		MHz	dBm	dB	dBm	dBm	dB		

Test Mode: LTE Band 2_TX CH18900_1.4M

Vertical

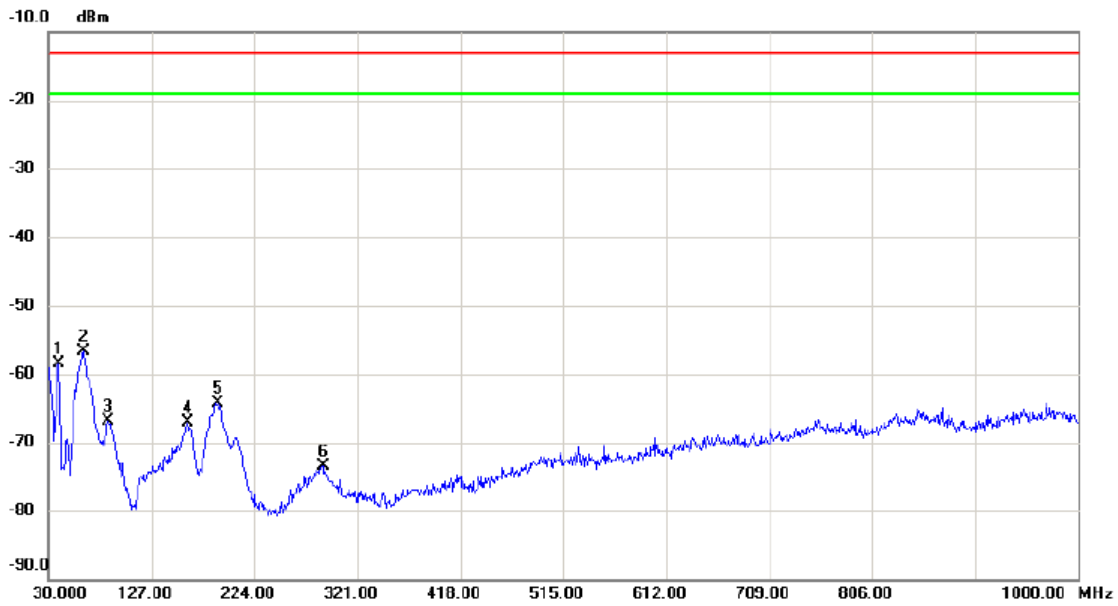

No.	Mk.	Freq. MHz	Reading Level dBm	Correct Factor dB	Measure- ment dBm	Limit dBm	Margin dB	Detector	Comment
1		39.700	-60.47	1.90	-58.57	-13.00	-45.57	peak	
2	*	62.980	-57.56	0.85	-56.71	-13.00	-43.71	peak	
3		86.260	-61.03	-5.91	-66.94	-13.00	-53.94	peak	
4		160.950	-69.91	2.87	-67.04	-13.00	-54.04	peak	
5		189.080	-62.73	-1.56	-64.29	-13.00	-51.29	peak	
6		288.990	-75.74	2.26	-73.48	-13.00	-60.48	peak	

Test Mode: LTE Band 2_TX CH18900_1.4M

Horizontal

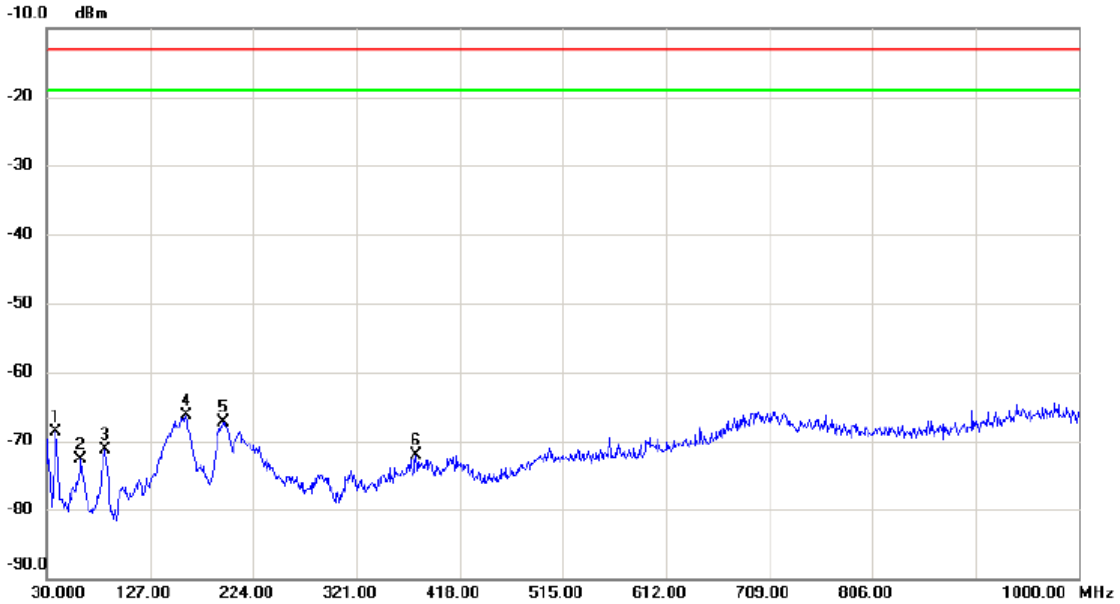

No.	Mk.	Freq. MHz	Reading Level dBm	Correct Factor dB	Measure- ment dBm	Limit dBm	Margin dB	Detector	Comment
1		37.760	-69.97	1.28	-68.69	-13.00	-55.69	peak	
2		62.010	-71.73	-0.97	-72.70	-13.00	-59.70	peak	
3		85.290	-63.36	-7.88	-71.24	-13.00	-58.24	peak	
4	*	160.950	-68.56	2.35	-66.21	-13.00	-53.21	peak	
5		195.870	-65.47	-1.77	-67.24	-13.00	-54.24	peak	
6		377.260	-77.90	5.77	-72.13	-13.00	-59.13	peak	

Test Mode: LTE Band 2_TX CH18900_1.4M

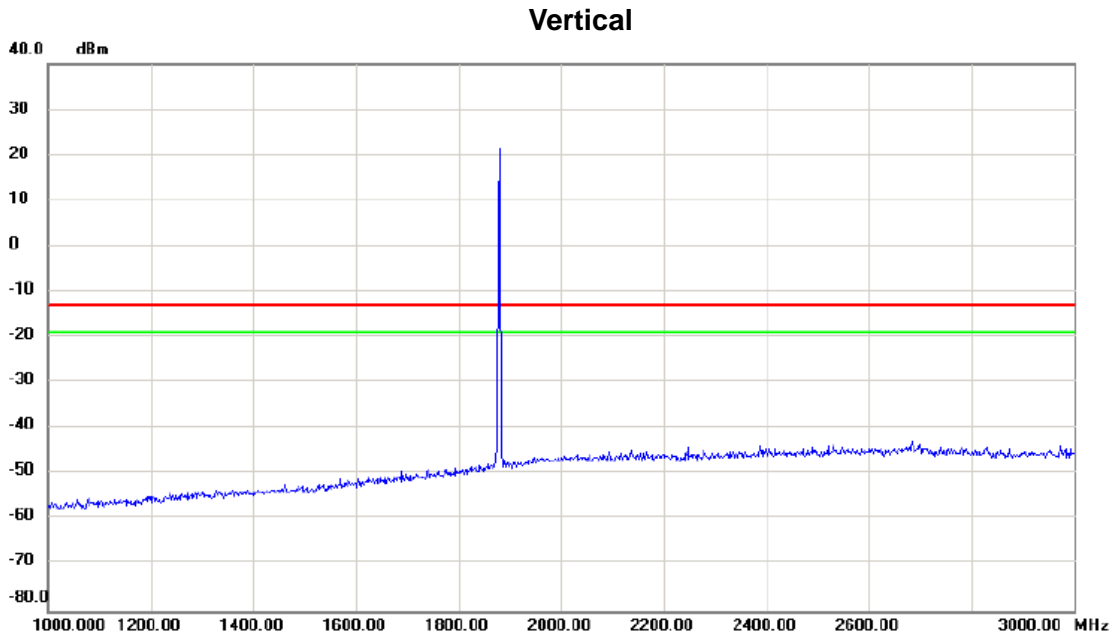

No.	Mk.	Freq. MHz	Reading Level dBm	Correct Factor dB	Measure- ment dBm	Limit dBm	Margin dB	Detector	Comment
		1890.00	20.00	0.00	20.00	-15.00	5.00		

Test Mode: LTE Band 2_TX CH18900_1.4M

Horizontal

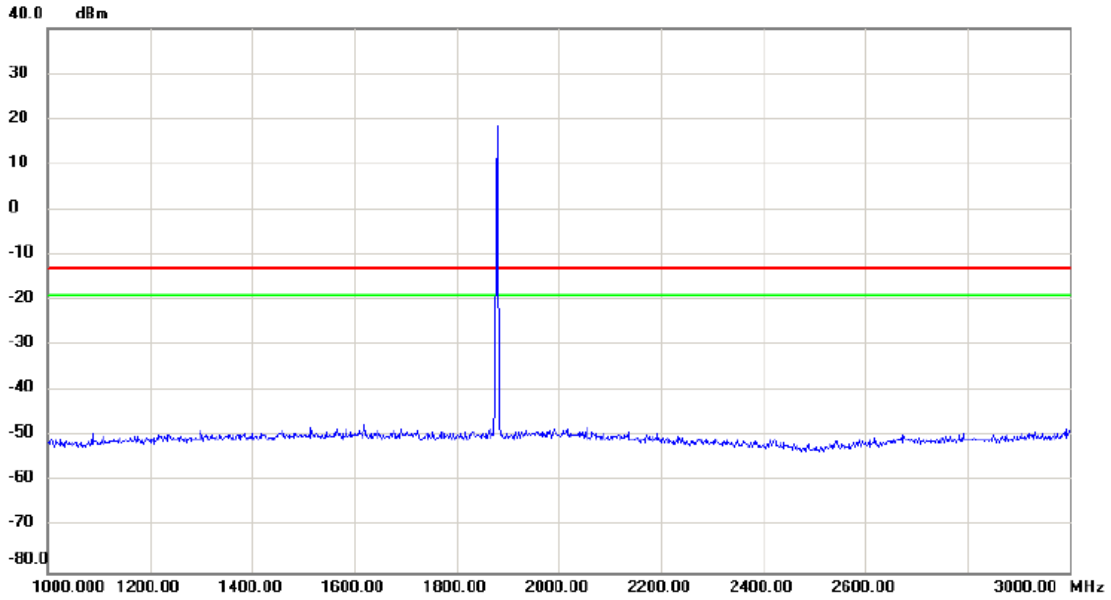

No.	Mk.	Freq.	Reading Level	Correct Factor	Measurement	Limit	Margin	Detector	Comment
		MHz	dBm	dB	dBm	dBm	dB		
		1900.00	18.00	0.00	18.00	-13.00	31.00		

Test Mode: LTE Band 2_TX CH18900_1.4M

Vertical

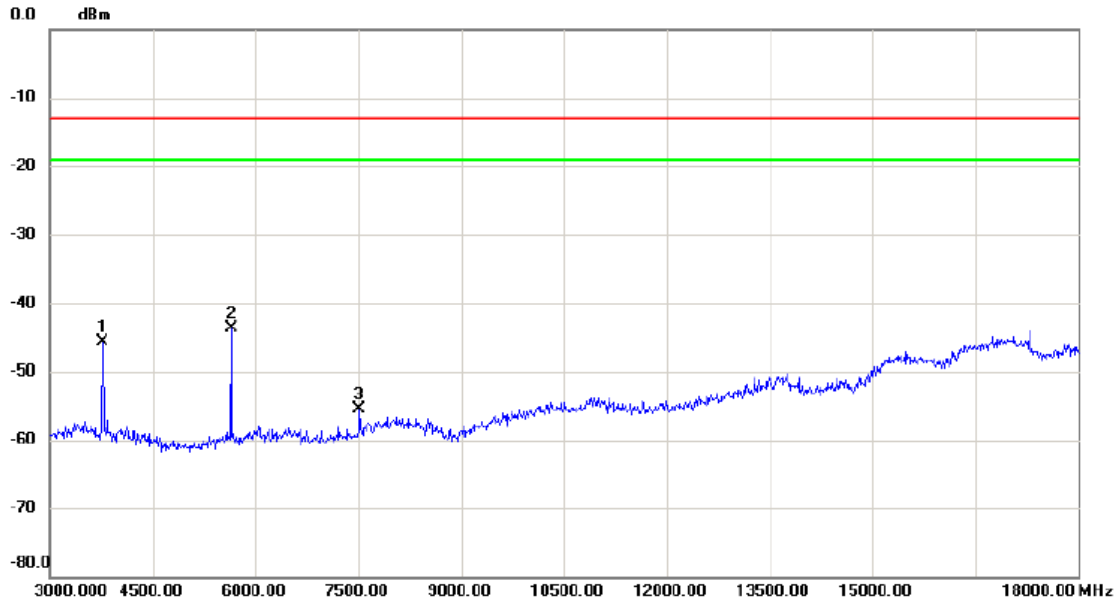

No.	Mk.	Freq. MHz	Reading Level dBm	Correct Factor dB	Measure- ment dBm	Limit dBm	Margin dB	Detector	Comment
1		3765.000	-60.12	14.51	-45.61	-13.00	-32.61	peak	
2	*	5640.000	-59.92	16.31	-43.61	-13.00	-30.61	peak	
3		7515.000	-73.49	17.92	-55.57	-13.00	-42.57	peak	

Test Mode: LTE Band 2_TX CH18900_1.4M

Horizontal

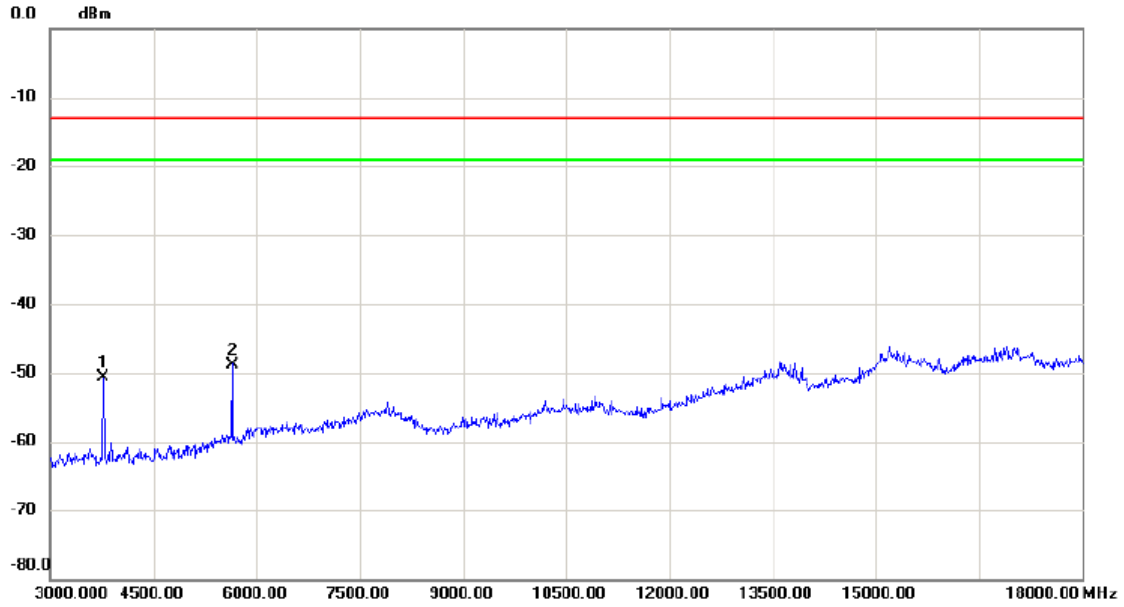

No.	Mk.	Freq. MHz	Reading Level dBm	Correct Factor dB	Measure- ment dBm	Limit dBm	Margin dB	Detector	Comment
1		3765.000	-62.10	11.36	-50.74	-13.00	-37.74	peak	
2	*	5640.000	-65.84	17.04	-48.80	-13.00	-35.80	peak	

Test Mode: LTE Band 2_TX CH18900_1.4M

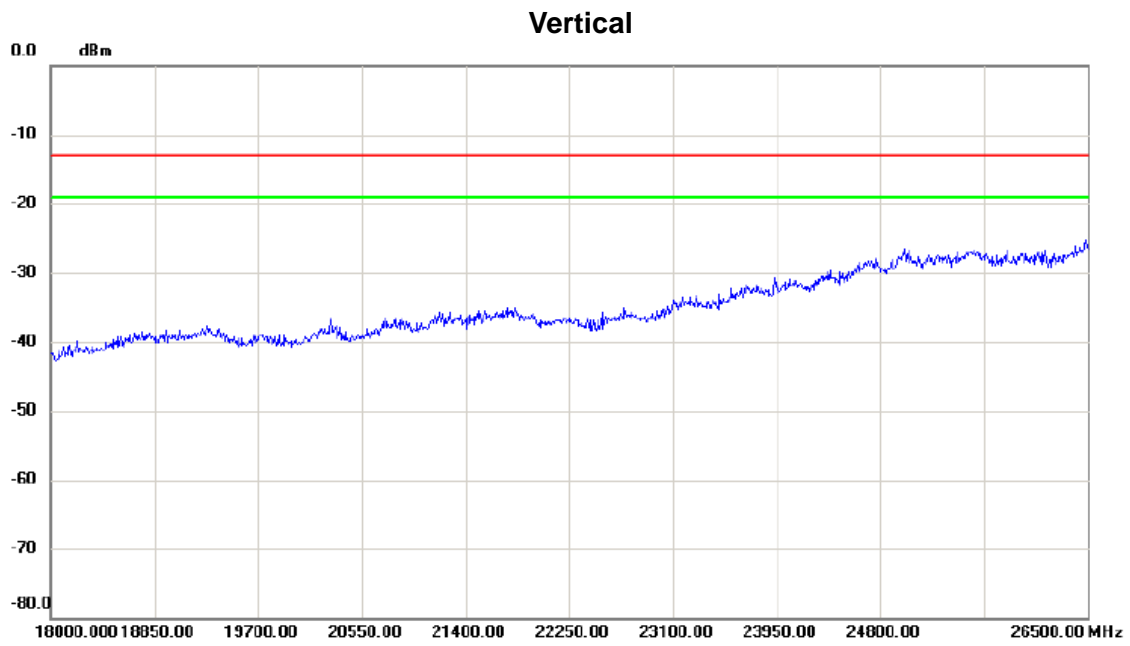

No.	Mk.	Freq.	Reading Level	Correct Factor	Measurement	Limit	Margin	Detector	Comment
		MHz	dBm	dB	dBm	dBm	dB		

Test Mode: LTE Band 2_TX CH18900_1.4M

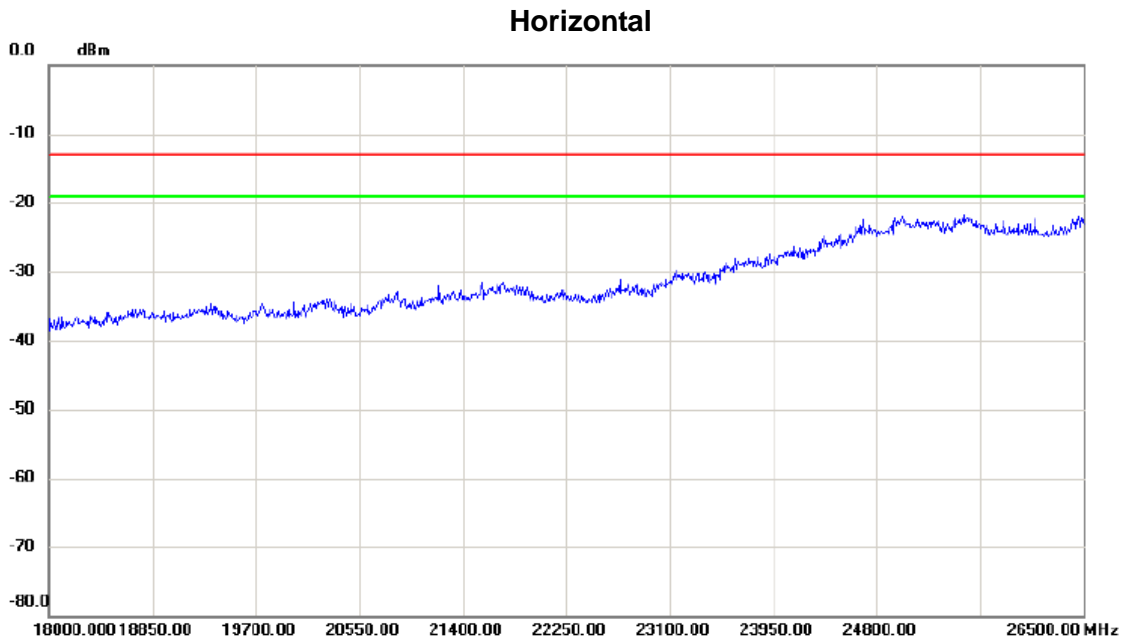

No.	Mk.	Freq. MHz	Reading Level dBm	Correct Factor dB	Measure- ment dBm	Limit dBm	Margin dB	Detector	Comment

Test Mode: LTE Band 2_TX CH18900_20M

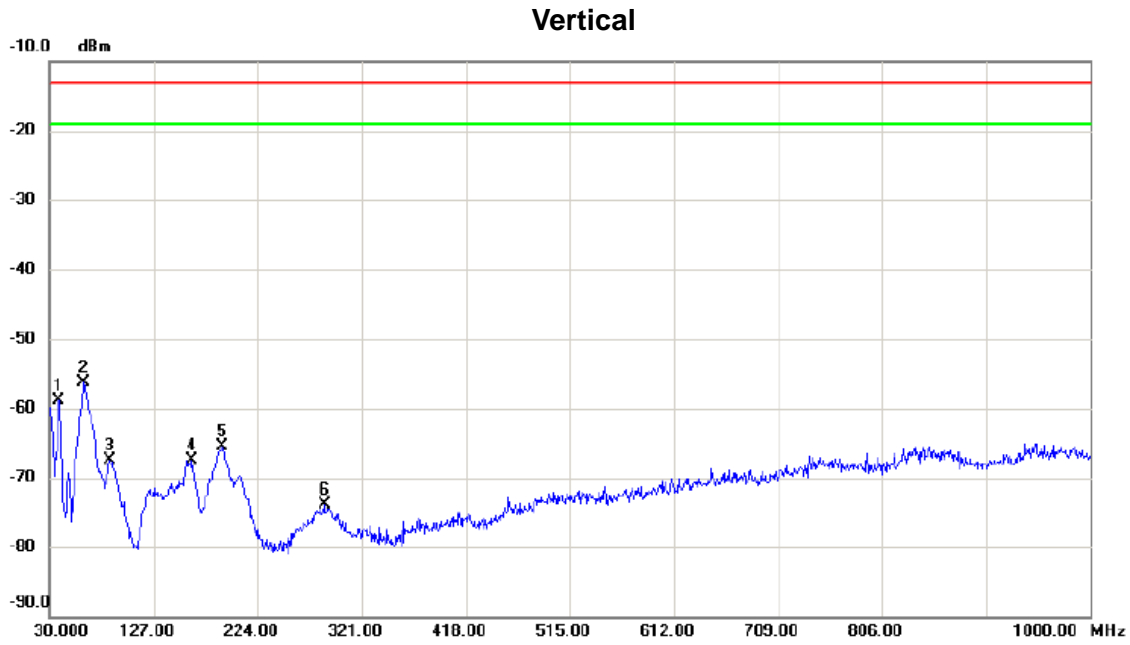

No.	Mk.	Freq. MHz	Reading Level dBm	Correct Factor dB	Measure- ment dBm	Limit dBm	Margin dB	Detector	Comment
1		38.730	-60.09	1.21	-58.88	-13.00	-45.88	peak	
2	*	62.010	-57.10	0.73	-56.37	-13.00	-43.37	peak	
3		86.260	-61.66	-5.91	-67.57	-13.00	-54.57	peak	
4		161.920	-70.03	2.55	-67.48	-13.00	-54.48	peak	
5		191.020	-63.70	-1.85	-65.55	-13.00	-52.55	peak	
6		286.080	-76.28	2.39	-73.89	-13.00	-60.89	peak	

Test Mode: LTE Band 2_TX CH18900_20M

Horizontal

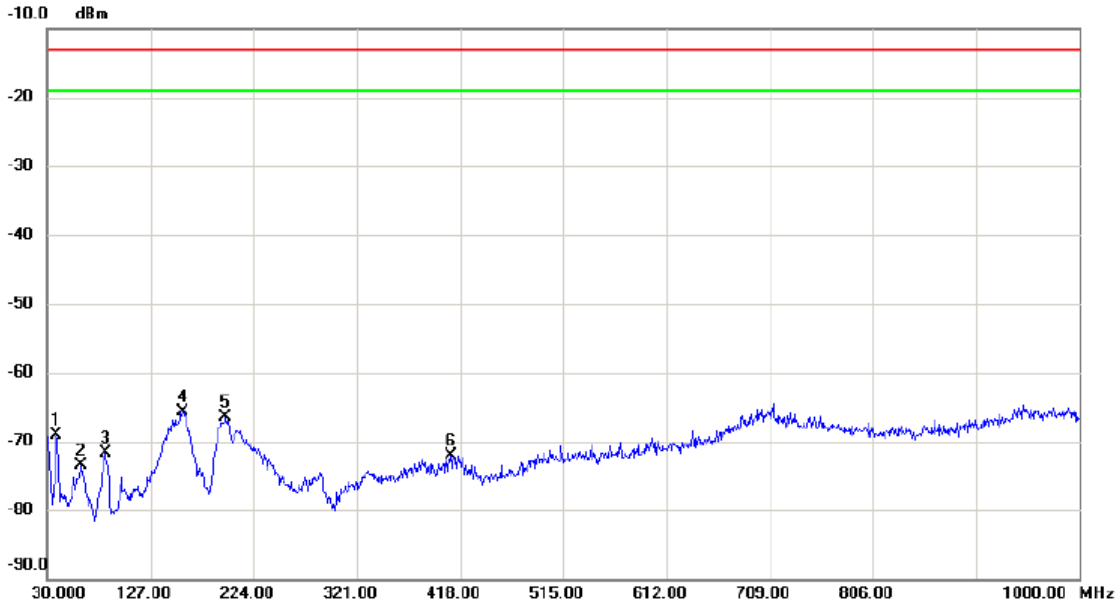

No.	Mk.	Freq. MHz	Reading Level dBm	Correct Factor dB	Measure- ment dBm	Limit dBm	Margin dB	Detector	Comment
1		38.730	-70.65	1.63	-69.02	-13.00	-56.02	peak	
2		61.040	-72.62	-0.87	-73.49	-13.00	-60.49	peak	
3		84.320	-63.77	-7.87	-71.64	-13.00	-58.64	peak	
4	*	157.070	-68.82	3.19	-65.63	-13.00	-52.63	peak	
5		197.810	-64.75	-1.84	-66.59	-13.00	-53.59	peak	
6		409.270	-78.48	6.34	-72.14	-13.00	-59.14	peak	

Test Mode: LTE Band 2_TX CH18900_20M

Vertical

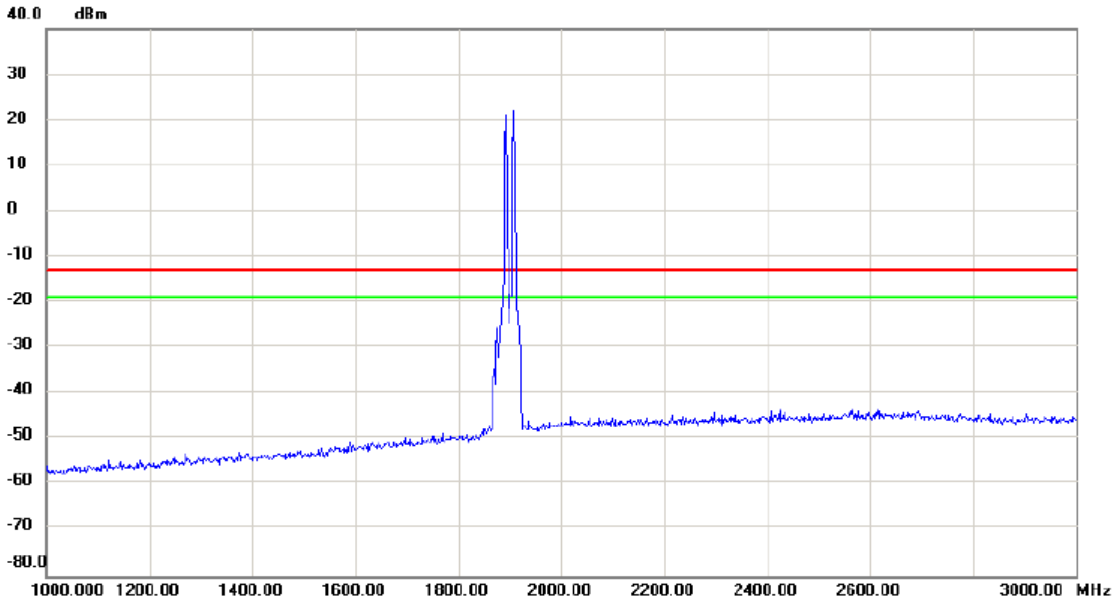

No.	Mk.	Freq.	Reading Level	Correct Factor	Measurement	Limit	Margin	Detector	Comment
		MHz	dBm	dB	dBm	dBm	dB		
		1900.00	20.00	0.00	20.00	-15.00	5.00		

Test Mode: LTE Band 2_TX CH18900_20M

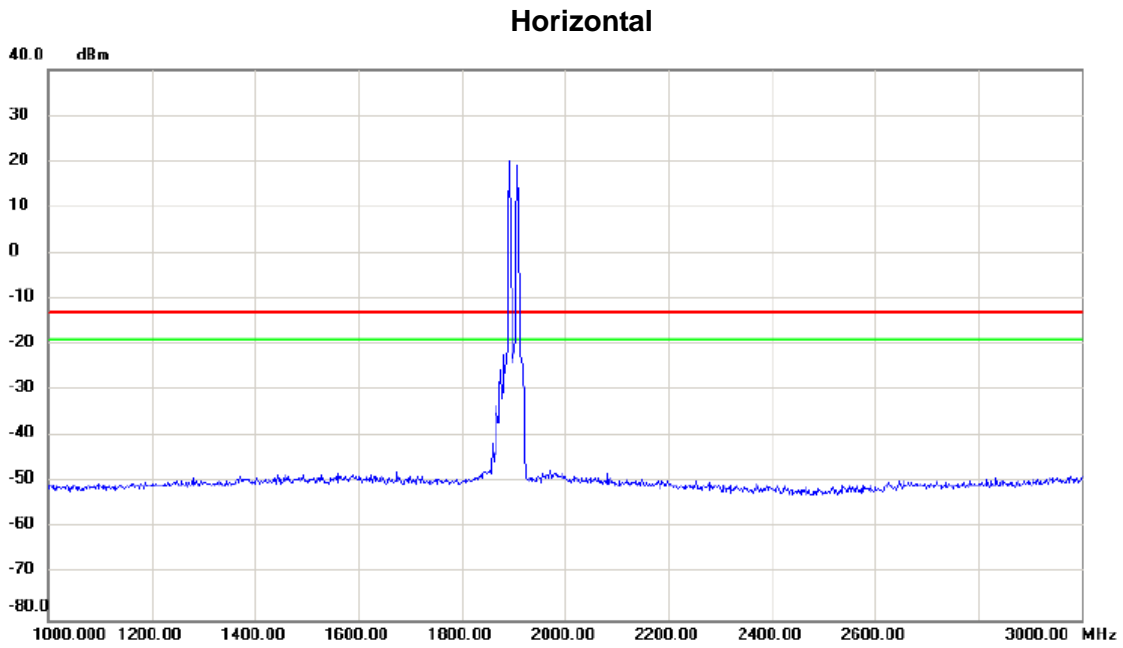

No.	Mk.	Freq.	Reading Level	Correct Factor	Measurement	Limit	Margin	Detector	Comment
		MHz	dBm	dB	dBm	dBm	dB		

Test Mode: LTE Band 2_TX CH18900_20M

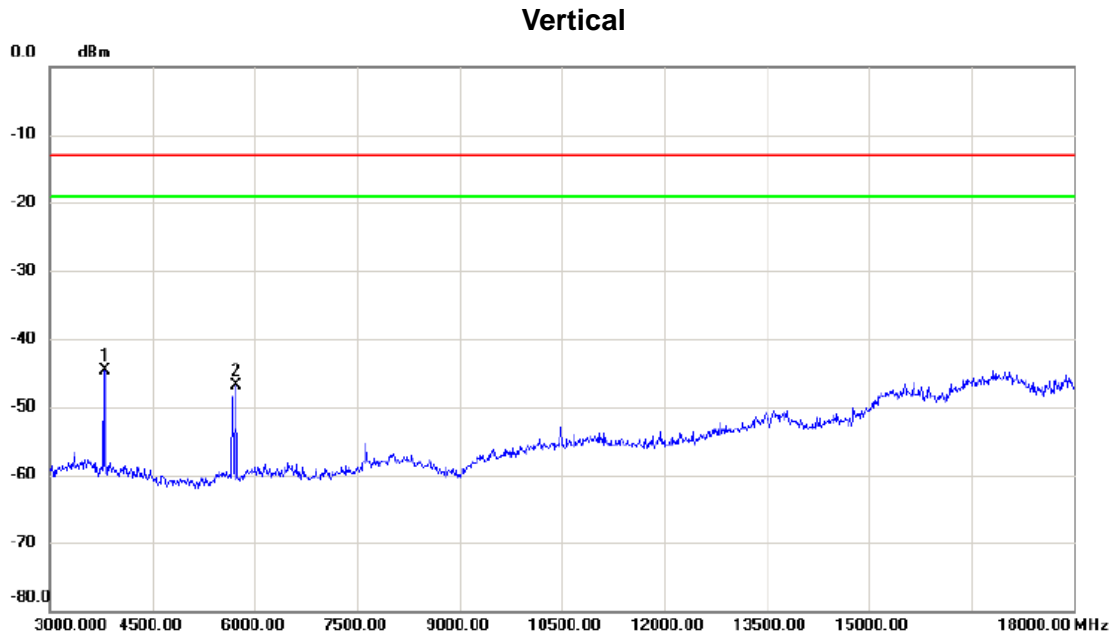

No.	Mk.	Freq. MHz	Reading Level dBm	Correct Factor dB	Measure- ment dBm	Limit dBm	Margin dB	Detector	Comment
1	*	3810.000	-59.26	14.56	-44.70	-13.00	-31.70	peak	
2		5730.000	-63.37	16.46	-46.91	-13.00	-33.91	peak	

Test Mode: LTE Band 2_TX CH18900_20M

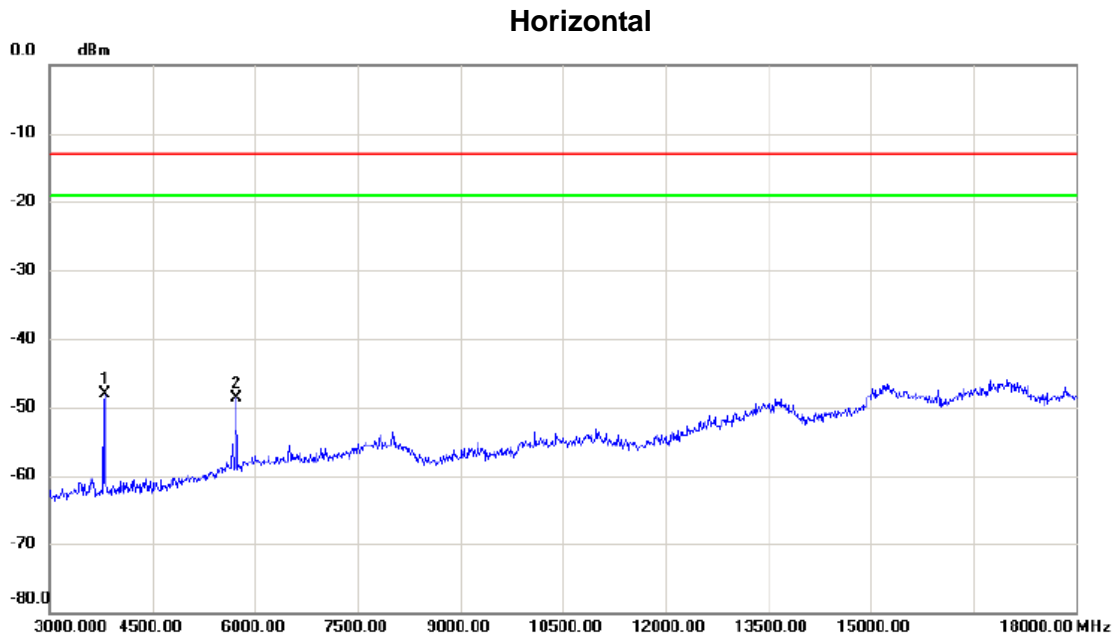

No.	Mk.	Freq. MHz	Reading Level dBm	Correct Factor dB	Measure- ment dBm	Limit dBm	Margin dB	Detector	Comment
1	*	3810.000	-59.54	11.48	-48.06	-13.00	-35.06	peak	
2		5730.000	-66.09	17.33	-48.76	-13.00	-35.76	peak	

Test Mode: LTE Band 2_TX CH18900_20M

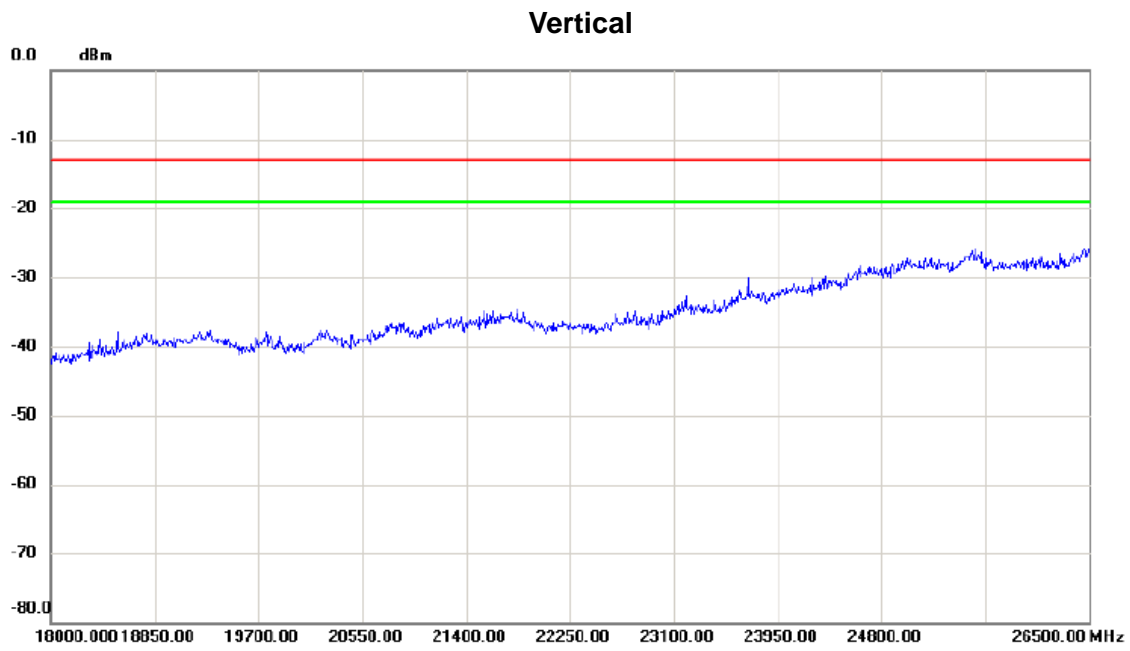

No.	Mk.	Freq.	Reading Level	Correct Factor	Measurement	Limit	Margin	Detector	Comment
		MHz	dBm	dB	dBm	dBm	dB		

Test Mode: LTE Band 2_TX CH18900_20M

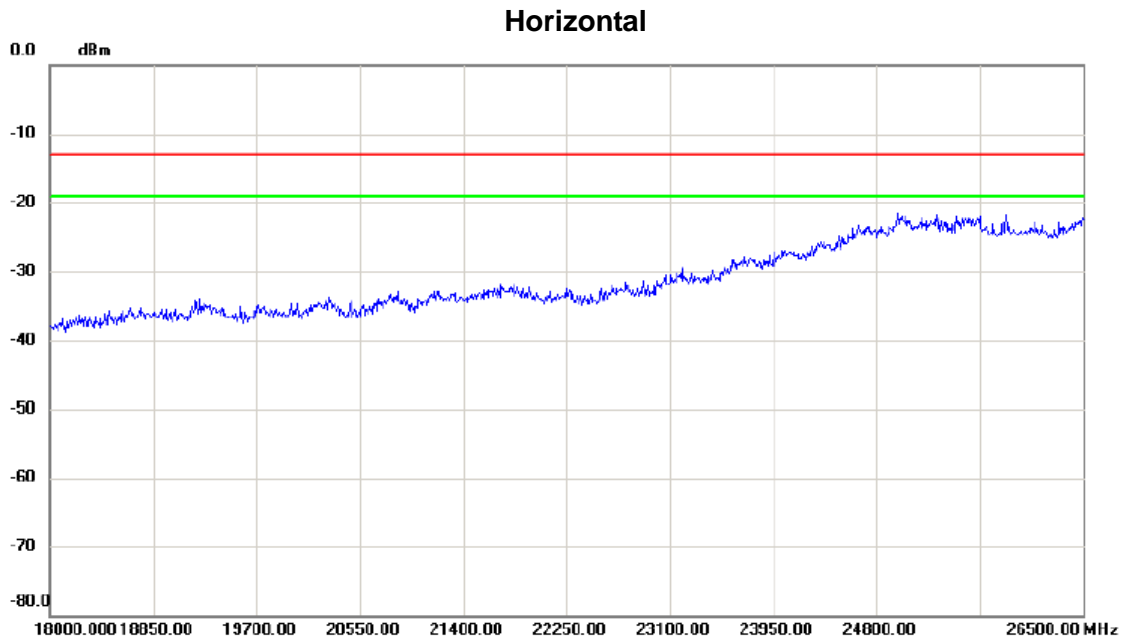

No.	Mk.	Freq. MHz	Reading Level dBm	Correct Factor dB	Measure- ment dBm	Limit dBm	Margin dB	Detector	Comment

ATTACHMENT E - BAND EDGE

DCS1900

GSM

Channel

512

Channel

810

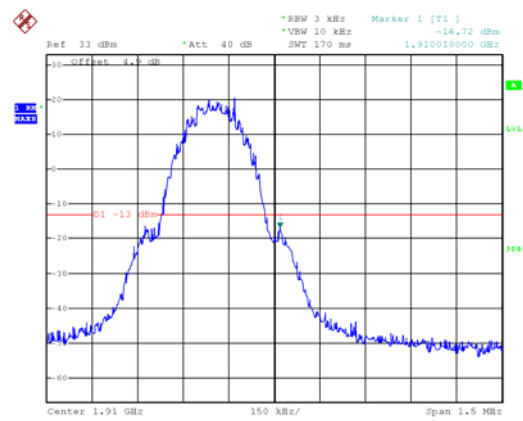
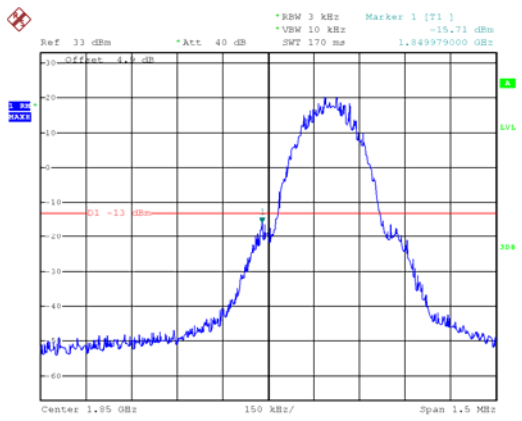

EDGE

Channel

512

Channel

810

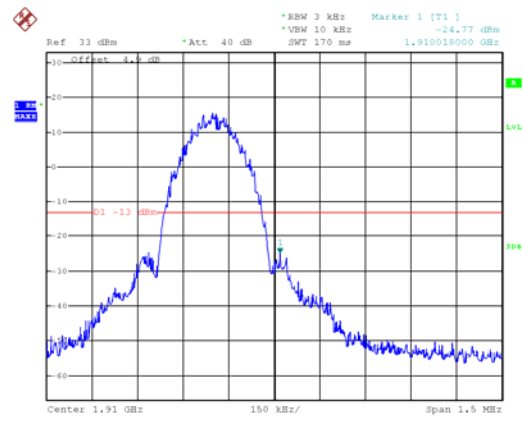
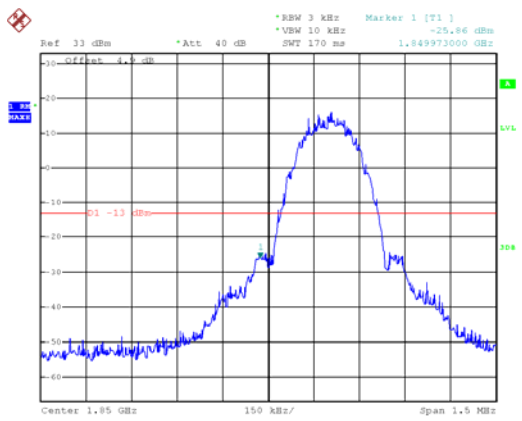

WCDMA Band 2

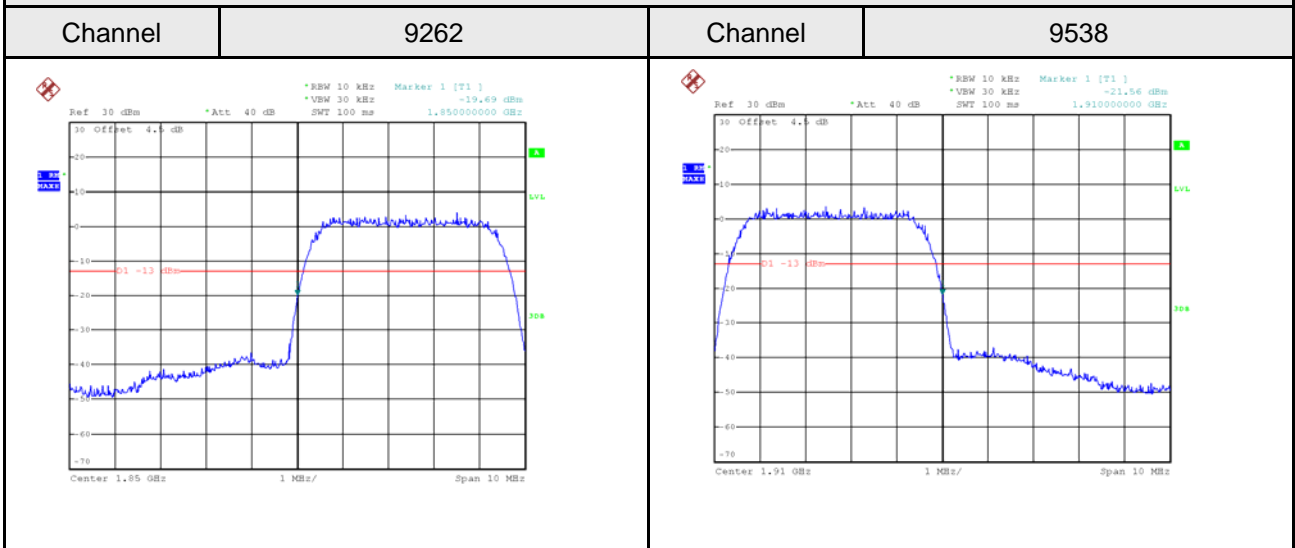

WCDMA_HSDPA Band 2

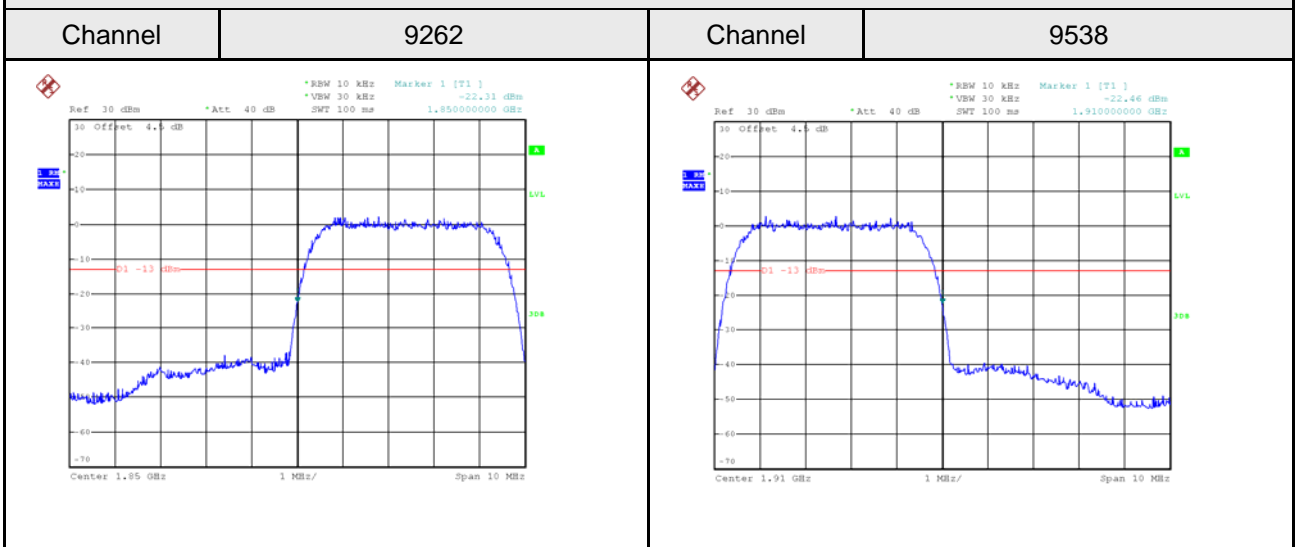

WCDMA_HSUPA Band 2

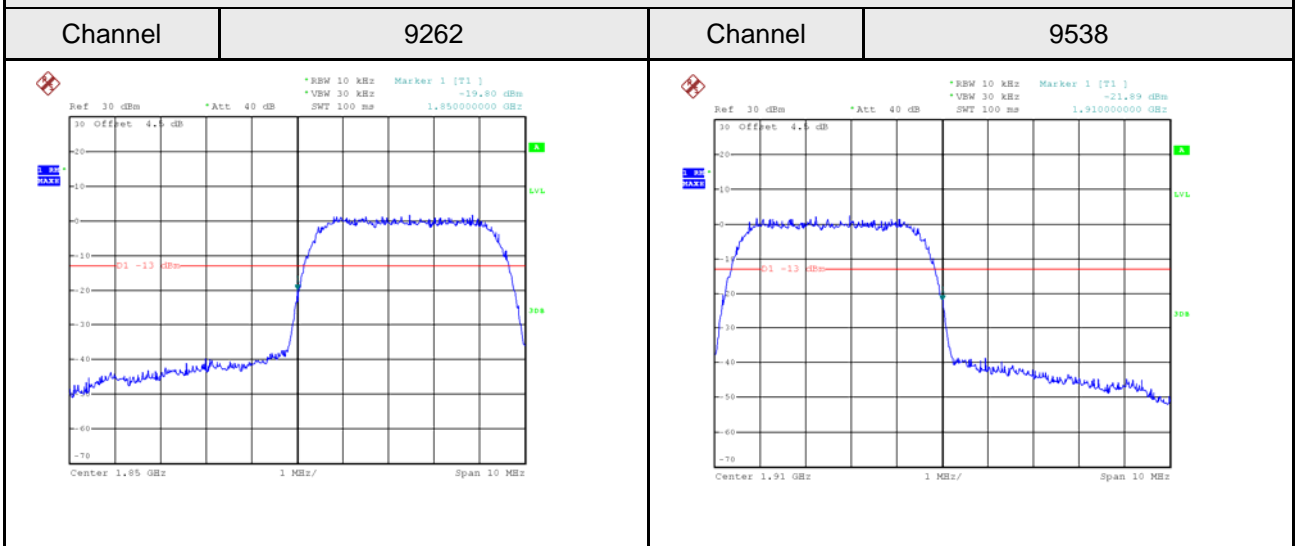

LTE Band 2_1.4M

1RB0

1RB5

Channel

18607

Channel

19193

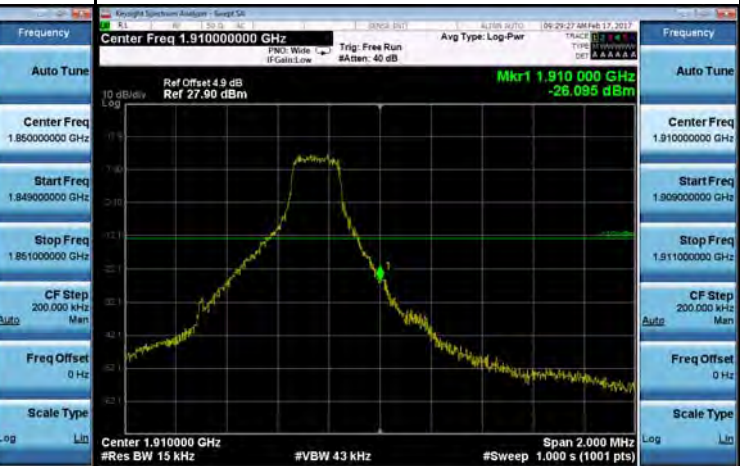
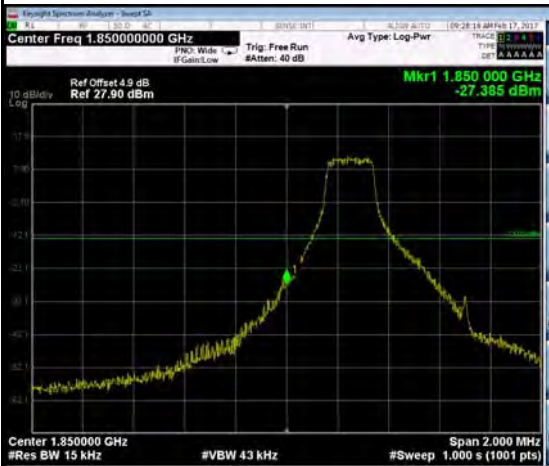

6RB0

Channel

18607

Channel

19193

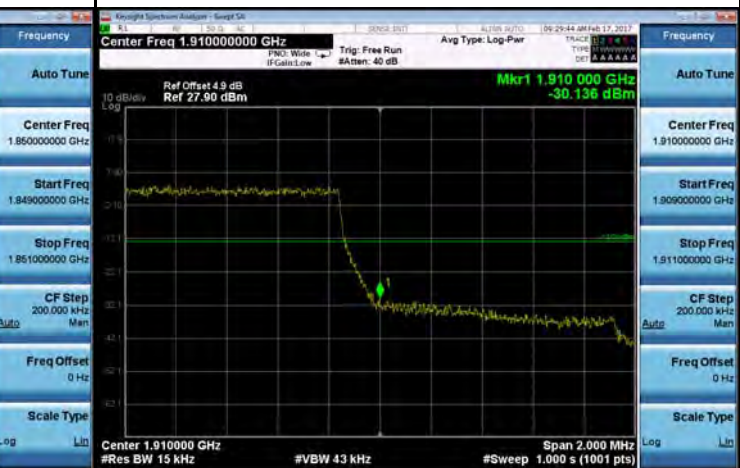

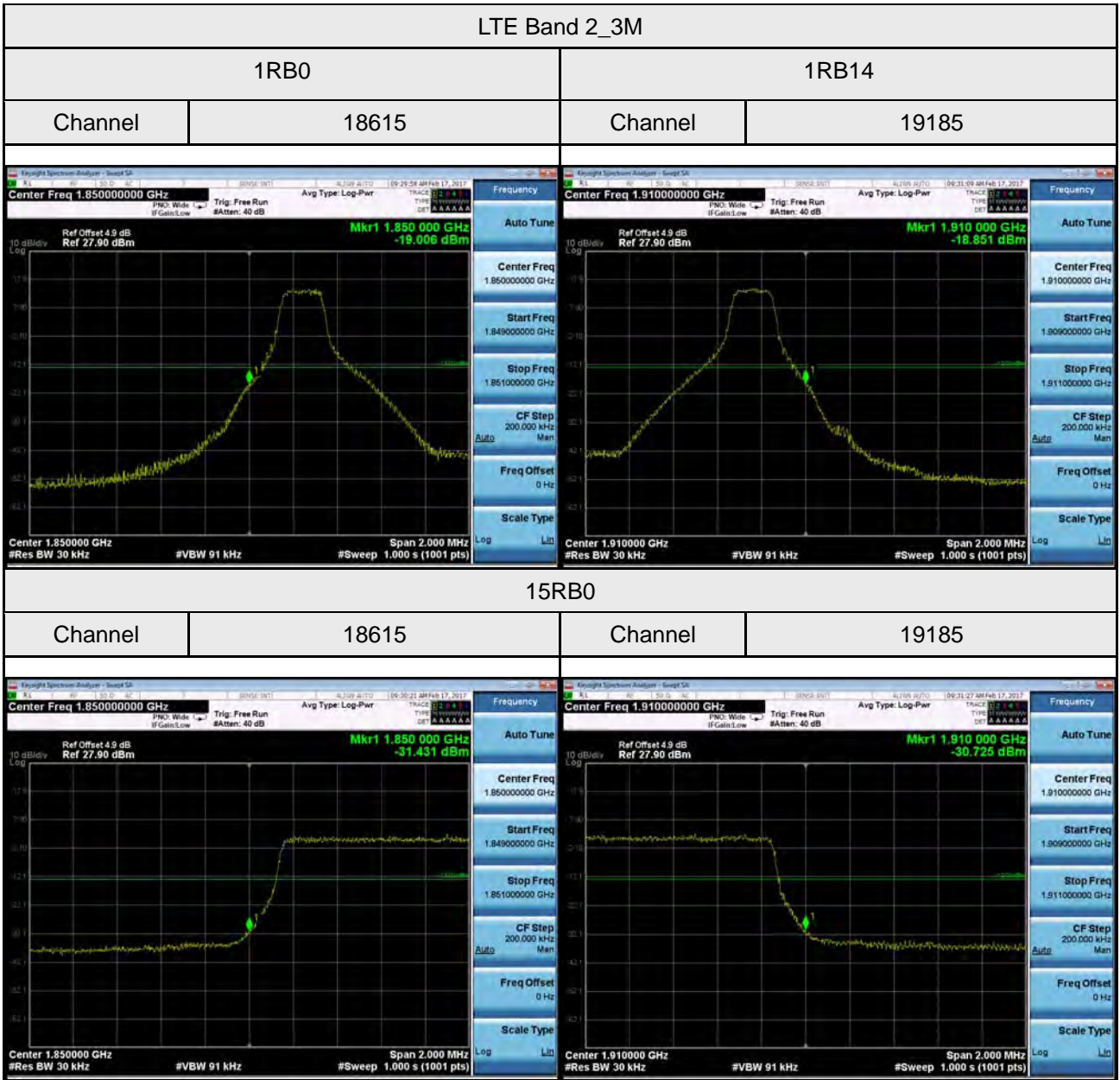

LTE Band 2_5M

1RB0

1RB24

Channel

18625

Channel

19175

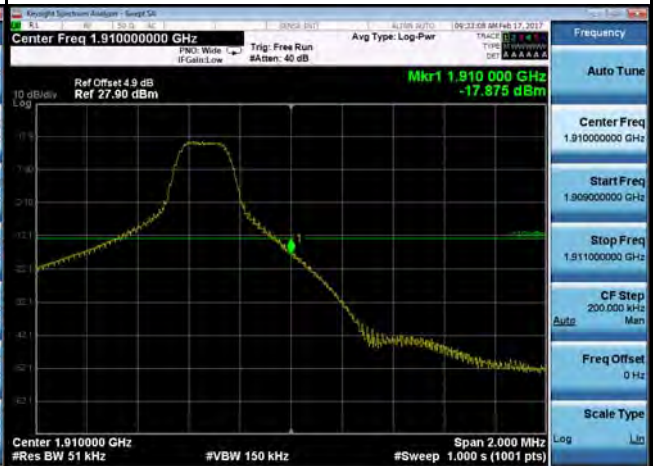
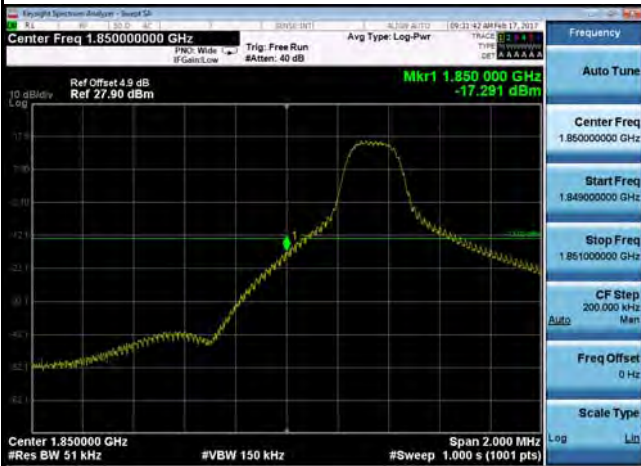

25RB0

Channel

18625

Channel

19175

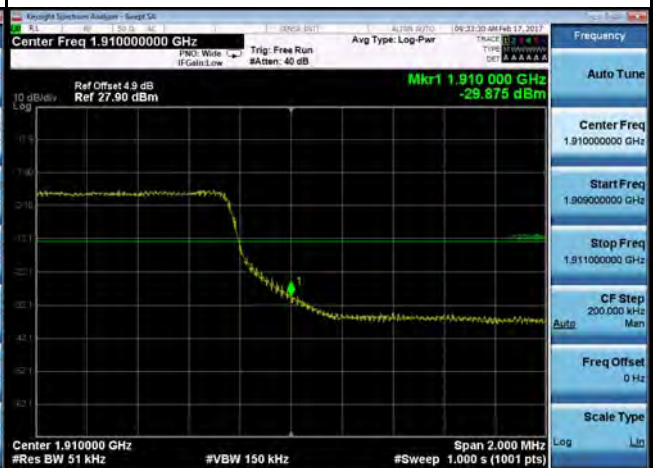
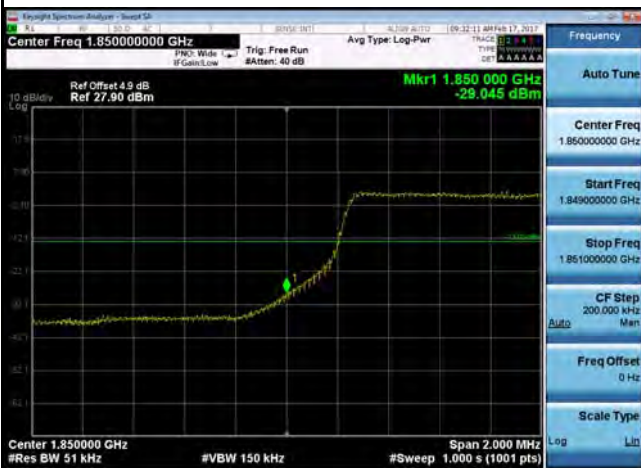

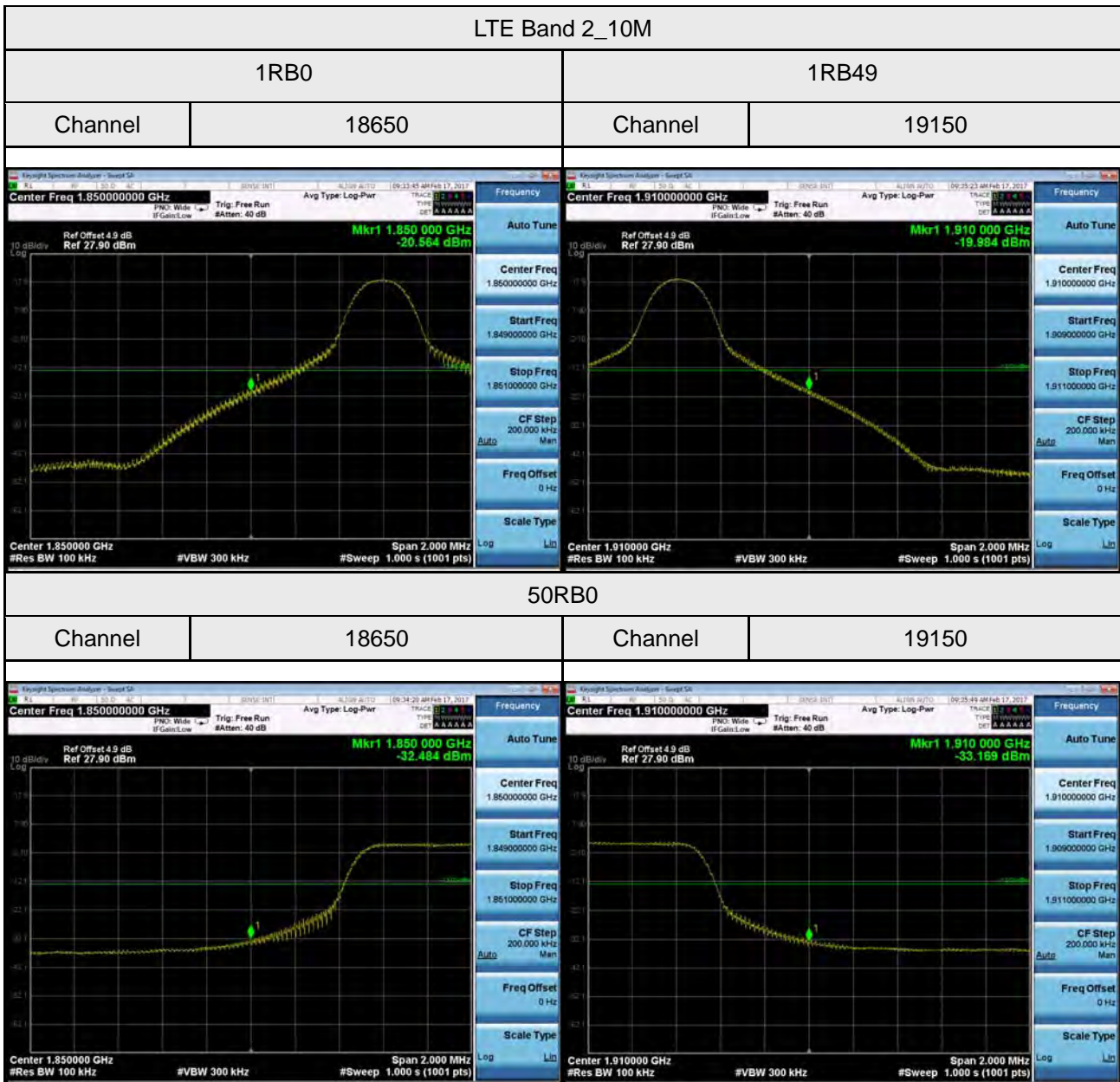

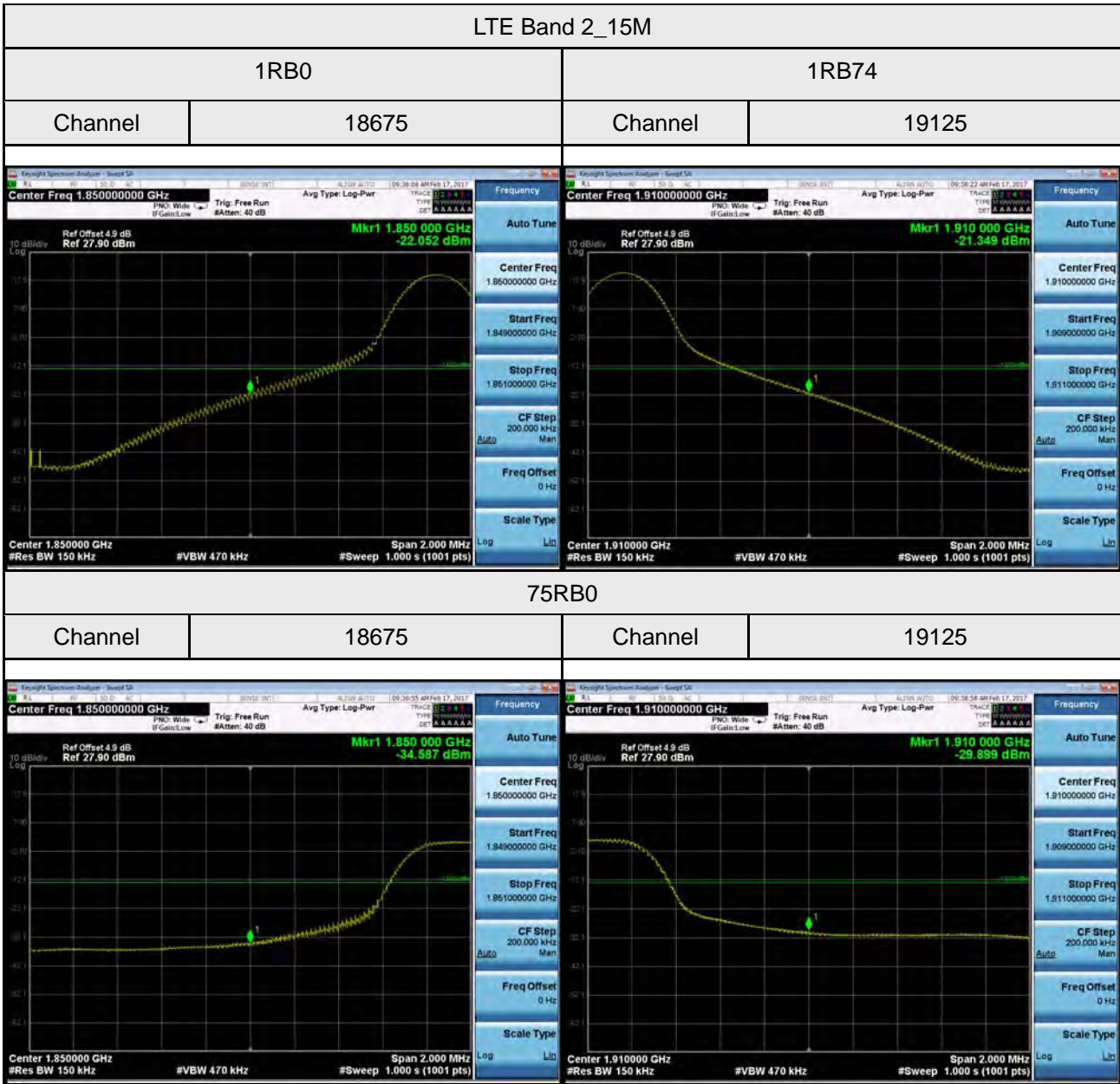

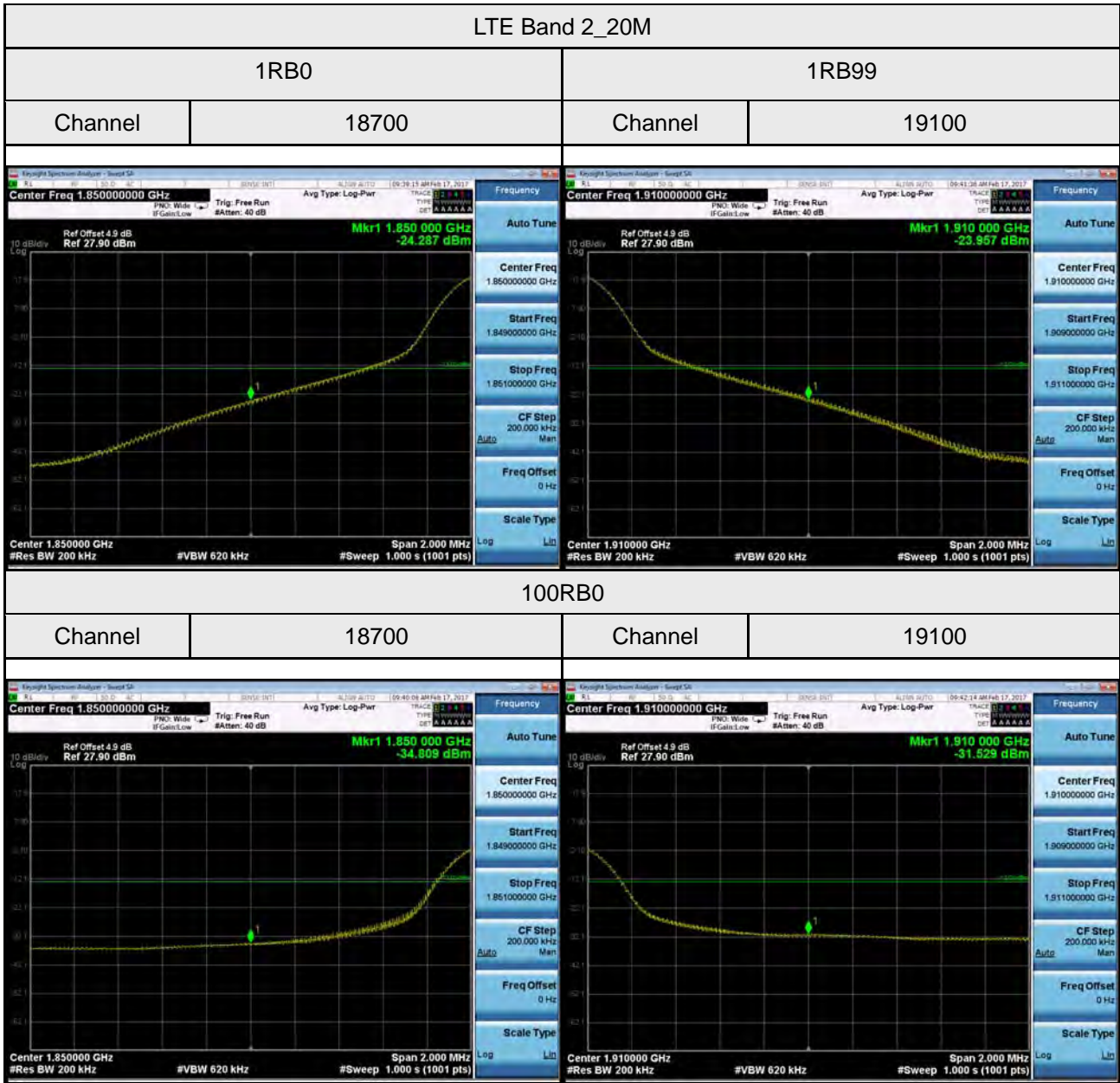

ATTACHMENT F - PEAK TO AVERAGE RATIO

DCS1900 Spectrum Plot

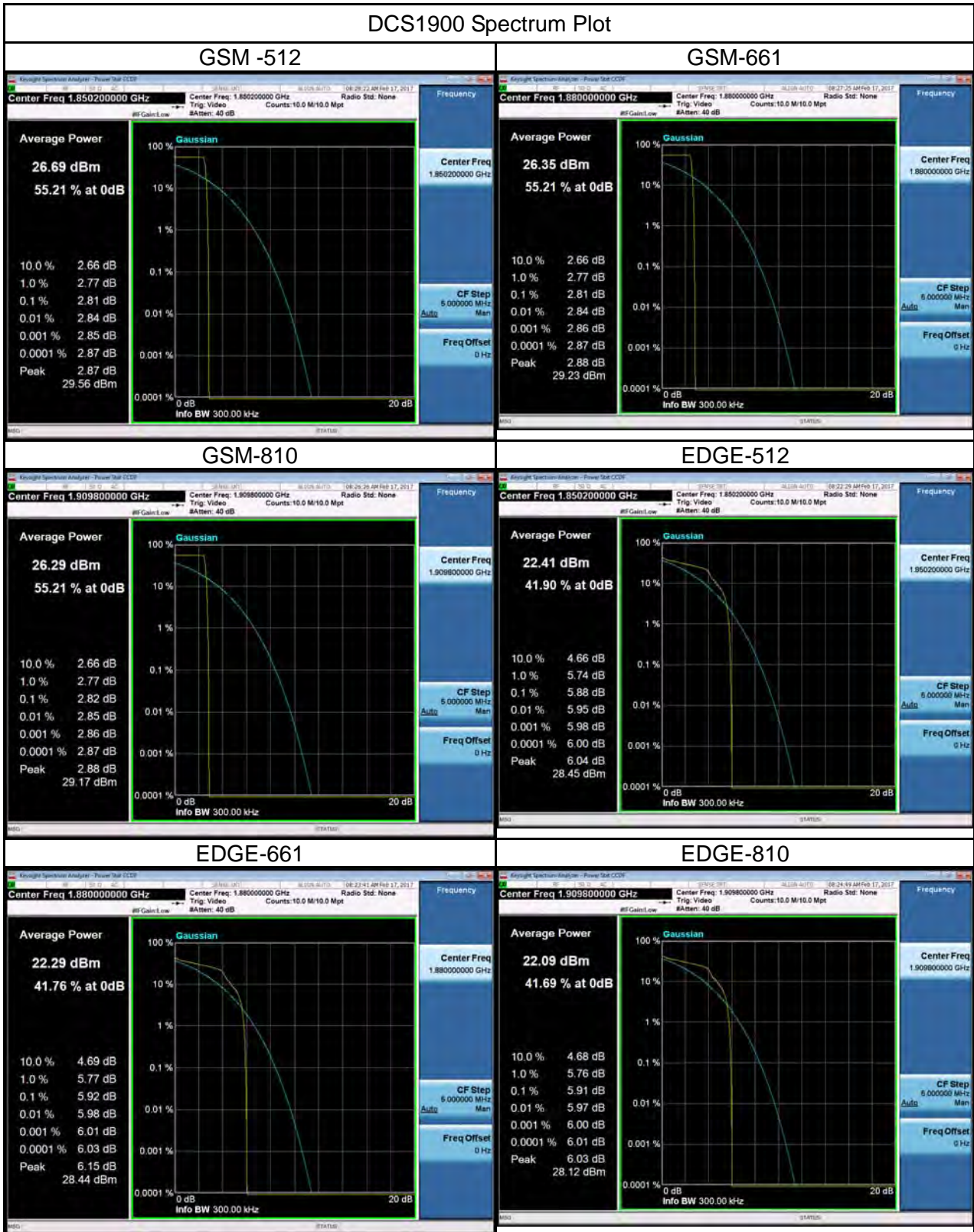

WCDMA Band 2 Spectrum Plot

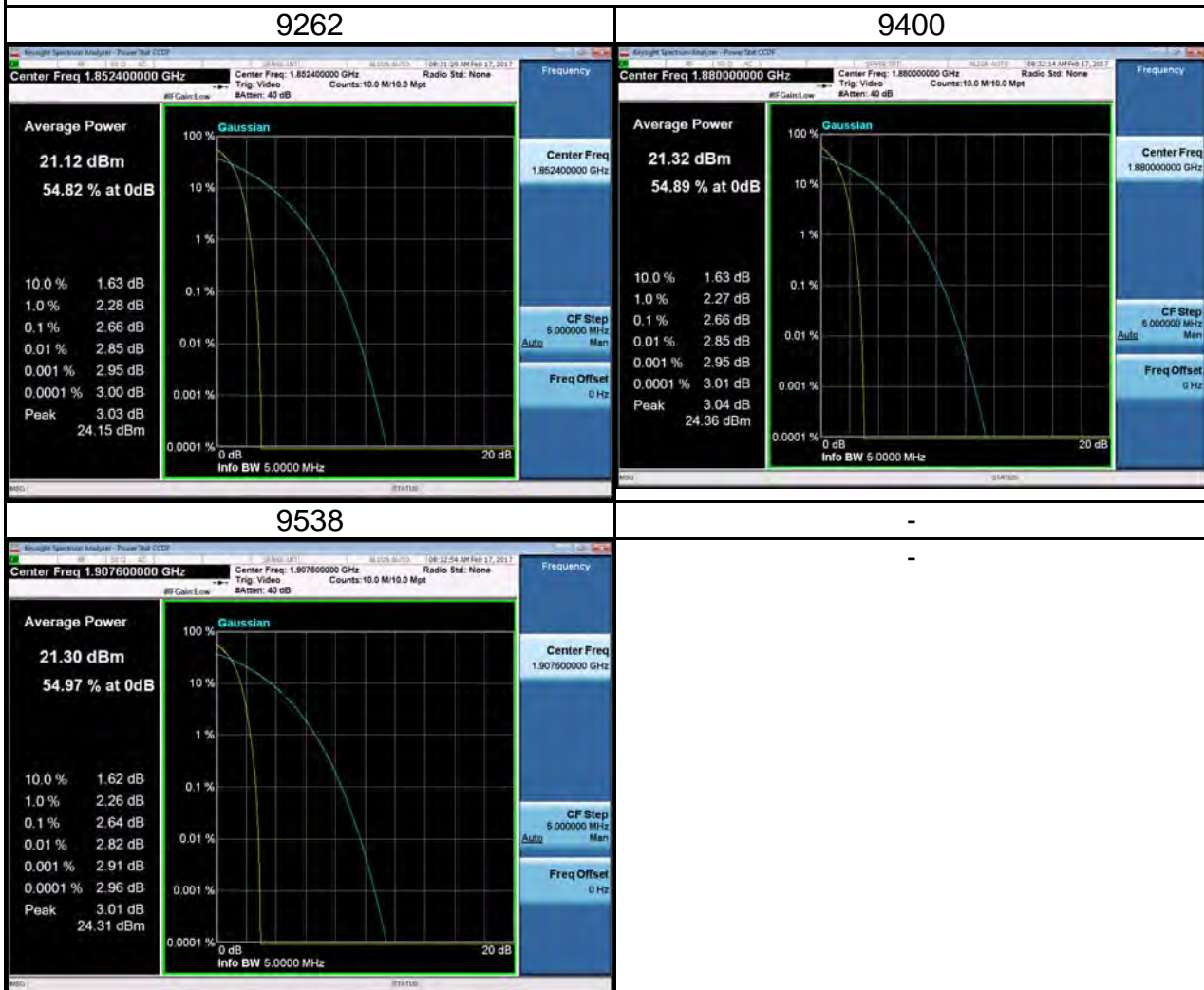

WCDMA_HSDPA Band 2 Spectrum Plot

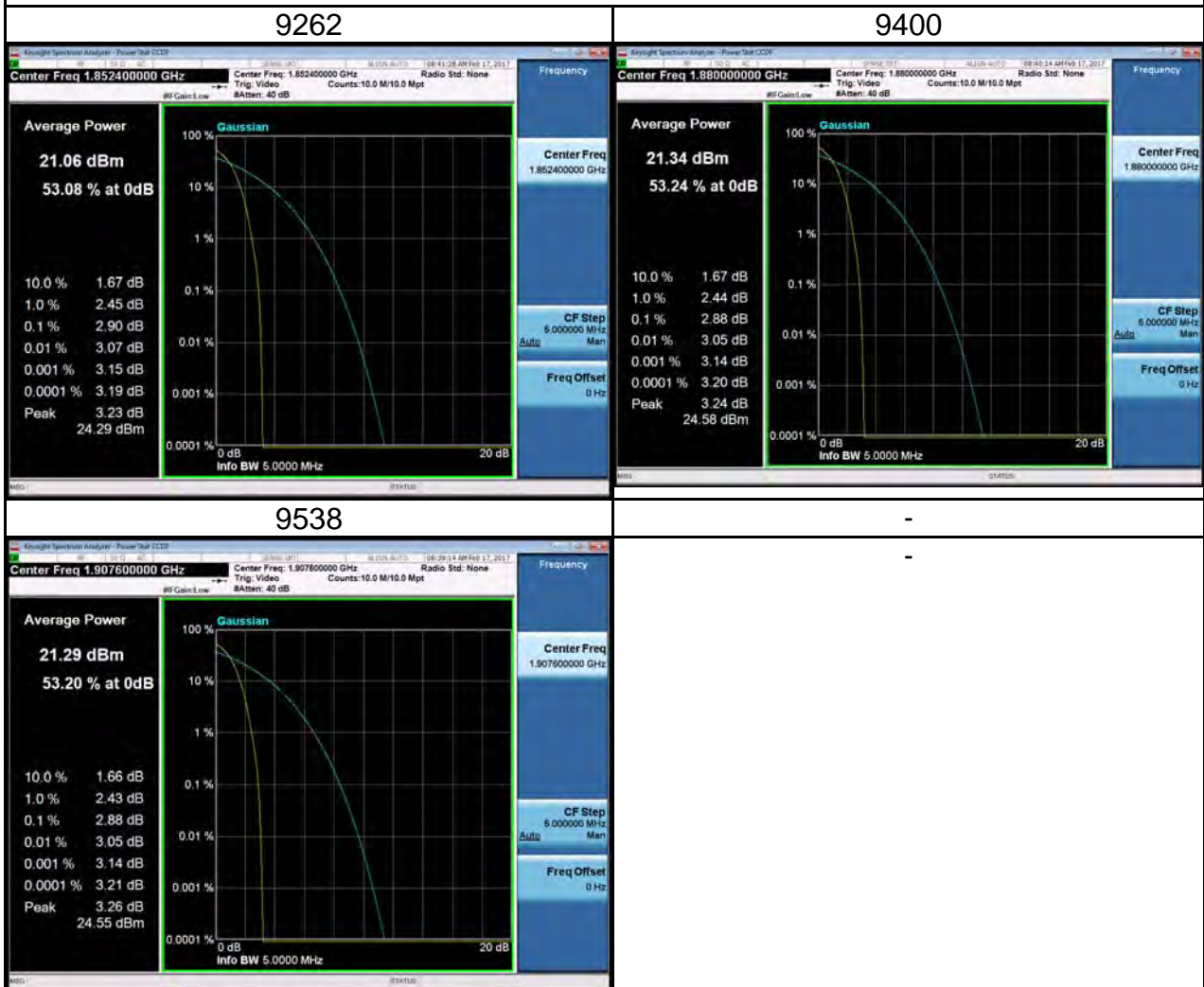

WCDMA_HSUPA Band 2 Spectrum Plot

9262

9400

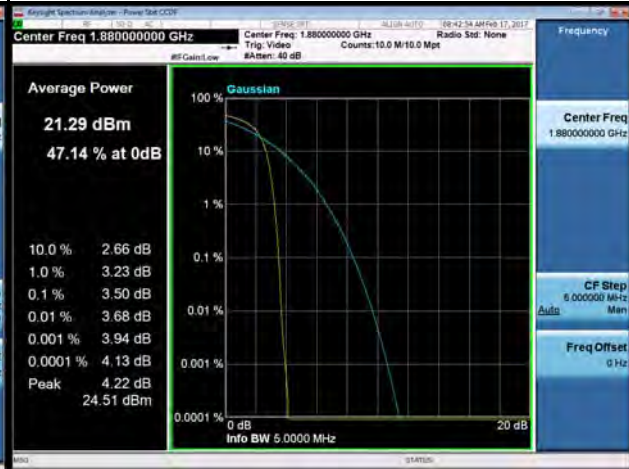

9538

-

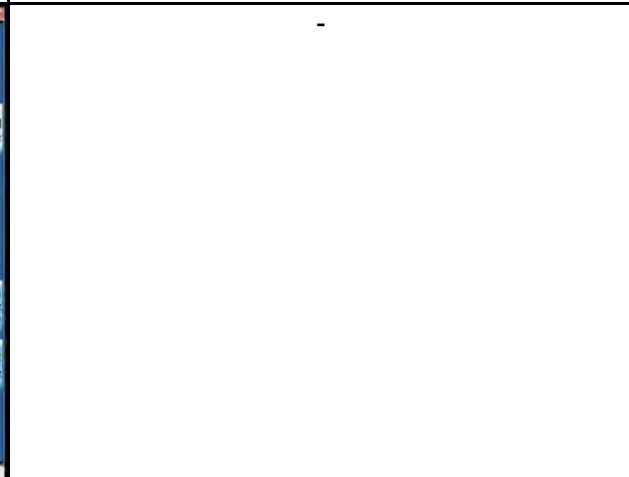

LTE Band 2 Spectrum Plot_1.4M

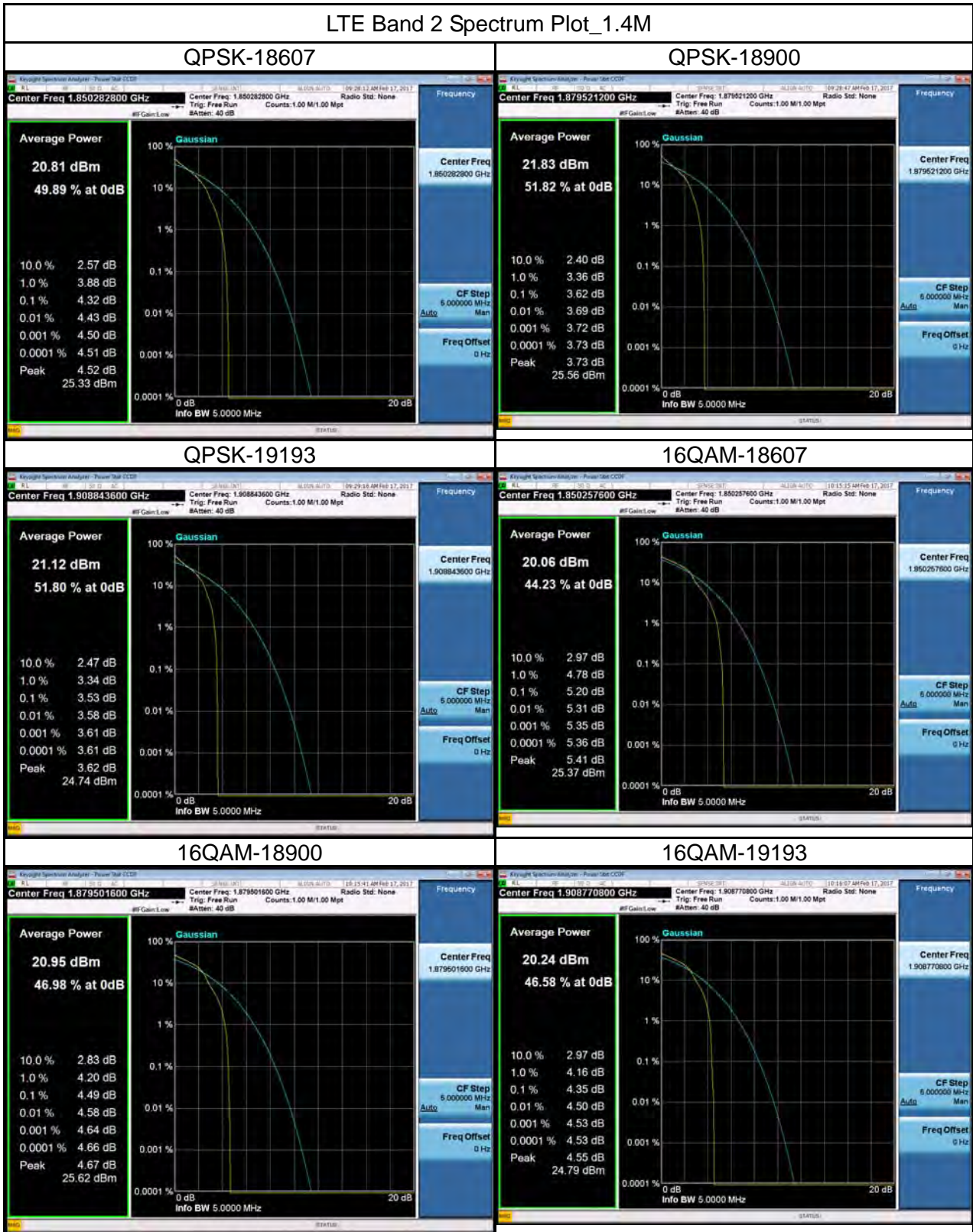

LTE Band 2 Spectrum Plot_3M



LTE Band 2 Spectrum Plot_5M

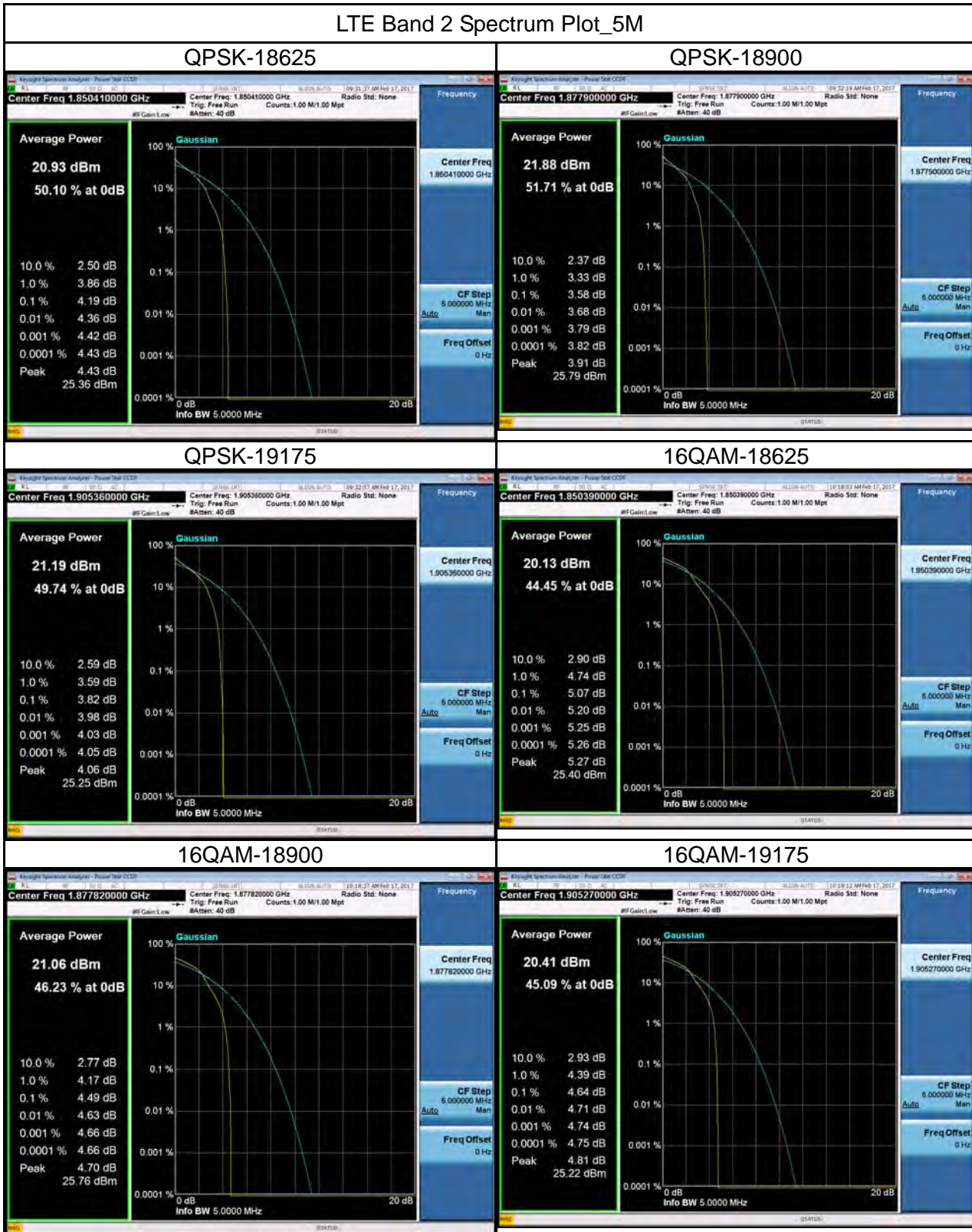

LTE Band 2 Spectrum Plot_10M

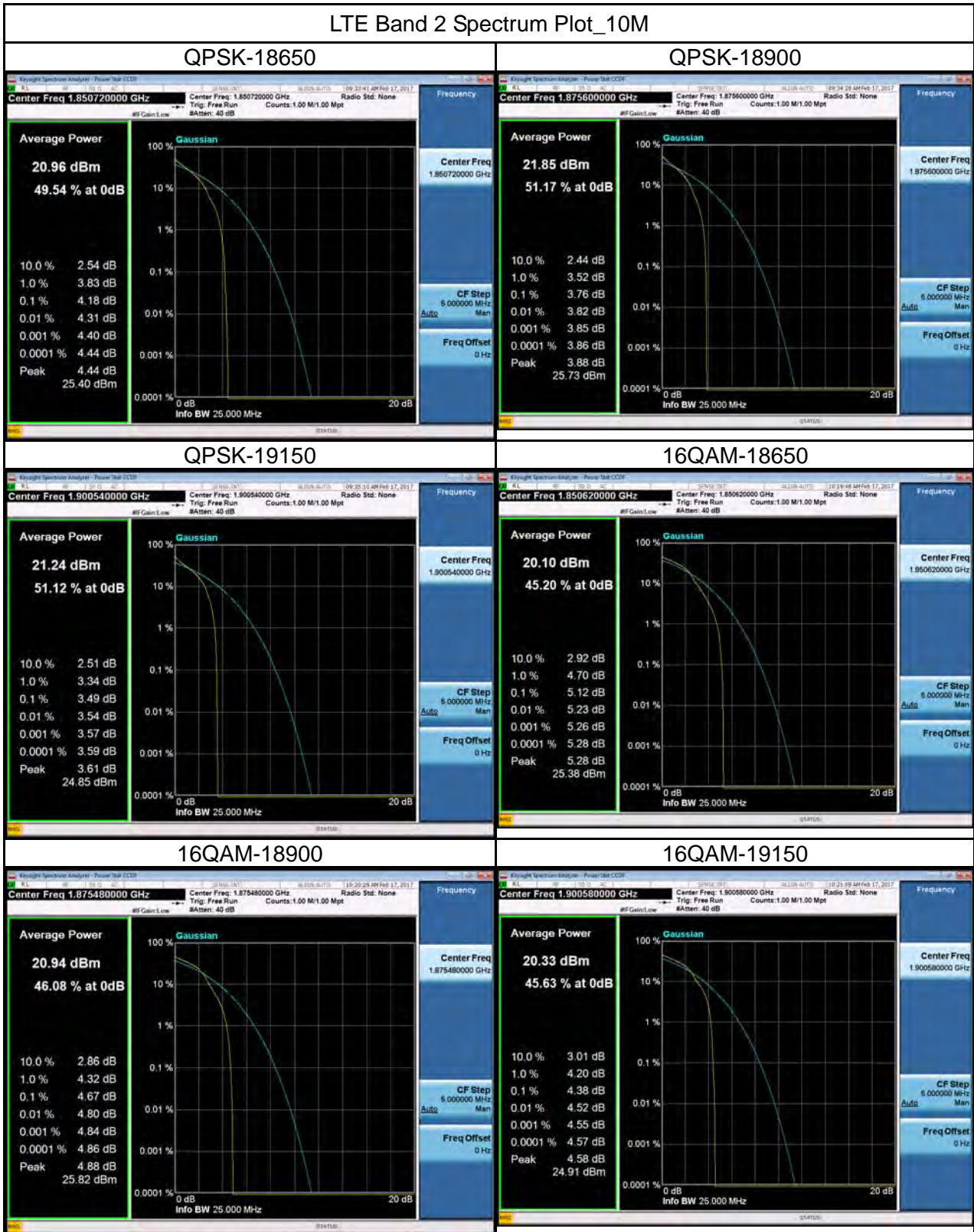

LTE Band 2 Spectrum Plot_15M



LTE Band 2 Spectrum Plot_20M

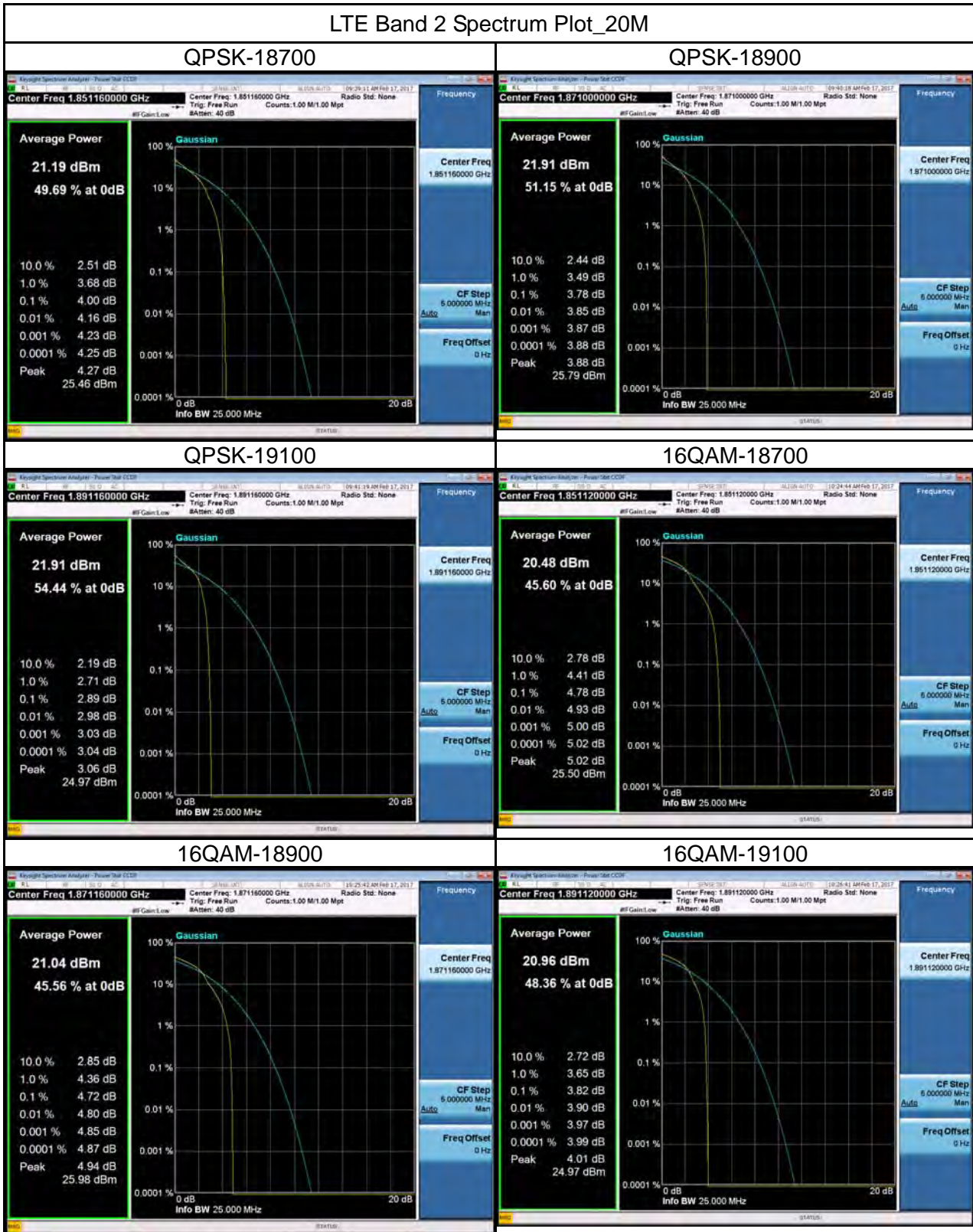

ATTACHMENT G - FREQUENCY STABILITY

Test Mode:	DCS1900_CH661
------------	---------------

Temperature vs. Frequency Stability

Temperature(°C)	Frequency Error (Hz)	Frequency Error (ppm)	Limit(ppm)
0	6.37	0.003442871	2.5
5	8.45	0.004567074	2.5
10	9.02	0.004875149	2.5
15	8.67	0.00468598	2.5
20	6.54	0.003534753	2.5
25	6.53	0.003529348	2.5
30	7.29	0.003940115	2.5
35	6.21	0.003356394	2.5
Max. Deviation (ppm)	9.02	0.004875149	2.5

Voltage vs. Frequency Stability

Voltage(Volts)	Frequency Error (Hz)	Frequency Error (ppm)	Limit(ppm)
3.8	6.34	0.003426657	2.5
4	6.81	0.003680683	2.5
4.2	7.25	0.003918495	2.5
Max. Deviation (ppm)	7.25	0.003918495	2.5

Test Mode:	WCDMA Band 2_CH9400
------------	---------------------

Temperature vs. Frequency Stability

Temperature(°C)	Frequency Error (Hz)	Frequency Error (ppm)	Limit(ppm)
0	9.32	0.004957447	2.5
5	5.67	0.003015957	2.5
10	8.21	0.004367021	2.5
15	6.64	0.003531915	2.5
20	5.21	0.002771277	2.5
25	4.89	0.002601064	2.5
30	6.59	0.003505319	2.5
35	6.63	0.003526596	2.5
Max. Deviation (ppm)	9.32	0.004957447	2.5

Voltage vs. Frequency Stability

Voltage(Volts)	Frequency Error (Hz)	Frequency Error (ppm)	Limit(ppm)
3.8	5.99	0.00318617	2.5
4	6.08	0.003234043	2.5
4.2	7.56	0.004021277	2.5
Max. Deviation (ppm)	7.56	0.004021277	2.5

Test Mode:	LTE Band 2_CH18900_1.4M
------------	-------------------------

Temperature vs. Frequency Stability

Temperature(°C)	Frequency Error (Hz)	Frequency Error (ppm)	Limit(ppm)
0	2.36	0.001255319	2.5
5	-3.65	0.001941489	2.5
10	2.58	0.00137234	2.5
15	5.88	0.00312766	2.5
20	-6.10	0.003244681	2.5
25	3.32	0.001765957	2.5
30	-4.48	0.002382979	2.5
35	3.67	0.001952128	2.5
Max. Deviation (ppm)	6.10	0.003244681	2.5

Voltage vs. Frequency Stability

Voltage(Volts)	Frequency Error (Hz)	Frequency Error (ppm)	Limit(ppm)
3.8	3.56	0.001893617	2.5
4	-2.48	0.001319149	2.5
4.2	3.86	0.002053191	2.5
Max. Deviation (ppm)	3.86	0.002053191	2.5

Test Mode:	LTE Band 2_CH18900_3M
------------	-----------------------

Temperature vs. Frequency Stability

Temperature(°C)	Frequency Error (Hz)	Frequency Error (ppm)	Limit(ppm)
0	5.22	0.002776596	2.5
5	-6.21	0.003303191	2.5
10	3.41	0.00181383	2.5
15	-1.87	0.000994681	2.5
20	1.26	0.000670213	2.5
25	3.65	0.001941489	2.5
30	2.88	0.001531915	2.5
35	-3.77	0.002005319	2.5
Max. Deviation (ppm)	6.21	0.003303191	2.5

Voltage vs. Frequency Stability

Voltage(Volts)	Frequency Error (Hz)	Frequency Error (ppm)	Limit(ppm)
3.8	2.56	0.001361702	2.5
4	5.03	0.002675532	2.5
4.2	-1.28	0.000680851	2.5
Max. Deviation (ppm)	5.03	0.002675532	2.5

Test Mode:	LTE Band 2_CH18900_5M
------------	-----------------------

Temperature vs. Frequency Stability

Temperature(°C)	Frequency Error (Hz)	Frequency Error (ppm)	Limit(ppm)
0	5.54	0.002946809	2.5
5	2.69	0.001430851	2.5
10	-5.31	0.002824468	2.5
15	5.26	0.002797872	2.5
20	4.88	0.002595745	2.5
25	-4.69	0.002494681	2.5
30	-3.99	0.00212234	2.5
35	2.78	0.001478723	2.5
Max. Deviation (ppm)	5.54	0.002946809	2.5

Voltage vs. Frequency Stability

Voltage(Volts)	Frequency Error (Hz)	Frequency Error (ppm)	Limit(ppm)
3.8	5.56	0.002957447	2.5
4	-2.69	0.001430851	2.5
4.2	2.87	0.001526596	2.5
Max. Deviation (ppm)	5.56	0.002957447	2.5

Test Mode:	LTE Band 2_CH18900_10M
------------	------------------------

Temperature vs. Frequency Stability

Temperature(°C)	Frequency Error (Hz)	Frequency Error (ppm)	Limit(ppm)
0	3.67	0.001952128	2.5
5	2.56	0.001361702	2.5
10	5.17	0.00275	2.5
15	-2.33	0.001239362	2.5
20	-3.52	0.00187234	2.5
25	4.69	0.002494681	2.5
30	-2.90	0.001542553	2.5
35	5.81	0.003090426	2.5
Max. Deviation (ppm)	5.81	0.003090426	2.5

Voltage vs. Frequency Stability

Voltage(Volts)	Frequency Error (Hz)	Frequency Error (ppm)	Limit(ppm)
3.8	-3.88	0.00206383	2.5
4	-4.37	0.002324468	2.5
4.2	5.24	0.002787234	2.5
Max. Deviation (ppm)	5.24	0.002787234	2.5

Test Mode:	LTE Band 2_CH18900_15M
------------	------------------------

Temperature vs. Frequency Stability

Temperature(°C)	Frequency Error (Hz)	Frequency Error (ppm)	Limit(ppm)
0	3.37	0.001792553	2.5
5	4.08	0.002170213	2.5
10	5.60	0.002978723	2.5
15	-5.98	0.003180851	2.5
20	-2.37	0.001260638	2.5
25	1.92	0.001021277	2.5
30	2.33	0.001239362	2.5
35	1.87	0.000994681	2.5
Max. Deviation (ppm)	5.98	0.003180851	2.5

Voltage vs. Frequency Stability

Voltage(Volts)	Frequency Error (Hz)	Frequency Error (ppm)	Limit(ppm)
3.8	6.31	0.003356383	2.5
4	1.88	0.001000000	2.5
4.2	3.62	0.001925532	2.5
Max. Deviation (ppm)	6.31	0.003356383	2.5

Test Mode:	LTE Band 2_CH18900_20M
------------	------------------------

Temperature vs. Frequency Stability

Temperature(°C)	Frequency Error (Hz)	Frequency Error (ppm)	Limit(ppm)
-30	-2.58	0.00137234	2.5
-20	-3.66	0.001946809	2.5
-10	4.21	0.002239362	2.5
0	1.84	0.000978723	2.5
10	5.90	0.003138298	2.5
20	6.01	0.003196809	2.5
30	-1.83	0.000973404	2.5
40	3.01	0.001601064	2.5
Max. Deviation (ppm)	6.01	0.003196809	2.5

Voltage vs. Frequency Stability

Voltage(Volts)	Frequency Error (Hz)	Frequency Error (ppm)	Limit(ppm)
3.8	2.37	0.001260638	2.5
4	5.88	0.00312766	2.5
4.2	-3.59	0.001909574	2.5
Max. Deviation (ppm)	5.88	0.00312766	2.5