

# FCC Radio Test Report

## FCC ID: QISCRO-LX3

This report concerns (check one): Original Grant Class I Change

**Project No.** : 1701C155A  
**Equipment** : Smart Phone  
**Model Name** : CRO-L03,CRO-L23  
**Applicant** : Huawei Technologies Co., Ltd.  
**Address** : Administration Building, Headquarters of Huawei Technologies Co., Ltd., Bantian, Longgang District, Shenzhen, 518129, P.R.C

**Date of Receipt** : Jan. 18, 2017  
**Date of Test** : Jan. 18, 2017 ~ Feb. 27, 2017  
**Issued Date** : Mar. 23, 2017  
**Tested by** : BTL Inc.

**Technical Engineer** : Shawn Xiao  
(Shawn Xiao)

**Authorized Signatory** : Steven Lu  
(Steven Lu)

# **B T L I N C .**

No.3,Jinshagang 1st Road, Shixia,Dalang Town, Dongguan,  
Guangdong, China.

TEL: +86-769-8318-3000 FAX: +86-769-8319-6000

**Declaration**

**BTL** represents to the client that testing is done in accordance with standard procedures as applicable and that test instruments used has been calibrated with standards traceable to international standard(s) and/or national standard(s).

**BTL's** reports apply only to the specific samples tested under conditions. It is manufacture's responsibility to ensure that additional production units of this model are manufactured with the identical electrical and mechanical components. **BTL** shall have no liability for any declarations, inferences or generalizations drawn by the client or others from **BTL** issued reports.

**BTL's** report must not be used by the client to claim product certification, approval, or endorsement by NVLAP, NIST, or any agency of the Federal Government.

This report is the confidential property of the client. As a mutual protection to the clients, the public and **BTL-self**, extracts from the test report shall not be reproduced except in full with **BTL's** authorized written approval.

**BTL's** laboratory quality assurance procedures are in compliance with the **ISO Guide17025** requirements, and accredited by the conformity assessment authorities listed in this test report.

**Limitation**

For the use of the authority's logo is limited unless the Test Standard(s)/Scope(s)/Item(s) mentioned in this test report is (are) included in the conformity assessment authorities acceptance respective.

<b>Table of Contents</b>	<b>Page</b>
<b>REPORT ISSUED HISTORY</b>	<b>5</b>
<b>1 . CERTIFICATION</b>	<b>6</b>
<b>2 . SUMMARY OF TEST RESULTS</b>	<b>7</b>
2.1 TEST FACILITY	8
2.2 MEASUREMENT UNCERTAINTY	8
<b>3 . GENERAL INFORMATION</b>	<b>9</b>
3.1 GENERAL DESCRIPTION OF EUT	9
3.2 DESCRIPTION OF TEST MODES AND TEST CONDITION	11
3.3 BLOCKDIGRAMSHOWINGTHECONFIGURATIONOFSYSTEMTESTED FOR RADIATED	14
3.4 DESCRIPTION OF SUPPORT UNITS	14
<b>4 . TEST RESULT</b>	<b>15</b>
4.1 OUTPUT POWER MEASUREMENT	15
4.1.1 LIMIT	15
4.1.2 TEST PROCEDURE	15
4.1.3 TESTSETUP LAYOUT	15
4.1.4 TEST DEVIATION	15
4.1.5 TEST RESULTS	15
4.2 OCCUPIED BANDWIDTH MEASUREMENT	16
4.2.1 TEST PROCEDURE	16
4.2.2 TEST SETUP LAYOUT	16
4.2.3 TEST DEVIATION	16
4.2.4 TEST RESULTS	16
4.3 CONDUCTED EMISSIONS MEASUREMENT	17
4.3.1 LIMIT	17
4.3.2 TEST PROCEDURES	17
4.3.3 TESTSETUP LAYOUT	17
4.3.4 TESTDEVIATION	17
4.3.5 TEST RESULTS	17
4.4 RADIATED EMISSIONS MEASUREMENT	18
4.4.1 LIMIT	18
4.4.2 TEST PROCEDURES	18
4.4.3 TESTSETUP LAYOUT	18
4.4.4 TESTDEVIATION	18
4.4.5 TEST RESULTS	18
4.5 BAND EDGE MEASUREMENT	19
4.5.1 LIMIT	19

<b>Table of Contents</b>	<b>Page</b>
<b>4.5.2 TEST PROCEDURES</b>	<b>19</b>
<b>4.5.3 TESTSETUP LAYOUT</b>	<b>19</b>
<b>4.5.4 TESTDEVIATION</b>	<b>19</b>
<b>4.5.5 TEST RESULTS</b>	<b>19</b>
<b>4.6 PEAK TO AVERAGE RATIO MEASUREMENT</b>	<b>20</b>
<b>4.6.1 LIMIT</b>	<b>20</b>
<b>4.6.2 TEST PROCEDURES</b>	<b>20</b>
<b>4.6.3 TESTSETUP LAYOUT</b>	<b>20</b>
<b>4.6.4 TESTDEVIATION</b>	<b>20</b>
<b>4.6.5 TEST RESULTS</b>	<b>20</b>
<b>4.7 FREQUENCY STABILITY MEASUREMENT</b>	<b>21</b>
<b>4.7.1 LIMIT</b>	<b>21</b>
<b>4.7.2 TEST PROCEDURES</b>	<b>21</b>
<b>4.7.3 TESTSETUP LAYOUT</b>	<b>21</b>
<b>4.7.4 TESTDEVIATION</b>	<b>21</b>
<b>4.7.5 TEST RESULTS</b>	<b>21</b>
<b>5. LIST OF MEASUREMENT EQUIPMENTS</b>	<b>22</b>
<b>ATTACHMENT A - OUTPUT POWER</b>	<b>24</b>
<b>ATTACHMENT B - OCCUPIED BANDWIDTH</b>	<b>33</b>
<b>ATTACHMENT C - CONDUCTED EMISSIONS</b>	<b>54</b>
<b>ATTACHMENT D - RADIATED EMISSION</b>	<b>65</b>
<b>ATTACHMENT E - BAND EDGE</b>	<b>110</b>
<b>ATTACHMENT F - PEAK TO AVERAGE RATIO</b>	<b>121</b>
<b>ATTACHMENT G - FREQUENCY STABILITY</b>	<b>132</b>

### REPORT ISSUED HISTORY

Issued No.	Description	Issued Date
BTL-FCCP-6-1701C155	Original Report.	Feb. 28, 2017
BTL-FCCP-6-1701C155A	Compared with the original report (BTL-FCCP-6-1701C155), the model CRO-L23 is added and differences please see the below table. According to the differences description below table, CRO-L23 shares the same test data of CRO-L03 of the same bands which does not affect the test results of the test report.	Mar. 23, 2017

Model	CRO-L03	CRO-L23
Brand	HUAWEI	HUAWEI
2G Frequency	GSM/GPRS/EDEG 850//1900	GSM/GPRS/EDEG 850//1900
3G Frequency	UMTS: B2/B5	UMTS: B2/B5
4G Frequency	FDD-LTE:B2/B4/B5/B7	FDD-LTE:B2/B4/B5/B7
Hardware version	The same	The same
Software version	The difference	The difference
SIM Card	Single (Hardware GPIO level is tested by software to identify odd and even cards.)	Double Hardware GPIO level is tested by software to identify odd and even cards. The dual-slot is added through the hardware, others are the same; The only difference between CRO-L03 and CRO-L23 is: CRO-L03 is single SIM point, and the CRO-L23 is double SIM points.
Dimensions	The same	The same
Appearance	The same	The same
main antenna	The same	The same
BT/Wi-Fi antenna	The same	The same
GPS antenna	The same	The same
PA(GSM)	The same	The same
PA(UMTS/FDD)	The same	The same

## 1. CERTIFICATION

Equipment : Smart Phone  
Brand Name : HUAWEI  
Model Name : CRO-L03,CRO-L23  
Applicant : Huawei Technologies Co., Ltd.  
Manufacturer: Huawei Technologies Co., Ltd  
Address : Administration Building, Headquarters of Huawei Technologies Co., Ltd.,  
Bantian, Longgang District Shenzhen China  
Factory : Huawei Technologies Co., Ltd  
Address : Administration Building, Headquarters of Huawei Technologies Co., Ltd.,  
Bantian, Longgang District Shenzhen China  
Date of Test : Jan. 18, 2017 ~ Feb. 27, 2017  
Test Sample : Engineering Sample  
Standard(s) : 47 CFR FCC Part 27  
47 CFR FCC Part 2 & ANSI/TIA-603-D-2010

The above equipment has been tested and found compliance with the requirement of the relative standards by BTL Inc.

The test data, data evaluation, and equipment configuration contained in our test report (Ref No. BTL-FCCP-6-1701C155A) were obtained utilizing the test procedures, test instruments, test sites that has been accredited by the Authority of TAF according to the ISO-17025 quality assessment standard and technical standard(s).

**Test results included in this report is only for the LTE Band 4, 7 part.**

## 2. SUMMARY OF TEST RESULTS

Test procedures according to the technical standard(s):

FCC Part 27 & Part 2			
Standard(s) Section	Test Item	Judgment	Tested By
2.1046 27.50(d)(4)	Radiated power	PASS	Paul Li
2.1046 27.50(d)(4)	Conducted Output Power	PASS	Paul Li
2.1049 27.53(h)	Occupied Bandwidth	PASS	Paul Li
2.1051 27.53(h)	Conducted Spurious Emissions	PASS	Paul Li
2.1053 27.53(h)	Radiated Spurious Emissions	PASS	Biao Chen
27.53(h)	Band Edge Measurements	PASS	Paul Li
27.50	Peak To Average Ratio	PASS	Paul Li
2.1055 27.54	Frequency Stability	PASS	Paul Li

**NOTE:**

(1) "N/A" denotes test is not applicable to this device.

## 2.1 TEST FACILITY

The test facilities used to collect the test data in this report is at the location of No.3,Jinshagang 1st Road, Shixia, Dalang Town, Dongguan, Guangdong, China.

BTL's test firm number for FCC: 319330

## 2.2 MEASUREMENT UNCERTAINTY

Where relevant, the following measurement uncertainty levels have been estimated for tests performed on the EUT as specified in CISPR 16-4-2. The BTL measurement uncertainty is less than the CISPR 16-4-2  $U_{CISPR}$  requirement.

The reported uncertainty of measurement  $y \pm U$ , where expanded uncertainty  $U$  is based on a standard uncertainty multiplied by a coverage factor of  $k=2$ , providing a level of confidence of approximately 95 %.

Test Site	Method	Measurement Frequency Range	Ant. H / V	U,(dB)
DG-CB03 (3m)	CISPR	9KHz ~ 30MHz	V	3.79
		9KHz ~ 30MHz	H	3.57
		30MHz ~ 200MHz	V	3.82
		30MHz ~ 200MHz	H	3.78
		200MHz ~ 1,000MHz	V	4.10
		200MHz ~ 1,000MHz	H	4.06

Test Site	Method	Measurement Frequency Range	Ant. H / V	U,(dB)
DG-CB03 (3m)	CISPR	1GHz ~ 18GHz	V	3.12
		1GHz ~ 18GHz	H	3.68

Test Site	Method	Measurement Frequency Range	Ant. H / V	U,(dB)
DG-CB03 (1m)	CISPR	18GHz ~ 40GHz	V	4.15
		18GHz ~ 40GHz	H	4.14

Note: Unless specifically mentioned, the uncertainty of measurement has not been taken into account to declare the compliance or non-compliance to the specification.



### 3. GENERAL INFORMATION

#### 3.1 GENERAL DESCRIPTION OF EUT

Equipment	Smart Phone			
Brand Name	HUAWEI			
Model Name	CRO-L03,CRO-L23			
Model Difference	Please refer to page 5.			
Modulation Type	LTE	QPSK, 16QAM		
Operation Frequency	LTE 4 (Channel Bandwidth: 1.4MHz)	1710.7 ~ 1754.3 MHz		
	LTE 4 (Channel Bandwidth: 3MHz)	1711.5 ~ 1753.5 MHz		
	LTE 4 (Channel Bandwidth: 5MHz)	1712.5 ~ 1752.5 MHz		
	LTE 4 (Channel Bandwidth: 10MHz)	1715.0 ~ 1750.0 MHz		
	LTE 4 (Channel Bandwidth: 15MHz)	1717.5 ~ 1747.5 MHz		
	LTE 4 (Channel Bandwidth: 20MHz)	1720.0 ~ 1745.0 MHz		
	LTE 7 (Channel Bandwidth: 5MHz)	2502.5 ~ 2567.5 MHz		
	LTE 7 (Channel Bandwidth: 10MHz)	2505.0 ~ 2565.0 MHz		
	LTE 7 (Channel Bandwidth: 15MHz)	2507.5 ~ 2562.5 MHz		
LTE 7 (Channel Bandwidth: 20MHz)	2510.0 ~ 2560.0 MHz			
Max. EIRP Power	LTE 4 (Channel Bandwidth: 1.4MHz)	QPSK	20.27	dBm
		16QAM	19.59	dBm
	LTE 4 (Channel Bandwidth: 3MHz)	QPSK	20.27	dBm
		16QAM	19.09	dBm
	LTE 4 (Channel Bandwidth: 5MHz)	QPSK	20.27	dBm
		16QAM	19.35	dBm
	LTE 4 (Channel Bandwidth: 10MHz)	QPSK	20.21	dBm
		16QAM	19.15	dBm
	LTE 4 (Channel Bandwidth: 15MHz)	QPSK	20.04	dBm
		16QAM	19.15	dBm
	LTE 4 (Channel Bandwidth: 20MHz)	QPSK	20.29	dBm
		16QAM	19.84	dBm
	LTE 7 (Channel Bandwidth: 5MHz)	QPSK	20.31	dBm
		16QAM	19.32	dBm
	LTE 7 (Channel Bandwidth: 10MHz)	QPSK	20.30	dBm
		16QAM	19.10	dBm
	LTE 7 (Channel Bandwidth: 15MHz)	QPSK	20.32	dBm
		16QAM	19.31	dBm
LTE 7 (Channel Bandwidth: 20MHz)	QPSK	20.30	dBm	
	16QAM	19.34	dBm	
Antenna Type	Internal Antenna			
Antenna Gain	1.83 dBi for LTE 5, 2.39 dBi for LTE 7			
Hardware Version	HL1CROM			

IMEI No.	CRO-L03	Radiated	862555030018808
		Conducted	862555030018808
	CRO-L23	Radiated	SIM 1:862556030020463 SIM 2:862556030520462
Power Source	#1 DC Voltage supplied from AC/DC adapter. #2 Battery Supplied.		
Power Rating	#1:AC 100–240V 50/60Hz DC 5V 1A #2:DC 3.82V 2200mAh		

Note:

1. For a more detailed features description, please refer to the manufacturer's specifications or the user's manual.

### 3.2 DESCRIPTION OF TEST MODES AND TEST CONDITION

Following channel(s) was (were) selected for the final test as listed below:

LTE BAND 4					
Test Item	Available Channel	Tested Channel	Channel Bandwidth	Modulation	Mode
EIRP	19957 to 20393	19957, 20175, 20393	1.4MHz	QPSK, 16QAM	1 RB / 0 RB Offset
	19965 to 20385	19965, 20175, 20385	3MHz	QPSK, 16QAM	1 RB / 0 RB Offset
	19975 to 20375	19975, 20175, 20375	5MHz	QPSK, 16QAM	1 RB / 0 RB Offset
	20000 to 20350	20000, 20175, 20350	10MHz	QPSK, 16QAM	1 RB / 0 RB Offset
	20025 to 20325	20025, 20175, 20325	15MHz	QPSK, 16QAM	1 RB / 0 RB Offset
	20050 to 20300	20050, 20175, 20300	20MHz	QPSK, 16QAM	1 RB / 0 RB Offset
Occupied Bandwidth	19957 to 20393	19957, 20175, 20393	1.4MHz	QPSK, 16QAM	6 RB / 0 RB Offset
	19965 to 20385	19965, 20175, 20385	3MHz	QPSK, 16QAM	15 RB / 0 RB Offset
	19975 to 20375	19975, 20175, 20375	5MHz	QPSK, 16QAM	25 RB / 0 RB Offset
	20000 to 20350	20000, 20175, 20350	10MHz	QPSK, 16QAM	50 RB / 0 RB Offset
	20025 to 20325	20025, 20175, 20325	15MHz	QPSK, 16QAM	75 RB / 0 RB Offset
	20050 to 20300	20050, 20175, 20300	20MHz	QPSK, 16QAM	100 RB / 0 RB Offset
Conducted Emission	19957 to 20393	20175	1.4MHz	QPSK	1 RB / 0 RB Offset
	19965 to 20385	20175	3MHz	QPSK	1 RB / 0 RB Offset
	19975 to 20375	20175	5MHz	QPSK	1 RB / 0 RB Offset
	20000 to 20350	20175	10MHz	QPSK	1 RB / 0 RB Offset
	20025 to 20325	20175	15MHz	QPSK	1 RB / 0 RB Offset
	20050 to 20300	20175	20MHz	QPSK	1 RB / 0 RB Offset
Radiated Emission	19957 to 20393	20175	1.4MHz	QPSK	1 RB / 0 RB Offset
	20050 to 20300	20175	20MHz	QPSK	1 RB / 0 RB Offset

LTE BAND 4						
Test Item	Available Channel	Tested Channel	Channel Bandwidth	Modulation	Mode	
Band Edge	19957 to 20393	19957	1.4MHz	QPSK	1 RB / 0 RB Offset	
		20393	1.4MHz	QPSK	6 RB / 0 RB Offset	
	19965 to 20385	19965	3MHz	QPSK	1 RB / 5 RB Offset	
		20385	3MHz	QPSK	6 RB / 0 RB Offset	
	19975 to 20375	19975	5MHz	QPSK	1 RB / 0 RB Offset	
		20375	5MHz	QPSK	15 RB / 0 RB Offset	
	20000 to 20350	20000	10MHz	QPSK	1 RB / 14 RB Offset	
		20350	10MHz	QPSK	15 RB / 0 RB Offset	
	20025 to 20325	20025	15MHz	QPSK	1 RB / 0 RB Offset	
		20325	15MHz	QPSK	25 RB / 0 RB Offset	
	20050 to 20300	20050	20MHz	QPSK	1 RB / 24 RB Offset	
		20300	20MHz	QPSK	25 RB / 0 RB Offset	
	Peak To Average Ratio	19957 to 20393	19957, 20175, 20393	1.4MHz	QPSK, 16QAM	1 RB / 0 RB Offset
		19965 to 20385	19965, 20175, 20385	3MHz	QPSK, 16QAM	1 RB / 0 RB Offset
		19975 to 20375	19975, 20175, 20375	5MHz	QPSK, 16QAM	1 RB / 0 RB Offset
		20000 to 20350	20000, 20175, 20350	10MHz	QPSK, 16QAM	1 RB / 0 RB Offset
20025 to 20325		20025, 20175, 20325	15MHz	QPSK, 16QAM	1 RB / 0 RB Offset	
20050 to 20300		20050, 20175, 20300	20MHz	QPSK, 16QAM	1 RB / 0 RB Offset	
Frequency Stability	19957 to 20393	20175	1.4MHz	QPSK	1 RB / 0 RB Offset	
	19965 to 20385	20175	3MHz	QPSK	1 RB / 0 RB Offset	
	19975 to 20375	20175	5MHz	QPSK	1 RB / 0 RB Offset	
	20000 to 20350	20175	10MHz	QPSK	1 RB / 0 RB Offset	
	20025 to 20325	20175	15MHz	QPSK	1 RB / 0 RB Offset	
	20050 to 20300	20175	20MHz	QPSK	1 RB / 0 RB Offset	

LTE BAND 7						
Test Item	Available Channel	Tested Channel	Channel Bandwidth	Modulation	Mode	
EIRP	20775 to 21425	20775, 21100, 21425	5MHz	QPSK, 16QAM	1 RB / 0 RB Offset	
	20800 to 21400	20800, 21100, 21400	10MHz	QPSK, 16QAM	1 RB / 0 RB Offset	
	20825 to 21375	20825, 21100, 21375	15MHz	QPSK, 16QAM	1 RB / 0 RB Offset	
	20850 to 21350	20850, 21100, 21350	20MHz	QPSK, 16QAM	1 RB / 0 RB Offset	
Occupied Bandwidth	20775 to 21425	20775, 21100, 21425	5MHz	QPSK, 16QAM	25 RB / 0 RB Offset	
	20800 to 21400	20800, 21100, 21400	10MHz	QPSK, 16QAM	50 RB / 0 RB Offset	
	20825 to 21375	20825, 21100, 21375	15MHz	QPSK, 16QAM	75 RB / 0 RB Offset	
	20850 to 21350	20850, 21100, 21350	20MHz	QPSK, 16QAM	100 RB / 0 RB Offset	
Conducted Emission	20775 to 21425	21100	5MHz	QPSK	1 RB / 0 RB Offset	
	20800 to 21400	21100	10MHz	QPSK	1 RB / 0 RB Offset	
	20825 to 21375	21100	15MHz	QPSK	1 RB / 0 RB Offset	
	20850 to 21350	21100	20MHz	QPSK	1 RB / 0 RB Offset	
Radiated Emission	20775 to 21425	21100	5MHz	QPSK	1 RB / 0 RB Offset	
	20850 to 21350	21100	20MHz <b>(Note)</b>	QPSK	1 RB / 0 RB Offset	
Band Edge	20775 to 21425	20775	5MHz	QPSK	1 RB / 0 RB Offset 25 RB / 0 RB Offset	
		21425	5MHz	QPSK	1 RB / 24 RB Offset 25 RB / 0 RB Offset	
	20800 to 21400	20800	10MHz	QPSK	1 RB / 0 RB Offset 50 RB / 0 RB Offset	
		21400	10MHz	QPSK	1 RB / 49 RB Offset 50 RB / 0 RB Offset	
	20825 to 21375	20825	15MHz	QPSK	1 RB / 0 RB Offset 75 RB / 0 RB Offset	
		21375	15MHz	QPSK	1 RB / 74 RB Offset 75 RB / 0 RB Offset	
	20850 to 21350	20850	20MHz	QPSK	1 RB / 0 RB Offset 100 RB / 0 RB Offset	
		21350	20MHz	QPSK	1 RB / 99 RB Offset 100 RB / 0 RB Offset	
	Peak To Average Ratio	20775 to 21425	20775, 21100, 21425	5MHz	QPSK, 16QAM	1 RB / 0 RB Offset
		20800 to 21400	20800, 21100, 21400	10MHz	QPSK, 16QAM	1 RB / 0 RB Offset
		20825 to 21375	20825, 21100, 21375	15MHz	QPSK, 16QAM	1 RB / 0 RB Offset
		20850 to 21350	20850, 21100, 21350	20MHz	QPSK, 16QAM	1 RB / 0 RB Offset
Frequency Stability	20775 to 21425	21100	5MHz	QPSK	1 RB / 0 RB Offset	
	20800 to 21400	21100	10MHz	QPSK	1 RB / 0 RB Offset	
	20825 to 21375	21100	15MHz	QPSK	1 RB / 0 RB Offset	
	20850 to 21350	21100	20MHz	QPSK	1 RB / 0 RB Offset	

Note: For 18G to 26.5G, the highest bandwidth is worst case and recording in the test report.

**EUT TEST CONDITIONS:**

Test Item	Environmental Conditions	Test Voltage
EIRP	24°C, 63%RH	DC 3.82V
Conducted Output Power	25°C, 65%RH	DC 3.82V
Occupied Bandwidth	25°C, 65%RH	DC 3.82V
Conducted Emission	25°C, 65%RH	DC 3.82V
Radiated Emission	25°C, 60%RH	AC 120V/60Hz
Band Edge	25°C, 65%RH	DC 3.82V
Peak to Average Ratio	25°C, 65%RH	DC 3.82V
Frequency Stability	25°C, 65%RH	DC 3.82V

**3.3 BLOCK DIAGRAM SHOWING THE CONFIGURATION OF SYSTEM TESTED FOR RADIATED**

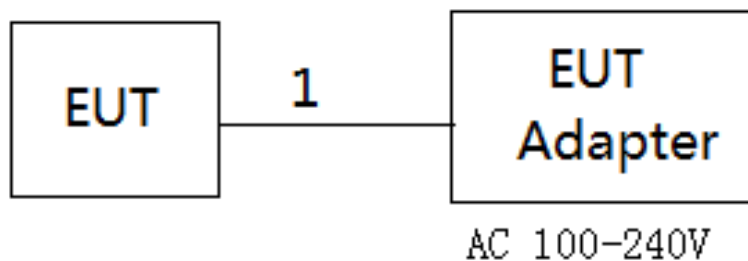

**3.4 DESCRIPTION OF SUPPORT UNITS**

The EUT has been tested as an independent unit together with other necessary accessories or support units. The following support units or accessories were used to form a representative test configuration during the tests.

Item	Equipment	Mfr/Brand	Model/Type No.	FCC ID	Series No.
-	-	-	-	-	-

Item	Shielded Type	Ferrite Core	Length	Note
1	NO	NO	1.2m	USB Cable

## 4. TEST RESULT

### 4.1 OUTPUT POWER MEASUREMENT

#### 4.1.1 LIMIT

Mobile / Portable station are limited to 1 watts e.i.r.p. (LTE 4)

Mobile / Portable station are limited to 2 watts e.i.r.p. (LTE 7)

#### 4.1.2 TEST PROCEDURE

##### EIRP/ERP:

EIRP= Conducted Power +Antenan gain

ERP power=EIPR power-2.15dBi.

##### Conducted Power:

The EUT was set up for the maximum power with GSM, GPRS, EDGE, WCDMA, CDMA, and LTE link data modulation and link up with simulator. Set the EUT to transmit under low, middle and high channel and record the power level shown on simulator.

#### 4.1.3 TESTSETUP LAYOUT

##### Conducted Power Measurement

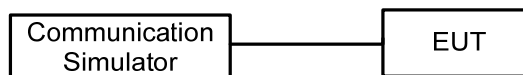

#### 4.1.4 TEST DEVIATION

No deviation

#### 4.1.5 TEST RESULTS

Please refer to the Attachment A.

## 4.2 OCCUPIED BANDWIDTH MEASUREMENT

### 4.2.1 TEST PROCEDURE

The EUT makes a call to the communication simulator. All measurements were done at low, middle and high operational frequency range. The communication simulator station system controlled a EUT to export maximum output power under transmission mode and specific channel frequency. Use OBW measurement function of Spectrum analyzer to measure 99 % occupied bandwidth and 26dB bandwidth.

### 4.2.2 TEST SETUP LAYOUT

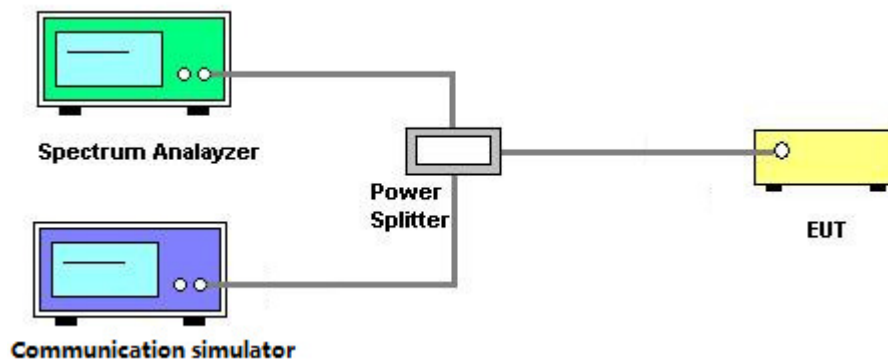

### 4.2.3 TEST DEVIATION

No deviation

### 4.2.4 TEST RESULTS

Please refer to the Attachment B.



### 4.3 CONDUCTED EMISSIONS MEASUREMENT

#### 4.3.1 LIMIT

The power of any emission outside of the authorized operating frequency ranges must be attenuated below the transmitting power (P) by a factor of at least  $43 + 10 \log(P)$  dB. The emission limit equal to -13dBm.

#### 4.3.2 TEST PROCEDURES

1. The testing follows FCC KDB 971168 v02r02 Section 6.0.
2. The EUT was connected to spectrum analyzer and system simulator via a power divider.
3. The band edges of low and high channels for the highest RF powers were measured. Set  $RBW \geq 1\%$  EBW in the 1MHz band immediately outside and adjacent to the band edge.
4. Set spectrum analyzer with RMS detector.
5. The RF fundamental frequency should be excluded against the limit line in the operating frequency band.
6. The limit line is derived from  $43+10\log(P)$ dB below the transmitter power P(Watts)  
 $=P(W)-[43+10\log(P)](dB)$   
 $=[30+10\log(P)](dBm)-[43+10\log(P)](dB)$   
 $=-13dBm$

#### 4.3.3 TESTSETUP LAYOUT

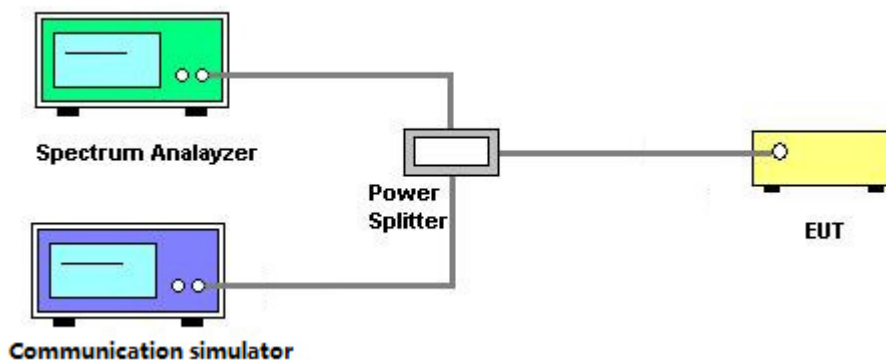

#### 4.3.4 TESTDEVIATION

No deviation

#### 4.3.5 TEST RESULTS

Please refer to the Attachment C.

## 4.4 RADIATED EMISSIONS MEASUREMENT

### 4.4.1 LIMIT

The power of any emission outside of the authorized operating frequency ranges must be attenuated below the transmitting power (P) by a factor of at least  $43 + 10 \log(P)$  dB. The emission limit equal to -13dBm.

### 4.4.2 TEST PROCEDURES

1. Substitution method is used for E.I.R.P measurement. In the semi-anechoic chamber, EUT placed on the 0.8m height of Turn Table, rotated the table around 360 degrees to search the maximum radiation power and receiver antenna shall be rotated vertical and horizontal polarization and moved height from 1m to 4m to find the maximum polar radiated power. The "Read Value" is the spectrum reading the maximum power value.
2. The substitution horn antenna is substituted for EUT at the same position and signals generator export the CW signal to the substitution antenna via a TX cable. Rotated the Turn Table and moved receiving antenna to find the maximum radiation power. Adjust output power level of S.G to get a Value of spectrum reading equal to "Read Value " of step a. Record the power level of S.G
3.  $EIRP = \text{Output power level of S.G} - \text{TX cable loss} + \text{Antenna gain of substitution horn.}$
4. E.R.P power can be calculated form E.I.R.P power by subtracting the gain of dipole,  $E.R.P \text{ power} = E.I.P.R \text{ power} - 2.15\text{dBi.}$
5. The resolution bandwidth and video bandwidth of test receiver/spectrum analyzer is 1MHz/3MHz.

### 4.4.3 TESTSETUP LAYOUT

This test setup layout is the same as that shown in **section 4.1.3.**

### 4.4.4 TESTDEVIATION

No deviation

### 4.4.5 TEST RESULTS

Please refer to the Attachment D.

## 4.5 BAND EDGE MEASUREMENT

### 4.5.1 LIMIT

For operations in the 699-716 , 704-716 and 777-787MHz band, the power of any emission outside a licensee's frequency band(s) of operation shall be attenuated below the transmitter power (P) within the licensed band(s) of operation, measured in watts, by at least  $43 + 10 \log (P)$  dB. Compliance with this provision is based on the use of measurement instrumentation employing a resolution bandwidth of 100 kilohertz or greater.

However, in the 100 kilohertz bands immediately outside and adjacent to a licensee's frequency block, a resolution bandwidth of at least 30 kHz may be employed.

For operations in the 1710–1755 MHz bands, the power of any emission outside a licensee's frequency block shall be attenuated below the transmitter power (P) by at least  $43 + 10 \log_{10}(P)$  dB.

### 4.5.2 TEST PROCEDURES

1. All measurements were done at low and high operational frequency range.
2. The center frequency of spectrum is the band edge frequency and span is 5MHz. RB of the spectrum is 100kHz and VB of the spectrum is 300kHz (WCDMA).
3. The center frequency of spectrum is the band edge frequency and span is 1MHz. RB of the spectrum is 13kHz and VB of the spectrum is 51kHz (LTE Bandwidth 1.4MHz).
4. The center frequency of spectrum is the band edge frequency and span is 1MHz. RB of the spectrum is 30kHz and VB of the spectrum is 100kHz (LTE Bandwidth 3MHz).
5. The center frequency of spectrum is the band edge frequency and span is 1MHz. RB of the spectrum is 100kHz and VB of the spectrum is 300kHz (LTE Bandwidth 5MHz/10MHz).
6. Record the max trace plot into the test report.

### 4.5.3 TESTSETUP LAYOUT

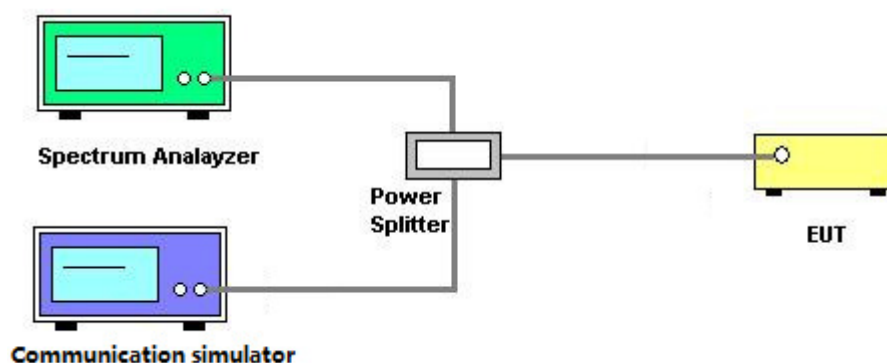

### 4.5.4 TESTDEVIATION

No deviation

### 4.5.5 TEST RESULTS

Please refer to the Attachment E.

## 4.6 PEAK TO AVERAGE RATIO MEASUREMENT

### 4.6.1 LIMIT

In measuring transmissions in this band using an average power technique, the peak to-average ratio (PAR) of the transmission may not exceed 13 dB.

### 4.6.2 TEST PROCEDURES

1. Set resolution/measurement bandwidth  $\geq$  signal's occupied bandwidth;
2. Set the number of counts to a value that stabilizes the measured CCDF curve;
3. Record the maximum PAPR level associated with a probability of 0.1%.

### 4.6.3 TESTSETUP LAYOUT

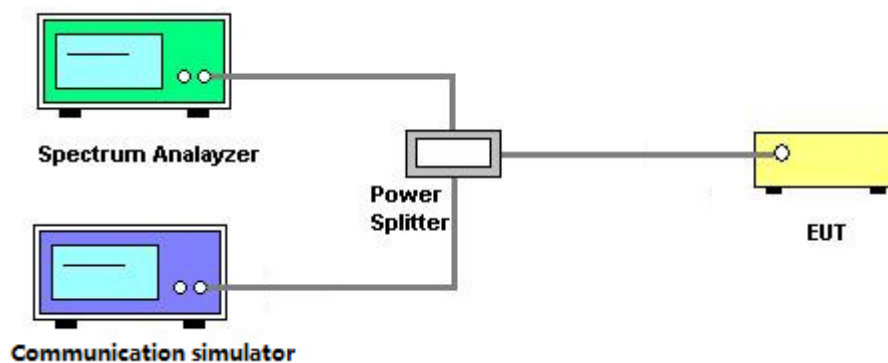

### 4.6.4 TESTDEVIATION

No deviation

### 4.6.5 TEST RESULTS

Please refer to the Attachment F.

## 4.7 FREQUENCY STABILITY MEASUREMENT

### 4.7.1 LIMIT

1.5 ppm is for base and fixed station. 2.5 ppm is for mobile station.

### 4.7.2 TEST PROCEDURES

1. Device is placed at the oven room. The oven room could control the temperatures and humidity. Power warm up is at least 15 min and power applied should perform before recording frequency error.
2. EUT is connected the external power supply to control the DC input power. The test voltage range is from minimum to maximum working voltage. Each step shall be record the frequency error rate.
3. The temperature range step is 10 degrees in this test items. All temperature levels shall be hold the  $\pm 0.5^{\circ}\text{C}$  during the measurement testing. The each temperature step shall be at least 0.5 hours, consider the EUT could be test under the stability condition.
4. The frequency error was recorded frequency error from the communication simulator.

### 4.7.3 TESTSETUP LAYOUT

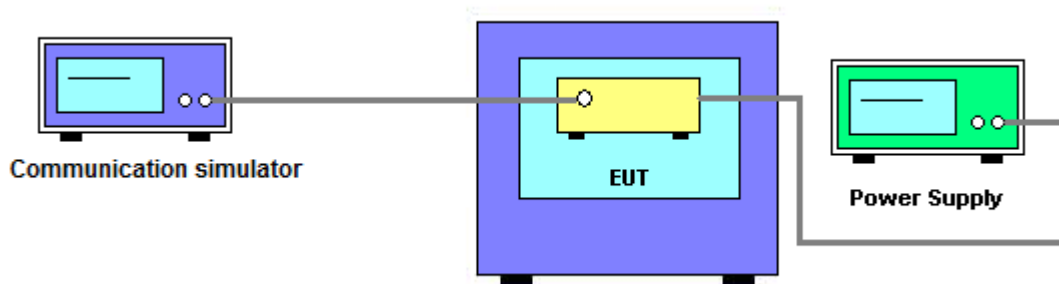

### 4.7.4 TESTDEVIATION

No deviation

### 4.7.5 TEST RESULTS

Please refer to the Attachment G.

## 5. LIST OF MEASUREMENT EQUIPMENTS

Radiated Emission & ERP or EIRP Measurement					
Item	Kind of Equipment	Manufacturer	Type No.	Serial No.	Calibrated until
1	Antenna	Schwarbeck	VULB9160	9160-3232	Mar. 27, 2017
2	Double Ridged Guide Antenna	ETS	3115	75789	Mar. 27, 2017
3	Broad-Band Horn Antenna	Schwarzbeck	BBHA 9170	9170319	Apr. 23, 2017
4	Amplifier	Agilent	8449B	3008A02274	Mar. 10, 2017
5	Amplifier	HP	8447D	2944A09673	Mar. 10, 2017
6	HighPass Filter	Wairwright Instruments Gmbh	WHK 1.5/15G-10ST	11	Mar. 10, 2017
7	Band Reject Filter	Wairwright Instruments Gmbh	WRCG 1710/1785-1690 /1805-60/12SS	38	Feb. 24, 2018
8	Band Reject Filter	Wairwright Instruments Gmbh	WRCG 824/849-810/86 3-60/9SS	7	Feb. 24, 2018
9	Band Reject Filter	Wairwright Instruments Gmbh	WRCG 880/915-860/93 5-60/9SS	14	Feb. 24, 2018
10	Band Reject Filter	Wairwright Instruments Gmbh	WRCG 1850/1910-1830 /1930-60/10SS	17	Feb. 24, 2018
11	HighPass Filter	Wairwright Instruments Gmbh	WHK3.1/18G-10 SS	24	Mar. 10, 2017
12	Microwave Preamplifier With Adaptor	EMC INSTRUMENT	EMC2654045	980039 & HA01	Mar. 27, 2017
13	Receiver	Agilent	N9038A	MY52130039	Sep. 04, 2017
14	wideband radio communication tester	R&S	CMW500	152372	Mar. 27, 2017
15	High pass filter	ZHPF-M1000-4000 -1	ZHPF-M3-12.75 G-3869	B2015073763	Aug. 04, 2017
16	High pass filter	ZHPF-M3-12.75G-3869	ZHPF-M1000-4000-1	B2015073762	Aug. 04, 2017
17	High pass filter	ZHPF-M6-18G-172 7	ZHPF-M6-186-1 727	B2015073764	Aug. 04, 2017
18	Cable	emci	LMR-400(30MHz-1GHz)(8m+5m)	N/A	Jun. 27, 2017
19	Cable	emci	EMC104-SM-S M-12000(12m)	N/A	Jul. 06, 2017
20	Controller	ETS-Lindgren	2090	N/A	N/A
21	Measurement Software	Farad	EZ-EMC Ver.NB-03A1-01	N/A	N/A

Conducted Emission & Band Edge & Occupied Bandwidth Measurement					
Item	Kind of Equipment	Manufacturer	Type No.	Serial No.	Calibrated until
1	EXA Spectrum Analyzer	Agilent	N9010A	MY50520044	Mar. 27, 2017
2	POWER SPLITTER	Mini-Circuits	ZFRSC-123-S +	331000910-1	Feb. 25, 2018
3	wideband radio communication tester	R&S	CMW500	152372	Mar. 27, 2017
4	Cable	N/A	RG316(0.3m)	N/A	Jul. 06, 2017
5	Cable	N/A	RG316(0.3m)	N/A	Jul. 06, 2017

Frequency Stability Measurement					
Item	Kind of Equipment	Manufacturer	Type No.	Serial No.	Calibrated until
1	DC power supply	GW Instek	GPC-3030DN	EK880675	Oct. 13, 2017
2	POWER SPLITTER	Mini-Circuits	ZFRSC-123-S +	331000910-1	Feb. 25, 2018
3	wideband radio communication tester	R&S	CMW500	152372	Mar. 27, 2017
4	Const Temp, & Humidity Chamber	Giant Force	ITH-225-20-S	IAB0309-001	Sep. 04, 2017
5	Cable	N/A	RG316(0.3m)	N/A	Jul. 06, 2017

Remark: "N/A" denotes no model name, serial no. or calibration specified.  
All calibration period of equipment list is one year.

## ATTACHMENT A - OUTPUT POWER



**Conducted Power:**

LTE Band / BW	Modulation	RB Sizer	RB Offset	Low CH	Mid CH	High CH
				19957 CH	20175 CH	20393 CH
				1710.7 MHz	1732.5 MHz	1754.3 MHz
4 / 1.4M	QPSK	1	0	22.36	21.73	20.91
		1	2	22.42	21.73	20.99
		1	5	22.09	21.69	20.92
		3	0	22.27	21.75	21.03
		3	1	22.18	21.66	20.97
		3	3	22.31	21.73	21.04
		6	0	21.22	20.64	20.02
	16QAM	1	0	21.60	21.05	20.09
		1	2	21.74	21.00	20.04
		1	5	21.27	20.99	20.02
		3	0	21.34	20.92	20.22
		3	1	21.26	20.79	20.18
		3	3	21.34	20.83	20.20
		6	0	20.18	19.54	19.16

LTE Band / BW	Modulation	RB Sizer	RB Offset	Low CH	Mid CH	High CH
				19965 CH	20175 CH	20385 CH
				1711.5 MHz	1732.5 MHz	1753.5 MHz
4 / 3M	QPSK	1	0	22.27	21.69	21.01
		1	7	22.30	21.68	21.03
		1	14	22.42	21.68	20.96
		8	0	21.48	20.72	20.07
		8	3	21.28	20.70	20.09
		8	7	21.37	20.70	20.07
		15	0	20.95	20.66	20.06
	16QAM	1	0	21.17	20.98	20.07
		1	7	21.21	20.98	20.09
		1	14	21.24	20.97	20.02
		8	0	20.51	19.81	19.14
		8	3	20.51	19.78	19.15
		8	7	20.46	19.77	19.13
		15	0	20.40	19.72	19.14

LTE Band / BW	Modulation	RB Sizer	RB Offset	Low CH	Mid CH	High CH
				19975 CH	20175 CH	20375 CH
				1712.5 MHz	1732.5 MHz	1752.5 MHz
4 / 5M	QPSK	1	0	22.42	21.79	21.17
		1	12	22.42	21.70	21.13
		1	24	22.01	21.70	21.08
		12	0	21.26	20.74	20.06
		12	6	21.27	20.69	20.04
		12	13	21.25	20.70	20.04
		25	0	21.23	20.65	20.08
	16QAM	1	0	21.50	21.25	20.17
		1	12	21.49	21.16	20.14
		1	24	21.22	21.15	20.09
		12	0	20.57	19.90	19.11
		12	6	20.54	19.87	19.12
		12	13	20.79	19.86	19.07
		25	0	20.46	19.74	19.05

LTE Band / BW	Modulation	RB Sizer	RB Offset	Low CH	Mid CH	High CH
				20000 CH	20175 CH	20350 CH
				1715 MHz	1732.5 MHz	1750 MHz
4 / 10M	QPSK	1	0	22.36	21.84	21.06
		1	24	22.15	21.65	21.03
		1	49	22.13	21.76	21.28
		25	0	21.24	20.74	20.03
		25	12	21.18	20.68	20.04
		25	25	21.16	20.71	20.03
		50	0	21.21	20.73	20.05
	16QAM	1	0	21.25	21.17	20.10
		1	24	21.30	21.00	20.05
		1	49	20.91	21.07	20.02
		25	0	20.45	19.79	19.16
		25	12	20.30	19.72	19.12
		25	25	20.26	19.76	19.13
		50	0	20.33	19.75	19.10

LTE Band / BW	Modulation	RB Sizer	RB Offset	Low CH	Mid CH	High CH
				20025 CH	20175 CH	20325 CH
				1717.5 MHz	1732.5 MHz	1747.5 MHz
4 / 15M	QPSK	1	0	22.19	21.86	21.16
		1	37	22.16	21.52	21.12
		1	74	22.07	21.70	21.02
		36	0	21.23	21.70	20.11
		36	19	21.19	20.93	20.10
		36	39	21.17	20.78	20.07
		75	0	21.22	20.81	20.10
	16QAM	1	0	21.30	21.20	20.54
		1	37	21.01	20.99	20.49
		1	74	21.16	21.09	20.46
		36	0	20.33	20.99	19.09
		36	19	20.30	19.78	19.07
		36	39	20.27	19.80	19.06
		75	0	20.33	19.80	19.11

LTE Band / BW	Modulation	RB Sizer	RB Offset	Low CH	Mid CH	High CH
				20050 CH	20175 CH	20300 CH
				1720 MHz	1732.5 MHz	1745 MHz
4 / 20M	QPSK	1	0	22.44	21.86	21.47
		1	50	22.19	21.13	21.45
		1	99	22.12	21.70	21.21
		50	0	21.25	20.79	20.46
		50	25	21.16	20.81	20.52
		50	50	21.13	20.98	20.62
		100	0	21.15	20.94	20.44
	16QAM	1	0	21.99	21.61	20.79
		1	50	21.70	20.24	20.70
		1	99	21.51	21.22	20.69
		50	0	20.30	19.90	19.37
		50	25	20.22	19.79	19.30
		50	50	20.19	19.84	19.33
		100	0	20.21	19.83	19.36

LTE Band / BW	Modulation	RB Sizer	RB Offset	Low CH	Mid CH	High CH
				20775 CH	21100 CH	21425 CH
				2502.5 MHz	2535 MHz	2567.5 MHz
7 / 5M	QPSK	1	0	22.01	21.85	22.46
		1	12	22.04	21.82	22.46
		1	24	21.76	21.80	22.41
		12	0	20.57	20.81	21.33
		12	6	20.69	20.79	21.32
		12	13	20.73	20.79	21.34
		25	0	20.72	20.74	21.29
	16QAM	1	0	20.99	21.39	21.21
		1	12	21.01	21.45	21.33
		1	24	20.99	21.47	21.30
		12	0	19.97	20.06	20.37
		12	6	19.99	20.43	20.38
		12	13	20.01	20.22	20.37
		25	0	19.89	20.05	20.23

LTE Band / BW	Modulation	RB Sizer	RB Offset	Low CH	Mid CH	High CH
				20800 CH	21100 CH	21400 CH
				2505 MHz	2535 MHz	2565 MHz
7 / 10M	QPSK	1	0	21.84	22.04	22.45
		1	24	21.92	22.00	22.41
		1	49	22.00	22.02	22.39
		25	0	20.86	20.90	21.27
		25	12	20.86	20.86	21.27
		25	25	20.87	20.89	21.26
		50	0	20.88	20.88	21.29
	16QAM	1	0	20.67	21.25	21.21
		1	24	20.74	21.18	21.23
		1	49	20.76	21.21	21.22
		25	0	19.87	19.91	20.32
		25	12	19.87	19.83	20.34
		25	25	19.90	19.90	20.36
		50	0	19.87	19.88	20.31

LTE Band / BW	Modulation	RB Sizer	RB Offset	Low CH	Mid CH	High CH
				20825 CH	21100 CH	21375 CH
				2507.5 MHz	2535 MHz	2562.5 MHz
7 / 15M	QPSK	1	0	21.72	22.13	22.45
		1	37	21.80	22.02	22.43
		1	74	21.93	22.11	22.47
		36	0	20.79	20.98	21.42
		36	19	20.82	20.95	21.37
		36	39	20.91	21.00	21.35
		75	0	20.86	21.00	21.39
	16QAM	1	0	20.56	21.34	21.45
		1	37	20.62	21.24	21.42
		1	74	20.70	21.31	21.46
		36	0	19.73	20.00	20.29
		36	19	19.74	19.97	20.23
		36	39	19.84	20.00	20.25
		75	0	19.78	19.98	20.28

LTE Band / BW	Modulation	RB Sizer	RB Offset	Low CH	Mid CH	High CH
				20850 CH	21100 CH	21350 CH
				2510 MHz	2535 MHz	2560 MHz
7 / 20M	QPSK	1	0	21.95	22.17	22.45
		1	50	21.83	21.99	22.42
		1	99	21.92	22.15	22.43
		50	0	20.75	20.99	21.28
		50	25	20.78	20.94	21.25
		50	50	20.88	20.99	21.26
		100	0	20.78	20.95	21.24
	16QAM	1	0	21.20	21.40	21.46
		1	50	21.26	21.31	21.49
		1	99	21.39	21.37	21.46
		50	0	19.78	19.98	20.21
		50	25	19.81	19.93	20.16
		50	50	19.89	19.98	20.22
		100	0	19.81	19.94	20.21

**EIRP Power:**

LTE Band / BW	Modulation	RB Sizer	RB Offset	Low CH	Mid CH	High CH
				19957 CH	20175 CH	20393 CH
				1710.7 MHz	1732.5 MHz	1754.3 MHz
4 / 1.4M	QPSK	1	0	20.21	19.58	18.76
		1	2	<b>20.27</b>	19.58	18.84
		1	5	19.94	19.54	18.77
		3	0	20.12	19.60	18.88
		3	1	20.03	19.51	18.82
		3	3	20.16	19.58	18.89
		6	0	19.07	18.49	17.87
	16QAM	1	0	19.45	18.90	17.94
		1	2	<b>19.59</b>	18.85	17.89
		1	5	19.12	18.84	17.87
		3	0	19.19	18.77	18.07
		3	1	19.11	18.64	18.03
		3	3	19.19	18.68	18.05
		6	0	18.03	17.39	17.01

LTE Band / BW	Modulation	RB Sizer	RB Offset	Low CH	Mid CH	High CH
				19965 CH	20175 CH	20385 CH
				1711.5 MHz	1732.5 MHz	1753.5 MHz
4 / 3M	QPSK	1	0	20.12	19.54	18.86
		1	7	20.15	19.53	18.88
		1	14	<b>20.27</b>	19.53	18.81
		8	0	19.33	18.57	17.92
		8	3	19.13	18.55	17.94
		8	7	19.22	18.55	17.92
		15	0	18.80	18.51	17.91
	16QAM	1	0	19.02	18.83	17.92
		1	7	19.06	18.83	17.94
		1	14	<b>19.09</b>	18.82	17.87
		8	0	18.36	17.66	16.99
		8	3	18.36	17.63	17.00
		8	7	18.31	17.62	16.98
		15	0	18.25	17.57	16.99

LTE Band / BW	Modulation	RB Sizer	RB Offset	Low CH	Mid CH	High CH
				19975 CH	20175 CH	20375 CH
				1712.5 MHz	1732.5 MHz	1752.5 MHz
4 / 5M	QPSK	1	0	<b>20.27</b>	19.64	19.02
		1	12	20.27	19.55	18.98
		1	24	19.86	19.55	18.93
		12	0	19.11	18.59	17.91
		12	6	19.12	18.54	17.89
		12	13	19.10	18.55	17.89
		25	0	19.08	18.50	17.93
	16QAM	1	0	<b>19.35</b>	19.10	18.02
		1	12	19.34	19.01	17.99
		1	24	19.07	19.00	17.94
		12	0	18.42	17.75	16.96
		12	6	18.39	17.72	16.97
		12	13	18.64	17.71	16.92
		25	0	18.31	17.59	16.90

LTE Band / BW	Modulation	RB Sizer	RB Offset	Low CH	Mid CH	High CH
				20000 CH	20175 CH	20350 CH
				1715 MHz	1732.5 MHz	1750 MHz
4 / 10M	QPSK	1	0	<b>20.21</b>	19.69	18.91
		1	24	20.00	19.50	18.88
		1	49	19.98	19.61	19.13
		25	0	19.09	18.59	17.88
		25	12	19.03	18.53	17.89
		25	25	19.01	18.56	17.88
		50	0	19.06	18.58	17.90
	16QAM	1	0	19.10	19.02	17.95
		1	24	<b>19.15</b>	18.85	17.90
		1	49	18.76	18.92	17.87
		25	0	18.30	17.64	17.01
		25	12	18.15	17.57	16.97
		25	25	18.11	17.61	16.98
		50	0	18.18	17.60	16.95

LTE Band / BW	Modulation	RB Sizer	RB Offset	Low CH	Mid CH	High CH
				20025 CH	20175 CH	20325 CH
				1717.5 MHz	1732.5 MHz	1747.5 MHz
4 / 15M	QPSK	1	0	<b>20.04</b>	19.71	19.01
		1	37	20.01	19.37	18.97
		1	74	19.92	19.55	18.87
		36	0	19.08	19.55	17.96
		36	19	19.04	18.78	17.95
		36	39	19.02	18.63	17.92
		75	0	19.07	18.66	17.95
	16QAM	1	0	<b>19.15</b>	19.05	18.39
		1	37	18.86	18.84	18.34
		1	74	19.01	18.94	18.31
		36	0	18.18	18.84	16.94
		36	19	18.15	17.63	16.92
		36	39	18.12	17.65	16.91
		75	0	18.18	17.65	16.96

LTE Band / BW	Modulation	RB Sizer	RB Offset	Low CH	Mid CH	High CH
				20050 CH	20175 CH	20300 CH
				1720 MHz	1732.5 MHz	1745 MHz
4 / 20M	QPSK	1	0	<b>20.29</b>	19.71	19.32
		1	50	20.04	18.98	19.30
		1	99	19.97	19.55	19.06
		50	0	19.10	18.64	18.31
		50	25	19.01	18.66	18.37
		50	50	18.98	18.83	18.47
		100	0	19.00	18.79	18.29
	16QAM	1	0	<b>19.84</b>	19.46	18.64
		1	50	19.55	18.09	18.55
		1	99	19.36	19.07	18.54
		50	0	18.15	17.75	17.22
		50	25	18.07	17.64	17.15
		50	50	18.04	17.69	17.18
		100	0	18.06	17.68	17.21

LTE Band / BW	Modulation	RB Sizer	RB Offset	Low CH	Mid CH	High CH
				20775 CH	21100 CH	21425 CH
				2502.5 MHz	2535 MHz	2567.5 MHz
7 / 5M	QPSK	1	0	19.86	19.70	<b>20.31</b>
		1	12	19.89	19.67	20.31
		1	24	19.61	19.65	20.26
		12	0	18.42	18.66	19.18
		12	6	18.54	18.64	19.17
		12	13	18.58	18.64	19.19
		25	0	18.57	18.59	19.14
	16QAM	1	0	18.84	19.24	19.06
		1	12	18.86	19.30	19.18
		1	24	18.84	<b>19.32</b>	19.15
		12	0	17.82	17.91	18.22
		12	6	17.84	18.28	18.23
		12	13	17.86	18.07	18.22
		25	0	17.74	17.90	18.08

LTE Band / BW	Modulation	RB Sizer	RB Offset	Low CH	Mid CH	High CH
				20800 CH	21100 CH	21400 CH
				2505 MHz	2535 MHz	2565 MHz
7 / 10M	QPSK	1	0	19.69	19.89	<b>20.30</b>
		1	24	19.77	19.85	20.26
		1	49	19.85	19.87	20.24
		25	0	18.71	18.75	19.12
		25	12	18.71	18.71	19.12
		25	25	18.72	18.74	19.11
		50	0	18.73	18.73	19.14
	16QAM	1	0	18.52	<b>19.10</b>	19.06
		1	24	18.59	19.03	19.08
		1	49	18.61	19.06	19.07
		25	0	17.72	17.76	18.17
		25	12	17.72	17.68	18.19
		25	25	17.75	17.75	18.21
		50	0	17.72	17.73	18.16

LTE Band / BW	Modulation	RB Sizer	RB Offset	Low CH	Mid CH	High CH
				20825 CH	21100 CH	21375 CH
				2507.5 MHz	2535 MHz	2562.5 MHz
7 / 15M	QPSK	1	0	19.57	19.98	20.30
		1	37	19.65	19.87	20.28
		1	74	19.78	19.96	<b>20.32</b>
		36	0	18.64	18.83	19.27
		36	19	18.67	18.80	19.22
		36	39	18.76	18.85	19.20
		75	0	18.71	18.85	19.24
	16QAM	1	0	18.41	19.19	19.30
		1	37	18.47	19.09	19.27
		1	74	18.55	19.16	<b>19.31</b>
		36	0	17.58	17.85	18.14
		36	19	17.59	17.82	18.08
		36	39	17.69	17.85	18.10
		75	0	17.63	17.83	18.13

LTE Band / BW	Modulation	RB Sizer	RB Offset	Low CH	Mid CH	High CH
				20850 CH	21100 CH	21350 CH
				2510 MHz	2535 MHz	2560 MHz
7 / 20M	QPSK	1	0	19.80	20.02	<b>20.30</b>
		1	50	19.68	19.84	20.27
		1	99	19.77	20.00	20.28
		50	0	18.60	18.84	19.13
		50	25	18.63	18.79	19.10
		50	50	18.73	18.84	19.11
		100	0	18.63	18.80	19.09
	16QAM	1	0	19.05	19.25	19.31
		1	50	19.11	19.16	<b>19.34</b>
		1	99	19.24	19.22	19.31
		50	0	17.63	17.83	18.06
		50	25	17.66	17.78	18.01
		50	50	17.74	17.83	18.07
		100	0	17.66	17.79	18.06



## ATTACHMENT B - OCCUPIED BANDWIDTH

LTE Band 4_1.4M					
QPSK			16QAM		
Channel	Frequency (MHz)	99% Occupied Bandwidth (MHz)	Channel	Frequency (MHz)	99% Occupied Bandwidth (MHz)
19957	1710.7	1.0918	19957	1710.7	1.0903
20175	1732.5	1.0862	20175	1732.5	1.0918
20393	1754.3	1.0929	20393	1754.3	1.0985
Channel	Frequency (MHz)	26dB Bandwidth (MHz)	Channel	Frequency (MHz)	26dB Bandwidth (MHz)
19957	1710.7	1.2360	19957	1710.7	1.2330
20175	1732.5	1.2370	20175	1732.5	1.2360
20393	1754.3	1.2220	20393	1754.3	1.2410

### Spectrum Plot

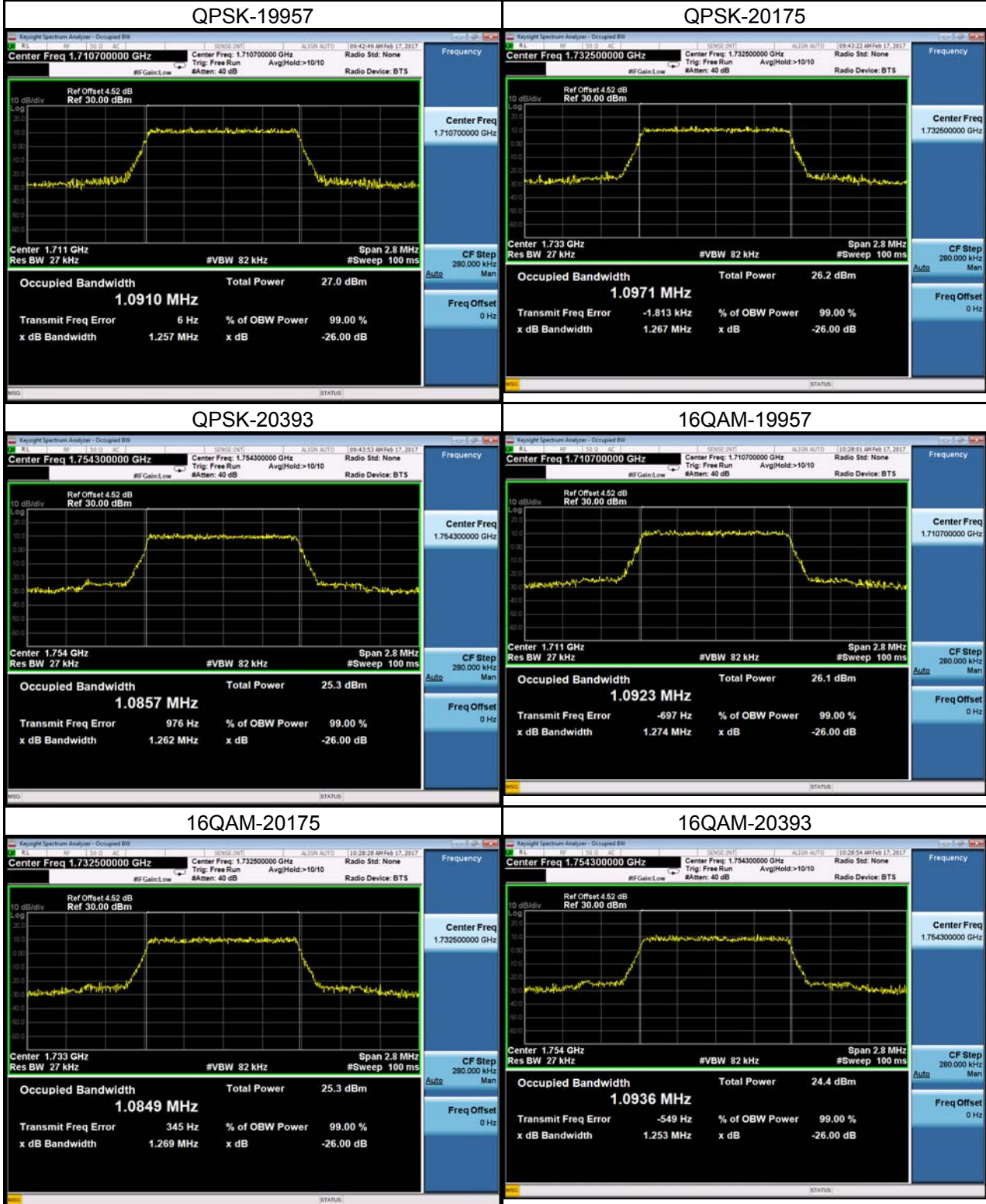

LTE Band 4_3M					
QPSK			16QAM		
Channel	Frequency (MHz)	99% Occupied Bandwidth (MHz)	Channel	Frequency (MHz)	99% Occupied Bandwidth (MHz)
19965	1711.5	2.7113	19965	1711.5	2.7058
20175	1732.5	2.6979	20175	1732.5	2.7014
20385	1753.5	2.7040	20385	1753.5	2.6968
Channel	Frequency (MHz)	26dB Bandwidth (MHz)	Channel	Frequency (MHz)	26dB Bandwidth (MHz)
19965	1711.5	2.9920	19965	1711.5	2.9650
20175	1732.5	2.9570	20175	1732.5	2.9690
20385	1753.5	2.9540	20385	1753.5	2.9780

### Spectrum Plot

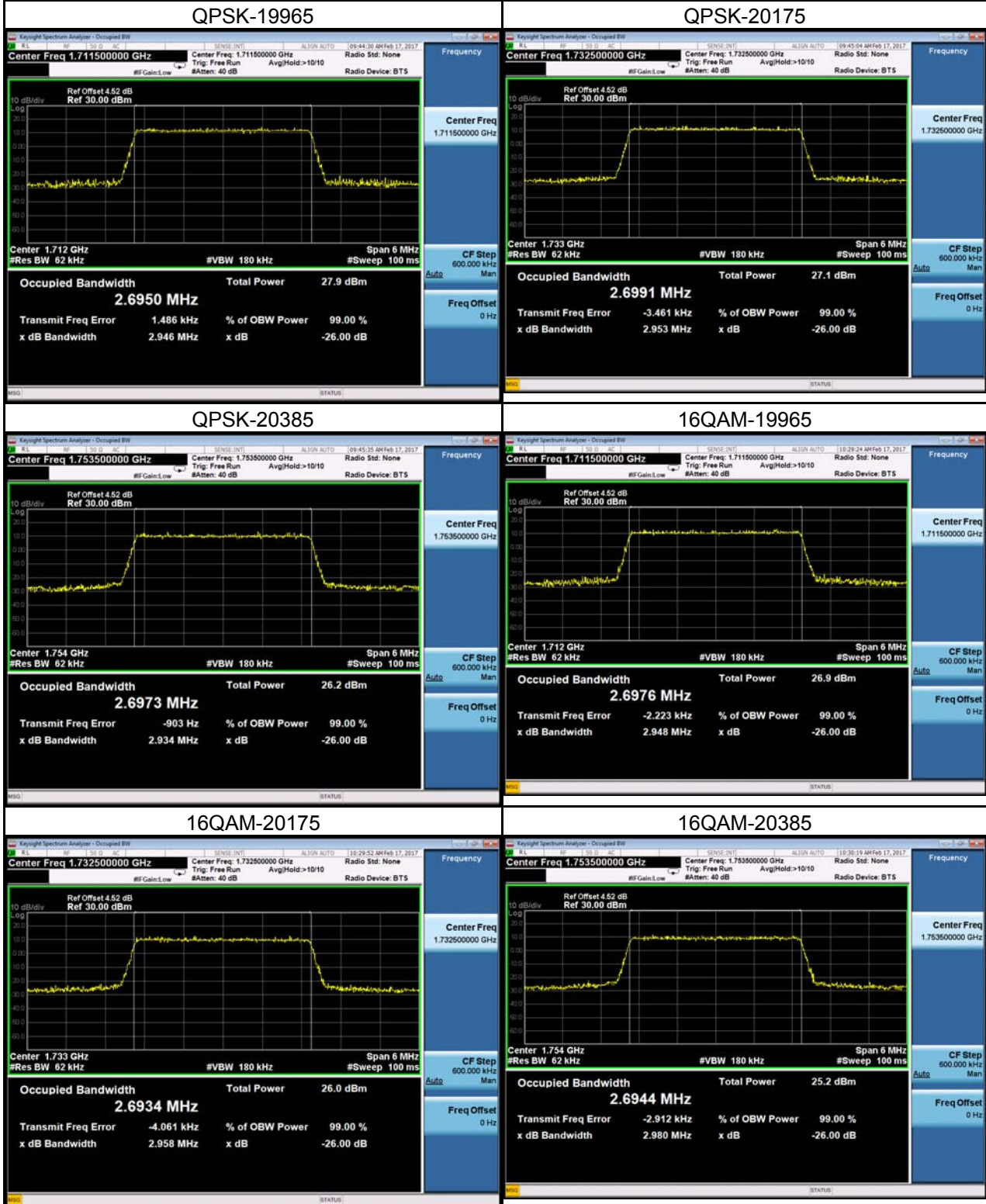

LTE Band 4_5M					
QPSK			16QAM		
Channel	Frequency (MHz)	99% Occupied Bandwidth (MHz)	Channel	Frequency (MHz)	99% Occupied Bandwidth (MHz)
19975	1712.5	4.1529	19975	1712.5	4.5026
20175	1732.5	4.5101	20175	1732.5	4.5134
20375	1752.5	4.5046	20375	1752.5	4.5021
Channel	Frequency (MHz)	26dB Bandwidth (MHz)	Channel	Frequency (MHz)	26dB Bandwidth (MHz)
19975	1712.5	4.9520	19975	1712.5	4.9680
20175	1732.5	4.9490	20175	1732.5	4.9620
20375	1752.5	4.9760	20375	1752.5	4.9300

### Spectrum Plot



LTE Band 4_10M					
QPSK			16QAM		
Channel	Frequency (MHz)	99% Occupied Bandwidth (MHz)	Channel	Frequency (MHz)	99% Occupied Bandwidth (MHz)
20000	1715	9.0069	20000	1715	8.9864
20175	1732.5	8.9895	20175	1732.5	8.9904
20350	1750	9.0007	20350	1750	8.9973
Channel	Frequency (MHz)	26dB Bandwidth (MHz)	Channel	Frequency (MHz)	26dB Bandwidth (MHz)
20000	1715	9.8620	20000	1715	9.8580
20175	1732.5	9.9090	20175	1732.5	9.8200
20350	1750	9.9420	20350	1750	9.9250



### Spectrum Plot



LTE Band 4_15M					
QPSK			16QAM		
Channel	Frequency (MHz)	99% Occupied Bandwidth (MHz)	Channel	Frequency (MHz)	99% Occupied Bandwidth (MHz)
20025	1717.5	13.4660	20025	1717.5	13.5080
20175	1732.5	13.4660	20175	1732.5	13.4770
20325	1747.5	13.4810	20325	1747.5	13.4750
Channel	Frequency (MHz)	26dB Bandwidth (MHz)	Channel	Frequency (MHz)	26dB Bandwidth (MHz)
20025	1717.5	14.9100	20025	1717.5	14.8400
20175	1732.5	14.8500	20175	1732.5	14.7500
20325	1747.5	15.1400	20325	1747.5	14.9300

### Spectrum Plot

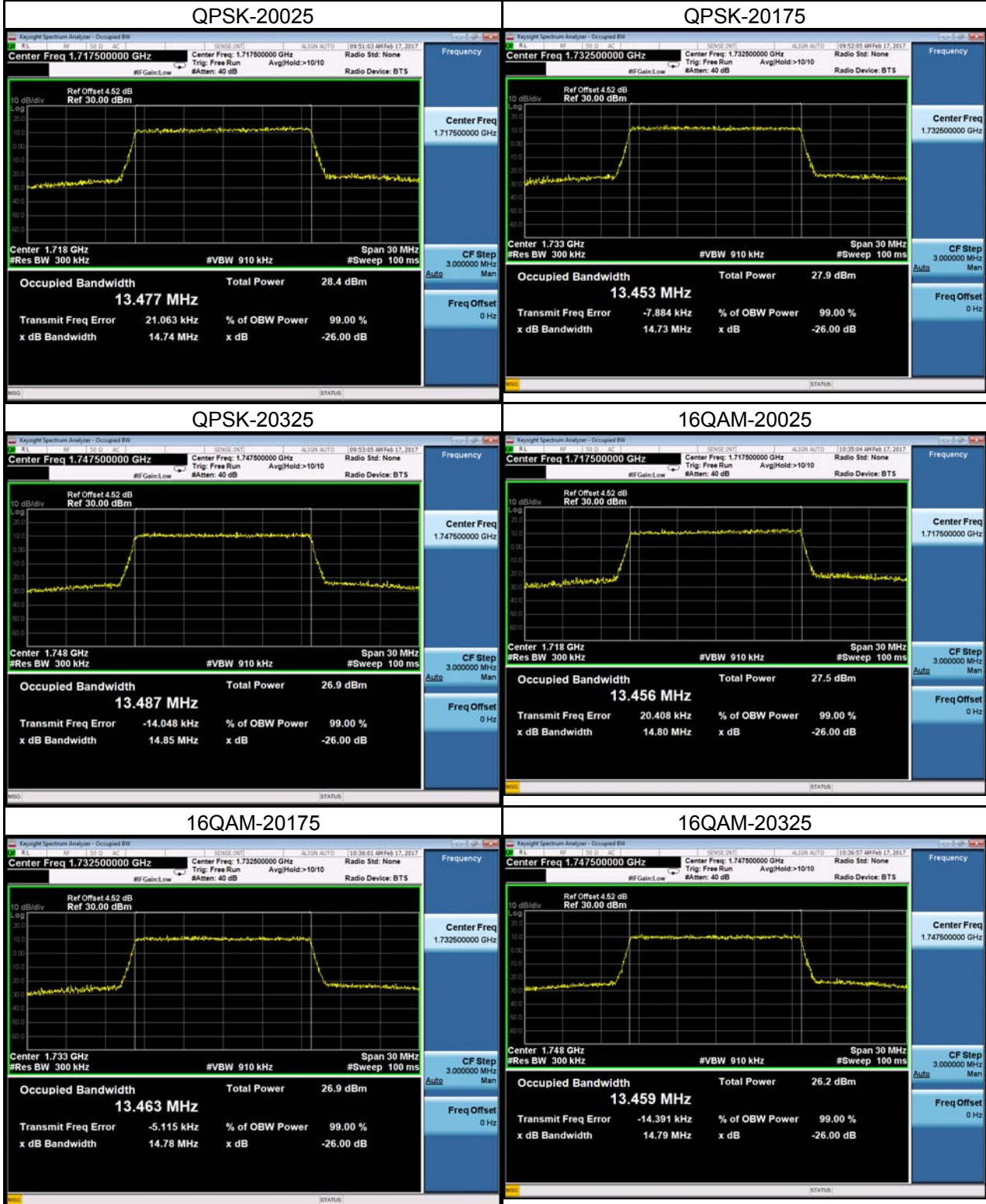

LTE Band 4_20M					
QPSK			16QAM		
Channel	Frequency (MHz)	99% Occupied Bandwidth (MHz)	Channel	Frequency (MHz)	99% Occupied Bandwidth (MHz)
20050	1720	17.8560	20050	1720	17.8570
20175	1732.5	17.9910	20175	1732.5	17.9540
20300	1745	18.0020	20300	1745	18.0080
Channel	Frequency (MHz)	26dB Bandwidth (MHz)	Channel	Frequency (MHz)	26dB Bandwidth (MHz)
20050	1720	19.5100	20050	1720	19.5600
20175	1732.5	19.7000	20175	1732.5	19.6700
20300	1745	19.6800	20300	1745	19.7500

### Spectrum Plot



LTE Band 7_5M					
QPSK			16QAM		
Channel	Frequency (MHz)	99% Occupied Bandwidth (MHz)	Channel	Frequency (MHz)	99% Occupied Bandwidth (MHz)
20775	2502.5	4.5125	20775	2502.5	4.5131
21100	2535	4.5159	21100	2535	4.5203
21425	2567.5	4.5100	21425	2567.5	4.4996
Channel	Frequency (MHz)	26dB Bandwidth (MHz)	Channel	Frequency (MHz)	26dB Bandwidth (MHz)
20775	2502.5	4.9870	20775	2502.5	4.9570
21100	2535	4.9880	21100	2535	4.9520
21425	2567.5	4.9790	21425	2567.5	4.9570

### Spectrum Plot



LTE Band 7_10M					
QPSK			16QAM		
Channel	Frequency (MHz)	99% Occupied Bandwidth (MHz)	Channel	Frequency (MHz)	99% Occupied Bandwidth (MHz)
20800	2505	9.0001	20800	2505	9.0031
21100	2535	9.0143	21100	2535	9.0031
21400	2565	8.9858	21400	2565	8.9914
Channel	Frequency (MHz)	26dB Bandwidth (MHz)	Channel	Frequency (MHz)	26dB Bandwidth (MHz)
20800	2505	9.9430	20800	2505	9.9310
21100	2535	9.9310	21100	2535	9.8900
21400	2565	9.9600	21400	2565	9.9000



### Spectrum Plot



LTE Band 7_15M					
QPSK			16QAM		
Channel	Frequency (MHz)	99% Occupied Bandwidth (MHz)	Channel	Frequency (MHz)	99% Occupied Bandwidth (MHz)
20825	2507.5	13.4490	20825	2507.5	13.4820
21100	2535	13.5090	21100	2535	13.4840
21375	2562.5	13.4790	21375	2562.5	13.5040
Channel	Frequency (MHz)	26dB Bandwidth (MHz)	Channel	Frequency (MHz)	26dB Bandwidth (MHz)
20825	2507.5	14.9500	20825	2507.5	15.0300
21100	2535	15.0300	21100	2535	15.0500
21375	2562.5	14.9700	21375	2562.5	15.0500

### Spectrum Plot



LTE Band 7_20M					
QPSK			16QAM		
Channel	Frequency (MHz)	99% Occupied Bandwidth (MHz)	Channel	Frequency (MHz)	99% Occupied Bandwidth (MHz)
20850	2510	17.9560	20850	2510	17.9570
21100	2535	17.9970	21100	2535	19.5200
21350	2560	17.9870	21350	2560	17.9880
Channel	Frequency (MHz)	26dB Bandwidth (MHz)	Channel	Frequency (MHz)	26dB Bandwidth (MHz)
20850	2510	19.6500	20850	2510	19.7900
21100	2535	19.8400	21100	2535	19.8400
21350	2560	19.7400	21350	2560	19.7400

### Spectrum Plot

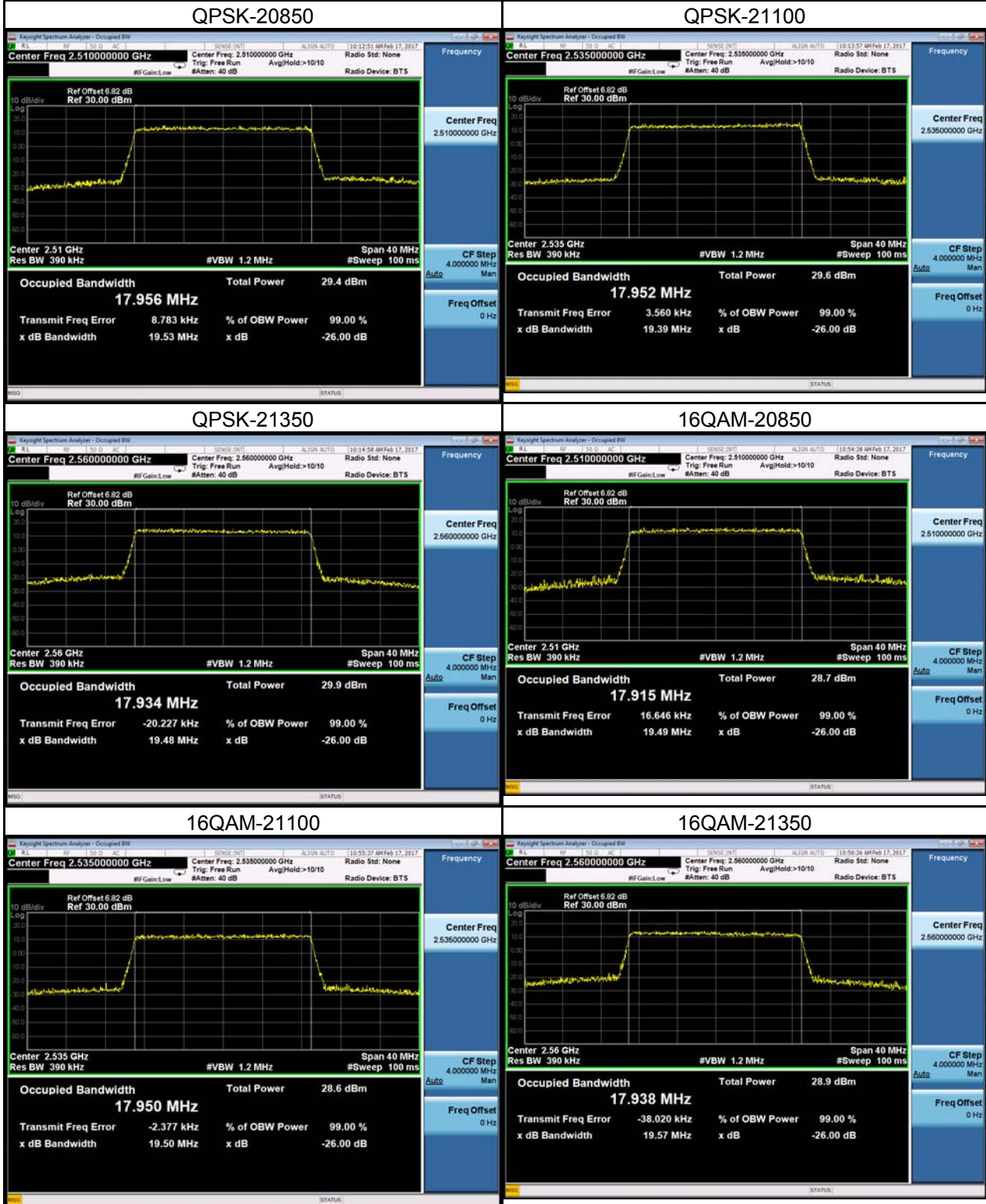

## ATTACHMENT C - CONDUCTED EMISSIONS

LTE Band 4_1.4M			
Channel	Frequency(MHz)	Channel	Frequency(MHz)
20175	1732.5	20175	1732.5
Channel	Frequency(MHz)	-	-
20175	1732.5	-	-

LTE Band 4_3M			
Channel	Frequency(MHz)	Channel	Frequency(MHz)
20175	1732.5	20175	1732.5
Channel	Frequency(MHz)	-	-
20175	1732.5	-	-



LTE Band 4_5M			
Channel	Frequency(MHz)	Channel	Frequency(MHz)
20175	1732.5	20175	1732.5
Channel	Frequency(MHz)	-	-
20175	1732.5	-	-
		-	

LTE Band 4_10M			
Channel	Frequency(MHz)	Channel	Frequency(MHz)
20175	1732.5	20175	1732.5
Channel	Frequency(MHz)	-	-
20175	1732.5	-	-

LTE Band 4_15M			
Channel	Frequency(MHz)	Channel	Frequency(MHz)
20175	1732.5	20175	1732.5
Channel	Frequency(MHz)	-	-
20175	1732.5	-	-

LTE Band 4_20M			
Channel	Frequency(MHz)	Channel	Frequency(MHz)
20175	1732.5	20175	1732.5
Channel	Frequency(MHz)	-	-
20175	1732.5	-	-

LTE Band 7_5M			
Channel	Frequency(MHz)	Channel	Frequency(MHz)
21100	2535	21100	2535
Channel	Frequency(MHz)	-	-
21100	2535	-	-

LTE Band 7_10M			
Channel	Frequency(MHz)	Channel	Frequency(MHz)
21100	2535	21100	2535
Channel	Frequency(MHz)	-	-
21100	2535	-	-

LTE Band 7_15M			
Channel	Frequency(MHz)	Channel	Frequency(MHz)
21100	2535	21100	2535
Channel	Frequency(MHz)	-	-
21100	2535	-	-

LTE Band 7_20M			
Channel	Frequency(MHz)	Channel	Frequency(MHz)
21100	2535	21100	2535
Channel	Frequency(MHz)	-	-
21100	2535	-	-



## ATTACHMENT D - RADIATED EMISSION

Test Mode: TX Mode\_Adapter: BYD

Ant 0°

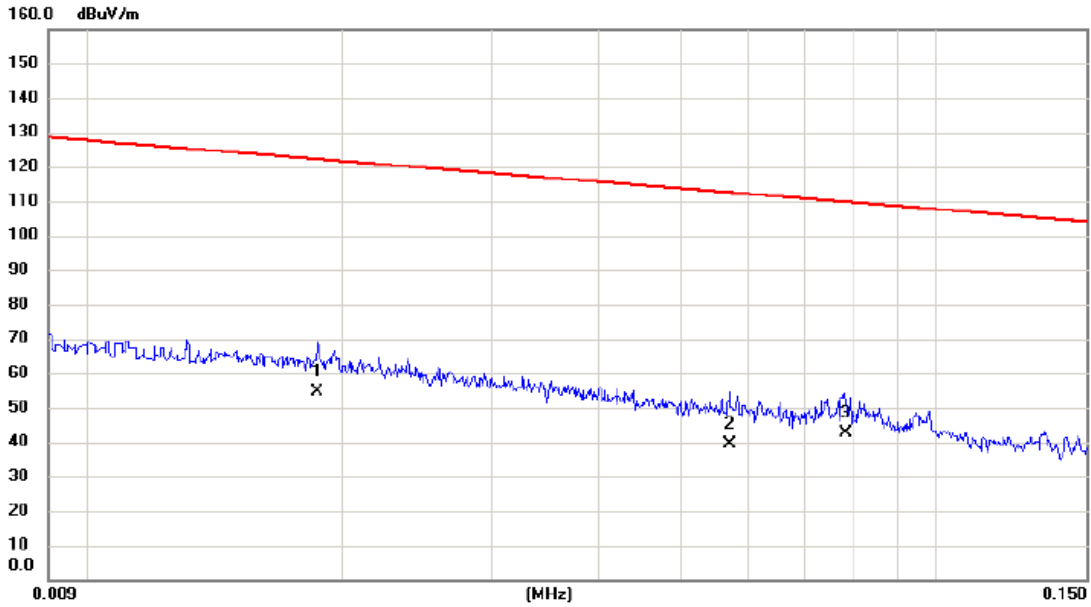

No.	Mk.	Freq. MHz	Reading Level dBuV	Correct Factor dB	Measure- ment dBuV/m	Limit dBuV/m	Margin dB	Detector	Comment
1		0.0187	31.10	23.60	54.70	122.17	-67.47	AVG	
2		0.0570	19.50	19.75	39.25	112.49	-73.24	AVG	
3	*	0.0781	23.20	19.39	42.59	109.75	-67.16	AVG	

Test Mode: TX Mode\_Adapter: BYD

Ant 0°

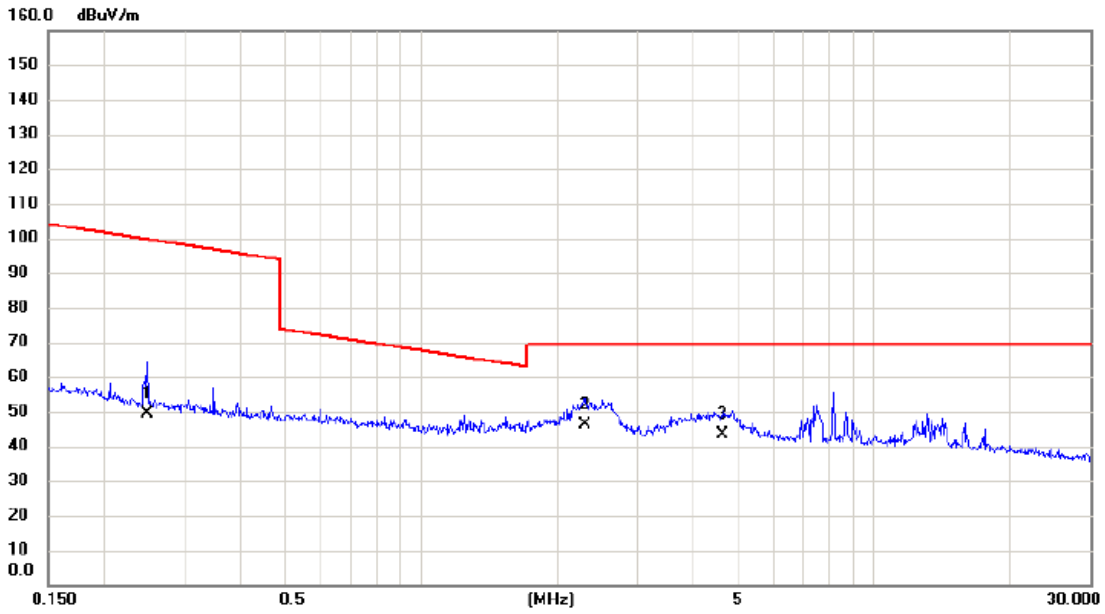

No.	Mk.	Freq. MHz	Reading Level dBuV	Correct Factor dB	Measure- ment dBuV/m	Limit dBuV/m	Margin dB	Detector	Comment
1		0.2481	30.80	18.65	49.45	99.71	-50.26	AVG	
2	*	2.2968	28.70	17.52	46.22	69.54	-23.32	QP	
3		4.6223	25.90	17.46	43.36	69.54	-26.18	QP	

Test Mode: TX Mode\_Adapter: BYD

Ant 90°

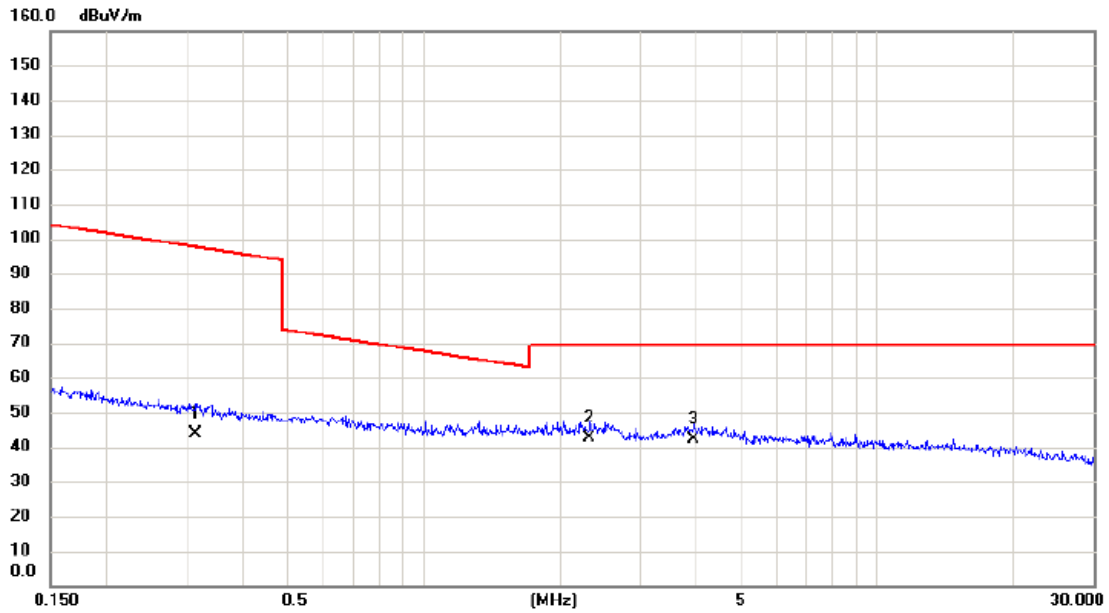

No.	Mk.	Freq. MHz	Reading Level dBuV	Correct Factor dB	Measure- ment dBuV/m	Limit dBuV/m	Margin dB	Detector	Comment
1		0.3133	25.33	18.57	43.90	97.69	-53.79	AVG	
2	*	2.3213	25.12	17.49	42.61	69.54	-26.93	QP	
3		3.9430	23.45	18.63	42.08	69.54	-27.46	QP	

Test Mode: TX Mode\_Adapter: BYD

Ant 90°

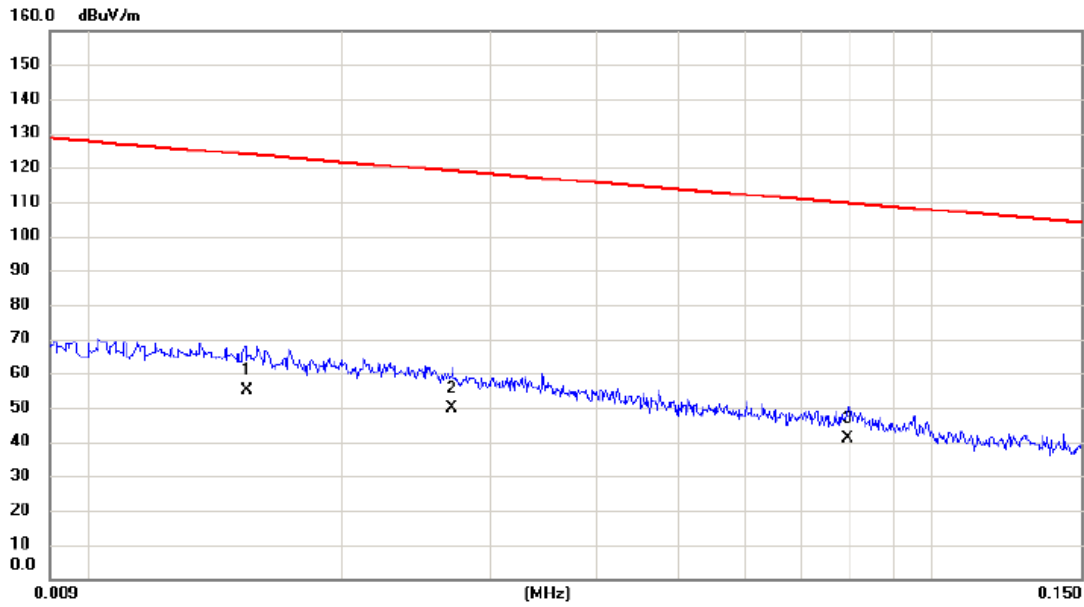

No.	Mk.	Freq.	Reading Level	Correct Factor	Measurement	Limit	Margin	Detector	Comment
		MHz	dBuV	dB	dBuV/m	dBuV/m	dB		
1		0.0154	31.05	23.80	54.85	123.85	-69.00	AVG	
2		0.0270	27.14	22.66	49.80	118.98	-69.18	AVG	
3	*	0.0793	21.75	19.34	41.09	109.62	-68.53	AVG	

Test Mode: TX Mode\_Adapter: PHITEK

Ant 0°

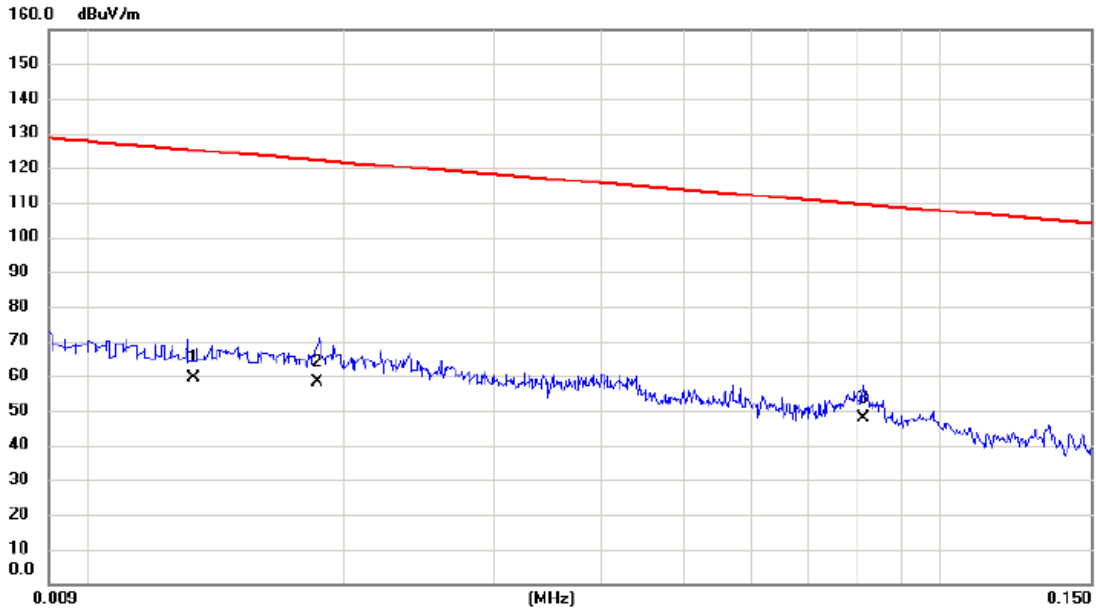

No.	Mk.	Freq.	Reading Level	Correct Factor	Measurement	Limit	Margin	Detector	Comment
		MHz	dBuV	dB	dBuV/m	dBuV/m	dB		
1		0.0133	35.49	23.92	59.41	125.13	-65.72	AVG	
2		0.0186	34.66	23.60	58.26	122.21	-63.95	AVG	
3	*	0.0812	28.36	19.26	47.62	109.41	-61.79	AVG	

Test Mode: TX Mode\_Adapter: PHITEK

Ant 0°

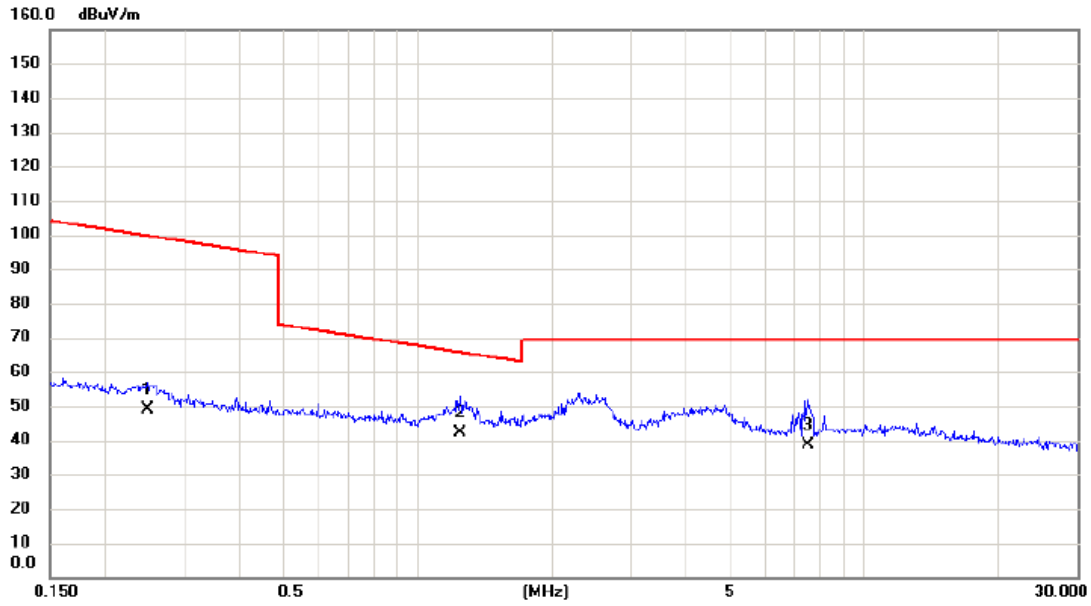

No.	Mk.	Freq. MHz	Reading Level dBuV	Correct Factor dB	Measure- ment dBuV/m	Limit dBuV/m	Margin dB	Detector	Comment
1		0.2482	30.31	18.65	48.96	99.71	-50.75	AVG	
2	*	1.2465	24.63	17.74	42.37	65.69	-23.32	QP	
3		7.4853	22.49	16.26	38.75	69.54	-30.79	QP	

Test Mode: TX Mode\_Adapter: PHITEK

Ant 90°

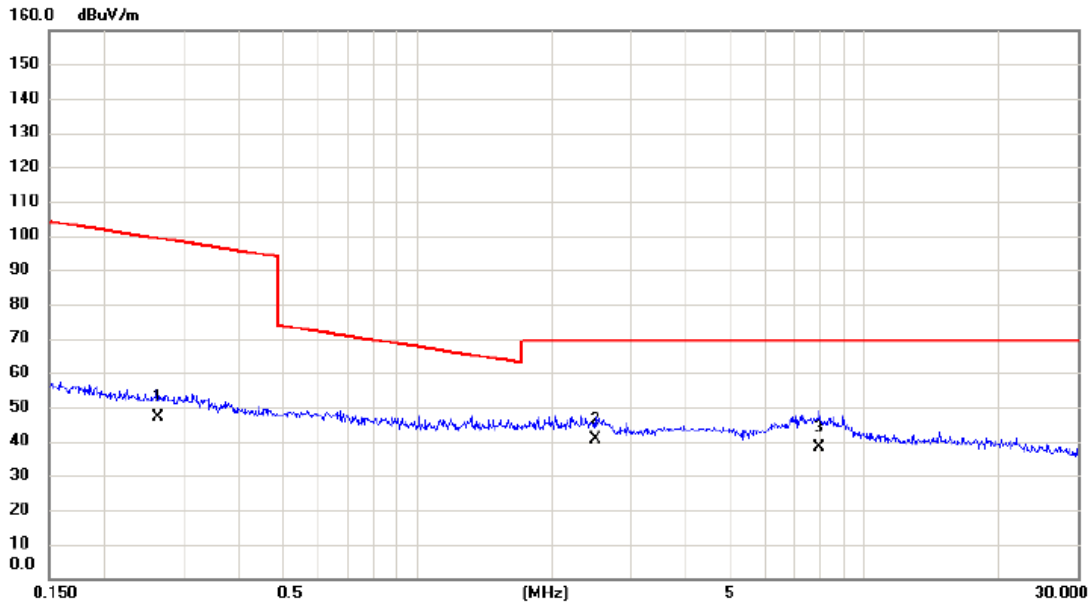

No.	Mk.	Freq.	Reading Level	Correct Factor	Measurement	Limit	Margin	Detector	Comment
		MHz	dBuV	dB	dBuV/m	dBuV/m	dB		
1		0.2635	28.32	18.63	46.95	99.19	-52.24	AVG	
2	*	2.5128	23.44	17.25	40.69	69.54	-28.85	QP	
3		7.9372	22.16	16.19	38.35	69.54	-31.19	QP	



Test Mode: TX Mode\_Adapter: PHITEK

Ant 90°

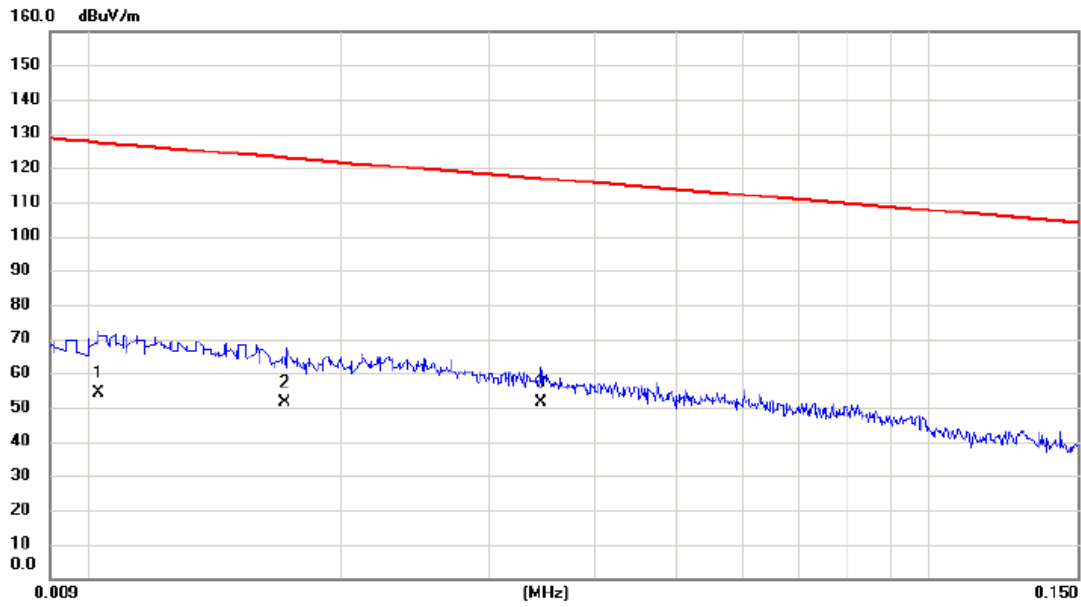

No.	Mk.	Freq. MHz	Reading Level dBuV	Correct Factor dB	Measure- ment dBuV/m	Limit dBuV/m	Margin dB	Detector	Comment
1		0.0103	30.28	24.10	54.38	127.35	-72.97	AVG	
2		0.0171	27.56	23.69	51.25	122.94	-71.69	AVG	
3	*	0.0346	29.71	21.72	51.43	116.82	-65.39	AVG	

Test Mode: TX Mode\_Adapter: Huntkey

Ant 0°

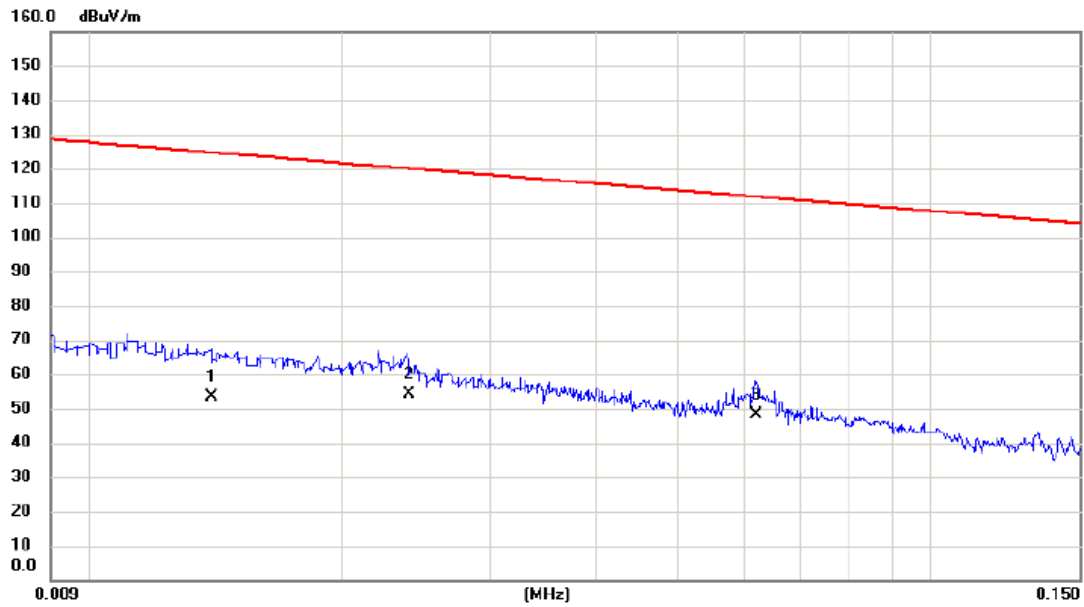

No.	Mk.	Freq. MHz	Reading Level dBuV	Correct Factor dB	Measure- ment dBuV/m	Limit dBuV/m	Margin dB	Detector	Comment
1		0.0140	29.34	23.88	53.22	124.68	-71.46	AVG	
2		0.0240	31.28	23.03	54.31	120.00	-65.69	AVG	
3	*	0.0620	28.66	19.69	48.35	111.76	-63.41	AVG	

Test Mode: TX Mode\_Adapter: Huntkey

Ant 0°

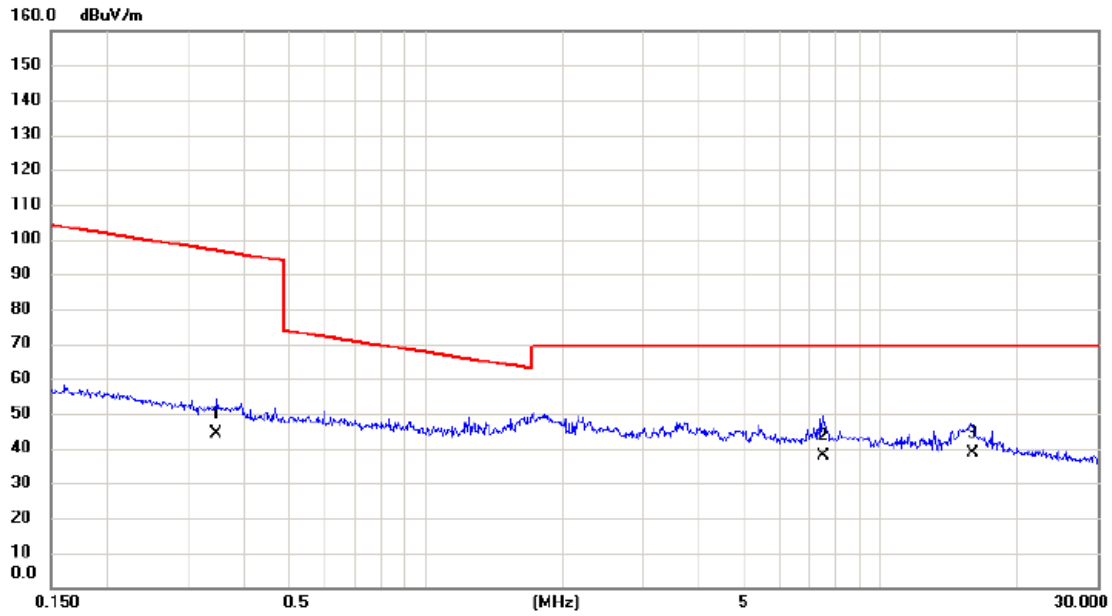

No.	Mk.	Freq. MHz	Reading Level dBuV	Correct Factor dB	Measure- ment dBuV/m	Limit dBuV/m	Margin dB	Detector	Comment
1		0.3461	25.66	18.54	44.20	96.82	-52.62	AVG	
2		7.4860	21.38	16.26	37.64	69.54	-31.90	QP	
3	*	15.8868	23.17	15.54	38.71	69.54	-30.83	QP	

Test Mode: TX Mode\_Adapter: Huntkey

Ant 90°

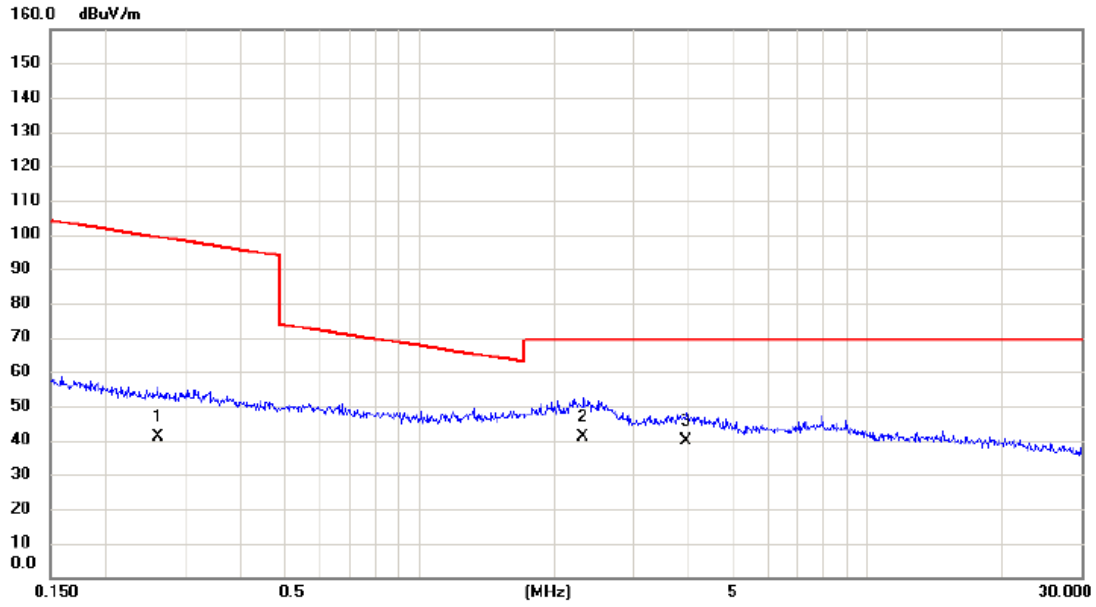

No.	Mk.	Freq.	Reading Level	Correct Factor	Measurement	Limit	Margin	Detector	Comment
		MHz	dBuV	dB	dBuV/m	dBuV/m	dB		
1		0.2611	22.47	18.64	41.11	99.27	-58.16	AVG	
2	*	2.3226	23.64	17.49	41.13	69.54	-28.41	QP	
3		3.9427	21.13	18.63	39.76	69.54	-29.78	QP	

Test Mode: TX Mode\_Adapter: Huntkey

Ant 90°

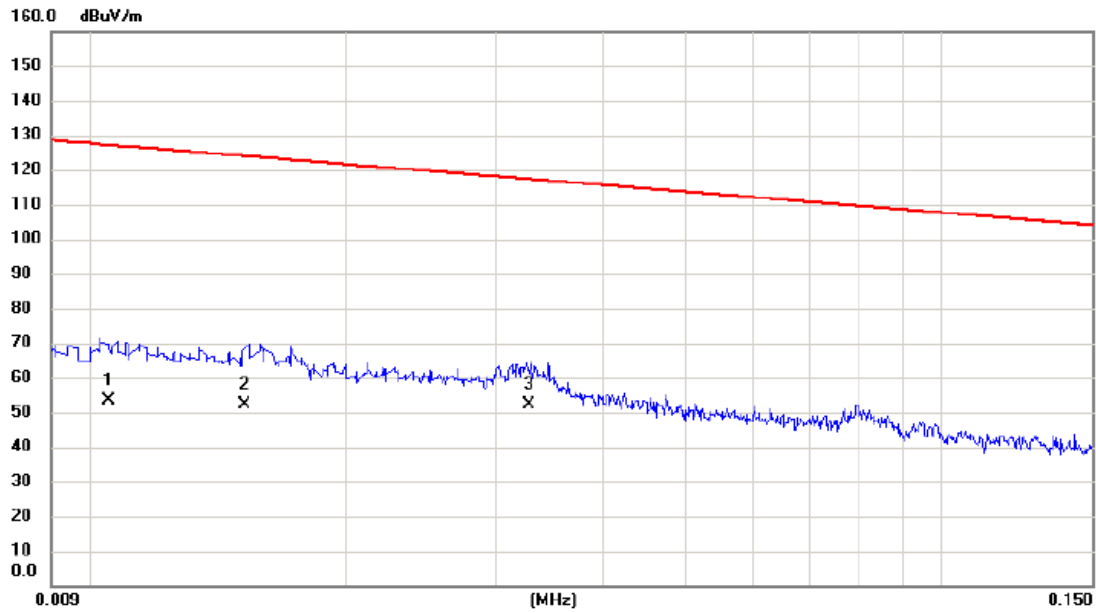

No.	Mk.	Freq.	Reading Level	Correct Factor	Measurement	Limit	Margin	Detector	Comment
		MHz	dBuV	dB	dBuV/m	dBuV/m	dB		
1		0.0105	29.25	24.09	53.34	127.18	-73.84	AVG	
2		0.0152	28.36	23.81	52.17	123.97	-71.80	AVG	
3	*	0.0328	30.26	21.94	52.20	117.29	-65.09	AVG	

Test Mode: LTE Band 4\_TX CH20175\_1.4M

Vertical

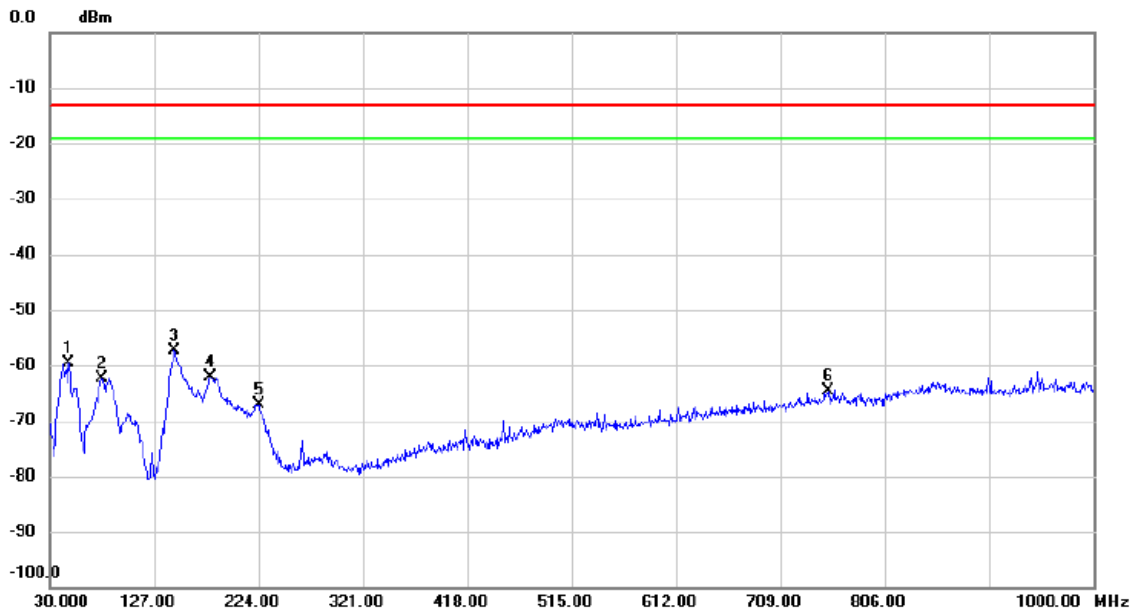

No.	Mk.	Freq. MHz	Reading Level dBm	Correct Factor dB	Measure- ment dBm	Limit dBm	Margin dB	Detector	Comment
1		47.945	-60.75	1.16	-59.59	-13.00	-46.59	peak	
2		78.015	-56.73	-5.63	-62.36	-13.00	-49.36	peak	
3	*	145.430	-59.95	2.69	-57.26	-13.00	-44.26	peak	
4		179.865	-62.90	0.76	-62.14	-13.00	-49.14	peak	
5		224.000	-66.39	-0.64	-67.03	-13.00	-54.03	peak	
6		754.105	-77.02	12.43	-64.59	-13.00	-51.59	peak	

Test Mode: LTE Band 4\_TX CH20175\_1.4M

### Horizontal

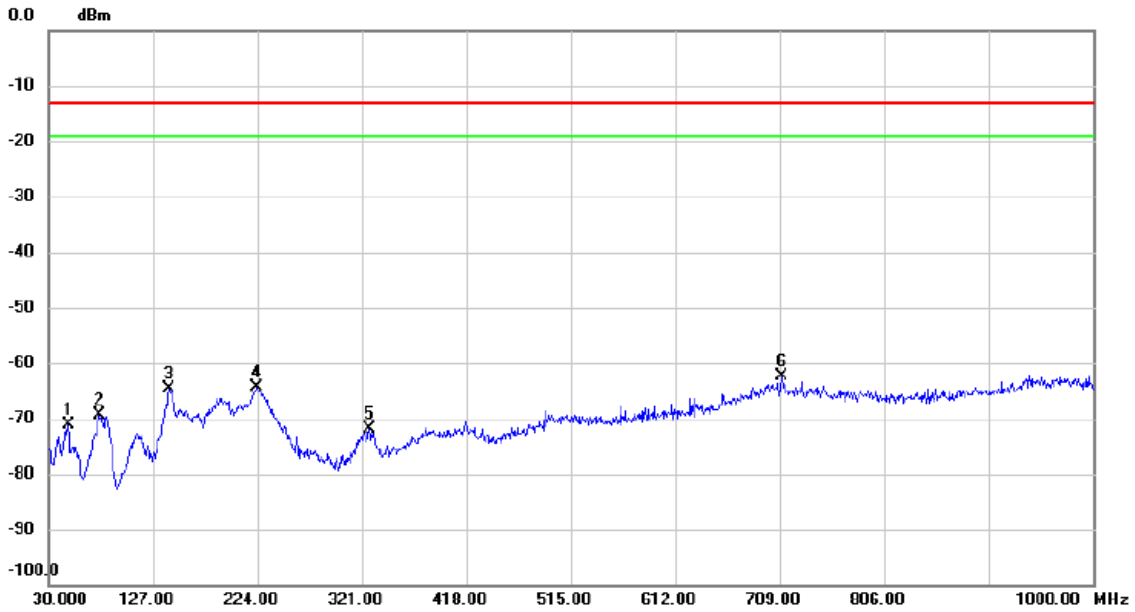

No. Mk.	Freq. MHz	Reading Level dBm	Correct Factor dB	Measure- ment dBm	Limit dBm	Margin dB	Detector	Comment
1	48.915	-72.83	1.65	-71.18	-13.00	-58.18	peak	
2	77.530	-62.09	-7.24	-69.33	-13.00	-56.33	peak	
3	141.550	-67.89	3.30	-64.59	-13.00	-51.59	peak	
4	223.030	-65.84	1.36	-64.48	-13.00	-51.48	peak	
5	327.790	-74.37	2.38	-71.99	-13.00	-58.99	peak	
6 *	711.425	-76.11	13.70	-62.41	-13.00	-49.41	peak	

Test Mode: LTE Band 4\_TX CH20175\_1.4M

**Vertical**

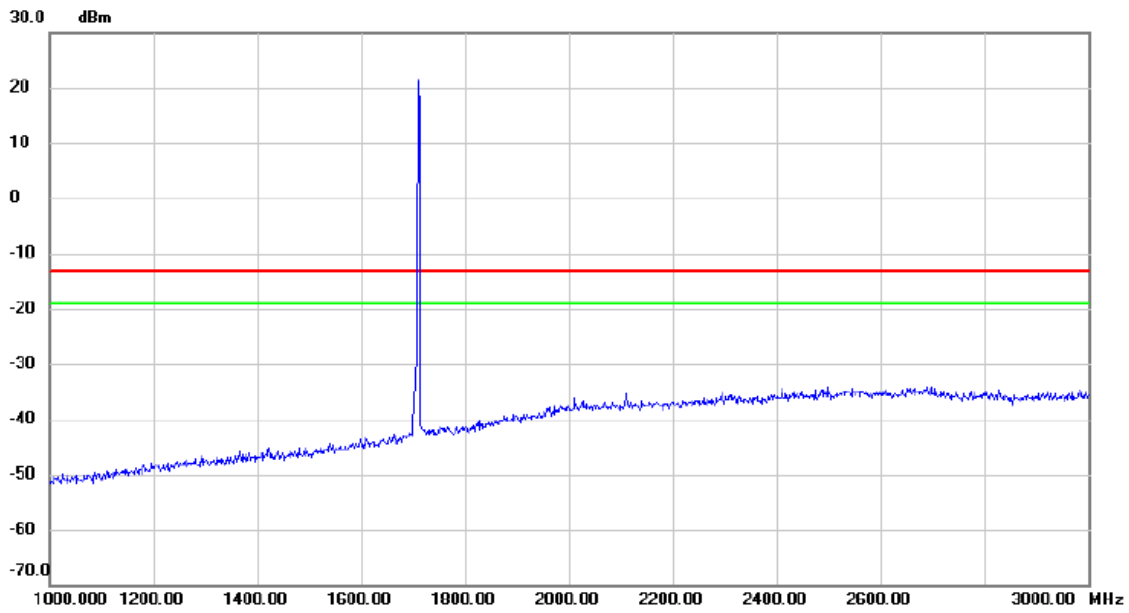

No.	Mk.	Freq.	Reading Level	Correct Factor	Measurement	Limit	Margin	Detector	Comment
		MHz	dBm	dB	dBm	dBm	dB		
		1750.00	20.00	0.00	20.00	-15.00	5.00		



Test Mode: LTE Band 4\_TX CH20175\_1.4M

Horizontal

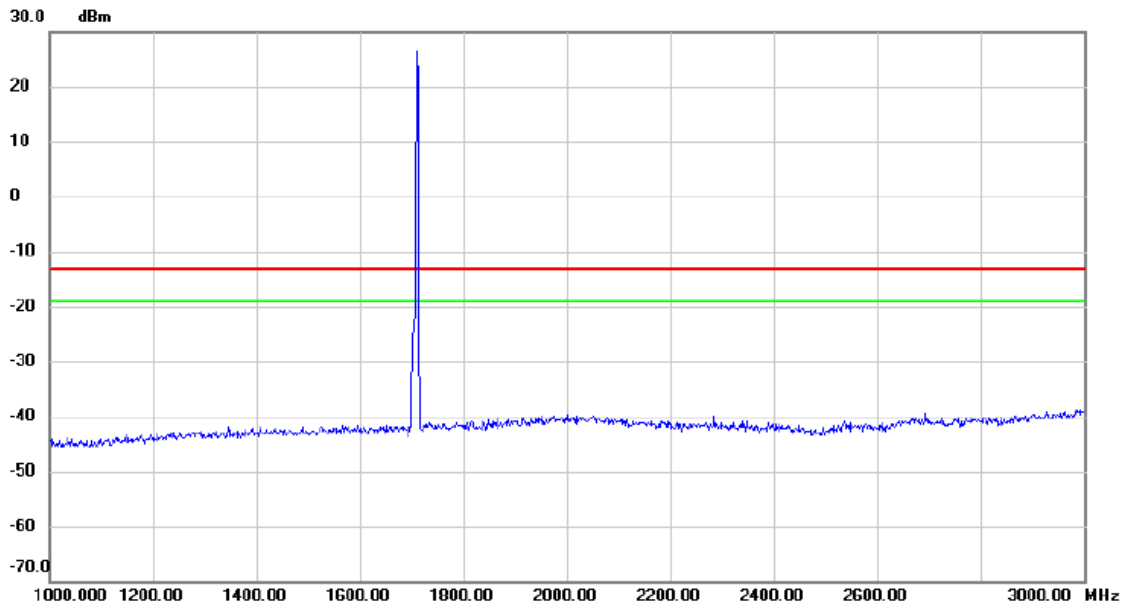

No.	Mk.	Freq.	Reading Level	Correct Factor	Measurement	Limit	Margin	Detector	Comment
		MHz	dBm	dB	dBm	dBm	dB		
		1750.00	25.00	0.00	25.00	-10.00	15.00		

Test Mode: LTE Band 4\_TX CH20175\_1.4M

**Vertical**

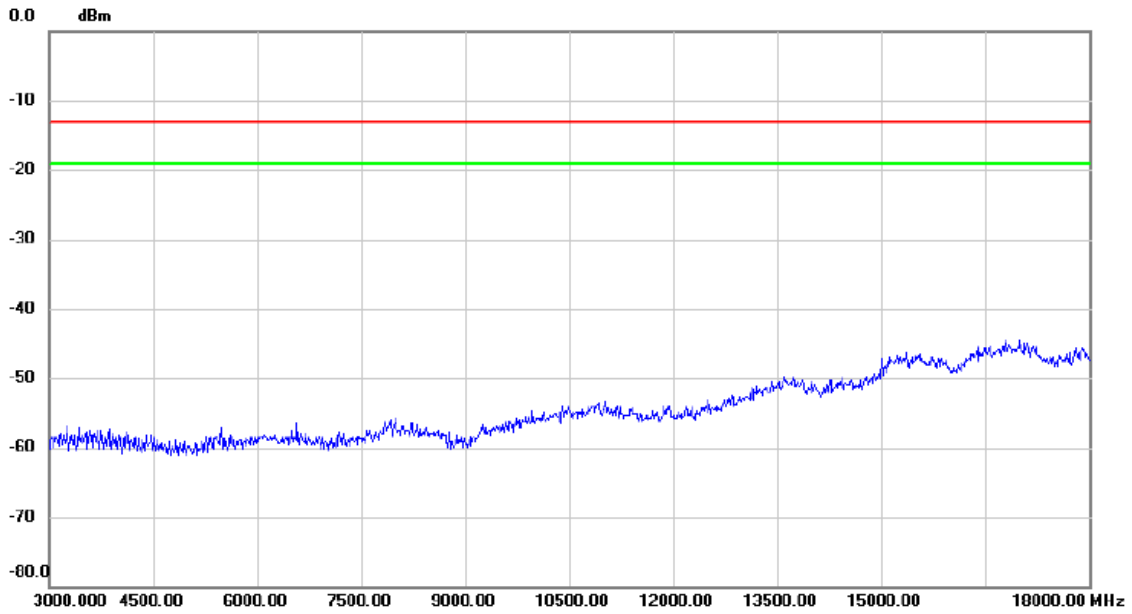

No.	Mk.	Freq.	Reading Level	Correct Factor	Measurement	Limit	Margin	Detector	Comment
		MHz	dBm	dB	dBm	dBm	dB		

Test Mode: LTE Band 4\_TX CH20175\_1.4M

**Horizontal**

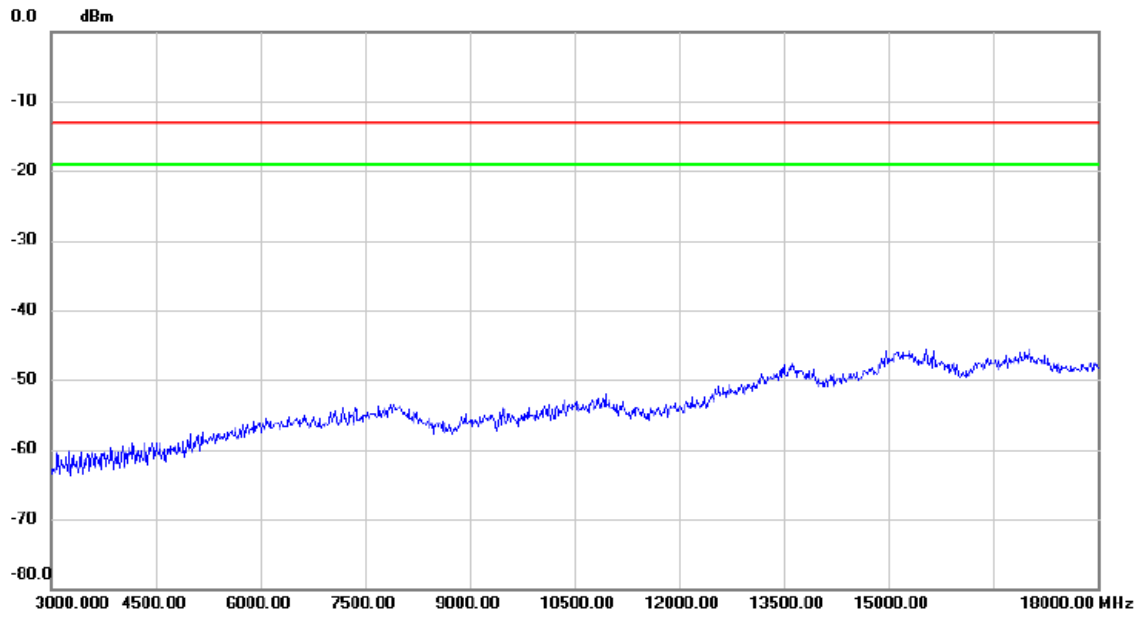

No.	Mk.	Freq.	Reading Level	Correct Factor	Measurement	Limit	Margin	Detector	Comment
		MHz	dBm	dB	dBm	dBm	dB		

Test Mode: LTE Band 4\_TX CH20175\_1.4M

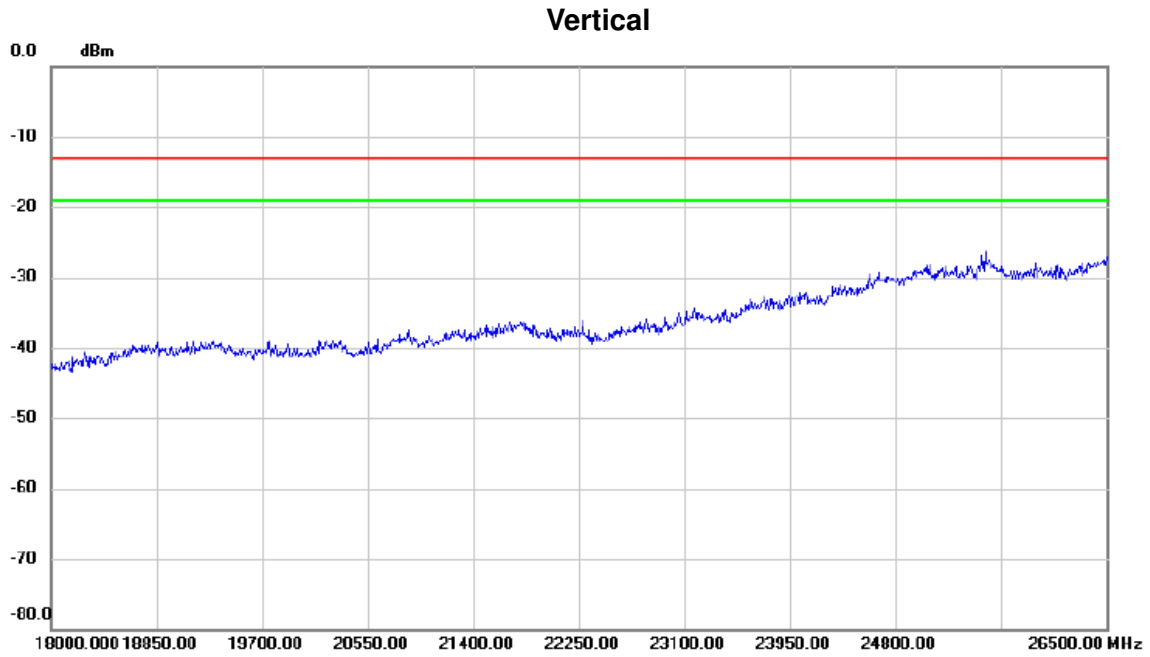

No.	Mk.	Freq.	Reading Level	Correct Factor	Measurement	Limit	Margin	Detector	Comment
		MHz	dBm	dB	dBm	dBm	dB		

Test Mode: LTE Band 4\_TX CH20175\_1.4M

### Horizontal

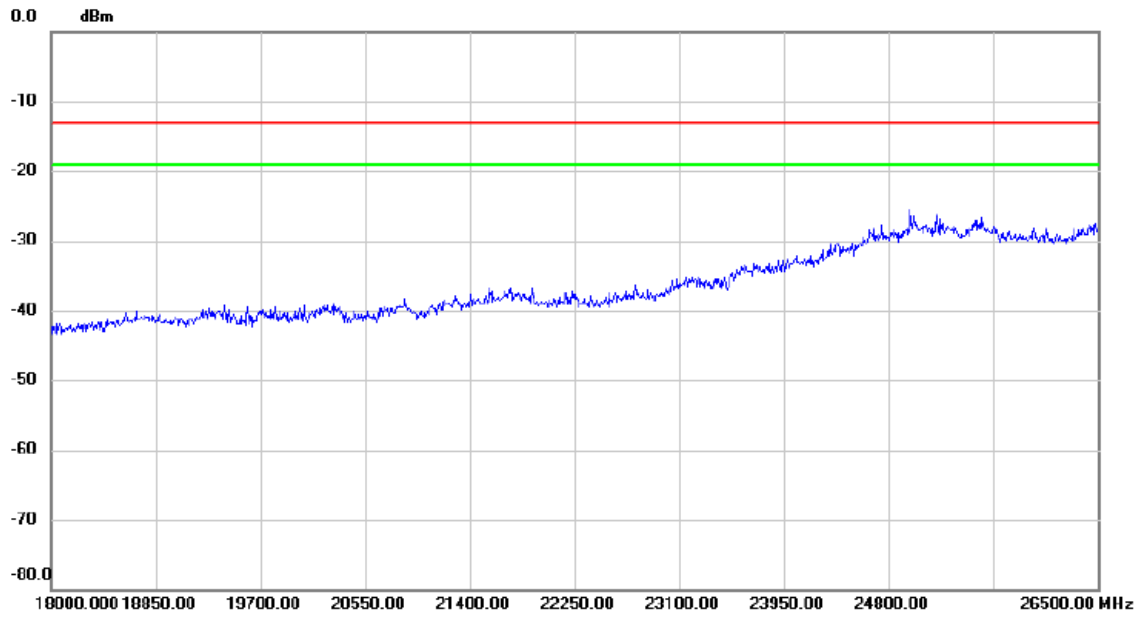

No.	Mk.	Freq. MHz	Reading Level dBm	Correct Factor dB	Measure- ment dBm	Limit dBm	Margin dB	Detector	Comment

Test Mode: LTE Band 4\_TX CH20175\_20M

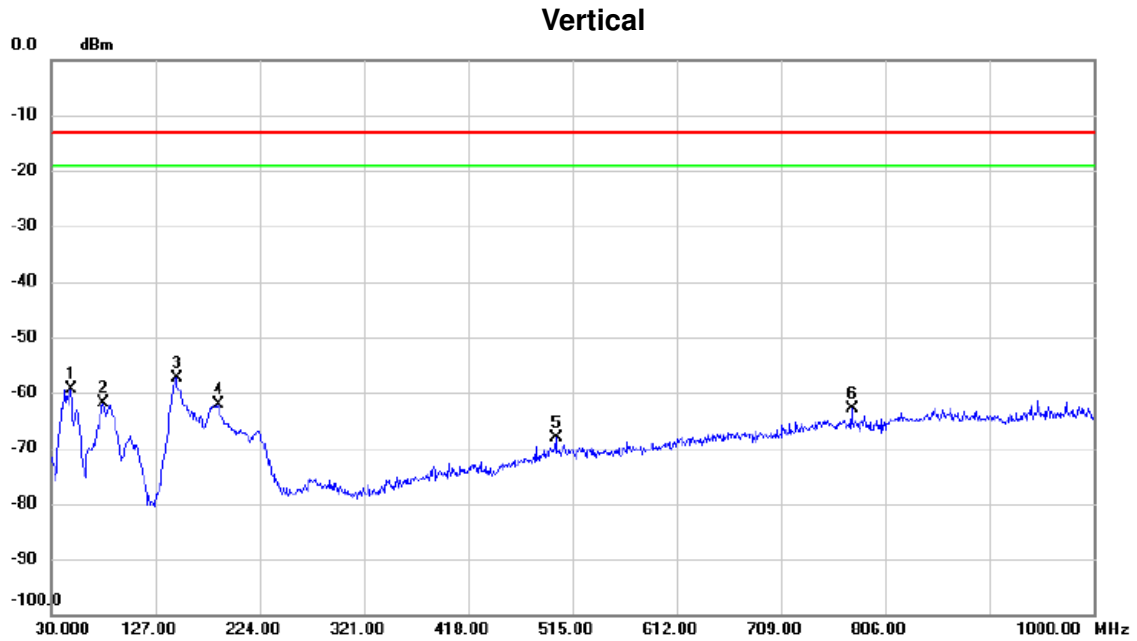

No. Mk.	Freq. MHz	Reading Level dBm	Correct Factor dB	Measure- ment dBm	Limit dBm	Margin dB	Detector	Comment
1	48.430	-60.32	1.03	-59.29	-13.00	-46.29	peak	
2	78.500	-56.24	-5.67	-61.91	-13.00	-48.91	peak	
3 *	146.400	-60.19	2.79	-57.40	-13.00	-44.40	peak	
4	185.685	-61.40	-0.69	-62.09	-13.00	-49.09	peak	
5	499.480	-75.70	7.52	-68.18	-13.00	-55.18	peak	
6	774.960	-75.11	12.18	-62.93	-13.00	-49.93	peak	

Test Mode: LTE Band 4\_TX CH20175\_20M

**Horizontal**

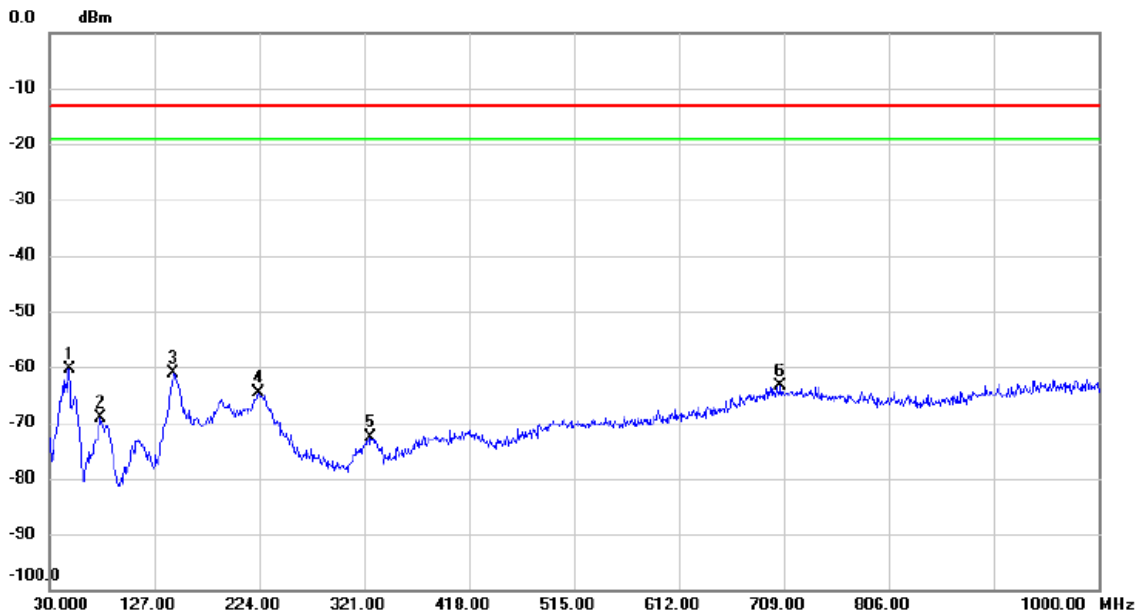

No.	Mk.	Freq. MHz	Reading Level dBm	Correct Factor dB	Measure- ment dBm	Limit dBm	Margin dB	Detector	Comment
1	*	48.430	-62.08	1.83	-60.25	-13.00	-47.25	peak	
2		77.530	-61.89	-7.24	-69.13	-13.00	-56.13	peak	
3		144.460	-64.67	3.63	-61.04	-13.00	-48.04	peak	
4		223.030	-66.02	1.36	-64.66	-13.00	-51.66	peak	
5		326.335	-74.88	2.37	-72.51	-13.00	-59.51	peak	
6		706.090	-77.10	13.83	-63.27	-13.00	-50.27	peak	

Test Mode: LTE Band 4\_TX CH20175\_20M

**Vertical**

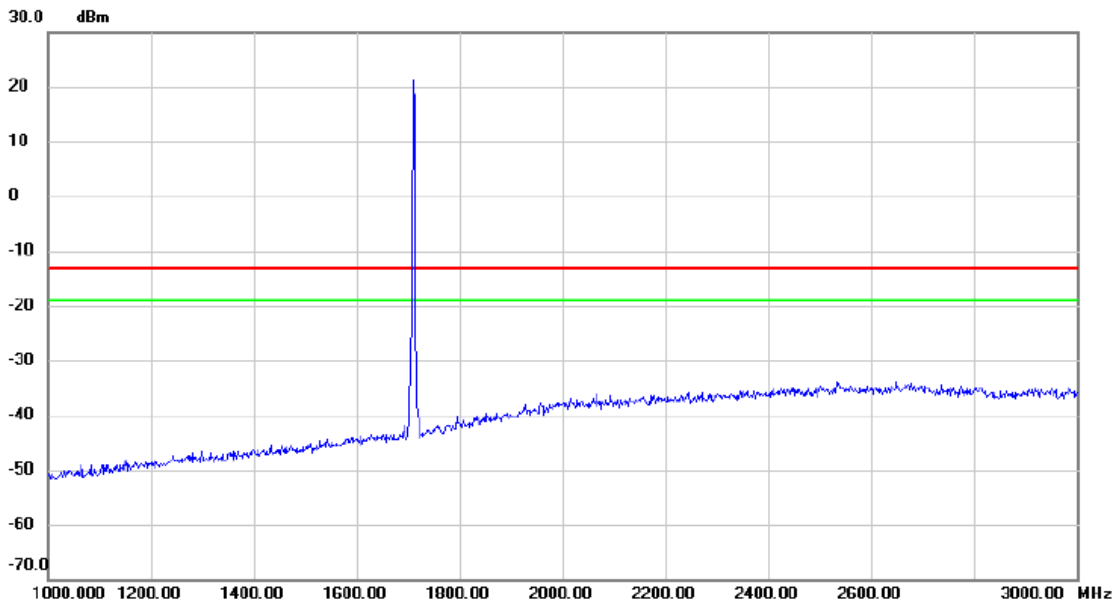

No.	Mk.	Freq.	Reading Level	Correct Factor	Measurement	Limit	Margin	Detector	Comment
		MHz	dBm	dB	dBm	dBm	dB		
		1750.000	20.0	0.0	20.0	-15.0	35.0		



Test Mode: LTE Band 4\_TX CH20175\_20M

**Horizontal**

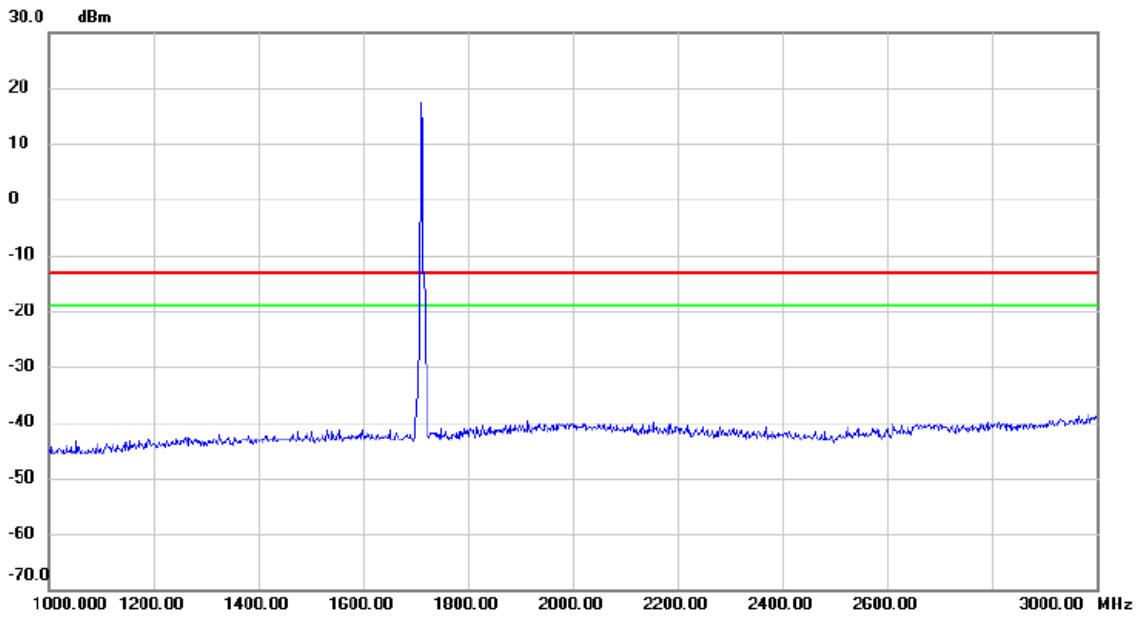

No.	Mk.	Freq.	Reading Level	Correct Factor	Measurement	Limit	Margin	Detector	Comment
		MHz	dBm	dB	dBm	dBm	dB		
		1750.000	18.0	0.0	18.0	-15.0	3.0		

Test Mode: LTE Band 4\_TX CH20175\_20M

**Vertical**

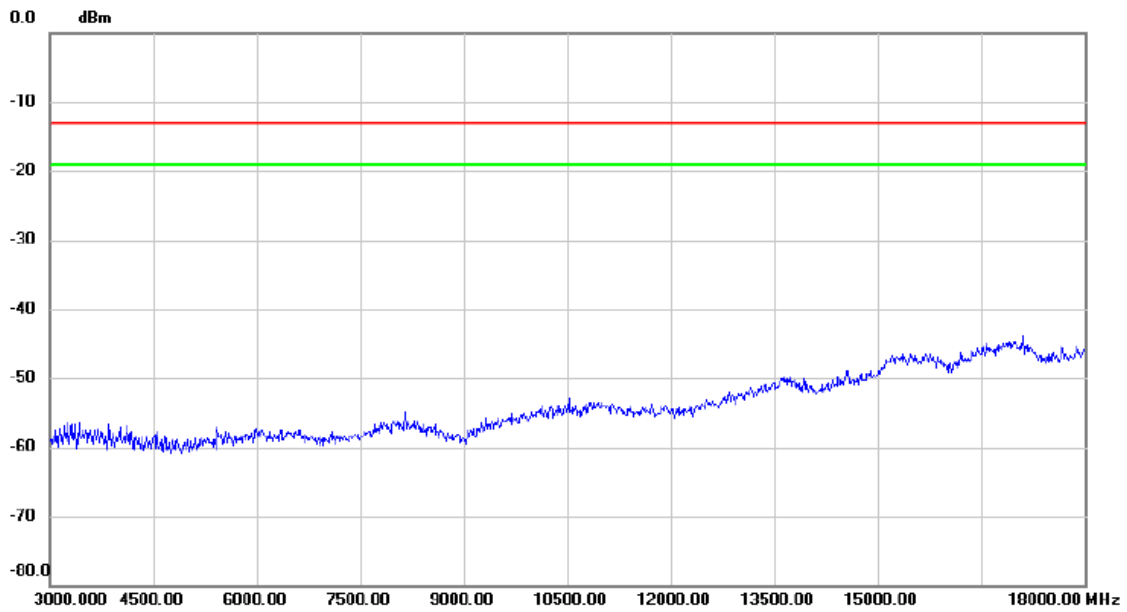

No.	Mk.	Freq.	Reading Level	Correct Factor	Measurement	Limit	Margin	Detector	Comment
		MHz	dBm	dB	dBm	dBm	dB		

Test Mode: LTE Band 4\_TX CH20175\_20M

**Horizontal**

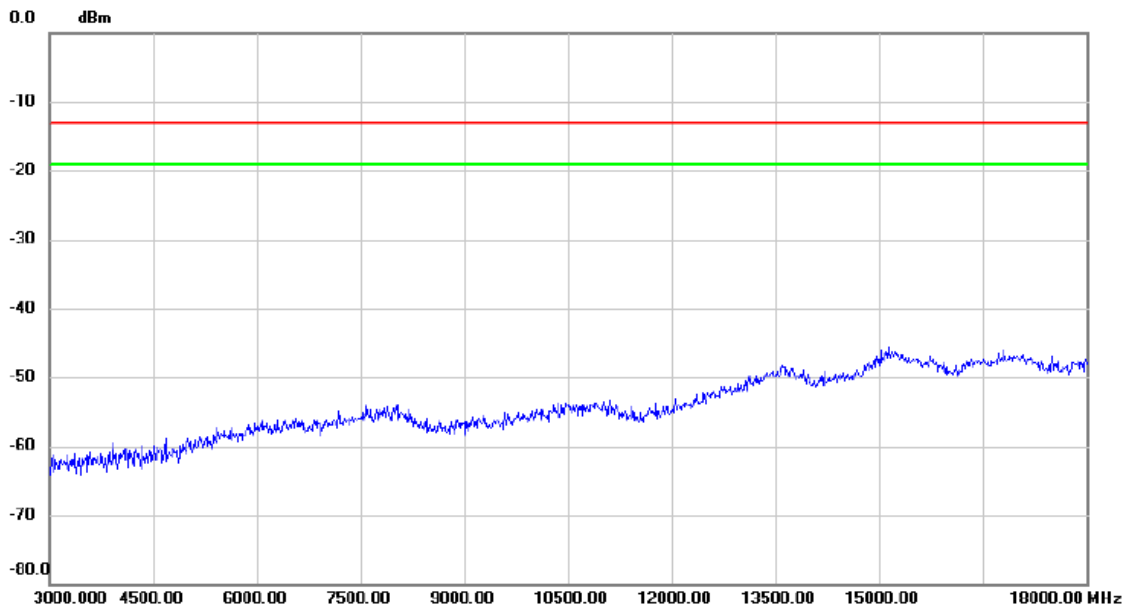

No.	Mk.	Freq.	Reading Level	Correct Factor	Measurement	Limit	Margin	Detector	Comment
		MHz	dBm	dB	dBm	dBm	dB		

Test Mode: LTE Band 4\_TX CH20175\_20M

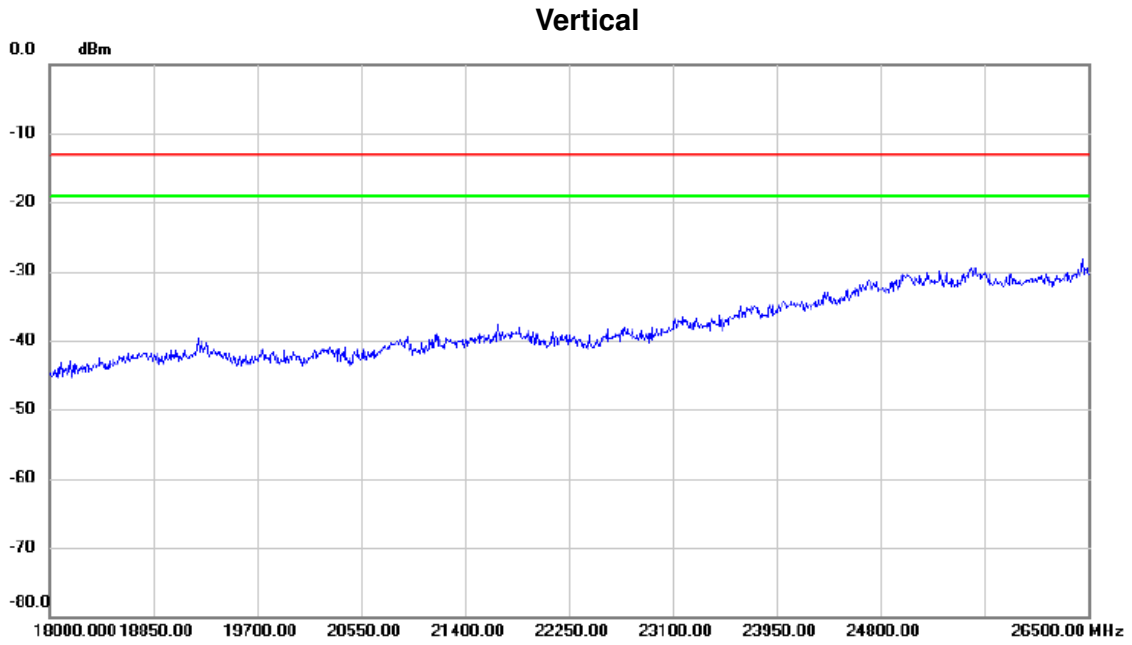

No.	Mk.	Freq.	Reading Level	Correct Factor	Measurement	Limit	Margin	Detector	Comment
		MHz	dBm	dB	dBm	dBm	dB		

Test Mode: LTE Band 4\_TX CH20175\_20M

**Horizontal**

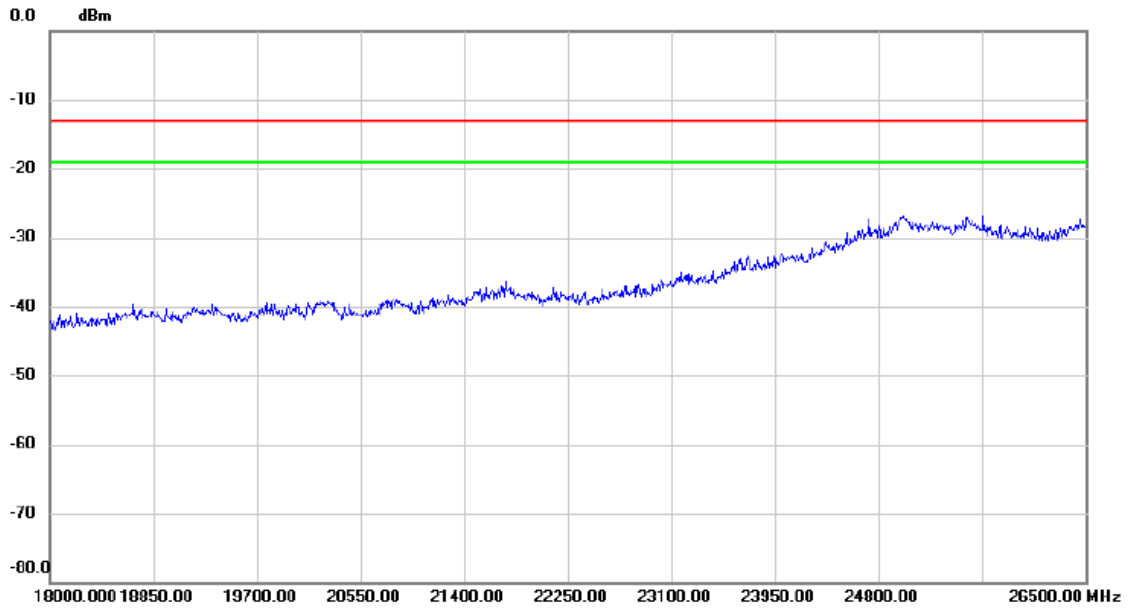

No.	Mk.	Freq.	Reading Level	Correct Factor	Measurement	Limit	Margin	Detector	Comment
		MHz	dBm	dB	dBm	dBm	dB		

Test Mode: LTE Band 7\_TX CH21100\_5M

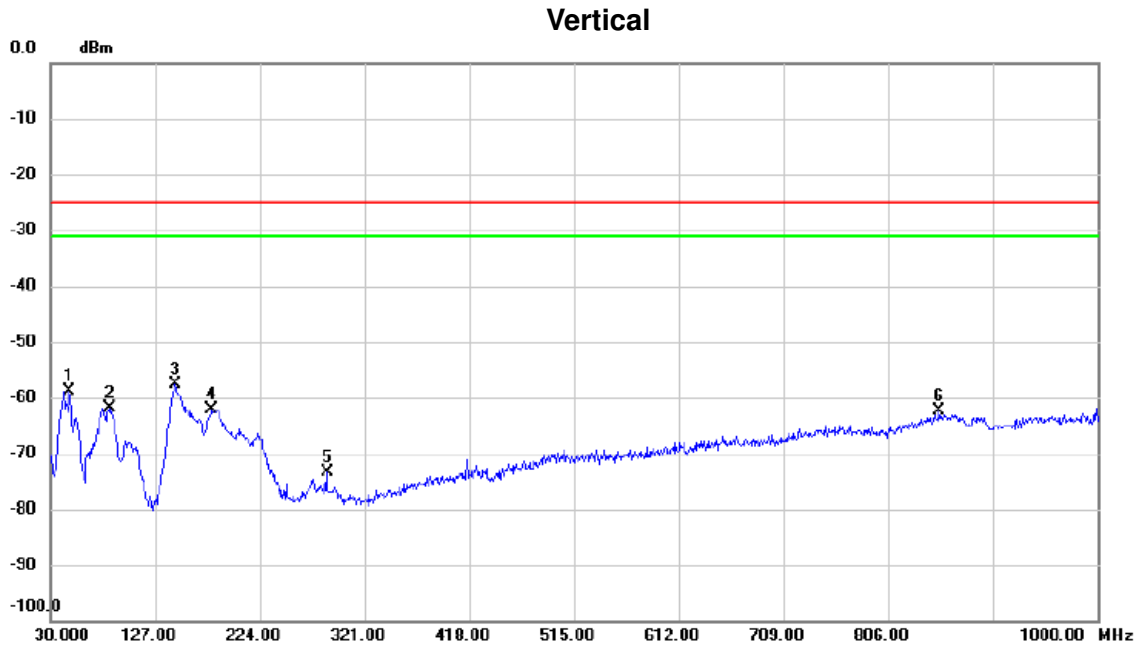

No.	Mk.	Freq. MHz	Reading Level dBm	Correct Factor dB	Measure- ment dBm	Limit dBm	Margin dB	Detector	Comment
1		47.945	-60.02	1.16	-58.86	-25.00	-33.86	peak	
2		85.290	-55.50	-6.35	-61.85	-25.00	-36.85	peak	
3	*	145.430	-60.21	2.69	-57.52	-25.00	-32.52	peak	
4		179.865	-62.90	0.76	-62.14	-25.00	-37.14	peak	
5		286.080	-75.65	2.39	-73.26	-25.00	-48.26	peak	
6		853.530	-76.81	14.35	-62.46	-25.00	-37.46	peak	

Test Mode: LTE Band 7\_TX CH21100\_5M

**Horizontal**

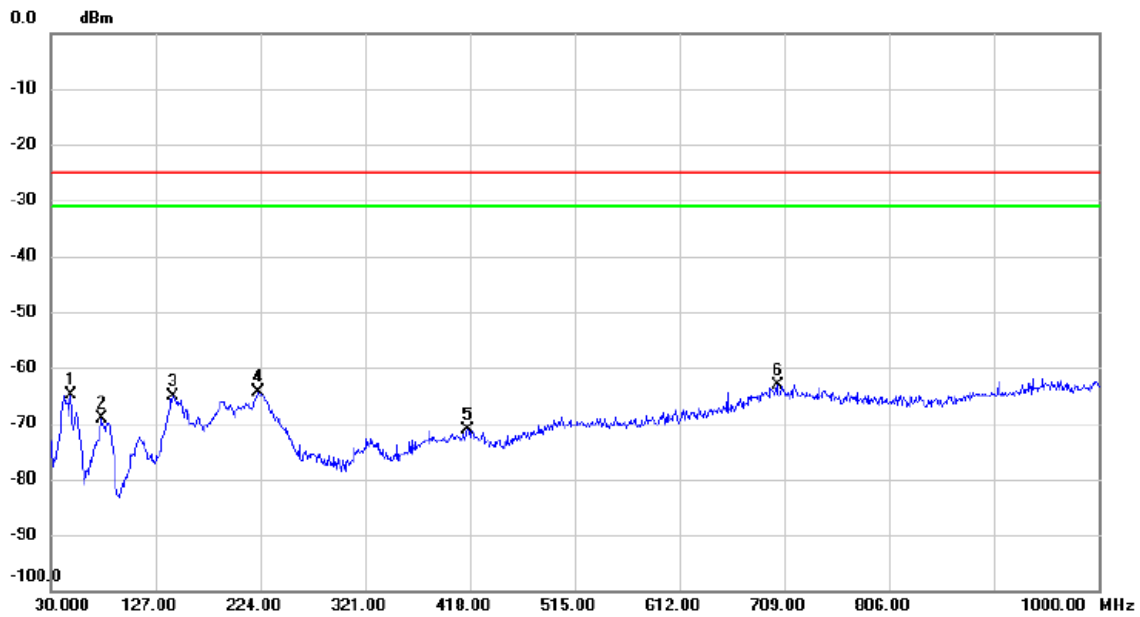

No.	Mk.	Freq. MHz	Reading Level dBm	Correct Factor dB	Measure- ment dBm	Limit dBm	Margin dB	Detector	Comment
1		48.430	-66.69	1.83	-64.86	-25.00	-39.86	peak	
2		77.530	-61.97	-7.24	-69.21	-25.00	-44.21	peak	
3		143.490	-68.65	3.52	-65.13	-25.00	-40.13	peak	
4		221.575	-65.41	0.97	-64.44	-25.00	-39.44	peak	
5		416.060	-77.90	6.68	-71.22	-25.00	-46.22	peak	
6	*	702.695	-77.06	13.91	-63.15	-25.00	-38.15	peak	

Test Mode: LTE Band 7\_TX CH21100\_5M

**Vertical**

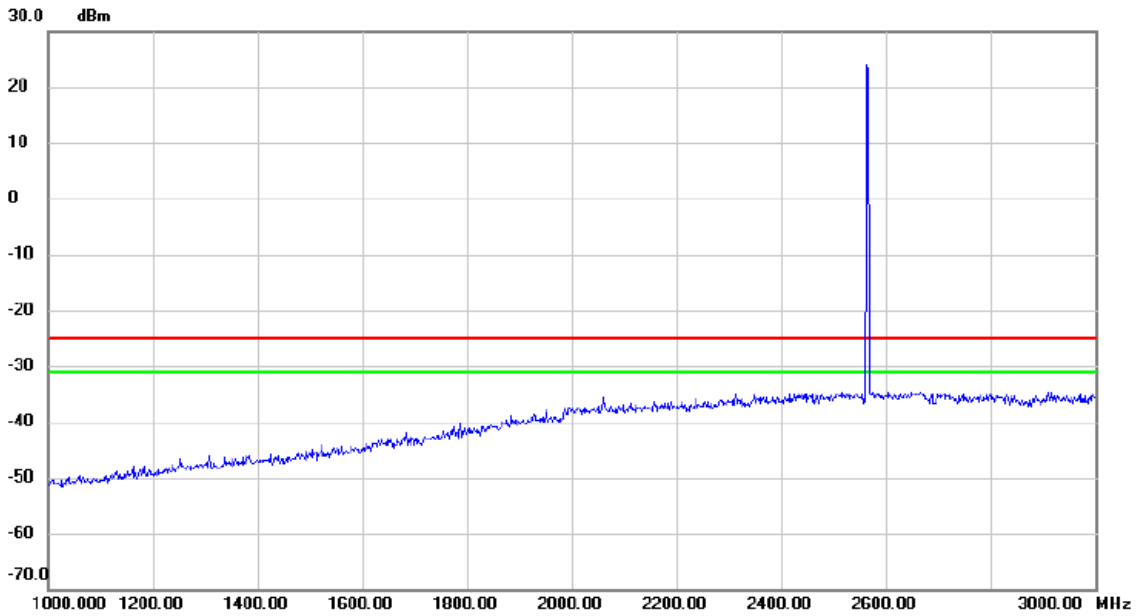

No.	Mk.	Freq. MHz	Reading Level dBm	Correct Factor dB	Measure- ment dBm	Limit dBm	Margin dB	Detector	Comment



Test Mode: LTE Band 7\_TX CH21100\_5M

**Horizontal**

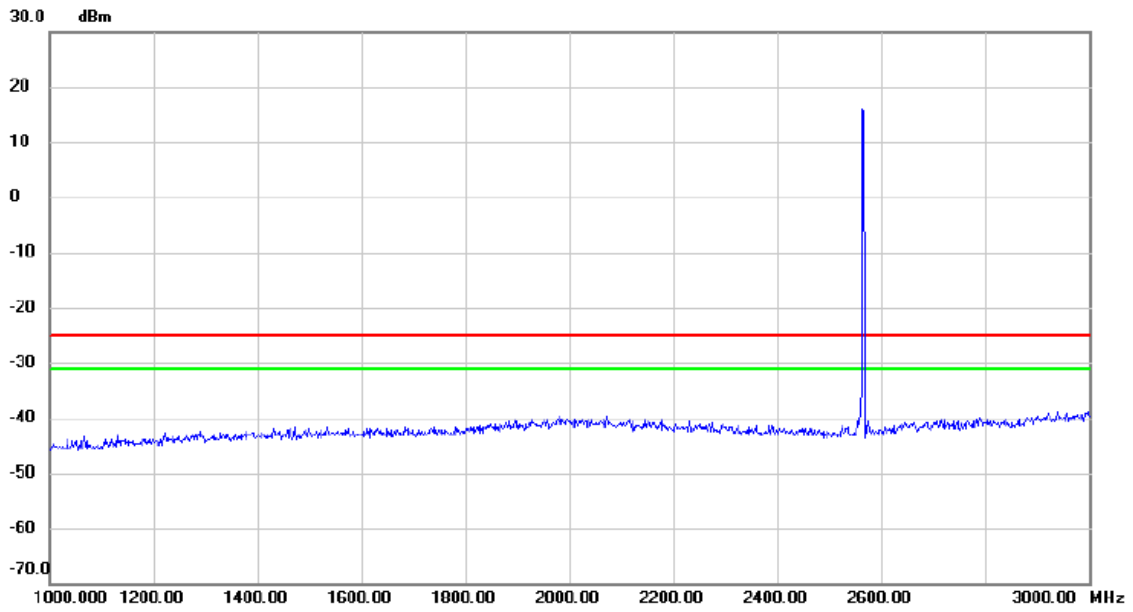

No.	Mk.	Freq.	Reading Level	Correct Factor	Measurement	Limit	Margin	Detector	Comment
		MHz	dBm	dB	dBm	dBm	dB		
		2600.00	15.00		15.00	-25.00	40.00		

Test Mode: LTE Band 7\_TX CH21100\_5M

**Vertical**

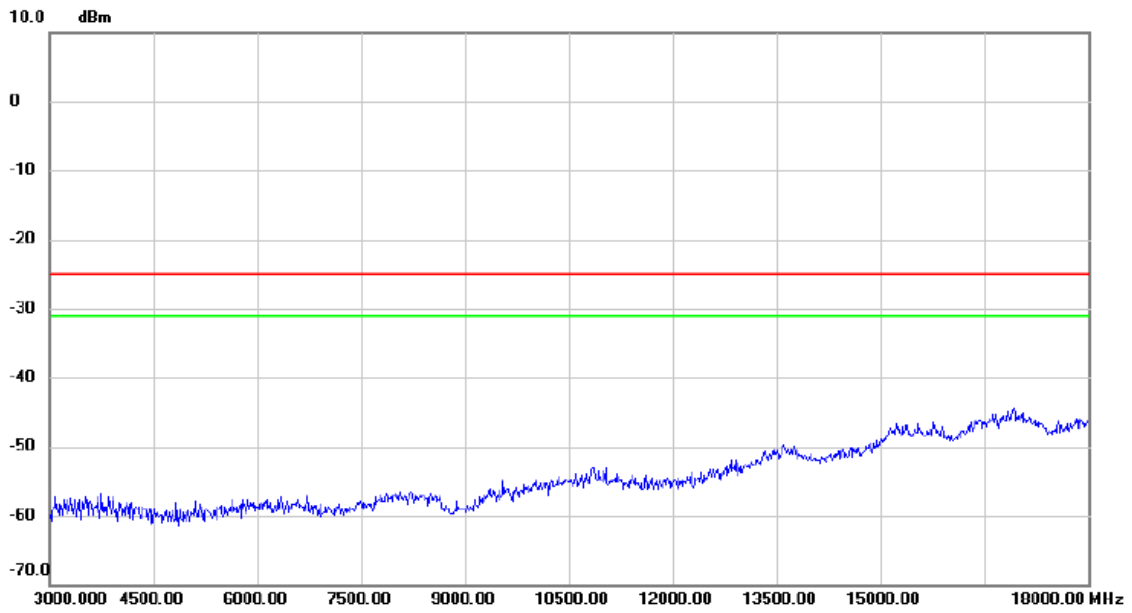

No.	Mk.	Freq.	Reading Level	Correct Factor	Measurement	Limit	Margin	Detector	Comment
		MHz	dBm	dB	dBm	dBm	dB		

Test Mode: LTE Band 7\_TX CH21100\_5M

**Horizontal**

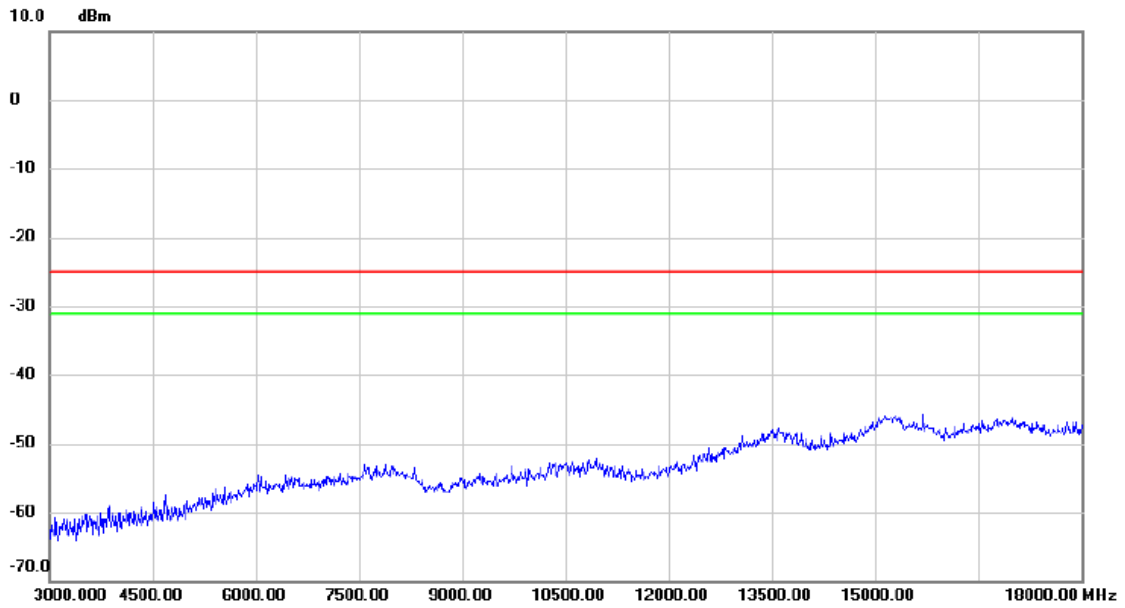

No.	Mk.	Freq.	Reading Level	Correct Factor	Measurement	Limit	Margin	Detector	Comment
		MHz	dBm	dB	dBm	dBm	dB		

Test Mode: LTE Band 7\_TX CH21100\_5M

**Vertical**

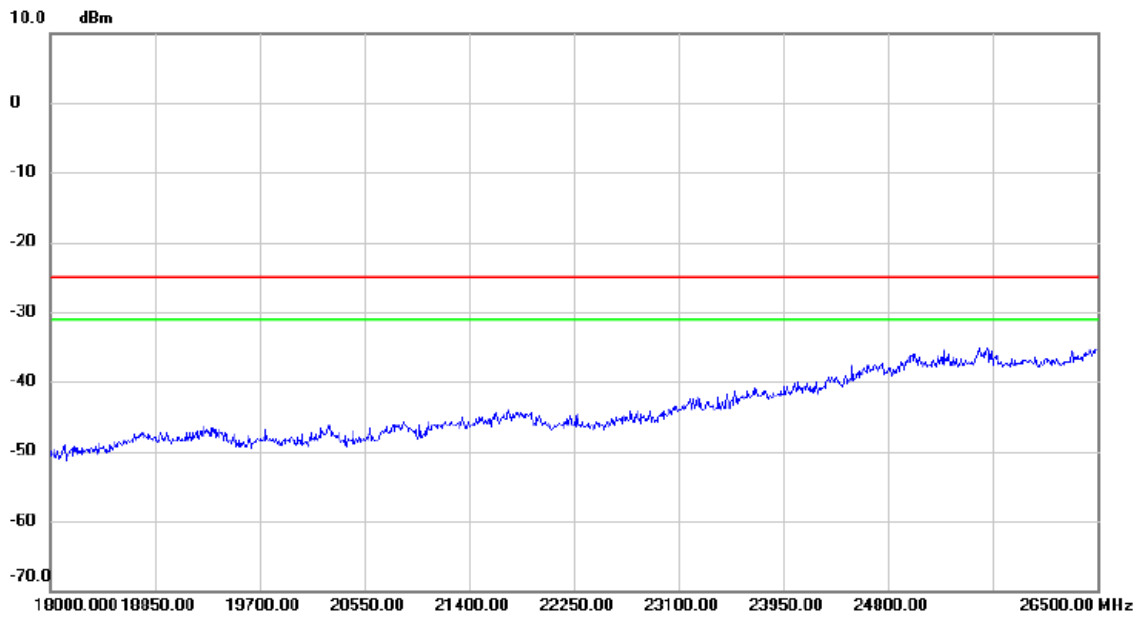

No.	Mk.	Freq.	Reading Level	Correct Factor	Measurement	Limit	Margin	Detector	Comment
		MHz	dBm	dB	dBm	dBm	dB		

Test Mode: LTE Band 7\_TX CH21100\_5M

### Horizontal

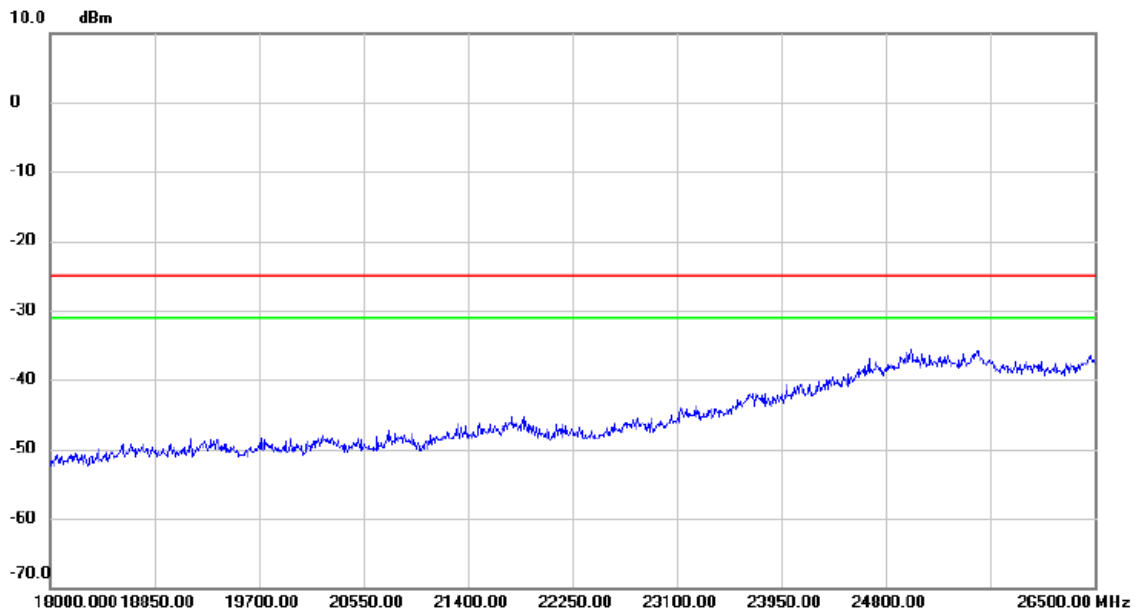

No.	Mk.	Freq. MHz	Reading Level dBm	Correct Factor dB	Measure- ment dBm	Limit dBm	Margin dB	Detector	Comment

Test Mode: LTE Band 7\_TX CH21100\_20M

**Vertical**

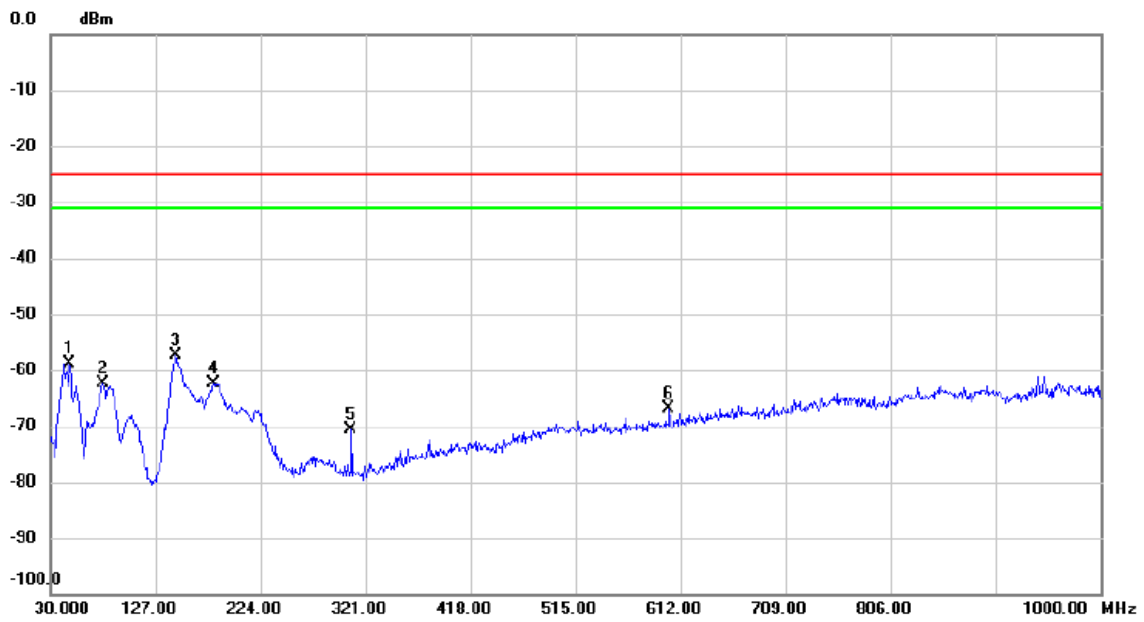

No.	Mk.	Freq. MHz	Reading Level dBm	Correct Factor dB	Measure- ment dBm	Limit dBm	Margin dB	Detector	Comment
1		47.945	-59.93	1.16	-58.77	-25.00	-33.77	peak	
2		78.985	-56.71	-5.70	-62.41	-25.00	-37.41	peak	
3	*	145.915	-60.20	2.74	-57.46	-25.00	-32.46	peak	
4		180.835	-62.94	0.56	-62.38	-25.00	-37.38	peak	
5		307.420	-71.51	0.80	-70.71	-25.00	-45.71	peak	
6		601.330	-75.53	8.74	-66.79	-25.00	-41.79	peak	

Test Mode: LTE Band 7\_TX CH21100\_20M

### Horizontal

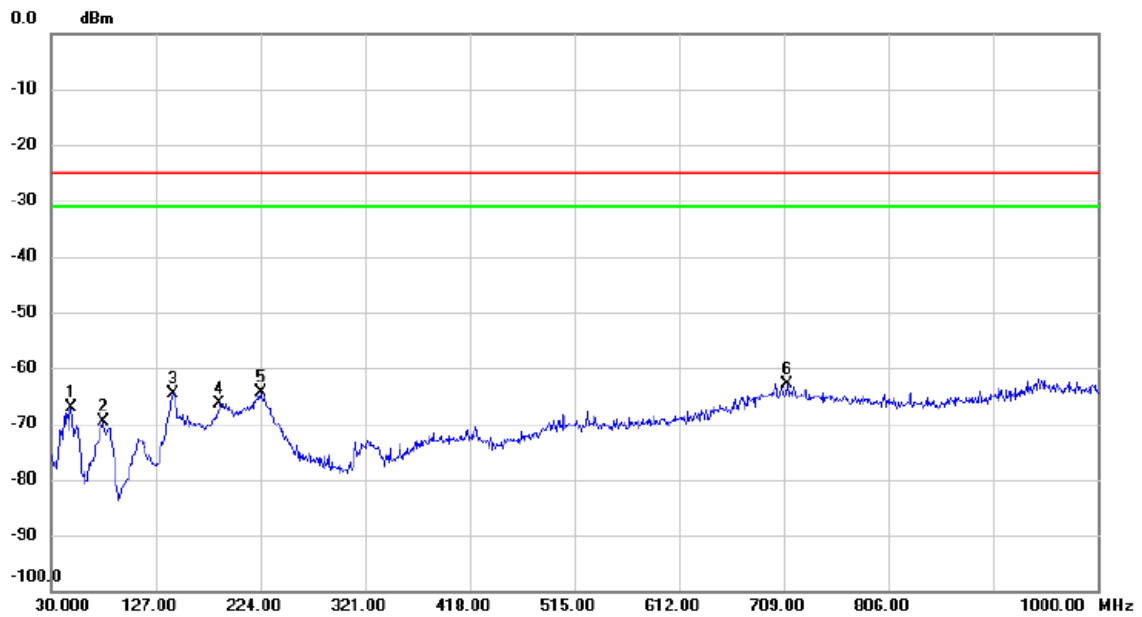

No.	Mk.	Freq. MHz	Reading Level dBm	Correct Factor dB	Measure- ment dBm	Limit dBm	Margin dB	Detector	Comment
1		48.430	-68.97	1.83	-67.14	-25.00	-42.14	peak	
2		78.015	-62.46	-7.26	-69.72	-25.00	-44.72	peak	
3		143.005	-67.96	3.46	-64.50	-25.00	-39.50	peak	
4		186.170	-64.55	-1.83	-66.38	-25.00	-41.38	peak	
5		224.000	-66.01	1.62	-64.39	-25.00	-39.39	peak	
6	*	711.910	-76.53	13.69	-62.84	-25.00	-37.84	peak	

Test Mode: LTE Band 7\_TX CH21100\_20M

**Vertical**

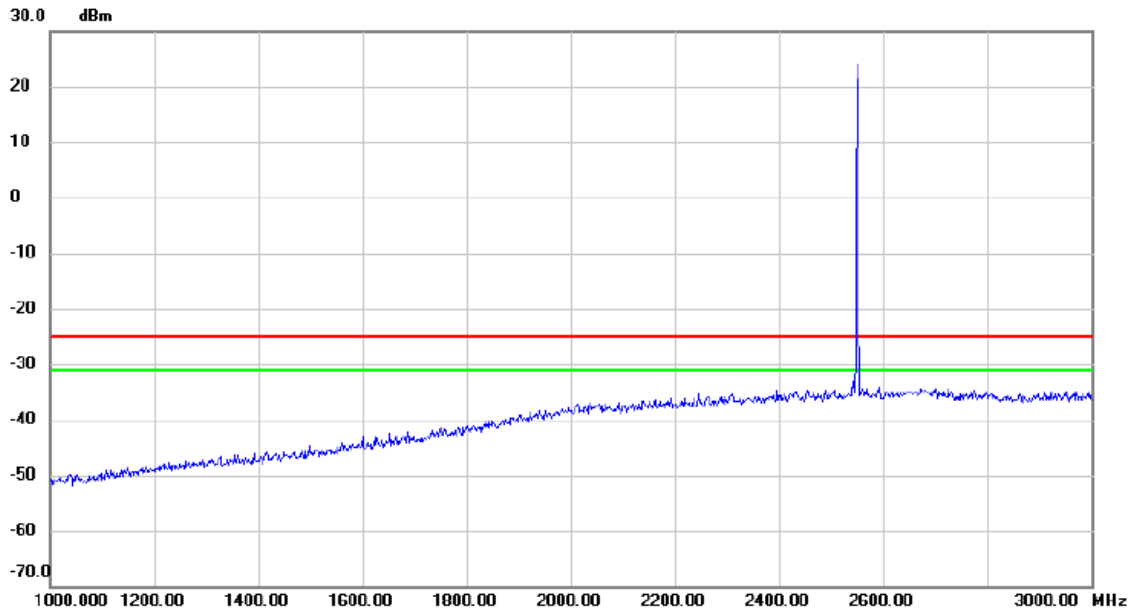

No.	Mk.	Freq. MHz	Reading Level dBm	Correct Factor dB	Measure- ment dBm	Limit dBm	Margin dB	Detector	Comment
-----	-----	--------------	-------------------------	-------------------------	-------------------------	--------------	--------------	----------	---------



Test Mode: LTE Band 7\_TX CH21100\_20M

**Horizontal**

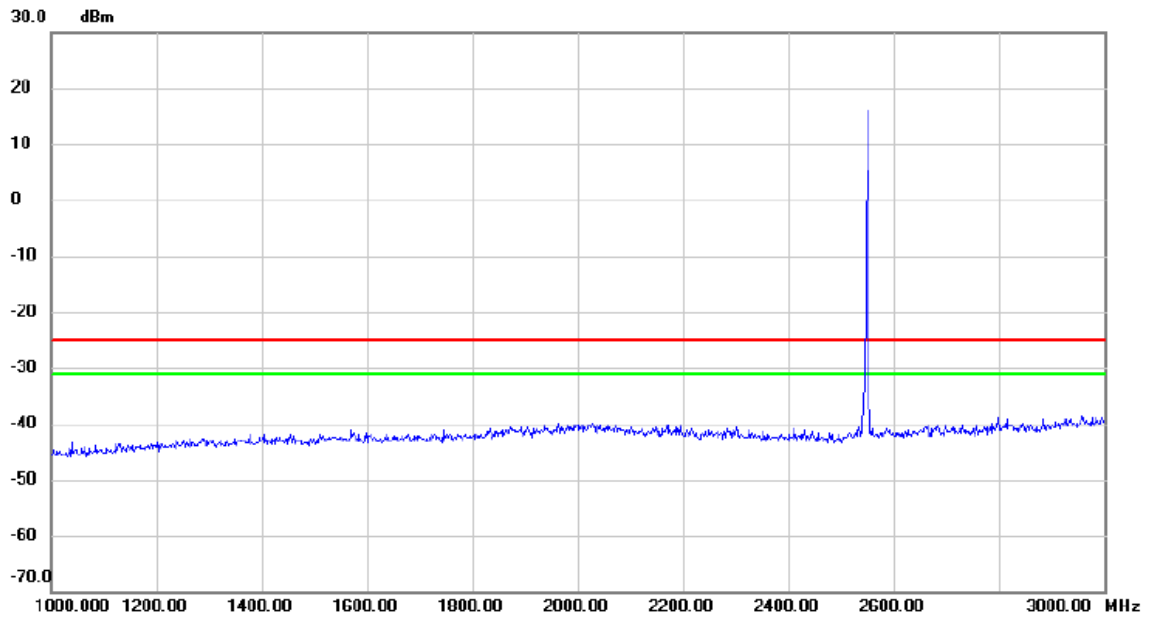

No.	Mk.	Freq. MHz	Reading Level dBm	Correct Factor dB	Measure- ment dBm	Limit dBm	Margin dB	Detector	Comment

Test Mode: LTE Band 7\_TX CH21100\_20M

**Vertical**

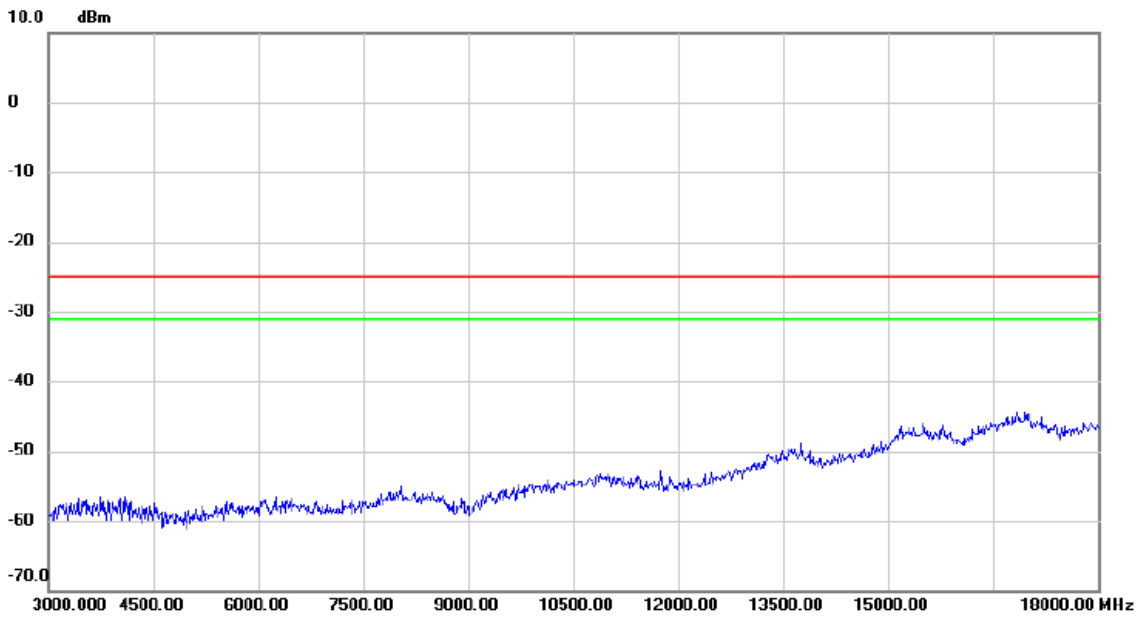

No.	Mk.	Freq.	Reading Level	Correct Factor	Measurement	Limit	Margin	Detector	Comment
		MHz	dBm	dB	dBm	dBm	dB		

Test Mode: LTE Band 7\_TX CH21100\_20M

**Horizontal**

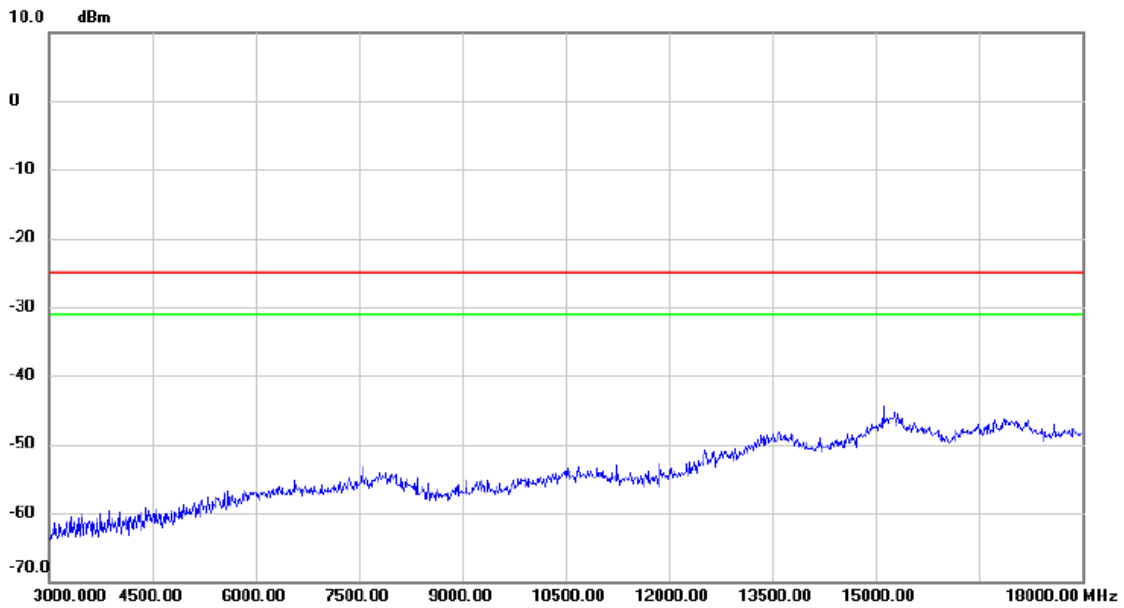

No.	Mk.	Freq.	Reading Level	Correct Factor	Measurement	Limit	Margin	Detector	Comment
		MHz	dBm	dB	dBm	dBm	dB		

Test Mode: LTE Band 7\_TX CH21100\_20M

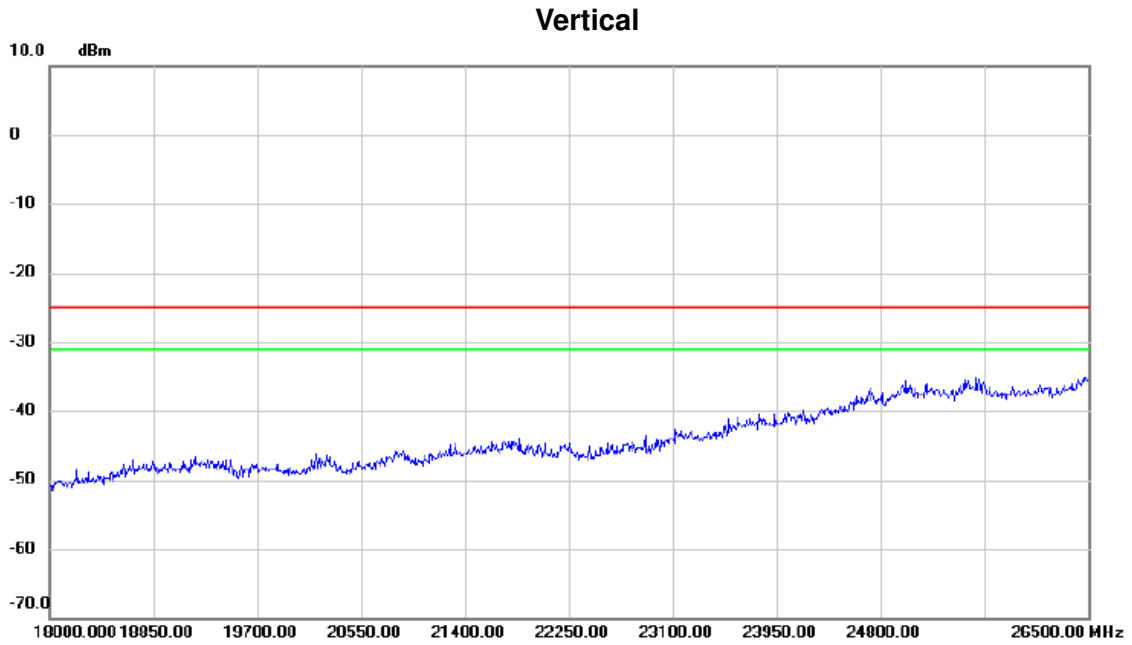

No.	Mk.	Freq. MHz	Reading Level dBm	Correct Factor dB	Measure- ment dBm	Limit dBm	Margin dB	Detector	Comment
-----	-----	--------------	-------------------------	-------------------------	-------------------------	--------------	--------------	----------	---------

Test Mode: LTE Band 7\_TX CH21100\_20M

**Horizontal**

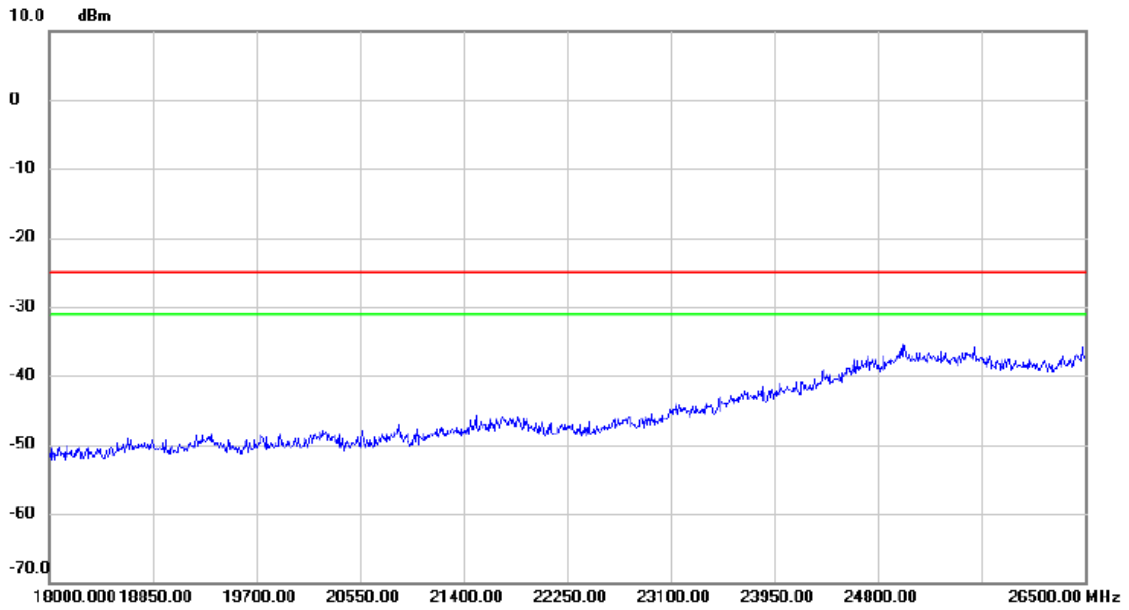

No.	Mk.	Freq.	Reading Level	Correct Factor	Measurement	Limit	Margin	Detector	Comment
		MHz	dBm	dB	dBm	dBm	dB		

# ATTACHMENT E - BAND EDGE

LTE Band 4\_1.4M

1RB0

1RB5

Channel

19957

Channel

20393

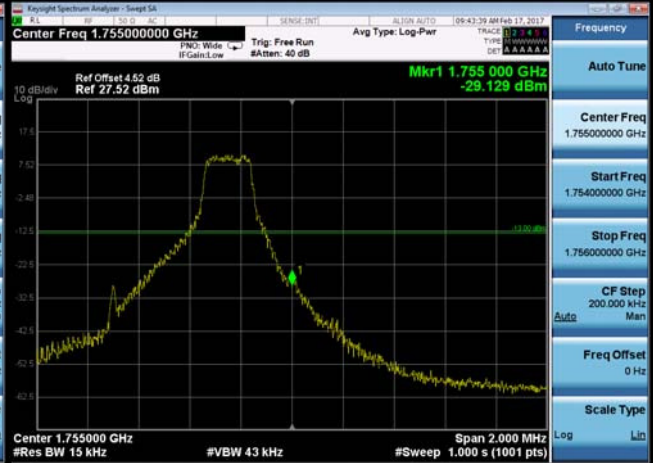
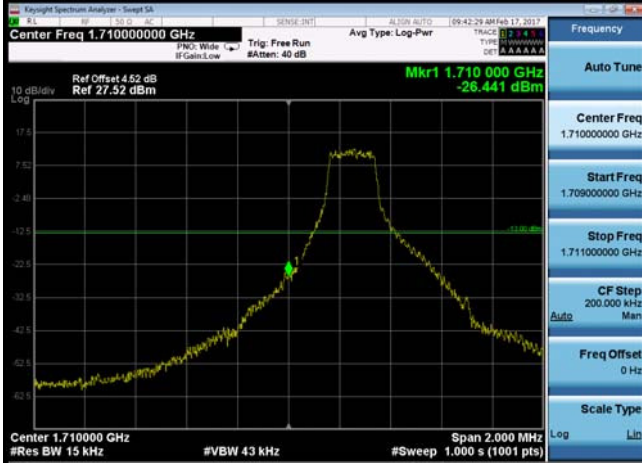

6RB0

Channel

19957

Channel

20393

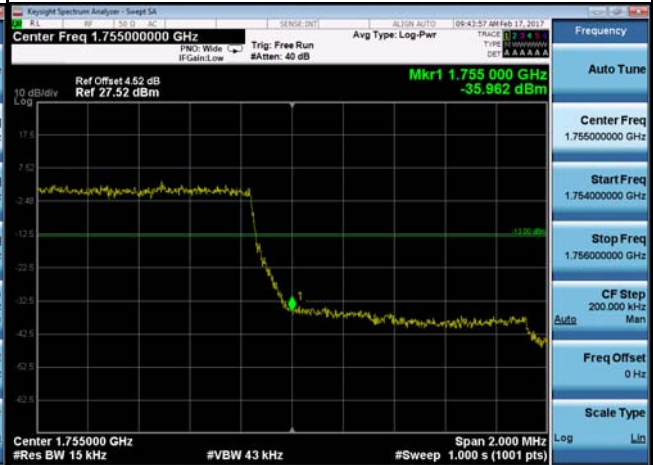
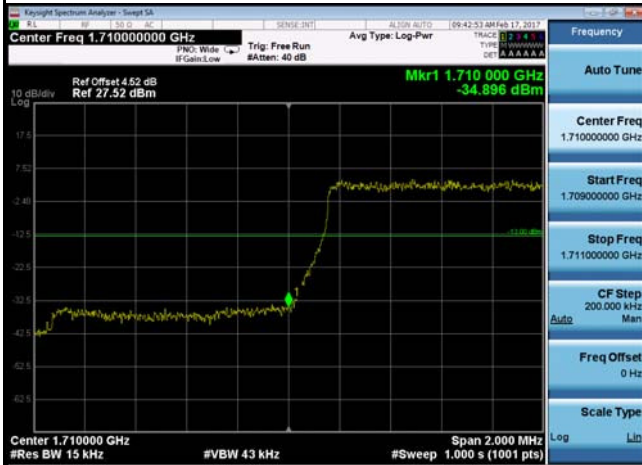

LTE Band 4\_3M

1RB0

1RB14

Channel

19965

Channel

20385

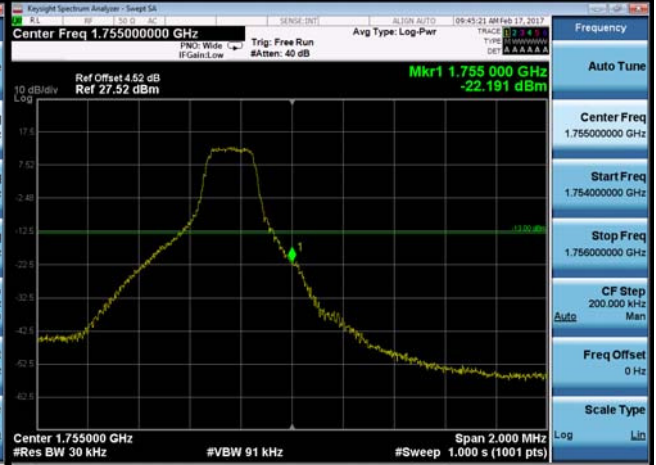
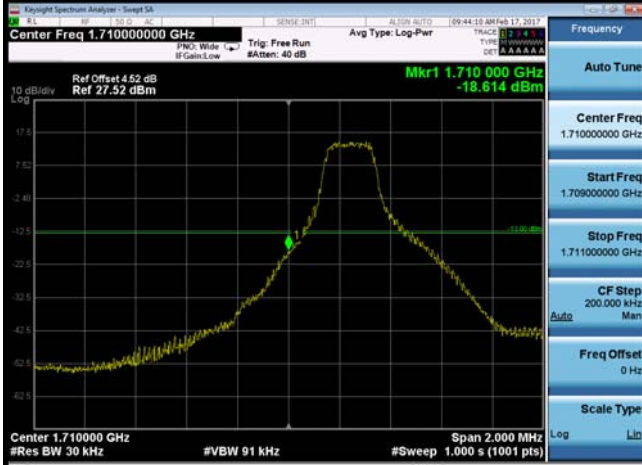

15RB0

Channel

19965

Channel

20385

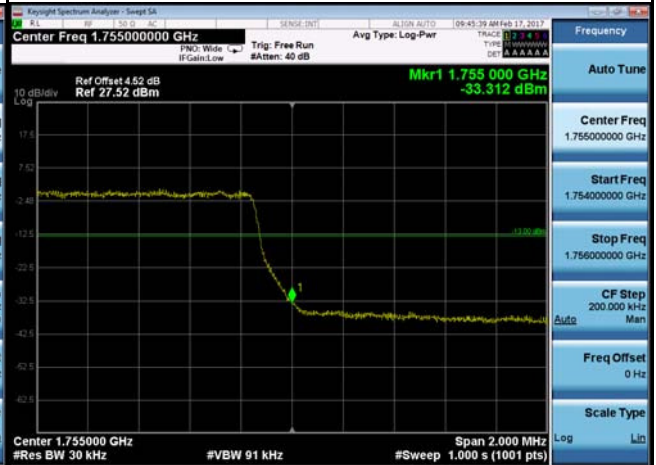
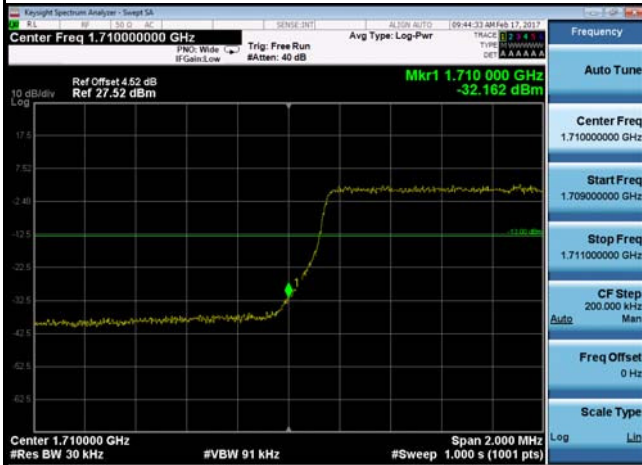



LTE Band 4\_5M

1RB0

1RB24

Channel

19975

Channel

20375

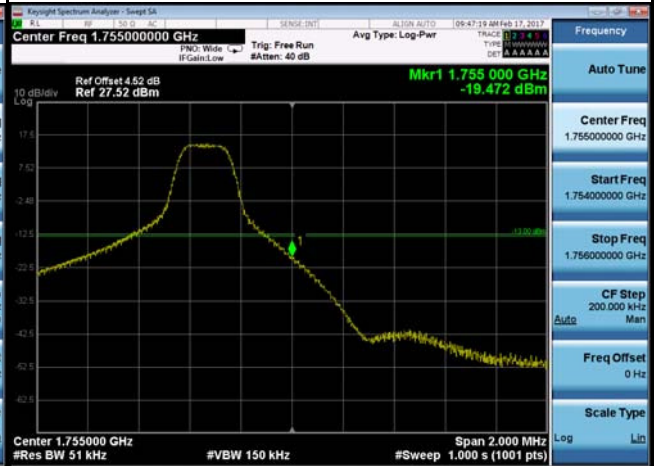
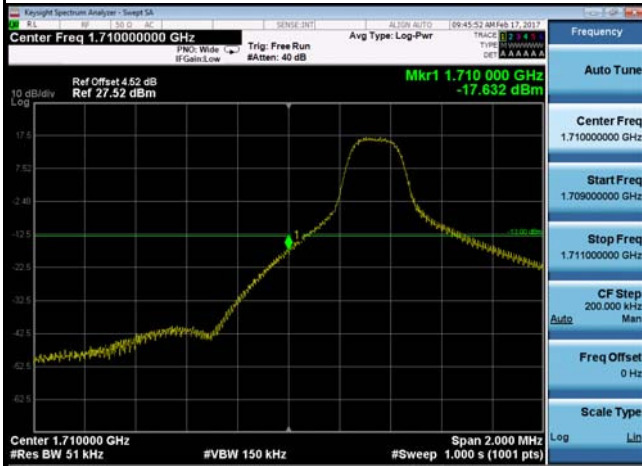

25RB0

Channel

19975

Channel

20375

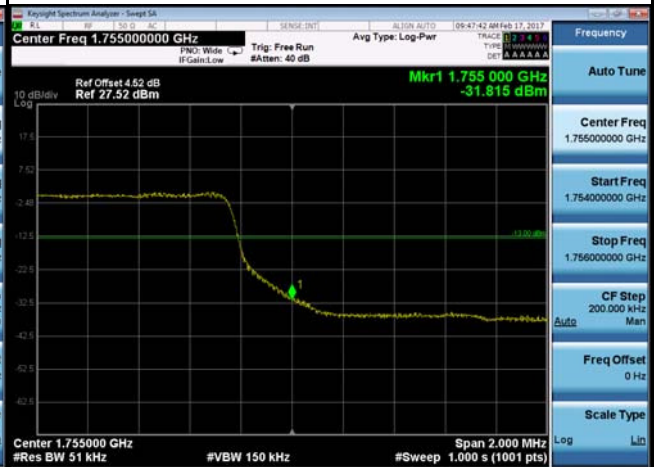
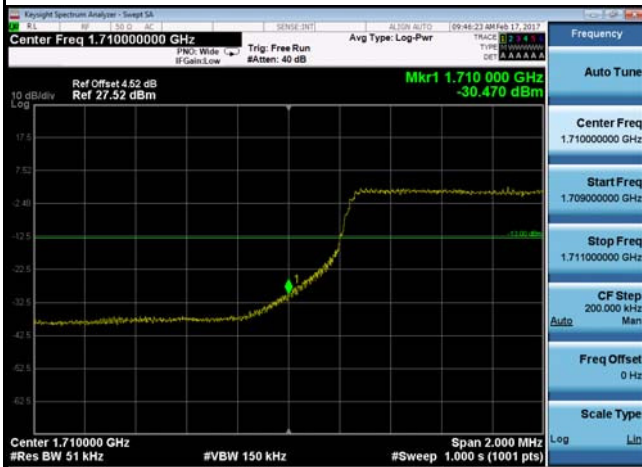

LTE Band 4\_10M

1RB0

1RB49

Channel

20000

Channel

20350

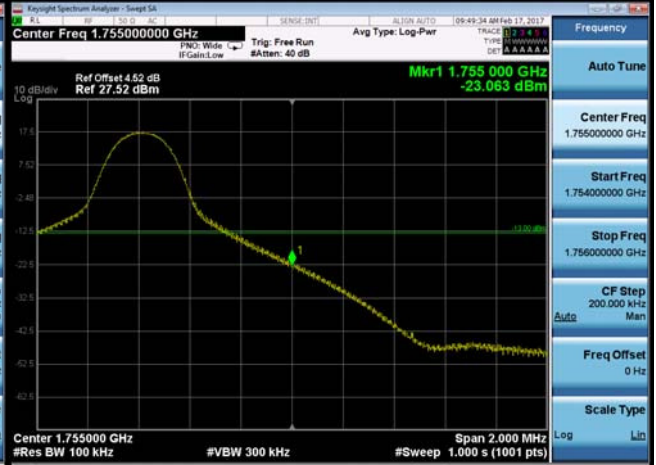
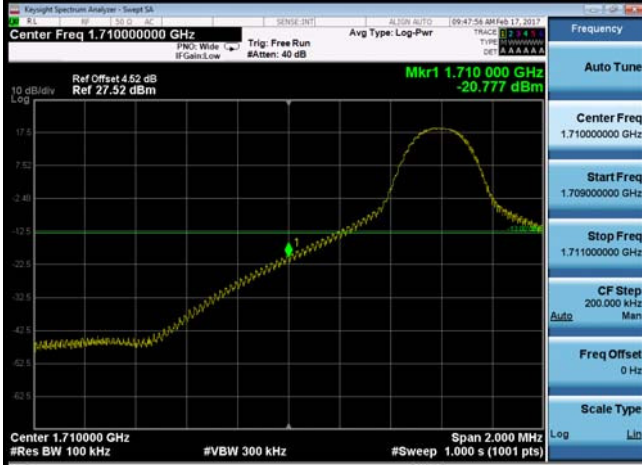

50RB0

Channel

20000

Channel

20350

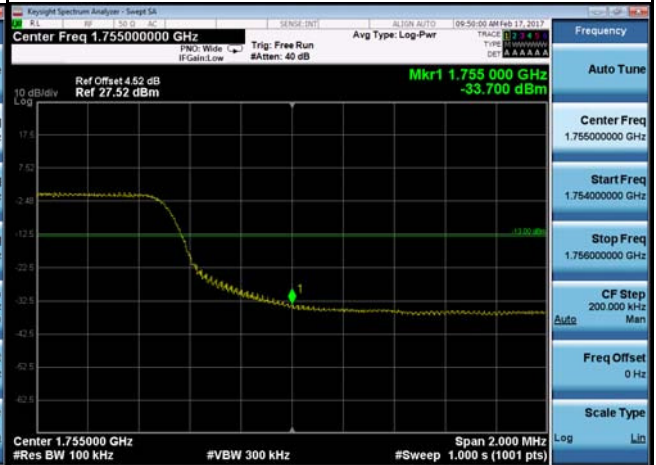
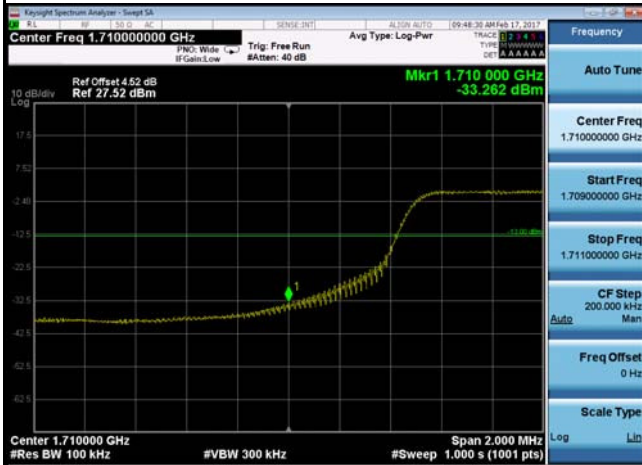

LTE Band 4\_15M

1RB0

1RB74

Channel

20025

Channel

20325

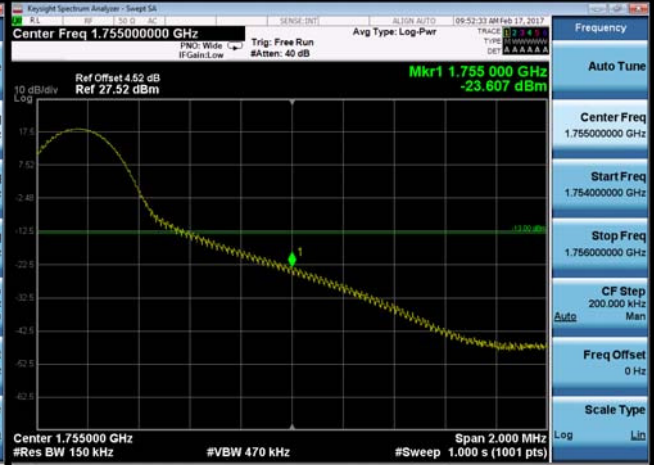
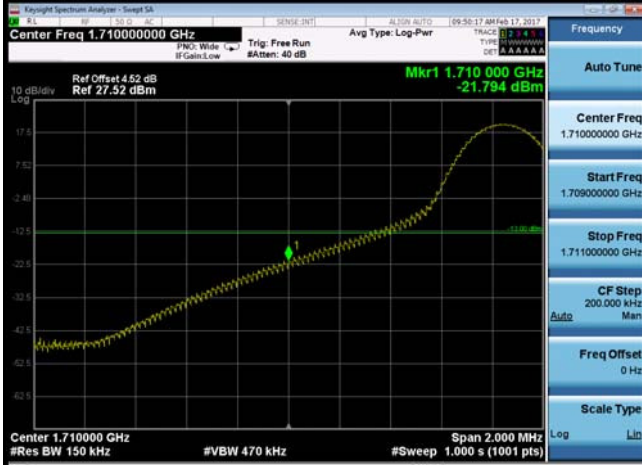

75RB0

Channel

20025

Channel

20325

