

FCC Radio Test Report

FCC ID: QISCRO-LX2

This report concerns (check one): Original Grant Class II Change

Project No. : 1701C155G
Equipment : Smart Phone
Model Name : CRO-L22, CRO-L02
Applicant : Huawei Technologies Co.,Ltd.
Address : Administration Building, Headquarters of Huawei Technologies Co., Ltd., Bantian, Longgang District Shenzhen China

Date of Receipt : Jan. 18, 2017(CRO-L03)
Mar. 28, 2017(CRO-L22, CRO-L02)
May 09, 2017
Date of Test : Jan. 18, 2017 ~ Feb. 27, 2017(CRO-L03)
Mar. 28, 2017 ~ Apr. 12, 2017(CRO-L22, CRO-L02)
May 16, 2017 ~ Jun. 05, 2017
Issued Date : Jun. 06, 2017
Tested by : BTL Inc.

Technical Engineer :

(Shawn Xiao)

Authorized Signatory :

(Steven Lu)

B T L I N C .

No.3,Jinshagang 1st Road, Shixia,Dalang Town, Dongguan,
Guangdong, China.

TEL: +86-769-8318-3000 FAX: +86-769-8319-6000

Declaration

BTL represents to the client that testing is done in accordance with standard procedures as applicable and that test instruments used has been calibrated with standards traceable to international standard(s) and/or national standard(s).

BTL's reports apply only to the specific samples tested under conditions. It is manufacture's responsibility to ensure that additional production units of this model are manufactured with the identical electrical and mechanical components. **BTL** shall have no liability for any declarations, inferences or generalizations drawn by the client or others from **BTL** issued reports.

BTL's report must not be used by the client to claim product certification, approval, or endorsement by NVLAP, NIST, or any agency of the Federal Government.

This report is the confidential property of the client. As a mutual protection to the clients, the public and **BTL-self**, extracts from the test report shall not be reproduced except in full with **BTL's** authorized written approval.

BTL's laboratory quality assurance procedures are in compliance with the **ISO Guide17025** requirements, and accredited by the conformity assessment authorities listed in this test report.

Limitation

For the use of the authority's logo is limited unless the Test Standard(s)/Scope(s)/Item(s) mentioned in this test report is (are) included in the conformity assessment authorities acceptance respective.

Table of Contents

Page

REPORT ISSUED HISTORY	5
1 . CERTIFICATION	6
2 . SUMMARY OF TEST RESULTS	7
2.1 TEST FACILITY	8
2.2 MEASUREMENT UNCERTAINTY	8
3 . GENERAL INFORMATION	9
3.1 GENERAL DESCRIPTION OF EUT	9
3.2 DESCRIPTION OF TEST MODES AND TEST CONDITION	11
3.3 BLOCKDIAGRAMSHOWINGTHECONFIGURATIONOFSYSTEMTESTED FOR RADIATED	13
3.4 DESCRIPTION OF SUPPORT UNITS	13
4 . TEST RESULT	14
4.1 OUTPUT POWER MEASUREMENT	14
4.1.1 LIMIT	14
4.1.2 TEST PROCEDURE	14
4.1.3 TESTSETUP LAYOUT	14
4.1.4 TEST DEVIATION	14
4.1.5 TEST RESULTS	14
4.2 OCCUPIED BANDWIDTH MEASUREMENT	15
4.2.1 TEST PROCEDURE	15
4.2.2 TEST SETUP LAYOUT	15
4.2.3 TEST DEVIATION	15
4.2.4 TEST RESULTS	15
4.3 CONDUCTED EMISSIONS MEASUREMENT	16
4.3.1 LIMIT	16
4.3.2 TEST PROCEDURES	16
4.3.3 TESTSETUP LAYOUT	16
4.3.4 TESTDEVIATION	16
4.3.5 TEST RESULTS	16
4.4 RADIATED EMISSIONS MEASUREMENT	17
4.4.1 LIMIT	17
4.4.2 TEST PROCEDURES	17
4.4.3 TESTSETUP LAYOUT	17
4.4.4 TESTDEVIATION	17
4.4.5 TEST RESULTS	17
4.5 BAND EDGE MEASUREMENT	18
4.5.1 LIMIT	18

Table of Contents	Page
4.5.2 TEST PROCEDURES	18
4.5.3 TESTSETUP LAYOUT	18
4.5.4 TESTDEVIATION	18
4.5.5 TEST RESULTS	18
4.6 PEAK TO AVERAGE RATIO MEASUREMENT	19
4.6.1 LIMIT	19
4.6.2 TEST PROCEDURES	19
4.6.3 TESTSETUP LAYOUT	19
4.6.4 TESTDEVIATION	19
4.6.5 TEST RESULTS	19
4.7 FREQUENCY STABILITY MEASUREMENT	20
4.7.1 LIMIT	20
4.7.2 TEST PROCEDURES	20
4.7.3 TESTSETUP LAYOUT	20
4.7.4 TESTDEVIATION	20
4.7.5 TEST RESULTS	20
5 . LIST OF MEASUREMENT EQUIPMENTS	21
ATTACHMENT A - OUTPUT POWER	23
ATTACHMENT B - OCCUPIED BANDWIDTH	30
ATTACHMENT C - CONDUCTED EMISSIONS	44
ATTACHMENT D - RADIATED EMISSION	53
ATTACHMENT E - BAND EDGE	102
ATTACHMENT F - PEAK TO AVERAGE RATIO	109
ATTACHMENT G - FREQUENCY STABILITY	118

REPORT ISSUED HISTORY

Issued No.	Description	Issued Date
BTL-FCCP-4-1701C155	Original Report.	Feb. 28, 2017
BTL-FCCP-4-1701C155B	Compared with the original report (BTL-FCCP-4-1701C155), the differences please see the below table. According to the differences description below table, CRO-L22 and CRO-L02 shares the same test data of CRO-L03 of the same bands. The Radiated Spurious Emissions in GSM850 band of SIM 1 & SIM 2 add evaluated and recorded in the test report, the rest are the same.	Apr. 13, 2017
BTL-FCCP-4-1701C155G	Compared with the original report (BTL-FCCP-4-1701C155B), the antenna is changed and battery, earphone are added. The Radiated Spurious Emissions had been evaluated and recorded in the test report, the rest are the same.	Jun. 06, 2017

Project ID	1701C155	1701C155B, 1701C155G	
Model	CRO-L03	CRO-L22	CRO-L02
Brand	HUAWEI	HUAWEI	HUAWEI
2G Frequency	850/1900	850/1900	850/1900
3G Frequency	B2/B5	B2/B5	B2/B5
4G Frequency	B2/B4/B5/B7	B5/B7	B5/B7
Hardware version	The same	The same	The same
Software version	The difference	The difference	The difference
SIM Card	Single	Dual	Single
Dimensions	The same	The same	The same
Appearance	The same	The same	The same
main antenna	The same	The same	The same
BT/Wi-Fi antenna	The same	The same	The same
GPS antenna	The same	The same	The same
PA(GSM)	The same	The same	The same
PA(WCDMA/FDD)	The same	The same	The same

1. CERTIFICATION

Equipment : Smart Phone
Brand Name : HUAWEI
Model Name : CRO-L22, CRO-L02
Applicant : Huawei Technologies Co.,Ltd.
Manufacturer : Huawei Technologies Co.,Ltd.
Address : Administration Building, Headquarters of Huawei Technologies Co., Ltd.,
Bantian, Longgang District Shenzhen China
Factory : Huawei Technologies Co.,Ltd.
Address : Administration Building, Headquarters of Huawei Technologies Co., Ltd.,
Bantian, Longgang District Shenzhen China
Date of Test : Jan. 18, 2017 ~ Feb. 27, 2017(CRO-L03)
Mar. 28, 2017 ~ Apr. 12, 2017(CRO-L22, CRO-L02)
May 16, 2017 ~ Jun. 05, 2017
Test Sample : Engineering Sample
Standard(s) : 47 CFR FCC Part 22 Subpart H
47 CFR FCC Part 2
ANSI/TIA-603-D-2010
KDB 971168 D01 Power Meas License Digital Systems v02r02

The above equipment has been tested and found compliance with the requirement of the relative standards by BTL Inc.

The test data, data evaluation, and equipment configuration contained in our test report (Ref No. BTL-FCCP-4-1701C155G) were obtained utilizing the test procedures, test instruments, test sites that has been accredited by the Authority of TAF according to the ISO-17025 quality assessment standard and technical standard(s).

Test result included in this report is only for the GSM850, WCDMA Band 5 and LTE Band 5 part.

2. SUMMARY OF TEST RESULTS

Test procedures according to the technical standard(s):

FCC Part 22 Subpart H& Part 2			
Standard(s) Section	Test Item	Judgment	Tested By
2.1046 22.913(a)	Radiated power	PASS	Paul Li
2.1046 22.913(a)	Conducted Output Power	PASS	Paul Li
2.1049(h) 22.917(a)	Occupied Bandwidth	PASS	Paul Li
2.1051 22.917(a)	Conducted Spurious Emissions	PASS	Paul Li
2.1053 22.917(a)	Radiated Spurious Emissions	PASS	Biao Chen
22.917(a)	Band Edge Measurements	PASS	Paul Li
-	Peak To Average Ratio	PASS	Paul Li
2.1055 22.355	Frequency Stability	PASS	Paul Li

NOTE:

(1) "N/A" denotes test is not applicable to this device.

2.1 TEST FACILITY

The test facilities used to collect the test data in this report is at the location of No.3,Jinshagang 1st Road, Shixia, Dalang Town, Dongguan, Guangdong, China.
BTL's test firm number for FCC: 319330

2.2 MEASUREMENT UNCERTAINTY

Where relevant, the following measurement uncertainty levels have been estimated for tests performed on the EUT as specified in CISPR 16-4-2. The BTL measurement uncertainty is less than the CISPR 16-4-2 U_{CISPR} requirement.

The reported uncertainty of measurement $y \pm U$, where expanded uncertainty U is based on a standard uncertainty multiplied by a coverage factor of $k=2$, providing a level of confidence of approximately 95 %.

Test Site	Method	Measurement Frequency Range	Ant. H / V	U,(dB)
DG-CB03 (3m)	CISPR	9KHz ~ 30MHz	V	3.79
		9KHz ~ 30MHz	H	3.57
		30MHz ~ 200MHz	V	3.82
		30MHz ~ 200MHz	H	3.78
		200MHz ~ 1,000MHz	V	4.10
		200MHz ~ 1,000MHz	H	4.06

Test Site	Method	Measurement Frequency Range	Ant. H / V	U,(dB)
DG-CB03 (3m)	CISPR	1GHz ~ 18GHz	V	3.12
		1GHz ~ 18GHz	H	3.68

Test Site	Method	Measurement Frequency Range	Ant. H / V	U,(dB)
DG-CB03 (1m)	CISPR	18GHz ~ 40GHz	V	4.15
		18GHz ~ 40GHz	H	4.14

Note: Unless specifically mentioned, the uncertainty of measurement has not been taken into account to declare the compliance or non-compliance to the specification.

3. GENERAL INFORMATION

3.1 GENERAL DESCRIPTION OF EUT

Equipment	Smart Phone		
Brand Name	HUAWEI		
Model Name	CRO-L22, CRO-L02		
Model Difference	Please refer to page 5.		
Modulation Type	GSM/GPRS	GMSK	
	EDGE	GMSK, 8PSK	
	WCDMA	Uplink: BPSK Downlink: QPSK	
	WCDMA(HSDPA/HSUPA/HSPA+/DC-HSDPA/DC-HSUPA)	16QAM/64QAM	
	LTE	QPSK, 16QAM	
Operation Frequency	GSM /EDGE/GPRS	824.2 ~ 848.8 MHz	
	WCDMA Band 5	826.4 ~ 846.6 MHz	
	LTE 5 (Channel Bandwidth: 1.4MHz)	824.7 ~ 848.3 MHz	
	LTE 5 (Channel Bandwidth: 3MHz)	825.5 ~ 847.5 MHz	
	LTE 5 (Channel Bandwidth: 5MHz)	826.5 ~ 846.5 MHz	
	LTE 5 (Channel Bandwidth: 10MHz)	829.0 ~ 844.0 MHz	
Max. ERP Power	GSM/GPRS	GMSK	30.70 dBm
	EDGE	8PSK	24.56 dBm
	WCDMA	BPSK	20.38 dBm
	WCDMA_HSDPA	16QAM	19.42 dBm
	WCDMA_HSUPA	16QAM	18.80 dBm
	LTE 5 (Channel Bandwidth: 1.4MHz)	QPSK	20.45 dBm
		16QAM	19.49 dBm
	LTE 5 (Channel Bandwidth: 3MHz)	QPSK	20.35 dBm
		16QAM	19.30 dBm
	LTE 5 (Channel Bandwidth: 5MHz)	QPSK	20.51 dBm
		16QAM	19.56 dBm
	LTE 5 (Channel Bandwidth: 10MHz)	QPSK	20.38 dBm
16QAM		19.38 dBm	
Antenna Type	Internal Antenna		
Antenna Gain	0.94 dBi for GSM, 0.94 dBi for WCDMA, 0.94 dBi for LTE		
Hardware Version	HL1CROM		
Software Version	CRO-L22:Cairo-L22C636B015 CRO-L02:Cairo-L02C636B022		

IMEI No.	CRO-L22	Radiated	SIM 1:862556030020380
			SIM 2:862556030520389
	CRO-L02	Radiated	862553030005446
		Conducted	862553030005446
Power Source	#1 DC Voltage supplied from AC/DC adapter. #2 Battery Supplied.		
Power Rating	#1:AC 100–240V 50/60Hz DC 5V 1A #2:DC 3.82V 2200mAh		

Note:

- For a more detailed features description, please refer to the manufacturer's specifications or the user's manual.
-

Item	Mfr/Brand	Model.
Battery	SCUD (FUJIAN) Electronics Co., Ltd	HB3742A0EZC+
	Shenzhen Desay Battery Tech Co., Ltd.	
	Sunwoda Electronic Co.,LTD.	
USB Cable	FOXCONN INTERCONNECT TECHNOLOGY LIMITED	CUBB01M-HC208-DH
	HONGLIN TECHNOLOGY CO.,LTD	130-26654
	Luxshare Precision Industry Co., Ltd.	L99U2013-CS-H
Earphone	Jiangxi Lianchuang Hongsheng Electronic Co.,LTD	MEMD1632B580C00
	BOLUO COUNTY QUANCHENG ELECTRONIC CO.,LTD	1311-3291-3.5mm-229
	MERRY ELECTRONICS CO., LTD.	EMC309-001
	Jiangxi Lianchuang Hongsheng Electronic Co.,LTD (Black)	MEMD1532B528000
	BOLUO COUNTY QUANCHENG ELECTRONIC CO.,LTD (Black)	1293#+3283# 3.5MM-150
	GoerTek (Black),	HA1-3
	GoerTek (White)	NA12
Adapter	HUIZHOU BYD ELECTRONIC CO., LTD.	HW-050100U01
	Shenzhen Huntkey Electric Co., Ltd.	
	DONG GUAN PHITEK ELECTRONICS CO., LTD.	

3.2 DESCRIPTION OF TEST MODES AND TEST CONDITION

Following channel(s) was (were) selected for the final test as listed below:

GSM MODE			
Test Item	Available Channel	Tested Channel	Mode
ERP	128 to 251	128, 190, 251	GSM, EDGE
Conducted Output Power	128 to 251	128, 190, 251	GSM, EDGE
Occupied Bandwidth	128 to 251	128, 190, 251	GSM, EDGE
Condcudeted Emission	128 to 251	190	GSM, EDGE
Radiated Emission	128 to 251	190	GSM, EDGE
Band Edge	128 to 251	128, 251	GSM, EDGE
Peak to Average Ratio	128 to 251	128, 190, 251	GSM, EDGE
Frequency Stability	128 to 251	190	GSM, EDGE

WCDMA MODE			
Test Item	Available Channel	Tested Channel	Mode
ERP	4132 to 4233	4132, 4182, 4233	WCDMA, HSDPA, HSUPA
Conducted Output Power	4132 to 4233	4132, 4182, 4233	WCDMA, HSDPA, HSUPA
Condcudeted Emission	4132 to 4233	4182	WCDMA, HSDPA, HSUPA
Radiated Emission	4132 to 4233	4182	WCDMA, HSDPA, HSUPA
Band Edge	4132 to 4233	4132, 4233	WCDMA, HSDPA, HSUPA
Peak to Average Ratio	4132 to 4233	4132, 4182, 4233	WCDMA, HSDPA, HSUPA
Frequency Stability	4132 to 4233	4182	WCDMA, HSDPA, HSUPA

Note: 1. This device was tested under all bandwidths, RB configurations and modulations. The worst case was found in **QPSK** modulation.

2. For 18G to 26.5G, the highest bandwidth is worst case and recording in the test report.

LTE BAND 5 MODE						
Test Item	Available Channel	Tested Channel	Channel Bandwidth	Modulation	Mode	
ERP	20407 to 20643	20407, 20525, 20643	1.4MHz	QPSK, 16QAM	1 RB / 0 RB Offset	
	20450 to 20600	20450, 20525, 20600	10MHz	QPSK, 16QAM	1 RB / 0 RB Offset	
Occupied Bandwidth	20407 to 20643	20407, 20525, 20643	1.4MHz	QPSK, 16QAM	6 RB / 0 RB Offset	
	20415 to 20635	20415, 20525, 20635	3MHz	QPSK, 16QAM	15 RB / 0 RB Offset	
	20425 to 20625	20425, 20525, 20625	5MHz	QPSK, 16QAM	25 RB / 0 RB Offset	
	20450 to 20600	20450, 20525, 20600	10MHz	QPSK, 16QAM	50 RB / 0 RB Offset	
Conducted Emission	20407 to 20643	20525	1.4MHz	QPSK	1 RB / 0 RB Offset	
	20415 to 20635	20525	3MHz	QPSK	1 RB / 0 RB Offset	
	20425 to 20625	20525	5MHz	QPSK	1 RB / 0 RB Offset	
	20450 to 20600	20525	10MHz	QPSK	1 RB / 0 RB Offset	
Radiated Emission	20407 to 20643	20525	1.4MHz	QPSK	1 RB / 0 RB Offset	
	20450 to 20600	20525	10MHz	QPSK	1 RB / 0 RB Offset	
Band Edge	20407 to 20643	20407	1.4MHz	QPSK	1 RB / 0 RB Offset 6 RB / 0 RB Offset	
		20643	1.4MHz	QPSK	1 RB / 5 RB Offset 6 RB / 0 RB Offset	
	20415 to 20635	20415	3MHz	QPSK	1 RB / 0 RB Offset 15 RB / 0 RB Offset	
		20635	3MHz	QPSK	1 RB / 14 RB Offset 15 RB / 0 RB Offset	
	20425 to 20625	20425	5MHz	QPSK	1 RB / 0 RB Offset 25 RB / 0 RB Offset	
		20625	5MHz	QPSK	1 RB / 24 RB Offset 25 RB / 0 RB Offset	
	20450 to 20600	20450	10MHz	QPSK	1 RB / 0 RB Offset 50 RB / 0 RB Offset	
		20600	10MHz	QPSK	1 RB / 49 RB Offset 50 RB / 0 RB Offset	
	Peak To Average Ratio	20407 to 20643	20407, 20525, 20643	1.4MHz	QPSK, 16QAM	1 RB / 0 RB Offset
		20415 to 20635	20415, 20525, 20635	3MHz	QPSK, 16QAM	1 RB / 0 RB Offset
		20425 to 20625	20425, 20525, 20625	5MHz	QPSK, 16QAM	1 RB / 0 RB Offset
		20450 to 20600	20450, 20525, 20600	10MHz	QPSK, 16QAM	1 RB / 0 RB Offset
Frequency Stability	20407 to 20643	20525	1.4MHz	QPSK	1 RB / 0 RB Offset	
	20415 to 20635	20525	3MHz	QPSK	1 RB / 0 RB Offset	
	20425 to 20625	20525	5MHz	QPSK	1 RB / 0 RB Offset	
	20450 to 20600	20525	10MHz	QPSK	1 RB / 0 RB Offset	

EUT TEST CONDITIONS:

Test Item	Environmental Conditions	Test Voltage
ERP	25°C, 60%RH	DC 3.82V
Conducted Output Power	25°C, 65%RH	DC 3.82V
Occupied Bandwidth	25°C, 65%RH	DC 3.82V
Conducted Emission	25°C, 65%RH	DC 3.82V
Radiated Emission	25°C, 60%RH	AC 120V/60Hz
Band Edge	25°C, 65%RH	DC 3.82V
Peak to Average Ratio	25°C, 65%RH	DC 3.82V
Frequency Stability	25°C, 65%RH	DC 3.82V

3.3 BLOCK DIAGRAM SHOWING THE CONFIGURATION OF SYSTEM TESTED FOR RADIATED

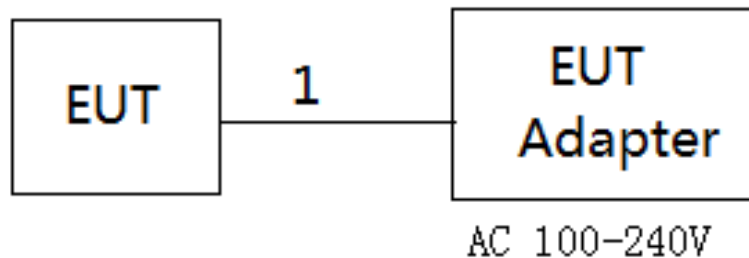

3.4 DESCRIPTION OF SUPPORT UNITS

The EUT has been tested as an independent unit together with other necessary accessories or support units. The following support units or accessories were used to form a representative test configuration during the tests.

Item	Equipment	Mfr/Brand	Model/Type No.	FCC ID	Series No.
-	-	-	-	-	-

Item	Shielded Type	Ferrite Core	Length	Note
1	NO	NO	1.2m	USB Cable

4. TEST RESULT

4.1 OUTPUT POWER MEASUREMENT

4.1.1 LIMIT

Mobile / Portable station are limited to 7 watts e.r.p.

4.1.2 TEST PROCEDURE

EIRP/ERP:

1. EIRP= Conducted Power +Antenan gain
ERP power=EIPR power-2.15dBi.

Conducted Power:

The EUT was set up for the maximum power with GSM, GPRS, EDGE, WCDMA and LTE link data modulation and link up with simulator. Set the EUT to transmit under low, middle and high channel and record the power level shown on simulator.

4.1.3 TESTSETUP LAYOUT

Conducted Power Measurement

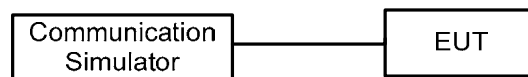

4.1.4 TEST DEVIATION

No deviation

4.1.5 TEST RESULTS

Please refer to the Attachment A.

4.2 OCCUPIED BANDWIDTH MEASUREMENT

4.2.1 TEST PROCEDURE

The EUT makes a call to the communication simulator. All measurements were done at low, middle and high operational frequency range. The communication simulator station system controlled a EUT to export maximum output power under transmission mode and specific channel frequency. Use OBW measurement function of Spectrum analyzer to measure 99 % occupied bandwidth and 26dB bandwidth.

4.2.2 TEST SETUP LAYOUT

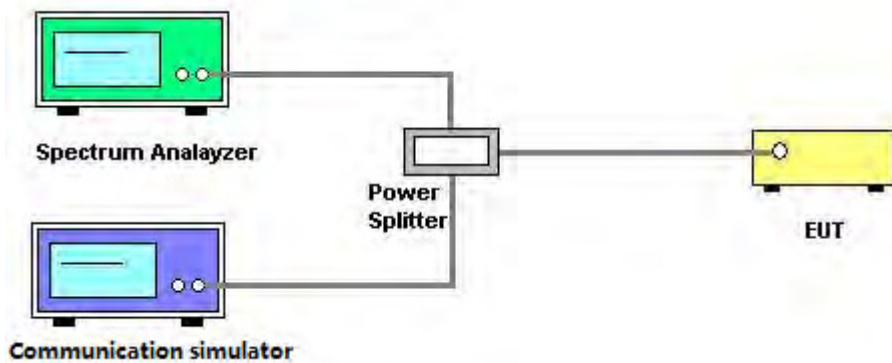

4.2.3 TEST DEVIATION

No deviation

4.2.4 TEST RESULTS

Please refer to the Attachment B.

4.3 CONDUCTED EMISSIONS MEASUREMENT

4.3.1 LIMIT

The power of any emission outside of the authorized operating frequency ranges must be attenuated below the transmitting power (P) by a factor of at least $43 + 10 \log(P)$ dB. The emission limit equal to -13dBm .

4.3.2 TEST PROCEDURES

1. The testing follows FCC KDB 971168 v02r02 Section 6.0.
2. The EUT was connected to spectrum analyzer and system simulator via a power divider.
3. The band edges of low and high channels for the highest RF powers were measured. Set $\text{RBW} \geq 1\%$ EBW in the 1MHz band immediately outside and adjacent to the band edge.
4. Set spectrum analyzer with RMS detector.
5. The RF fundamental frequency should be excluded against the limit line in the operating frequency band.
6. The limit line is derived from $43+10\log(P)\text{dB}$ below the transmitter power P(Watts)

$$= P(W) - [43 + 10\log(P)](\text{dB})$$

$$= [30 + 10\log(P)](\text{dBm}) - [43 + 10\log(P)](\text{dB})$$

$$= -13\text{dBm}$$

4.3.3 TESTSETUP LAYOUT

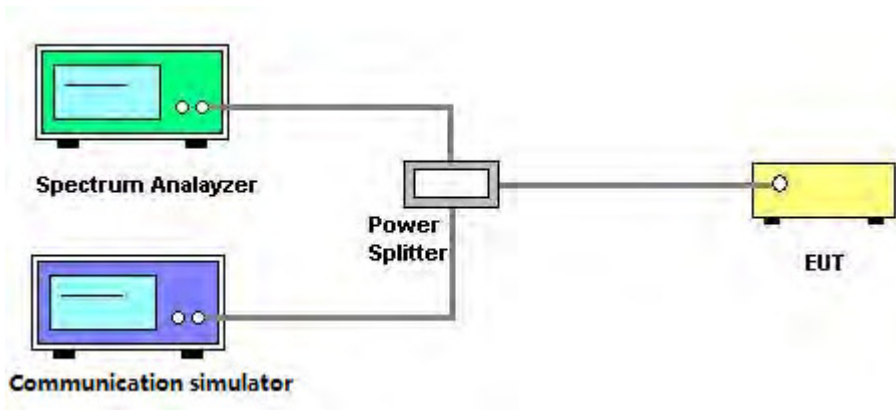

4.3.4 TESTDEVIATION

No deviation

4.3.5 TEST RESULTS

Please refer to the Attachment C.

4.4 RADIATED EMISSIONS MEASUREMENT

4.4.1 LIMIT

The power of any emission outside of the authorized operating frequency ranges must be attenuated below the transmitting power (P) by a factor of at least $43 + 10 \log(P)$ dB. The emission limit equal to -13dBm.

4.4.2 TEST PROCEDURES

1. Substitution method is used for E.I.R.P measurement. In the semi-anechoic chamber, EUT placed on the 0.8m height of Turn Table, rotated the table around 360 degrees to search the maximum radiation power and receiver antenna shall be rotated vertical and horizontal polarization and moved height from 1m to 4m to find the maximum polar radiated power. The "Read Value" is the spectrum reading the maximum power value.
2. The substitution horn antenna is substituted for EUT at the same position and signals generator export the CW signal to the substitution antenna via a TX cable. Rotated the Turn Table and moved receiving antenna to find the maximum radiation power. Adjust output power level of S.G to get a Value of spectrum reading equal to "Read Value " of step a. Record the power level of S.G
3. EIRP = Output power level of S.G – TX cable loss + Antenna gain of substitution horn.
4. E.R.P power can be calculated form E.I.R.P power by subtracting the gain of dipole, E.R.P power = E.I.P.R power - 2.15dBi.
5. The resolution bandwidth and video bandwidth of test receiver/spectrum analyzer is 1MHz/3MHz.

4.4.3 TESTSETUP LAYOUT

This test setup layout is the same as that shown in **section 4.1.3**.

4.4.4 TESTDEVIATION

No deviation

4.4.5 TEST RESULTS

Please refer to the Attachment D.

4.5 BAND EDGE MEASUREMENT

4.5.1 LIMIT

A Power of any emission outside of the authorized operating frequency ranges must be attenuated below the transmitting power (P) by a factor of at least $43 + 10 \log(P)$ dB. In the 1 MHz bands immediately outside and adjacent to the frequency block a resolution bandwidth of at least one percent of the emission bandwidth of the fundamental emission of the transmitter may be employed.

4.5.2 TEST PROCEDURES

1. All measurements were done at low and high operational frequency range.
2. The center frequency of spectrum is the band edge frequency and span is 1MHz. RB of the spectrum is 3kHz and VB of the spectrum is 10kHz (GSM/GPRS/EDGE).
3. The center frequency of spectrum is the band edge frequency and span is 5MHz. RB of the spectrum is 100kHz and VB of the spectrum is 300kHz (WCDMA).
4. The center frequency of spectrum is the band edge frequency and span is 1MHz. RB of the spectrum is 13kHz and VB of the spectrum is 51kHz (LTE Bandwidth 1.4MHz).
5. The center frequency of spectrum is the band edge frequency and span is 1MHz. RB of the spectrum is 30kHz and VB of the spectrum is 100kHz (LTE Bandwidth 3MHz).
6. The center frequency of spectrum is the band edge frequency and span is 1MHz. RB of the spectrum is 100kHz and VB of the spectrum is 300kHz (LTE Bandwidth 5MHz/10MHz).
7. Record the max trace plot into the test report.

4.5.3 TESTSETUP LAYOUT

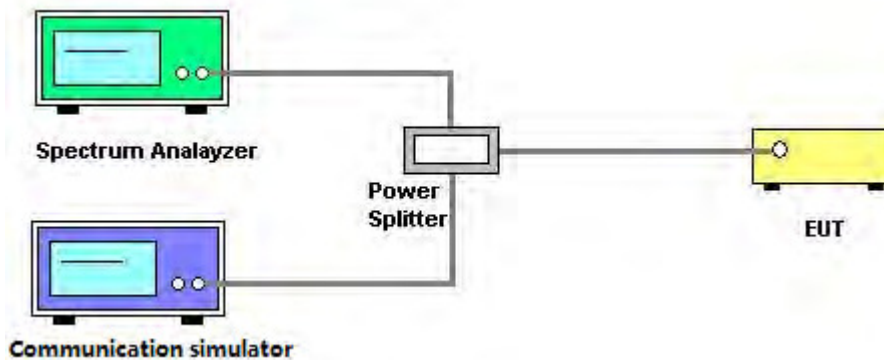

4.5.4 TESTDEVIATION

No deviation

4.5.5 TEST RESULTS

Please refer to the Attachment E.

4.6 PEAK TO AVERAGE RATIO MEASUREMENT

4.6.1 LIMIT

In measuring transmissions in this band using an average power technique, the peak to-average ratio (PAR) of the transmission may not exceed 13 dB.

4.6.2 TEST PROCEDURES

1. Set resolution/measurement bandwidth \geq signal's occupied bandwidth;
2. Set the number of counts to a value that stabilizes the measured CCDF curve;
3. Record the maximum PAPR level associated with a probability of 0.1%.

4.6.3 TESTSETUP LAYOUT

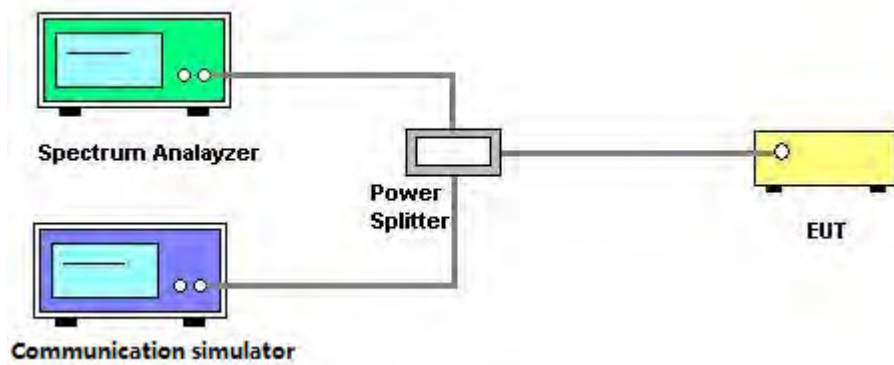

4.6.4 TESTDEVIATION

No deviation

4.6.5 TEST RESULTS

Please refer to the Attachment F.

4.7 FREQUENCY STABILITY MEASUREMENT

4.7.1 LIMIT

1.5 ppm is for base and fixed station. 2.5 ppm is for mobile station.

4.7.2 TEST PROCEDURES

1. Device is placed at the oven room. The oven room could control the temperatures and humidity. Power warm up is at least 15 min and power applied should perform before recording frequency error.
2. EUT is connected the external power supply to control the DC input power. The test voltage range is from minimum to maximum working voltage. Each step shall be record the frequency error rate.
3. The temperature range step is 10 degrees in this test items. All temperature levels shall be hold the $\pm 0.5^{\circ}\text{C}$ during the measurement testing. The each temperature step shall be at least 0.5 hours, consider the EUT could be test under the stability condition.
4. The frequency error was recorded frequency error from the communication simulator.

4.7.3 TESTSETUP LAYOUT

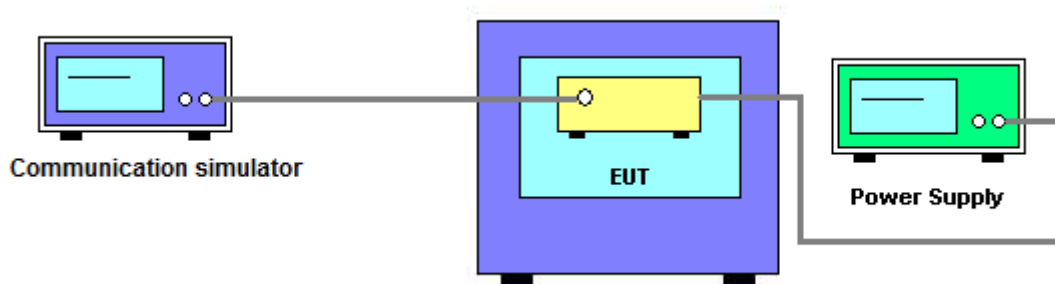

4.7.4 TESTDEVIATION

No deviation

4.7.5 TEST RESULTS

Please refer to the Attachment G.

5. LIST OF MEASUREMENT EQUIPMENTS

Radiated Emission & ERP or EIRP Measurement					
Item	Kind of Equipment	Manufacturer	Type No.	Serial No.	Calibrated until
1	Antenna	Schwarbeck	VULB9160	9160-3232	Mar. 26, 2018
2	Double Ridged Guide Antenna	ETS	3115	75789	Mar. 26, 2018
3	Broad-Band Horn Antenna	Schwarzbeck	BBHA 9170	9170319	Apr. 23, 2017
4	Amplifier	Agilent	8449B	3008A02274	Mar. 09, 2018
5	Amplifier	HP	8447D	2944A09673	Oct. 20, 2017
6	HighPass Filter	Wairwright Instruments Gmbh	WHK 1.5/15G-10ST	11	Mar. 09, 2018
7	Band Reject Filter	Wairwright Instruments Gmbh	WRCG 1710/1785-1690/180 5-60/12SS	38	Feb. 22, 2018
8	Band Reject Filter	Wairwright Instruments Gmbh	WRCG 824/849-810/863-60/ 9SS	7	Feb. 22, 2018
9	Band Reject Filter	Wairwright Instruments Gmbh	WRCG 880/915-860/935-60/ 9SS	14	Feb. 22, 2018
10	Band Reject Filter	Wairwright Instruments Gmbh	WRCG 1850/1910-1830/193 0-60/10SS	17	Feb. 22, 2018
11	HighPass Filter	Wairwright Instruments Gmbh	WHK3.1/18G-10SS	24	Mar. 09, 2018
12	Wireless Communication Test SET	Agilent	E5515C	MY48364183	Mar. 26, 2018
13	Microwave Preamplifier With Adaptor	EMC INSTRUMENT	EMC2654045	980039 & HA01	Mar. 26, 2018
14	Receiver	Agilent	N9038A	MY52130039	Sep. 04, 2017
15	wideband radio communication tester	R&S	CMW500	152372	Mar. 26, 2018
16	High pass filter	ZHPF-M1000-4000-1	ZHPF-M3-12.75G-3869	B2015073763	Aug. 04, 2017
17	High pass filter	ZHPF-M3-12.75G-3869	ZHPF-M1000-4000-1	B2015073762	Aug. 04, 2017
18	High pass filter	ZHPF-M6-18G-1727	ZHPF-M6-186-1727	B2015073764	Aug. 04, 2017
19	Cable	emci	LMR-400(30MHz-1GHz)(8m+5m)	N/A	Jun. 27, 2017
20	Cable	emci	EMC104-SM-SM-12000(12m)	N/A	Jul. 06, 2017
21	Controller	ETS-Lindgren	2090	N/A	N/A
22	Measurement Software	Farad	EZ-EMC Ver.NB-03A1-01	N/A	N/A

Conducted Emission & Band Edge & Occupied Bandwidth Measurement					
Item	Kind of Equipment	Manufacturer	Type No.	Serial No.	Calibrated until
1	Wireless Communication Test SET	Agilent	E5515C	MY48364183	Mar. 26, 2018
2	EXA Spectrum Analyzer	Agilent	N9010A	MY50520044	Mar. 26, 2018
3	POWER SPLITTER	Mini-Circuits	ZFRSC-123-S+	331000910-1	Feb. 25, 2018
4	wideband radio communication tester	R&S	CMW500	152372	Mar. 26, 2018
5	Cable	N/A	RG316(0.3m)	N/A	Jul. 06, 2017
6	Cable	N/A	RG316(0.3m)	N/A	Jul. 06, 2017

Frequency Stability Measurement					
Item	Kind of Equipment	Manufacturer	Type No.	Serial No.	Calibrated until
1	Wireless Communication Test SET	Agilent	E5515C	MY48364183	Mar. 26, 2018
2	DC power supply	GW Instek	GPC-3030DN	EK880675	Oct. 13, 2017
3	POWER SPLITTER	Mini-Circuits	ZFRSC-123-S+	331000910-1	Feb. 25, 2018
4	wideband radio communication tester	R&S	CMW500	152372	Mar. 26, 2018
5	Const Temp, & Humidity Chamber	Giant?Force	ITH-225-20-S	IAB0309-001	Sep. 04, 2017
6	Cable	N/A	RG316(0.3m)	N/A	Jul. 06, 2017

Remark: "N/A" denotes no model name, serial no. or calibration specified.
 All calibration period of equipment list is one year.

ATTACHMENT A - OUTPUT POWER

Conducted Power:

GSM850 (Capsensor Off)	Burst Conducted Power (dBm)		
	128CH	190CH	251CH
	824.2MHz	836.6MHz	848.8MHz
GSM (CS)	32.71	32.82	32.85
GPRS/EDGE (GMSK)	32.71	32.82	32.85
	31.92	32.01	32.03
	30.05	30.18	30.23
EDGE (8PSK)	28.92	29.05	29.09
	26.71	26.55	26.62
	25.74	25.64	25.70
	23.92	23.74	23.80
	22.80	22.71	22.72

Modulation	Band	WCDMA V(Capsensor Off)		
	Tx Channel	4132CH	4182CH	4233CH
	Rx Channel	4357CH	4407CH	4458CH
	Frequency	826.4MHz	836.4MHz	846.6MHz
BPSK	RMC 12.2K	22.36	22.52	22.45
	RMC 64K	22.36	22.53	22.50
	RMC 144K	22.39	22.51	22.52
	RMC 384K	22.38	22.51	22.48
16QAM	HSDPA Subtest-1	21.36	21.57	21.47
	HSDPA Subtest-2	21.40	21.52	21.53
	HSDPA Subtest-3	20.94	21.10	21.06
	HSDPA Subtest-4	20.89	21.06	21.05
16QAM	HSUPA Subtest-1	19.36	19.51	19.46
	HSUPA Subtest-2	19.34	19.47	19.45
	HSUPA Subtest-3	20.52	20.70	20.68
	HSUPA Subtest-4	19.94	20.11	20.08
	HSUPA Subtest-5	20.83	20.95	20.94

LTE Band / BW	Modulation	RB Sizing	RB Offset	Low CH	Mid CH	High CH
				20407 CH	20525 CH	20643 CH
				824.7 MHz	836.5 MHz	848.3 MHz
5 / 1.4M	QPSK	1	0	22.53	22.11	21.86
		1	2	22.60	22.16	21.94
		1	5	22.53	22.09	21.90
		3	0	22.54	22.13	21.95
		3	1	22.47	22.07	21.89
		3	3	22.55	22.10	21.97
	16QAM	6	0	21.50	21.08	20.91
		1	0	21.54	21.46	20.91
		1	2	21.64	21.49	20.96
		1	5	21.56	21.43	20.94
		3	0	21.57	21.34	21.12
		3	1	21.50	21.23	21.07
		3	3	21.56	21.29	21.12
		6	0	20.63	20.01	20.10

LTE Band / BW	Modulation	RB Sizing	RB Offset	Low CH	Mid CH	High CH
				20415 CH	20525 CH	20635 CH
				825.5 MHz	836.5 MHz	847.5 MHz
5 / 3M	QPSK	1	0	22.46	22.11	21.86
		1	7	22.50	22.10	21.87
		1	14	22.44	22.06	21.86
		8	0	21.59	21.17	20.96
		8	3	21.60	21.12	20.97
		8	7	21.57	21.12	20.95
		15	0	21.54	21.11	20.94
	16QAM	1	0	21.37	21.44	20.91
		1	7	21.40	21.45	20.91
		1	14	21.32	21.40	20.85
		8	0	20.69	20.24	20.00
		8	3	20.70	20.26	19.99
		8	7	20.68	20.21	19.97
		15	0	20.58	20.20	19.90

LTE Band / BW	Modulation	RB Sizing	RB Offset	Low CH	Mid CH	High CH
				20425 CH	20525 CH	20625 CH
				826.5 MHz	836.5 MHz	846.5 MHz
5 / 5M	QPSK	1	0	22.66	22.19	21.93
		1	12	22.62	22.11	21.96
		1	24	22.51	22.08	21.91
		12	0	21.58	21.20	20.91
		12	6	21.56	21.15	20.91
		12	13	21.54	21.12	20.90
		25	0	21.51	21.12	20.85
	16QAM	1	0	21.71	21.67	20.99
		1	12	21.67	21.62	21.00
		1	24	21.58	21.57	20.95
		12	0	20.69	20.36	19.97
		12	6	20.66	20.31	19.96
		12	13	20.64	20.28	19.95
		25	0	20.56	20.19	19.81

LTE Band / BW	Modulation	RB Sizer	RB Offset	Low CH	Mid CH	High CH
				20450 CH	20525 CH	20600 CH
				829.0 MHz	836.5 MHz	844.0 MHz
5 / 10M	QPSK	1	0	22.53	22.24	21.90
		1	24	22.45	22.17	21.89
		1	49	22.34	22.18	21.88
		25	0	21.47	21.15	20.92
		25	12	21.42	21.13	20.89
		25	25	21.39	21.11	20.90
	16QAM	50	0	21.47	21.18	20.91
		1	0	21.45	21.53	20.94
		1	24	21.35	21.48	20.93
		1	49	21.25	21.51	20.88
		25	0	20.54	20.23	20.04
		25	12	20.47	20.20	19.99
		25	25	20.45	20.18	20.01
		50	0	20.48	20.21	19.97

ERP Power:

GSM850 (Capsensor Off)	ERP Power (dBm)		
	128CH	190CH	251CH
	824.2MHz	836.6MHz	848.8MHz
GSM (CS)	30.56	30.67	30.70
GPRS/EDGE (GMSK)	30.56	30.67	30.70
	29.77	29.86	29.88
	27.90	28.03	28.08
	26.77	26.90	26.94
EDGE (8PSK)	24.56	24.40	24.47
	23.59	23.49	23.55
	21.77	21.59	21.65
	20.65	20.56	20.57

Modulation	Band	WCDMA V(Capsensor Off)		
	Tx Channel	4132CH	4182CH	4233CH
	Rx Channel	4357CH	4407CH	4458CH
	Frequency	826.4MHz	836.4MHz	846.6MHz
BPSK	RMC 12.2K	20.21	20.37	20.30
	RMC 64K	20.21	20.38	20.35
	RMC 144K	20.24	20.36	20.37
	RMC 384K	20.23	20.36	20.33
16QAM	HSDPA Subtest-1	19.21	19.42	19.32
	HSDPA Subtest-2	19.25	19.37	19.38
	HSDPA Subtest-3	18.79	18.95	18.91
	HSDPA Subtest-4	18.74	18.91	18.90
16QAM	HSUPA Subtest-1	17.21	17.36	17.31
	HSUPA Subtest-2	17.19	17.32	17.30
	HSUPA Subtest-3	18.37	18.55	18.53
	HSUPA Subtest-4	17.79	17.96	17.93
	HSUPA Subtest-5	18.68	18.80	18.79

LTE Band / BW	Modulation	RB Sizing	RB Offset	Low CH	Mid CH	High CH
				20407 CH	20525 CH	20643 CH
				824.7 MHz	836.5 MHz	848.3 MHz
5 / 1.4M	QPSK	1	0	20.38	19.96	19.71
		1	2	20.45	20.01	19.79
		1	5	20.38	19.94	19.75
		3	0	20.39	19.98	19.80
		3	1	20.32	19.92	19.74
		3	3	20.40	19.95	19.82
	16QAM	6	0	19.35	18.93	18.76
		1	0	19.39	19.31	18.76
		1	2	19.49	19.34	18.81
		1	5	19.41	19.28	18.79
		3	0	19.42	19.19	18.97
		3	1	19.35	19.08	18.92
		3	3	19.41	19.14	18.97
		6	0	18.48	17.86	17.95

LTE Band / BW	Modulation	RB Sizing	RB Offset	Low CH	Mid CH	High CH
				20415 CH	20525 CH	20635 CH
				825.5 MHz	836.5 MHz	847.5 MHz
5 / 3M	QPSK	1	0	20.31	19.96	19.71
		1	7	20.35	19.95	19.72
		1	14	20.29	19.91	19.71
		8	0	19.44	19.02	18.81
		8	3	19.45	18.97	18.82
		8	7	19.42	18.97	18.80
		15	0	19.39	18.96	18.79
	16QAM	1	0	19.22	19.29	18.76
		1	7	19.25	19.30	18.76
		1	14	19.17	19.25	18.70
		8	0	18.54	18.09	17.85
		8	3	18.55	18.11	17.84
		8	7	18.53	18.06	17.82
		15	0	18.43	18.05	17.75

LTE Band / BW	Modulation	RB Sizing	RB Offset	Low CH	Mid CH	High CH
				20425 CH	20525 CH	20625 CH
				826.5 MHz	836.5 MHz	846.5 MHz
5 / 5M	QPSK	1	0	20.51	20.04	19.78
		1	12	20.47	19.96	19.81
		1	24	20.36	19.93	19.76
		12	0	19.43	19.05	18.76
		12	6	19.41	19.00	18.76
		12	13	19.39	18.97	18.75
		25	0	19.36	18.97	18.70
	16QAM	1	0	19.56	19.52	18.84
		1	12	19.52	19.47	18.85
		1	24	19.43	19.42	18.80
		12	0	18.54	18.21	17.82
		12	6	18.51	18.16	17.81
		12	13	18.49	18.13	17.80
		25	0	18.41	18.04	17.66

LTE Band / BW	Modulation	RB Sizer	RB Offset	Low CH	Mid CH	High CH
				20450 CH	20525 CH	20600 CH
				829.0 MHz	836.5 MHz	844.0 MHz
5 / 10M	QPSK	1	0	20.38	20.09	19.75
		1	24	20.30	20.02	19.74
		1	49	20.19	20.03	19.73
		25	0	19.32	19.00	18.77
		25	12	19.27	18.98	18.74
		25	25	19.24	18.96	18.75
	16QAM	50	0	19.32	19.03	18.76
		1	0	19.30	19.38	18.79
		1	24	19.20	19.33	18.78
		1	49	19.10	19.36	18.73
		25	0	18.39	18.08	17.89
		25	12	18.32	18.05	17.84
		25	25	18.30	18.03	17.86
		50	0	18.33	18.06	17.82

ATTACHMENT B - OCCUPIED BANDWIDTH

GSM850					
GSM			EDGE		
CS			8PSK		
Channel	Frequency (MHz)	99% Occupied Bandwidth (MHz)	Channel	Frequency (MHz)	99% Occupied Bandwidth (MHz)
128	824.2	0.247	128	824.2	0.252
190	836.6	0.244	190	836.6	0.250
251	848.8	0.246	251	848.8	0.253
Channel	Frequency (MHz)	26dB Bandwidth (MHz)	Channel	Frequency (MHz)	26dB Bandwidth (MHz)
128	824.2	0.320	128	824.2	0.317
190	836.6	0.318	190	836.6	0.316
251	848.8	0.316	251	848.8	0.322

Spectrum Plot

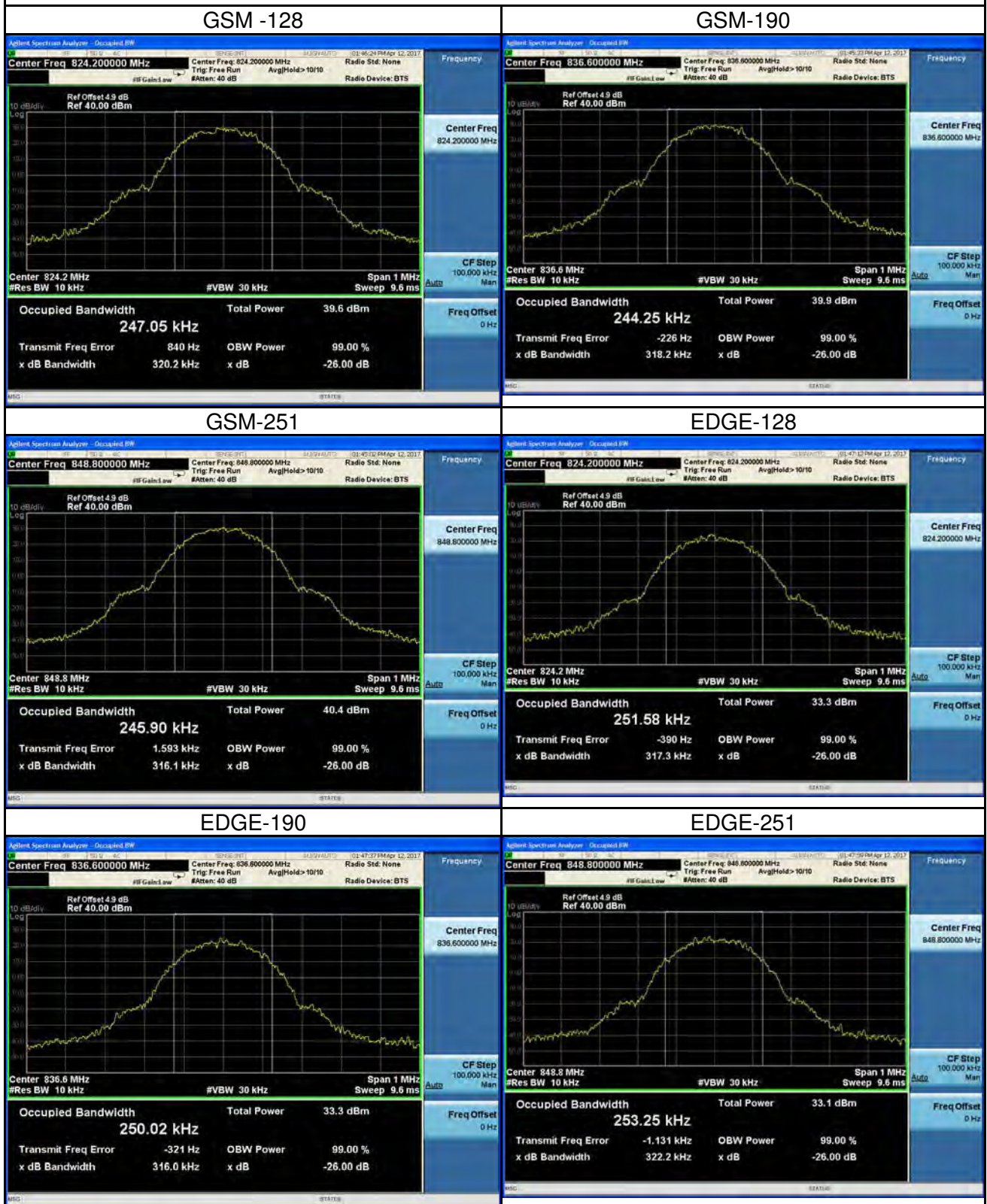

WCDMA Band V					
Channel	Frequency (MHz)	99% Occupied Bandwidth (MHz)	Channel	Frequency (MHz)	26dB Bandwidth (MHz)
4132	826.4	4.2031	4132	826.4	4.856
4182	836.4	4.2047	4182	836.4	4.876
4233	846.6	4.1938	4233	846.6	4.859

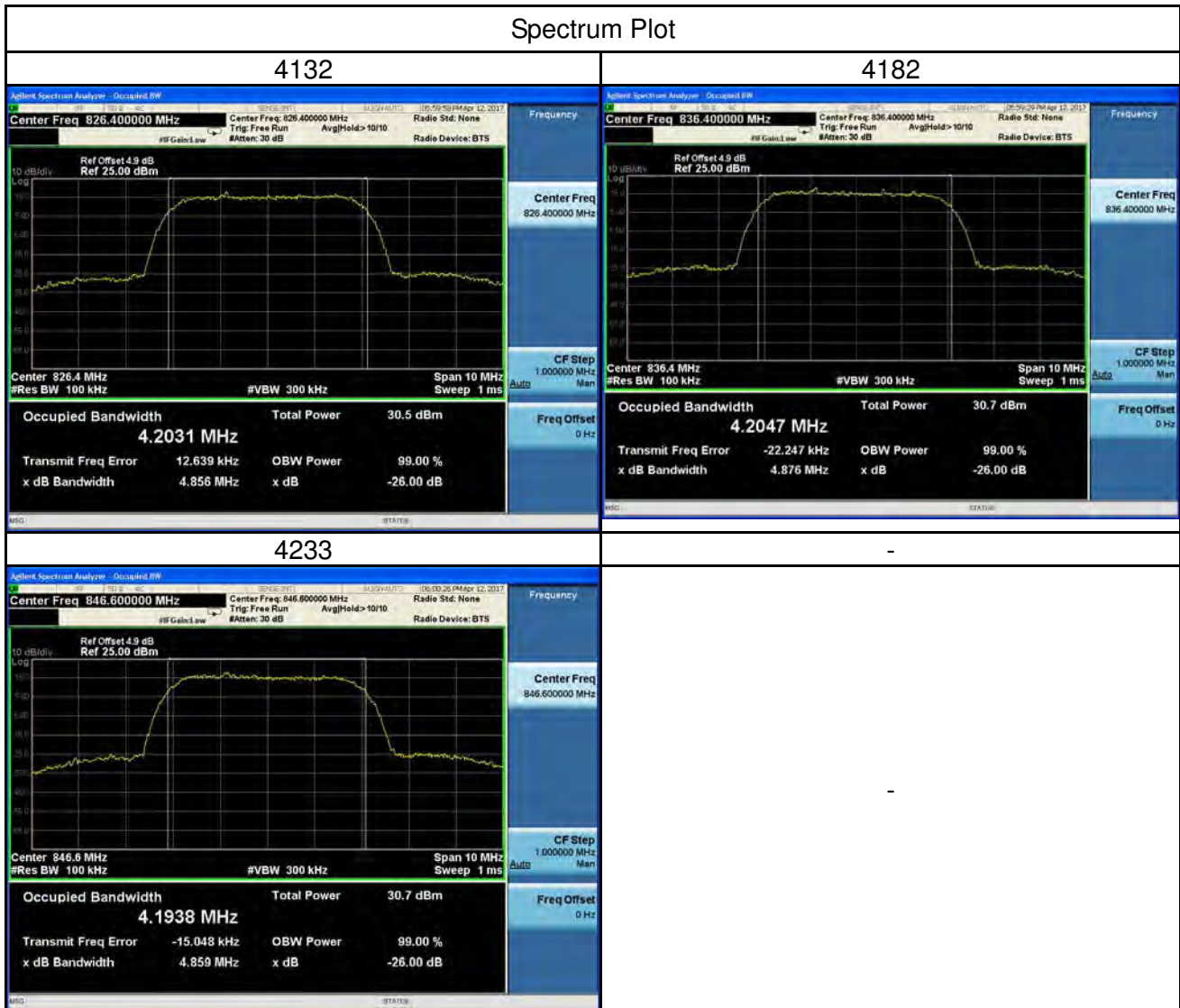

WCDMA_HSDPA Band V					
Channel	Frequency (MHz)	99% Occupied Bandwidth (MHz)	Channel	Frequency (MHz)	26dB Bandwidth (MHz)
4132	826.4	4.1954	4132	826.4	4.889
4182	836.4	4.2163	4182	836.4	4.888
4233	846.6	4.1901	4233	846.6	4.852

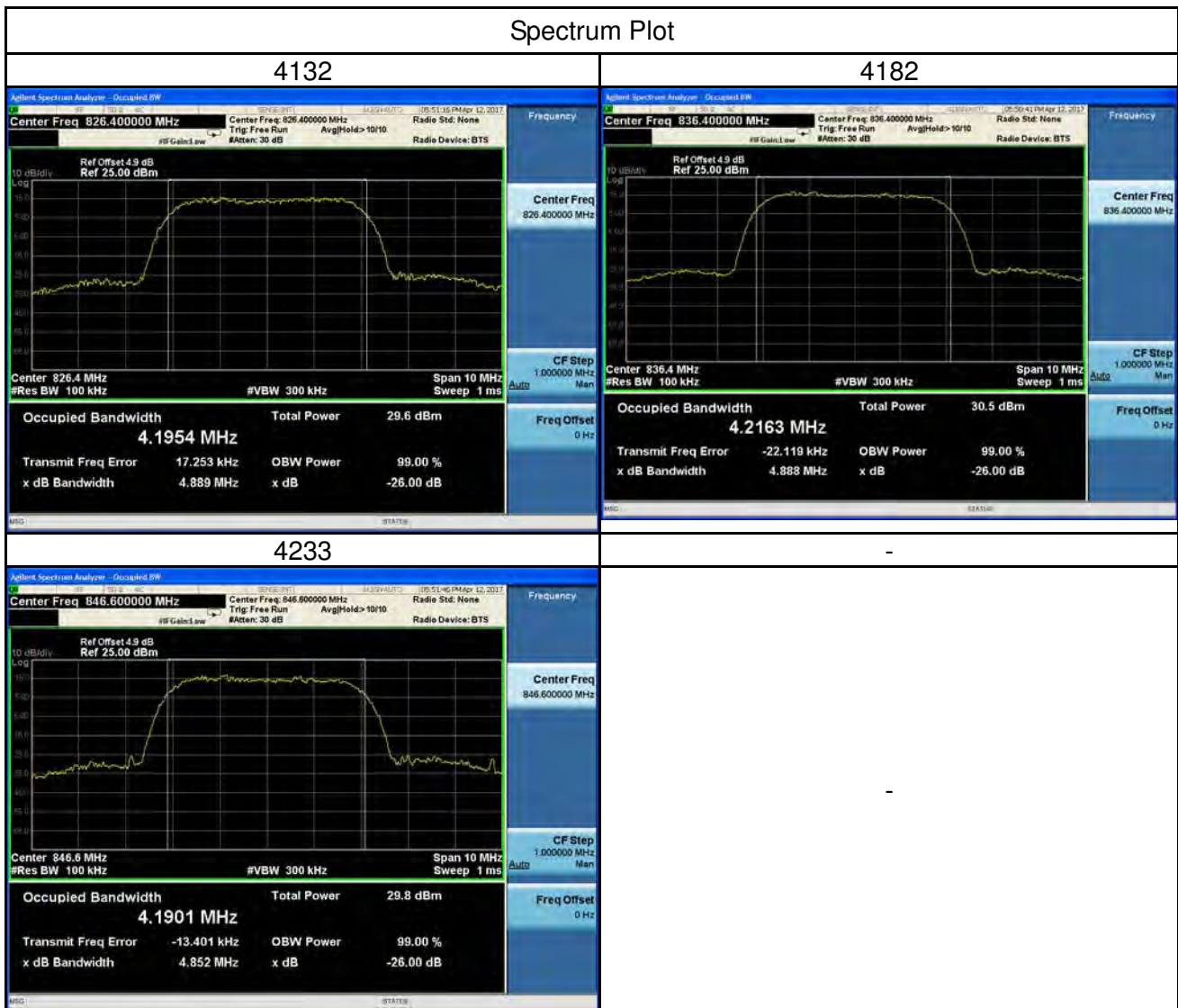

WCDMA_HSUPA Band V					
Channel	Frequency (MHz)	99% Occupied Bandwidth (MHz)	Channel	Frequency (MHz)	26dB Bandwidth (MHz)
4132	826.4	4.2051	4132	826.4	4.891
4182	836.4	4.2110	4182	836.4	4.848
4233	846.6	4.1881	4233	846.6	4.850

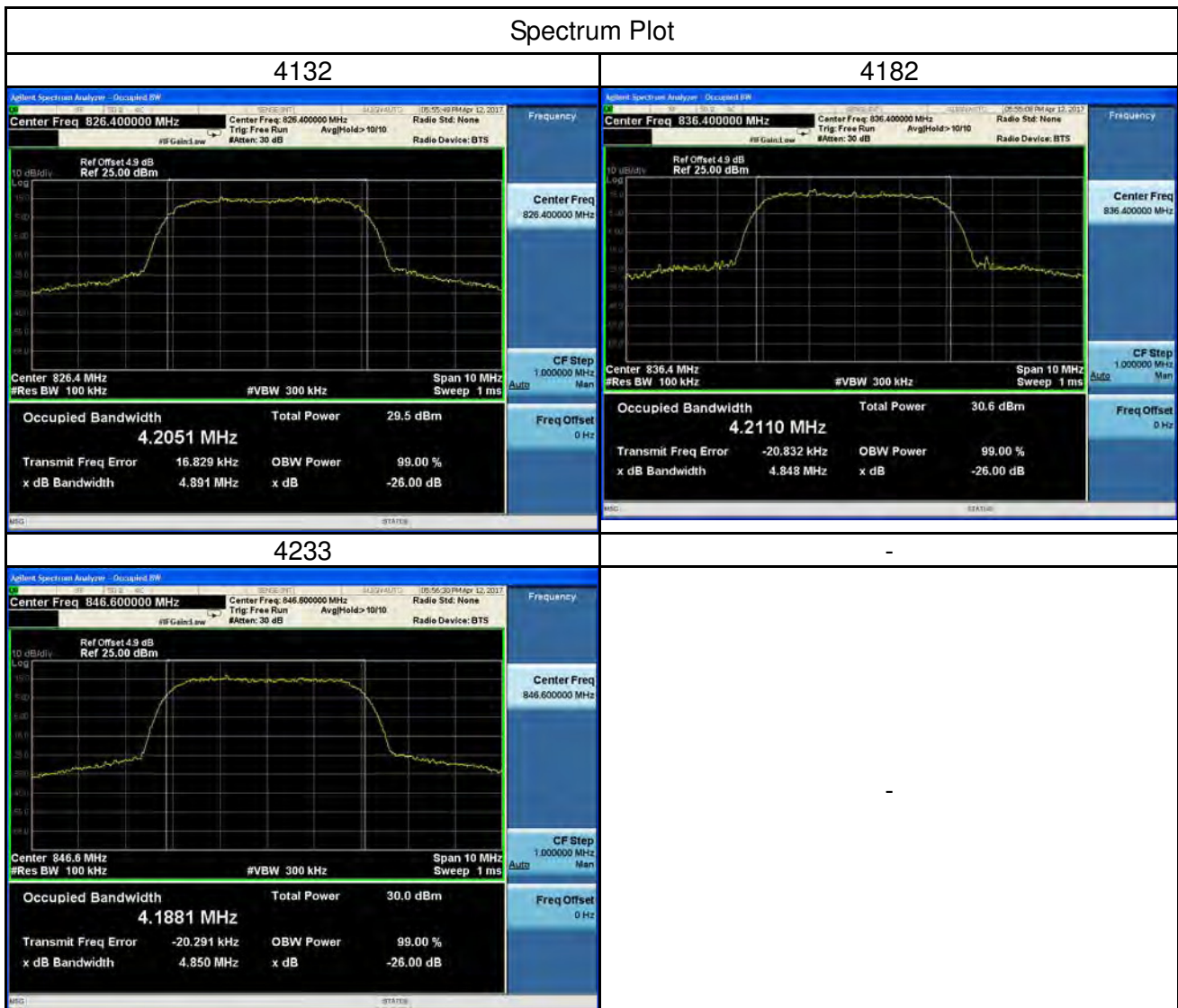

LTE Band 5_1.4M					
QPSK			16QAM		
Channel	Frequency (MHz)	99% Occupied Bandwidth (MHz)	Channel	Frequency (MHz)	99% Occupied Bandwidth (MHz)
20407	824.7	1.093	20407	824.7	1.094
20525	836.5	1.098	20525	836.5	1.091
20643	848.3	1.086	20643	848.3	1.091
Channel	Frequency (MHz)	26dB Bandwidth (MHz)	Channel	Frequency (MHz)	26dB Bandwidth (MHz)
20407	824.7	1.260	20407	824.7	1.268
20525	836.5	1.275	20525	836.5	1.254
20643	848.3	1.239	20643	848.3	1.266

Spectrum Plot

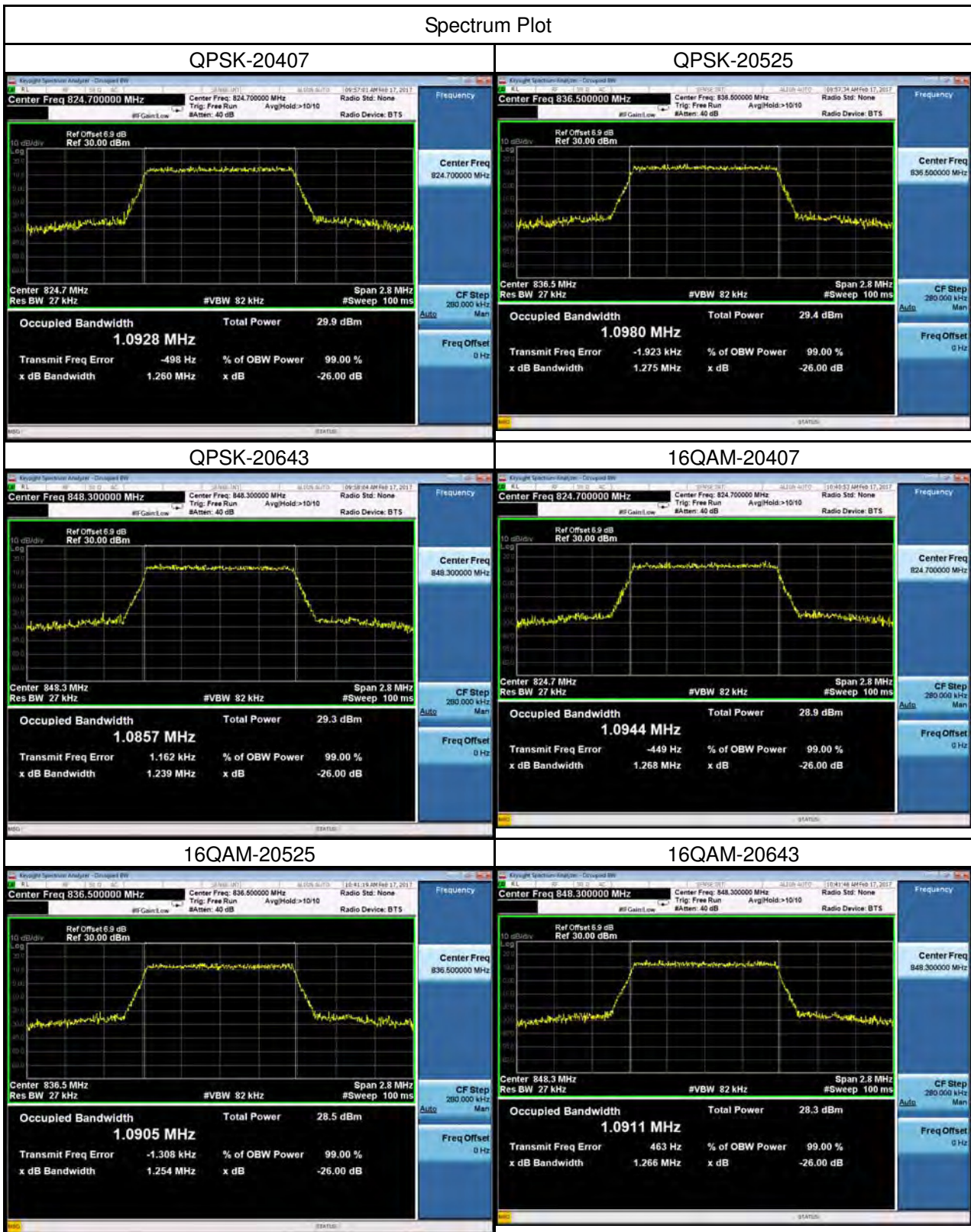

LTE Band 5_3M					
QPSK			16QAM		
Channel	Frequency (MHz)	99% Occupied Bandwidth (MHz)	Channel	Frequency (MHz)	99% Occupied Bandwidth (MHz)
20415	825.5	2.691	20415	825.5	2.701
20525	836.5	2.702	20525	836.5	2.696
20635	847.5	2.694	20635	847.5	2.692
Channel	Frequency (MHz)	26dB Bandwidth (MHz)	Channel	Frequency (MHz)	26dB Bandwidth (MHz)
20415	825.5	2.948	20415	825.5	2.956
20525	836.5	2.954	20525	836.5	2.953
20635	847.5	2.942	20635	847.5	2.986

Spectrum Plot

QPSK-20415

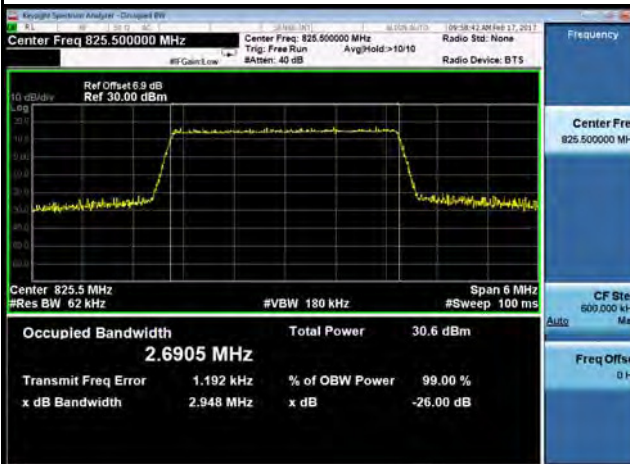

QPSK-20525



QPSK-20635

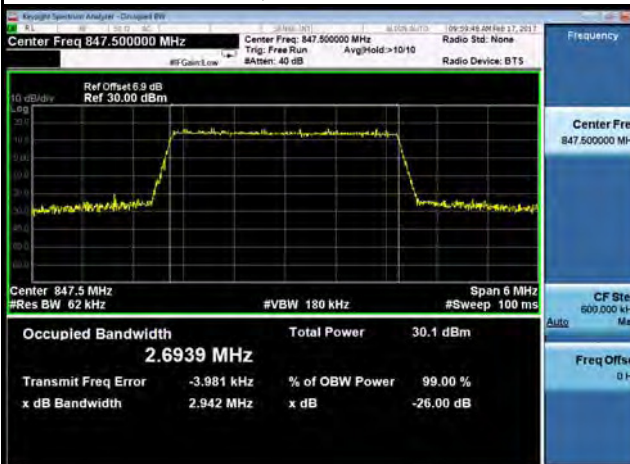

16QAM-20415



16QAM-20525

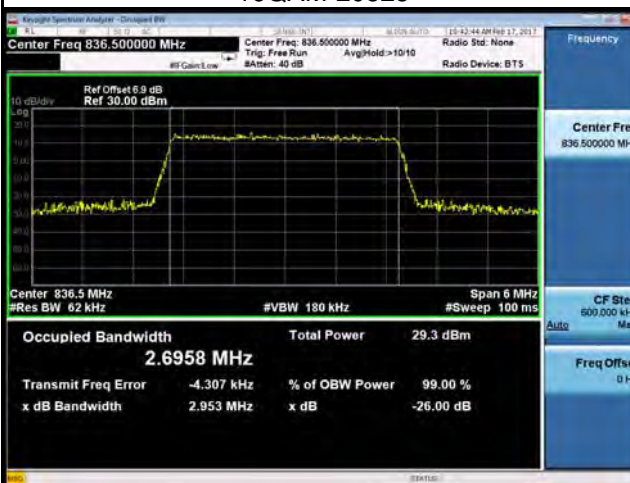

16QAM-20635

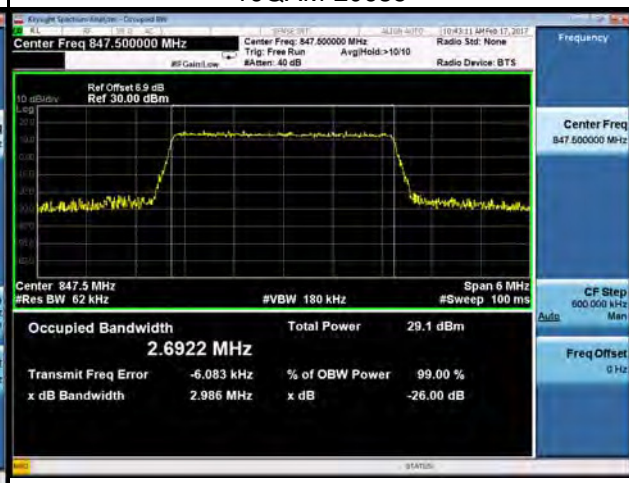

LTE Band 5_5M					
QPSK			16QAM		
Channel	Frequency (MHz)	99% Occupied Bandwidth (MHz)	Channel	Frequency (MHz)	99% Occupied Bandwidth (MHz)
20425	826.5	4.528	20425	826.5	4.510
20525	836.5	4.528	20525	836.5	4.518
20625	846.5	4.519	20625	846.5	4.511
Channel	Frequency (MHz)	26dB Bandwidth (MHz)	Channel	Frequency (MHz)	26dB Bandwidth (MHz)
20425	826.5	5.042	20425	826.5	5.021
20525	836.5	5.042	20525	836.5	5.007
20625	846.5	5.022	20625	846.5	4.990

Spectrum Plot

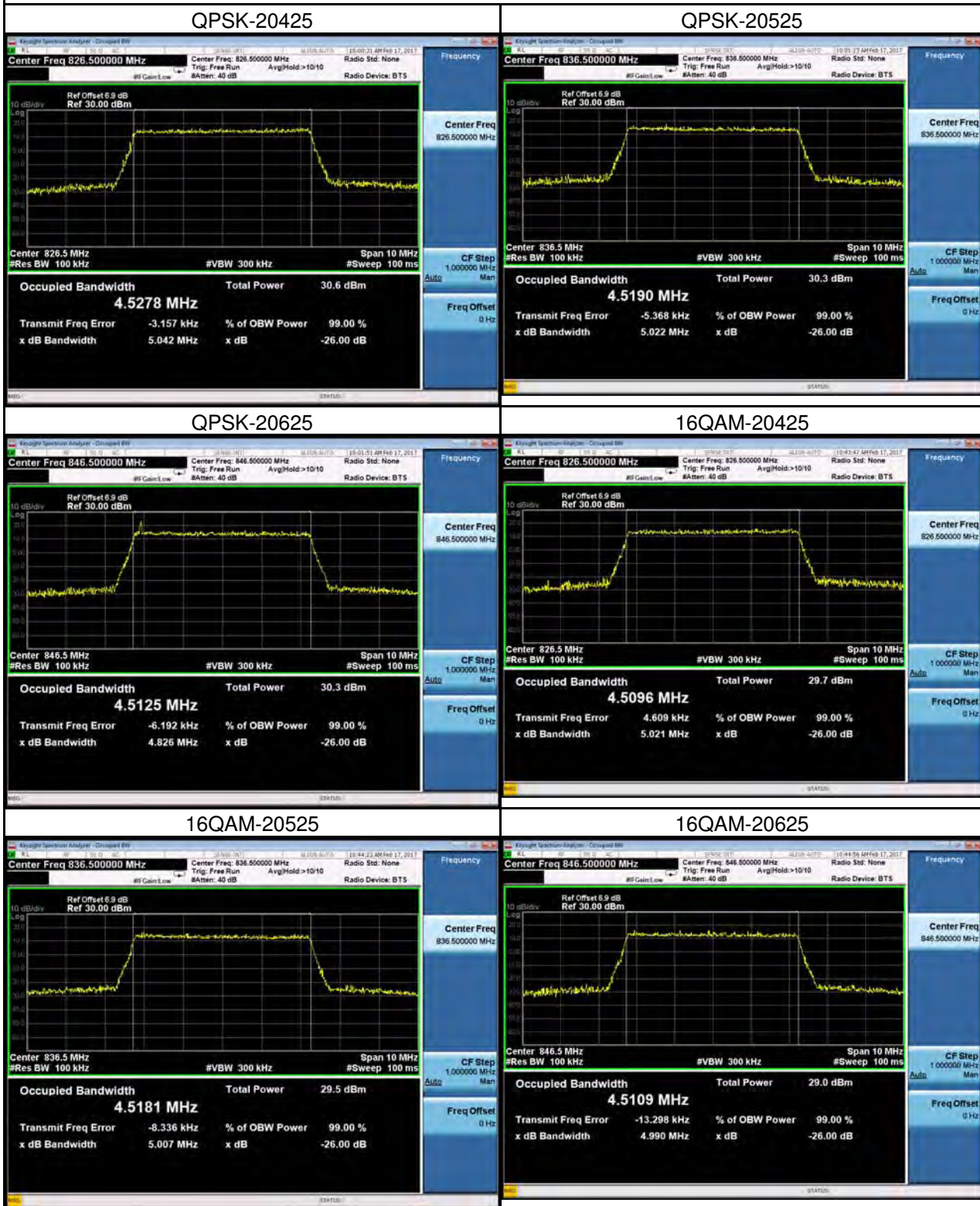

LTE Band 5_10M					
QPSK			16QAM		
Channel	Frequency (MHz)	99% Occupied Bandwidth (MHz)	Channel	Frequency (MHz)	99% Occupied Bandwidth (MHz)
20450	829.0	8.968	20450	829.0	8.970
20525	836.5	8.985	20525	836.5	8.984
20600	844.0	8.999	20600	844.0	8.987
Channel	Frequency (MHz)	26dB Bandwidth (MHz)	Channel	Frequency (MHz)	26dB Bandwidth (MHz)
20450	829.0	9.980	20450	829.0	9.905
20525	836.5	9.938	20525	836.5	9.943
20600	844.0	9.923	20600	844.0	9.940

Spectrum Plot

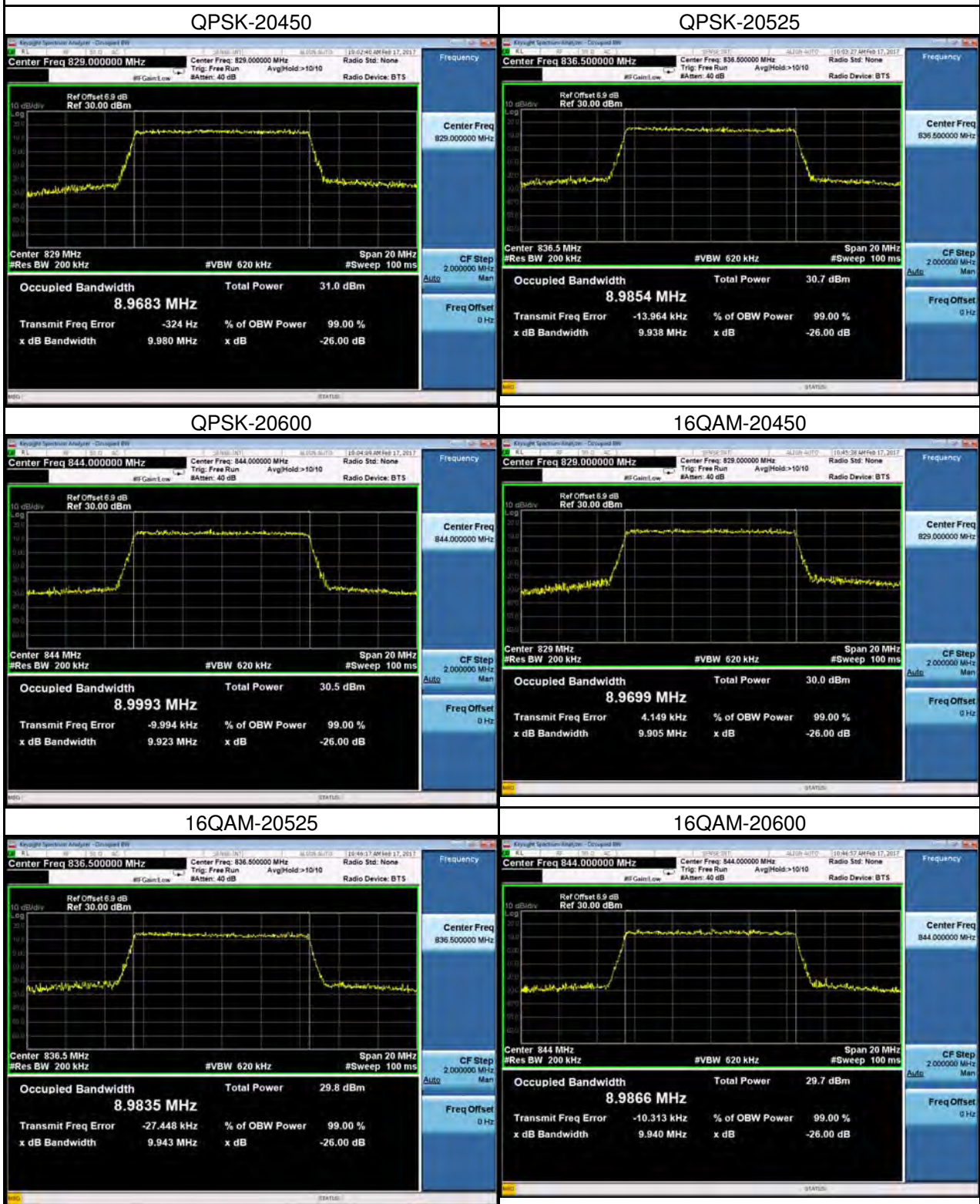

ATTACHMENT C - CONDUCTED EMISSIONS

GSM850			
GSM		GSM	
Channel	Frequency(MHz)	Channel	Frequency(MHz)
190	836.6	190	836.6
GSM		EDGE	
Channel	Frequency(MHz)	Channel	Frequency(MHz)
190	836.6	190	836.6
EDGE		EDGE	
Channel	Frequency(MHz)	Channel	Frequency(MHz)
190	836.6	190	836.6

WCDMA Band V

Channel	Frequency(MHz)	Channel	Frequency(MHz)
4182	836.4	4182	836.4
Channel	Frequency(MHz)	-	-
4182	836.4	-	-

WCDMA_HSDPA Band V			
Channel	Frequency(MHz)	Channel	Frequency(MHz)
4182	836.4	4182	836.4
Channel	Frequency(MHz)	-	-
4182	836.4	-	-

WCDMA_HSUPA Band V			
Channel	Frequency(MHz)	Channel	Frequency(MHz)
4182	836.4	4182	836.4
Channel	Frequency(MHz)	-	-
4182	836.4	-	-

LTE Band 5_1.4M

Channel	Frequency(MHz)	Channel	Frequency(MHz)
20525	836.5	20525	836.5
Channel	Frequency(MHz)	-	-
20525	836.5	-	-

LTE Band 5_3M

Channel	Frequency(MHz)	Channel	Frequency(MHz)
20525	836.5	20525	836.5
Channel	Frequency(MHz)	-	-
20525	836.5	-	-

LTE Band 5_5M			
Channel	Frequency(MHz)	Channel	Frequency(MHz)
20525	836.5	20525	836.5
Channel	Frequency(MHz)	-	-
20525	836.5	-	-

LTE Band 5_10M

Channel	Frequency(MHz)	Channel	Frequency(MHz)
20525	836.5	20525	836.5
Channel	Frequency(MHz)	-	-
20525	836.5	-	-

ATTACHMENT D - RADIATED EMISSION

Test Mode: TX Mode_Adapter: BYD

Ant 0°

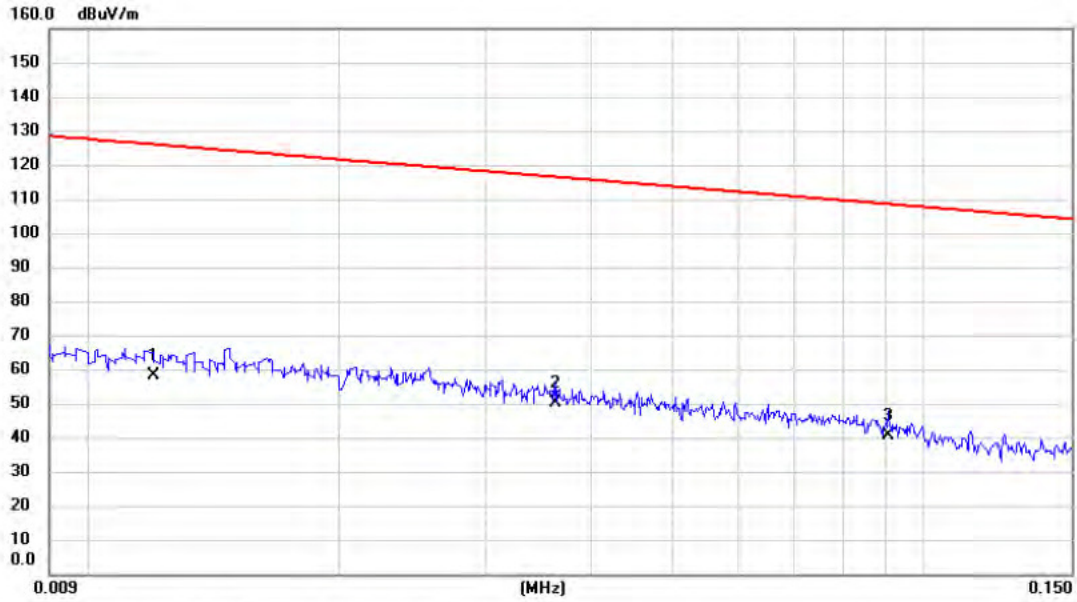

No.	Mk.	Freq. MHz	Reading Level dBuV	Correct Factor dB	Measure- ment dBuV/m	Limit dBuV/m	Margin dB	Detector	Comment
1		0.012	37.62	20.66	58.28	126.02	-67.74	AVG	
2	*	0.036	30.88	19.13	50.01	116.43	-66.42	AVG	
3		0.091	22.83	17.85	40.68	108.45	-67.77	AVG	

Test Mode: TX Mode_Adapter: BYD

Ant 0°

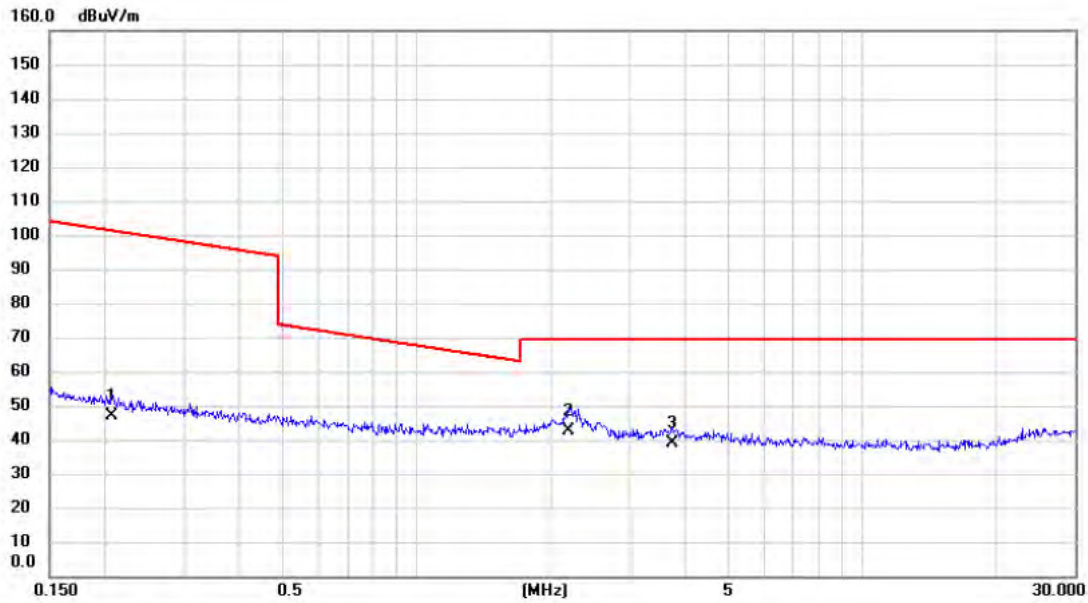

No.	Mk.	Freq. MHz	Reading Level dBuV	Correct Factor dB	Measure- ment dBuV/m	Limit dBuV/m	Margin dB	Detector	Comment
1		0.207	30.18	16.77	46.95	101.28	-54.33	AVG	
2	*	2.190	27.02	15.45	42.47	69.54	-27.07	QP	
3		3.740	23.89	15.03	38.92	69.54	-30.62	QP	

Test Mode: TX Mode_Adapter: BYD

Ant 90°

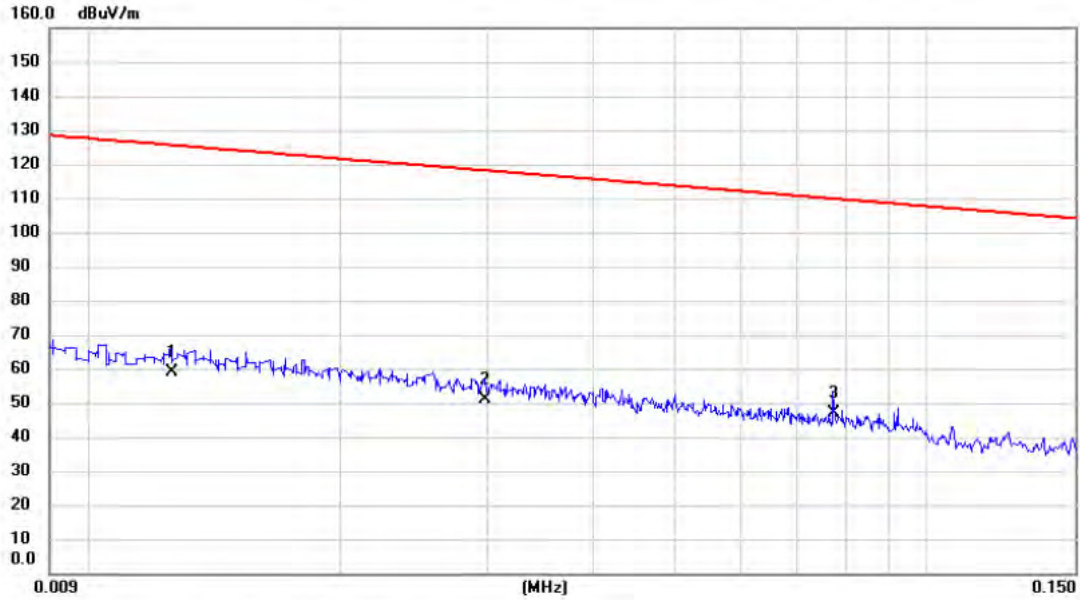

No.	Mk.	Freq. MHz	Reading Level dBuV	Correct Factor dB	Measure- ment dBuV/m	Limit dBuV/m	Margin dB	Detector	Comment
1		0.013	38.39	20.58	58.97	125.60	-66.63	AVG	
2		0.030	31.68	19.33	51.01	118.15	-67.14	AVG	
3	*	0.077	28.73	18.17	46.90	109.84	-62.94	AVG	

Test Mode: TX Mode_Adapter: BYD

Ant 90°

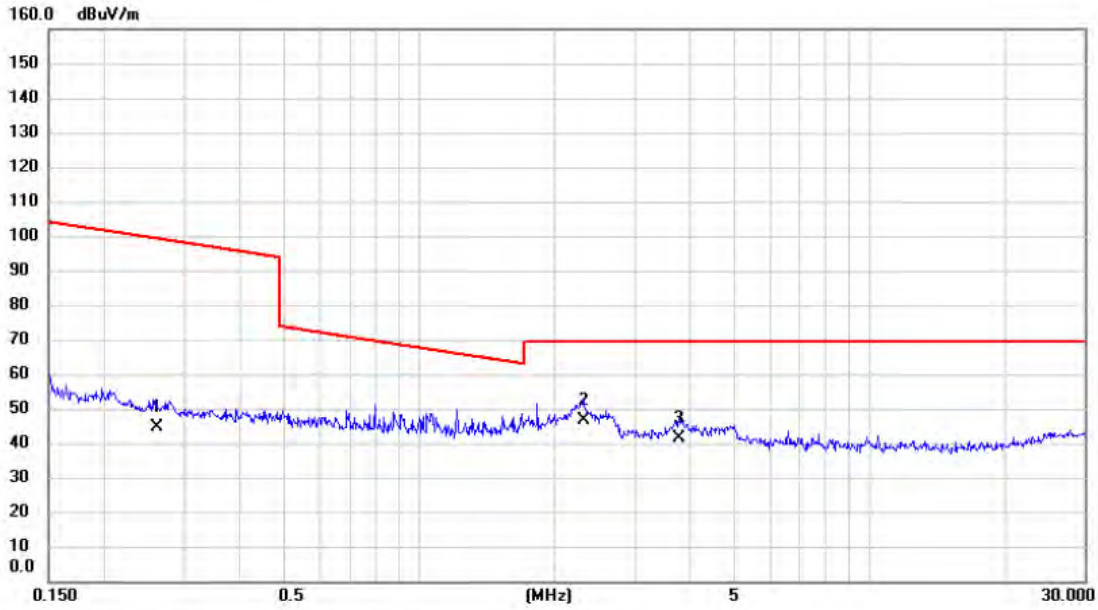

No.	Mk.	Freq. MHz	Reading Level dBuV	Correct Factor dB	Measure- ment dBuV/m	Limit dBuV/m	Margin dB	Detector	Comment
1		0.260	27.92	16.64	44.56	99.30	-54.74	AVG	
2	*	2.309	31.16	15.42	46.58	69.54	-22.96	QP	
3		3.779	26.45	15.02	41.47	69.54	-28.07	QP	

Test Mode: TX Mode_Adapter: PHITEK

Ant 0°

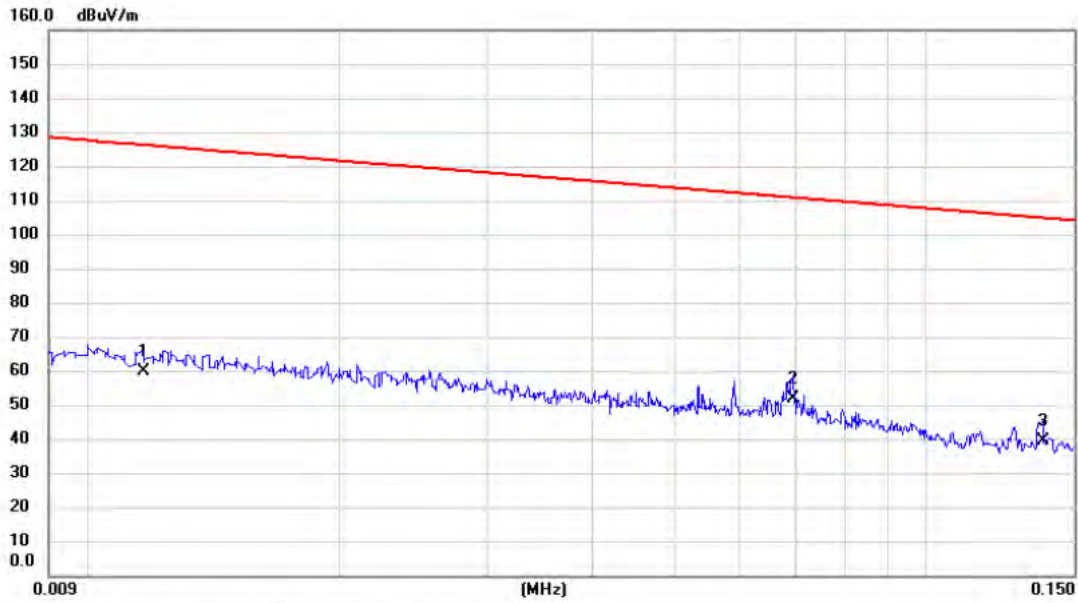

No.	Mk.	Freq. MHz	Reading Level dBuV	Correct Factor dB	Measure- ment dBuV/m	Limit dBuV/m	Margin dB	Detector	Comment
1		0.012	38.93	20.70	59.63	126.24	-66.61	AVG	
2	*	0.069	33.45	18.34	51.79	110.79	-59.00	AVG	
3		0.138	22.36	17.11	39.47	104.82	-65.35	AVG	

Test Mode: TX Mode_Adapter: PHITEK

Ant 0°

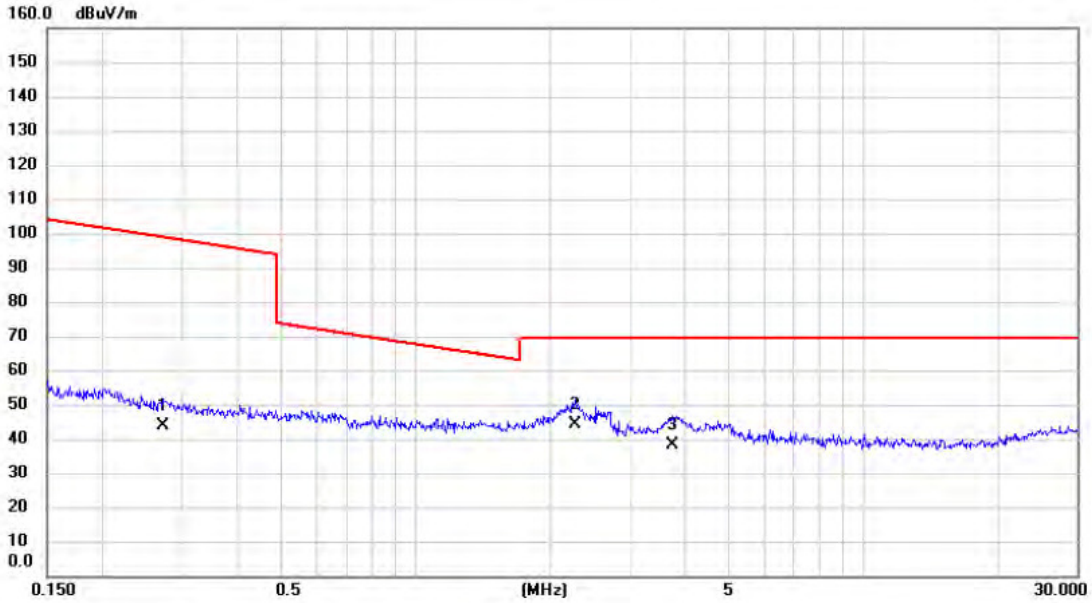

No.	Mk.	Freq. MHz	Reading Level dBuV	Correct Factor dB	Measure- ment dBuV/m	Limit dBuV/m	Margin dB	Detector	Comment
1		0.273	27.14	16.63	43.77	98.88	-55.11	AVG	
2	*	2.272	28.90	15.43	44.33	69.54	-25.21	QP	
3		3.740	23.24	15.03	38.27	69.54	-31.27	QP	

Test Mode: TX Mode_Adapter: PHITEK

Ant 90°

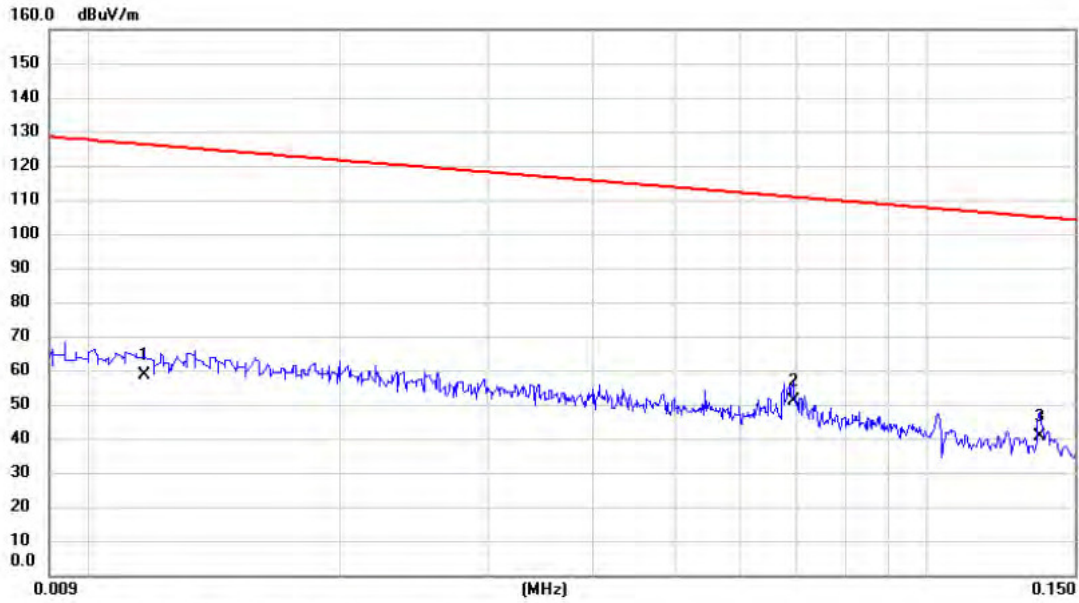

No.	Mk.	Freq. MHz	Reading Level dBuV	Correct Factor dB	Measure- ment dBuV/m	Limit dBuV/m	Margin dB	Detector	Comment
1		0.012	38.04	20.70	58.74	126.24	-67.50	AVG	
2	*	0.069	32.58	18.34	50.92	110.79	-59.87	AVG	
3		0.136	23.59	17.13	40.72	104.92	-64.20	AVG	

Test Mode: TX Mode_Adapter: PHITEK

Ant 90°

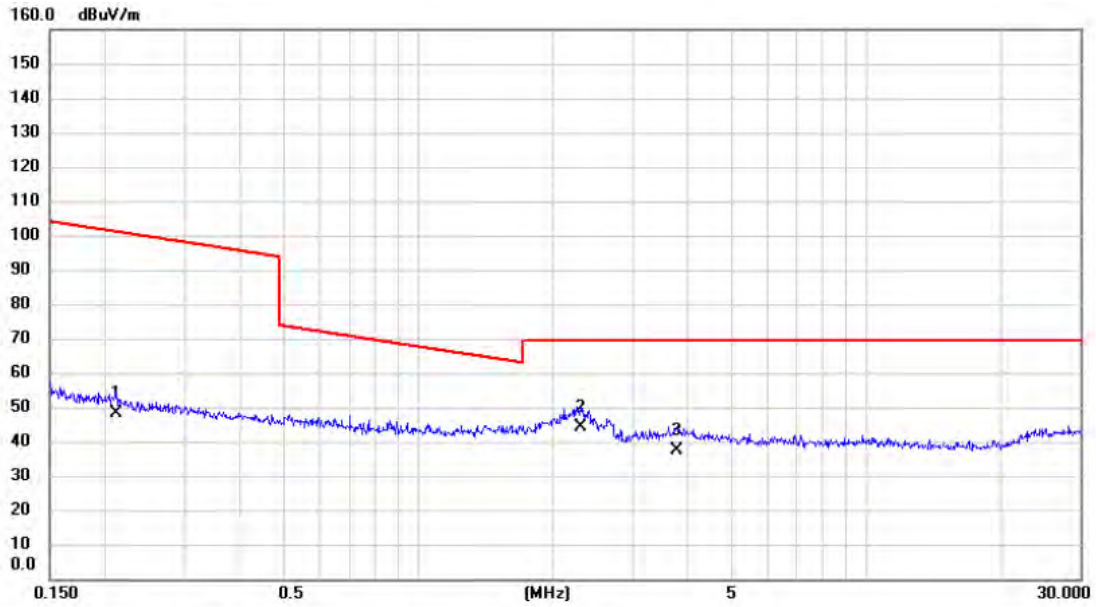

No.	Mk.	Freq. MHz	Reading Level dBuV	Correct Factor dB	Measure- ment dBuV/m	Limit dBuV/m	Margin dB	Detector	Comment
1		0.212	31.47	16.76	48.23	101.09	-52.86	AVG	
2	*	2.297	28.86	15.42	44.28	69.54	-25.26	QP	
3		3.779	22.37	15.02	37.39	69.54	-32.15	QP	

Test Mode: TX Mode_Adapter: Huntkey

Ant 0°

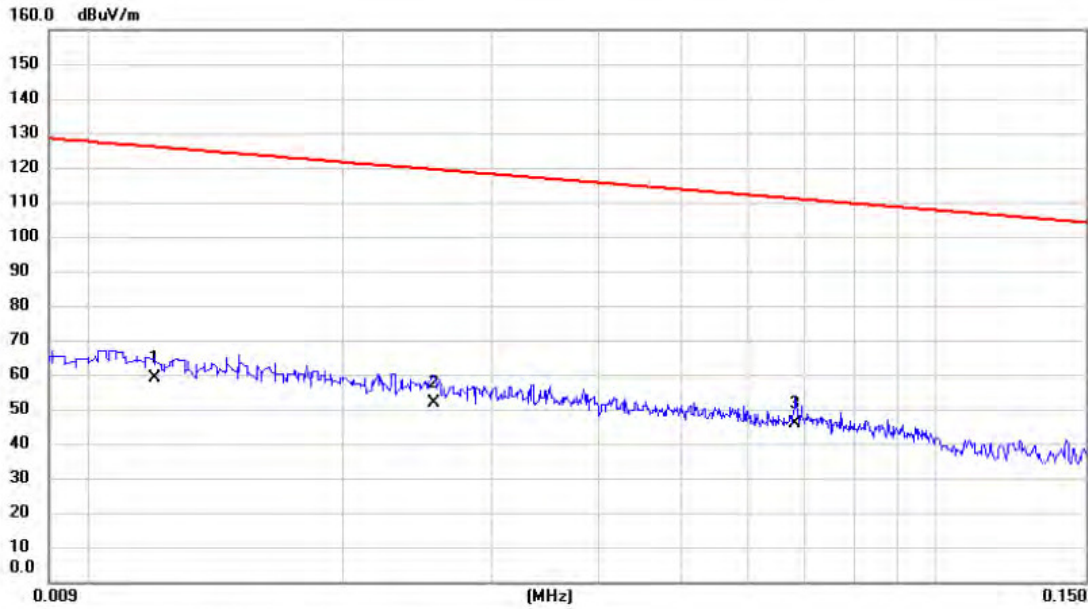

No.	Mk.	Freq. MHz	Reading Level dBuV	Correct Factor dB	Measure- ment dBuV/m	Limit dBuV/m	Margin dB	Detector	Comment
1		0.012	38.21	20.66	58.87	126.02	-67.15	AVG	
2		0.026	32.35	19.45	51.80	119.44	-67.64	AVG	
3	*	0.068	27.43	18.37	45.80	110.93	-65.13	AVG	

Test Mode: TX Mode_Adapter: Huntkey

Ant 0°

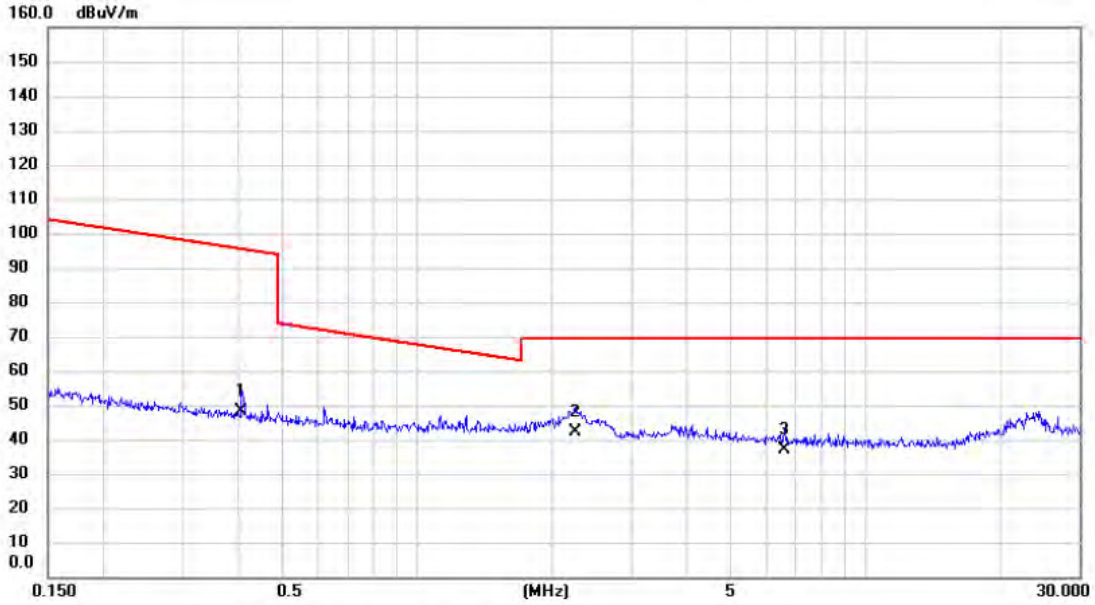

No.	Mk.	Freq. MHz	Reading Level dBuV	Correct Factor dB	Measure- ment dBuV/m	Limit dBuV/m	Margin dB	Detector	Comment
1		0.406	31.76	16.54	48.30	95.43	-47.13	AVG	
2	*	2.249	26.95	15.44	42.39	69.54	-27.15	QP	
3		6.592	22.67	14.18	36.85	69.54	-32.69	QP	

Test Mode: TX Mode_Adapter: Huntkey

Ant 90°

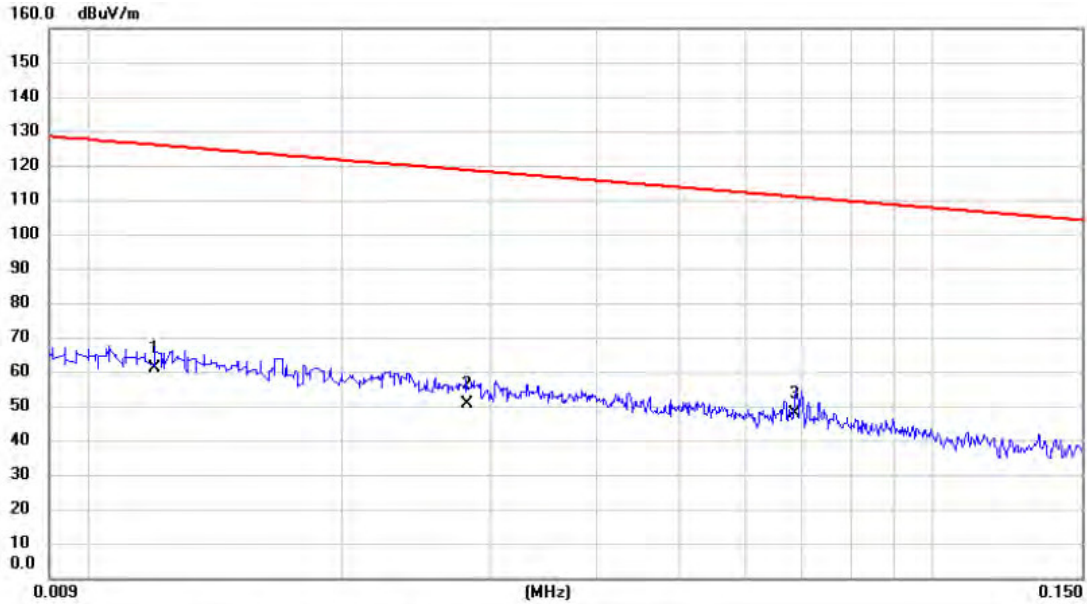

No.	Mk.	Freq. MHz	Reading Level dBuV	Correct Factor dB	Measure- ment dBuV/m	Limit dBuV/m	Margin dB	Detector	Comment
1		0.012	40.19	20.66	60.85	126.02	-65.17	AVG	
2		0.028	31.28	19.38	50.66	118.63	-67.97	AVG	
3	*	0.069	29.27	18.36	47.63	110.87	-63.24	AVG	

Test Mode: TX Mode_Adapter: Huntkey

Ant 90°

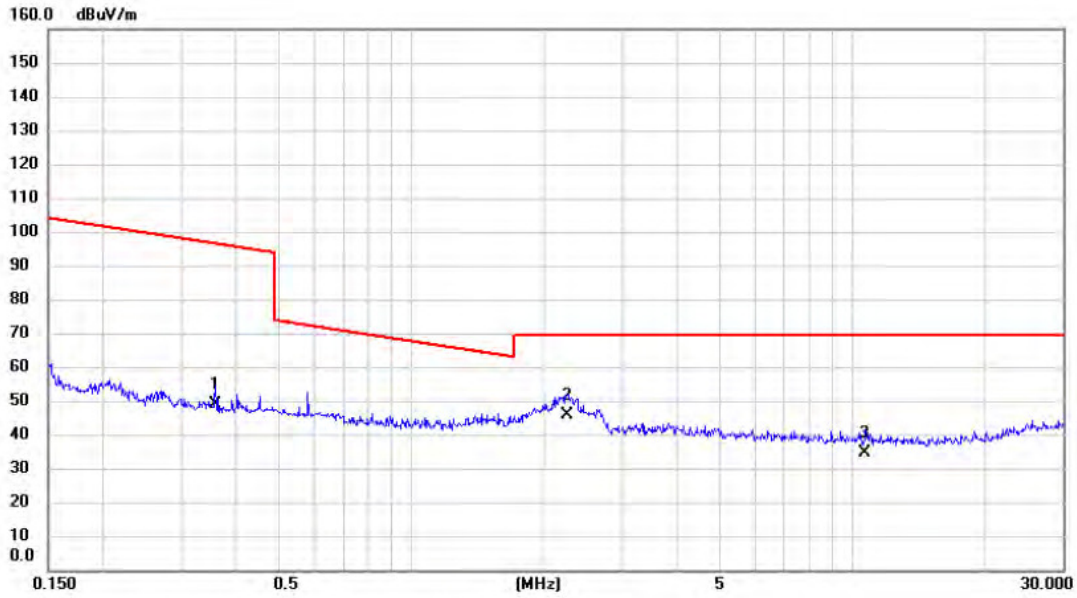

No.	Mk.	Freq. MHz	Reading Level dBuV	Correct Factor dB	Measure- ment dBuV/m	Limit dBuV/m	Margin dB	Detector	Comment
1		0.359	32.24	16.57	48.81	96.49	-47.68	AVG	
2	*	2.249	30.42	15.44	45.86	69.54	-23.68	QP	
3		10.676	20.65	13.80	34.45	69.54	-35.09	QP	

SIM Card 1

Test Mode: GSM850_TX CH190_GSM

Vertical



No.	Mk.	Freq. MHz	Reading Level dBm	Correct Factor dB	Measure- ment dBm	Limit dBm	Margin dB	Detector	Comment
1	*	57.160	-67.50	11.74	-55.76	-13.00	-42.76	peak	
2		144.460	-77.17	12.60	-64.57	-13.00	-51.57	peak	
3		280.260	-78.84	12.64	-66.20	-13.00	-53.20	peak	
4		405.390	-77.09	14.26	-62.83	-13.00	-49.83	peak	
5		502.390	-76.99	17.55	-59.44	-13.00	-46.44	peak	
6		642.070	-76.79	19.89	-56.90	-13.00	-43.90	peak	

Test Mode: GSM850_TX CH190_GSM

Horizontal



No.	Mk.	Freq. MHz	Reading Level dBm	Correct Factor dB	Measure- ment dBm	Limit dBm	Margin dB	Detector	Comment
1		30.000	-72.57	11.88	-60.69	-13.00	-47.69	peak	
2		150.280	-78.08	14.20	-63.88	-13.00	-50.88	peak	
3		234.670	-77.97	12.85	-65.12	-13.00	-52.12	peak	
4		418.000	-77.36	16.78	-60.58	-13.00	-47.58	peak	
5		529.550	-76.83	18.08	-58.75	-13.00	-45.75	peak	
6	*	717.730	-76.77	23.55	-53.22	-13.00	-40.22	peak	

Test Mode: GSM850_TX CH190_GSM

Vertical

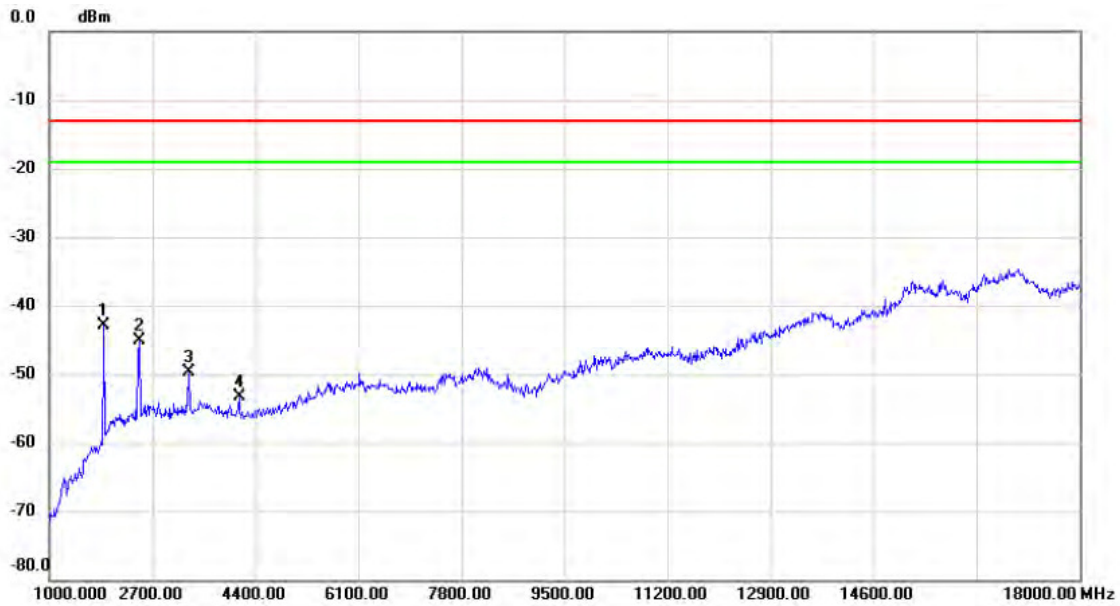

No.	Mk.	Freq. MHz	Reading Level dBm	Correct Factor dB	Measure- ment dBm	Limit dBm	Margin dB	Detector	Comment
1	*	1901.000	-52.47	9.61	-42.86	-13.00	-29.86	peak	
2		2479.000	-57.23	12.15	-45.08	-13.00	-32.08	peak	
3		3295.000	-63.21	13.52	-49.69	-13.00	-36.69	peak	
4		4128.000	-67.94	14.66	-53.28	-13.00	-40.28	peak	

Test Mode: GSM850_TX CH190_GSM

Horizontal



No.	Mk.	Freq. MHz	Reading Level dBm	Correct Factor dB	Measure- ment dBm	Limit dBm	Margin dB	Detector	Comment
1	*	1646.000	-59.33	8.15	-51.18	-13.00	-38.18	peak	
2		2479.000	-57.70	5.34	-52.36	-13.00	-39.36	peak	
3		3295.000	-61.78	9.84	-51.94	-13.00	-38.94	peak	

Test Mode: GSM850_TX CH190_EDGE

Vertical

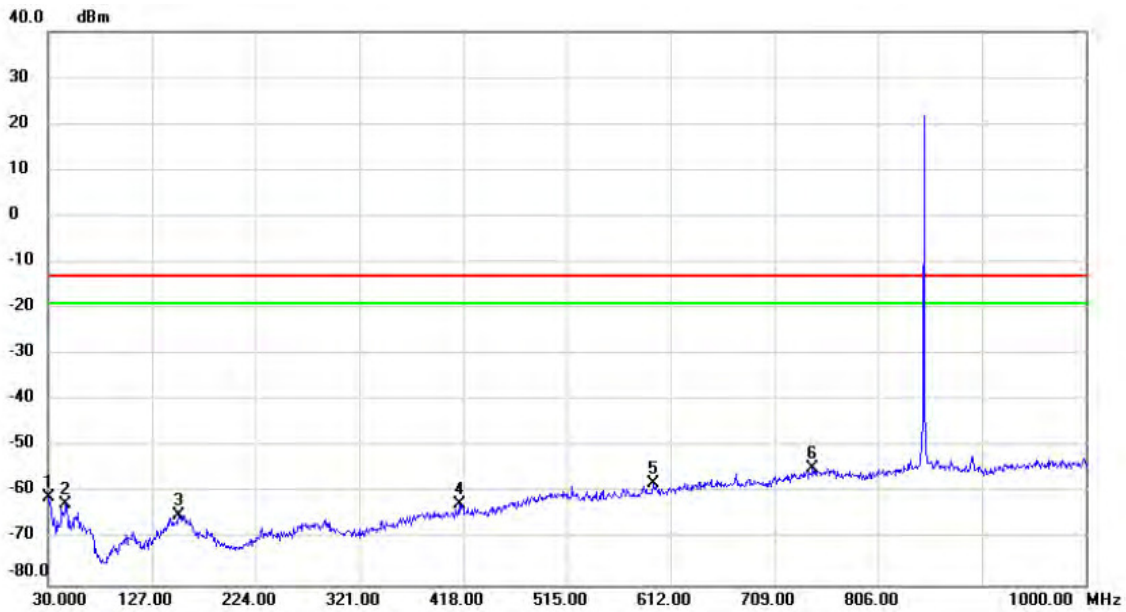

No.	Mk.	Freq. MHz	Reading Level dBm	Correct Factor dB	Measure- ment dBm	Limit dBm	Margin dB	Detector	Comment
1		30.000	-70.55	9.74	-60.81	-13.00	-47.81	peak	
2		46.490	-73.97	11.54	-62.43	-13.00	-49.43	peak	
3		152.220	-77.98	13.16	-64.82	-13.00	-51.82	peak	
4		414.120	-76.84	14.49	-62.35	-13.00	-49.35	peak	
5		595.510	-76.65	18.59	-58.06	-13.00	-45.06	peak	
6	*	744.890	-76.82	22.28	-54.54	-13.00	-41.54	peak	

Test Mode: GSM850_TX CH190_EDGE

Horizontal

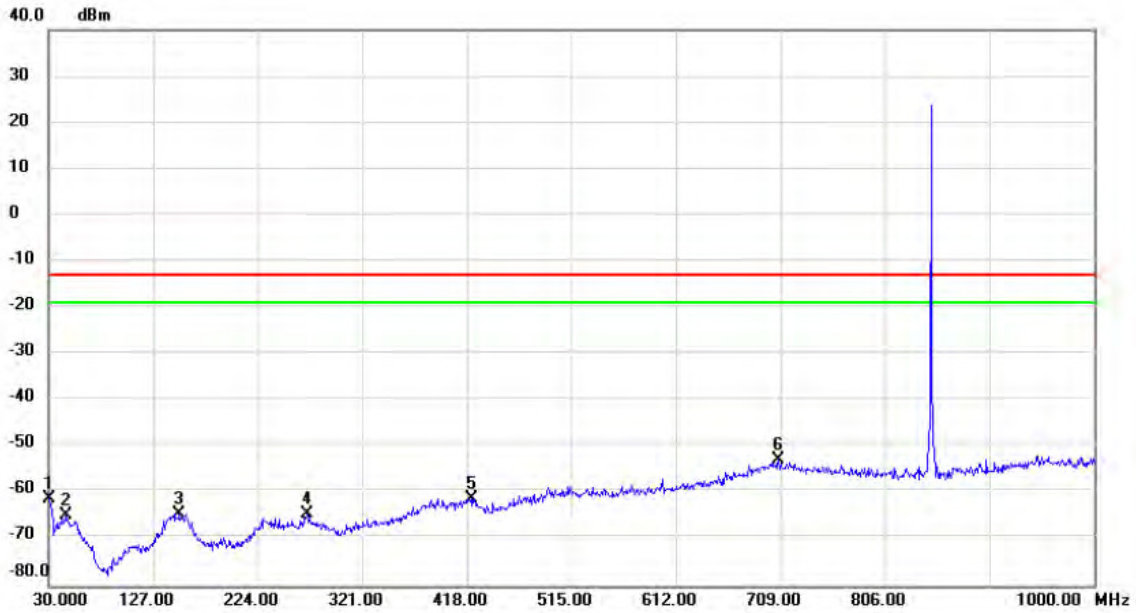

No.	Mk.	Freq. MHz	Reading Level dBm	Correct Factor dB	Measure- ment dBm	Limit dBm	Margin dB	Detector	Comment
1		30.000	-73.04	11.88	-61.16	-13.00	-48.16	peak	
2		45.520	-77.69	12.87	-64.82	-13.00	-51.82	peak	
3		151.250	-78.50	14.05	-64.45	-13.00	-51.45	peak	
4		269.590	-77.47	12.98	-64.49	-13.00	-51.49	peak	
5		421.880	-77.82	16.67	-61.15	-13.00	-48.15	peak	
6	*	707.060	-76.70	23.81	-52.89	-13.00	-39.89	peak	

Test Mode: GSM850_TX CH190_EDGE

Vertical

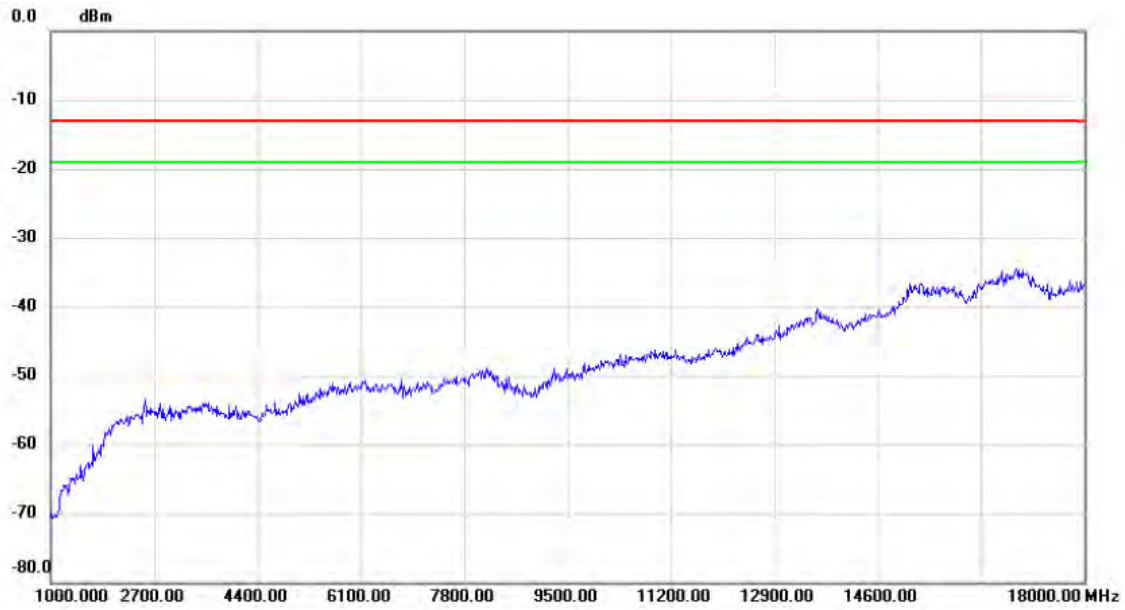

No.	Mk.	Freq. MHz	Reading Level dBm	Correct Factor dB	Measure- ment dBm	Limit dBm	Margin dB	Detector	Comment
-----	-----	--------------	-------------------------	-------------------------	-------------------------	--------------	--------------	----------	---------

Test Mode: GSM850_TX CH190_EDGE

Horizontal

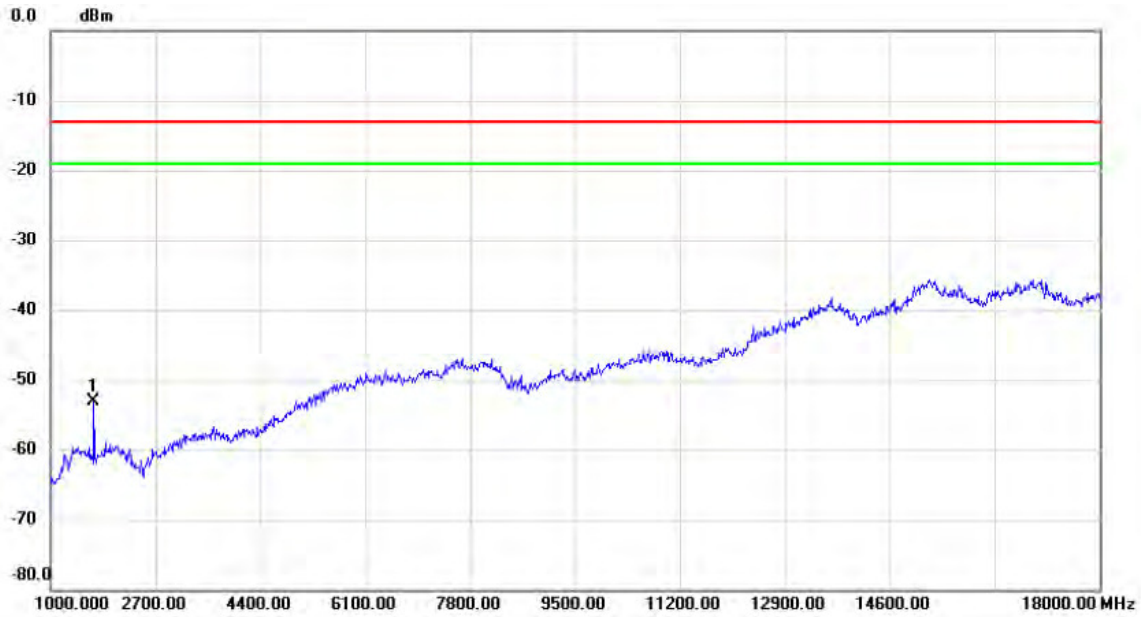

No.	Mk.	Freq. MHz	Reading Level dBm	Correct Factor dB	Measure- ment dBm	Limit dBm	Margin dB	Detector	Comment
1	*	1697.000	-61.36	8.17	-53.19	-13.00	-40.19	peak	

SIM Card 2

Test Mode: GSM850_TX CH190_GSM

Vertical

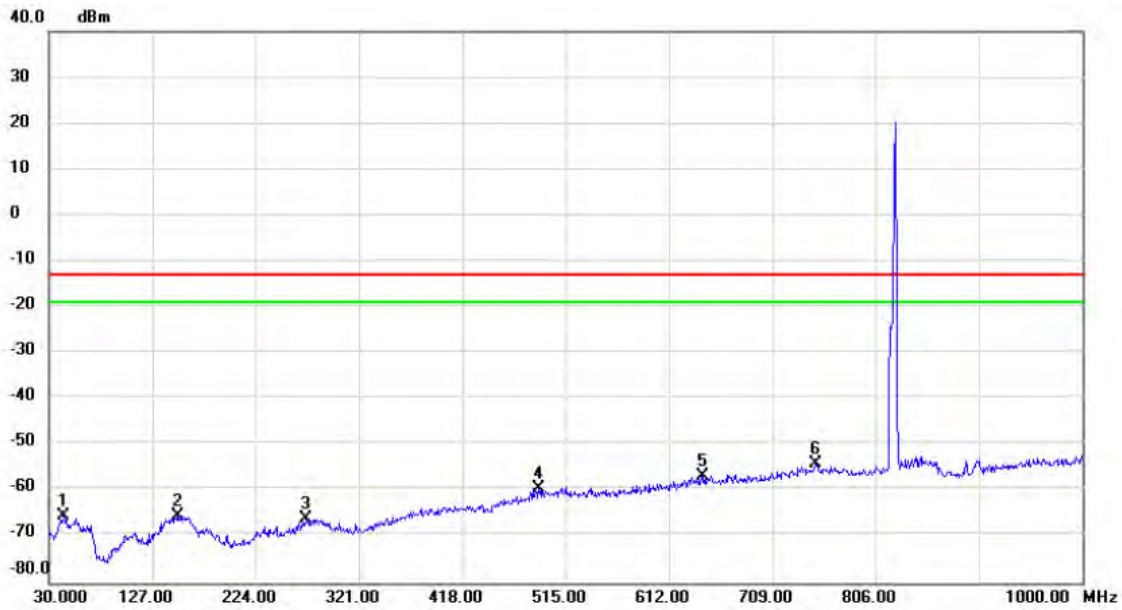

No.	Mk.	Freq. MHz	Reading Level dBm	Correct Factor dB	Measure- ment dBm	Limit dBm	Margin dB	Detector	Comment
1		43.580	-77.58	11.99	-65.59	-13.00	-52.59	peak	
2		151.250	-78.49	13.15	-65.34	-13.00	-52.34	peak	
3		270.560	-78.14	12.22	-65.92	-13.00	-52.92	peak	
4		489.780	-76.28	16.95	-59.33	-13.00	-46.33	peak	
5		644.010	-76.62	19.95	-56.67	-13.00	-43.67	peak	
6	*	749.740	-76.64	22.47	-54.17	-13.00	-41.17	peak	

Test Mode: GSM850_TX CH190_GSM

Horizontal

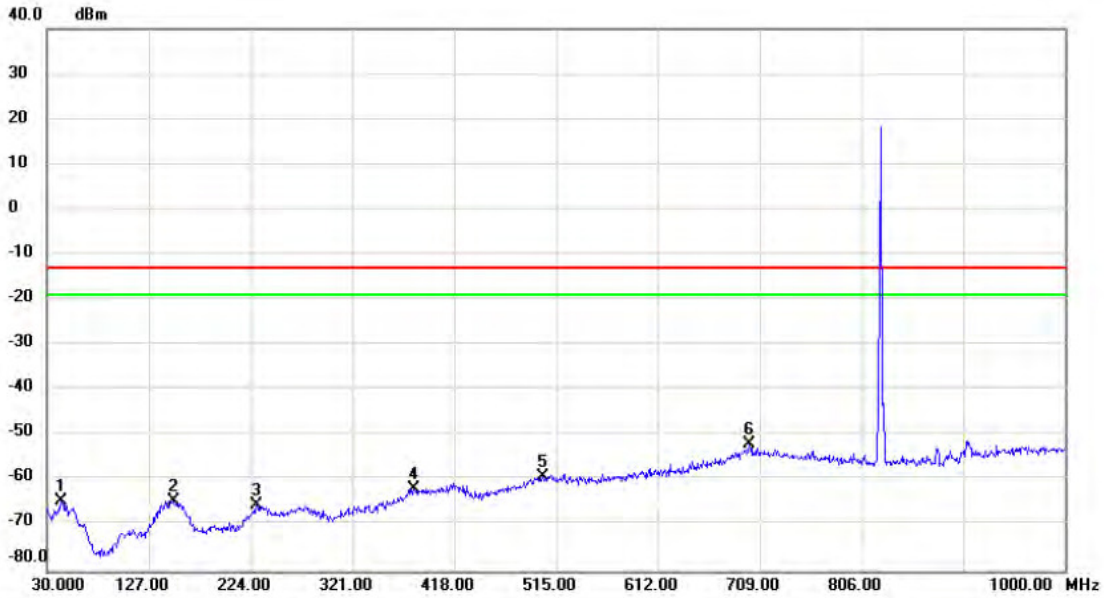

No.	Mk.	Freq. MHz	Reading Level dBm	Correct Factor dB	Measure- ment dBm	Limit dBm	Margin dB	Detector	Comment
1		43.580	-77.44	12.78	-64.66	-13.00	-51.66	peak	
2		150.280	-78.62	14.20	-64.42	-13.00	-51.42	peak	
3		229.820	-78.75	13.20	-65.55	-13.00	-52.55	peak	
4		379.200	-77.81	16.00	-61.81	-13.00	-48.81	peak	
5		502.390	-77.17	18.06	-59.11	-13.00	-46.11	peak	
6	*	699.300	-75.95	23.93	-52.02	-13.00	-39.02	peak	

Test Mode: GSM850_TX CH190_GSM

Vertical

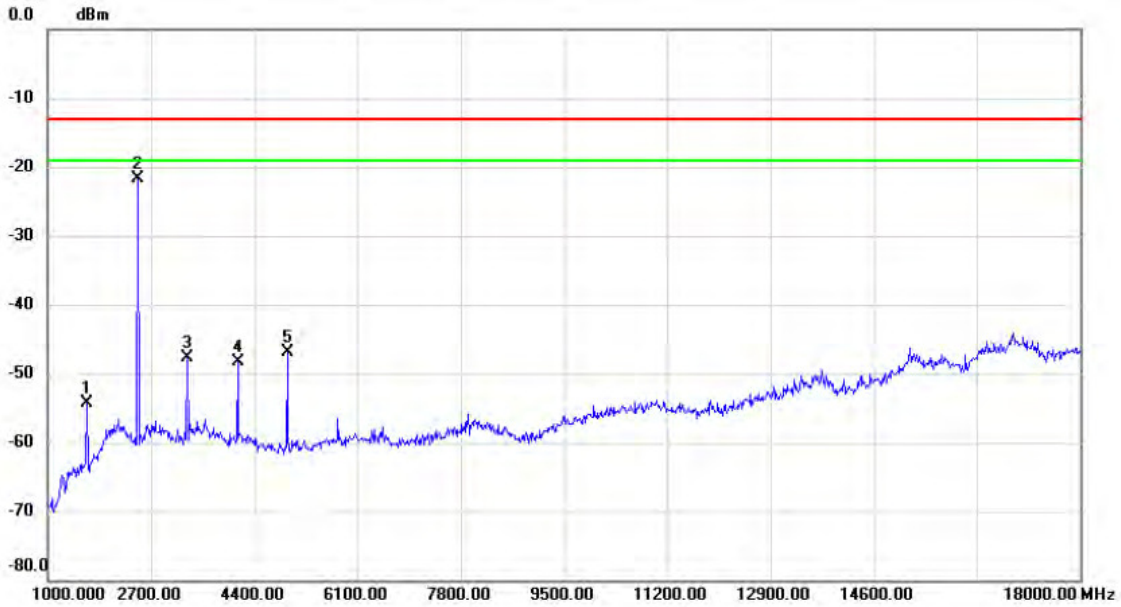

No.	Mk.	Freq. MHz	Reading Level dBm	Correct Factor dB	Measure- ment dBm	Limit dBm	Margin dB	Detector	Comment
1		1646.000	-60.37	6.12	-54.25	-13.00	-41.25	peak	
2	*	2479.000	-33.92	12.15	-21.77	-13.00	-8.77	peak	
3		3295.000	-61.25	13.52	-47.73	-13.00	-34.73	peak	
4		4128.000	-62.99	14.66	-48.33	-13.00	-35.33	peak	
5		4944.000	-61.47	14.56	-46.91	-13.00	-33.91	peak	

Test Mode: GSM850_TX CH190_GSM

Horizontal

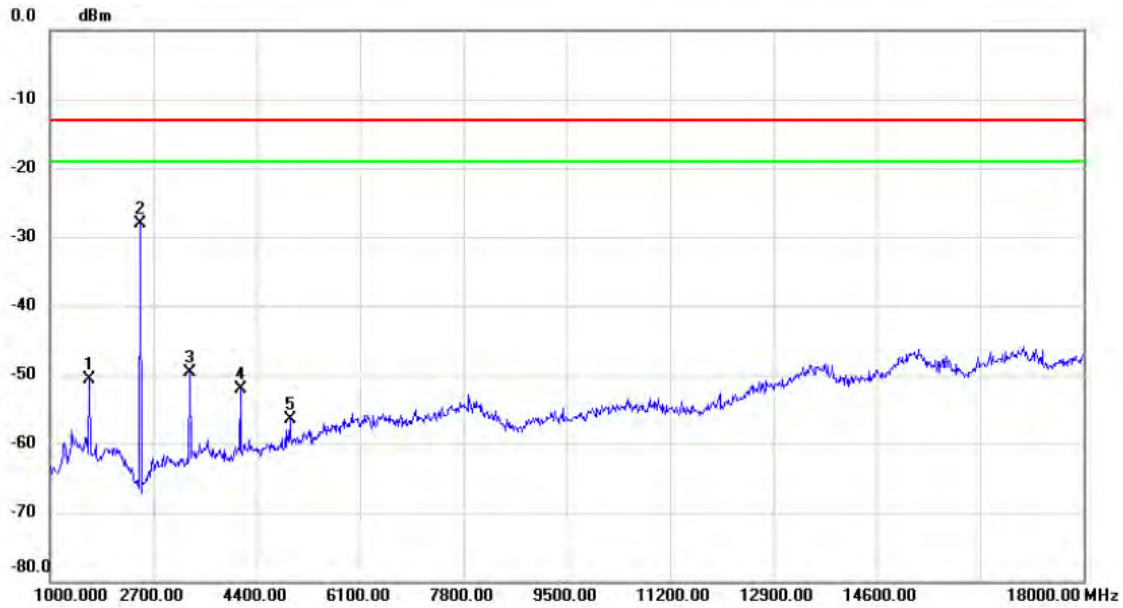

No.	Mk.	Freq. MHz	Reading Level dBm	Correct Factor dB	Measure- ment dBm	Limit dBm	Margin dB	Detector	Comment
1		1646.000	-58.83	8.15	-50.68	-13.00	-37.68	peak	
2	*	2479.000	-33.35	5.34	-28.01	-13.00	-15.01	peak	
3		3295.000	-59.60	9.84	-49.76	-13.00	-36.76	peak	
4		4128.000	-64.44	12.28	-52.16	-13.00	-39.16	peak	
5		4944.000	-70.89	14.49	-56.40	-13.00	-43.40	peak	

Test Mode: GSM850_TX CH190_EDGE

Vertical

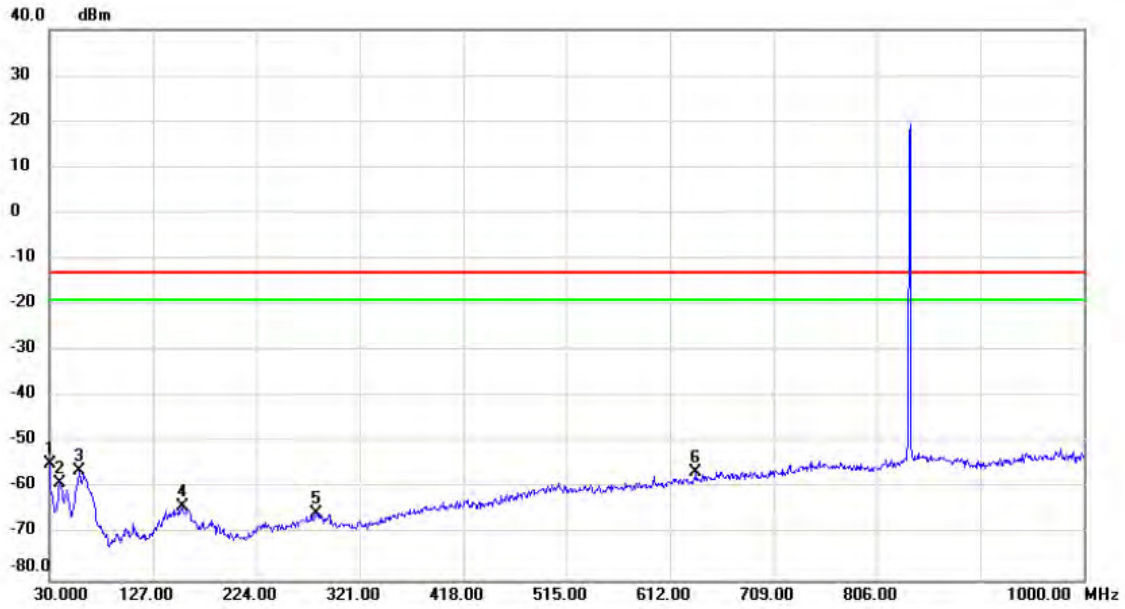

No.	Mk.	Freq. MHz	Reading Level dBm	Correct Factor dB	Measure- ment dBm	Limit dBm	Margin dB	Detector	Comment
1	*	30.000	-64.29	9.74	-54.55	-13.00	-41.55	peak	
2		39.700	-70.82	11.90	-58.92	-13.00	-45.92	peak	
3		58.130	-67.43	11.31	-56.12	-13.00	-43.12	peak	
4		154.160	-77.26	13.16	-64.10	-13.00	-51.10	peak	
5		280.260	-78.17	12.64	-65.53	-13.00	-52.53	peak	
6		636.250	-76.14	19.73	-56.41	-13.00	-43.41	peak	

Test Mode: GSM850_TX CH190_EDGE

Horizontal

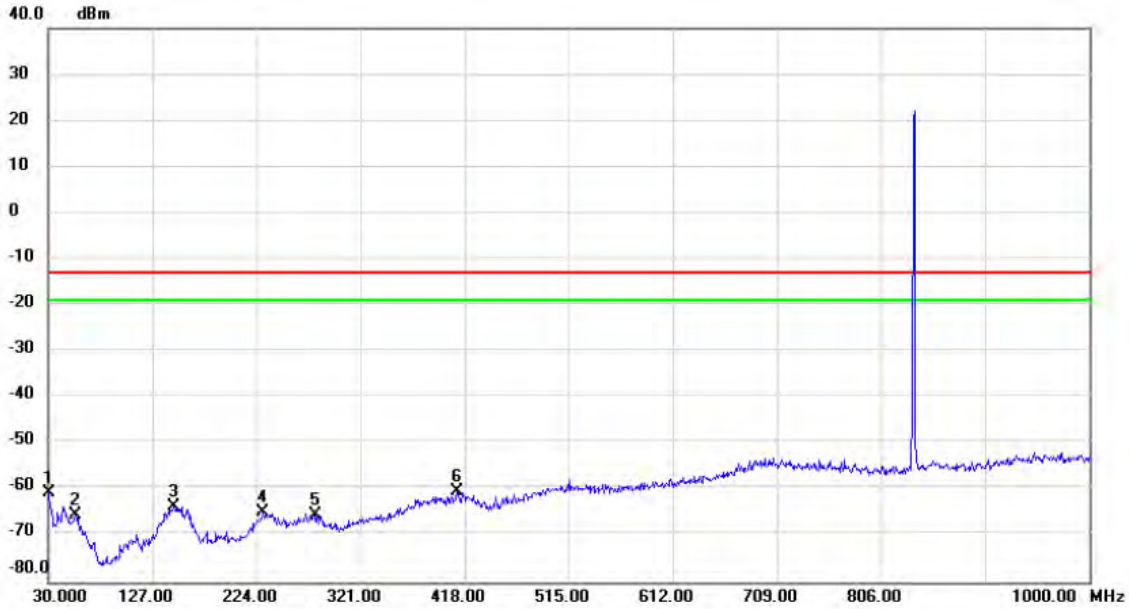

No.	Mk.	Freq. MHz	Reading Level dBm	Correct Factor dB	Measure- ment dBm	Limit dBm	Margin dB	Detector	Comment
1		30.000	-72.54	11.88	-60.66	-13.00	-47.66	peak	
2		55.220	-77.98	12.53	-65.45	-13.00	-52.45	peak	
3		147.370	-77.60	13.95	-63.65	-13.00	-50.65	peak	
4		229.820	-77.91	13.20	-64.71	-13.00	-51.71	peak	
5		278.320	-78.13	12.59	-65.54	-13.00	-52.54	peak	
6 *		410.240	-76.80	16.39	-60.41	-13.00	-47.41	peak	

Test Mode: GSM850_TX CH190_EDGE

Vertical



No.	Mk.	Freq. MHz	Reading Level dBm	Correct Factor dB	Measure- ment dBm	Limit dBm	Margin dB	Detector	Comment
1		1680.000	-64.94	6.59	-58.35	-13.00	-45.35	peak	
2	*	2479.000	-40.50	12.15	-28.35	-13.00	-15.35	peak	
3		3295.000	-66.19	13.52	-52.67	-13.00	-39.67	peak	
4		4128.000	-67.66	14.66	-53.00	-13.00	-40.00	peak	
5		4944.000	-69.83	14.56	-55.27	-13.00	-42.27	peak	

Test Mode: GSM850_TX CH190_EDGE

Horizontal



No.	Mk.	Freq. MHz	Reading Level dBm	Correct Factor dB	Measure- ment dBm	Limit dBm	Margin dB	Detector	Comment
1		1680.000	-66.68	8.17	-58.51	-13.00	-45.51	peak	
2	*	2513.000	-38.85	5.30	-33.55	-13.00	-20.55	peak	

Test Mode: WCDMA Band V_TX CH4182

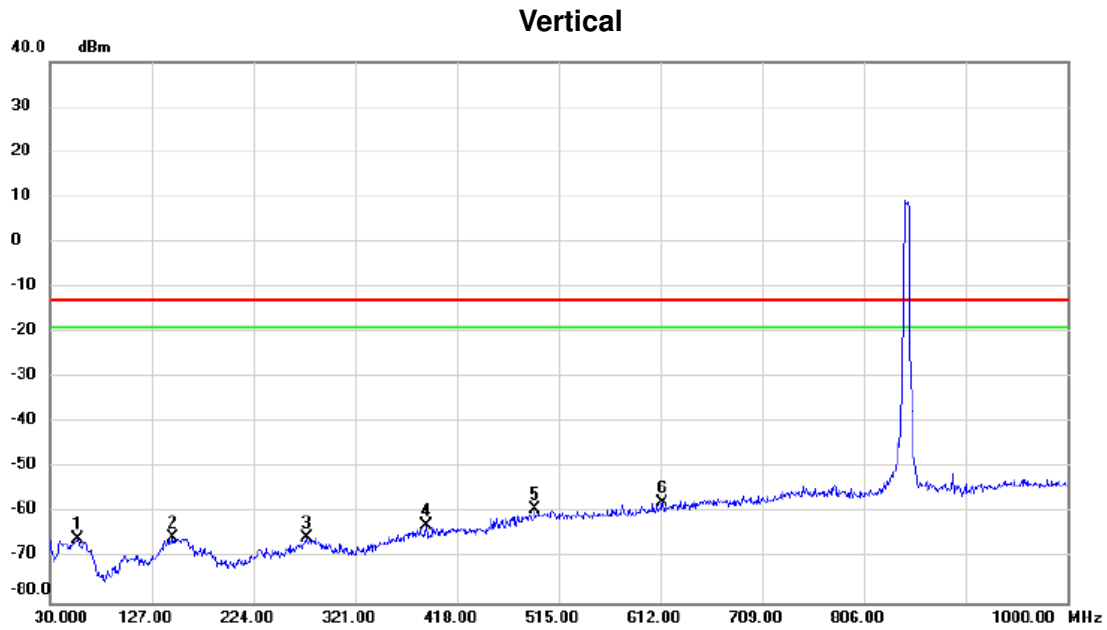

No.	Mk.	Freq. MHz	Reading Level dBm	Correct Factor dB	Measure- ment dBm	Limit dBm	Margin dB	Detector	Comment
1		56.190	-77.93	12.18	-65.75	-13.00	-52.75	peak	
2		147.370	-78.29	12.89	-65.40	-13.00	-52.40	peak	
3		275.410	-77.97	12.44	-65.53	-13.00	-52.53	peak	
4		388.900	-76.75	13.95	-62.80	-13.00	-49.80	peak	
5		492.690	-76.13	17.12	-59.01	-13.00	-46.01	peak	
6	*	613.940	-76.61	19.10	-57.51	-13.00	-44.51	peak	

Test Mode: WCDMA Band V_TX CH4182

Horizontal

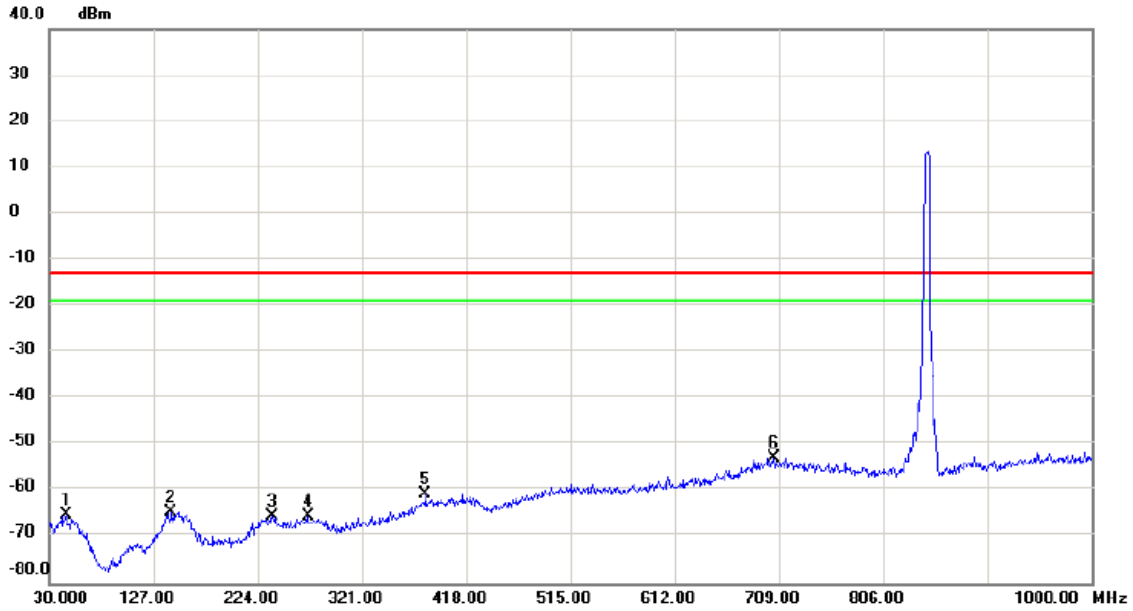

No.	Mk.	Freq. MHz	Reading Level dBm	Correct Factor dB	Measure- ment dBm	Limit dBm	Margin dB	Detector	Comment
1		45.520	-78.11	12.87	-65.24	-13.00	-52.24	peak	
2		143.490	-78.13	13.52	-64.61	-13.00	-51.61	peak	
3		237.580	-78.13	12.61	-65.52	-13.00	-52.52	peak	
4		270.560	-78.45	12.99	-65.46	-13.00	-52.46	peak	
5		380.170	-76.72	16.10	-60.62	-13.00	-47.62	peak	
6 *		704.150	-76.75	23.88	-52.87	-13.00	-39.87	peak	

Test Mode: WCDMA Band V_TX CH4182

Vertical

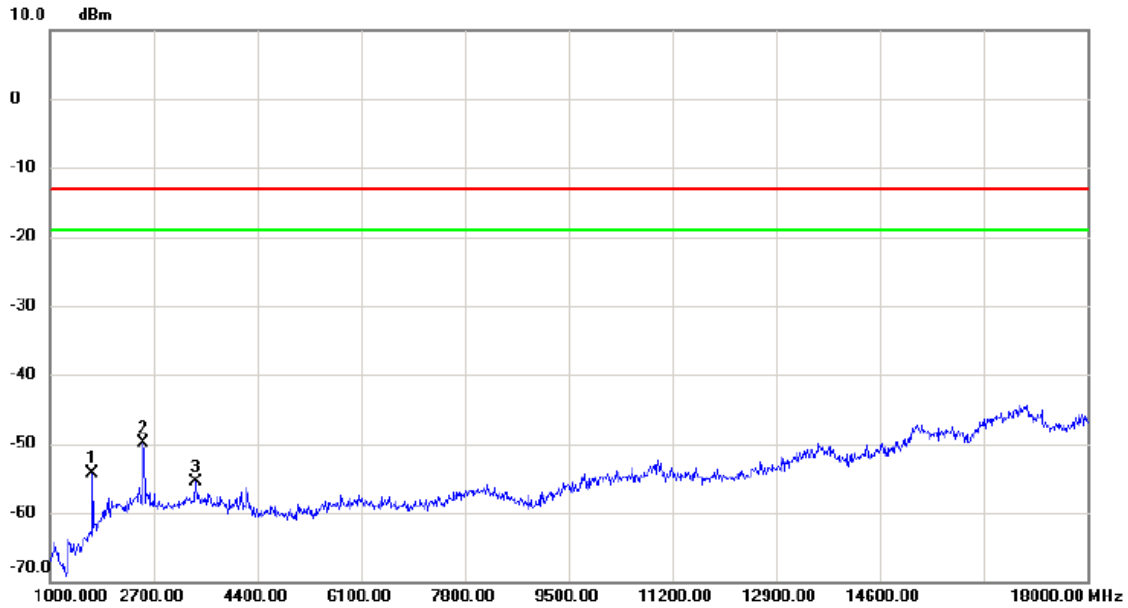

No.	Mk.	Freq. MHz	Reading Level dBm	Correct Factor dB	Measure- ment dBm	Limit dBm	Margin dB	Detector	Comment
1		1697.000	-61.20	6.82	-54.38	-13.00	-41.38	peak	
2	*	2530.000	-62.05	12.21	-49.84	-13.00	-36.84	peak	
3		3380.000	-69.40	13.83	-55.57	-13.00	-42.57	peak	

Test Mode: WCDMA Band V_TX CH4182

Horizontal

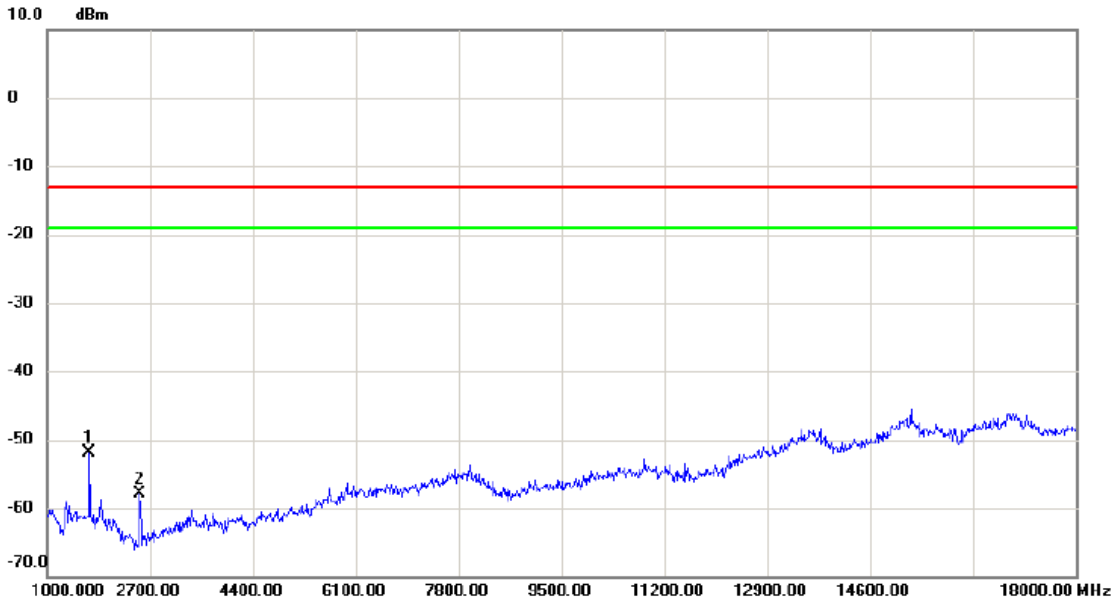

No.	Mk.	Freq. MHz	Reading Level dBm	Correct Factor dB	Measure- ment dBm	Limit dBm	Margin dB	Detector	Comment
1	*	1697.000	-60.07	8.17	-51.90	-13.00	-38.90	peak	
2		2530.000	-63.30	5.42	-57.88	-13.00	-44.88	peak	

Test Mode: WCDMA Band V_TX CH4182_HSDPA

Vertical

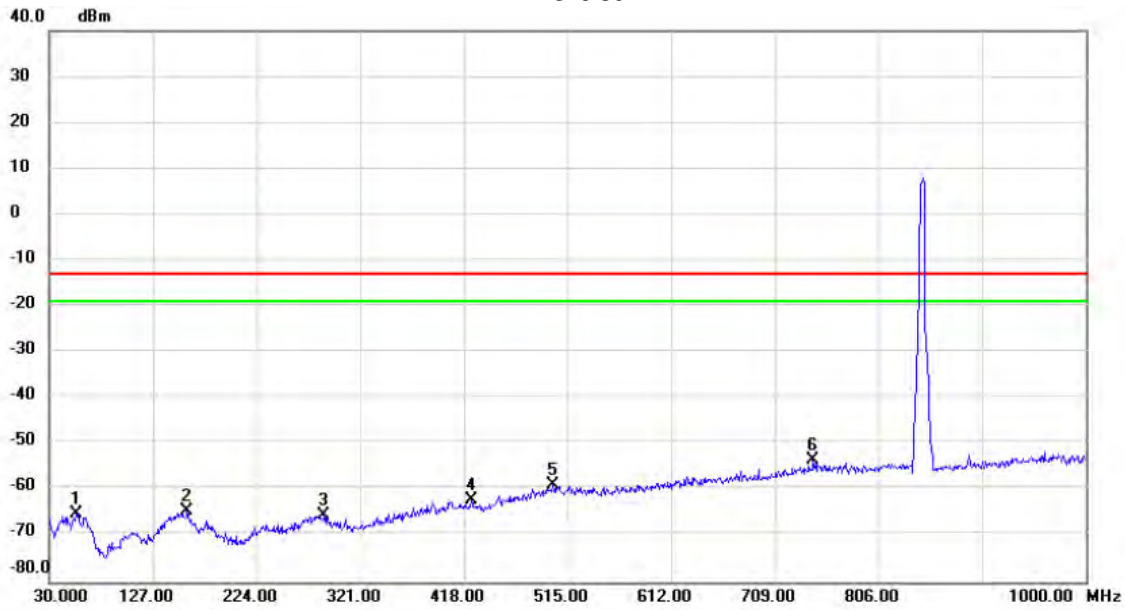

No.	Mk.	Freq. MHz	Reading Level dBm	Correct Factor dB	Measure- ment dBm	Limit dBm	Margin dB	Detector	Comment
1		55.220	-77.65	12.61	-65.04	-13.00	-52.04	peak	
2		159.010	-77.64	13.18	-64.46	-13.00	-51.46	peak	
3		287.050	-77.80	12.35	-65.45	-13.00	-52.45	peak	
4		424.790	-76.64	14.58	-62.06	-13.00	-49.06	peak	
5		501.420	-76.49	17.55	-58.94	-13.00	-45.94	peak	
6	*	744.890	-75.87	22.28	-53.59	-13.00	-40.59	peak	

Test Mode: WCDMA Band V_TX CH4182_HSDPA

Horizontal



No.	Mk.	Freq. MHz	Reading Level dBm	Correct Factor dB	Measure- ment dBm	Limit dBm	Margin dB	Detector	Comment
1		42.610	-77.68	12.59	-65.09	-13.00	-52.09	peak	
2		145.430	-77.73	13.73	-64.00	-13.00	-51.00	peak	
3		234.670	-77.79	12.85	-64.94	-13.00	-51.94	peak	
4		414.120	-77.00	16.59	-60.41	-13.00	-47.41	peak	
5		551.860	-76.28	18.14	-58.14	-13.00	-45.14	peak	
6	*	696.390	-76.55	23.73	-52.82	-13.00	-39.82	peak	

Test Mode: WCDMA Band V_TX CH4182_HSDPA

Vertical



No.	Mk.	Freq. MHz	Reading Level dBm	Correct Factor dB	Measure- ment dBm	Limit dBm	Margin dB	Detector	Comment
1		1697.000	-66.72	6.82	-59.90	-13.00	-46.90	peak	
2	*	2462.000	-67.03	12.11	-54.92	-13.00	-41.92	peak	

Test Mode: WCDMA Band V_TX CH4182_HSDPA

Horizontal

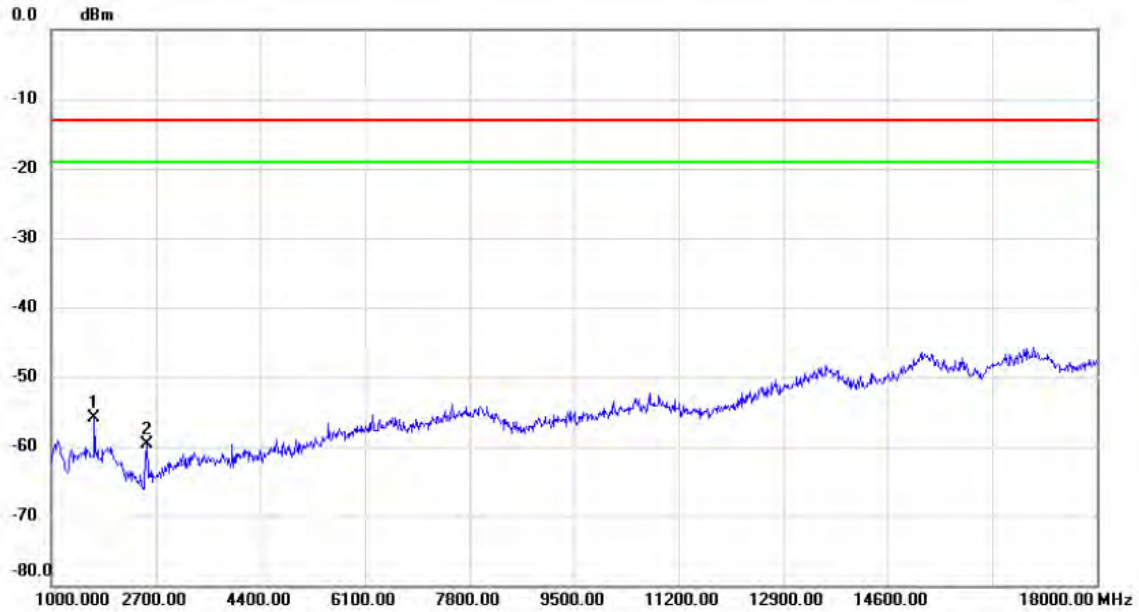

No.	Mk.	Freq. MHz	Reading Level dBm	Correct Factor dB	Measure- ment dBm	Limit dBm	Margin dB	Detector	Comment
1	*	1697.000	-64.08	8.17	-55.91	-13.00	-42.91	peak	
2		2547.000	-65.27	5.54	-59.73	-13.00	-46.73	peak	

Test Mode: WCDMA Band V_TX CH4182_HSUPA

Vertical

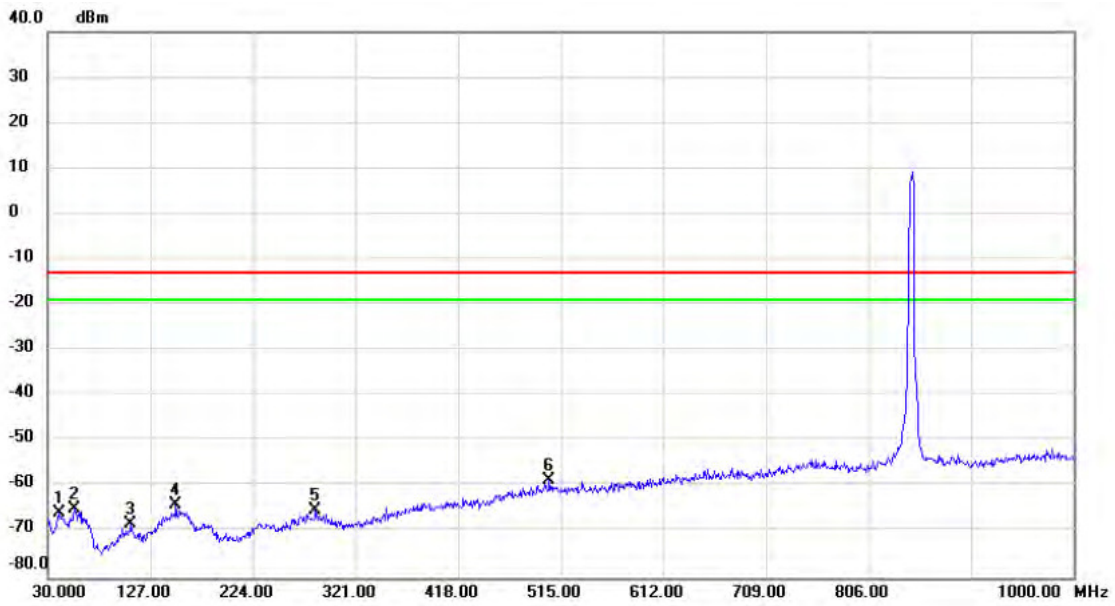

No.	Mk.	Freq. MHz	Reading Level dBm	Correct Factor dB	Measure- ment dBm	Limit dBm	Margin dB	Detector	Comment
1		40.670	-77.74	12.10	-65.64	-13.00	-52.64	peak	
2		55.220	-77.37	12.61	-64.76	-13.00	-51.76	peak	
3		108.570	-77.01	8.95	-68.06	-13.00	-55.06	peak	
4		151.250	-77.05	13.15	-63.90	-13.00	-50.90	peak	
5		283.170	-77.59	12.51	-65.08	-13.00	-52.08	peak	
6	*	504.330	-76.21	17.54	-58.67	-13.00	-45.67	peak	

Test Mode: WCDMA Band V_TX CH4182_HSUPA

Horizontal



No. Mk.	Freq. MHz	Reading Level dBm	Correct Factor dB	Measure- ment dBm	Limit dBm	Margin dB	Detector	Comment
1	41.640	-78.13	12.40	-65.73	-13.00	-52.73	peak	
2	148.340	-77.07	14.06	-63.01	-13.00	-50.01	peak	
3	236.610	-77.75	12.69	-65.06	-13.00	-52.06	peak	
4	387.930	-76.58	16.01	-60.57	-13.00	-47.57	peak	
5	536.340	-76.91	18.09	-58.82	-13.00	-45.82	peak	
6 *	710.940	-76.50	23.72	-52.78	-13.00	-39.78	peak	

Test Mode: WCDMA Band V_TX CH4182_HSUPA

Vertical



No.	Mk.	Freq. MHz	Reading Level dBm	Correct Factor dB	Measure- ment dBm	Limit dBm	Margin dB	Detector	Comment
1		1697.000	-63.96	6.82	-57.14	-13.00	-44.14	peak	
2		2462.000	-67.11	12.11	-55.00	-13.00	-42.00	peak	
3	*	3397.000	-67.43	13.89	-53.54	-13.00	-40.54	peak	

Test Mode: WCDMA Band V_TX CH4182_HSUPA

Horizontal

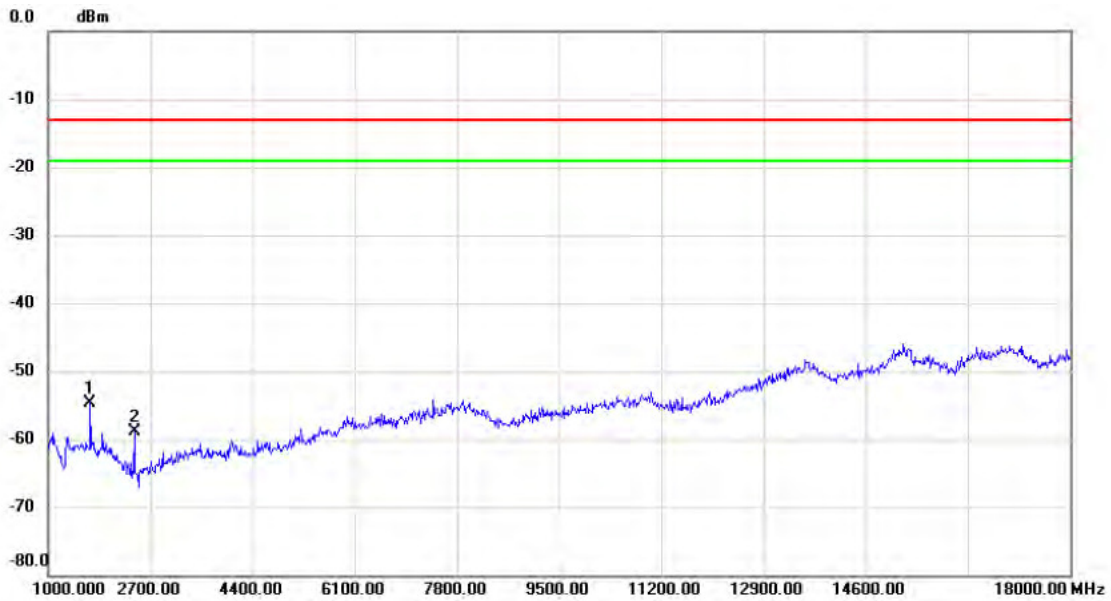

No.	Mk.	Freq. MHz	Reading Level dBm	Correct Factor dB	Measure- ment dBm	Limit dBm	Margin dB	Detector	Comment
1	*	1697.000	-62.97	8.17	-54.80	-13.00	-41.80	peak	
2		2428.000	-64.52	5.66	-58.86	-13.00	-45.86	peak	

Test Mode: LTE Band 5_TX CH20525_1.4M

Vertical

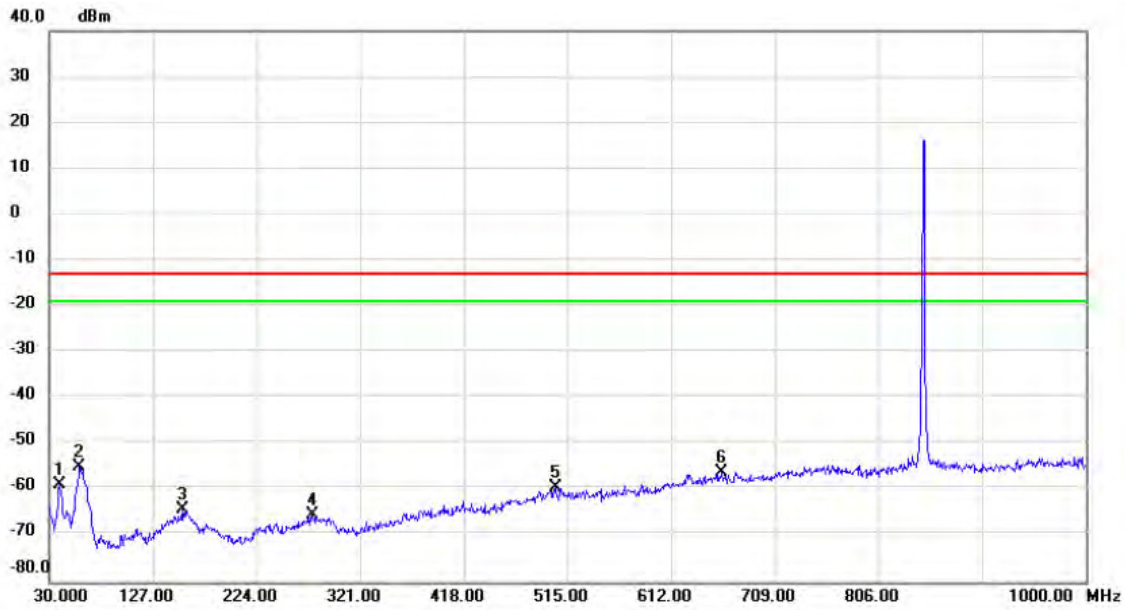

No.	Mk.	Freq. MHz	Reading Level dBm	Correct Factor dB	Measure- ment dBm	Limit dBm	Margin dB	Detector	Comment
1		39.700	-70.69	11.90	-58.79	-13.00	-45.79	peak	
2	*	58.130	-66.33	11.31	-55.02	-13.00	-42.02	peak	
3		154.160	-77.45	13.16	-64.29	-13.00	-51.29	peak	
4		276.380	-77.81	12.48	-65.33	-13.00	-52.33	peak	
5		503.360	-77.06	17.54	-59.52	-13.00	-46.52	peak	
6		659.530	-76.28	20.19	-56.09	-13.00	-43.09	peak	

Test Mode: LTE Band 5_TX CH20525_1.4M

Horizontal

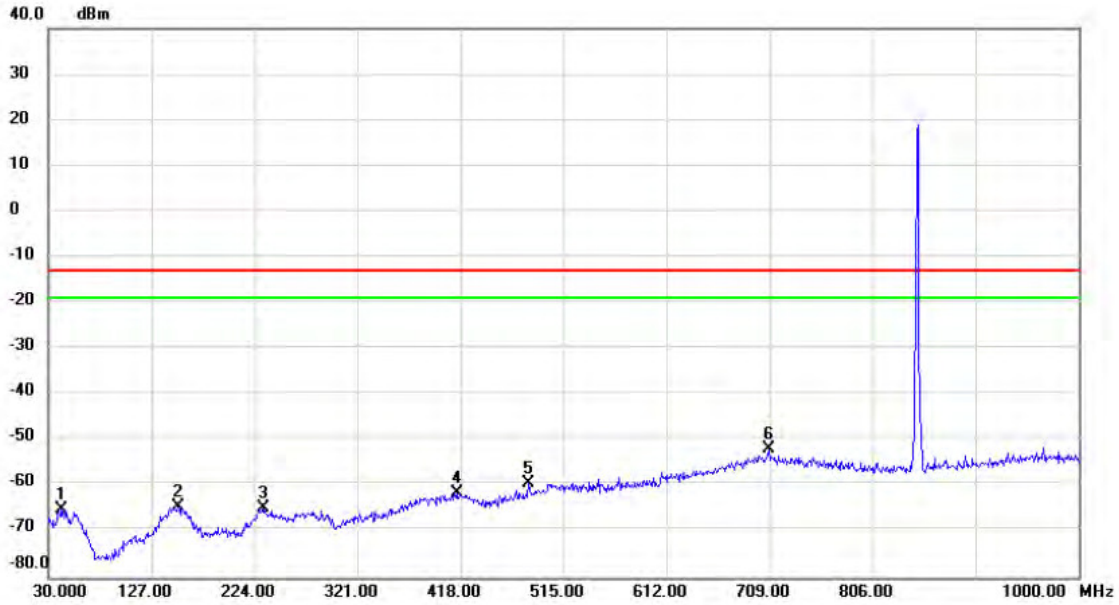

No.	Mk.	Freq. MHz	Reading Level dBm	Correct Factor dB	Measure- ment dBm	Limit dBm	Margin dB	Detector	Comment
1		42.610	-77.66	12.59	-65.07	-13.00	-52.07	peak	
2		152.220	-78.58	13.91	-64.67	-13.00	-51.67	peak	
3		231.760	-78.09	13.10	-64.99	-13.00	-51.99	peak	
4		414.120	-78.20	16.59	-61.61	-13.00	-48.61	peak	
5		482.020	-76.26	16.77	-59.49	-13.00	-46.49	peak	
6	*	708.030	-75.80	23.79	-52.01	-13.00	-39.01	peak	

Test Mode: LTE Band 5_TX CH20525_1.4M

Vertical

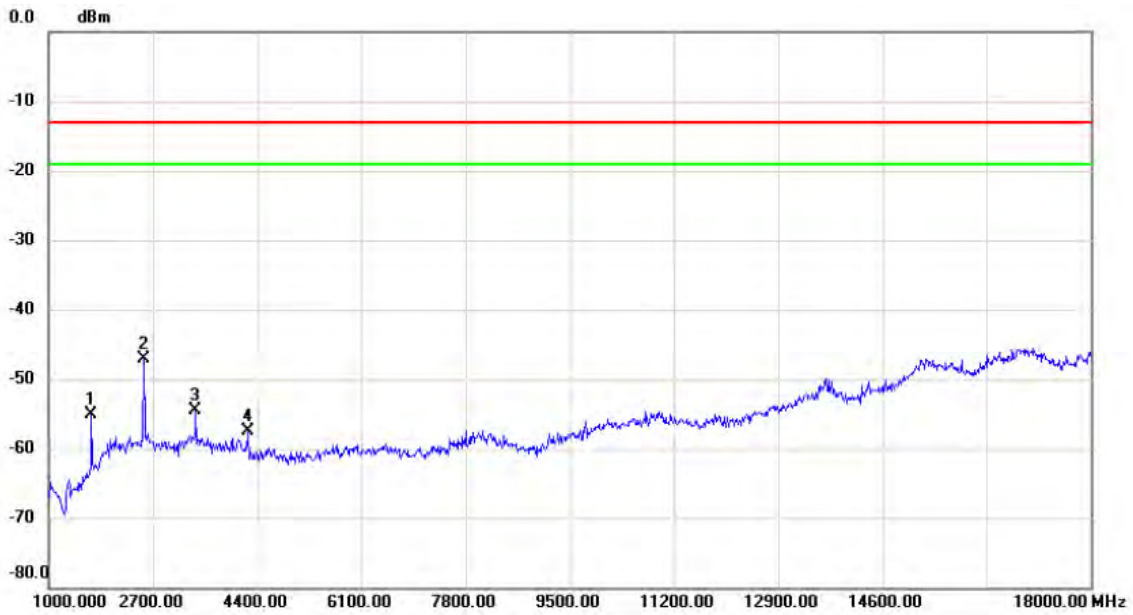

No.	Mk.	Freq. MHz	Reading Level dBm	Correct Factor dB	Measure- ment dBm	Limit dBm	Margin dB	Detector	Comment
1		1697.000	-61.93	6.82	-55.11	-13.00	-42.11	peak	
2	*	2547.000	-59.38	12.22	-47.16	-13.00	-34.16	peak	
3		3397.000	-68.35	13.89	-54.46	-13.00	-41.46	peak	
4		4247.000	-72.16	14.59	-57.57	-13.00	-44.57	peak	

Test Mode: LTE Band 5_TX CH20525_1.4M

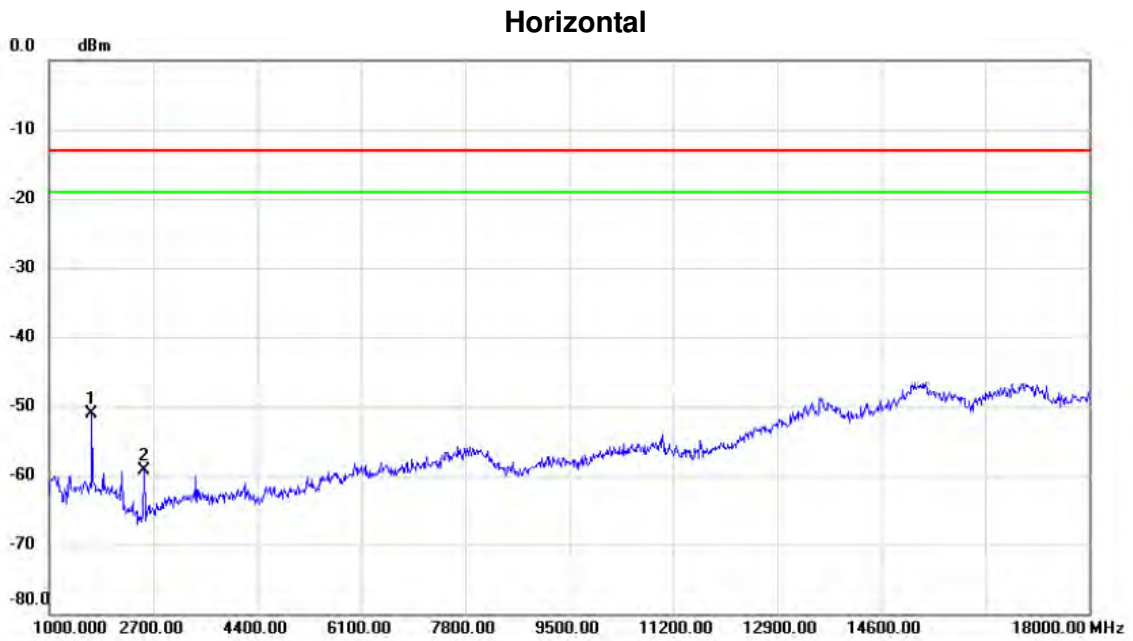

No.	Mk.	Freq. MHz	Reading Level dBm	Correct Factor dB	Measure- ment dBm	Limit dBm	Margin dB	Detector	Comment
1	*	1697.000	-59.35	8.17	-51.18	-13.00	-38.18	peak	
2		2547.000	-64.89	5.54	-59.35	-13.00	-46.35	peak	

Test Mode: LTE Band 5_TX CH20525_10M

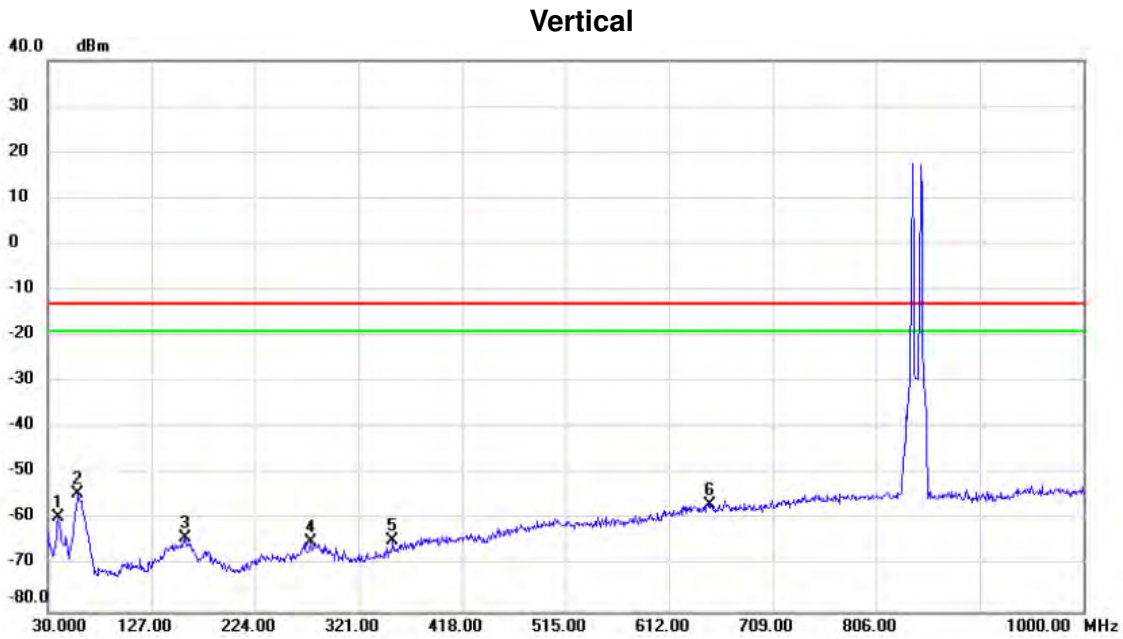

No.	Mk.	Freq. MHz	Reading Level dBm	Correct Factor dB	Measure- ment dBm	Limit dBm	Margin dB	Detector	Comment
1		39.700	-71.32	11.90	-59.42	-13.00	-46.42	peak	
2	*	58.130	-65.79	11.31	-54.48	-13.00	-41.48	peak	
3		158.040	-77.12	13.17	-63.95	-13.00	-50.95	peak	
4		276.380	-77.20	12.48	-64.72	-13.00	-51.72	peak	
5		353.010	-77.06	12.42	-64.64	-13.00	-51.64	peak	
6		650.800	-76.81	20.13	-56.68	-13.00	-43.68	peak	

Test Mode: LTE Band 5_TX CH20525_10M

Horizontal

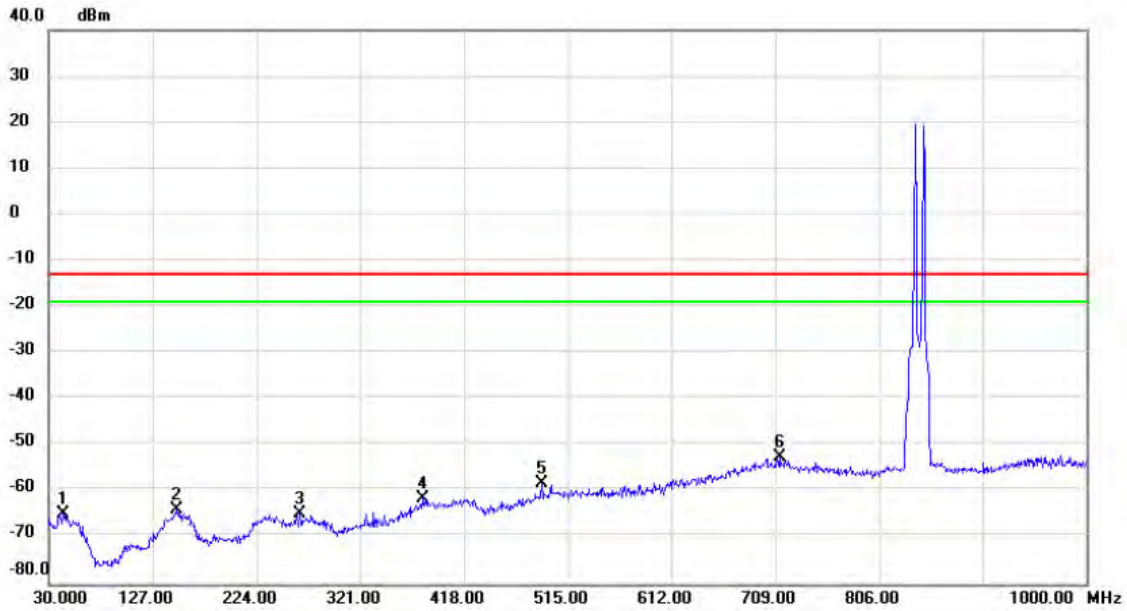

No. Mk.	Freq. MHz	Reading Level dBm	Correct Factor dB	Measurement dBm	Limit dBm	Margin dB	Detector	Comment
1	43.580	-77.73	12.78	-64.95	-13.00	-51.95	peak	
2	149.310	-78.03	14.16	-63.87	-13.00	-50.87	peak	
3	264.740	-77.18	12.45	-64.73	-13.00	-51.73	peak	
4	379.200	-77.48	16.00	-61.48	-13.00	-48.48	peak	
5	490.750	-75.71	17.39	-58.32	-13.00	-45.32	peak	
6 *	712.880	-76.22	23.67	-52.55	-13.00	-39.55	peak	

Test Mode: LTE Band 5_TX CH20525_10M

Vertical



No.	Mk.	Freq. MHz	Reading Level dBm	Correct Factor dB	Measure- ment dBm	Limit dBm	Margin dB	Detector	Comment
1		1680.000	-60.85	6.59	-54.26	-13.00	-41.26	peak	
2	*	2513.000	-61.72	12.21	-49.51	-13.00	-36.51	peak	
3		3363.000	-64.88	13.76	-51.12	-13.00	-38.12	peak	

Test Mode: LTE Band 5_TX CH20525_10M

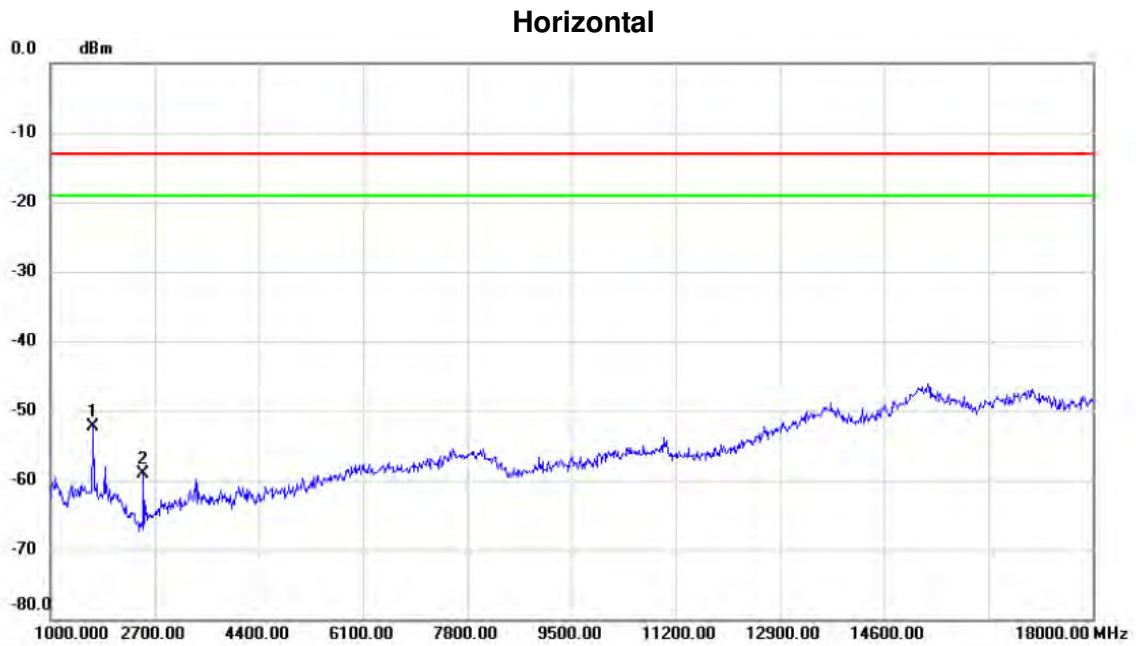

No.	Mk.	Freq. MHz	Reading Level dBm	Correct Factor dB	Measure- ment dBm	Limit dBm	Margin dB	Detector	Comment
1	*	1697.000	-60.38	8.17	-52.21	-13.00	-39.21	peak	
2		2513.000	-64.32	5.30	-59.02	-13.00	-46.02	peak	

ATTACHMENT E - BAND EDGE

GSM850

GSM

Channel

128

Channel

251

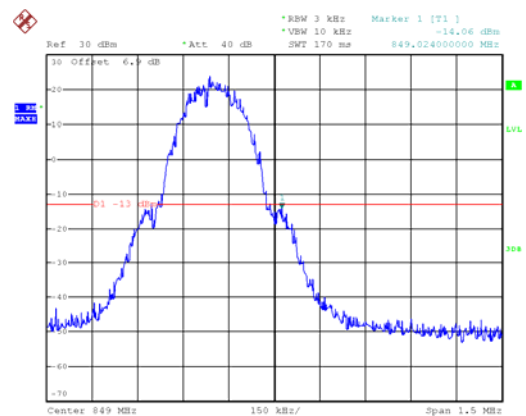
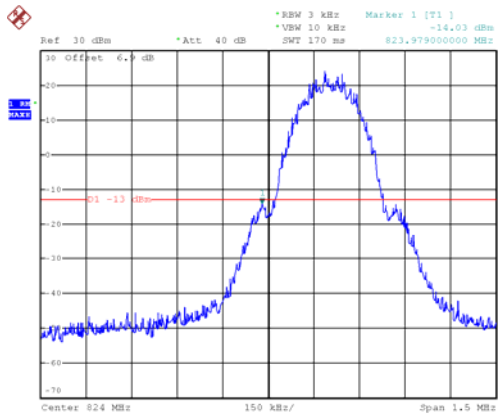

EDGE

Channel

128

Channel

251

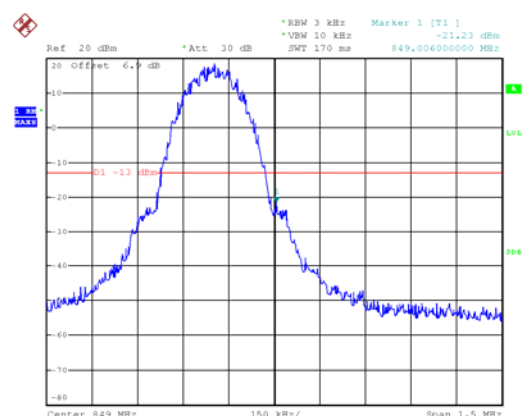
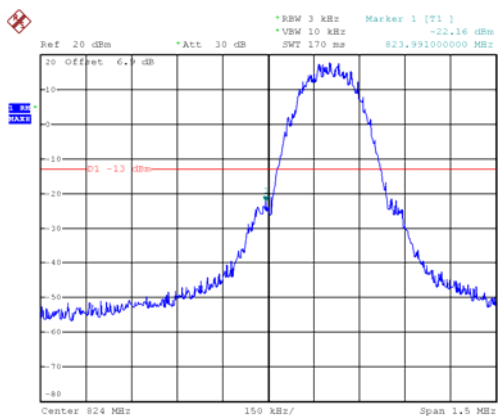

WCDMA Band V

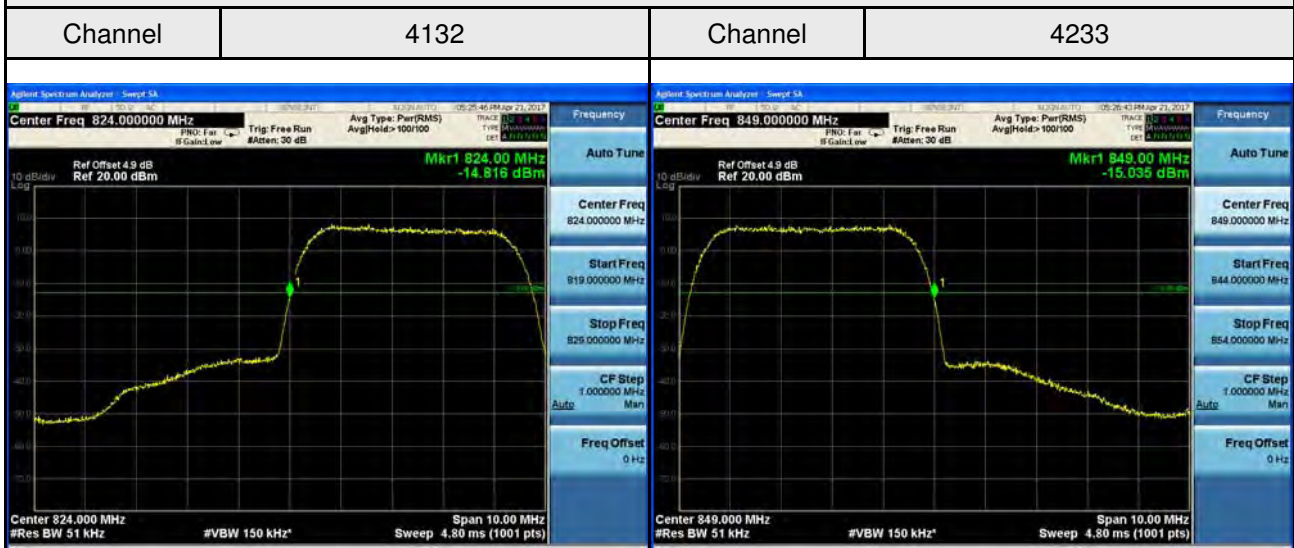

WCDMA_HSDPA Band V

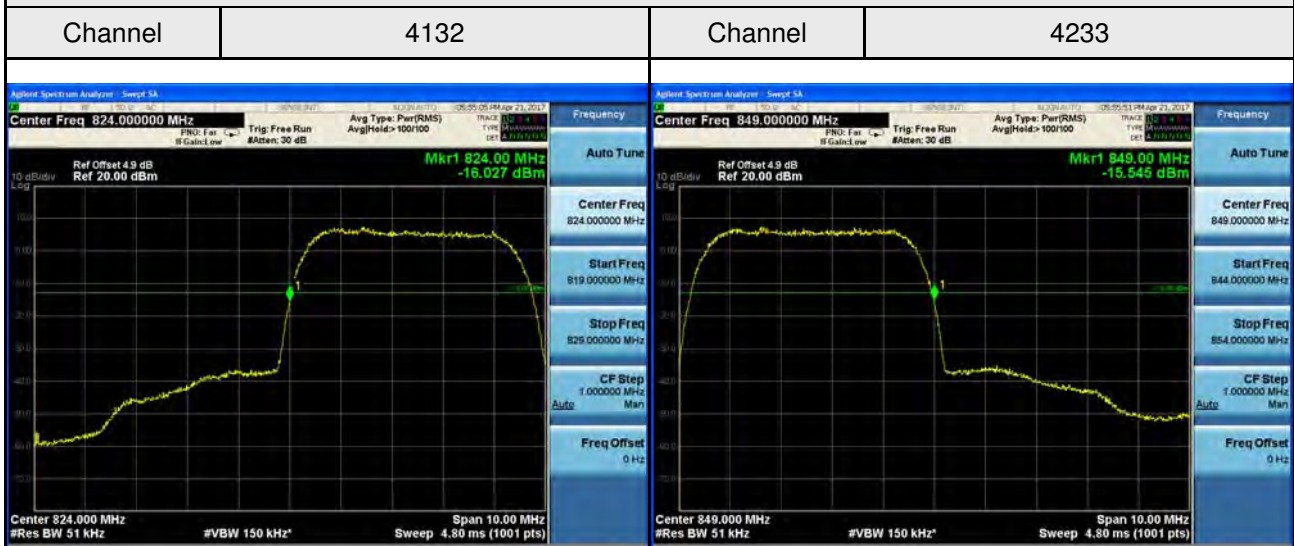

WCDMA_HSUPA Band V

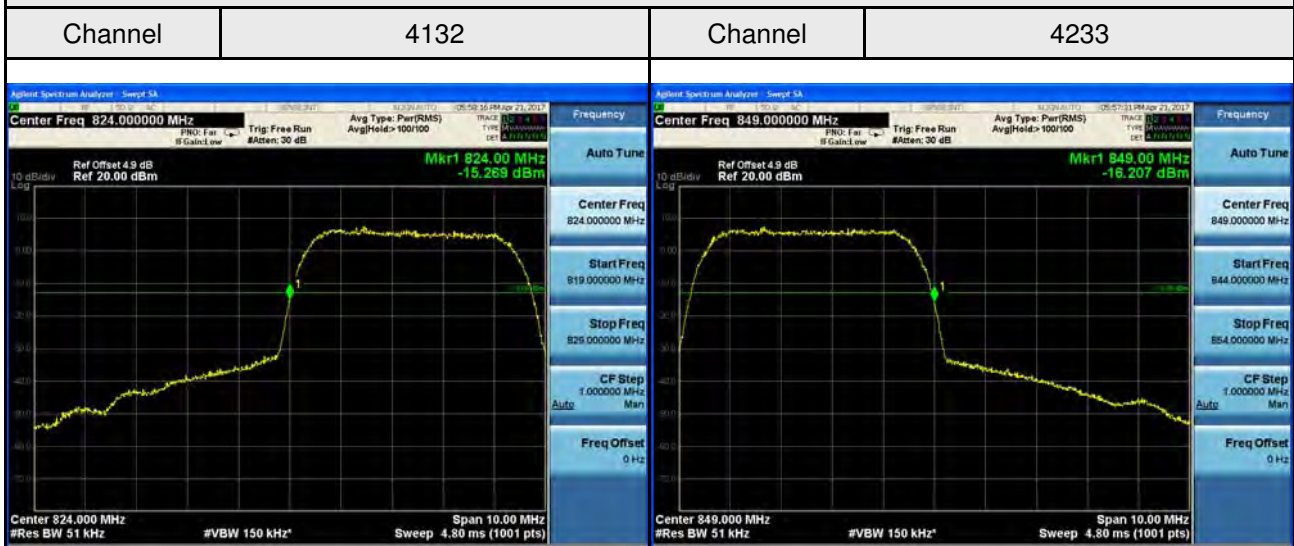

LTE Band 5_1.4M

1RB0

1RB5

Channel

20407

Channel

20643

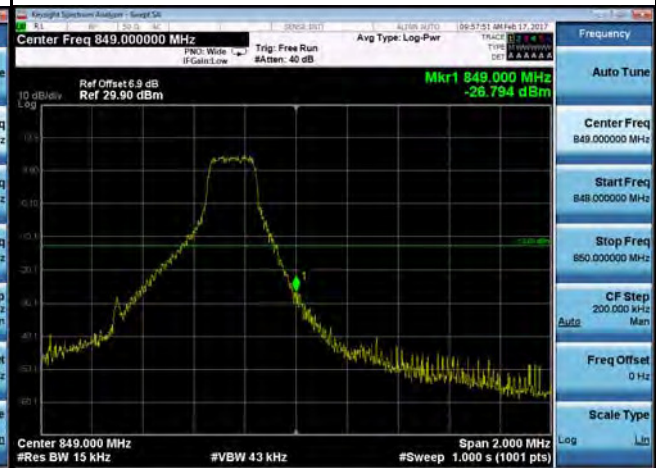
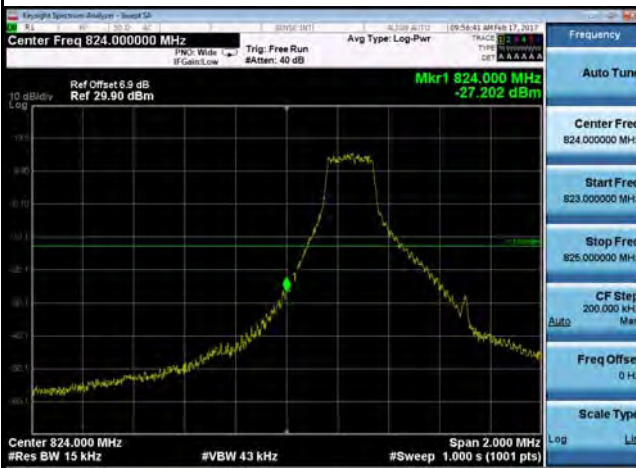

6RB0

Channel

20407

Channel

20643

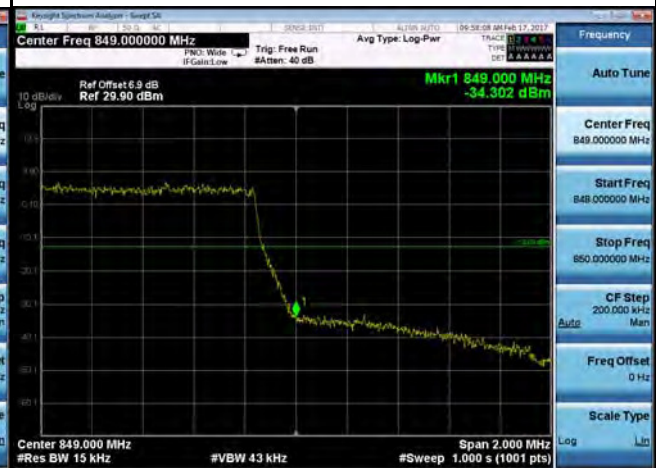
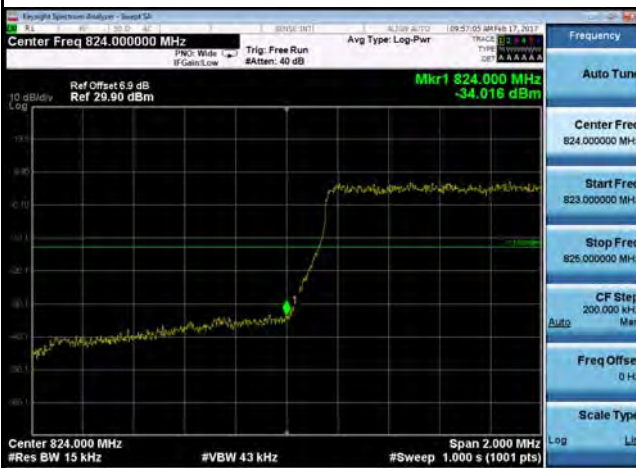

LTE Band 5_3M

1RB0

1RB14

Channel

20415

Channel

20635

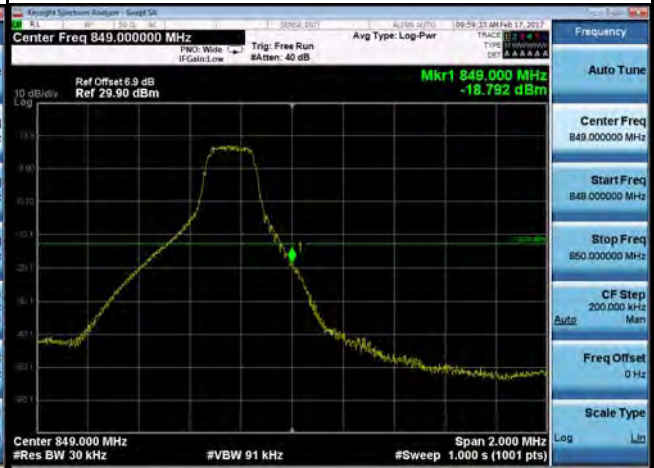
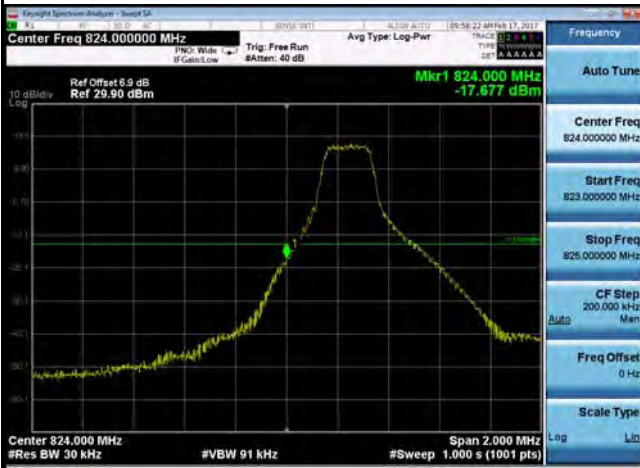

15RB0

Channel

20415

Channel

20635

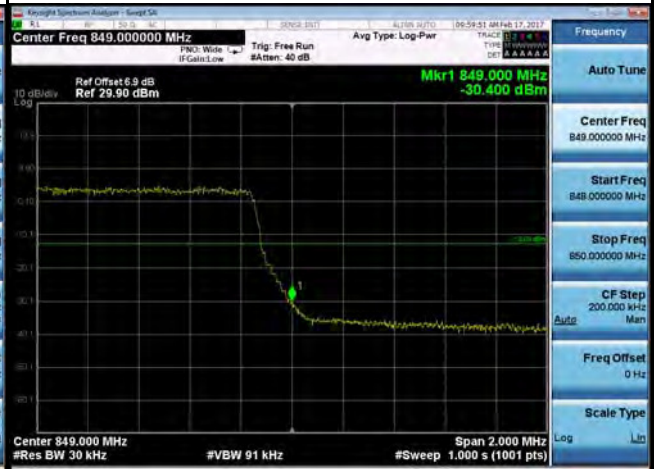
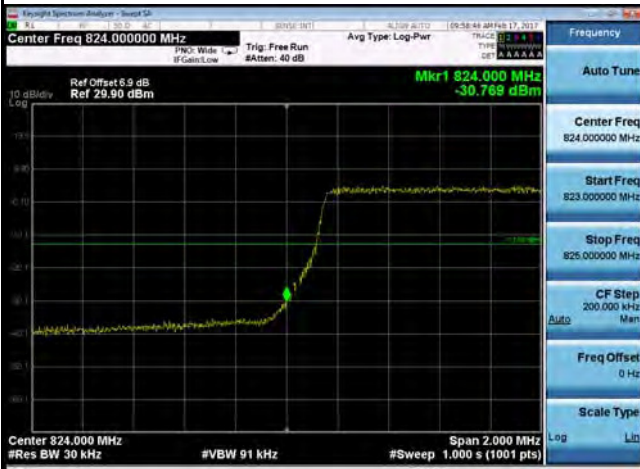

LTE Band 5_5M

1RB0

1RB24

Channel

20425

Channel

20625

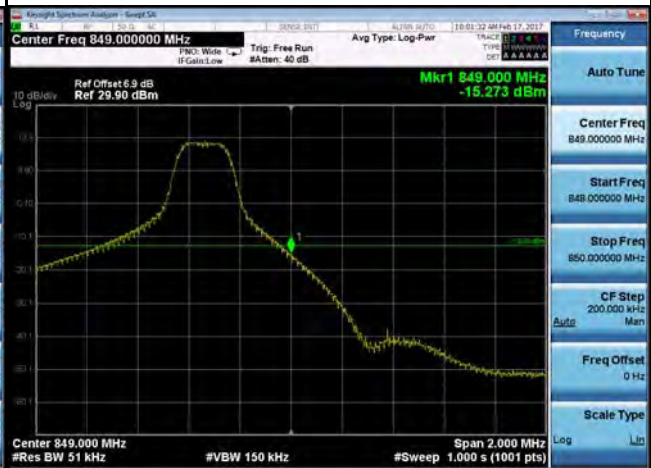

25RB0

Channel

20425

Channel

20625

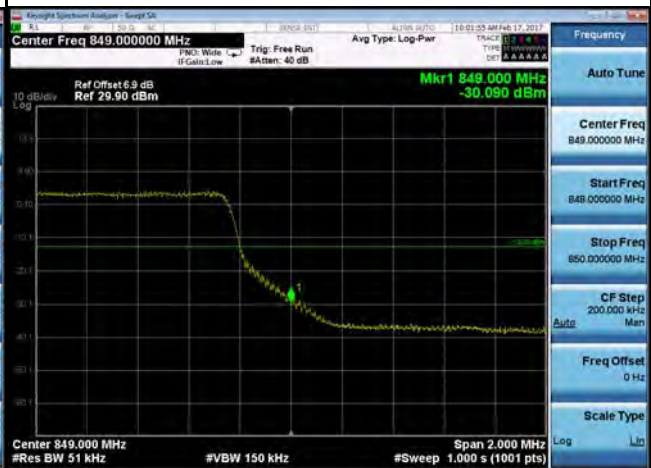

LTE Band 5_10M

1RB0

1RB49

Channel

20450

Channel

20600

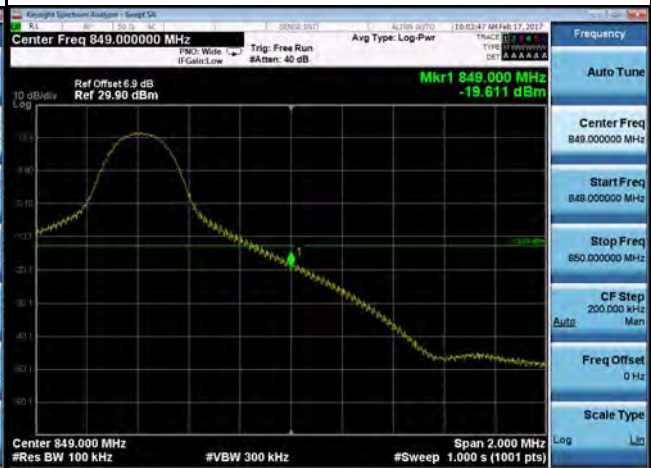
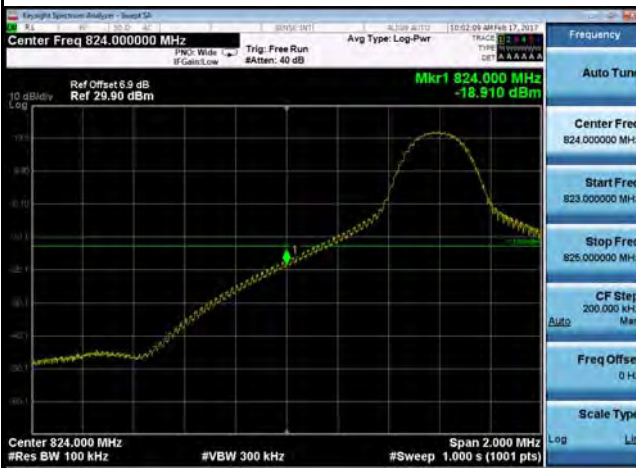

50RB0

Channel

20450

Channel

20600

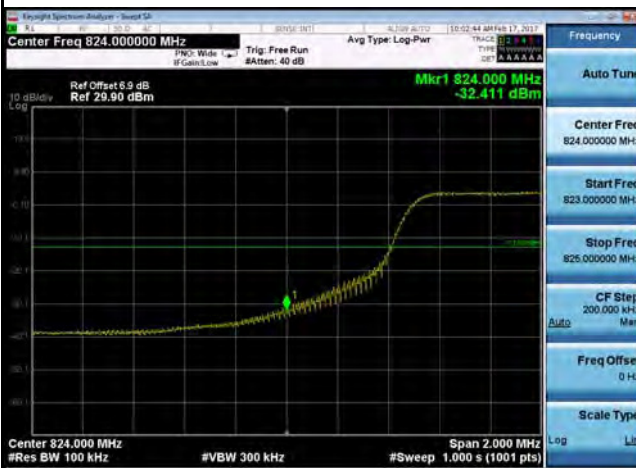

ATTACHMENT F - PEAK TO AVERAGE RATIO

GSM 850 Spectrum Plot



WCDMA Band V Spectrum Plot

4132

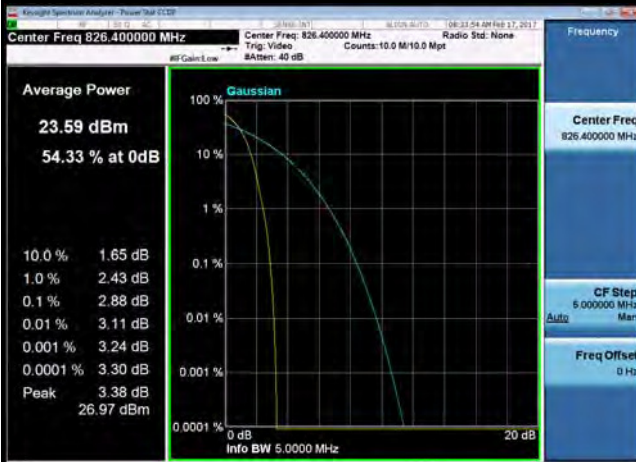

4182

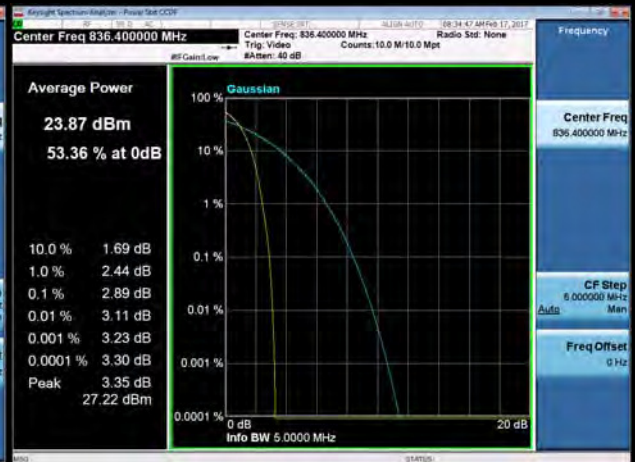

4233



-

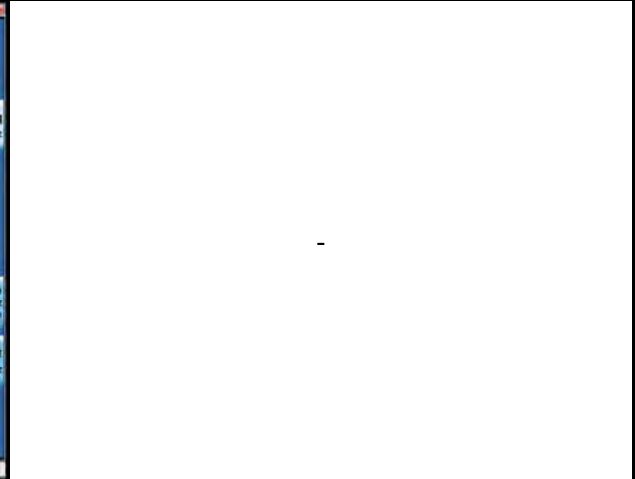

WCDMA_HSDPA Band V Spectrum Plot

4132

4182



4233

-

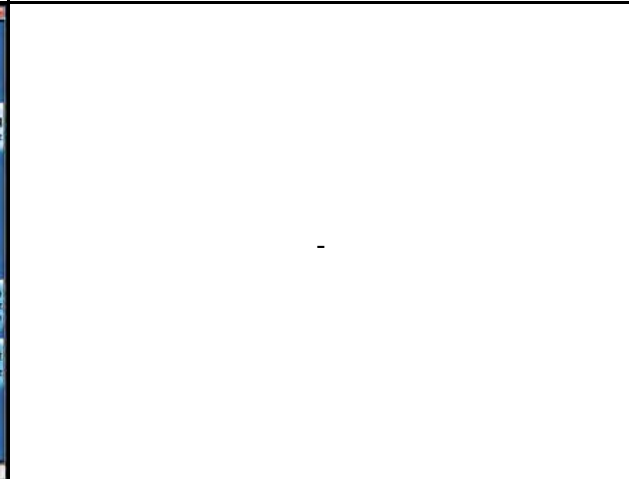

WCDMA_HSUPA Band V Spectrum Plot

4132



4182



4233

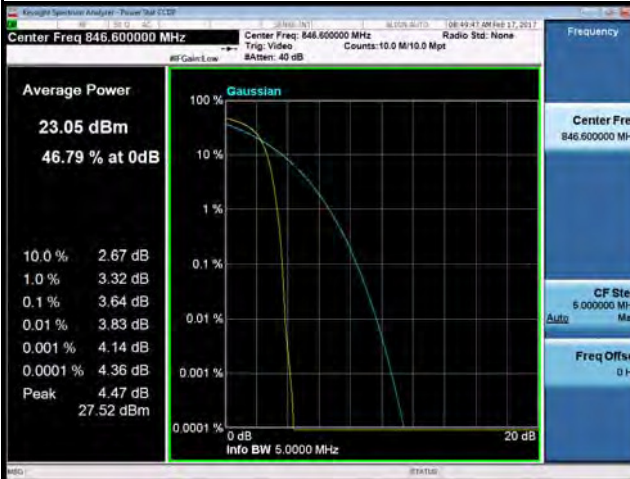

-

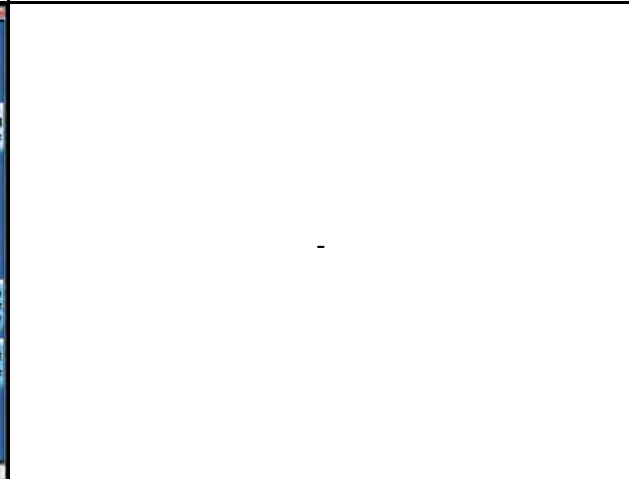

LTE Band 5 Spectrum Plot_1.4M



LTE Band 5 Spectrum Plot_3M

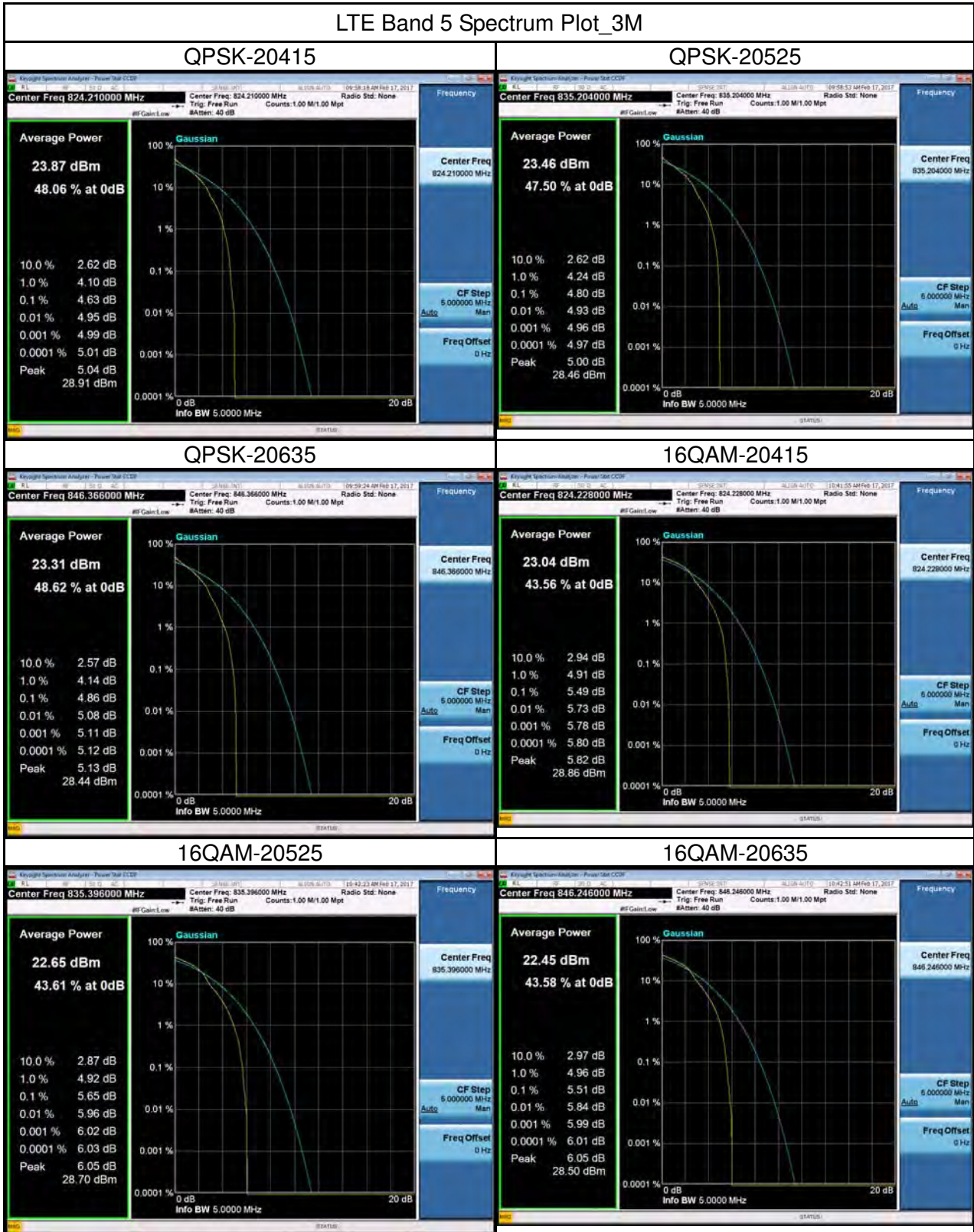

LTE Band 5 Spectrum Plot_5M

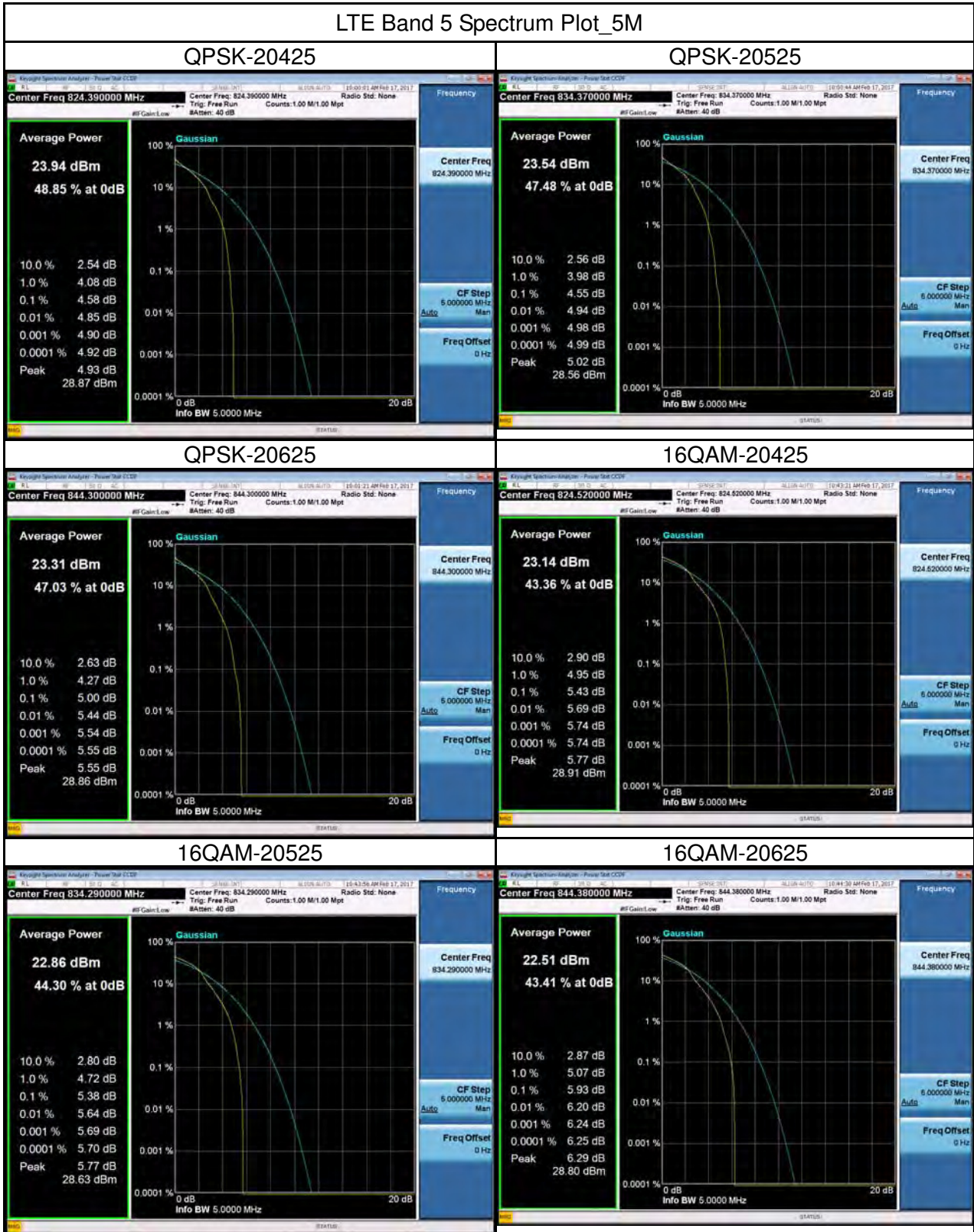

LTE Band 5 Spectrum Plot_10M

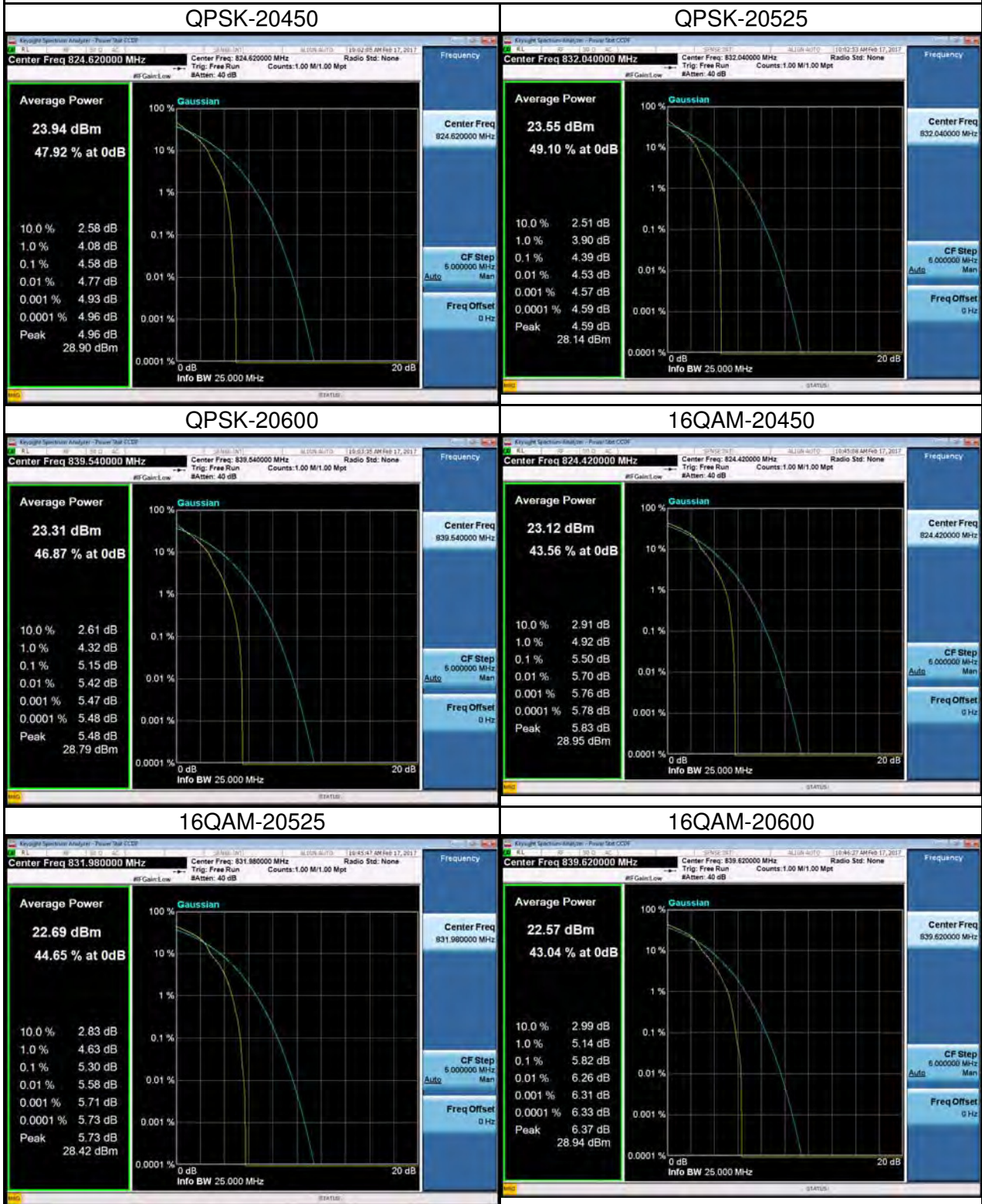

ATTACHMENT G - FREQUENCY STABILITY

Test Mode:	GSM850_CH190
------------	--------------

Temperature vs. Frequency Stability

Temperature(°C)	Frequency Error (Hz)	Frequency Error (ppm)	Limit(ppm)
0	6.84	0.008298957	2.5
5	7.23	0.008772143	2.5
10	5.36	0.006503276	2.5
15	4.66	0.005653967	2.5
20	7.59	0.00920893	2.5
25	4.81	0.005835962	2.5
30	5.29	0.006418345	2.5
35	4.63	0.005617569	2.5
Max. Deviation (ppm)	7.59	0.00920893	2.5

Voltage vs. Frequency Stability

Voltage(Volts)	Frequency Error (Hz)	Frequency Error (ppm)	Limit(ppm)
3.6	4.46	0.005411308	2.5
3.8	5.87	0.007122058	2.5
4.2	7.83	0.009500121	2.5
Max. Deviation (ppm)	7.83	0.009500121	2.5

Test Mode:	WCDMA Band 5_CH4182
------------	---------------------

Temperature vs. Frequency Stability

Temperature(°C)	Frequency Error (Hz)	Frequency Error (ppm)	Limit(ppm)
0	8.27	0.009887614	2.5
5	5.91	0.007065997	2.5
10	6.37	0.007615973	2.5
15	8.24	0.009851746	2.5
20	5.58	0.006671449	2.5
25	6.9	0.008249641	2.5
30	5.48	0.006551889	2.5
35	7.36	0.008799617	2.5
Max. Deviation (ppm)	8.27	0.009887614	2.5

Voltage vs. Frequency Stability

Voltage(Volts)	Frequency Error (Hz)	Frequency Error (ppm)	Limit(ppm)
3.6	8.54	0.010210426	2.5
3.8	7.63	0.009122429	2.5
4.2	6.94	0.008297465	2.5
Max. Deviation (ppm)	8.54	0.010210426	2.5

Test Mode:	LTE Band 5_CH20525_1.4M
------------	-------------------------

Temperature vs. Frequency Stability

Temperature(°C)	Frequency Error (Hz)	Frequency Error (ppm)	Limit(ppm)
0	6.37	0.007615063	2.5
5	2.15	0.002570233	2.5
10	-3.59	0.004291692	2.5
15	-1.52	0.001817095	2.5
20	5.06	0.006049014	2.5
25	3.58	0.004279737	2.5
30	4.36	0.005212194	2.5
35	-1.28	0.001530185	2.5
Max. Deviation (ppm)	6.37	0.007615063	2.5

Voltage vs. Frequency Stability

Voltage(Volts)	Frequency Error (Hz)	Frequency Error (ppm)	Limit(ppm)
3.6	4.21	0.005032875	2.5
3.8	1.88	0.00224746	2.5
4.2	-1.23	0.001470412	2.5
Max. Deviation (ppm)	4.21	0.005032875	2.5

Test Mode:	LTE Band 5_CH20525_3M
------------	-----------------------

Temperature vs. Frequency Stability

Temperature(°C)	Frequency Error (Hz)	Frequency Error (ppm)	Limit(ppm)
0	4.68	0.00559474	2.5
5	-1.35	0.001613867	2.5
10	2.69	0.00321578	2.5
15	-3.58	0.004279737	2.5
20	-4.35	0.005200239	2.5
25	2.38	0.002845188	2.5
30	-2.58	0.00308428	2.5
35	3.69	0.004411237	2.5
Max. Deviation (ppm)	4.68	0.00559474	2.5

Voltage vs. Frequency Stability

Voltage(Volts)	Frequency Error (Hz)	Frequency Error (ppm)	Limit(ppm)
3.6	3.21	0.003837418	2.5
3.8	4.27	0.005104603	2.5
4.2	-6.37	0.007615063	2.5
Max. Deviation (ppm)	6.37	0.007615063	2.5

Test Mode:	LTE Band 5_CH20525_5M
------------	-----------------------

Temperature vs. Frequency Stability

Temperature(°C)	Frequency Error (Hz)	Frequency Error (ppm)	Limit(ppm)
0	2.68	0.003203825	2.5
5	-5.25	0.006276151	2.5
10	-1.28	0.001530185	2.5
15	3.68	0.004399283	2.5
20	4.58	0.005475194	2.5
25	1.96	0.002343096	2.5
30	-4.25	0.005080693	2.5
35	1.58	0.001888822	2.5
Max. Deviation (ppm)	5.25	0.006276151	2.5

Voltage vs. Frequency Stability

Voltage(Volts)	Frequency Error (Hz)	Frequency Error (ppm)	Limit(ppm)
3.6	2.69	0.00321578	2.5
3.8	3.04	0.00363419	2.5
4.2	5.26	0.006288105	2.5
Max. Deviation (ppm)	5.26	0.006288105	2.5

Test Mode:	LTE Band 5_CH20525_10M
------------	------------------------

Temperature vs. Frequency Stability

Temperature(°C)	Frequency Error (Hz)	Frequency Error (ppm)	Limit(ppm)
0	6.28	0.007507472	2.5
5	-2.35	0.002809325	2.5
10	1.28	0.001530185	2.5
15	-5.09	0.006084877	2.5
20	3.22	0.003849372	2.5
25	5.69	0.006802152	2.5
30	4.24	0.005068739	2.5
35	-3.51	0.004196055	2.5
Max. Deviation (ppm)	6.28	0.007507472	2.5

Voltage vs. Frequency Stability

Voltage(Volts)	Frequency Error (Hz)	Frequency Error (ppm)	Limit(ppm)
3.6	-1.58	0.001888822	2.5
3.8	-4.16	0.004973102	2.5
4.2	3.13	0.003741781	2.5
Max. Deviation (ppm)	4.16	0.004973102	2.5