

# FCC Radio Test Report

## FCC ID: QISCRO-LX2

This report concerns (check one): Original Grant Class II Change

**Project No.** : 1701C155B  
**Equipment** : Smart Phone  
**Model Name** : CRO-L22, CRO-L02  
**Applicant** : Huawei Technologies Co., Ltd.  
**Address** : Administration Building, Headquarters of Huawei Technologies Co., Ltd., Bantian, Longgang District, Shenzhen, 518129, P.R.C

**Date of Receipt** : Jan. 18, 2017(CRO-L03)  
Mar. 28, 2017(CRO-L22, CRO-L02)  
**Date of Test** : Jan. 18, 2017 ~ Feb. 27, 2017(CRO-L03)  
Mar. 28, 2017 ~ Apr. 05, 2017(CRO-L22, CRO-L02)  
**Issued Date** : Apr. 13, 2017  
**Tested by** : BTL Inc.

**Technical Engineer** :

Shawn Xiao  
(Shawn Xiao)

**Authorized Signatory** :

Steven Lu  
(Steven Lu)

# **B T L I N C .**

No.3,Jinshagang 1st Road, Shixia,Dalang Town, Dongguan,  
Guangdong, China.

TEL: +86-769-8318-3000 FAX: +86-769-8319-6000

### **Declaration**

**BTL** represents to the client that testing is done in accordance with standard procedures as applicable and that test instruments used has been calibrated with standards traceable to international standard(s) and/or national standard(s).

**BTL's** reports apply only to the specific samples tested under conditions. It is manufacture's responsibility to ensure that additional production units of this model are manufactured with the identical electrical and mechanical components. **BTL** shall have no liability for any declarations, inferences or generalizations drawn by the client or others from **BTL** issued reports.

**BTL's** report must not be used by the client to claim product certification, approval, or endorsement by NVLAP, NIST, or any agency of the Federal Government.

This report is the confidential property of the client. As a mutual protection to the clients, the public and **BTL-self**, extracts from the test report shall not be reproduced except in full with **BTL's** authorized written approval.

**BTL's** laboratory quality assurance procedures are in compliance with the **ISO Guide17025** requirements, and accredited by the conformity assessment authorities listed in this test report.

### **Limitation**

For the use of the authority's logo is limited unless the Test Standard(s)/Scope(s)/Item(s) mentioned in this test report is (are) included in the conformity assessment authorities acceptance respective.

<b>Table of Contents</b>	<b>Page</b>
<b>REPORT ISSUED HISTORY</b>	<b>5</b>
<b>1 . CERTIFICATION</b>	<b>6</b>
<b>2 . SUMMARY OF TEST RESULTS</b>	<b>7</b>
2.1 TEST FACILITY	8
2.2 MEASUREMENT UNCERTAINTY	8
<b>3 . GENERAL INFORMATION</b>	<b>9</b>
3.1 GENERAL DESCRIPTION OF EUT	9
3.2 DESCRIPTION OF TEST MODES AND TEST CONDITION	10
3.3 BLOCKDIGRAMSHOWINGTHECONFIGURATIONOFSYSTEMTESTED FOR RADIATED	11
3.4 DESCRIPTION OF SUPPORT UNITS	11
<b>4 . TEST RESULT</b>	<b>12</b>
4.1 OUTPUT POWER MEASUREMENT	12
4.1.1 LIMIT	12
4.1.2 TEST PROCEDURE	12
4.1.3 TESTSETUP LAYOUT	12
4.1.4 TEST DEVIATION	12
4.1.5 TEST RESULTS	12
4.2 OCCUPIED BANDWIDTH MEASUREMENT	13
4.2.1 TEST PROCEDURE	13
4.2.2 TEST SETUP LAYOUT	13
4.2.3 TEST DEVIATION	13
4.2.4 TEST RESULTS	13
4.3 CONDUCTED EMISSIONS MEASUREMENT	14
4.3.1 LIMIT	14
4.3.2 TEST PROCEDURES	14
4.3.3 TESTSETUP LAYOUT	14
4.3.4 TESTDEVIATION	14
4.3.5 TEST RESULTS	14
4.4 RADIATED EMISSIONS MEASUREMENT	15
4.4.1 LIMIT	15
4.4.2 TEST PROCEDURES	15
4.4.3 TESTSETUP LAYOUT	15
4.4.4 TESTDEVIATION	15
4.4.5 TEST RESULTS	15
4.5 BAND EDGE MEASUREMENT	16
4.5.1 LIMIT	16

<b>Table of Contents</b>	<b>Page</b>
<b>4.5.2 TEST PROCEDURES</b>	<b>16</b>
<b>4.5.3 TESTSETUP LAYOUT</b>	<b>16</b>
<b>4.5.4 TESTDEVIATION</b>	<b>16</b>
<b>4.5.5 TEST RESULTS</b>	<b>16</b>
<b>4.6 PEAK TO AVERAGE RATIO MEASUREMENT</b>	<b>17</b>
<b>4.6.1 LIMIT</b>	<b>17</b>
<b>4.6.2 TEST PROCEDURES</b>	<b>17</b>
<b>4.6.3 TESTSETUP LAYOUT</b>	<b>17</b>
<b>4.6.4 TESTDEVIATION</b>	<b>17</b>
<b>4.6.5 TEST RESULTS</b>	<b>17</b>
<b>4.7 FREQUENCY STABILITY MEASUREMENT</b>	<b>18</b>
<b>4.7.1 LIMIT</b>	<b>18</b>
<b>4.7.2 TEST PROCEDURES</b>	<b>18</b>
<b>4.7.3 TESTSETUP LAYOUT</b>	<b>18</b>
<b>4.7.4 TESTDEVIATION</b>	<b>18</b>
<b>4.7.5 TEST RESULTS</b>	<b>18</b>
<b>5. LIST OF MEASUREMENT EQUIPMENTS</b>	<b>19</b>
<b>ATTACHMENT A - OUTPUT POWER</b>	<b>21</b>
<b>ATTACHMENT B - OCCUPIED BANDWIDTH</b>	<b>26</b>
<b>ATTACHMENT C - CONDUCTED EMISSIONS</b>	<b>35</b>
<b>ATTACHMENT D - RADIATED EMISSION</b>	<b>40</b>
<b>ATTACHMENT E - BAND EDGE</b>	<b>68</b>
<b>ATTACHMENT F - PEAK TO AVERAGE RATIO</b>	<b>73</b>
<b>ATTACHMENT G - FREQUENCY STABILITY</b>	<b>78</b>

### REPORT ISSUED HISTORY

Issued No.	Description	Issued Date
BTL-FCCP-6-1701C155	Original Result.	Feb. 28, 2017
BTL-FCCP-6-1701C155B	Compared with the original report (BTL-FCCP-6-1701C155), the differences please see the below table. According to the differences description below table, CRO-L22 and CRO-L02 shares the same test data of CRO-L03 of the same bands. Only the Radiated Spurious Emissions in LTE band of SIM 2 add evaluated and recorded in the test report, the rest are the same.	Apr. 13, 2017

Project ID	1701C155	1701C155B	
Model	CRO-L03	CRO-L22	CRO-L02
Brand	HUAWEI	HUAWEI	HUAWEI
2G Frequency	850/1900	850/1900	850/1900
3G Frequency	B2/B5	B2/B5	B2/B5
4G Frequency	B2/B4/B5/B7	B5/B7	B5/B7
Hardware version	The same	The same	The same
Software version	The difference	The difference	The difference
SIM Card	Single	Dual	Single
Dimensions	The same	The same	The same
Appearance	The same	The same	The same
main antenna	The same	The same	The same
BT/Wi-Fi antenna	The same	The same	The same
GPS antenna	The same	The same	The same
PA(GSM)	The same	The same	The same
PA(WCDMA/FDD)	The same	The same	The same

## 1. CERTIFICATION

Equipment : Smart Phone  
Brand Name : HUAWEI  
Model Name : CRO-L22, CRO-L02  
Applicant : Huawei Technologies Co., Ltd.  
Manufacturer: Huawei Technologies Co., Ltd  
Address : Administration Building, Headquarters of Huawei Technologies Co., Ltd.,  
Bantian, Longgang District Shenzhen China  
Factory : Huawei Technologies Co., Ltd  
Address : Administration Building, Headquarters of Huawei Technologies Co., Ltd.,  
Bantian, Longgang District Shenzhen China  
Date of Test : Jan. 18, 2017 ~ Feb. 27, 2017(CRO-L03)  
Mar. 28, 2017 ~ Apr. 12, 2017(CRO-L22, CRO-L02)  
Test Sample : Engineering Sample  
Standard(s) : 47 CFR FCC Part 27  
47 CFR FCC Part 2 & ANSI/TIA-603-D-2010

The above equipment has been tested and found compliance with the requirement of the relative standards by BTL Inc.

The test data, data evaluation, and equipment configuration contained in our test report (Ref No. BTL-FCCP-6-1701C155B) were obtained utilizing the test procedures, test instruments, test sites that has been accredited by the Authority of TAF according to the ISO-17025 quality assessment standard and technical standard(s).

**Test results included in this report is only for the LTE Band 7 part.**

## 2. SUMMARY OF TEST RESULTS

Test procedures according to the technical standard(s):

FCC Part 27 & Part 2			
Standard(s) Section	Test Item	Judgment	Tested By
2.1046 27.50(d)(4)	Radiated power	PASS	Paul Li
2.1046 27.50(d)(4)	Conducted Output Power	PASS	Paul Li
2.1049 27.53(h)	Occupied Bandwidth	PASS	Paul Li
2.1051 27.53(h)	Conducted Spurious Emissions	PASS	Paul Li
2.1053 27.53(h)	Radiated Spurious Emissions	PASS	Biao Chen
27.53(h)	Band Edge Measurements	PASS	Paul Li
27.50	Peak To Average Ratio	PASS	Paul Li
2.1055 27.54	Frequency Stability	PASS	Paul Li

**NOTE:**

(1) "N/A" denotes test is not applicable to this device.

## 2.1 TEST FACILITY

The test facilities used to collect the test data in this report is at the location of No.3,Jinshagang 1st Road, Shixia, Dalang Town, Dongguan, Guangdong, China.

BTL's test firm number for FCC: 319330

## 2.2 MEASUREMENT UNCERTAINTY

Where relevant, the following measurement uncertainty levels have been estimated for tests performed on the EUT as specified in CISPR 16-4-2. The BTL measurement uncertainty is less than the CISPR 16-4-2  $U_{CISPR}$  requirement.

The reported uncertainty of measurement  $y \pm U$ , where expanded uncertainty  $U$  is based on a standard uncertainty multiplied by a coverage factor of  $k=2$ , providing a level of confidence of approximately 95 %.

Test Site	Method	Measurement Frequency Range	Ant. H / V	U,(dB)
DG-CB03 (3m)	CISPR	9KHz ~ 30MHz	V	3.79
		9KHz ~ 30MHz	H	3.57
		30MHz ~ 200MHz	V	3.82
		30MHz ~ 200MHz	H	3.78
		200MHz ~ 1,000MHz	V	4.10
		200MHz ~ 1,000MHz	H	4.06

Test Site	Method	Measurement Frequency Range	Ant. H / V	U,(dB)
DG-CB03 (3m)	CISPR	1GHz ~ 18GHz	V	3.12
		1GHz ~ 18GHz	H	3.68

Test Site	Method	Measurement Frequency Range	Ant. H / V	U,(dB)
DG-CB03 (1m)	CISPR	18GHz ~ 40GHz	V	4.15
		18GHz ~ 40GHz	H	4.14

Note: Unless specifically mentioned, the uncertainty of measurement has not been taken into account to declare the compliance or non-compliance to the specification.



### 3. GENERAL INFORMATION

#### 3.1 GENERAL DESCRIPTION OF EUT

Equipment	Smart Phone		
Brand Name	HUAWEI		
Model Name	CRO-L22, CRO-L02		
Model Difference	Please refer to page 5.		
Modulation Type	LTE	QPSK, 16QAM	
Operation Frequency	LTE 7 (Channel Bandwidth: 5MHz)	2502.5 ~ 2567.5 MHz	
	LTE 7 (Channel Bandwidth: 10MHz)	2505.0 ~ 2565.0 MHz	
	LTE 7 (Channel Bandwidth: 15MHz)	2507.5 ~ 2562.5 MHz	
	LTE 7 (Channel Bandwidth: 20MHz)	2510.0 ~ 2560.0 MHz	

Max. EIRP Power	LTE 7 (Channel Bandwidth: 5MHz)	QPSK	20.31	dBm
		16QAM	19.32	dBm
	LTE 7 (Channel Bandwidth: 10MHz)	QPSK	20.30	dBm
		16QAM	19.10	dBm
	LTE 7 (Channel Bandwidth: 15MHz)	QPSK	20.32	dBm
		16QAM	19.31	dBm
	LTE 7 (Channel Bandwidth: 20MHz)	QPSK	20.30	dBm
		16QAM	19.34	dBm

Antenna Type	Internal Antenna		
Antenna Gain	1.83 dBi for LTE 5, 2.39 dBi for LTE 7		
Hardware Version	HL1CROM		
Software Version	Cairo-L03C469B015		
IMEI No.	CRO-L22	Radiated	SIM 1:862556030020380
			SIM 2:862556030520389
	CRO-L02	Radiated	862553030005446
		Conducted	862553030005446
Power Source	#1 DC Voltage supplied from AC/DC adapter. #2 Battery Supplied.		
Power Rating	#1:AC 100–240V 50/60Hz DC 5V 1A #2:DC 3.82V 2200mAh		

Note:

- For a more detailed features description, please refer to the manufacturer's specifications or the user's manual.

### 3.2 DESCRIPTION OF TEST MODES AND TEST CONDITION

Following channel(s) was (were) selected for the final test as listed below:

LTE BAND 7						
Test Item	Available Channel	Tested Channel	Channel Bandwidth	Modulation	Mode	
EIRP	20775 to 21425	20775, 21100, 21425	5MHz	QPSK, 16QAM	1 RB / 0 RB Offset	
	20800 to 21400	20800, 21100, 21400	10MHz	QPSK, 16QAM	1 RB / 0 RB Offset	
	20825 to 21375	20825, 21100, 21375	15MHz	QPSK, 16QAM	1 RB / 0 RB Offset	
	20850 to 21350	20850, 21100, 21350	20MHz	QPSK, 16QAM	1 RB / 0 RB Offset	
Occupied Bandwidth	20775 to 21425	20775, 21100, 21425	5MHz	QPSK, 16QAM	25 RB / 0 RB Offset	
	20800 to 21400	20800, 21100, 21400	10MHz	QPSK, 16QAM	50 RB / 0 RB Offset	
	20825 to 21375	20825, 21100, 21375	15MHz	QPSK, 16QAM	75 RB / 0 RB Offset	
	20850 to 21350	20850, 21100, 21350	20MHz	QPSK, 16QAM	100 RB / 0 RB Offset	
Conducted Emission	20775 to 21425	21100	5MHz	QPSK	1 RB / 0 RB Offset	
	20800 to 21400	21100	10MHz	QPSK	1 RB / 0 RB Offset	
	20825 to 21375	21100	15MHz	QPSK	1 RB / 0 RB Offset	
	20850 to 21350	21100	20MHz	QPSK	1 RB / 0 RB Offset	
Radiated Emission	20775 to 21425	21100	5MHz	QPSK	1 RB / 0 RB Offset	
	20850 to 21350	21100	20MHz (Note)	QPSK	1 RB / 0 RB Offset	
Band Edge	20775 to 21425	20775	5MHz	QPSK	1 RB / 0 RB Offset 25 RB / 0 RB Offset	
		21425	5MHz	QPSK	1 RB / 24 RB Offset 25 RB / 0 RB Offset	
	20800 to 21400	20800	10MHz	QPSK	1 RB / 0 RB Offset 50 RB / 0 RB Offset	
		21400	10MHz	QPSK	1 RB / 49 RB Offset 50 RB / 0 RB Offset	
	20825 to 21375	20825	15MHz	QPSK	1 RB / 0 RB Offset 75 RB / 0 RB Offset	
		21375	15MHz	QPSK	1 RB / 74 RB Offset 75 RB / 0 RB Offset	
	20850 to 21350	20850	20MHz	QPSK	1 RB / 0 RB Offset 100 RB / 0 RB Offset	
		21350	20MHz	QPSK	1 RB / 99 RB Offset 100 RB / 0 RB Offset	
	Peak To Average Ratio	20775 to 21425	20775, 21100, 21425	5MHz	QPSK, 16QAM	1 RB / 0 RB Offset
		20800 to 21400	20800, 21100, 21400	10MHz	QPSK, 16QAM	1 RB / 0 RB Offset
		20825 to 21375	20825, 21100, 21375	15MHz	QPSK, 16QAM	1 RB / 0 RB Offset
		20850 to 21350	20850, 21100, 21350	20MHz	QPSK, 16QAM	1 RB / 0 RB Offset
Frequency Stability	20775 to 21425	21100	5MHz	QPSK	1 RB / 0 RB Offset	
	20800 to 21400	21100	10MHz	QPSK	1 RB / 0 RB Offset	
	20825 to 21375	21100	15MHz	QPSK	1 RB / 0 RB Offset	
	20850 to 21350	21100	20MHz	QPSK	1 RB / 0 RB Offset	

Note: For 18G to 26.5G, the highest bandwidth is worst case and recording in the test report.

**EUT TEST CONDITIONS:**

Test Item	Environmental Conditions	Test Voltage
EIRP	24°C, 63%RH	DC 3.82V
Conducted Output Power	25°C, 65%RH	DC 3.82V
Occupied Bandwidth	25°C, 65%RH	DC 3.82V
Conducted Emission	25°C, 65%RH	DC 3.82V
Radiated Emission	25°C, 60%RH	AC 120V/60Hz
Band Edge	25°C, 65%RH	DC 3.82V
Peak to Average Ratio	25°C, 65%RH	DC 3.82V
Frequency Stability	25°C, 65%RH	DC 3.82V

**3.3 BLOCK DIAGRAM SHOWING THE CONFIGURATION OF SYSTEM TESTED FOR RADIATED**

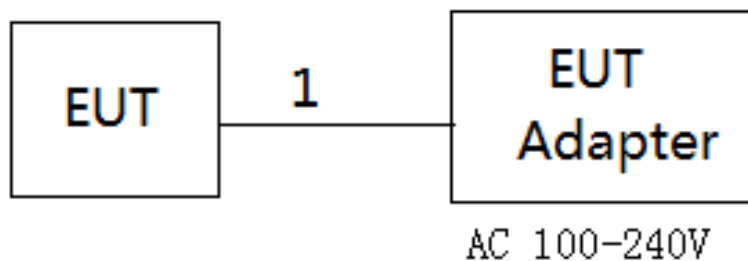

**3.4 DESCRIPTION OF SUPPORT UNITS**

The EUT has been tested as an independent unit together with other necessary accessories or support units. The following support units or accessories were used to form a representative test configuration during the tests.

Item	Equipment	Mfr/Brand	Model/Type No.	FCC ID	Series No.
-	-	-	-	-	-

Item	Shielded Type	Ferrite Core	Length	Note
1	NO	NO	1.2m	USB Cable

## 4. TEST RESULT

### 4.1 OUTPUT POWER MEASUREMENT

#### 4.1.1 LIMIT

Mobile / Portable station are limited to 2 watts e.i.r.p. (LTE 7)

#### 4.1.2 TEST PROCEDURE

##### EIRP/ERP:

EIRP= Conducted Power +Antenan gain

ERP power=EIPR power-2.15dBi.

##### Conducted Power:

The EUT was set up for the maximum power with GSM, GPRS, EDGE, WCDMA, CDMA, and LTE link data modulation and link up with simulator. Set the EUT to transmit under low, middle and high channel and record the power level shown on simulator.

#### 4.1.3 TESTSETUP LAYOUT

##### Conducted Power Measurement

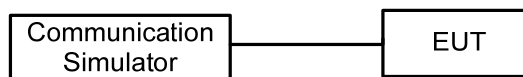

#### 4.1.4 TEST DEVIATION

No deviation

#### 4.1.5 TEST RESULTS

Please refer to the Attachment A.

## 4.2 OCCUPIED BANDWIDTH MEASUREMENT

### 4.2.1 TEST PROCEDURE

The EUT makes a call to the communication simulator. All measurements were done at low, middle and high operational frequency range. The communication simulator station system controlled a EUT to export maximum output power under transmission mode and specific channel frequency. Use OBW measurement function of Spectrum analyzer to measure 99 % occupied bandwidth and 26dB bandwidth.

### 4.2.2 TEST SETUP LAYOUT

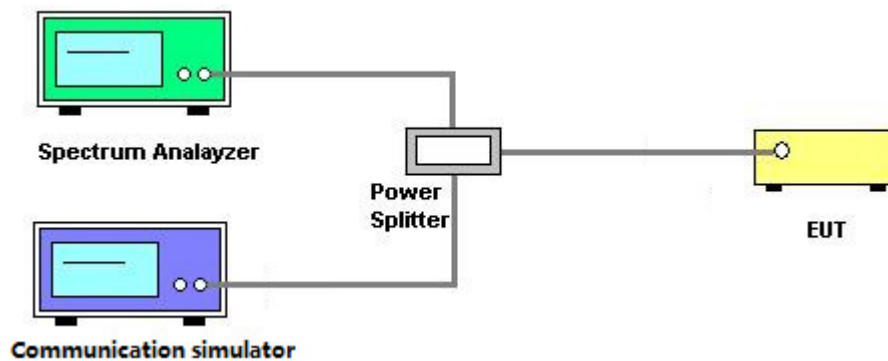

### 4.2.3 TEST DEVIATION

No deviation

### 4.2.4 TEST RESULTS

Please refer to the Attachment B.

### 4.3 CONDUCTED EMISSIONS MEASUREMENT

#### 4.3.1 LIMIT

The power of any emission outside of the authorized operating frequency ranges must be attenuated below the transmitting power (P) by a factor of at least  $43 + 10 \log(P)$  dB. The emission limit equal to -13dBm.

#### 4.3.2 TEST PROCEDURES

1. The testing follows FCC KDB 971168 v02r02 Section 6.0.
2. The EUT was connected to spectrum analyzer and system simulator via a power divider.
3. The band edges of low and high channels for the highest RF powers were measured. Set  $RBW \geq 1\%$  EBW in the 1MHz band immediately outside and adjacent to the band edge.
4. Set spectrum analyzer with RMS detector.
5. The RF fundamental frequency should be excluded against the limit line in the operating frequency band.
6. The limit line is derived from  $43+10\log(P)$ dB below the transmitter power P(Watts)  
 $=P(W)-[43+10\log(P)](dB)$   
 $=[30+10\log(P)](dBm)-[43+10\log(P)](dB)$   
 $=-13dBm$

#### 4.3.3 TESTSETUP LAYOUT

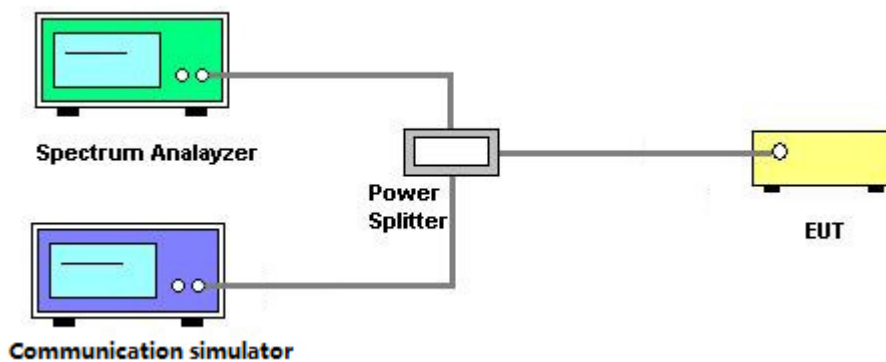

#### 4.3.4 TESTDEVIATION

No deviation

#### 4.3.5 TEST RESULTS

Please refer to the Attachment C.

## 4.4 RADIATED EMISSIONS MEASUREMENT

### 4.4.1 LIMIT

The power of any emission outside of the authorized operating frequency ranges must be attenuated below the transmitting power (P) by a factor of at least  $43 + 10 \log(P)$  dB. The emission limit equal to -13dBm.

### 4.4.2 TEST PROCEDURES

1. Substitution method is used for E.I.R.P measurement. In the semi-anechoic chamber, EUT placed on the 0.8m height of Turn Table, rotated the table around 360 degrees to search the maximum radiation power and receiver antenna shall be rotated vertical and horizontal polarization and moved height from 1m to 4m to find the maximum polar radiated power. The "Read Value" is the spectrum reading the maximum power value.
2. The substitution horn antenna is substituted for EUT at the same position and signals generator export the CW signal to the substitution antenna via a TX cable. Rotated the Turn Table and moved receiving antenna to find the maximum radiation power. Adjust output power level of S.G to get a Value of spectrum reading equal to "Read Value " of step a. Record the power level of S.G
3.  $EIRP = \text{Output power level of S.G} - \text{TX cable loss} + \text{Antenna gain of substitution horn.}$
4. E.R.P power can be calculated form E.I.R.P power by subtracting the gain of dipole,  $E.R.P \text{ power} = E.I.P.R \text{ power} - 2.15\text{dBi.}$
5. The resolution bandwidth and video bandwidth of test receiver/spectrum analyzer is 1MHz/3MHz.

### 4.4.3 TESTSETUP LAYOUT

This test setup layout is the same as that shown in **section 4.1.3.**

### 4.4.4 TESTDEVIATION

No deviation

### 4.4.5 TEST RESULTS

Please refer to the Attachment D.

## 4.5 BAND EDGE MEASUREMENT

### 4.5.1 LIMIT

For operations in the 699-716 , 704-716 and 777-787MHz band, the power of any emission outside a licensee's frequency band(s) of operation shall be attenuated below the transmitter power (P) within the licensed band(s) of operation, measured in watts, by at least  $43 + 10 \log (P)$  dB. Compliance with this provision is based on the use of measurement instrumentation employing a resolution bandwidth of 100 kilohertz or greater.

However, in the 100 kilohertz bands immediately outside and adjacent to a licensee's frequency block, a resolution bandwidth of at least 30 kHz may be employed.

For operations in the 1710–1755 MHz bands, the power of any emission outside a licensee's frequency block shall be attenuated below the transmitter power (P) by at least  $43 + 10 \log_{10}(P)$  dB.

### 4.5.2 TEST PROCEDURES

1. All measurements were done at low and high operational frequency range.
2. The center frequency of spectrum is the band edge frequency and span is 5MHz. RB of the spectrum is 100kHz and VB of the spectrum is 300kHz (WCDMA).
3. The center frequency of spectrum is the band edge frequency and span is 1MHz. RB of the spectrum is 13kHz and VB of the spectrum is 51kHz (LTE Bandwidth 1.4MHz).
4. The center frequency of spectrum is the band edge frequency and span is 1MHz. RB of the spectrum is 30kHz and VB of the spectrum is 100kHz (LTE Bandwidth 3MHz).
5. The center frequency of spectrum is the band edge frequency and span is 1MHz. RB of the spectrum is 100kHz and VB of the spectrum is 300kHz (LTE Bandwidth 5MHz/10MHz).
6. Record the max trace plot into the test report.

### 4.5.3 TESTSETUP LAYOUT

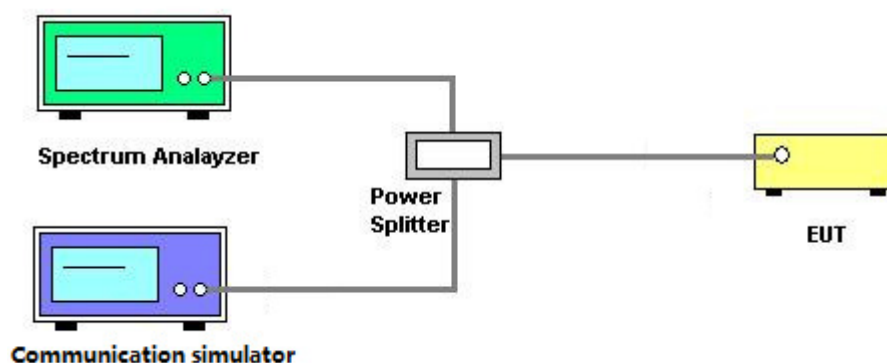

### 4.5.4 TESTDEVIATION

No deviation

### 4.5.5 TEST RESULTS

Please refer to the Attachment E.



## 4.6 PEAK TO AVERAGE RATIO MEASUREMENT

### 4.6.1 LIMIT

In measuring transmissions in this band using an average power technique, the peak to-average ratio (PAR) of the transmission may not exceed 13 dB.

### 4.6.2 TEST PROCEDURES

1. Set resolution/measurement bandwidth  $\geq$  signal's occupied bandwidth;
2. Set the number of counts to a value that stabilizes the measured CCDF curve;
3. Record the maximum PAPR level associated with a probability of 0.1%.

### 4.6.3 TESTSETUP LAYOUT

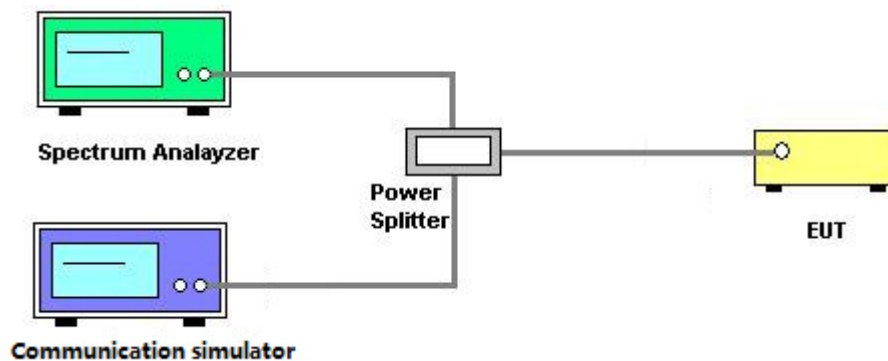

### 4.6.4 TESTDEVIATION

No deviation

### 4.6.5 TEST RESULTS

Please refer to the Attachment F.

## 4.7 FREQUENCY STABILITY MEASUREMENT

### 4.7.1 LIMIT

1.5 ppm is for base and fixed station. 2.5 ppm is for mobile station.

### 4.7.2 TEST PROCEDURES

1. Device is placed at the oven room. The oven room could control the temperatures and humidity. Power warm up is at least 15 min and power applied should perform before recording frequency error.
2. EUT is connected the external power supply to control the DC input power. The test voltage range is from minimum to maximum working voltage. Each step shall be record the frequency error rate.
3. The temperature range step is 10 degrees in this test items. All temperature levels shall be hold the  $\pm 0.5^{\circ}\text{C}$  during the measurement testing. The each temperature step shall be at least 0.5 hours, consider the EUT could be test under the stability condition.
4. The frequency error was recorded frequency error from the communication simulator.

### 4.7.3 TESTSETUP LAYOUT

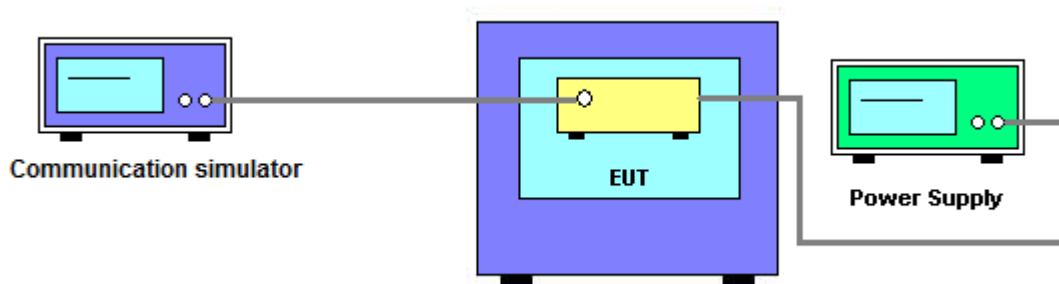

### 4.7.4 TESTDEVIATION

No deviation

### 4.7.5 TEST RESULTS

Please refer to the Attachment G.

## 5. LIST OF MEASUREMENT EQUIPMENTS

Radiated Emission & ERP or EIRP Measurement					
Item	Kind of Equipment	Manufacturer	Type No.	Serial No.	Calibrated until
1	Antenna	Schwarbeck	VULB9160	9160-3232	Mar. 26, 2018
2	Double Ridged Guide Antenna	ETS	3115	75789	Mar. 26, 2018
3	Broad-Band Horn Antenna	Schwarzbeck	BBHA 9170	9170319	Apr. 23, 2017
4	Amplifier	Agilent	8449B	3008A02274	Mar. 09, 2018
5	Amplifier	HP	8447D	2944A09673	Mar. 09, 2018
6	HighPass Filter	Wairwright Instruments Gmbh	WHK 1.5/15G-10ST	11	Mar. 09, 2018
7	Band Reject Filter	Wairwright Instruments Gmbh	WRCG 1710/1785-1690 /1805-60/12SS	38	Feb. 24, 2018
8	Band Reject Filter	Wairwright Instruments Gmbh	WRCG 824/849-810/86 3-60/9SS	7	Feb. 24, 2018
9	Band Reject Filter	Wairwright Instruments Gmbh	WRCG 880/915-860/93 5-60/9SS	14	Feb. 24, 2018
10	Band Reject Filter	Wairwright Instruments Gmbh	WRCG 1850/1910-1830 /1930-60/10SS	17	Feb. 24, 2018
11	HighPass Filter	Wairwright Instruments Gmbh	WHK3.1/18G-10 SS	24	Mar. 09, 2018
12	Microwave Preamplifier With Adaptor	EMC INSTRUMENT	EMC2654045	980039 & HA01	Mar. 26, 2018
13	Receiver	Agilent	N9038A	MY52130039	Sep. 04, 2017
14	wideband radio communication tester	R&S	CMW500	152372	Mar. 26, 2018
15	High pass filter	ZHPF-M1000-4000-1	ZHPF-M3-12.75 G-3869	B2015073763	Aug. 04, 2017
16	High pass filter	ZHPF-M3-12.75G-3869	ZHPF-M1000-4000-1	B2015073762	Aug. 04, 2017
17	High pass filter	ZHPF-M6-18G-1727	ZHPF-M6-186-1727	B2015073764	Aug. 04, 2017
18	Cable	emci	LMR-400(30MHz-1GHz)(8m+5m)	N/A	Jun. 27, 2017
19	Cable	emci	EMC104-SM-SM-12000(12m)	N/A	Jul. 06, 2017
20	Controller	ETS-Lindgren	2090	N/A	N/A
21	Measurement Software	Farad	EZ-EMC Ver.NB-03A1-01	N/A	N/A

Conducted Emission & Band Edge & Occupied Bandwidth Measurement					
Item	Kind of Equipment	Manufacturer	Type No.	Serial No.	Calibrated until
1	EXA Spectrum Analyzer	Agilent	N9010A	MY50520044	Mar. 26, 2018
2	POWER SPLITTER	Mini-Circuits	ZFRSC-123-S +	331000910-1	Feb. 25, 2018
3	wideband radio communication tester	R&S	CMW500	152372	Mar. 26, 2018
4	Cable	N/A	RG316(0.3m)	N/A	Jul. 06, 2017
5	Cable	N/A	RG316(0.3m)	N/A	Jul. 06, 2017

Frequency Stability Measurement					
Item	Kind of Equipment	Manufacturer	Type No.	Serial No.	Calibrated until
1	DC power supply	GW Instek	GPC-3030DN	EK880675	Oct. 12, 2018
2	POWER SPLITTER	Mini-Circuits	ZFRSC-123-S +	331000910-1	Feb. 25, 2018
3	wideband radio communication tester	R&S	CMW500	152372	Mar. 26, 2018
4	Const Temp,& Humidity Chamber	Giant Force	ITH-225-20-S	IAB0309-001	Sep. 04, 2017
5	Cable	N/A	RG316(0.3m)	N/A	Jul. 06, 2017

Remark: "N/A" denotes no model name, serial no. or calibration specified.  
All calibration period of equipment list is one year.

## ATTACHMENT A - OUTPUT POWER

**Conducted Power:**

LTE Band / BW	Modulation	RB Siset	RB Offset	Low CH	Mid CH	High CH
				20775 CH	21100 CH	21425 CH
				2502.5 MHz	2535 MHz	2567.5 MHz
7 / 5M	QPSK	1	0	22.01	21.85	22.46
		1	12	22.04	21.82	22.46
		1	24	21.76	21.80	22.41
		12	0	20.57	20.81	21.33
		12	6	20.69	20.79	21.32
		12	13	20.73	20.79	21.34
		25	0	20.72	20.74	21.29
	16QAM	1	0	20.99	21.39	21.21
		1	12	21.01	21.45	21.33
		1	24	20.99	21.47	21.30
		12	0	19.97	20.06	20.37
		12	6	19.99	20.43	20.38
		12	13	20.01	20.22	20.37
		25	0	19.89	20.05	20.23

LTE Band / BW	Modulation	RB Siset	RB Offset	Low CH	Mid CH	High CH
				20800 CH	21100 CH	21400 CH
				2505 MHz	2535 MHz	2565 MHz
7 / 10M	QPSK	1	0	21.84	22.04	22.45
		1	24	21.92	22.00	22.41
		1	49	22.00	22.02	22.39
		25	0	20.86	20.90	21.27
		25	12	20.86	20.86	21.27
		25	25	20.87	20.89	21.26
		50	0	20.88	20.88	21.29
	16QAM	1	0	20.67	21.25	21.21
		1	24	20.74	21.18	21.23
		1	49	20.76	21.21	21.22
		25	0	19.87	19.91	20.32
		25	12	19.87	19.83	20.34
		25	25	19.90	19.90	20.36
		50	0	19.87	19.88	20.31

LTE Band / BW	Modulation	RB Sizer	RB Offset	Low CH	Mid CH	High CH
				20825 CH	21100 CH	21375 CH
				2507.5 MHz	2535 MHz	2562.5 MHz
7 / 15M	QPSK	1	0	21.72	22.13	22.45
		1	37	21.80	22.02	22.43
		1	74	21.93	22.11	22.47
		36	0	20.79	20.98	21.42
		36	19	20.82	20.95	21.37
		36	39	20.91	21.00	21.35
		75	0	20.86	21.00	21.39
	16QAM	1	0	20.56	21.34	21.45
		1	37	20.62	21.24	21.42
		1	74	20.70	21.31	21.46
		36	0	19.73	20.00	20.29
		36	19	19.74	19.97	20.23
		36	39	19.84	20.00	20.25
		75	0	19.78	19.98	20.28

LTE Band / BW	Modulation	RB Sizer	RB Offset	Low CH	Mid CH	High CH
				20850 CH	21100 CH	21350 CH
				2510 MHz	2535 MHz	2560 MHz
7 / 20M	QPSK	1	0	21.95	22.17	22.45
		1	50	21.83	21.99	22.42
		1	99	21.92	22.15	22.43
		50	0	20.75	20.99	21.28
		50	25	20.78	20.94	21.25
		50	50	20.88	20.99	21.26
		100	0	20.78	20.95	21.24
	16QAM	1	0	21.20	21.40	21.46
		1	50	21.26	21.31	21.49
		1	99	21.39	21.37	21.46
		50	0	19.78	19.98	20.21
		50	25	19.81	19.93	20.16
		50	50	19.89	19.98	20.22
		100	0	19.81	19.94	20.21

**EIRP Power:**

LTE Band / BW	Modulation	RB Sizing	RB Offset	Low CH	Mid CH	High CH
				20775 CH	21100 CH	21425 CH
				2502.5 MHz	2535 MHz	2567.5 MHz
7 / 5M	QPSK	1	0	19.86	19.70	<b>20.31</b>
		1	12	19.89	19.67	20.31
		1	24	19.61	19.65	20.26
		12	0	18.42	18.66	19.18
		12	6	18.54	18.64	19.17
		12	13	18.58	18.64	19.19
		25	0	18.57	18.59	19.14
	16QAM	1	0	18.84	19.24	19.06
		1	12	18.86	19.30	19.18
		1	24	18.84	<b>19.32</b>	19.15
		12	0	17.82	17.91	18.22
		12	6	17.84	18.28	18.23
		12	13	17.86	18.07	18.22
		25	0	17.74	17.90	18.08

LTE Band / BW	Modulation	RB Sizing	RB Offset	Low CH	Mid CH	High CH
				20800 CH	21100 CH	21400 CH
				2505 MHz	2535 MHz	2565 MHz
7 / 10M	QPSK	1	0	19.69	19.89	<b>20.30</b>
		1	24	19.77	19.85	20.26
		1	49	19.85	19.87	20.24
		25	0	18.71	18.75	19.12
		25	12	18.71	18.71	19.12
		25	25	18.72	18.74	19.11
		50	0	18.73	18.73	19.14
	16QAM	1	0	18.52	<b>19.10</b>	19.06
		1	24	18.59	19.03	19.08
		1	49	18.61	19.06	19.07
		25	0	17.72	17.76	18.17
		25	12	17.72	17.68	18.19
		25	25	17.75	17.75	18.21
		50	0	17.72	17.73	18.16



LTE Band / BW	Modulation	RB Sizer	RB Offset	Low CH	Mid CH	High CH
				20825 CH	21100 CH	21375 CH
				2507.5 MHz	2535 MHz	2562.5 MHz
7 / 15M	QPSK	1	0	19.57	19.98	20.30
		1	37	19.65	19.87	20.28
		1	74	19.78	19.96	<b>20.32</b>
		36	0	18.64	18.83	19.27
		36	19	18.67	18.80	19.22
		36	39	18.76	18.85	19.20
		75	0	18.71	18.85	19.24
	16QAM	1	0	18.41	19.19	19.30
		1	37	18.47	19.09	19.27
		1	74	18.55	19.16	<b>19.31</b>
		36	0	17.58	17.85	18.14
		36	19	17.59	17.82	18.08
		36	39	17.69	17.85	18.10
		75	0	17.63	17.83	18.13

LTE Band / BW	Modulation	RB Sizer	RB Offset	Low CH	Mid CH	High CH
				20850 CH	21100 CH	21350 CH
				2510 MHz	2535 MHz	2560 MHz
7 / 20M	QPSK	1	0	19.80	20.02	<b>20.30</b>
		1	50	19.68	19.84	20.27
		1	99	19.77	20.00	20.28
		50	0	18.60	18.84	19.13
		50	25	18.63	18.79	19.10
		50	50	18.73	18.84	19.11
		100	0	18.63	18.80	19.09
	16QAM	1	0	19.05	19.25	19.31
		1	50	19.11	19.16	<b>19.34</b>
		1	99	19.24	19.22	19.31
		50	0	17.63	17.83	18.06
		50	25	17.66	17.78	18.01
		50	50	17.74	17.83	18.07
		100	0	17.66	17.79	18.06

## ATTACHMENT B - OCCUPIED BANDWIDTH

LTE Band 7_5M					
QPSK			16QAM		
Channel	Frequency (MHz)	99% Occupied Bandwidth (MHz)	Channel	Frequency (MHz)	99% Occupied Bandwidth (MHz)
20775	2502.5	4.5125	20775	2502.5	4.5131
21100	2535	4.5159	21100	2535	4.5203
21425	2567.5	4.5100	21425	2567.5	4.4996
Channel	Frequency (MHz)	26dB Bandwidth (MHz)	Channel	Frequency (MHz)	26dB Bandwidth (MHz)
20775	2502.5	4.9870	20775	2502.5	4.9570
21100	2535	4.9880	21100	2535	4.9520
21425	2567.5	4.9790	21425	2567.5	4.9570

### Spectrum Plot



LTE Band 7_10M					
QPSK			16QAM		
Channel	Frequency (MHz)	99% Occupied Bandwidth (MHz)	Channel	Frequency (MHz)	99% Occupied Bandwidth (MHz)
20800	2505	9.0001	20800	2505	9.0031
21100	2535	9.0143	21100	2535	9.0031
21400	2565	8.9858	21400	2565	8.9914
Channel	Frequency (MHz)	26dB Bandwidth (MHz)	Channel	Frequency (MHz)	26dB Bandwidth (MHz)
20800	2505	9.9430	20800	2505	9.9310
21100	2535	9.9310	21100	2535	9.8900
21400	2565	9.9600	21400	2565	9.9000

### Spectrum Plot



LTE Band 7_15M					
QPSK			16QAM		
Channel	Frequency (MHz)	99% Occupied Bandwidth (MHz)	Channel	Frequency (MHz)	99% Occupied Bandwidth (MHz)
20825	2507.5	13.4490	20825	2507.5	13.4820
21100	2535	13.5090	21100	2535	13.4840
21375	2562.5	13.4790	21375	2562.5	13.5040
Channel	Frequency (MHz)	26dB Bandwidth (MHz)	Channel	Frequency (MHz)	26dB Bandwidth (MHz)
20825	2507.5	14.9500	20825	2507.5	15.0300
21100	2535	15.0300	21100	2535	15.0500
21375	2562.5	14.9700	21375	2562.5	15.0500

### Spectrum Plot





LTE Band 7_20M					
QPSK			16QAM		
Channel	Frequency (MHz)	99% Occupied Bandwidth (MHz)	Channel	Frequency (MHz)	99% Occupied Bandwidth (MHz)
20850	2510	17.9560	20850	2510	17.9570
21100	2535	17.9970	21100	2535	19.5200
21350	2560	17.9870	21350	2560	17.9880
Channel	Frequency (MHz)	26dB Bandwidth (MHz)	Channel	Frequency (MHz)	26dB Bandwidth (MHz)
20850	2510	19.6500	20850	2510	19.7900
21100	2535	19.8400	21100	2535	19.8400
21350	2560	19.7400	21350	2560	19.7400

### Spectrum Plot

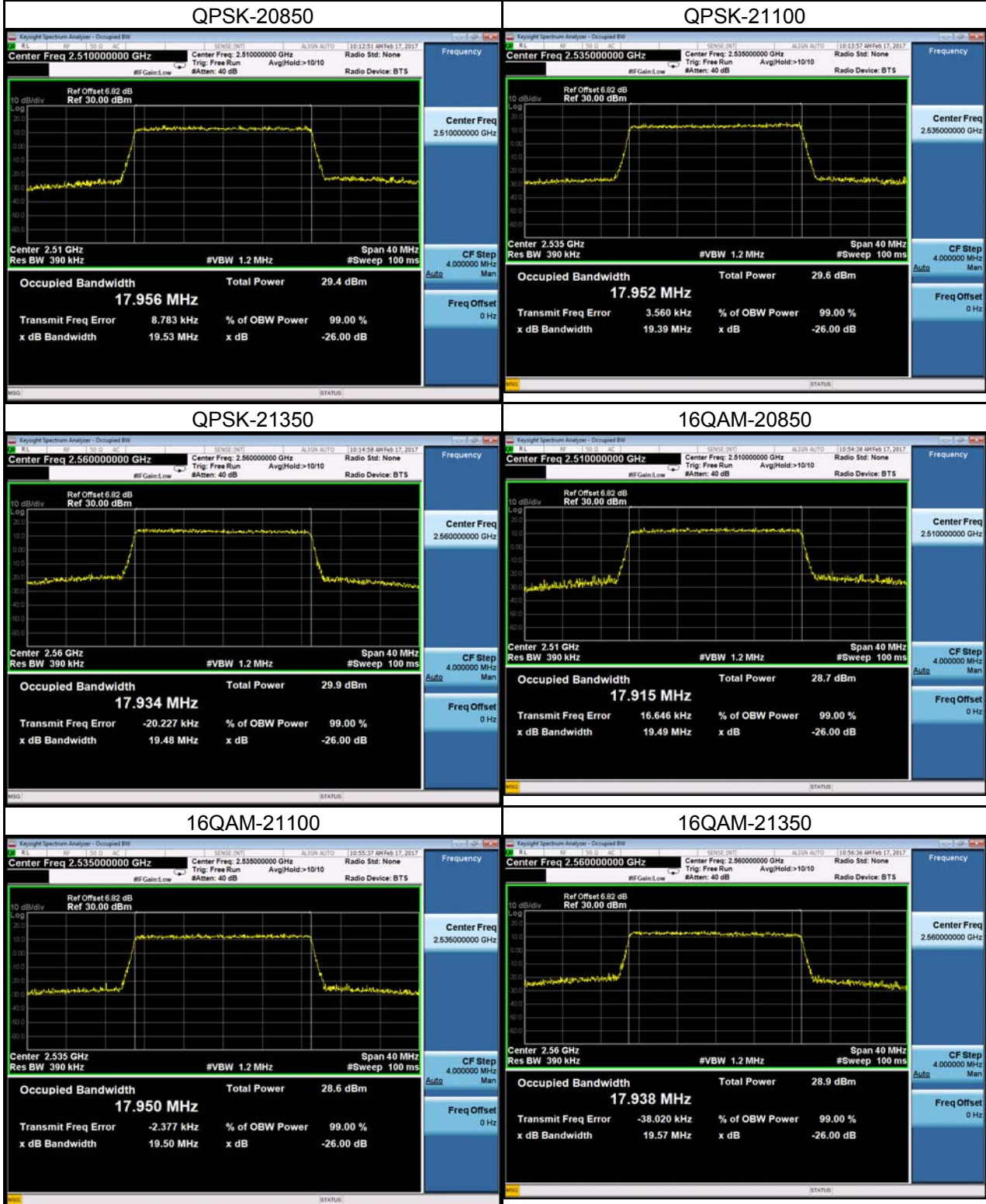

## ATTACHMENT C - CONDUCTED EMISSIONS

LTE Band 7_5M			
Channel	Frequency(MHz)	Channel	Frequency(MHz)
21100	2535	21100	2535
Channel	Frequency(MHz)	-	-
21100	2535	-	-

LTE Band 7_10M			
Channel	Frequency(MHz)	Channel	Frequency(MHz)
21100	2535	21100	2535
Channel	Frequency(MHz)	-	-
21100	2535	-	-

LTE Band 7_15M			
Channel	Frequency(MHz)	Channel	Frequency(MHz)
21100	2535	21100	2535
Channel	Frequency(MHz)	-	-
21100	2535	-	-

LTE Band 7_20M			
Channel	Frequency(MHz)	Channel	Frequency(MHz)
21100	2535	21100	2535
Channel	Frequency(MHz)	-	-
21100	2535	-	-

## ATTACHMENT D - RADIATED EMISSION



Test Mode: TX Mode\_Adapter: BYD

Ant 0°

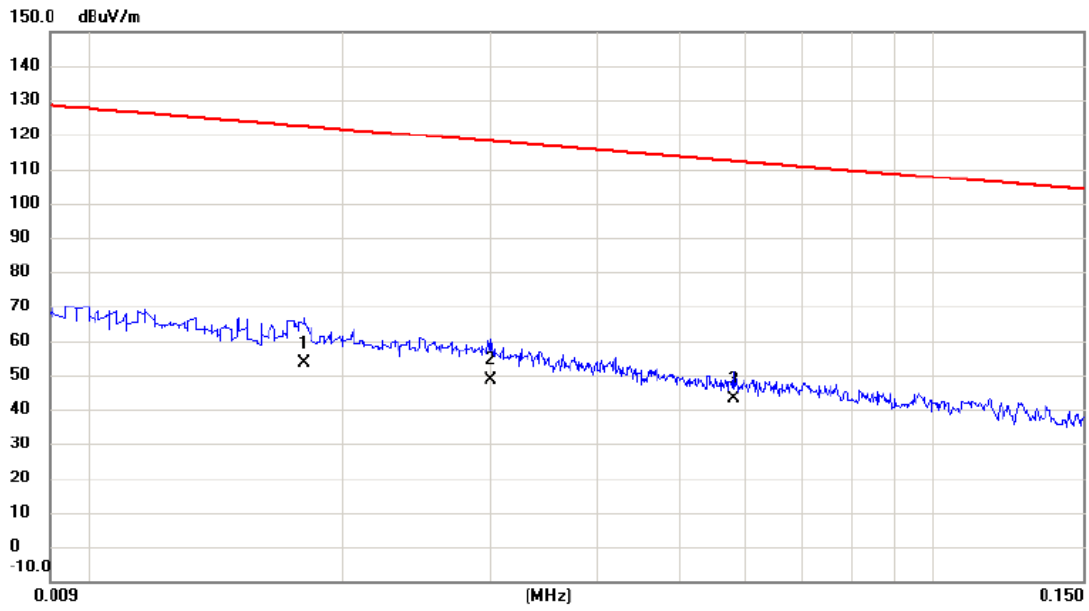

No.	Mk.	Freq.	Reading Level	Correct Factor	Measurement	Limit	Margin	Detector	Comment
		MHz	dBuV	dB	dBuV/m	dBuV/m	dB		
1	*	0.018	29.90	23.64	53.54	122.50	-68.96	AVG	
2		0.030	26.41	22.29	48.70	118.06	-69.36	AVG	
3		0.058	23.34	19.73	43.07	112.34	-69.27	AVG	

Test Mode: TX Mode\_Adapter: BYD

Ant 0°

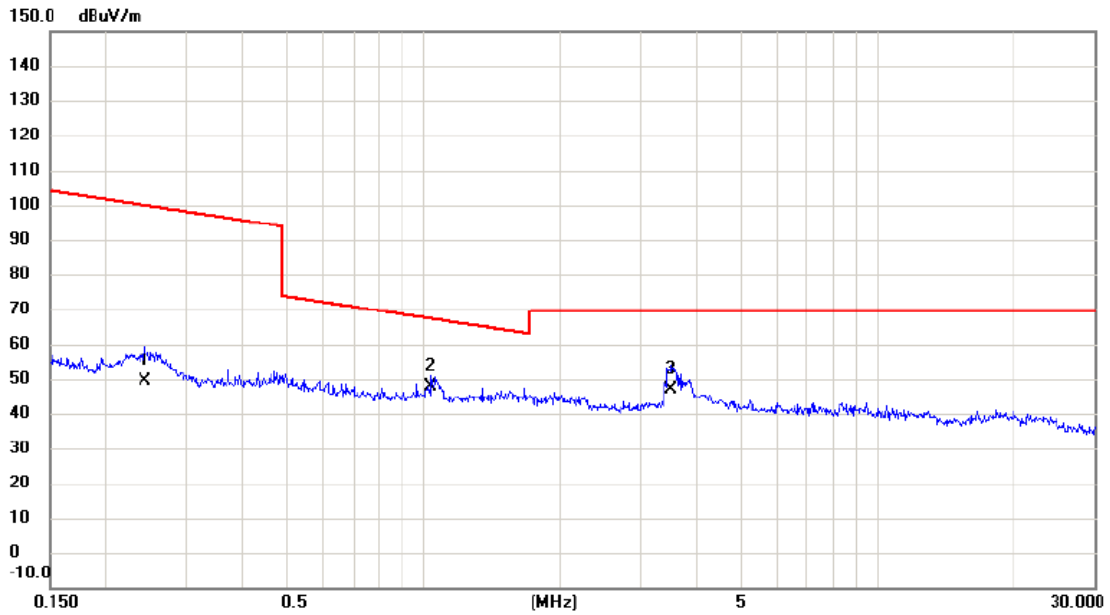

No.	Mk.	Freq. MHz	Reading Level dBuV	Correct Factor dB	Measure- ment dBuV/m	Limit dBuV/m	Margin dB	Detector	Comment
1		0.243	30.77	18.66	49.43	99.89	-50.46	AVG	
2	*	1.037	30.27	17.69	47.96	67.29	-19.33	QP	
3		3.509	29.14	17.71	46.85	69.54	-22.69	QP	

Test Mode: TX Mode\_Adapter: BYD

Ant 90°

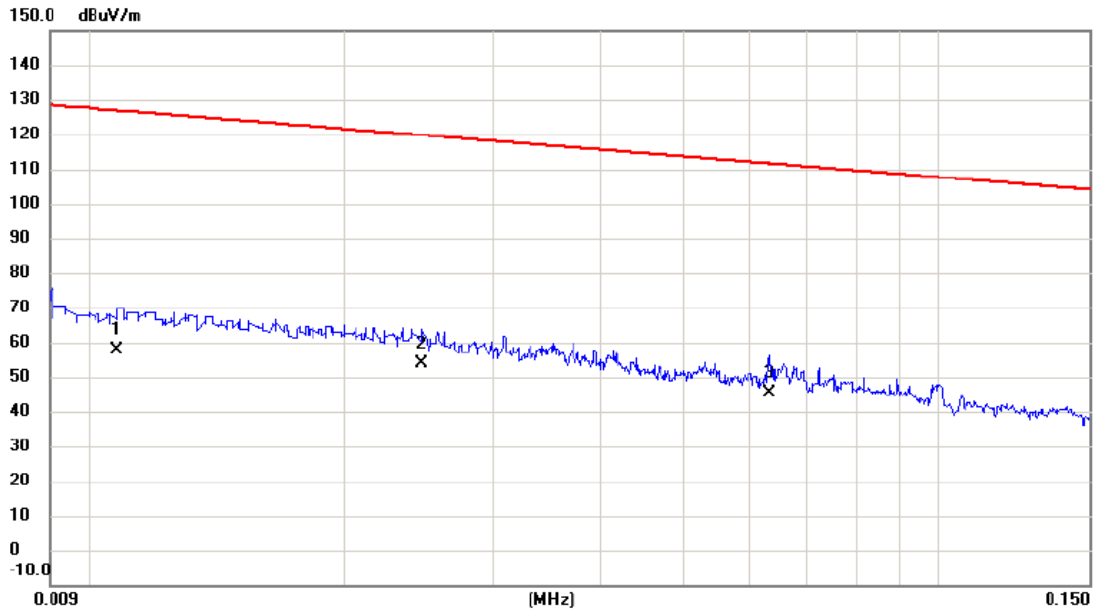

No.	Mk.	Freq. MHz	Reading Level dBuV	Correct Factor dB	Measure- ment dBuV/m	Limit dBuV/m	Margin dB	Detector	Comment
1		0.011	33.78	24.07	57.85	126.94	-69.09	AVG	
2	*	0.025	30.83	22.95	53.78	119.79	-66.01	AVG	
3		0.063	25.70	19.67	45.37	111.60	-66.23	AVG	

Test Mode: TX Mode\_Adapter: BYD

Ant 90°

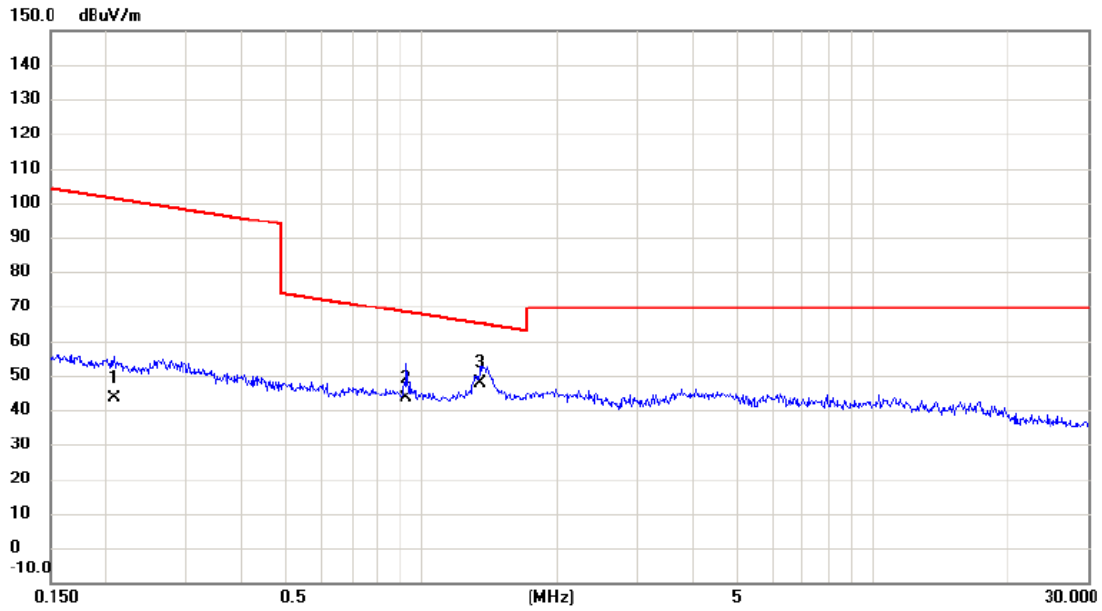

No.	Mk.	Freq. MHz	Reading Level dBuV	Correct Factor dB	Measure- ment dBuV/m	Limit dBuV/m	Margin dB	Detector	Comment
1		0.208	24.90	18.68	43.58	101.23	-57.65	AVG	
2		0.928	25.65	17.91	43.56	68.25	-24.69	QP	
3	*	1.345	30.01	17.76	47.77	65.03	-17.26	QP	

Test Mode: TX Mode\_Adapter: PHITEK

Ant 0°

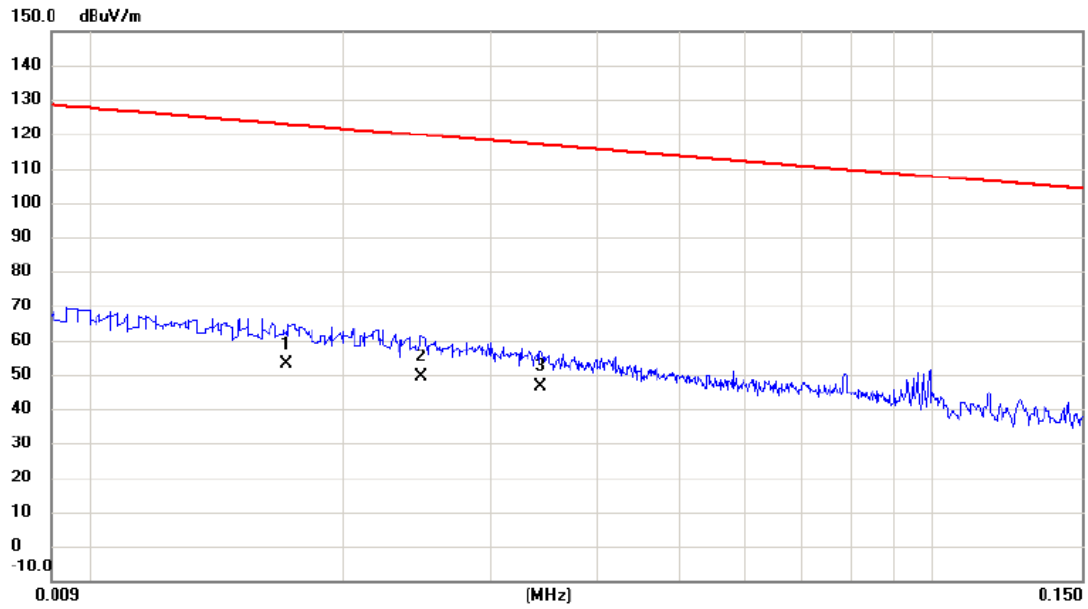

No.	Mk.	Freq. MHz	Reading Level dBuV	Correct Factor dB	Measure- ment dBuV/m	Limit dBuV/m	Margin dB	Detector	Comment
1	*	0.017	29.35	23.69	53.04	122.94	-69.90	AVG	
2		0.025	26.59	22.94	49.53	119.75	-70.22	AVG	
3		0.034	24.87	21.76	46.63	116.90	-70.27	AVG	

Test Mode: TX Mode\_Adapter: PHITEK

Ant 0°

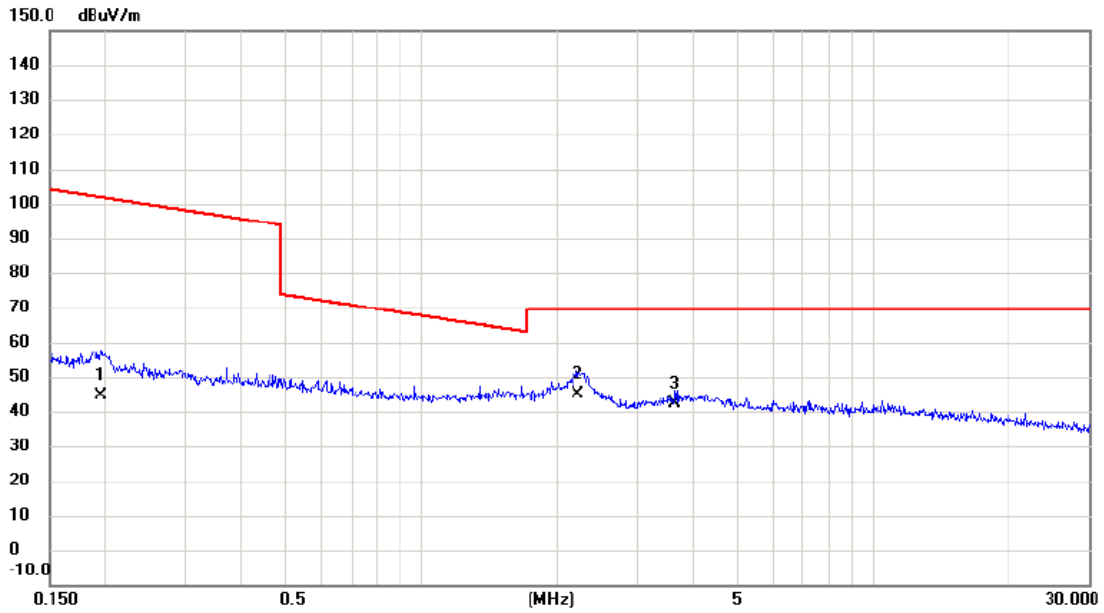

No.	Mk.	Freq. MHz	Reading Level dBuV	Correct Factor dB	Measure- ment dBuV/m	Limit dBuV/m	Margin dB	Detector	Comment
1		0.196	26.05	18.69	44.74	101.78	-57.04	AVG	
2	*	2.213	27.18	17.63	44.81	69.54	-24.73	QP	
3		3.642	24.33	18.00	42.33	69.54	-27.21	QP	

Test Mode: TX Mode\_Adapter: PHITEK

Ant 90°

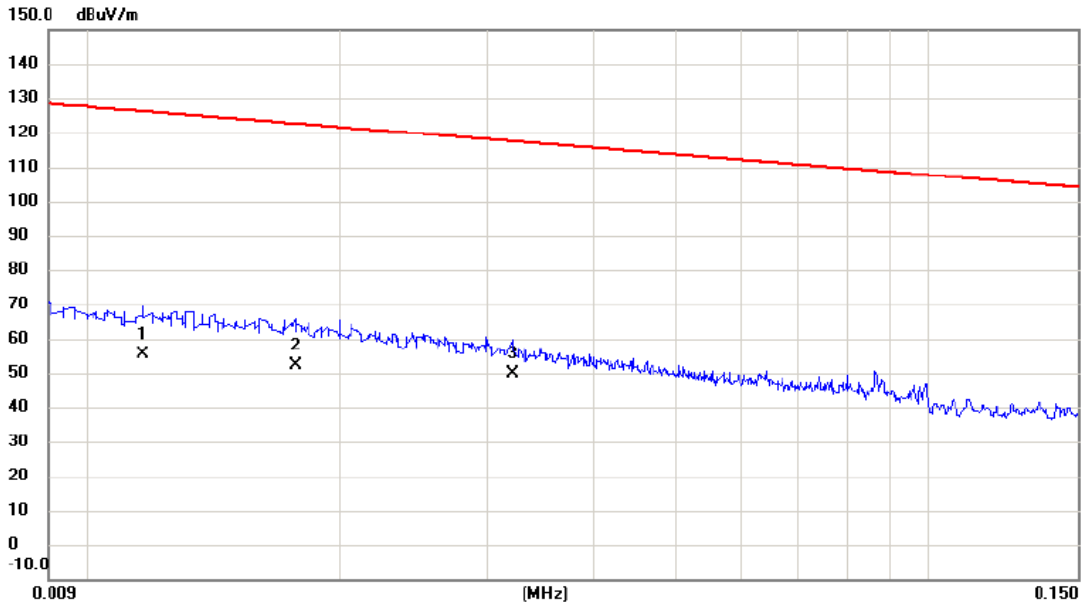

No.	Mk.	Freq.	Reading Level	Correct Factor	Measurement	Limit	Margin	Detector	Comment
		MHz	dBuV	dB	dBuV/m	dBuV/m	dB		
1		0.012	31.52	24.02	55.54	126.24	-70.70	AVG	
2		0.018	28.68	23.66	52.34	122.65	-70.31	AVG	
3	*	0.032	27.85	22.04	49.89	117.50	-67.61	AVG	

Test Mode: TX Mode\_Adapter: PHITEK

Ant 90°

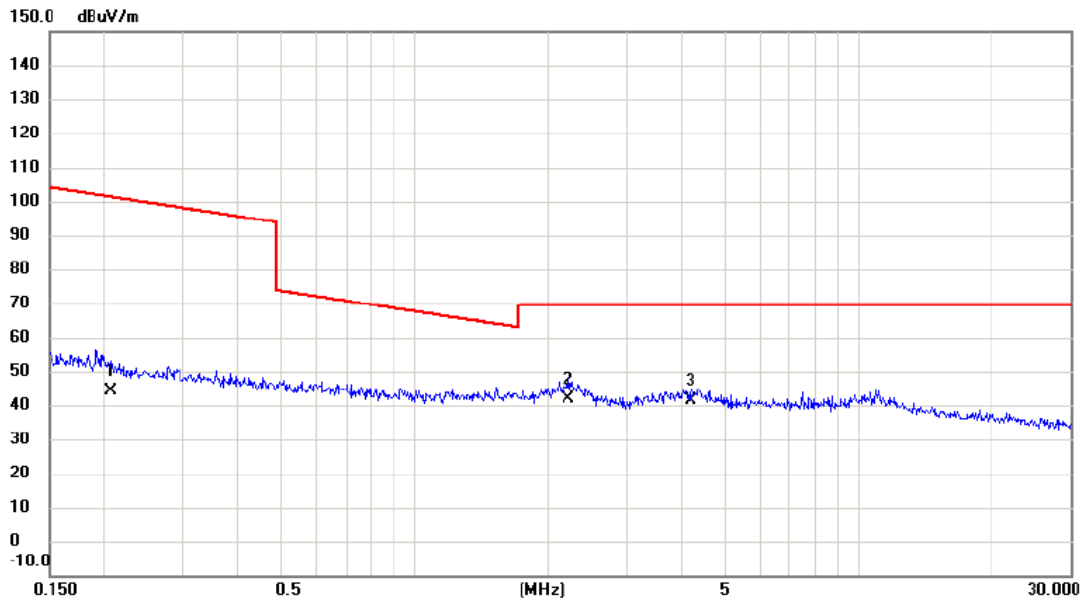

No. Mk.	Freq. MHz	Reading Level dBuV	Correct Factor dB	Measurement dBuV/m	Limit dBuV/m	Margin dB	Detector	Comment
1	0.207	25.68	18.68	44.36	101.28	-56.92	AVG	
2 *	2.225	24.35	17.62	41.97	69.54	-27.57	QP	
3	4.202	22.91	18.34	41.25	69.54	-28.29	QP	



Test Mode: TX Mode\_Adapter: Huntkey

Ant 0°

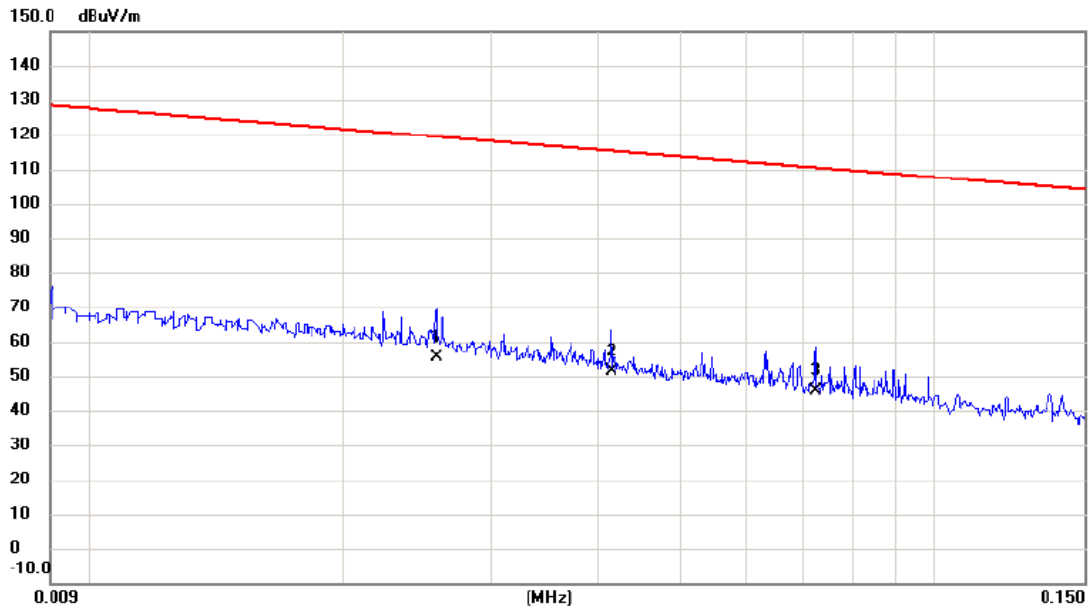

No.	Mk.	Freq. MHz	Reading Level dBuV	Correct Factor dB	Measure- ment dBuV/m	Limit dBuV/m	Margin dB	Detector	Comment
1	*	0.026	32.65	22.80	55.45	119.37	-63.92	AVG	
2		0.042	30.41	20.87	51.28	115.24	-63.96	AVG	
3		0.072	26.17	19.56	45.73	110.41	-64.68	AVG	

Test Mode: TX Mode\_Adapter: Huntkey

Ant 0°

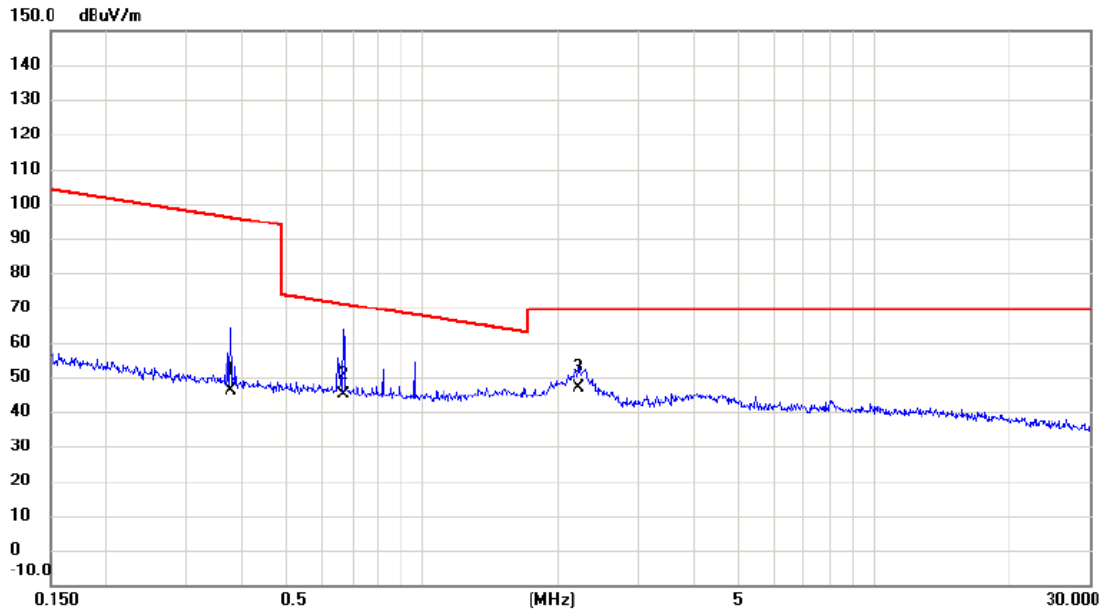

No.	Mk.	Freq. MHz	Reading Level dBuV	Correct Factor dB	Measure- ment dBuV/m	Limit dBuV/m	Margin dB	Detector	Comment
1		0.377	27.82	18.51	46.33	96.08	-49.75	AVG	
2		0.668	26.39	18.44	44.83	71.10	-26.27	QP	
3	*	2.225	29.44	17.62	47.06	69.54	-22.48	QP	

Test Mode: TX Mode\_Adapter: Huntkey

Ant 90°

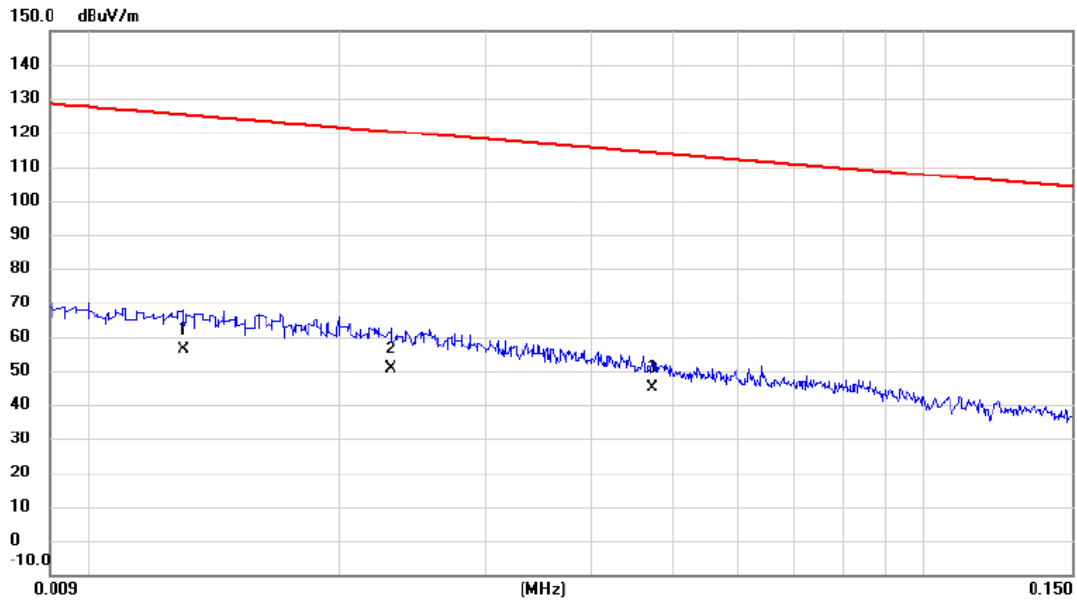

No.	Mk.	Freq.	Reading Level	Correct Factor	Measurement	Limit	Margin	Detector	Comment
		MHz	dBuV	dB	dBuV/m	dBuV/m	dB		
1		0.013	32.21	23.94	56.15	125.33	-69.18	AVG	
2		0.023	27.30	23.15	50.45	120.37	-69.92	AVG	
3	*	0.047	24.86	20.15	45.01	114.11	-69.10	AVG	

Test Mode: LTE Band 7\_TX CH21100\_5M

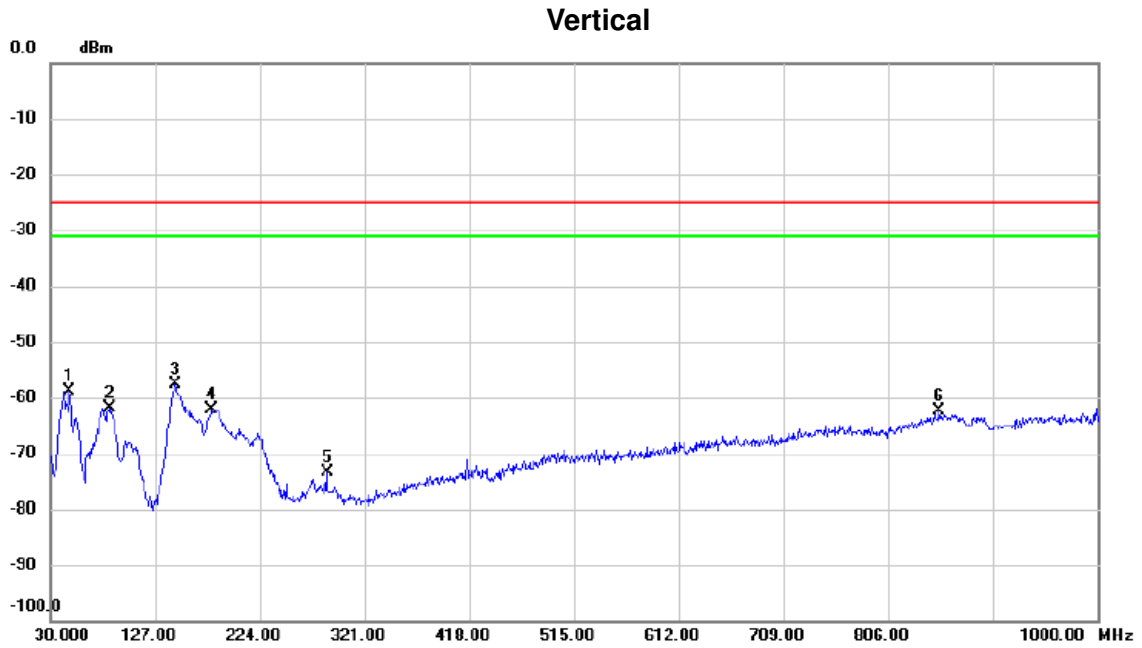

No.	Mk.	Freq. MHz	Reading Level dBm	Correct Factor dB	Measure- ment dBm	Limit dBm	Margin dB	Detector	Comment
1		47.945	-60.02	1.16	-58.86	-25.00	-33.86	peak	
2		85.290	-55.50	-6.35	-61.85	-25.00	-36.85	peak	
3	*	145.430	-60.21	2.69	-57.52	-25.00	-32.52	peak	
4		179.865	-62.90	0.76	-62.14	-25.00	-37.14	peak	
5		286.080	-75.65	2.39	-73.26	-25.00	-48.26	peak	
6		853.530	-76.81	14.35	-62.46	-25.00	-37.46	peak	

Test Mode: LTE Band 7\_TX CH21100\_5M

### Horizontal

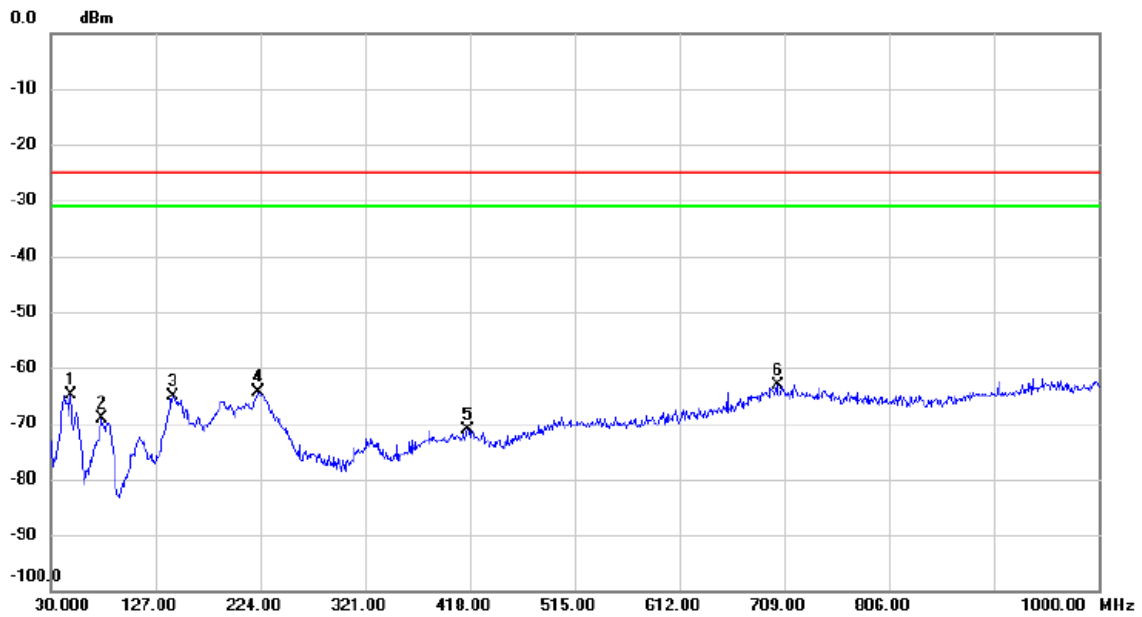

No.	Mk.	Freq. MHz	Reading Level dBm	Correct Factor dB	Measure- ment dBm	Limit dBm	Margin dB	Detector	Comment
1		48.430	-66.69	1.83	-64.86	-25.00	-39.86	peak	
2		77.530	-61.97	-7.24	-69.21	-25.00	-44.21	peak	
3		143.490	-68.65	3.52	-65.13	-25.00	-40.13	peak	
4		221.575	-65.41	0.97	-64.44	-25.00	-39.44	peak	
5		416.060	-77.90	6.68	-71.22	-25.00	-46.22	peak	
6	*	702.695	-77.06	13.91	-63.15	-25.00	-38.15	peak	

Test Mode: LTE Band 7\_TX CH21100\_5M

**Vertical**

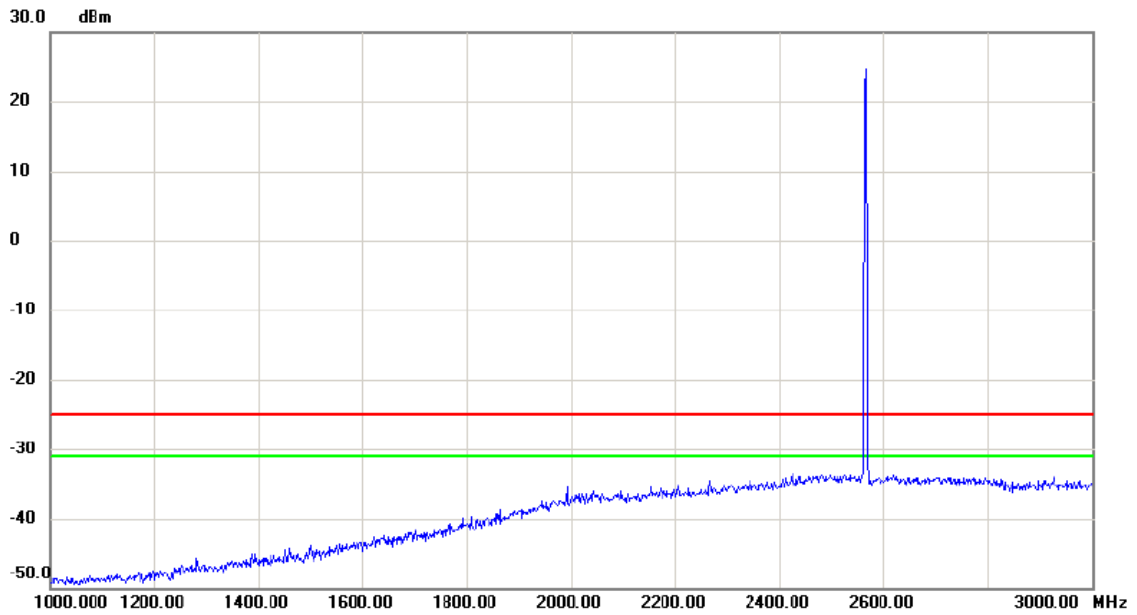

No.	Mk.	Freq. MHz	Reading Level dBm	Correct Factor dB	Measure- ment dBm	Limit dBm	Margin dB	Detector	Comment

Test Mode: LTE Band 7\_TX CH21100\_5M

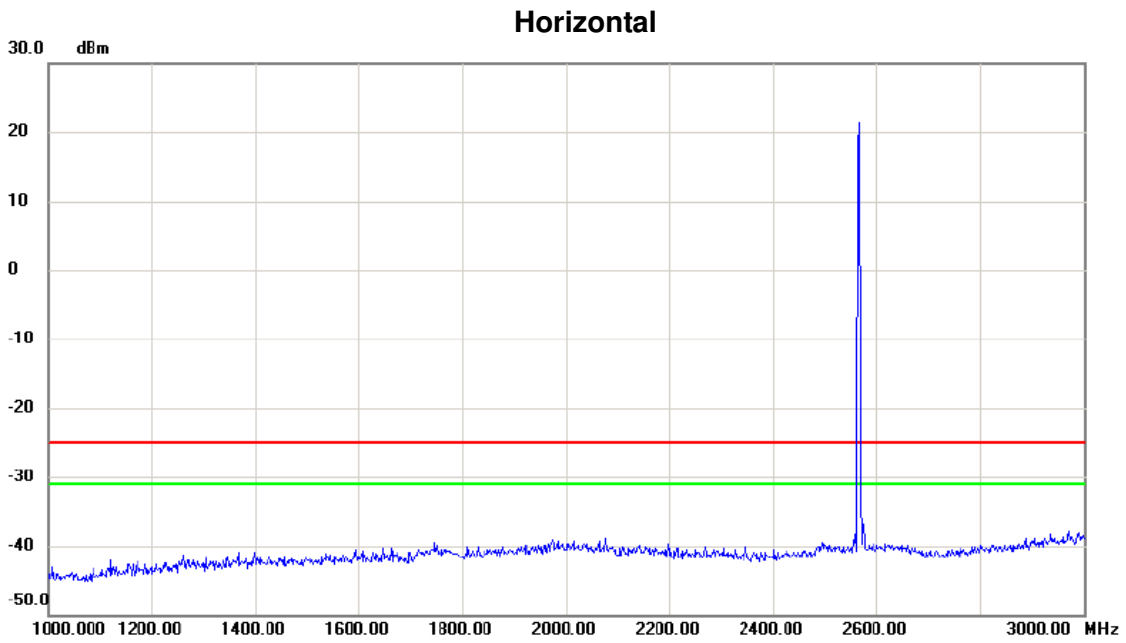

No.	Mk.	Freq.	Reading Level	Correct Factor	Measurement	Limit	Margin	Detector	Comment
		MHz	dBm	dB	dBm	dBm	dB		
		2550.00	20.00	0.00	20.00	-25.00	-5.00		

Test Mode: LTE Band 7\_TX CH21100\_5M

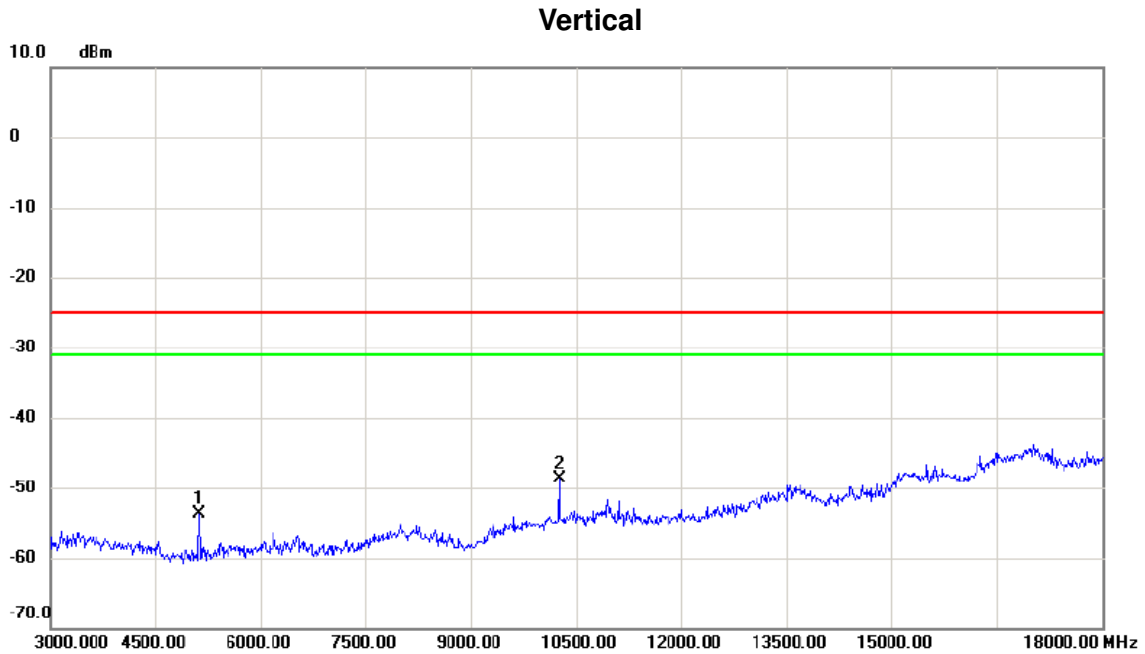

No.	Mk.	Freq. MHz	Reading Level dBm	Correct Factor dB	Measure- ment dBm	Limit dBm	Margin dB	Detector	Comment
1		5130.000	-68.77	14.97	-53.80	-25.00	-28.80	peak	
2	*	10260.000	-70.57	21.83	-48.74	-25.00	-23.74	peak	



Test Mode: LTE Band 7\_TX CH21100\_5M

### Horizontal

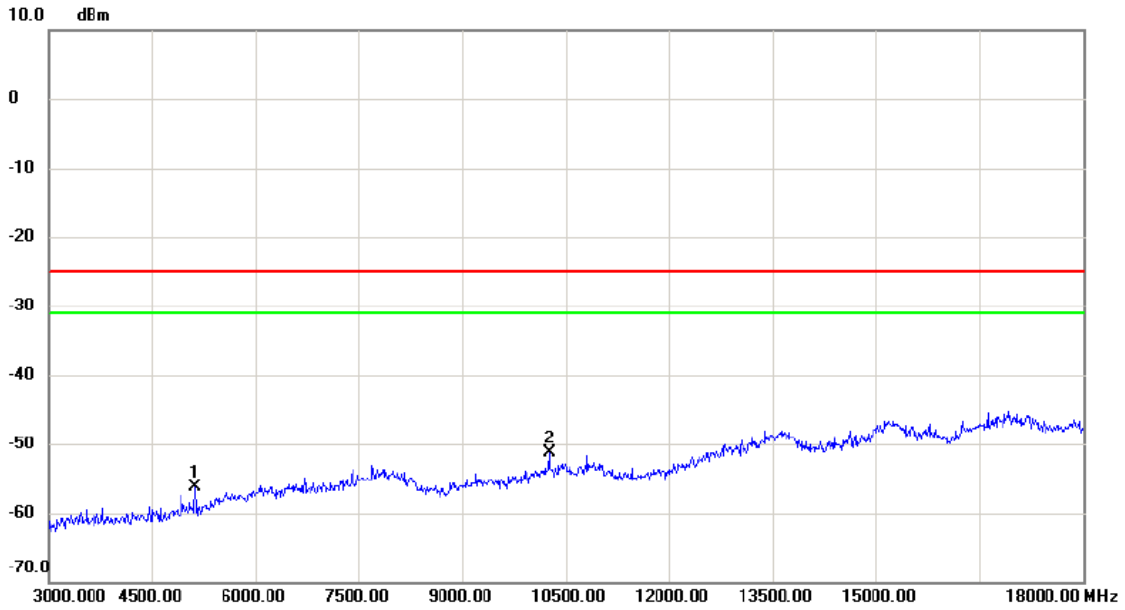

No.	Mk.	Freq. MHz	Reading Level dBm	Correct Factor dB	Measure- ment dBm	Limit dBm	Margin dB	Detector	Comment
1		5130.000	-71.42	15.16	-56.26	-25.00	-31.26	peak	
2	*	10260.000	-73.48	22.15	-51.33	-25.00	-26.33	peak	

Test Mode: LTE Band 7\_TX CH21100\_5M

**Vertical**

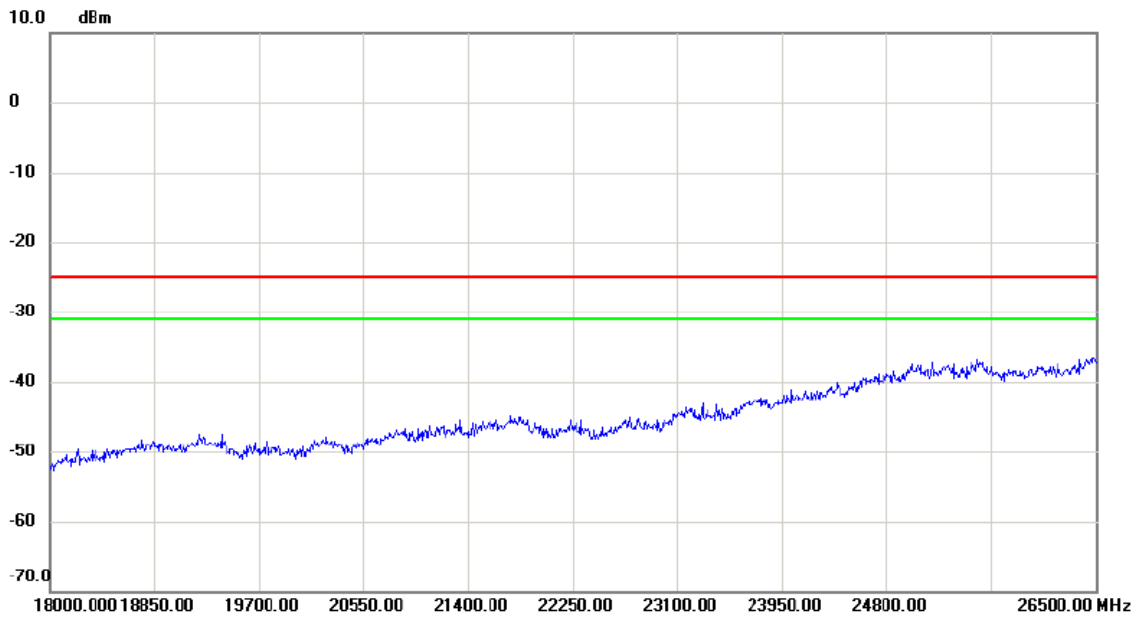

No.	Mk.	Freq. MHz	Reading Level dBm	Correct Factor dB	Measure- ment dBm	Limit dBm	Margin dB	Detector	Comment
-----	-----	--------------	-------------------------	-------------------------	-------------------------	--------------	--------------	----------	---------

Test Mode: LTE Band 7\_TX CH21100\_5M

### Horizontal

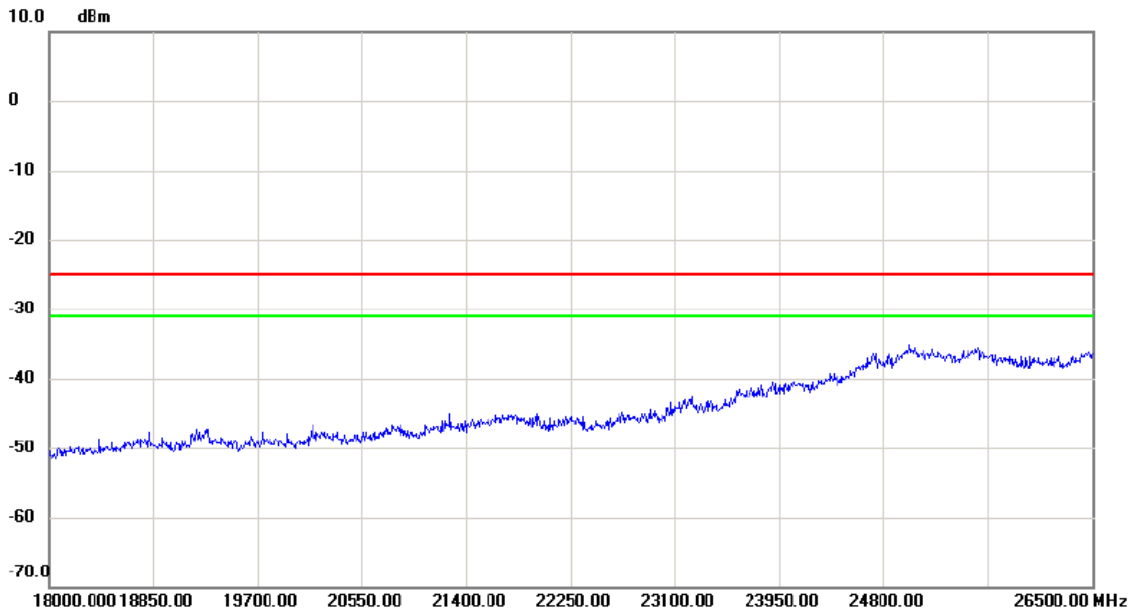

No.	Mk.	Freq.	Reading Level	Correct Factor	Measurement	Limit	Margin	Detector	Comment
		MHz	dBm	dB	dBm	dBm	dB		

Test Mode: LTE Band 7\_TX CH21100\_20M

**Vertical**

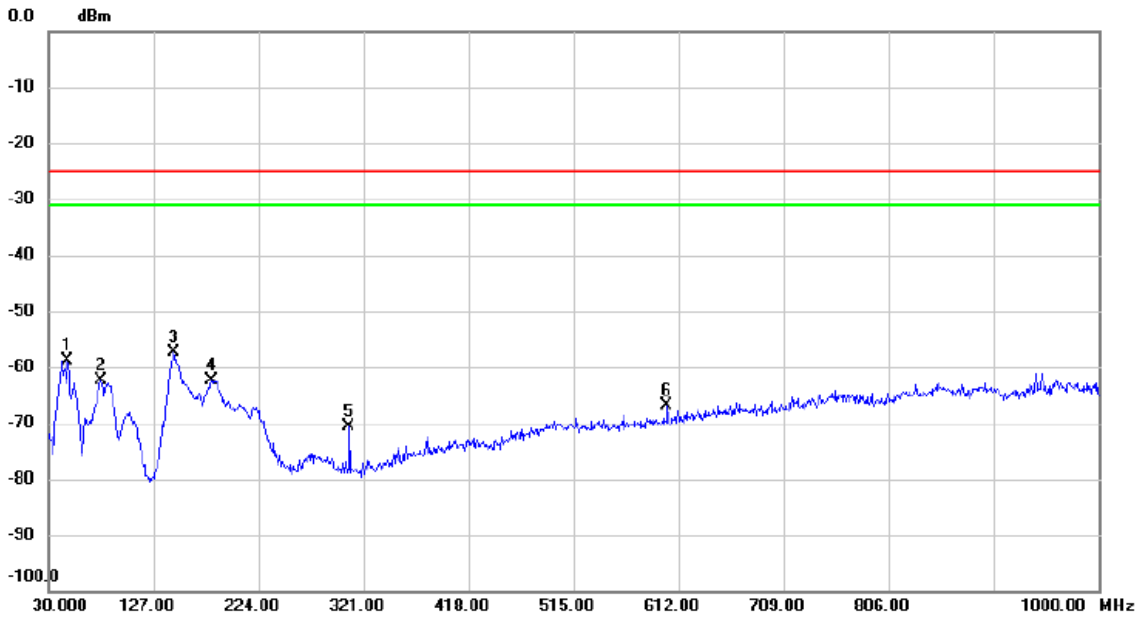

No.	Mk.	Freq. MHz	Reading Level dBm	Correct Factor dB	Measure- ment dBm	Limit dBm	Margin dB	Detector	Comment
1		47.945	-59.93	1.16	-58.77	-25.00	-33.77	peak	
2		78.985	-56.71	-5.70	-62.41	-25.00	-37.41	peak	
3	*	145.915	-60.20	2.74	-57.46	-25.00	-32.46	peak	
4		180.835	-62.94	0.56	-62.38	-25.00	-37.38	peak	
5		307.420	-71.51	0.80	-70.71	-25.00	-45.71	peak	
6		601.330	-75.53	8.74	-66.79	-25.00	-41.79	peak	

Test Mode: LTE Band 7\_TX CH21100\_20M

Horizontal

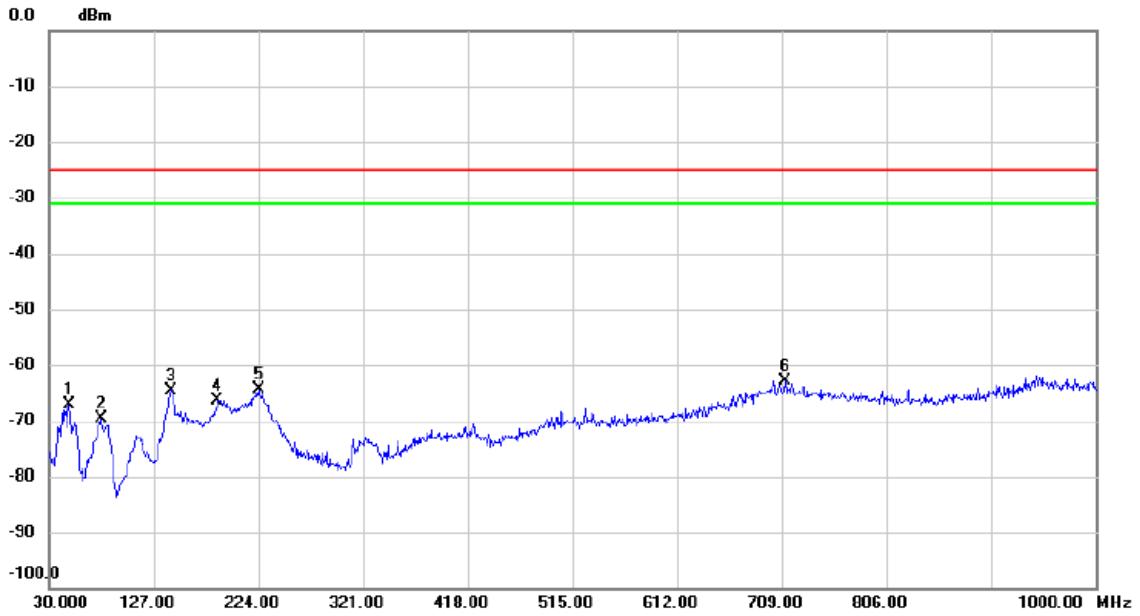

No.	Mk.	Freq. MHz	Reading Level dBm	Correct Factor dB	Measure- ment dBm	Limit dBm	Margin dB	Detector	Comment
1		48.430	-68.97	1.83	-67.14	-25.00	-42.14	peak	
2		78.015	-62.46	-7.26	-69.72	-25.00	-44.72	peak	
3		143.005	-67.96	3.46	-64.50	-25.00	-39.50	peak	
4		186.170	-64.55	-1.83	-66.38	-25.00	-41.38	peak	
5		224.000	-66.01	1.62	-64.39	-25.00	-39.39	peak	
6	*	711.910	-76.53	13.69	-62.84	-25.00	-37.84	peak	

Test Mode: LTE Band 7\_TX CH21100\_20M

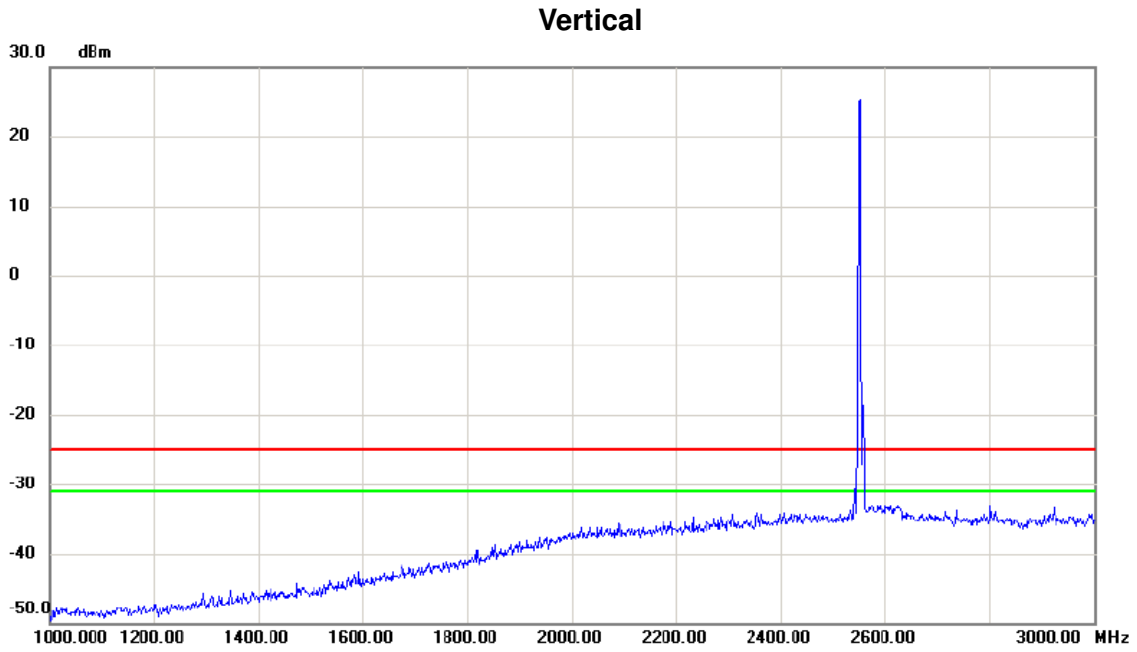

No.	Mk.	Freq. MHz	Reading Level dBm	Correct Factor dB	Measure- ment dBm	Limit dBm	Margin dB	Detector	Comment

Test Mode: LTE Band 7\_TX CH21100\_20M

### Horizontal

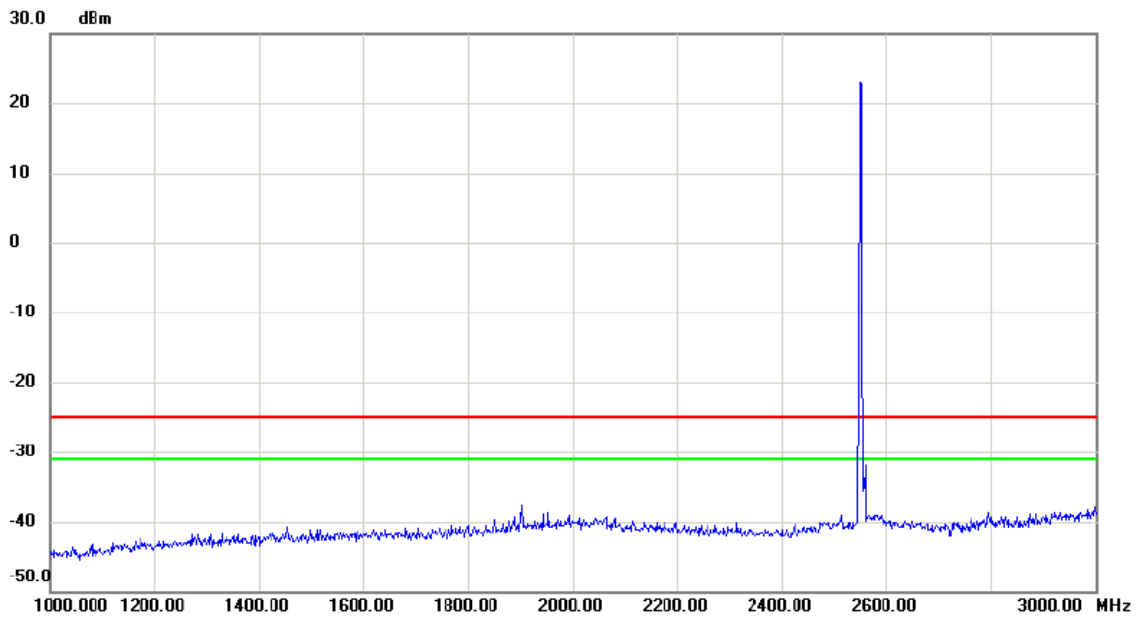

No.	Mk.	Freq. MHz	Reading Level dBm	Correct Factor dB	Measure- ment dBm	Limit dBm	Margin dB	Detector	Comment
		2550.000	22.0	0.0	22.0	-25.0	47.0		

Test Mode: LTE Band 7\_TX CH21100\_20M

Vertical

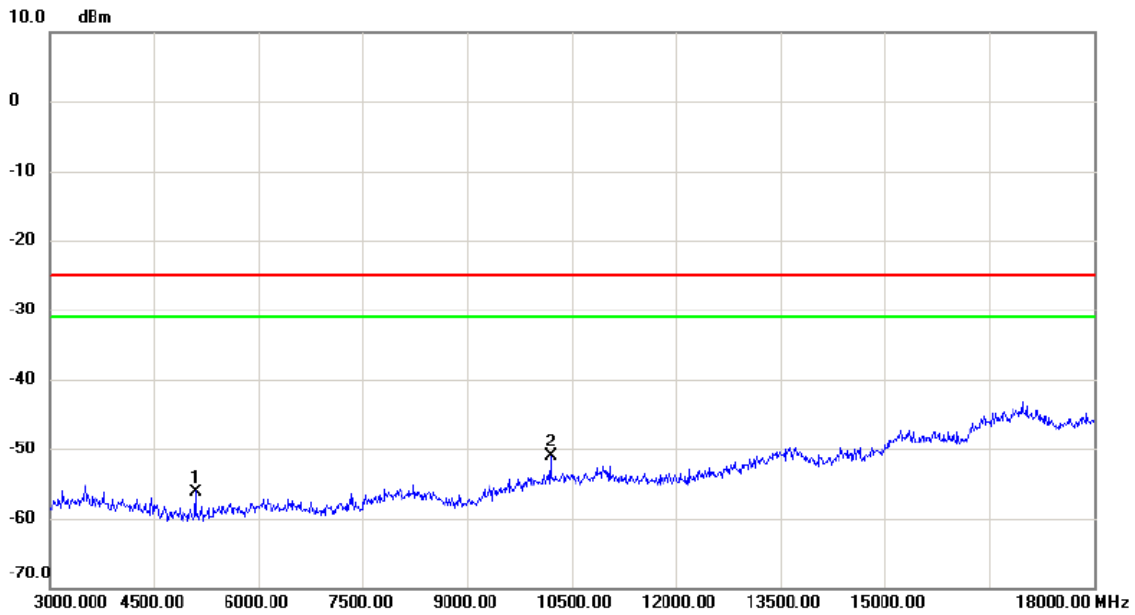

No.	Mk.	Freq. MHz	Reading Level dBm	Correct Factor dB	Measure- ment dBm	Limit dBm	Margin dB	Detector	Comment
1		5100.000	-71.08	14.88	-56.20	-25.00	-31.20	peak	
2	*	10200.000	-72.73	21.67	-51.06	-25.00	-26.06	peak	



Test Mode: LTE Band 7\_TX CH21100\_20M

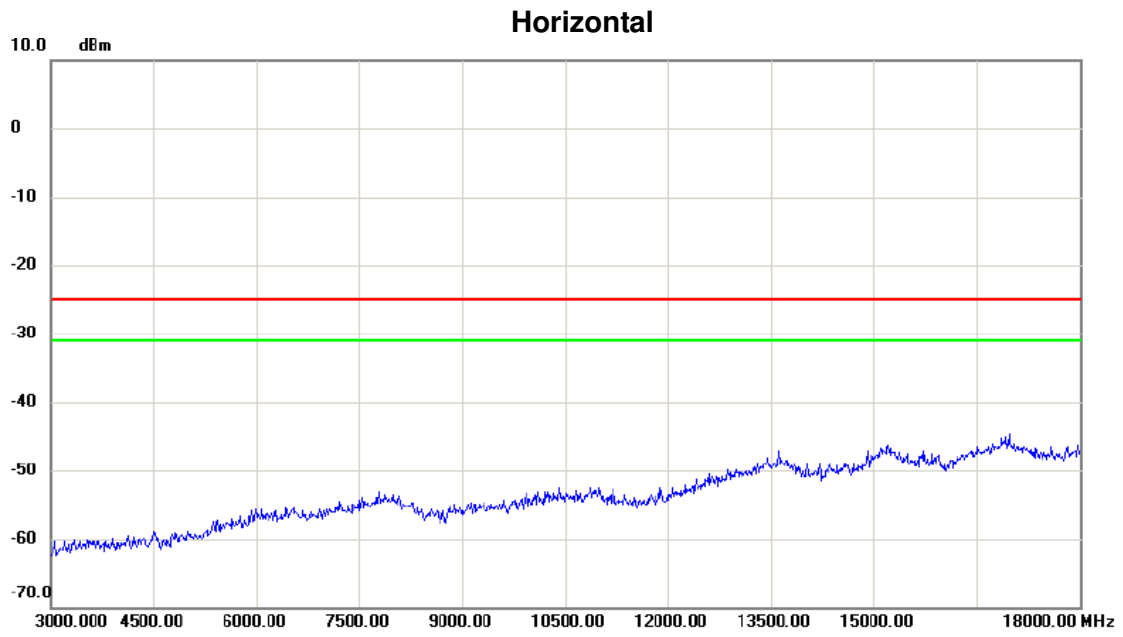

No.	Mk.	Freq. MHz	Reading Level dBm	Correct Factor dB	Measure- ment dBm	Limit dBm	Margin dB	Detector	Comment

Test Mode: LTE Band 7\_TX CH21100\_20M

**Vertical**

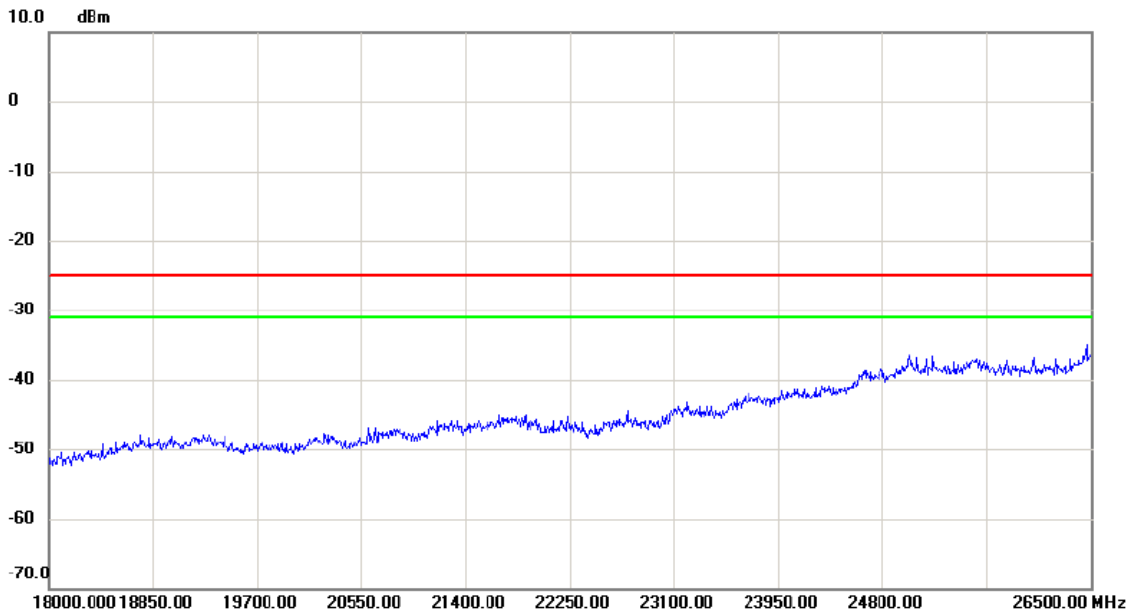

No.	Mk.	Freq.	Reading Level	Correct Factor	Measurement	Limit	Margin	Detector	Comment
		MHz	dBm	dB	dBm	dBm	dB		

Test Mode: LTE Band 7\_TX CH21100\_20M

### Horizontal

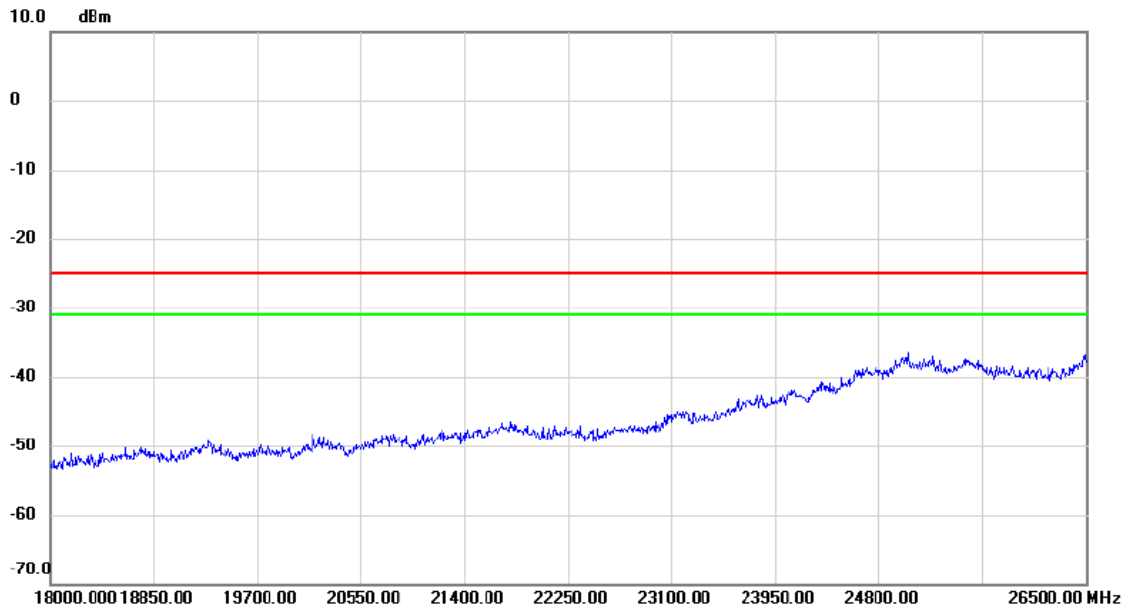

No.	Mk.	Freq.	Reading Level	Correct Factor	Measurement	Limit	Margin	Detector	Comment
		MHz	dBm	dB	dBm	dBm	dB		

## ATTACHMENT E - BAND EDGE

LTE Band 7\_5M

1RB0

1RB24

Channel

20775

Channel

21425

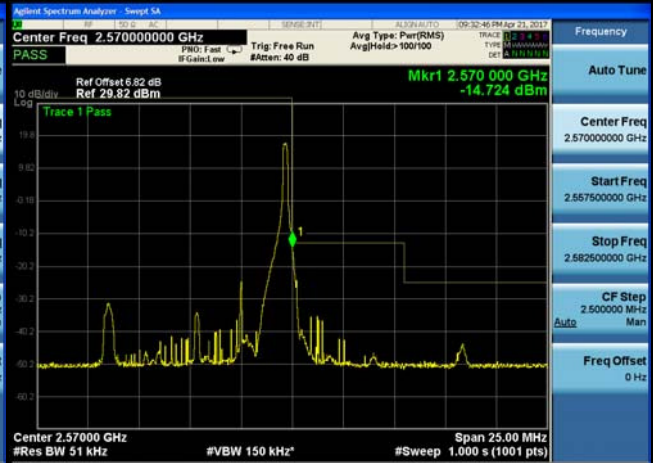
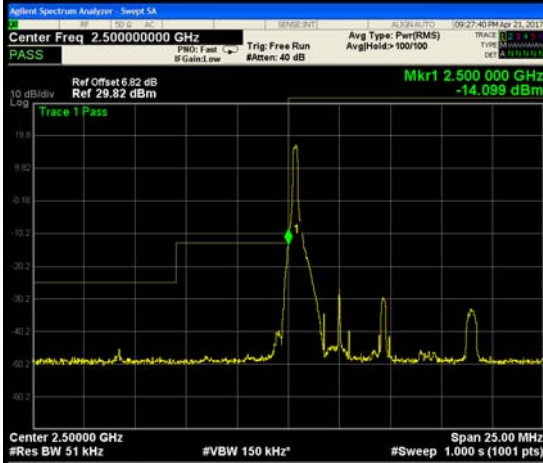

25RB0

Channel

20775

Channel

21425

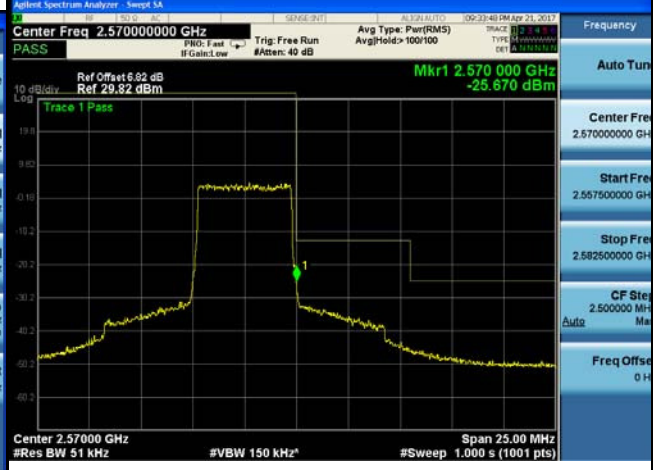
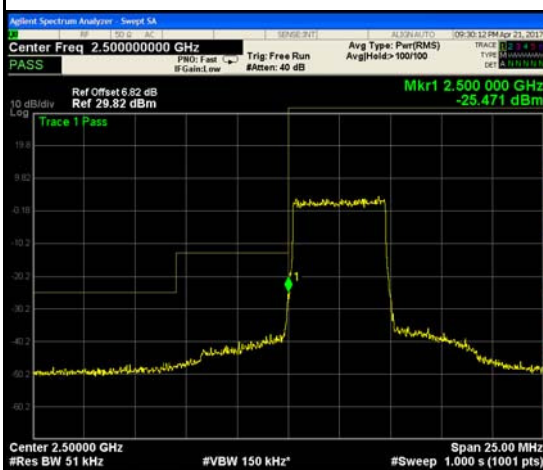

LTE Band 7\_10M

1RB0

1RB49

Channel

20800

Channel

21400

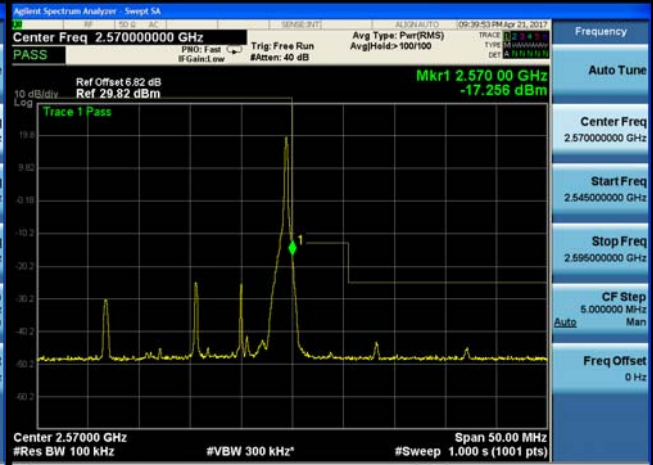

50RB0

Channel

20800

Channel

21400

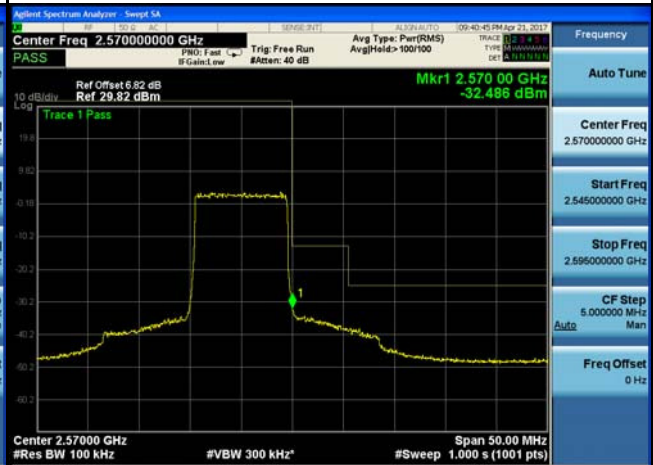

LTE Band 7\_15M

1RB0

1RB74

Channel

20825

Channel

21375

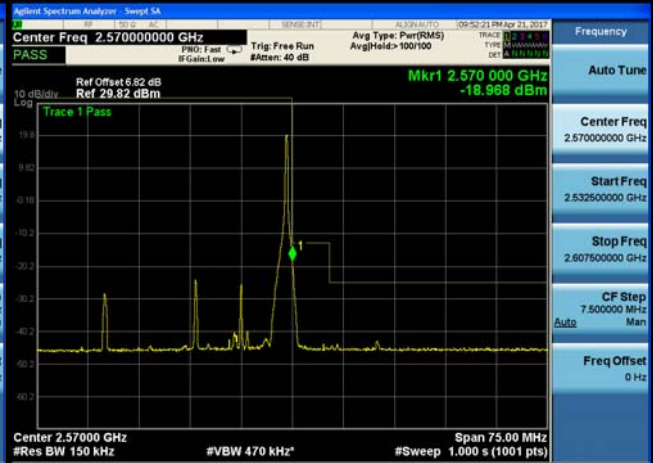
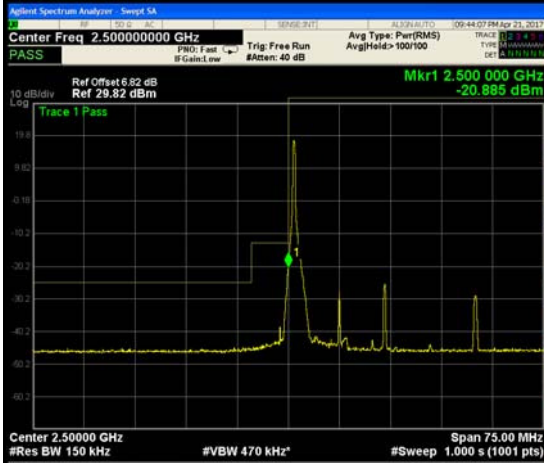

75RB0

Channel

20825

Channel

21375

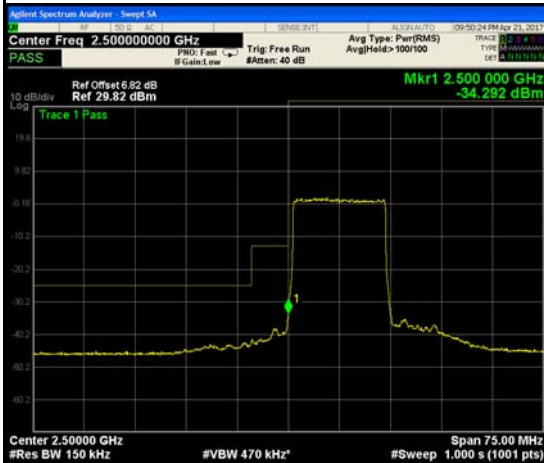

LTE Band 7\_20M

1RB0

1RB99

Channel

20850

Channel

21350

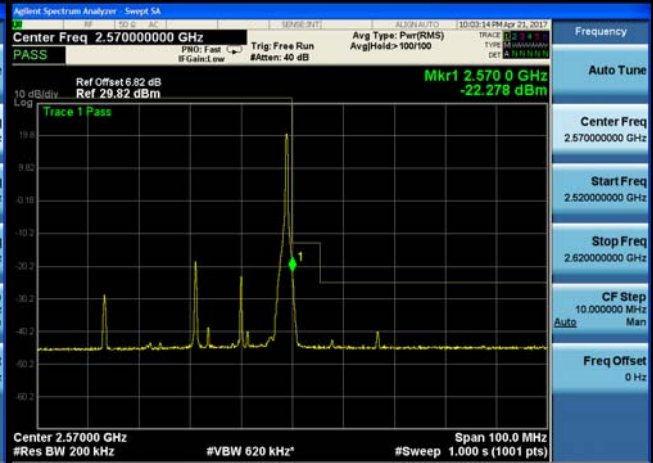
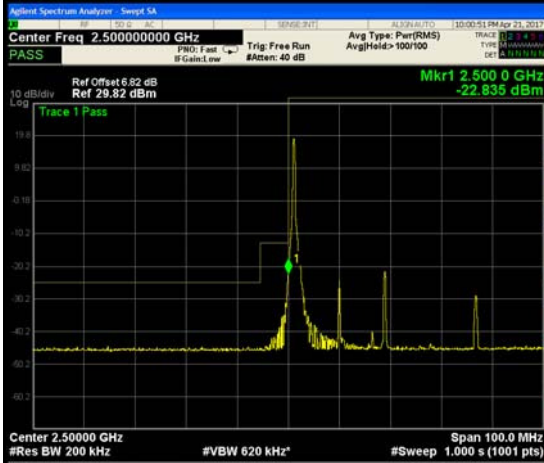

100RB0

Channel

20850

Channel

21350

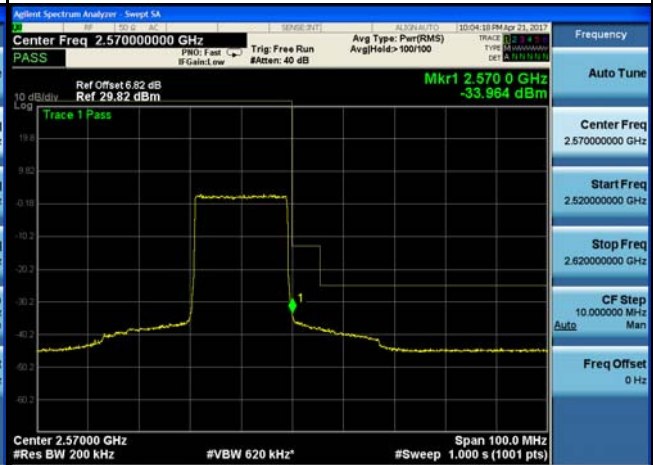



## ATTACHMENT F - PEAK TO AVERAGE RATIO

### LTE Band 7 Spectrum Plot\_5M

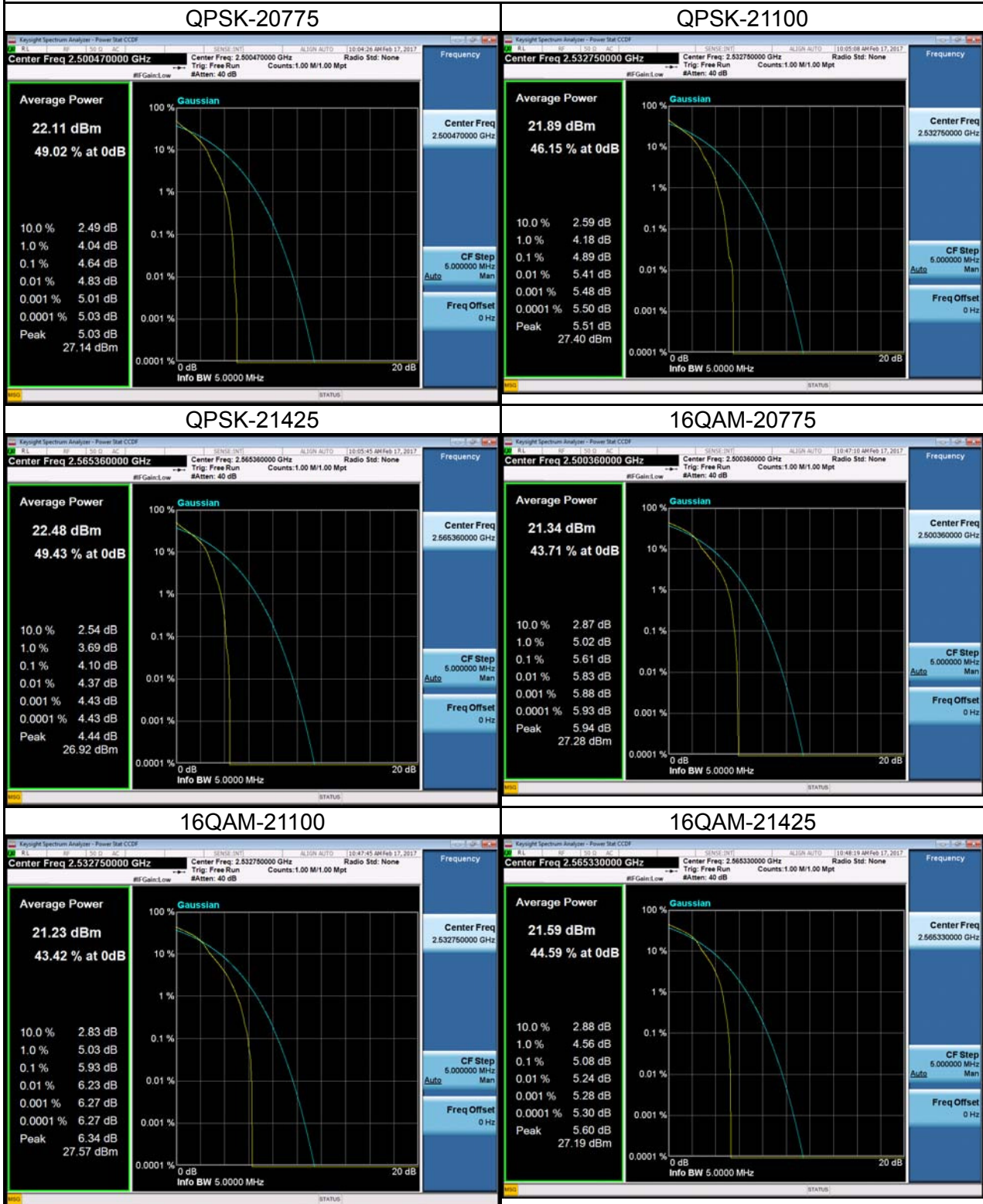

### LTE Band 7 Spectrum Plot\_10M

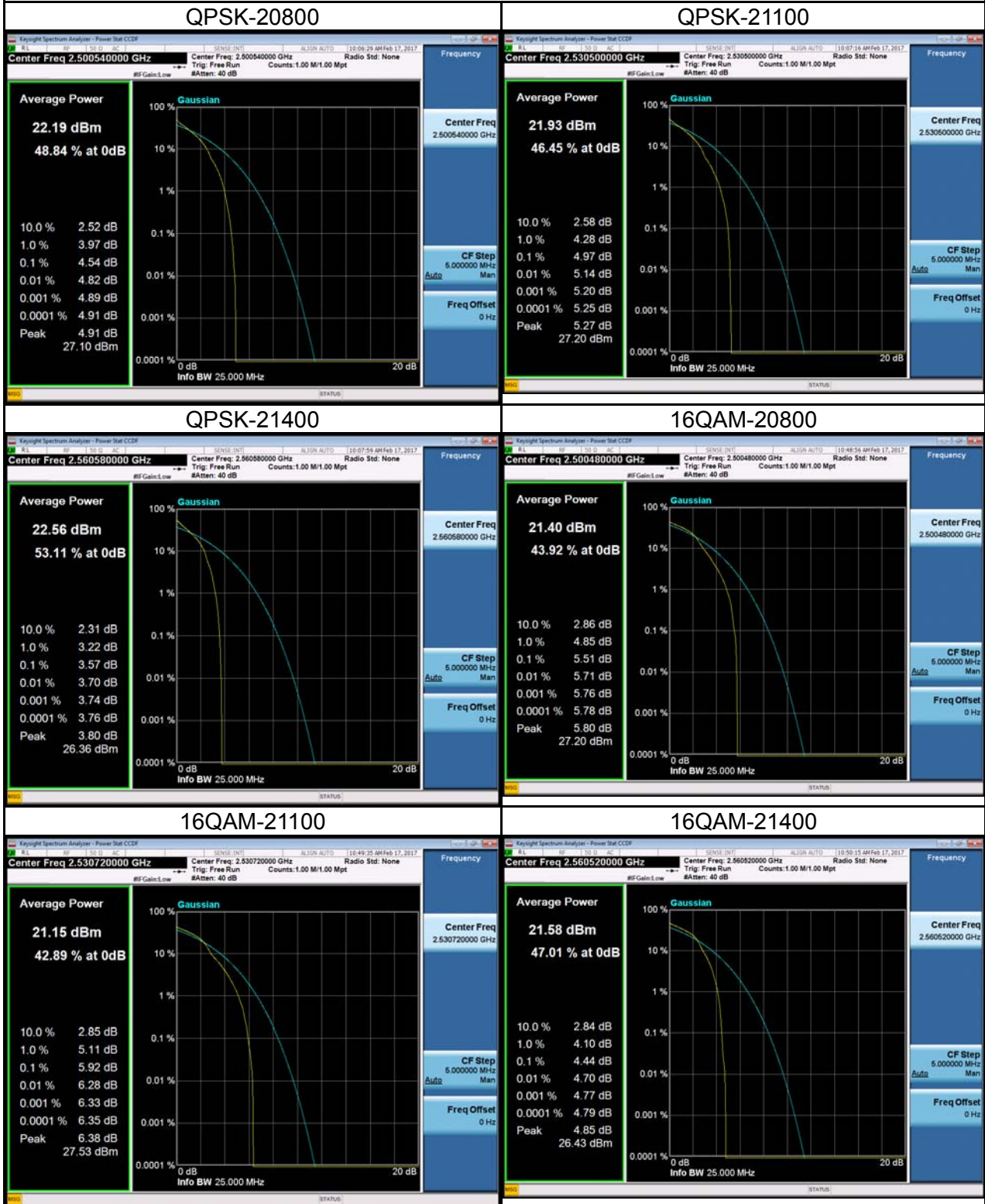

### LTE Band 7 Spectrum Plot\_15M

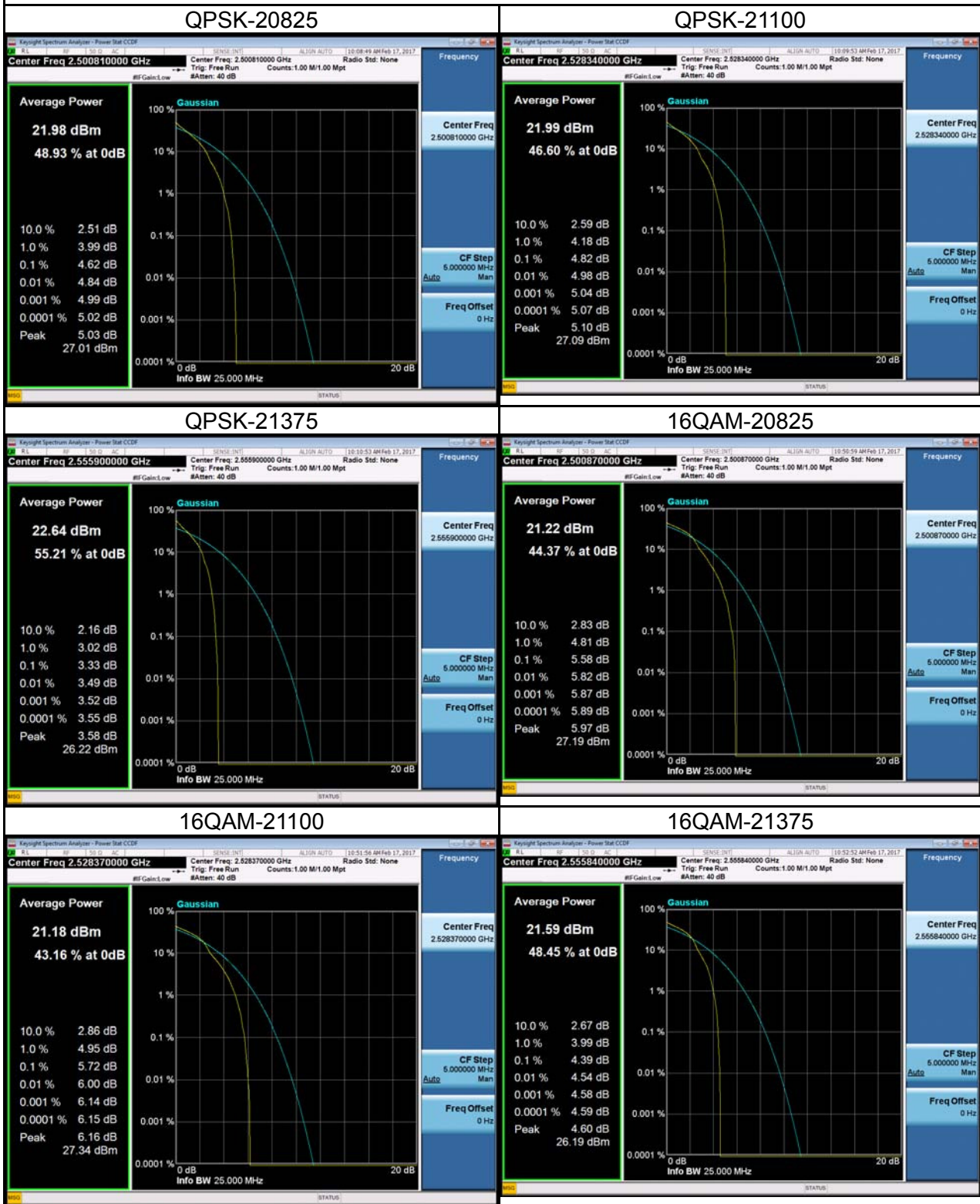

### LTE Band 7 Spectrum Plot\_20M

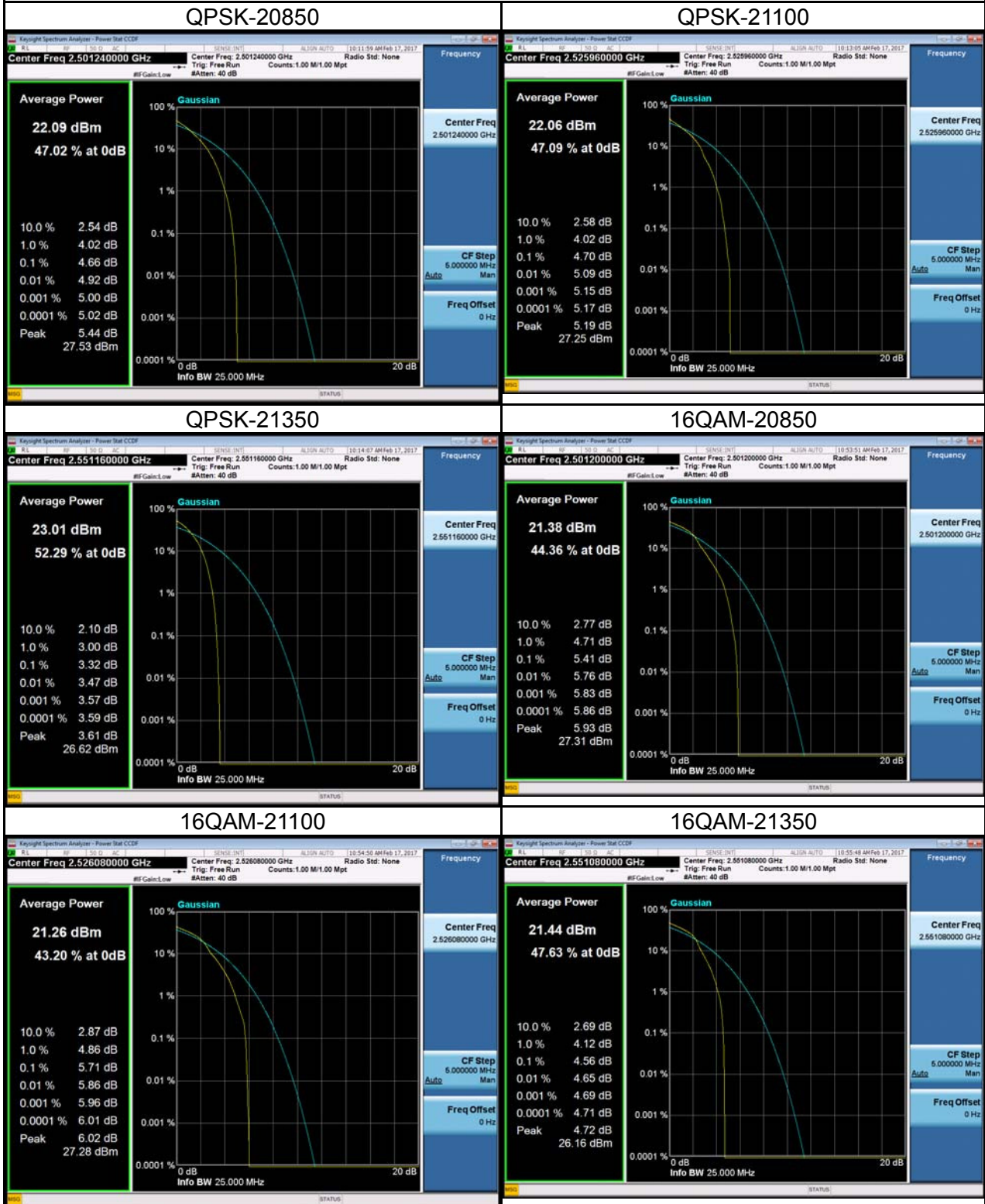

## ATTACHMENT G - FREQUENCY STABILITY

Test Mode:	LTE Band 7_CH21100_5M
------------	-----------------------

### Temperature vs. Frequency Stability

Temperature(°C)	Frequency Error (Hz)	Frequency Error (ppm)	Limit(ppm)
0	3.20	0.001262327	2.5
5	-6.24	0.002461538	2.5
10	1.98	0.000781065	2.5
15	-3.99	0.001573964	2.5
20	1.07	0.000422091	2.5
25	5.16	0.002035503	2.5
30	2.34	0.000923077	2.5
35	-1.99	0.00078501	2.5
Max. Deviation (ppm)	<b>6.24</b>	<b>0.002461538</b>	2.5

### Voltage vs. Frequency Stability

Voltage(Volts)	Frequency Error (Hz)	Frequency Error (ppm)	Limit(ppm)
3.6	6.64	0.002619329	2.5
3.8	6.27	0.002473373	2.5
4.2	3.57	0.001408284	2.5
Max. Deviation (ppm)	<b>6.64</b>	<b>0.002619329</b>	2.5

Test Mode:	LTE Band 7_CH21100_10M
------------	------------------------

### Temperature vs. Frequency Stability

Temperature(°C)	Frequency Error (Hz)	Frequency Error (ppm)	Limit(ppm)
0	3.22	0.001270217	2.5
5	6.14	0.002422091	2.5
10	-6.97	0.002749507	2.5
15	3.28	0.001293886	2.5
20	3.74	0.001475345	2.5
25	-4.61	0.00181854	2.5
30	5.14	0.002027613	2.5
35	3.24	0.001278107	2.5
Max. Deviation (ppm)	<b>6.14</b>	<b>0.002749507</b>	2.5

### Voltage vs. Frequency Stability

Voltage(Volts)	Frequency Error (Hz)	Frequency Error (ppm)	Limit(ppm)
3.6	3.19	0.001258383	2.5
3.8	5.21	0.002055227	2.5
4.2	-3.69	0.001455621	2.5
Max. Deviation (ppm)	<b>5.21</b>	<b>0.002055227</b>	2.5



Test Mode:	LTE Band 7_CH21100_15M
------------	------------------------

### Temperature vs. Frequency Stability

Temperature(°C)	Frequency Error (Hz)	Frequency Error (ppm)	Limit(ppm)
0	3.14	0.001238659	2.5
5	-5.21	0.002055227	2.5
10	-6.28	0.002477318	2.5
15	-3.08	0.00121499	2.5
20	2.27	0.000895464	2.5
25	1.66	0.000654832	2.5
30	5.14	0.002027613	2.5
35	2.68	0.001057199	2.5
Max. Deviation (ppm)	<b>6.28</b>	<b>0.002477318</b>	2.5

### Voltage vs. Frequency Stability

Voltage(Volts)	Frequency Error (Hz)	Frequency Error (ppm)	Limit(ppm)
3.6	2.12	0.000836292	2.5
3.8	1.87	0.000737673	2.5
4.2	-2.94	0.001159763	2.5
Max. Deviation (ppm)	<b>2.94</b>	<b>0.001159763</b>	2.5

Test Mode:	LTE Band 7_CH21100_20M
------------	------------------------

### Temperature vs. Frequency Stability

Temperature(°C)	Frequency Error (Hz)	Frequency Error (ppm)	Limit(ppm)
0	3.75	0.00147929	2.5
5	1.28	0.000504931	2.5
10	-6.29	0.002481262	2.5
15	1.82	0.000717949	2.5
20	4.37	0.001723866	2.5
25	5.24	0.002067061	2.5
30	-1.18	0.000465483	2.5
35	5.02	0.001980276	2.5
Max. Deviation (ppm)	<b>6.29</b>	<b>0.002481262</b>	2.5

### Voltage vs. Frequency Stability

Voltage(Volts)	Frequency Error (Hz)	Frequency Error (ppm)	Limit(ppm)
3.6	1.33	0.000524655	2.5
3.8	5.14	0.002027613	2.5
4.2	3.62	0.001428008	2.5
Max. Deviation (ppm)	<b>5.14</b>	<b>0.002027613</b>	2.5