

FCC Radio Test Report

FCC ID: QISCMR-AL19

This report concerns (check one): Original Grant Class II Change

Project No. : 1712C036
Equipment : Tablet
Model Name : CMR-AL19
Applicant : Huawei Technologies Co., Ltd.
Address : Administration Building, Headquarters of Huawei Technologies Co., Ltd., Bantian, Longgang District Shenzhen China

Date of Receipt : Dec, 02, 2017
Date of Test : Dec, 02, 2017 ~ Jan, 17, 2018
Issued Date : Jan, 18, 2018
Tested by : BTL Inc.

Technical Engineer : Shawn Xiao
(Shawn Xiao)

Authorized Signatory : Steven Lu
(Steven Lu)

B T L I N C .

No.3, Jinshagang 1st Road, Shixia, Dalang Town, Dongguan, Guangdong, China.

TEL: +86-769-8318-3000 FAX: +86-769-8319-6000



Declaration

BTL represents to the client that testing is done in accordance with standard procedures as applicable and that test instruments used has been calibrated with standards traceable to international standard(s) and/or national standard(s).

BTL's reports apply only to the specific samples tested under conditions. It is manufacture's responsibility to ensure that additional production units of this model are manufactured with the identical electrical and mechanical components. **BTL** shall have no liability for any declarations, inferences or generalizations drawn by the client or others from **BTL** issued reports.

BTL's report must not be used by the client to claim product certification, approval, or endorsement by NVLAP, NIST, or any agency of the Federal Government.

This report is the confidential property of the client. As a mutual protection to the clients, the public and **BTL-self**, extracts from the test report shall not be reproduced except in full with **BTL's** authorized written approval.

BTL's laboratory quality assurance procedures are in compliance with the **ISO Guide17025** requirements, and accredited by the conformity assessment authorities listed in this test report.

Limitation

For the use of the authority's logo is limited unless the Test Standard(s)/Scope(s)/Item(s) mentioned in this test report is (are) included in the conformity assessment authorities acceptance respective.

Table of Contents

Page

REPORT ISSUED HISTORY	5
1 . CERTIFICATION	6
2 . SUMMARY OF TEST RESULTS	7
2.1 TEST FACILITY	8
2.2 MEASUREMENT UNCERTAINTY	8
3 . GENERAL INFORMATION	9
3.1 GENERAL DESCRIPTION OF EUT	9
3.2 DESCRIPTION OF TEST MODES AND TEST CONDITION	11
3.3 BLOCKDIAGRAMSHOWINGTHECONFIGURATIONOFSYSTEMTESTED	12
3.4 DESCRIPTION OF SUPPORT UNITS	12
4 . TEST RESULT	13
4.1 OUTPUT POWER MEASUREMENT	13
4.1.1 LIMIT	13
4.1.2 TEST PROCEDURE	13
4.1.3 TESTSETUP LAYOUT	13
4.1.4 TEST DEVIATION	13
4.1.5 TEST RESULTS	13
4.2 OCCUPIED BANDWIDTH MEASUREMENT	14
4.2.1 TEST PROCEDURE	14
4.2.2 TEST SETUP LAYOUT	14
4.2.3 TEST DEVIATION	14
4.2.4 TEST RESULTS	14
4.3 CONDUCTED EMISSIONS MEASUREMENT	15
4.3.1 LIMIT	15
4.3.2 TEST PROCEDURES	15
4.3.3 TESTSETUP LAYOUT	15
4.3.4 TESTDEVIATION	15
4.3.5 TEST RESULTS	15
4.4 RADIATED EMISSIONS MEASUREMENT	16
4.4.1 LIMIT	16
4.4.2 TEST PROCEDURES	16
4.4.3 TESTSETUP LAYOUT	17
4.4.4 TESTDEVIATION	18
4.4.5 TEST RESULTS	18
4.5 BAND EDGE MEASUREMENT	19
4.5.1 LIMIT	19
4.5.2 TEST PROCEDURES	19

Table of Contents	Page
4.5.3 TESTSETUP LAYOUT	19
4.5.4 TESTDEVIATION	19
4.5.5 TEST RESULTS	19
4.6 PEAK TO AVERAGE RATIO MEASUREMENT	20
4.6.1 LIMIT	20
4.6.2 TEST PROCEDURES	20
4.6.3 TESTSETUP LAYOUT	20
4.6.4 TESTDEVIATION	20
4.6.5 TEST RESULTS	20
4.7 FREQUENCY STABILITY MEASUREMENT	21
4.7.1 LIMIT	21
4.7.2 TEST PROCEDURES	21
4.7.3 TESTSETUP LAYOUT	21
4.7.4 TESTDEVIATION	21
4.7.5 TEST RESULTS	21
5. LIST OF MEASUREMENT EQUIPMENTS	22
APPENDIX A - OUTPUT POWER	24
APPENDIX B - OCCUPIED BANDWIDTH	27
APPENDIX C - CONDUCTED EMISSIONS	33
APPENDIX D - RADIATED EMISSION	38
APPENDIX E - BAND EDGE	87
APPENDIX F - PEAK TO AVERAGE RATIO	90
APPENDIX G - FREQUENCY STABILITY	95

REPORT ISSUED HISTORY

Issued No.	Description	Issued Date
BTL-FCCP-7-1712C036	Original Issue.	Jan, 18, 2018

1. CERTIFICATION

Equipment : Tablet
Brand Name : HUAWEI
Model Name : CMR-AL19
Applicant : Huawei Technologies Co.,Ltd.
Manufacturer : Huawei Technologies Co.,Ltd.
Address : Administration Building, Huawei Base, Bantian, Longgang District ,
Shenzhen 518129, P.R.China
Factory : Huawei Technologies Co.,Ltd.
Address : Administration Building, Huawei Base, Bantian, Longgang District ,
Shenzhen 518129, P.R.China
Date of Test : Dec, 02, 2017 ~ Jan, 17, 2018
Test Sample : Engineering Sample
Standard(s) : 47 CFR FCC Part 24 Subpart E
47 CFR FCC Part 2
ANSI/TIA-603-D-2010
KDB 971168 D01 Power Meas License Digital Systems v02r02

The above equipment has been tested and found compliance with the requirement of the relative standards by BTL Inc.

The test data, data evaluation, and equipment configuration contained in our test report (Ref No. BTL-FCCP-7-1712C036) were obtained utilizing the test procedures, test instruments, test sites that has been accredited by the Authority of NVLAP according to the ISO-17025 quality assessment standard and technical standard(s).

Test results included in this report is only for the DCS1900 and WCDMA Band 2 part.

2. SUMMARY OF TEST RESULTS

Test procedures according to the technical standard(s):

FCC Part 24 Subpart E & Part 2			
Standard(s) Section	Test Item	Judgment	Tested By
2.1046 24.232(c)	Radiated power	PASS	Paul Li
2.1046 24.232(c)	Conducted Output Power	PASS	Paul Li
2.1049 24.238(a)	Occupied Bandwidth	PASS	Paul Li
2.1051 24.238(a)	Conducted Spurious Emissions	PASS	Paul Li
2.1053 24.238(a)	Radiated Spurious Emissions	PASS	Paul Li
24.238(a)	Band Edge Measurements	PASS	Paul Li
24.232(d)	Peak To Average Ratio	PASS	Paul Li
2.1055 24.235	Frequency Stability	PASS	Paul Li

Note:

(1) "N/A" denotes test is not applicable to this device.

2.1 TEST FACILITY

The test facilities used to collect the test data in this report is at the location of No.3, Jinshagang 1st Road, Shixia, Dalang Town, Dongguan, Guangdong, China.

BTL's test firm number for FCC: 854385

BTL's designation number for FCC: CN5020

2.2 MEASUREMENT UNCERTAINTY

Where relevant, the following measurement uncertainty levels have been estimated for tests performed on the EUT as specified in CISPR 16-4-2. The BTL measurement uncertainty is less than the CISPR 16-4-2 U_{CISPR} requirement.

The reported uncertainty of measurement $y \pm U$, where expanded uncertainty U is based on a standard uncertainty multiplied by a coverage factor of $k=2$, providing a level of confidence of approximately **95%**.

A. Radiated Measurement :

Test Site	Method	Measurement Frequency Range	Ant. H / V	U,(dB)
DG-CB03 (3m)	CISPR	9KHz ~ 30MHz	V	3.79
		9KHz ~ 30MHz	H	3.57
		30MHz ~ 200MHz	V	3.82
		30MHz ~ 200MHz	H	3.78
		200MHz ~ 1,000MHz	V	4.10
		200MHz ~ 1,000MHz	H	4.06

Test Site	Method	Measurement Frequency Range	Ant. H / V	U,(dB)
DG-CB03 (3m)	CISPR	1GHz ~ 18GHz	V	3.12
		1GHz ~ 18GHz	H	3.68

Test Site	Method	Measurement Frequency Range	Ant. H / V	U,(dB)
DG-CB03 (1m)	CISPR	18GHz ~ 40GHz	V	4.15
		18GHz ~ 40GHz	H	4.14

Note: Unless specifically mentioned, the uncertainty of measurement has not been taken into account to declare the compliance or non-compliance to the specification.

3. GENERAL INFORMATION

3.1 GENERAL DESCRIPTION OF EUT

Equipment	Tablet			
Brand Name	HUAWEI			
Model Name	CMR-AL19			
Model Difference	N/A			
Modulation Type	GSM/GPRS	GMSK		
	EDGE	GMSK, 8PSK		
	WCDMA	UP: BPSK DL: QPSK		
	WCDMA(HSDPA/HSUPA)	16QAM		
Operation Frequency	GSM /EDGE/GPRS	1850.2 ~ 1909.8 MHz		
	WCDMA Band 2	1852.4 ~ 1907.6 MHz		
Max. EIRP Power	GSM/GPRS	GMSK	31.08	dBm
	EDGE	8PSK	27.56	dBm
	WCDMA	BPSK	24.18	dBm
	WCDMA_HSDPA	16QAM	23.83	dBm
	WCDMA_HSUPA	16QAM	22.77	dBm
Antenna Type	Fixed Internal Antenna			
Antenna Gain	1.3 dBi			
Hardware Version	SH1CMRONLM			
Software Version	CMR-AL19 8.0.1.3(SP1C331)			
IMEI No.	Radiated	867030030002165		
	Conducted	867030030002397		
Power Source	#1 Supplied from AC/DC adapter. #2 Battery Supplied.			
Power Rating	#1 Input: 100V~240V AC and 50/60 Hz,0.5A Output: 5V -- --2A OR 9V -- --2A #2 --- --3.82V 7350mAh			

Note:

1. For a more detailed features description, please refer to the manufacturer's specifications or the user's manual.
2. The EUT contains following accessory devices.

Item	Mfr/Brand	Model.
Battery	SCUD (FUJIAN) Electronics Co., Ltd	HB2994I8ECW
	Sunwoda Electronic Co., LTD.	HB2994I8ECW
	Huizhou Desay Battery Co., Ltd	HB2994I8ECW
USB Cable	HONGLIN TECHNOLOGY CO.,LTD	130-26988
	Luxshare Precision Industry Co., Ltd	L99UC001-CS-H
	FOXCONN INTERCONNECT TECHNOLOGY LIMITED	CUDU01B-HC288-EH
	foxlink cheng uei precision industry Co., Ltd	6691-10YZ-0183
USB Type-C to 3.5 mm headset jack adapter cable	FOSTER ELECTRIC CO. (HONG KONG) LTD	620891
	Boluo County Quancheng Electronic Co.,Ltd.	6001-7001-TC-294
	Jiangxi Lianchuang Hongsheng Electronic Co.,LTD	HWTYPEC3R5009AW
	MERRY ELECTRONICS CO., LTD.	L99UD002-CS-H
Adapter	Salcomp (Shenzhen) Co., Ltd.	HW-059200UHQ
	HUIZHOU BYD ELECTRONIC CO.,LTD	

3.2 DESCRIPTION OF TEST MODES AND TEST CONDITION

Pre-Scan has been conducted to determine the worst-case mode from all possible combinations between available modulations, data rates, XYZ axis and antenna ports
 The worst case was found when positioned on X-plane for EIRP and X-axis for radiated emission.
 Following channel(s) was (were) selected for the final test as listed below:

GSM MODE			
Test Item	Available Channel	Tested Channel	Mode
EIRP	512 to 810	512, 661, 810	GSM, EDGE
Conducted Output Power	512 to 810	512, 661, 810	GSM, EDGE
Occupied Bandwidth	512 to 810	512, 661, 810	GSM, EDGE
Condcudeted Emission	512 to 810	661	GSM, EDGE
Radiated Emission	512 to 810	661	GSM, EDGE
Band Edge	512 to 810	512, 810	GSM, EDGE
Peak to Average Ratio	512 to 810	512, 661, 810	GSM, EDGE
Frequency Stability	512 to 810	661	GSM

WCDMA MODE			
Test Item	Available Channel	Tested Channel	Mode
EIRP	9262 to 9538	9262, 9400, 9538	WCDMA, HSDPA, HSUPA, DC-HSDPA
Conducted Output Power	9262 to 9538	9262, 9400, 9538	WCDMA, HSDPA, HSUPA, DC-HSDPA
Condcudeted Emission	9262 to 9538	9400	WCDMA, HSDPA, HSUPA
Radiated Emission	9262 to 9538	9400	WCDMA, HSDPA, HSUPA
Band Edge	9262 to 9538	9262, 9538	WCDMA, HSDPA, HSUPA
Peak to Average Ratio	9262 to 9538	9262, 9400, 9538	WCDMA, HSDPA, HSUPA
Frequency Stability	9262 to 9538	9262	WCDMA

Note: This device was tested under all bandwidths, RB configurations and modulations. The worst case was found in **QPSK** modulation.

EUT TEST CONDITIONS:

Test Item	Environmental Conditions	Test Voltage
EIRP	25°C, 60%RH	DC 3.82V
Conducted Output Power	25°C, 65%RH	DC 3.82V
Occupied Bandwidth	25°C, 65%RH	DC 3.82V
Conducted Emission	25°C, 65%RH	DC 3.82V
Radiated Emission	25°C, 60%RH	AC 120V/60Hz
Band Edge	25°C, 65%RH	DC 3.82V
Peak to Average Ratio	25°C, 65%RH	DC 3.82V
Frequency Stability	25°C, 65%RH	DC 3.82V

3.3 BLOCK DIAGRAM SHOWING THE CONFIGURATION OF SYSTEM TESTED

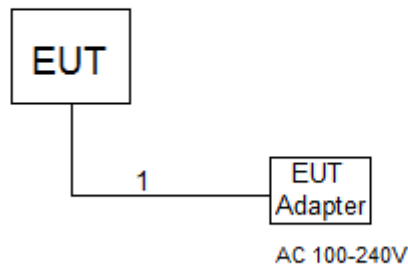

3.4 DESCRIPTION OF SUPPORT UNITS

The EUT has been tested as an independent unit together with other necessary accessories or support units. The following support units or accessories were used to form a representative test configuration during the tests.

Item	Equipment	Mfr/Brand	Model/Type No.	FCC ID	Series No.
-	-	-	-	-	-

Item	Shielded Type	Ferrite Core	Length	Note
1	NO	NO	1.2m	USB cable

4. TEST RESULT

4.1 OUTPUT POWER MEASUREMENT

4.1.1 LIMIT

Mobile / Portable station are limited to 2 watts e.i.r.p.

4.1.2 TEST PROCEDURE

EIRP/ERP:

EIRP= Conducted Power +Antenan gain

ERP power=EIPR power-2.15dBi.

Conducted Power:

The EUT was set up for the maximum power with GSM, GPRS, EDGE, WCDMA and CDMA data modulation and link up with simulator. Set the EUT to transmit under low, middle and high channel and record the power level shown on simulator.

4.1.3 TESTSETUP LAYOUT

Conducted Power Measurement

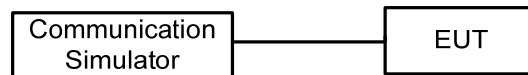

4.1.4 TEST DEVIATION

No deviation

4.1.5 TEST RESULTS

Please refer to the Appendix A.

4.2 OCCUPIED BANDWIDTH MEASUREMENT

4.2.1 TEST PROCEDURE

The EUT makes a call to the communication simulator. All measurements were done at low, middle and high operational frequency range. The communication simulator station system controlled a EUT to export maximum output power under transmission mode and specific channel frequency. Use OBW measurement function of Spectrum analyzer to measure 99 % occupied bandwidth and 26dB bandwidth.

4.2.2 TEST SETUP LAYOUT

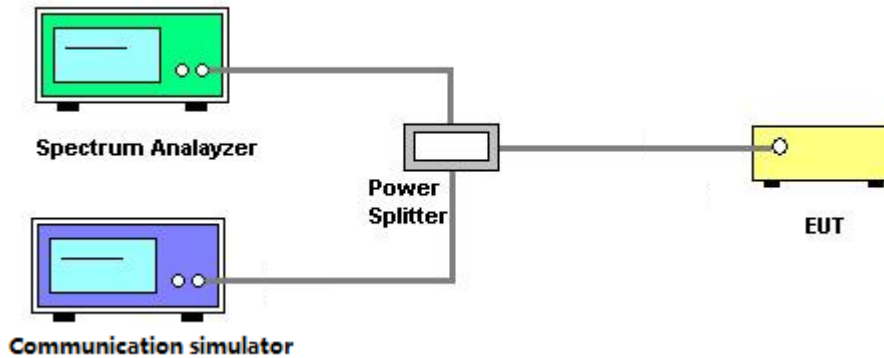

4.2.3 TEST DEVIATION

No deviation

4.2.4 TEST RESULTS

Please refer to the Appendix B.

4.3 CONDUCTED EMISSIONS MEASUREMENT

4.3.1 LIMIT

The power of any emission outside of the authorized operating frequency ranges must be attenuated below the transmitting power (P) by a factor of at least $43 + 10 \log(P)$ dB. The emission limit equal to -13dBm .

4.3.2 TEST PROCEDURES

1. The testing follows FCC KDB 971168 v02r02 Section 6.0.
2. The EUT was connected to spectrum analyzer and system simulator via a power divider.
3. The band edges of low and high channels for the highest RF powers were measured. Set $\text{RBW} \geq 1\%$ EBW in the 1MHz band immediately outside and adjacent to the band edge.
4. Set spectrum analyzer with RMS detector.
5. The RF fundamental frequency should be excluded against the limit line in the operating frequency band.
6. The limit line is derived from $43+10\log(P)\text{dB}$ below the transmitter power P(Watts)
 $=P(W)-[43+10\log(P)](\text{dB})$
 $=[30+10\log(P)](\text{dBm})-[43+10\log(P)](\text{dB})$
 $=-13\text{dBm}$

4.3.3 TESTSETUP LAYOUT

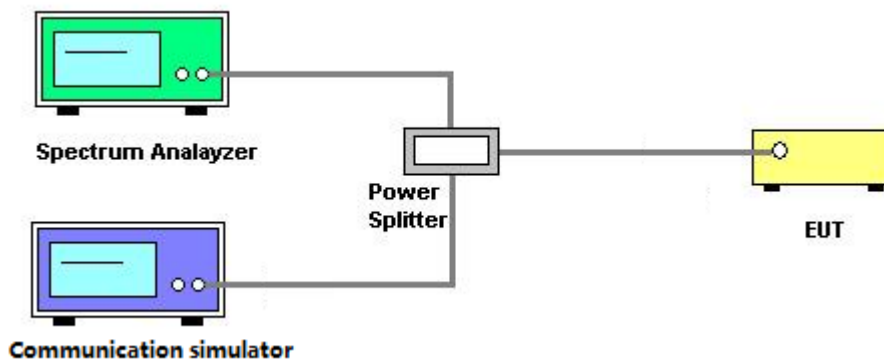

4.3.4 TESTDEVIATION

No deviation

4.3.5 TEST RESULTS

Please refer to the Appendix C.

4.4 RADIATED EMISSIONS MEASUREMENT

4.4.1 LIMIT

The power of any emission outside of the authorized operating frequency ranges must be attenuated below the transmitting power (P) by a factor of at least $43 + 10 \log(P)$ dB. The emission limit equal to -13dBm.

4.4.2 TEST PROCEDURES

1. Substitution method is used for E.I.R.P measurement. In the semi-anechoic chamber, EUT placed on the 0.8m height of Turn Table, rotated the table around 360 degrees to search the maximum radiation power and receiver antenna shall be rotated vertical and horizontal polarization and moved height from 1m to 4m to find the maximum polar radiated power. The "Read Value" is the spectrum reading the maximum power value.
2. The substitution horn antenna is substituted for EUT at the same position and signals generator export the CW signal to the substitution antenna via a TX cable. Rotated the Turn Table and moved receiving antenna to find the maximum radiation power. Adjust output power level of S.G to get a Value of spectrum reading equal to "Read Value " of step a. Record the power level of S.G
3. EIRP = Output power level of S.G – TX cable loss + Antenna gain of substitution horn.
4. E.R.P power can be calculated form E.I.R.P power by subtracting the gain of dipole, E.R.P power = E.I.P.R power - 2.15dBi.
5. The resolution bandwidth and video bandwidth of test receiver/spectrum analyzer is 1MHz/3MHz.

4.4.3 TESTSETUP LAYOUT

Below 1G

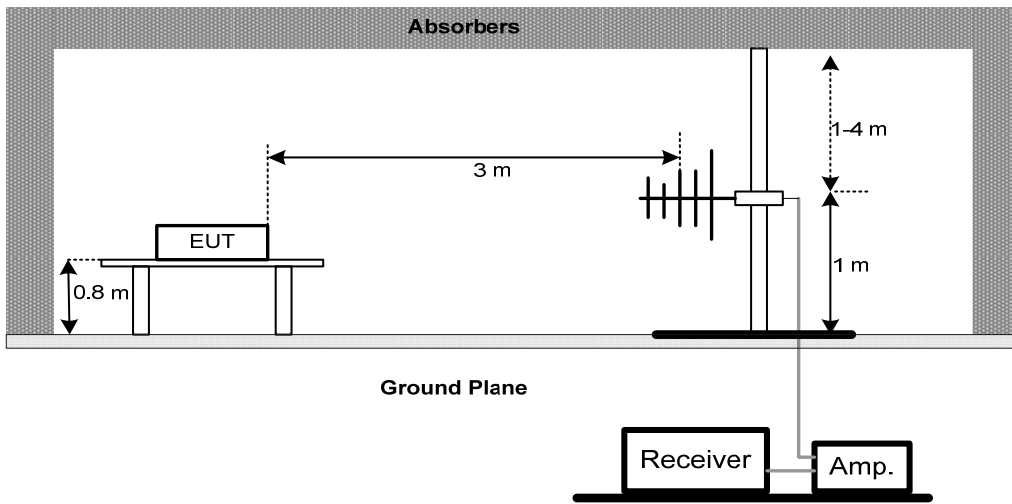

Above 1G

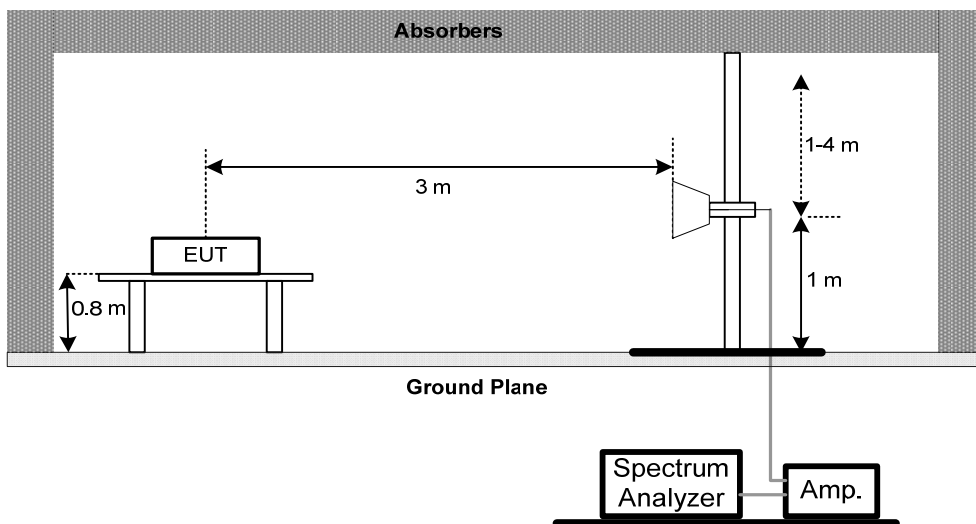

Below 30MHz

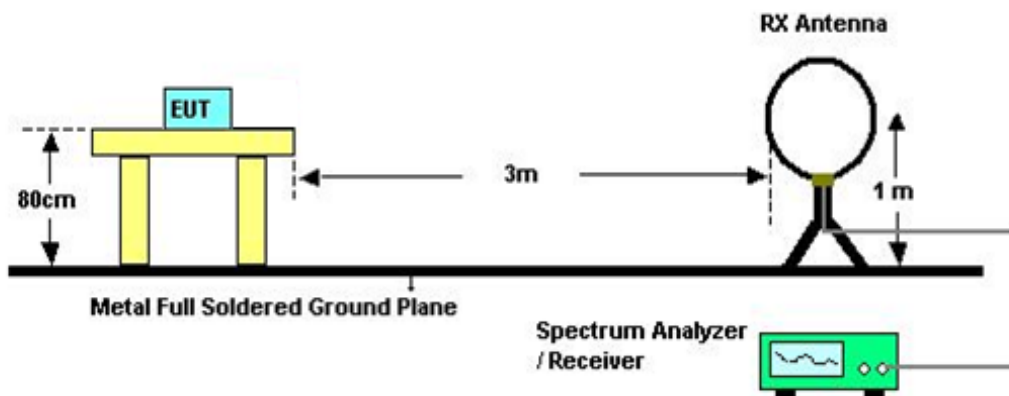

4.4.4 TEST DEVIATION

No deviation

4.4.5 TEST RESULTS

Please refer to the Appendix D.

4.5 BAND EDGE MEASUREMENT

4.5.1 LIMIT

A Power of any emission outside of the authorized operating frequency ranges must be attenuated below the transmitting power (P) by a factor of at least $43 + 10 \log(P)$ dB. In the 1 MHz bands immediately outside and adjacent to the frequency block a resolution bandwidth of at least one percent of the emission bandwidth of the fundamental emission of the transmitter may be employed.

4.5.2 TEST PROCEDURES

1. All measurements were done at low and high operational frequency range.
2. The center frequency of spectrum is the band edge frequency and span is 1MHz. RB of the spectrum is 3kHz and VB of the spectrum is 10kHz (GSM/GPRS/EDGE).
3. The center frequency of spectrum is the band edge frequency and span is 5MHz. RB of the spectrum is 100kHz and VB of the spectrum is 300kHz (WCDMA).
4. Record the max trace plot into the test report.

4.5.3 TESTSETUP LAYOUT

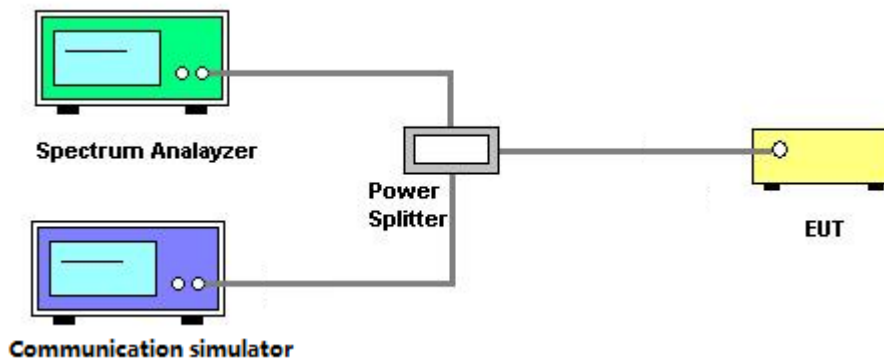

4.5.4 TESTDEVIATION

No deviation

4.5.5 TEST RESULTS

Please refer to the Appendix E.

4.6 PEAK TO AVERAGE RATIO MEASUREMENT

4.6.1 LIMIT

In measuring transmissions in this band using an average power technique, the peak to-average ratio (PAR) of the transmission may not exceed 13 dB.

4.6.2 TEST PROCEDURES

1. Set resolution/measurement bandwidth \geq signal's occupied bandwidth;
2. Set the number of counts to a value that stabilizes the measured CCDF curve;
3. Record the maximum PAPR level associated with a probability of 0.1%.

4.6.3 TESTSETUP LAYOUT

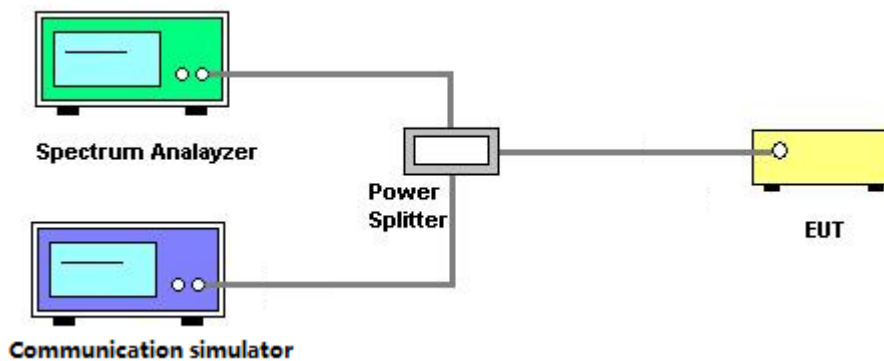

4.6.4 TESTDEVIATION

No deviation

4.6.5 TEST RESULTS

Please refer to the Appendix F.

4.7 FREQUENCY STABILITY MEASUREMENT

4.7.1 LIMIT

1.5 ppm is for base and fixed station. 2.5 ppm is for mobile station.

4.7.2 TEST PROCEDURES

1. Device is placed at the oven room. The oven room could control the temperatures and humidity. Power warm up is at least 15 min and power applied should perform before recording frequency error.
2. EUT is connected the external power supply to control the DC input power. The test voltage range is from minimum to maximum working voltage. Each step shall be record the frequency error rate.
3. The temperature range step is 10 degrees in this test items. All temperature levels shall be hold the $\pm 0.5^{\circ}\text{C}$ during the measurement testing. The each temperature step shall be at least 0.5 hours, consider the EUT could be test under the stability condition.
4. The frequency error was recorded frequency error from the communication simulator.

4.7.3 TESTSETUP LAYOUT

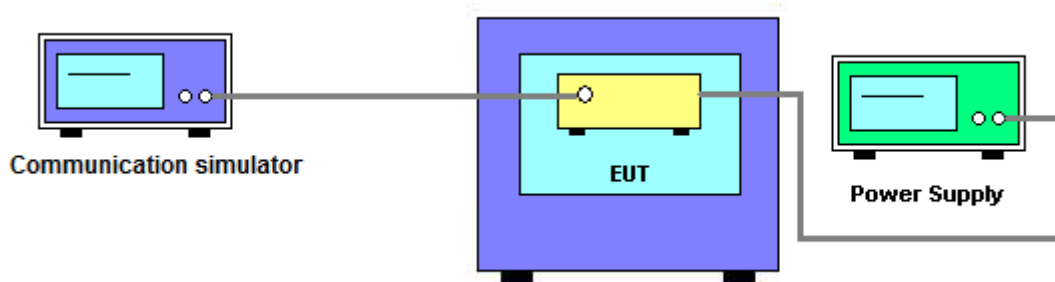

4.7.4 TESTDEVIATION

No deviation

4.7.5 TEST RESULTS

Please refer to the Appendix G.

5. LIST OF MEASUREMENT EQUIPMENTS

Radiated Emission & ERP or EIRP Measurement					
Item	Kind of Equipment	Manufacturer	Type No.	Serial No.	Calibrated until
1	Antenna	Schwarbeck	VULB9160	9160-3232	Mar. 26, 2018
2	Double Ridged Guide Antenna	ETS	3115	75789	Mar. 26, 2018
3	Broad-Band Horn Antenna	Schwarzbeck	BBHA 9170	9170319	Apr. 22, 2018
4	Amplifier	Agilent	8449B	3008A02274	Mar. 09, 2018
5	Amplifier	HP	8447D	2944A09673	Oct. 19, 2018
6	HighPass Filter	Wairwright Instruments Gmbh	WHK 1.5/15G-10ST	11	Mar. 09, 2018
7	Band Reject Filter	Wairwright Instruments Gmbh	WRCG 1710/1785-1690/180 5-60/12SS	38	Feb. 22, 2018
8	Band Reject Filter	Wairwright Instruments Gmbh	WRCG 824/849-810/863-60/ 9SS	7	Feb. 22, 2018
9	Band Reject Filter	Wairwright Instruments Gmbh	WRCG 880/915-860/935-60/ 9SS	14	Feb. 22, 2018
10	Band Reject Filter	Wairwright Instruments Gmbh	WRCG 1850/1910-1830/193 0-60/10SS	17	Feb. 22, 2018
11	HighPass Filter	Wairwright Instruments Gmbh	WHK3.1/18G-10SS	24	Mar. 09, 2018
12	Wireless Communication Test SET	Agilent	E5515C	MY48364183	Mar. 26, 2018
13	Microwave Preamplifier With Adaptor	EMC INSTRUMENT	EMC2654045	980039 & HA01	Mar. 26, 2018
14	Receiver	Agilent	N9038A	MY52130039	Sep. 03, 2018
15	wideband radio communication tester	R&S	CMW500	152372	Mar. 26, 2018
16	High pass filter	ZHPF-M1000-4000-1	ZHPF-M3-12.75G-3869	B2015073763	Aug. 03, 2018
17	High pass filter	ZHPF-M3-12.75G-3869	ZHPF-M1000-4000-1	B2015073762	Aug. 03, 2018
18	High pass filter	ZHPF-M6-18G-1727	ZHPF-M6-186-1727	B2015073764	Aug. 03, 2018
19	Cable	emci	LMR-400(30MHz-1GHz)(8m+5m)	N/A	Jun. 26, 2018
20	Cable	emci	EMC104-SM-SM-12000(12m)	N/A	Jul. 05, 2018
21	Controller	ETS-Lindgren	2090	N/A	N/A
22	Measurement Software	Farad	EZ-EMC Ver.NB-03A1-01	N/A	N/A

Conducted Emission & Band Edge & Occupied Bandwidth Measurement					
Item	Kind of Equipment	Manufacturer	Type No.	Serial No.	Calibrated until
1	Wireless Communication Test SET	Agilent	E5515C	MY48364183	Mar. 26, 2018
2	EXA Spectrum Analyzer	Agilent	N9010A	MY50520044	Mar. 26, 2018
3	POWER SPLITTER	Mini-Circuits	ZFRSC-123-S+	331000910-1	Feb. 25, 2018
4	wideband radio communication tester	R&S	CMW500	152372	Mar. 26, 2018
5	Cable	N/A	RG316(0.3m)	N/A	Jul. 05, 2018
6	Cable	N/A	RG316(0.3m)	N/A	Jul. 05, 2018

Frequency Stability Measurement					
Item	Kind of Equipment	Manufacturer	Type No.	Serial No.	Calibrated until
1	Wireless Communication Test SET	Agilent	E5515C	MY48364183	Mar. 26, 2018
2	DC power supply	GW Instek	GPC-3030DN	EK880675	Oct. 12, 2018
3	POWER SPLITTER	Mini-Circuits	ZFRSC-123-S+	331000910-1	Feb. 25, 2018
4	wideband radio communication tester	R&S	CMW500	152372	Mar. 26, 2018
5	Const Temp, & Humidity Chamber	Bell	BTH-50C	20170306001	Mar. 26, 2018
6	Cable	N/A	RG316(0.3m)	N/A	Jul. 05, 2018

Remark: "N/A" denotes no model name, serial no. or calibration specified.
 All calibration period of equipment list is one year.

APPENDIX A - OUTPUT POWER

Conducted Power:

DCS1900 (Capsensor Off)	Burst Conducted Power (dBm)		
	512CH	661CH	810CH
	1850.2MHz	1880MHz	1909.8MHz
GSM (CS)	29.78	29.47	29.06
GPRS/EDGE (GMSK)	29.74	29.46	29.05
	27.89	27.62	27.20
	25.91	25.65	25.26
	23.88	23.66	23.31
EDGE (8PSK)	26.26	26.26	25.96
	24.05	23.75	23.45
	21.67	21.49	21.25
	19.47	19.43	19.11

Modulation	Band	WCDMA Band II(Capsensor Off)		
	Tx Channel	9262CH	9400CH	9538CH
	Frequency	1852.4MHz	1880MHz	1907.6MHz
BPSK	RMC 12.2K	22.84	22.74	22.75
	RMC 64K	22.82	22.73	22.78
	RMC 144K	22.88	22.79	22.78
	RMC 384K	22.88	22.81	22.78
16QAM	HSDPA Subtest-1	22.53	22.42	22.43
	HSDPA Subtest-2	22.47	22.38	22.39
	HSDPA Subtest-3	22.51	22.44	22.4
	HSDPA Subtest-4	22.48	22.43	22.39
16QAM	HSUPA Subtest-1	20.81	20.44	20.47
	HSUPA Subtest-2	19.05	18.81	18.84
	HSUPA Subtest-3	20.67	20.12	20.07
	HSUPA Subtest-4	19.17	19.18	19.11
	HSUPA Subtest-5	21.47	21.1	21.16

EIRP Power

DCS1900 (Capsensor Off)	EIRP Power (dBm)		
	512CH	661CH	810CH
	1850.2MHz	1880MHz	1909.8MHz
GSM (CS)	31.08	30.77	30.36
GPRS/EDGE (GMSK)	31.04	30.76	30.35
	29.19	28.92	28.50
	27.21	26.95	26.56
	25.18	24.96	24.61
EDGE (8PSK)	27.56	27.56	27.26
	25.35	25.05	24.75
	22.97	22.79	22.55
	20.77	20.73	20.41

Modulation	Band	WCDMA Band II(Capsensor Off)		
	Tx Channel	9262CH	9400CH	9538CH
	Rx Channel	9662CH	9800CH	9938CH
	Frequency	1852.4MHz	1880MHz	1907.6MHz
BPSK	RMC 12.2K	24.14	24.04	24.05
	RMC 64K	24.12	24.03	24.08
	RMC 144K	24.18	24.09	24.08
	RMC 384K	24.18	24.11	24.08
16QAM	HSDPA Subtest-1	23.83	23.72	23.73
	HSDPA Subtest-2	23.77	23.68	23.69
	HSDPA Subtest-3	23.81	23.74	23.70
	HSDPA Subtest-4	23.78	23.73	23.69
16QAM	HSUPA Subtest-1	22.11	21.74	21.77
	HSUPA Subtest-2	20.35	20.11	20.14
	HSUPA Subtest-3	21.97	21.42	21.37
	HSUPA Subtest-4	20.47	20.48	20.41
	HSUPA Subtest-5	22.77	22.40	22.46

APPENDIX B - OCCUPIED BANDWIDTH

DCS1900					
GSM			EDGE		
CS			8PSK		
Channel	Frequency (MHz)	99% Occupied Bandwidth (MHz)	Channel	Frequency (MHz)	99% Occupied Bandwidth (MHz)
512	1850.2	0.2476	512	1850.2	0.2459
661	1880	0.2495	661	1880	0.2466
810	1909.8	0.2460	810	1909.8	0.2464
Channel	Frequency (MHz)	26dB Bandwidth (MHz)	Channel	Frequency (MHz)	26dB Bandwidth (MHz)
512	1850.2	0.3232	512	1850.2	0.3221
661	1880	0.3130	661	1880	0.3091
810	1909.8	0.3127	810	1909.8	0.3199

Spectrum Plot

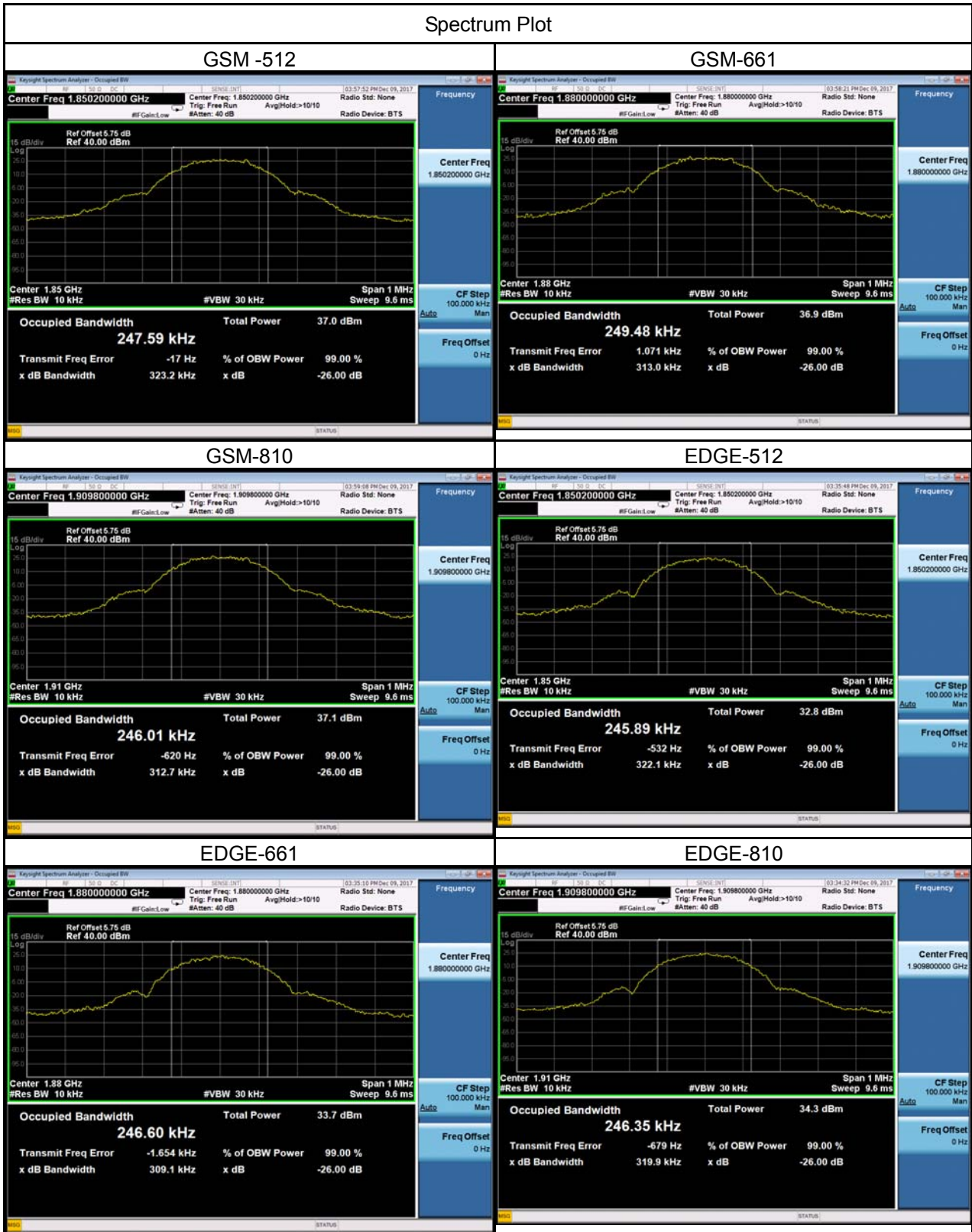

WCDMA Band II					
BPSK					
Channel	Frequency (MHz)	99% Occupied Bandwidth (MHz)	Channel	Frequency (MHz)	26dB Bandwidth (MHz)
9262	1852.4	4.1642	9262	1852.4	4.714
9400	1880	4.1616	9400	1880	4.707
9538	1907.6	4.1589	9538	1907.6	4.721



WCDMA_HSDPA Band II					
16QAM					
Channel	Frequency (MHz)	99% Occupied Bandwidth (MHz)	Channel	Frequency (MHz)	26dB Bandwidth (MHz)
9262	1852.4	4.1509	9262	1852.4	4.711
9400	1880	4.1547	9400	1880	4.715
9538	1907.6	4.1512	9538	1907.6	4.705



WCDMA_HSUPA Band II					
16QAM					
Channel	Frequency (MHz)	99% Occupied Bandwidth (MHz)	Channel	Frequency (MHz)	26dB Bandwidth (MHz)
9262	1852.4	4.1447	9262	1852.4	4.727
9400	1880	4.1488	9400	1880	4.731
9538	1907.6	4.1531	9538	1907.6	4.735



APPENDIX C - CONDUCTED EMISSIONS

DCS1900			
GSM		GSM	
Channel	Frequency(MHz)	Channel	Frequency(MHz)
661	1880	661	1880
GSM		EDGE	
Channel	Frequency(MHz)	Channel	Frequency(MHz)
661	1880	661	1880
EDGE		EDGE	
Channel	Frequency(MHz)	Channel	Frequency(MHz)
661	1880	661	1880

WCDMA Band II

Channel	Frequency(MHz)	Channel	Frequency(MHz)
9400	1880	9400	1880
Date: 11.DEC.2017 13:36:08		Date: 11.DEC.2017 13:35:14	
Channel	Frequency(MHz)	-	-
9400	1880	-	-

WCDMA_HSDPA Band II

Channel	Frequency(MHz)	Channel	Frequency(MHz)
9400	1880	9400	1880

Date: 11.DEC.2017 13:38:19

Date: 11.DEC.2017 13:39:07

Channel	Frequency(MHz)		
9400	1880	-	-

Frequency

Auto Tune

Center Freq
10.015000000 GHz

Start Freq
30.0000000 MHz

Stop Freq
20.000000000 GHz

CF Step
1.997000000 GHz
Auto Man

Freq Offset
0 Hz

Scale Type
Log

WCDMA_HSUPA Band II

Channel	Frequency(MHz)	Channel	Frequency(MHz)
9400	1880	9400	1880
Channel	Frequency(MHz)	-	-
9400	1880	-	-

APPENDIX D - RADIATED EMISSION

Test Mode: TX Mode_Adapter: BYD

Ant 0°

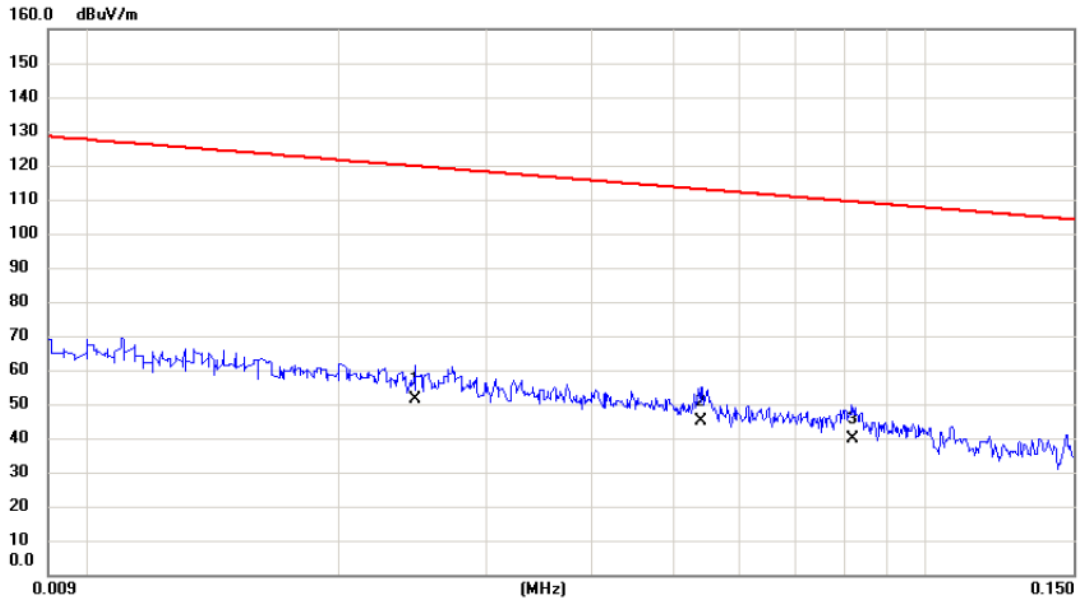

No.	Mk.	Freq. MHz	Reading Level dBuV	Correct Factor dB	Measure- ment dBuV/m	Limit dBuV/m	Margin dB	Detector	Comment
1		0.0246	31.82	19.48	51.30	119.79	-68.49	AVG	
2	*	0.0540	26.18	18.64	44.82	112.96	-68.14	AVG	
3		0.0817	21.62	18.07	39.69	109.36	-69.67	AVG	

Test Mode: TX Mode_Adapter: BYD

Ant 0°

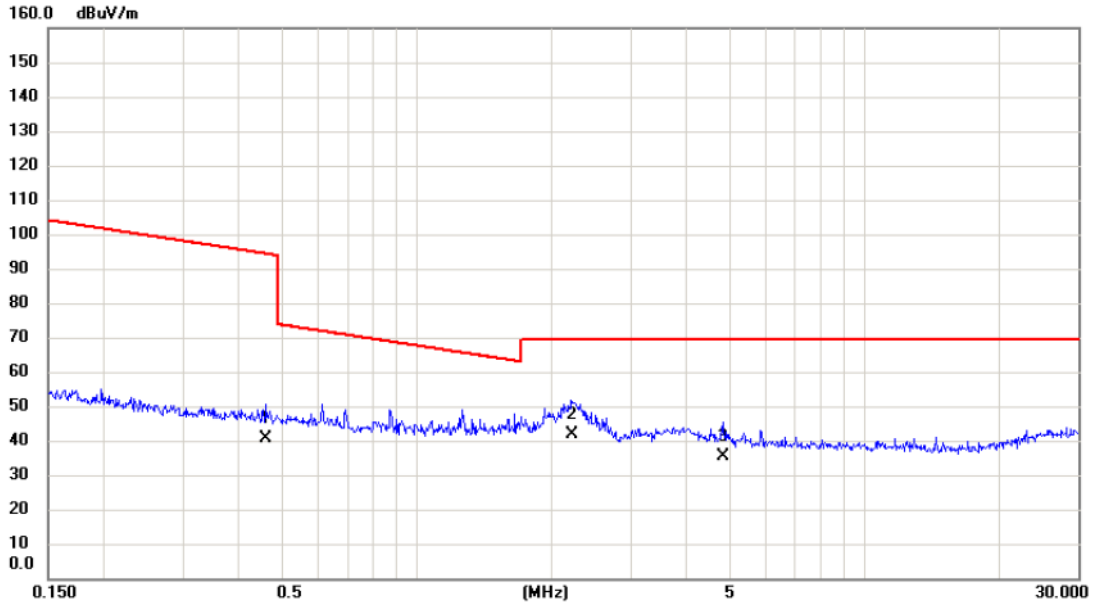

No.	Mk.	Freq. MHz	Reading Level dBuV	Correct Factor dB	Measure- ment dBuV/m	Limit dBuV/m	Margin dB	Detector	Comment
1		0.4588	24.03	16.50	40.53	94.37	-53.84	AVG	
2	*	2.2132	26.19	15.45	41.64	69.54	-27.90	QP	
3		4.8224	20.85	14.48	35.33	69.54	-34.21	QP	

Test Mode: TX Mode _ Adapter: BYD

Ant 90°

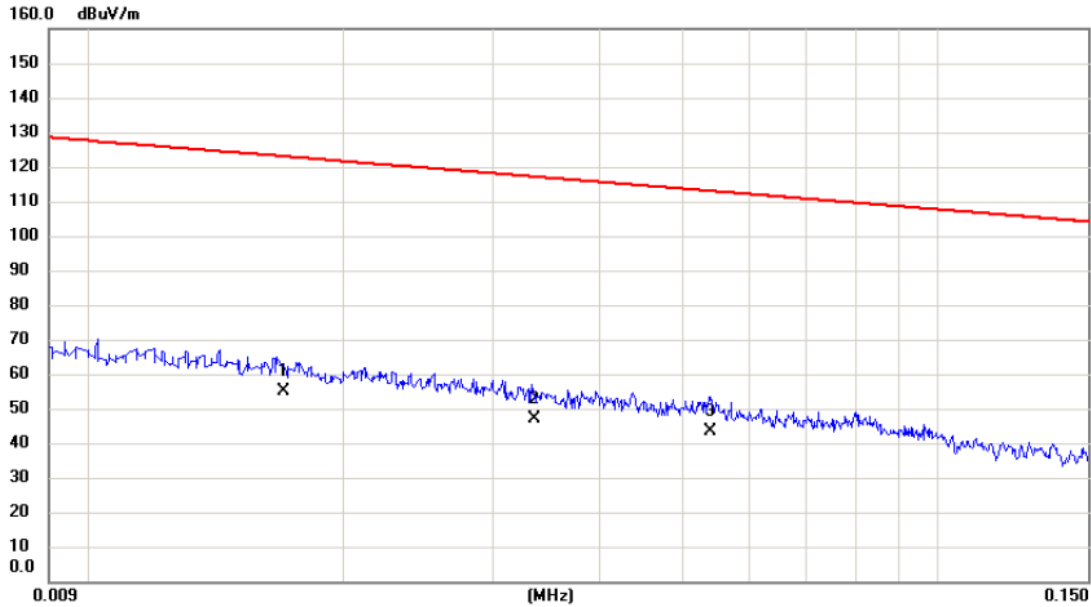

No.	Mk.	Freq.	Reading Level	Correct Factor	Measurement	Limit	Margin	Detector	Comment
		MHz	dBuV	dB	dBuV/m	dBuV/m	dB		
1	*	0.0170	35.08	20.01	55.09	123.00	-67.91	AVG	
2		0.0335	27.94	19.22	47.16	117.10	-69.94	AVG	
3		0.0540	24.70	18.64	43.34	112.96	-69.62	AVG	

Test Mode: TX Mode_Adapter: BYD

Ant 90°

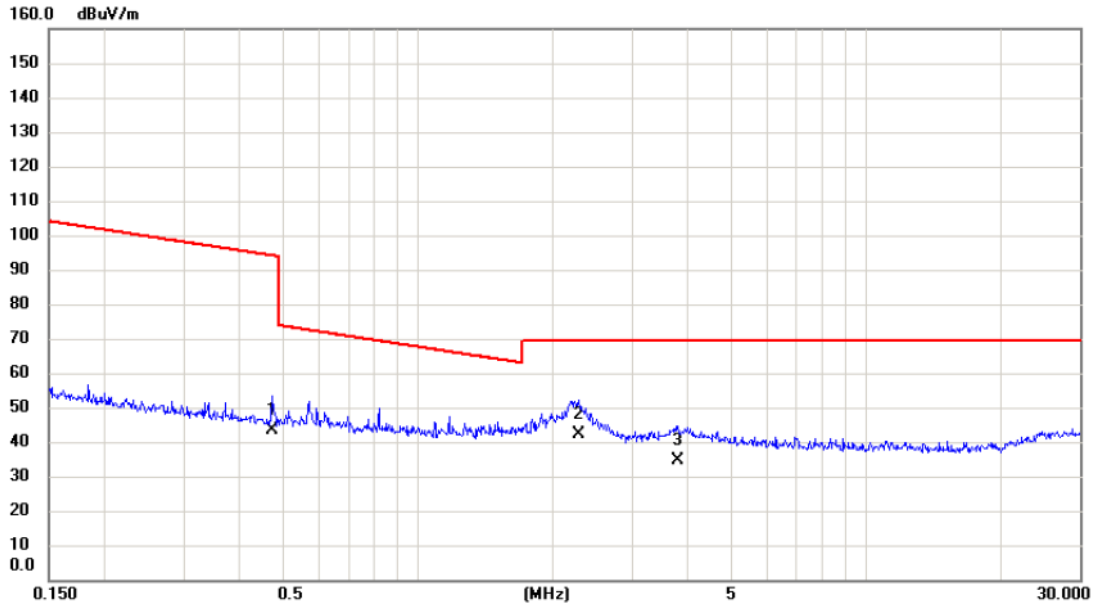

No.	Mk.	Freq. MHz	Reading Level dBuV	Correct Factor dB	Measure- ment dBuV/m	Limit dBuV/m	Margin dB	Detector	Comment
1		0.4736	26.77	16.49	43.26	94.10	-50.84	AVG	
2	*	2.2847	26.60	15.43	42.03	69.54	-27.51	QP	
3		3.7994	19.57	15.01	34.58	69.54	-34.96	QP	

Test Mode: TX Mode _ Adapter: Salcomp

Ant 0°

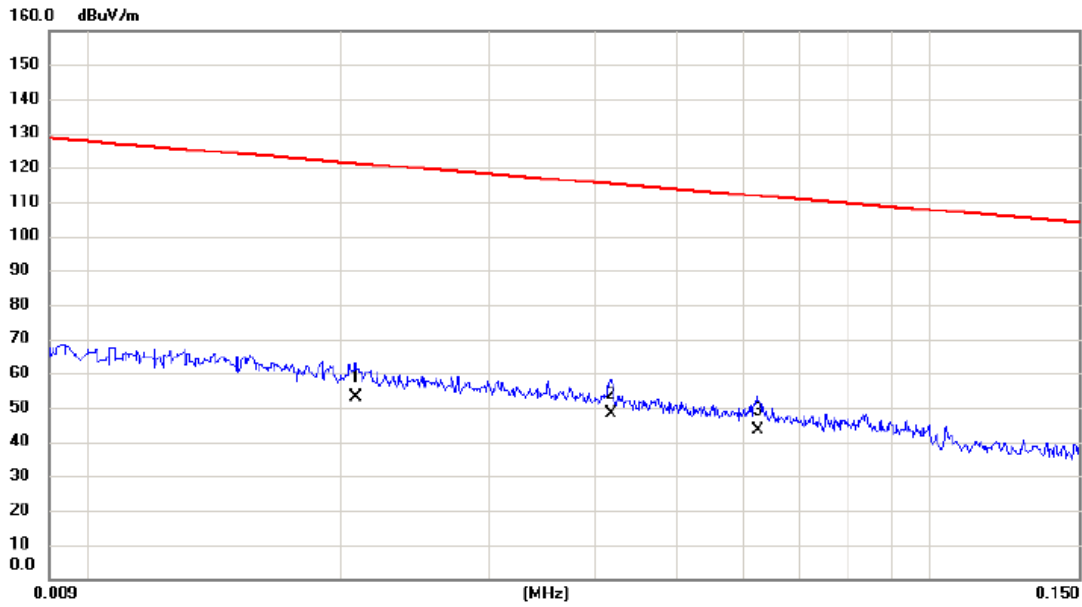

No.	Mk.	Freq. MHz	Reading Level dBuV	Correct Factor dB	Measure- ment dBuV/m	Limit dBuV/m	Margin dB	Detector	Comment
1		0.0208	33.46	19.60	53.06	121.24	-68.18	AVG	
2	*	0.0418	29.27	18.97	48.24	115.18	-66.94	AVG	
3		0.0624	24.90	18.48	43.38	111.70	-68.32	AVG	

Test Mode: TX Mode _ Adapter: Salcomp

Ant 0°

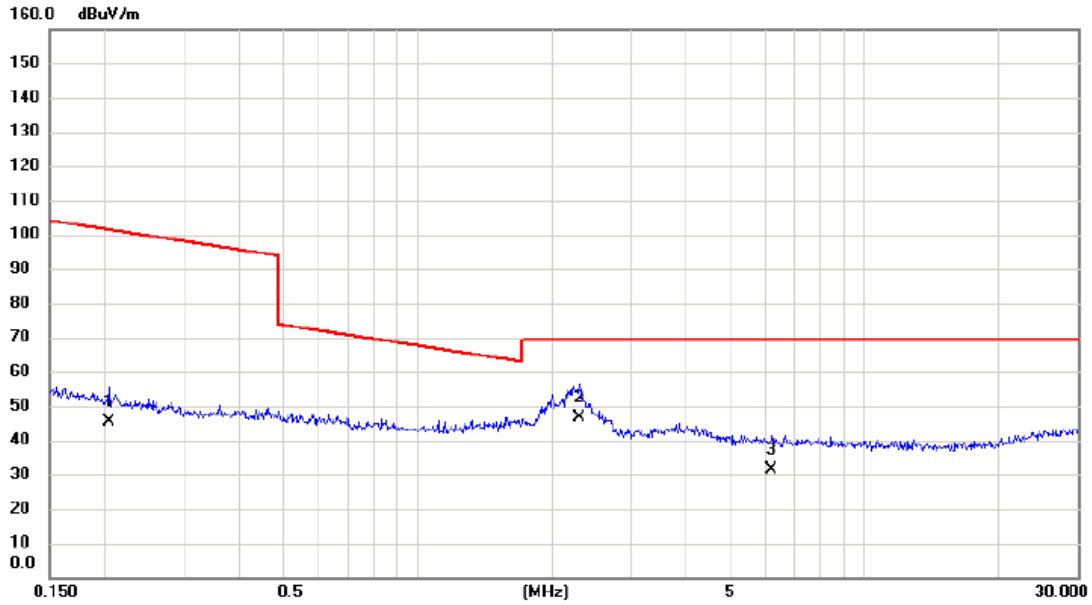

No.	Mk.	Freq. MHz	Reading Level dBuV	Correct Factor dB	Measure- ment dBuV/m	Limit dBuV/m	Margin dB	Detector	Comment
1		0.2040	28.66	16.79	45.45	101.41	-55.96	AVG	
2	*	2.2968	30.99	15.43	46.42	69.54	-23.12	QP	
3		6.1860	17.36	14.22	31.58	69.54	-37.96	QP	

Test Mode: TX Mode _ Adapter: Salcomp

Ant 90°

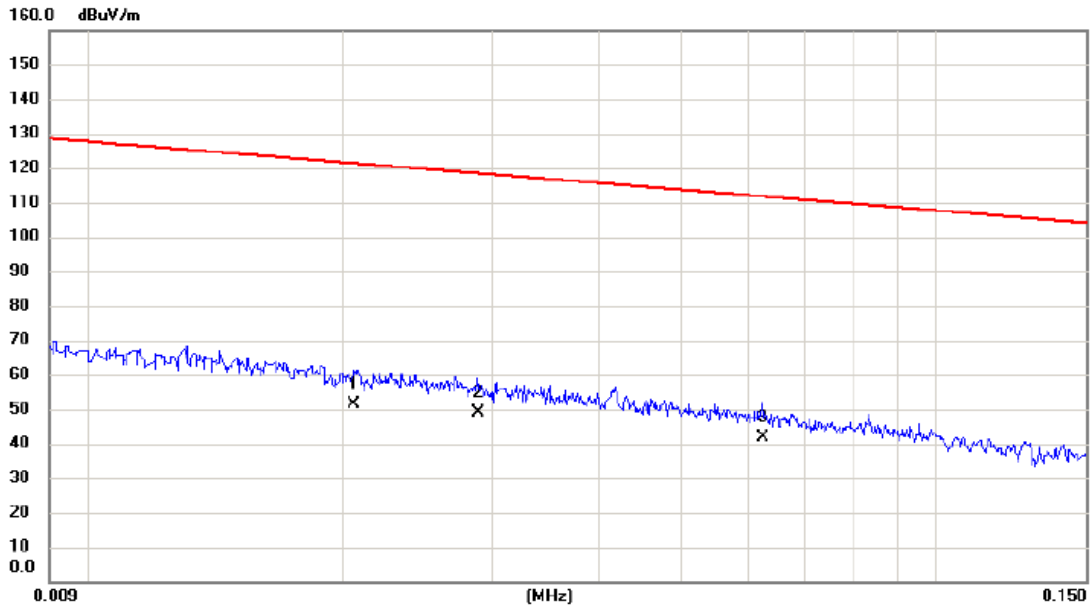

No.	Mk.	Freq. MHz	Reading Level dBuV	Correct Factor dB	Measure- ment dBuV/m	Limit dBuV/m	Margin dB	Detector	Comment
1		0.0206	31.94	19.60	51.54	121.33	-69.79	AVG	
2	*	0.0288	29.49	19.36	48.85	118.42	-69.57	AVG	
3		0.0624	23.34	18.48	41.82	111.70	-69.88	AVG	

Test Mode: TX Mode _ Adapter: Salcomp

Ant 90°

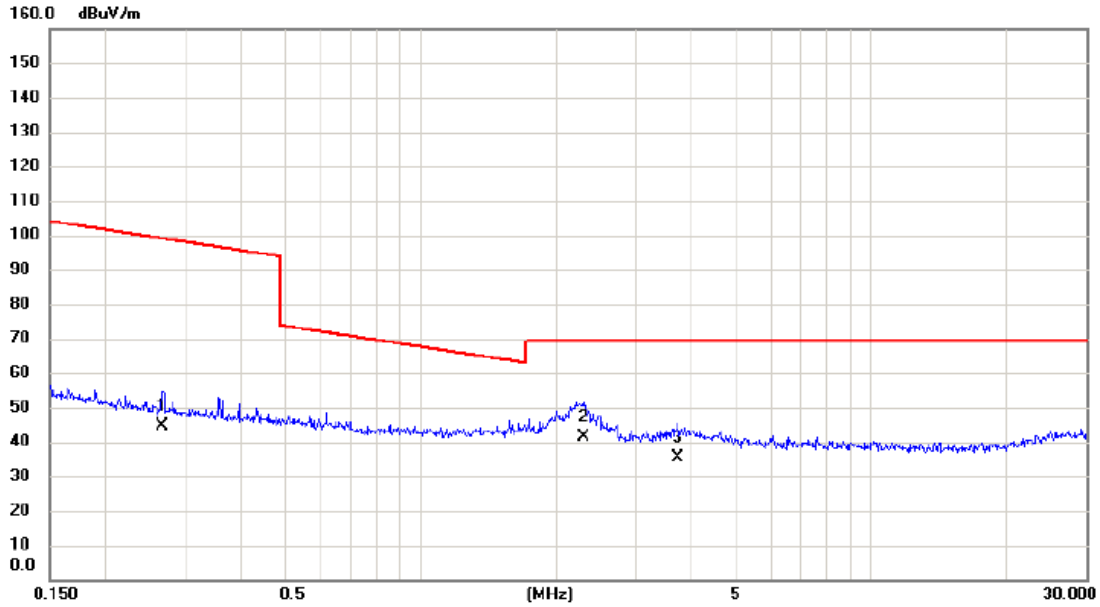

No.	Mk.	Freq. MHz	Reading Level dBuV	Correct Factor dB	Measure- ment dBuV/m	Limit dBuV/m	Margin dB	Detector	Comment
1		0.2672	28.05	16.65	44.70	99.07	-54.37	AVG	
2	*	2.2968	25.92	15.43	41.35	69.54	-28.19	QP	
3		3.7198	20.20	15.02	35.22	69.54	-34.32	QP	

Test Mode: DCS1900_TX CH512_GSM

Vertical

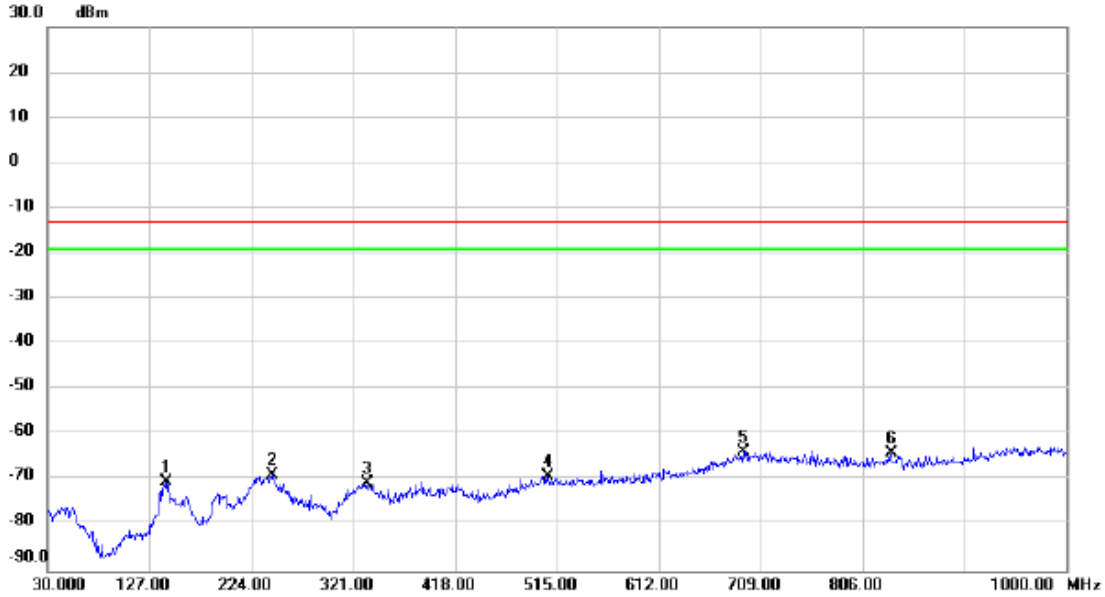

No.	Mk.	Freq. MHz	Reading Level dBm	Correct Factor dB	Measure- ment dBm	Limit dBm	Margin dB	Detector	Comment
1		142.520	-73.69	3.41	-70.28	-13.00	-57.28	peak	
2		243.400	-71.19	2.22	-68.97	-13.00	-55.97	peak	
3		334.580	-72.98	2.46	-70.52	-13.00	-57.52	peak	
4		506.270	-77.15	8.07	-69.08	-13.00	-56.08	peak	
5	*	692.510	-77.18	13.47	-63.71	-13.00	-50.71	peak	
6		833.160	-75.98	11.91	-64.07	-13.00	-51.07	peak	

Test Mode: DCS1900_TX CH512_GSM

Horizontal



No.	Mk.	Freq. MHz	Reading Level dBm	Correct Factor dB	Measure- ment dBm	Limit dBm	Margin dB	Detector	Comment
1		45.520	-77.68	2.87	-74.81	-13.00	-61.81	peak	
2		142.520	-73.82	3.41	-70.41	-13.00	-57.41	peak	
3		229.820	-72.04	3.20	-68.84	-13.00	-55.84	peak	
4		338.460	-72.73	2.51	-70.22	-13.00	-57.22	peak	
5		559.620	-76.34	8.30	-68.04	-13.00	-55.04	peak	
6	*	714.820	-77.10	13.62	-63.48	-13.00	-50.48	peak	

Test Mode: DCS1900_TX CH512_GSM

Vertical

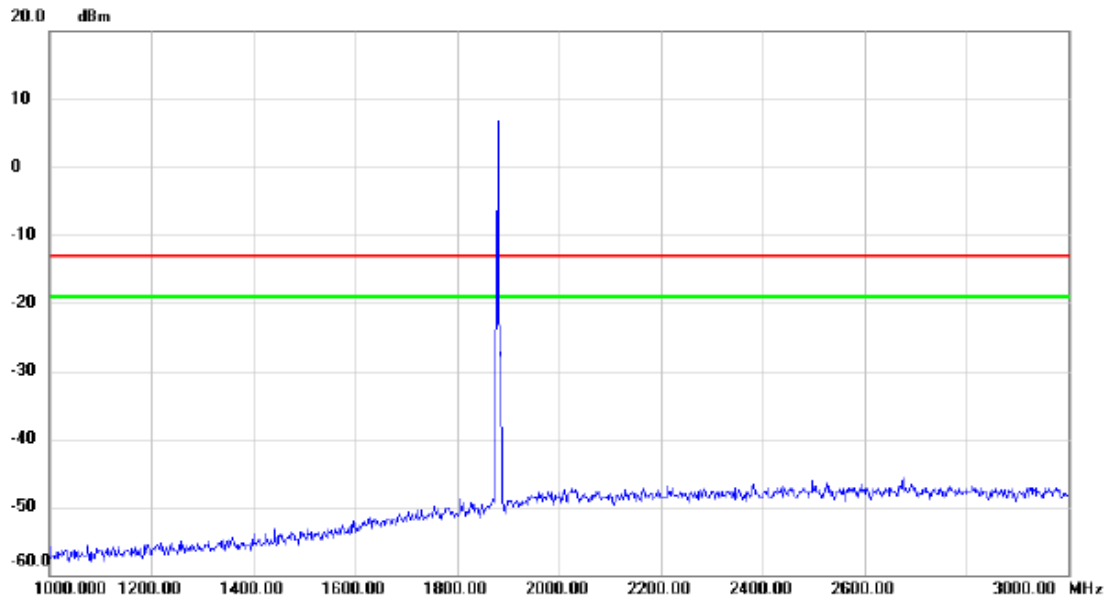

No.	Mk.	Freq.	Reading Level	Correct Factor	Measurement	Limit	Margin	Detector	Comment
		MHz	dBm	dB	dBm	dBm	dB		
		1900.00	10.00	0.00	10.00	-13.00	23.00		

Test Mode: DCS1900_TX CH512_GSM

Horizontal

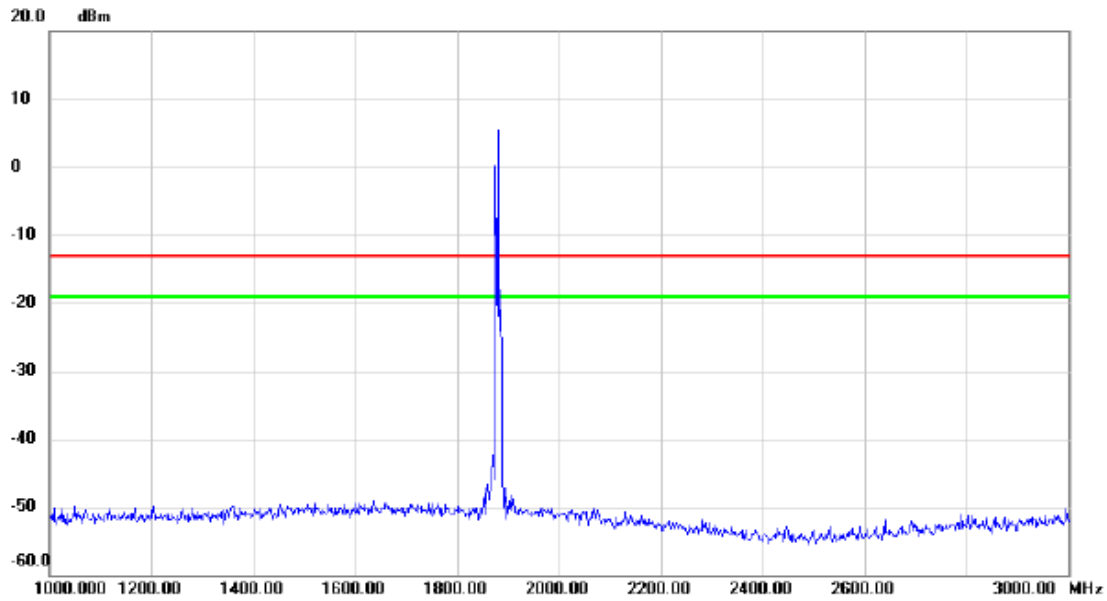

No.	Mk.	Freq.	Reading Level	Correct Factor	Measurement	Limit	Margin	Detector	Comment
		MHz	dBm	dB	dBm	dBm	dB		
		1900.00	5.00	0.00	5.00	-13.00	18.00		

Test Mode: DCS1900_TX CH512_GSM

Vertical

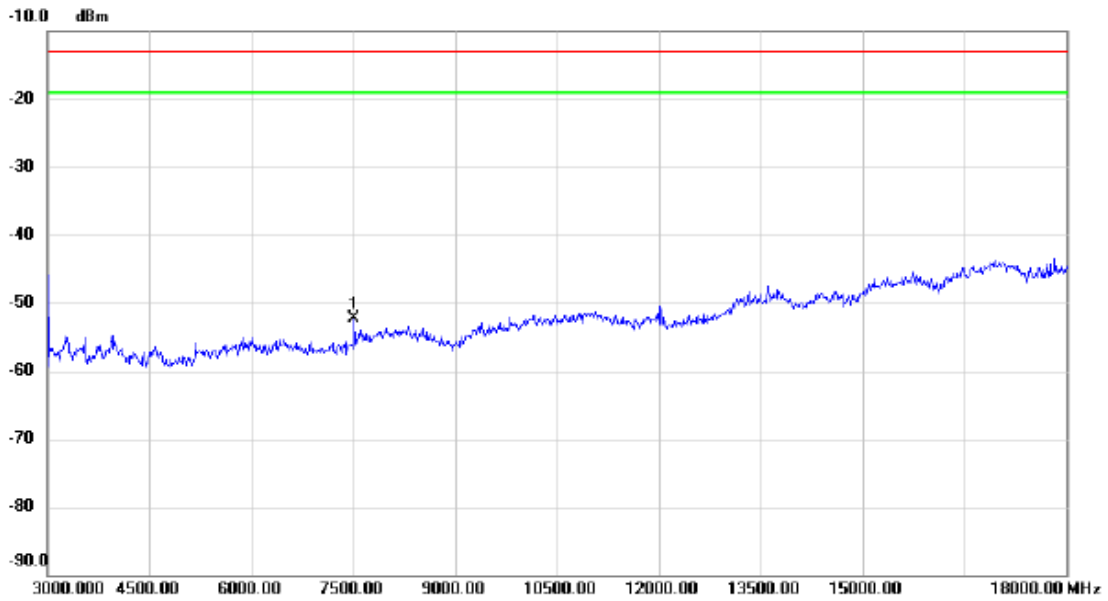

No.	Mk.	Freq. MHz	Reading Level dBm	Correct Factor dB	Measure- ment dBm	Limit dBm	Margin dB	Detector	Comment
1	*	7515.000	-70.17	17.92	-52.25	-13.00	-39.25	peak	

Test Mode: DCS1900_TX CH512_GSM

Horizontal

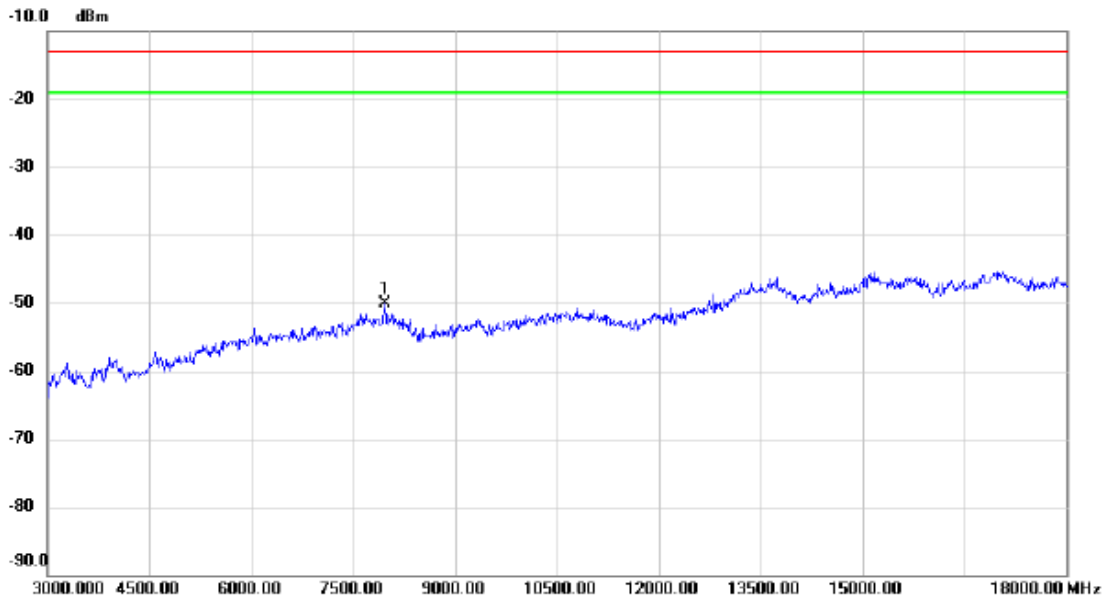

No.	Mk.	Freq. MHz	Reading Level dBm	Correct Factor dB	Measure- ment dBm	Limit dBm	Margin dB	Detector	Comment
1	*	7965.000	-71.85	21.72	-50.13	-13.00	-37.13	peak	

Test Mode: DCS1900_TX CH512_GSM

Vertical

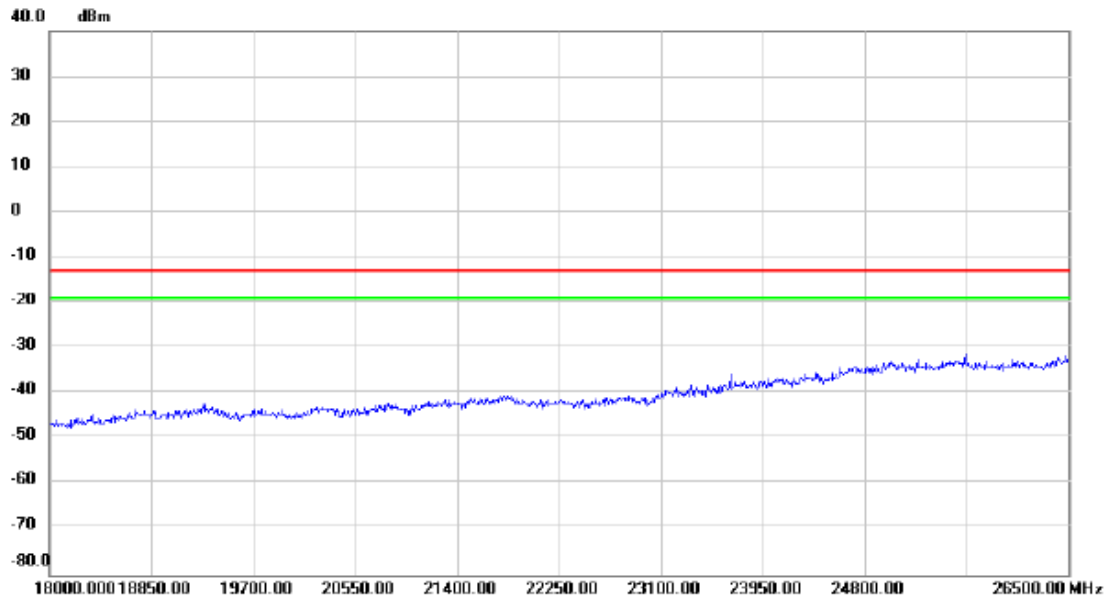

No.	Mk.	Freq.	Reading Level	Correct Factor	Measurement	Limit	Margin	Detector	Comment
		MHz	dBm	dB	dBm	dBm	dB		

Test Mode: DCS1900_TX CH512_GSM

Horizontal

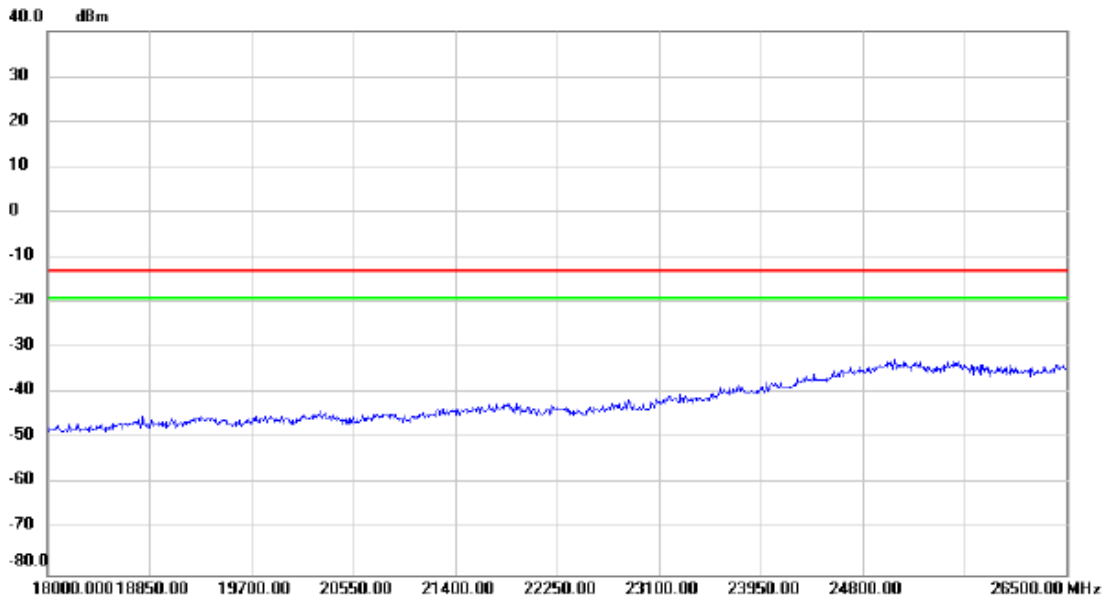

No.	Mk.	Freq.	Reading Level	Correct Factor	Measurement	Limit	Margin	Detector	Comment
		MHz	dBm	dB	dBm	dBm	dB		
		18000.000	-50						
		18850.00	-48						
		19700.00	-47						
		20550.00	-46						
		21400.00	-45						
		22250.00	-44						
		23100.00	-43						
		23950.00	-42						
		24800.00	-41						
		26500.00	-40						

Test Mode: DCS1900_TX CH512_EDGE

Vertical

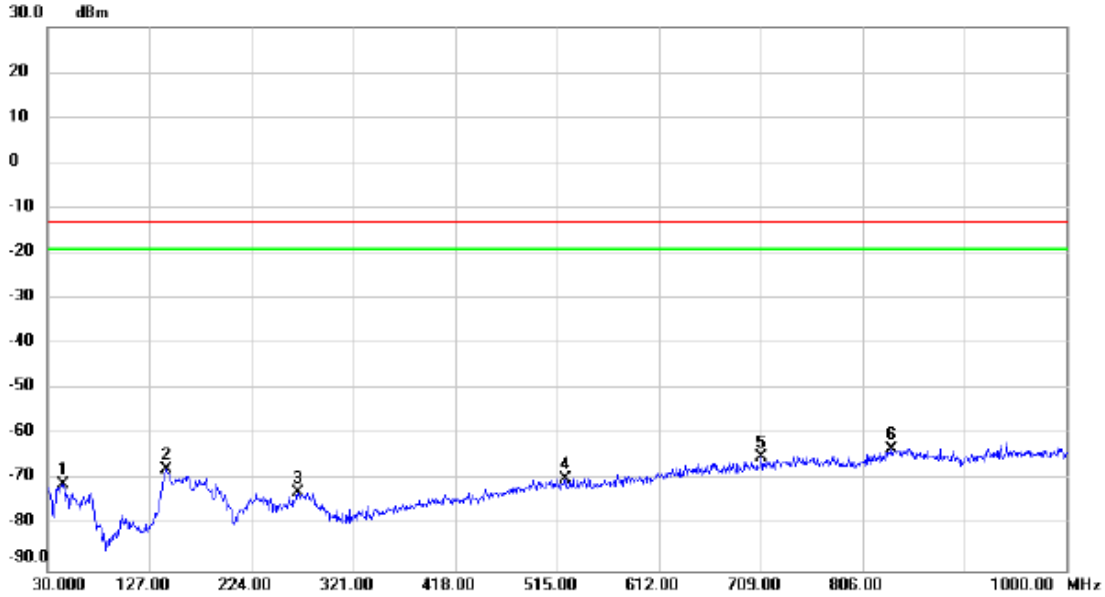

No.	Mk.	Freq. MHz	Reading Level dBm	Correct Factor dB	Measure- ment dBm	Limit dBm	Margin dB	Detector	Comment
1		44.550	-72.97	1.96	-71.01	-13.00	-58.01	peak	
2		143.490	-70.03	2.50	-67.53	-13.00	-54.53	peak	
3		268.620	-74.61	1.99	-72.62	-13.00	-59.62	peak	
4		523.730	-77.14	7.50	-69.64	-13.00	-56.64	peak	
5		709.970	-75.83	10.88	-64.95	-13.00	-51.95	peak	
6	*	833.160	-76.69	13.60	-63.09	-13.00	-50.09	peak	

Test Mode: DCS1900_TX CH512_EDGE

Horizontal

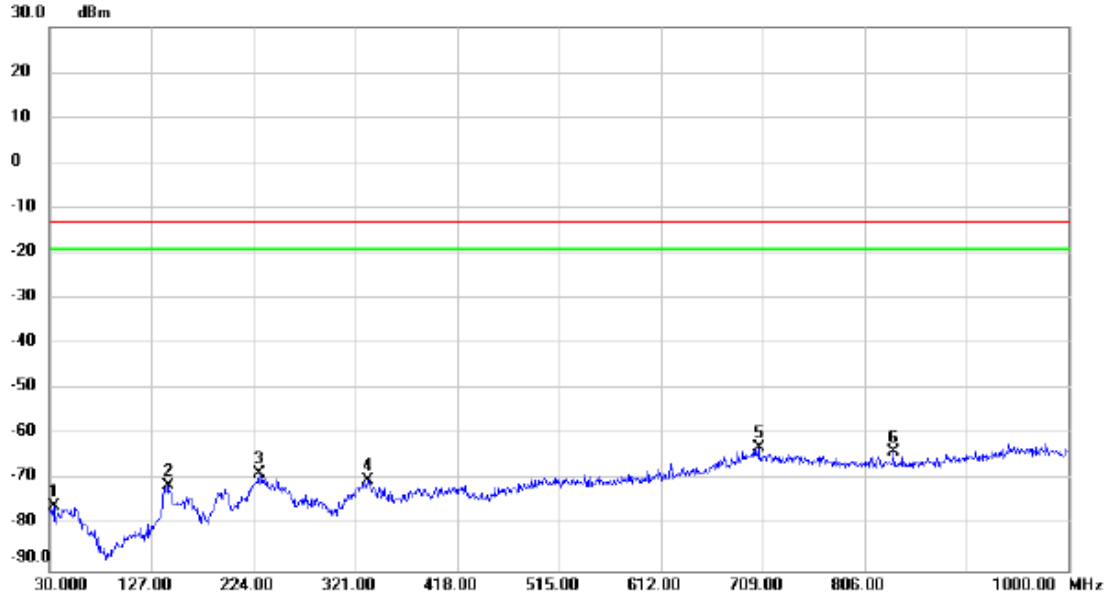

No.	Mk.	Freq. MHz	Reading Level dBm	Correct Factor dB	Measure- ment dBm	Limit dBm	Margin dB	Detector	Comment
1		33.880	-76.35	0.65	-75.70	-13.00	-62.70	peak	
2		142.520	-74.57	3.41	-71.16	-13.00	-58.16	peak	
3		229.820	-71.74	3.20	-68.54	-13.00	-55.54	peak	
4		333.610	-72.59	2.45	-70.14	-13.00	-57.14	peak	
5	*	705.120	-76.64	13.86	-62.78	-13.00	-49.78	peak	
6		833.160	-75.67	11.91	-63.76	-13.00	-50.76	peak	

Test Mode: DCS1900_TX CH512_EDGE

Vertical

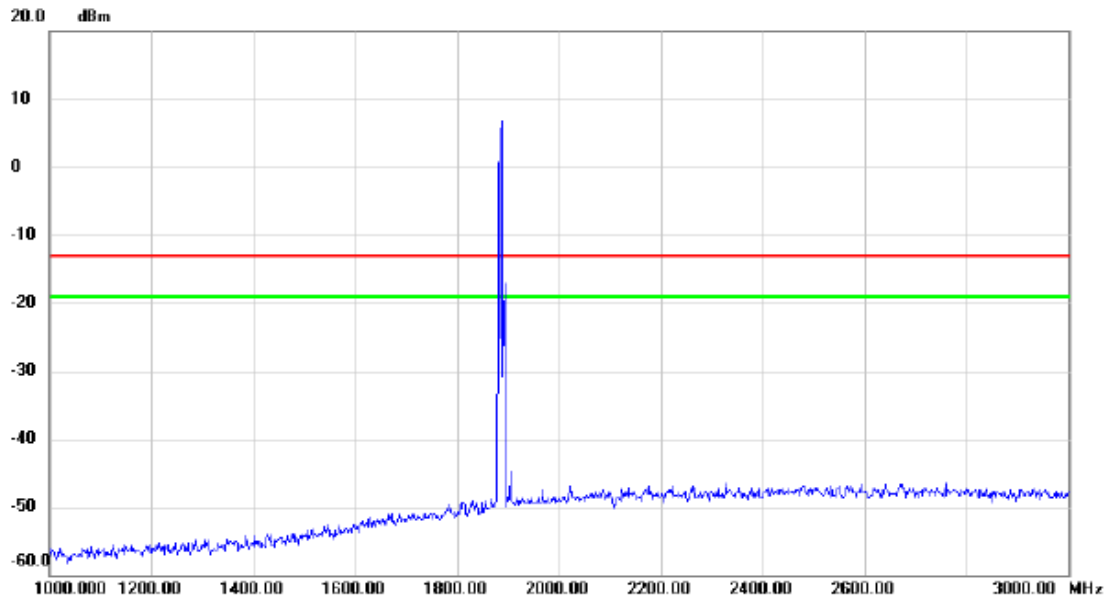

No.	Mk.	Freq.	Reading Level	Correct Factor	Measurement	Limit	Margin	Detector	Comment
		MHz	dBm	dB	dBm	dBm	dB		
		1900.00	5.00	0.00	5.00	-13.00	18.00		

Test Mode: DCS1900_TX CH512_EDGE

Horizontal

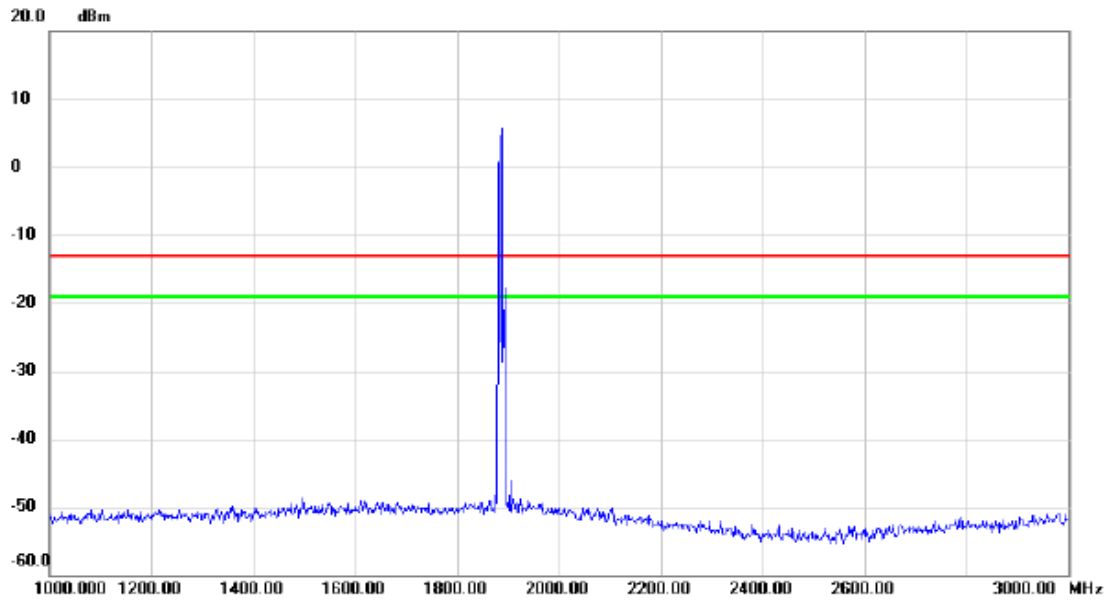

No.	Mk.	Freq.	Reading Level	Correct Factor	Measurement	Limit	Margin	Detector	Comment
		MHz	dBm	dB	dBm	dBm	dB		
		1900.000	5.0	0.0	5.0	-13.0	18.0		

Test Mode: DCS1900_TX CH512_EDGE

Vertical

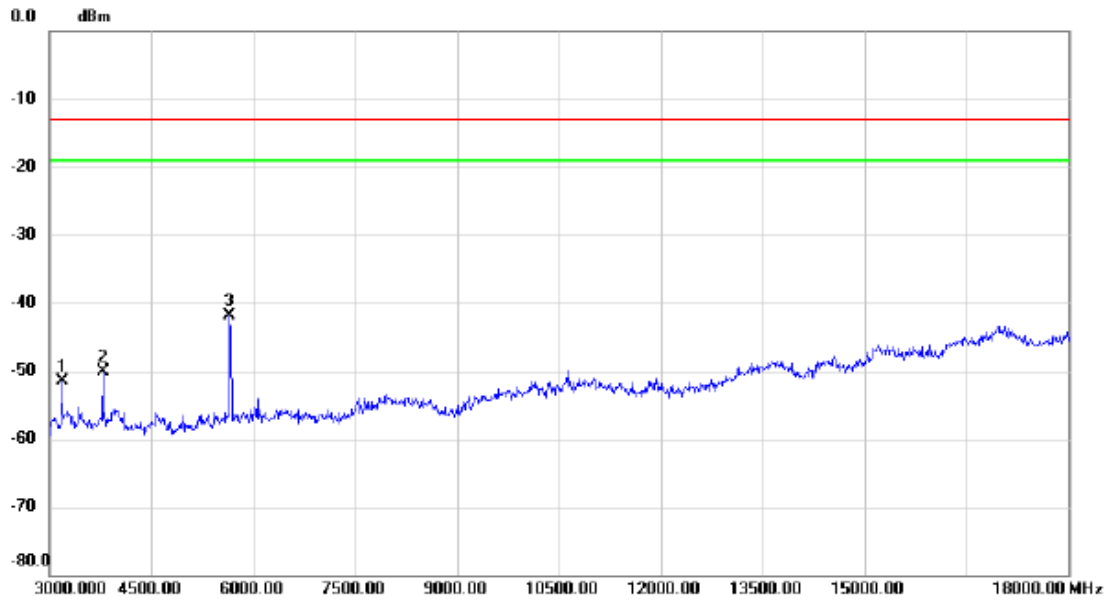

No.	Mk.	Freq. MHz	Reading Level dBm	Correct Factor dB	Measure- ment dBm	Limit dBm	Margin dB	Detector	Comment
1		3180.000	-64.52	13.10	-51.42	-13.00	-38.42	peak	
2		3780.000	-64.65	14.53	-50.12	-13.00	-37.12	peak	
3	*	5655.000	-58.18	16.33	-41.85	-13.00	-28.85	peak	

Test Mode: DCS1900_TX CH512_EDGE

Horizontal

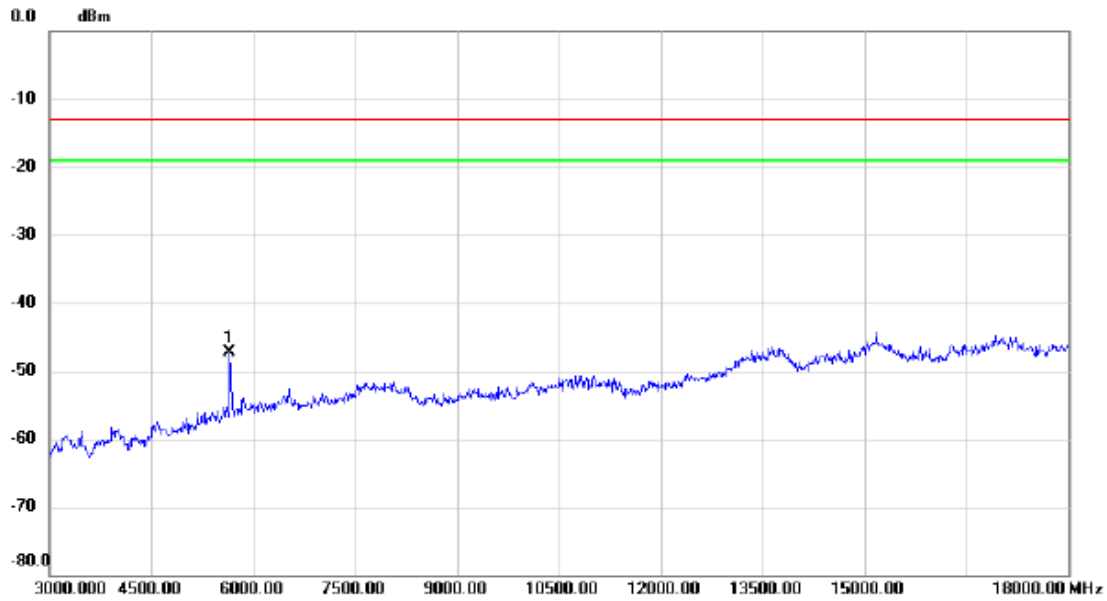

No.	Mk.	Freq. MHz	Reading Level dBm	Correct Factor dB	Measure- ment dBm	Limit dBm	Margin dB	Detector	Comment
1	*	5655.000	-64.41	17.09	-47.32	-13.00	-34.32	peak	

Test Mode: DCS1900_TX CH512_EDGE

Vertical

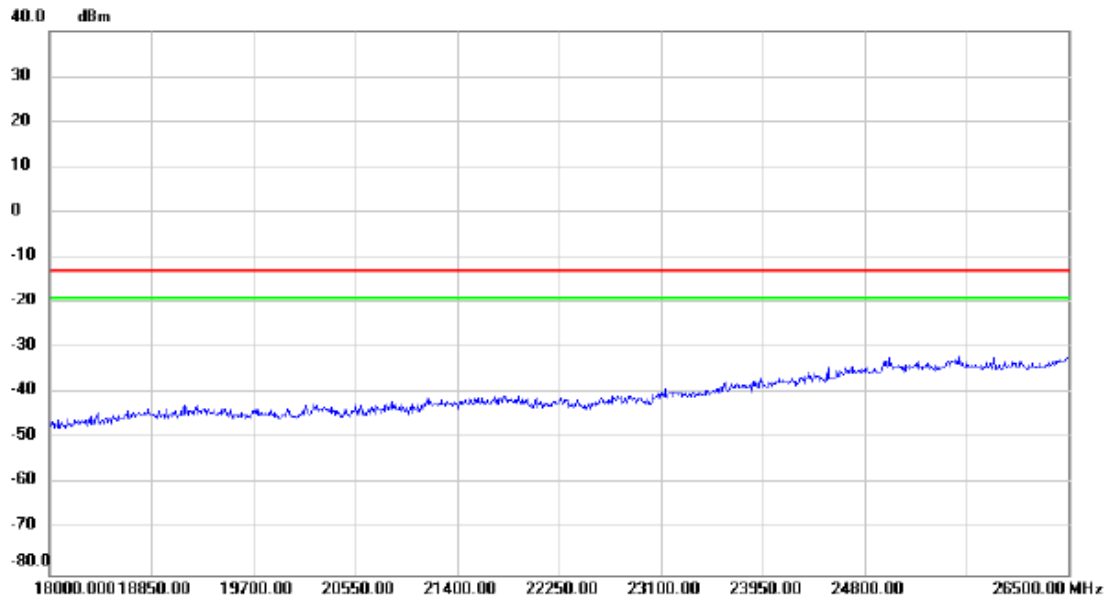

No.	Mk.	Freq.	Reading Level	Correct Factor	Measurement	Limit	Margin	Detector	Comment
		MHz	dBm	dB	dBm	dBm	dB		

Test Mode: DCS1900_TX CH512_EDGE

Horizontal

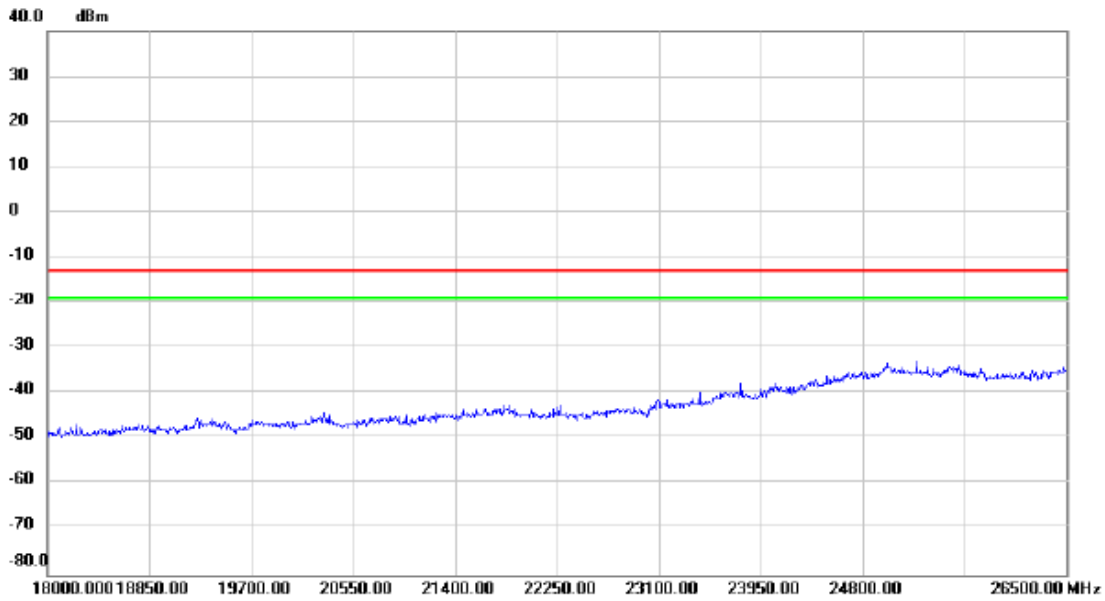

No.	Mk.	Freq.	Reading Level	Correct Factor	Measurement	Limit	Margin	Detector	Comment
		MHz	dBm	dB	dBm	dBm	dB		

Test Mode: WCDMA Band II_TX CH9400

Vertical



No.	Mk.	Freq. MHz	Reading Level dBm	Correct Factor dB	Measure- ment dBm	Limit dBm	Margin dB	Detector	Comment
1		41.640	-74.16	2.06	-72.10	-13.00	-59.10	peak	
2		139.610	-72.47	2.04	-70.43	-13.00	-57.43	peak	
3		264.740	-74.98	1.43	-73.55	-13.00	-60.55	peak	
4		495.600	-76.91	7.29	-69.62	-13.00	-56.62	peak	
5		648.860	-77.44	10.09	-67.35	-13.00	-54.35	peak	
6	*	844.800	-77.33	14.21	-63.12	-13.00	-50.12	peak	

Test Mode: WCDMA Band II_TX CH9400

Horizontal

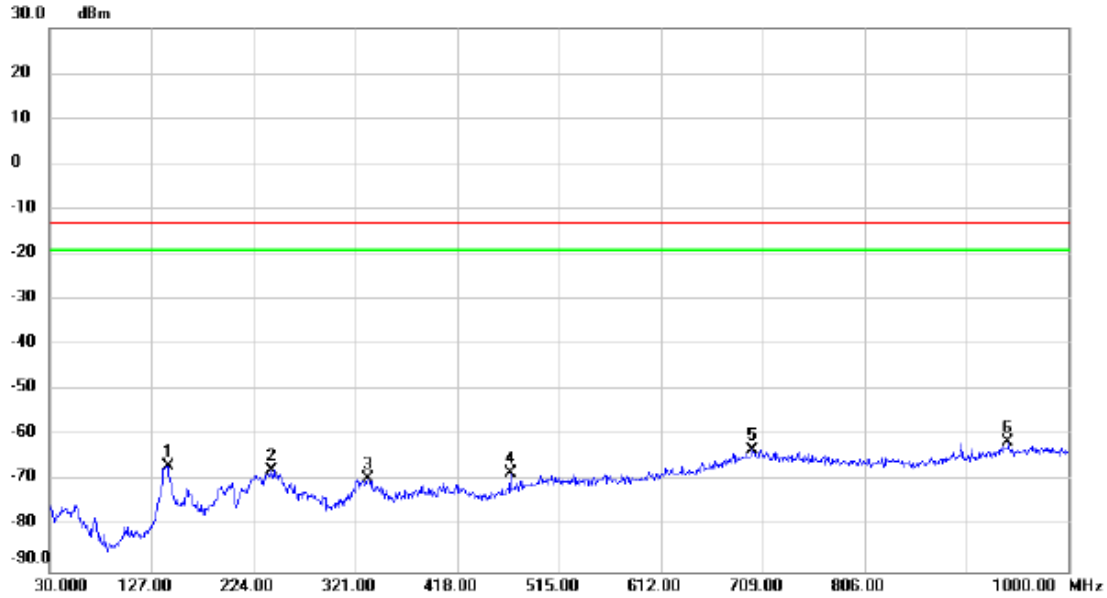

No.	Mk.	Freq. MHz	Reading Level dBm	Correct Factor dB	Measure- ment dBm	Limit dBm	Margin dB	Detector	Comment
1		142.520	-70.02	3.41	-66.61	-13.00	-53.61	peak	
2		241.460	-69.97	2.32	-67.65	-13.00	-54.65	peak	
3		333.610	-72.05	2.45	-69.60	-13.00	-56.60	peak	
4		468.440	-74.20	6.08	-68.12	-13.00	-55.12	peak	
5		699.300	-76.93	13.93	-63.00	-13.00	-50.00	peak	
6	*	942.770	-76.14	14.66	-61.48	-13.00	-48.48	peak	

Test Mode: WCDMA Band II_TX CH9400

Vertical

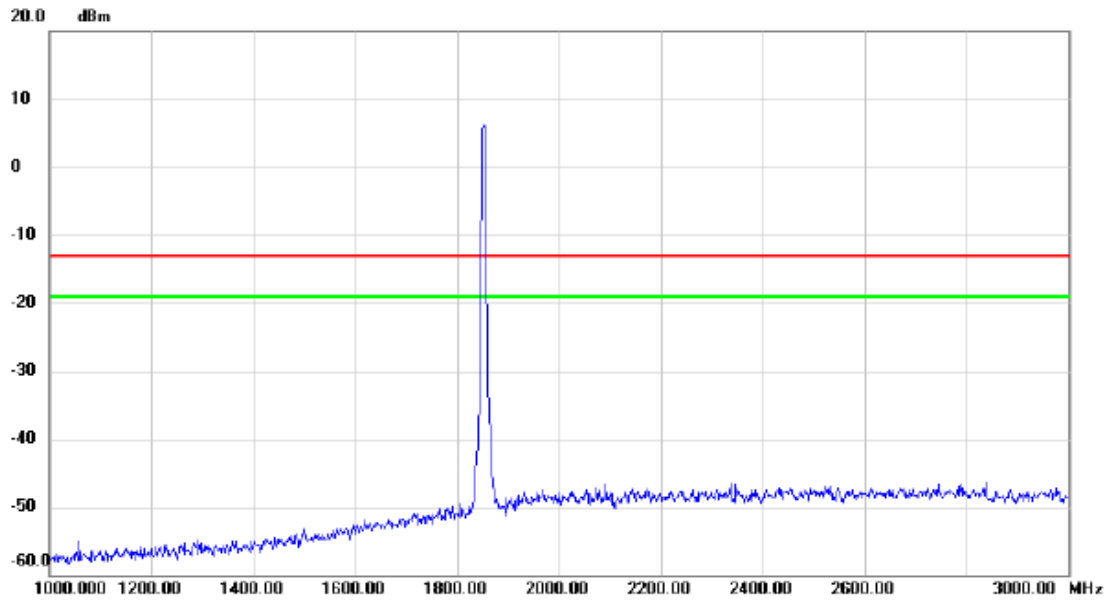

No.	Mk.	Freq.	Reading Level	Correct Factor	Measurement	Limit	Margin	Detector	Comment
		MHz	dBm	dB	dBm	dBm	dB		
		1880.00	5.00	0.00	5.00	-13.00	-18.00		

Test Mode: WCDMA Band II_TX CH9400

Horizontal

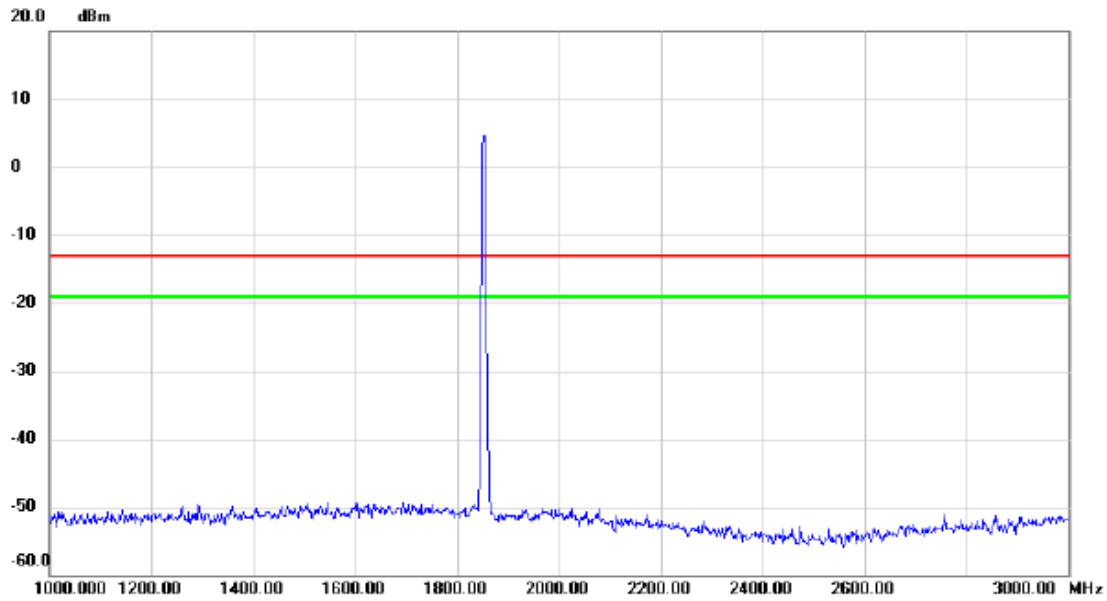

No.	Mk.	Freq.	Reading Level	Correct Factor	Measurement	Limit	Margin	Detector	Comment
		MHz	dBm	dB	dBm	dBm	dB		
		1880.00	5.0		5.0	-13.0	18.0		

Test Mode: WCDMA Band II_TX CH9400

Vertical

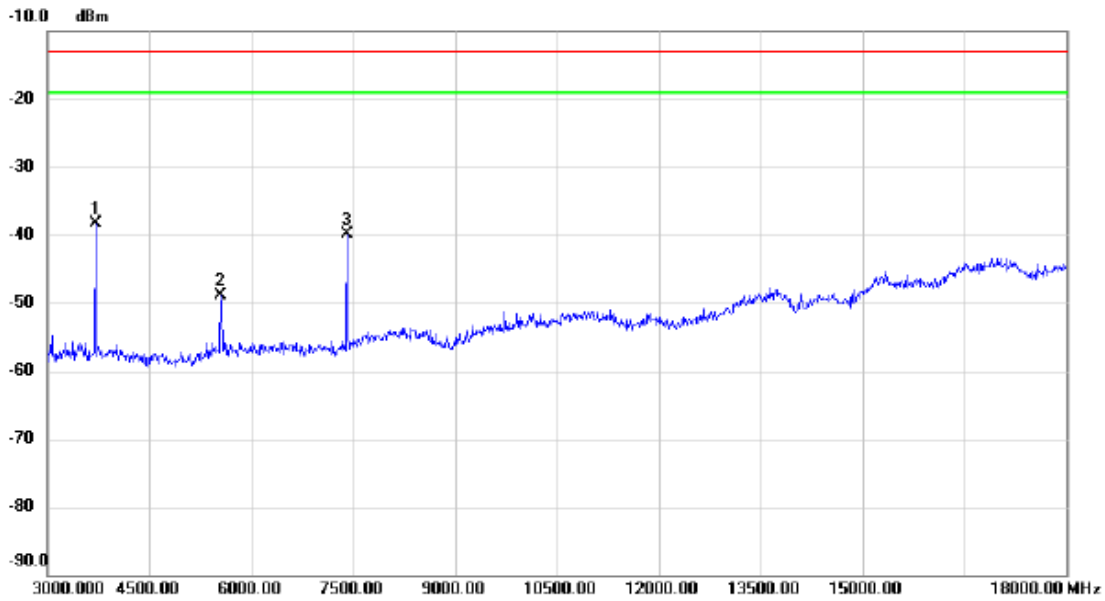

No.	Mk.	Freq. MHz	Reading Level dBm	Correct Factor dB	Measure- ment dBm	Limit dBm	Margin dB	Detector	Comment
1	*	3705.000	-52.83	14.46	-38.37	-13.00	-25.37	peak	
2		5550.000	-65.08	16.16	-48.92	-13.00	-35.92	peak	
3		7410.000	-57.58	17.64	-39.94	-13.00	-26.94	peak	

Test Mode: WCDMA Band II_TX CH9400

Horizontal

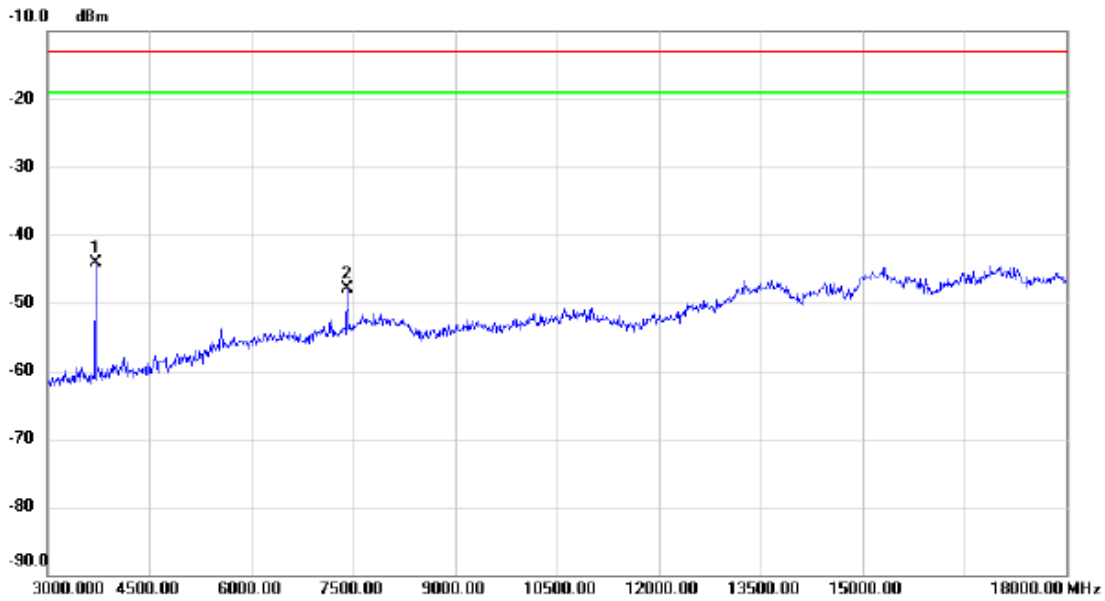

No.	Mk.	Freq. MHz	Reading Level dBm	Correct Factor dB	Measure- ment dBm	Limit dBm	Margin dB	Detector	Comment
1	*	3705.000	-55.24	11.19	-44.05	-13.00	-31.05	peak	
2		7410.000	-68.34	20.35	-47.99	-13.00	-34.99	peak	

Test Mode: WCDMA Band II_TX CH9400

Vertical

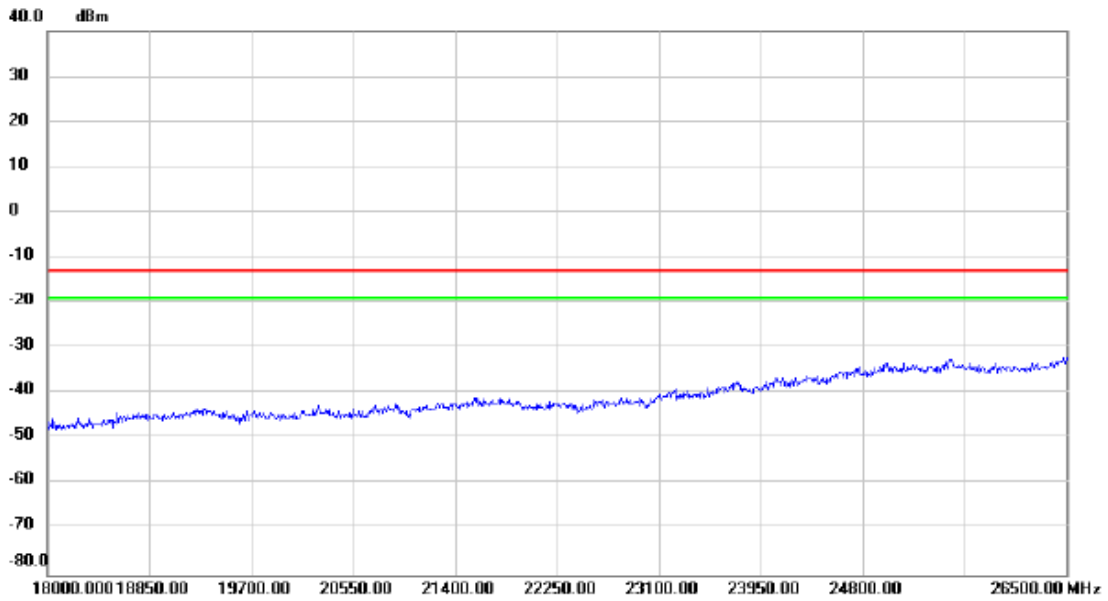

No.	Mk.	Freq.	Reading Level	Correct Factor	Measurement	Limit	Margin	Detector	Comment
		MHz	dBm	dB	dBm	dBm	dB		

Test Mode: WCDMA Band II_TX CH9400

Horizontal

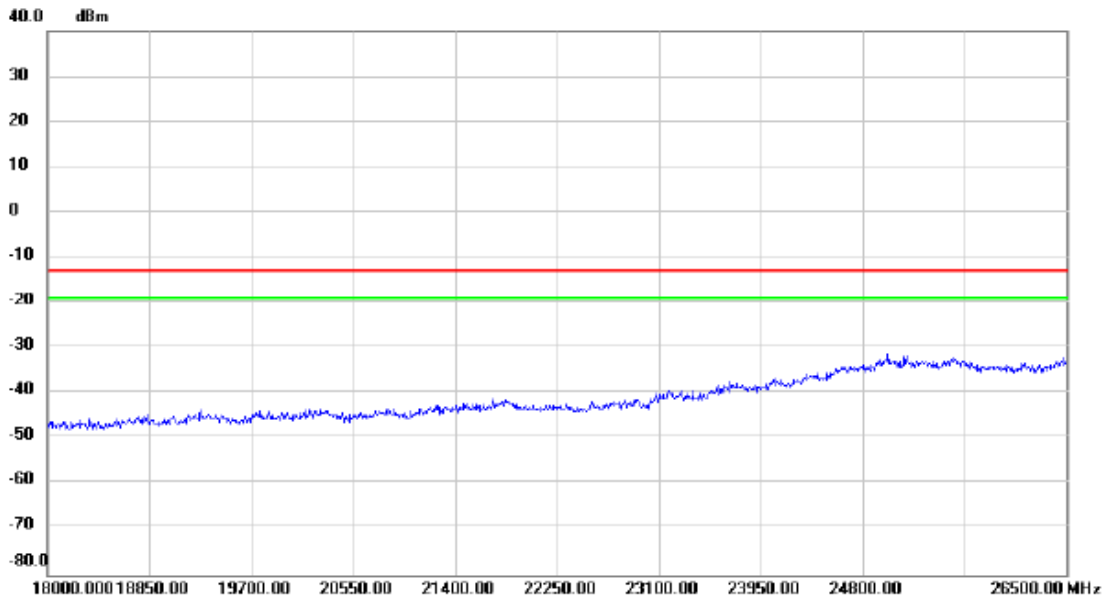

No.	Mk.	Freq.	Reading Level	Correct Factor	Measurement	Limit	Margin	Detector	Comment
		MHz	dBm	dB	dBm	dBm	dB		

Test Mode: WCDMA Band II_HSDPA_TX CH9400

Vertical

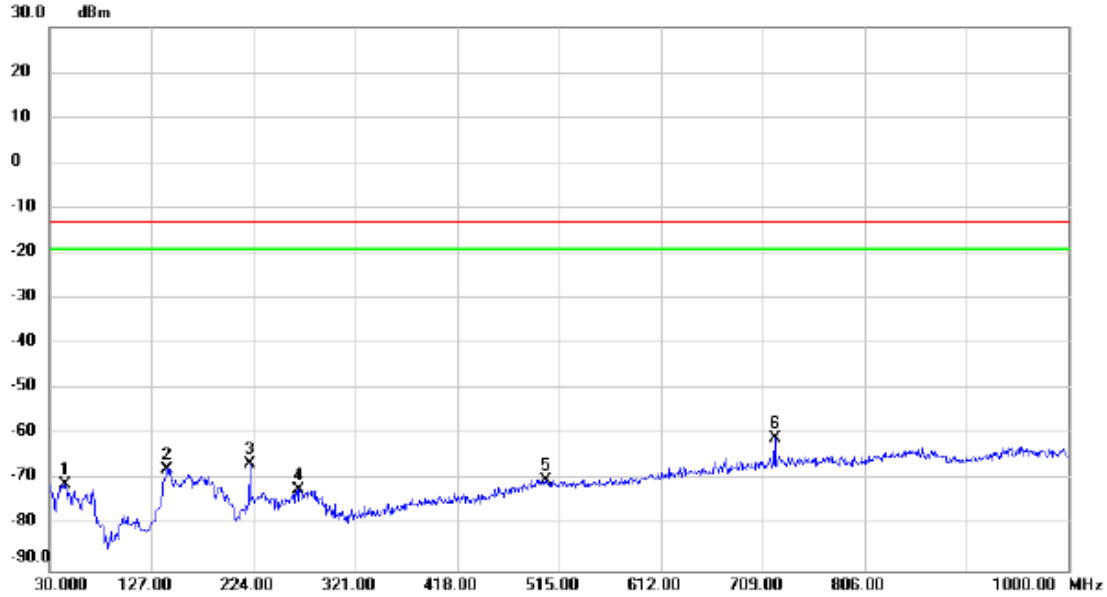

No.	Mk.	Freq. MHz	Reading Level dBm	Correct Factor dB	Measure- ment dBm	Limit dBm	Margin dB	Detector	Comment
1		44.550	-72.90	1.96	-70.94	-13.00	-57.94	peak	
2		141.550	-69.96	2.31	-67.65	-13.00	-54.65	peak	
3		220.120	-64.98	-1.37	-66.35	-13.00	-53.35	peak	
4		267.650	-74.00	1.85	-72.15	-13.00	-59.15	peak	
5		502.390	-77.48	7.55	-69.93	-13.00	-56.93	peak	
6	*	720.640	-72.17	11.31	-60.86	-13.00	-47.86	peak	

Test Mode: WCDMA Band II_HSDPA_TX CH9400

Horizontal



No.	Mk.	Freq. MHz	Reading Level dBm	Correct Factor dB	Measure- ment dBm	Limit dBm	Margin dB	Detector	Comment
1		45.520	-78.47	2.87	-75.60	-13.00	-62.60	peak	
2		144.460	-73.73	3.63	-70.10	-13.00	-57.10	peak	
3		229.820	-70.90	3.20	-67.70	-13.00	-54.70	peak	
4		335.550	-71.61	2.48	-69.13	-13.00	-56.13	peak	
5		547.980	-76.19	8.10	-68.09	-13.00	-55.09	peak	
6	*	727.430	-76.88	13.32	-63.56	-13.00	-50.56	peak	

Test Mode: WCDMA Band II_HSDPA_TX CH9400

Vertical

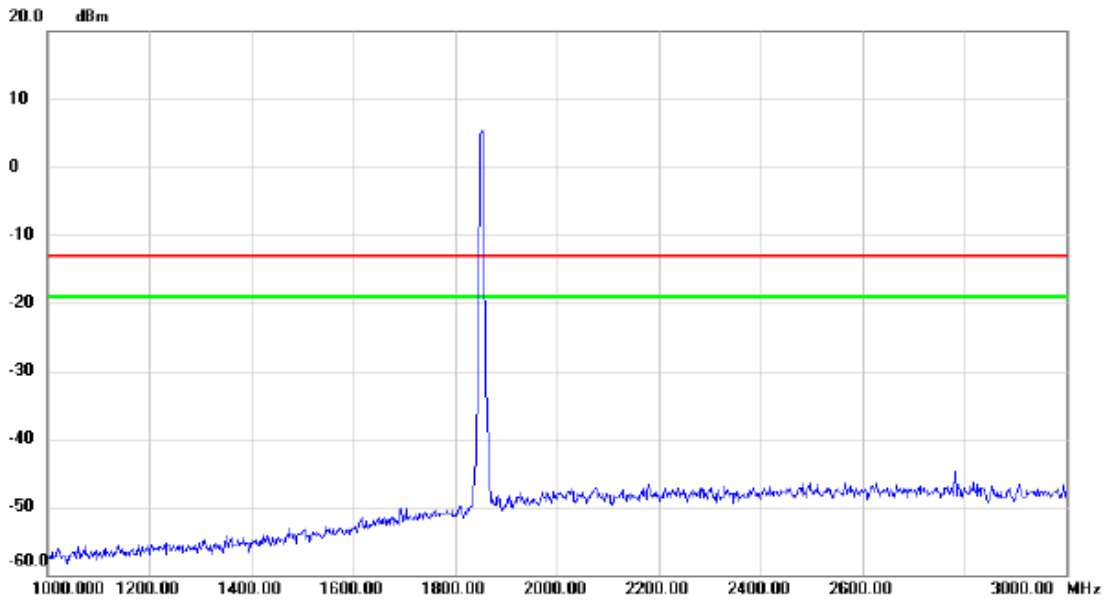

No.	Mk.	Freq.	Reading Level	Correct Factor	Measurement	Limit	Margin	Detector	Comment
		MHz	dBm	dB	dBm	dBm	dB		
		1880.00	5.0	0.0	5.0	-13.0	18.0		

Test Mode: WCDMA Band II_HSDPA_TX CH9400

Horizontal

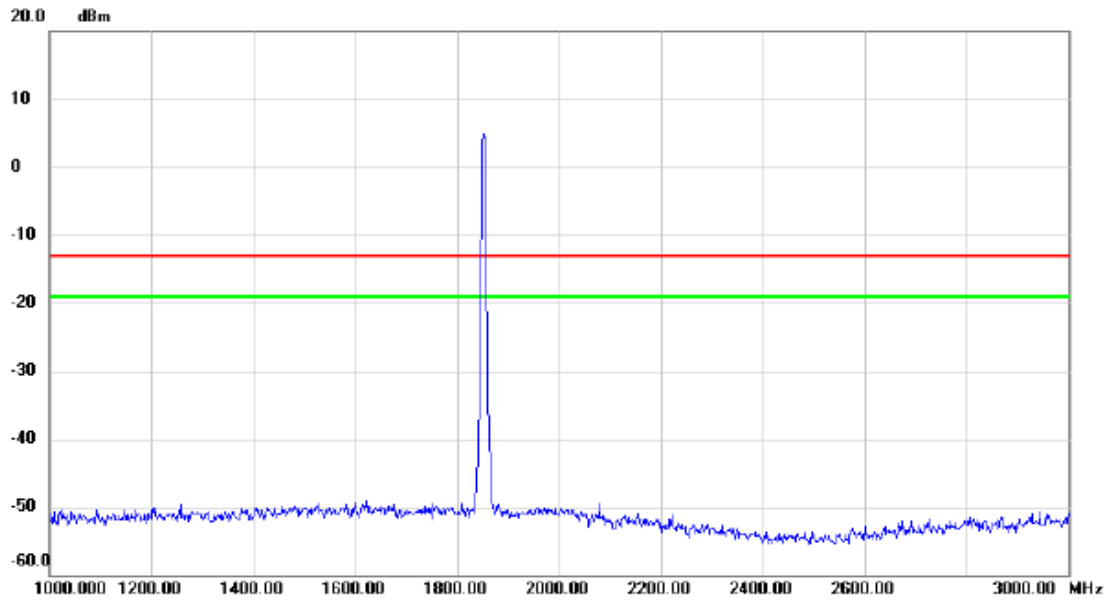

No.	Mk.	Freq.	Reading Level	Correct Factor	Measurement	Limit	Margin	Detector	Comment
		MHz	dBm	dB	dBm	dBm	dB		
		1880.00	5.0		5.0	-13.0	18.0		

Test Mode: WCDMA Band II_HSDPA_TX CH9400

Vertical

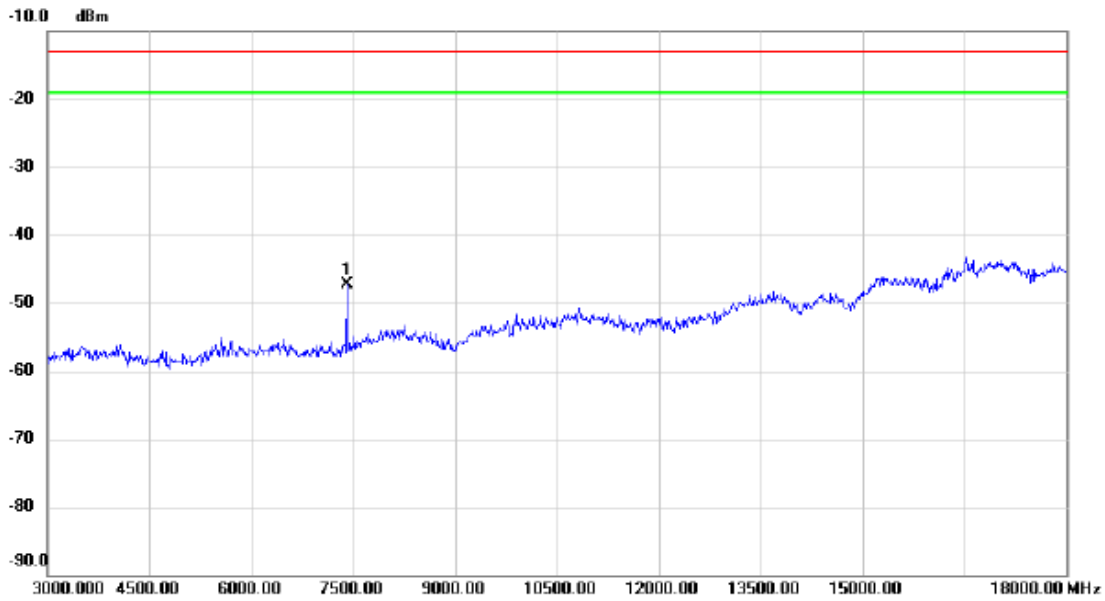

No.	Mk.	Freq. MHz	Reading Level dBm	Correct Factor dB	Measure- ment dBm	Limit dBm	Margin dB	Detector	Comment
1	*	7410.000	-64.95	17.64	-47.31	-13.00	-34.31	peak	

Test Mode: WCDMA Band II_HSDPA_TX CH9400

Horizontal

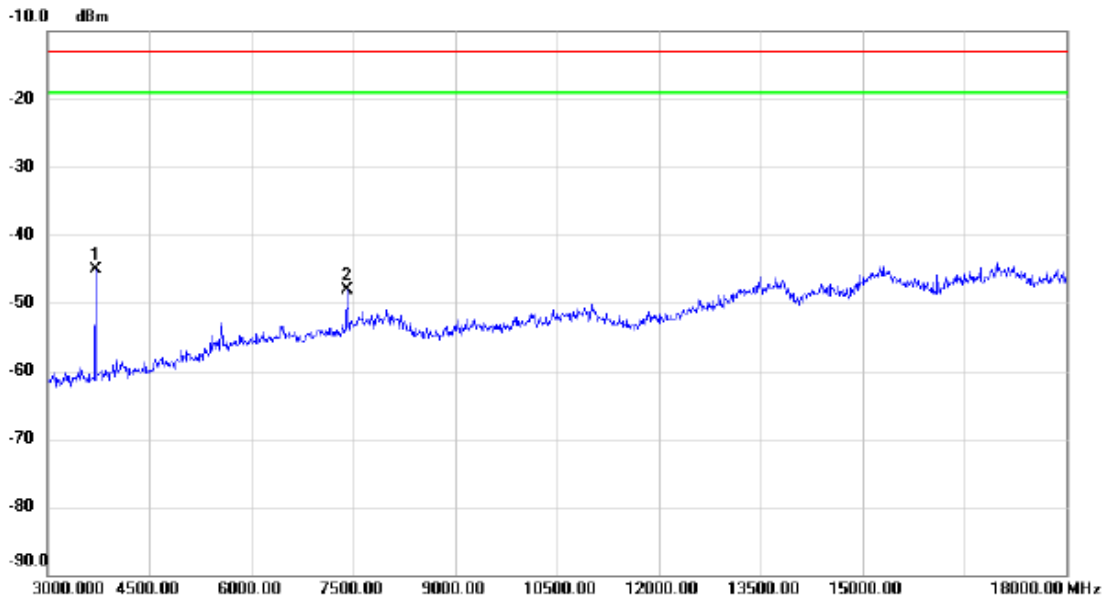

No.	Mk.	Freq. MHz	Reading Level dBm	Correct Factor dB	Measure- ment dBm	Limit dBm	Margin dB	Detector	Comment
1	*	3705.000	-56.19	11.19	-45.00	-13.00	-32.00	peak	
2		7410.000	-68.53	20.35	-48.18	-13.00	-35.18	peak	

Test Mode: WCDMA Band II_HSDPA_TX CH9400

Vertical

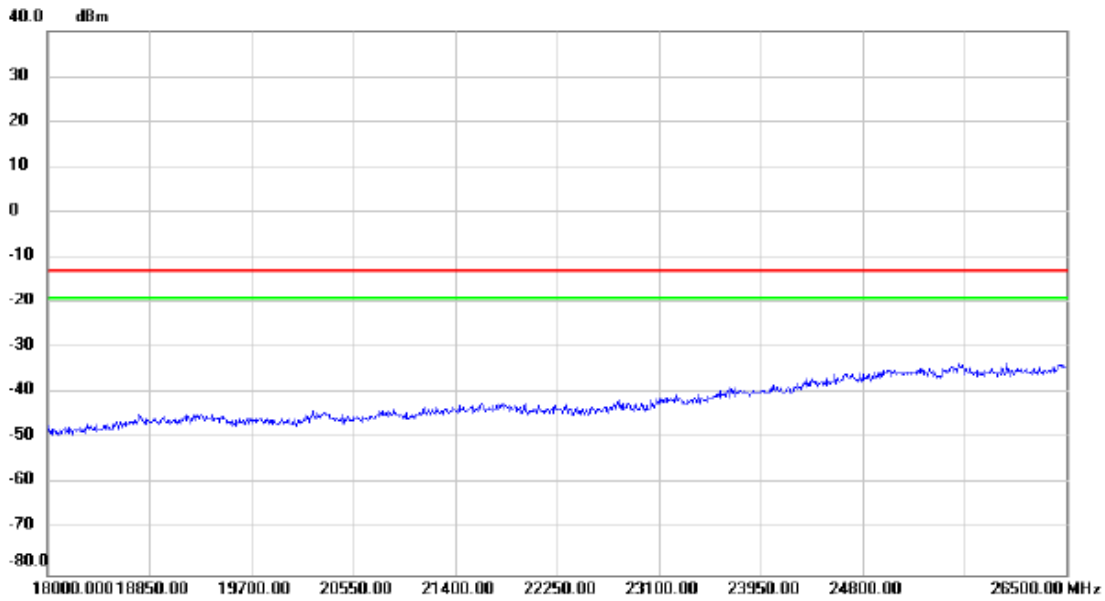

No.	Mk.	Freq.	Reading Level	Correct Factor	Measurement	Limit	Margin	Detector	Comment
		MHz	dBm	dB	dBm	dBm	dB		

Test Mode: WCDMA Band II_HSDPA_TX CH9400

Horizontal

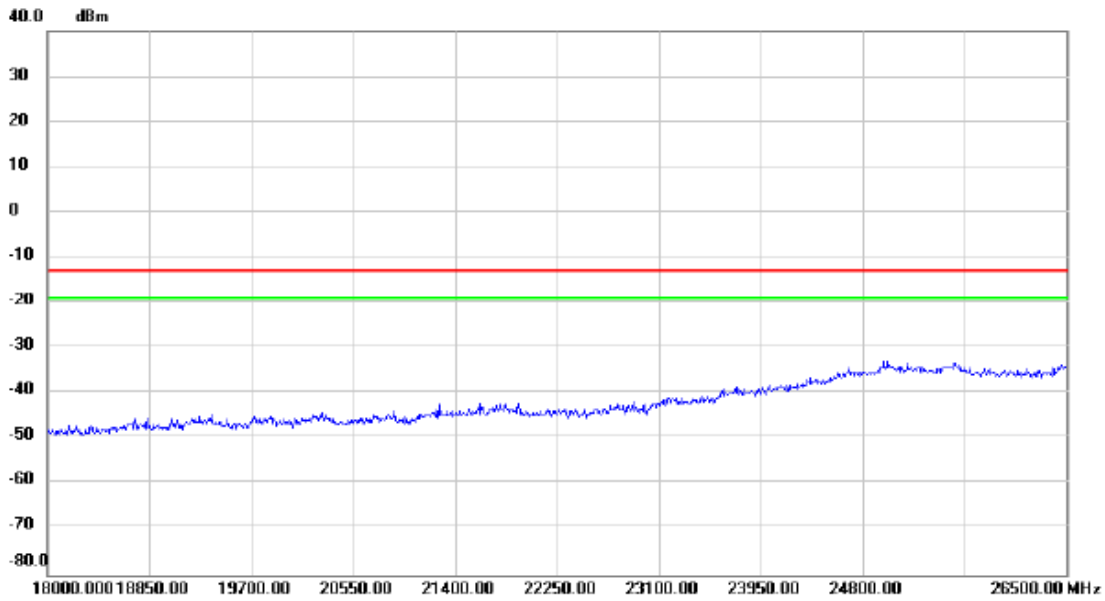

No.	Mk.	Freq.	Reading Level	Correct Factor	Measurement	Limit	Margin	Detector	Comment
		MHz	dBm	dB	dBm	dBm	dB		

Test Mode: WCDMA Band II_HSUPA_TX CH9400

Vertical

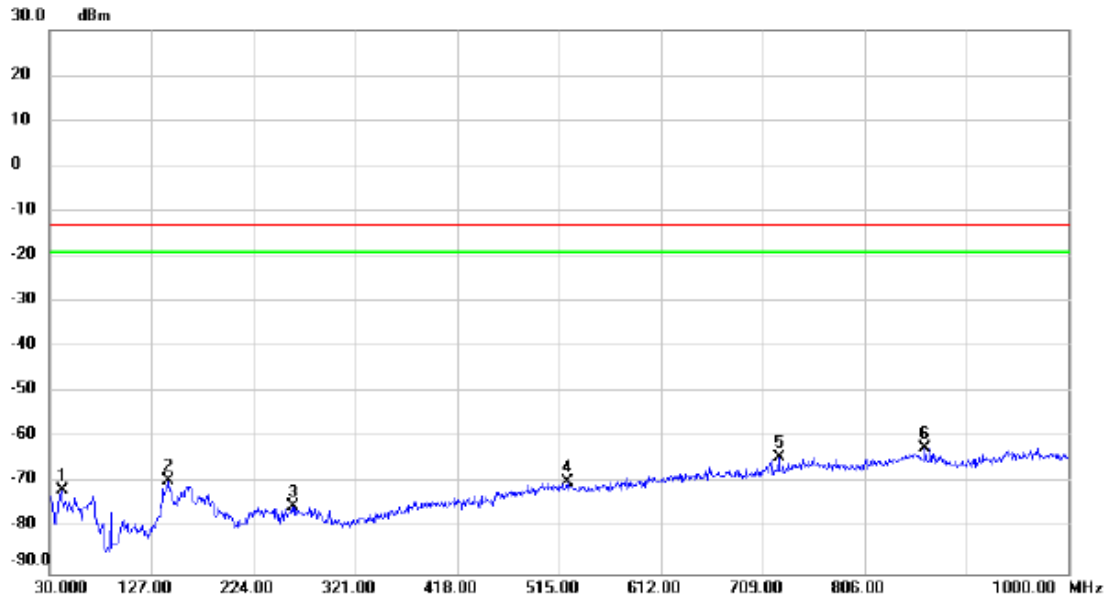

No.	Mk.	Freq. MHz	Reading Level dBm	Correct Factor dB	Measure- ment dBm	Limit dBm	Margin dB	Detector	Comment
1		41.640	-73.49	2.06	-71.43	-13.00	-58.43	peak	
2		143.490	-72.00	2.50	-69.50	-13.00	-56.50	peak	
3		261.830	-76.30	1.01	-75.29	-13.00	-62.29	peak	
4		522.760	-77.34	7.50	-69.84	-13.00	-56.84	peak	
5		724.520	-75.70	11.46	-64.24	-13.00	-51.24	peak	
6	*	863.230	-76.16	14.00	-62.16	-13.00	-49.16	peak	

Test Mode: WCDMA Band II_HSUPA_TX CH9400

Horizontal

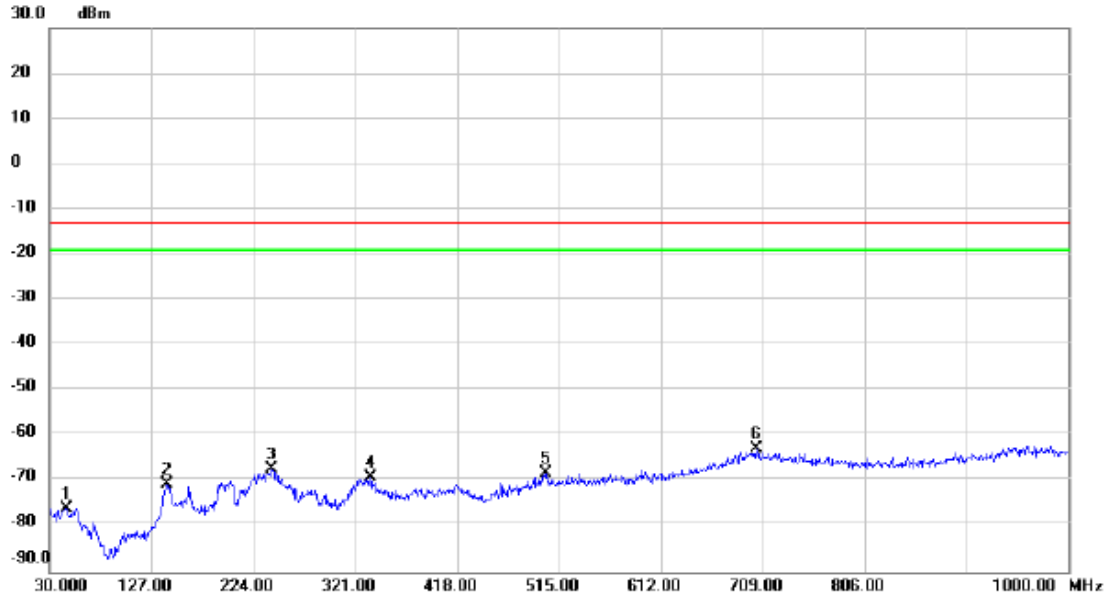

No.	Mk.	Freq. MHz	Reading Level dBm	Correct Factor dB	Measure- ment dBm	Limit dBm	Margin dB	Detector	Comment
1		45.520	-78.86	2.87	-75.99	-13.00	-62.99	peak	
2		141.550	-73.83	3.30	-70.53	-13.00	-57.53	peak	
3		241.460	-69.77	2.32	-67.45	-13.00	-54.45	peak	
4		335.550	-71.55	2.48	-69.07	-13.00	-56.07	peak	
5		502.390	-76.41	8.06	-68.35	-13.00	-55.35	peak	
6	*	703.180	-76.64	13.90	-62.74	-13.00	-49.74	peak	

Test Mode: WCDMA Band II_HSUPA_TX CH9400

Vertical

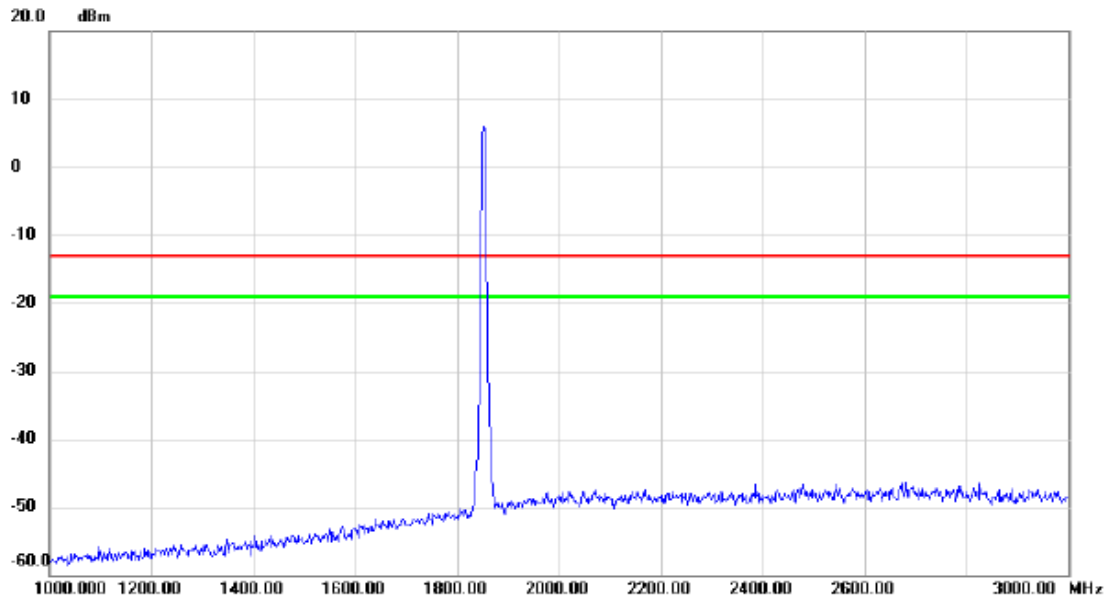

No.	Mk.	Freq.	Reading Level	Correct Factor	Measurement	Limit	Margin	Detector	Comment
		MHz	dBm	dB	dBm	dBm	dB		
		1880.00	5.00	0.00	5.00	-13.00	18.00		

Test Mode: WCDMA Band II_HSUPA_TX CH9400

Horizontal

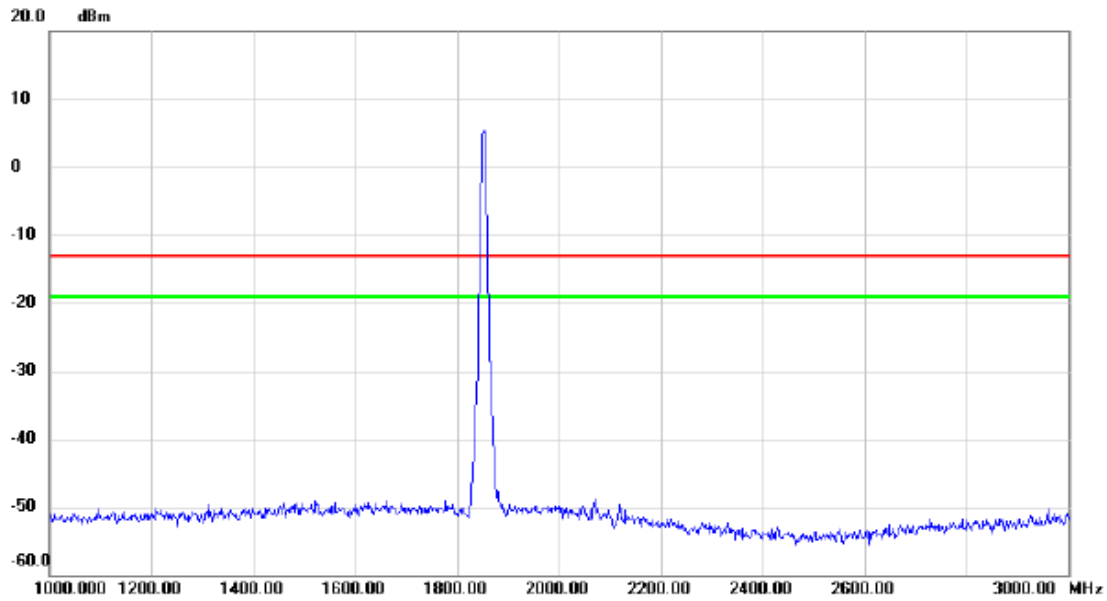

No.	Mk.	Freq.	Reading Level	Correct Factor	Measurement	Limit	Margin	Detector	Comment
		MHz	dBm	dB	dBm	dBm	dB		
		1880.00	5.0		5.0	-13.0	18.0		

Test Mode: WCDMA Band II_HSUPA_TX CH9400

Vertical

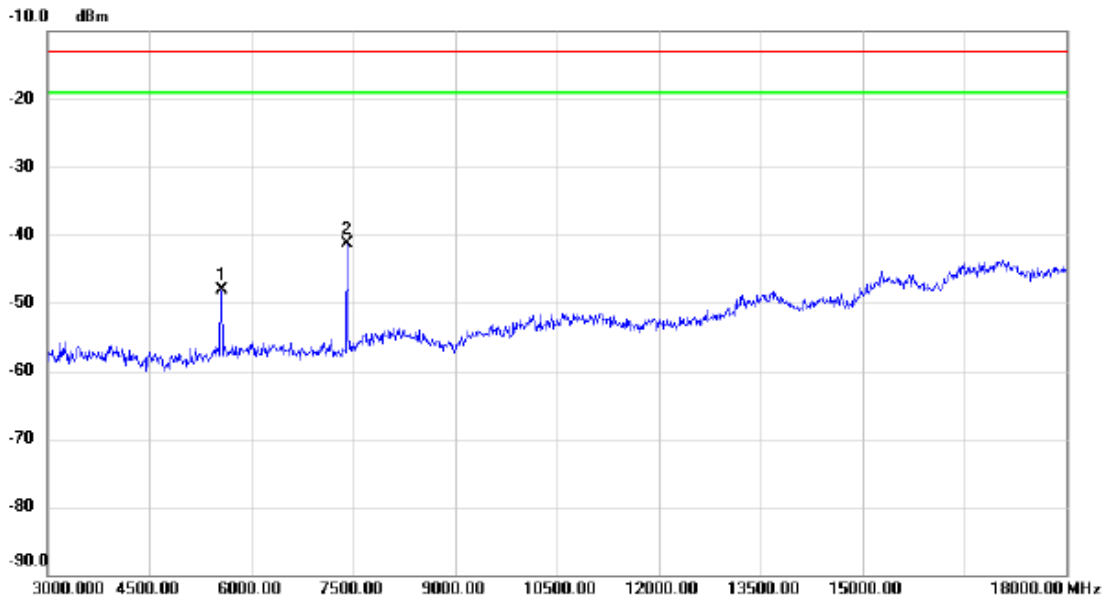

No.	Mk.	Freq. MHz	Reading Level dBm	Correct Factor dB	Measure- ment dBm	Limit dBm	Margin dB	Detector	Comment
1		5565.000	-64.37	16.18	-48.19	-13.00	-35.19	peak	
2	*	7410.000	-58.92	17.64	-41.28	-13.00	-28.28	peak	

Test Mode: WCDMA Band II_HSUPA_TX CH9400

Horizontal

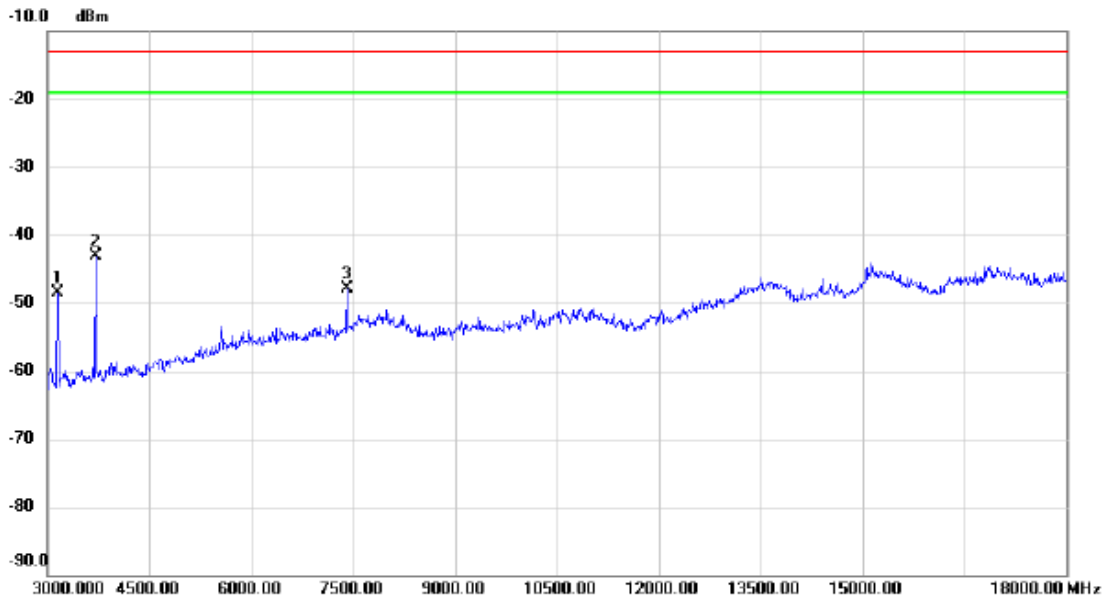

No.	Mk.	Freq. MHz	Reading Level dBm	Correct Factor dB	Measure- ment dBm	Limit dBm	Margin dB	Detector	Comment
1		3150.000	-57.70	9.29	-48.41	-13.00	-35.41	peak	
2	*	3705.000	-54.31	11.19	-43.12	-13.00	-30.12	peak	
3		7410.000	-68.26	20.35	-47.91	-13.00	-34.91	peak	

Test Mode: WCDMA Band II_HSUPA_TX CH9400

Vertical

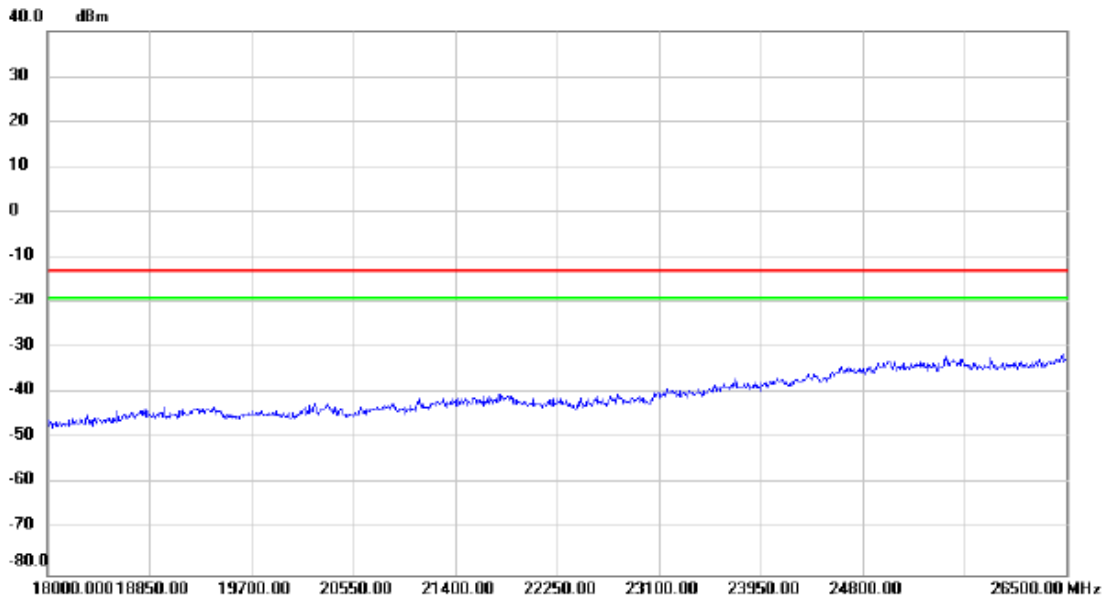

No.	Mk.	Freq.	Reading Level	Correct Factor	Measurement	Limit	Margin	Detector	Comment
		MHz	dBm	dB	dBm	dBm	dB		

Test Mode: WCDMA Band II_HSUPA_TX CH9400

Horizontal

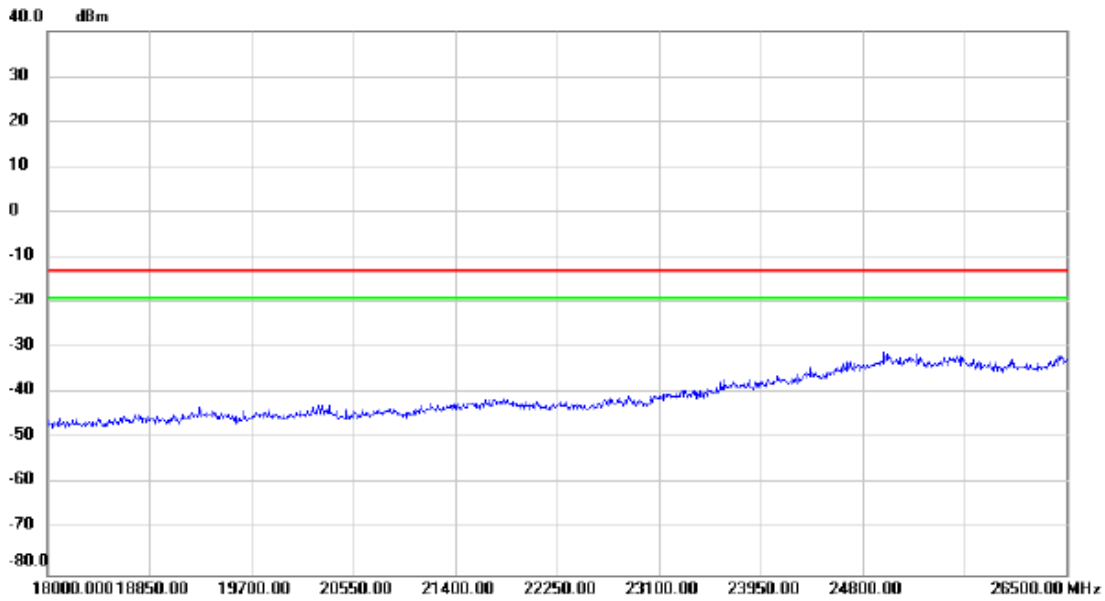

No.	Mk.	Freq.	Reading Level	Correct Factor	Measurement	Limit	Margin	Detector	Comment
		MHz	dBm	dB	dBm	dBm	dB		

APPENDIX E - BAND EDGE

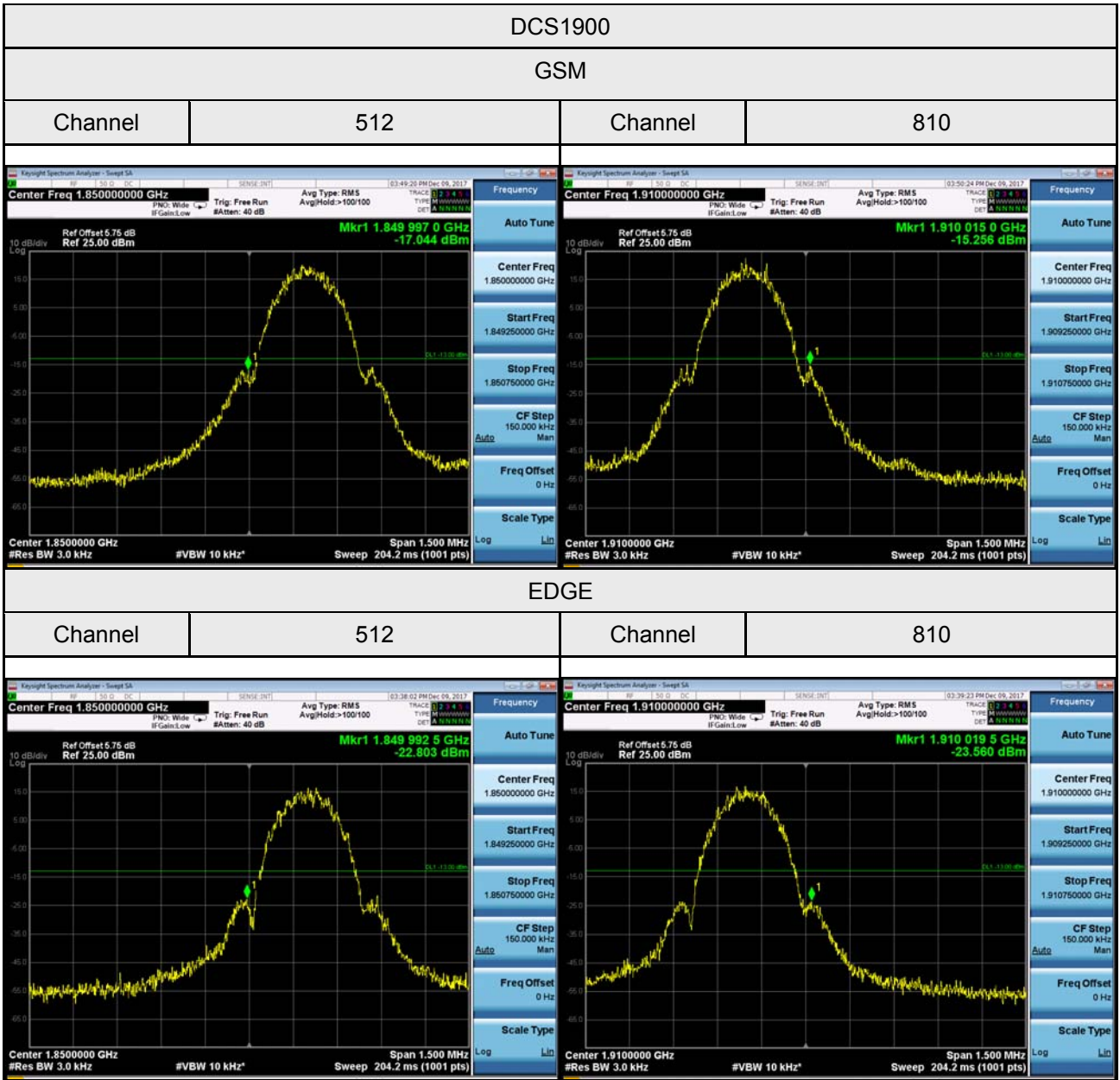

WCDMA Band II

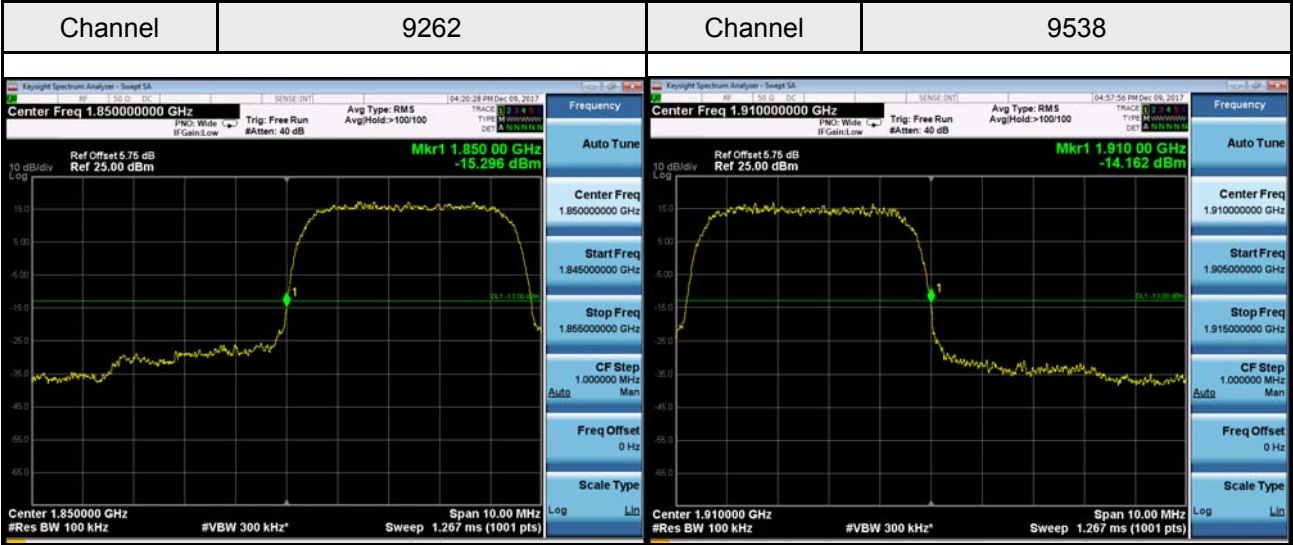

WCDMA_HSDPA Band II

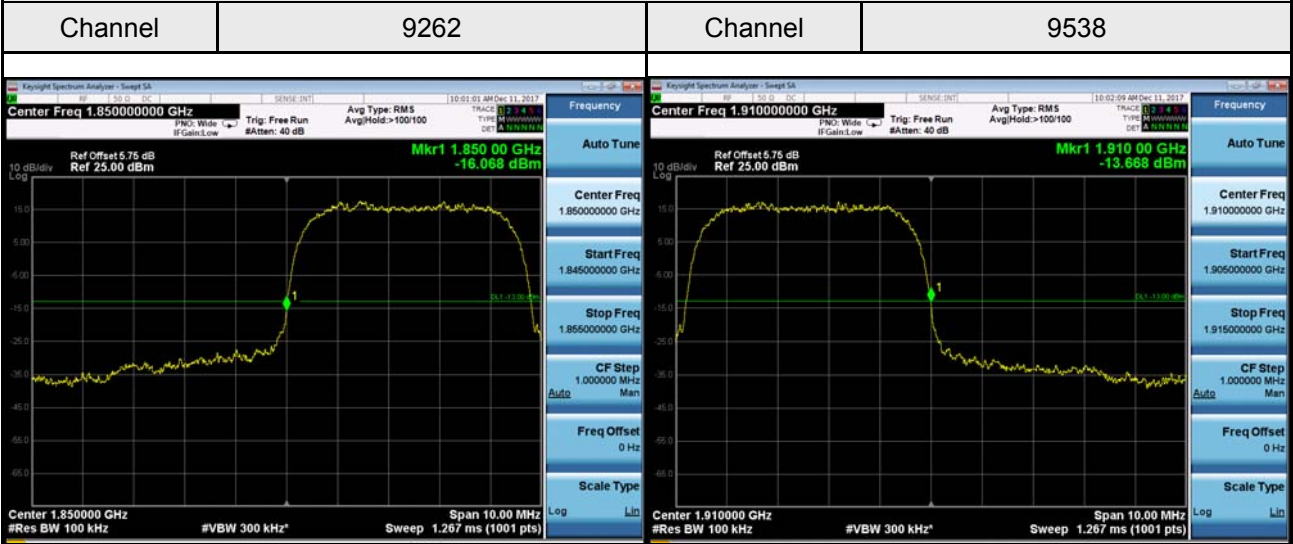

WCDMA_HSUPA Band II

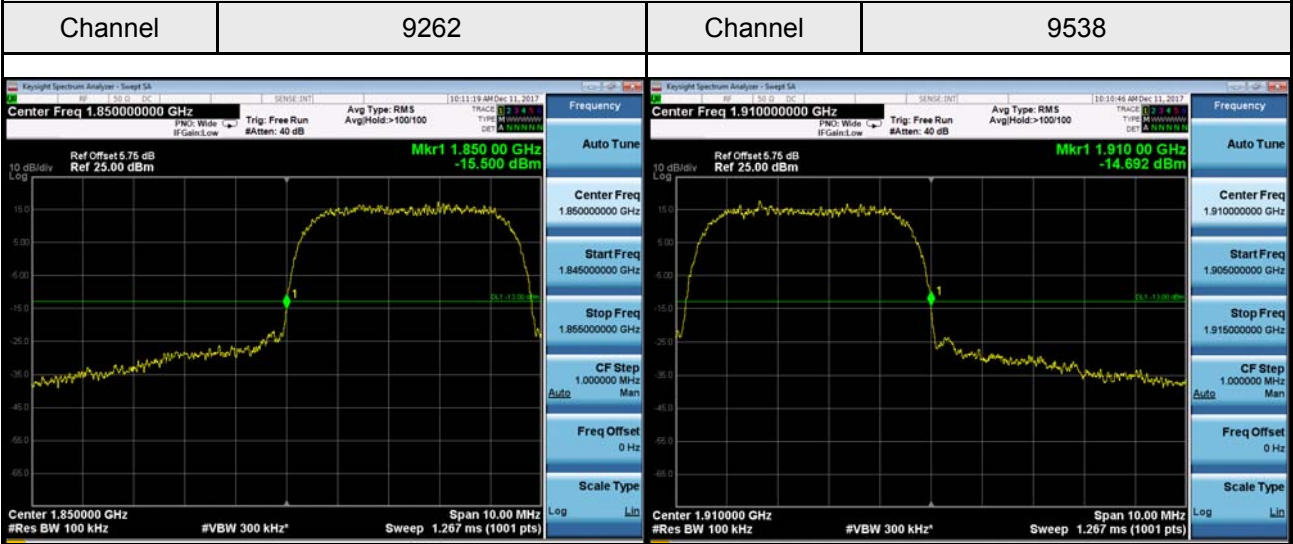

APPENDIX F - PEAK TO AVERAGE RATIO

DCS1900 Spectrum Plot

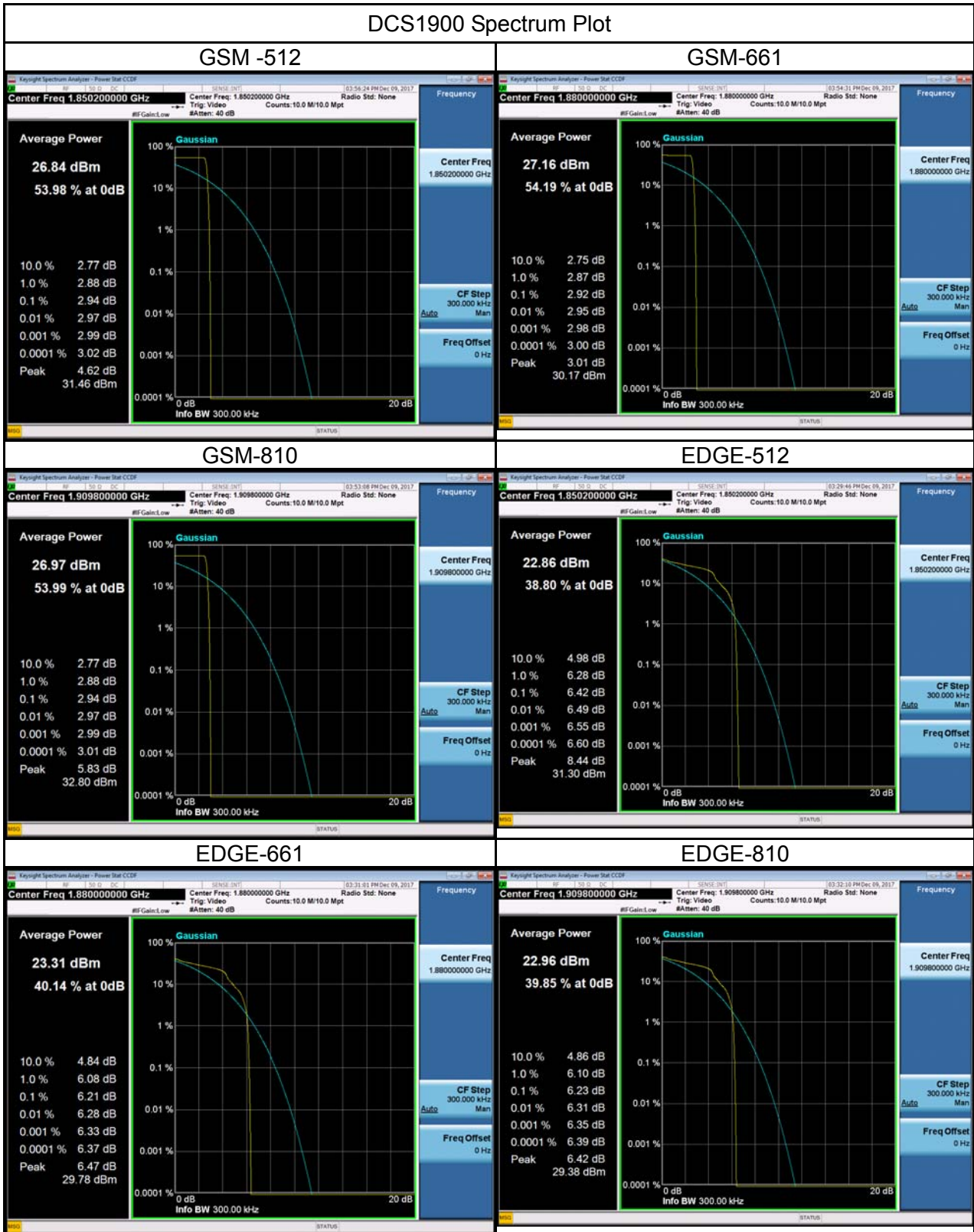

WCDMA Band II Spectrum Plot

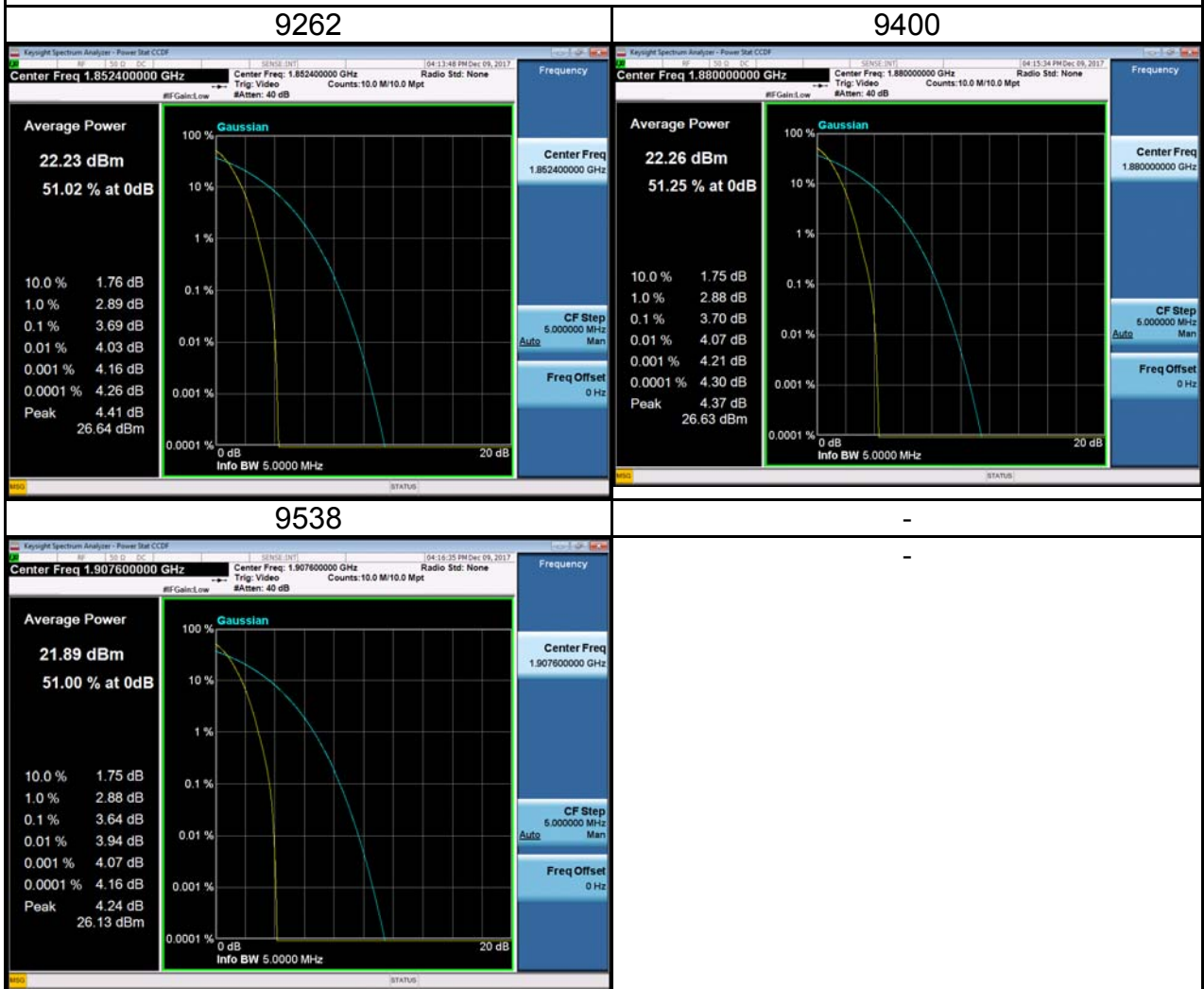

WCDMA_HSDPA Band II Spectrum Plot

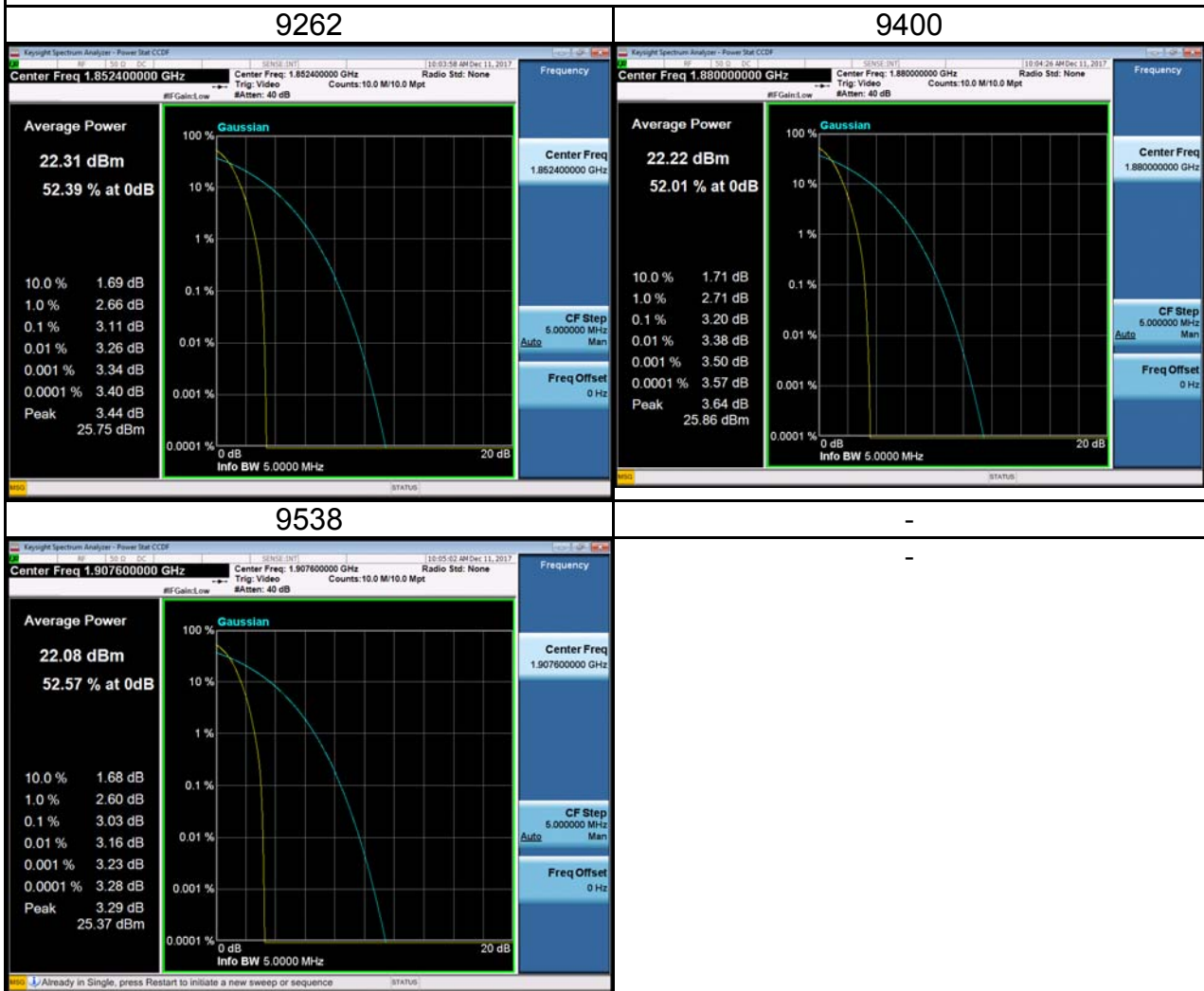

WCDMA_HSUPA Band II Spectrum Plot

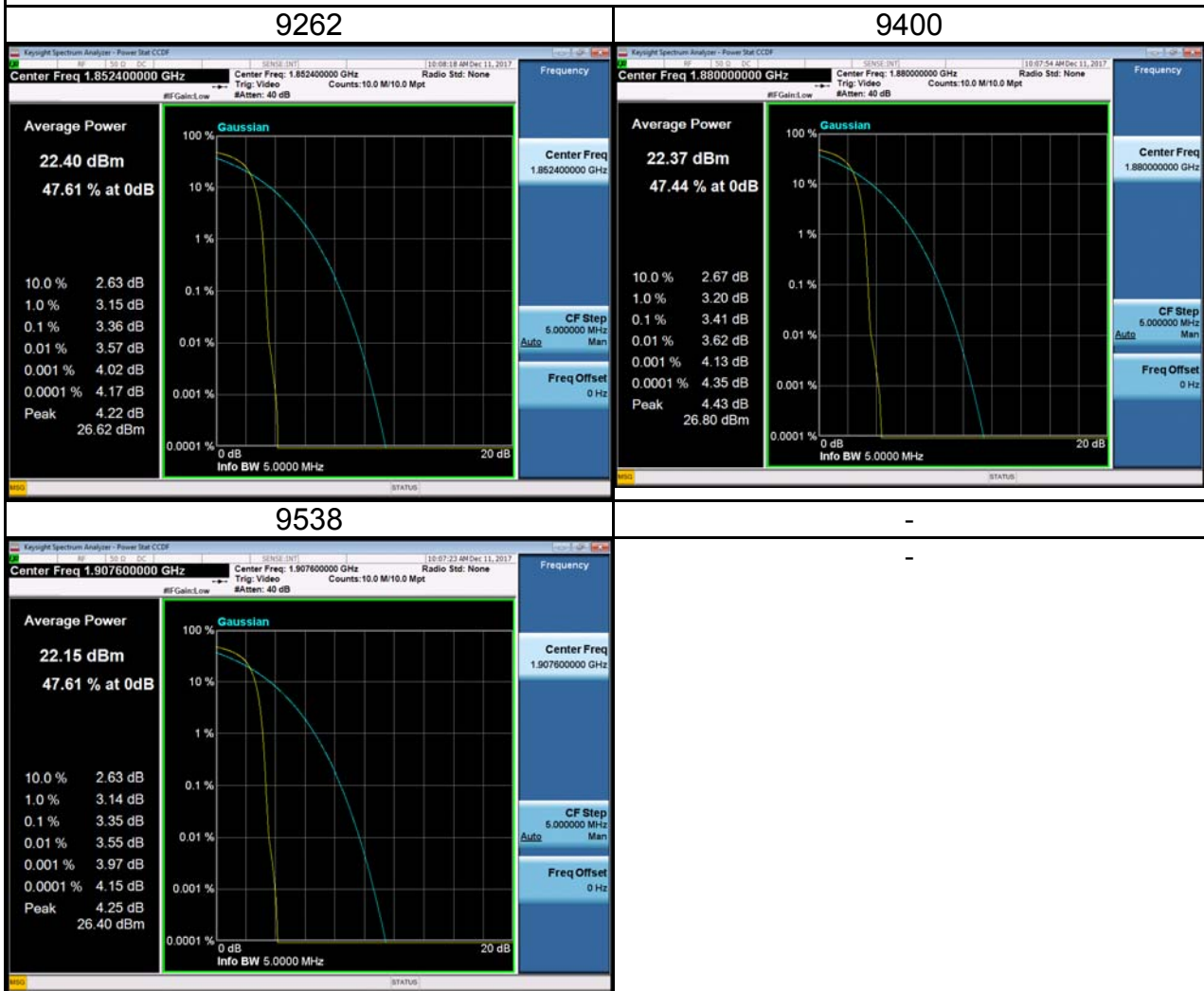

APPENDIX G - FREQUENCY STABILITY

Test Mode:	DCS1900_CH661
------------	---------------

Temperature vs. Frequency Stability

Temperature(°C)	Frequency Error (Hz)	Frequency Error (ppm)	Limit(ppm)
-30	5.21	0.006321281	2.5
-20	7.48	0.009075467	2.5
-10	3.13	0.003797622	2.5
0	6.16	0.007473914	2.5
10	4.15	0.005035186	2.5
20	2.21	0.002681388	2.5
30	3.58	0.004343606	2.5
40	7.13	0.008650813	2.5
50	5.22	0.006333414	2.5
Max. Deviation (ppm)	7.48	0.009075467	2.5

Voltage vs. Frequency Stability

Voltage(Volts)	Frequency Error (Hz)	Frequency Error (ppm)	Limit(ppm)
3.50V	2.99	0.00362776	2.5
3.82V	5.32	0.006454744	2.5
4.40V	3.58	0.004343606	2.5
Max. Deviation (ppm)	5.32	0.006454744	2.5

Test Mode:	WCDMA Band II_CH9400
------------	----------------------

Temperature vs. Frequency Stability

Temperature(°C)	Frequency Error (Hz)	Frequency Error (ppm)	Limit(ppm)
-30	8.11	0.00431383	2.5
-20	5.34	0.002840426	2.5
-10	6.45	0.003430851	2.5
0	3.27	0.001739362	2.5
10	5.29	0.00281383	2.5
20	4.44	0.002361702	2.5
30	3.41	0.00181383	2.5
40	7.87	0.00418617	2.5
50	5.39	0.002867021	2.5
Max. Deviation (ppm)	8.11	0.00431383	2.5

Voltage vs. Frequency Stability

Voltage(Volts)	Frequency Error (Hz)	Frequency Error (ppm)	Limit(ppm)
3.50V	6.88	0.003659574	2.5
3.82V	2.45	0.001303191	2.5
4.40V	5.12	0.002723404	2.5
Max. Deviation (ppm)	6.88	0.003659574	2.5