

FCC Radio Test Report

FCC ID: QISCMR-AL09

This report concerns (check one): Original Grant Class II Change

Project No. : 1712C036A
Equipment : Tablet
Model Name : CMR-AL09
Applicant : Huawei Technologies Co., Ltd.
Address : Administration Building, Headquarters of Huawei Technologies Co., Ltd., Bantian, Longgang District Shenzhen China

Date of Receipt : Dec, 02, 2017
Date of Test : Dec, 02, 2017 ~ Jan, 17, 2018
Issued Date : Jan, 23, 2018
Tested by : BTL Inc.

Technical Engineer : Shawn Xiao
(Shawn Xiao)

Authorized Signatory : Steven Lu
(Steven Lu)

B T L I N C .

No.3, Jinshagang 1st Road, Shixia, Dalang Town, Dongguan, Guangdong, China.

TEL: +86-769-8318-3000 FAX: +86-769-8319-6000



Declaration

BTL represents to the client that testing is done in accordance with standard procedures as applicable and that test instruments used has been calibrated with standards traceable to international standard(s) and/or national standard(s).

BTL's reports apply only to the specific samples tested under conditions. It is manufacture's responsibility to ensure that additional production units of this model are manufactured with the identical electrical and mechanical components. **BTL** shall have no liability for any declarations, inferences or generalizations drawn by the client or others from **BTL** issued reports.

BTL's report must not be used by the client to claim product certification, approval, or endorsement by NVLAP, NIST, or any agency of the Federal Government.

This report is the confidential property of the client. As a mutual protection to the clients, the public and **BTL-self**, extracts from the test report shall not be reproduced except in full with **BTL's** authorized written approval.

BTL's laboratory quality assurance procedures are in compliance with the **ISO Guide17025** requirements, and accredited by the conformity assessment authorities listed in this test report.

Limitation

For the use of the authority's logo is limited unless the Test Standard(s)/Scope(s)/Item(s) mentioned in this test report is (are) included in the conformity assessment authorities acceptance respective.

Table of Contents**Page**

REPORT ISSUED HISTORY	5
1 . CERTIFICATION	6
2 . SUMMARY OF TEST RESULTS	7
2.1 TEST FACILITY	8
2.2 MEASUREMENT UNCERTAINTY	8
3 . GENERAL INFORMATION	9
3.1 GENERAL DESCRIPTION OF EUT	9
3.2 DESCRIPTION OF TEST MODES AND TEST CONDITION	12
3.3 BLOCKDIAGRAMSHOWINGTHECONFIGURATIONOFSYSTEMTESTED FOR RADIATED	16
3.4 DESCRIPTION OF SUPPORT UNITS	16
4 . TEST RESULT	17
4.1 OUTPUT POWER MEASUREMENT	17
4.1.1 LIMIT	17
4.1.2 TEST PROCEDURE	17
4.1.3 TESTSETUP LAYOUT	17
4.1.4 TEST DEVIATION	17
4.1.5 TEST RESULTS	17
4.2 OCCUPIED BANDWIDTH MEASUREMENT	18
4.2.1 TEST PROCEDURE	18
4.2.2 TEST SETUP LAYOUT	18
4.2.3 TEST DEVIATION	18
4.2.4 TEST RESULTS	18
4.3 CONDUCTED EMISSIONS MEASUREMENT	19
4.3.1 LIMIT	19
4.3.2 TEST PROCEDURES	19
4.3.3 TESTSETUP LAYOUT	19
4.3.4 TESTDEVIATION	19
4.3.5 TEST RESULTS	19
4.4 RADIATED EMISSIONS MEASUREMENT	20
4.4.1 LIMIT	20
4.4.2 TEST PROCEDURES	20
4.4.3 TESTSETUP LAYOUT	21
4.4.4 TESTDEVIATION	22
4.4.5 TEST RESULTS	22
4.5 BAND EDGE MEASUREMENT	23
4.5.1 LIMIT	23

Table of Contents	Page
4.5.2 TEST PROCEDURES	23
4.5.3 TESTSETUP LAYOUT	23
4.5.4 TESTDEVIATION	23
4.5.5 TEST RESULTS	23
4.6 PEAK TO AVERAGE RATIO MEASUREMENT	24
4.6.1 LIMIT	24
4.6.2 TEST PROCEDURES	24
4.6.3 TESTSETUP LAYOUT	24
4.6.4 TESTDEVIATION	24
4.6.5 TEST RESULTS	24
4.7 FREQUENCY STABILITY MEASUREMENT	25
4.7.1 LIMIT	25
4.7.2 TEST PROCEDURES	25
4.7.3 TESTSETUP LAYOUT	25
4.7.4 TESTDEVIATION	25
4.7.5 TEST RESULTS	25
5. LIST OF MEASUREMENT EQUIPMENTS	26
APPENDIX A - OUTPUT POWER	28
APPENDIX B - OCCUPIED BANDWIDTH	41
APPENDIX C - CONDUCTED EMISSIONS	65
APPENDIX D - RADIATED EMISSION	79
APPENDIX E - BAND EDGE	124
APPENDIX F - PEAK TO AVERAGE RATIO	136
APPENDIX G - FREQUENCY STABILITY	150

REPORT ISSUED HISTORY

Issued No.	Description	Issued Date
BTL-FCCP-6-1712C036	Original Report	Jan, 18, 2018
BTL-FCCP-6-1712C036A	Compared with the previous report (BTL-FCCP-6-1712C036), The model name is changed which does not affected the test result the rest are kept the same.	Jan. 23, 2018

1. CERTIFICATION

Equipment : Tablet
Brand Name : HUAWEI
Model Name : CMR-AL09
Applicant : Huawei Technologies Co.,Ltd.
Manufacturer : Huawei Technologies Co.,Ltd.
Address : Administration Building, Huawei Base, Bantian, Longgang District ,
Shenzhen 518129, P.R.China
Factory : Huawei Technologies Co.,Ltd.
Address : Administration Building, Huawei Base, Bantian, Longgang District ,
Shenzhen 518129, P.R.China
Date of Test : Dec, 02, 2017 ~ Jan, 17, 2018
Test Sample : Engineering Sample
Standard(s) : 47 CFR FCC Part 22 Subpart H
47 CFR FCC Part 2
ANSI/TIA-603-D-2010
KDB 971168 D01 Power Meas License Digital Systems v02r02

The above equipment has been tested and found compliance with the requirement of the relative standards by BTL Inc.

The test data, data evaluation, and equipment configuration contained in our test report (Ref No. BTL-FCCP-6-1712C036A) were obtained utilizing the test procedures, test instruments, test sites that has been accredited by the Authority of NVLAP according to the ISO-17025 quality assessment standard and technical standard(s).

Test result included in this report is only for the GSM850, WCDMA Band 5, LTE Band 5 and Band 26 part.

2. SUMMARY OF TEST RESULTS

Test procedures according to the technical standard(s):

FCC Part 22 Subpart H & Part 2			
Standard(s) Section	Test Item	Judgment	Tested By
2.1046 22.913(a)	Radiated power	PASS	Paul Li
2.1046 22.913(a)	Conducted Output Power	PASS	Paul Li
2.1049(h) 22.917(a)	Occupied Bandwidth	PASS	Paul Li
2.1051 22.917(a)	Conducted Spurious Emissions	PASS	Paul Li
2.1053 22.917(a)	Radiated Spurious Emissions	PASS	Paul Li
22.917(a)	Band Edge Measurements	PASS	Paul Li
-	Peak To Average Ratio	PASS	Paul Li
2.1055 22.355	Frequency Stability	PASS	Paul Li

Note:

(1) "N/A" denotes test is not applicable to this device.

2.1 TEST FACILITY

The test facilities used to collect the test data in this report is at the location of No.3, Jinshagang 1st Road, Shixia, Dalang Town, Dongguan, Guangdong, China.

BTL's test firm number for FCC: 854385

BTL's designation number for FCC: CN5020

2.2 MEASUREMENT UNCERTAINTY

Where relevant, the following measurement uncertainty levels have been estimated for tests performed on the EUT as specified in CISPR 16-4-2. The BTL measurement uncertainty is less than the CISPR 16-4-2 U_{cispr} requirement.

The reported uncertainty of measurement $y \pm U$, where expanded uncertainty U is based on a standard uncertainty multiplied by a coverage factor of $k=2$, providing a level of confidence of approximately **95%**.

A. Radiated Measurement :

Test Site	Method	Measurement Frequency Range	Ant. H / V	U,(dB)
DG-CB03 (3m)	CISPR	9KHz ~ 30MHz	V	3.79
		9KHz ~ 30MHz	H	3.57
		30MHz ~ 200MHz	V	3.82
		30MHz ~ 200MHz	H	3.78
		200MHz ~ 1,000MHz	V	4.10
		200MHz ~ 1,000MHz	H	4.06

Test Site	Method	Measurement Frequency Range	Ant. H / V	U,(dB)
DG-CB03 (3m)	CISPR	1GHz ~ 18GHz	V	3.12
		1GHz ~ 18GHz	H	3.68

Test Site	Method	Measurement Frequency Range	Ant. H / V	U,(dB)
DG-CB03 (1m)	CISPR	18GHz ~ 40GHz	V	4.15
		18GHz ~ 40GHz	H	4.14

Note: Unless specifically mentioned, the uncertainty of measurement has not been taken into account to declare the compliance or non-compliance to the specification.

3. GENERAL INFORMATION

3.1 GENERAL DESCRIPTION OF EUT

Equipment	Tablet			
Brand Name	HUAWEI			
Model Name	CMR-AL09			
Model Difference	N/A			
Modulation Type	GSM/GPRS	GMSK		
	EDGE	GMSK, 8PSK		
	WCDMA	UP: BPSK DL: QPSK,		
	WCDMA(HSDPA/HSUPA)	16QAM		
	LTE	UP: QPSK,16QAM DL: QPSK,16QAM,64AQM		
Operation Frequency	GSM /EDGE/GPRS	824.2 ~ 848.8 MHz		
	WCDMA Band 5	826.4 ~ 846.6 MHz		
	LTE 5 (Channel Bandwidth: 1.4MHz)	824.7 ~ 848.3 MHz		
	LTE 5 (Channel Bandwidth: 3MHz)	825.5 ~ 847.5 MHz		
	LTE 5 (Channel Bandwidth: 5MHz)	826.5 ~ 846.5 MHz		
	LTE 5 (Channel Bandwidth: 10MHz)	829.0 ~ 844.0 MHz		
	LTE 26 (Channel Bandwidth: 1.4MHz)	824.7 ~ 848.3 MHz		
	LTE 26 (Channel Bandwidth: 3MHz)	825.5 ~ 847.5 MHz		
	LTE 26 (Channel Bandwidth: 5MHz)	826.5 ~ 846.5 MHz		
	LTE 26 (Channel Bandwidth: 10MHz)	829 ~ 844 MHz		
LTE 26 (Channel Bandwidth: 15MHz)	831.5 ~ 841.5 MHz			
Max. ERP Power	GSM/GPRS	GMSK	29.07	dBm
	EDGE	8PSK	22.90	dBm
	WCDMA	BPSK	20.42	dBm
	WCDMA_HSDPA	16QAM	19.00	dBm
	WCDMA_HSUPA	16QAM	18.54	dBm
	LTE 5 (Channel Bandwidth: 1.4MHz)	QPSK	19.74	dBm
		16QAM	19.16	dBm
	LTE 5 (Channel Bandwidth: 3MHz)	QPSK	19.87	dBm
		16QAM	19.09	dBm
	LTE 5 (Channel Bandwidth: 5MHz)	QPSK	20.17	dBm
		16QAM	19.59	dBm
	LTE 5 (Channel Bandwidth: 10MHz)	QPSK	20.04	dBm
16QAM		19.28	dBm	

Max. ERP Power	LTE 26 (Channel Bandwidth: 1.4MHz)	QPSK	19.85	dBm
		16QAM	19.22	dBm
	LTE 26 (Channel Bandwidth: 3MHz)	QPSK	19.98	dBm
		16QAM	19.14	dBm
	LTE 26 (Channel Bandwidth: 5MHz)	QPSK	20.52	dBm
		16QAM	19.78	dBm
	LTE 26 (Channel Bandwidth: 10MHz)	QPSK	20.40	dBm
		16QAM	19.66	dBm
LTE 26 (Channel Bandwidth: 15MHz)	QPSK	20.04	dBm	
	16QAM	19.40	dBm	
Antenna Type	Fixed Internal Antenna			
Antenna Gain	-1.2			
Hardware Version	SH1CMRONLM			
Software Version	CMR-AL09 8.0.1.3(SP1C331)			
IMEI No.	Radiated	867030030002165		
	Conducted	867030030002397		
Power Source	#1 Supplied from AC/DC adapter. #2 Battery Supplied.			
Power Rating	#1 Input: 100V~240V AC and 50/60 Hz,0.5A Output: 5V ---2A OR 9V ---2A #2 ---3.82V 7350mAh			

Note:

1. For a more detailed features description, please refer to the manufacturer's specifications or the user's manual.
2. The EUT contains following accessory devices.

Item	Mfr/Brand	Model.
Battery	SCUD (FUJIAN) Electronics Co., Ltd	HB2994I8ECW
	Sunwoda Electronic Co., LTD.	HB2994I8ECW
	Huizhou Desay Battery Co., Ltd	HB2994I8ECW
USB Cable	HONGLIN TECHNOLOGY CO.,LTD	130-26988
	Luxshare Precision Industry Co., Ltd	L99UC001-CS-H
	FOXCONN INTERCONNECT TECHNOLOGY LIMITED	CUDU01B-HC288-EH
	foxlink cheng uei precision industry Co., Ltd	6691-10YZ-0183
USB Type-C to 3.5 mm headset jack adapter cable	FOSTER ELECTRIC CO. (HONG KONG) LTD	620891
	Boluo County Quancheng Electronic Co.,Ltd.	6001-7001-TC-294
	Jiangxi Lianchuang Hongsheng Electronic Co.,LTD	HWTYPEC3R5009AW
	MERRY ELECTRONICS CO., LTD.	L99UD002-CS-H
Adapter	Salcomp (Shenzhen) Co., Ltd.	HW-059200UHQ
	HUIZHOU BYD ELECTRONIC CO.,LTD	

3.2 DESCRIPTION OF TEST MODES AND TEST CONDITION

Following channel(s) was (were) selected for the final test as listed below:

GSM MODE			
Test Item	Available Channel	Tested Channel	Mode
ERP	128 to 251	128, 190, 251	GSM, EDGE
Conducted Output Power	128 to 251	128, 190, 251	GSM, EDGE
Occupied Bandwidth	128 to 251	128, 190, 251	GSM, EDGE
Condcudeted Emission	128 to 251	190	GSM, EDGE
Radiated Emission	128 to 251	128	GSM, EDGE
Band Edge	128 to 251	128, 251	GSM, EDGE
Peak to Average Ratio	128 to 251	128, 190, 251	GSM, EDGE
Frequency Stability	128 to 251	190	GSM

WCDMA MODE			
Test Item	Available Channel	Tested Channel	Mode
ERP	4132 to 4233	4132, 4182, 4233	WCDMA, HSDPA, HSUPA
Conducted Output Power	4132 to 4233	4132, 4182, 4233	WCDMA, HSDPA, HSUPA
Condcudeted Emission	4132 to 4233	4182	WCDMA, HSDPA, HSUPA
Radiated Emission	4132 to 4233	4182	WCDMA, HSDPA, HSUPA
Band Edge	4132 to 4233	4132, 4233	WCDMA, HSDPA, HSUPA
Peak to Average Ratio	4132 to 4233	4132, 4182, 4233	WCDMA, HSDPA, HSUPA
Frequency Stability	4132 to 4233	4182	WCDMA

Note: This device was tested under all bandwidths, RB configurations and modulations. The worst case was found in **QPSK** modulation.

LTE BAND 5						
Test Item	Available Channel	Tested Channel	Channel Bandwidth	Modulation	Mode	
ERP	20407 to 20643	20407, 20525, 20643	1.4MHz	QPSK, 16QAM	1RB/3RB/6RB	
	20415 to 20635	20415, 20525, 20635	3MHz	QPSK, 16QAM	1RB/8RB/15RB	
	20425 to 20625	20425, 20525, 20625	5MHz	QPSK, 16QAM	1RB/12RB/25RB	
	20450 to 20600	20450, 20525, 20600	10MHz	QPSK, 16QAM	1RB/25RB/50RB	
Occupied Bandwidth	20407 to 20643	20407, 20525, 20643	1.4MHz	QPSK, 16QAM	6 RB	
	20415 to 20635	20415, 20525, 20635	3MHz	QPSK, 16QAM	15 RB	
	20425 to 20625	20425, 20525, 20625	5MHz	QPSK, 16QAM	25 RB	
	20450 to 20600	20450, 20525, 20600	10MHz	QPSK, 16QAM	50 RB	
Conducted Emission	20407 to 20643	20525	1.4MHz	QPSK	1 RB	
	20415 to 20635	20525	3MHz	QPSK	1 RB	
	20425 to 20625	20525	5MHz	QPSK	1 RB	
	20450 to 20600	20525	10MHz	QPSK	1 RB	
Radiated Emission	20407 to 20643	20525	1.4MHz	QPSK	1 RB	
	20450 to 20600	20525	10MHz	QPSK	1 RB	
Band Edge	20407 to 20643	20407	1.4MHz	QPSK	1 RB 6 RB	
		20643	1.4MHz	QPSK	1 RB 6 RB	
	20415 to 20635	20415	3MHz	QPSK	1 RB 15 RB	
		20635	3MHz	QPSK	1 RB 15 RB	
	20425 to 20625	20425	5MHz	QPSK	1 RB 25 RB	
		20625	5MHz	QPSK	1 RB 25 RB	
	20450 to 20600	20450	10MHz	QPSK	1 RB 50 RB	
		20600	10MHz	QPSK	1 RB 50 RB	
	Peak To Average Ratio	20407 to 20643	20407, 20525, 20643	1.4MHz	QPSK, 16QAM	1 RB
		20415 to 20635	20415, 20525, 20635	3MHz	QPSK, 16QAM	1 RB
20425 to 20625		20425, 20525, 20625	5MHz	QPSK, 16QAM	1 RB	
20450 to 20600		20450, 20525, 20600	10MHz	QPSK, 16QAM	1 RB	
Frequency Stability	20407 to 20643	20525	1.4MHz	QPSK	1 RB	
	20415 to 20635	20525	3MHz	QPSK	1 RB	
	20425 to 20625	20525	5MHz	QPSK	1 RB	
	20450 to 20600	20525	10MHz	QPSK	1 RB	

Note: This device was tested under all bandwidths, RB configurations and modulations. The worst case was found in QPSK modulation.

LTE BAND 26					
Test Item	Available Channel	Tested Channel	Channel Bandwidth	Modulation	Mode
ERP	26797 to 27033	26797, 26915, 27033	1.4MHz	QPSK, 16QAM	1RB/3RB/6RB
	26805 to 27025	26805, 26915, 27025	3MHz	QPSK, 16QAM	1RB/8RB/15RB
	26815 to 27015	26815, 26915, 27015	5MHz	QPSK, 16QAM	1RB/12RB/25RB
	26840 to 26990	26840, 26915, 26990	10MHz	QPSK, 16QAM	1RB/25RB/50RB
	26865 to 26965	26865, 26915, 26965	15MHz	QPSK, 16QAM	1RB/36RB/75RB
Occupied Bandwidth	26797 to 27033	26797, 26915, 27033	1.4MHz	QPSK, 16QAM	6RB
	26805 to 27025	26805, 26915, 27025	3MHz	QPSK, 16QAM	15 RB
	26815 to 27015	26815, 26915, 27015	5MHz	QPSK, 16QAM	25 RB
	26840 to 26990	26840, 26915, 26990	10MHz	QPSK, 16QAM	50 RB
	26865 to 26965	26865, 26915, 26965	15MHz	QPSK, 16QAM	75 RB
Conducted Emission	26797 to 27033	26915	1.4MHz	QPSK	1 RB
	26805 to 27025	26915	3MHz	QPSK	1 RB
	26815 to 27015	26915	5MHz	QPSK	1 RB
	26840 to 26990	26915	10MHz	QPSK	1 RB
	26915 to 26965	26915	15MHz	QPSK	1 RB
Radiated Emission	26797 to 27033	27033	1.4MHz	QPSK	1 RB
	26915 to 26965	26865	15MHz	QPSK	1 RB
Band Edge	26797 to 27033	26797	1.4MHz	QPSK	1 RB 6 RB
		27033	1.4MHz	QPSK	1 RB 6 RB
	26805 to 27025	26805	3MHz	QPSK	1 RB 15 RB
		27025	3MHz	QPSK	1 RB 15 RB
	26815 to 27015	26815	5MHz	QPSK	1 RB 25 RB
		27015	5MHz	QPSK	1 RB 25 RB
	26840 to 26990	26840	10MHz	QPSK	1 RB 50 RB
		26990	10MHz	QPSK	1 RB 50 RB
	26865 to 26965	26865	15MHz	QPSK	1 RB 75 RB
		26965	15MHz	QPSK	1 RB 75 RB

LTE BAND 26					
Test Item	Available Channel	Tested Channel	Channel Bandwidth	Modulation	Mode
Peak to Average Ratio	26797 to 27033	26797, 26915, 27033	1.4MHz	QPSK, 16QAM	1 RB
	26805 to 27025	26805, 26915, 27025	3MHz	QPSK, 16QAM	15 RB
	26815 to 27015	26815, 26915, 27015	5MHz	QPSK, 16QAM	25 RB
	26840 to 26990	26840, 26915, 26990	10MHz	QPSK, 16QAM	50 RB
	26865 to 26965	26865, 26915, 26965	15MHz	QPSK, 16QAM	75 RB
Frequency Stability	26797 to 27033	26915	1.4MHz	QPSK	1 RB
	26805 to 27025	26915	3MHz	QPSK	1 RB
	26815 to 27015	26915	5MHz	QPSK	1 RB
	26840 to 26990	26915	10MHZ	QPSK	1 RB
	26915 to 26965	26915	15MHZ	QPSK	1 RB

EUT TEST CONDITIONS:

Test Item	Environmental Conditions	Test Voltage
ERP	25°C, 60%RH	DC 3.82V
Conducted Output Power	25°C, 65%RH	DC 3.82V
Occupied Bandwidth	25°C, 65%RH	DC 3.82V
Conducted Emission	25°C, 65%RH	DC 3.82V
Radiated Emission	25°C, 60%RH	AC 120V/60Hz
Band Edge	25°C, 65%RH	DC 3.82V
Peak to Average Ratio	25°C, 65%RH	DC 3.82V
Frequency Stability	25°C, 65%RH	DC 3.82V

3.3 BLOCK DIAGRAM SHOWING THE CONFIGURATION OF SYSTEM TESTED FOR RADIATED

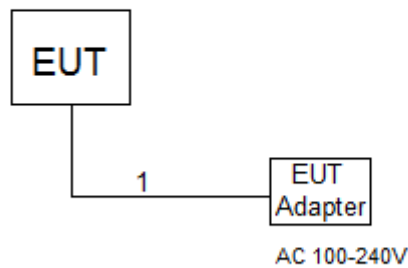

3.4 DESCRIPTION OF SUPPORT UNITS

The EUT has been tested as an independent unit together with other necessary accessories or support units. The following support units or accessories were used to form a representative test configuration during the tests.

Item	Equipment	Mfr/Brand	Model/Type No.	FCC ID	Series No.
-	-	-	-	-	-

Item	Shielded Type	Ferrite Core	Length	Note
1	NO	NO	1.2m	USB cable

4. TEST RESULT

4.1 OUTPUT POWER MEASUREMENT

4.1.1 LIMIT

Mobile / Portable station are limited to 7 watts e.r.p.

4.1.2 TEST PROCEDURE

EIRP/ERP:

1. EIRP= Conducted Power +Antenan gain
ERP power=EIPR power-2.15dBi.

Conducted Power:

The EUT was set up for the maximum power with GSM, GPRS, EDGE, WCDMA and LTE link data modulation and link up with simulator. Set the EUT to transmit under low, middle and high channel and record the power level shown on simulator.

4.1.3 TESTSETUP LAYOUT

Conducted Power Measurement

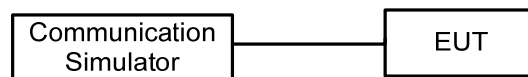

4.1.4 TEST DEVIATION

No deviation

4.1.5 TEST RESULTS

Please refer to the Appendix A.

4.2 OCCUPIED BANDWIDTH MEASUREMENT

4.2.1 TEST PROCEDURE

The EUT makes a call to the communication simulator. All measurements were done at low, middle and high operational frequency range. The communication simulator station system controlled a EUT to export maximum output power under transmission mode and specific channel frequency. Use OBW measurement function of Spectrum analyzer to measure 99 % occupied bandwidth and 26dB bandwidth.

4.2.2 TEST SETUP LAYOUT

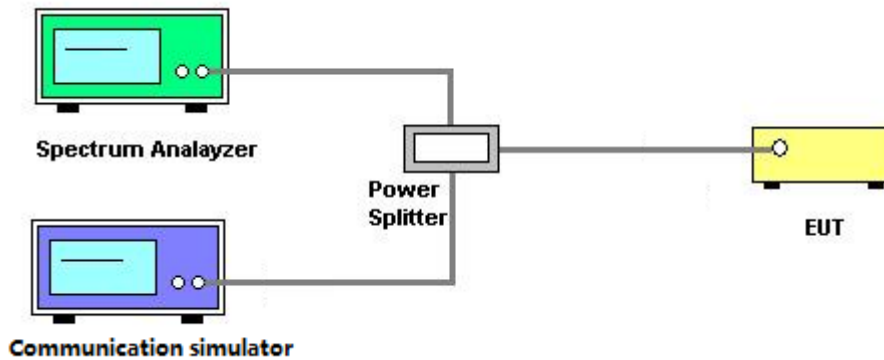

4.2.3 TEST DEVIATION

No deviation

4.2.4 TEST RESULTS

Please refer to the Appendix B.

4.3 CONDUCTED EMISSIONS MEASUREMENT

4.3.1 LIMIT

The power of any emission outside of the authorized operating frequency ranges must be attenuated below the transmitting power (P) by a factor of at least $43 + 10 \log(P)$ dB. The emission limit equal to -13dBm .

4.3.2 TEST PROCEDURES

1. The testing follows FCC KDB 971168 v02r02 Section 6.0.
2. The EUT was connected to spectrum analyzer and system simulator via a power divider.
3. The band edges of low and high channels for the highest RF powers were measured. Set $\text{RBW} \geq 1\%$ EBW in the 1MHz band immediately outside and adjacent to the band edge.
4. Set spectrum analyzer with RMS detector.
5. The RF fundamental frequency should be excluded against the limit line in the operating frequency band.
6. The limit line is derived from $43+10\log(P)\text{dB}$ below the transmitter power P(Watts)
 $=P(W)-[43+10\log(P)](\text{dB})$
 $=[30+10\log(P)](\text{dBm})-[43+10\log(P)](\text{dB})$
 $=-13\text{dBm}$

4.3.3 TESTSETUP LAYOUT

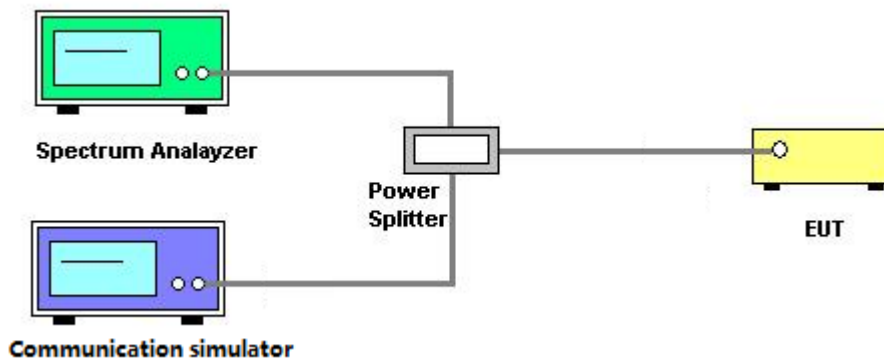

4.3.4 TESTDEVIATION

No deviation

4.3.5 TEST RESULTS

Please refer to the Appendix C.

4.4 RADIATED EMISSIONS MEASUREMENT

4.4.1 LIMIT

The power of any emission outside of the authorized operating frequency ranges must be attenuated below the transmitting power (P) by a factor of at least $43 + 10 \log(P)$ dB. The emission limit equal to -13dBm.

4.4.2 TEST PROCEDURES

1. Substitution method is used for E.I.R.P measurement. In the semi-anechoic chamber, EUT placed on the 0.8m height of Turn Table, rotated the table around 360 degrees to search the maximum radiation power and receiver antenna shall be rotated vertical and horizontal polarization and moved height from 1m to 4m to find the maximum polar radiated power. The "Read Value" is the spectrum reading the maximum power value.
2. The substitution horn antenna is substituted for EUT at the same position and signals generator export the CW signal to the substitution antenna via a TX cable. Rotated the Turn Table and moved receiving antenna to find the maximum radiation power. Adjust output power level of S.G to get a Value of spectrum reading equal to "Read Value " of step a. Record the power level of S.G
3. EIRP = Output power level of S.G – TX cable loss + Antenna gain of substitution horn.
4. E.R.P power can be calculated form E.I.R.P power by subtracting the gain of dipole, E.R.P power = E.I.P.R power - 2.15dBi.
5. The resolution bandwidth and video bandwidth of test receiver/spectrum analyzer is 1MHz/3MHz.

4.4.3 TESTSETUP LAYOUT

Below 1G

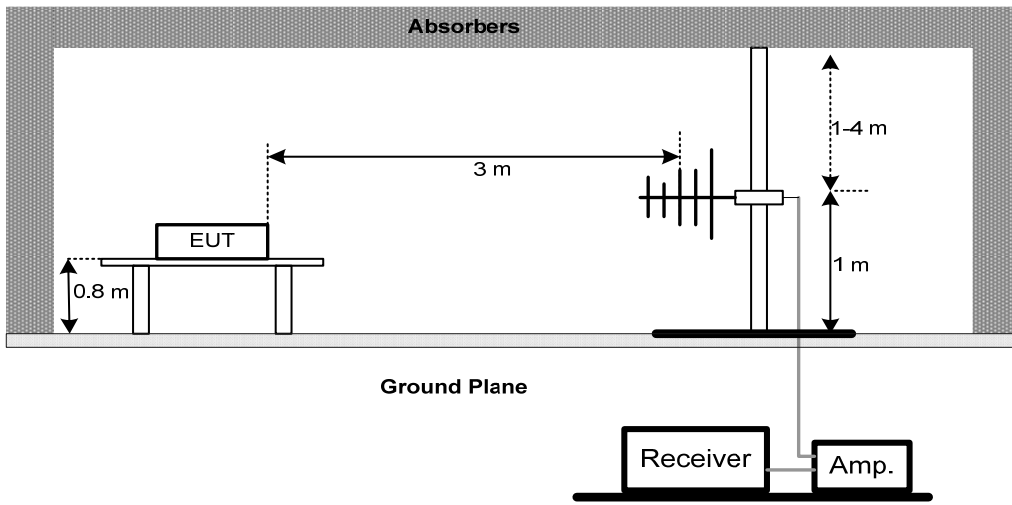

Above 1G

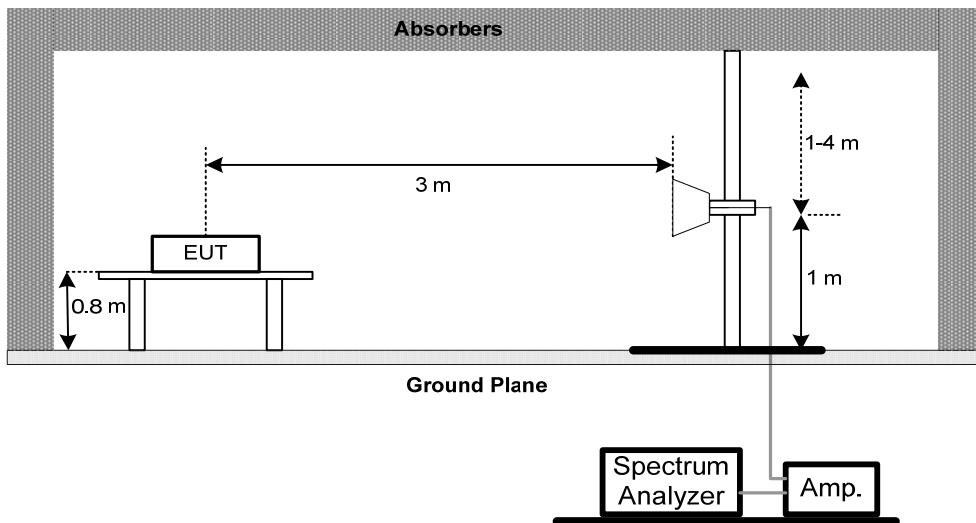

Below 30MHz

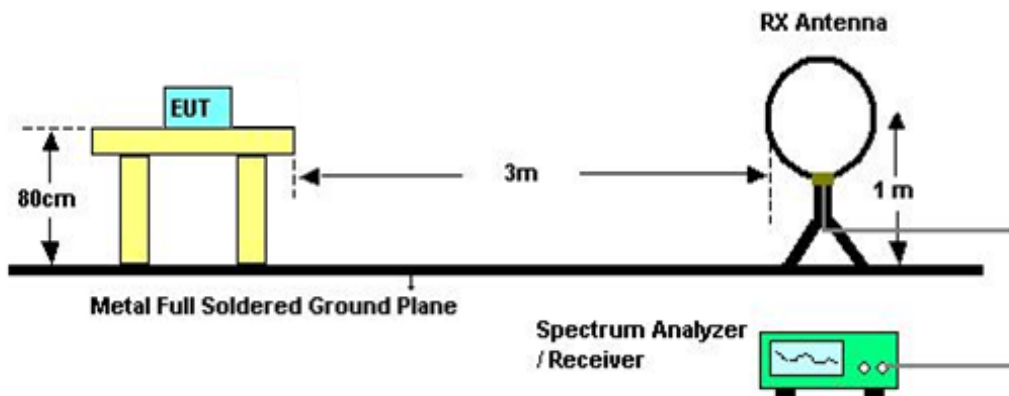

4.4.4 TEST DEVIATION

No deviation

4.4.5 TEST RESULTS

Please refer to the Appendix D.

4.5 BAND EDGE MEASUREMENT

4.5.1 LIMIT

A Power of any emission outside of the authorized operating frequency ranges must be attenuated below the transmitting power (P) by a factor of at least $43 + 10 \log(P)$ dB. In the 1 MHz bands immediately outside and adjacent to the frequency block a resolution bandwidth of at least one percent of the emission bandwidth of the fundamental emission of the transmitter may be employed.

4.5.2 TEST PROCEDURES

1. All measurements were done at low and high operational frequency range.
2. The center frequency of spectrum is the band edge frequency and span is 1MHz. RB of the spectrum is 3kHz and VB of the spectrum is 10kHz (GSM/GPRS/EDGE).
3. The center frequency of spectrum is the band edge frequency and span is 5MHz. RB of the spectrum is 100kHz and VB of the spectrum is 300kHz (WCDMA).
4. The center frequency of spectrum is the band edge frequency and span is 1MHz. RB of the spectrum is 13kHz and VB of the spectrum is 51kHz (LTE Bandwidth 1.4MHz).
5. The center frequency of spectrum is the band edge frequency and span is 1MHz. RB of the spectrum is 30kHz and VB of the spectrum is 100kHz (LTE Bandwidth 3MHz).
6. The center frequency of spectrum is the band edge frequency and span is 1MHz. RB of the spectrum is 100kHz and VB of the spectrum is 300kHz (LTE Bandwidth 5MHz/10MHz).
7. Record the max trace plot into the test report.

4.5.3 TESTSETUP LAYOUT

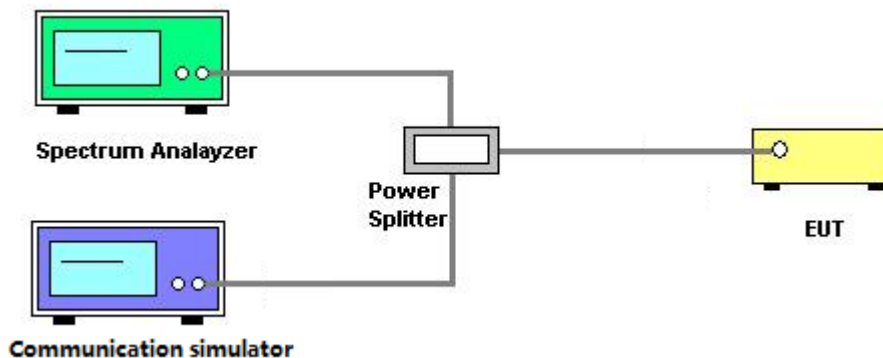

4.5.4 TESTDEVIATION

No deviation

4.5.5 TEST RESULTS

Please refer to the Appendix E.

4.6 PEAK TO AVERAGE RATIO MEASUREMENT

4.6.1 LIMIT

In measuring transmissions in this band using an average power technique, the peak to-average ratio (PAR) of the transmission may not exceed 13 dB.

4.6.2 TEST PROCEDURES

1. Set resolution/measurement bandwidth \geq signal's occupied bandwidth;
2. Set the number of counts to a value that stabilizes the measured CCDF curve;
3. Record the maximum PAPR level associated with a probability of 0.1%.

4.6.3 TESTSETUP LAYOUT

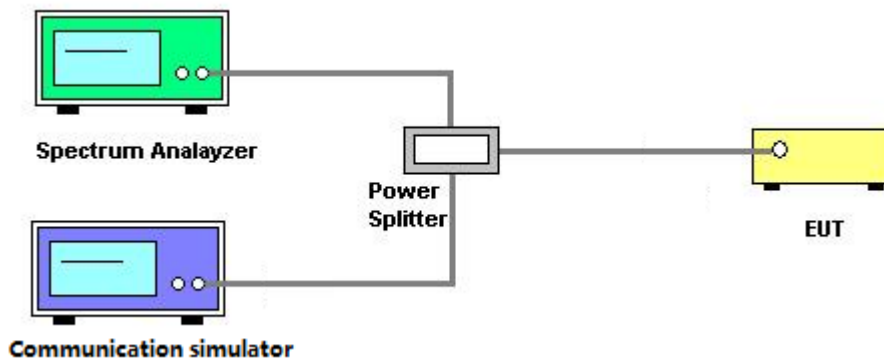

4.6.4 TESTDEVIATION

No deviation

4.6.5 TEST RESULTS

Please refer to the Appendix F.

4.7 FREQUENCY STABILITY MEASUREMENT

4.7.1 LIMIT

1.5 ppm is for base and fixed station. 2.5 ppm is for mobile station.

4.7.2 TEST PROCEDURES

1. Device is placed at the oven room. The oven room could control the temperatures and humidity. Power warm up is at least 15 min and power applied should perform before recording frequency error.
2. EUT is connected the external power supply to control the DC input power. The test voltage range is from minimum to maximum working voltage. Each step shall be record the frequency error rate.
3. The temperature range step is 10 degrees in this test items. All temperature levels shall be hold the $\pm 0.5^{\circ}\text{C}$ during the measurement testing. The each temperature step shall be at least 0.5 hours, consider the EUT could be test under the stability condition.
4. The frequency error was recorded frequency error from the communication simulator.

4.7.3 TESTSETUP LAYOUT

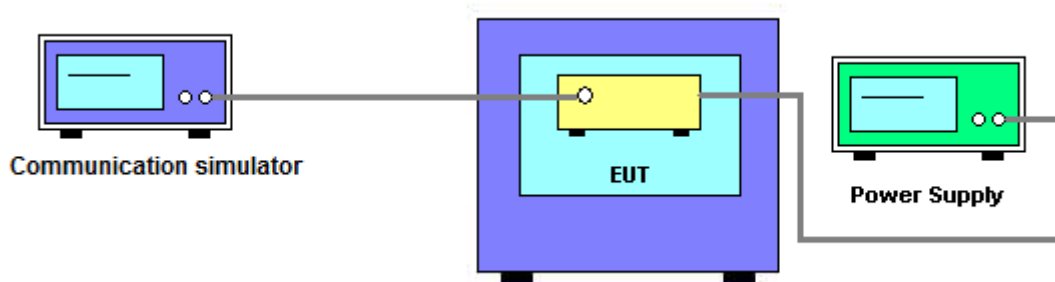

4.7.4 TESTDEVIATION

No deviation

4.7.5 TEST RESULTS

Please refer to the Appendix G.

5. LIST OF MEASUREMENT EQUIPMENTS

Radiated Emission Measurement					
Item	Kind of Equipment	Manufacturer	Type No.	Serial No.	Calibrated until
1	Antenna	Schwarbeck	VULB9160	9160-3232	Mar. 26, 2018
2	Double Ridged Guide Antenna	ETS	3115	75789	Mar. 26, 2018
3	Broad-Band Horn Antenna	Schwarzbeck	BBHA 9170	9170319	Apr. 22, 2018
4	Amplifier	Agilent	8449B	3008A02274	Mar. 09, 2018
5	Amplifier	HP	8447D	2944A09673	Oct. 19, 2018
6	HighPass Filter	Wairwright Instruments Gmbh	WHK 1.5/15G-10ST	11	Mar. 09, 2018
7	Band Reject Filter	Wairwright Instruments Gmbh	WRCG 1710/1785-1690/180 5-60/12SS	38	Feb. 22, 2018
8	Band Reject Filter	Wairwright Instruments Gmbh	WRCG 824/849-810/863-60/ 9SS	7	Feb. 22, 2018
9	Band Reject Filter	Wairwright Instruments Gmbh	WRCG 880/915-860/935-60/ 9SS	14	Feb. 22, 2018
10	Band Reject Filter	Wairwright Instruments Gmbh	WRCG 1850/1910-1830/193 0-60/10SS	17	Feb. 22, 2018
11	HighPass Filter	Wairwright Instruments Gmbh	WHK3.1/18G-10SS	24	Mar. 09, 2018
12	Wireless Communication Test SET	Agilent	E5515C	MY48364183	Mar. 26, 2018
13	Microwave Preamplifier With Adaptor	EMC INSTRUMENT	EMC2654045	980039 & HA01	Mar. 26, 2018
14	Receiver	Agilent	N9038A	MY52130039	Sep. 03, 2018
15	wideband radio communication tester	R&S	CMW500	152372	Mar. 26, 2018
16	High pass filter	ZHPF-M1000-4000-1	ZHPF-M3-12.75G-3869	B2015073763	Aug. 03, 2018
17	High pass filter	ZHPF-M3-12.75G-3869	ZHPF-M1000-4000-1	B2015073762	Aug. 03, 2018
18	High pass filter	ZHPF-M6-18G-1727	ZHPF-M6-186-1727	B2015073764	Aug. 03, 2018
19	Cable	emci	LMR-400(30MHz-1GHz)(8m+5m)	N/A	Jun. 26, 2018
20	Cable	emci	EMC104-SM-SM-12000(12m)	N/A	Jul. 05, 2018
21	Controller	ETS-Lindgren	2090	N/A	N/A
22	Measurement Software	Farad	EZ-EMC Ver.NB-03A1-01	N/A	N/A

Conducted Emission & Band Edge & Occupied Bandwidth Measurement					
Item	Kind of Equipment	Manufacturer	Type No.	Serial No.	Calibrated until
1	Wireless Communication Test SET	Agilent	E5515C	MY48364183	Mar. 26, 2018
2	EXA Spectrum Analyzer	Agilent	N9010A	MY50520044	Mar. 26, 2018
3	POWER SPLITTER	Mini-Circuits	ZFRSC-123-S+	331000910-1	Feb. 25, 2018
4	wideband radio communication tester	R&S	CMW500	152372	Mar. 26, 2018
5	Cable	N/A	RG316(0.3m)	N/A	Jul. 05, 2018
6	Cable	N/A	RG316(0.3m)	N/A	Jul. 05, 2018

Frequency Stability Measurement					
Item	Kind of Equipment	Manufacturer	Type No.	Serial No.	Calibrated until
1	Wireless Communication Test SET	Agilent	E5515C	MY48364183	Mar. 26, 2018
2	DC power supply	GW Instek	GPC-3030DN	EK880675	Oct. 12, 2018
3	POWER SPLITTER	Mini-Circuits	ZFRSC-123-S+	331000910-1	Feb. 25, 2018
4	wideband radio communication tester	R&S	CMW500	152372	Mar. 26, 2018
5	Const Temp, & Humidity Chamber	Bell	BTH-50C	20170306001	Mar. 26, 2018
6	Cable	N/A	RG316(0.3m)	N/A	Jul. 05, 2018

Remark: "N/A" denotes no model name, serial no. or calibration specified.
 All calibration period of equipment list is one year.

APPENDIX A - OUTPUT POWER

Conducted Power:

GSM850 (Capsensor Off)		Burst Conducted Power (dBm)		
		128CH	190CH	251CH
		824.2MHz	836.6MHz	848.8MHz
GSM (CS)		32.35	32.34	32.42
GPRS/EDGE (GMSK)	1 Tx Slot	32.34	32.32	32.41
	2 Tx Slot	30.52	30.45	30.48
	3 Tx Slot	28.7	28.53	28.54
	4 Tx Slot	26.62	26.58	26.59
EDGE (8PSK)	1 Tx Slot	26.25	25.86	25.98
	2 Tx Slot	24.63	24.64	24.67
	3 Tx Slot	22.55	22.52	22.55
	4 Tx Slot	21.36	21.42	21.43

Modulation	Band	WCDMA V(Capsensor Off)		
	Tx Channel	4132CH	4182CH	4233CH
	Frequency	826.4MHz	836.4MHz	846.6MHz
BPSK	RMC 12.2K	23.48	23.55	23.58
	RMC 64K	23.62	23.68	23.67
	RMC 144K	23.51	23.65	23.62
	RMC 384K	23.65	23.7	23.77
16QAM	HSDPA Subtest-1	22.18	22.21	22.2
	HSDPA Subtest-2	22.18	22.25	22.34
	HSDPA Subtest-3	22.2	22.27	22.35
	HSDPA Subtest-4	22.19	22.25	22.2
16QAM	HSUPA Subtest-1	21.52	21.44	21.67
	HSUPA Subtest-2	20.11	20.31	20.33
	HSUPA Subtest-3	21.57	21.77	21.89
	HSUPA Subtest-4	20.33	20.55	20.58
	HSUPA Subtest-5	21.46	21.46	21.43

LTE Band / BW	Modulation	RB Sizer	RB Offset	Low CH	Mid CH	High CH
				20407 CH	20525 CH	20643 CH
				824.7 MHz	836.5 MHz	848.3 MHz
5 / 1.4M	QPSK	1	0	22.88	23.06	22.94
		1	2	22.93	23.09	22.98
		1	5	22.85	22.94	22.74
		3	0	22.88	23.06	22.91
		3	1	22.89	23.07	22.91
		3	3	22.87	23.09	22.87
		6	0	21.96	22.10	22.13
	16QAM	1	0	22.13	22.21	22.51
		1	2	22.18	22.23	22.50
		1	5	22.10	22.09	22.22
		3	0	22.23	22.07	22.20
		3	1	22.29	22.06	22.21
		3	3	22.27	22.08	22.16
		6	0	21.25	21.24	21.08

LTE Band / BW	Modulation	RB Sizer	RB Offset	Low CH	Mid CH	High CH
				20415 CH	20525 CH	20635 CH
				825.5 MHz	836.5 MHz	847.5 MHz
5 / 3M	QPSK	1	0	22.71	22.93	22.85
		1	7	23.00	23.22	23.08
		1	14	22.55	22.83	22.59
		8	0	21.95	22.08	22.12
		8	3	21.96	22.09	22.15
		8	7	21.84	21.99	22.05
		15	0	21.90	22.04	22.10
	16QAM	1	0	22.07	22.17	22.05
		1	7	22.32	22.44	22.36
		1	14	21.92	22.05	21.82
		8	0	20.95	21.12	21.11
		8	3	20.96	21.18	21.14
		8	7	20.84	21.09	21.05
		15	0	20.83	21.13	21.05

LTE Band / BW	Modulation	RB Sizing	RB Offset	Low CH	Mid CH	High CH
				20425 CH	20525 CH	20625 CH
				826.5 MHz	836.5 MHz	846.5 MHz
5 / 5M	QPSK	1	0	23.17	23.35	23.13
		1	12	23.38	23.52	23.43
		1	24	23.16	23.17	23.01
		12	0	22.34	22.51	22.56
		12	6	22.39	22.52	22.59
		12	13	22.32	22.52	22.47
	16QAM	25	0	22.29	22.50	22.38
		1	0	22.37	22.44	22.66
		1	12	22.53	22.64	22.94
		1	24	22.38	22.44	22.42
		12	0	21.34	21.59	21.50
		12	6	21.39	21.65	21.59
		12	13	21.36	21.66	21.47
		25	0	21.30	21.62	21.32

LTE Band / BW	Modulation	RB Sizing	RB Offset	Low CH	Mid CH	High CH
				20450 CH	20525 CH	20600 CH
				829.0 MHz	836.5 MHz	844.0 MHz
5 / 10M	QPSK	1	0	23.24	23.29	23.28
		1	24	23.31	23.39	23.21
		1	49	23.10	22.94	22.96
		25	0	22.35	22.52	22.54
		25	12	22.41	22.65	22.49
		25	25	22.30	22.42	22.30
		50	0	22.32	22.53	22.39
	16QAM	1	0	22.40	22.56	22.56
		1	24	22.43	22.63	22.49
		1	49	22.29	22.40	22.17
		25	0	21.36	21.58	21.46
		25	12	21.48	21.71	21.48
		25	25	21.38	21.41	21.28
		50	0	21.37	21.60	21.40

LTE Band / BW	Modulation	RB Sizer	RB Offset	Low CH	Mid CH	High CH
				26797 CH	26915 CH	27033 CH
				824.7MHz	836.5MHz	848.3MHz
26 / 1.4M	QPSK	1	0	22.89	22.98	23.18
		1	2	22.98	23.09	23.20
		1	5	22.85	22.97	22.92
		3	0	22.92	23.00	23.16
		3	1	22.94	23.10	23.16
		3	3	22.93	23.10	23.12
		6	0	22.02	22.21	22.19
	16QAM	1	0	22.07	22.47	22.47
		1	2	22.15	22.57	22.46
		1	5	22.03	22.46	22.19
		3	0	22.01	22.28	22.16
		3	1	22.04	22.32	22.16
		3	3	22.03	22.31	22.12
		6	0	21.09	21.21	21.18

LTE Band / BW	Modulation	RB Sizer	RB Offset	Low CH	Mid CH	High CH
				26805 CH	26915 CH	27025 CH
				825.5MHz	836.5MHz	847.5MHz
26 / 3M	QPSK	1	0	22.76	23.00	22.94
		1	7	22.99	23.15	23.33
		1	14	22.69	22.78	22.79
		8	0	22.05	22.21	22.26
		8	3	22.06	22.18	22.29
		8	7	21.97	22.11	22.14
		15	0	22.00	22.14	22.18
	16QAM	1	0	22.05	22.29	22.09
		1	7	22.31	22.43	22.49
		1	14	21.93	22.10	21.90
		8	0	21.08	21.29	21.25
		8	3	21.11	21.26	21.27
		8	7	21.02	21.19	21.13
		15	0	20.99	21.16	21.20

LTE Band / BW	Modulation	RB Sizer	RB Offset	Low CH	Mid CH	High CH
				26815 CH	26915 CH	27015 CH
				826.5MHz	836.5MHz	846.5MHz
26 / 5M	QPSK	1	0	23.36	23.44	23.63
		1	12	23.60	23.63	23.87
		1	24	23.48	23.50	23.33
		12	0	22.59	22.80	22.73
		12	6	22.64	22.78	22.82
		12	13	22.62	22.70	22.76
	16QAM	25	0	22.53	22.75	22.63
		1	0	22.43	22.86	22.83
		1	12	22.71	22.97	23.13
		1	24	22.62	22.85	22.81
		12	0	21.61	21.91	21.83
		12	6	21.67	21.92	21.92
		12	13	21.65	21.83	21.75
		25	0	21.57	21.80	21.64

LTE Band / BW	Modulation	RB Sizer	RB Offset	Low CH	Mid CH	High CH
				26840 CH	26915 CH	26990 CH
				829.0MHz	836.5MHz	844.0MHz
26 / 10M	QPSK	1	0	23.34	23.30	23.54
		1	24	23.70	23.66	23.75
		1	49	23.06	23.27	23.20
		25	0	22.52	22.68	22.67
		25	12	22.63	22.80	22.67
		25	25	22.48	22.62	22.42
		50	0	22.52	22.63	22.50
	16QAM	1	0	22.35	22.63	22.83
		1	24	22.75	22.92	23.01
		1	49	22.19	22.50	22.53
		25	0	21.55	21.65	21.67
		25	12	21.68	21.77	21.67
		25	25	21.53	21.60	21.42
		50	0	21.56	21.62	21.54

LTE Band / BW	Modulation	RB Sizer	RB Offset	Low CH	Mid CH	High CH
				26865 CH	26915 CH	26965 CH
				831.5MHz	836.5MHz	841.5MHz
26 / 15M	QPSK	1	0	23.15	23.23	23.39
		1	37	23.19	23.33	23.33
		1	74	22.74	23.13	22.96
		36	0	22.54	23.13	22.78
		36	19	22.61	22.77	22.66
		36	39	22.40	22.52	22.37
		75	0	22.50	22.56	22.54
	16QAM	1	0	22.56	22.40	22.49
		1	37	22.75	22.49	22.46
		1	74	22.26	22.20	22.17
		36	0	21.59	22.20	21.70
		36	19	21.67	21.77	21.60
		36	39	21.47	21.60	21.38
		75	0	21.53	21.63	21.50

ERP Power:

GSM850 (Capsensor Off)	ERP Power (dBm)		
	128CH	190CH	251CH
	824.2MHz	836.6MHz	848.8MHz
GSM (CS)	29.00	28.99	29.07
GPRS/EDGE (GMSK)	28.99	28.97	29.06
	27.17	27.10	27.13
	25.35	25.18	25.19
	23.27	23.23	23.24
EDGE (8PSK)	22.90	22.51	22.63
	21.28	21.29	21.32
	19.20	19.17	19.20
	18.01	18.07	18.08

Modulation	Band	WCDMA V(Capsensor Off)		
		Tx Channel	4132CH	4182CH
	Rx Channel	4357CH	4407CH	4458CH
	Frequency	826.4MHz	836.4MHz	846.6MHz
BPSK	RMC 12.2K	20.13	20.2	20.23
	RMC 64K	20.27	20.33	20.32
	RMC 144K	20.16	20.3	20.27
	RMC 384K	20.3	20.35	20.42
16QAM	HSDPA Subtest-1	18.83	18.86	18.85
	HSDPA Subtest-2	18.83	18.9	18.99
	HSDPA Subtest-3	18.85	18.92	19.00
	HSDPA Subtest-4	18.84	18.9	18.85
16QAM	HSUPA Subtest-1	18.17	18.09	18.32
	HSUPA Subtest-2	16.76	16.96	16.98
	HSUPA Subtest-3	18.22	18.42	18.54
	HSUPA Subtest-4	16.98	17.2	17.23
	HSUPA Subtest-5	18.11	18.11	18.08

LTE Band / BW	Modulation	RB Sizer	RB Offset	Low CH	Mid CH	High CH
				20407 CH	20525 CH	20643 CH
				824.7 MHz	836.5 MHz	848.3 MHz
5 / 1.4M	QPSK	1	0	19.53	19.71	19.59
		1	2	19.58	19.74	19.63
		1	5	19.50	19.59	19.39
		3	0	19.53	19.71	19.56
		3	1	19.54	19.72	19.56
		3	3	19.52	19.74	19.52
		6	0	18.61	18.75	18.78
	16QAM	1	0	18.78	18.86	19.16
		1	2	18.83	18.88	19.15
		1	5	18.75	18.74	18.87
		3	0	18.88	18.72	18.85
		3	1	18.94	18.71	18.86
		3	3	18.92	18.73	18.81
		6	0	17.90	17.89	17.73

LTE Band / BW	Modulation	RB Sizer	RB Offset	Low CH	Mid CH	High CH
				20415 CH	20525 CH	20635 CH
				825.5 MHz	836.5 MHz	847.5 MHz
5 / 3M	QPSK	1	0	19.36	19.58	19.50
		1	7	19.65	19.87	19.73
		1	14	19.20	19.48	19.24
		8	0	18.60	18.73	18.77
		8	3	18.61	18.74	18.80
		8	7	18.49	18.64	18.70
		15	0	18.55	18.69	18.75
	16QAM	1	0	18.72	18.82	18.70
		1	7	18.97	19.09	19.01
		1	14	18.57	18.70	18.47
		8	0	17.60	17.77	17.76
		8	3	17.61	17.83	17.79
		8	7	17.49	17.74	17.70
		15	0	17.48	17.78	17.70

LTE Band / BW	Modulation	RB Sizer	RB Offset	Low CH	Mid CH	High CH
				20425 CH	20525 CH	20625 CH
				826.5 MHz	836.5 MHz	846.5 MHz
5 / 5M	QPSK	1	0	19.82	20.00	19.78
		1	12	20.03	20.17	20.08
		1	24	19.81	19.82	19.66
		12	0	18.99	19.16	19.21
		12	6	19.04	19.17	19.24
		12	13	18.97	19.17	19.12
	16QAM	25	0	18.94	19.15	19.03
		1	0	19.02	19.09	19.31
		1	12	19.18	19.29	19.59
		1	24	19.03	19.09	19.07
		12	0	17.99	18.24	18.15
		12	6	18.04	18.30	18.24
		12	13	18.01	18.31	18.12
		25	0	17.95	18.27	17.97

LTE Band / BW	Modulation	RB Sizer	RB Offset	Low CH	Mid CH	High CH
				20450 CH	20525 CH	20600 CH
				829.0 MHz	836.5 MHz	844.0 MHz
5 / 10M	QPSK	1	0	19.89	19.94	19.93
		1	24	19.96	20.04	19.86
		1	49	19.75	19.59	19.61
		25	0	19.00	19.17	19.19
		25	12	19.06	19.30	19.14
		25	25	18.95	19.07	18.95
		50	0	18.97	19.18	19.04
	16QAM	1	0	19.05	19.21	19.21
		1	24	19.08	19.28	19.14
		1	49	18.94	19.05	18.82
		25	0	18.01	18.23	18.11
		25	12	18.13	18.36	18.13
		25	25	18.03	18.06	17.93
		50	0	18.02	18.25	18.05

LTE Band / BW	Modulation	RB Sizer	RB Offset	Low CH	Mid CH	High CH
				26797 CH	26915 CH	27033 CH
				824.7MHz	836.5MHz	848.3MHz
26 / 1.4M	QPSK	1	0	19.54	19.63	19.83
		1	2	19.63	19.74	19.85
		1	5	19.50	19.62	19.57
		3	0	19.57	19.65	19.81
		3	1	19.59	19.75	19.81
		3	3	19.58	19.75	19.77
		6	0	18.67	18.86	18.84
	16QAM	1	0	18.72	19.12	19.12
		1	2	18.80	19.22	19.11
		1	5	18.68	19.11	18.84
		3	0	18.66	18.93	18.81
		3	1	18.69	18.97	18.81
		3	3	18.68	18.96	18.77
		6	0	17.74	17.86	17.83

LTE Band / BW	Modulation	RB Sizer	RB Offset	Low CH	Mid CH	High CH
				26805 CH	26915 CH	27025 CH
				825.5MHz	836.5MHz	847.5MHz
26 / 3M	QPSK	1	0	19.41	19.65	19.59
		1	7	19.64	19.80	19.98
		1	14	19.34	19.43	19.44
		8	0	18.70	18.86	18.91
		8	3	18.71	18.83	18.94
		8	7	18.62	18.76	18.79
		15	0	18.65	18.79	18.83
	16QAM	1	0	18.70	18.94	18.74
		1	7	18.96	19.08	19.14
		1	14	18.58	18.75	18.55
		8	0	17.73	17.94	17.90
		8	3	17.76	17.91	17.92
		8	7	17.67	17.84	17.78
		15	0	17.64	17.81	17.85

LTE Band / BW	Modulation	RB Siset	RB Offset	Low CH	Mid CH	High CH
				26815 CH	26915 CH	27015 CH
				826.5MHz	836.5MHz	846.5MHz
26 / 5M	QPSK	1	0	20.01	20.09	20.28
		1	12	20.25	20.28	20.52
		1	24	20.13	20.15	19.98
		12	0	19.24	19.45	19.38
		12	6	19.29	19.43	19.47
		12	13	19.27	19.35	19.41
	16QAM	25	0	19.18	19.40	19.28
		1	0	19.08	19.51	19.48
		1	12	19.36	19.62	19.78
		1	24	19.27	19.50	19.46
		12	0	18.26	18.56	18.48
		12	6	18.32	18.57	18.57
		12	13	18.30	18.48	18.40
		25	0	18.22	18.45	18.29

LTE Band / BW	Modulation	RB Siset	RB Offset	Low CH	Mid CH	High CH
				26840 CH	26915 CH	26990 CH
				829.0MHz	836.5MHz	844.0MHz
26 / 10M	QPSK	1	0	19.99	19.95	20.19
		1	24	20.35	20.31	20.40
		1	49	19.71	19.92	19.85
		25	0	19.17	19.33	19.32
		25	12	19.28	19.45	19.32
		25	25	19.13	19.27	19.07
		50	0	19.17	19.28	19.15
	16QAM	1	0	19.00	19.28	19.48
		1	24	19.40	19.57	19.66
		1	49	18.84	19.15	19.18
		25	0	18.20	18.30	18.32
		25	12	18.33	18.42	18.32
		25	25	18.18	18.25	18.07
		50	0	18.21	18.27	18.19

LTE Band / BW	Modulation	RB Sizer	RB Offset	Low CH	Mid CH	High CH
				26865 CH	26915 CH	26965 CH
				831.5MHz	836.5MHz	841.5MHz
26 / 15M	QPSK	1	0	19.80	19.88	20.04
		1	37	19.84	19.98	19.98
		1	74	19.39	19.78	19.61
		36	0	19.19	19.78	19.43
		36	19	19.26	19.42	19.31
		36	39	19.05	19.17	19.02
		75	0	19.15	19.21	19.19
	16QAM	1	0	19.21	19.05	19.14
		1	37	19.40	19.14	19.11
		1	74	18.91	18.85	18.82
		36	0	18.24	18.85	18.35
		36	19	18.32	18.42	18.25
		36	39	18.12	18.25	18.03
		75	0	18.18	18.28	18.15

APPENDIX B - OCCUPIED BANDWIDTH

GSM850					
GSM			EDGE		
CS			8PSK		
Channel	Frequency (MHz)	99% Occupied Bandwidth (MHz)	Channel	Frequency (MHz)	99% Occupied Bandwidth (MHz)
128	824.2	0.242	128	824.2	0.250
190	836.6	0.248	190	836.6	0.248
251	848.8	0.243	251	848.8	0.252
Channel	Frequency (MHz)	26dB Bandwidth (MHz)	Channel	Frequency (MHz)	26dB Bandwidth (MHz)
128	824.2	0.320	128	824.2	0.322
190	836.6	0.320	190	836.6	0.317
251	848.8	0.317	251	848.8	0.322

Spectrum Plot

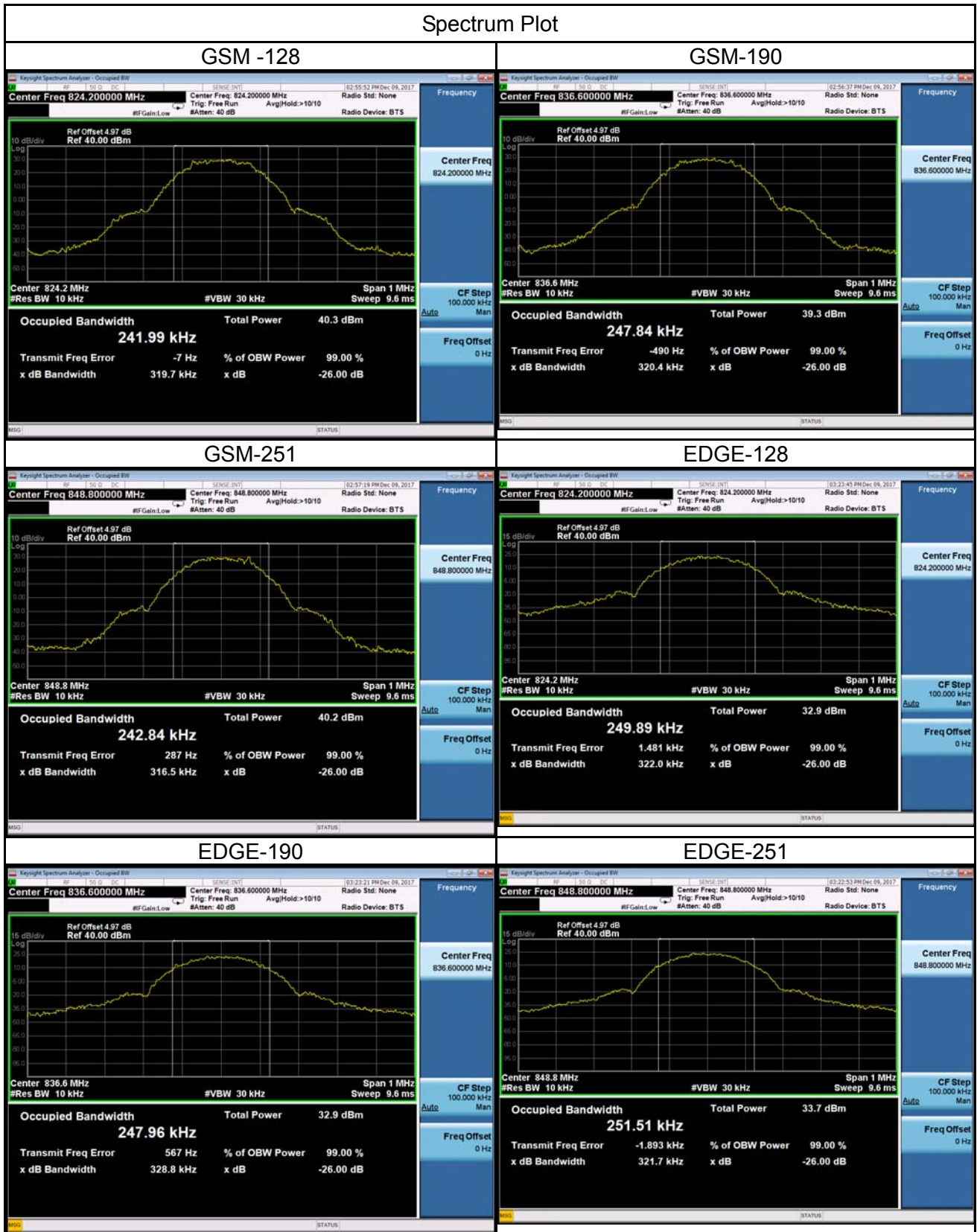

WCDMA Band V

BPSK

Channel	Frequency (MHz)	99% Occupied Bandwidth (MHz)	Channel	Frequency (MHz)	26dB Bandwidth (MHz)
4132	826.4	4.1590	4132	826.4	4.739
4182	836.4	4.1597	4182	836.4	4.731
4233	846.6	4.1584	4233	846.6	4.711

Spectrum Plot

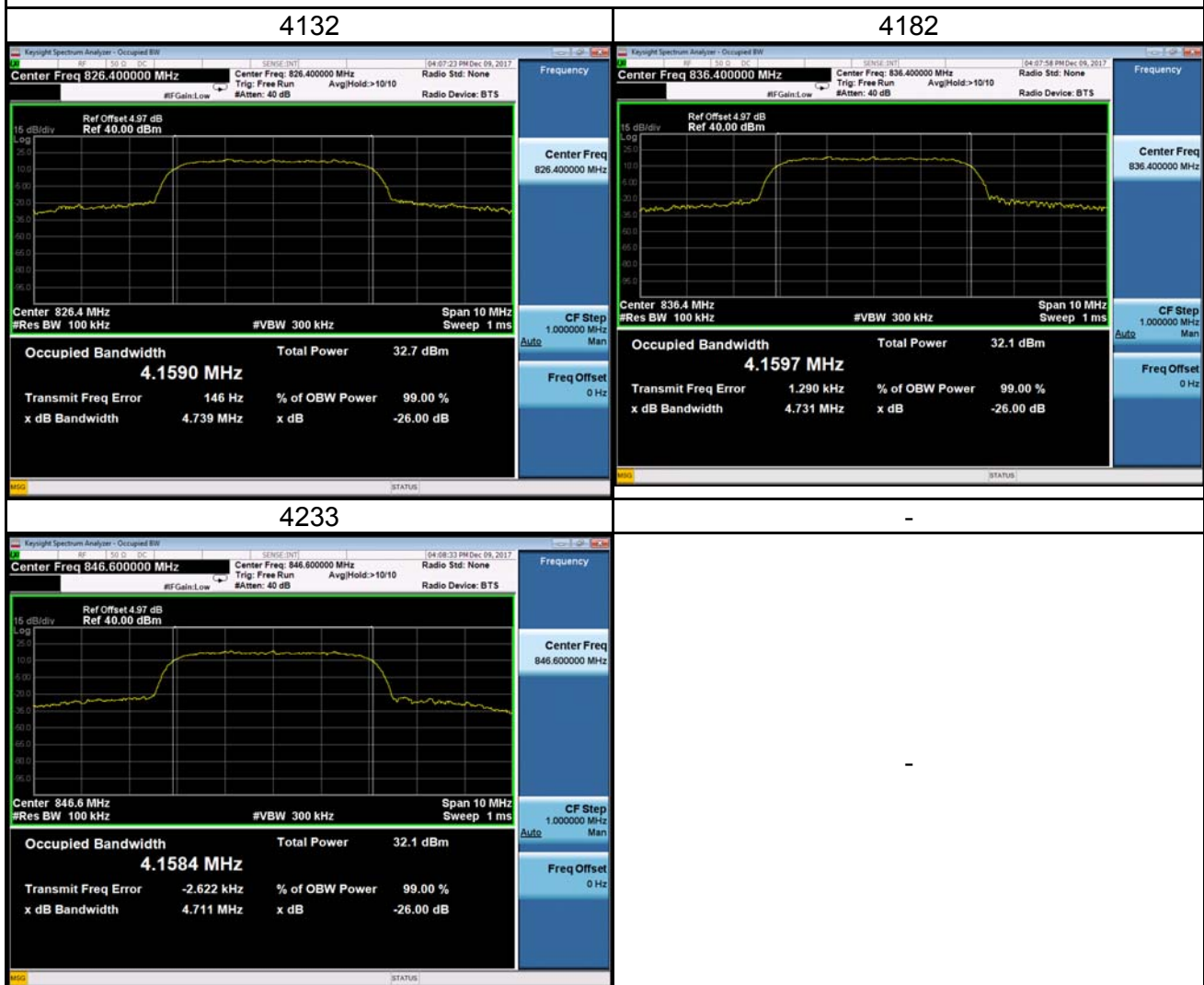

WCDMA_HSDPA Band V

16QAM

Channel	Frequency (MHz)	99% Occupied Bandwidth (MHz)	Channel	Frequency (MHz)	26dB Bandwidth (MHz)
4132	826.4	4.1508	4132	826.4	4.722
4182	836.4	4.1438	4182	836.4	4.713
4233	846.6	4.1514	4233	846.6	4.717

Spectrum Plot

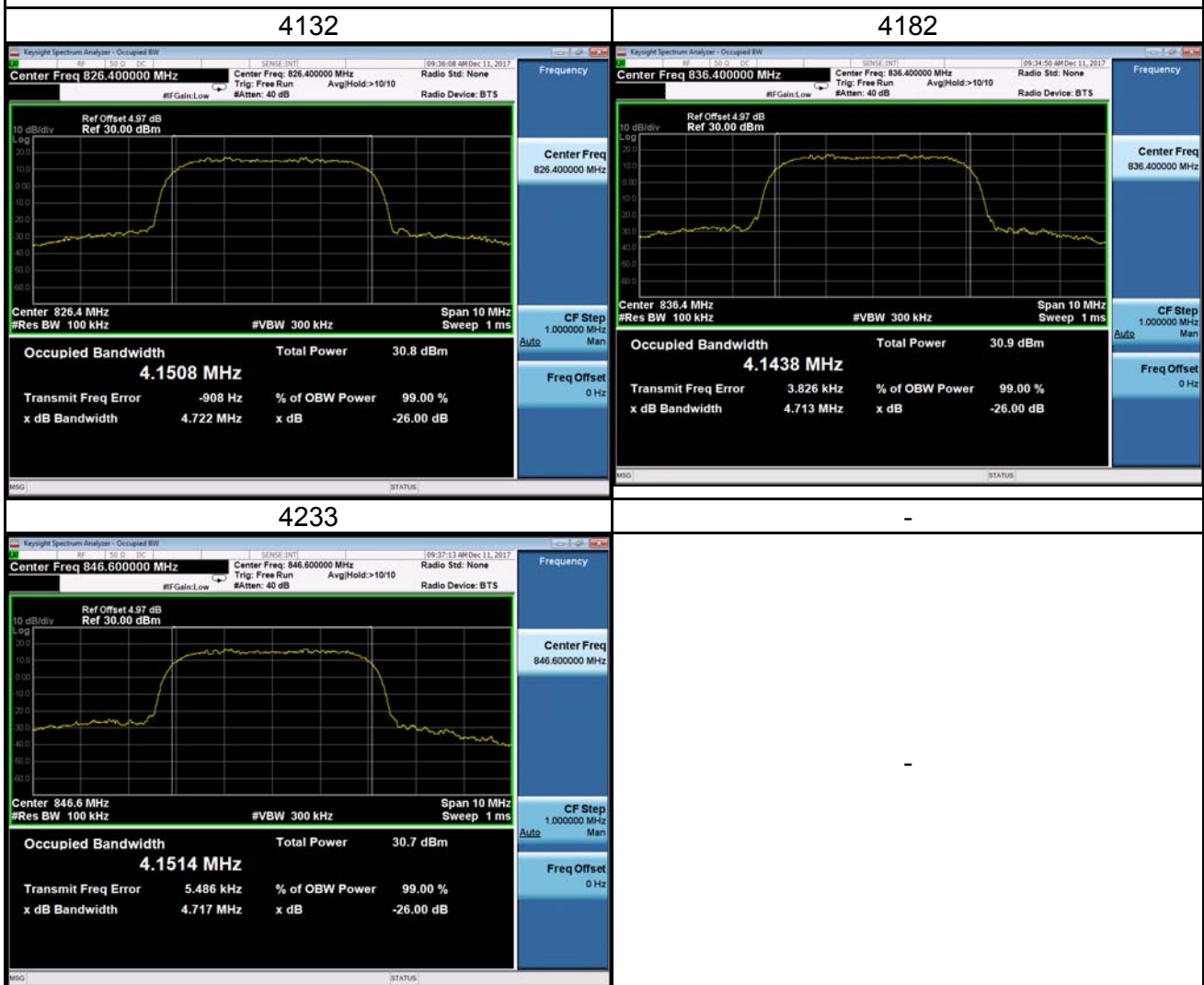

WCDMA_HSUPA Band V

16QAM

Channel	Frequency (MHz)	99% Occupied Bandwidth (MHz)	Channel	Frequency (MHz)	26dB Bandwidth (MHz)
4132	826.4	4.1427	4132	826.4	4.706
4182	836.4	4.1396	4182	836.4	4.715
4233	846.6	4.1499	4233	846.6	4.713

Spectrum Plot

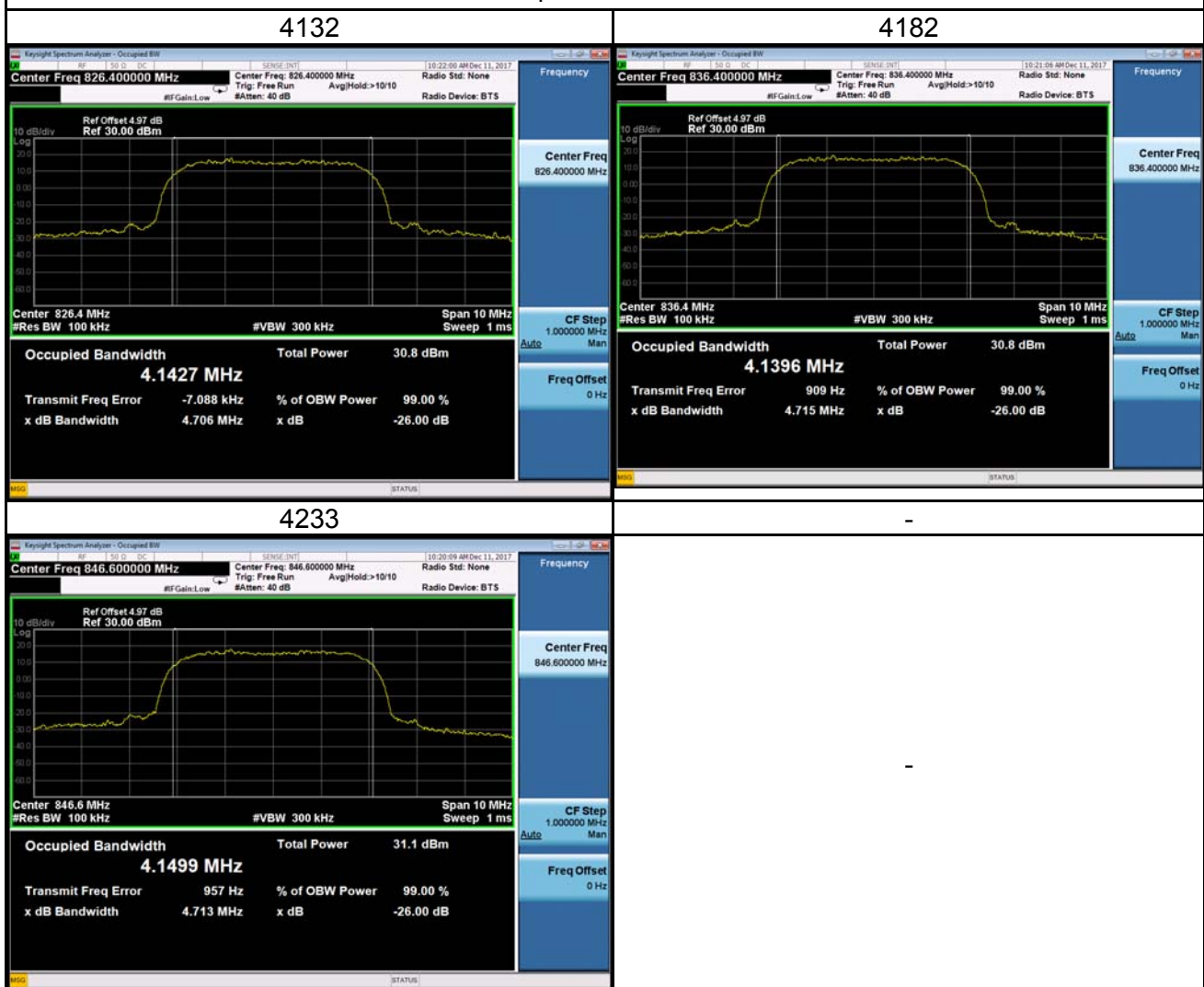

LTE Band 5_1.4M					
QPSK			16QAM		
Channel	Frequency (MHz)	99% Occupied Bandwidth (MHz)	Channel	Frequency (MHz)	99% Occupied Bandwidth (MHz)
20407	824.7	1.0934	20407	824.7	1.0910
20525	836.5	1.0870	20525	836.5	1.0907
20643	848.3	1.0908	20643	848.3	1.0889
Channel	Frequency (MHz)	26dB Bandwidth (MHz)	Channel	Frequency (MHz)	26dB Bandwidth (MHz)
20407	824.7	1.237	20407	824.7	1.238
20525	836.5	1.226	20525	836.5	1.232
20643	848.3	1.230	20643	848.3	1.238

Spectrum Plot

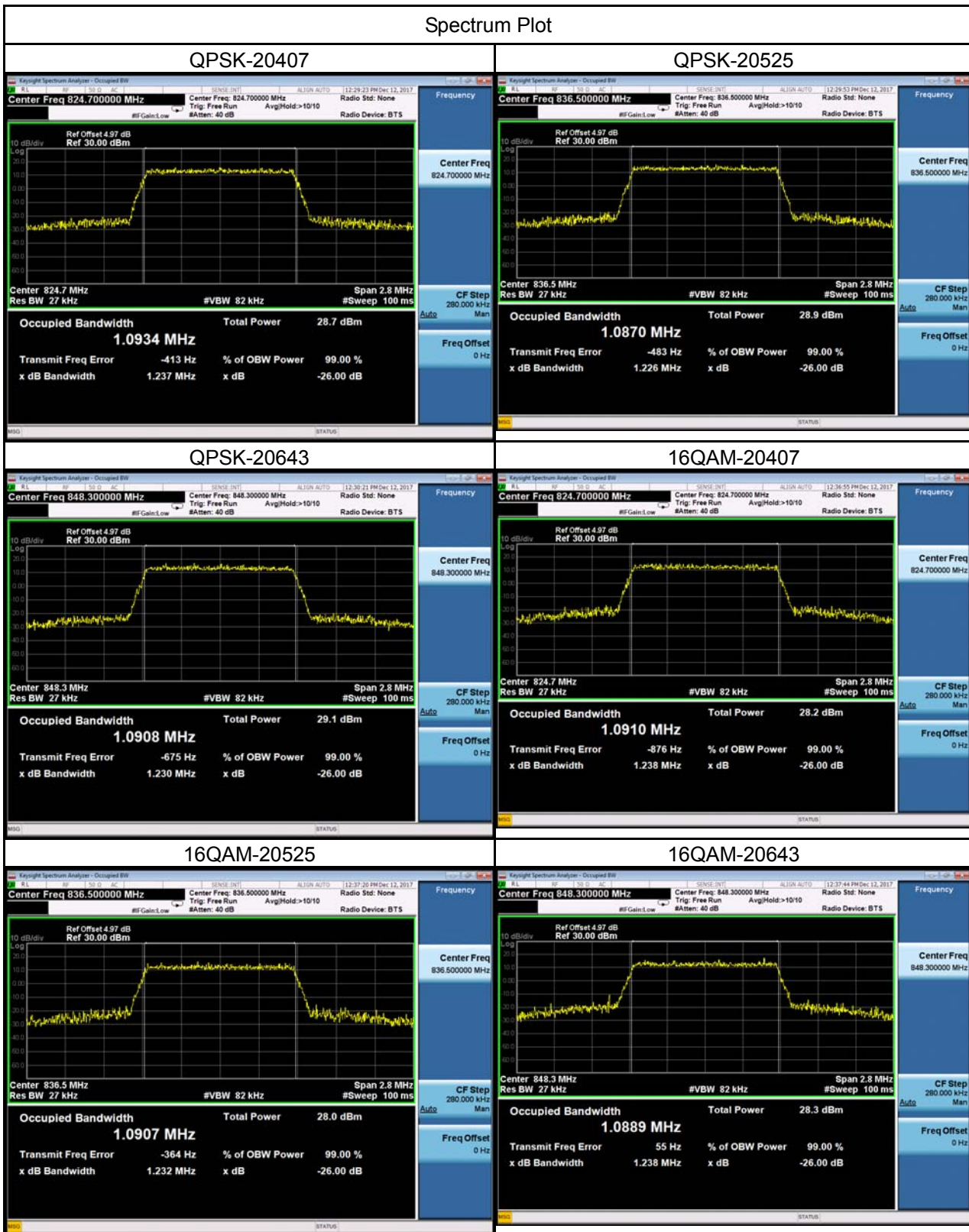

LTE Band 5_3M					
QPSK			16QAM		
Channel	Frequency (MHz)	99% Occupied Bandwidth (MHz)	Channel	Frequency (MHz)	99% Occupied Bandwidth (MHz)
20415	825.5	2.7025	20415	825.5	2.6985
20525	836.5	2.6938	20525	836.5	2.6982
20635	847.5	2.6937	20635	847.5	2.7022
Channel	Frequency (MHz)	26dB Bandwidth (MHz)	Channel	Frequency (MHz)	26dB Bandwidth (MHz)
20415	825.5	2.961	20415	825.5	2.964
20525	836.5	2.955	20525	836.5	2.987
20635	847.5	2.942	20635	847.5	2.963

Spectrum Plot

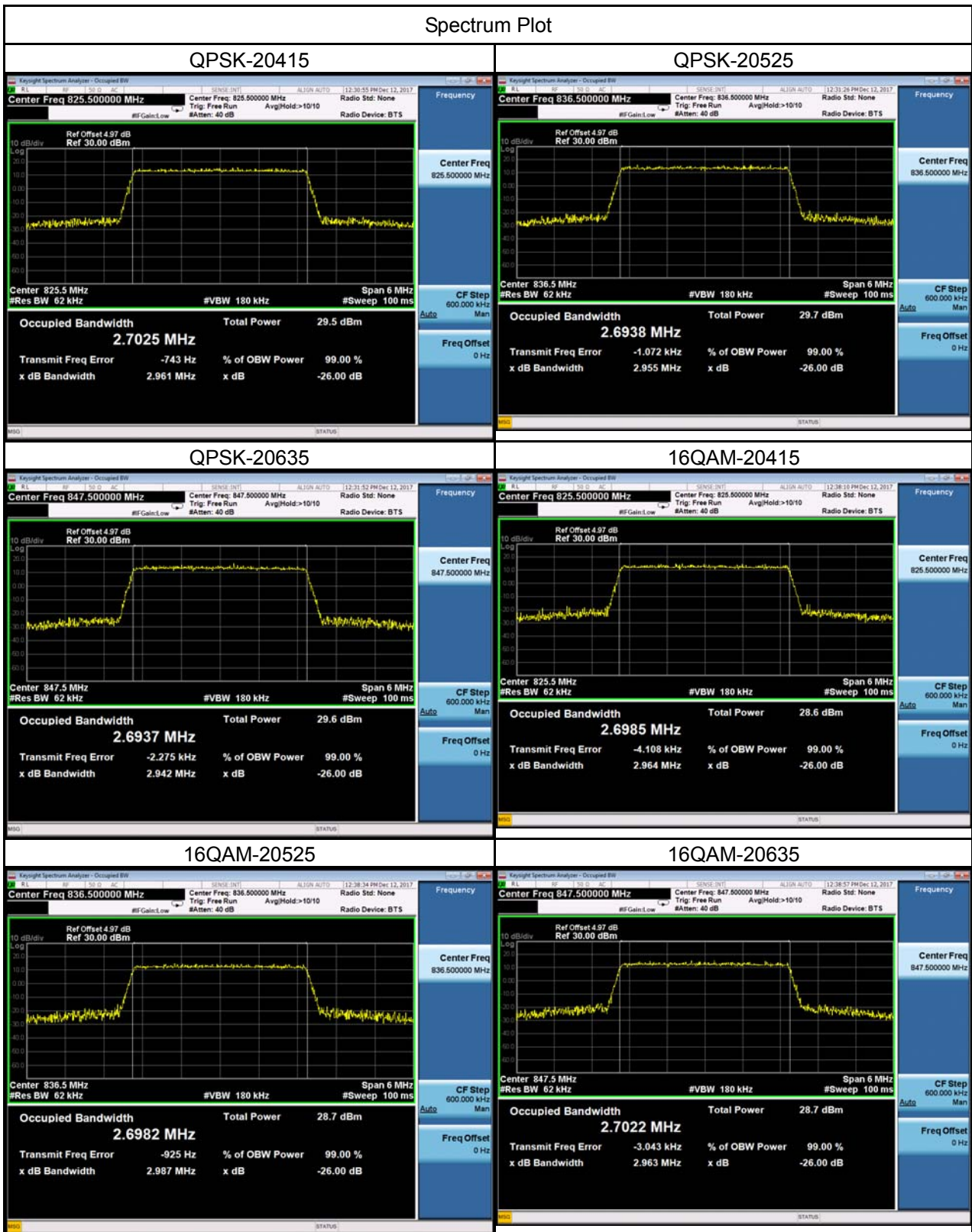

LTE Band 5_5M					
QPSK			16QAM		
Channel	Frequency (MHz)	99% Occupied Bandwidth (MHz)	Channel	Frequency (MHz)	99% Occupied Bandwidth (MHz)
20425	826.5	4.5224	20425	826.5	4.4990
20525	836.5	4.5131	20525	836.5	4.5029
20625	846.5	4.5025	20625	846.5	4.5010
Channel	Frequency (MHz)	26dB Bandwidth (MHz)	Channel	Frequency (MHz)	26dB Bandwidth (MHz)
20425	826.5	4.948	20425	826.5	4.982
20525	836.5	4.927	20525	836.5	4.965
20625	846.5	4.967	20625	846.5	4.950

Spectrum Plot

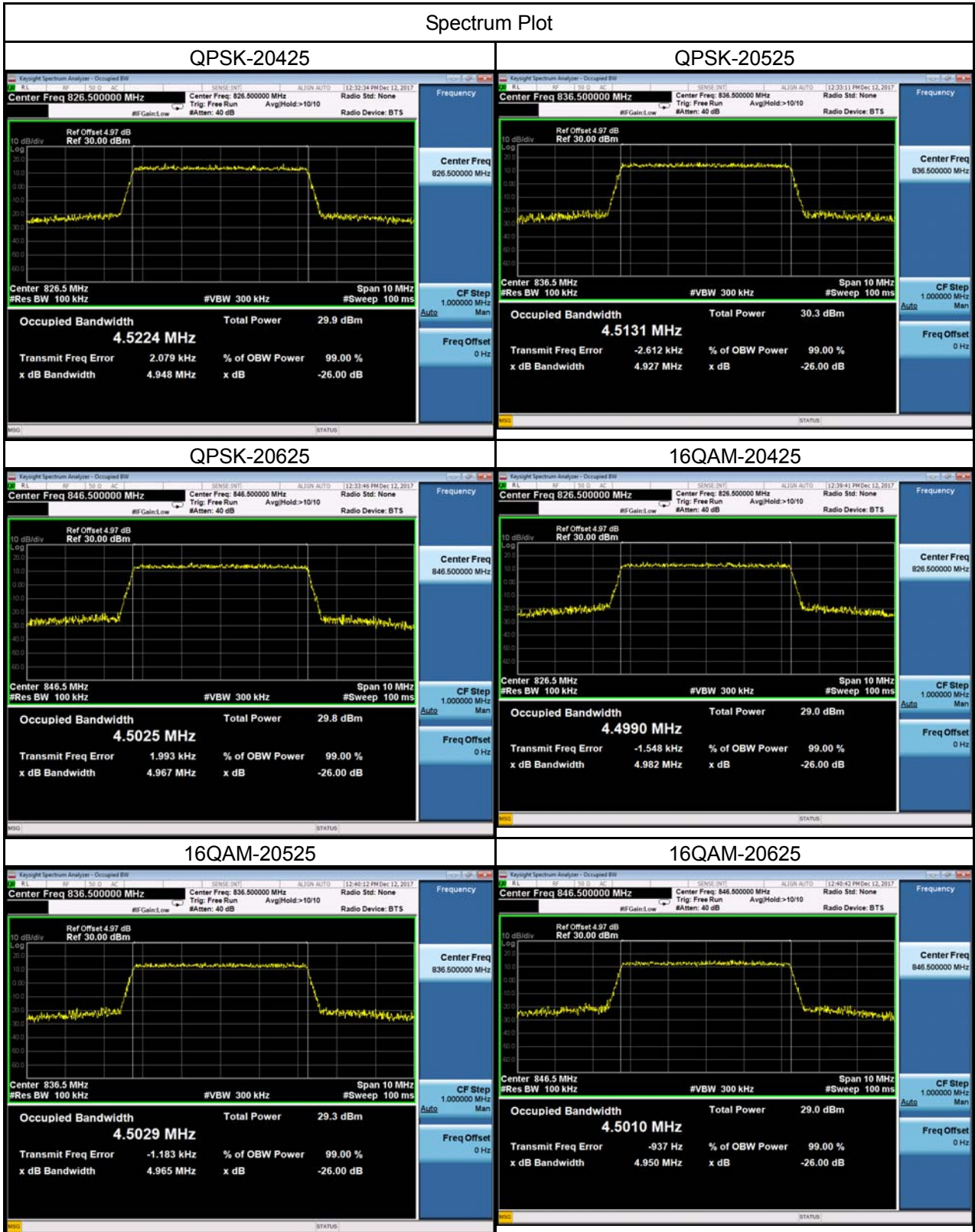

LTE Band 5_10M					
QPSK			16QAM		
Channel	Frequency (MHz)	99% Occupied Bandwidth (MHz)	Channel	Frequency (MHz)	99% Occupied Bandwidth (MHz)
20450	829.0	8.9861	20450	829.0	8.9815
20525	836.5	8.9873	20525	836.5	8.9758
20600	844.0	8.9692	20600	844.0	8.9905
Channel	Frequency (MHz)	26dB Bandwidth (MHz)	Channel	Frequency (MHz)	26dB Bandwidth (MHz)
20450	829.0	9.856	20450	829.0	9.825
20525	836.5	9.859	20525	836.5	9.934
20600	844.0	9.822	20600	844.0	9.896

Spectrum Plot

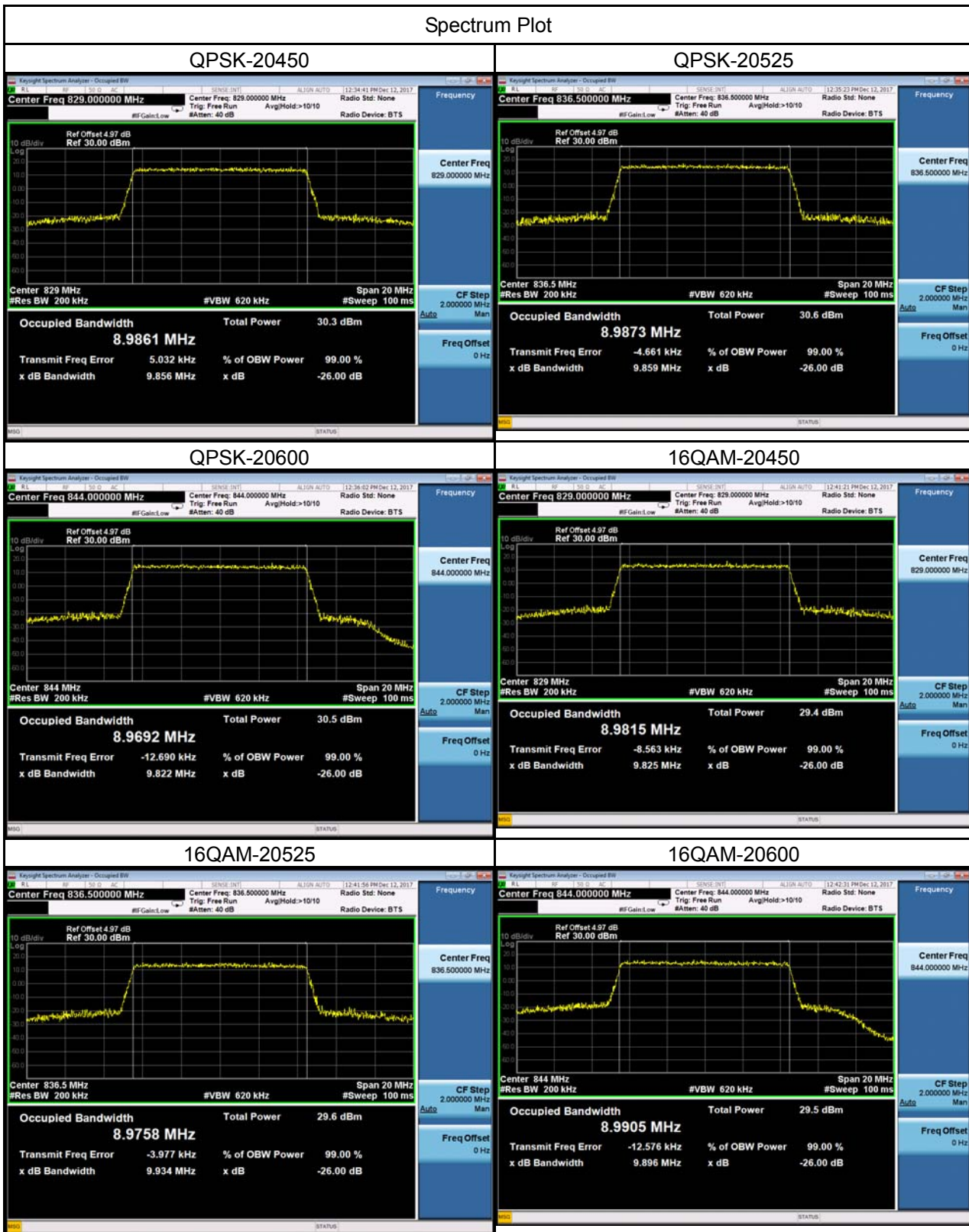

LTE Band 26_1.4M					
QPSK			16QAM		
Channel	Frequency (MHz)	99% Occupied Bandwidth (MHz)	Channel	Frequency (MHz)	99% Occupied Bandwidth (MHz)
26797	814.7	1.0956	26797	814.7	1.0944
26915	831	1.0918	26915	831	1.0974
27033	848.3	1.0900	27033	848.3	1.0978
Channel	Frequency (MHz)	26dB Bandwidth (MHz)	Channel	Frequency (MHz)	26dB Bandwidth (MHz)
26797	814.7	1.243	26797	814.7	1.237
26915	831	1.236	26915	831	1.249
27033	848.3	1.237	27033	848.3	1.247

Spectrum Plot



LTE Band 26_3M					
QPSK			16QAM		
Channel	Frequency (MHz)	99% Occupied Bandwidth (MHz)	Channel	Frequency (MHz)	99% Occupied Bandwidth (MHz)
26805	815.5	2.7070	26805	815.5	2.7025
26915	831	2.7175	26915	831	2.7073
27025	847.5	2.7090	27025	847.5	2.6993
Channel	Frequency (MHz)	26dB Bandwidth (MHz)	Channel	Frequency (MHz)	26dB Bandwidth (MHz)
26805	815.5	3.010	26805	815.5	2.983
26915	831	3.000	26915	831	2.990
27025	847.5	2.984	27025	847.5	2.981

Spectrum Plot

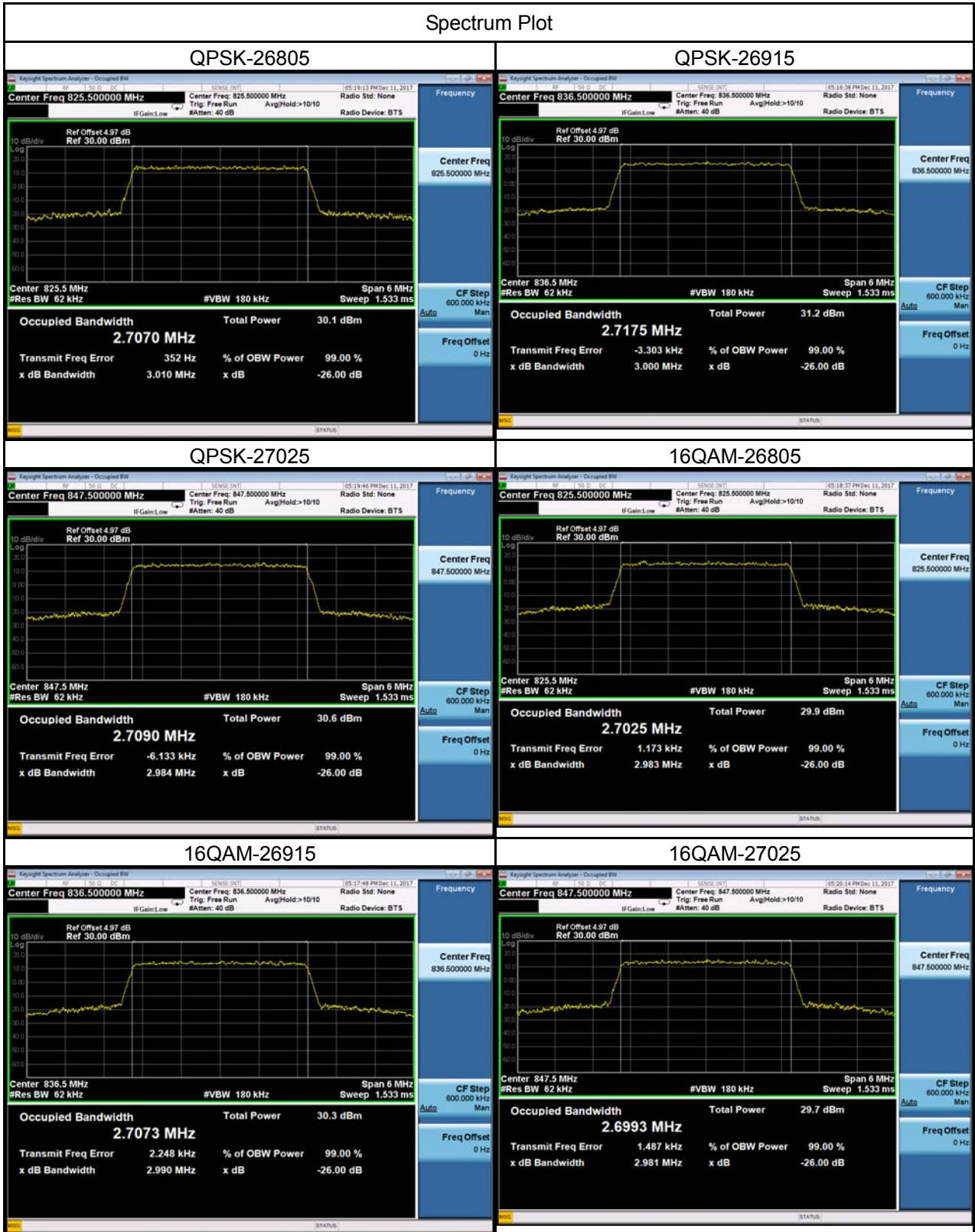

LTE Band 26_5M					
QPSK			16QAM		
Channel	Frequency (MHz)	99% Occupied Bandwidth (MHz)	Channel	Frequency (MHz)	99% Occupied Bandwidth (MHz)
26815	816.5	4.5063	26815	816.5	4.5105
26915	831	4.4955	26915	831	4.5136
27015	846.5	4.5047	27015	846.5	4.5039
Channel	Frequency (MHz)	26dB Bandwidth (MHz)	Channel	Frequency (MHz)	26dB Bandwidth (MHz)
26815	816.5	4.988	26815	816.5	4.930
26915	831	4.951	26915	831	4.987
27015	846.5	4.976	27015	846.5	4.993

Spectrum Plot



LTE Band 26_10M					
QPSK			16QAM		
Channel	Frequency (MHz)	99% Occupied Bandwidth (MHz)	Channel	Frequency (MHz)	99% Occupied Bandwidth (MHz)
26840	819	9.0003	26840	819	8.9890
26915	831	8.9803	26915	831	8.9897
26990	844	8.9904	26990	844	9.0008
Channel	Frequency (MHz)	26dB Bandwidth (MHz)	Channel	Frequency (MHz)	26dB Bandwidth (MHz)
26840	819	9.865	26840	819	9.883
26915	831	9.850	26915	831	9.883
26990	844	9.875	26990	844	9.907

Spectrum Plot



LTE Band 26_15M					
QPSK			16QAM		
Channel	Frequency (MHz)	99% Occupied Bandwidth (MHz)	Channel	Frequency (MHz)	99% Occupied Bandwidth (MHz)
26865	821.5	13.468	26865	821.5	13.499
26915	831	13.496	26915	831	13.477
26965	841.5	13.514	26965	841.5	13.496
Channel	Frequency (MHz)	26dB Bandwidth (MHz)	Channel	Frequency (MHz)	26dB Bandwidth (MHz)
26865	821.5	14.75	26865	821.5	14.91
26915	831	14.88	26915	831	14.91
26965	841.5	14.84	26965	841.5	14.91

Spectrum Plot

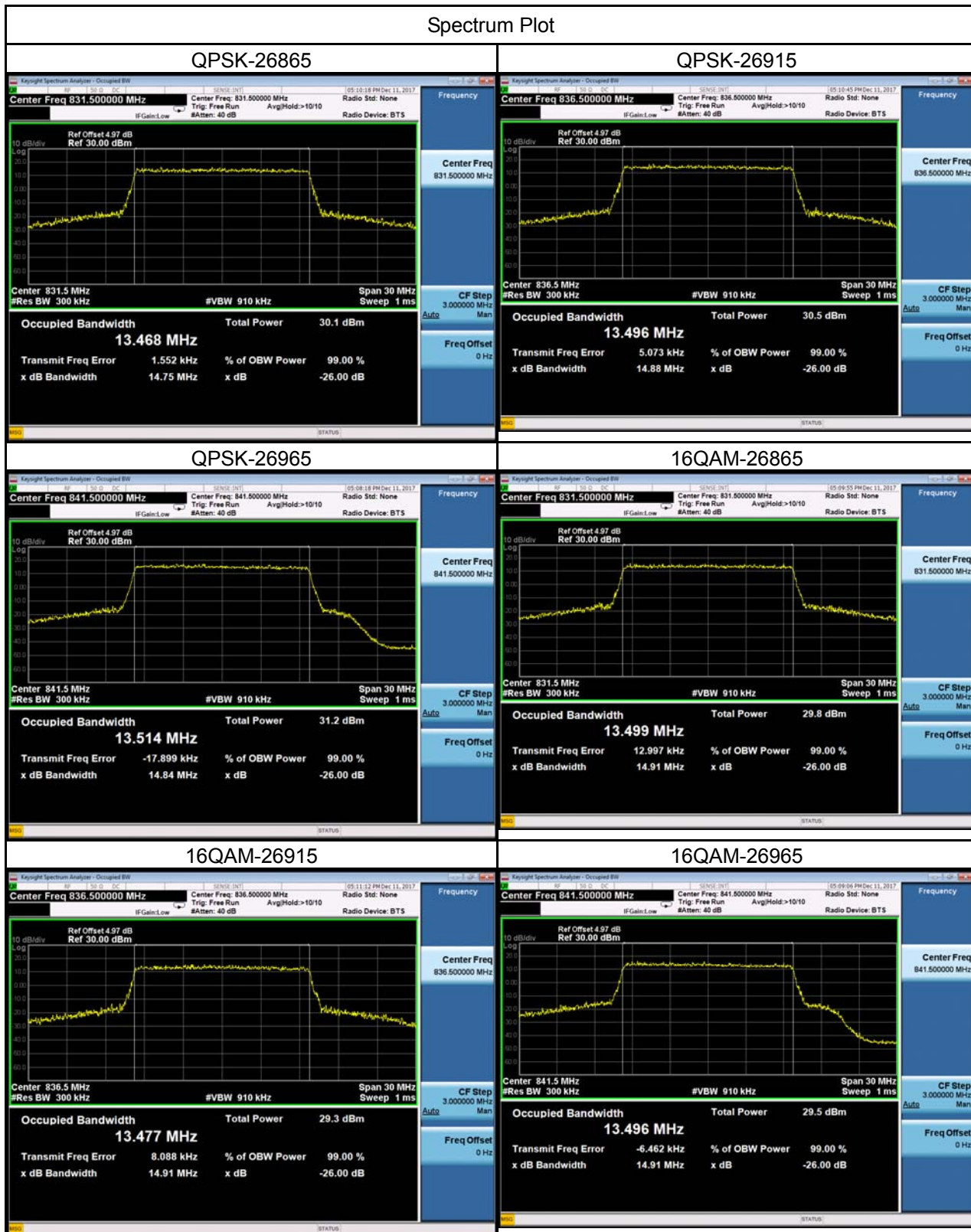

APPENDIX C - CONDUCTED EMISSIONS

GSM850			
GSM		GSM	
Channel	Frequency(MHz)	Channel	Frequency(MHz)
190	836.6	190	836.6
Date: 11.DEC.2017 13:52:22		Date: 11.DEC.2017 13:56:08	
GSM		EDGE	
Channel	Frequency(MHz)	Channel	Frequency(MHz)
190	836.6	190	836.6
Date: 11.DEC.2017 13:55:12		Date: 11.DEC.2017 13:55:12	
EDGE		EDGE	
Channel	Frequency(MHz)	Channel	Frequency(MHz)
190	836.6	190	836.6
Date: 11.DEC.2017 13:54:49		Date: 11.DEC.2017 13:54:49	

WCDMA Band V			
Channel	Frequency(MHz)	Channel	Frequency(MHz)
4182	836.4	4182	836.4
Date: 11.DEC.2017 13:30:54		Date: 11.DEC.2017 13:33:46	
Channel	Frequency(MHz)	-	-
4182	836.4	-	-

WCDMA_HSDPA Band V

Channel	Frequency(MHz)	Channel	Frequency(MHz)
4182	836.4	4182	836.4
Date: 11.DEC.2017 13:40:52		Date: 11.DEC.2017 13:40:13	

Channel	Frequency(MHz)		
4182	836.4	-	-

--	--

WCDMA_HSUPA Band V

Channel	Frequency(MHz)	Channel	Frequency(MHz)
4182	836.4	4182	836.4
Date: 11.DEC.2017 13:42:47		Date: 11.DEC.2017 13:43:29	

Channel	Frequency(MHz)	-	-
4182	836.4	-	-

--	--

LTE Band 5_1.4M

Channel	Frequency(MHz)	Channel	Frequency(MHz)
20525	836.5	20525	836.5
Channel	Frequency(MHz)	-	-
20525	836.5	-	-

LTE Band 5_3M			
Channel	Frequency(MHz)	Channel	Frequency(MHz)
20525	836.5	20525	836.5
Date: 11.DEC.2017 10:50:04		Date: 11.DEC.2017 10:24:21	
Channel	Frequency(MHz)	-	-
20525	836.5	-	-

LTE Band 5_5M			
Channel	Frequency(MHz)	Channel	Frequency(MHz)
20525	836.5	20525	836.5
Channel	Frequency(MHz)	-	-
20525	836.5	-	-

LTE Band 5_10M

Channel	Frequency(MHz)	Channel	Frequency(MHz)
20525	836.5	20525	836.5
Channel	Frequency(MHz)	-	-
20525	836.5	-	-

LTE Band 26_1.4M

Channel	Frequency(MHz)	Channel	Frequency(MHz)
26915	831	26915	831
Date: 13.MAY.2017 11:47:25		Date: 13.MAY.2017 12:34:53	
Channel	Frequency(MHz)	-	-
26915	831	-	-

LTE Band 26_3M

Channel	Frequency(MHz)	Channel	Frequency(MHz)
26915	831	26915	831
Date: 13.MAY.2017 11:46:20		Date: 13.MAY.2017 11:46:40	

Channel	Frequency(MHz)	-	-
26915	831	-	-

--	--

LTE Band 26_5M

Channel	Frequency(MHz)	Channel	Frequency(MHz)
26915	831	26915	831
Date: 13.MAY.2017 11:45:53		Date: 13.MAY.2017 11:45:36	
Channel	Frequency(MHz)	-	-
26915	831	-	-

LTE Band 26_10M

Channel	Frequency(MHz)	Channel	Frequency(MHz)
26915	831	26915	831
Date: 13.MAY.2017 11:44:55		Date: 13.MAY.2017 11:45:13	

Channel	Frequency(MHz)		
26915	831	-	-

	<p>Frequency</p> <p>Auto Tune</p> <p>Center Freq 4.515000000 GHz</p> <p>Start Freq 30.000000 MHz</p> <p>Stop Freq 9.000000000 GHz</p> <p>CF Step 897.000000 MHz</p> <p>Freq Offset 0 Hz</p> <p>Scale Type Log</p>
--	---

LTE Band 26_15M

Channel	Frequency(MHz)	Channel	Frequency(MHz)
26915	831	26915	831
Date: 13.MAY.2017 11:43:53		Date: 13.MAY.2017 11:44:13	

Channel	Frequency(MHz)		
26915	831	-	-

Frequency

Auto Tune

Center Freq
4.515000000 GHz

Start Freq
30.000000 MHz

Stop Freq
9.000000000 GHz

CF Step
897.000000 MHz

Freq Offset
0 Hz

Scale Type
Log

APPENDIX D - RADIATED EMISSION

Test Mode: TX Mode_Adapter: BYD

Ant 0°

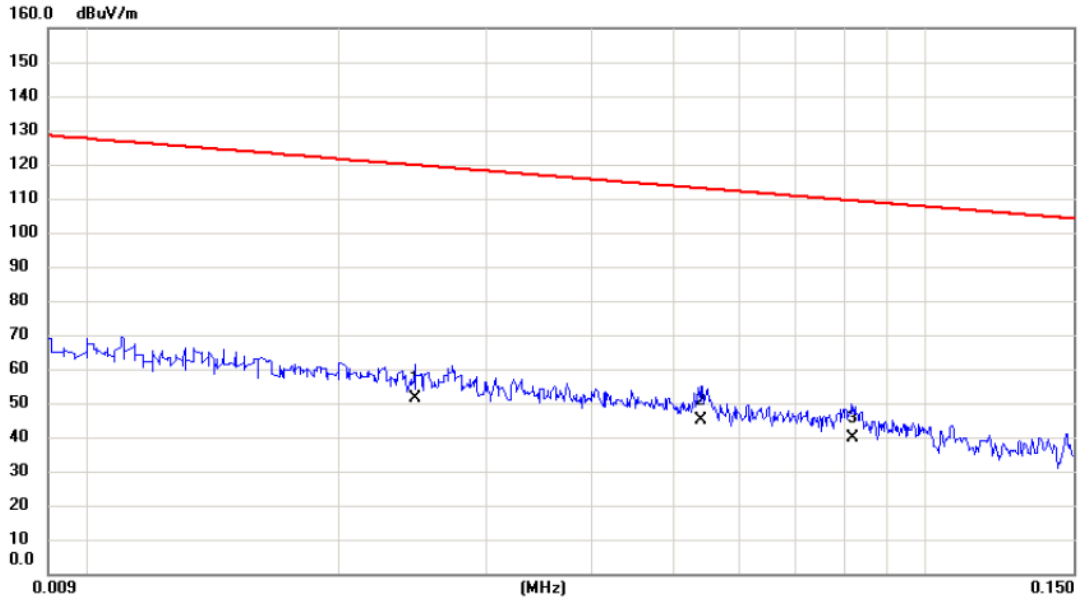

No.	Mk.	Freq. MHz	Reading Level dBuV	Correct Factor dB	Measure- ment dBuV/m	Limit dBuV/m	Margin dB	Detector	Comment
1		0.0246	31.82	19.48	51.30	119.79	-68.49	AVG	
2	*	0.0540	26.18	18.64	44.82	112.96	-68.14	AVG	
3		0.0817	21.62	18.07	39.69	109.36	-69.67	AVG	

Test Mode: TX Mode_Adapter: BYD

Ant 0°

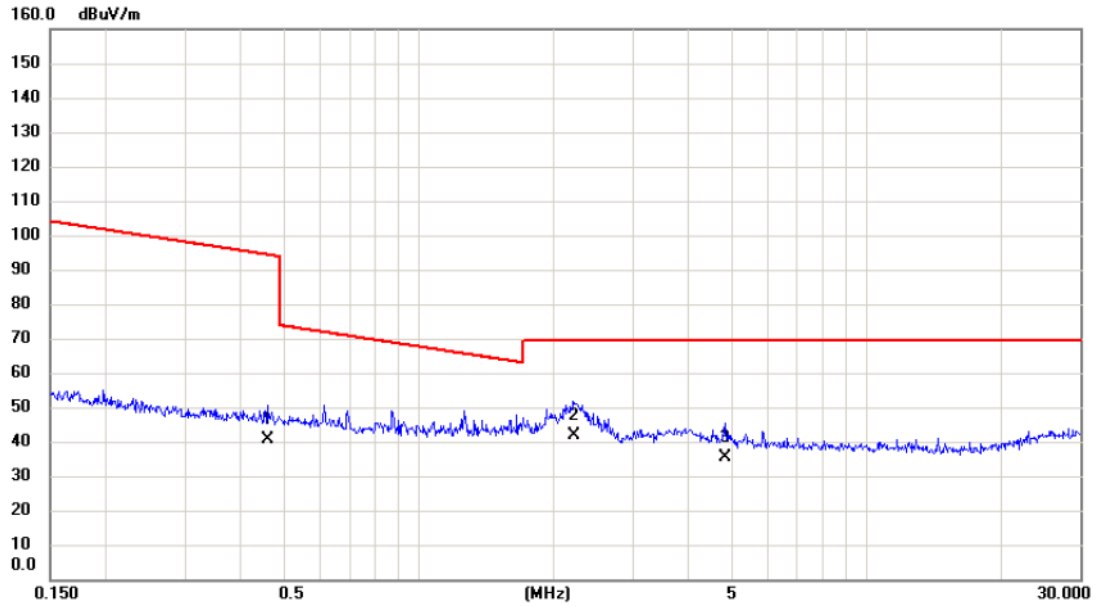

No.	Mk.	Freq. MHz	Reading Level dBuV	Correct Factor dB	Measure- ment dBuV/m	Limit dBuV/m	Margin dB	Detector	Comment
1		0.4588	24.03	16.50	40.53	94.37	-53.84	AVG	
2	*	2.2132	26.19	15.45	41.64	69.54	-27.90	QP	
3		4.8224	20.85	14.48	35.33	69.54	-34.21	QP	

Test Mode: TX Mode _ Adapter: BYD

Ant 90°

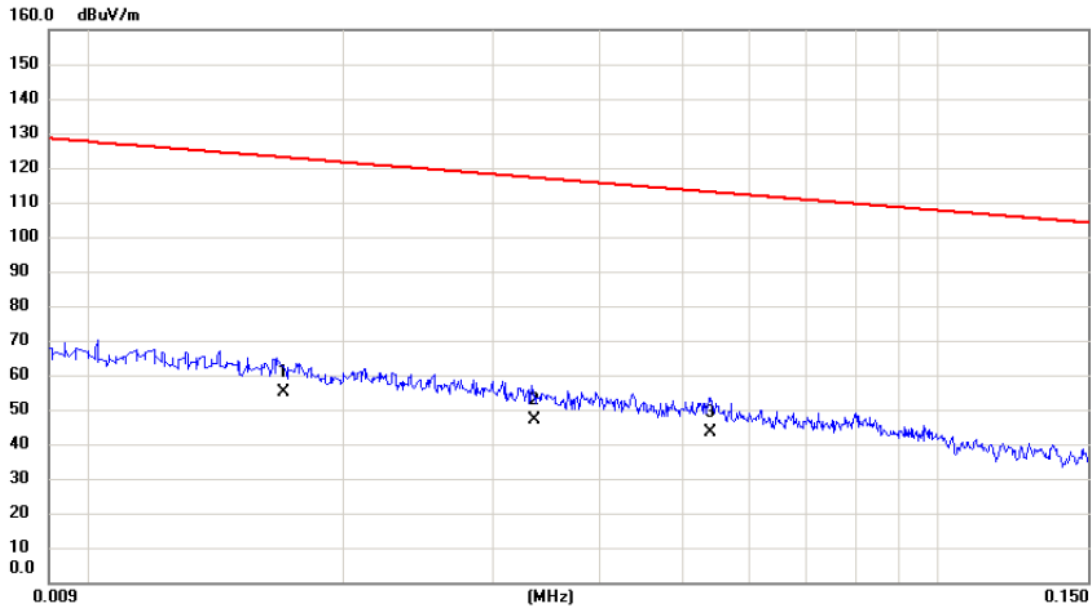

No.	Mk.	Freq.	Reading Level	Correct Factor	Measurement	Limit	Margin	Detector	Comment
		MHz	dBuV	dB	dBuV/m	dBuV/m	dB		
1	*	0.0170	35.08	20.01	55.09	123.00	-67.91	AVG	
2		0.0335	27.94	19.22	47.16	117.10	-69.94	AVG	
3		0.0540	24.70	18.64	43.34	112.96	-69.62	AVG	

Test Mode: TX Mode_Adapter: BYD

Ant 90°

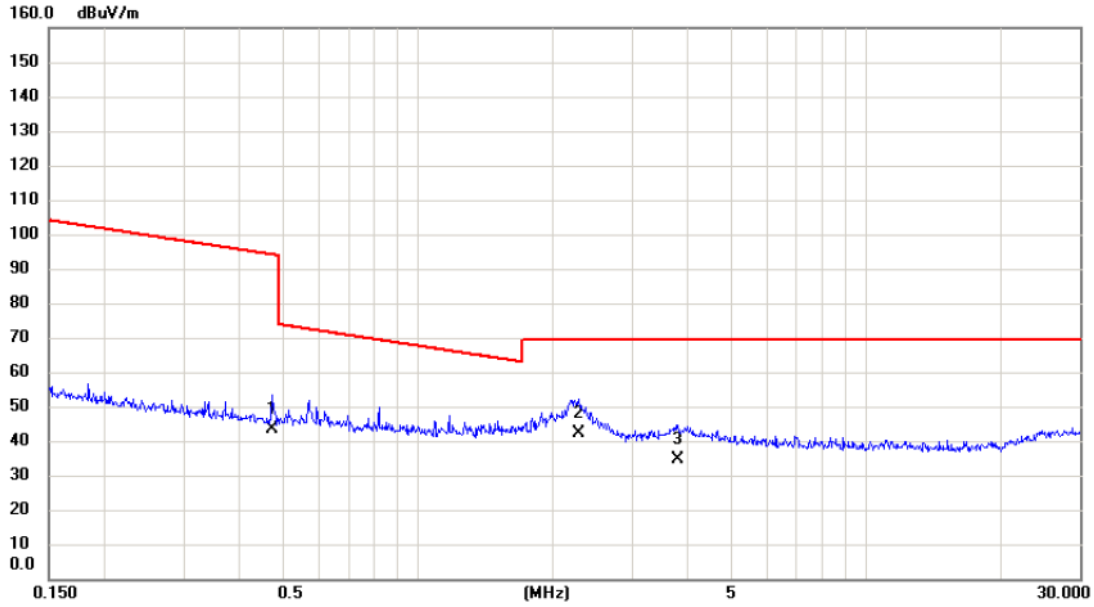

No.	Mk.	Freq. MHz	Reading Level dBuV	Correct Factor dB	Measure- ment dBuV/m	Limit dBuV/m	Margin dB	Detector	Comment
1		0.4736	26.77	16.49	43.26	94.10	-50.84	AVG	
2	*	2.2847	26.60	15.43	42.03	69.54	-27.51	QP	
3		3.7994	19.57	15.01	34.58	69.54	-34.96	QP	

Test Mode: TX Mode _ Adapter: Salcomp

Ant 0°

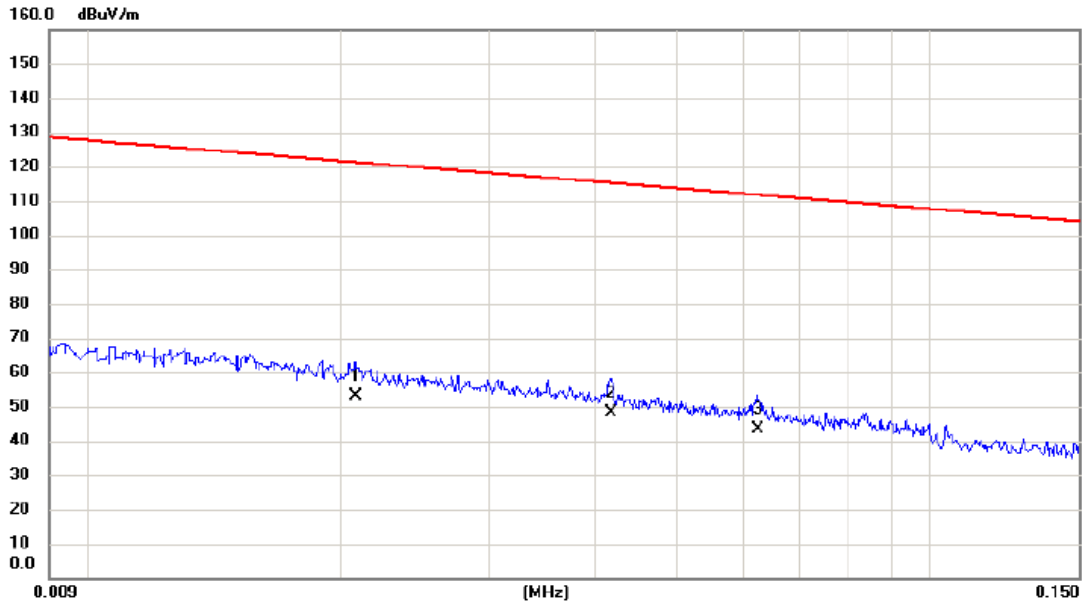

No.	Mk.	Freq. MHz	Reading Level dBuV	Correct Factor dB	Measure- ment dBuV/m	Limit dBuV/m	Margin dB	Detector	Comment
1		0.0208	33.46	19.60	53.06	121.24	-68.18	AVG	
2	*	0.0418	29.27	18.97	48.24	115.18	-66.94	AVG	
3		0.0624	24.90	18.48	43.38	111.70	-68.32	AVG	

Test Mode: TX Mode _ Adapter: Salcomp

Ant 0°

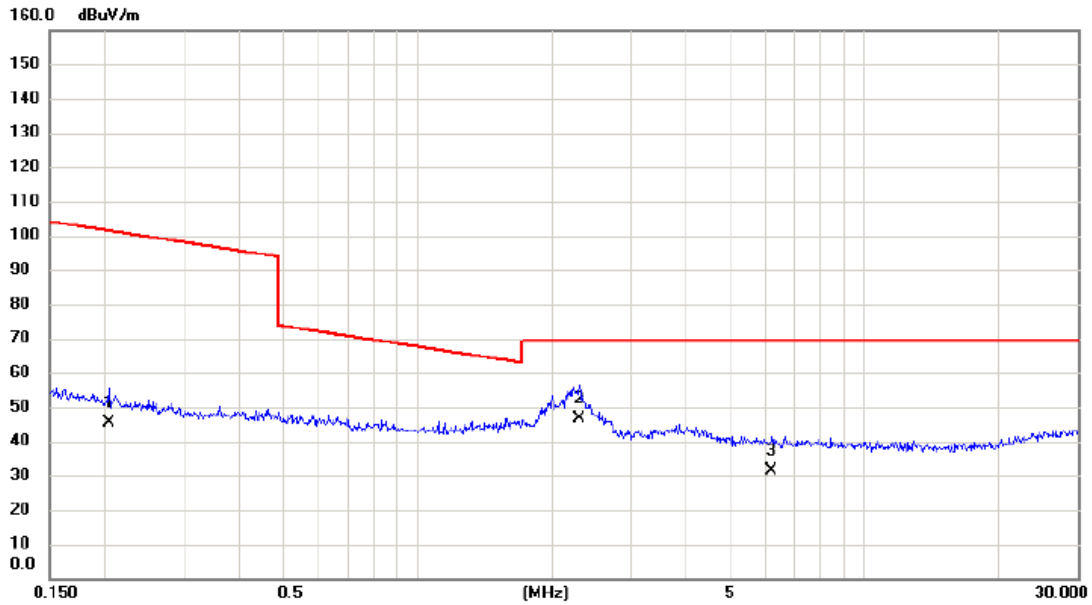

No.	Mk.	Freq. MHz	Reading Level dBuV	Correct Factor dB	Measure- ment dBuV/m	Limit dBuV/m	Margin dB	Detector	Comment
1		0.2040	28.66	16.79	45.45	101.41	-55.96	AVG	
2	*	2.2968	30.99	15.43	46.42	69.54	-23.12	QP	
3		6.1860	17.36	14.22	31.58	69.54	-37.96	QP	

Test Mode: TX Mode _ Adapter: Salcomp

Ant 90°

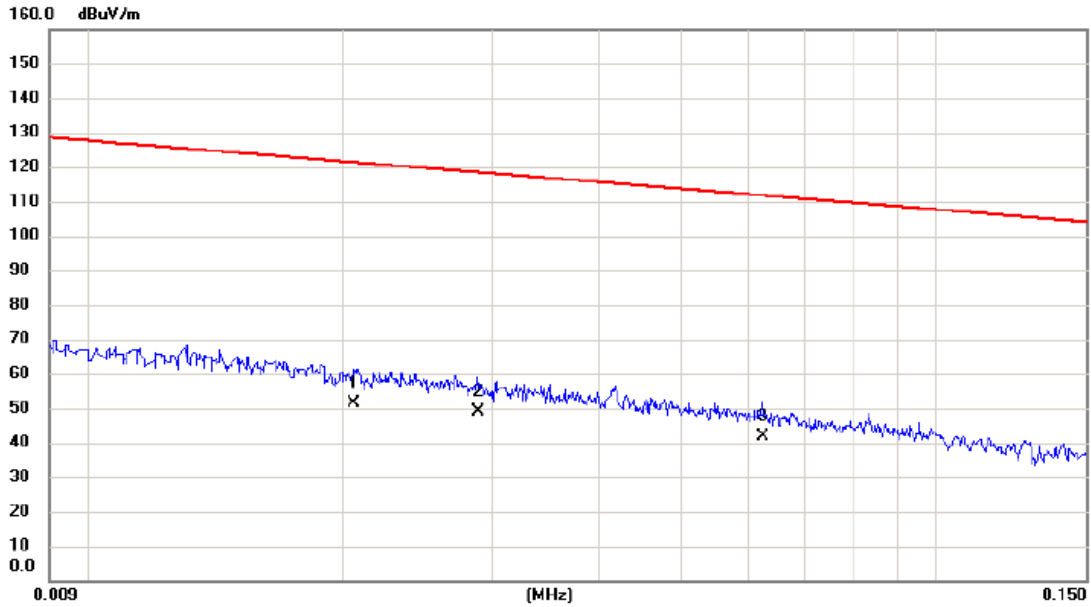

No.	Mk.	Freq. MHz	Reading Level dBuV	Correct Factor dB	Measure- ment dBuV/m	Limit dBuV/m	Margin dB	Detector	Comment
1		0.0206	31.94	19.60	51.54	121.33	-69.79	AVG	
2	*	0.0288	29.49	19.36	48.85	118.42	-69.57	AVG	
3		0.0624	23.34	18.48	41.82	111.70	-69.88	AVG	

Test Mode: TX Mode _ Adapter: Salcomp

Ant 90°

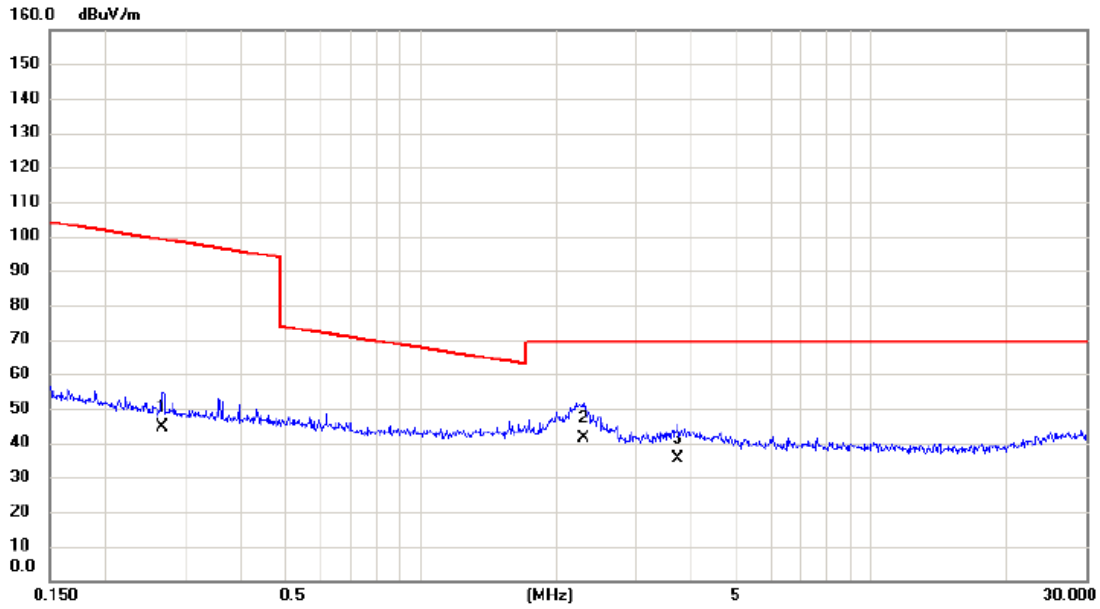

No.	Mk.	Freq. MHz	Reading Level dBuV	Correct Factor dB	Measure- ment dBuV/m	Limit dBuV/m	Margin dB	Detector	Comment
1		0.2672	28.05	16.65	44.70	99.07	-54.37	AVG	
2	*	2.2968	25.92	15.43	41.35	69.54	-28.19	QP	
3		3.7198	20.20	15.02	35.22	69.54	-34.32	QP	

Test Mode: GSM850_TX CH128_GSM

Vertical

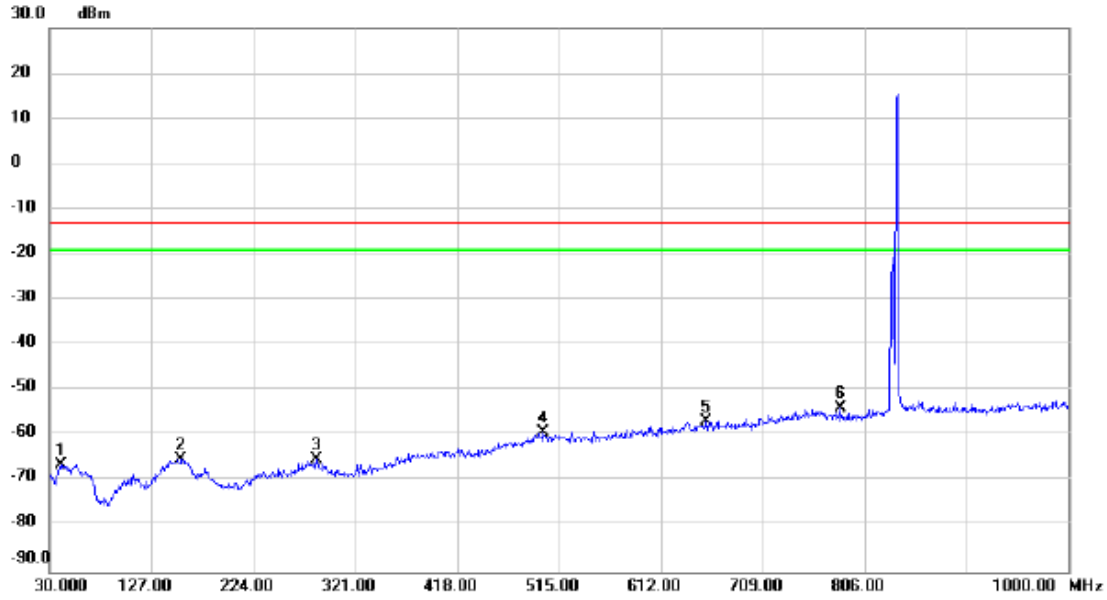

No.	Mk.	Freq. MHz	Reading Level dBm	Correct Factor dB	Measure- ment dBm	Limit dBm	Margin dB	Detector	Comment
1		40.670	-78.45	12.10	-66.35	-13.00	-53.35	peak	
2		155.130	-78.35	13.17	-65.18	-13.00	-52.18	peak	
3		284.140	-77.70	12.47	-65.23	-13.00	-52.23	peak	
4		500.450	-76.92	17.55	-59.37	-13.00	-46.37	peak	
5		654.680	-76.90	20.15	-56.75	-13.00	-43.75	peak	
6	*	782.720	-76.02	22.09	-53.93	-13.00	-40.93	peak	

Test Mode: GSM850_TX CH128_GSM

Horizontal

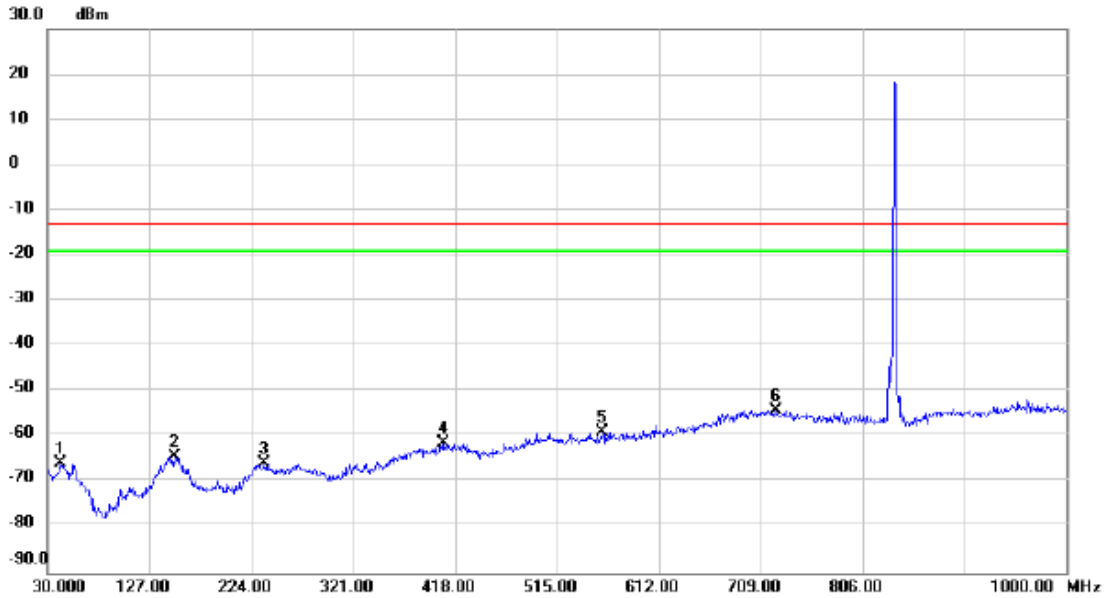

No.	Mk.	Freq. MHz	Reading Level dBm	Correct Factor dB	Measure- ment dBm	Limit dBm	Margin dB	Detector	Comment
1		41.640	-78.38	12.40	-65.98	-13.00	-52.98	peak	
2		150.280	-78.41	14.20	-64.21	-13.00	-51.21	peak	
3		236.610	-78.50	12.69	-65.81	-13.00	-52.81	peak	
4		406.360	-77.55	16.20	-61.35	-13.00	-48.35	peak	
5		558.650	-77.31	18.28	-59.03	-13.00	-46.03	peak	
6	*	723.550	-77.49	23.41	-54.08	-13.00	-41.08	peak	

Test Mode: GSM850_TX CH128_GSM

Vertical

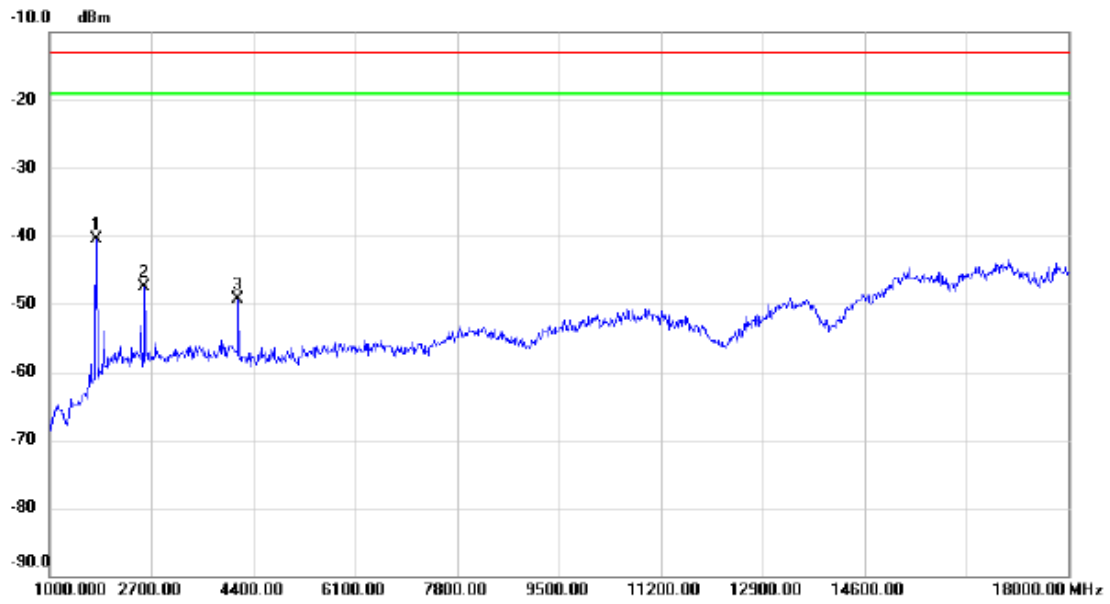

No.	Mk.	Freq. MHz	Reading Level dBm	Correct Factor dB	Measure- ment dBm	Limit dBm	Margin dB	Detector	Comment
1	*	1782.000	-48.41	7.98	-40.43	-13.00	-27.43	peak	
2		2581.000	-59.79	12.24	-47.55	-13.00	-34.55	peak	
3		4145.000	-63.99	14.65	-49.34	-13.00	-36.34	peak	

Test Mode: GSM850_TX CH128_GSM

Horizontal

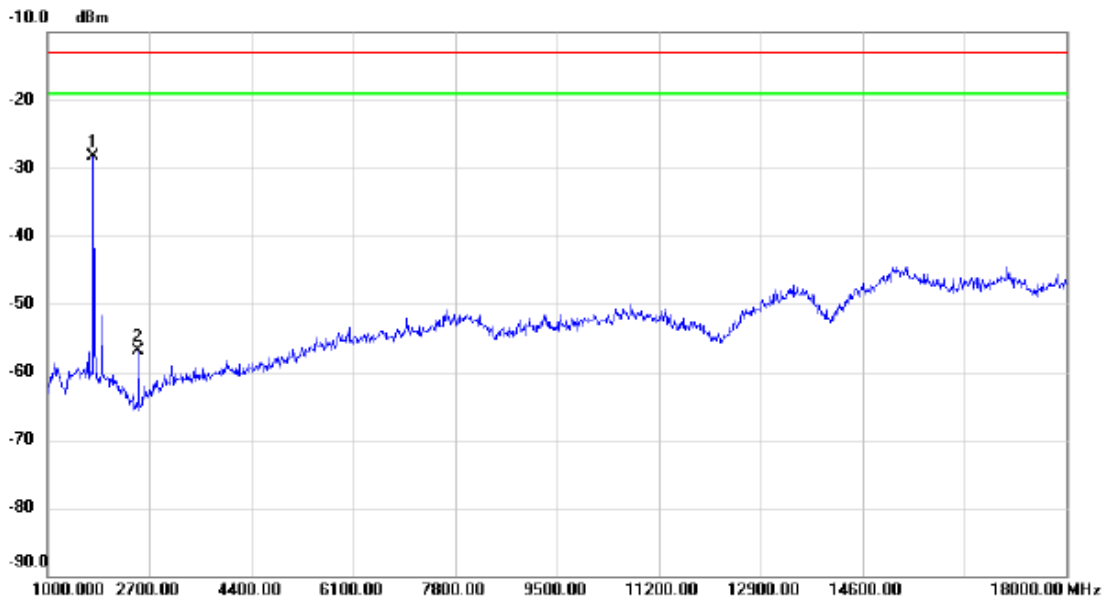

No.	Mk.	Freq. MHz	Reading Level dBm	Correct Factor dB	Measure- ment dBm	Limit dBm	Margin dB	Detector	Comment
1	*	1765.000	-36.44	8.21	-28.23	-13.00	-15.23	peak	
2		2513.000	-62.20	5.30	-56.90	-13.00	-43.90	peak	

Test Mode: GSM850_TX CH128_EDGE

Vertical

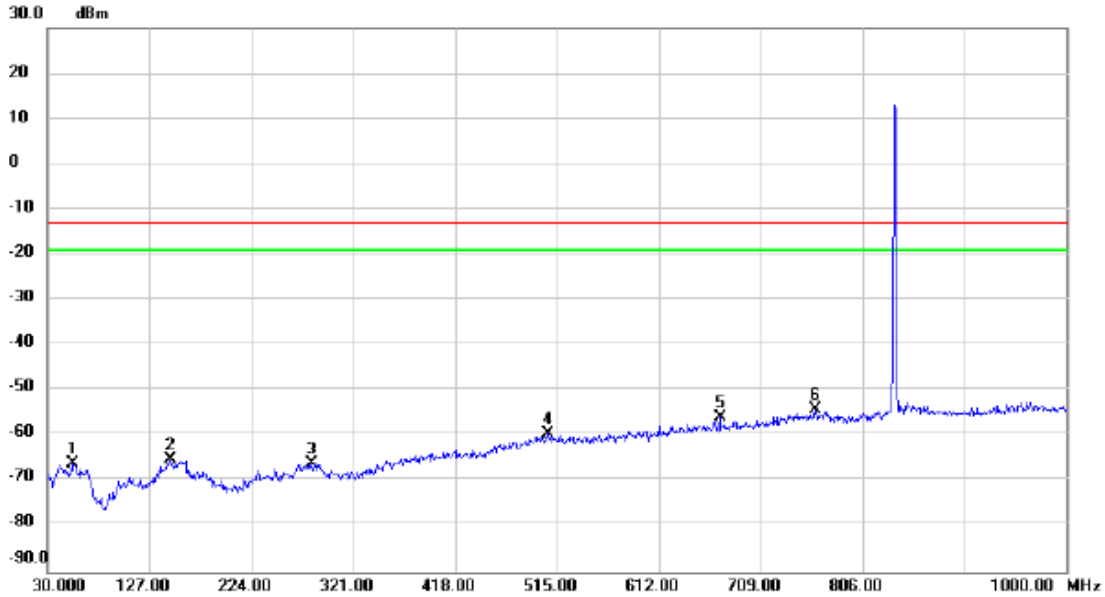

No.	Mk.	Freq. MHz	Reading Level dBm	Correct Factor dB	Measure- ment dBm	Limit dBm	Margin dB	Detector	Comment
1		54.250	-78.41	12.40	-66.01	-13.00	-53.01	peak	
2		146.400	-78.13	12.79	-65.34	-13.00	-52.34	peak	
3		281.230	-78.86	12.60	-66.26	-13.00	-53.26	peak	
4		506.270	-77.16	17.54	-59.62	-13.00	-46.62	peak	
5		670.200	-76.32	20.27	-56.05	-13.00	-43.05	peak	
6	*	761.380	-76.44	22.34	-54.10	-13.00	-41.10	peak	

Test Mode: GSM850_TX CH128_EDGE

Horizontal

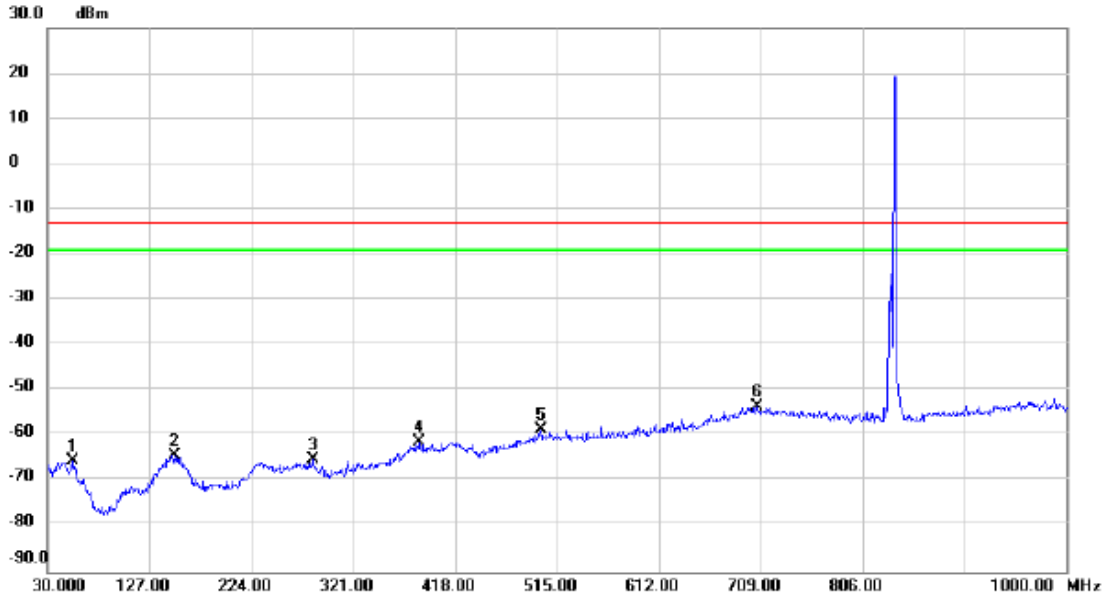

No.	Mk.	Freq. MHz	Reading Level dBm	Correct Factor dB	Measure- ment dBm	Limit dBm	Margin dB	Detector	Comment
1		53.280	-77.75	12.19	-65.56	-13.00	-52.56	peak	
2		151.250	-78.30	14.05	-64.25	-13.00	-51.25	peak	
3		282.200	-77.69	12.30	-65.39	-13.00	-52.39	peak	
4		384.050	-77.53	16.06	-61.47	-13.00	-48.47	peak	
5		500.450	-76.56	18.06	-58.50	-13.00	-45.50	peak	
6	*	705.120	-77.27	23.86	-53.41	-13.00	-40.41	peak	

Test Mode: GSM850_TX CH128_EDGE

Vertical

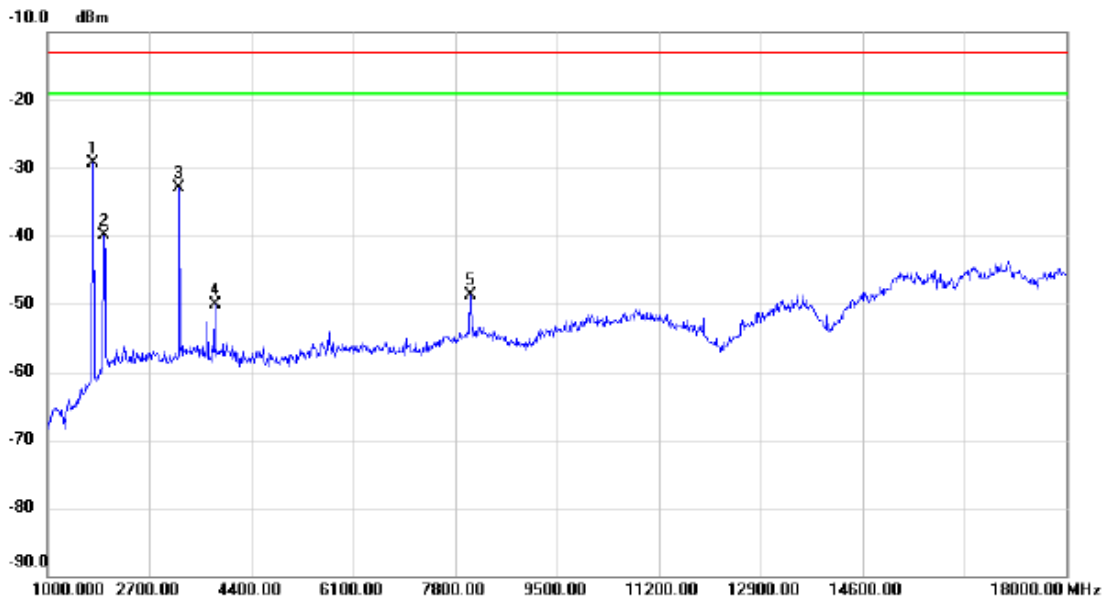

No.	Mk.	Freq. MHz	Reading Level dBm	Correct Factor dB	Measure- ment dBm	Limit dBm	Margin dB	Detector	Comment
1	*	1765.000	-36.96	7.75	-29.21	-13.00	-16.21	peak	
2		1935.000	-50.05	10.07	-39.98	-13.00	-26.98	peak	
3		3193.000	-46.10	13.15	-32.95	-13.00	-19.95	peak	
4		3788.000	-64.61	14.54	-50.07	-13.00	-37.07	peak	
5		8055.000	-68.35	19.60	-48.75	-13.00	-35.75	peak	

Test Mode: GSM850_TX CH128_EDGE

Horizontal

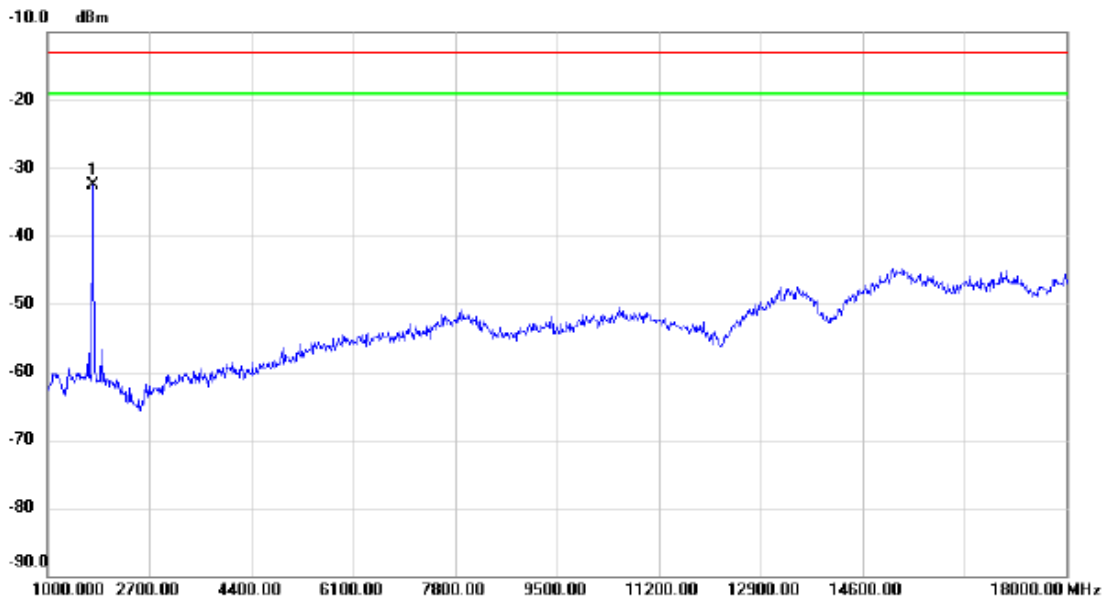

No.	Mk.	Freq. MHz	Reading Level dBm	Correct Factor dB	Measure- ment dBm	Limit dBm	Margin dB	Detector	Comment
1	*	1748.000	-40.65	8.20	-32.45	-13.00	-19.45	peak	

Test Mode: WCDMA Band V_TX CH4182

Vertical

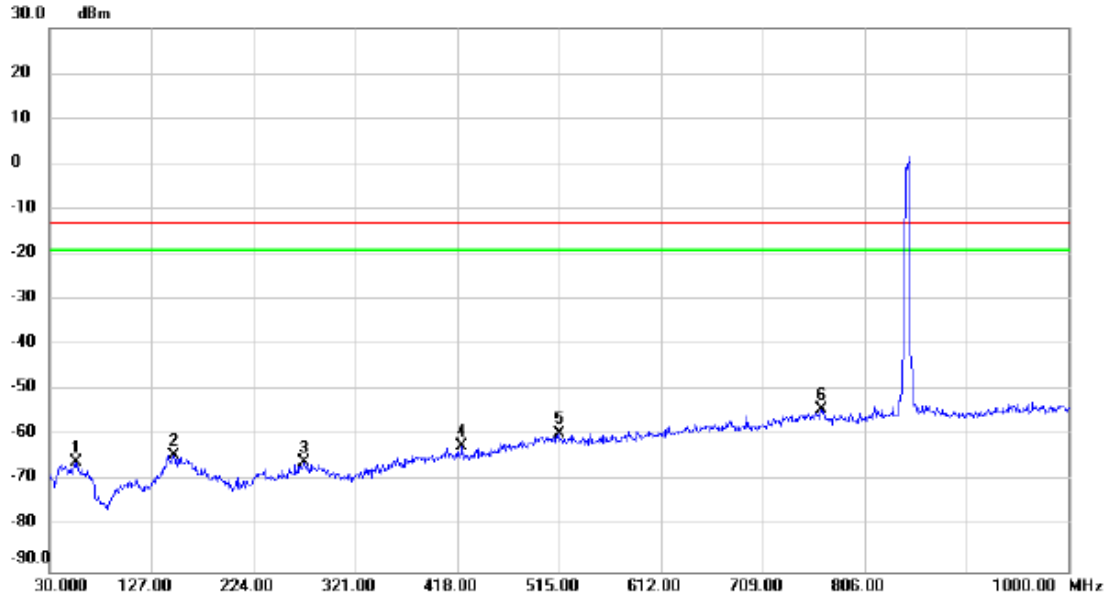

No.	Mk.	Freq. MHz	Reading Level dBm	Correct Factor dB	Measure- ment dBm	Limit dBm	Margin dB	Detector	Comment
1		55.220	-68.42	2.61	-65.81	-13.00	-52.81	peak	
2		148.340	-67.32	2.98	-64.34	-13.00	-51.34	peak	
3		272.500	-68.20	2.30	-65.90	-13.00	-52.90	peak	
4		422.850	-67.01	4.61	-62.40	-13.00	-49.40	peak	
5		515.000	-66.94	7.52	-59.42	-13.00	-46.42	peak	
6	*	765.260	-66.39	12.30	-54.09	-13.00	-41.09	peak	

Test Mode: WCDMA Band V_TX CH4182

Horizontal



No.	Mk.	Freq. MHz	Reading Level dBm	Correct Factor dB	Measure- ment dBm	Limit dBm	Margin dB	Detector	Comment
1		43.580	-66.90	2.78	-64.12	-13.00	-51.12	peak	
2		148.340	-68.25	4.06	-64.19	-13.00	-51.19	peak	
3		231.760	-68.58	3.10	-65.48	-13.00	-52.48	peak	
4		412.180	-67.46	6.49	-60.97	-13.00	-47.97	peak	
5		498.510	-66.98	7.95	-59.03	-13.00	-46.03	peak	
6	*	696.390	-66.25	13.73	-52.52	-13.00	-39.52	peak	

Test Mode: WCDMA Band V_TX CH4182

Vertical

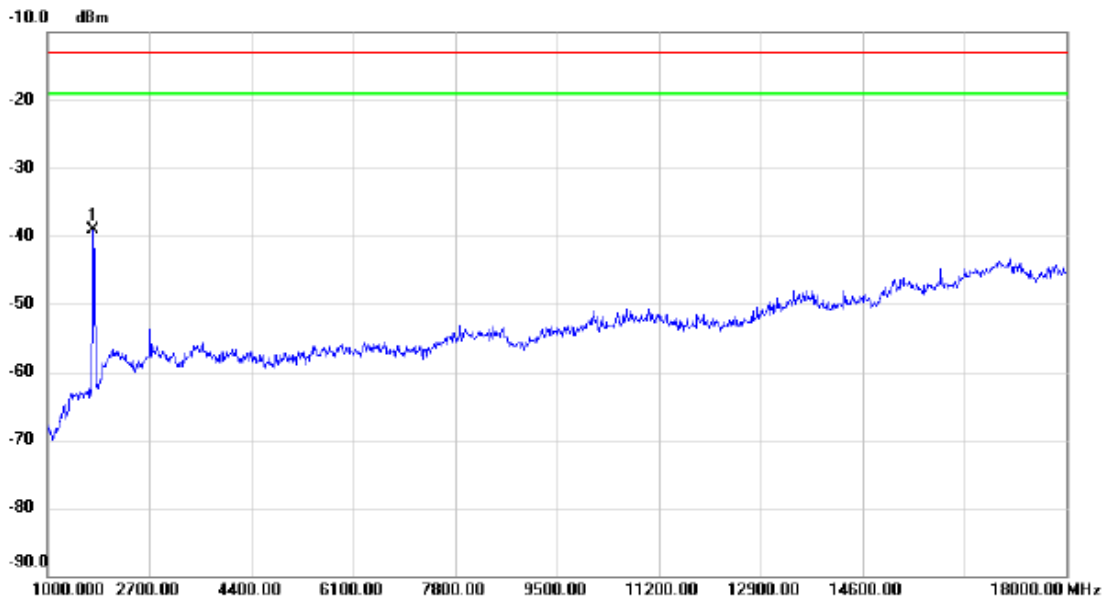

No.	Mk.	Freq. MHz	Reading Level dBm	Correct Factor dB	Measure- ment dBm	Limit dBm	Margin dB	Detector	Comment
1	*	1765.000	-46.76	7.75	-39.01	-13.00	-26.01	peak	

Test Mode: WCDMA Band V_TX CH4182

Horizontal

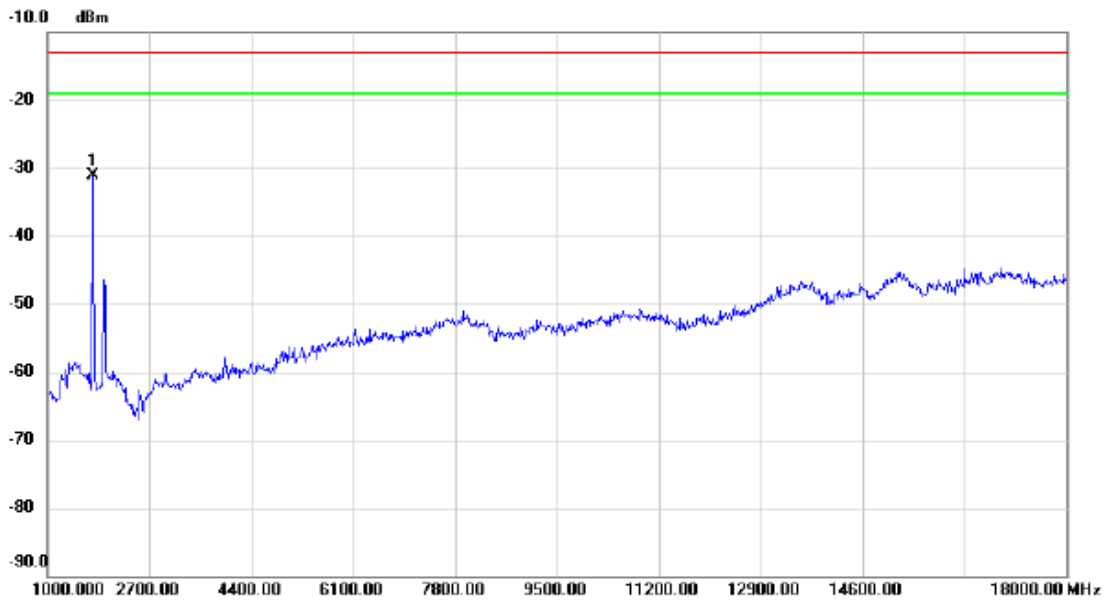

No.	Mk.	Freq. MHz	Reading Level dBm	Correct Factor dB	Measure- ment dBm	Limit dBm	Margin dB	Detector	Comment
1	*	1748.000	-39.21	8.20	-31.01	-13.00	-18.01	peak	

Test Mode: WCDMA Band V_TX CH4182_HSDPA

Vertical

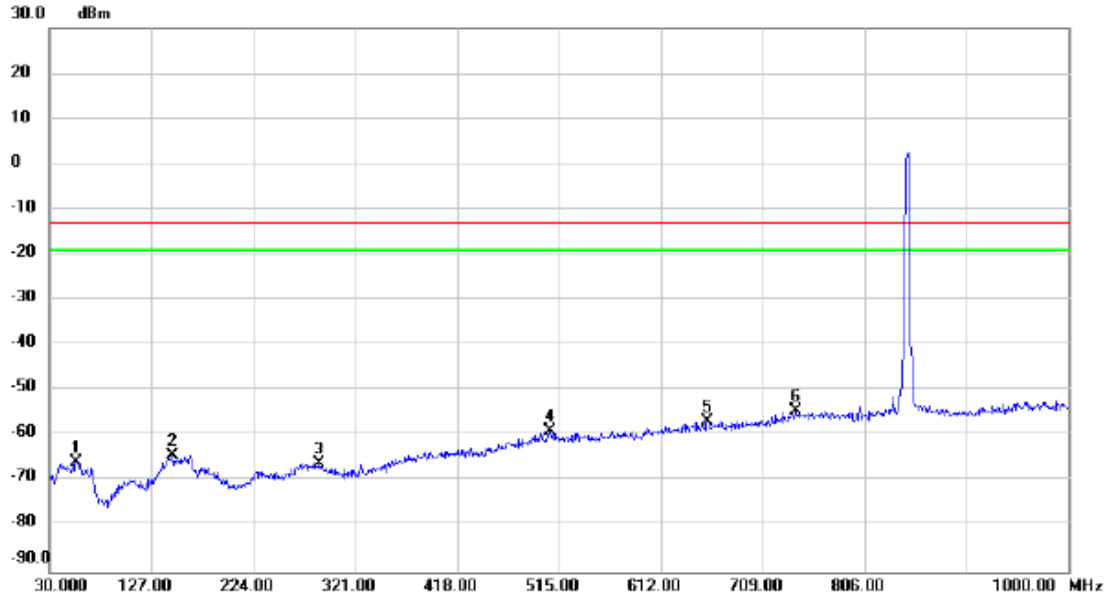

No.	Mk.	Freq. MHz	Reading Level dBm	Correct Factor dB	Measure- ment dBm	Limit dBm	Margin dB	Detector	Comment
1		55.220	-78.42	12.61	-65.81	-13.00	-52.81	peak	
2		147.370	-77.22	12.89	-64.33	-13.00	-51.33	peak	
3		287.050	-78.53	12.35	-66.18	-13.00	-53.18	peak	
4		506.270	-76.61	17.54	-59.07	-13.00	-46.07	peak	
5		656.620	-76.90	20.17	-56.73	-13.00	-43.73	peak	
6	*	741.010	-76.63	22.12	-54.51	-13.00	-41.51	peak	

Test Mode: WCDMA Band V_TX CH4182_HSDPA

Horizontal



No.	Mk.	Freq. MHz	Reading Level dBm	Correct Factor dB	Measure- ment dBm	Limit dBm	Margin dB	Detector	Comment
1		43.580	-78.55	12.78	-65.77	-13.00	-52.77	peak	
2		148.340	-78.71	14.06	-64.65	-13.00	-51.65	peak	
3		229.820	-77.90	13.20	-64.70	-13.00	-51.70	peak	
4		416.060	-77.65	16.68	-60.97	-13.00	-47.97	peak	
5		515.000	-76.73	18.07	-58.66	-13.00	-45.66	peak	
6	*	705.120	-77.25	23.86	-53.39	-13.00	-40.39	peak	

Test Mode: WCDMA Band V_TX CH4182_HSDPA

Vertical

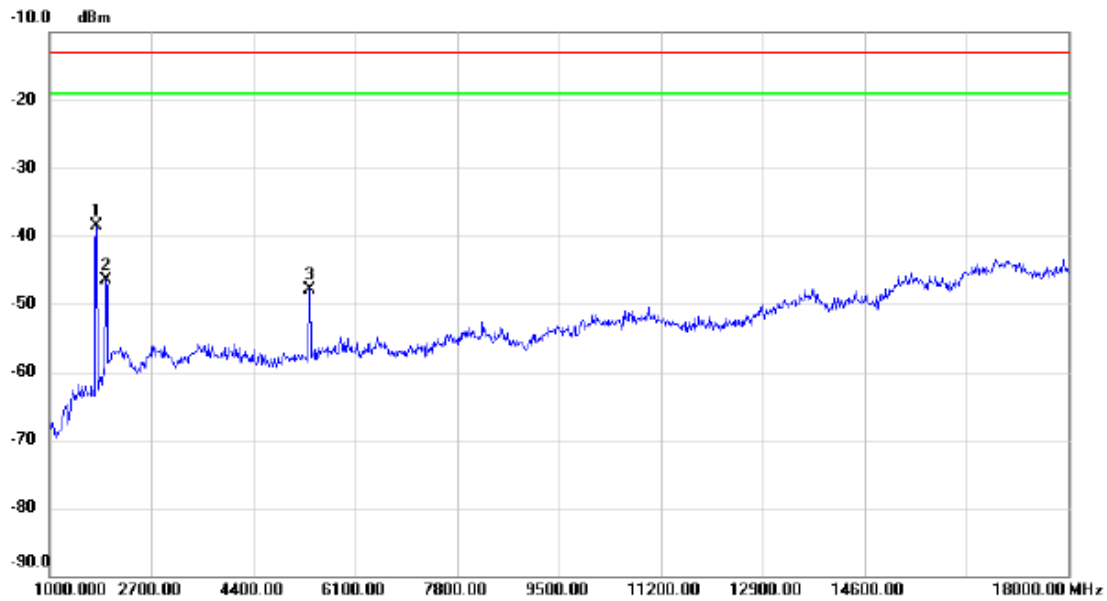

No.	Mk.	Freq. MHz	Reading Level dBm	Correct Factor dB	Measure- ment dBm	Limit dBm	Margin dB	Detector	Comment
1	*	1782.000	-46.45	7.98	-38.47	-13.00	-25.47	peak	
2		1935.000	-56.59	10.07	-46.52	-13.00	-33.52	peak	
3		5335.000	-63.56	15.58	-47.98	-13.00	-34.98	peak	

Test Mode: WCDMA Band V_TX CH4182_HSDPA

Horizontal

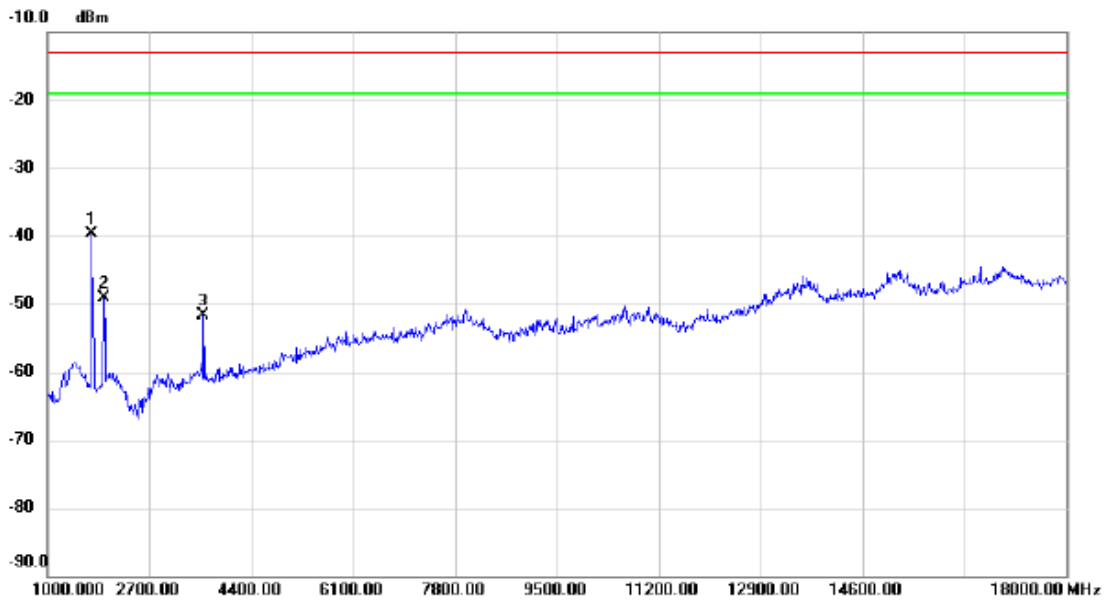

No.	Mk.	Freq. MHz	Reading Level dBm	Correct Factor dB	Measure- ment dBm	Limit dBm	Margin dB	Detector	Comment
1	*	1731.000	-47.90	8.19	-39.71	-13.00	-26.71	peak	
2		1935.000	-57.44	8.29	-49.15	-13.00	-36.15	peak	
3		3601.000	-62.65	10.91	-51.74	-13.00	-38.74	peak	

Test Mode: WCDMA Band V_TX CH4182_HSUPA

Vertical

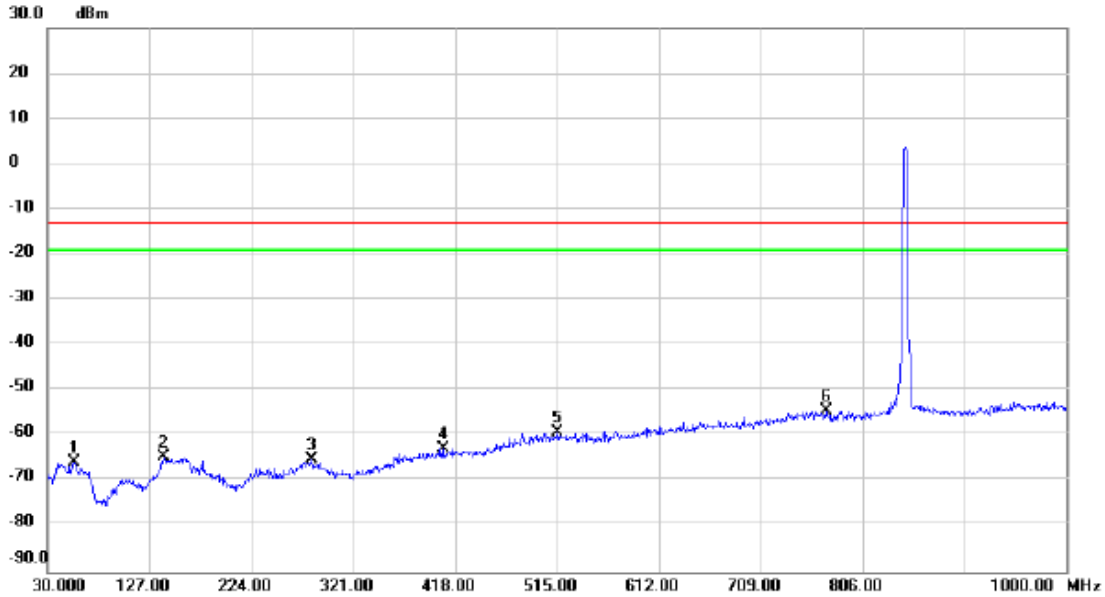

No.	Mk.	Freq. MHz	Reading Level dBm	Correct Factor dB	Measure- ment dBm	Limit dBm	Margin dB	Detector	Comment
1		55.220	-78.58	12.61	-65.97	-13.00	-52.97	peak	
2		140.580	-76.98	12.21	-64.77	-13.00	-51.77	peak	
3		281.230	-77.85	12.60	-65.25	-13.00	-52.25	peak	
4		406.360	-77.17	14.28	-62.89	-13.00	-49.89	peak	
5		515.970	-76.69	17.52	-59.17	-13.00	-46.17	peak	
6	*	771.080	-76.67	22.23	-54.44	-13.00	-41.44	peak	

Test Mode: WCDMA Band V_TX CH4182_HSUPA

Horizontal

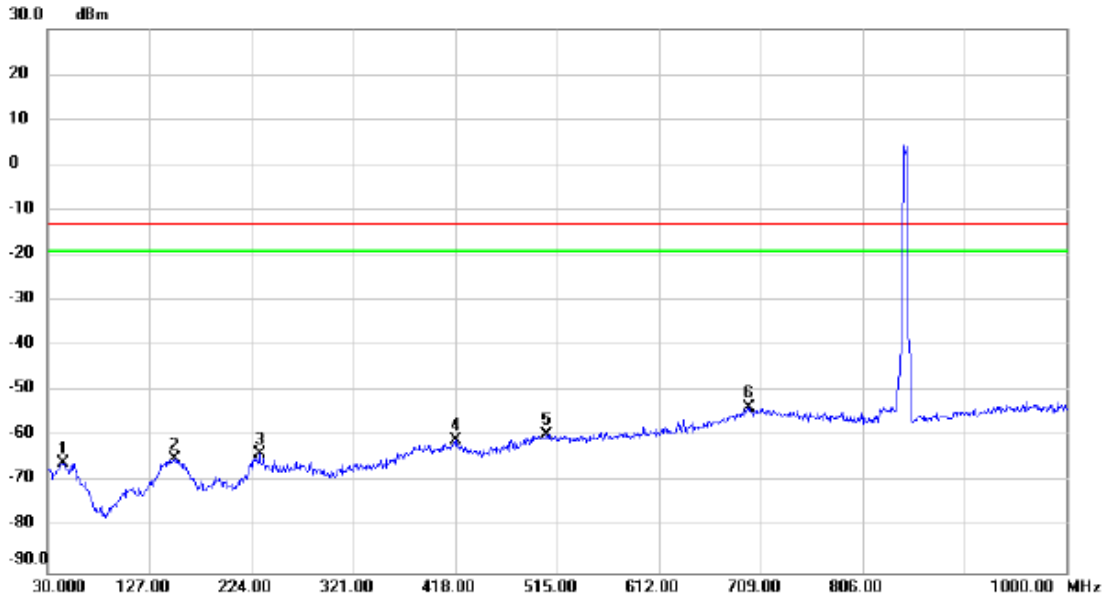

No.	Mk.	Freq. MHz	Reading Level dBm	Correct Factor dB	Measure- ment dBm	Limit dBm	Margin dB	Detector	Comment
1		44.550	-78.72	12.97	-65.75	-13.00	-52.75	peak	
2		150.280	-79.01	14.20	-64.81	-13.00	-51.81	peak	
3		231.760	-76.85	13.10	-63.75	-13.00	-50.75	peak	
4		418.000	-77.44	16.78	-60.66	-13.00	-47.66	peak	
5		505.300	-77.50	18.06	-59.44	-13.00	-46.44	peak	
6	*	697.360	-77.24	23.80	-53.44	-13.00	-40.44	peak	

Test Mode: WCDMA Band V_TX CH4182_HSUPA

Vertical

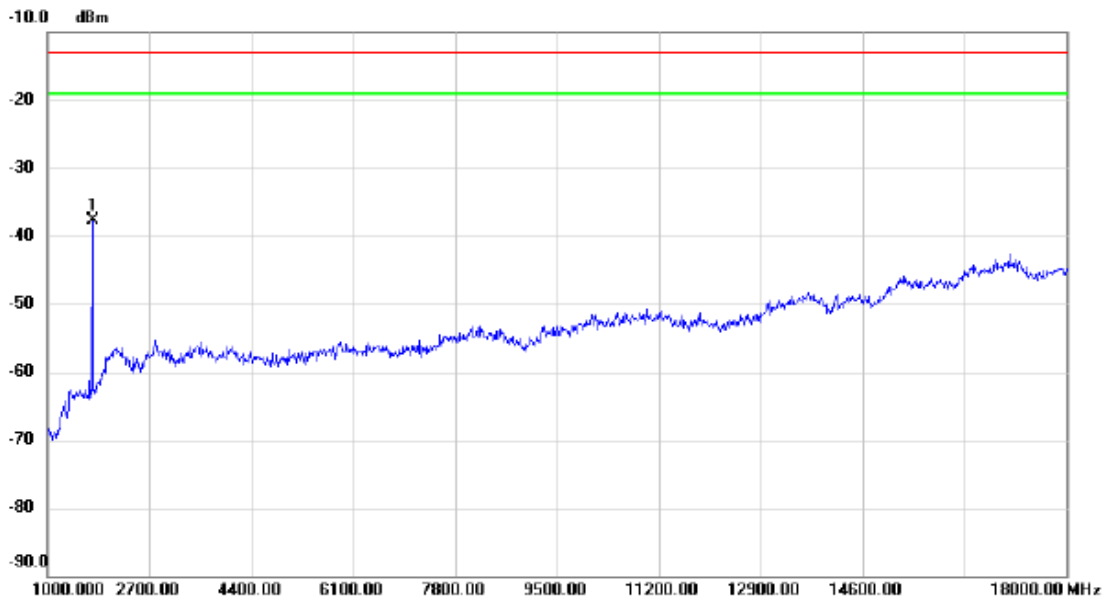

No.	Mk.	Freq. MHz	Reading Level dBm	Correct Factor dB	Measure- ment dBm	Limit dBm	Margin dB	Detector	Comment
1	*	1748.000	-45.31	7.52	-37.79	-13.00	-24.79	peak	

Test Mode: WCDMA Band V_TX CH4182_HSUPA

Horizontal

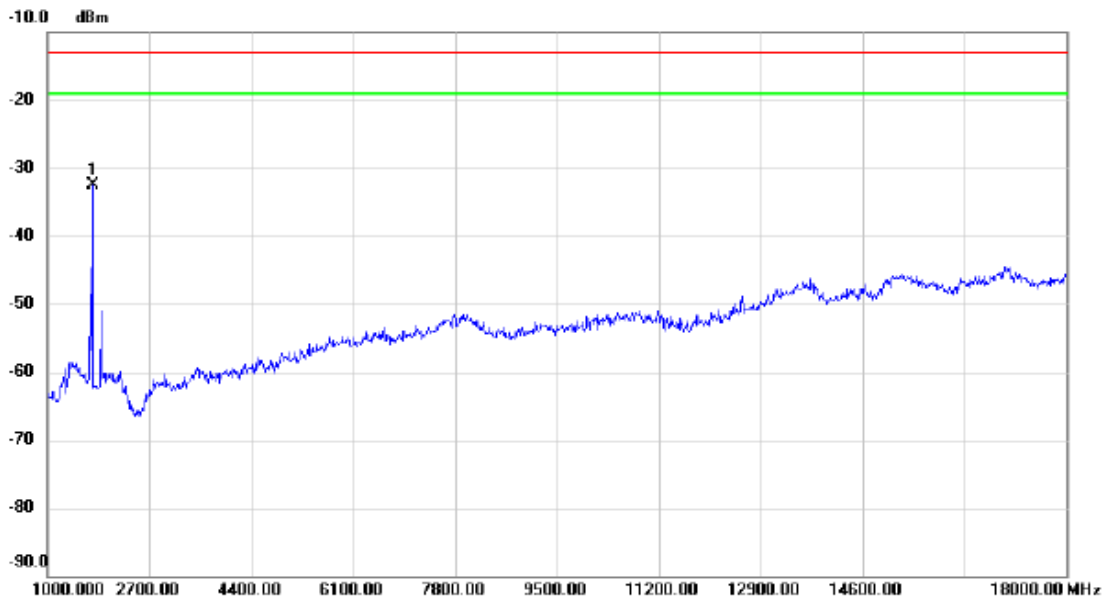

No.	Mk.	Freq. MHz	Reading Level dBm	Correct Factor dB	Measure- ment dBm	Limit dBm	Margin dB	Detector	Comment
1	*	1748.000	-40.68	8.20	-32.48	-13.00	-19.48	peak	

Test Mode: LTE Band 5_TX CH20525_1.4M

Vertical

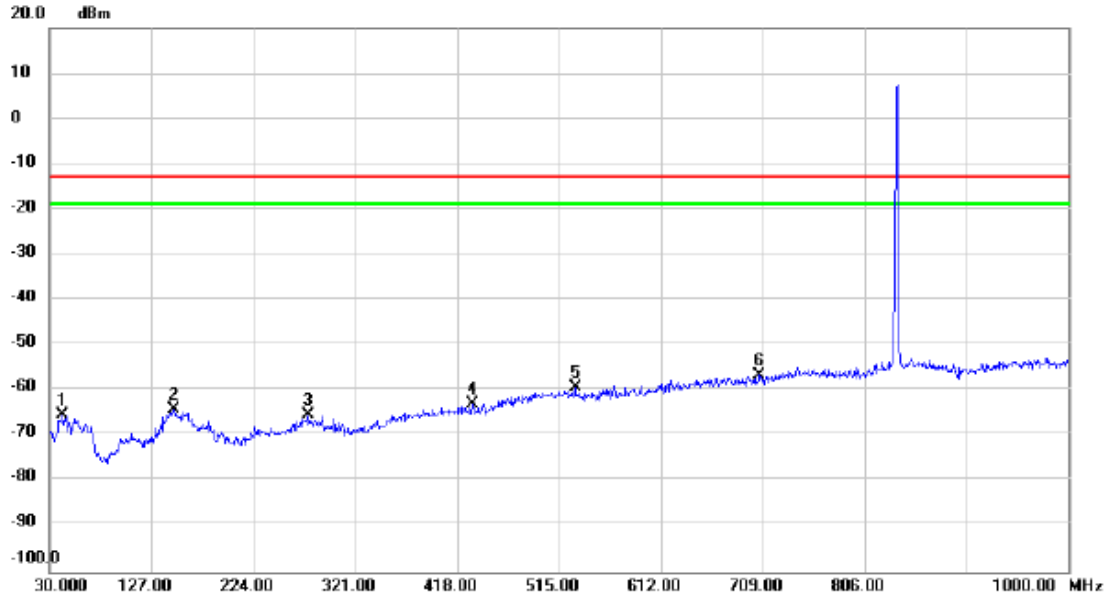

No.	Mk.	Freq. MHz	Reading Level dBm	Correct Factor dB	Measure- ment dBm	Limit dBm	Margin dB	Detector	Comment
1		42.610	-77.40	12.03	-65.37	-13.00	-52.37	peak	
2		148.340	-77.07	12.98	-64.09	-13.00	-51.09	peak	
3		276.380	-77.79	12.48	-65.31	-13.00	-52.31	peak	
4		432.550	-77.29	14.47	-62.82	-13.00	-49.82	peak	
5		530.520	-76.94	17.49	-59.45	-13.00	-46.45	peak	
6	*	706.090	-77.22	20.72	-56.50	-13.00	-43.50	peak	

Test Mode: LTE Band 5_TX CH20525_1.4M

Horizontal

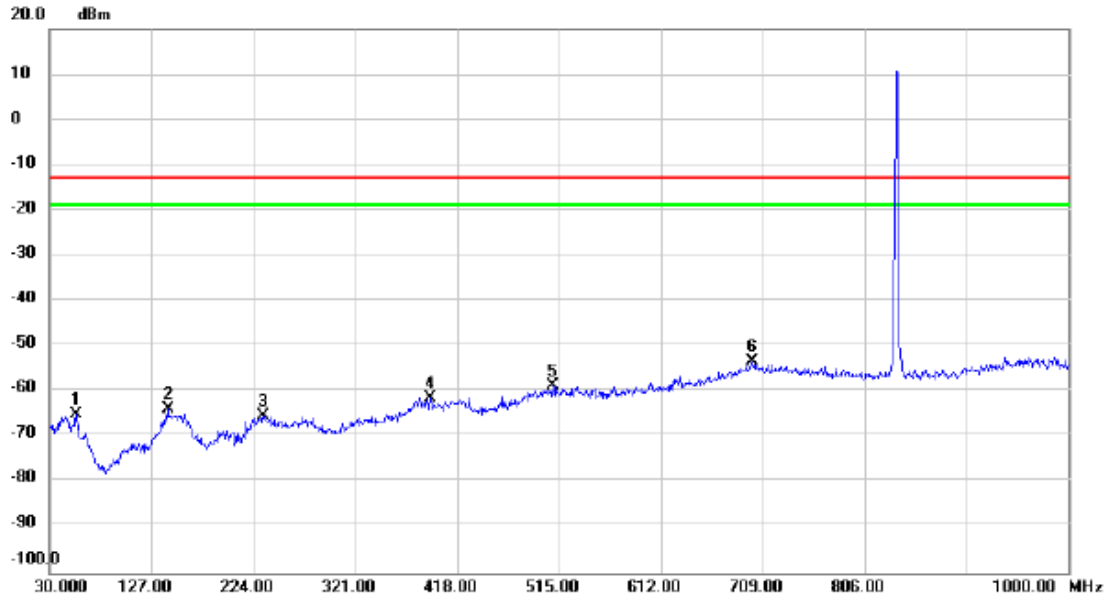

No.	Mk.	Freq. MHz	Reading Level dBm	Correct Factor dB	Measure- ment dBm	Limit dBm	Margin dB	Detector	Comment
1		55.220	-77.54	12.53	-65.01	-13.00	-52.01	peak	
2		142.520	-77.33	13.41	-63.92	-13.00	-50.92	peak	
3		233.700	-78.33	12.94	-65.39	-13.00	-52.39	peak	
4		392.780	-77.35	15.96	-61.39	-13.00	-48.39	peak	
5		509.180	-76.96	18.07	-58.89	-13.00	-45.89	peak	
6	*	699.300	-77.42	23.93	-53.49	-13.00	-40.49	peak	

Test Mode: LTE Band 5_TX CH20525_1.4M

Vertical

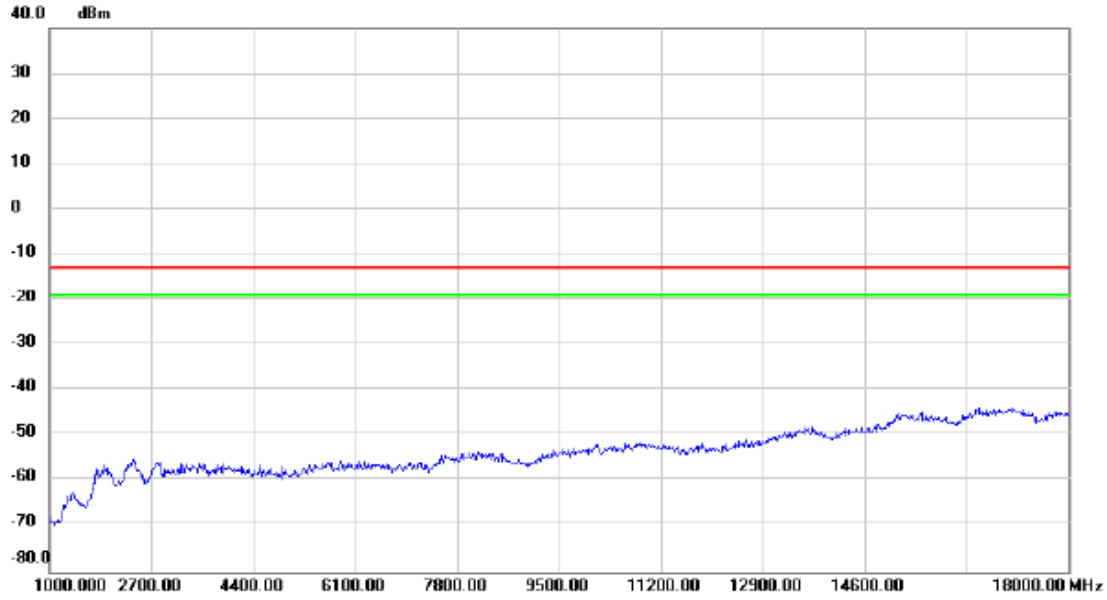

No.	Mk.	Freq.	Reading Level	Correct Factor	Measurement	Limit	Margin	Detector	Comment
		MHz	dBm	dB	dBm	dBm	dB		

Test Mode: LTE Band 5_TX CH20525_1.4M

Horizontal

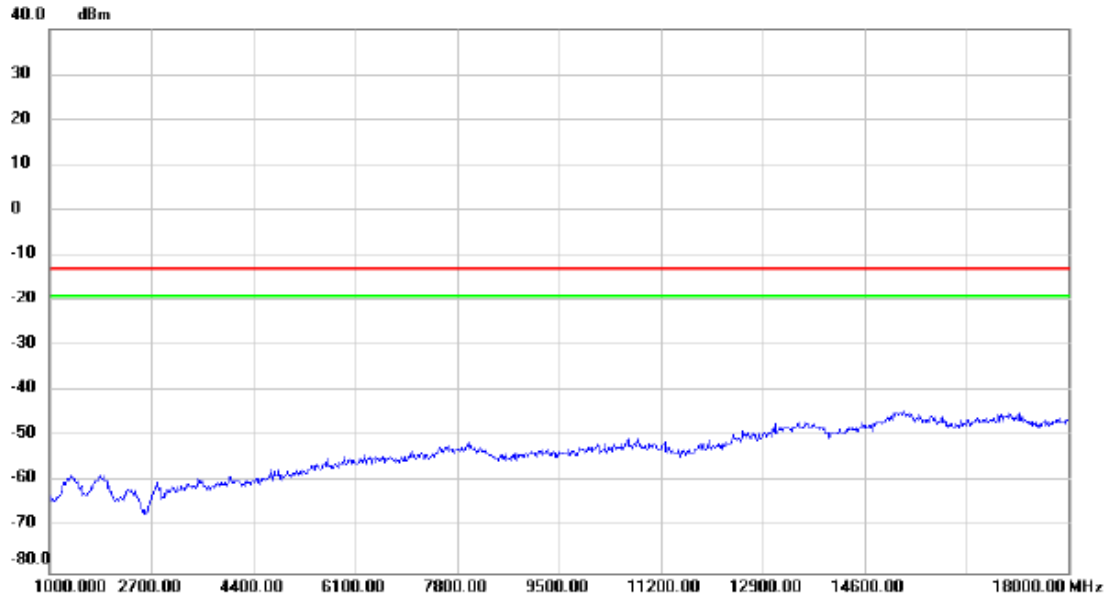

No.	Mk.	Freq.	Reading Level	Correct Factor	Measurement	Limit	Margin	Detector	Comment
		MHz	dBm	dB	dBm	dBm	dB		

Test Mode: LTE Band 5_TX CH20525_10M

Vertical

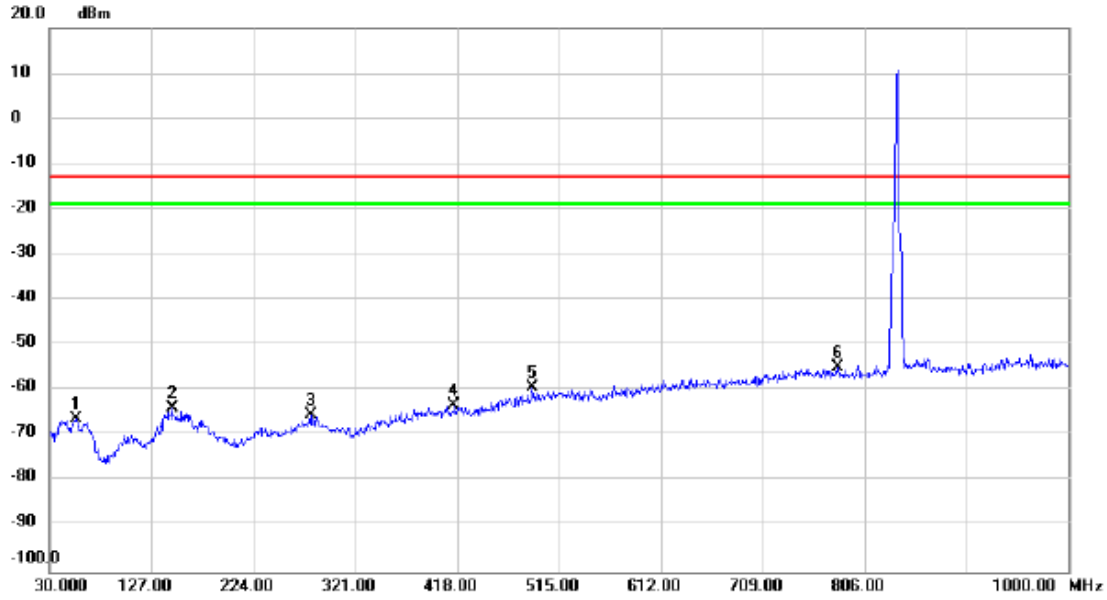

No.	Mk.	Freq. MHz	Reading Level dBm	Correct Factor dB	Measure- ment dBm	Limit dBm	Margin dB	Detector	Comment
1		55.220	-78.78	12.61	-66.17	-13.00	-53.17	peak	
2		146.400	-76.60	12.79	-63.81	-13.00	-50.81	peak	
3		278.320	-78.04	12.57	-65.47	-13.00	-52.47	peak	
4		415.090	-77.80	14.52	-63.28	-13.00	-50.28	peak	
5		489.780	-76.39	16.95	-59.44	-13.00	-46.44	peak	
6	*	780.780	-77.03	22.11	-54.92	-13.00	-41.92	peak	

Test Mode: LTE Band 5_TX CH20525_10M

Horizontal



No.	Mk.	Freq. MHz	Reading Level dBm	Correct Factor dB	Measure- ment dBm	Limit dBm	Margin dB	Detector	Comment
1		51.340	-77.68	11.64	-66.04	-13.00	-53.04	peak	
2		149.310	-79.15	14.16	-64.99	-13.00	-51.99	peak	
3		232.730	-77.22	13.02	-64.20	-13.00	-51.20	peak	
4		385.990	-77.35	16.03	-61.32	-13.00	-48.32	peak	
5		508.210	-76.91	18.07	-58.84	-13.00	-45.84	peak	
6	*	709.000	-76.79	23.76	-53.03	-13.00	-40.03	peak	

Test Mode: LTE Band 5_TX CH20525_10M

Vertical

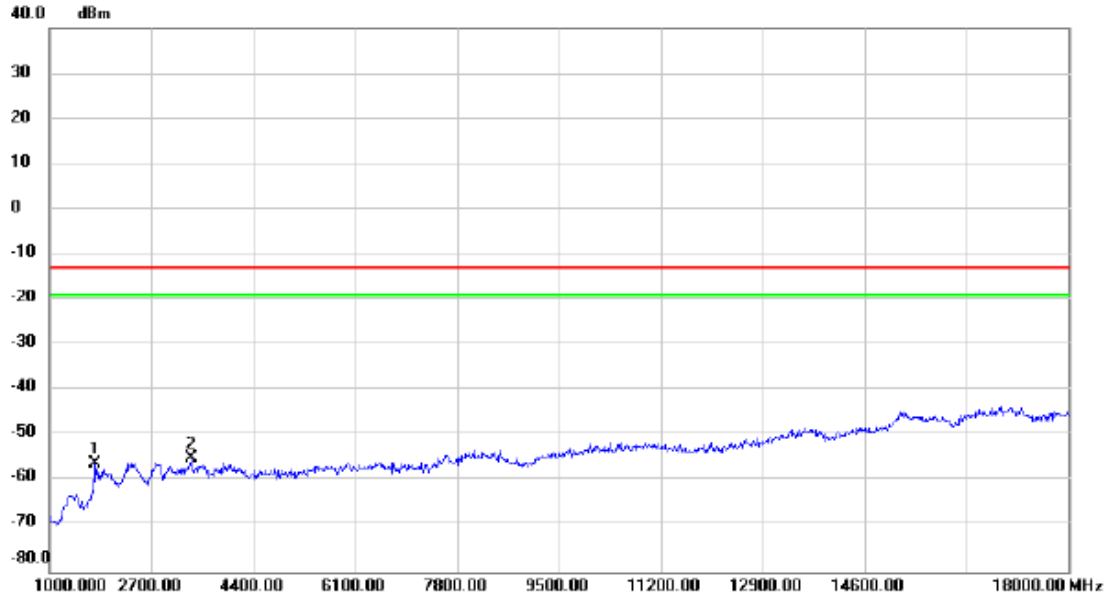

No.	Mk.	Freq. MHz	Reading Level dBm	Correct Factor dB	Measure- ment dBm	Limit dBm	Margin dB	Detector	Comment
1		1748.000	-63.59	7.52	-56.07	-13.00	-43.07	peak	
2	*	3363.000	-68.79	13.76	-55.03	-13.00	-42.03	peak	

Test Mode: LTE Band 5_TX CH20525_10M

Horizontal

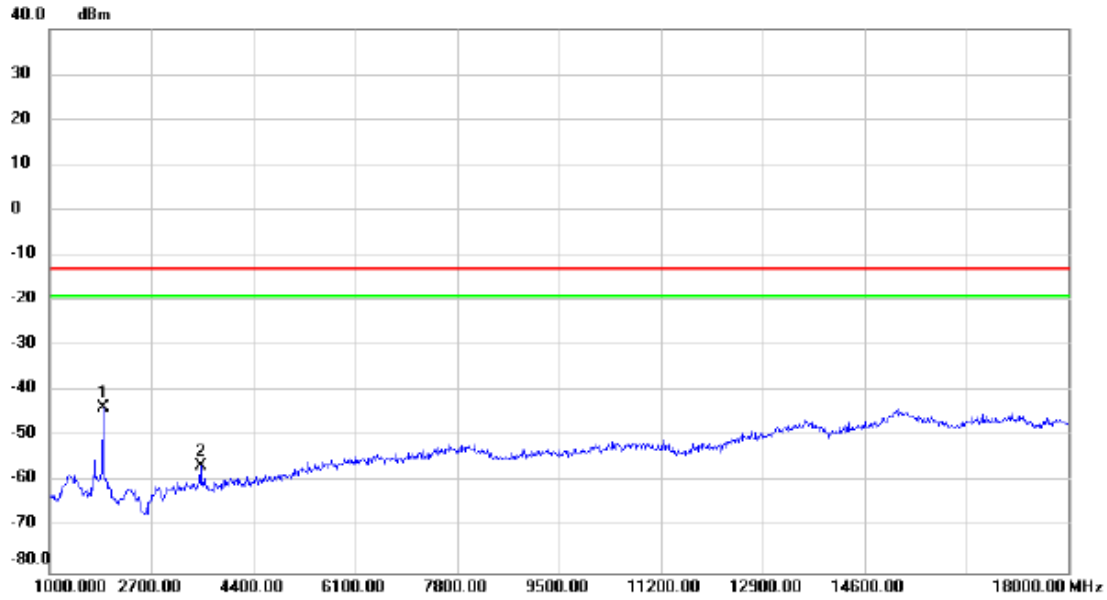

No.	Mk.	Freq. MHz	Reading Level dBm	Correct Factor dB	Measure- ment dBm	Limit dBm	Margin dB	Detector	Comment
1	*	1884.000	-51.84	8.26	-43.58	-13.00	-30.58	peak	
2		3516.000	-67.15	10.67	-56.48	-13.00	-43.48	peak	

Test Mode: LTE Band 26_TX CH27033_1.4M

Vertical

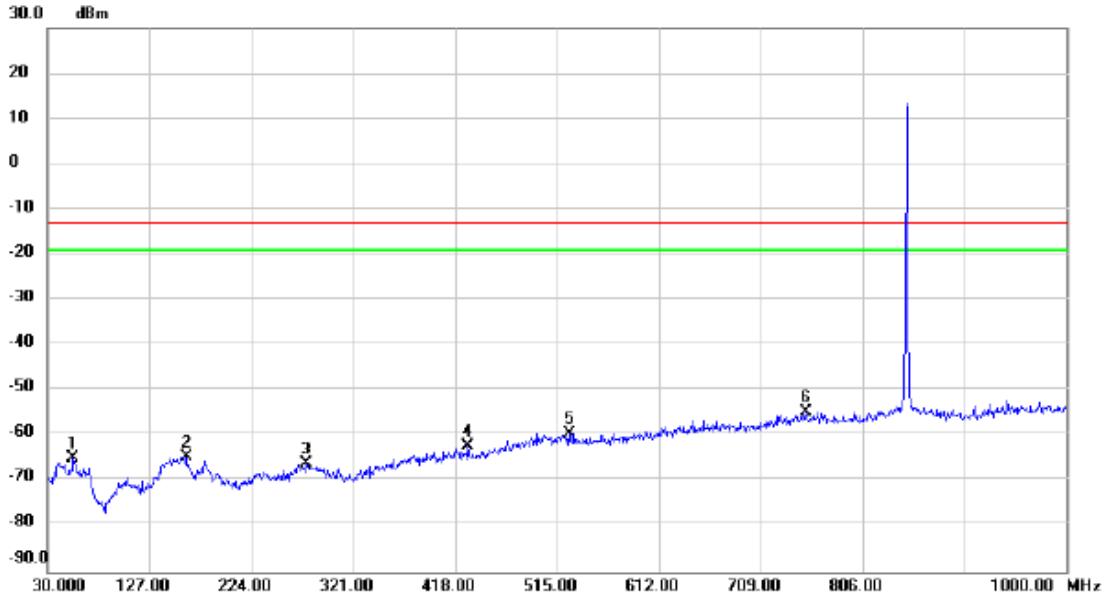

No.	Mk.	Freq. MHz	Reading Level dBm	Correct Factor dB	Measure- ment dBm	Limit dBm	Margin dB	Detector	Comment
1		54.250	-77.27	12.40	-64.87	-13.00	-51.87	peak	
2		161.920	-77.13	12.55	-64.58	-13.00	-51.58	peak	
3		276.380	-78.71	12.48	-66.23	-13.00	-53.23	peak	
4		430.610	-76.60	14.50	-62.10	-13.00	-49.10	peak	
5		526.640	-76.98	17.50	-59.48	-13.00	-46.48	peak	
6	*	752.650	-77.14	22.45	-54.69	-13.00	-41.69	peak	

Test Mode: LTE Band 26_TX CH27033_1.4M

Horizontal



No.	Mk.	Freq. MHz	Reading Level dBm	Correct Factor dB	Measure- ment dBm	Limit dBm	Margin dB	Detector	Comment
1		43.580	-78.34	12.78	-65.56	-13.00	-52.56	peak	
2		151.250	-78.59	14.05	-64.54	-13.00	-51.54	peak	
3		228.850	-78.46	12.94	-65.52	-13.00	-52.52	peak	
4		413.150	-77.30	16.54	-60.76	-13.00	-47.76	peak	
5		497.540	-76.51	17.88	-58.63	-13.00	-45.63	peak	
6	*	701.240	-77.70	23.95	-53.75	-13.00	-40.75	peak	

Test Mode: LTE Band 26_TX CH27033_1.4M

Vertical

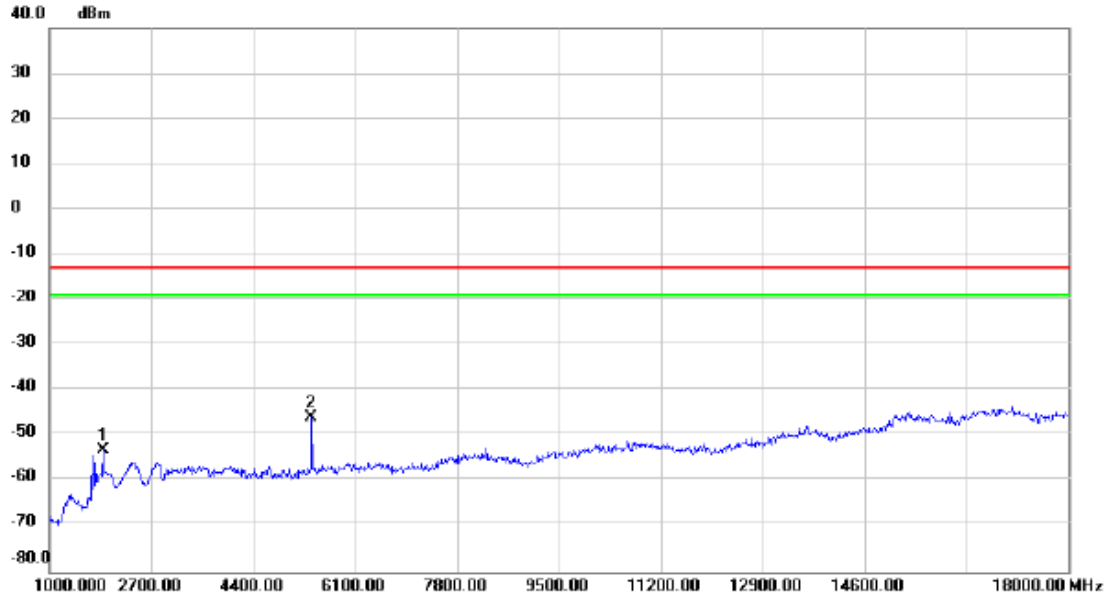

No.	Mk.	Freq. MHz	Reading Level dBm	Correct Factor dB	Measure- ment dBm	Limit dBm	Margin dB	Detector	Comment
1		1884.000	-62.51	9.38	-53.13	-13.00	-40.13	peak	
2	*	5369.000	-61.62	15.68	-45.94	-13.00	-32.94	peak	

Test Mode: LTE Band 26_TX CH27033_1.4M

Horizontal

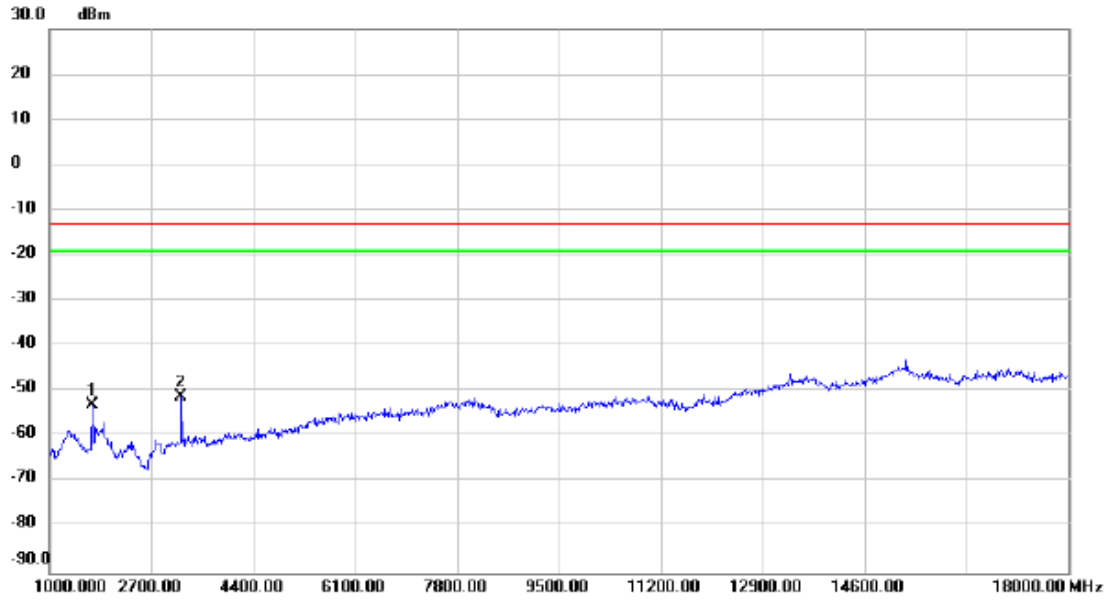

No.	Mk.	Freq. MHz	Reading Level dBm	Correct Factor dB	Measure- ment dBm	Limit dBm	Margin dB	Detector	Comment
1		1714.000	-61.08	8.18	-52.90	-13.00	-39.90	peak	
2	*	3193.000	-60.73	9.45	-51.28	-13.00	-38.28	peak	

Test Mode: LTE Band 26_TX CH26865_15M

Vertical

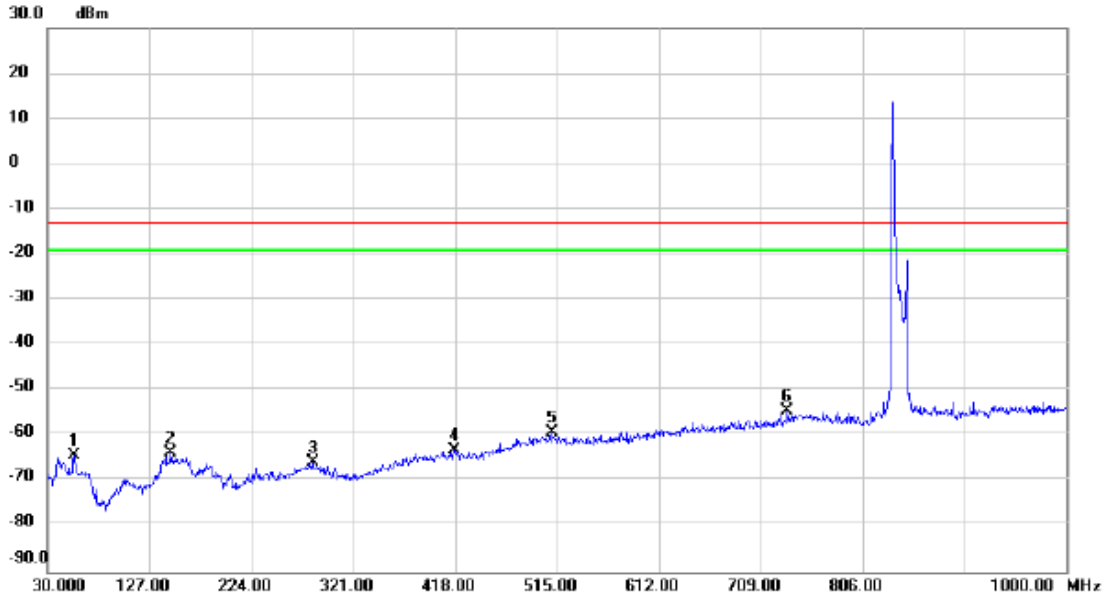

No.	Mk.	Freq. MHz	Reading Level dBm	Correct Factor dB	Measure- ment dBm	Limit dBm	Margin dB	Detector	Comment
1		55.220	-77.09	12.61	-64.48	-13.00	-51.48	peak	
2		147.370	-76.71	12.89	-63.82	-13.00	-50.82	peak	
3		282.200	-78.39	12.56	-65.83	-13.00	-52.83	peak	
4		417.030	-77.77	14.57	-63.20	-13.00	-50.20	peak	
5		510.150	-76.70	17.53	-59.17	-13.00	-46.17	peak	
6	*	734.220	-76.29	21.85	-54.44	-13.00	-41.44	peak	

Test Mode: LTE Band 26_TX CH26865_15M

Horizontal



No.	Mk.	Freq. MHz	Reading Level dBm	Correct Factor dB	Measure- ment dBm	Limit dBm	Margin dB	Detector	Comment
1		41.640	-77.79	12.40	-65.39	-13.00	-52.39	peak	
2		147.370	-78.14	13.95	-64.19	-13.00	-51.19	peak	
3		230.790	-77.60	13.18	-64.42	-13.00	-51.42	peak	
4		376.290	-77.00	15.66	-61.34	-13.00	-48.34	peak	
5		505.300	-75.95	18.06	-57.89	-13.00	-44.89	peak	
6	*	679.900	-77.28	22.61	-54.67	-13.00	-41.67	peak	

Test Mode: LTE Band 26_TX CH26865_15M

Vertical

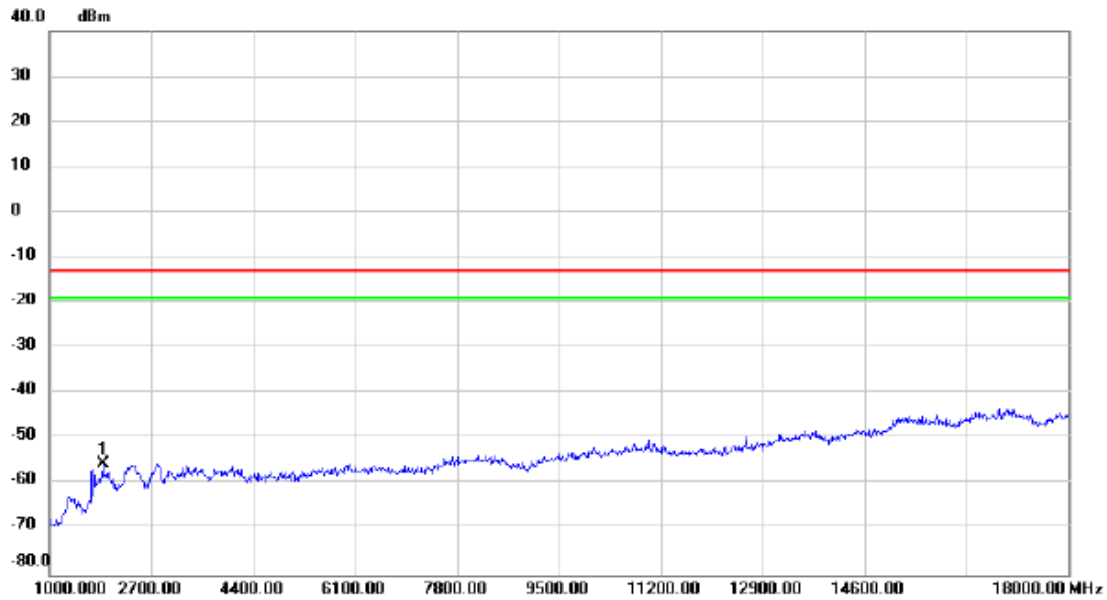

No.	Mk.	Freq. MHz	Reading Level dBm	Correct Factor dB	Measure- ment dBm	Limit dBm	Margin dB	Detector	Comment
1	*	1884.000	-64.89	9.38	-55.51	-13.00	-42.51	peak	

Test Mode: LTE Band 26_TX CH26865_15M

Horizontal

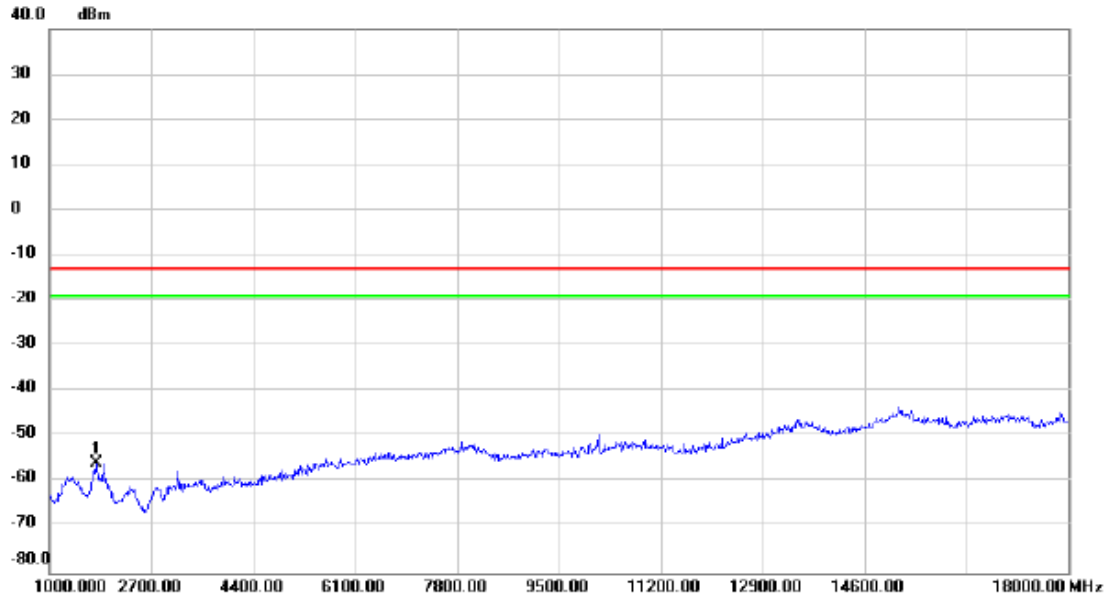

No.	Mk.	Freq. MHz	Reading Level dBm	Correct Factor dB	Measure- ment dBm	Limit dBm	Margin dB	Detector	Comment
1	*	1782.000	-63.93	8.22	-55.71	-13.00	-42.71	peak	