



EMC Test Report

Product Name: CLT-L29

Model Number: Smart Phone

Report No: SYBH(Z-EMC) 20180601017001-2

FCC ID: QISCLT-L29

Reliability Laboratory of Huawei Technologies Co., Ltd.

Global Compliance and Testing Center of Huawei Technologies
Co., Ltd

Administration Building, Headquarters of Huawei Technologies Co., Ltd., Bantian, Longgang District,
Shenzhen, 518129, P.R.C

Tel: +86 755 28780808 Fax: +86 755 89652518

Notice

1. The laboratory has passed the accreditation by China National Accreditation Service for Conformity Assessment (CNAS). The accreditation number is L0310 for site 1.
2. The laboratory has passed the accreditation by The American Association for Laboratory Accreditation (A2LA). The accreditation number is 2174.01 for site 1.
3. The laboratory has been listed by Industry Canada to perform electromagnetic emission measurements. The recognition numbers of test site are 6369A-1 for site 1.
4. The laboratory has been recognized by the US Federal Communications Commission (FCC) to perform compliance testing subject to the Commission's Declaration Of Conformity (DOC) and Certification rules. The Designation Number is CN1173, and the Test Firm Registration Number is 294140 for site 1.
5. The laboratory has passed the accreditation by The American Association for Laboratory Accreditation (NVLAP). The accreditation number is 4086F-1 for site 2.
6. The laboratory (Reliability Lab of Huawei Technologies Co., Ltd) is also named as “Global Compliance and Testing Center of Huawei Technologies Co., Ltd” , the both names have coexisted since 2009.
7. The test report is invalid if not marked with the stamps or the signatures of the persons responsible for performing, revising and approving the test report.
8. The test report is invalid if there is any evidence of erasure and/or falsification.
9. If there is any dissidence for the test report, please file objection to the test centre within 15 days from the date of receiving the test report.
10. Normally, the test report is only responsible for the samples that have undergone the test.
11. Context of the test report cannot be used partially or in full for publicity and/or promotional purposes without previous written approval of the laboratory.



Applicant: Huawei Technologies Co., Ltd.
Address: Administration Building, Headquarters of Huawei Technologies Co., Ltd., Bantian, Longgang District, Shenzhen, 518129, P.R.C

Date of Receipt Test Item: 2018-12-04
Start Date of Test: 2018-12-04
End Date of Test: 2018-12-24

Test Result: Pass

**Approved By
(Lab Manager)**

2018-12-26
Date

He Hao
Name

He Hao
Signature

**Prepared by
(Test Engineer)**

2018-12-24
Date

Peng Shaohua
Name

Peng Shaohua
Signature



Modification Record

No.	Last Report No.	Modification Description
1	NA	First Report.
2	SYBH(Z-EMC) 20171128003001-2	Second report: detail please refer to 1.1 on page 8.

TABLE OF CONTENT



1	General Information	6
1.1	EUT Description	6
1.1	Differences Description	8
1.2	Test Site Information	10
1.3	Applied Standards	10
2	Summary of Results.....	11
3	System Configuration during EMC Test.....	12
3.1	Test Mode	12
3.2	Test System Configuration.....	13
3.3	Cables Used during Test.....	15
3.4	Associated Equipment Used during Test.....	15
4	Electromagnetic Interference (EMI).....	16
4.1	Radiated Disturbance 30MHz to 40GHz	16
4.2	Conducted Disturbance 0.15 MHz to 30MHz.....	19
5	Main Test Instruments.....	20
6	System Measurement Uncertainty	20
7	Test Data and Graph.....	21
7.1	Radiated Disturbance	21
7.2	Conducted Disturbance.....	24

1 General Information

1.1 EUT Description

EUT Description	
Product Name	Smart Phone
Model Number	CLT-L29
Input voltage	3.82V DC
TX Frequency	GSM 850: 824MHz to 849MHz PCS 1900: 1850MHz to 1910MHz WCDMA Band II: 1850MHz to 1910MHz WCDMA Band IV: 1710MHz to 1755MHz WCDMA Band V:: 824MHz to 849MHz LTE BAND 2: 1850MHz to 1910MHz LTE BAND 4: 1710MHz to 1755MHz LTE BAND 5: 824MHz to 849MHz LTE BAND 7: 2500MHz to 2570MHz LTE BAND 12: 699MHz to 716MHz LTE BAND 17: 704MHz to 716MHz LTE BAND 26: 814MHz to 849MHz LTE BAND 38: 2570MHz to 2620MHz LTE BAND 41: 2545MHz to 2655MHz WIFI 2.4G: 2412MHz to 2462MHz Bluetooth: 2400MHz to 2483.5MHz WIFI 5G:5150MHz to 5350MHz 5470MHz to 5850MHz NFC: 13.56MHz
RX Frequency	GSM 850: 869MHz to 894MHz GSM 1900: 1930MHz to 1990MHz WCDMA Band II: 1930MHz to 1990MHz WCDMA Band IV: 2110MHz to 2155MHz WCDMA Band V:: 869MHz to 894MHz LTE BAND 2: 1930MHz to 1990MHz LTE BAND 4: 2110MHz to 2155MHz LTE BAND 5: 869MHz to 894MHz LTE BAND 7: 2620MHz to 2690MHz LTE BAND 12: 729MHz to 746MHz LTE BAND 17: 704MHz to 716MHz LTE BAND 26: 859MHz to 894MHz LTE BAND 38: 2570MHz to 2620MHz LTE BAND 41: 2545MHz to 2655MHz WIFI 2.4G: 2412MHz to 2462MHz Bluetooth: 2400MHz to 2483.5MHz WIFI 5G:5150MHz to 5350MHz 5470MHz to 5850MHz NFC:13.56MHz GPS: 1575.42MHz
S/N	WCR0117C22000045
HW Version	HL1CLTM
SW Version	CLT-L29 8.1.0.178(C900)
EUT Accessory	

<p>USB(04071289)</p>	<p>Data Cable USB A Male to USB Type C, Shielded Manufacturer: LUXSHARE-ICT Co., Ltd. Chang Shu Honglin Technology Co.,Ltd. Fuyu Electronical Technology(Huaian) Co., Ltd. MING JI ELECTRONICS CO.,LTD.</p>
<p>Earphone(22040296)</p>	<p>Manufacturer: JIANGXI LIANCHUANG HONGSHENG ELECTRONIC CO., LTD BOLUO COUNTY QUANCHENG ELECTRONIC CO., LTD Goer Tek Inc MERRY ELECTRONICS (SHENZHEN) CO., LTD. Foster Electric Co.,(GuangZhou)LTD.</p>
<p>Earphone Transfer Line(22040294)</p>	<p>Manufacturer: JIANGXI LIANCHUANG HONGSHENG ELECTRONIC CO., LTD MERRY ELECTRONICS (SHENZHEN) CO., LTD. FOSTER ELECTRIC CO.(HONG KONG)LTD BOLUO COUNTY QUANCHENG ELECTRONIC CO., LTD</p>
<p>Adapter</p>	<p>Manufacturer: Huawei Technologies Co.,Ltd. Model: HW-050450U00 Input voltage: 100-240V 50/60Hz ,0.75A Output voltage: 5V === 2A OR 5V === 4.5A OR 4.5V === 5A Rated Power: 10W/22.5W SN: H828K8H3V05002 K8281OH6920035 CA37Y9J7H01360 P8281OH6830035</p>
<p>Adapter</p>	<p>Manufacturer: Huawei Technologies Co.,Ltd. Model: HW-050450E00 Input voltage: 100-240V 50/60Hz ,0.75A Output voltage: 5V === 2A OR 5V === 4.5A OR 4.5V === 5A Rated Power: 10W/22.5W SN:P8301OH7412711 H8301OH7412711 K83059H4V07826 CA37Y9J7H01229</p>
<p>Adapter</p>	<p>Manufacturer: Huawei Technologies Co.,Ltd. Model: HW-050450B00 Input voltage: 100-240V 50/60Hz ,0.75A Output voltage: 5V === 2A OR 5V === 4.5A OR 4.5V === 5A Rated Power: 10W/22.5W SN:P82922H3J31705 H82922H3J31705 K82971H3R11886 CA37Y9J7H01187</p>
<p>Adapter</p>	<p>Manufacturer: Huawei Technologies Co.,Ltd. Model: HW-050450A00 Input voltage: 100-240V 50/60Hz ,0.75A Output voltage: 5V === 2A OR 5V === 4.5A OR 4.5V === 5A Rated Power: 10W/22.5W</p>

	SN: H83011H3S04782 K83171H4J05584 P82922HKI31874
Rechargeable Li-ion	Manufacturer: Huawei Technologies Co.,Ltd. Battery Model: HB436486ECW Rated capacity: 3900mAh Nominal Voltage:  +3.82V Charging Voltage:  +4.4V SN: 4XSDSIH405X00092 4XTDLCH31990010D 4XSCAYH315X00135

Remark: The above EUT's information is declared by manufacturer. Please refer to the specifications or user's manual for more detailed information.

1.1 Differences Description

The mobile phone CLT-L29 (NEW) and CLT-L29 (BEFORE) are LTE/UMTS/GSM mobile phone with Bluetooth. The differences between CLT-L29 (NEW) and CLT-L29 (BEFORE) are showed in the following table. Other parts of the mobile phone are the same, including the appearance, the antenna, Chipset, Bluetooth mode, Wifi mode, Adapter, Battery, and so on.

	CLT-L29(NEW)	CLT-L29(BEFORE)
GSM four bands	the same	the same
WCDMA bands	the same	the same
LTE bands	the same	the same
FCC bands	the same	the same
Uplink CA	CA_2C/CA_7C/CA_38 C/CA_41C	NA
SIM card	Two	Two
NFC	the same	the same
External camera	the same	the same
internal camera	the same	the same
FLASH	the same	the same
Mainboard	the same	the same
PCB layout	the same	the same
Appearance	the same	the same
Bluetooth mode	the same	the same
WLAN mode	the same	the same
BT/ WLAN antenna	the same	the same
GSM/ WCDMA /LTE antenna	the same	The same
SAR sensor	Delete Antenna Board bottom side U309 SAR sensor and the capacitances around, then move U302 SAR sensor to U309	Antenna Board bottom side U309 has one SAR sensor and three capacitances around, U302 has one SAR sensor
Adapter	the same	the same
Battery	the same	the same
Chipset	the same	the same
Memory	the same	the same
RF Parameter	The same RF Parameter in the same band	The same RF Parameter in the same band
Dimension	the same	the same
Main Frequency NV	The same NV in the	The same NV in the



	same band	same band
--	-----------	-----------

With the consideration of identities and differences listed above, RE and CE were tested.



1.2 Test Site Information

Site 1:	RELIABILITY LABORATORY OF HUAWEI TECHNOLOGIES CO., LTD.
Test Site Location:	No.2 New City Avenue Songshan Lake Sci. &Tech. Industry Park, Dongguan, Guangdong, P.R.C
Site 2:	Sporton International (Shenzhen) Inc.
Test Site Location:	No.3 Building, the third floor of south, Shahe River west, Fengzeyuan warehouse, Nanshan District, Shenzhen, Guangdong, P.R.China

1.3 Applied Standards

APPLIED STANDARD

47 CFR FCC Part 15 Subpart B

2 Summary of Results

Summary of Results				
Test Items	Test Mode	Performance Class & Required Performance Criteria	Result	Site
<u>Radiated Emissions</u> Enclosure Port	Mode1~ Mode4 Mode6 Mode7	CLASS B	Pass	Site2
<u>Conducted Emissions</u> <input checked="" type="checkbox"/> DC Power Port <input checked="" type="checkbox"/> AC Power Port <input type="checkbox"/> Telecommunication Ports	Mode1 Mode3 Mode6 Mode7	CLASS B	Pass	Site1
Note: 1, Measurement taken is within the uncertainty of test system. 2, <input checked="" type="checkbox"/> The item has been tested; <input type="checkbox"/> The item has not been tested.				

During the measurement, the environmental conditions complied with the range listed as below.

Item	Required
Ambient temperature	15°C ~ 35°C
Relative humidity	25% ~ 75%
Atmospheric pressure	86kPa ~ 106kPa

3 System Configuration during EMC Test

3.1 Test Mode

The EUT was configured, installed, arranged and operated in a manner consistent with typical application. The following mode(s) were applied during the compliance test.

Test Mode	
Mode 1:	Charging+ Camera On + Idle
Mode 2:	Earphone + Camera On + Idle
Mode 3:	Charging+ video Playing + Idle
Mode 4:	Earphone + video Playing + Idle
Mode 5	Charging+Traffic+BT+WIFI+NFC+GPS
Mode 6	USB Copy(EUT with PC)
Mode 7	USB&DP+ Earphone +Display

Remark:

- 1) If there is one kind of accessories with different models, each one should be applied throughout the compliance test respectively, however, only the worst case will be recorded in this report.
- 2) If EUT has more than one typical operation, only the worst test mode will be recorded in this report.

Traffic Mode:

When the EUT state is switched on and with Radio Resource Control (RRC) connection established.

Idle Mode:

When the EUT state is switched on but without Radio Resource Control (RRC) connection.

Worst Case:

- 1) Radiated Emission
Adapter(Model: HW-050450U00, SN: K8281OH6920035) + Camera On + Idle
the result is the worst(30MHz~1GHz).
Adapter(Model: HW-050450U00, SN: K8281OH6920035) + Camera On + Idle
the result is the worst) the result is the worst(1GHz~40GHz).
- 2) Conducted Emission
Adapter(Model: HW-050450U00, SN: P8281OH6830035) + Camera On + Idle
the result is the worst.

3.2 Test System Configuration

Connection Diagram (Mode 2/Mode 4)

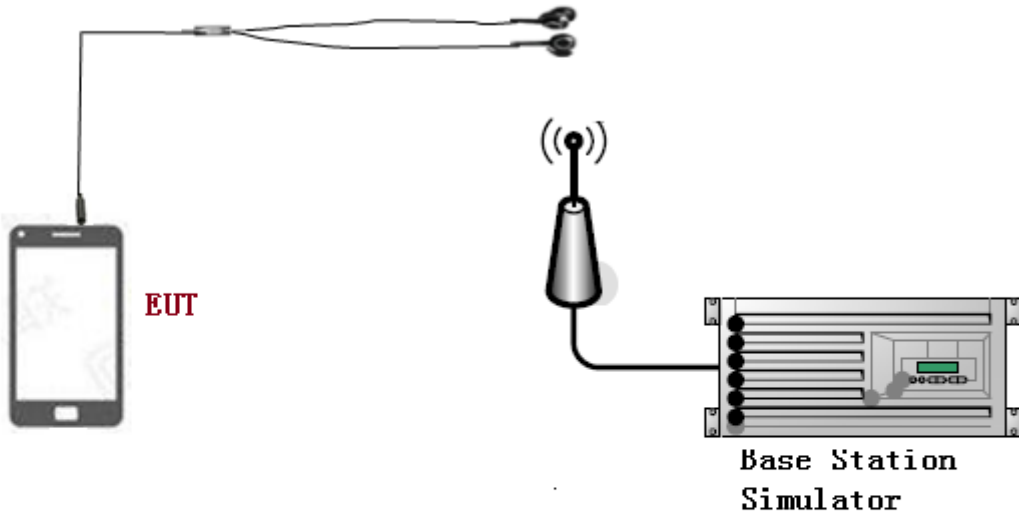

Connection Diagram (Mode 1/Mode 3/Mode 5)

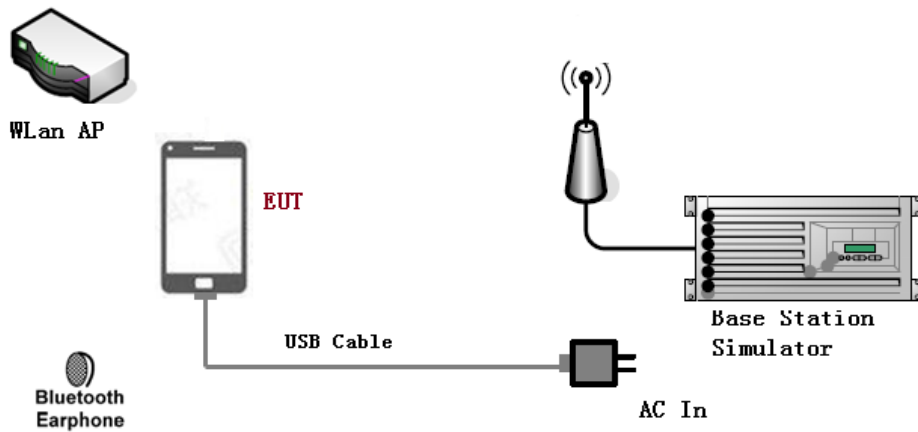

Connection Diagram (Mode 6)

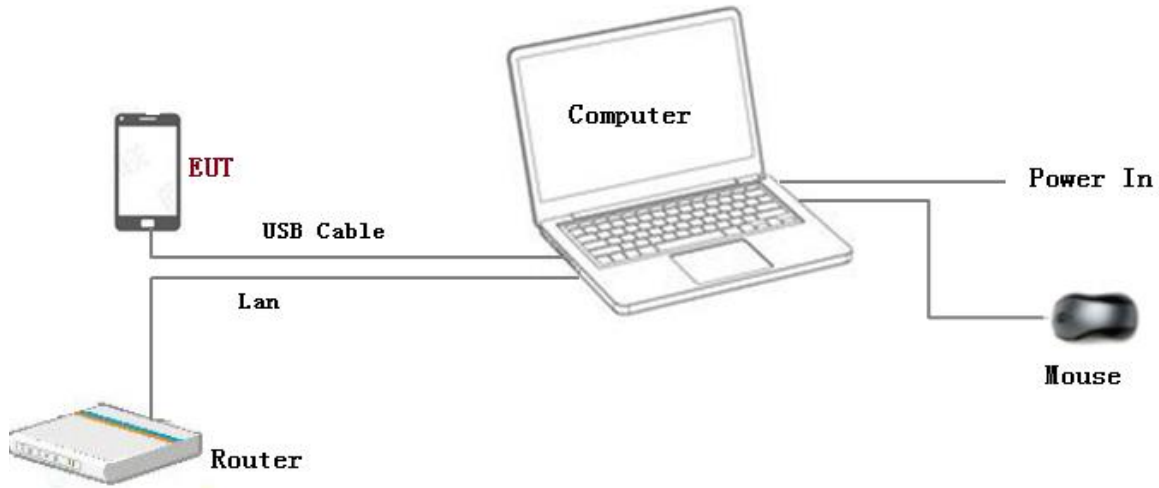

Connection Diagram (Mode 7)

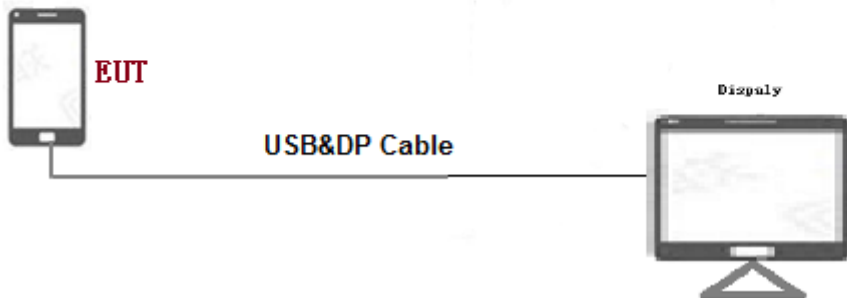

3.3 Cables Used during Test

Cable	Quantity	Length	Type of Cable
USB	1	<3m	Shielded
Earphone	1	<3m	Unshielded
USB&DP cable	1	<3m	Shielded

3.4 Associated Equipment Used during Test

Radio Communication Tester	CMU200	R&S	3608082535	2019-05-07	12
Radio Communication Tester	CMU200	R&S	123430	2019-08-14	12
Radio Communication Tester	MT8820C	Anritsu	A110518805	2019-05-08	12
Radio Communication Tester	CMW500	R&S	150791	2019-10-07	12
Notebook	S3	ThinkPad	A140714638	/	/
Mouse	M-U0025-O	Lenovo	HS423HB22TB	/	/
display	L197	Lenovo	8M03373A0956 983	/	/

4 Electromagnetic Interference (EMI)

4.1 Radiated Disturbance 30MHz to 40GHz

4.1.1 Test Procedure

The test site semi-anechoic chamber has met the requirement of NSA tolerance 4dB according to the standards: ANCI C63.4: 2014. The test distance was 3m. The set-up and test methods were according to ANCI C63.4: 2014.

A preliminary scan and a final scan of the emissions were made from 30 MHz to 18 GHz by using test script of software; The emissions were measured using Quasi-Peak Detector (30MHz~1GHz) and AV/PK detector (above 1GHz). The maximal emission value was acquired by adjusting the antenna height, polarisation and turntable azimuth in accordance with the software setup. Normally, the height range of antenna was 1m to 4m. The azimuth range of turntable was 0° to 360°. The receiving antenna has two polarizations V and H.

Measurement bandwidth (RBW) for 30MHz to 1000 MHz: 120 kHz;

Measurement bandwidth (RBW) for 1000MHz to 18000 MHz: 1MHz;

EUT was configured in idle mode and the test performed at worst emission state.

4.1.2 Test setup

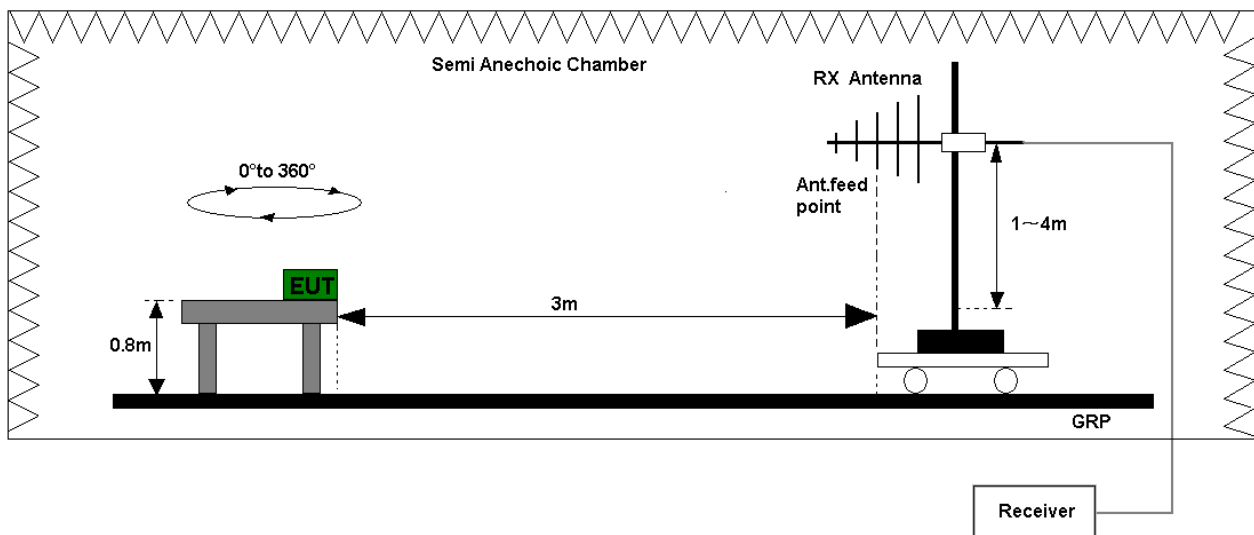

Figure 1. Test set-up of radiated disturbance(30MHz-1GHz)

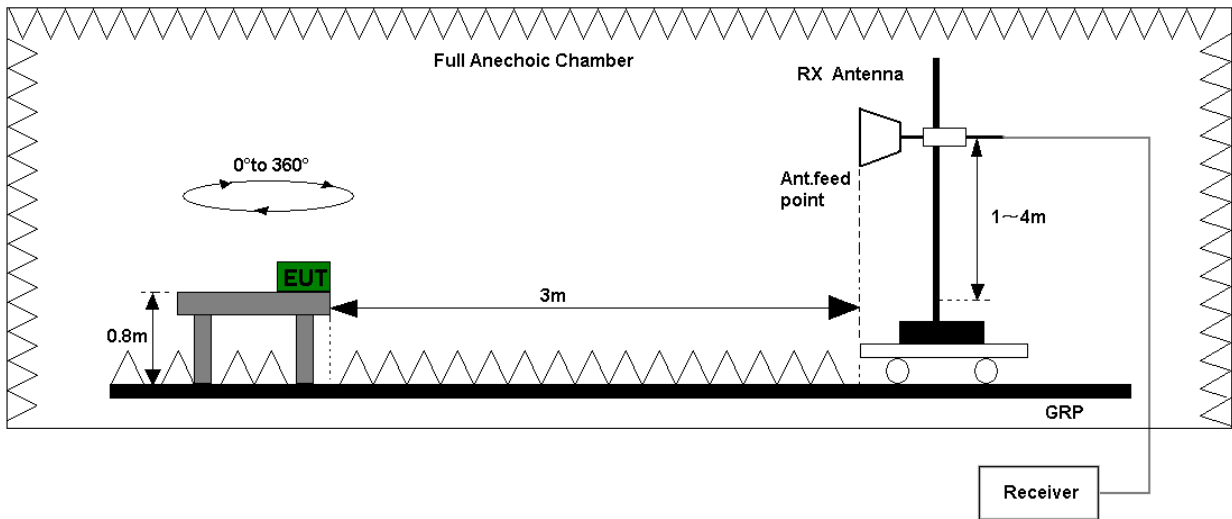

Figure 2. Test set-up of radiated disturbance(above 1GHz)



4.1.3 Test Results

The EUT has met the requirements for Radiated Emission of enclosure port.
 Refer to the section 7.1.1 of this report for test data.

Test Limits (Class B)				
Frequency of Emission (MHz)	Radiated Limit			
	Unit(μ V/m)		Unit(dB μ V/m)	
30-88	100		40	
88-216	150		43.5	
216-960	200		46	
Above 960	500		54	
Above 1000	AV	PK	AV	PK
	500	5000	54	74

4.2 Conducted Disturbance 0.15 MHz to 30MHz

4.2.1 Test Procedure

The Table-top EUT was placed upon a non-metallic table 0.8 m above the horizontal metal reference ground plane. EUT was connected to LISN and LISN was connected to reference Ground Plane. EUT was 80cm away from LISN. The set-up and test methods were according to ANCI C63.4: 2014 Conducted Disturbance at AC Port measurements were undertaken on the L and N Lines. The emissions were measured using a Quasi-Peak Detector and Average Detector.

EUT was communicated with the simulator through Air interface, the simulator controls the EUT to transmitter the maximum power which defined in specification of product. The EUT operated on the typical channel.

Measurement bandwidth (RBW) for 150 kHz to 30 MHz: 9 kHz;

The EUT was set in the shielded chamber and operated under nominal conditions.

4.2.2 Test Setup

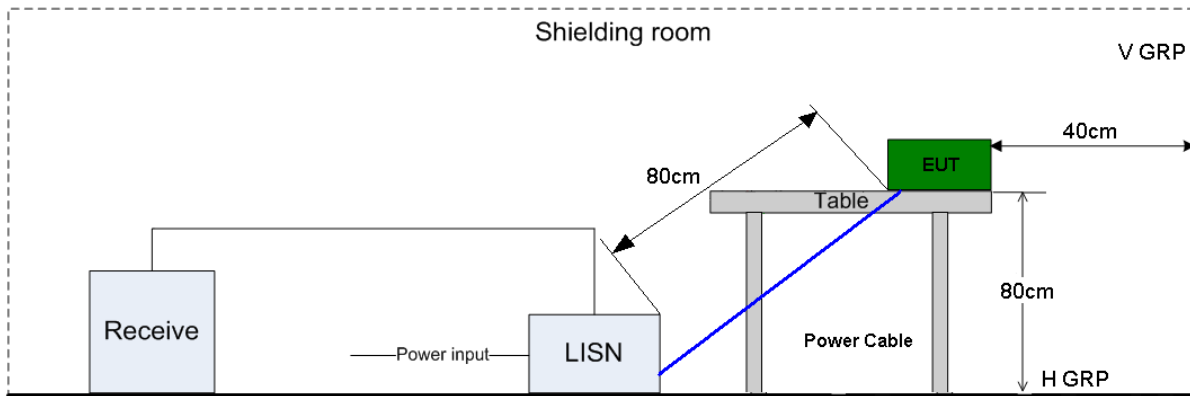

Figure 3. Test Set-up of conducted disturbance

4.2.3 Test Results

The EUT has met requirements for Conducted disturbance of power lines.

Refer to the section 7.2.1 of this report for test data.

Test Limit of AC Power Port		
Frequency range	150kHz ~ 30MHz	
Frequency	Voltage limits	
	QP (dB μ V)	AV (dB μ V)
0.15MHz~0.5MHz	66-56	56-46
0.5MHz-5MHz	56	46
5MHz~30MHz	60	50

5 Main Test Instruments

Main Test Equipments						
Test item	Test Instrument	Model	S/N	Manufacturer	Calibrated Deadline	Cal interval
RE	EMI Test Receiver&SA	N9038A	MY52260185	Agilent	Aug.29, 2019	12
	Bilog Antenna	CBL6112D	35407	TeseQ	Jun. 4, 2019	12
	Double Ridge Horn Antenna	3117	119436	ETS Lindgren	Jun. 27, 2019	12
	SHF-EHF Horn	AH-840	101071	com-power	Mar.29, 2019	12
	LF Amplifier	BPA-530	102209	Burgeon	Apr.19, 2019	12
	HF Amplifier	AMF-7D-00101800-30-10P-R	1707137	MITEQ	Oct. 17, 2019	12
CE	EMI Test receiver	ESCI	101163	R&S	Jan. 19, 2019	12
	Artificial Mains Network	ENV4200	100134	R&S	Jan. 18, 2019	12
	Artificial Mains Network	ENV216	100382	R&S	May. 08, 2019	12
Software Information						
Test Item	Software Name	Manufacturer		Version		
RE	EMC32	R&S		V9.25.0		
CE	EMC32	R&S		V9.25.0		

6 System Measurement Uncertainty

For a 95% confidence level, the measurement expanded uncertainties for defined systems, in accordance with the recommendations of ISO 17025 were:

System Measurement Uncertainty		
Items	Extended Uncertainty	
RE(30MHz-1GHz)	Field strength (dBμV/m)	U=4.1dB; k=2
RE(1GHz-18GHz)	Field strength (dBμV/m)	U=5.1dB; k=2
RE(18GHz-40GHz)	Field strength (dBμV/m)	U=5.1dB; k=2
CE	Disturbance Voltage (dBμV)	U=2.5dB; k=2

7 Test Data and Graph

Only the worst test results were shown

7.1 Radiated Disturbance

7.1.1 30MHz~1GHz

Test Mode 1: Charging+Camera On +idle

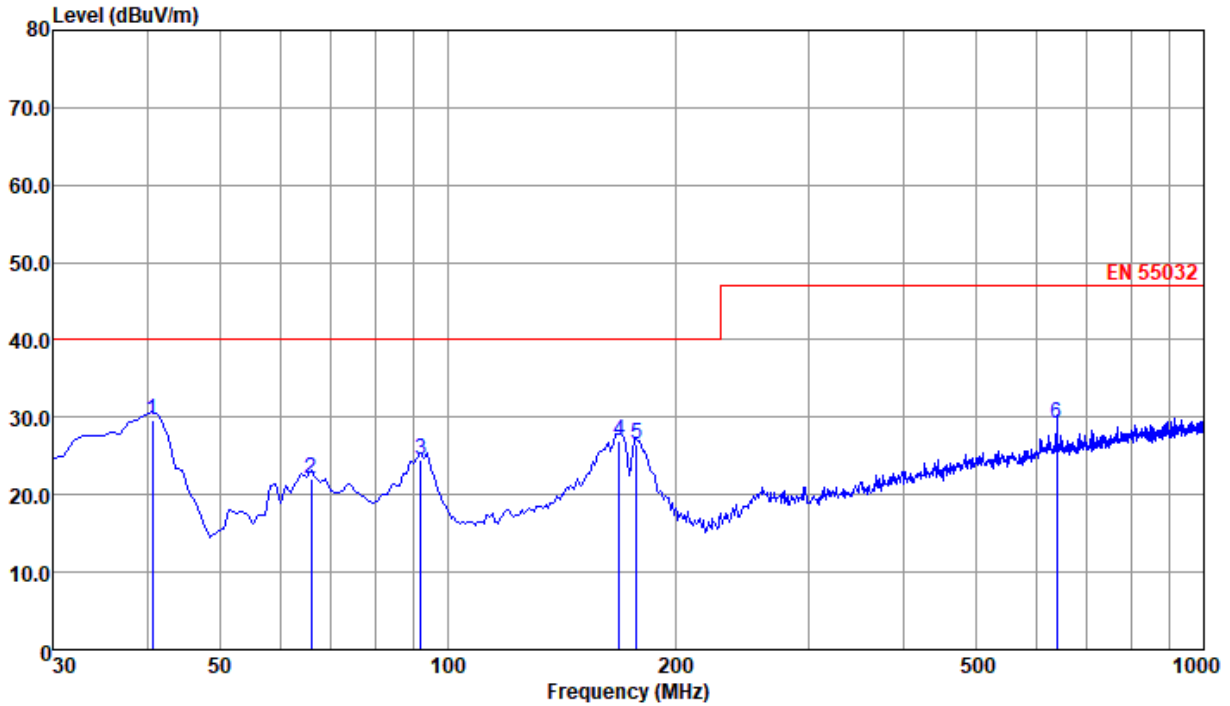

	Freq	Level	Over Limit	Limit Line	ReadAntenna Level	Antenna Factor	Cable Loss	Preamp Factor	Remark
	MHz	dBuV/m	dB	dBuV/m	dBuV	dB/m	dB	dB	
1	pp 40.67	29.72	-10.28	40.00	42.84	18.19	0.39	31.70	QP
2	65.89	22.08	-17.92	40.00	40.43	12.70	0.55	31.60	QP
3	92.08	24.47	-15.53	40.00	40.09	15.10	0.78	31.50	QP
4	168.71	26.92	-13.08	40.00	41.16	15.66	1.42	31.32	QP
5	177.44	26.42	-13.58	40.00	40.92	15.31	1.47	31.28	QP
6	638.19	29.30	-17.70	47.00	32.73	24.65	3.12	31.20	QP

Note:

Level = Reading level by receiver + Transd (Antenna factor + cable loss – preamplifier gain)

The reading level is calculated by software which is not shown in the sheet.

7.1.2 1GHz~18GHz

Test Mode 1: Charging+Camera On +idle

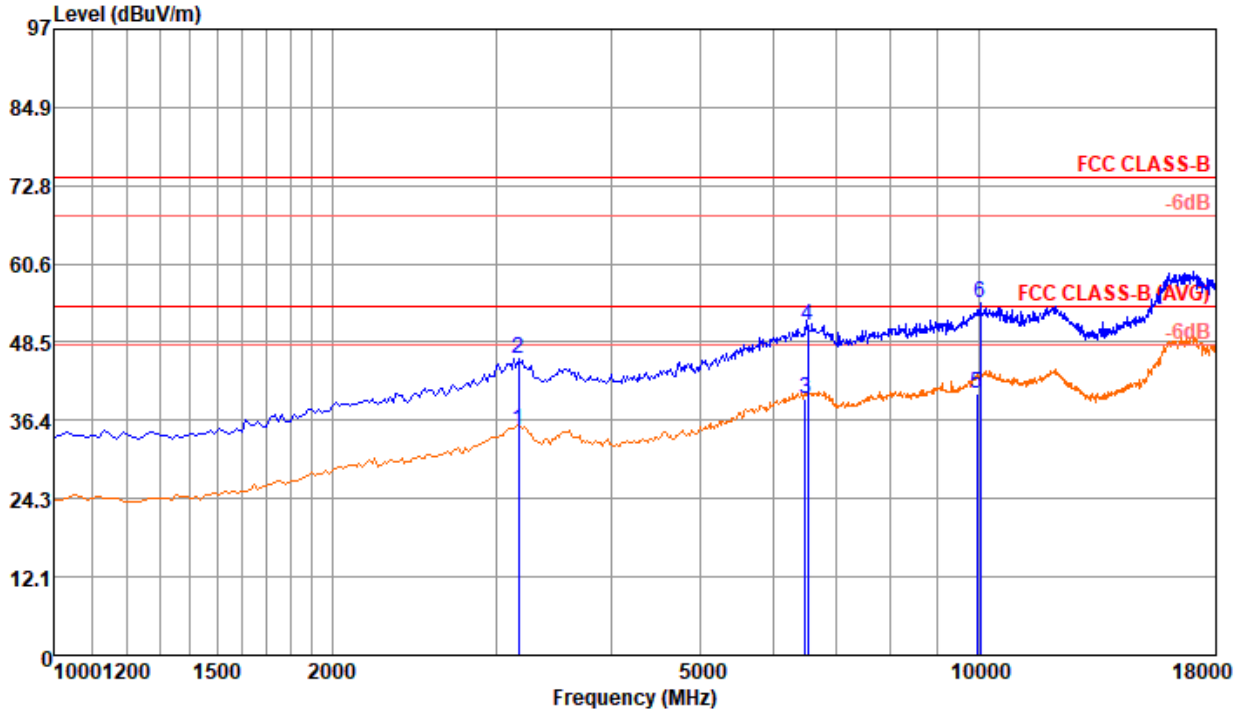

	Freq	Level	Over Limit	Limit Line	ReadAntenna Level	Cable Factor	Preamp Loss	Preamp Factor	Remark
	MHz	dBuV/m	dB	dBuV/m	dBuV	dB/m	dB	dB	
1	3196.00	34.86	-19.14	54.00	49.27	34.25	9.04	57.70	Average
2	3176.00	45.86	-28.14	74.00	60.27	34.25	9.04	57.70	Peak
3	6474.00	39.84	-14.16	54.00	47.89	34.84	15.12	58.01	Average
4	6525.00	51.04	-22.96	74.00	58.90	34.88	15.35	58.09	Peak
5 pp	9925.00	40.46	-13.54	54.00	45.13	36.74	14.23	55.64	Average
6 pk	10077.00	54.54	-19.46	74.00	58.90	36.82	14.53	55.71	Peak

7.1.3 18GHz~40GHz

Test Mode 1: Charging+Camera On +idle

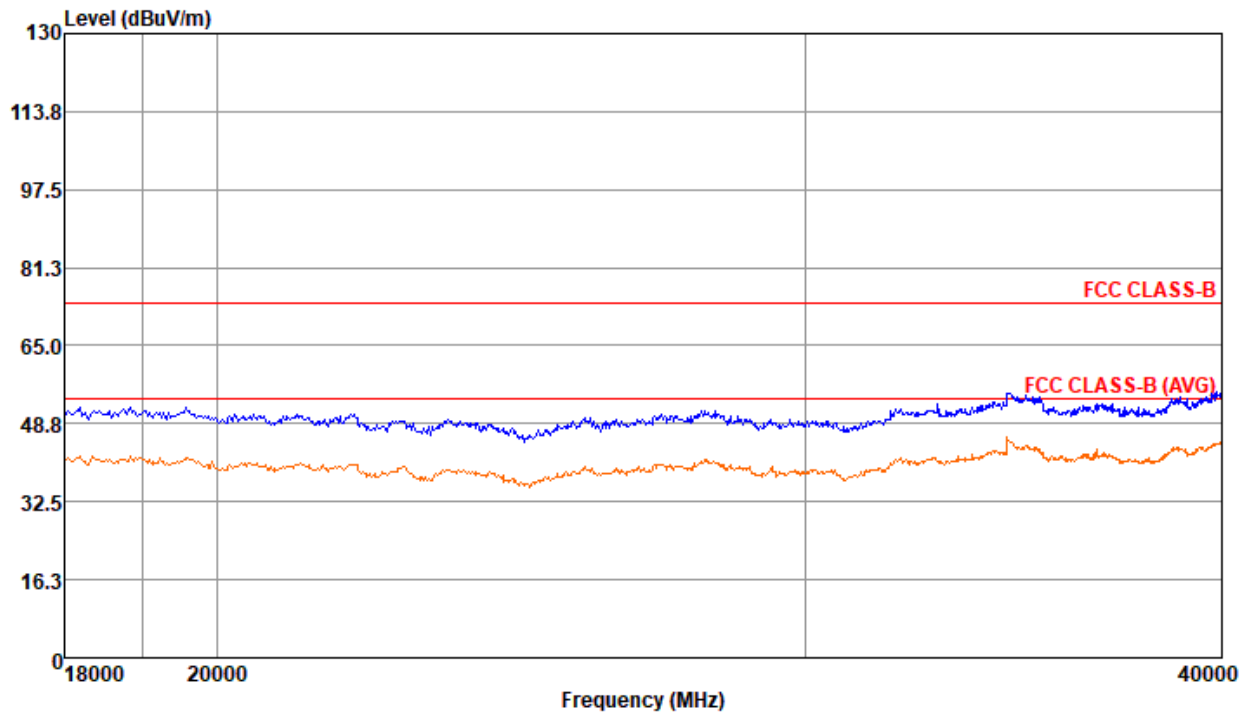

7.2 Conducted Disturbance

7.2.1 AC Port Test Data

Test Mode 1: Charging+Camera On +idle

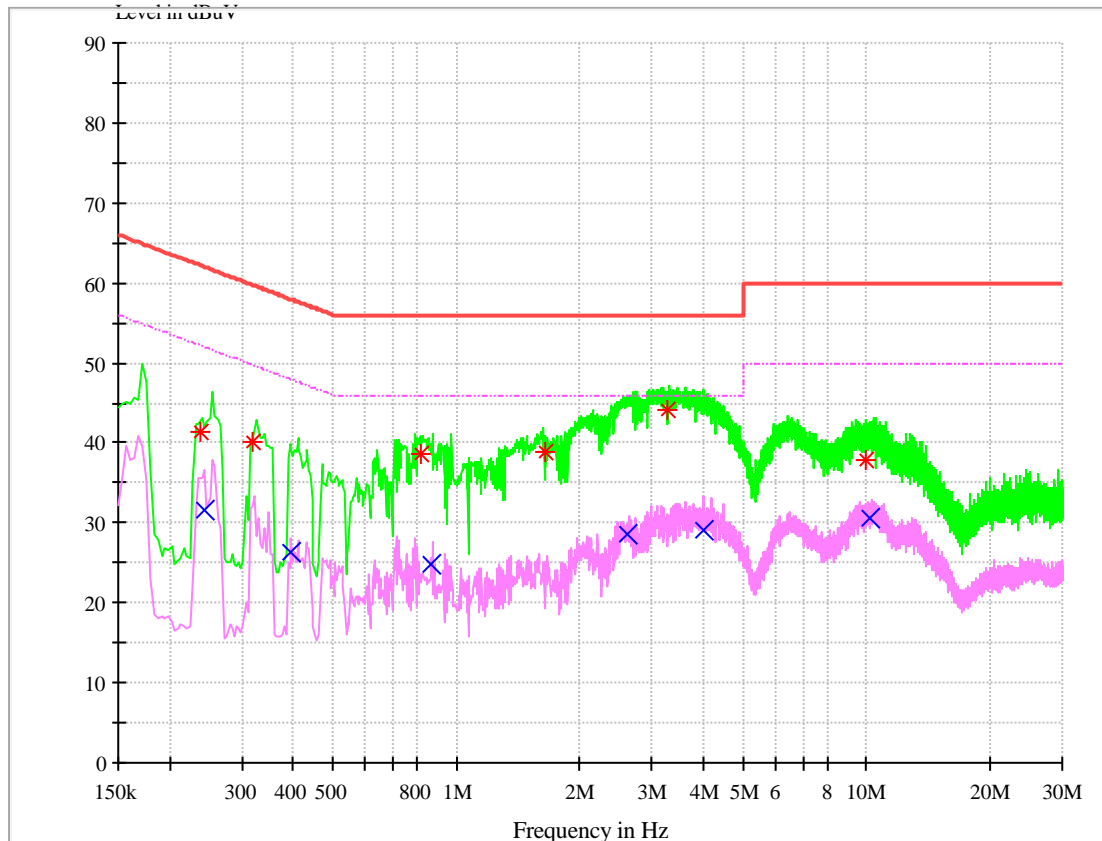

MEASUREMENT RESULT: QP Detector

Frequency (MHz)	Level (dB μ V)	Limit (dB μ V)	Transd. (dB)	Margin (dB)	Line	PE
0.237870	41.39	62.17	9.7	20.78	L1	FLO
0.318518	40.12	59.75	9.7	19.63	L1	FLO
0.815749	38.71	56.00	9.7	17.29	N	FLO
1.644010	38.76	56.00	9.7	17.24	L1	FLO
3.281335	44.16	56.00	9.7	11.84	L1	FLO
9.917086	37.83	60.00	9.7	22.17	N	FLO

MEASUREMENT RESULT: AV Detector

Frequency (MHz)	Level (dB μ V)	Limit (dB μ V)	Transd. (dB)	Margin (dB)	Line	PE
0.244431	31.57	51.94	9.7	20.37	N	FLO
0.396034	26.41	47.94	9.7	21.53	L1	FLO
0.863237	24.82	46.00	9.7	21.18	L1	FLO
2.612058	28.48	46.00	9.7	17.52	N	FLO
4.022631	28.99	46.00	9.7	17.01	L1	FLO
10.213114	30.69	50.00	9.7	19.31	L1	FLO

-----END-----