



中国认可
国际互认
检测
TESTING
CNAS L0310



FCC&IC RF Test Report

Product Name: Smart Phone

Model Number: CLT-L04

Report No.: SYBH(Z-RF)20171129004001-2004

FCC ID: QISCLT-L04

IC: 6369A-CLTL04

Reliability Laboratory of Huawei Technologies Co., Ltd.

(Global Compliance and Testing Center of Huawei Technologies Co., Ltd)

Administration Building, Headquarters of Huawei Technologies Co., Ltd., Bantian, Longgang District,
Shenzhen, 518129, P.R.C

Tel: +86 755 28780808 Fax: +86 755 89652518

Notice

1. The laboratory has passed the accreditation by China National Accreditation Service for Conformity Assessment (CNAS). The accreditation number is L0310.
2. The laboratory has passed the accreditation by The American Association for Laboratory Accreditation (A2LA). The accreditation number is 2174.01 .
3. The laboratory has been recognized by the US Federal Communications Commission (FCC) to perform compliance testing subject to the Commission's Certification rules. The Designation Number is CN1173, and the Test Firm Registration Number is 294140.
4. The laboratory has been listed by Industry Canada to perform electromagnetic emission measurements. The recognition numbers of test site are 6369A-1.
5. The laboratory (Reliability Lab of Huawei Technologies Co., Ltd) is also named “Global Compliance and Testing Center of Huawei Technologies Co., Ltd”, the both names have coexisted since 2009.
6. The test report is invalid if not marked with the signatures of the persons responsible for preparing and approving the test report.
7. The test report is invalid if there is any evidence of erasure and/or falsification.
8. The test report is only valid for the test samples.
9. Content of the test report, in part or in full, cannot be used for publicity and/or promotional purposes without prior written approval from the laboratory.



Applicant: Huawei Technologies Co., Ltd.
Address: Administration Building, Headquarters of Huawei Technologies Co., Ltd.,
 Bantian, Longgang District, Shenzhen, 518129, P.R.C

Date of Receipt Sample: 2018-01-08
Start Date of Test: 2018-01-08
End Date of Test: 2018-02-07

Test Result: Pass

Approved by Senior Engineer:	2018-02-07	Roger zhang	<i>Roger Zhang</i>
	Date	Name	Signature

Prepared by:	2018-02-07	Pan Man	<i>Panman</i>
	Date	Name	Signature



CONTENT

1	General Information.....	5
1.1	Applied Standard.....	5
1.2	Test Location	5
1.3	Test Environment Condition.....	5
2	Test Summary	6
3	Description of the Equipment under Test (EUT).....	7
3.1	General Description	7
3.2	EUT Identity	7
3.3	Technical Description.....	9
4	General Test Conditions / Configurations.....	10
4.1	EUT Configurations.....	10
4.2	Test Environments	10
4.3	Test Setups.....	11
4.4	Test Conditions	14
5	Main Test Instruments	15
6	Appendixes.....	16



1 General Information

1.1 Applied Standard

Applied Rules: 47 CFR FCC Part 2, Subpart J
47 CFR FCC Part 15, Subpart C

IC RSS-Gen (Issue 4, November 2014)
IC RSS-247 (Issue 2, February 2017)

Test Method: FCC KDB 558074 D01 DTS Meas Guidance v04
ANSI C63.10-2013, American National Standard for Testing Unlicensed
Wireless Devices.

1.2 Test Location

Test Location 1: Reliability Laboratory of Huawei Technologies Co., Ltd.
Address: Administration Building, Headquarters of Huawei Technologies Co., Ltd.,
Bantian, Longgang District, Shenzhen, 518129, P.R.C

1.3 Test Environment Condition

Ambient Temperature: 19.5to 25 °C
Ambient Relative Humidity: 40 to 55 %
Atmospheric Pressure: Not applicable

2 Test Summary

Test Item	FCC Part No.	IC Standard No.	Requirements	Test Result	Verdict
DTS (6 dB) Bandwidth	15.247(a)(2)	RSS-247, 5.2	≥ 500 kHz.	Appendix A	Pass
Occupied Bandwidth	---	RSS-247, 5.2 RSS-Gen, 6.6	No limit.	Appendix B	Pass
Duty Cycle	KDB 558074 D01 (6.0)	KDB 558074 D01 (6.0)	No limit.	Appendix C	Pass
Maximum Conducted Average Output Power	15.247(b)(3)	RSS-247, 5.4	For directional gain: < 30 dBm – (G[dBi] – 6 [dB]), Average; Otherwise: < 30 dBm, Average;	Appendix D	Pass
Maximum Power Spectral Density Level	15.247(e)	RSS-247, 5.2	For directional gain: < 8 dBm/3 kHz – (G[dBi] – 6 [dB]), Average. Otherwise: < 8 dBm/3 kHz, Average.	Appendix E	Pass
Band Edges Compliance	15.247(d)	RSS-247, 5.5	< -30 dB/100 kHz if total average power ≤ power limit.	Appendix F	Pass
Unwanted Emissions into Non-Restricted Frequency Bands				Appendix G	Pass
Unwanted Emissions into Restricted Frequency Bands (Radiated)	15.247(d) 15.209 (NOTE 1)	RSS-247, 5.5 RSS-Gen, 6.13	FCC Part 15.209 field strength limit; RSS-Gen 6.13 field strength limit.	Appendix H	Pass
AC Power Line Conducted Emissions	15.207	RSS-Gen, 8.8	FCC Part 15.207 conducted limit; RSS-Gen, 8.8 conducted limit.	Appendix I	Pass
NOTE : According to KDB 558074 D01, antenna-port conducted measurements are acceptable as an alternative to radiated measurements for demonstrating compliance to the limits in the restricted frequency bands. If conducted measurements are performed, then proper impedance matching must be ensured and an additional radiated test for cabinet/case emissions will also be required.					



3 Description of the Equipment under Test (EUT)

3.1 General Description

CLT-L04 is subscriber equipment in the LTE/ WCDMA/GSM system. The LTE frequency band is Band 1,Band 2,Band 3,Band 4,Band 5, Band 6, Band 7,Band 8, Band 9,Band 12,Band17, Band 18 ,Band 19, Band 20, Band 26, Band 28, Band 32, Band 34,Band 38,Band39, Band 40 and Band 41. The SUPA/HSDPA/UMTS frequency band is Band I, Band II, Band IV, Band V, Band VI, Band VIII and Band XIX, The GSM/GPRS/EDGE frequency band includes GSM850 and GSM900 and DCS1800 and PCS1900, The Mobile Phone implements such functions as RF signal receiving/transmitting, LTE/ WCDMA /GSM protocol processing, voice, video, MMS service, GPS, NFC and WIFI etc. Externally it provides earphone port (to provide voice service) and dual USIM card interfaces. It also provides Bluetooth module to synchronize data between a PC and the phone, or to use the built-in modem of the phone to access the Internet with a PC, or to exchange data with other Bluetooth devices.

Note1: Only Bluetooth BLE test data included in this report.















3.2 EUT Identity

NOTE: Unless otherwise noted in the report, the functional boards installed in the units shall be selected from the below list, but not means all the functional boards listed below shall be installed in one unit.

3.2.1 Board

Board		
Description	Hardware Version	Software Version
Main Board	HL1CLTM	CLT-L04 8.0.1.72(SP2C900)

3.2.2 Sub- Assembly

Sub-Assembly			
Sub-Assembly Name	Model	Manufacturer	Description
Adapter	HW-050450B00	Huawei Technologies Co.,Ltd.	Input Voltage: 100V-240V~50/60Hz, 0.75A Output voltage: 5V  2A OR 4.5V  5A OR 5V  4.5A Rated Power: 10W/22.5W
Adapter	HW-050450E00	Huawei Technologies Co.,Ltd.	Input Voltage: 100V-240V~50/60Hz, 0.75A Output Voltage: 5V  2A OR 4.5V  5A OR 5V  4.5A Rated Power: 10W/22.5W
Adapter	HW-050450U00	Huawei Technologies Co.,Ltd.	Input Voltage: 100V-240V~50/60Hz, 0.75A Output Voltage: 5V  2A OR 4.5V  5A OR 5V  4.5A Rated Power: 10W/22.5W
Adapter	HW-050450A00	Huawei Technologies Co.,Ltd.	Input Voltage: ~100-240V 50/60Hz 0.75A Output Voltage: 5V  2A OR 4.5V  5A OR 5V  4.5A Rated Power: 10W/22.5W
Rechargeable Li-ion	HB436486ECW	Huawei Technologies Co.,Ltd.	Rated capacity: 3900mAh Nominal Voltage:  +3.82V Charging Voltage:  +4.4V



3.3 Technical Description

Characteristics	Description	
TX/RX Operating Range	2400-2483.5 MHz band	$f_c = 2402 \text{ MHz} + N * 2 \text{ MHz}$, where: <ul style="list-style-type: none">- f_c = "Operating Frequency" in MHz,- N = "Channel Number" with the range from 0 to 39.
Modulation Type	Digital	GFSK,
Emission Designator	GFSK for BT 4.2: 1M06FXD	
Bluetooth Power Class	Class 1	



4 General Test Conditions / Configurations

4.1 EUT Configurations

4.1.1 General Configurations

Configuration	Description
Test Antenna Ports	Until otherwise specified, - All TX tests are performed at all TX antenna ports of the EUT, and - All RX tests are performed at all RX antenna ports of the EUT.
Multiple RF Sources	Other than the tested RF source of the EUT, other RF source(s) are disabled or shutdown during measurements.

4.1.2 Customized Configurations

# EUT Conf.	Signal Description	Operating Frequency	Duty cycle
TM1_Ch0	GFSK for BT 4.2 modulation, package type DH5, hopping off.	Ch No. 0 / 2402 MHz	61%
TM1_Ch19	GFSK for BT 4.2 modulation, package type DH5, hopping off.	Ch No. 19 / 2440 MHz	61%
TM1_Ch39	GFSK for BT 4.2 modulation, package type DH5, hopping off.	Ch No. 39 / 2480 MHz	61%

4.2 Test Environments

NOTE: The values used in the test report may be stringent than the declared.

Environment Parameter	Selected Values During Tests		
	Temperature	Voltage	Relative Humidity
NTNV	Ambient	3.82 VDC	Ambient

4.3 Test Setups

4.3.1 Test Setup 1

The Bluetooth component's antenna ports(s) of the EUT are connected to the measurement instrument per an appropriate attenuator. The EUT is controlled by Bluetooth System Simulator and/or PC/software to emit the specified signals for the purpose of measurements.

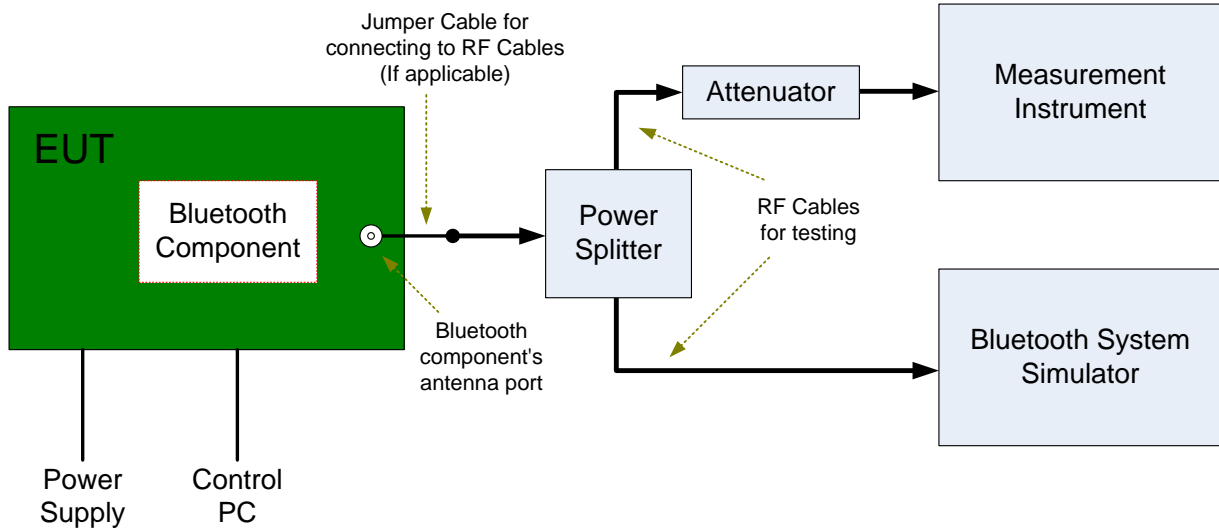

4.3.2 Test Setup 2

The test site semi-anechoic chamber has met the requirement of NSA tolerance 4 dB according to the standards: ANSI C63.4. The test distance is 3m. The setup is according to ANSI C63.4 and CAN/CSA-CEI/IEC CISPR 22.

The maximal emission value is acquired by adjusting the antenna height, polarisation and turntable azimuth. Normally, the height range of antenna is 1 m to 4 m, the azimuth range of turntable is 0° to 360°, and the receive antenna has two polarizations Vertical (V) and Horizontal (H).

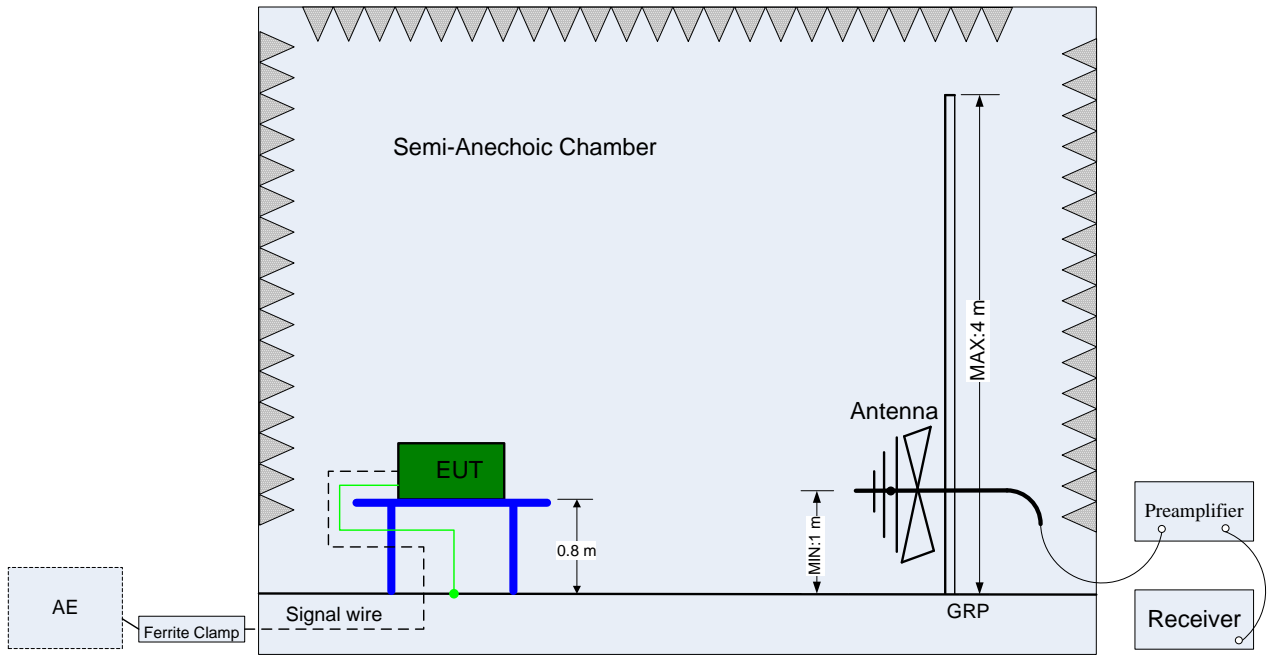

(Below 1 GHz)

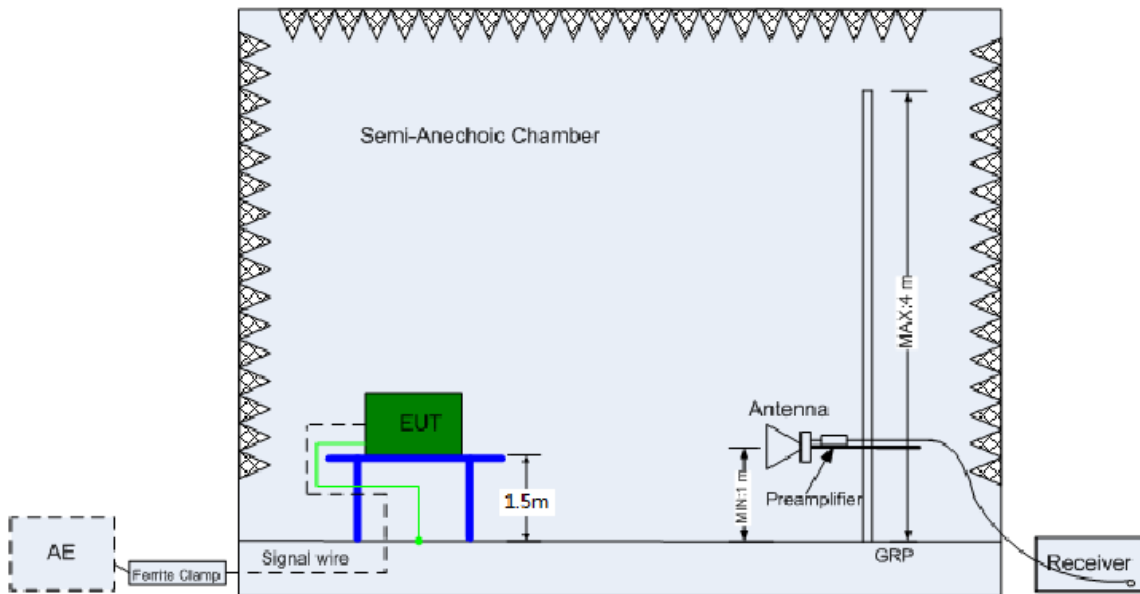

(Above 1 GHz)

4.3.3 Test Setup 3

The mains cable of the EUT (maybe per AC/DC Adapter) must be connected to LISN. The LISN shall be placed 0.8 m from the boundary of EUT and bonded to a ground reference plane for LISN mounted on top of the ground reference plane. This distance is between the closest points of the LISN and the EUT. All other units of the EUT and associated equipment shall be at least 0.8m from the LISN.

Ground connections, where required for safety purposes, shall be connected to the reference ground point of the LISN and, where not otherwise provided or specified by the manufacturer, shall be of same length as the mains cable and run parallel to the mains connection at a separation distance of not more than 0.1 m.

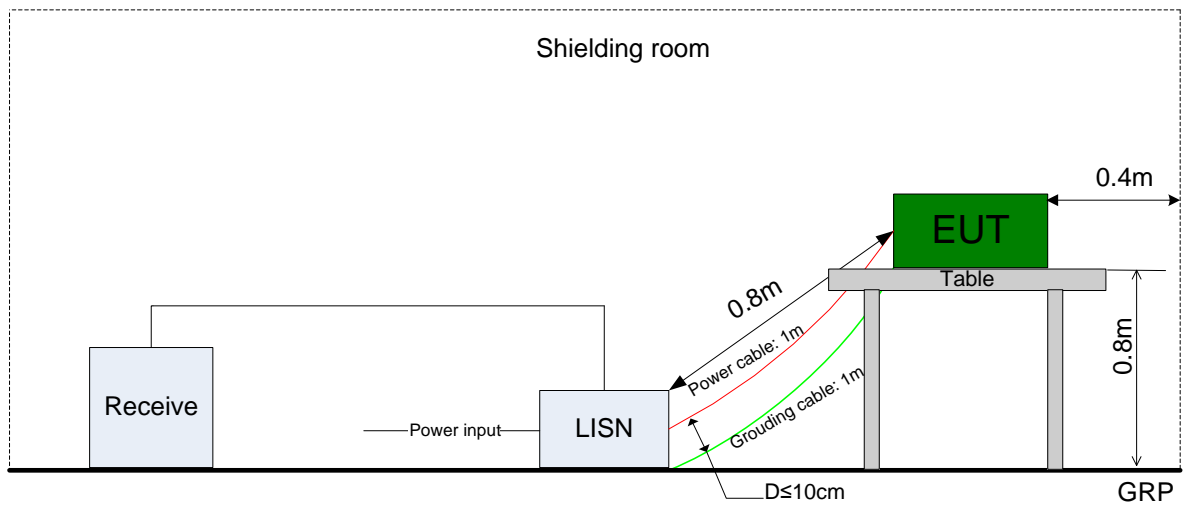

4.4 Test Conditions

Test Case	Test Conditions		
	Configuration	Description	
6dB Emission Bandwidth (EBW)	Meas. Method	FCC KDB 558074 D01 §8.1 Option 2.	
	Test Env.	NTNV	
	Test Setup	Test Setup 1	
	EUT Conf.	TM1_Ch0, TM1_Ch19, TM1_Ch39.	
Occupied Bandwidth	Meas. Method	FCC KDB 558074 D01 §8.2 Option 2.	
	Test Env.	NTNV	
	Test Setup	Test Setup 1	
	EUT Conf.	TM1_Ch0, TM1_Ch19, TM1_Ch39.	
Maximum Conducted Average Output Power	Meas. Method	FCC KDB 558074 D01 §9.2 .2. 4	
	Test Env.	NTNV	
	Test Setup	Test Setup 1	
	EUT Conf.	TM1_Ch0, TM1_Ch19, TM1_Ch39.	
Maximum Power Spectral Density Level	Meas. Method	FCC KDB 558074 D01§10.1	
	Test Env.	NTNV	
	Test Setup	Test Setup 1	
	EUT Conf.	TM1_Ch0, TM1_Ch19, TM1_Ch39.	
Band edge spurious emission	Meas. Method	FCC KDB 558074 D01§13.0.	
	Test Env.	NTNV	
	Test Setup	Test Setup 1	
	EUT Conf.	TM1_Ch0, TM1_Ch39.	
Unwanted Emissions into Non-Restricted Frequency Bands	Meas. Method	FCC KDB 558074 D01§11.0	
	Test Env.	NTNV	
	Test Setup	Test Setup 1	
	EUT Conf.	TM1_Ch0, TM1_Ch19, TM1_Ch39.	
Unwanted Emissions into Restricted Frequency Bands (Radiated)	Meas. Method	ANSI C63.10; FCC KDB 558074 D01§12.1, Radiated	
	Test Env.	NTNV	
	Test Setup	Test Setup 2	
	EUT Conf.	30 MHz -1 GHz	TM1_Ch0 (Worst Conf.).
		1-3 GHz	TM1_Ch0, TM1_Ch19, TM1_Ch39.
3-18 GHz		TM1_Ch19 (Worst Conf.),	
18-26.5 GHz		TM1_Ch0 (Worst Conf.).	
AC Power Line Conducted Emissions	Meas. Method	AC mains conducted. Pre: RBW = 10 kHz; Det. = Peak. Final: RBW = 9 kHz; Det. = CISPR Quasi-Peak & Average.	
	Test Env.	NTNV	
	Test Setup	Test Setup 3	
	EUT Conf.	TM1_Ch39.	

**5 Main Test Instruments**

Main Test Equipments					
Equipment Name	Manufacturer	Model	Serial Number	Cal Date	Cal- Due
Power supply	KEITHLEY	2303	000500E	2017/5/31	2018/5/30
Wireless Communication Test set	Agilent	N4010A	MY49081592	2017/7/31	2018/7/30
Universal Radio Communication Tester	R&S	CMU200	110932	2017/5/2	2018/5/1
Spectrum Analyzer	Agilent	N9020A	MY52090652	2017/7/10	2018/7/9
Universal Radio Communication Tester	R & S	CMW500	126854	2017/10/19	2018/10/18
Signal Analyzer	R&S	FSQ31	200021	2017/7/31	2018/7/30
Spectrum Analyzer	Agilent	N9030A	MY49431698	2017/7/31	2018/7/30
Temperature Chamber	WEISS	WKL64	56246002940010	2017/12/13	2018/12/12
Signal generator	Agilent	E8257D	MY49281095	2017/7/31	2018/7/30
Vector Signal Generator	R&S	SMU200A	104162	2017/7/31	2018/7/30
Test receiver	R&S	ESU26	100387	2017/2/21	2018/2/20
Test receiver	R&S	ESCI	101163	2017/2/21	2018/2/20
Spectrum analyzer	R&S	FSU3	200474	2017/2/21	2018/2/20
Spectrum analyzer	R&S	FSU43	100144	2017/2/21	2018/2/20
LOOP Antennas(9kHz-30MHz)	R&S	HFH2-Z2	100262	2017/4/25	2019/4/25
LOOP Antennas(9kHz-30MHz)	R&S	HFH2-Z2	100263	2017/4/25	2019/4/25
Trilog Broadband Antenna (30M~3GHz)	SCHWARZBECK	VULB 9163	9163-490	2017/3/29	2019/3/29
Trilog Broadband Antenna (30M~3GHz)	SCHWARZBECK	VULB 9163	9163-521	2017/4/9	2019/4/9
Double-Ridged Waveguide Horn Antenna (1G~18GHz)	R&S	HF907	100304	2017/5/27	2019/5/27
Pyramidal Horn Antenna(18GHz-26.5GHz)	ETS-Lindgren	3160-09	206665	2017/3/24	2018/3/23



Artificial Main Network	R&S	ENV4200	100134	2017/5/15	2018/5/14
Line Impedance Stabilization Network	R&S	ENV216	100382	2017/5/15	2018/5/14
Power Detecting & Sampling Unit	R&S	OSP-B157	100914	2017/7/31	2018/7/30
Software Information					
Test Item	Software Name		Manufacturer		Version
RE	EMC32		R&S		V9.25.0
CE	EMC32		R&S		V9.25.0

6 Appendixes

Appendix No.	Description
SYBH(Z-RF)20171129004001-2004-A	Appendix for Bluetooth BLE

END



Appendix for Test report



Appendix A: DTS (6 dB) Bandwidth

In this document, the "DTS6dBBW" refers to the measured "DTS (6 dB) Bandwidth" value. In this Appendix, the "fc(DTS6dBBW)" refers to the centre of the measured "DTS6dBBW". The introduction of the "fc(DTS6dBBW)" is due to that other measurements use it as the spectrum analyzer setting.

For measurements on smart antenna systems (devices with multiple transmit chains), the test is performed at each chain, and used as respective results for each chain.

Part I - Test Results

Test Mode	Test Channel	Frequency[MHz]	DTS6dBBW[MHz]	Verdict
TM1_Ch0	L	2402	0.72	pass
TM1_Ch19	M	2440	0.72	pass
TM1_Ch39	H	2480	0.72	pass



Part II - Test Plots

2.1 TM1_Ch0_L

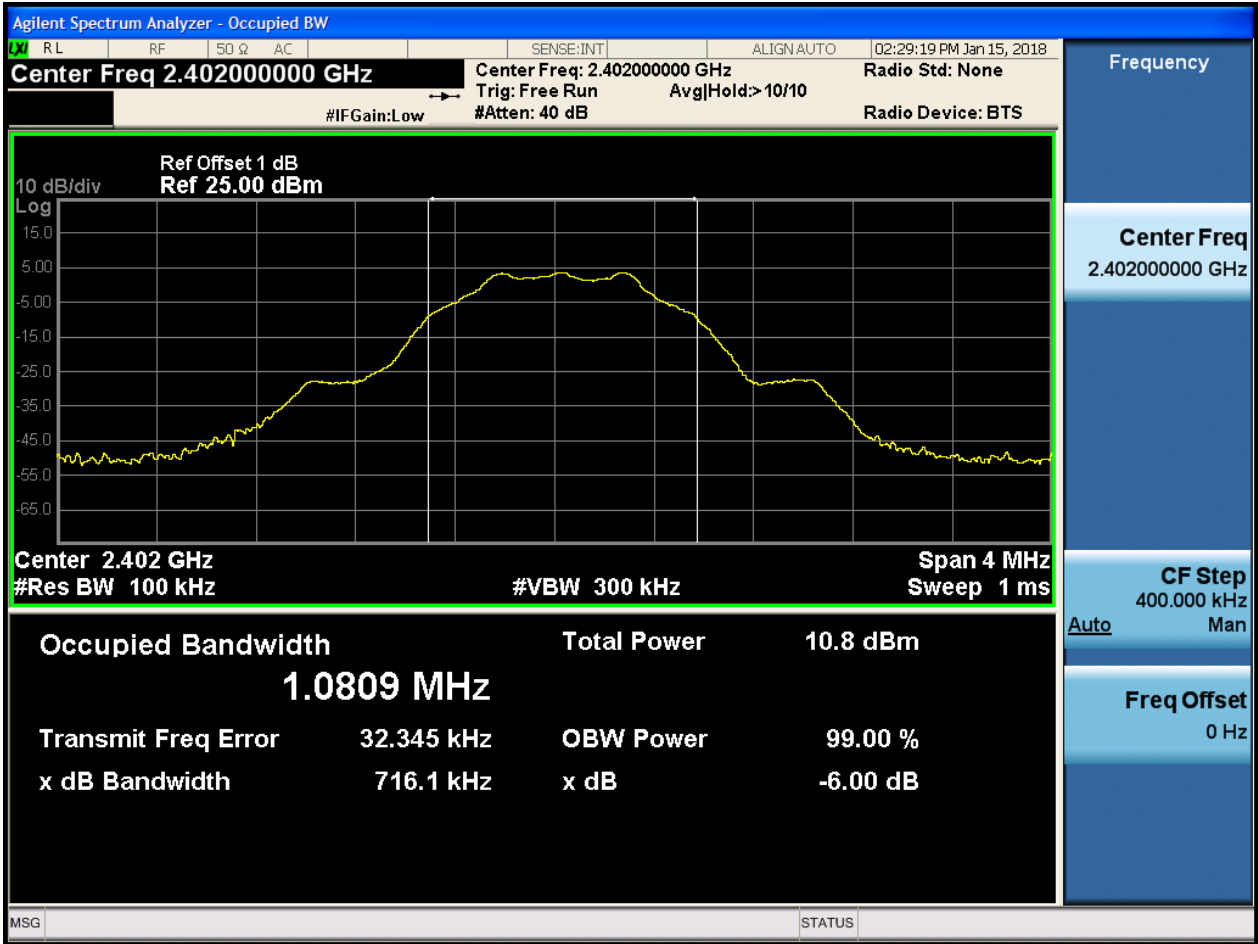



2.2 TM1_Ch19_M

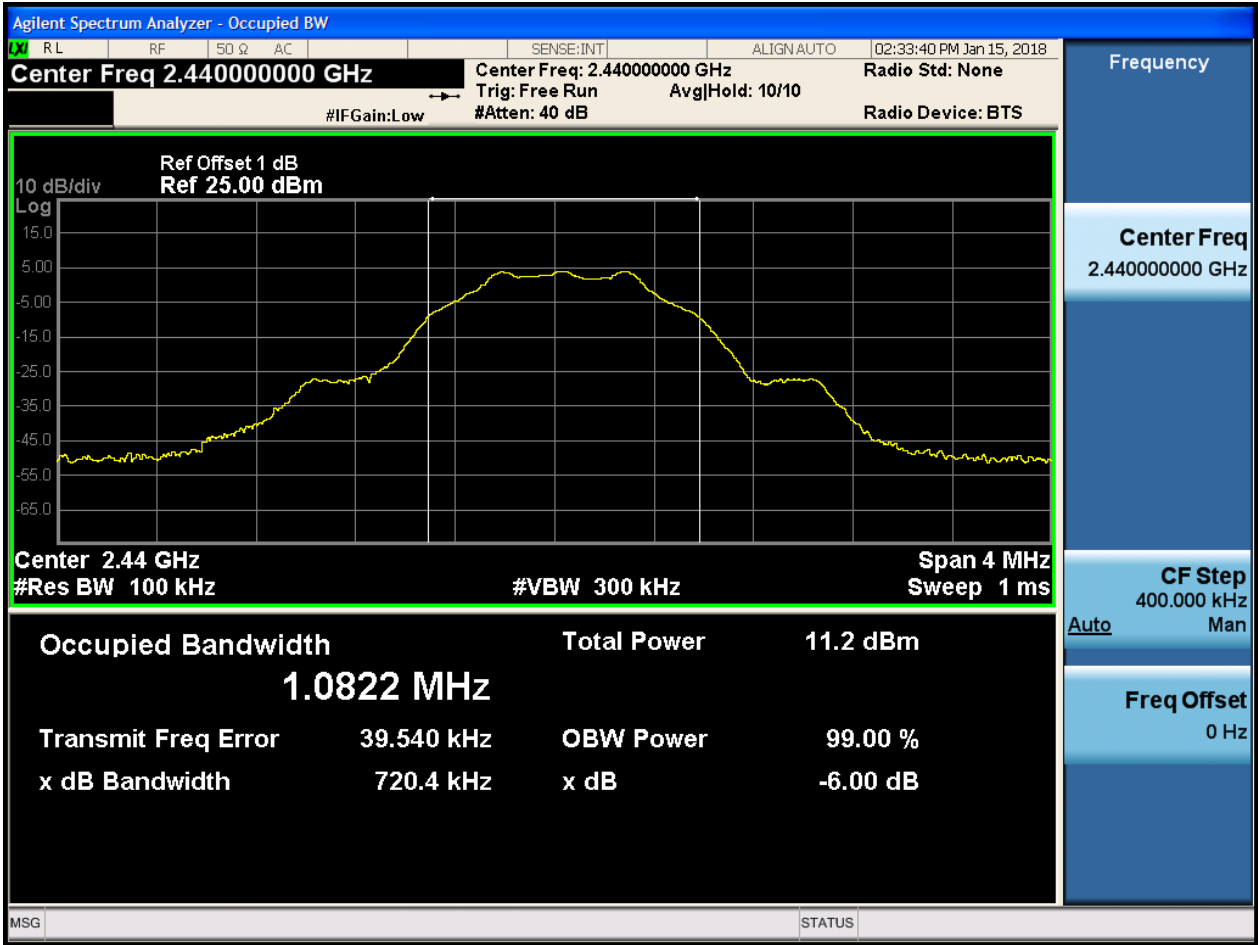



2.3 TM1_Ch39_H

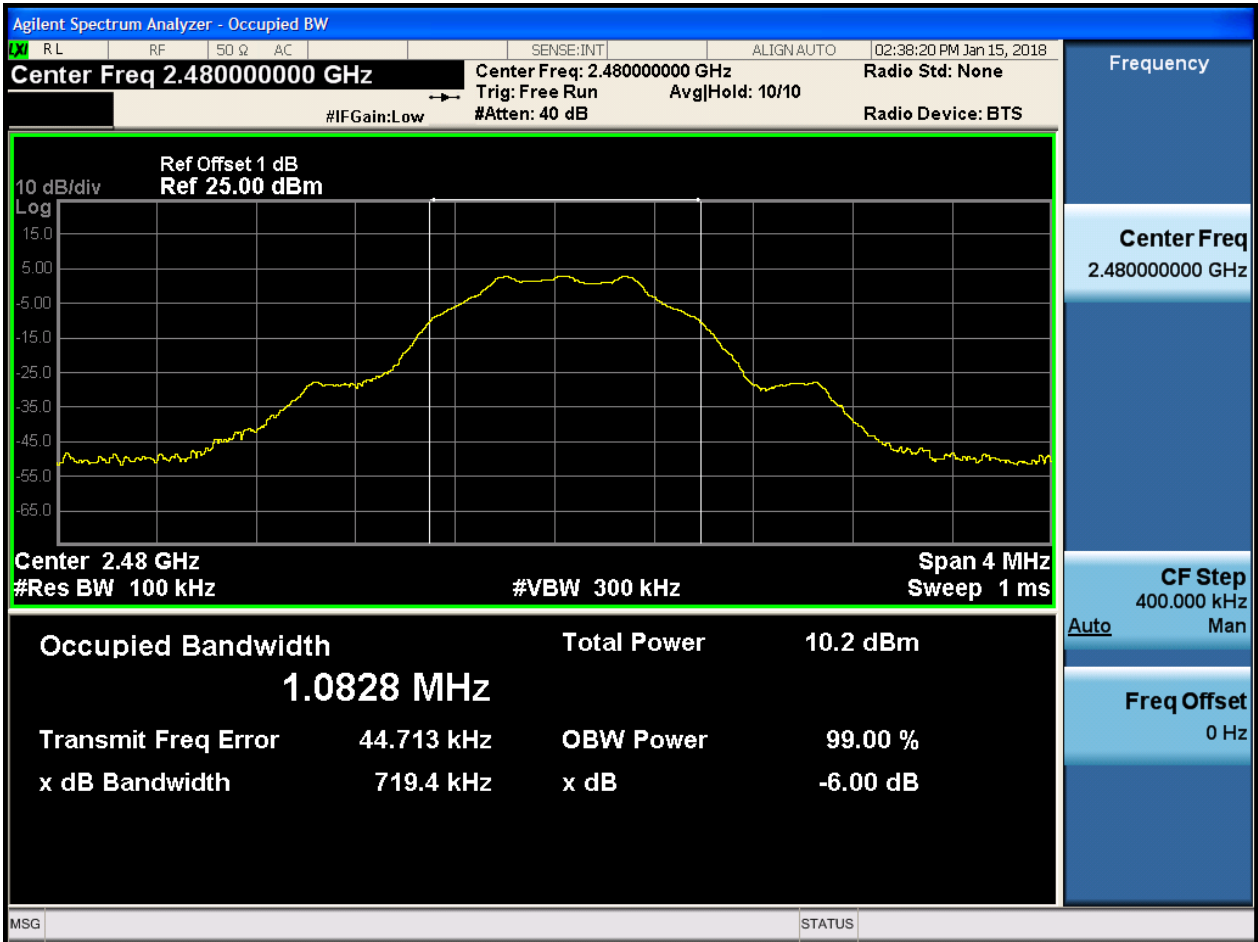

Appendix B: Occupied Bandwidth

For measurements on smart antenna systems (devices with multiple transmit chains), the test is performed at each chain, and used as respective results for each chain.

Part I - Test Results

Test Mode	Test Channel	Frequency[MHz]	Occupied Bandwidth [MHz]	Verdict
TM1 _Ch0	L	2402	1.05	pass
TM1 _Ch19	M	2440	1.05	pass
TM1 _Ch39	H	2480	1.06	pass

Part II - Test Plots

2.1 TM1_Ch0_L

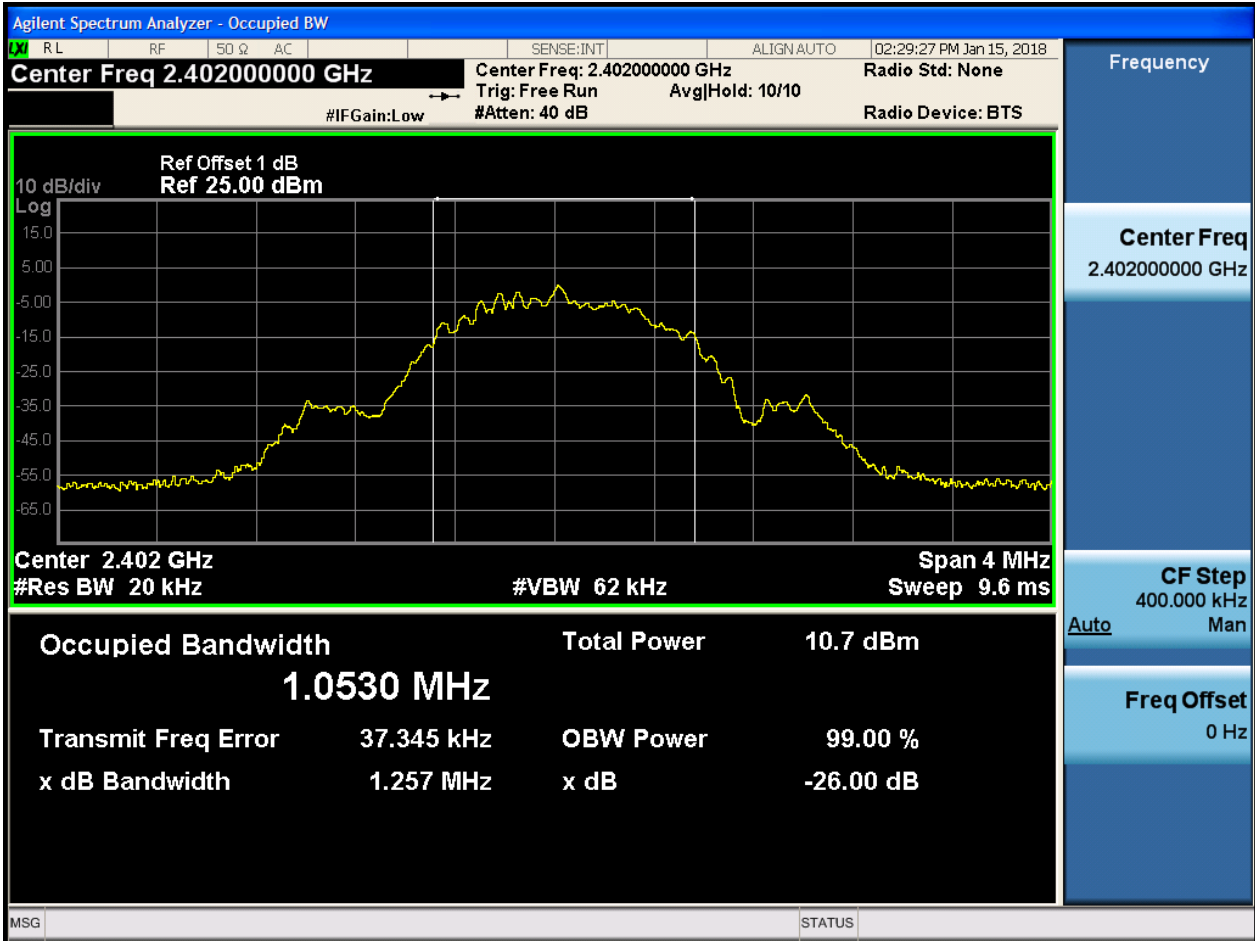



2.2 TM1_Ch19_M

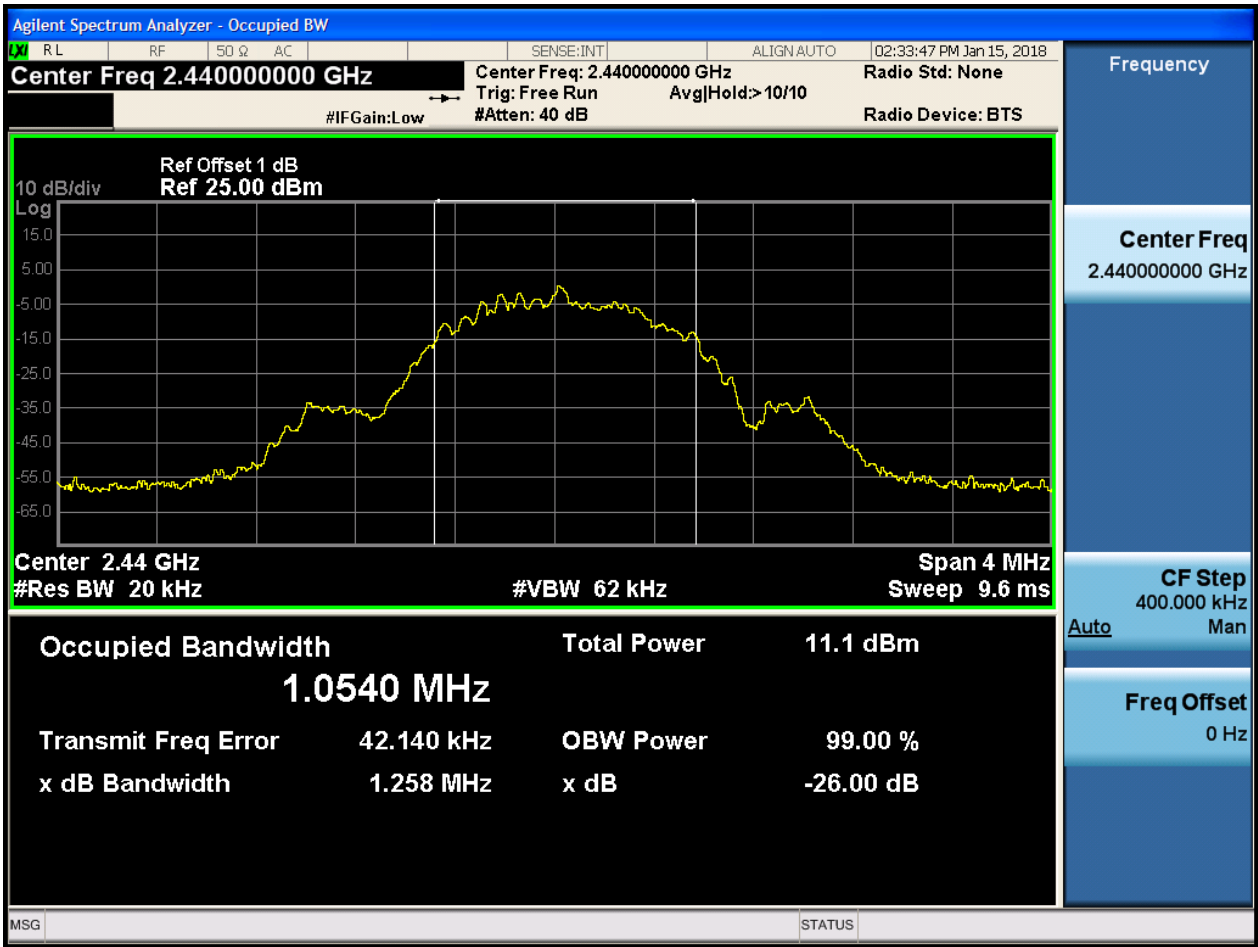



2.3 TM1_Ch39_H

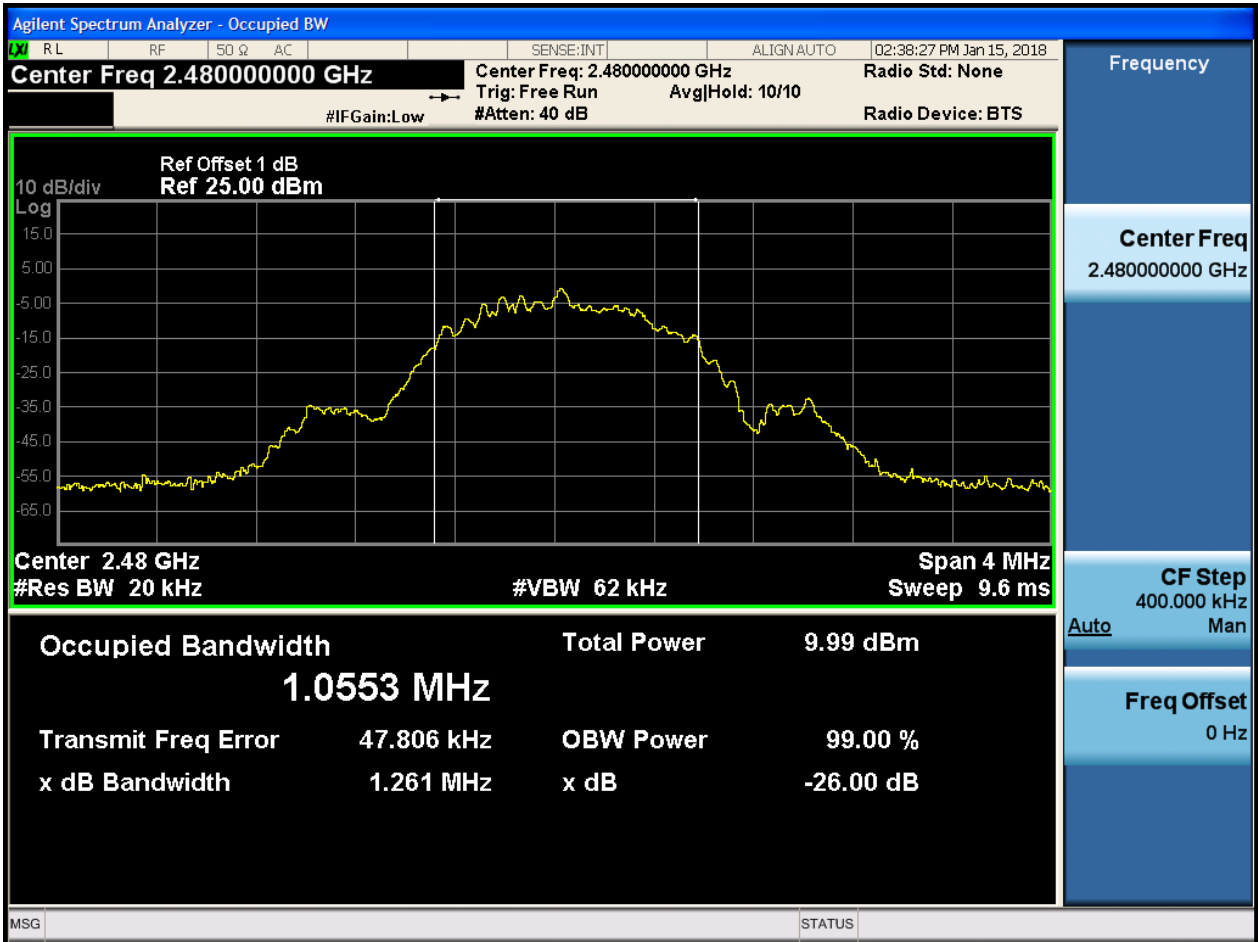



Appendix C: Duty Cycle

Part I - Test Results

Test Mode	TX Freq. [MHz]	Duty cycle [%]
TM1	CH0,CH19,CH39	61

Part II - Test Plots

2.1 TM1

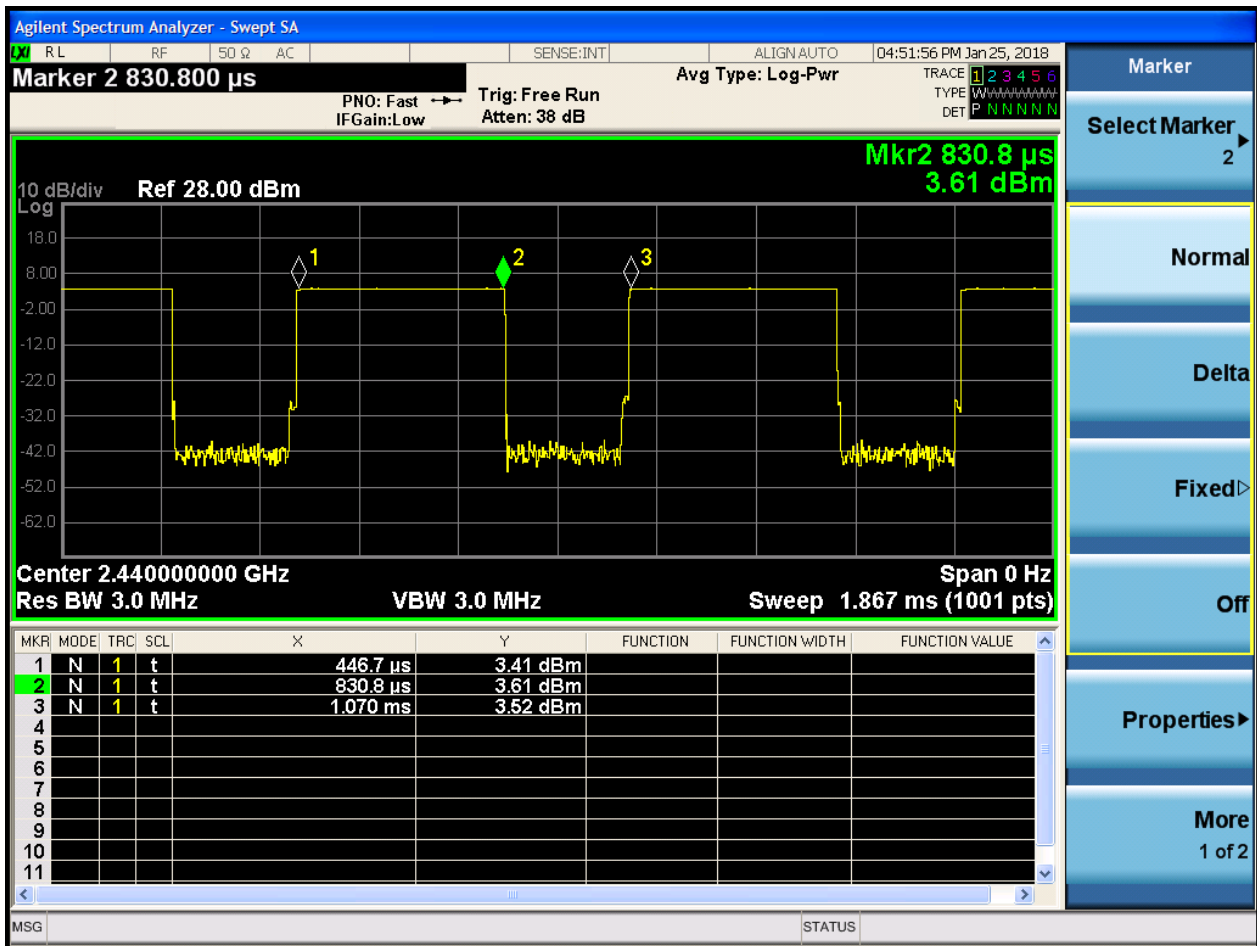

Appendix D: Maximum Conducted Average Output Power

Part I - Test Results

Test Mode	Test Channel	Frequency[MHz]	Duty Cycle [%]	Power[dBm]	Verdict
TM1 _Ch0	L	2402	61	4.05	pass
TM1 _Ch19	M	2440	61	4.87	pass
TM1 _Ch39	H	2480	61	3.36	pass



Part II - Test Plots

2.1 TM1_Ch0_L





2.2 TM1_Ch19_M





2.3 TM1_Ch39_H



Appendix E: Maximum Power Spectral Density Level

Part I - Test Results

Test Mode	Test Channel	Frequency[MHz]	Duty Cycle [%]	PSD[dBm/10 kHz]	Verdict
TM1 _Ch0	L	2402	61	-8.46	pass
TM1 _Ch19	M	2440	61	-8.42	pass
TM1 _Ch39	H	2480	61	-7.03	pass



Part II - Test Plots

2.1 TM1_Ch0_L





2.2 TM1_Ch19_M





2.3 TM1_Ch39_H



Appendix F: Band Edges Compliance

Part I - Test Results

Test Mode	Test Channel	Frequency[MHz]	Carrier Power[dBm]	Max.Spurious Level[dBm]	Verdict
TM1 _Ch0	L	2402	3.65	-49.28	pass
TM1 _Ch39	H	2480	2.96	-49.50	pass



Part II - Test Plots

2.1 TM1_Ch0_L

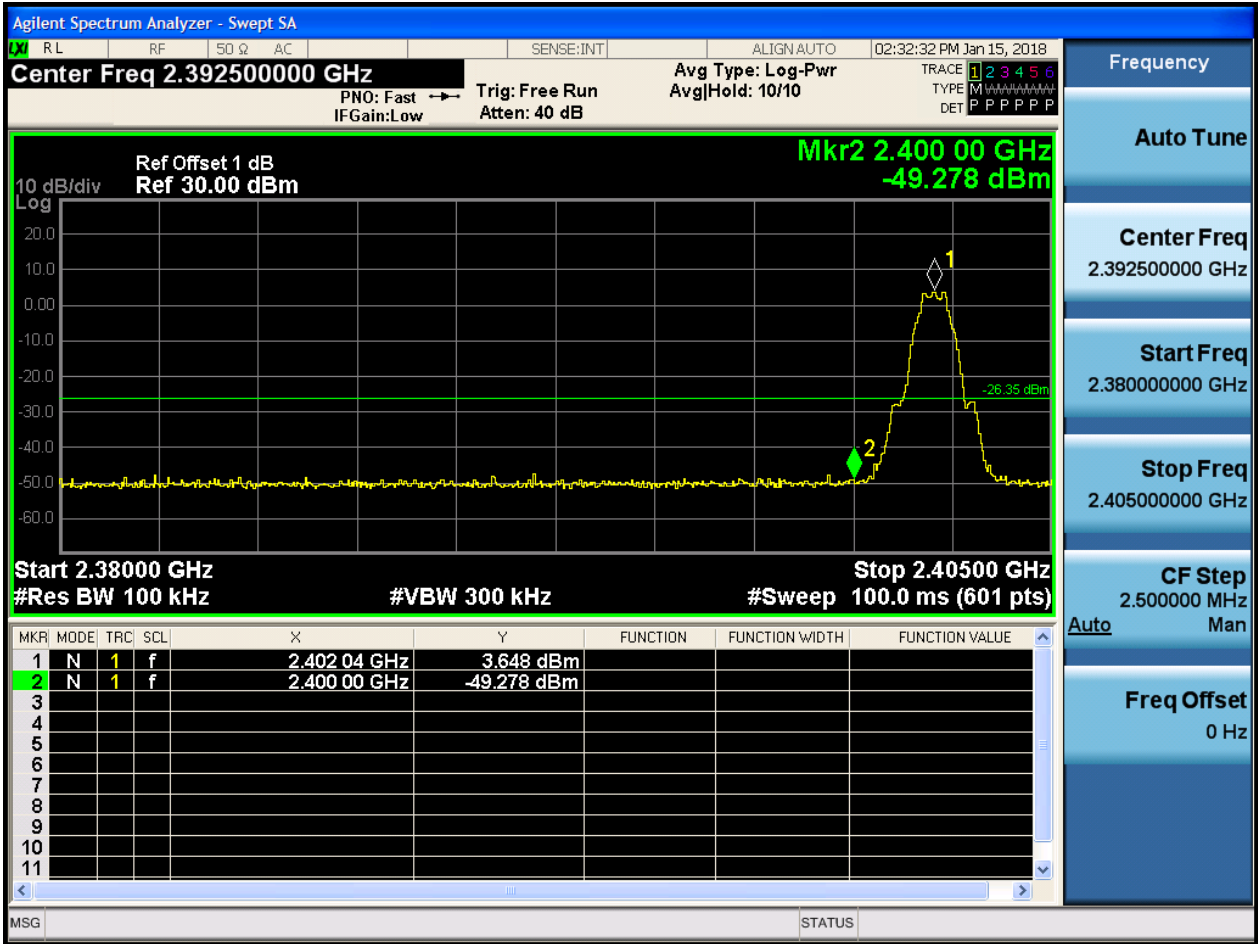



2.2 TM1_Ch39_H

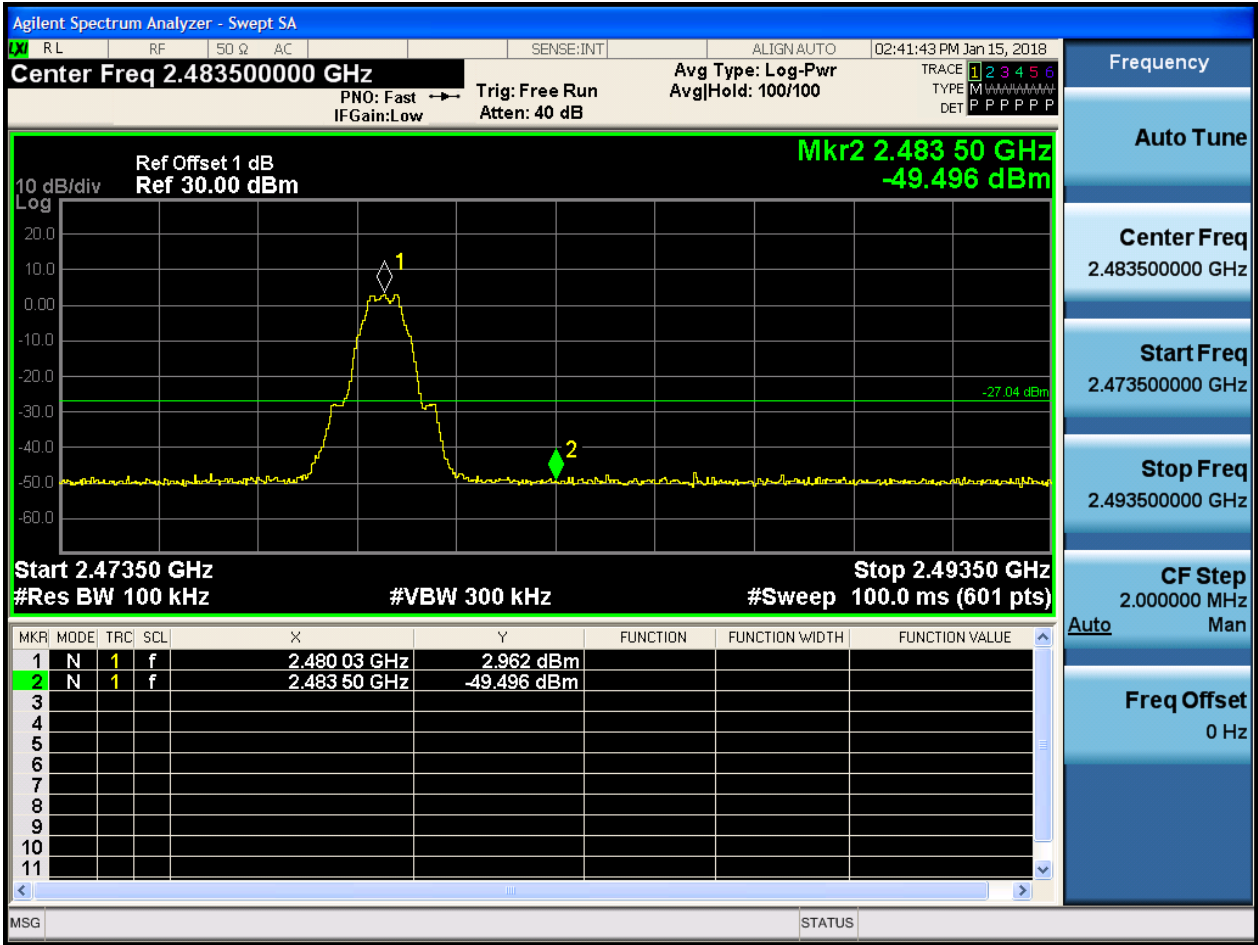

Appendix G: Unwanted Emissions into Non-Restricted Frequency

Bands

In this Appendix, the "Pref", which is used as the reference level, refers to the peak power level in any 100 kHz bandwidth within the fundamental emission, the "Puw" refers to the maximum emission power in 100 kHz band segments outside of the authorized frequency band.

Considering that the higher ratio of RBW to the span for the frequency ranges below 30 MHz makes the results determination be complicated, a narrower RBW other than 100 kHz is used for these ranges. The measured value should add a RBW correction factor (RBWCF) where $RBWCF [dB] = 10 \times \lg(100 [kHz]/\text{narrower RBW [kHz]})$. As to this Appendix, the narrower RBW is 1 kHz and RBWCF is 20 dB for the frequency 9 kHz to 150 kHz, and the narrower RBW is 10 kHz and RBWCF is 10 dB for the frequency 150 kHz to 30 MHz.

For measurements on smart antenna systems (devices with multiple transmit chains), the test is performed at each chain and used as respective results for each chain, due to the relative-limit requirement.

In the result table, the "< Limit" denotes that "The Puw [dBm] is less than Pref[dBm]-30[dBm], see test plots for detailed".

Part I - Test Results

Test Mode	Test Channel	Frequency[MHz]	Pref[dBm]	Puw[dBm]	Verdict
TM1_Ch0	L	2402	3.67	<limit	pass
TM1_Ch19	M	2440	4.05	<limit	pass
TM1_Ch39	H	2480	3.05	<limit	pass



Part II - Test Plots

2.1 TM1_Ch0_L

Pref:





P_{uw}:

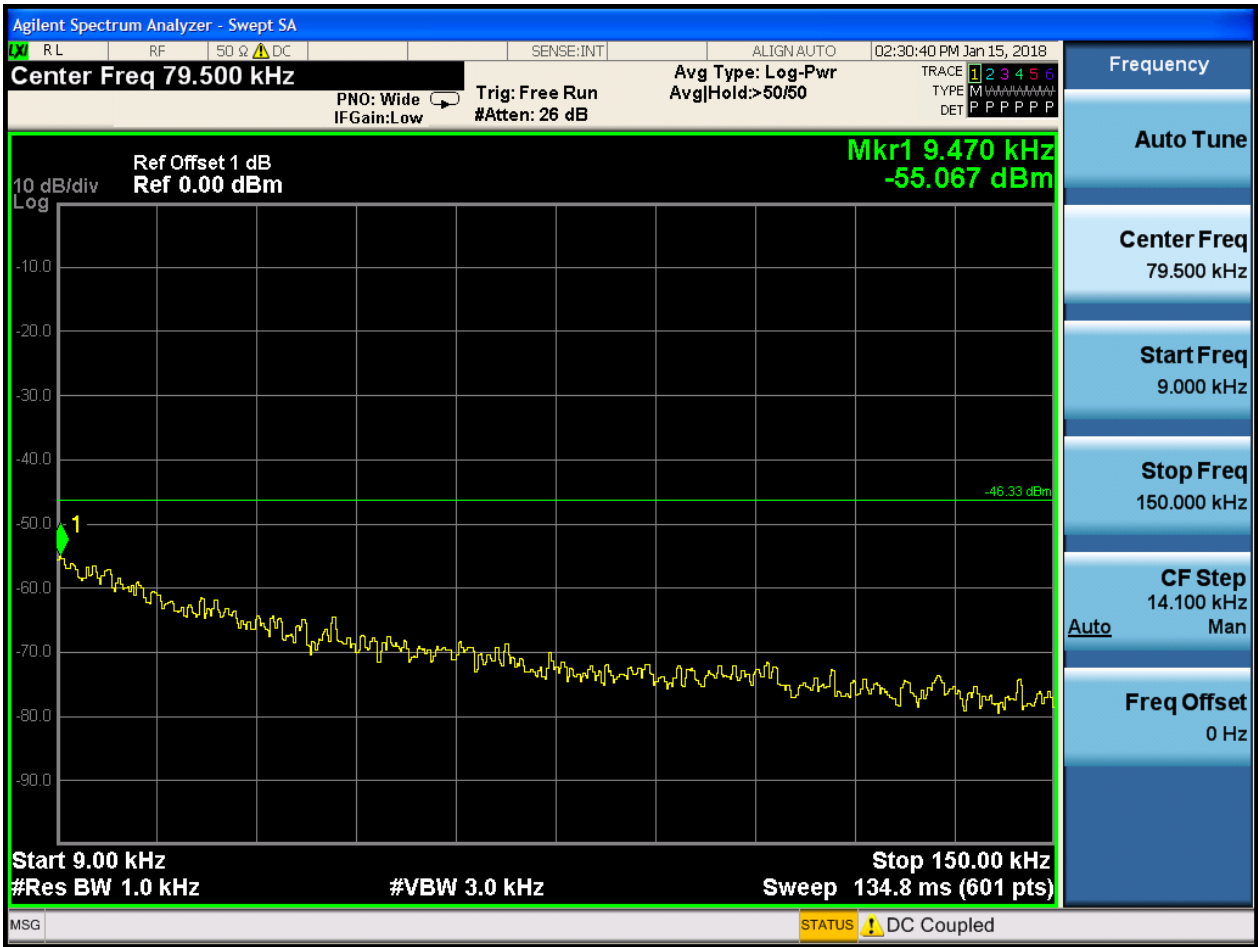

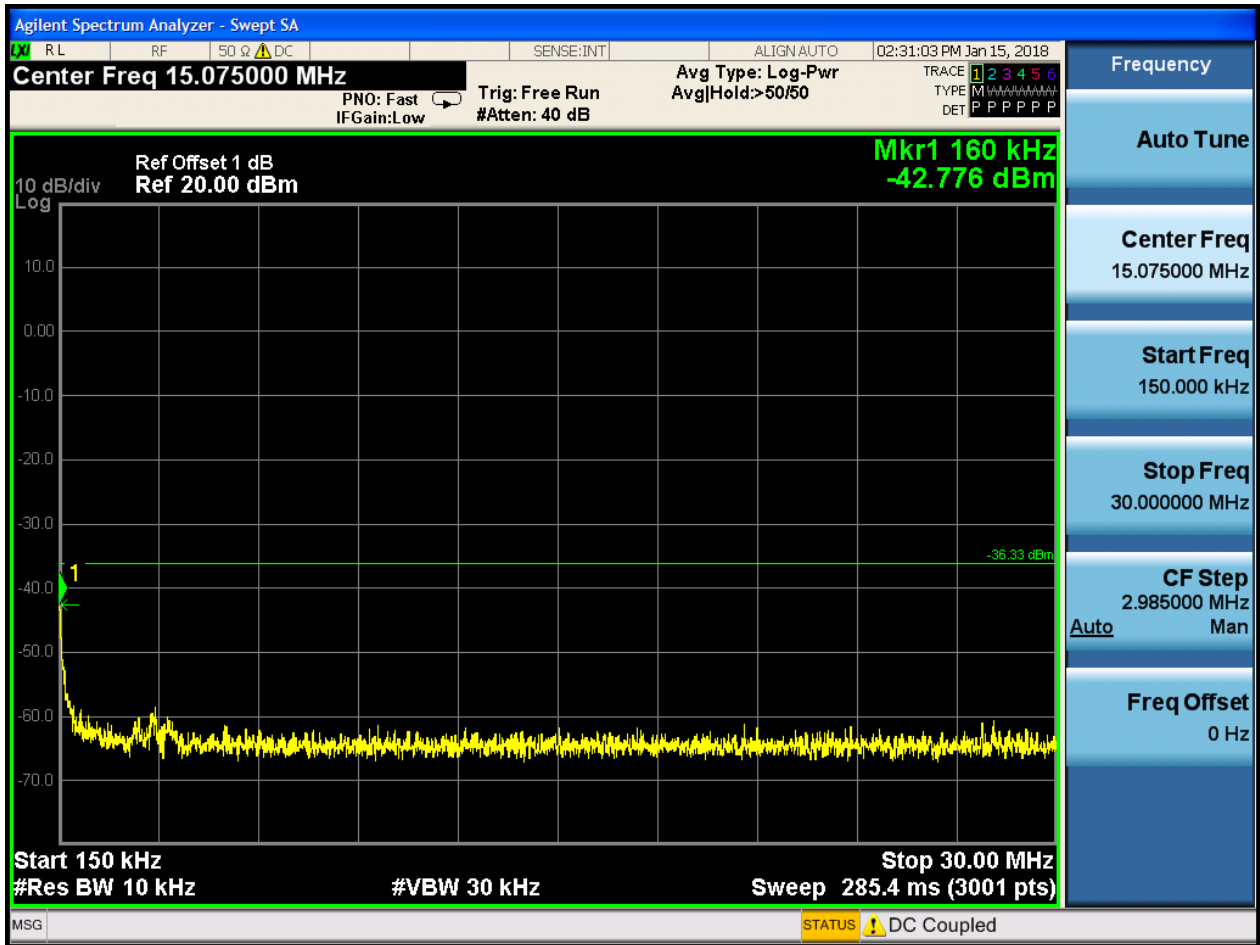

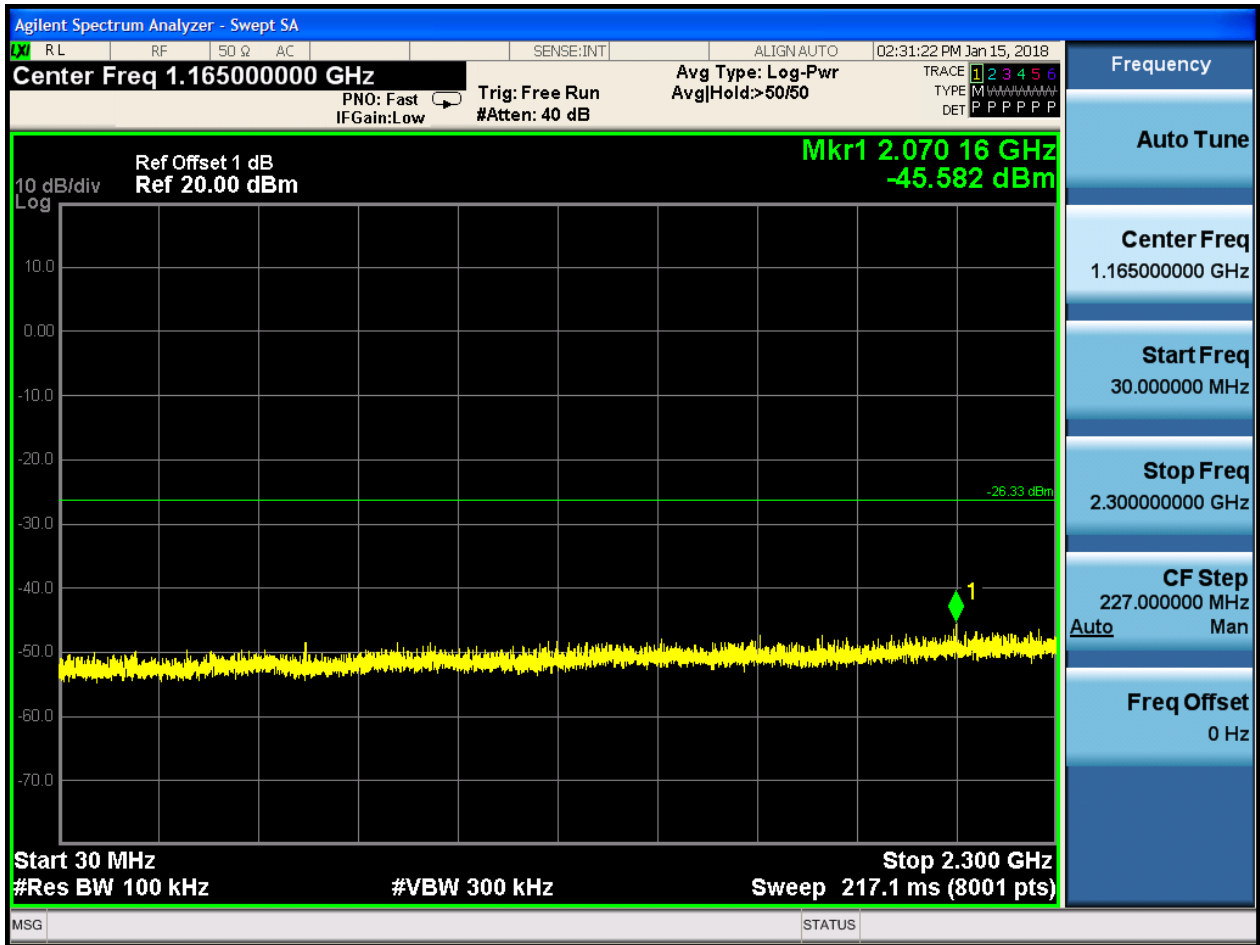

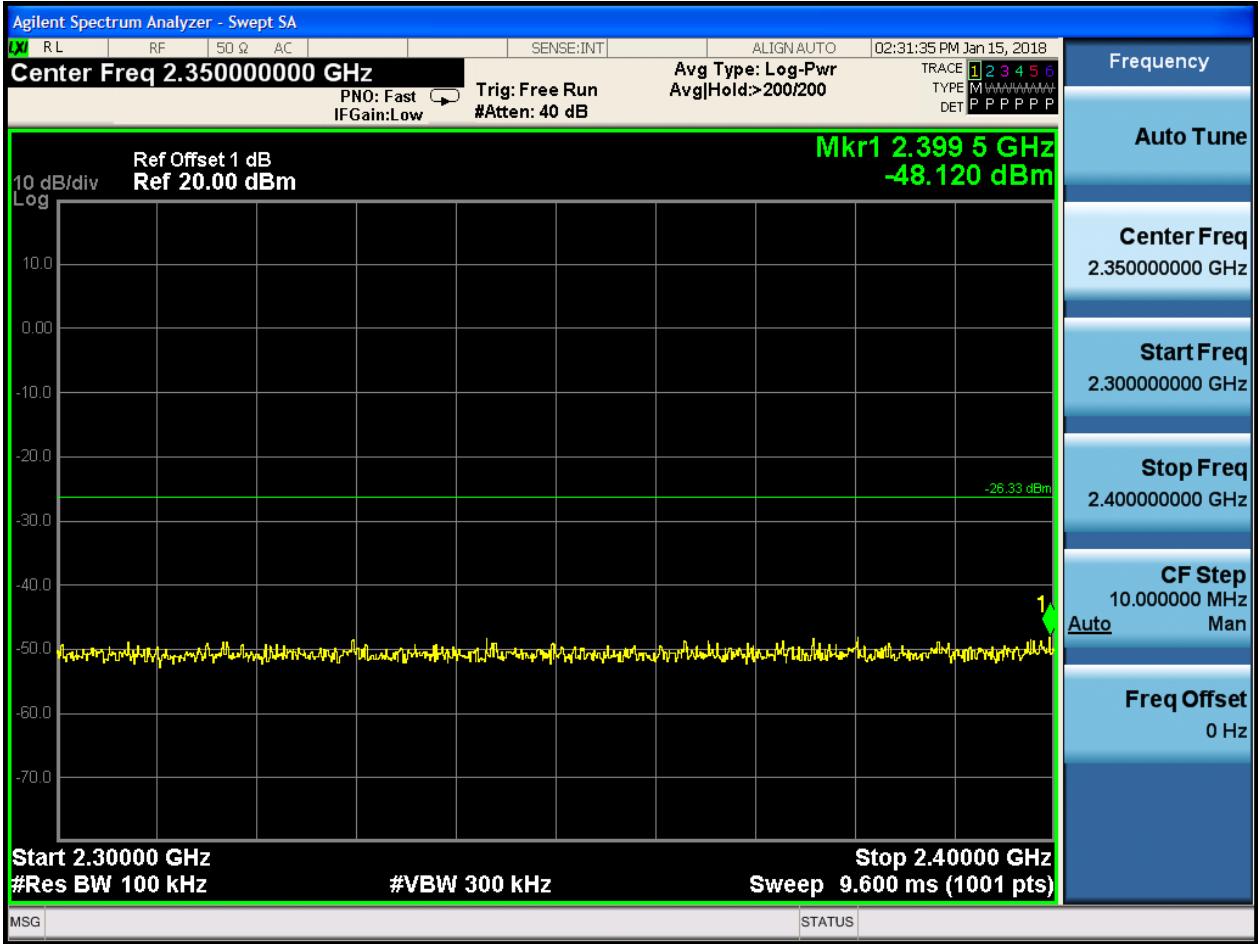

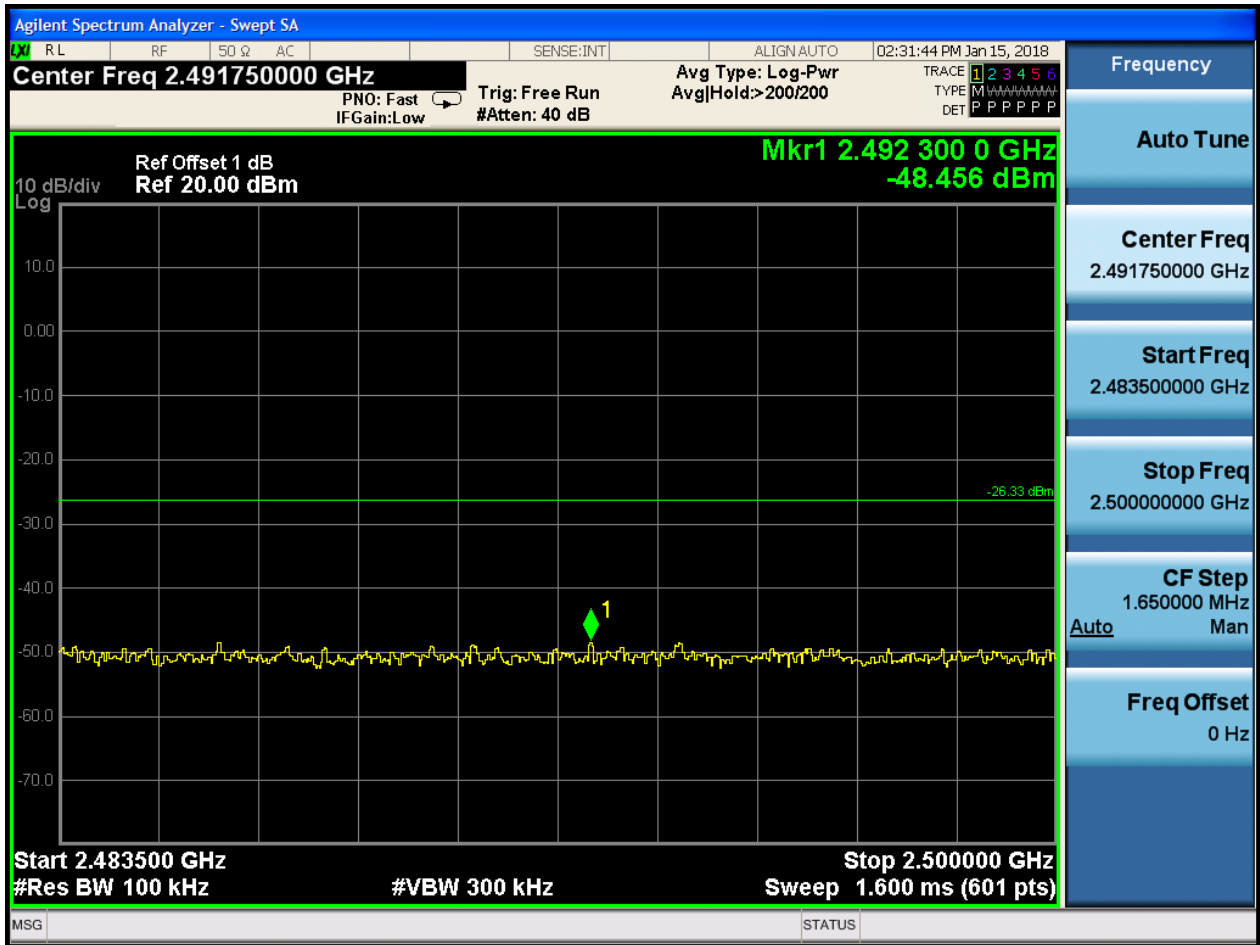

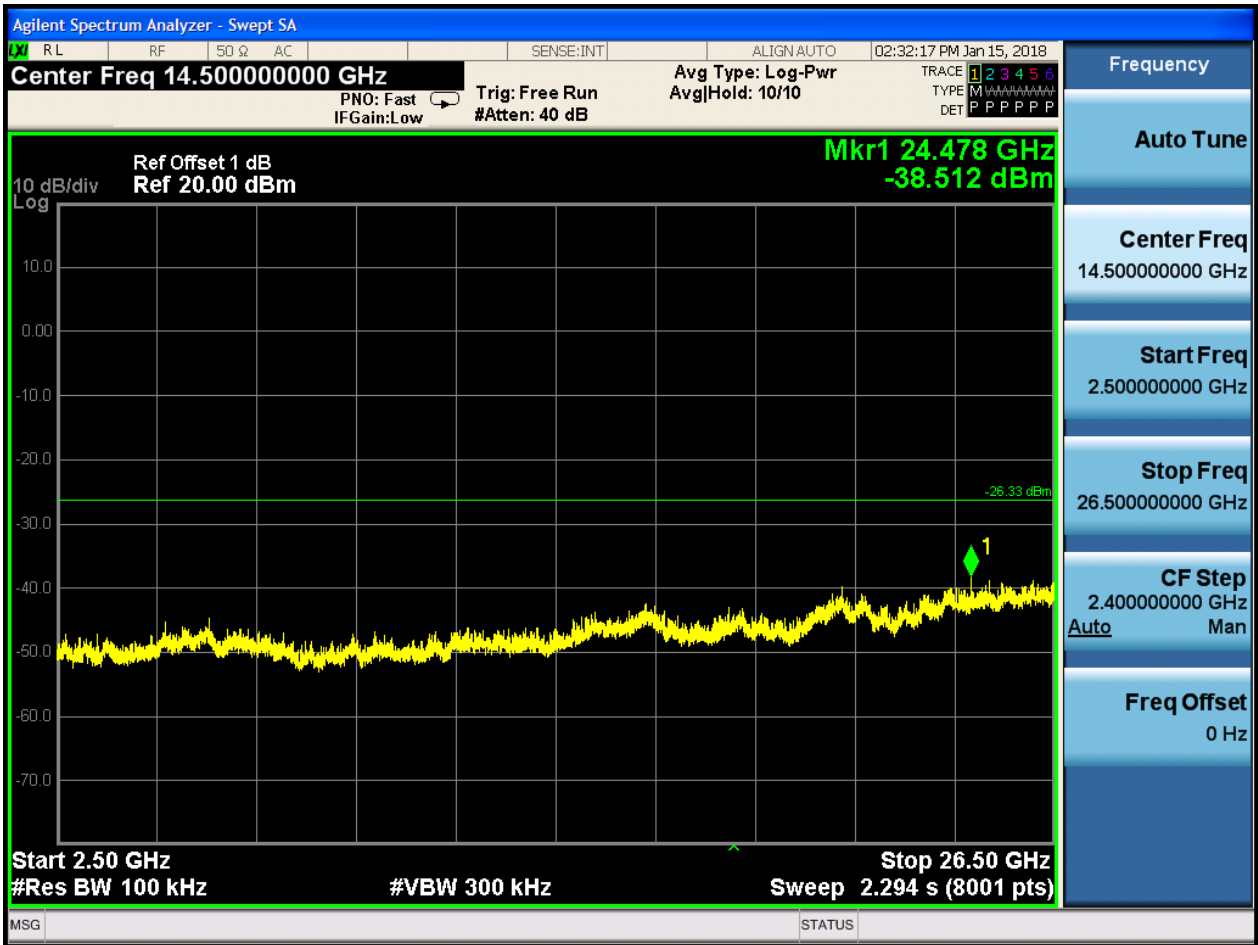



2.2 TM1_Ch19_M

Pref:

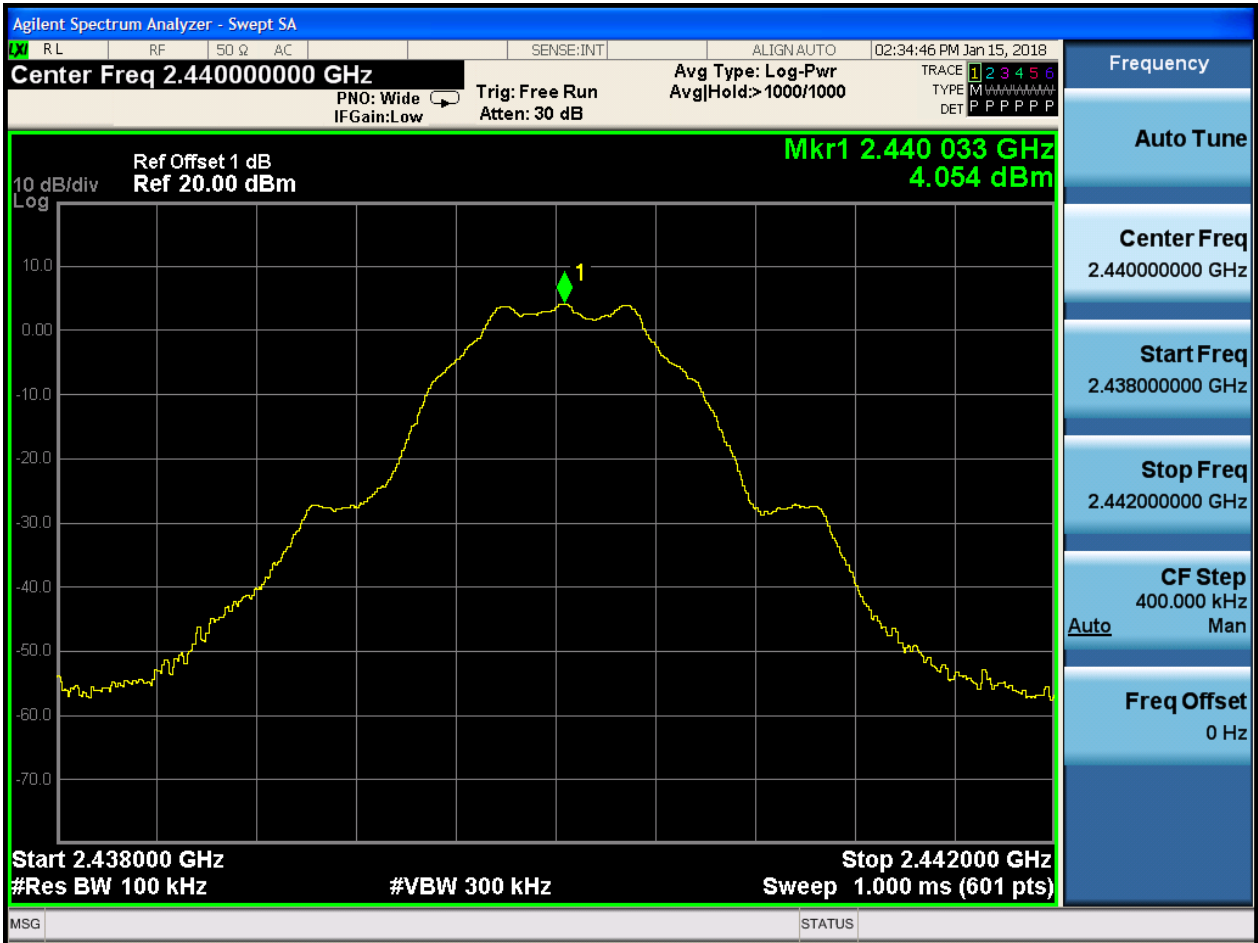



Puw:

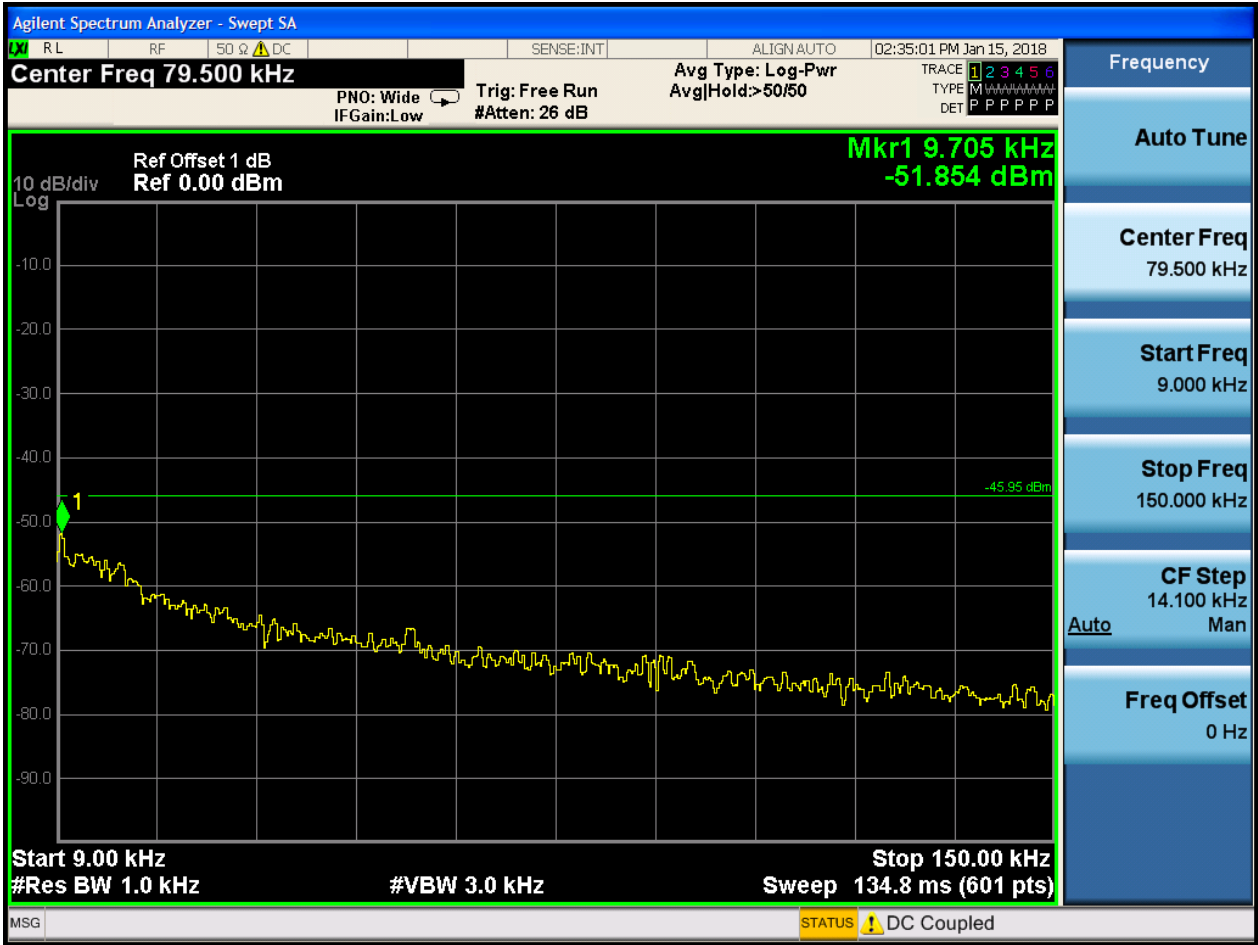

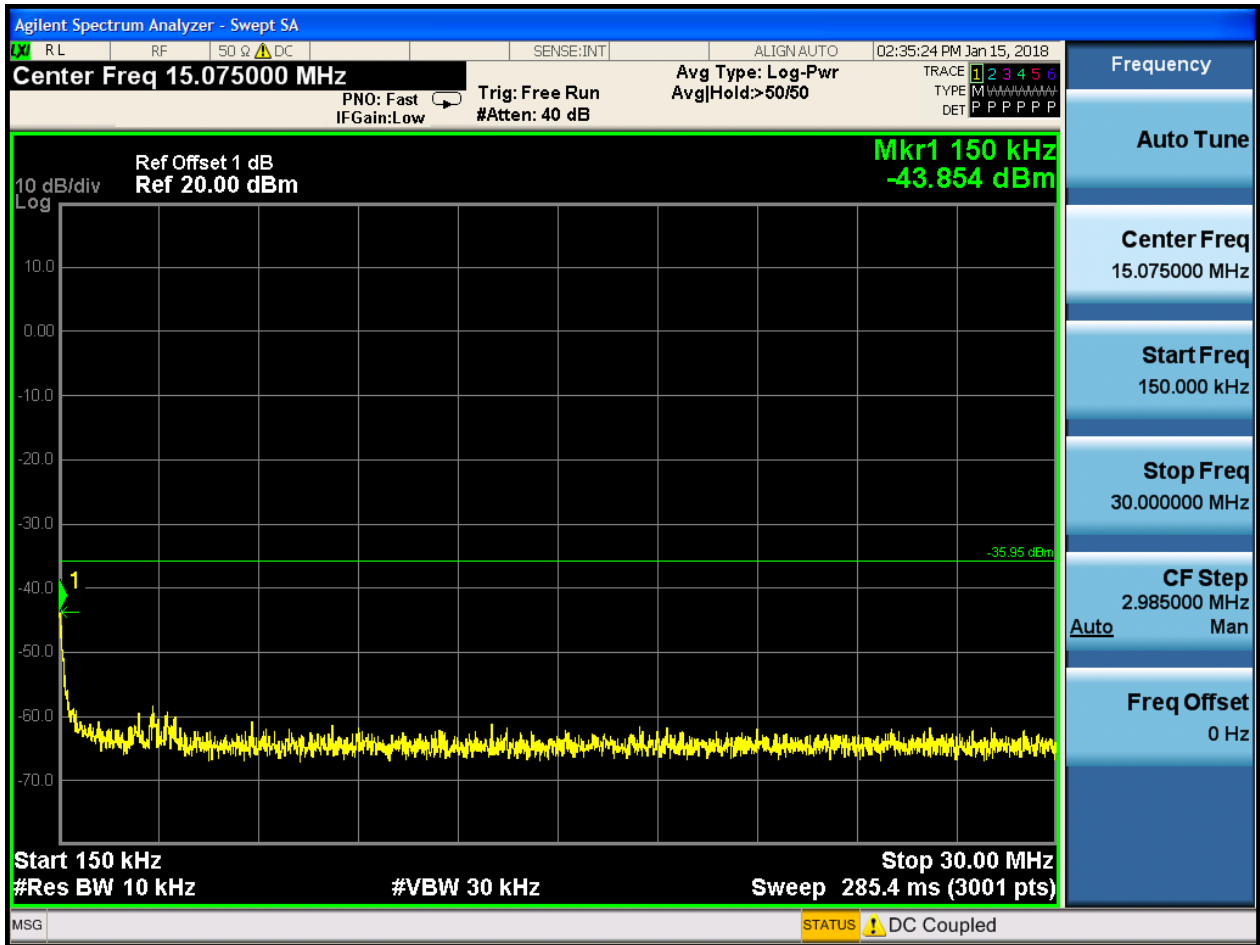

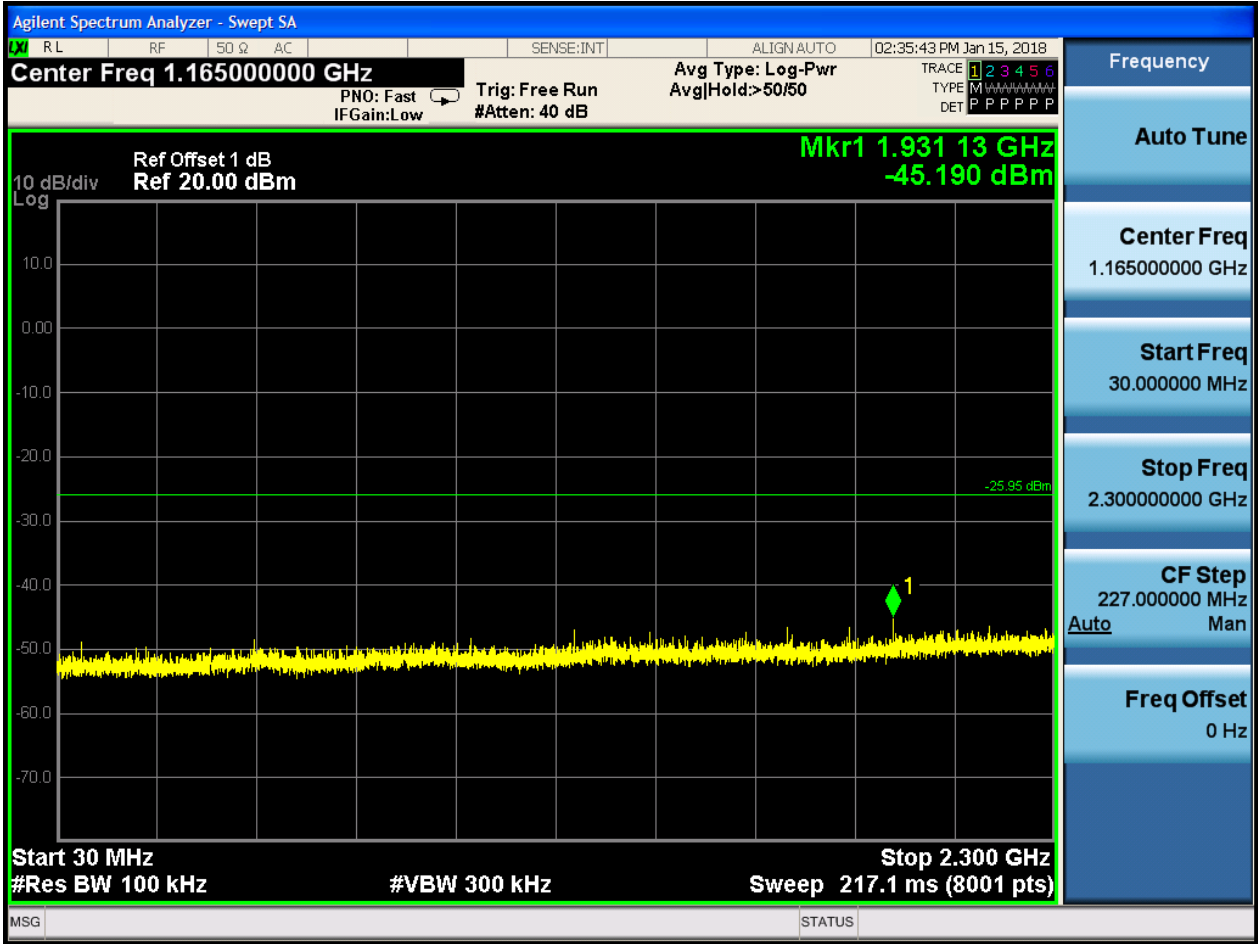

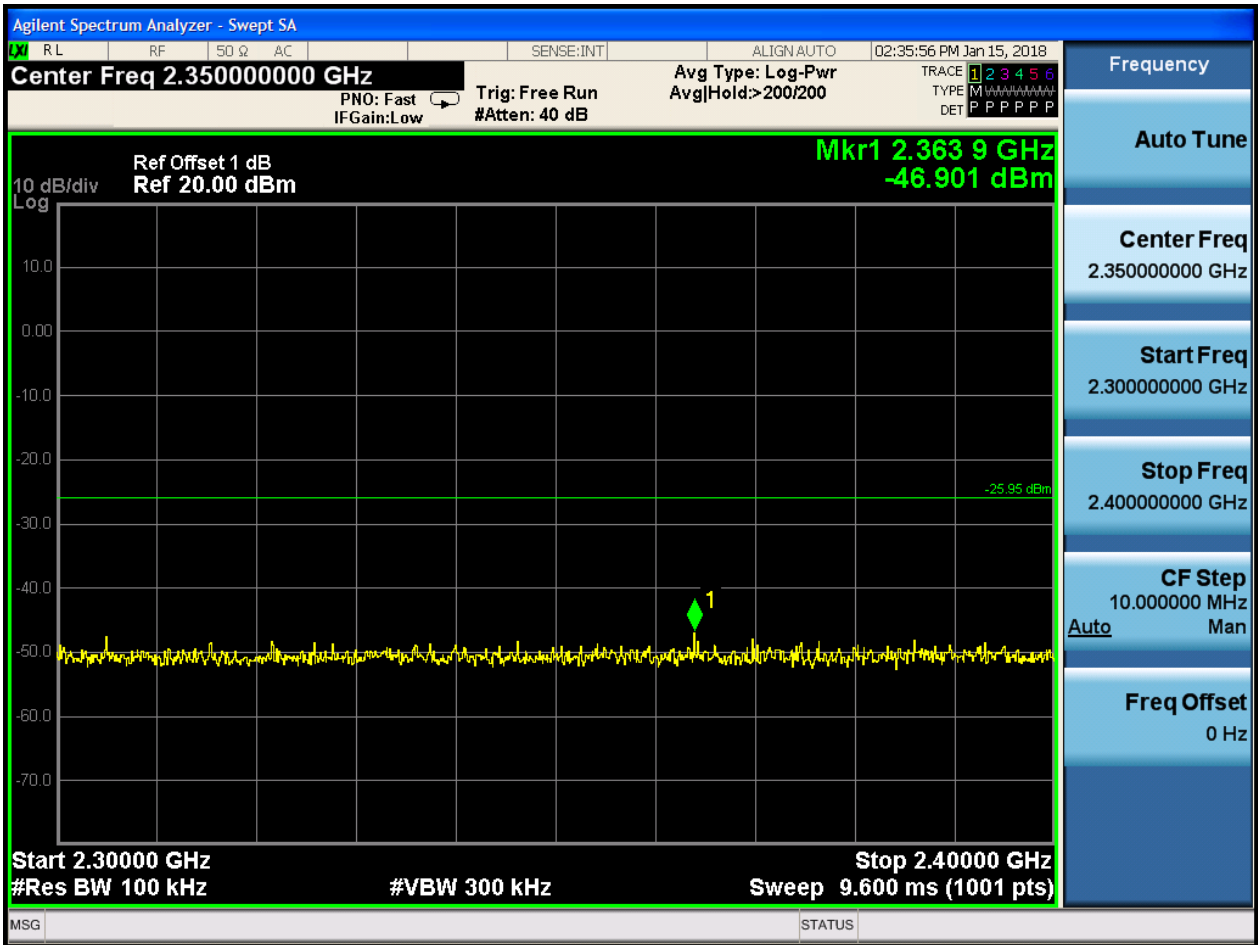

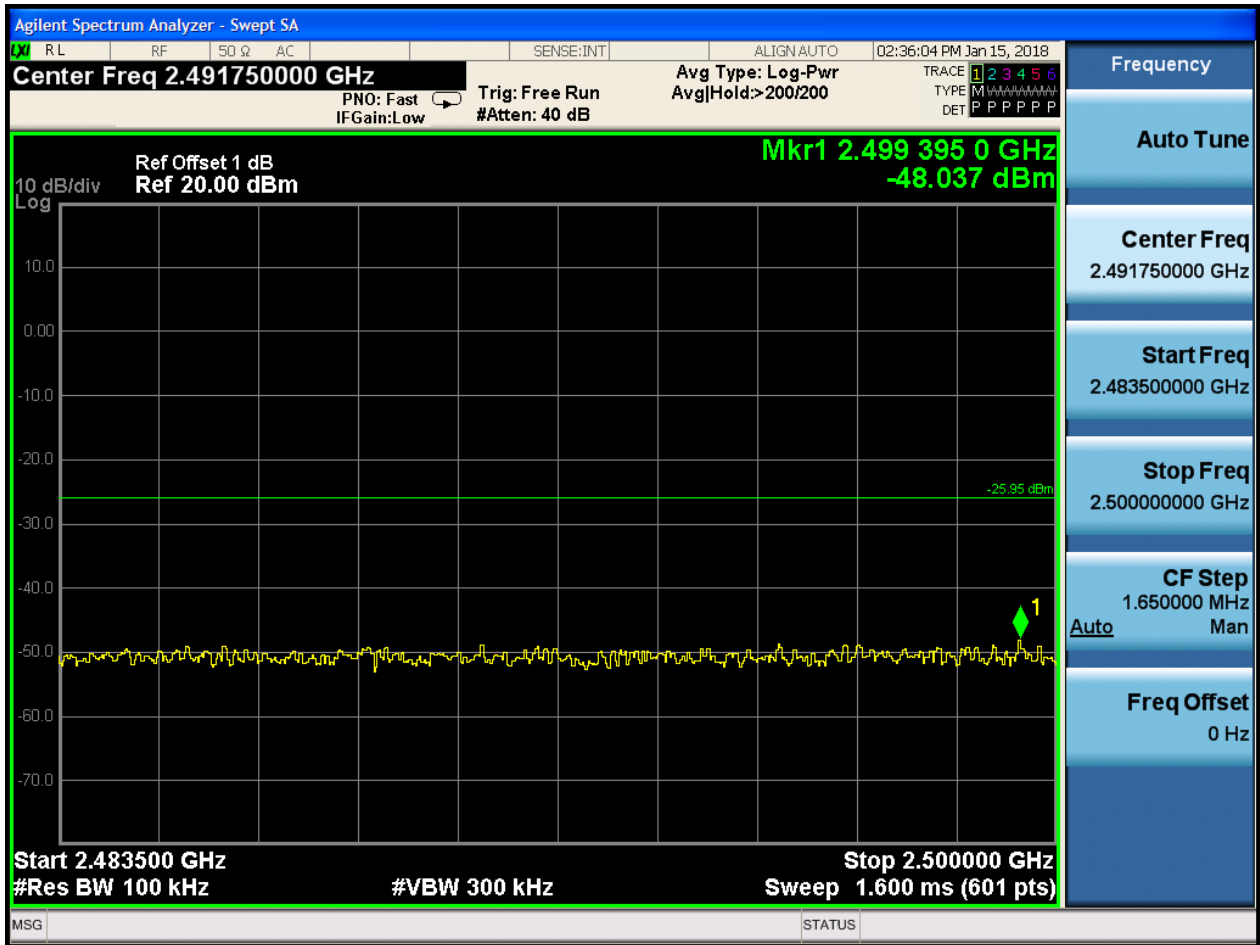

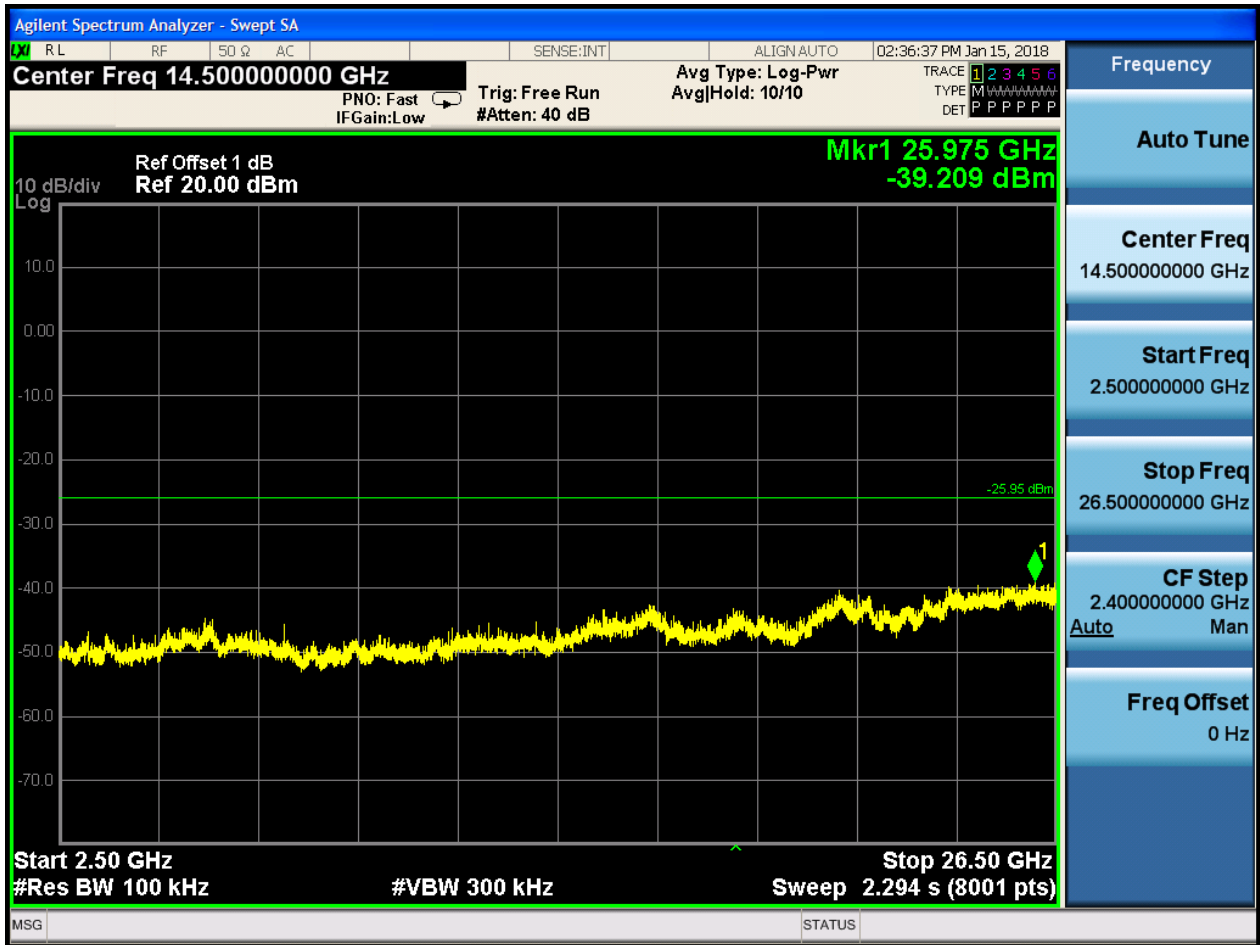



2.3 TM1_Ch39_H

Pref:

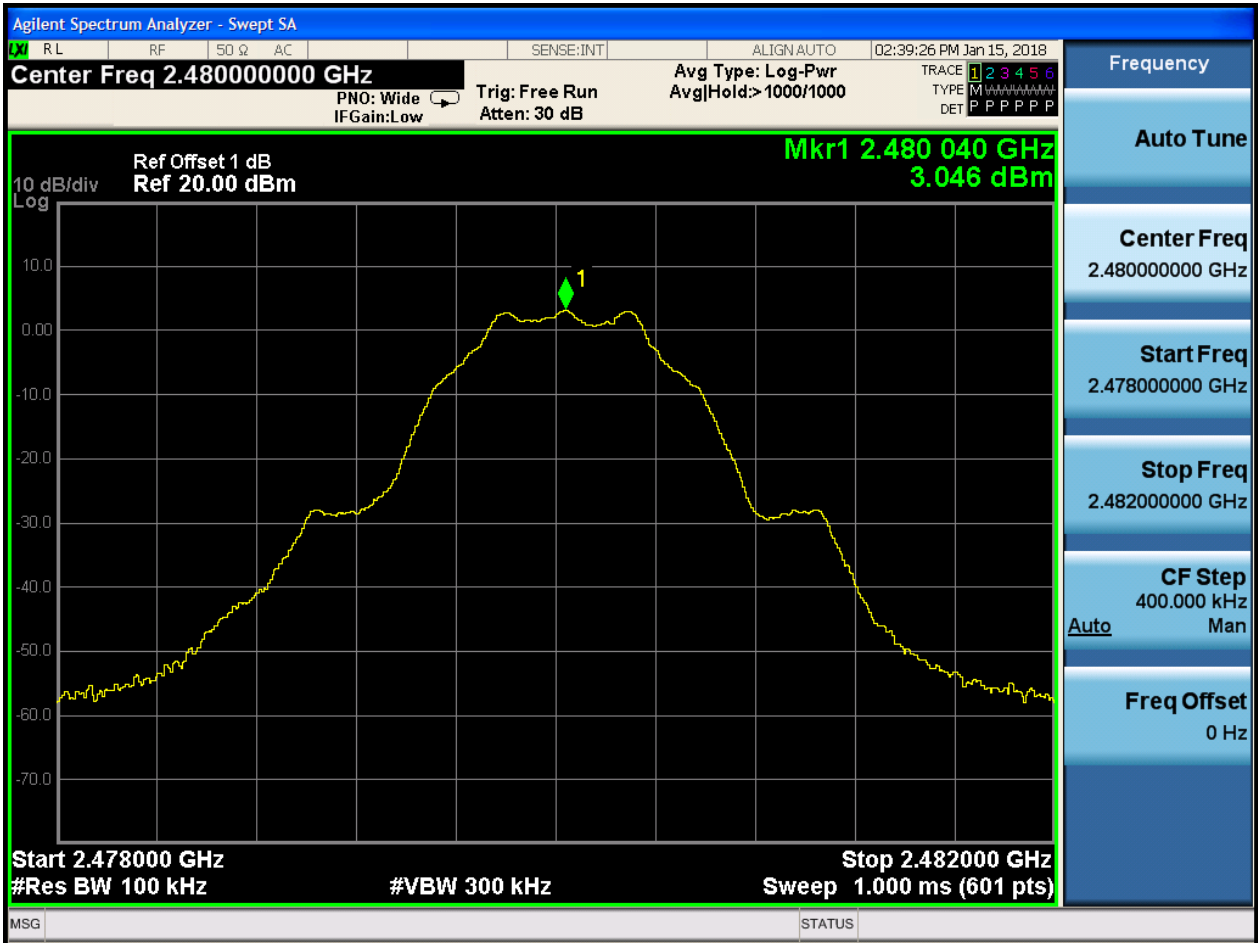



P_{uw}:

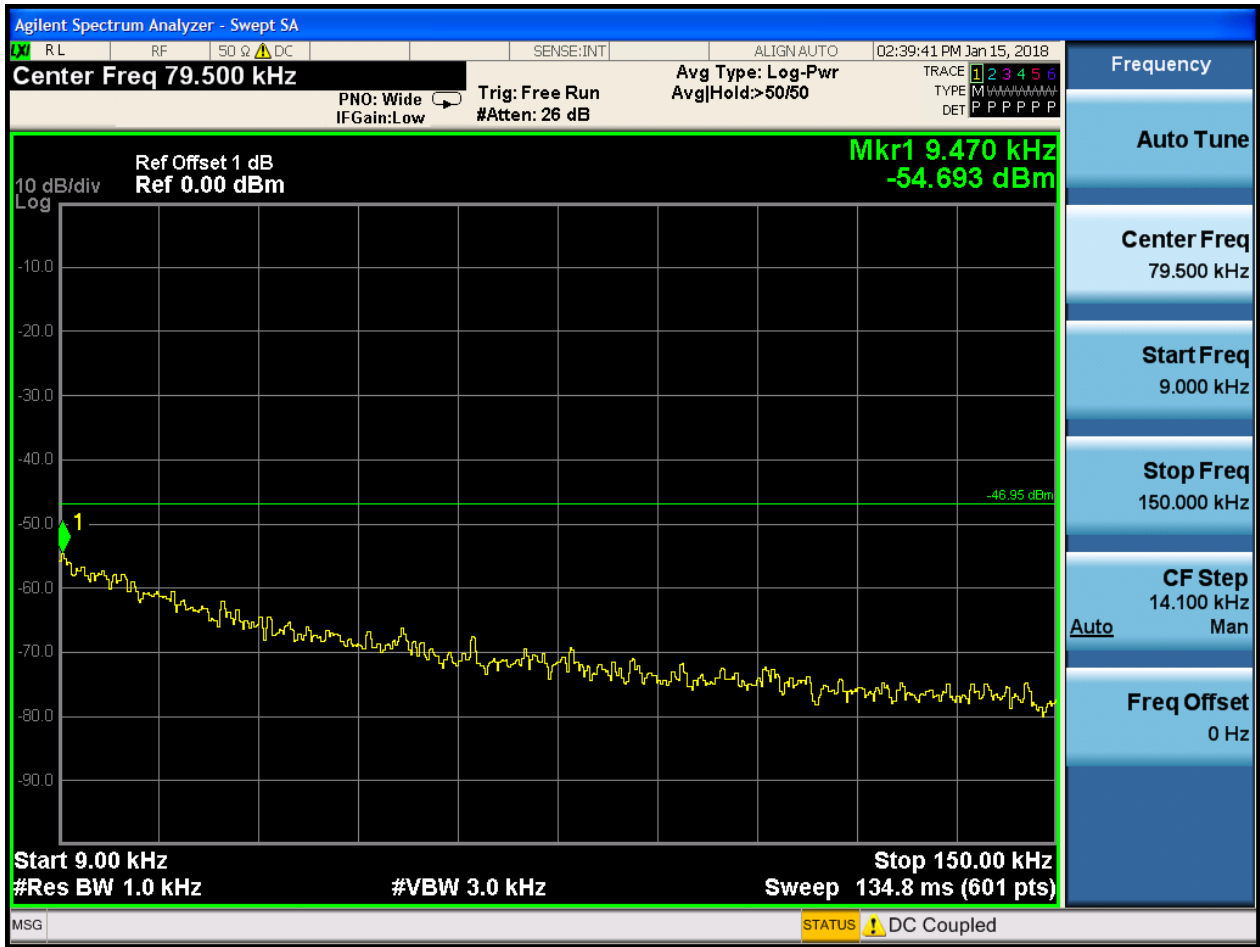

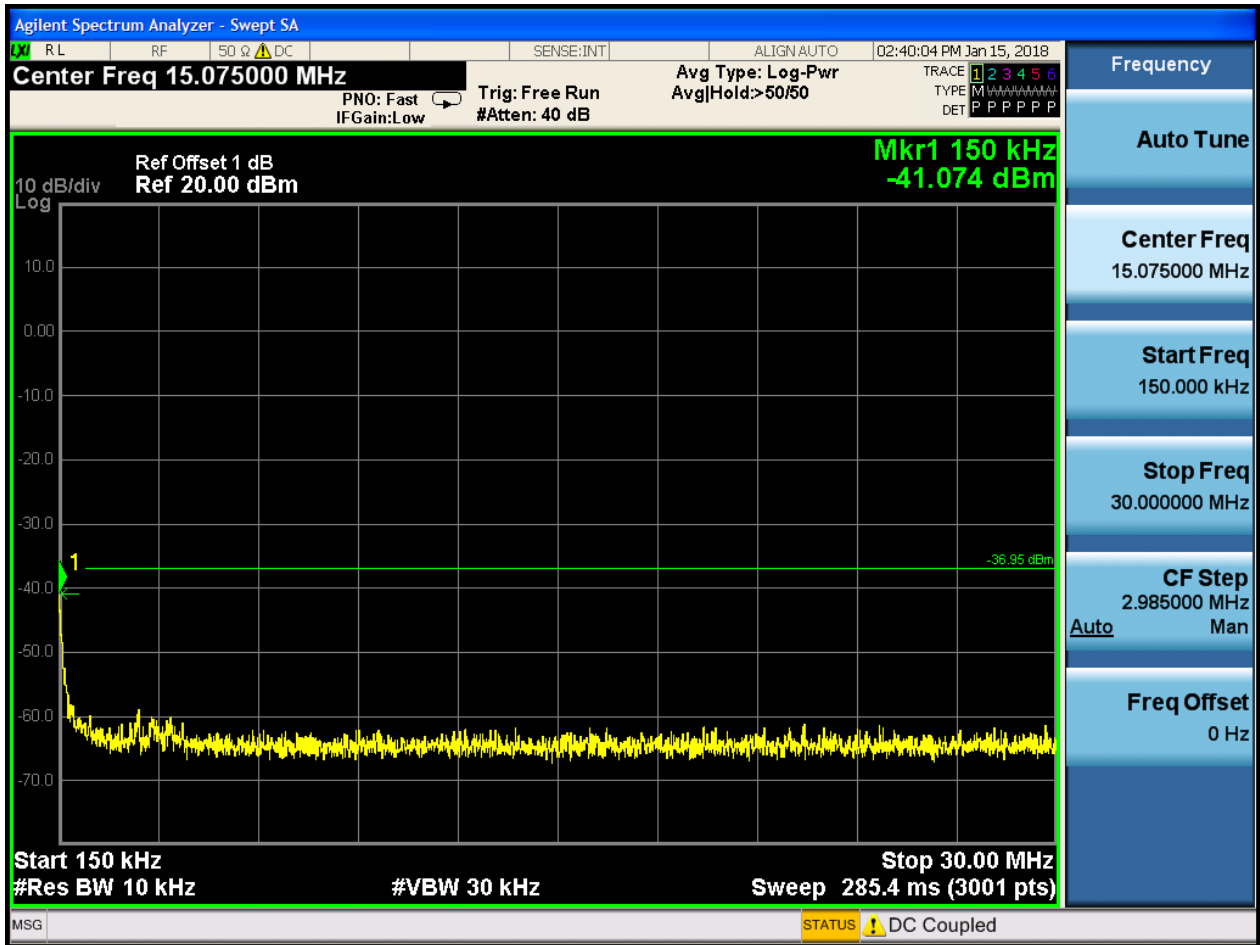

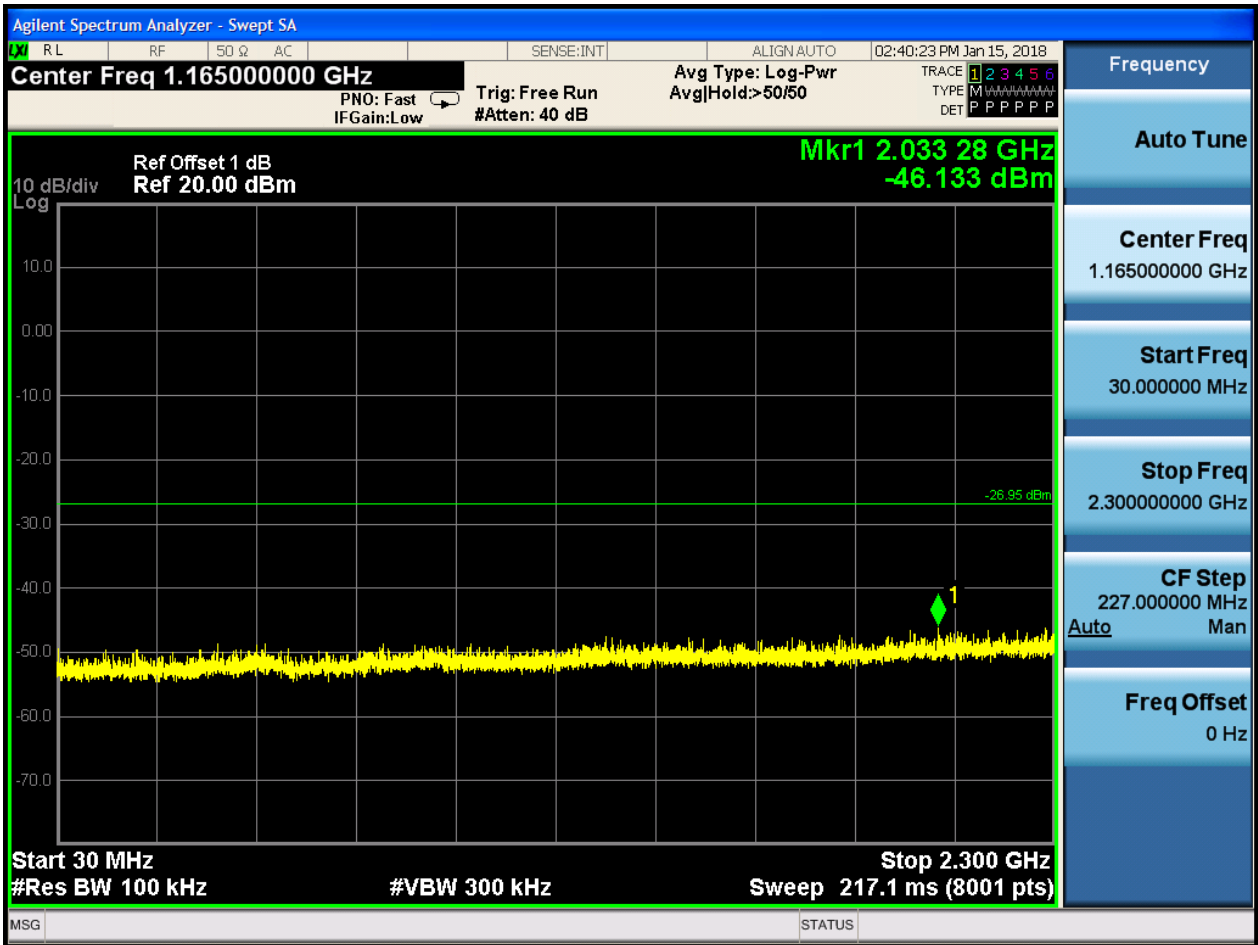

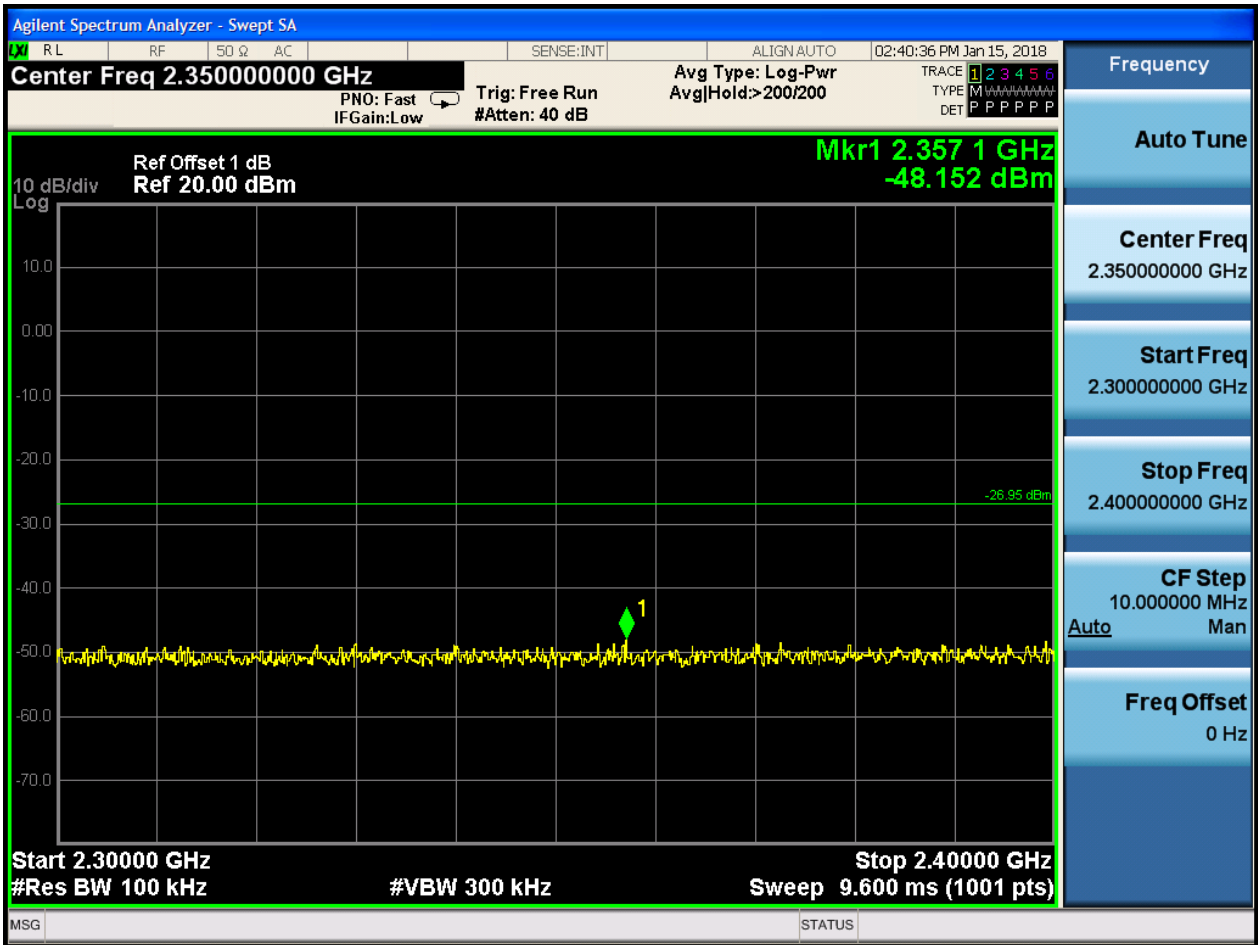

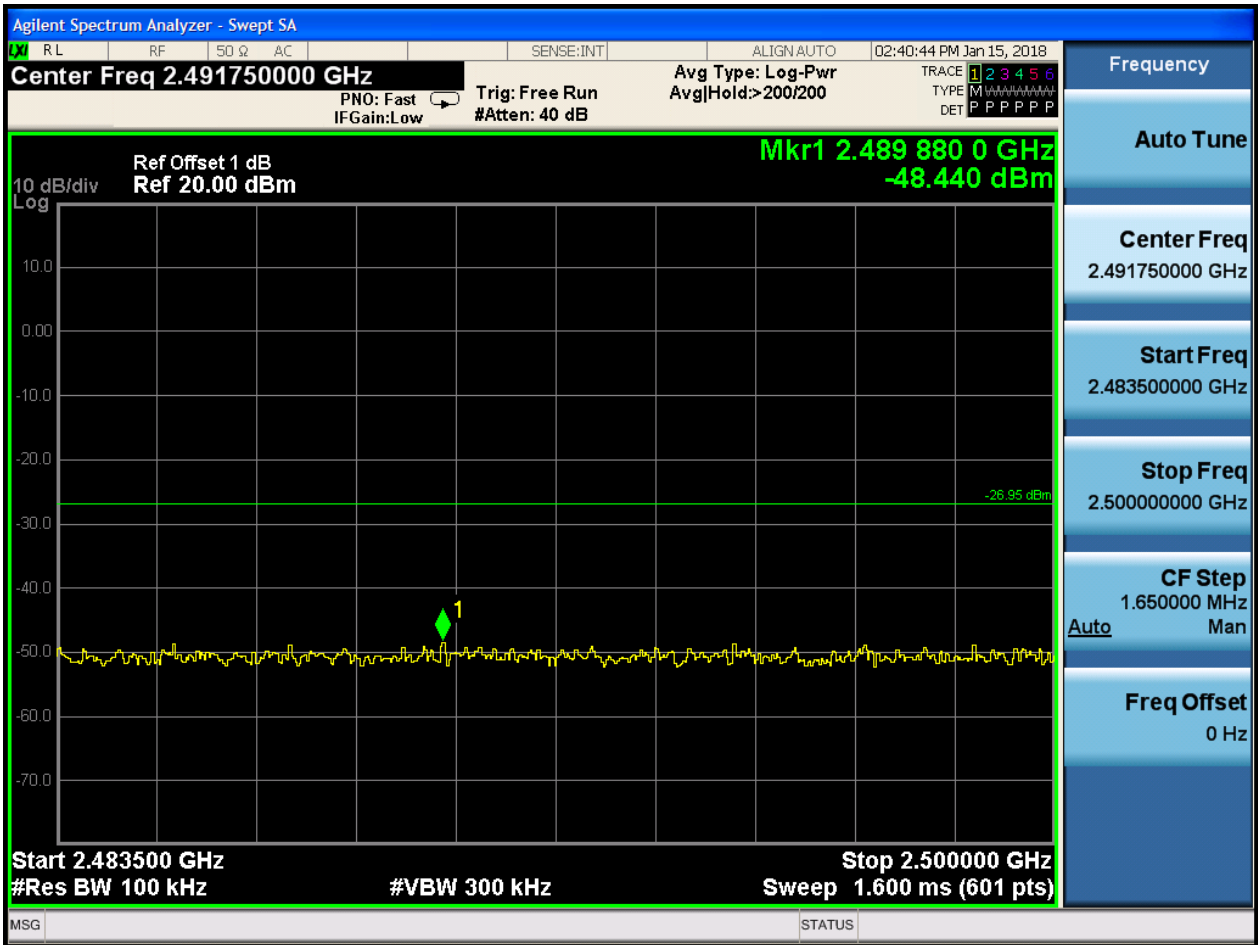

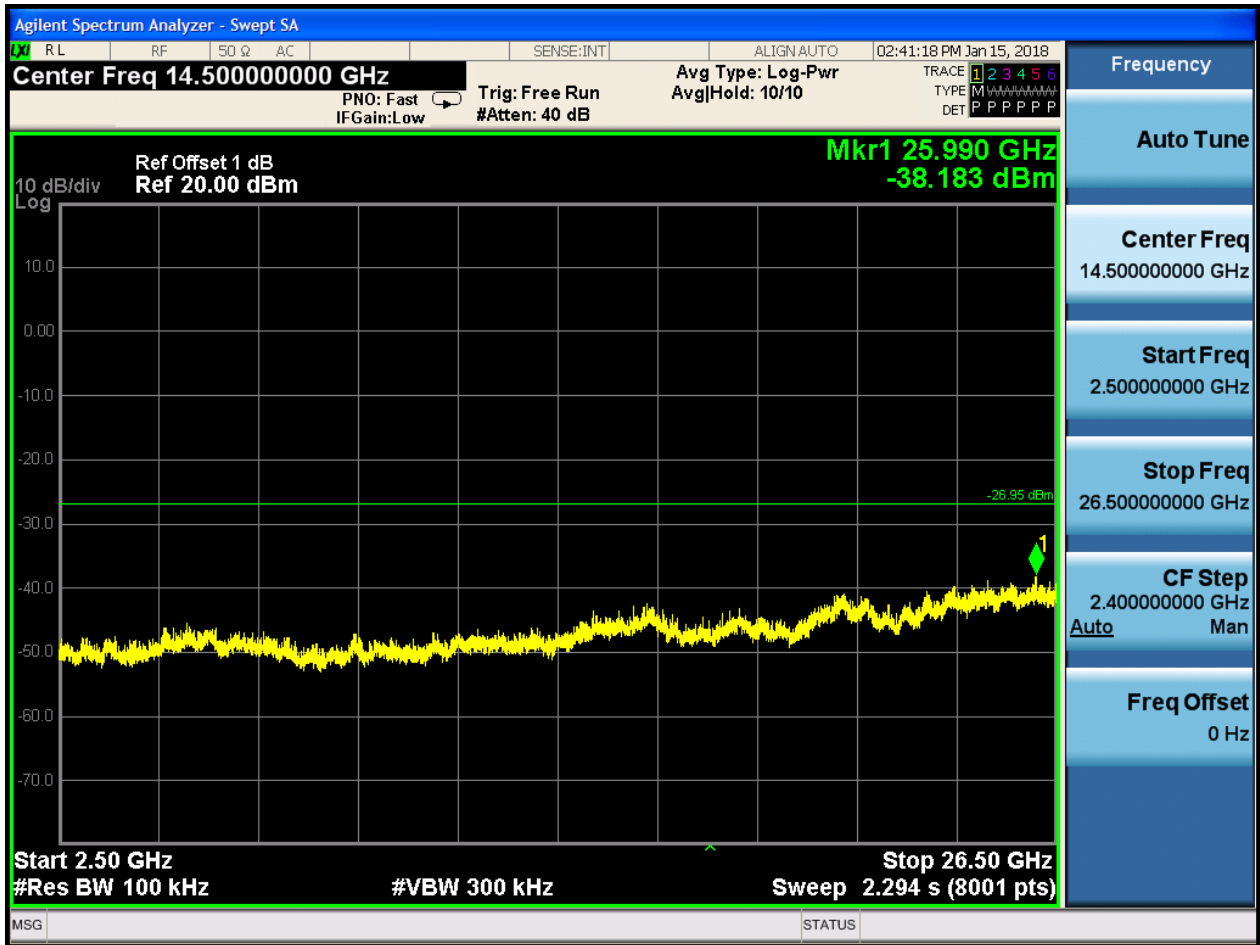



Appendix H: Radiated Spurious Emission & Spurious in Restricted Band

Note: We tested all modes, but the data presented below is the worst case.

Below 1GHz, RBW = 100 kHz, VBW = 300 kHz.

Above 1GHz, RBW = 1 MHz, VBW = 3 MHz.

The simultaneous transmission has been considered

1.1 Part 1: Testing Range of “9 kHz to 30MHz”

NOTE1: No peak found in the Test Range of “9 kHz to 30MHz”

1.2 Part 2: Testing Range of “30 MHz to 1 GHz”

Note 1: The test results and plot for testing range of “30 MHz to 1 GHz” showed as below is the WORST case for all Test Modes and Channels. This range will not be presented for each Test Mode and each Channel.

Note 2: The emissions in this range are mainly from the Platform Device (Notepad PC and its ancillary components).

Full Spectrum

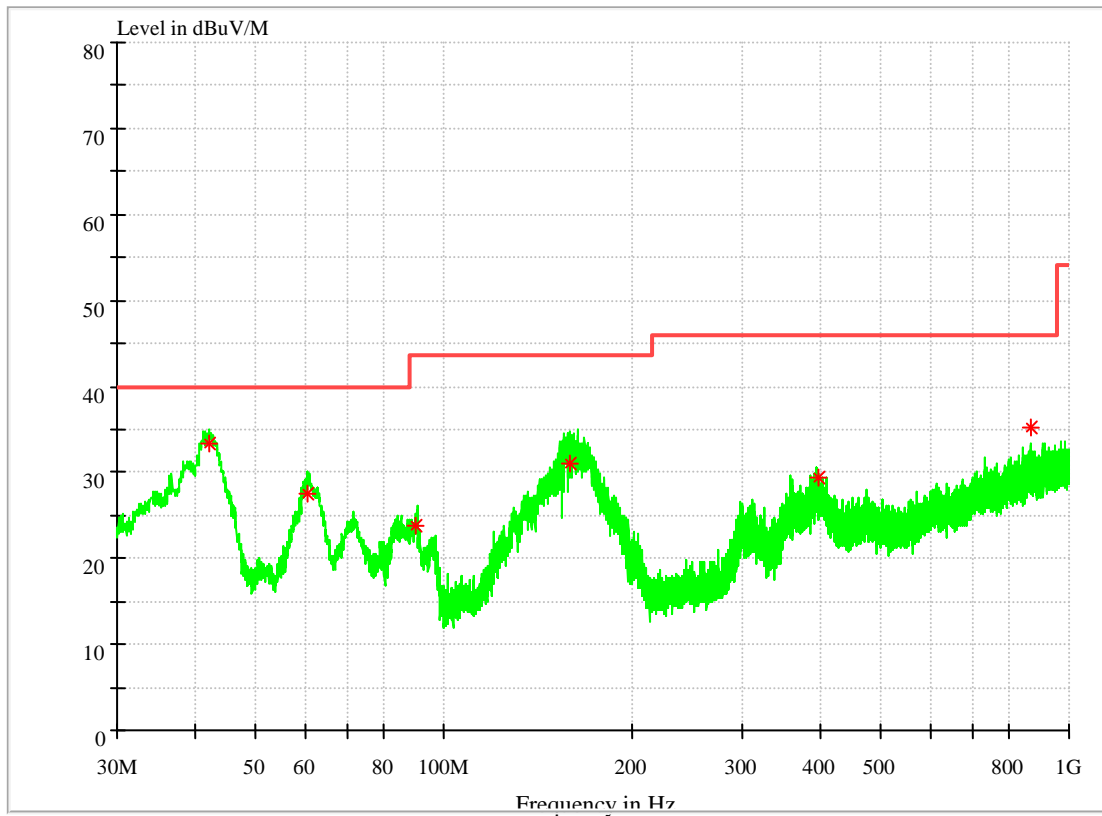



Frequency (MHz)	Level (dB μ V/m)	Limit (dB μ V/m)	Margin (dB)	Height (cm)	Pol	Azimuth	Transd. (dB)
42.046760	33.25	40.00	6.75	101.0	H	78.0	17.9
60.640540	27.61	40.00	12.39	101.0	H	165.0	11.9
90.246000	23.86	43.50	19.64	102.0	H	137.0	9.8
158.976060	31.12	43.50	12.38	101.0	H	259.0	11.7
396.723140	29.44	46.00	16.56	101.0	H	0.0	18.9
869.518460	35.18	46.00	10.82	292.0	H	140.0	26.4

Note:

1, Level = Reading level by receiver + Transd (Antenna factor + cable loss – preamplifier gain)

The reading level is calculated by software which is not shown in the sheet.

2, Margin = Limit - Level

1.3 Part 3: Testing Range of “1GHz to 3GHz”

Note 1: The testing range of “1GHz to 3 GHz” is for checking radiated emissions located in restricted bands near the EUT operating bands.

Note 2: Two limits are required in the testing range above 1 GHz, that is Peak limit (74 dB μ V/m) and Average Limit (54 dB μ V/m).

Note 3: The peak spike exceeds the limit line is EUT’s operating frequency.

Test Mode:

1.3.1 Test Mode: TM1

Full Spectrum

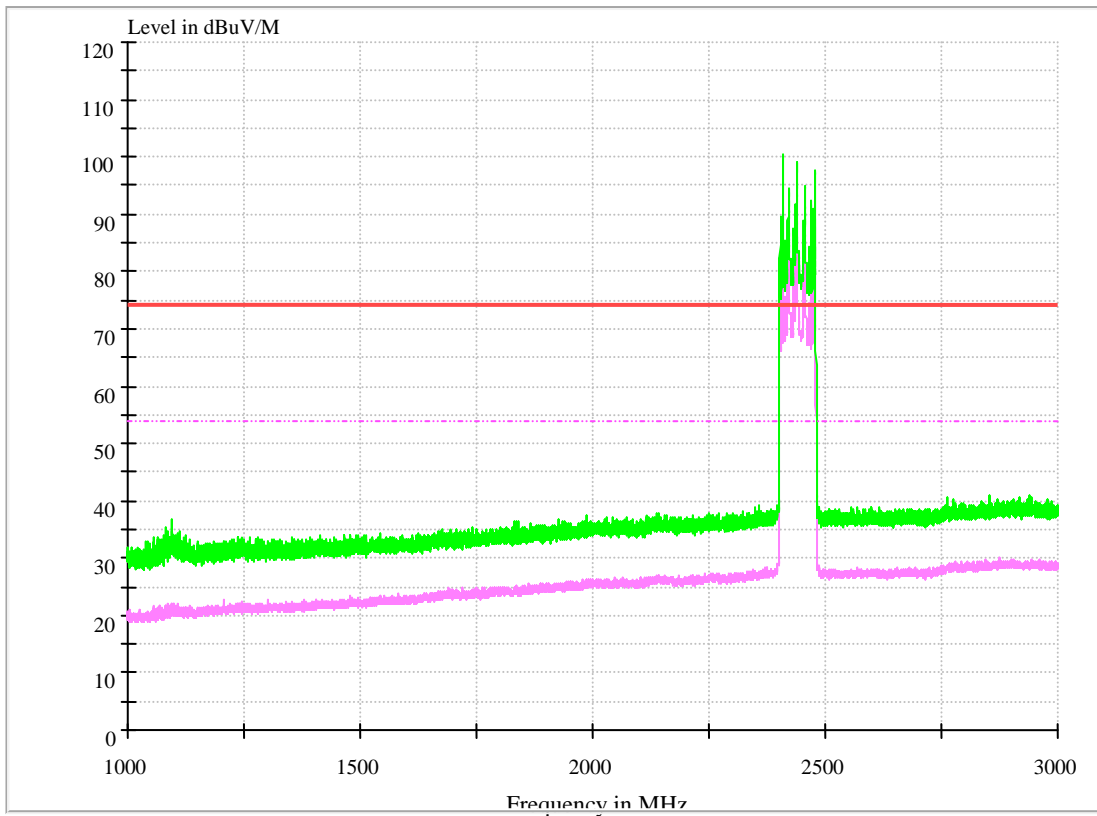

1.3.1.1 Channel 0

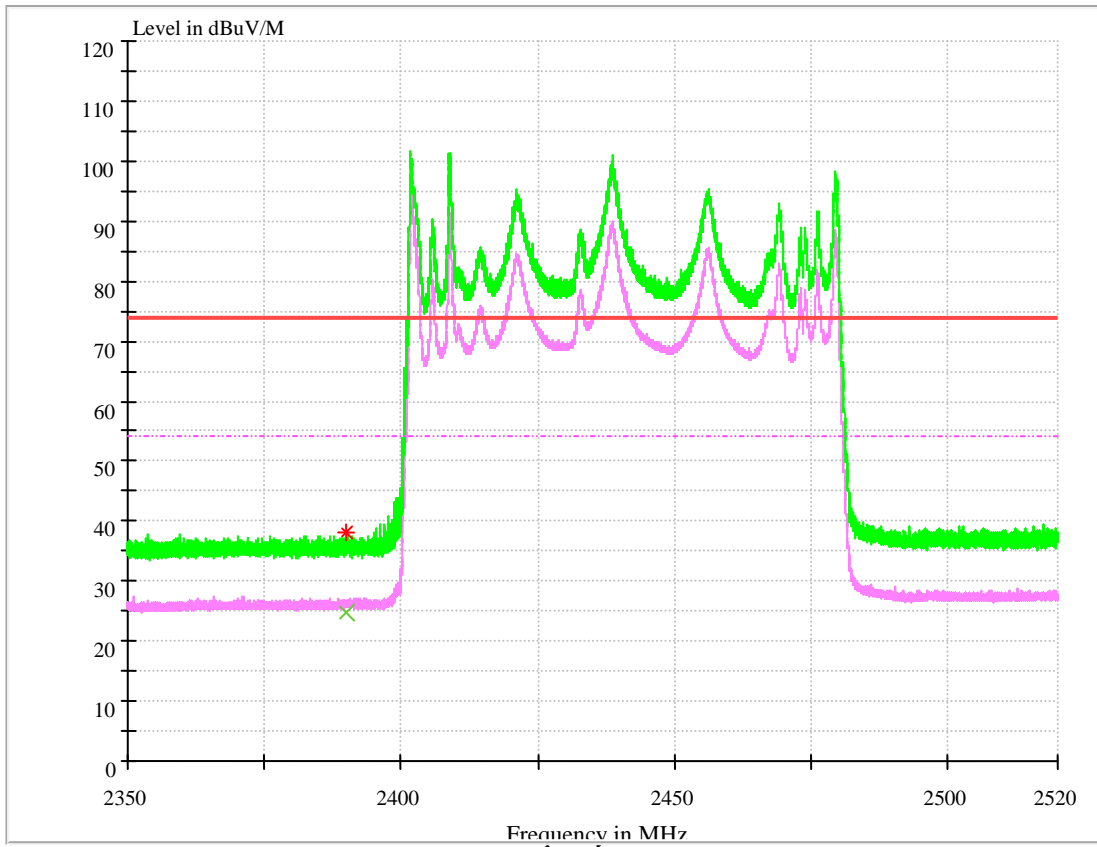

MEASUREMENT RESULT: AV Detector

Frequency (MHz)	Level (dB μ V/m)	Limit (dB μ V/m)	Margin (dB)	Height (cm)	Pol	Azimuth h	Transd. (dB)
2390	24.75	54.00	29.25	150.0	H	45.0	-8.6

MEASUREMENT RESULT: PK Detector

Frequency (MHz)	Level (dB μ V/m)	Limit (dB μ V/m)	Margin (dB)	Height (cm)	Pol	Azimuth h (deg)	Transd. (dB)
2390	38.26	74.00	35.74	150.0	H	96.0	-8.6

Note:

1, Level =Reading level by receiver + Transd (Antenna factor + cable loss – preamplifier gain)

The reading level is calculated by software which is not shown in the sheet.

2, Margin=Limit - Level

1.3.1.2 Channel 39

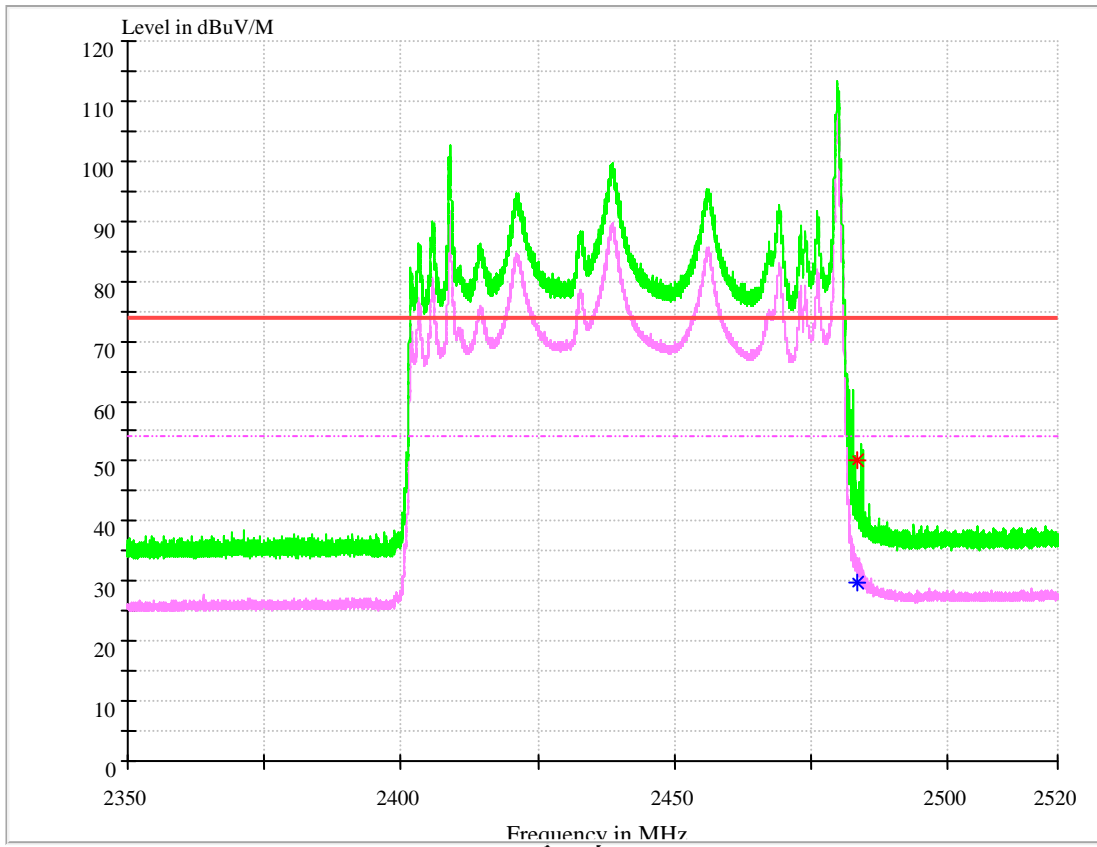

MEASUREMENT RESULT: AV Detector

Frequency (MHz)	Level (dB μ V/m)	Limit (dB μ V/m)	Margin (dB)	Height (cm)	Pol	Azimuth h	Transd. (dB)
2483.5	28.75	54.00	25.25	150.0	H	86.0	-6.8

MEASUREMENT RESULT: PK Detector

Frequency (MHz)	Level (dB μ V/m)	Limit (dB μ V/m)	Margin (dB)	Height (cm)	Pol	Azimuth h (deg)	Transd. (dB)
2483.5	45.13	74.00	28.87	150.0	H	132.0	-6.8

Note:

1, Level =Reading level by receiver + Transd (Antenna factor + cable loss – preamplifier gain)

The reading level is calculated by software which is not shown in the sheet.

2, Margin=Limit - Level

1.4 Part 4: Testing Range of “3 GHz to 18 GHz”

- Note 1: The test results and plot for testing range of “3 GHz to 18 GHz” showed as below is the WORST case for all Test Modes and Channels. This range will not be presented for each Test Mode and each Channel.
- Note 2: The testing range of “3 GHz to 18 GHz” is for checking radiated emissions located in restricted bands faraway from the EUT operating bands.
- Note 3: Two limits are required in the testing range above 1 GHz, that is Peak limit (74 dB μ V/m) and Average Limit (54 dB μ V/m).

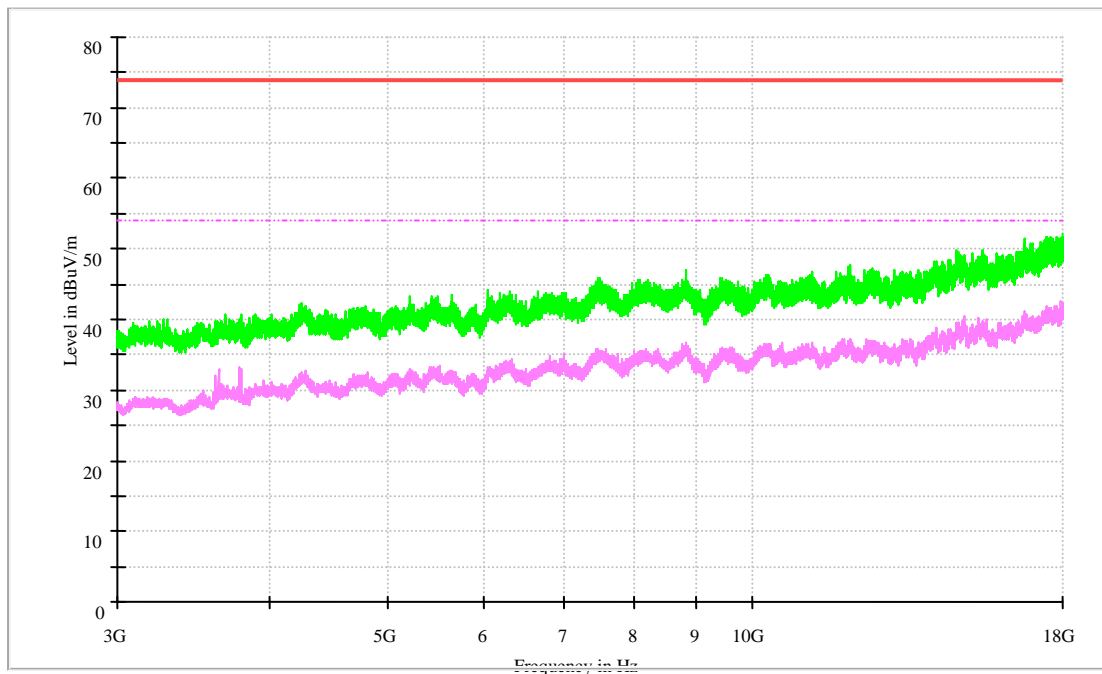



1.5 Part 5: Testing Range of “18 GHz to 26.5 GHz”

NOTE: No peak found in the Test Range of “18 GHz to 26.5GHz”

Appendix I: Conducted Emission at Power Port

Note: RBW = 9 kHz, VBW = 30 kHz

Channel 39

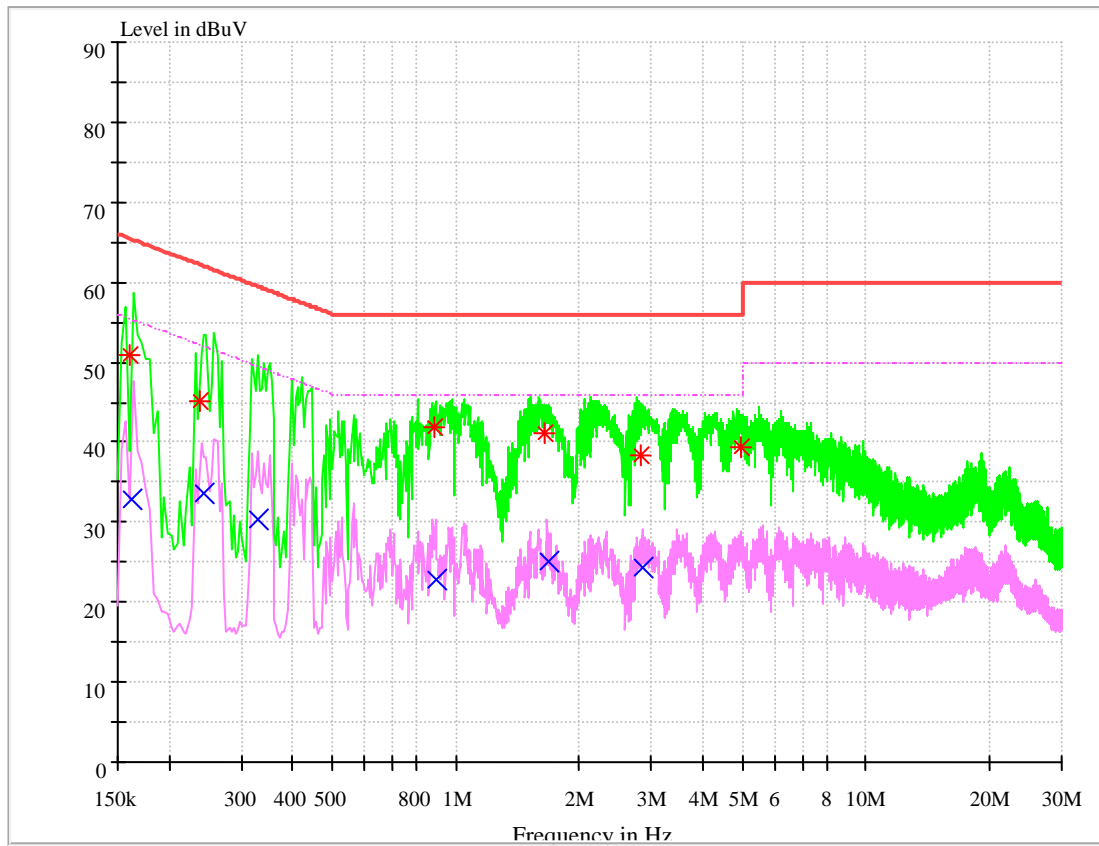

MEASUREMENT RESULT: PK Detector

Frequency (MHz)	Level (dB μ V)	Limit (dB μ V)	Transd. (dB)	Margin (dB)	Line	PE
0.160701	50.79	65.43	9.7	14.63	L1	FLO
0.238044	45.10	62.16	9.7	17.07	L1	FLO
0.891598	41.87	56.00	9.7	14.13	N	FLO
1.638734	41.13	56.00	9.7	14.87	L1	FLO
2.810877	38.46	56.00	9.7	17.54	L1	FLO
4.941005	39.41	56.00	9.7	16.59	N	FLO

MEASUREMENT RESULT: AV Detector

Frequency (MHz)	Level (dB μ V)	Limit (dB μ V)	Transd. (dB)	Margin (dB)	Line	PE
0.161571	32.84	55.38	9.7	22.54	N	FLO
0.244341	33.63	51.95	9.7	18.32	L1	FLO
0.328808	30.40	49.48	9.7	19.08	L1	FLO
0.899221	22.74	46.00	9.7	23.26	N	FLO
1.680693	25.13	46.00	9.7	20.87	L1	FLO
2.866952	24.25	46.00	9.7	21.75	L1	FLO

Note:

1, Level =Reading level by receiver + Transd (Antenna factor + cable loss – preamplifier gain)

The reading level is calculated by software which is not shown in the sheet.

2, Margin=Limit - Level

END