



中国认可
国际互认
检测
TESTING
CNAS L0310



FCC&IC RF Test Report

Product Name: Smart Phone

Model Number: CLT-L04

Report No.: SYBH(Z-RF)20171129004001-2003

FCC ID: QISCLT-L04

IC: 6369A-CLTL04

Reliability Laboratory of Huawei Technologies Co., Ltd.

(Global Compliance and Testing Center of Huawei Technologies Co., Ltd)

Administration Building, Headquarters of Huawei Technologies Co., Ltd., Bantian, Longgang District,
Shenzhen, 518129, P.R.C

Tel: +86 755 28780808

Fax: +86 755 89652518



Notice

1. The laboratory has passed the accreditation by China National Accreditation Service for Conformity Assessment (CNAS). The accreditation number is L0310.
2. The laboratory has passed the accreditation by The American Association for Laboratory Accreditation (A2LA). The accreditation number is 2174.01.
3. The laboratory has been recognized by the US Federal Communications Commission (FCC) to perform compliance testing subject to the Commission's Certification rules. The Designation Number is CN1173, and the Test Firm Registration Number is 294140.
4. The laboratory has been listed by Industry Canada to perform electromagnetic emission measurements. The recognition numbers of test site are 6369A-1.
5. The laboratory (Reliability Lab of Huawei Technologies Co., Ltd) is also named "Global Compliance and Testing Center of Huawei Technologies Co., Ltd", the both names have coexisted since 2009.
6. The test report is invalid if not marked with the signatures of the persons responsible for preparing and approving the test report.
7. The test report is invalid if there is any evidence of erasure and/or falsification.
8. The test report is only valid for the test samples.
9. Content of the test report, in part or in full, cannot be used for publicity and/or promotional purposes without prior written approval from the laboratory.



Applicant: Huawei Technologies Co., Ltd.
Address: Administration Building, Headquarters of Huawei Technologies Co., Ltd.,
Bantian, Longgang District, Shenzhen, 518129, P.R.C

Date of Receipt Sample: 2018-01-08
Start Date of Test: 2018-01-08
End Date of Test: 2018-02-07

Test Result: Pass

Approved by Senior Engineer:	2018-02-07	Roger zhang	<i>Roger Zhang</i>
	Date	Name	Signature

Prepared by:	2018-02-07	Pan Man	<i>Panman</i>
	Date	Name	Signature



CONTENT

1	General Information.....	5
1.1	Applied Standard.....	5
1.2	Test Location	5
1.3	Test Environment Condition.....	5
2	Test Summary	6
2.1	Measurement Technical Requirements.....	6
3	Description of the Equipment under Test (EUT)	9
3.1	General Description	9
3.2	EUT Identity	9
3.3	Technical Description.....	11
4	General Test Conditions / Configurations.....	13
4.1	Test Modes	13
4.2	EUT Configurations.....	13
4.3	Test Environments	17
4.4	Test Setups.....	18
4.5	Test Conditions	21
5	Main Test Instruments	22
6	Appendixes.....	22



1 General Information

1.1 **Applied Standard**

Applied Rules: 47 CFR FCC Part 2, Subpart J
47 CFR FCC Part 15, Subpart C
47 CFR FCC Part 15, Subpart E

IC RSS-Gen (Issue 4, November 2014)
IC RSS-247 (Issue2,February 2017)

Test Method: KDB 789033 D02 General UNII Test Procedures New Rules v02
FCC KDB 558074 D01 DTS Meas Guidance v04
FCC KDB 662911 D01 Multiple Transmitter Output v02r01
ANSI C63.10-2013, American National Standard for Testing Unlicensed Wireless Devices

1.2 **Test Location**

Test Location 1: Reliability Laboratory of Huawei Technologies Co., Ltd.
Address: Administration Building, Headquarters of Huawei Technologies Co., Ltd., Bantian, Longgang District, Shenzhen, 518129, P.R.C

1.3 **Test Environment Condition**

Temperature: 15 to 30 °C (Ambient)
Relative Humidity: 20 to 85 % (Ambient)
Atmospheric Pressure: Not applicable

2 Test Summary

2.1 Measurement Technical Requirements

2.1.1 U-NII (5150-5250, 5250-5350, 5470-5725 MHz,5725-5850)

Test Item	Band	FCC Rule	IC Rule No.	Requirements	Test Result	Verdict
Emission Bandwidth	5150-5250	15.403(i) 15.407(a) (1)	RSS-gen, §6.6	No limit.	Appendix A	Pass
	5250-5350	15.403(i) 15.407(a) (2)	RSS-gen, §6.6			
	5470-5725	15.403(i) 15.407(a) (2)	RSS-gen, §6.6			
	5725-5850	15.403(i) 15.407(e)	RSS-gen, §6.6 RSS-247, §6.2.4.1	≥ 500 kHz.		
Occupied Bandwidth	5150-5250	KDB 789033 D02 § D	RSS-gen, §6.6	No limit.	Appendix B	Pass
	5250-5350		RSS-gen, §6.6			
	5470-5725		RSS-gen, §6.6			
	5725-5850		RSS-gen, §6.6 15.407 (e)			
Duty Cycle	5150-5850	--	--	No limit.	Appendix C	Pass
Maximum Output Power	5150-5250	15.407(a) (1) 15.407(a) (4)	RSS-247, §6.2.1 RSS-gen, §6.12	FCC: conducted < 250mW (avg during transmission) IC e.i.r.p <MIN{200mW,10dBm+10*Ig (OBW)} (avg during transmission)	Appendix D	Pass
	5250-5350	15.407(a) (2) 15.407(a)	RSS-247, §6.2.2 RSS-gen, §6.12	conducted <MIN{250mW,11dBm+10*Ig (EBW)} (avg during		

Test Item	Band	FCC Rule	IC Rule No.	Requirements	Test Result	Verdict
		(4)		transmission)		
	5470-5725	15.407(a) (2) 15.407(a) (4)	RSS-247, §6.2.3 RSS-gen, §6.12	FCC: conducted <MIN{250mW,11dBm+10*Ig(EBW)} (avg during transmission) IC: conducted <MIN{250mW,11dBm+10*Ig(OBW)} (avg during transmission) e.i.r.p <MIN{1W,17dBm+10*Ig(OBW)} (avg during transmission)		
	5725-5850	15.407(a) (3)	RSS-247, §6.2.4 RSS-gen, §6.12	conducted < 1W (avg during transmission)		
maximum Power Spectral Density	5150-5250	15.407(a) (1) 15.407(a) (4)	RSS-247, §6.2.1	FCC conducted <11dBm/MHz (avg during transmission) IC: e.i.r.p <10dBm/MHz (avg during transmission)	Appendix E	Pass
	5250-5350	15.407(a) (2) 15.407(a) (4)	RSS-247, §6.2.2	conducted <11dBm/MHz (avg during transmission)		
	5470-5725	15.407(a) (2) 15.407(a) (4)	RSS-247, §6.2.3	conducted <11dBm/MHz (avg during transmission)		
	5725-5850	15.407(a) (3) 15.407(a) (4)	RSS-247, §6.2.4	conducted <30dBm/500KHz (avg during transmission)		



Test Item	Band	FCC Rule	IC Rule No.	Requirements	Test Result	Verdict
Frequency Stability	5150-5250 5250-5350 5470-5725 5725-5850	15.407(g)	RSS-Gen, 6.11	FCC Part 15.407(g) IC RSS-Gen, 6.11	Appendix F	Pass



3 Description of the Equipment under Test (EUT)

3.1 General Description

CLT-L04 is subscriber equipment in the LTE/ WCDMA/GSM system. The LTE frequency band is Band 1,Band 2,Band 3,Band 4,Band 5, Band 6, Band 7,Band 8, Band 9,Band 12,Band17, Band 18 ,Band 19, Band 20, Band 26, Band 28, Band 32, Band 34,Band 38,Band39, Band 40 and Band 41. The SUPA/HSDPA/UMTS frequency band is Band I, Band II, Band IV, Band V, Band VI, Band VIII and Band XIX, The GSM/GPRS/EDGE frequency band includes GSM850 and GSM900 and DCS1800 and PCS1900, The Mobile Phone implements such functions as RF signal receiving/transmitting, LTE/ WCDMA /GSM protocol processing, voice, video, MMS service, GPS, NFC and WIFI etc. Externally it provides earphone port (to provide voice service) and dual USIM card interfaces. It also provides Bluetooth module to synchronize data between a PC and the phone, or to use the built-in modem of the phone to access the Internet with a PC, or to exchange data with other Bluetooth devices.

Note1: Only 5G WIFI test data included in this report.















3.2 EUT Identity

NOTE: Unless otherwise noted in the report, the functional boards installed in the units shall be selected from the below list, but not means all the functional boards listed below shall be installed in one unit.

3.2.1 Board

Board		
Description	Hardware Version	Software Version
Main Board	HL1CLTM	CLT-L04 8.0.1.72(SP2C900)

3.2.2 Sub-Assembly

Sub-Assembly			
Sub-Assembly Name	Model	Manufacturer	Description
Adapter	HW-050450B00	Huawei Technologies Co.,Ltd.	Input Voltage: 100V-240V~50/60Hz, 0.75A Output voltage: 5V  2A OR 4.5V  5A OR 5V  4.5A Rated Power: 10W/22.5W
Adapter	HW-050450E00	Huawei Technologies Co.,Ltd.	Input Voltage: 100V-240V~50/60Hz, 0.75A Output Voltage: 5V  2A OR 4.5V  5A OR 5V  4.5A Rated Power: 10W/22.5W
Adapter	HW-050450U00	Huawei Technologies Co.,Ltd.	Input Voltage: 100V-240V~50/60Hz, 0.75A Output Voltage: 5V  2A OR 4.5V  5A OR 5V  4.5A Rated Power: 10W/22.5W
Adapter	HW-050450A00	Huawei Technologies Co.,Ltd.	Input Voltage: ~100-240V 50/60Hz 0.75A Output Voltage: 5V  2A OR 4.5V  5A OR 5V  4.5A Rated Power: 10W/22.5W
Rechargeable Li-ion	HB436486ECW	Huawei Technologies Co.,Ltd.	Rated capacity: 3900mAh Nominal Voltage:  +3.82V Charging Voltage:  +4.4V

3.3 Technical Description

Characteristics	Description	
IEEE 802.11 WLAN Mode Supported	<input checked="" type="checkbox"/> 802.11a (20 MHz channel bandwidth), <input checked="" type="checkbox"/> 802.11n (20 MHz channel bandwidth), <input checked="" type="checkbox"/> 802.11n (40 MHz channel bandwidth), <input checked="" type="checkbox"/> 802.11ac (20 MHz channel bandwidth), <input checked="" type="checkbox"/> 802.11ac (40 MHz channel bandwidth), <input checked="" type="checkbox"/> 802.11ac (80 MHz channel bandwidth),	
TX/RX Operating Range	All	$f_c = 5000 \text{ MHz} + N * 5 \text{ MHz}$, where: - f_c = "Operating Frequency" in MHz, - N = "Channel Number".
	5150-5250 MHz (U-NII)	$N = 36$ to 48 with step of 4 for the 20 MHz channel bandwidth. $N = 38$ to 46 with step of 8 for the 40 MHz channel bandwidth. $N = 42$ for the 80 MHz channel bandwidth.
	5250-5350 MHz (U-NII)	$N = 52$ to 64 with step of 4 for the 20 MHz channel bandwidth. $N = 54$ to 62 with step of 8 for the 40 MHz channel bandwidth. $N = 58$ for the 80 MHz channel bandwidth.
	5470-5600 MHz (U-NII)(for IC)	$N = 100$ to 116 with step of 4 for the 20 MHz channel bandwidth. $N = 102$ to 110 with step of 8 for the 40 MHz channel bandwidth. $N = 106$ for the 80 MHz channel bandwidth.
	5470-5650 MHz (U-NII) (for FCC)	$N = 100$ to 128 with step of 4 for the 20 MHz channel bandwidth. $N = 102$ to 126 with step of 8 for the 40 MHz channel bandwidth. $N = 106$ to 122 with step of 16 for the 80 MHz channel bandwidth.
	5650-5725 MHz (U-NII)	$N = 132$ to 144 with step of 4 for the 20 MHz channel bandwidth. $N = 134$ to 142 with step of 8 for the 40 MHz channel bandwidth. $N = 138$ for the 80 MHz channel bandwidth.
	5725-5850MHz(U-NII)	$N = 149$ to 165 with step of 4 for the 20 MHz channel bandwidth. $N = 151$ to 159 with step of 8 for the 40 MHz channel bandwidth. $N = 155$ for the 80 MHz channel bandwidth.
Modulation Type	BPSK/QPSK/16QAM/64QAM (OFDM).	
Emission Designator	U-NII(5150-5250, 5250-5350, 5470-5725, 5725-5850)	17M7G7D (for 802.11a mod), 18M6G7D (for 802.11n 20 MHz mode), 36M7G7D (for 802.11n 40 MHz mode), 18M5G7D (for 802.11ac 20 MHz mode) 36M6G7D (for 802.11ac 40 MHz mode) 76M3G7D (for 802.11ac 80 MHz mode)
TPC	<input type="checkbox"/> Supported, <input checked="" type="checkbox"/> Not Supported	
Antenna	Type	<input type="checkbox"/> External, <input checked="" type="checkbox"/> Integrated
	Ports	<input checked="" type="checkbox"/> Ant 1, <input checked="" type="checkbox"/> Ant 2, <input type="checkbox"/> Ant 3, <input type="checkbox"/> Ant 4
	Smart System	<input checked="" type="checkbox"/> SISO (for 802.11a/n/ac), <input checked="" type="checkbox"/> CDD (for 802.11a), <input checked="" type="checkbox"/> MIMO (for 802.11n/ac), <input type="checkbox"/> Diversity (for 802.11a) : Tx & Rx
	Gain	Ant1:-2.11 dBi (per antenna port, max.)



Characteristics	Description			
		Ant2 :-1.17dBi (per antenna port, max.)		
	Remark	When the EUT is put into service, the practical maximum antenna gain should NOT exceed the value as described above.		
Power Supply	Type	<input checked="" type="checkbox"/> AC/DC Adapter	<input type="checkbox"/> PoE:	<input type="checkbox"/> Other:

4 General Test Conditions / Configurations

4.1 Test Modes

NOTE: Worst cases for each IEEE 802.11 mode are selected to perform tests.

Test Mode	Test Modes Description
11A	IEEE 802.11a with data rate of 6 Mbps using SISO mode.
11A_CDD	IEEE 802.11a with data rate of 6 Mbps using CDD mode.
11N20	IEEE 802.11n with data rate of MCS0 and bandwidth of 20 MHz using SISO mode.
11N20m	IEEE 802.11n with data rate of MCS8 and bandwidth of 20 MHz using MIMO mode.
11N40	IEEE 802.11n with data rate of MCS0 and bandwidth of 40 MHz using SISO mode.
11N40m	IEEE 802.11n with data rate of MCS8 and bandwidth of 40 MHz using MIMO mode.
11AC20	IEEE 802.11ac with data rate of MCS0 and bandwidth of 20 MHz using SISO mode.
11AC20m	IEEE 802.11ac with data rate of MCS8 and bandwidth of 20 MHz using SISO mode.
11AC40	IEEE 802.11ac with data rate of MCS0 and bandwidth of 40 MHz using SISO mode.
11AC40m	IEEE 802.11ac with data rate of MCS8 and bandwidth of 40 MHz using MIMO mode.
11AC80	IEEE 802.11ac with data rate of MCS0 and bandwidth of 80 MHz using SISO mode.
11AC80m	IEEE 802.11ac with data rate of MCS8 and bandwidth of 80 MHz using MIMO mode.

4.2 EUT Configurations

4.2.1 General Configurations

Configuration	Description
Test Antenna Ports	Until otherwise specified, <ul style="list-style-type: none"> ● All TX tests are performed at all TX antenna ports of the EUT, and ● All RX tests are performed at all RX antenna ports of the EUT.
Multiple RF Sources	Other than the tested RF source of the EUT, other RF source(s) are disabled or shutdown during measurements.



4.2.2 Customized Configurations

4.2.2.1 U-NII

Test Mode	Antenna Port	Power Conf.,	Duty cycle [%]
11A20	ANT 1	CH36:12.5 CH64 :12.5 CH100: 12.5 CH140:12.5 CH144: 12.5 Others: 15.5	94
11A20	ANT 2	CH36:9.5 CH 64: 9.5 CH100: 9.5 CH140:9.5 CH144: 9.5 Others: 12.5	93
11A20_CDD	ANT 1	CH36:12.5 CH64 :12.5 CH100: 12.5 CH104:12.5 CH140: 12.5 Others: 15.5	93
11A20_CDD	ANT 2	CH36:9.5 CH 64: 9.5 CH100: 9.5 CH140:9.5 CH144: 9.5 Others: 12.5	93
11N20	ANT 1	CH36:12.5 CH64: 12.5 CH100: 12.5 CH140:12.5 CH144:12.5 Others: 15.5	92
11N20	ANT 2	CH36: 9.5 CH 64: 9.5 CH100: 9.5 CH140:9.5 CH144: 9.5 Others: 12.5	93
11N20MIMO	ANT 1	CH36:12.5 CH64: 12.5	88



		CH100: 12.5 CH140:12.5 CH144:12.5 Others: 15.5	
11N20MIMO	ANT 2	CH36:9.5 CH 64: 9.5 CH100: 9.5 CH140:9.5 CH144: 9.5 Others: 12.5	88
11N40	ANT 1	CH38:10 CH62: 10 CH102:10 CH142:10 Others: 13	91
11N40	ANT 2	CH38:8.5 CH62: 8.5 CH102:8.5 CH142:8.5 Others: 10	92
11N40MIMO	ANT 1	CH38:10 CH62: 10 CH102:10 CH142:10 Others: 13	87
11N40MIMO	ANT 2	CH38:8.5 CH62: 8.5 CH102:8.5 CH142:8.5 Others: 10	87
11AC20	ANT 1	CH36:12.5 CH64: 12.5 CH100: 12.5 CH140:12.5 CH144:12.5 Others: 15.5	93
11AC20	ANT 2	CH36:9.5 CH64: 9.5 CH100: 9.5 CH140:9.5 CH144:9.5 Others: 12.5	93
11AC20MIMO	ANT 1	CH36:12.5 CH64: 12.5	88



		CH100: 12.5 CH140:12.5 CH144:12.5 Others: 15.5	
11AC20MIMO	ANT 2	CH36:9.5 CH64: 9.5 CH100: 9.5 CH140:9.5 CH144:9.5 Others: 12.5	87
11AC40	ANT 1	CH38:10 CH62: 10 CH102:10 CH142:10 Others: 13	92
11AC40	ANT 2	CH38:8.5 CH62: 8.5 CH102:8.5 CH142:8.5 Others: 10	92
11AC40MIMO	ANT 1	CH38:10 CH62: 10 CH102:10 CH142:10 Others: 13	87
11AC40MIMO	ANT 2	CH38:8.5 CH62: 8.5 CH102:8.5 CH142:8.5 Others: 10	87
11AC80	ANT 1	CH42:10 CH58:10 CH106: 10 CH138: 10 Others: 11.5	91
11AC80	ANT 2	All:8.5	91
11AC80MIMO	ANT 1	CH42:10 CH58:10 CH106: 10 CH138: 10 Others: 11.5	86
11AC80MIMO	ANT 2	All:8.5	86



4.3 Test Environments

Environment Parameter	Selected Values During Tests	
Relative Humidity	Ambient	
Temperature	TN	Ambient
Voltage	VL	3.6V
	VN	3.82V
	VH	4.35V

NOTE: VL= lower extreme test voltage
VN= nominal voltage
VH= upper extreme test voltage
TN= normal temperature

4.4 Test Setups

4.4.1 Test Setup 1

The WLAN component's antenna ports(s) of the EUT are connected to the measurement instrument per an appropriate attenuator. The EUT is controlled by PC/software to emit the specified signals for the purpose of measurements.

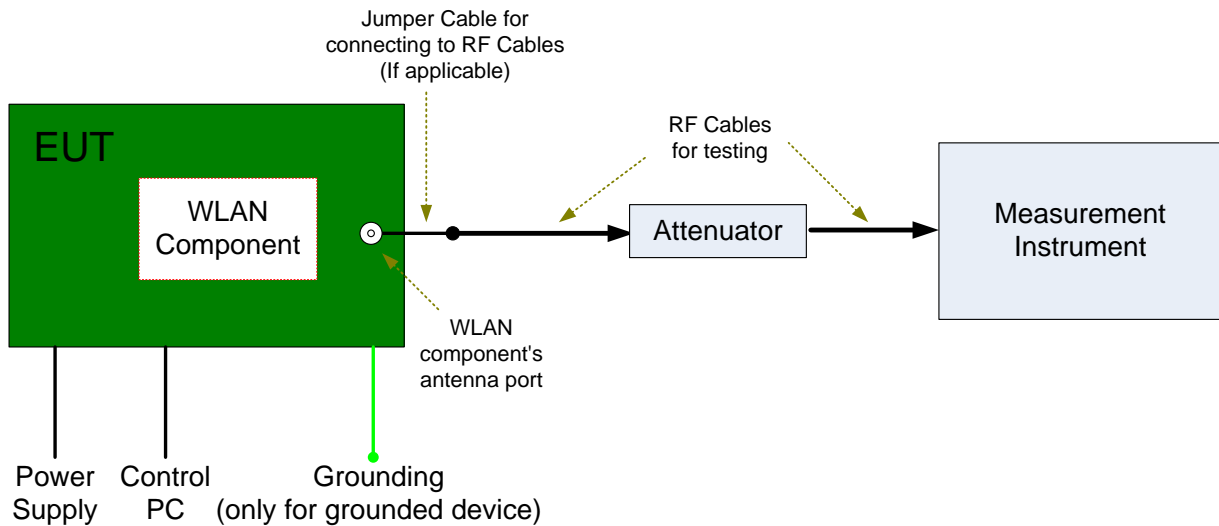

4.4.2 Test Setup 2

The test site semi-anechoic chamber has met the requirement of NSA tolerance 4 dB according to the standards: ANSI C63.4. The test distance is 3 m (for 30 MHz to 26.5 GHz) or 1 m (for 26.5 GHz to 40 GHz). The setup is according to ANSI C63.10, ANSI C63.4 and CAN/CSA-CEI/IEC CISPR 22.

The maximal emission value is acquired by adjusting the antenna height, polarisation and turntable azimuth. Normally, the height range of antenna is 1 m to 4 m, the azimuth range of turntable is 0° to 360°, and the receive antenna has two polarizations Vertical (V) and Horizontal (H).

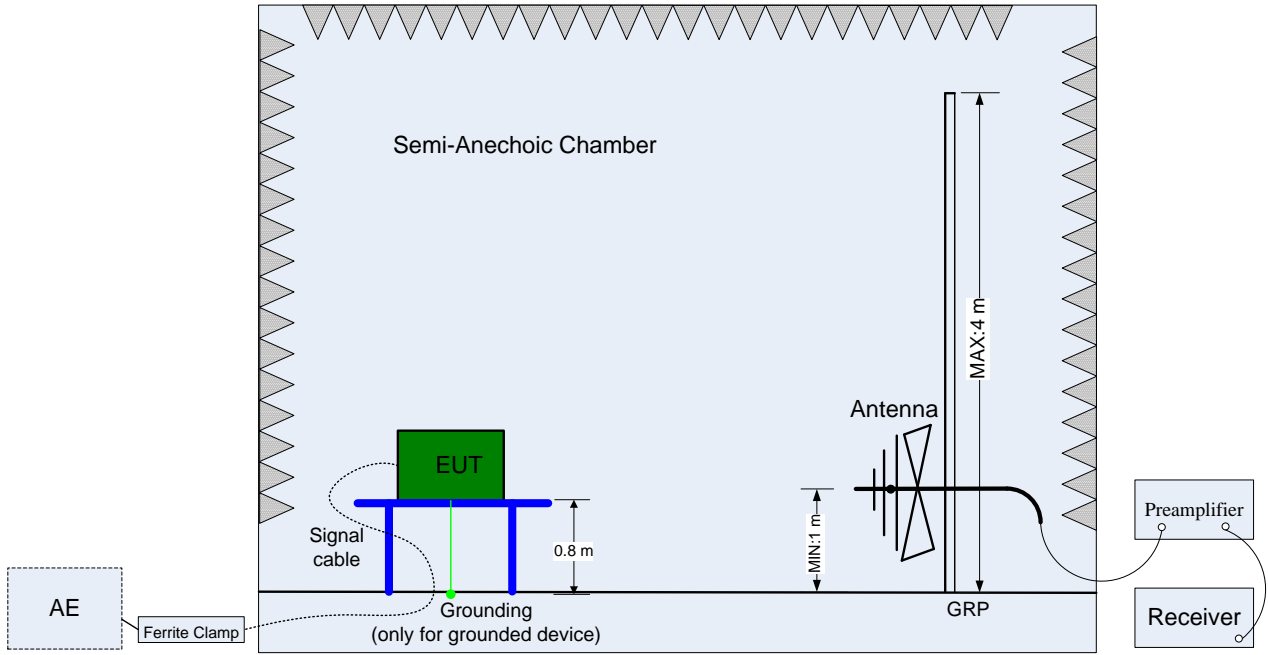

(Below 1 GHz)

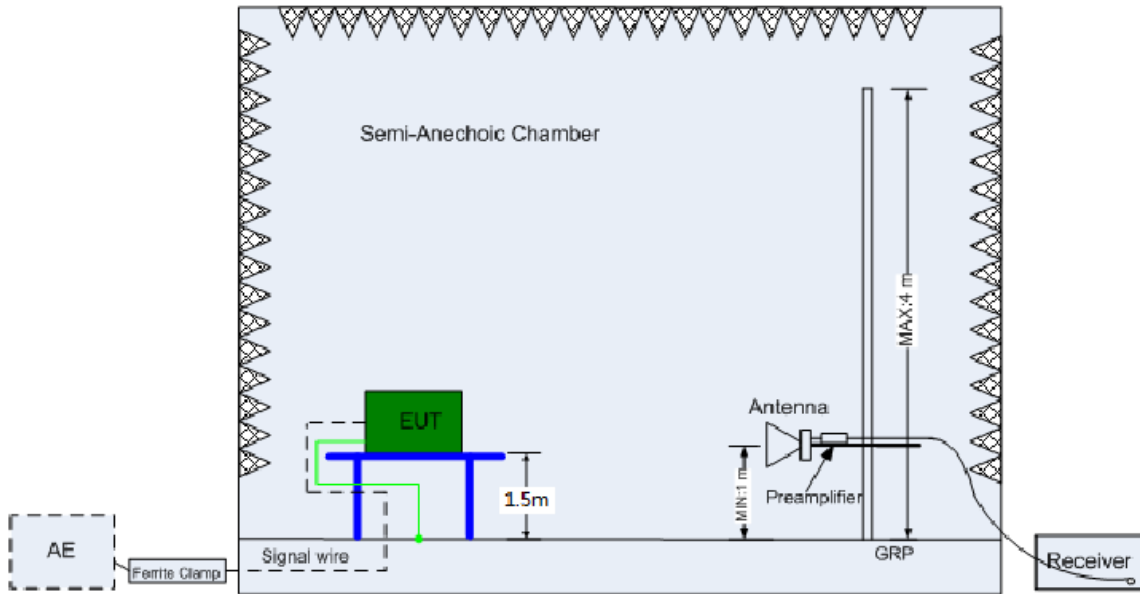

(Above 1 GHz)

4.4.3 Test Setup 3

The mains cable of the EUT (maybe per AC/DC Adapter) must be connected to LISN. The LISN shall be placed 0.8 m from the boundary of EUT and bonded to a ground reference plane for LISN mounted on top of the ground reference plane. This distance is between the closest points of the LISN and the EUT. All other units of the EUT and associated equipment shall be at least 0.8 m from the LISN.

Ground connections, where required for safety purposes, shall be connected to the reference ground point of the LISN and, where not otherwise provided or specified by the manufacturer, shall be of same length as the mains cable and run parallel to the mains connection at a separation distance of not more than 0.1 m.

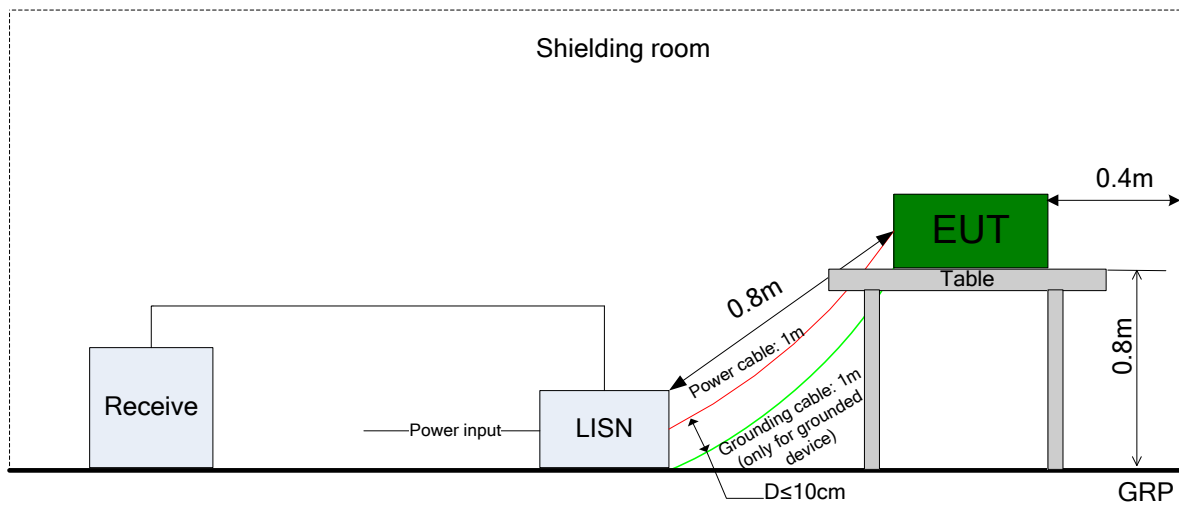

4.5 Test Conditions

4.5.1 U-NII

Test Case	Test Conditions	
	Configuration	Description
Emission Bandwidth (EBW)	Meas. Method	FCC KDB 789033 D02 §C).
	Test Env.	NTNV
	Test Setup	Test Setup 1
	EUT Conf.	All EUT conf. with Tx modes.
Occupied Bandwidth (OBW)	Meas. Method	FCC KDB 789033 D02 §D).
	Test Env.	NTNV
	Test Setup	Test Setup 1
	EUT Conf.	All EUT conf. with Tx modes.
Maximum Conducted Output Power	Meas. Method	FCC KDB 789033 D02 §E)2)b) Method SA-1 and d) Method SA-2.
	Test Env.	NTNV
	Test Setup	Test Setup 1
	EUT Conf.	All EUT conf. with Tx modes.
Maximum Power Spectral Density	Meas. Method	FCC KDB 789033 D02 §F).
	Test Env.	NTNV
	Test Setup	Test Setup 1
	EUT Conf.	All EUT conf. with Tx modes.
Frequency Stability	Meas. Method	15.407(g) Frequency Stability
	Test Env.	(1)VL, VN and VH of Rated Voltage at Ambient Climate. (2) -5 °C,5°C,15°C,25°C,35°C,45°C,50°C
	Test Setup	Test Setup 1
	EUT Conf.	Ch.36,Ch.165



5 Main Test Instruments

NOTE: Unless otherwise specified, the calibration intervals for test instruments were Annual (per year). The other intervals, if applicable, are marked with (##y), which denotes ## years calibration interval.

Main Test Equipments					
Equipment Name	Manufacturer	Model	Serial Number	Cal Date	Cal- Due
Power supply	KEITHLEY	2303	000500E	2017/5/31	2018/5/30
Wireless Communication Test set	Agilent	N4010A	MY49081592	2017/7/31	2018/7/30
Universal Radio Communication Tester	R&S	CMU200	110932	2017/5/2	2018/5/1
Spectrum Analyzer	Agilent	N9020A	MY52090652	2017/7/10	2018/7/9
Universal Radio Communication Tester	R & S	CMW500	126854	2017/10/19	2018/10/18
Signal Analyzer	R&S	FSQ31	200021	2017/7/31	2018/7/30
Spectrum Analyzer	Agilent	N9030A	MY49431698	2017/7/31	2018/7/30
Temperature Chamber	WEISS	WKL64	56246002940010	2017/12/13	2018/12/12
Signal generator	Agilent	E8257D	MY49281095	2017/7/31	2018/7/30
Vector Signal Generator	R&S	SMU200A	104162	2017/7/31	2018/7/30
Power Detecting & Sampling Unit	R&S	OSP-B157	100914	2017/7/31	2018/7/30

6 Appendixes

Appendix No.	Description
SYBH(Z-RF)20171129004001-2003-A	Appendix for 5G WLAN

END