

FCC Radio Test Report

FCC ID: QISCAG-L23

This report concerns (check one): Original Grant Class II Change

Project No. : 1701C155L
Equipment : Smart Phone
Model Name : CAG-L23
Applicant : Huawei Technologies Co., Ltd.
Address : Administration Building, Headquarters of Huawei Technologies Co., Ltd., Bantian, Longgang District, Shenzhen, 518129, P.R.C

Date of Receipt : Jan. 18, 2017
May 09, 2017
Date of Test : Jan. 18, 2017 ~ Feb. 27, 2017
May 14, 2017 ~ Jun. 05, 2017
Issued Date : Jan. 19, 2018
Tested by : BTL Inc.

Technical Engineer :

Shawn Xiao
(Shawn Xiao)

Authorized Signatory :

Steven Lu
(Steven Lu)

B T L I N C .

No.3, Jinshagang 1st Road, Shixia, Dalang Town, Dongguan, Guangdong, China.

TEL: +86-769-8318-3000 FAX: +86-769-8319-6000



Declaration

BTL represents to the client that testing is done in accordance with standard procedures as applicable and that test instruments used has been calibrated with standards traceable to international standard(s) and/or national standard(s).

BTL's reports apply only to the specific samples tested under conditions. It is manufacture's responsibility to ensure that additional production units of this model are manufactured with the identical electrical and mechanical components. **BTL** shall have no liability for any declarations, inferences or generalizations drawn by the client or others from **BTL** issued reports.

BTL's report must not be used by the client to claim product certification, approval, or endorsement by NVLAP, NIST, or any agency of the Federal Government.

This report is the confidential property of the client. As a mutual protection to the clients, the public and **BTL-self**, extracts from the test report shall not be reproduced except in full with **BTL's** authorized written approval.

BTL's laboratory quality assurance procedures are in compliance with the **ISO Guide17025** requirements, and accredited by the conformity assessment authorities listed in this test report.

Limitation

For the use of the authority's logo is limited unless the Test Standard(s)/Scope(s)/Item(s) mentioned in this test report is (are) included in the conformity assessment authorities acceptance respective.

Table of Contents	Page
REPORT ISSUED HISTORY	5
1 . CERTIFICATION	6
2 . SUMMARY OF TEST RESULTS	7
2.1 TEST FACILITY	8
2.2 MEASUREMENT UNCERTAINTY	8
3 . GENERAL INFORMATION	9
3.1 GENERAL DESCRIPTION OF EUT	9
3.2 DESCRIPTION OF TEST MODES AND TEST CONDITION	12
3.3 BLOCKDIGRAMSHOWINGTHECONFIGURATIONOFSYSTEMTESTED FOR RADIATED	15
3.4 DESCRIPTION OF SUPPORT UNITS	15
4 . TEST RESULT	16
4.1 OUTPUT POWER MEASUREMENT AND RADIATED POWER	16
4.1.1 LIMIT	16
4.1.2 TEST PROCEDURE	16
4.1.3 TESTSETUP LAYOUT	17
4.1.4 TEST DEVIATION	18
4.1.5 TEST RESULTS	18
4.2 OCCUPIED BANDWIDTH MEASUREMENT	19
4.2.1 TEST PROCEDURE	19
4.2.2 TEST SETUP LAYOUT	19
4.2.3 TEST DEVIATION	19
4.2.4 TEST RESULTS	19
4.3 CONDUCTED EMISSIONS MEASUREMENT	20
4.3.1 LIMIT	20
4.3.2 TEST PROCEDURES	20
4.3.3 TESTSETUP LAYOUT	20
4.3.4 TESTDEVIATION	20
4.3.5 TEST RESULTS	20
4.4 RADIATED EMISSIONS MEASUREMENT	21
4.4.1 LIMIT	21
4.4.2 TEST PROCEDURES	21
4.4.3 TESTSETUP LAYOUT	21
4.4.4 TESTDEVIATION	21
4.4.5 TEST RESULTS	21
4.5 BAND EDGE MEASUREMENT	22
4.5.1 LIMIT	22

Table of Contents	Page
4.5.2 TEST PROCEDURES	22
4.5.3 TESTSETUP LAYOUT	22
4.5.4 TESTDEVIATION	22
4.5.5 TEST RESULTS	22
4.6 PEAK TO AVERAGE RATIO MEASUREMENT	23
4.6.1 LIMIT	23
4.6.2 TEST PROCEDURES	23
4.6.3 TESTSETUP LAYOUT	23
4.6.4 TESTDEVIATION	23
4.6.5 TEST RESULTS	23
4.7 FREQUENCY STABILITY MEASUREMENT	24
4.7.1 LIMIT	24
4.7.2 TEST PROCEDURES	24
4.7.3 TESTSETUP LAYOUT	24
4.7.4 TESTDEVIATION	24
4.7.5 TEST RESULTS	24
5. LIST OF MEASUREMENT EQUIPMENTS	25
ATTACHMENT A - OUTPUT POWER	27
ATTACHMENT B - OCCUPIED BANDWIDTH	38
ATTACHMENT C - CONDUCTED EMISSIONS	62
ATTACHMENT D - RADIATED EMISSION	76
ATTACHMENT E - BAND EDGE	139
ATTACHMENT F - PEAK TO AVERAGE RATIO	151
ATTACHMENT G - FREQUENCY STABILITY	175

REPORT ISSUED HISTORY

Issued No.	Description	Issued Date
BTL-FCCP-6-1701C155	Original Report.	Feb. 28, 2017
BTL-FCCP-6-1701C155A	Compared with the original report (BTL-FCCP-6-1701C155), the model CRO-L23 is added and differences please see the below table. According to the differences description below table, CRO-L23 shares the same test data of CRO-L03 of the same bands which does not affect the test results of the test report.	Mar. 23, 2017
BTL-FCCP-6-1701C155E	Compared with the original report (BTL-FCCP-6-1701C155A), the antenna is changed and battery, earphone are added. The Radiated Spurious Emissions had been evaluated and recorded in the test report, the rest are the same.	Jun.06, 2017
BTL-FCCP-6-1701C155L	Compared with previous report (BTL-FCCP-6-1701C155E) 1. Changed FCC ID. 2. Changed model name CRO-L03, CRO-L23 to CAG-L23. (Only differ in Android Edition) The changes do not affect the test results, the rest are kept the same.	Jan. 19, 2018

1. CERTIFICATION

Equipment : Smart Phone
Brand Name : HUAWEI
Model Name : CAG-L23
Applicant : Huawei Technologies Co., Ltd.
Manufacturer: Huawei Technologies Co., Ltd
Address : Administration Building, Headquarters of Huawei Technologies Co., Ltd.,
Bantian, Longgang District Shenzhen China
Factory : Huawei Technologies Co., Ltd
Address : Administration Building, Headquarters of Huawei Technologies Co., Ltd.,
Bantian, Longgang District Shenzhen China
Date of Test : Jan. 18, 2017 ~ Feb. 27, 2017
May 14, 2017 ~ Jun, 05, 2017
Test Sample : Engineering Sample
Standard(s) : 47 CFR FCC Part 27
47 CFR FCC Part 2 & ANSI/TIA-603-D-2010

The above equipment has been tested and found compliance with the requirement of the relative standards by BTL Inc.

The test data, data evaluation, and equipment configuration contained in our test report (Ref No. BTL-FCCP-6-1701C155L) were obtained utilizing the test procedures, test instruments, test sites that has been accredited by the Authority of NVLAP according to the ISO-17025 quality assessment standard and technical standard(s).

Test results included in this report is only for the WCDMA Band 4, LTE Band 4, 7 part.

2. SUMMARY OF TEST RESULTS

Test procedures according to the technical standard(s):

FCC Part 27 & Part 2			
Standard(s) Section	Test Item	Judgment	Tested By
2.1046 27.50(d)(4)	Radiated power	PASS	Paul Li
2.1046 27.50(d)(4)	Conducted Output Power	PASS	Paul Li
2.1049 27.53(h)	Occupied Bandwidth	PASS	Paul Li
2.1051 27.53(h)	Conducted Spurious Emissions	PASS	Paul Li
2.1053 27.53(h)	Radiated Spurious Emissions	PASS	Paul Li
27.53(h)	Band Edge Measurements	PASS	Paul Li
27.50	Peak To Average Ratio	PASS	Paul Li
2.1055 27.54	Frequency Stability	PASS	Paul Li

NOTE:

(1) "N/A" denotes test is not applicable to this device.

2.1 TEST FACILITY

The test facilities used to collect the test data in this report is at the location of No.3,Jinshagang 1st Road, Shixia, Dalang Town, Dongguan, Guangdong, China.

BTL's test firm number for FCC: 854385

BTL's designation number for FCC: CN5020

2.2 MEASUREMENT UNCERTAINTY

Where relevant, the following measurement uncertainty levels have been estimated for tests performed on the EUT as specified in CISPR 16-4-2. The BTL measurement uncertainty is less than the CISPR 16-4-2 U_{CISPR} requirement.

The reported uncertainty of measurement $y \pm U$, where expanded uncertainty U is based on a standard uncertainty multiplied by a coverage factor of $k=2$, providing a level of confidence of approximately 95 %.

Test Site	Method	Measurement Frequency Range	Ant. H / V	U,(dB)
DG-CB03 (3m)	CISPR	9KHz ~ 30MHz	V	3.79
		9KHz ~ 30MHz	H	3.57
		30MHz ~ 200MHz	V	3.82
		30MHz ~ 200MHz	H	3.78
		200MHz ~ 1,000MHz	V	4.10
		200MHz ~ 1,000MHz	H	4.06

Test Site	Method	Measurement Frequency Range	Ant. H / V	U,(dB)
DG-CB03 (3m)	CISPR	1GHz ~ 18GHz	V	3.12
		1GHz ~ 18GHz	H	3.68

Test Site	Method	Measurement Frequency Range	Ant. H / V	U,(dB)
DG-CB03 (1m)	CISPR	18GHz ~ 40GHz	V	4.15
		18GHz ~ 40GHz	H	4.14

Note: Unless specifically mentioned, the uncertainty of measurement has not been taken into account to declare the compliance or non-compliance to the specification.

3. GENERAL INFORMATION

3.1 GENERAL DESCRIPTION OF EUT

Equipment	Smart Phone	
Brand Name	HUAWEI	
Model Name	CAG-L23	
Model Difference	N/A	
Modulation Type	WCDMA	UP: QPSK DP: QPSK,16QAM,64AQM
	LTE	UP: QPSK,16QAM DP: QPSK,16QAM,64AQM
	WCDMA Band 4	1712.4 ~1752.6MHz
Operation Frequency	LTE 4 (Channel Bandwidth: 1.4MHz)	1710.7 ~ 1754.3 MHz
	LTE 4 (Channel Bandwidth: 3MHz)	1711.5 ~ 1753.5 MHz
	LTE 4 (Channel Bandwidth: 5MHz)	1712.5 ~ 1752.5 MHz
	LTE 4 (Channel Bandwidth: 10MHz)	1715.0 ~ 1750.0 MHz
	LTE 4 (Channel Bandwidth: 15MHz)	1717.5 ~ 1747.5 MHz
	LTE 4 (Channel Bandwidth: 20MHz)	1720.0 ~ 1745.0 MHz
	LTE 7 (Channel Bandwidth: 5MHz)	2502.5 ~ 2567.5 MHz
	LTE 7 (Channel Bandwidth: 10MHz)	2505.0 ~ 2565.0 MHz
	LTE 7 (Channel Bandwidth: 15MHz)	2507.5 ~ 2562.5 MHz
LTE 7 (Channel Bandwidth: 20MHz)	2510.0 ~ 2560.0 MHz	

Max. EIRP Power	WCDMA Band 4(WCDMA)	QPSK	20.04	dBm
	WCDMA Band 4(HSDPA)	QPSK	19.02	dBm
	WCDMA Band 4(HSUPA)	QPSK	17.98	dBm
	WCDMA Band 4(DC-HSDPA)	QPSK	19.02	dBm
	LTE 4 (Channel Bandwidth: 1.4MHz)	QPSK	20.27	dBm
		16QAM	19.59	dBm
	LTE 4 (Channel Bandwidth: 3MHz)	QPSK	20.27	dBm
		16QAM	19.09	dBm
	LTE 4 (Channel Bandwidth: 5MHz)	QPSK	20.27	dBm
		16QAM	19.35	dBm
	LTE 4 (Channel Bandwidth: 10MHz)	QPSK	20.21	dBm
		16QAM	19.15	dBm
	LTE 4 (Channel Bandwidth: 15MHz)	QPSK	20.04	dBm
		16QAM	19.15	dBm
	LTE 4 (Channel Bandwidth: 20MHz)	QPSK	20.29	dBm
		16QAM	19.84	dBm
	LTE 7 (Channel Bandwidth: 5MHz)	QPSK	20.31	dBm
		16QAM	19.32	dBm
	LTE 7 (Channel Bandwidth: 10MHz)	QPSK	20.30	dBm
		16QAM	19.10	dBm
LTE 7 (Channel Bandwidth: 15MHz)	QPSK	20.32	dBm	
	16QAM	19.31	dBm	
LTE 7 (Channel Bandwidth: 20MHz)	QPSK	20.30	dBm	
	16QAM	19.34	dBm	

Antenna Type	Internal Antenna	
Antenna Gain	WCDMA Band 4	1.57 dBi
	LTE 4,	1.57 dBi
	LTE 7	1.78 dBi
Hardware Version	HL1CROM	
Software Version	Cairo-L23C469B022	
IMEI No.1	Radiated	862555030018808
	Conducted	862555030018808
Power Source	#1 DC Voltage supplied from AC/DC adapter. #2 Battery Supplied.	
Power Rating	#1:AC 100–240V 50/60Hz DC 5V 1A #2:DC 3.82V 2200mAh	

Note:

1. For a more detailed features description, please refer to the manufacturer's specifications or the user's manual.

2.

Item	Mfr/Brand	Model.
Battery	SCUD (FUJIAN) Electronics Co., Ltd	HB3742A0EZC+
	Shenzhen Desay Battery Tech Co., Ltd.	
	Sunwoda Electronic Co.,LTD.	
USB Cable	FOXCONN INTERCONNECT TECHNOLOGY LIMITED	CUBB01M-HC208-DH
	HONGLIN TECHNOLOGY CO.,LTD	130-26654
	Luxshare Precision Industry Co., Ltd.	L99U2013-CS-H
Earphone	Jiangxi Lianchuang Hongsheng Electronic Co.,LTD	MEMD1632B580C00
	BOLUO COUNTY QUANCHENG ELECTRONIC CO.,LTD	1311-3291-3.5mm-229
	MERRY ELECTRONICS CO., LTD.	EMC309-001
	Jiangxi Lianchuang Hongsheng Electronic Co.,LTD (Black)	MEMD1532B528000
	BOLUO COUNTY QUANCHENG ELECTRONIC CO.,LTD (Black)	1293#+3283# 3.5MM-150
	GoerTek (Black),	HA1-3
	GoerTek (White)	NA12
Adapter	HUIZHOU BYD ELECTRONIC CO., LTD.	HW-050100U01
	Shenzhen Huntkey Electric Co., Ltd.	
	DONG GUAN PHITEK ELECTRONICS CO., LTD.	

3.2 DESCRIPTION OF TEST MODES AND TEST CONDITION

Following channel(s) was (were) selected for the final test as listed below:

WCDMA BAND 4			
Test Item	Available Channel	Tested Channel	Mode
EIRP	1312 to 1513	1312, 1413, 1513	WCDMA,HSDPA, HSUPA
Frequency Stability	1312 to 1513	1413	WCDMA
Occupied Bandwidth	1312 to 1513	1312, 1413, 1513	WCDMA,HSDPA, HSUPA
Band Edge	1312 to 1513	1312, 1513	WCDMA,HSDPA, HSUPA
Peak to Average Ratio	1312 to 1513	1312, 1413, 1513	WCDMA,HSDPA, HSUPA
Condcudeted Emission	1312 to 1513	1413	WCDMA,HSDPA, HSUPA
Radiated Emission	1312 to 1513	1312	WCDMA,HSDPA, HSUPA

LTE BAND 4					
Test Item	Available Channel	Tested Channel	Channel Bandwidth	Modulation	Mode
EIRP	19957 to 20393	19957, 20175, 20393	1.4MHz	QPSK, 16QAM	1 RB / 0 RB Offset
	19965 to 20385	19965, 20175, 20385	3MHz	QPSK, 16QAM	1 RB / 0 RB Offset
	19975 to 20375	19975, 20175, 20375	5MHz	QPSK, 16QAM	1 RB / 0 RB Offset
	20000 to 20350	20000, 20175, 20350	10MHz	QPSK, 16QAM	1 RB / 0 RB Offset
	20025 to 20325	20025, 20175, 20325	15MHz	QPSK, 16QAM	1 RB / 0 RB Offset
	20050 to 20300	20050, 20175, 20300	20MHz	QPSK, 16QAM	1 RB / 0 RB Offset
Occupied Bandwidth	19957 to 20393	19957, 20175, 20393	1.4MHz	QPSK, 16QAM	6 RB / 0 RB Offset
	19965 to 20385	19965, 20175, 20385	3MHz	QPSK, 16QAM	15 RB / 0 RB Offset
	19975 to 20375	19975, 20175, 20375	5MHz	QPSK, 16QAM	25 RB / 0 RB Offset
	20000 to 20350	20000, 20175, 20350	10MHz	QPSK, 16QAM	50 RB / 0 RB Offset
	20025 to 20325	20025, 20175, 20325	15MHz	QPSK, 16QAM	75 RB / 0 RB Offset
	20050 to 20300	20050, 20175, 20300	20MHz	QPSK, 16QAM	100 RB / 0 RB Offset
Conducted Emission	19957 to 20393	20175	1.4MHz	QPSK	1 RB / 0 RB Offset
	19965 to 20385	20175	3MHz	QPSK	1 RB / 0 RB Offset
	19975 to 20375	20175	5MHz	QPSK	1 RB / 0 RB Offset
	20000 to 20350	20175	10MHz	QPSK	1 RB / 0 RB Offset
	20025 to 20325	20175	15MHz	QPSK	1 RB / 0 RB Offset
	20050 to 20300	20175	20MHz	QPSK	1 RB / 0 RB Offset
Radiated Emission	19957 to 20393	20175	1.4MHz	QPSK	1 RB / 0 RB Offset
	20050 to 20300	20175	20MHz	QPSK	1 RB / 0 RB Offset

LTE BAND 4						
Test Item	Available Channel	Tested Channel	Channel Bandwidth	Modulation	Mode	
Band Edge	19957 to 20393	19957	1.4MHz	QPSK	1 RB / 0 RB Offset	
		20393	1.4MHz	QPSK	6 RB / 0 RB Offset	
	19965 to 20385	19965	3MHz	QPSK	1 RB / 5 RB Offset	
		20385	3MHz	QPSK	6 RB / 0 RB Offset	
	19975 to 20375	19975	5MHz	QPSK	1 RB / 0 RB Offset	
		20375	5MHz	QPSK	15 RB / 0 RB Offset	
	20000 to 20350	20000	10MHz	QPSK	1 RB / 14 RB Offset	
		20350	10MHz	QPSK	15 RB / 0 RB Offset	
	20025 to 20325	20025	15MHz	QPSK	1 RB / 0 RB Offset	
		20325	15MHz	QPSK	25 RB / 0 RB Offset	
	20050 to 20300	20050	20MHz	QPSK	1 RB / 24 RB Offset	
		20300	20MHz	QPSK	25 RB / 0 RB Offset	
	Peak To Average Ratio	19957 to 20393	19957, 20175, 20393	1.4MHz	QPSK, 16QAM	1 RB / 0 RB Offset
		19965 to 20385	19965, 20175, 20385	3MHz	QPSK, 16QAM	1 RB / 0 RB Offset
		19975 to 20375	19975, 20175, 20375	5MHz	QPSK, 16QAM	1 RB / 0 RB Offset
		20000 to 20350	20000, 20175, 20350	10MHz	QPSK, 16QAM	1 RB / 0 RB Offset
20025 to 20325		20025, 20175, 20325	15MHz	QPSK, 16QAM	1 RB / 0 RB Offset	
20050 to 20300		20050, 20175, 20300	20MHz	QPSK, 16QAM	1 RB / 0 RB Offset	
Frequency Stability	19957 to 20393	20175	1.4MHz	QPSK	1 RB / 0 RB Offset	
	19965 to 20385	20175	3MHz	QPSK	1 RB / 0 RB Offset	
	19975 to 20375	20175	5MHz	QPSK	1 RB / 0 RB Offset	
	20000 to 20350	20175	10MHz	QPSK	1 RB / 0 RB Offset	
	20025 to 20325	20175	15MHz	QPSK	1 RB / 0 RB Offset	
	20050 to 20300	20175	20MHz	QPSK	1 RB / 0 RB Offset	

LTE BAND 7						
Test Item	Available Channel	Tested Channel	Channel Bandwidth	Modulation	Mode	
EIRP	20775 to 21425	20775, 21100, 21425	5MHz	QPSK, 16QAM	1 RB / 0 RB Offset	
	20800 to 21400	20800, 21100, 21400	10MHz	QPSK, 16QAM	1 RB / 0 RB Offset	
	20825 to 21375	20825, 21100, 21375	15MHz	QPSK, 16QAM	1 RB / 0 RB Offset	
	20850 to 21350	20850, 21100, 21350	20MHz	QPSK, 16QAM	1 RB / 0 RB Offset	
Occupied Bandwidth	20775 to 21425	20775, 21100, 21425	5MHz	QPSK, 16QAM	25 RB / 0 RB Offset	
	20800 to 21400	20800, 21100, 21400	10MHz	QPSK, 16QAM	50 RB / 0 RB Offset	
	20825 to 21375	20825, 21100, 21375	15MHz	QPSK, 16QAM	75 RB / 0 RB Offset	
	20850 to 21350	20850, 21100, 21350	20MHz	QPSK, 16QAM	100 RB / 0 RB Offset	
Conducted Emission	20775 to 21425	21100	5MHz	QPSK	1 RB / 0 RB Offset	
	20800 to 21400	21100	10MHz	QPSK	1 RB / 0 RB Offset	
	20825 to 21375	21100	15MHz	QPSK	1 RB / 0 RB Offset	
	20850 to 21350	21100	20MHz	QPSK	1 RB / 0 RB Offset	
Radiated Emission	20775 to 21425	21100	5MHz	QPSK	1 RB / 0 RB Offset	
	20850 to 21350	21100	20MHz (Note)	QPSK	1 RB / 0 RB Offset	
Band Edge	20775 to 21425	20775	5MHz	QPSK	1 RB / 0 RB Offset 25 RB / 0 RB Offset	
		21425	5MHz	QPSK	1 RB / 24 RB Offset 25 RB / 0 RB Offset	
	20800 to 21400	20800	10MHz	QPSK	1 RB / 0 RB Offset 50 RB / 0 RB Offset	
		21400	10MHz	QPSK	1 RB / 49 RB Offset 50 RB / 0 RB Offset	
	20825 to 21375	20825	15MHz	QPSK	1 RB / 0 RB Offset 75 RB / 0 RB Offset	
		21375	15MHz	QPSK	1 RB / 74 RB Offset 75 RB / 0 RB Offset	
	20850 to 21350	20850	20MHz	QPSK	1 RB / 0 RB Offset 100 RB / 0 RB Offset	
		21350	20MHz	QPSK	1 RB / 99 RB Offset 100 RB / 0 RB Offset	
	Peak To Average Ratio	20775 to 21425	20775, 21100, 21425	5MHz	QPSK, 16QAM	1 RB / 0 RB Offset
		20800 to 21400	20800, 21100, 21400	10MHz	QPSK, 16QAM	1 RB / 0 RB Offset
		20825 to 21375	20825, 21100, 21375	15MHz	QPSK, 16QAM	1 RB / 0 RB Offset
		20850 to 21350	20850, 21100, 21350	20MHz	QPSK, 16QAM	1 RB / 0 RB Offset
Frequency Stability	20775 to 21425	21100	5MHz	QPSK	1 RB / 0 RB Offset	
	20800 to 21400	21100	10MHz	QPSK	1 RB / 0 RB Offset	
	20825 to 21375	21100	15MHz	QPSK	1 RB / 0 RB Offset	
	20850 to 21350	21100	20MHz	QPSK	1 RB / 0 RB Offset	

Note: For 18G to 26.5G, the highest bandwidth is worst case and recording in the test report.

EUT TEST CONDITIONS:

Test Item	Environmental Conditions	Test Voltage
EIRP	24°C, 63%RH	DC 3.82V
Conducted Output Power	25°C, 65%RH	DC 3.82V
Occupied Bandwidth	25°C, 65%RH	DC 3.82V
Conducted Emission	25°C, 65%RH	DC 3.82V
Radiated Emission	25°C, 60%RH	AC 120V/60Hz
Band Edge	25°C, 65%RH	DC 3.82V
Peak to Average Ratio	25°C, 65%RH	DC 3.82V
Frequency Stability	25°C, 65%RH	DC 3.82V

3.3 BLOCK DIAGRAM SHOWING THE CONFIGURATION OF SYSTEM TESTED FOR RADIATED

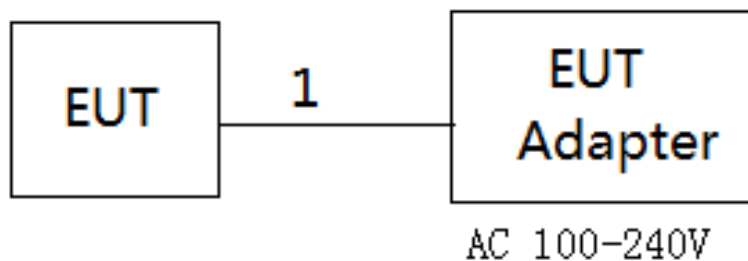

3.4 DESCRIPTION OF SUPPORT UNITS

The EUT has been tested as an independent unit together with other necessary accessories or support units. The following support units or accessories were used to form a representative test configuration during the tests.

Item	Equipment	Mfr/Brand	Model/Type No.	FCC ID	Series No.
-	-	-	-	-	-

Item	Shielded Type	Ferrite Core	Length	Note
1	NO	NO	1.2m	USB Cable

4. TEST RESULT

4.1 OUTPUT POWER MEASUREMENT AND RADIATED POWER

4.1.1 LIMIT

Mobile / Portable station are limited to 1 watts e.i.r.p. (LTE 4)

Mobile / Portable station are limited to 2 watts e.i.r.p. (LTE 7)

4.1.2 TEST PROCEDURE

Conducted Power:

The EUT was set up for the maximum power with GSM, GPRS, EDGE, WCDMA, CDMA, and LTE link data modulation and link up with simulator. Set the EUT to transmit under low, middle and high channel and record the power level shown on simulator.

Radiated Power:

1. Substitution method is used for E.I.R.P measurement. In the semi-anechoic chamber, EUT placed on the 0.8m height of Turn Table, rotated the table around 360 degrees to search the maximum radiation power and receiver antenna shall be rotated vertical and horizontal polarization and moved height from 1m to 4m to find the maximum polar radiated power. The "Read Value" is the spectrum reading the maximum power value.
2. The substitution horn antenna is substituted for EUT at the same position and signals generator export the CW signal to the substitution antenna via a TX cable. Rotated the Turn Table and moved receiving antenna to find the maximum radiation power. Adjust output power level of S.G to get a Value of spectrum reading equal to "Read Value " of step a. Record the power level of S.G
3. EIRP = Output power level of S.G – TX cable loss + Antenna gain of substitution horn.
4. E.R.P power can be calculated form E.I.R.P power by subtracting the gain of dipole, E.R.P power = E.I.P.R power - 2.15dBi.
5. The resolution bandwidth and video bandwidth of test receiver/spectrum analyzer is 1MHz/3MHz.

4.1.3 TESTSETUP LAYOUT
Conducted Power Measurement

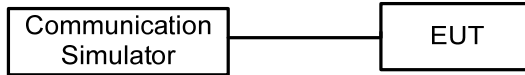

Radiated Power Measurement-

30MHz to 1GHz-Pre-test

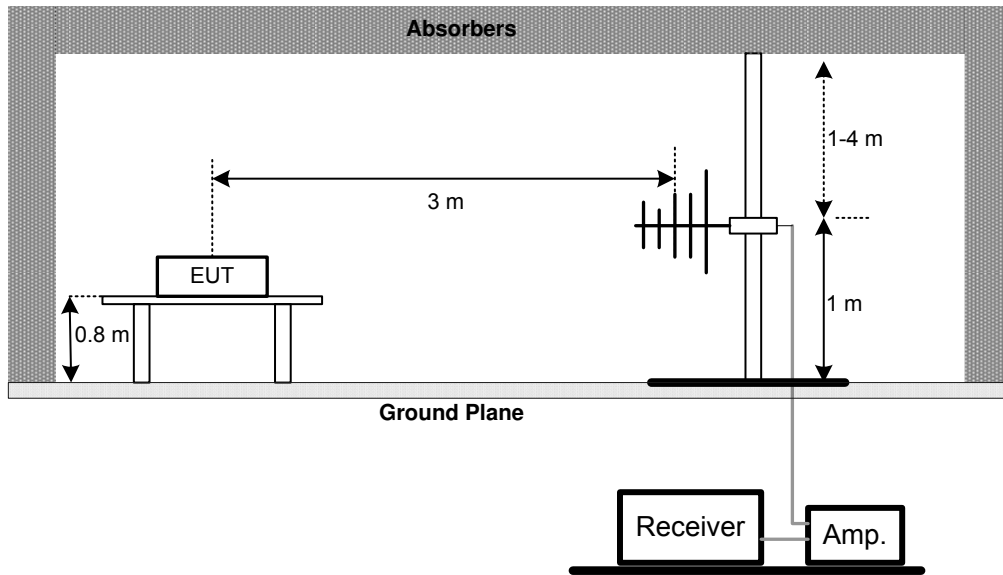

Above 1GHz-Pre-test

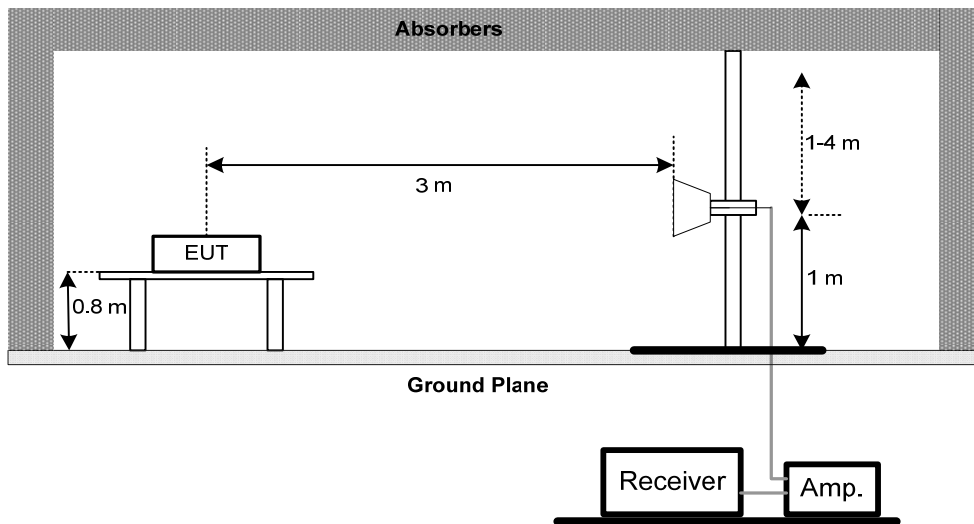

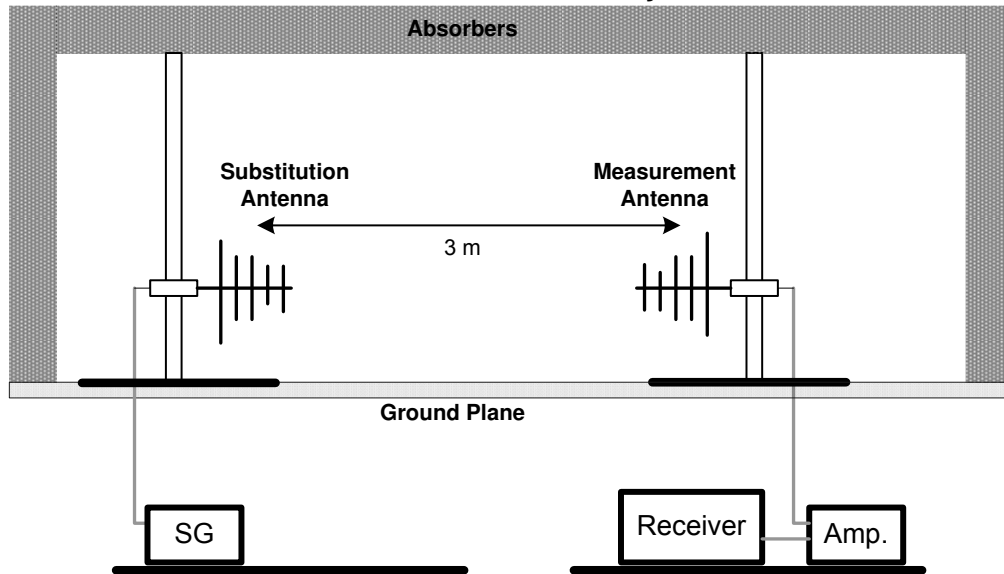
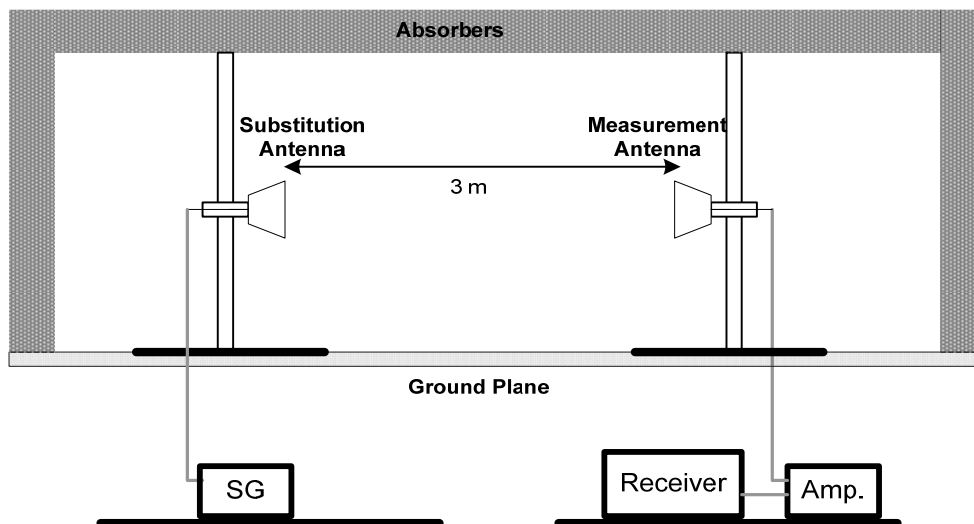
30MHz to 1GHz- Substitution method to verify the maximum ERP/EIRP**Above 1GHz- Substitution method to verify the maximum ERP/EIRP****4.1.4 TEST DEVIATION**

No deviation

4.1.5 TEST RESULTS

Please refer to the Attachment A.

4.2 OCCUPIED BANDWIDTH MEASUREMENT

4.2.1 TEST PROCEDURE

The EUT makes a call to the communication simulator. All measurements were done at low, middle and high operational frequency range. The communication simulator station system controlled a EUT to export maximum output power under transmission mode and specific channel frequency. Use OBW measurement function of Spectrum analyzer to measure 99 % occupied bandwidth and 26dB bandwidth.

4.2.2 TEST SETUP LAYOUT

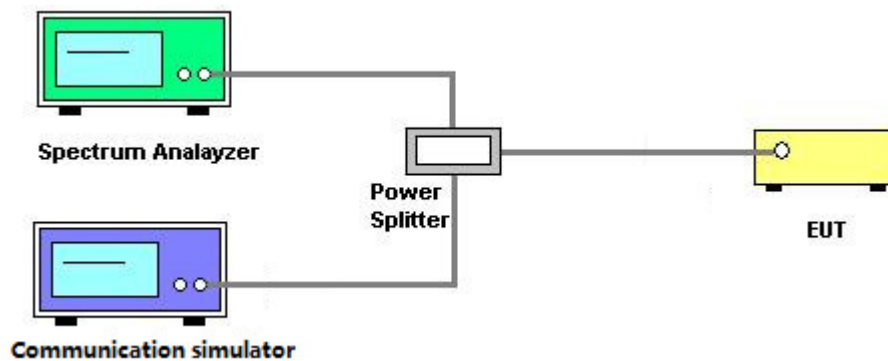

4.2.3 TEST DEVIATION

No deviation

4.2.4 TEST RESULTS

Please refer to the Attachment B.

4.3 CONDUCTED EMISSIONS MEASUREMENT

4.3.1 LIMIT

The power of any emission outside of the authorized operating frequency ranges must be attenuated below the transmitting power (P) by a factor of at least $43 + 10 \log(P)$ dB. The emission limit equal to -13dBm.

4.3.2 TEST PROCEDURES

1. The testing follows FCC KDB 971168 v02r02 Section 6.0.
2. The EUT was connected to spectrum analyzer and system simulator via a power divider.
3. The band edges of low and high channels for the highest RF powers were measured. Set $RBW \geq 1\%$ EBW in the 1MHz band immediately outside and adjacent to the band edge.
4. Set spectrum analyzer with RMS detector.
5. The RF fundamental frequency should be excluded against the limit line in the operating frequency band.
6. The limit line is derived from $43+10\log(P)$ dB below the transmitter power P(Watts)
 $=P(W)-[43+10\log(P)](dB)$
 $=[30+10\log(P)](dBm)-[43+10\log(P)](dB)$
 $=-13dBm$

4.3.3 TESTSETUP LAYOUT

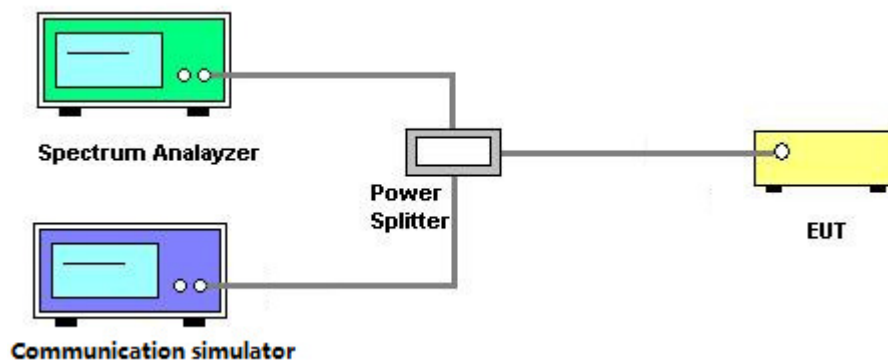

4.3.4 TESTDEVIATION

No deviation

4.3.5 TEST RESULTS

Please refer to the Attachment C.

4.4 RADIATED EMISSIONS MEASUREMENT

4.4.1 LIMIT

The power of any emission outside of the authorized operating frequency ranges must be attenuated below the transmitting power (P) by a factor of at least $43 + 10 \log(P)$ dB. The emission limit equal to -13dBm.

4.4.2 TEST PROCEDURES

1. Substitution method is used for E.I.R.P measurement. In the semi-anechoic chamber, EUT placed on the 0.8m height of Turn Table, rotated the table around 360 degrees to search the maximum radiation power and receiver antenna shall be rotated vertical and horizontal polarization and moved height from 1m to 4m to find the maximum polar radiated power. The "Read Value" is the spectrum reading the maximum power value.
2. The substitution horn antenna is substituted for EUT at the same position and signals generator export the CW signal to the substitution antenna via a TX cable. Rotated the Turn Table and moved receiving antenna to find the maximum radiation power. Adjust output power level of S.G to get a Value of spectrum reading equal to "Read Value " of step a. Record the power level of S.G
3. EIRP = Output power level of S.G – TX cable loss + Antenna gain of substitution horn.
4. E.R.P power can be calculated form E.I.R.P power by subtracting the gain of dipole, E.R.P power = E.I.P.R power - 2.15dBi.
5. The resolution bandwidth and video bandwidth of test receiver/spectrum analyzer is 1MHz/3MHz.

4.4.3 TESTSETUP LAYOUT

This test setup layout is the same as that shown in **section 4.1.3**.

4.4.4 TESTDEVIATION

No deviation

4.4.5 TEST RESULTS

Please refer to the Attachment D.

4.5 BAND EDGE MEASUREMENT

4.5.1 LIMIT

For operations in the 699-716 , 704-716 and 777-787MHz band, the power of any emission outside a licensee's frequency band(s) of operation shall be attenuated below the transmitter power (P) within the licensed band(s) of operation, measured in watts, by at least $43 + 10 \log (P)$ dB. Compliance with this provision is based on the use of measurement instrumentation employing a resolution bandwidth of 100 kilohertz or greater.

However, in the 100 kilohertz bands immediately outside and adjacent to a licensee's frequency block, a resolution bandwidth of at least 30 kHz may be employed.

For operations in the 1710–1755 MHz bands, the power of any emission outside a licensee's frequency block shall be attenuated below the transmitter power (P) by at least $43 + 10 \log_{10}(P)$ dB.

4.5.2 TEST PROCEDURES

1. All measurements were done at low and high operational frequency range.
2. The center frequency of spectrum is the band edge frequency and span is 5MHz. RB of the spectrum is 100kHz and VB of the spectrum is 300kHz (WCDMA).
3. The center frequency of spectrum is the band edge frequency and span is 1MHz. RB of the spectrum is 13kHz and VB of the spectrum is 51kHz (LTE Bandwidth 1.4MHz).
4. The center frequency of spectrum is the band edge frequency and span is 1MHz. RB of the spectrum is 30kHz and VB of the spectrum is 100kHz (LTE Bandwidth 3MHz).
5. The center frequency of spectrum is the band edge frequency and span is 1MHz. RB of the spectrum is 100kHz and VB of the spectrum is 300kHz (LTE Bandwidth 5MHz/10MHz).
6. Record the max trace plot into the test report.

4.5.3 TESTSETUP LAYOUT

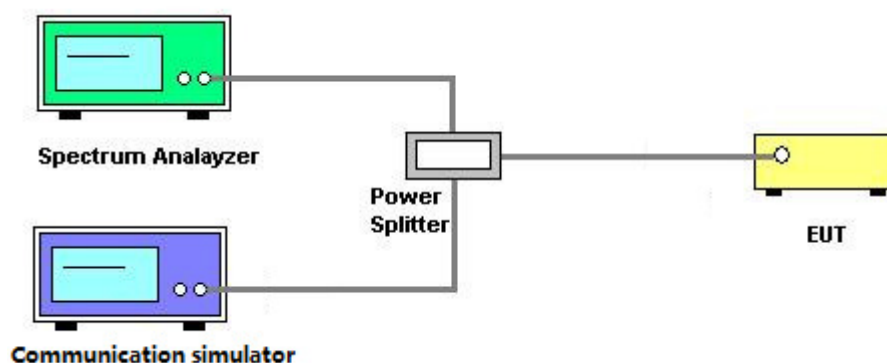

4.5.4 TESTDEVIATION

No deviation

4.5.5 TEST RESULTS

Please refer to the Attachment E.

4.6 PEAK TO AVERAGE RATIO MEASUREMENT

4.6.1 LIMIT

In measuring transmissions in this band using an average power technique, the peak to-average ratio (PAR) of the transmission may not exceed 13 dB.

4.6.2 TEST PROCEDURES

1. Set resolution/measurement bandwidth \geq signal's occupied bandwidth;
2. Set the number of counts to a value that stabilizes the measured CCDF curve;
3. Record the maximum PAPR level associated with a probability of 0.1%.

4.6.3 TESTSETUP LAYOUT

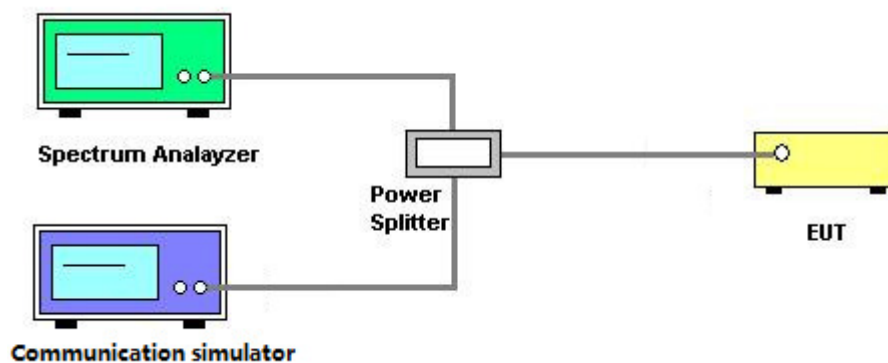

4.6.4 TESTDEVIATION

No deviation

4.6.5 TEST RESULTS

Please refer to the Attachment F.

4.7 FREQUENCY STABILITY MEASUREMENT

4.7.1 LIMIT

1.5 ppm is for base and fixed station. 2.5 ppm is for mobile station.

4.7.2 TEST PROCEDURES

1. Device is placed at the oven room. The oven room could control the temperatures and humidity. Power warm up is at least 15 min and power applied should perform before recording frequency error.
2. EUT is connected the external power supply to control the DC input power. The test voltage range is from minimum to maximum working voltage. Each step shall be record the frequency error rate.
3. The temperature range step is 10 degrees in this test items. All temperature levels shall be hold the $\pm 0.5^{\circ}\text{C}$ during the measurement testing. The each temperature step shall be at least 0.5 hours, consider the EUT could be test under the stability condition.
4. The frequency error was recorded frequency error from the communication simulator.

4.7.3 TESTSETUP LAYOUT

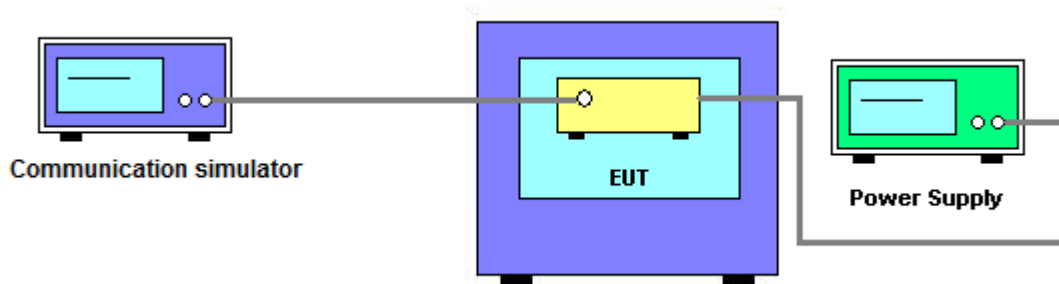

4.7.4 TESTDEVIATION

No deviation

4.7.5 TEST RESULTS

Please refer to the Attachment G.

5. LIST OF MEASUREMENT EQUIPMENTS

Radiated Emission & ERP or EIRP Measurement					
Item	Kind of Equipment	Manufacturer	Type No.	Serial No.	Calibrated until
1	Antenna	Schwarbeck	VULB9160	9160-3232	Mar. 26, 2018
2	Double Ridged Guide Antenna	ETS	3115	75789	Mar. 26, 2018
3	Broad-Band Horn Antenna	Schwarzbeck	BBHA 9170	9170319	Jun. 08, 2018
4	Amplifier	Agilent	8449B	3008A02274	Mar. 09, 2018
5	Amplifier	HP	8447D	2944A09673	Oct. 20, 2017
6	HighPass Filter	Wairwright Instruments Gmbh	WHK 1.5/15G-10ST	11	Mar. 09, 2018
7	Band Reject Filter	Wairwright Instruments Gmbh	WRCG 1710/1785-1690/180 5-60/12SS	38	Feb. 22, 2018
8	Band Reject Filter	Wairwright Instruments Gmbh	WRCG 824/849-810/863-60/ 9SS	7	Feb. 22, 2018
9	Band Reject Filter	Wairwright Instruments Gmbh	WRCG 880/915-860/935-60/ 9SS	14	Feb. 22, 2018
10	Band Reject Filter	Wairwright Instruments Gmbh	WRCG 1850/1910-1830/193 0-60/10SS	17	Feb. 22, 2018
11	HighPass Filter	Wairwright Instruments Gmbh	WHK3.1/18G-10SS	24	Mar. 09, 2018
12	Wireless Communication Test SET	Agilent	E5515C	MY48364183	Mar. 26, 2018
13	Microwave Preamplifier With Adaptor	EMC INSTRUMENT	EMC2654045	980039 & HA01	Mar. 26, 2018
14	Receiver	Agilent	N9038A	MY52130039	Sep. 04, 2017
15	wideband radio communication tester	R&S	CMW500	152372	Mar. 26, 2018
16	High pass filter	ZHPF-M1000-4000-1	ZHPF-M3-12.75G-3869	B2015073763	Aug. 04, 2017
17	High pass filter	ZHPF-M3-12.75G-3869	ZHPF-M1000-4000-1	B2015073762	Aug. 04, 2017
18	High pass filter	ZHPF-M6-18G-1727	ZHPF-M6-186-1727	B2015073764	Aug. 04, 2017
19	Cable	emci	LMR-400(30MHz-1GHz)(8m+5m)	N/A	Jun. 27, 2017
20	Cable	emci	EMC104-SM-SM-12000(12m)	N/A	Jun. 26, 2018
21	Controller	ETS-Lindgren	2090	N/A	N/A
22	Measurement Software	Farad	EZ-EMC Ver.NB-03A1-01	N/A	N/A
23	Antenna	EM	EM-6876-1	230	Mar. 06, 2018

Conducted Emission & Band Edge & Occupied Bandwidth Measurement					
Item	Kind of Equipment	Manufacturer	Type No.	Serial No.	Calibrated until
1	Wireless Communication Test SET	Agilent	E5515C	MY48364183	Mar. 26, 2018
2	EXA Spectrum Analyzer	Agilent	N9010A	MY50520044	Mar. 26, 2018
3	POWER SPLITTER	Mini-Circuits	ZFRSC-123-S+	331000910-1	Feb. 25, 2018
4	wideband radio communication tester	R&S	CMW500	152372	Mar. 26, 2018
5	Cable	N/A	RG316(0.3m)	N/A	Jul. 06, 2017
6	Cable	N/A	RG316(0.3m)	N/A	Jul. 06, 2017

Frequency Stability Measurement					
Item	Kind of Equipment	Manufacturer	Type No.	Serial No.	Calibrated until
1	Wireless Communication Test SET	Agilent	E5515C	MY48364183	Mar. 26, 2018
2	DC power supply	GW Instek	GPC-3030DN	EK880675	Oct. 13, 2017
3	POWER SPLITTER	Mini-Circuits	ZFRSC-123-S+	331000910-1	Feb. 25, 2018
4	wideband radio communication tester	R&S	CMW500	152372	Mar. 26, 2018
5	Const Temp, & Humidity Chamber	Giant?Force	ITH-225-20-S	IAB0309-001	Sep. 04, 2017
6	Cable	N/A	RG316(0.3m)	N/A	Jul. 06, 2017

Substitution method					
Item	Kind of Equipment	Manufacturer	Type No.	Serial No.	Calibrated until
1	Antenna	Schwarbeck	VULB9160	9160-3231	Mar. 26, 2018
2	Double Ridged Guide Antenna	ETS	3115	75846	Mar. 26, 2018
3	Signal Generator	R&S	SMR40	100504	Mar. 26, 2018
4	MXG Analog Signal Generator	Agilent	N5181A	MY49060710	Aug. 20, 2018

Remark: "N/A" denotes no model name, serial no. or calibration specified.
 All calibration period of equipment list is one year.

ATTACHMENT A - OUTPUT POWER

Conducted Power:

Modulation	Band	WCDMA IV		
	Tx Channel	1312 CH	1413 CH	1513 CH
QPSK	Rx Channel	1537 CH	1638 CH	1738 CH
	Frequency	1712.4	1732.6	1752.6
	RMC 12.2K	22.15	21.92	22.05
	RMC 64K	22.19	21.97	22.06
	RMC 144K	22.18	21.93	22.08
QPSK	RMC 384K	22.19	21.97	22.09
	HSDPA Subtest-1	21.16	20.93	21.06
	HSDPA Subtest-2	21.17	20.95	21.09
	HSDPA Subtest-3	20.71	20.54	20.67
	HSDPA Subtest-4	20.62	20.49	20.65
QPSK	HSUPA Subtest-1	19.11	19.09	19.05
	HSUPA Subtest-2	19.06	19.05	19.03
	HSUPA Subtest-3	20.13	20.03	20.09
	HSUPA Subtest-4	19.75	19.53	19.55
	HSUPA Subtest-5	20.98	20.62	20.88
QPSK	DC-HSDPA Subtest-1	21.16	20.93	21.06
	DC-HSDPA Subtest-2	21.17	20.95	21.09
	DC-HSDPA Subtest-3	20.71	20.54	20.67
	DC-HSDPA Subtest-4	20.62	20.49	20.65

LTE Band / BW	Modulation	RB Siset	RB Offset	Low CH	Mid CH	High CH
				19957 CH	20175 CH	20393 CH
				1710.7 MHz	1732.5 MHz	1754.3 MHz
4 / 1.4M	QPSK	1	0	22.36	21.73	20.91
		1	2	22.42	21.73	20.99
		1	5	22.09	21.69	20.92
		3	0	22.27	21.75	21.03
		3	1	22.18	21.66	20.97
		3	3	22.31	21.73	21.04
	16QAM	6	0	21.22	20.64	20.02
		1	0	21.60	21.05	20.09
		1	2	21.74	21.00	20.04
		1	5	21.27	20.99	20.02
		3	0	21.34	20.92	20.22
		3	1	21.26	20.79	20.18
		3	3	21.34	20.83	20.20
		6	0	20.18	19.54	19.16

LTE Band / BW	Modulation	RB Siset	RB Offset	Low CH	Mid CH	High CH
				19965 CH	20175 CH	20385 CH
				1711.5 MHz	1732.5 MHz	1753.5 MHz
4 / 3M	QPSK	1	0	22.27	21.69	21.01
		1	7	22.30	21.68	21.03
		1	14	22.42	21.68	20.96
		8	0	21.48	20.72	20.07
		8	3	21.28	20.70	20.09
		8	7	21.37	20.70	20.07
		15	0	20.95	20.66	20.06
	16QAM	1	0	21.17	20.98	20.07
		1	7	21.21	20.98	20.09
		1	14	21.24	20.97	20.02
		8	0	20.51	19.81	19.14
		8	3	20.51	19.78	19.15
		8	7	20.46	19.77	19.13
		15	0	20.40	19.72	19.14

LTE Band / BW	Modulation	RB Siset	RB Offset	Low CH	Mid CH	High CH
				19975 CH	20175 CH	20375 CH
				1712.5 MHz	1732.5 MHz	1752.5 MHz
4 / 5M	QPSK	1	0	22.42	21.79	21.17
		1	12	22.42	21.70	21.13
		1	24	22.01	21.70	21.08
		12	0	21.26	20.74	20.06
		12	6	21.27	20.69	20.04
		12	13	21.25	20.70	20.04
		25	0	21.23	20.65	20.08
	16QAM	1	0	21.50	21.25	20.17
		1	12	21.49	21.16	20.14
		1	24	21.22	21.15	20.09
		12	0	20.57	19.90	19.11
		12	6	20.54	19.87	19.12
		12	13	20.79	19.86	19.07
		25	0	20.46	19.74	19.05

LTE Band / BW	Modulation	RB Sizer	RB Offset	Low CH	Mid CH	High CH
				20000 CH	20175 CH	20350 CH
				1715 MHz	1732.5 MHz	1750 MHz
4 / 10M	QPSK	1	0	22.36	21.84	21.06
		1	24	22.15	21.65	21.03
		1	49	22.13	21.76	21.28
		25	0	21.24	20.74	20.03
		25	12	21.18	20.68	20.04
		25	25	21.16	20.71	20.03
		50	0	21.21	20.73	20.05
	16QAM	1	0	21.25	21.17	20.10
		1	24	21.30	21.00	20.05
		1	49	20.91	21.07	20.02
		25	0	20.45	19.79	19.16
		25	12	20.30	19.72	19.12
		25	25	20.26	19.76	19.13
		50	0	20.33	19.75	19.10

LTE Band / BW	Modulation	RB Sizer	RB Offset	Low CH	Mid CH	High CH
				20025 CH	20175 CH	20325 CH
				1717.5 MHz	1732.5 MHz	1747.5 MHz
4 / 15M	QPSK	1	0	22.19	21.86	21.16
		1	37	22.16	21.52	21.12
		1	74	22.07	21.70	21.02
		36	0	21.23	21.70	20.11
		36	19	21.19	20.93	20.10
		36	39	21.17	20.78	20.07
		75	0	21.22	20.81	20.10
	16QAM	1	0	21.30	21.20	20.54
		1	37	21.01	20.99	20.49
		1	74	21.16	21.09	20.46
		36	0	20.33	20.99	19.09
		36	19	20.30	19.78	19.07
		36	39	20.27	19.80	19.06
		75	0	20.33	19.80	19.11

LTE Band / BW	Modulation	RB Sizer	RB Offset	Low CH	Mid CH	High CH
				20050 CH	20175 CH	20300 CH
				1720 MHz	1732.5 MHz	1745 MHz
4 / 20M	QPSK	1	0	22.44	21.86	21.47
		1	50	22.19	21.13	21.45
		1	99	22.12	21.70	21.21
		50	0	21.25	20.79	20.46
		50	25	21.16	20.81	20.52
		50	50	21.13	20.98	20.62
		100	0	21.15	20.94	20.44
	16QAM	1	0	21.99	21.61	20.79
		1	50	21.70	20.24	20.70
		1	99	21.51	21.22	20.69
		50	0	20.30	19.90	19.37
		50	25	20.22	19.79	19.30
		50	50	20.19	19.84	19.33
		100	0	20.21	19.83	19.36

LTE Band / BW	Modulation	RB Sizer	RB Offset	Low CH	Mid CH	High CH
				20775 CH	21100 CH	21425 CH
				2502.5 MHz	2535 MHz	2567.5 MHz
7 / 5M	QPSK	1	0	22.01	21.85	22.46
		1	12	22.04	21.82	22.46
		1	24	21.76	21.80	22.41
		12	0	20.57	20.81	21.33
		12	6	20.69	20.79	21.32
		12	13	20.73	20.79	21.34
		25	0	20.72	20.74	21.29
	16QAM	1	0	20.99	21.39	21.21
		1	12	21.01	21.45	21.33
		1	24	20.99	21.47	21.30
		12	0	19.97	20.06	20.37
		12	6	19.99	20.43	20.38
		12	13	20.01	20.22	20.37
		25	0	19.89	20.05	20.23

LTE Band / BW	Modulation	RB Sizer	RB Offset	Low CH	Mid CH	High CH
				20800 CH	21100 CH	21400 CH
				2505 MHz	2535 MHz	2565 MHz
7 / 10M	QPSK	1	0	21.84	22.04	22.45
		1	24	21.92	22.00	22.41
		1	49	22.00	22.02	22.39
		25	0	20.86	20.90	21.27
		25	12	20.86	20.86	21.27
		25	25	20.87	20.89	21.26
		50	0	20.88	20.88	21.29
	16QAM	1	0	20.67	21.25	21.21
		1	24	20.74	21.18	21.23
		1	49	20.76	21.21	21.22
		25	0	19.87	19.91	20.32
		25	12	19.87	19.83	20.34
		25	25	19.90	19.90	20.36
		50	0	19.87	19.88	20.31

LTE Band / BW	Modulation	RB Sizer	RB Offset	Low CH	Mid CH	High CH
				20825 CH	21100 CH	21375 CH
				2507.5 MHz	2535 MHz	2562.5 MHz
7 / 15M	QPSK	1	0	21.72	22.13	22.45
		1	37	21.80	22.02	22.43
		1	74	21.93	22.11	22.47
		36	0	20.79	20.98	21.42
		36	19	20.82	20.95	21.37
		36	39	20.91	21.00	21.35
		75	0	20.86	21.00	21.39
	16QAM	1	0	20.56	21.34	21.45
		1	37	20.62	21.24	21.42
		1	74	20.70	21.31	21.46
		36	0	19.73	20.00	20.29
		36	19	19.74	19.97	20.23
		36	39	19.84	20.00	20.25
		75	0	19.78	19.98	20.28

LTE Band / BW	Modulation	RB Sizer	RB Offset	Low CH	Mid CH	High CH
				20850 CH	21100 CH	21350 CH
				2510 MHz	2535 MHz	2560 MHz
7 / 20M	QPSK	1	0	21.95	22.17	22.45
		1	50	21.83	21.99	22.42
		1	99	21.92	22.15	22.43
		50	0	20.75	20.99	21.28
		50	25	20.78	20.94	21.25
		50	50	20.88	20.99	21.26
		100	0	20.78	20.95	21.24
	16QAM	1	0	21.20	21.40	21.46
		1	50	21.26	21.31	21.49
		1	99	21.39	21.37	21.46
		50	0	19.78	19.98	20.21
		50	25	19.81	19.93	20.16
		50	50	19.89	19.98	20.22
		100	0	19.81	19.94	20.21

EIRP Power:

Modulation	Band	WCDMA IV		
	Tx Channel	1312 CH	1413 CH	1513 CH
QPSK	Rx Channel	1537 CH	1638 CH	1738 CH
	Frequency	1712.4	1732.6	1752.6
	RMC 12.2K	20.00	19.77	19.90
	RMC 64K	20.04	19.82	19.91
QPSK	RMC 144K	20.03	19.78	19.93
	RMC 384K	20.04	19.82	19.94
	HSDPA Subtest-1	19.01	18.78	18.91
	HSDPA Subtest-2	19.02	18.80	18.94
QPSK	HSDPA Subtest-3	18.56	18.39	18.52
	HSDPA Subtest-4	18.47	18.34	18.50
	HSUPA Subtest-1	16.96	16.94	16.90
	HSUPA Subtest-2	16.91	16.90	16.88
QPSK	HSUPA Subtest-3	17.98	17.88	17.94
	HSUPA Subtest-4	17.60	17.38	17.40
	HSUPA Subtest-5	16.96	16.94	16.90
QPSK	DC-HSDPA Subtest-1	17.71	17.56	17.67
	DC-HSDPA Subtest-2	19.01	18.78	18.91
	DC-HSDPA Subtest-3	19.02	18.80	18.94
	DC-HSDPA Subtest-4	18.56	18.39	18.52

LTE Band / BW	Modulation	RB Sizer	RB Offset	Low CH	Mid CH	High CH
				19957 CH	20175 CH	20393 CH
				1710.7 MHz	1732.5 MHz	1754.3 MHz
4 / 1.4M	QPSK	1	0	20.21	19.58	18.76
		1	2	20.27	19.58	18.84
		1	5	19.94	19.54	18.77
		3	0	20.12	19.60	18.88
		3	1	20.03	19.51	18.82
		3	3	20.16	19.58	18.89
		6	0	19.07	18.49	17.87
	16QAM	1	0	19.45	18.90	17.94
		1	2	19.59	18.85	17.89
		1	5	19.12	18.84	17.87
		3	0	19.19	18.77	18.07
		3	1	19.11	18.64	18.03
		3	3	19.19	18.68	18.05
		6	0	18.03	17.39	17.01

LTE Band / BW	Modulation	RB Sizer	RB Offset	Low CH	Mid CH	High CH
				19965 CH	20175 CH	20385 CH
				1711.5 MHz	1732.5 MHz	1753.5 MHz
4 / 3M	QPSK	1	0	20.12	19.54	18.86
		1	7	20.15	19.53	18.88
		1	14	20.27	19.53	18.81
		8	0	19.33	18.57	17.92
		8	3	19.13	18.55	17.94
		8	7	19.22	18.55	17.92
		15	0	18.80	18.51	17.91
	16QAM	1	0	19.02	18.83	17.92
		1	7	19.06	18.83	17.94
		1	14	19.09	18.82	17.87
		8	0	18.36	17.66	16.99
		8	3	18.36	17.63	17.00
		8	7	18.31	17.62	16.98
		15	0	18.25	17.57	16.99

LTE Band / BW	Modulation	RB Sizer	RB Offset	Low CH	Mid CH	High CH
				19975 CH	20175 CH	20375 CH
				1712.5 MHz	1732.5 MHz	1752.5 MHz
4 / 5M	QPSK	1	0	20.27	19.64	19.02
		1	12	20.27	19.55	18.98
		1	24	19.86	19.55	18.93
		12	0	19.11	18.59	17.91
		12	6	19.12	18.54	17.89
		12	13	19.10	18.55	17.89
		25	0	19.08	18.50	17.93
	16QAM	1	0	19.35	19.10	18.02
		1	12	19.34	19.01	17.99
		1	24	19.07	19.00	17.94
		12	0	18.42	17.75	16.96
		12	6	18.39	17.72	16.97
		12	13	18.64	17.71	16.92
		25	0	18.31	17.59	16.90

LTE Band / BW	Modulation	RB Sizer	RB Offset	Low CH	Mid CH	High CH
				20000 CH	20175 CH	20350 CH
				1715 MHz	1732.5 MHz	1750 MHz
4 / 10M	QPSK	1	0	20.21	19.69	18.91
		1	24	20.00	19.50	18.88
		1	49	19.98	19.61	19.13
		25	0	19.09	18.59	17.88
		25	12	19.03	18.53	17.89
		25	25	19.01	18.56	17.88
		50	0	19.06	18.58	17.90
	16QAM	1	0	19.10	19.02	17.95
		1	24	19.15	18.85	17.90
		1	49	18.76	18.92	17.87
		25	0	18.30	17.64	17.01
		25	12	18.15	17.57	16.97
		25	25	18.11	17.61	16.98
		50	0	18.18	17.60	16.95

LTE Band / BW	Modulation	RB Sizer	RB Offset	Low CH	Mid CH	High CH
				20025 CH	20175 CH	20325 CH
				1717.5 MHz	1732.5 MHz	1747.5 MHz
4 / 15M	QPSK	1	0	20.04	19.71	19.01
		1	37	20.01	19.37	18.97
		1	74	19.92	19.55	18.87
		36	0	19.08	19.55	17.96
		36	19	19.04	18.78	17.95
		36	39	19.02	18.63	17.92
		75	0	19.07	18.66	17.95
	16QAM	1	0	19.15	19.05	18.39
		1	37	18.86	18.84	18.34
		1	74	19.01	18.94	18.31
		36	0	18.18	18.84	16.94
		36	19	18.15	17.63	16.92
		36	39	18.12	17.65	16.91
		75	0	18.18	17.65	16.96

LTE Band / BW	Modulation	RB Sizer	RB Offset	Low CH	Mid CH	High CH
				20050 CH	20175 CH	20300 CH
				1720 MHz	1732.5 MHz	1745 MHz
4 / 20M	QPSK	1	0	20.29	19.71	19.32
		1	50	20.04	18.98	19.30
		1	99	19.97	19.55	19.06
		50	0	19.10	18.64	18.31
		50	25	19.01	18.66	18.37
		50	50	18.98	18.83	18.47
		100	0	19.00	18.79	18.29
	16QAM	1	0	19.84	19.46	18.64
		1	50	19.55	18.09	18.55
		1	99	19.36	19.07	18.54
		50	0	18.15	17.75	17.22
		50	25	18.07	17.64	17.15
		50	50	18.04	17.69	17.18
		100	0	18.06	17.68	17.21

LTE Band / BW	Modulation	RB Sizer	RB Offset	Low CH	Mid CH	High CH
				20775 CH	21100 CH	21425 CH
				2502.5 MHz	2535 MHz	2567.5 MHz
7 / 5M	QPSK	1	0	19.86	19.70	20.31
		1	12	19.89	19.67	20.31
		1	24	19.61	19.65	20.26
		12	0	18.42	18.66	19.18
		12	6	18.54	18.64	19.17
		12	13	18.58	18.64	19.19
		25	0	18.57	18.59	19.14
	16QAM	1	0	18.84	19.24	19.06
		1	12	18.86	19.30	19.18
		1	24	18.84	19.32	19.15
		12	0	17.82	17.91	18.22
		12	6	17.84	18.28	18.23
		12	13	17.86	18.07	18.22
		25	0	17.74	17.90	18.08

LTE Band / BW	Modulation	RB Sizer	RB Offset	Low CH	Mid CH	High CH
				20800 CH	21100 CH	21400 CH
				2505 MHz	2535 MHz	2565 MHz
7 / 10M	QPSK	1	0	19.69	19.89	20.30
		1	24	19.77	19.85	20.26
		1	49	19.85	19.87	20.24
		25	0	18.71	18.75	19.12
		25	12	18.71	18.71	19.12
		25	25	18.72	18.74	19.11
		50	0	18.73	18.73	19.14
	16QAM	1	0	18.52	19.10	19.06
		1	24	18.59	19.03	19.08
		1	49	18.61	19.06	19.07
		25	0	17.72	17.76	18.17
		25	12	17.72	17.68	18.19
		25	25	17.75	17.75	18.21
		50	0	17.72	17.73	18.16

LTE Band / BW	Modulation	RB Sizer	RB Offset	Low CH	Mid CH	High CH
				20825 CH	21100 CH	21375 CH
				2507.5 MHz	2535 MHz	2562.5 MHz
7 / 15M	QPSK	1	0	19.57	19.98	20.30
		1	37	19.65	19.87	20.28
		1	74	19.78	19.96	20.32
		36	0	18.64	18.83	19.27
		36	19	18.67	18.80	19.22
		36	39	18.76	18.85	19.20
		75	0	18.71	18.85	19.24
	16QAM	1	0	18.41	19.19	19.30
		1	37	18.47	19.09	19.27
		1	74	18.55	19.16	19.31
		36	0	17.58	17.85	18.14
		36	19	17.59	17.82	18.08
		36	39	17.69	17.85	18.10
		75	0	17.63	17.83	18.13

LTE Band / BW	Modulation	RB Sizer	RB Offset	Low CH	Mid CH	High CH
				20850 CH	21100 CH	21350 CH
				2510 MHz	2535 MHz	2560 MHz
7 / 20M	QPSK	1	0	19.80	20.02	20.30
		1	50	19.68	19.84	20.27
		1	99	19.77	20.00	20.28
		50	0	18.60	18.84	19.13
		50	25	18.63	18.79	19.10
		50	50	18.73	18.84	19.11
		100	0	18.63	18.80	19.09
	16QAM	1	0	19.05	19.25	19.31
		1	50	19.11	19.16	19.34
		1	99	19.24	19.22	19.31
		50	0	17.63	17.83	18.06
		50	25	17.66	17.78	18.01
		50	50	17.74	17.83	18.07
		100	0	17.66	17.79	18.06

ATTACHMENT B - OCCUPIED BANDWIDTH

WCDMA Band 4 WCDMA					
Channel	Frequency (MHz)	99% Occupied Bandwidth (MHz)	Channel	Frequency (MHz)	26dB Bandwidth (MHz)
1312	1712.4	4.2172	19957	1710.7	4.846
1413	1732.6	4.2070	20175	1732.5	4.877
1513	1752.6	4.2093	20393	1754.3	4.872

Spectrum Plot

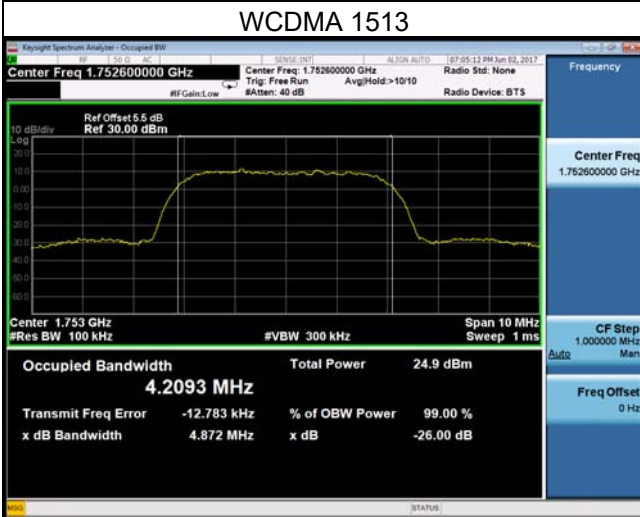

WCDMA Band 4 HSDPA					
Channel	Frequency (MHz)	99% Occupied Bandwidth (MHz)	Channel	Frequency (MHz)	26dB Bandwidth (MHz)
1312	1712.4	4.2010	19957	1710.7	4.882
1413	1732.6	4.2155	20175	1732.5	4.878
1513	1752.6	4.2075	20393	1754.3	4.879

Spectrum Plot

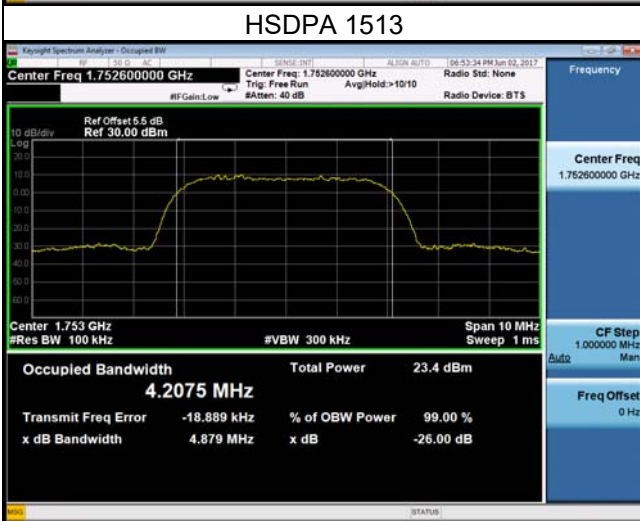
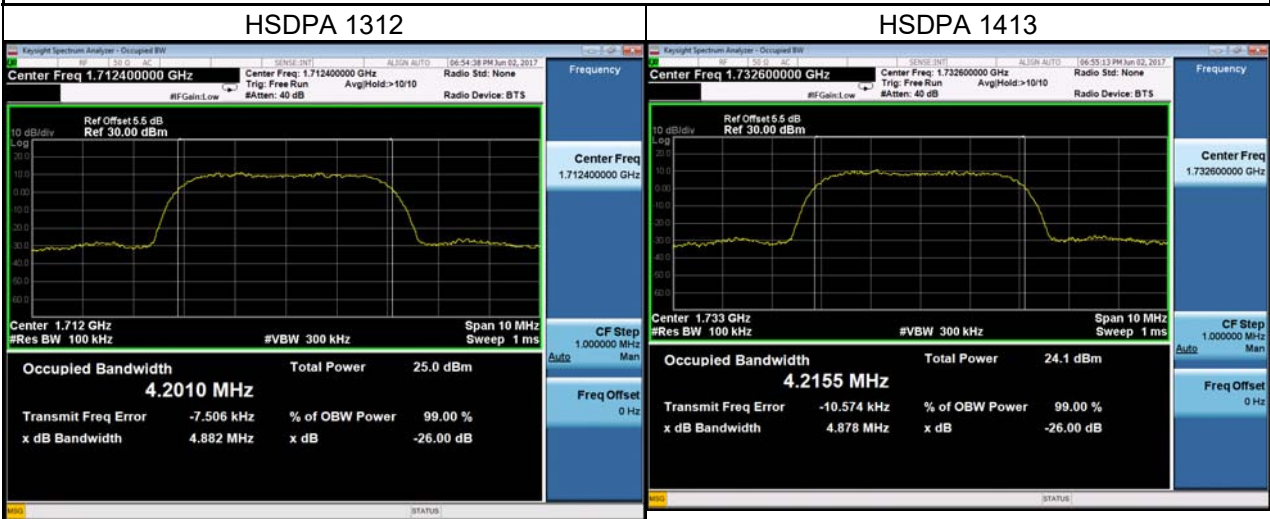

WCDMA Band 4 HSUPA					
Channel	Frequency (MHz)	99% Occupied Bandwidth (MHz)	Channel	Frequency (MHz)	26dB Bandwidth (MHz)
1312	1712.4	4.2153	19957	1710.7	4.879
1413	1732.6	4.2241	20175	1732.5	4.872
1513	1752.6	4.2215	20393	1754.3	4.906

Spectrum Plot

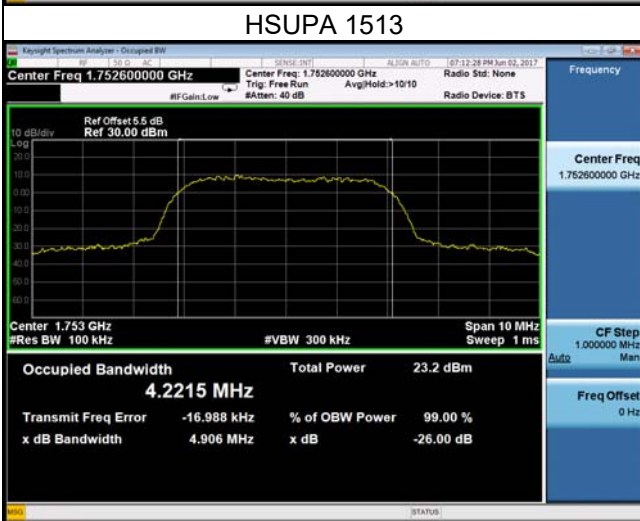
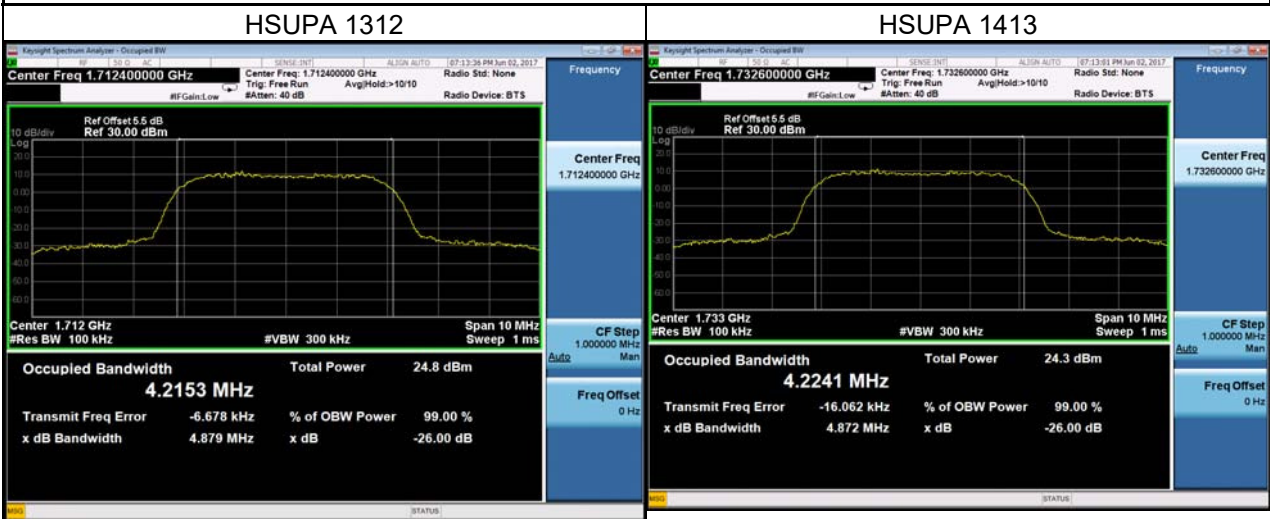

LTE Band 4_1.4M					
QPSK			16QAM		
Channel	Frequency (MHz)	99% Occupied Bandwidth (MHz)	Channel	Frequency (MHz)	99% Occupied Bandwidth (MHz)
19957	1710.7	1.0910	19957	1710.7	1.0923
20175	1732.5	1.0971	20175	1732.5	1.0849
20393	1754.3	1.0857	20393	1754.3	1.0936
Channel	Frequency (MHz)	26dB Bandwidth (MHz)	Channel	Frequency (MHz)	26dB Bandwidth (MHz)
19957	1710.7	1.257	19957	1710.7	1.274
20175	1732.5	1.267	20175	1732.5	1.269
20393	1754.3	1.262	20393	1754.3	1.253

Spectrum Plot

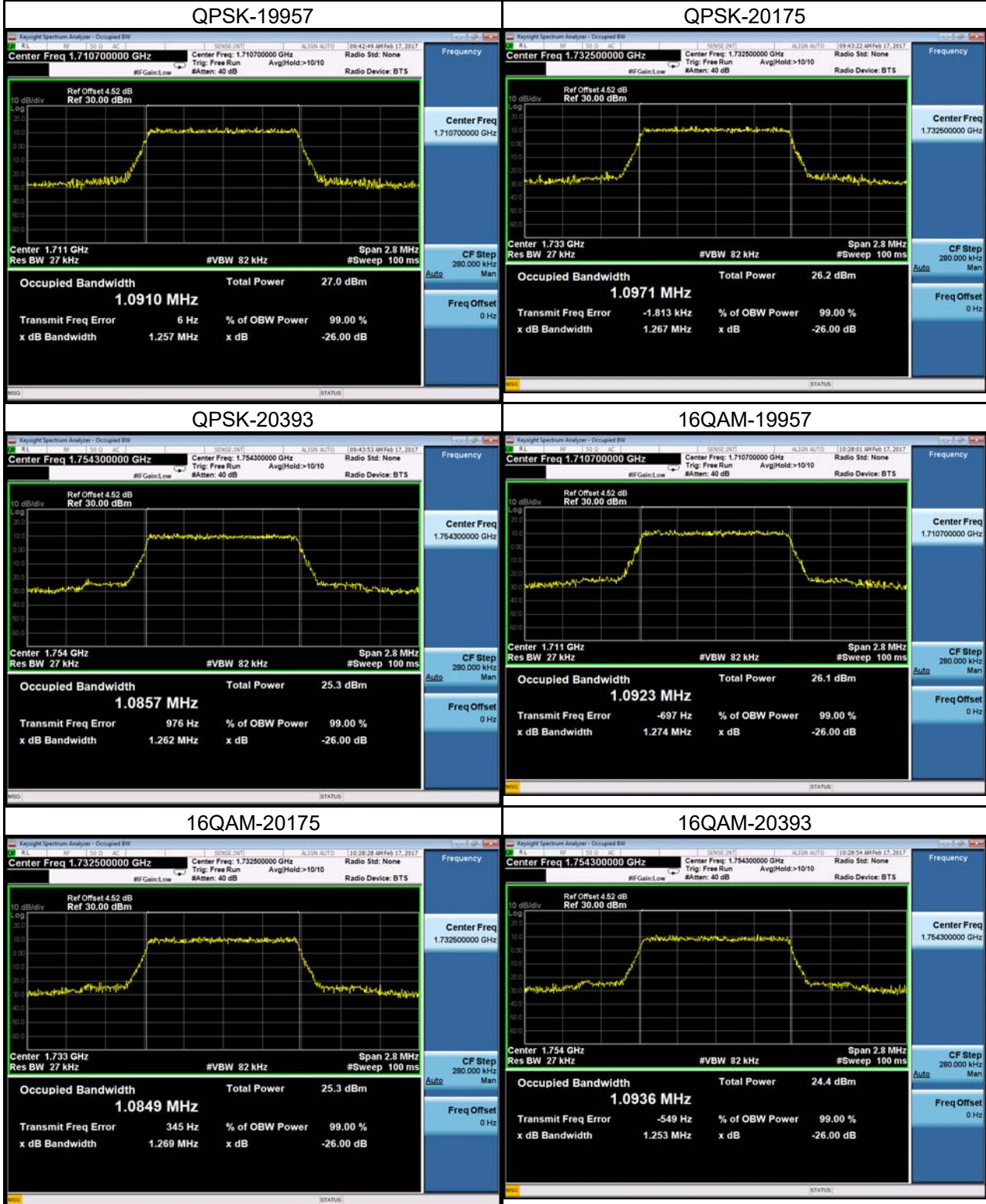

LTE Band 4_3M					
QPSK			16QAM		
Channel	Frequency (MHz)	99% Occupied Bandwidth (MHz)	Channel	Frequency (MHz)	99% Occupied Bandwidth (MHz)
19965	1711.5	2.6950	19965	1711.5	2.6976
20175	1732.5	2.6991	20175	1732.5	2.6934
20385	1753.5	2.6973	20385	1753.5	2.6944
Channel	Frequency (MHz)	26dB Bandwidth (MHz)	Channel	Frequency (MHz)	26dB Bandwidth (MHz)
19965	1711.5	2.946	19965	1711.5	2.948
20175	1732.5	2.953	20175	1732.5	2.958
20385	1753.5	2.934	20385	1753.5	2.980

Spectrum Plot



LTE Band 4_5M					
QPSK			16QAM		
Channel	Frequency (MHz)	99% Occupied Bandwidth (MHz)	Channel	Frequency (MHz)	99% Occupied Bandwidth (MHz)
19975	1712.5	4.5133	19975	1712.5	4.5156
20175	1732.5	4.5221	20175	1732.5	4.5101
20375	1752.5	4.5200	20375	1752.5	4.5179
Channel	Frequency (MHz)	26dB Bandwidth (MHz)	Channel	Frequency (MHz)	26dB Bandwidth (MHz)
19975	1712.5	5.107	19975	1712.5	5.035
20175	1732.5	4.986	20175	1732.5	4.972
20375	1752.5	5.045	20375	1752.5	5.030

Spectrum Plot



LTE Band 4_10M					
QPSK			16QAM		
Channel	Frequency (MHz)	99% Occupied Bandwidth (MHz)	Channel	Frequency (MHz)	99% Occupied Bandwidth (MHz)
20000	1715	8.9897	20000	1715	8.9724
20175	1732.5	8.9767	20175	1732.5	8.9621
20350	1750	9.0127	20350	1750	8.9876
Channel	Frequency (MHz)	26dB Bandwidth (MHz)	Channel	Frequency (MHz)	26dB Bandwidth (MHz)
20000	1715	9.965	20000	1715	9.944
20175	1732.5	9.906	20175	1732.5	9.937
20350	1750	9.958	20350	1750	9.910

Spectrum Plot



LTE Band 4_15M					
QPSK			16QAM		
Channel	Frequency (MHz)	99% Occupied Bandwidth (MHz)	Channel	Frequency (MHz)	99% Occupied Bandwidth (MHz)
20025	1717.5	13.477	20025	1717.5	13.456
20175	1732.5	13.453	20175	1732.5	13.463
20325	1747.5	13.487	20325	1747.5	13.459
Channel	Frequency (MHz)	26dB Bandwidth (MHz)	Channel	Frequency (MHz)	26dB Bandwidth (MHz)
20025	1717.5	14.74	20025	1717.5	14.80
20175	1732.5	14.73	20175	1732.5	14.78
20325	1747.5	14.85	20325	1747.5	14.79

Spectrum Plot

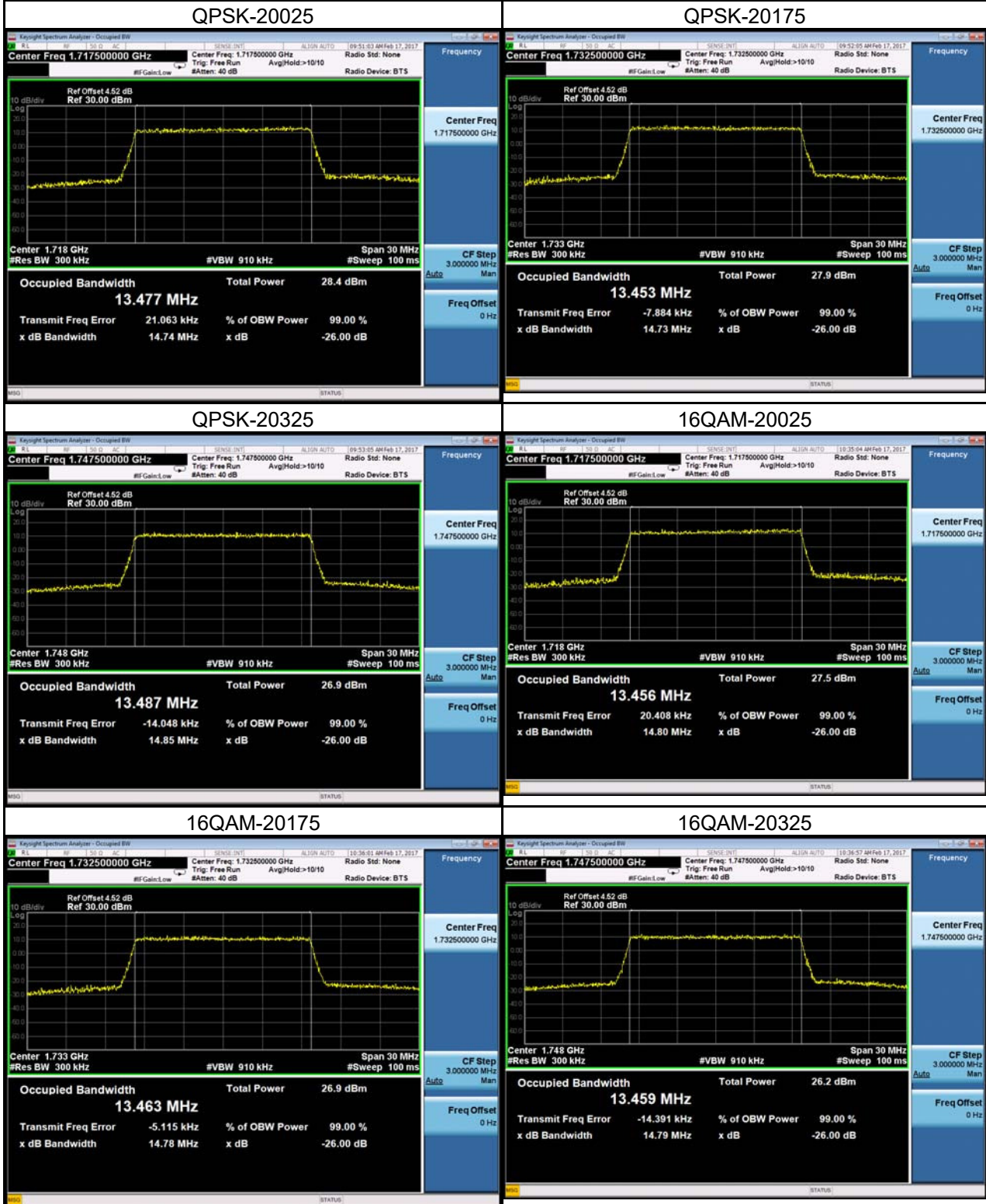

LTE Band 4_20M					
QPSK			16QAM		
Channel	Frequency (MHz)	99% Occupied Bandwidth (MHz)	Channel	Frequency (MHz)	99% Occupied Bandwidth (MHz)
20050	1720	17.985	20050	1720	17.933
20175	1732.5	17.954	20175	1732.5	17.927
20300	1745	17.949	20300	1745	17.941
Channel	Frequency (MHz)	26dB Bandwidth (MHz)	Channel	Frequency (MHz)	26dB Bandwidth (MHz)
20050	1720	19.52	20050	1720	19.51
20175	1732.5	19.49	20175	1732.5	19.46
20300	1745	19.59	20300	1745	19.58

Spectrum Plot

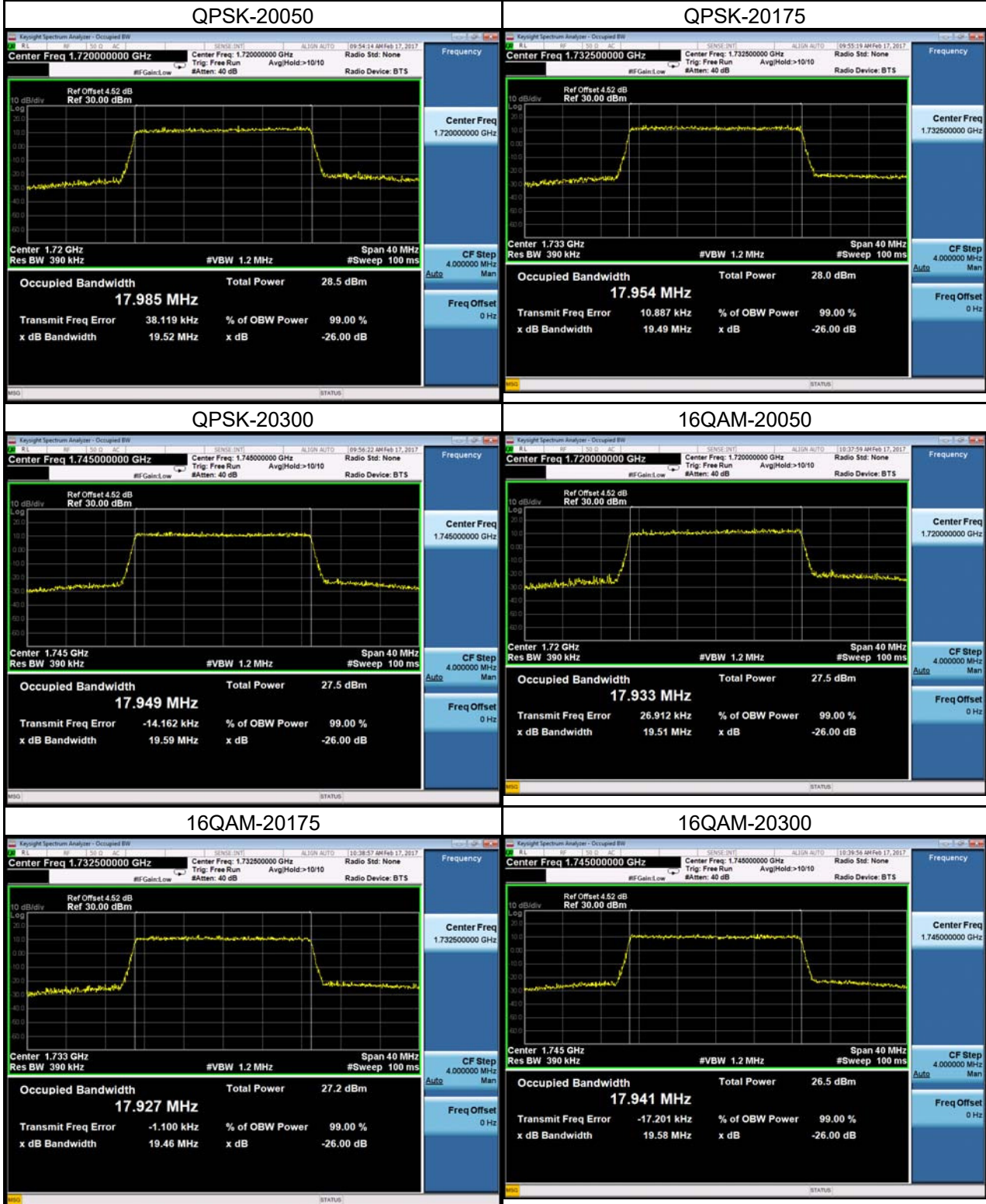

LTE Band 7_5M					
QPSK			16QAM		
Channel	Frequency (MHz)	99% Occupied Bandwidth (MHz)	Channel	Frequency (MHz)	99% Occupied Bandwidth (MHz)
20775	2502.5	4.5275	20775	2502.5	4.5062
21100	2535	4.5206	21100	2535	4.5099
21425	2567.5	4.5196	21425	2567.5	4.5170
Channel	Frequency (MHz)	26dB Bandwidth (MHz)	Channel	Frequency (MHz)	26dB Bandwidth (MHz)
20775	2502.5	5.104	20775	2502.5	5.054
21100	2535	5.022	21100	2535	5.021
21425	2567.5	5.007	21425	2567.5	5.010

Spectrum Plot



LTE Band 7_10M					
QPSK			16QAM		
Channel	Frequency (MHz)	99% Occupied Bandwidth (MHz)	Channel	Frequency (MHz)	99% Occupied Bandwidth (MHz)
20800	2505	8.9723	20800	2505	8.9803
21100	2535	8.9700	21100	2535	8.9856
21400	2565	8.9871	21400	2565	8.9634
Channel	Frequency (MHz)	26dB Bandwidth (MHz)	Channel	Frequency (MHz)	26dB Bandwidth (MHz)
20800	2505	9.896	20800	2505	9.907
21100	2535	9.842	21100	2535	9.958
21400	2565	9.932	21400	2565	9.843

Spectrum Plot



LTE Band 7_15M					
QPSK			16QAM		
Channel	Frequency (MHz)	99% Occupied Bandwidth (MHz)	Channel	Frequency (MHz)	99% Occupied Bandwidth (MHz)
20825	2507.5	13.460	20825	2507.5	13.456
21100	2535	13.472	21100	2535	13.468
21375	2562.5	13.474	21375	2562.5	13.470
Channel	Frequency (MHz)	26dB Bandwidth (MHz)	Channel	Frequency (MHz)	26dB Bandwidth (MHz)
20825	2507.5	14.78	20825	2507.5	14.76
21100	2535	14.79	21100	2535	14.76
21375	2562.5	14.76	21375	2562.5	14.79

Spectrum Plot

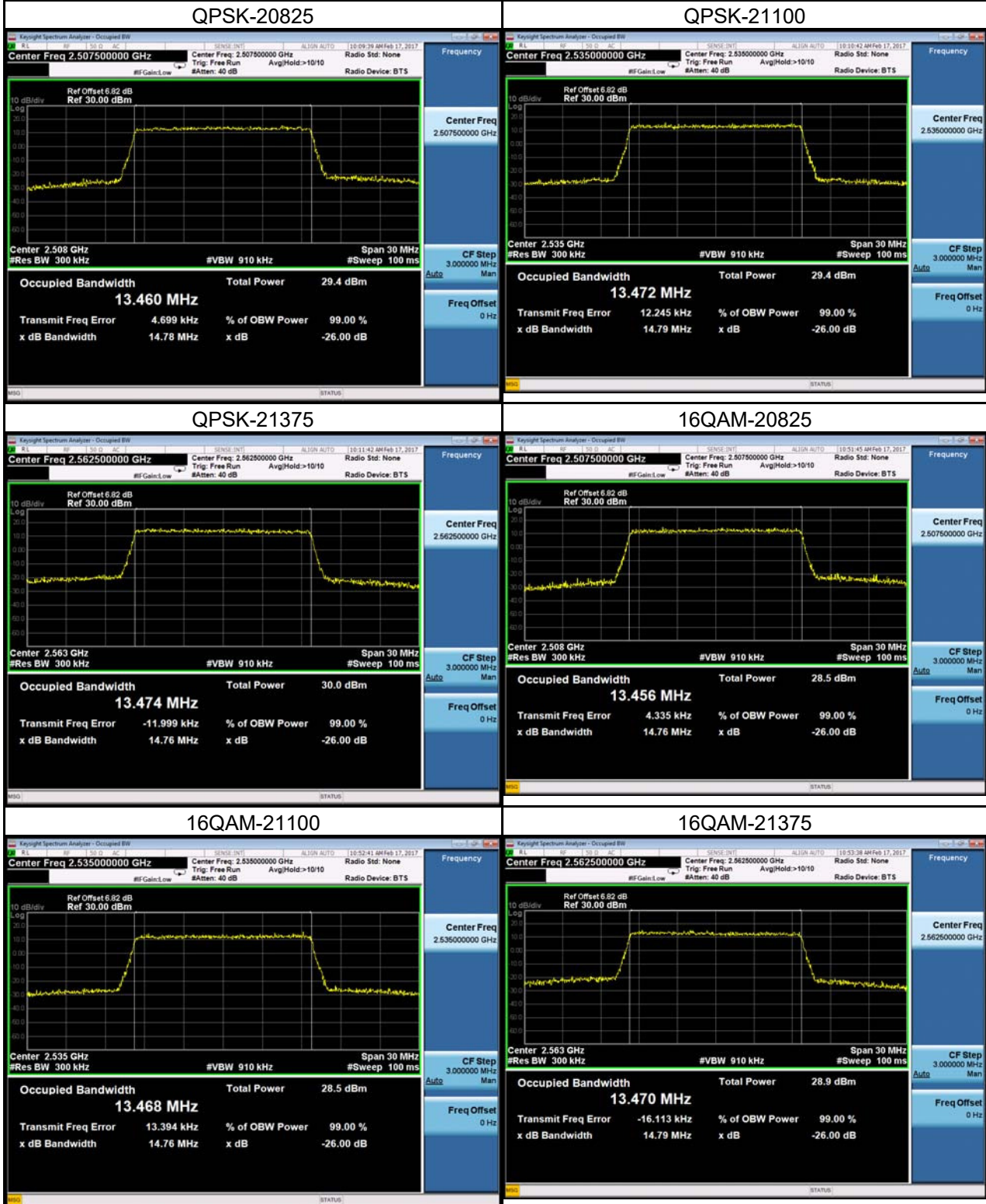

LTE Band 7_20M					
QPSK			16QAM		
Channel	Frequency (MHz)	99% Occupied Bandwidth (MHz)	Channel	Frequency (MHz)	99% Occupied Bandwidth (MHz)
20850	2510	17.956	20850	2510	17.915
21100	2535	17.952	21100	2535	17.950
21350	2560	17.934	21350	2560	17.938
Channel	Frequency (MHz)	26dB Bandwidth (MHz)	Channel	Frequency (MHz)	26dB Bandwidth (MHz)
20850	2510	19.53	20850	2510	19.49
21100	2535	19.39	21100	2535	19.50
21350	2560	19.48	21350	2560	19.57

Spectrum Plot

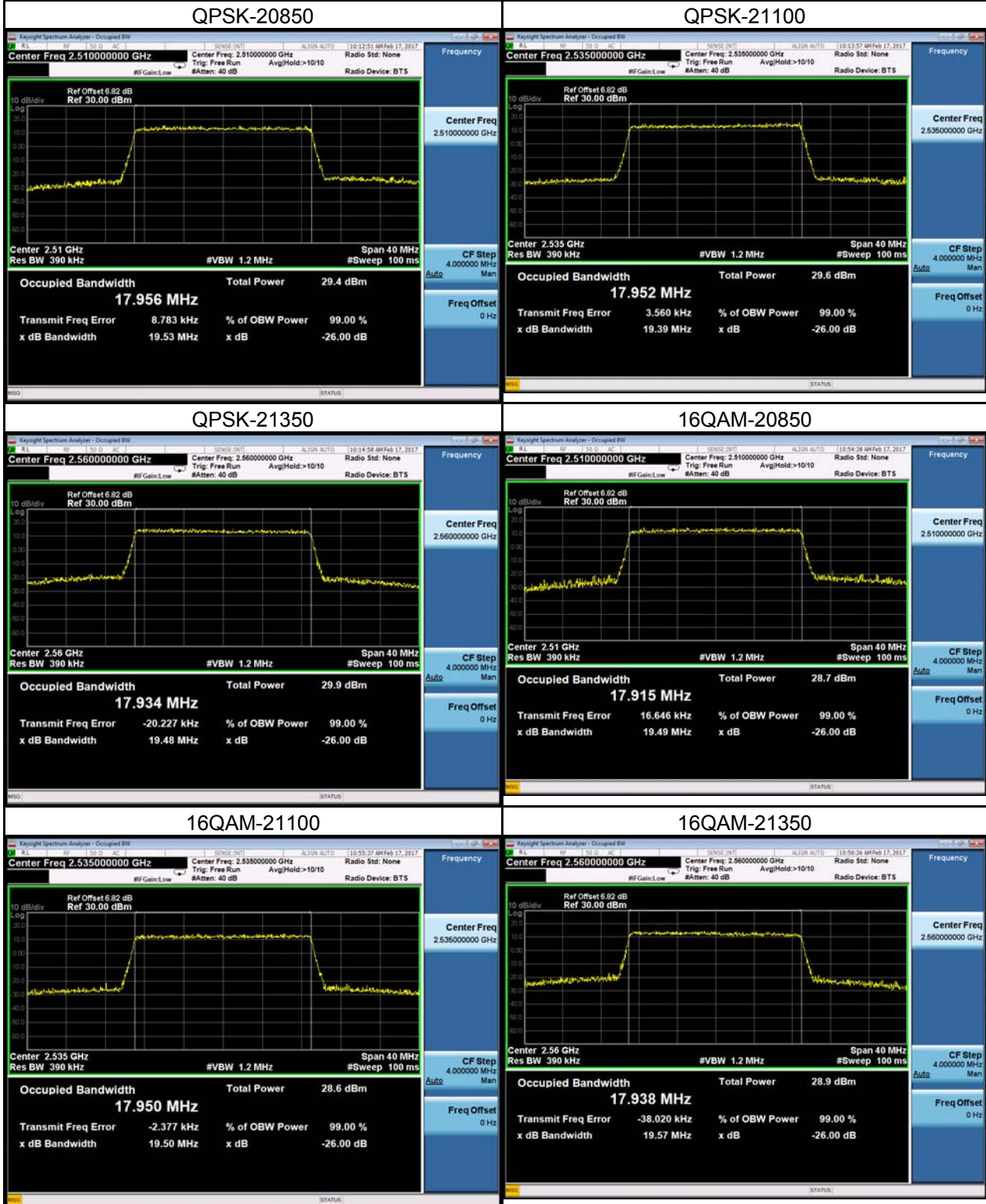

ATTACHMENT C - CONDUCTED EMISSIONS

WCDMA Band 4_WCDMA			
Channel	Frequency(MHz)	Channel	Frequency(MHz)
1413	1732.6	1413	1732.6
Date: 2.JUN.2017 17:07:20		Date: 2.JUN.2017 17:09:06	
Channel	Frequency(MHz)	-	-
1413	1732.6	-	-
		-	

WCDMA Band 4_HSDPA

Channel	Frequency(MHz)	Channel	Frequency(MHz)
1413	1732.6	1413	1732.6

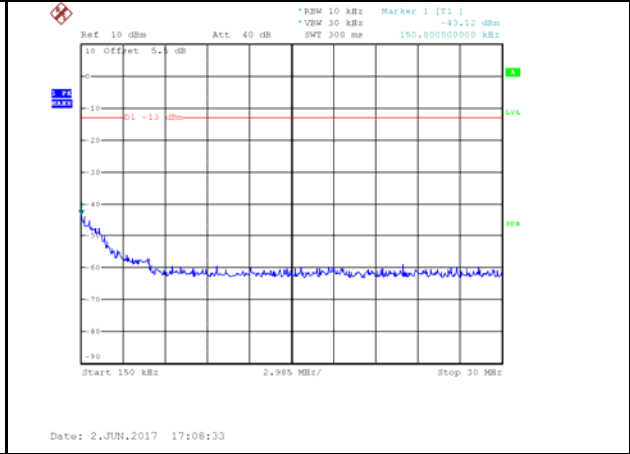
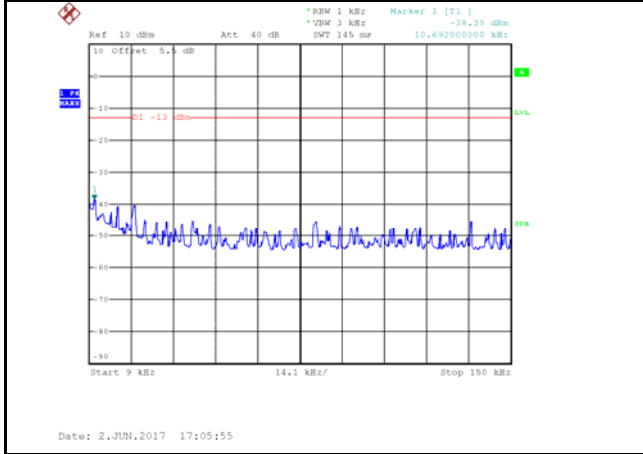

Channel	Frequency(MHz)	-	-
1413	1732.6	-	-



	-
	-

WCDMA Band 4_HSUPA

Channel	Frequency(MHz)	Channel	Frequency(MHz)
1413	1732.6	1413	1732.6

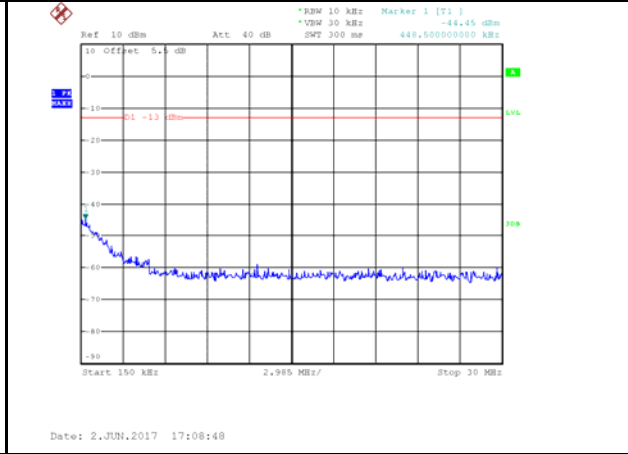
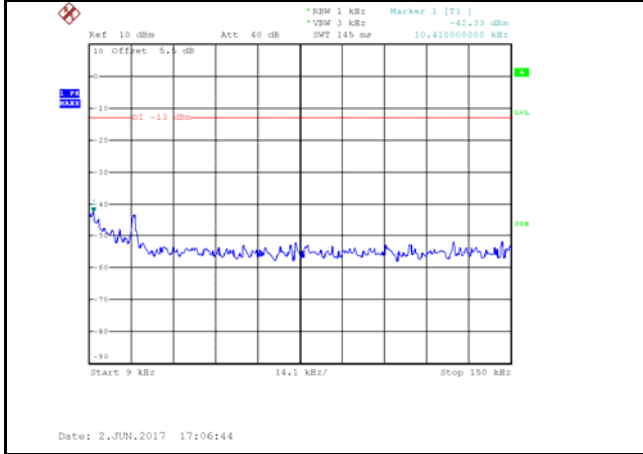

Channel	Frequency(MHz)	-	-
1413	1732.6	-	-

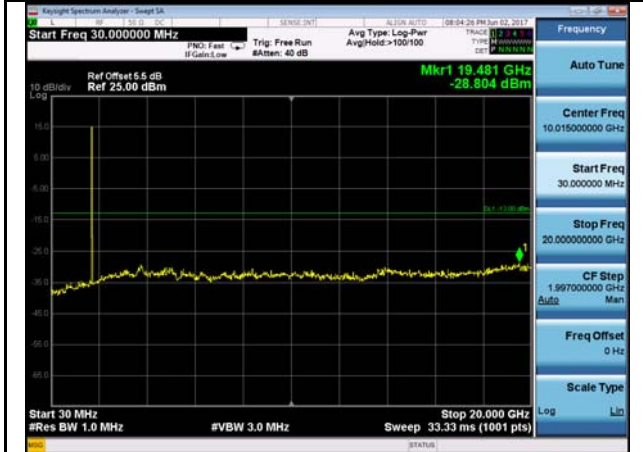

	-
	-

LTE Band 4_1.4M			
Channel	Frequency(MHz)	Channel	Frequency(MHz)
20175	1732.5	20175	1732.5
Channel	Frequency(MHz)	-	-
20175	1732.5	-	-

LTE Band 4_3M			
Channel	Frequency(MHz)	Channel	Frequency(MHz)
20175	1732.5	20175	1732.5
Channel	Frequency(MHz)	-	-
20175	1732.5	-	-

LTE Band 4_5M			
Channel	Frequency(MHz)	Channel	Frequency(MHz)
20175	1732.5	20175	1732.5
Channel	Frequency(MHz)	-	-
20175	1732.5	-	-

LTE Band 4_10M			
Channel	Frequency(MHz)	Channel	Frequency(MHz)
20175	1732.5	20175	1732.5
Channel	Frequency(MHz)	-	-
20175	1732.5	-	-

LTE Band 4_15M			
Channel	Frequency(MHz)	Channel	Frequency(MHz)
20175	1732.5	20175	1732.5
Channel	Frequency(MHz)	-	-
20175	1732.5	-	-

LTE Band 4_20M			
Channel	Frequency(MHz)	Channel	Frequency(MHz)
20175	1732.5	20175	1732.5
Channel	Frequency(MHz)	-	-
20175	1732.5	-	-

LTE Band 7_5M			
Channel	Frequency(MHz)	Channel	Frequency(MHz)
21100	2535	21100	2535
Channel	Frequency(MHz)	-	-
21100	2535	-	-

LTE Band 7_10M			
Channel	Frequency(MHz)	Channel	Frequency(MHz)
21100	2535	21100	2535
Channel	Frequency(MHz)	-	-
21100	2535	-	-

LTE Band 7_15M			
Channel	Frequency(MHz)	Channel	Frequency(MHz)
21100	2535	21100	2535
Channel	Frequency(MHz)	-	-
21100	2535	-	-

LTE Band 7_20M			
Channel	Frequency(MHz)	Channel	Frequency(MHz)
21100	2535	21100	2535
Channel	Frequency(MHz)	-	-
21100	2535	-	-

ATTACHMENT D - RADIATED EMISSION

Test Mode: TX Mode_Adapter: BYD

Ant 0°

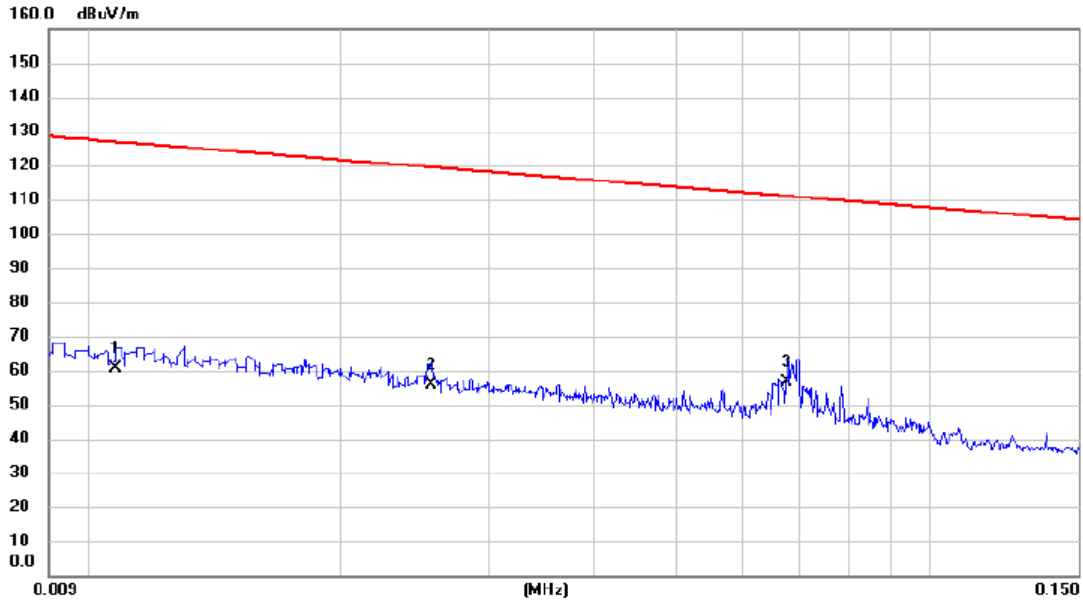

No.	Mk.	Freq.	Reading Level	Correct Factor	Measurement	Limit	Margin	Detector	Comment
		MHz	dBuV	dB	dBuV/m	dBuV/m	dB		
1		0.011	39.85	20.82	60.67	126.94	-66.27	AVG	
2		0.026	36.51	19.45	55.96	119.44	-63.48	AVG	
3	*	0.068	38.28	18.38	56.66	110.99	-54.33	AVG	

Test Mode: TX Mode_Adapter: BYD

Ant 0°

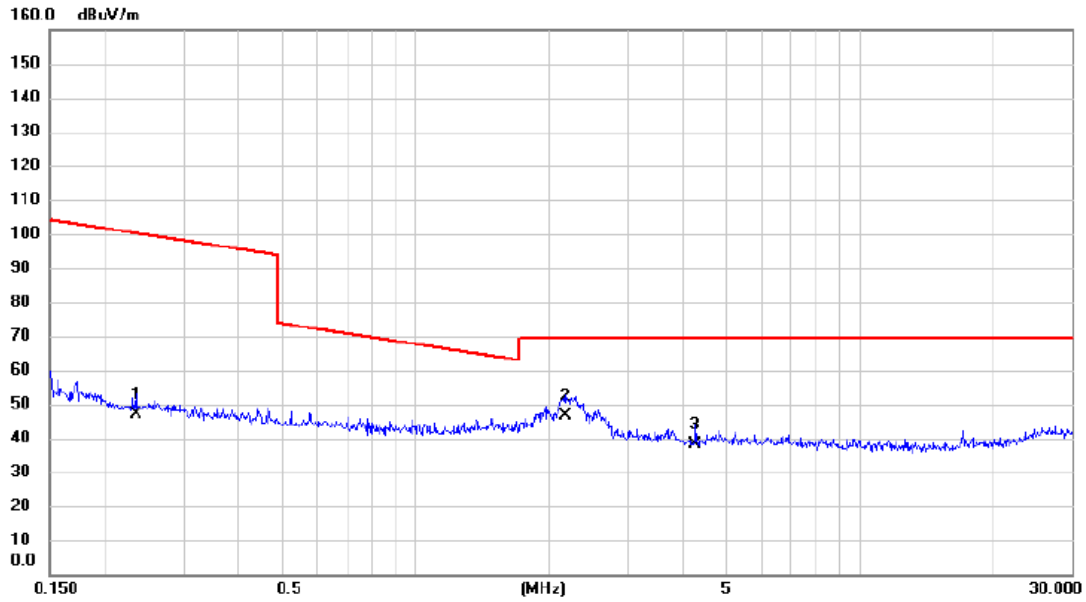

No.	Mk.	Freq. MHz	Reading Level dBuV	Correct Factor dB	Measure- ment dBuV/m	Limit dBuV/m	Margin dB	Detector	Comment
1		0.234	30.11	16.70	46.81	100.22	-53.41	AVG	
2	*	2.178	31.15	15.46	46.61	69.54	-22.93	QP	
3		4.269	23.36	14.80	38.16	69.54	-31.38	QP	

Test Mode: TX Mode_Adapter: BYD

Ant 90°

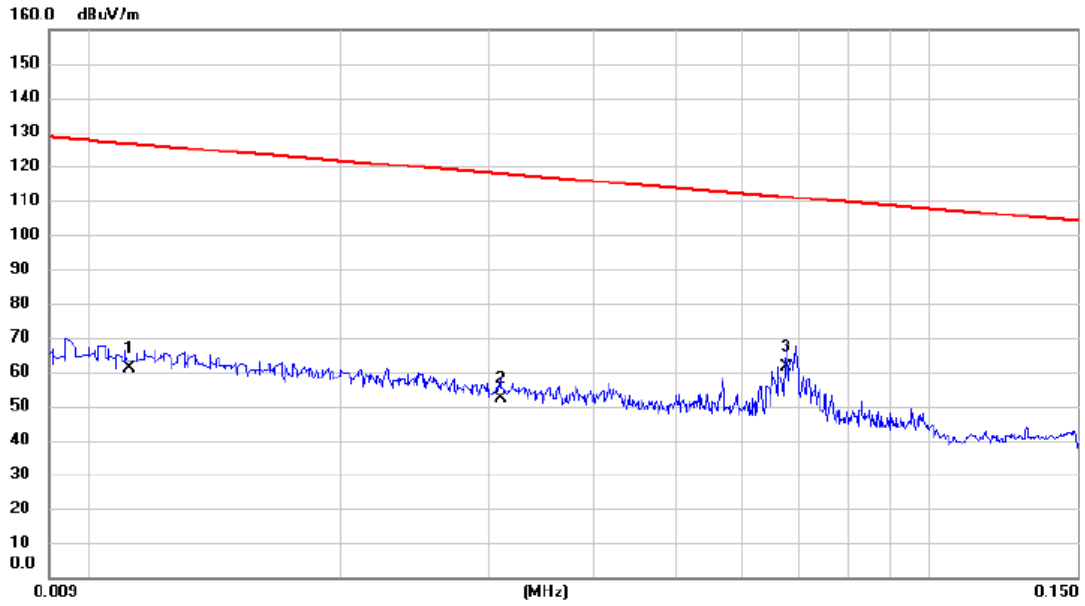

No.	Mk.	Freq. MHz	Reading Level dBuV	Correct Factor dB	Measure- ment dBuV/m	Limit dBuV/m	Margin dB	Detector	Comment
1		0.011	40.42	20.76	61.18	126.62	-65.44	AVG	
2		0.031	32.94	19.29	52.23	117.78	-65.55	AVG	
3	*	0.068	42.88	18.38	61.26	111.01	-49.75	AVG	

Test Mode: TX Mode_Adapter: BYD

Ant 90°

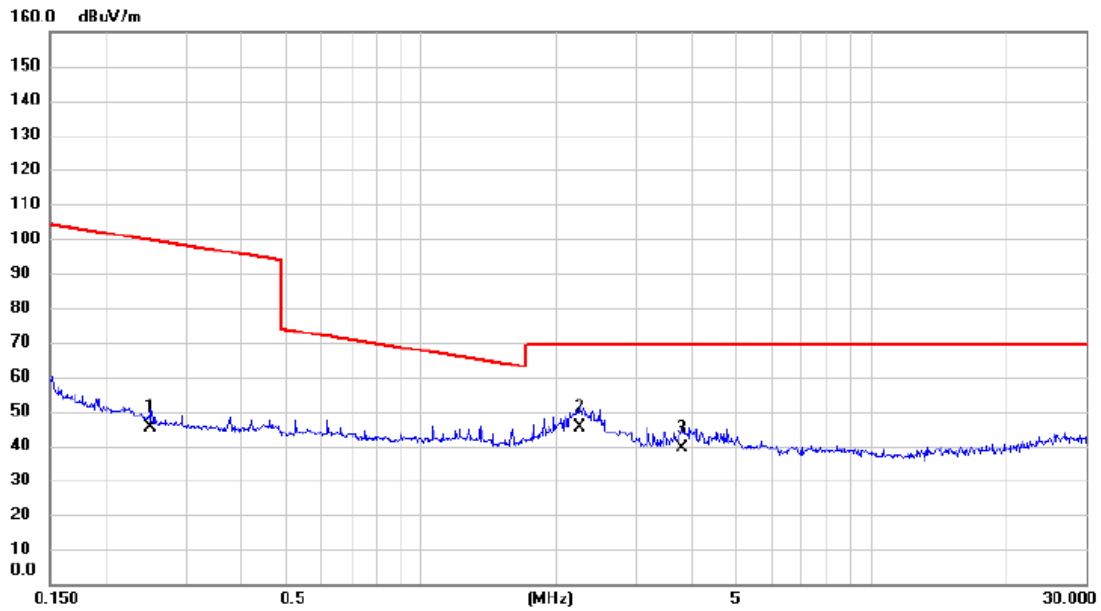

No.	Mk.	Freq. MHz	Reading Level dBuV	Correct Factor dB	Measure- ment dBuV/m	Limit dBuV/m	Margin dB	Detector	Comment
1		0.251	28.91	16.65	45.56	99.62	-54.06	AVG	
2	*	2.249	29.77	15.44	45.21	69.54	-24.33	QP	
3		3.799	24.28	15.01	39.29	69.54	-30.25	QP	

Test Mode: TX Mode_Adapter: PHITEK

Ant 0°

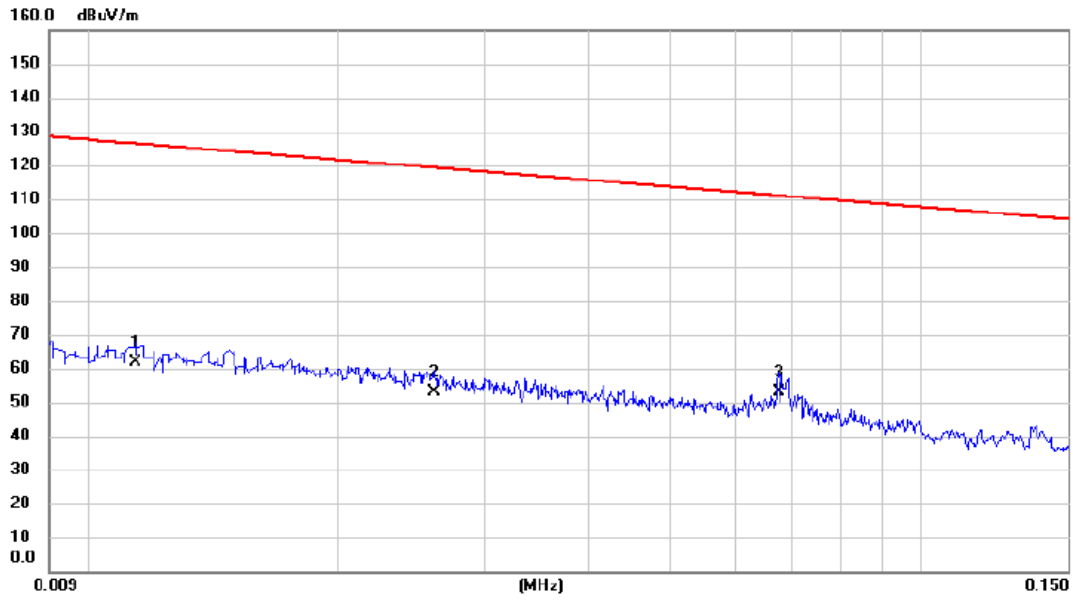

No.	Mk.	Freq. MHz	Reading Level dBuV	Correct Factor dB	Measure- ment dBuV/m	Limit dBuV/m	Margin dB	Detector	Comment
1		0.011	41.14	20.74	61.88	126.47	-64.59	AVG	
2		0.026	33.54	19.44	52.98	119.27	-66.29	AVG	
3	*	0.068	34.64	18.38	53.02	111.02	-58.00	AVG	

Test Mode: TX Mode_Adapter: PHITEK

Ant 0°

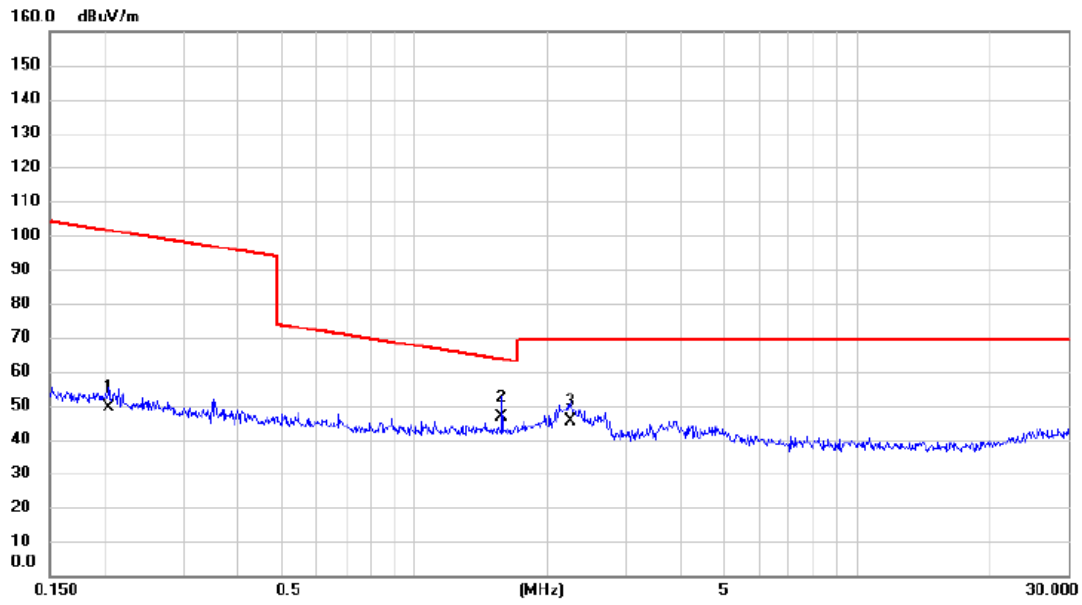

No.	Mk.	Freq. MHz	Reading Level dBuV	Correct Factor dB	Measure- ment dBuV/m	Limit dBuV/m	Margin dB	Detector	Comment
1		0.204	32.63	16.78	49.41	101.41	-52.00	AVG	
2	*	1.577	31.10	15.66	46.76	63.65	-16.89	QP	
3		2.249	29.92	15.44	45.36	69.54	-24.18	QP	

Test Mode: TX Mode_Adapter: PHITEK

Ant 90°

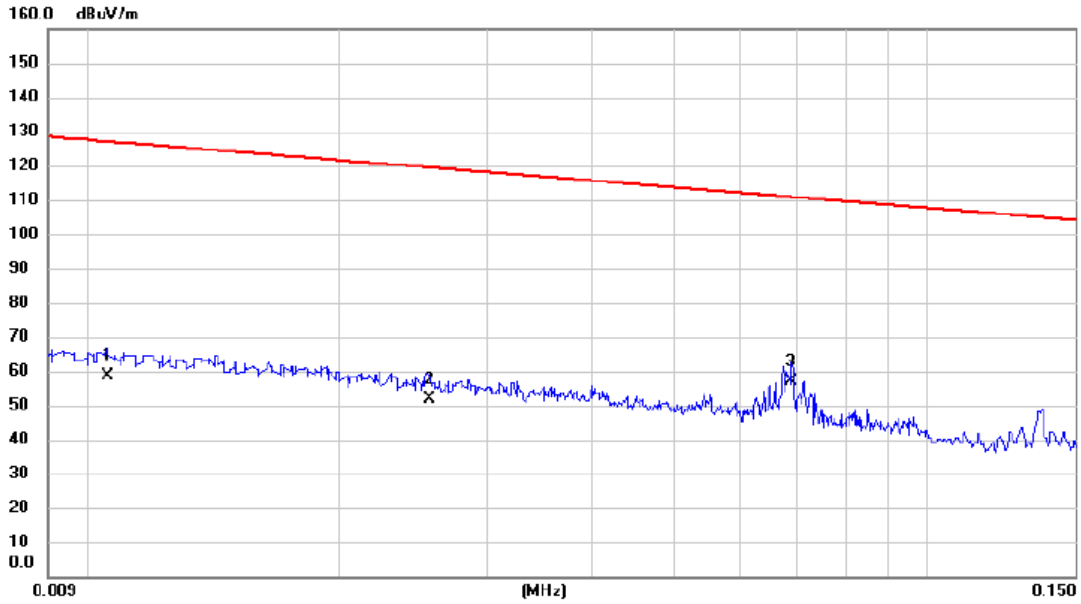

No.	Mk.	Freq. MHz	Reading Level dBuV	Correct Factor dB	Measure- ment dBuV/m	Limit dBuV/m	Margin dB	Detector	Comment
1		0.011	37.66	20.84	58.50	127.10	-68.60	AVG	
2		0.026	32.46	19.45	51.91	119.44	-67.53	AVG	
3	*	0.069	38.68	18.35	57.03	110.83	-53.80	AVG	

Test Mode: TX Mode_Adapter: PHITEK

Ant 90°

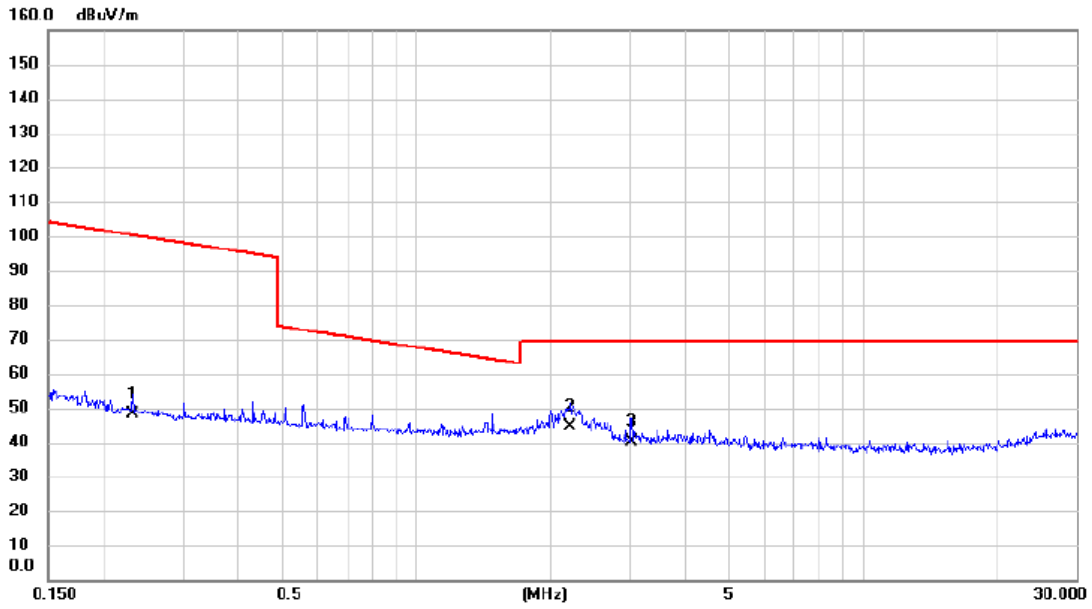

No. Mk.	Freq. MHz	Reading Level dBuV	Correct Factor dB	Measurement dBuV/m	Limit dBuV/m	Margin dB	Detector	Comment
1	0.232	31.58	16.71	48.29	100.31	-52.02	AVG	
2 *	2.213	28.97	15.45	44.42	69.54	-25.12	QP	
3	3.025	24.90	15.22	40.12	69.54	-29.42	QP	

Test Mode: TX Mode_Adapter: Huntkey

Ant 0°

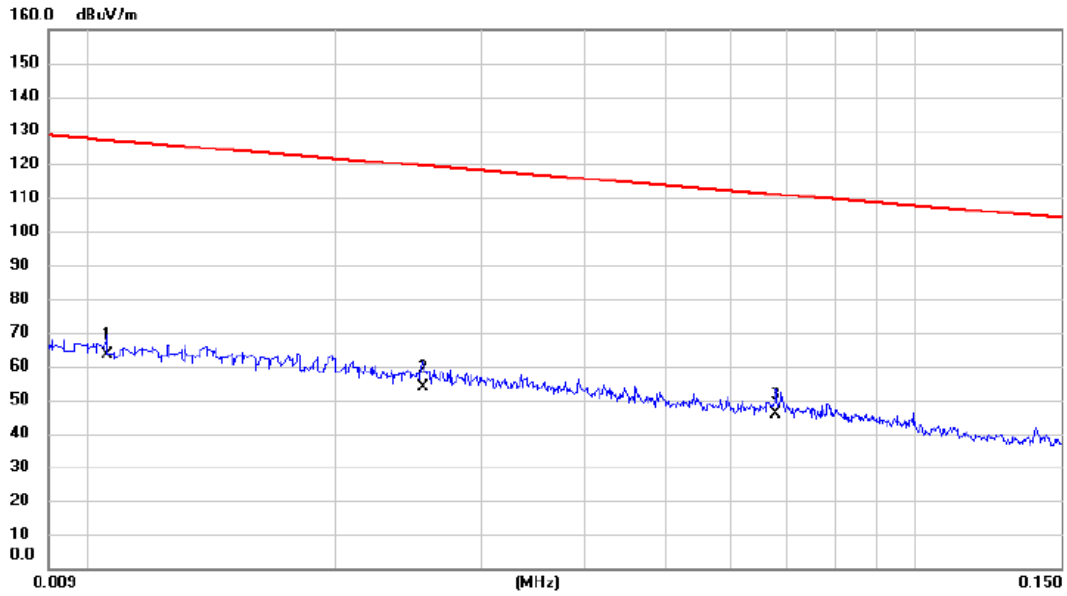

No.	Mk.	Freq. MHz	Reading Level dBuV	Correct Factor dB	Measure- ment dBuV/m	Limit dBuV/m	Margin dB	Detector	Comment
1	*	0.011	42.76	20.84	63.60	127.10	-63.50	AVG	
2		0.025	34.27	19.46	53.73	119.47	-65.74	AVG	
3		0.068	27.27	18.37	45.64	110.98	-65.34	AVG	

Test Mode: TX Mode_Adapter: Huntkey

Ant 0°

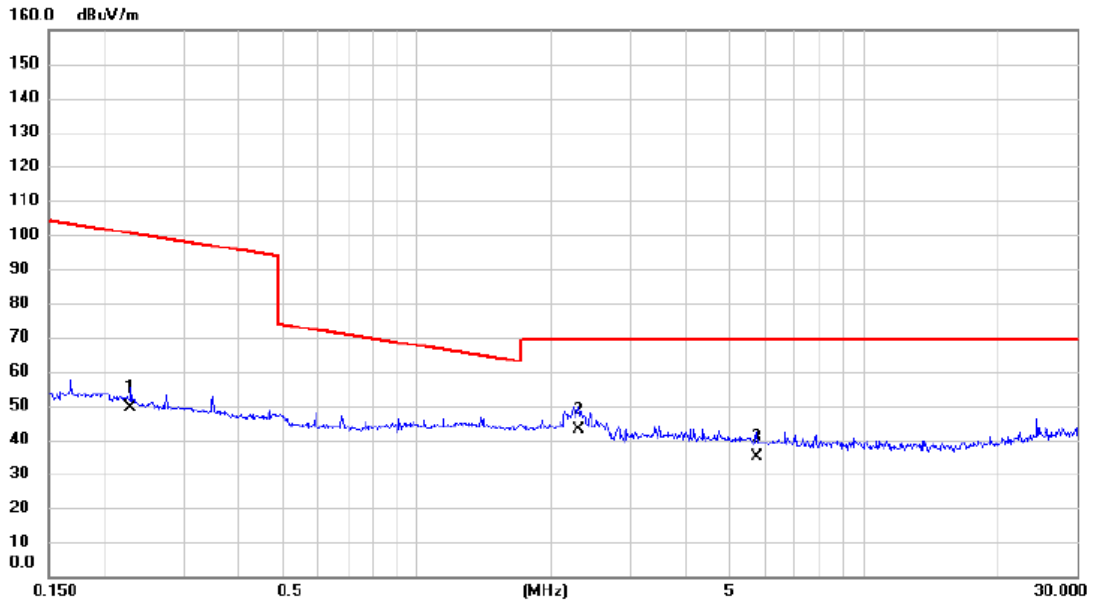

No.	Mk.	Freq.	Reading Level	Correct Factor	Measurement	Limit	Margin	Detector	Comment
		MHz	dBuV	dB	dBuV/m	dBuV/m	dB		
1		0.229	32.83	16.71	49.54	100.41	-50.87	AVG	
2	*	2.297	27.52	15.42	42.94	69.54	-26.60	QP	
3		5.774	20.81	14.28	35.09	69.54	-34.45	QP	

Test Mode: TX Mode_Adapter: Huntkey

Ant 90°

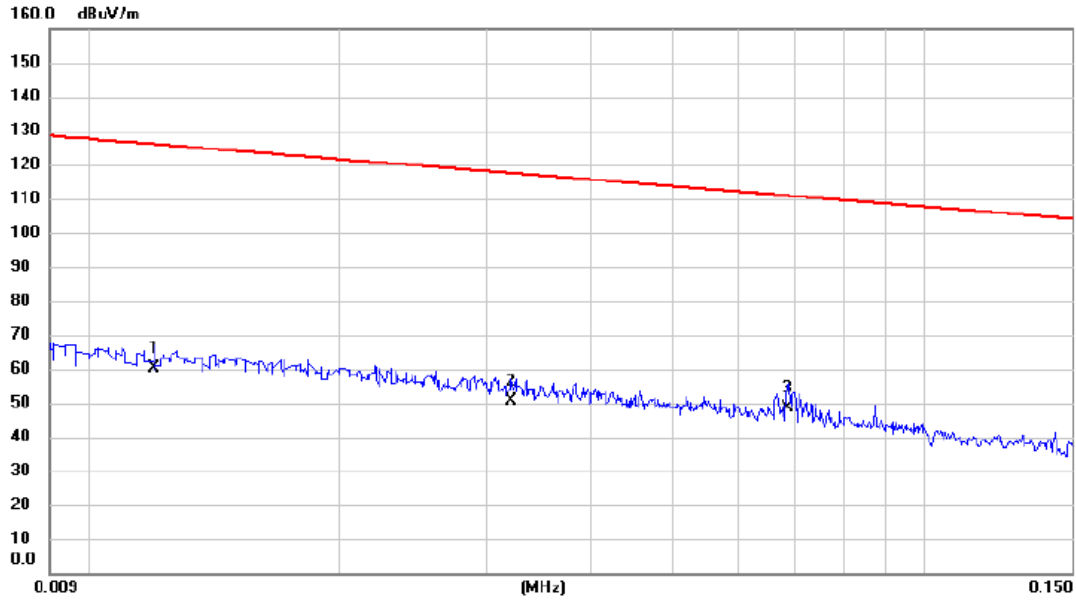

No.	Mk.	Freq. MHz	Reading Level dBuV	Correct Factor dB	Measure- ment dBuV/m	Limit dBuV/m	Margin dB	Detector	Comment
1		0.012	39.57	20.66	60.23	126.02	-65.79	AVG	
2		0.032	31.45	19.26	50.71	117.47	-66.76	AVG	
3	*	0.069	30.26	18.36	48.62	110.87	-62.25	AVG	

Test Mode: TX Mode_Adapter: Huntkey

Ant 90°

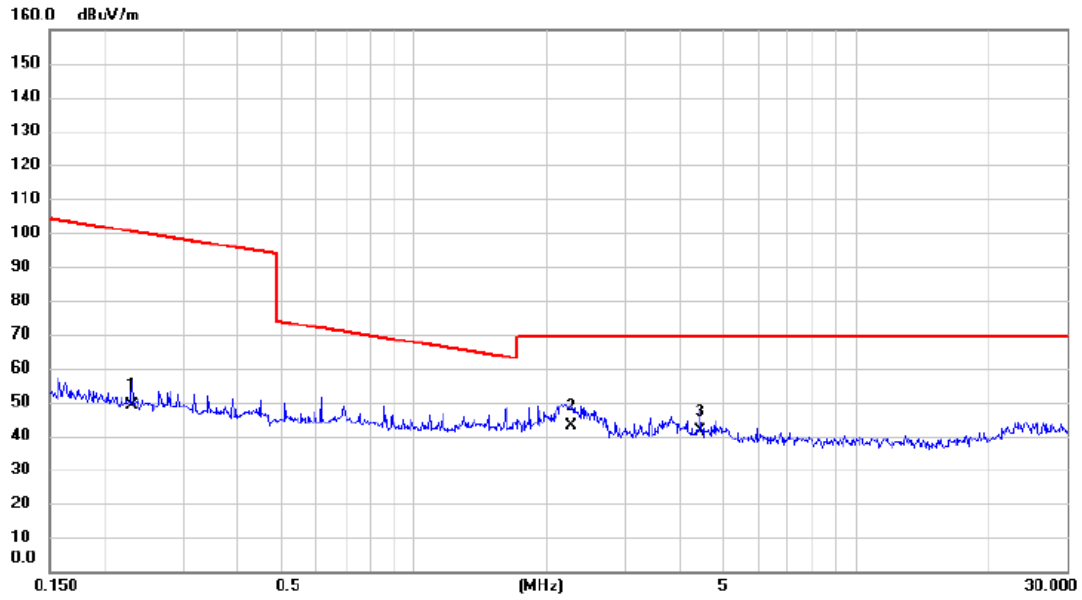

No.	Mk.	Freq. MHz	Reading Level dBuV	Correct Factor dB	Measure- ment dBuV/m	Limit dBuV/m	Margin dB	Detector	Comment
1		0.230	32.41	16.71	49.12	100.36	-51.24	AVG	
2	*	2.272	27.49	15.43	42.92	69.54	-26.62	QP	
3		4.431	26.68	14.71	41.39	69.54	-28.15	QP	

Test Mode: WCDMA Band 4_TX CH1312

Vertical

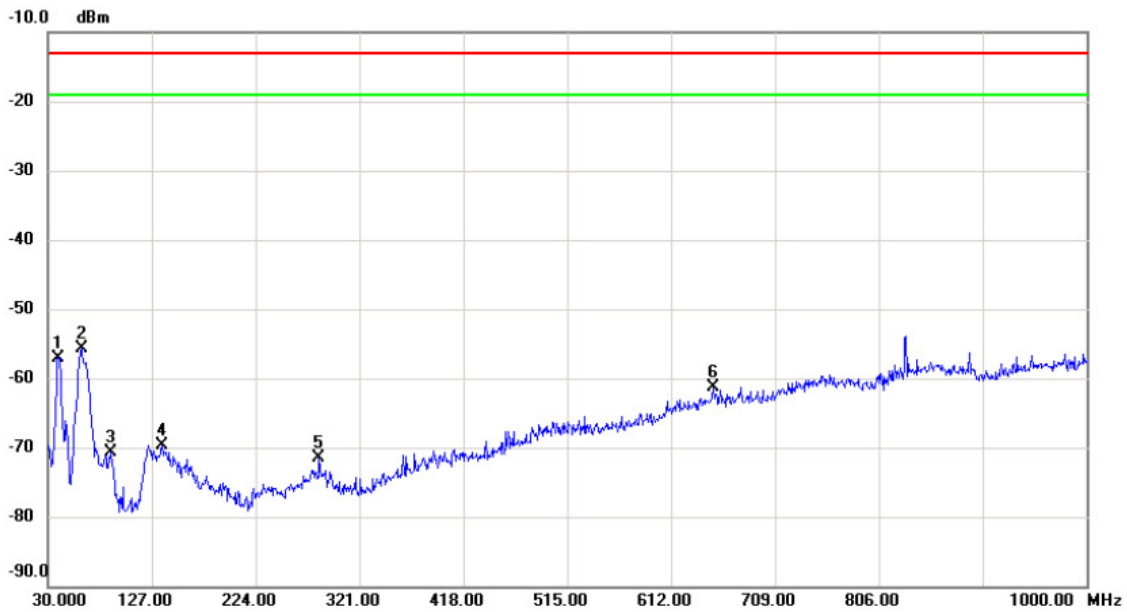

No.	Mk.	Freq. MHz	Reading Level dBm	Correct Factor dB	Measure- ment dBm	Limit dBm	Margin dB	Detector	Comment
1		39.700	-59.76	2.72	-57.04	-13.00	-44.04	peak	
2	*	61.040	-57.35	1.59	-55.76	-13.00	-42.76	peak	
3		88.200	-66.84	-3.85	-70.69	-13.00	-57.69	peak	
4		136.700	-72.33	2.72	-69.61	-13.00	-56.61	peak	
5		283.170	-76.52	4.95	-71.57	-13.00	-58.57	peak	
6		651.770	-76.12	14.75	-61.37	-13.00	-48.37	peak	

Test Mode: WCDMA Band 4_TX CH1312

Horizontal

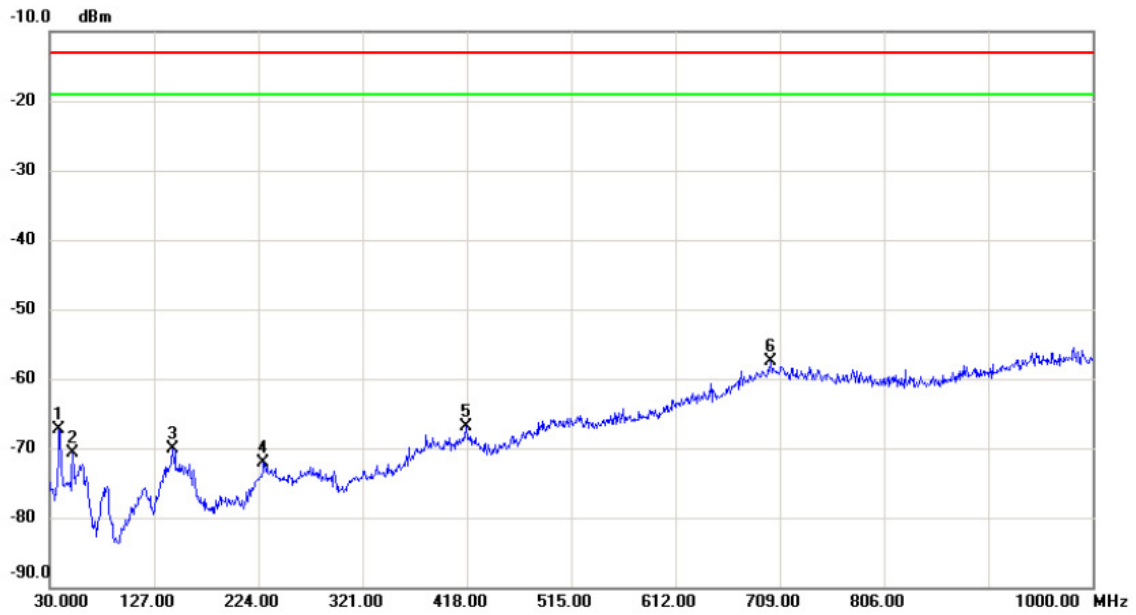

No.	Mk.	Freq. MHz	Reading Level dBm	Correct Factor dB	Measure- ment dBm	Limit dBm	Margin dB	Detector	Comment
1		38.730	-69.83	2.44	-67.39	-13.00	-54.39	peak	
2		51.340	-73.35	2.56	-70.79	-13.00	-57.79	peak	
3		144.460	-75.24	5.16	-70.08	-13.00	-57.08	peak	
4		228.850	-77.10	5.01	-72.09	-13.00	-59.09	peak	
5		417.030	-76.98	10.01	-66.97	-13.00	-53.97	peak	
6	*	700.270	-76.40	18.85	-57.55	-13.00	-44.55	peak	

Test Mode: WCDMA Band 4_TX CH1312

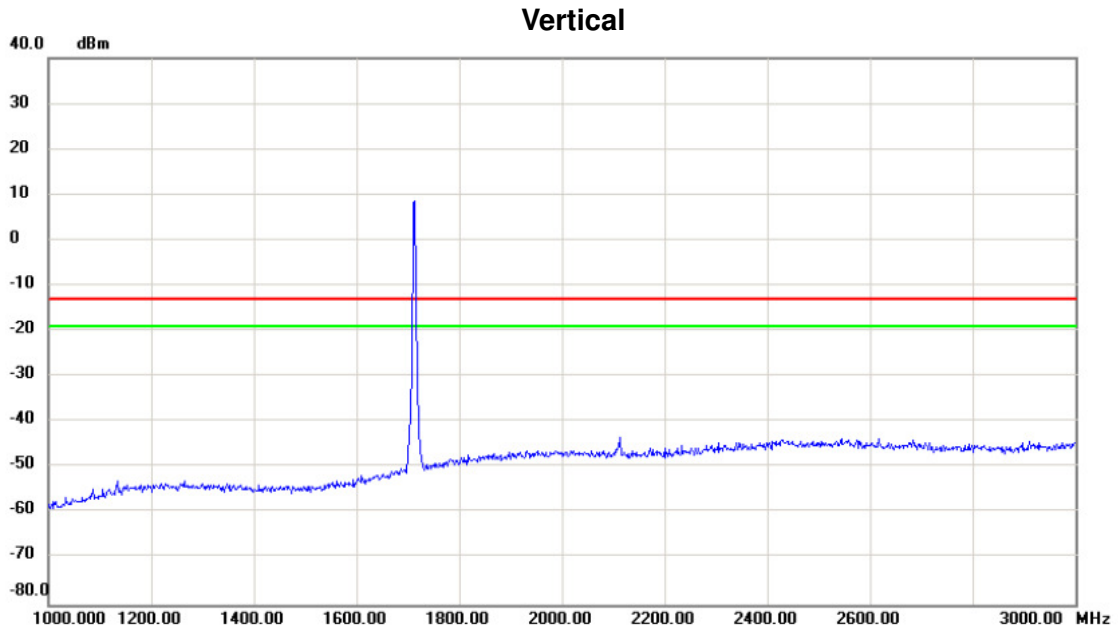

No.	Mk.	Freq. MHz	Reading Level dBm	Correct Factor dB	Measure- ment dBm	Limit dBm	Margin dB	Detector	Comment
		1730.00	10.00	0.00	10.00	-15.00	25.00		

Test Mode: WCDMA Band 4_TX CH1312

Horizontal

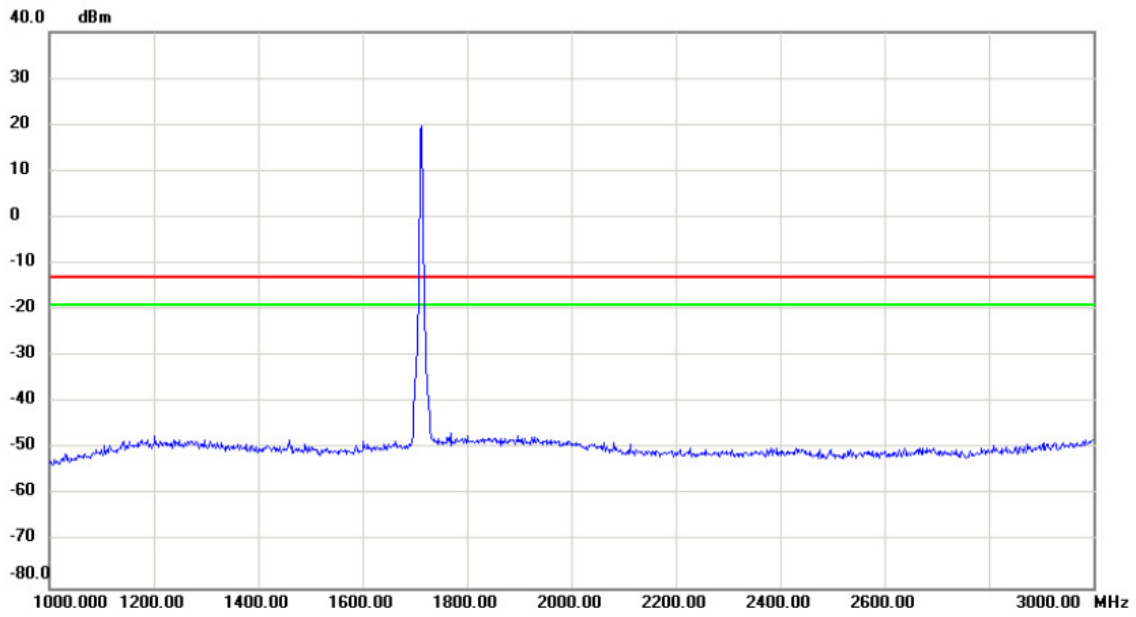

No.	Mk.	Freq.	Reading Level	Correct Factor	Measurement	Limit	Margin	Detector	Comment
		MHz	dBm	dB	dBm	dBm	dB		
		1730.00	20.00	0.00	20.00	-15.00	35.00		

Test Mode: WCDMA Band 4_TX CH1312

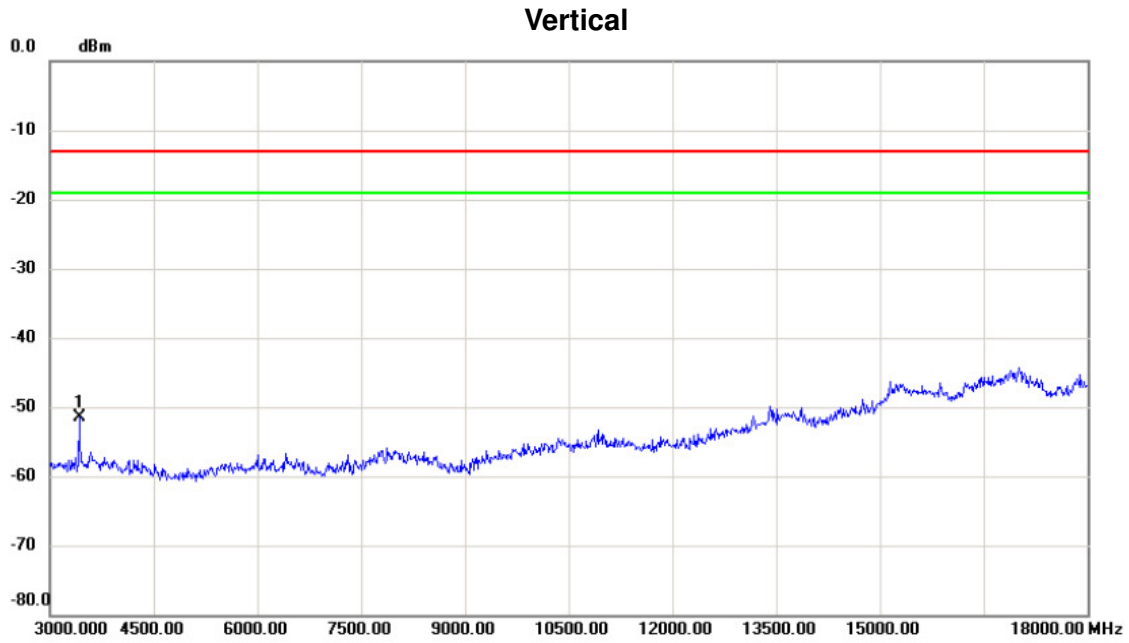

No.	Mk.	Freq. MHz	Reading Level dBm	Correct Factor dB	Measure- ment dBm	Limit dBm	Margin dB	Detector	Comment
1	*	3420.000	-65.54	13.97	-51.57	-13.00	-38.57	peak	

Test Mode: WCDMA Band 4_TX CH1312

Horizontal

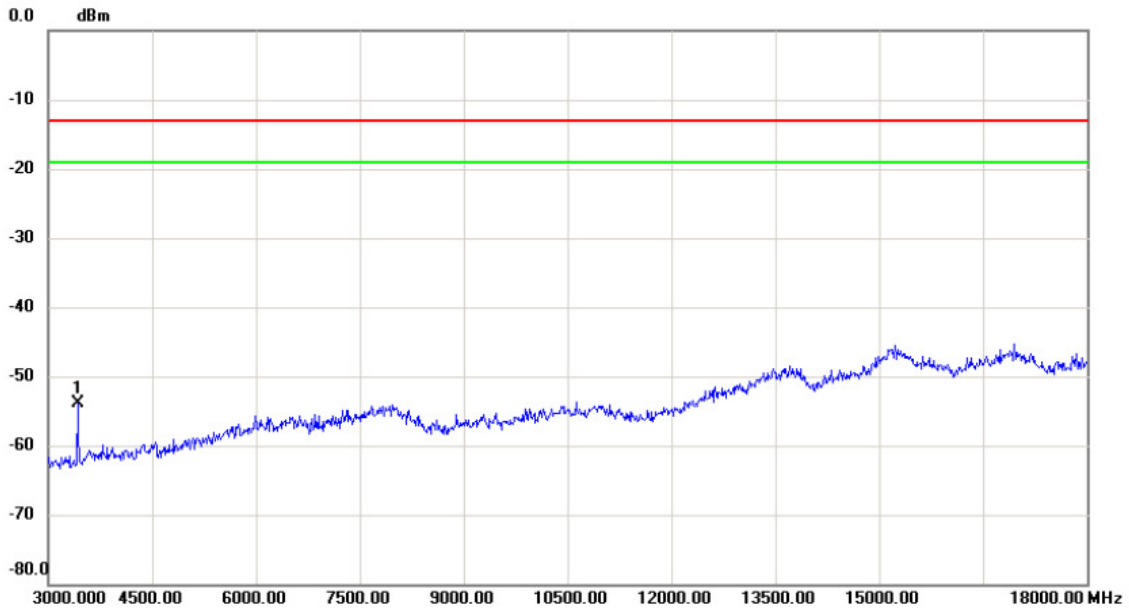

No.	Mk.	Freq. MHz	Reading Level dBm	Correct Factor dB	Measure- ment dBm	Limit dBm	Margin dB	Detector	Comment
1	*	3420.000	-64.30	10.32	-53.98	-13.00	-40.98	peak	

Test Mode: WCDMA Band 4_TX CH1312_ HSDPA

Vertical

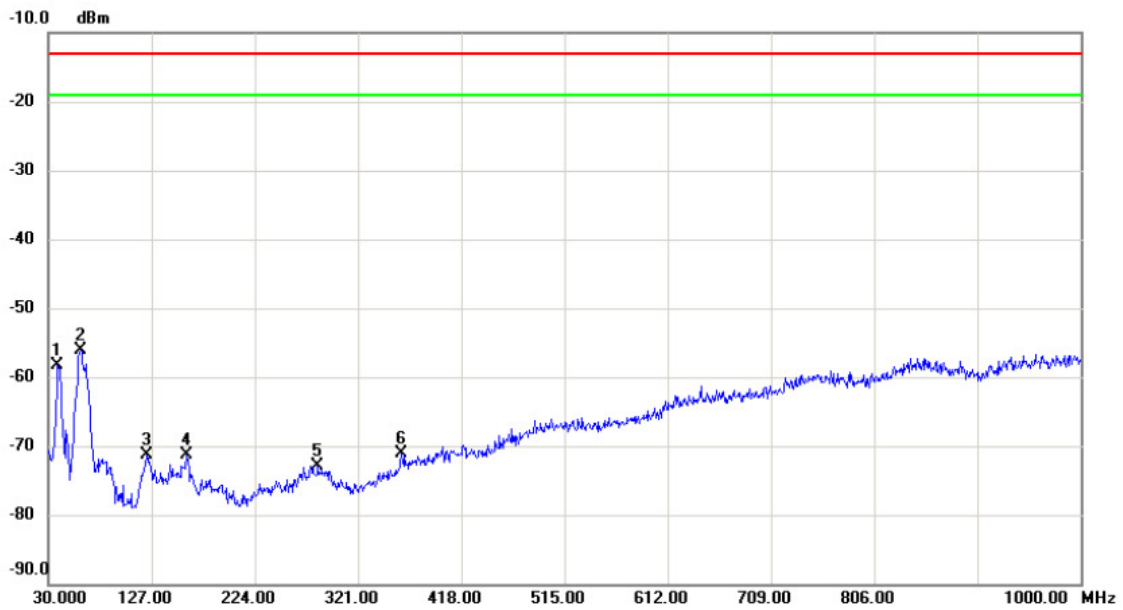

No.	Mk.	Freq. MHz	Reading Level dBm	Correct Factor dB	Measure- ment dBm	Limit dBm	Margin dB	Detector	Comment
1		38.730	-60.23	2.02	-58.21	-13.00	-45.21	peak	
2	*	60.070	-57.52	1.46	-56.06	-13.00	-43.06	peak	
3		122.150	-70.64	-0.71	-71.35	-13.00	-58.35	peak	
4		159.980	-76.13	4.80	-71.33	-13.00	-58.33	peak	
5		283.170	-77.79	4.95	-72.84	-13.00	-59.84	peak	
6		361.740	-76.87	5.85	-71.02	-13.00	-58.02	peak	

Test Mode: WCDMA Band 4_TX CH1312_ HSDPA

Horizontal

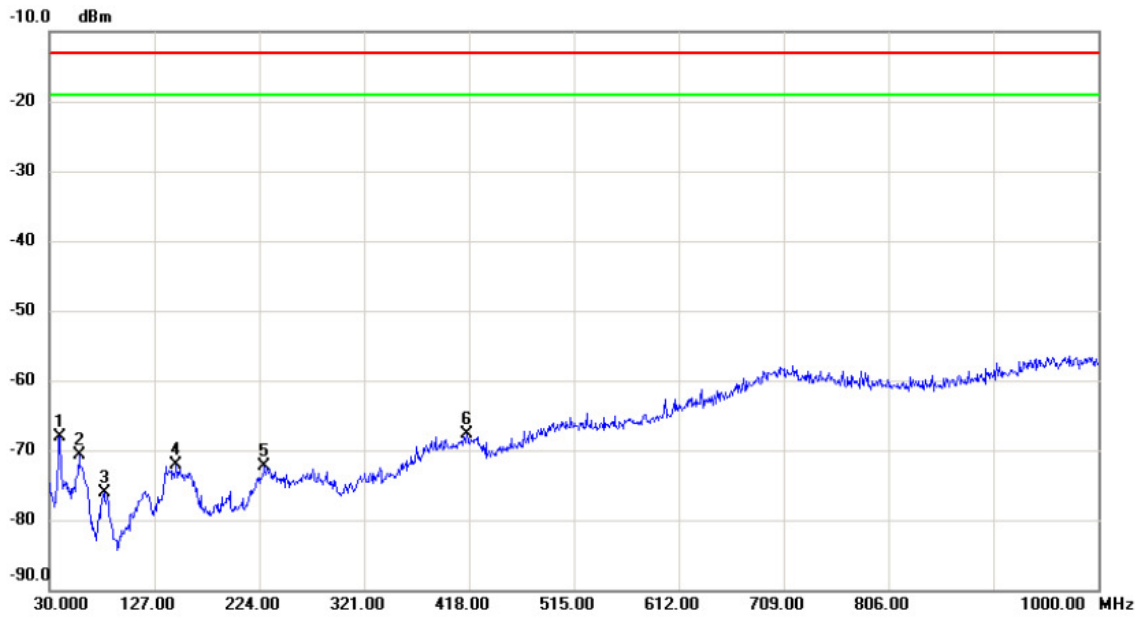

No.	Mk.	Freq. MHz	Reading Level dBm	Correct Factor dB	Measure- ment dBm	Limit dBm	Margin dB	Detector	Comment
1		39.700	-70.85	2.79	-68.06	-13.00	-55.06	peak	
2		57.160	-72.80	2.15	-70.65	-13.00	-57.65	peak	
3		80.440	-69.74	-6.30	-76.04	-13.00	-63.04	peak	
4		147.370	-77.51	5.49	-72.02	-13.00	-59.02	peak	
5		228.850	-77.27	5.01	-72.26	-13.00	-59.26	peak	
6	*	416.060	-77.60	9.95	-67.65	-13.00	-54.65	peak	

Test Mode: WCDMA Band 4_TX CH1312_ HSDPA

Vertical

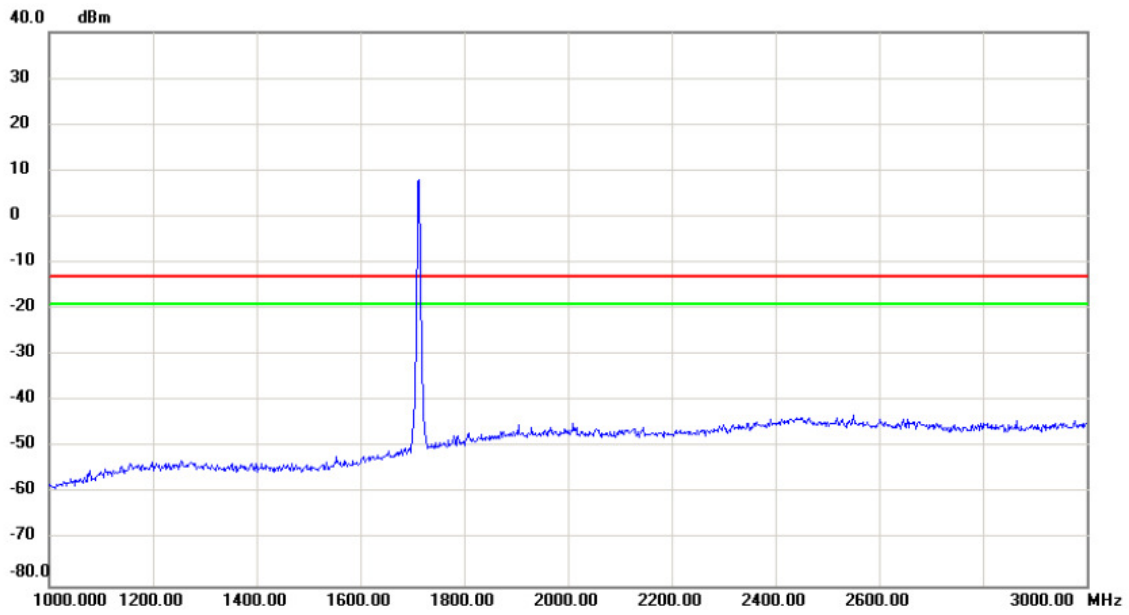

No.	Mk.	Freq.	Reading Level	Correct Factor	Measurement	Limit	Margin	Detector	Comment
		MHz	dBm	dB	dBm	dBm	dB		
		1730.000	8.00	0.00	8.00	-15.00	23.00		

Test Mode: WCDMA Band 4_TX CH1312_ HSDPA

Horizontal

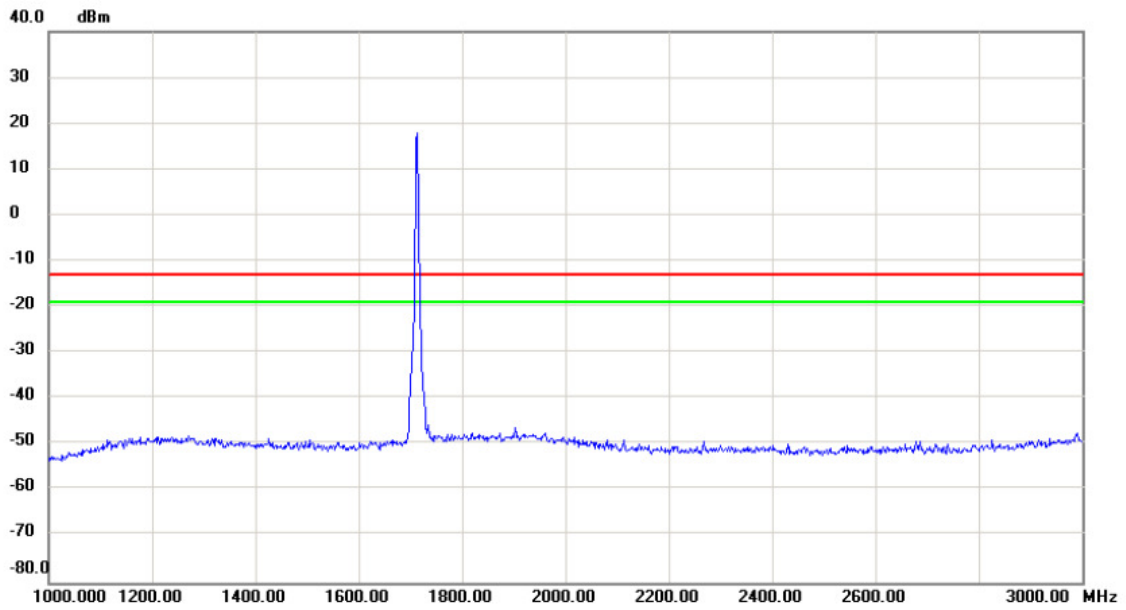

No.	Mk.	Freq.	Reading Level	Correct Factor	Measurement	Limit	Margin	Detector	Comment
		MHz	dBm	dB	dBm	dBm	dB		
		1730.00	18.00	0.00	18.00	-15.00	3.00		

Test Mode: WCDMA Band 4_TX CH1312_ HSDPA

Vertical

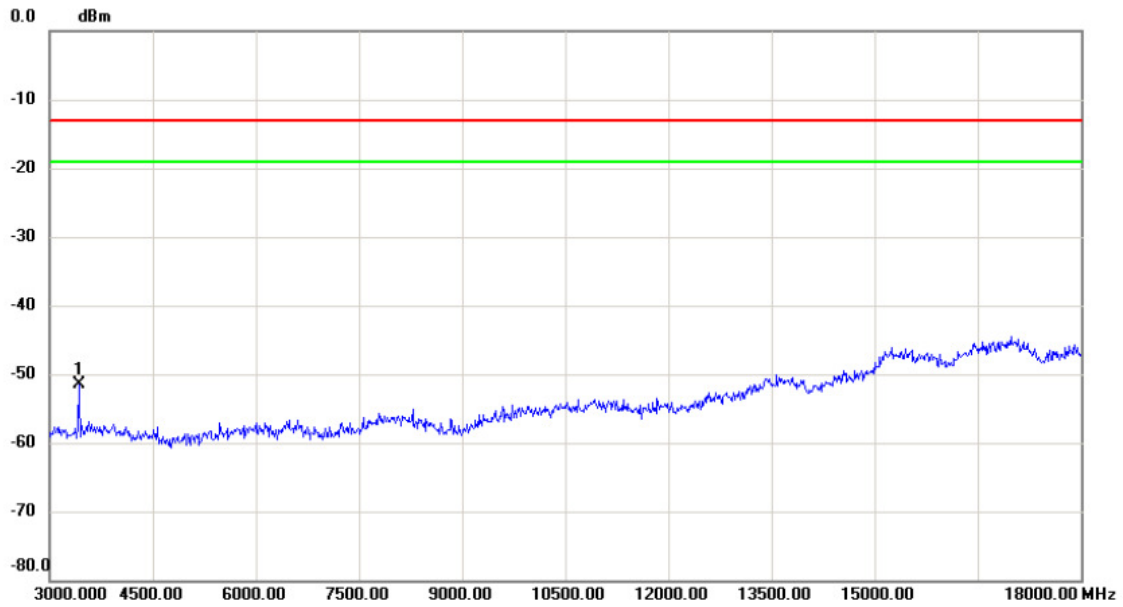

No.	Mk.	Freq. MHz	Reading Level dBm	Correct Factor dB	Measure- ment dBm	Limit dBm	Margin dB	Detector	Comment
1	*	3420.000	-65.40	13.97	-51.43	-13.00	-38.43	peak	

Test Mode: WCDMA Band 4_TX CH1312_ HSDPA

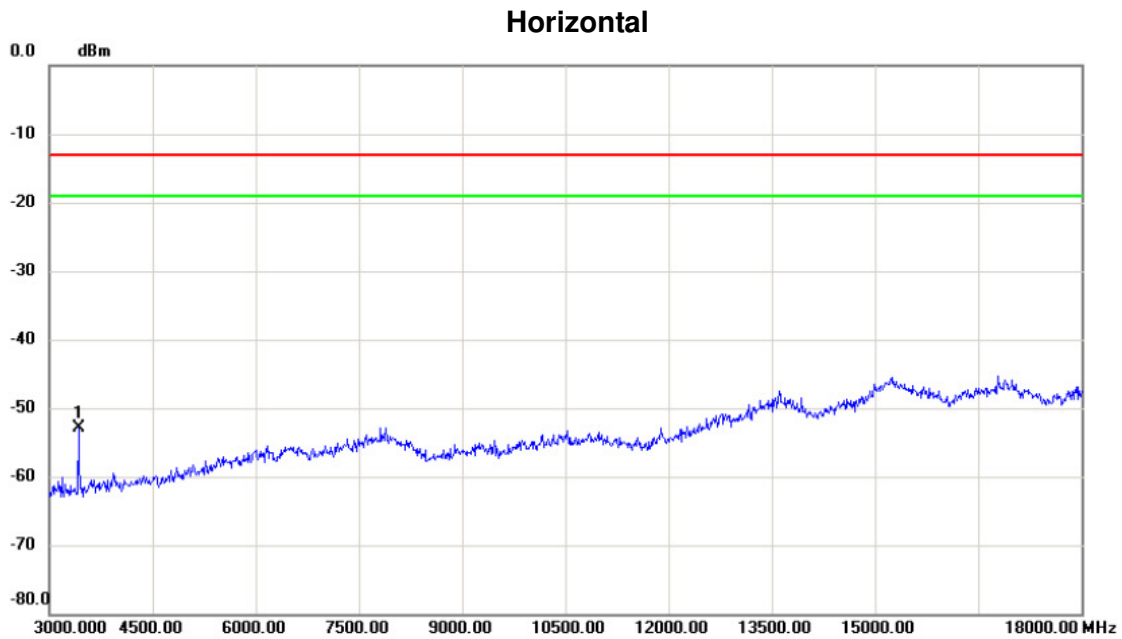

No.	Mk.	Freq. MHz	Reading Level dBm	Correct Factor dB	Measure- ment dBm	Limit dBm	Margin dB	Detector	Comment
1	*	3420.000	-63.31	10.32	-52.99	-13.00	-39.99	peak	

Test Mode: WCDMA Band 4_TX CH1312_HSUPA

Vertical

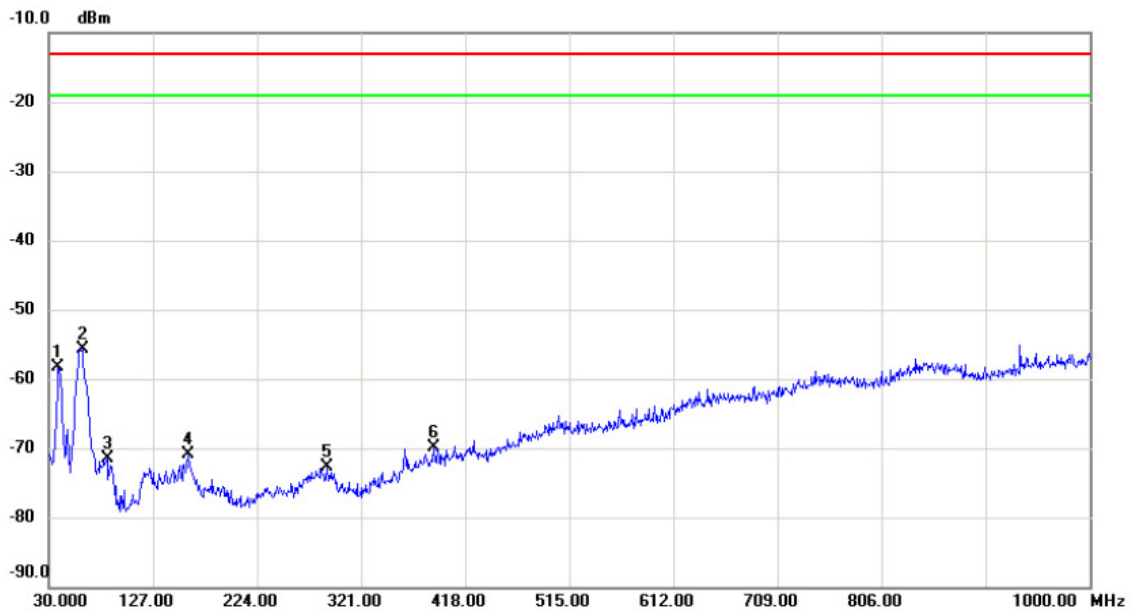

No.	Mk.	Freq. MHz	Reading Level dBm	Correct Factor dB	Measure- ment dBm	Limit dBm	Margin dB	Detector	Comment
1		38.730	-60.27	2.02	-58.25	-13.00	-45.25	peak	
2	*	61.040	-57.36	1.59	-55.77	-13.00	-42.77	peak	
3		84.320	-66.18	-5.24	-71.42	-13.00	-58.42	peak	
4		159.980	-75.77	4.80	-70.97	-13.00	-57.97	peak	
5		288.990	-77.44	4.74	-72.70	-13.00	-59.70	peak	
6		388.900	-76.95	7.06	-69.89	-13.00	-56.89	peak	

Test Mode: WCDMA Band 4_TX CH1312_HSUPA

Horizontal

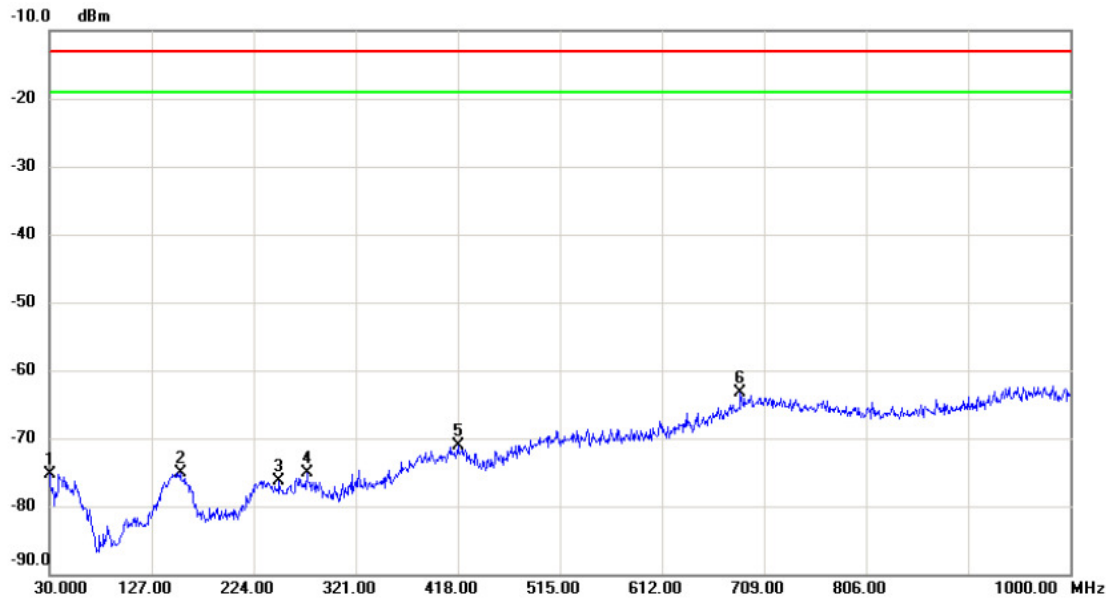

No.	Mk.	Freq. MHz	Reading Level dBm	Correct Factor dB	Measure- ment dBm	Limit dBm	Margin dB	Detector	Comment
1		30.000	-77.11	1.88	-75.23	-13.00	-62.23	peak	
2		154.160	-78.63	3.62	-75.01	-13.00	-62.01	peak	
3		248.250	-78.17	1.96	-76.21	-13.00	-63.21	peak	
4		274.440	-77.95	2.79	-75.16	-13.00	-62.16	peak	
5		418.000	-77.87	6.78	-71.09	-13.00	-58.09	peak	
6	*	686.690	-76.28	13.07	-63.21	-13.00	-50.21	peak	

Test Mode: WCDMA Band 4_TX CH1312_HSUPA

Vertical

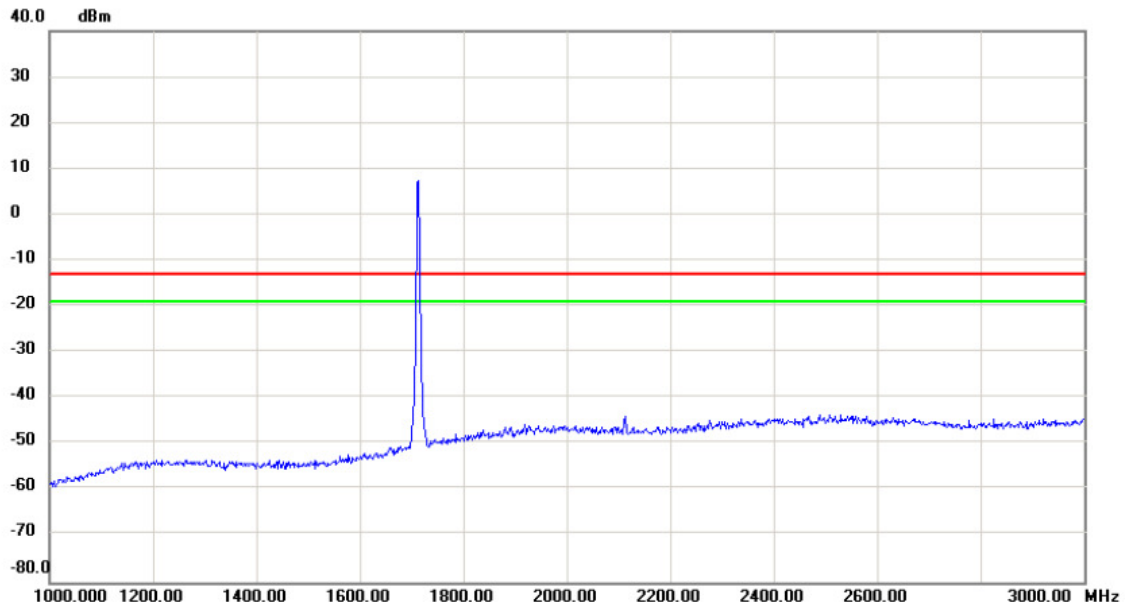

No.	Mk.	Freq. MHz	Reading Level dBm	Correct Factor dB	Measure- ment dBm	Limit dBm	Margin dB	Detector	Comment
-----	-----	--------------	-------------------------	-------------------------	-------------------------	--------------	--------------	----------	---------

Test Mode: WCDMA Band 4_TX CH1312_HSUPA

Horizontal

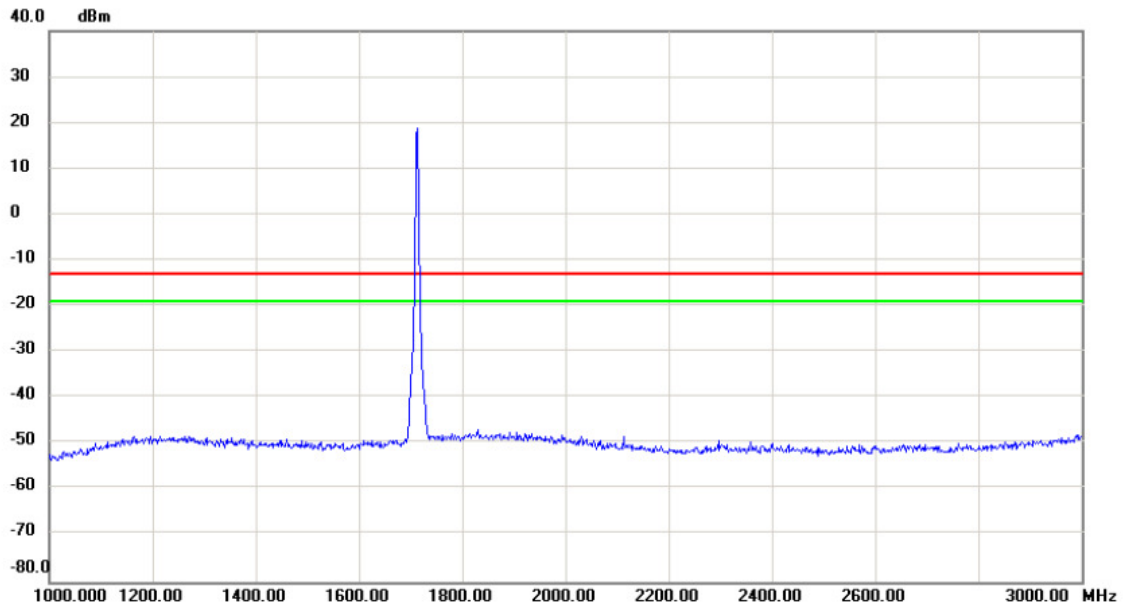

No.	Mk.	Freq.	Reading Level	Correct Factor	Measurement	Limit	Margin	Detector	Comment
		MHz	dBm	dB	dBm	dBm	dB		
		1730.00	18.00		18.00	-15.00	3.00		

Test Mode: WCDMA Band 4_TX CH1312_ HSUPA

Vertical

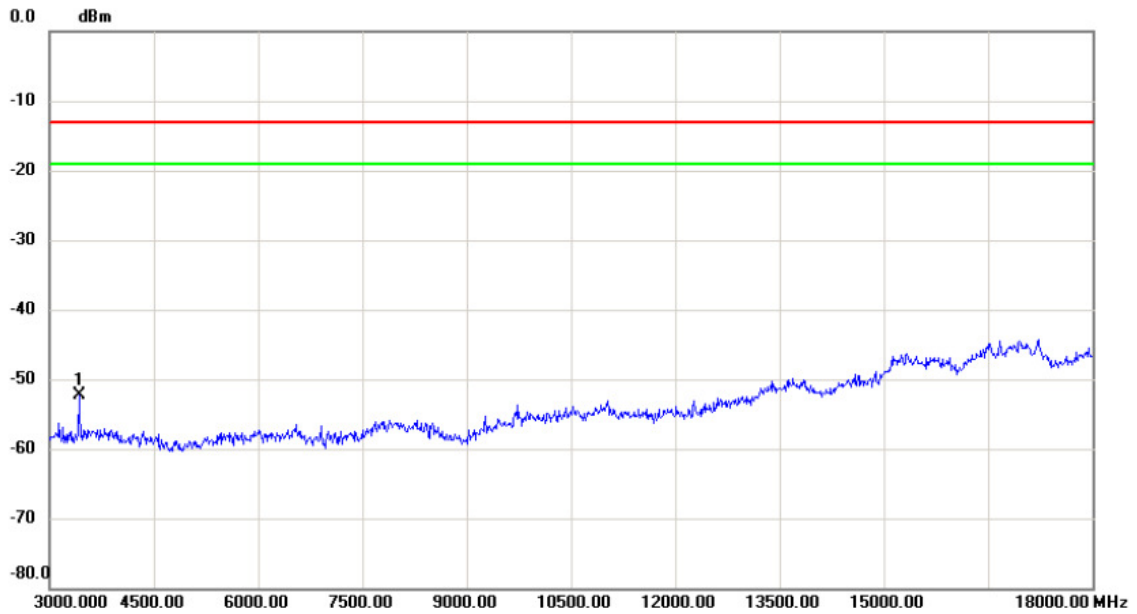

No.	Mk.	Freq. MHz	Reading Level dBm	Correct Factor dB	Measure- ment dBm	Limit dBm	Margin dB	Detector	Comment
1	*	3420.000	-66.20	13.97	-52.23	-13.00	-39.23	peak	

Test Mode: WCDMA Band 4_TX CH1312_HSUPA

Horizontal

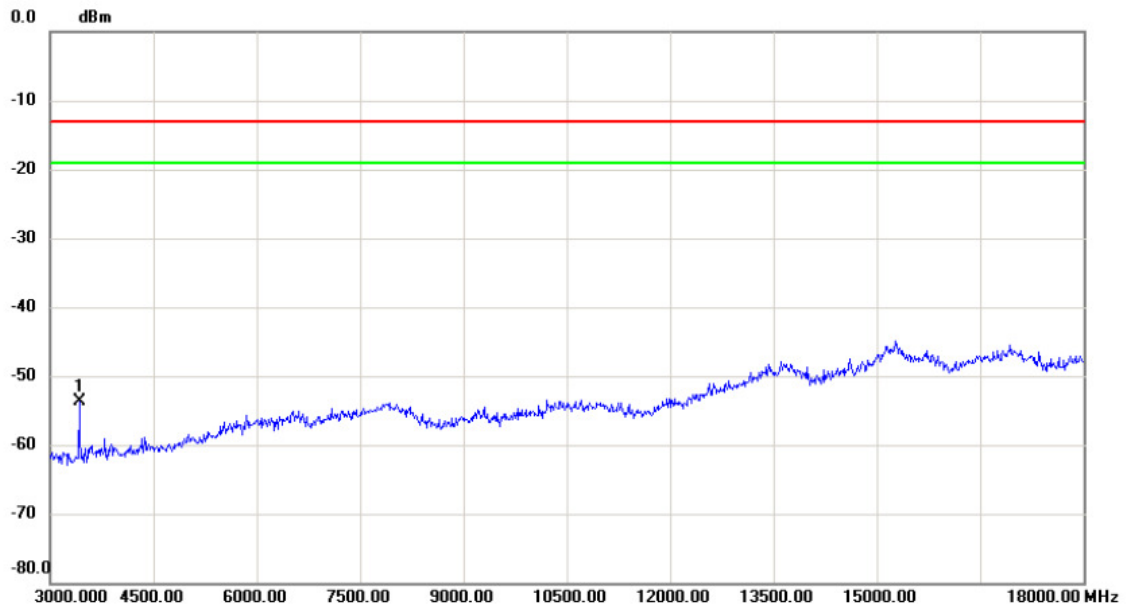

No.	Mk.	Freq. MHz	Reading Level dBm	Correct Factor dB	Measure- ment dBm	Limit dBm	Margin dB	Detector	Comment
1	*	3420.000	-64.06	10.32	-53.74	-13.00	-40.74	peak	

Test Mode: LTE Band 4_TX CH20175_1.4M

Vertical

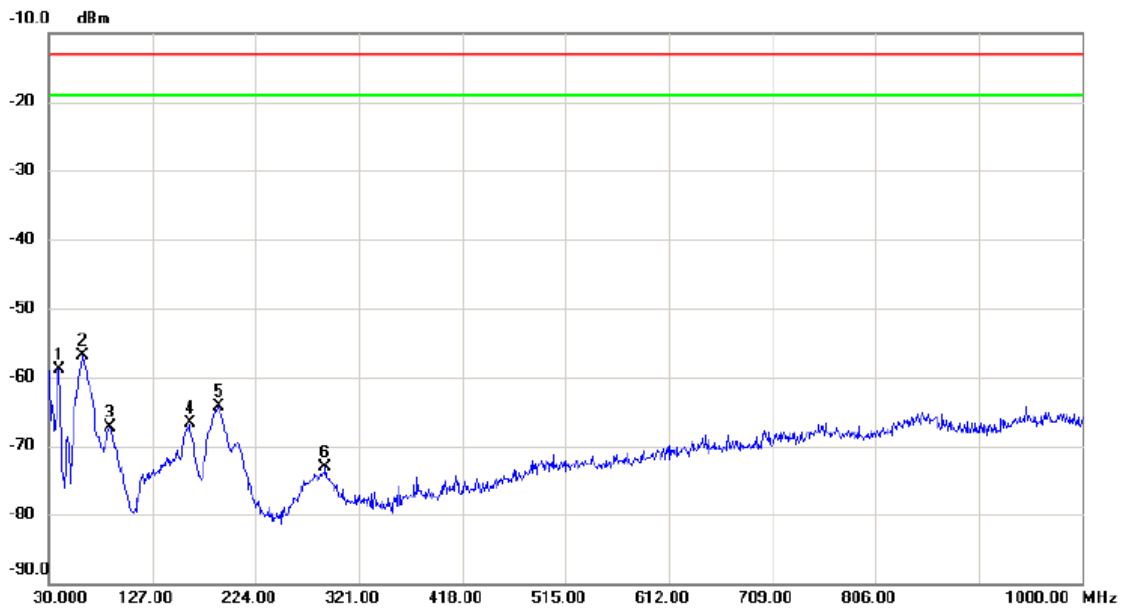

No.	Mk.	Freq. MHz	Reading Level dBm	Correct Factor dB	Measure- ment dBm	Limit dBm	Margin dB	Detector	Comment
1		39.700	-60.72	1.90	-58.82	-13.00	-45.82	peak	
2	*	61.040	-57.56	0.60	-56.96	-13.00	-43.96	peak	
3		87.230	-61.86	-5.46	-67.32	-13.00	-54.32	peak	
4		161.920	-69.35	2.55	-66.80	-13.00	-53.80	peak	
5		190.050	-62.44	-1.80	-64.24	-13.00	-51.24	peak	
6		289.960	-75.36	2.22	-73.14	-13.00	-60.14	peak	

Test Mode: LTE Band 4_TX CH20175_1.4M

Horizontal

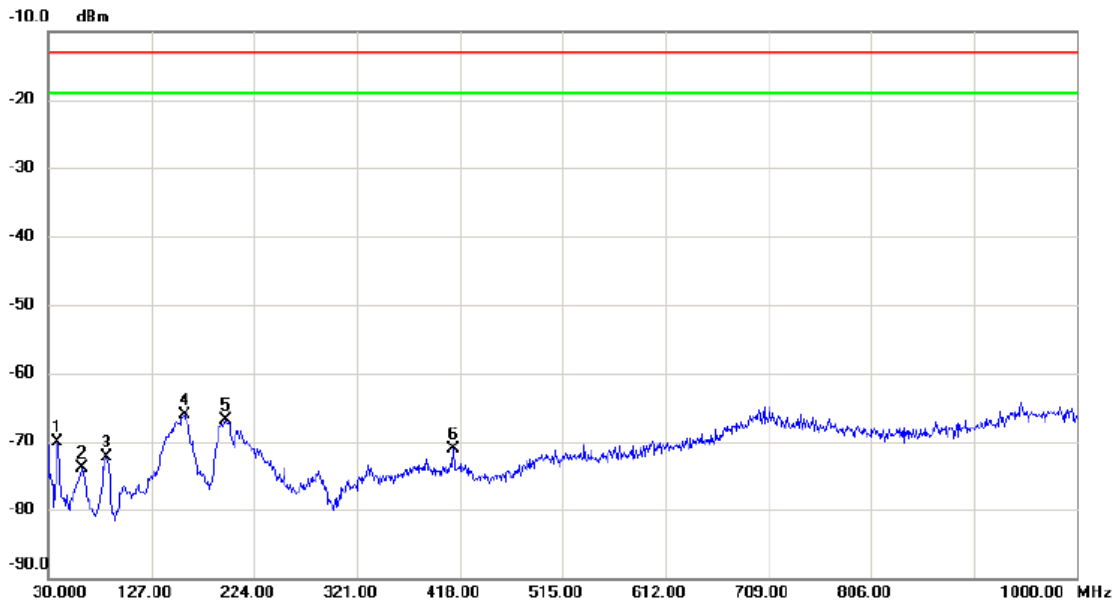

No.	Mk.	Freq. MHz	Reading Level dBm	Correct Factor dB	Measure- ment dBm	Limit dBm	Margin dB	Detector	Comment
1		38.730	-71.80	1.63	-70.17	-13.00	-57.17	peak	
2		61.040	-73.08	-0.87	-73.95	-13.00	-60.95	peak	
3		84.320	-64.40	-7.87	-72.27	-13.00	-59.27	peak	
4	*	158.040	-69.15	3.04	-66.11	-13.00	-53.11	peak	
5		196.840	-65.02	-1.81	-66.83	-13.00	-53.83	peak	
6		412.180	-77.68	6.49	-71.19	-13.00	-58.19	peak	

Test Mode: LTE Band 4_TX CH20175_1.4M

Vertical

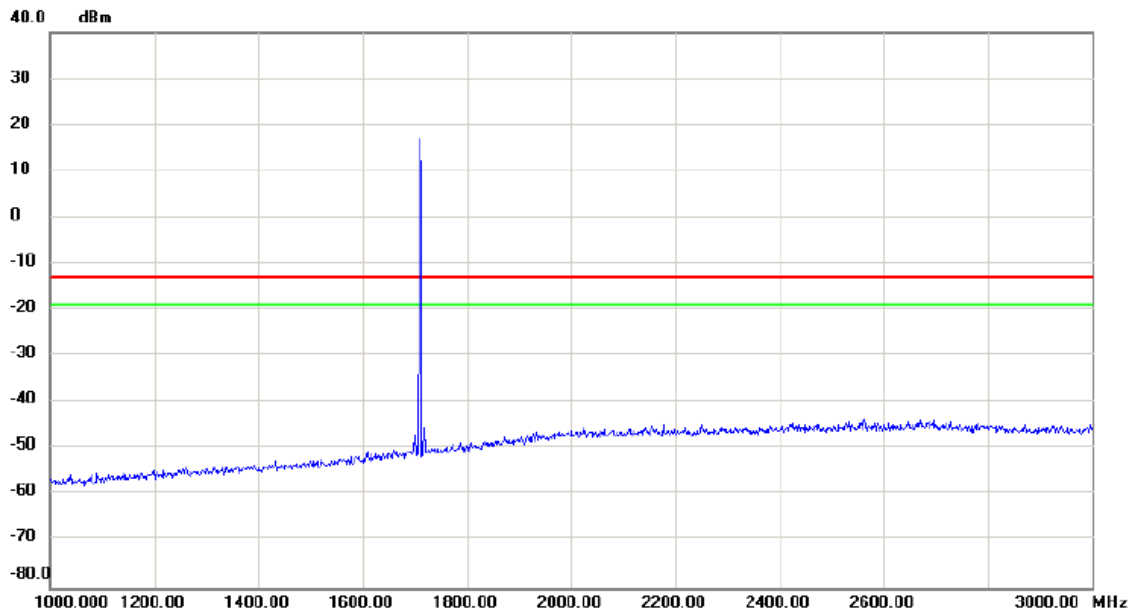

No.	Mk.	Freq.	Reading Level	Correct Factor	Measurement	Limit	Margin	Detector	Comment
		MHz	dBm	dB	dBm	dBm	dB		
		1750.00	15.00	0.00	15.00	-15.00	30.00		

Test Mode: LTE Band 4_TX CH20175_1.4M

Horizontal

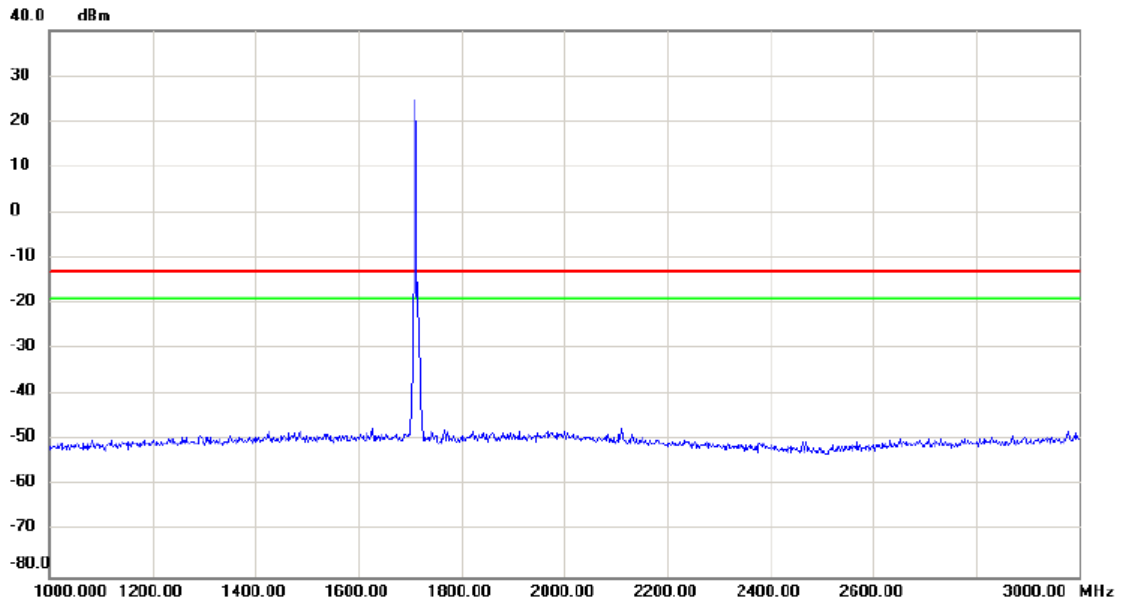

No.	Mk.	Freq.	Reading Level	Correct Factor	Measurement	Limit	Margin	Detector	Comment
		MHz	dBm	dB	dBm	dBm	dB		
		1750.00	25.00	0.00	25.00	-10.00	35.00		

Test Mode: LTE Band 4_TX CH20175_1.4M

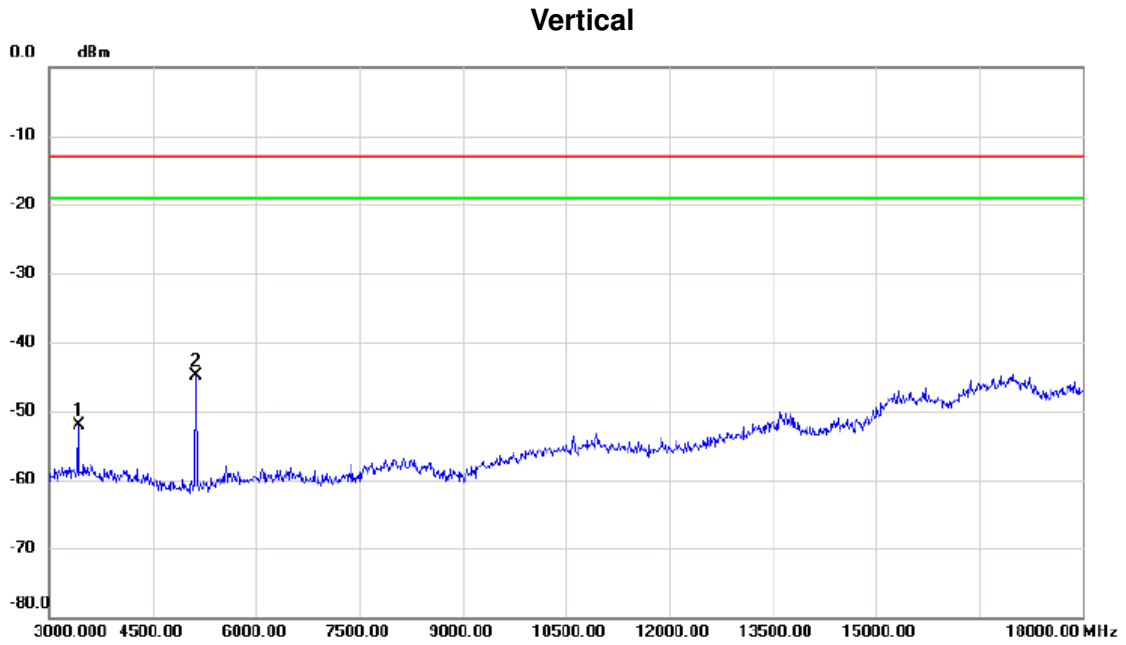

No.	Mk.	Freq. MHz	Reading Level dBm	Correct Factor dB	Measure- ment dBm	Limit dBm	Margin dB	Detector	Comment
1		3420.000	-66.16	13.97	-52.19	-13.00	-39.19	peak	
2	*	5130.000	-59.84	14.97	-44.87	-13.00	-31.87	peak	

Test Mode: LTE Band 4_TX CH20175_1.4M

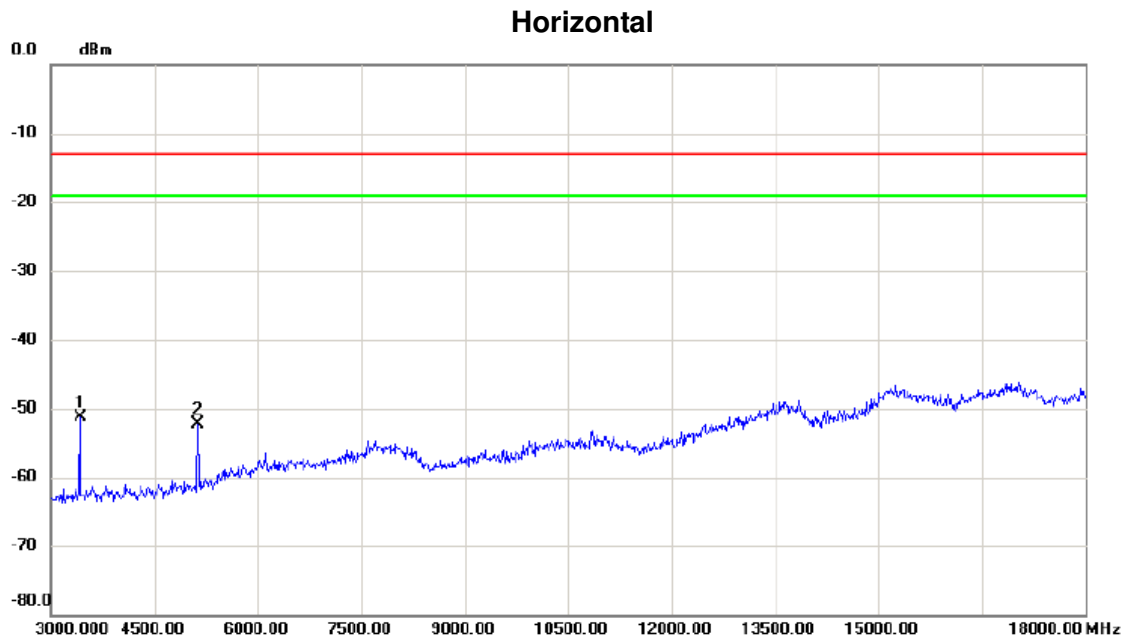

No.	Mk.	Freq. MHz	Reading Level dBm	Correct Factor dB	Measure- ment dBm	Limit dBm	Margin dB	Detector	Comment
1	*	3420.000	-61.56	10.32	-51.24	-13.00	-38.24	peak	
2		5130.000	-67.53	15.16	-52.37	-13.00	-39.37	peak	

Test Mode: LTE Band 4_TX CH20175_1.4M

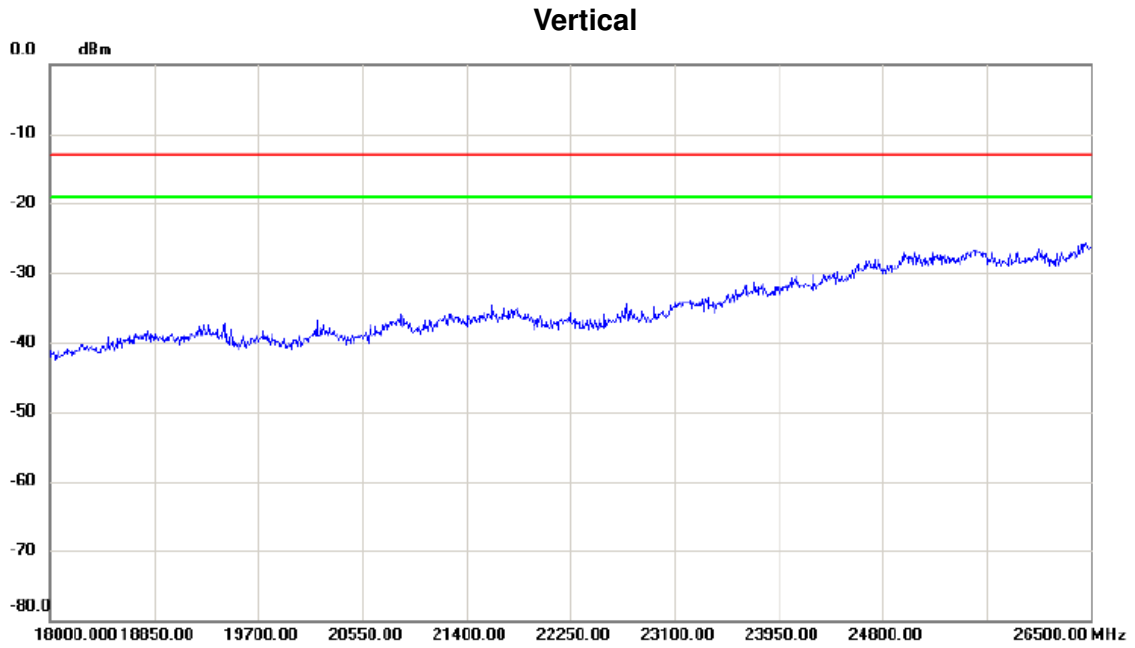

No.	Mk.	Freq.	Reading Level	Correct Factor	Measurement	Limit	Margin	Detector	Comment
		MHz	dBm	dB	dBm	dBm	dB		

Test Mode: LTE Band 4_TX CH20175_1.4M

Horizontal

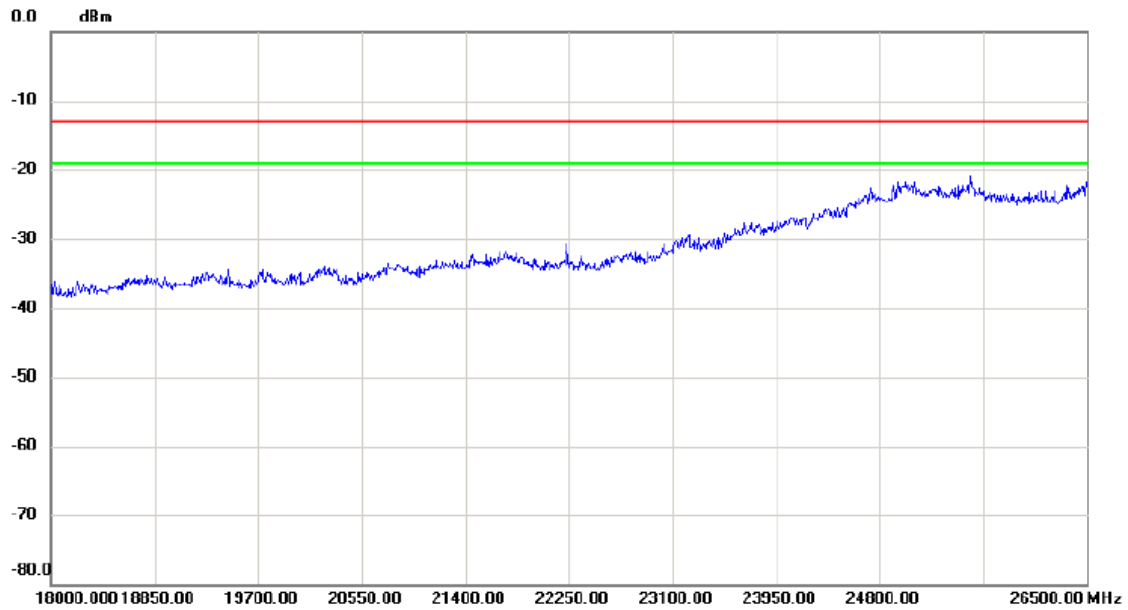

No.	Mk.	Freq.	Reading Level	Correct Factor	Measurement	Limit	Margin	Detector	Comment
		MHz	dBm	dB	dBm	dBm	dB		

Test Mode: LTE Band 4_TX CH20175_20M

Vertical

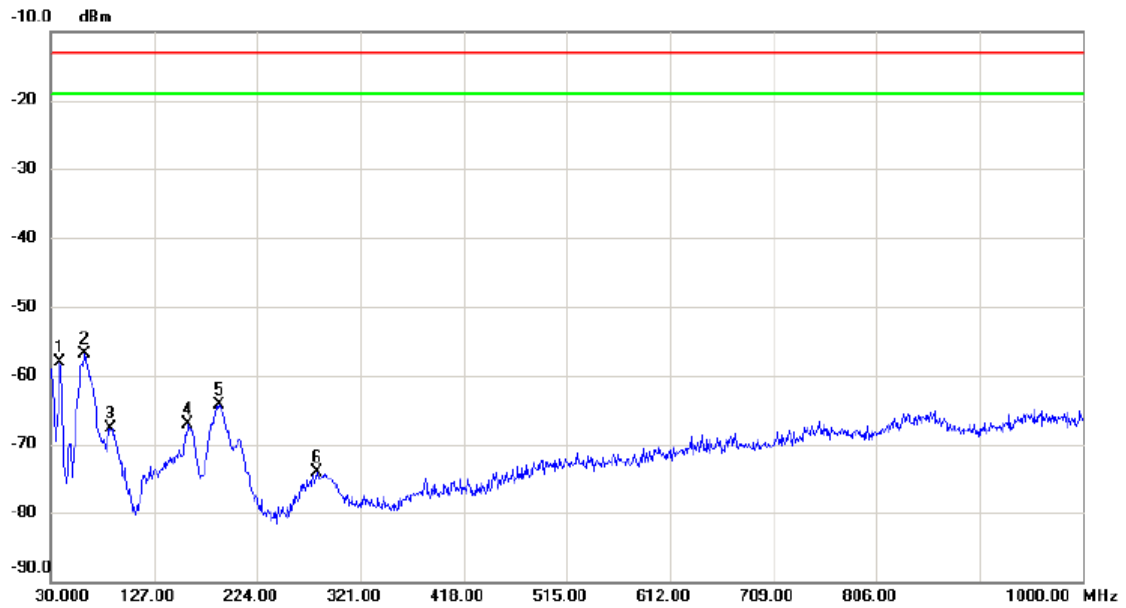

No.	Mk.	Freq. MHz	Reading Level dBm	Correct Factor dB	Measure- ment dBm	Limit dBm	Margin dB	Detector	Comment
1		38.730	-59.33	1.21	-58.12	-13.00	-45.12	peak	
2	*	62.010	-57.58	0.73	-56.85	-13.00	-43.85	peak	
3		86.260	-61.79	-5.91	-67.70	-13.00	-54.70	peak	
4		159.010	-70.18	3.18	-67.00	-13.00	-54.00	peak	
5		188.110	-63.08	-1.31	-64.39	-13.00	-51.39	peak	
6		280.260	-76.66	2.64	-74.02	-13.00	-61.02	peak	

Test Mode: LTE Band 4_TX CH20175_20M

Horizontal

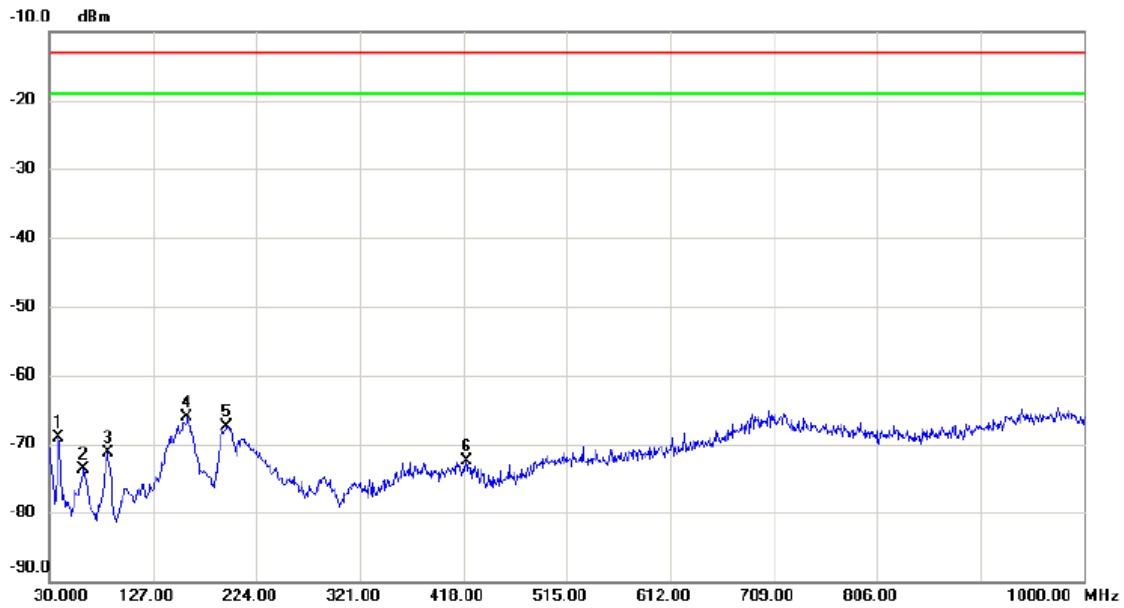

No.	Mk.	Freq. MHz	Reading Level dBm	Correct Factor dB	Measure- ment dBm	Limit dBm	Margin dB	Detector	Comment
1		38.730	-70.76	1.63	-69.13	-13.00	-56.13	peak	
2		62.010	-72.75	-0.97	-73.72	-13.00	-60.72	peak	
3		84.320	-63.38	-7.87	-71.25	-13.00	-58.25	peak	
4	*	159.010	-68.98	2.90	-66.08	-13.00	-53.08	peak	
5		195.870	-65.64	-1.77	-67.41	-13.00	-54.41	peak	
6		420.910	-79.32	6.78	-72.54	-13.00	-59.54	peak	

Test Mode: LTE Band 4_TX CH20175_20M

Vertical

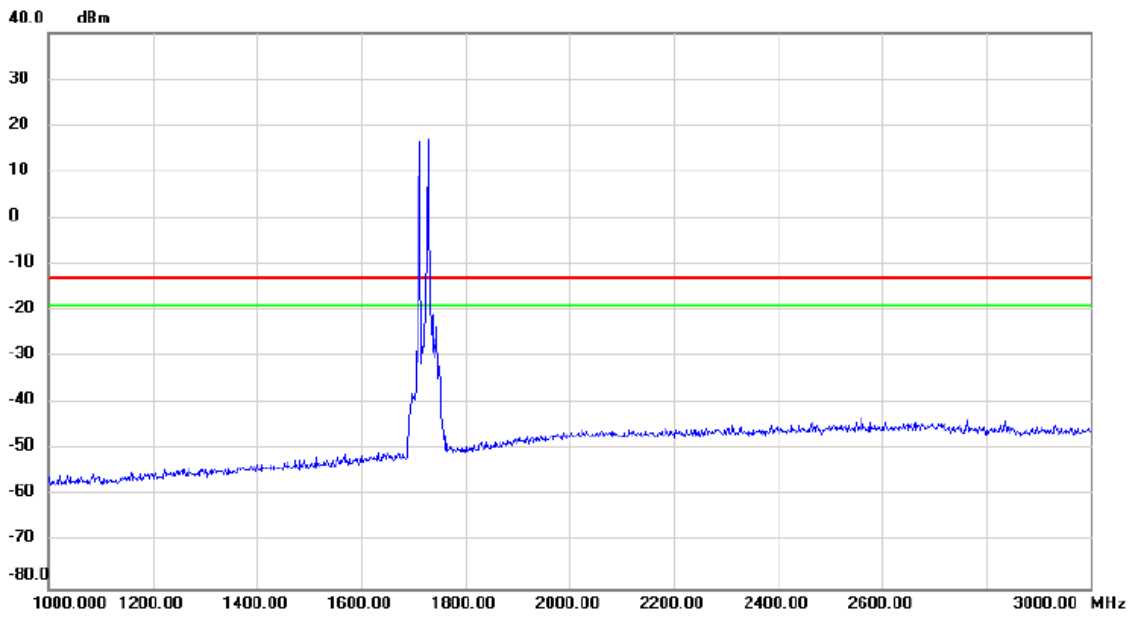

No.	Mk.	Freq.	Reading Level	Correct Factor	Measurement	Limit	Margin	Detector	Comment
		MHz	dBm	dB	dBm	dBm	dB		

Test Mode: LTE Band 4_TX CH20175_20M

Horizontal

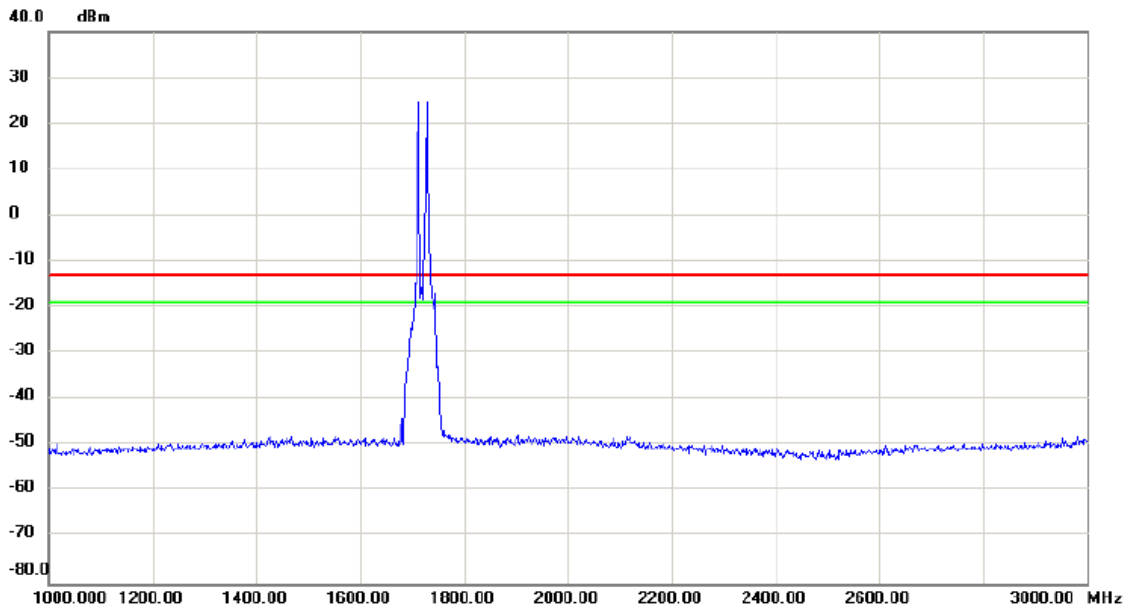

No.	Mk.	Freq.	Reading Level	Correct Factor	Measurement	Limit	Margin	Detector	Comment
		MHz	dBm	dB	dBm	dBm	dB		
		1750.00	25.00	0.00	25.00	-15.00	40.00		

Test Mode: LTE Band 4_TX CH20175_20M

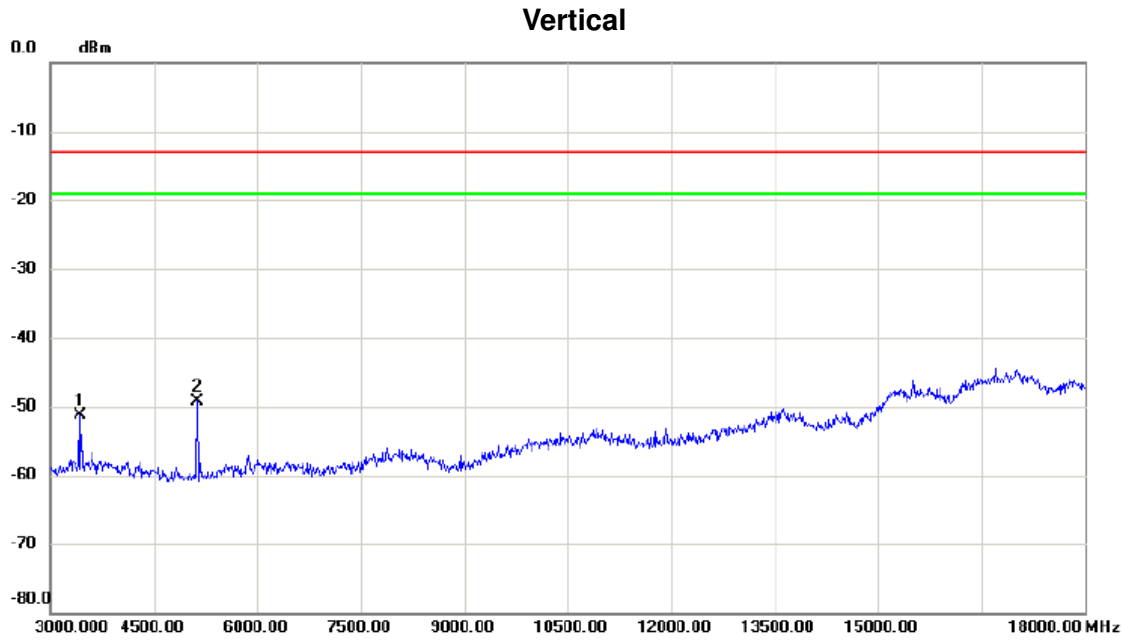

No.	Mk.	Freq. MHz	Reading Level dBm	Correct Factor dB	Measure- ment dBm	Limit dBm	Margin dB	Detector	Comment
1		3420.000	-65.32	13.97	-51.35	-13.00	-38.35	peak	
2	*	5130.000	-64.17	14.97	-49.20	-13.00	-36.20	peak	

Test Mode: LTE Band 4_TX CH20175_20M

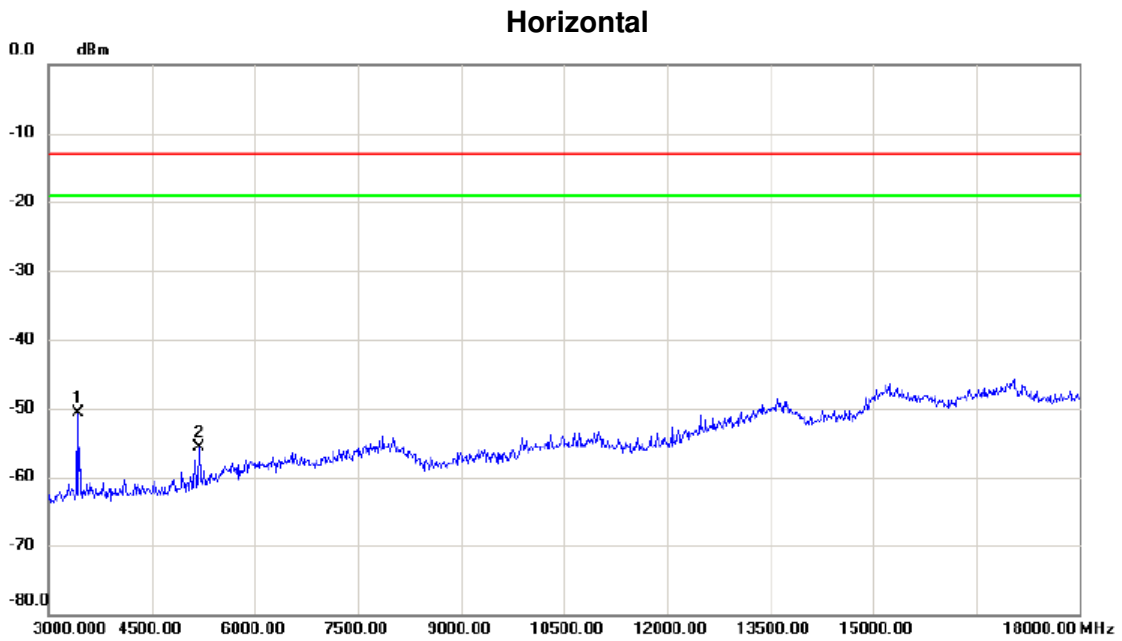

No.	Mk.	Freq. MHz	Reading Level dBm	Correct Factor dB	Measure- ment dBm	Limit dBm	Margin dB	Detector	Comment
1	*	3420.000	-61.07	10.32	-50.75	-13.00	-37.75	peak	
2		5190.000	-71.15	15.39	-55.76	-13.00	-42.76	peak	

Test Mode: LTE Band 4_TX CH20175_20M

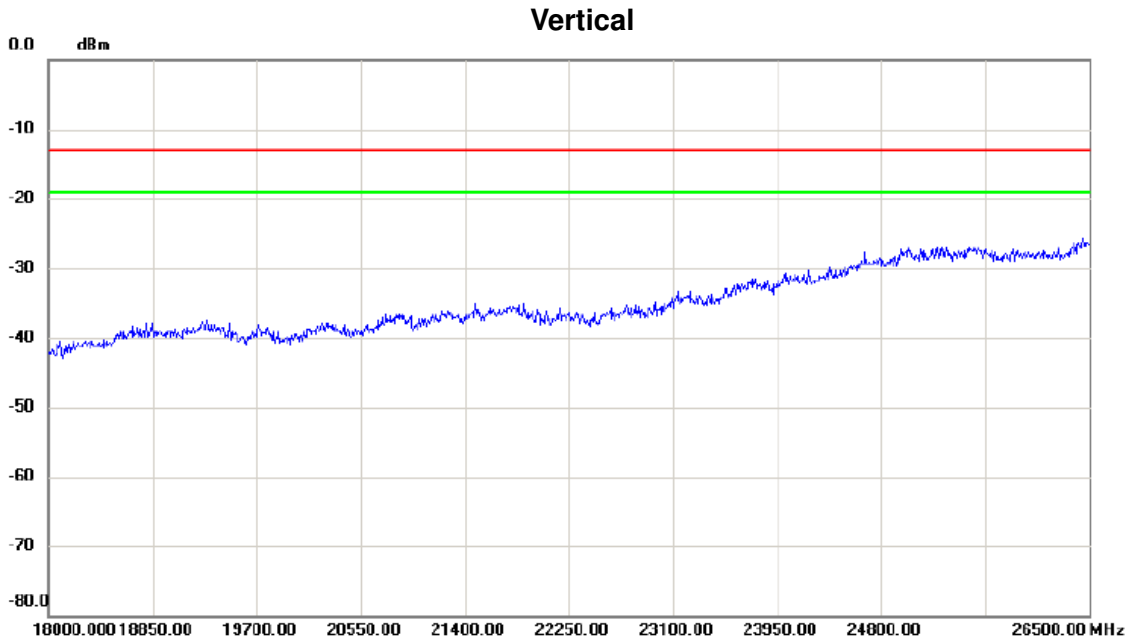

No.	Mk.	Freq.	Reading Level	Correct Factor	Measurement	Limit	Margin	Detector	Comment
		MHz	dBm	dB	dBm	dBm	dB		

Test Mode: LTE Band 4_TX CH20175_20M

Horizontal

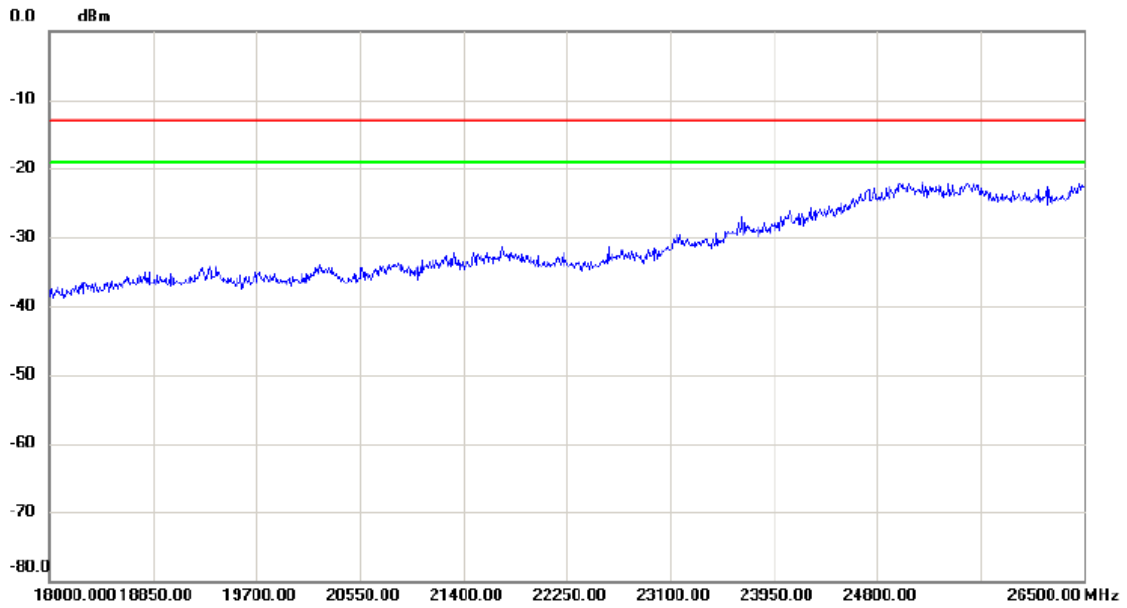

No.	Mk.	Freq.	Reading Level	Correct Factor	Measurement	Limit	Margin	Detector	Comment
		MHz	dBm	dB	dBm	dBm	dB		

Test Mode: LTE Band 7_TX CH21100_5M

Vertical

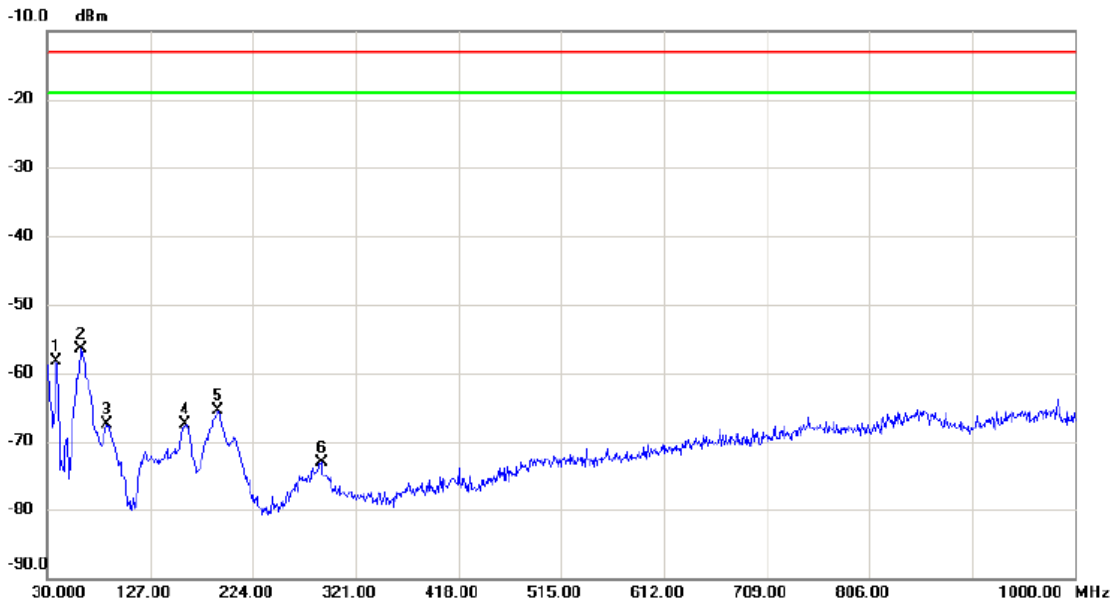

No.	Mk.	Freq. MHz	Reading Level dBm	Correct Factor dB	Measure- ment dBm	Limit dBm	Margin dB	Detector	Comment
1		38.730	-59.47	1.21	-58.26	-13.00	-45.26	peak	
2	*	62.010	-57.22	0.73	-56.49	-13.00	-43.49	peak	
3		86.260	-61.55	-5.91	-67.46	-13.00	-54.46	peak	
4		159.980	-70.59	3.18	-67.41	-13.00	-54.41	peak	
5		191.020	-63.58	-1.85	-65.43	-13.00	-52.43	peak	
6		288.990	-75.26	2.26	-73.00	-13.00	-60.00	peak	

Test Mode: LTE Band 7_TX CH21100_5M

Horizontal

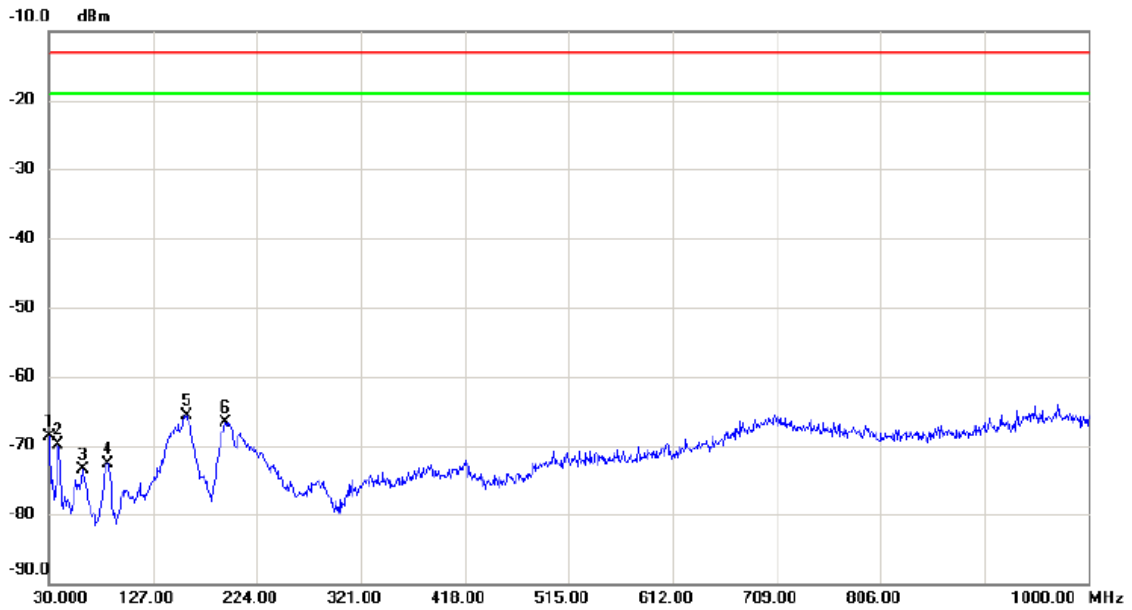

No.	Mk.	Freq. MHz	Reading Level dBm	Correct Factor dB	Measure- ment dBm	Limit dBm	Margin dB	Detector	Comment
1		30.000	-70.53	1.88	-68.65	-13.00	-55.65	peak	
2		38.730	-71.51	1.63	-69.88	-13.00	-56.88	peak	
3		61.040	-72.69	-0.87	-73.56	-13.00	-60.56	peak	
4		84.320	-64.77	-7.87	-72.64	-13.00	-59.64	peak	
5	*	158.040	-68.68	3.04	-65.64	-13.00	-52.64	peak	
6		194.900	-64.94	-1.74	-66.68	-13.00	-53.68	peak	

Test Mode: LTE Band 7_TX CH21100_5M

Vertical

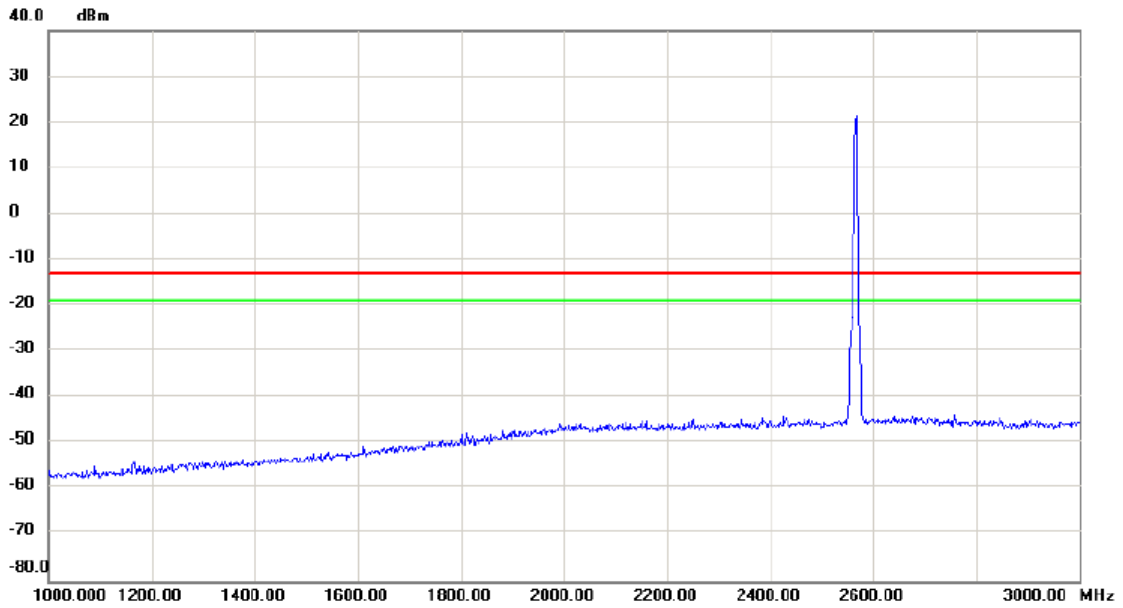

No.	Mk.	Freq.	Reading Level	Correct Factor	Measurement	Limit	Margin	Detector	Comment
		MHz	dBm	dB	dBm	dBm	dB		
		2550.00	20.00	0.00	20.00	-15.00	5.00		

Test Mode: LTE Band 7_TX CH21100_5M

Horizontal

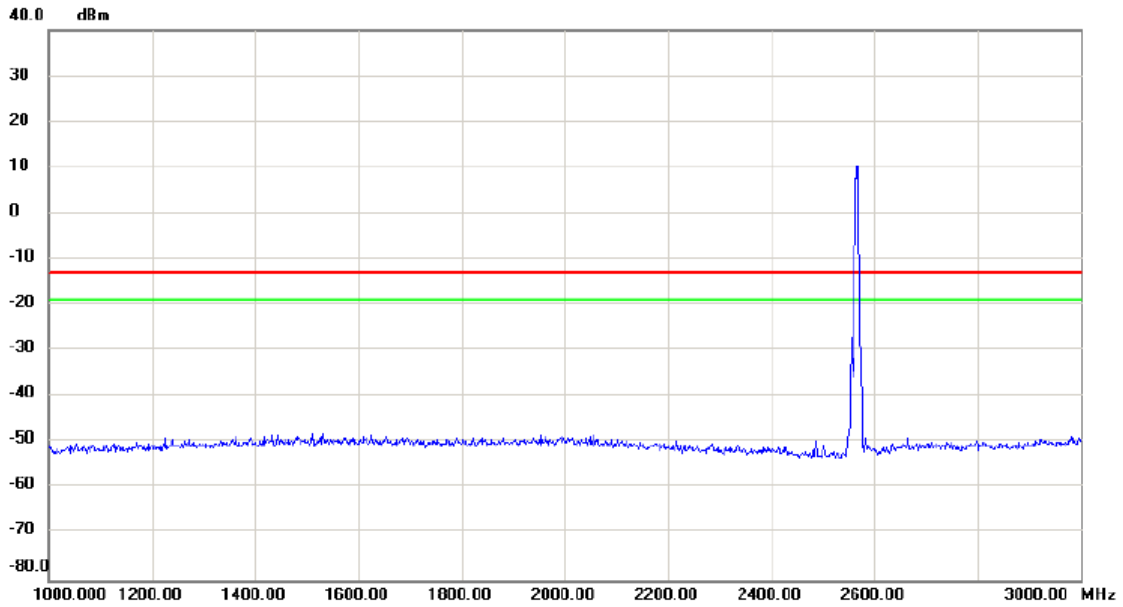

No.	Mk.	Freq. MHz	Reading Level dBm	Correct Factor dB	Measure- ment dBm	Limit dBm	Margin dB	Detector	Comment

Test Mode: LTE Band 7_TX CH21100_5M

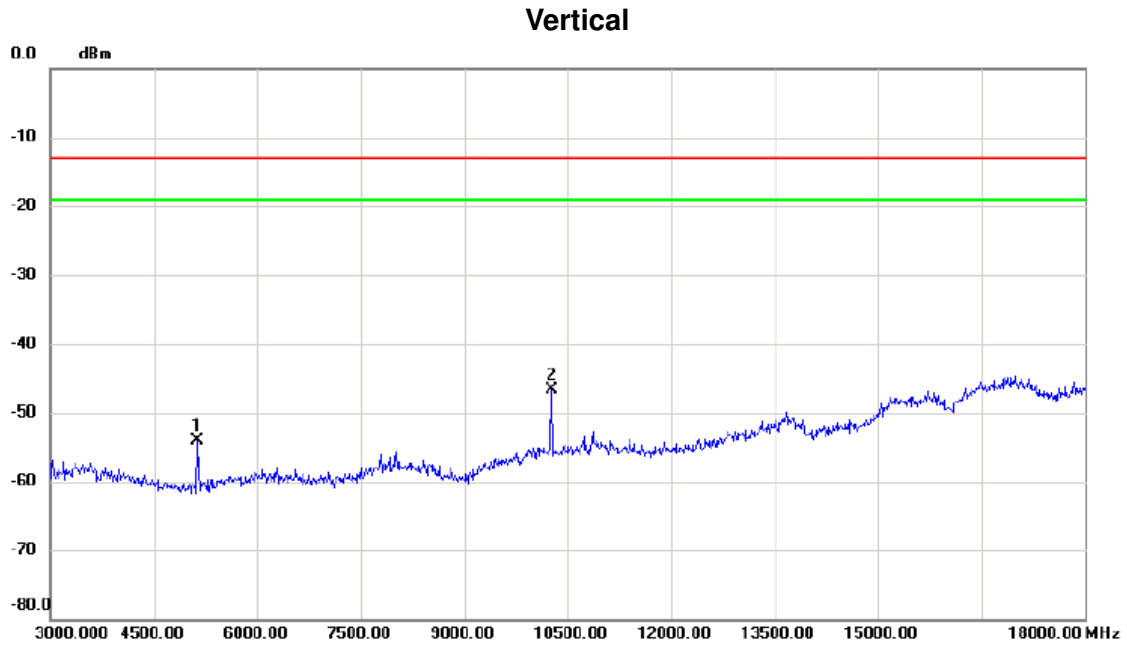

No.	Mk.	Freq. MHz	Reading Level dBm	Correct Factor dB	Measure- ment dBm	Limit dBm	Margin dB	Detector	Comment
1		5130.000	-69.09	14.97	-54.12	-13.00	-41.12	peak	
2	*	10260.000	-68.57	21.83	-46.74	-13.00	-33.74	peak	

Test Mode: LTE Band 7_TX CH21100_5M

Horizontal

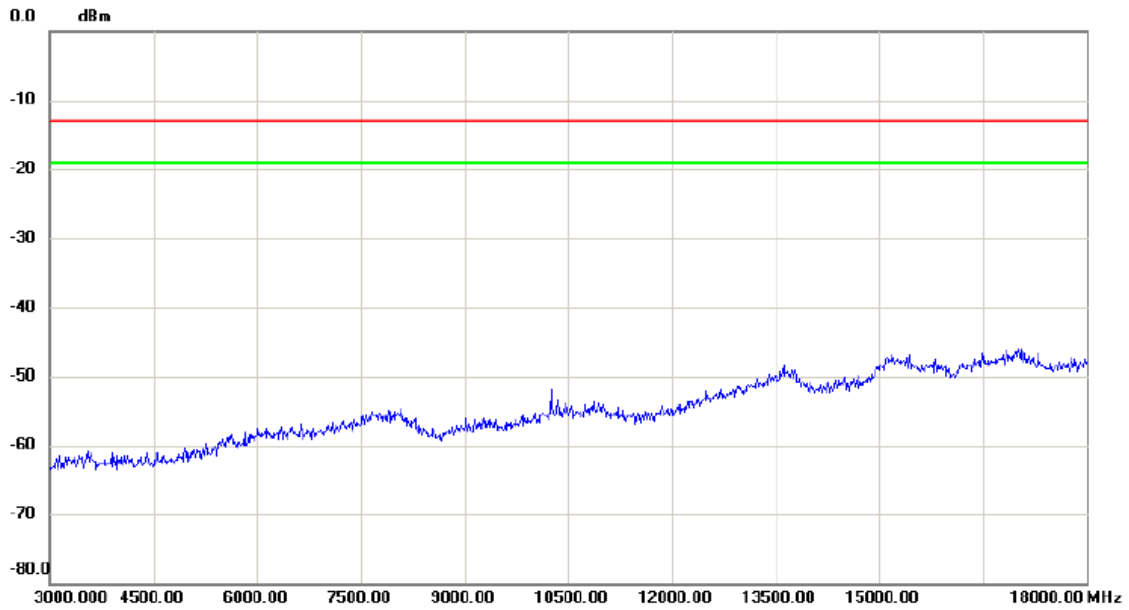

No.	Mk.	Freq.	Reading Level	Correct Factor	Measurement	Limit	Margin	Detector	Comment
		MHz	dBm	dB	dBm	dBm	dB		

Test Mode: LTE Band 7_TX CH21100_5M

Vertical

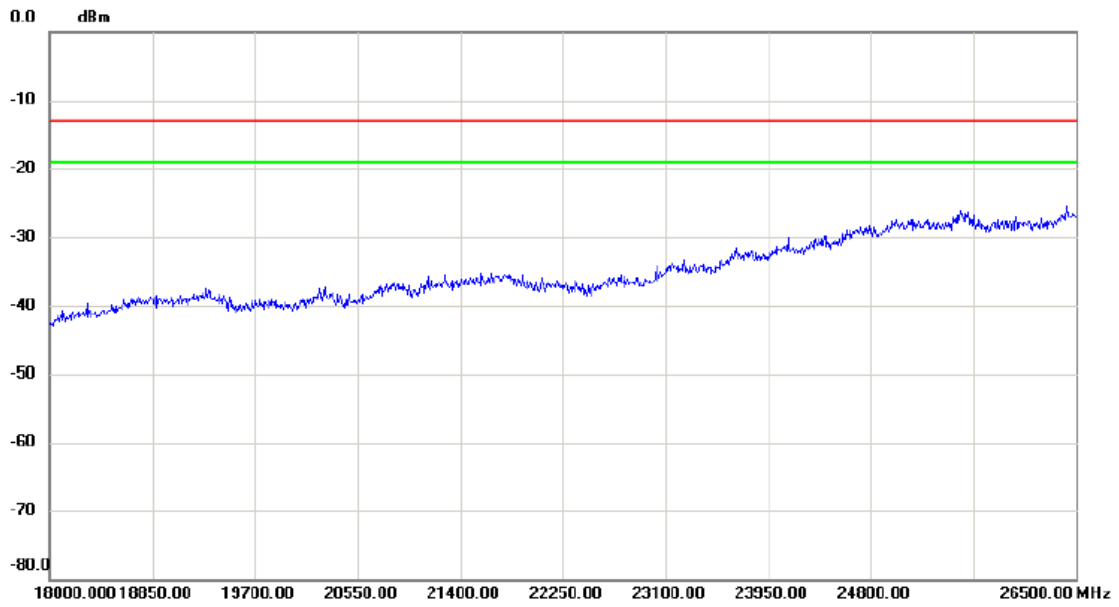

No.	Mk.	Freq.	Reading Level	Correct Factor	Measurement	Limit	Margin	Detector	Comment
		MHz	dBm	dB	dBm	dBm	dB		
		10000.000	-42						
		10950.00	-41						
		19700.00	-40						
		20550.00	-38						
		21400.00	-37						
		22250.00	-38						
		23100.00	-36						
		23950.00	-33						
		24800.00	-31						
		26500.00	-28						

Test Mode: LTE Band 7_TX CH21100_5M

Horizontal

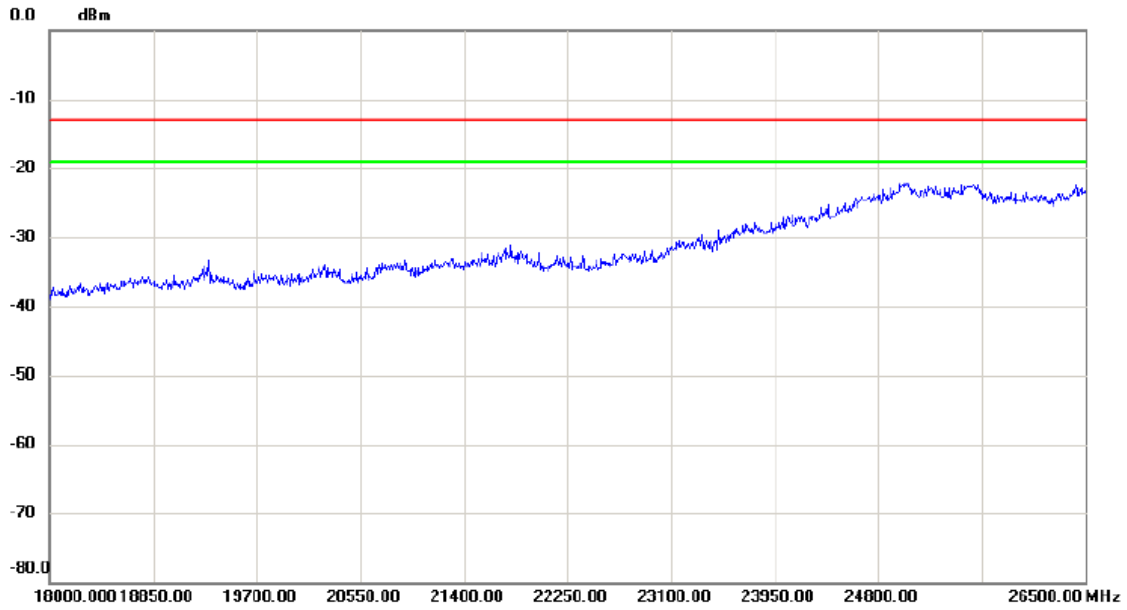

No.	Mk.	Freq. MHz	Reading Level dBm	Correct Factor dB	Measure- ment dBm	Limit dBm	Margin dB	Detector	Comment
-----	-----	--------------	-------------------------	-------------------------	-------------------------	--------------	--------------	----------	---------

Test Mode: LTE Band 7_TX CH21100_20M

Vertical

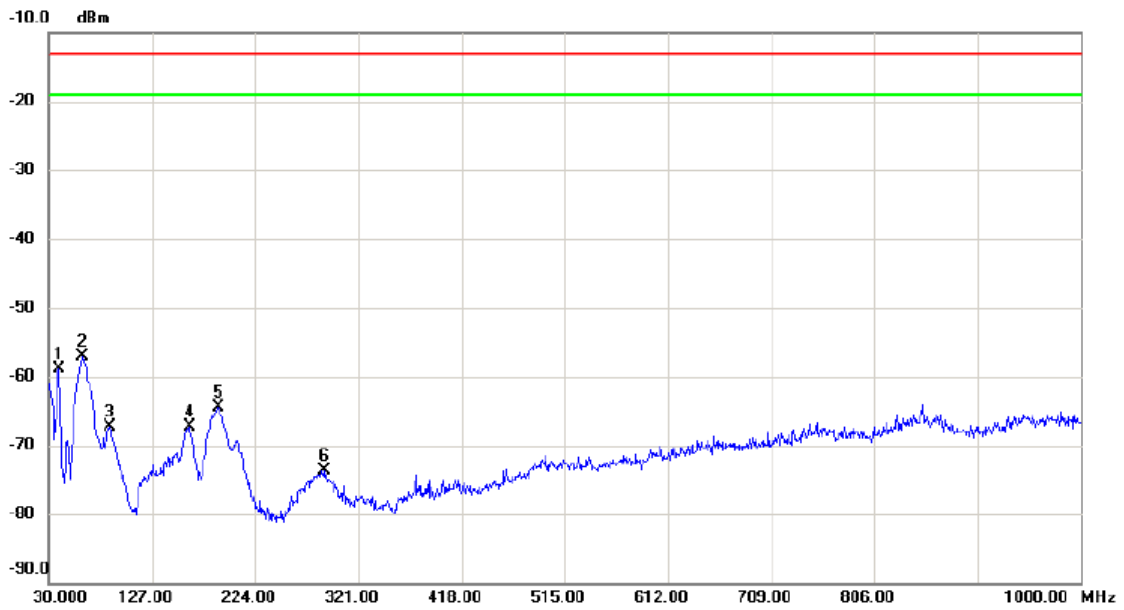

No.	Mk.	Freq. MHz	Reading Level dBm	Correct Factor dB	Measure- ment dBm	Limit dBm	Margin dB	Detector	Comment
1		39.700	-60.72	1.90	-58.82	-13.00	-45.82	peak	
2	*	62.010	-57.78	0.73	-57.05	-13.00	-44.05	peak	
3		87.230	-61.75	-5.46	-67.21	-13.00	-54.21	peak	
4		161.920	-69.91	2.55	-67.36	-13.00	-54.36	peak	
5		189.080	-62.97	-1.56	-64.53	-13.00	-51.53	peak	
6		288.990	-76.01	2.26	-73.75	-13.00	-60.75	peak	

Test Mode: LTE Band 7_TX CH21100_20M

Horizontal

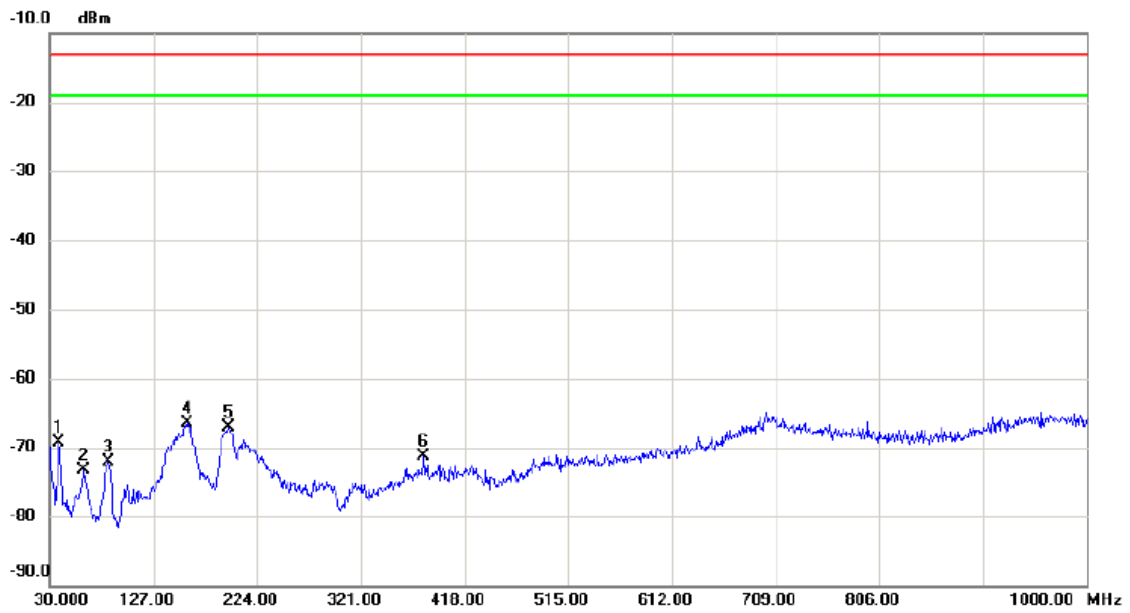

No.	Mk.	Freq. MHz	Reading Level dBm	Correct Factor dB	Measure- ment dBm	Limit dBm	Margin dB	Detector	Comment
1		38.730	-70.84	1.63	-69.21	-13.00	-56.21	peak	
2		62.010	-72.28	-0.97	-73.25	-13.00	-60.25	peak	
3		85.290	-64.23	-7.88	-72.11	-13.00	-59.11	peak	
4	*	158.040	-69.63	3.04	-66.59	-13.00	-53.59	peak	
5		196.840	-65.20	-1.81	-67.01	-13.00	-54.01	peak	
6		380.170	-77.37	6.10	-71.27	-13.00	-58.27	peak	

Test Mode: LTE Band 7_TX CH21100_20M

Vertical

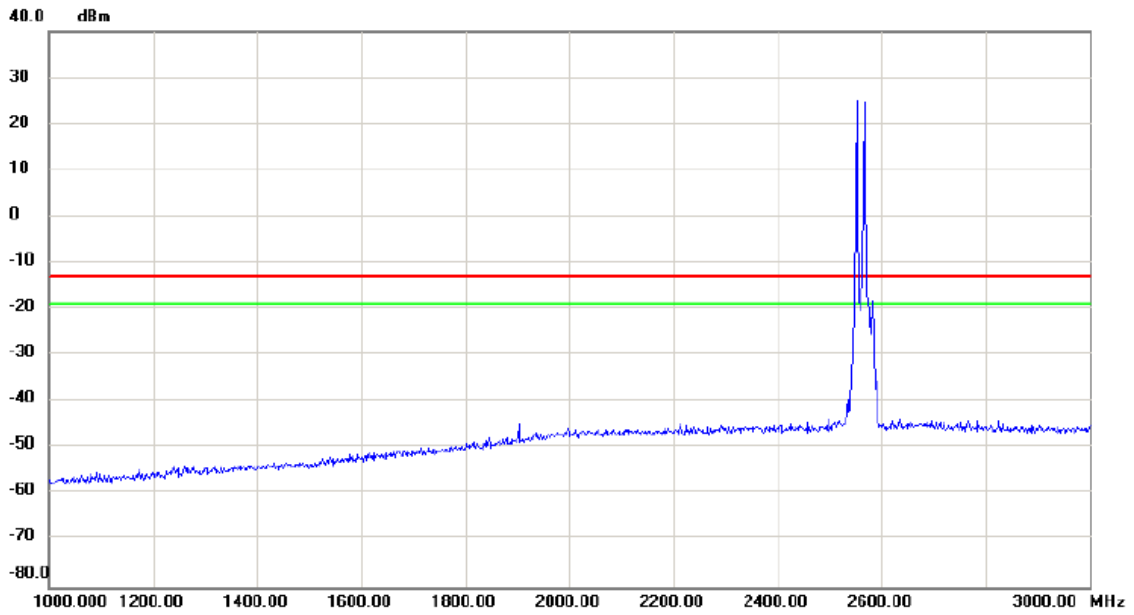

No.	Mk.	Freq.	Reading Level	Correct Factor	Measurement	Limit	Margin	Detector	Comment
		MHz	dBm	dB	dBm	dBm	dB		
		2550.00	25.0	0.0	25.0	-15.0	40.0		

Test Mode: LTE Band 7_TX CH21100_20M

Horizontal

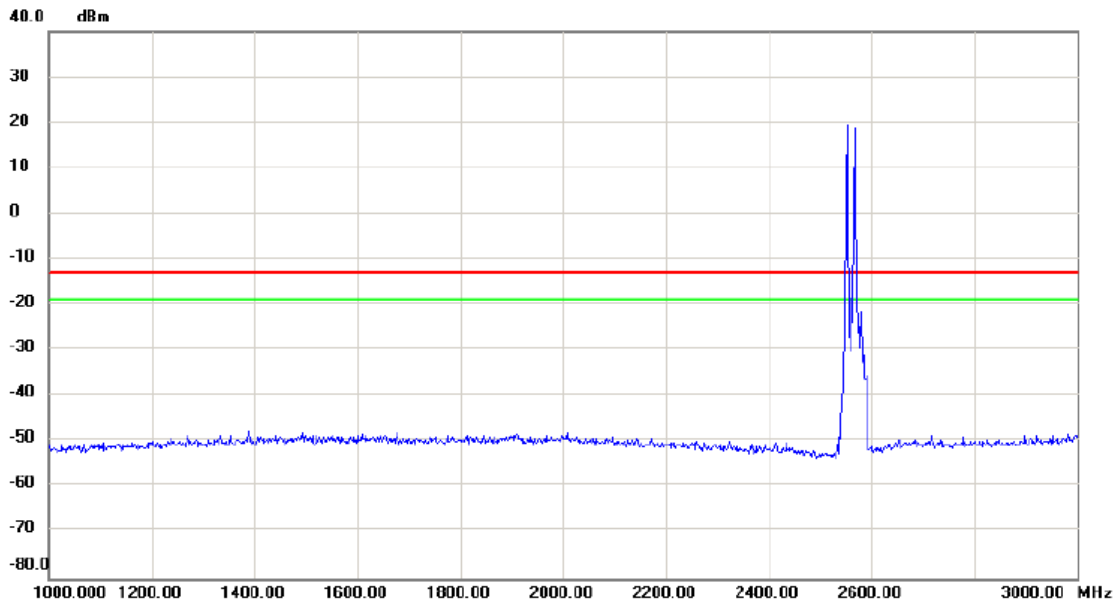

No.	Mk.	Freq.	Reading Level	Correct Factor	Measurement	Limit	Margin	Detector	Comment
		MHz	dBm	dB	dBm	dBm	dB		
		2550.00	18.00	0.00	18.00	-10.00	28.00		

Test Mode: LTE Band 7_TX CH21100_20M

Vertical

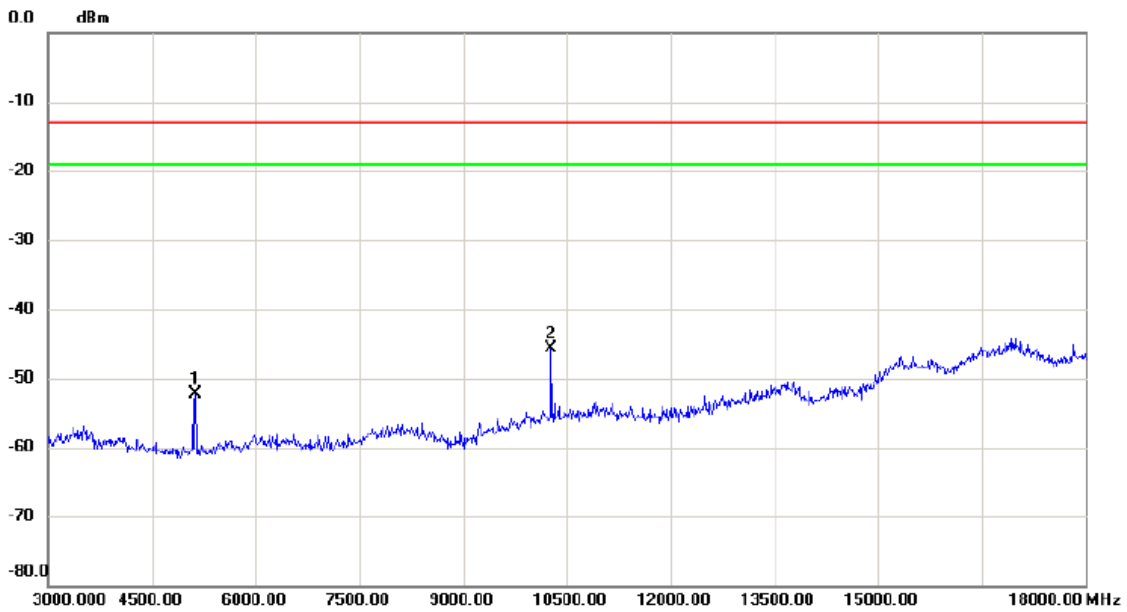

No.	Mk.	Freq. MHz	Reading Level dBm	Correct Factor dB	Measure- ment dBm	Limit dBm	Margin dB	Detector	Comment
1		5130.000	-67.35	14.97	-52.38	-13.00	-39.38	peak	
2	*	10275.000	-67.55	21.86	-45.69	-13.00	-32.69	peak	

Test Mode: LTE Band 7_TX CH21100_20M

Horizontal

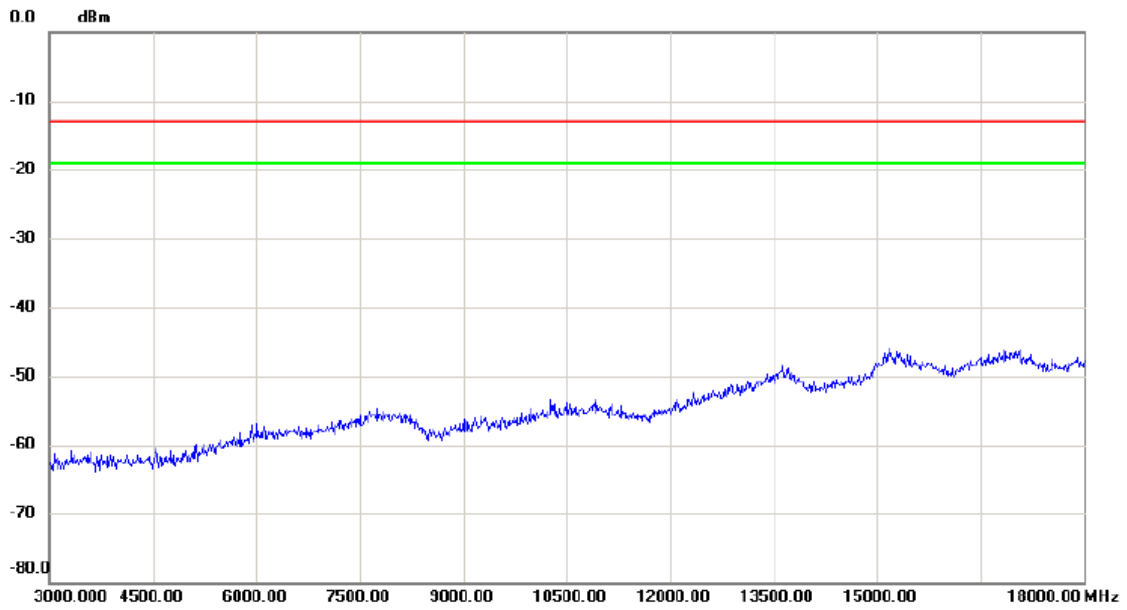

No.	Mk.	Freq.	Reading Level	Correct Factor	Measurement	Limit	Margin	Detector	Comment
		MHz	dBm	dB	dBm	dBm	dB		

Test Mode: LTE Band 7_TX CH21100_20M

Vertical

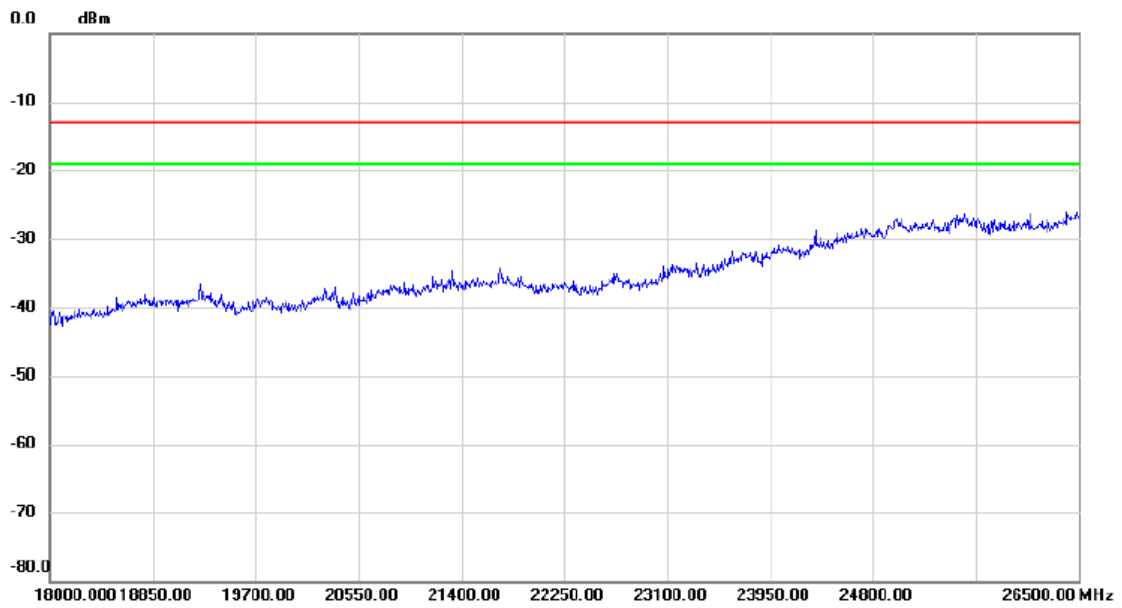

No.	Mk.	Freq. MHz	Reading Level dBm	Correct Factor dB	Measure- ment dBm	Limit dBm	Margin dB	Detector	Comment
-----	-----	--------------	-------------------------	-------------------------	-------------------------	--------------	--------------	----------	---------

Test Mode: LTE Band 7_TX CH21100_20M

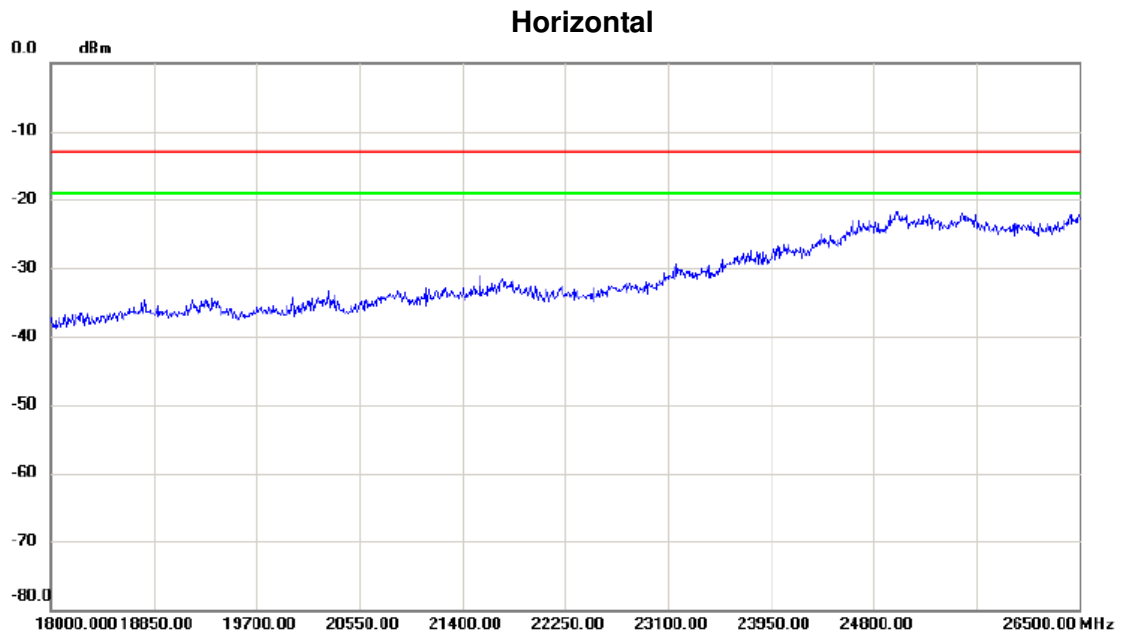

No.	Mk.	Freq. MHz	Reading Level dBm	Correct Factor dB	Measure- ment dBm	Limit dBm	Margin dB	Detector	Comment

ATTACHMENT E - BAND EDGE