

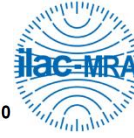

中国认可
国际互认
检测
TESTING
CNAS L0310



EMC Test Report

Product Name: BLA-L29

Model Number: Smart Phone

Report No: SYBH(Z-EMC)054092017-2

FCC ID: QISBLA-L29

Global Compliance and Testing Center of Huawei Technologies
Co., Ltd

Administration Building, Headquarters of Huawei Technologies Co., Ltd., Bantian, Longgang District,
Shenzhen, 518129, P.R.C

Tel: +86 755 28780808 Fax: +86 755 89652518

Notice

1. The laboratory has obtained the accreditation of China National Accreditation Service for Conformity Assessment (CNAS), and accreditation number: L0310.
2. The laboratory has passed the accreditation by The American Association for Laboratory Accreditation (A2LA). The accreditation number is 2174.01
3. The laboratory has been listed by Industry Canada to perform electromagnetic emission measurements. The recognition numbers of test site are 6369A-1.
4. The laboratory (Reliability Lab of Huawei Technologies Co., Ltd) is also named as “Global Compliance and Testing Center of Huawei Technologies Co., Ltd”, the both names have coexisted since 2009.
5. The laboratory has been recognized by the US Federal Communications Commission (FCC) to perform compliance testing subject to the Commission's Declaration Of Conformity (DOC) and Certification rules. The Designation Number is CN1173, and the Test Firm Registration Number is 294140.”
6. The test report is invalid if not marked with the stamps or the signatures of the persons responsible for performing, revising and approving the test report.
7. The test report is invalid if there is any evidence of erasure and/or falsification.
8. If there is any dissidence for the test report, please file objection to the test centre within 15 days from the date of receiving the test report.
9. Normally, the test report is only responsible for the samples that have undergone the test.
10. Context of the test report cannot be used partially or in full for publicity and/or promotional purposes without previous written approval of the laboratory.



Applicant: Huawei Technologies Co., Ltd.
Address: Administration Building, Headquarters of Huawei
Technologies Co., Ltd., Bantian, Longgang District,
Shenzhen, 518129, P.R.C

Date of Receipt Test Item: Sep.20,2017
Start Date of Test: Sep.20,2017
End Date of Test: Sep.28,2017

Test Result: Pass

**Approved By
(Lab Manager)**

2017-9-30
Date

Roger Zhang
Name

Roger Zhang

Signature

**Prepared by
(Test Engineer)**

2017-9-30
Date

Peng Shao Hua
Name

Peng Shao Hua

Signature



Modification Record

No.	Last Report No.	Modification Description
1	NA	First Report.



TABLE OF CONTENT











1	General Information	6
1.1	EUT Description	6
1.2	Test Site Information	9
1.3	Applied Standards	9
2	Summary of Results.....	10
3	System Configuration during EMC Test.....	11
3.1	Test Mode	11
3.2	Test System Configuration.....	12
3.3	Cables Used during Test.....	14
3.4	Associated Equipment Used during Test.....	14
4	Electromagnetic Interference (EMI).....	15
4.1	Radiated Disturbance 30MHz to 18GHz	15
4.2	Conducted Disturbance 0.15 MHz to 30MHz.....	18
5	Main Test Instruments.....	19
6	System Measurement Uncertainty	19
7	Test Data and Graph.....	20
7.1	Radiated Disturbance.....	20
7.2	Conducted Disturbance.....	22

1 General Information

1.1 EUT Description

EUT Description	
Product Name	Smart Phone
Model Number	BLA-L29
Input voltage	3.82V DC
TX Frequency	GSM 850: 824MHz to 849MHz PCS 1900: 1850MHz to 1910MHz WCDMA Band II: 1850MHz to 1910MHz WCDMA Band IV: 1710MHz to 1755MHz WCDMA Band V:: 824MHz to 849MHz LTE BAND 2: 1850MHz to 1910MHz LTE BAND 4: 1710MHz to 1755MHz LTE BAND 5: 824MHz to 849MHz LTE BAND 7: 2500MHz to 2570MHz LTE BAND 12: 699MHz to 716MHz LTE BAND 17: 704MHz to 716MHz LTE BAND 26: 814MHz to 849MHz LTE BAND 38: 2570MHz to 2620MHz LTE BAND 41: 2550MHz to 2650MHz WIFI/Bluetooth: 2400MHz to 2483.5MHz WIFI 5G:5150MHz to 5350MHz 5470MHz to 5850MHz NFC: 13.56MHz
RX Frequency	GSM 850: 869MHz to 894MHz GSM 1900: 1930MHz to 1990MHz WCDMA Band II: 1930MHz to 1990MHz WCDMA Band IV: 2110MHz to 2155MHz WCDMA Band V:: 869MHz to 894MHz LTE BAND 2: 1930MHz to 1990MHz LTE BAND 4: 2110MHz to 2155MHz LTE BAND 5: 869MHz to 894MHz LTE BAND 7: 2620MHz to 2690MHz LTE BAND 12: 729MHz to 746MHz LTE BAND 17: 704MHz to 716MHz LTE BAND 26: 859MHz to 894MHz LTE BAND 38: 2570MHz to 2620MHz LTE BAND 41: 2550MHz to 2650MHz WIFI/Bluetooth: 2400MHz to 2483.5MHz WIFI 5G:5150MHz to 5350MHz 5470MHz to 5850MHz NFC:13.56MHz GPS: 1575.42MHz
S/N	AQH117812000874
HW Version	HL1BLAM
SW Version	BLA-L29 8.0.0.68(C432)
EUT Accessory	
Data cable	Data Cable USB A Male to USB Type C, Shielded Brand: HUAWEI Model: L99UC018-CS-H

	<p>Manufacturer: LUXSHARE-ICT Co., Ltd.</p> <hr/> <p>Data Cable USB A Male to USB Type C, Shielded Brand: HUAWEI Model: 130-27309 Manufacturer: Chang Shu Honglin Technology Co.,Ltd.</p> <hr/> <p>Data Cable USB A Male to USB Type C, Shielded Brand: HUAWEI Model: 130-27363 Manufacturer: Chang Shu Honglin Technology Co.,Ltd.</p>
Earphone	<p>Brand: HUAWEI Model: MEMD1632B729000 Manufacturer: JIANGXI LIANCHUANG HONGSHENG ELECTRONIC CO., LTD</p> <hr/> <p>Model: 1311-3301-6001-TC-296 Manufacturer: BOLUO COUNTY QUANCHENG ELECTRONIC CO., LTD</p> <hr/> <p>Model: WINDY-C Manufacturer: Goer Tek Inc</p> <hr/> <p>Model: L99EP003-CS-H Manufacturer: MERRY ELECTRONICS (SHENZHEN) CO., LTD.</p> <hr/> <p>Brand: HUAWEI Model: MEND1632B729001 Manufacturer: JIANGXI LIANCHUANG HONGSHENG ELECTRONIC CO., LTD</p> <hr/> <p>Brand: HUAWEI Model: 1311-3301-6001-TC-305 Manufacturer: BOLUO COUNTY QUANCHENG ELECTRONIC CO., LTD</p>
Earphone Transfer Line	<p>Brand: HUAWEI Model: HWTYPEC3R5009AW Manufacturer: JIANGXI LIANCHUANG HONGSHENG ELECTRONIC CO., LTD</p> <hr/> <p>Brand: HUAWEI Model: L99UD002-CS-H Manufacturer: MERRY ELECTRONICS (SHENZHEN) CO., LTD.</p> <hr/> <p>Brand: HUAWEI Model: HWTYPEC3R5009AB Manufacturer: JIANGXI LIANCHUANG HONGSHENG ELECTRONIC CO., LTD</p> <hr/> <p>Brand: HUAWEI Model: L99UD006-CS-H Manufacturer: MERRY ELECTRONICS (SHENZHEN) CO., LTD.</p>
Adapter	<p>Manufacturer: Huawei Technologies Co.,Ltd. Model: HW-050450U00 Input voltage: 100-240V 50/60Hz ,0.75A Output voltage: 5V  2A OR 5V  4.5A OR 4.5V  5A</p>

	<p>Rated Power: 10W/22.5W SN:P82922H3J31684 P82810H6920076 H828K8H3V05002 P82810H6920035</p>
Adapter	<p>Manufacturer: Huawei Technologies Co.,Ltd. Model: HW-050450E00 nput voltage: 100-240V 50/60Hz ,0.75A Output voltage: 5V  2A OR 5V  4.5A OR 4.5V  5A Rated Power: 10W/22.5W SN:P8301OH7412711 P83009H4X00378 P83009H4XO4326 K83059H4V07826</p>
Adapter	<p>Manufacturer: Huawei Technologies Co.,Ltd. Model: HW-050450B00 nput voltage: 100-240V 50/60Hz ,0.75A Output voltage: 5V  2A OR 5V  4.5A OR 4.5V  5A Rated Power: 10W/22.5W SN:P82922H3J31705 K82971H3W11159 K82971H3R11886 P82922H3J31706</p>
Adapter	<p>Manufacturer: Huawei Technologies Co.,Ltd. Model: HW-050450A00 nput voltage: 100-240V 50/60Hz ,0.75A Output voltage: 5V  2A OR 5V  4.5A OR 4.5V  5A Rated Power: 10W/22.5W SN:K8317H4J05204 K83171H4J04782 K83171H4J05584 K83171H4J05592</p>
Rechargeable Li-ion	<p>Manufacturer: Huawei Technologies Co.,Ltd. Battery Model: HB436486ECW Rated capacity: 3900mAh Nominal Voltage:  +3.82V Charging Voltage:  +4.4V SN:4XSCAYH315X000FS 4XTDLCH319900131 4XSDSIH405X00092</p>

Remark: The above EUT's information is declared by manufacturer. Please refer to the specifications or user's manual for more detailed information.

1.2 Test Site Information

Test Site 1:	RELIABILITY LABORATORY OF HUAWEI TECHNOLOGIES CO., LTD.
Test Site Location:	Administration Building, Headquarters of Huawei Technologies Co., Ltd., Bantian, Longgang District, Shenzhen, 518129, P.R.C

1.3 Applied Standards

APPLIED STANDARD

47 CFR FCC Part 15:2016, Subpart B

2 Summary of Results

Summary of Results				
Test Items	Test Mode	Performance Class & Required Performance Criteria	Result	Site
<u>Radiated Emissions</u> Enclosure Port	Mode1~ Mode4 Mode7	CLASS B	Pass	Site1
<u>Conducted Emissions</u> <input checked="" type="checkbox"/> DC Power Port <input checked="" type="checkbox"/> AC Power Port <input type="checkbox"/> Telecommunication Ports	Mode 1 Mode3 Mode6 Mode7	CLASS B	Pass	Site1
Note: 1, Measurement taken is within the uncertainty of test system. 2, <input checked="" type="checkbox"/> The item has been tested; <input type="checkbox"/> The item has not been tested.				

During the measurement, the environmental conditions complied with the range listed as below.

Item	Required
Ambient temperature	15°C ~ 35°C
Relative humidity	25% ~ 75%
Atmospheric pressure	86kPa ~ 106kPa

3 System Configuration during EMC Test

3.1 Test Mode

The EUT was configured, installed, arranged and operated in a manner consistent with typical application. The following mode(s) were applied during the compliance test.

Test Mode	
Mode 1:	Adapter + Camera On + Idle
Mode 2:	Earphone + Camera On + Idle
Mode 3:	Adapter + Playing + Idle
Mode 4:	Earphone + Playing + Idle
Mode 5:	Earphone +Traffic
Mode 6:	Adapter +Traffic
Mode 7:	USB Copy(EUT with PC) + Idle

Remark:

- 1) If there is one kind of accessories with different models, each one should be applied throughout the compliance test respectively, however, only the worst case will be recorded in this report.
- 2) If EUT has more than one typical operation, only the worst test mode will be recorded in this report.

Traffic Mode:

When the EUT state is switched on and with Radio Resource Control (RRC) connection established.

Idle Mode:

When the EUT state is switched on but without Radio Resource Control (RRC) connection.

Worst Case:

- 1) Radiated Emission
Adapter(Model: HW-050450E00, SN:P83009H4X00378) + Camera On + Idle
the result is the worst.
- 2) Conducted Emission
Adapter(Model: HW-050450A00, SN: K83171H4J05584) + Camera On + Idle
the result is the worst.

3.2 Test System Configuration

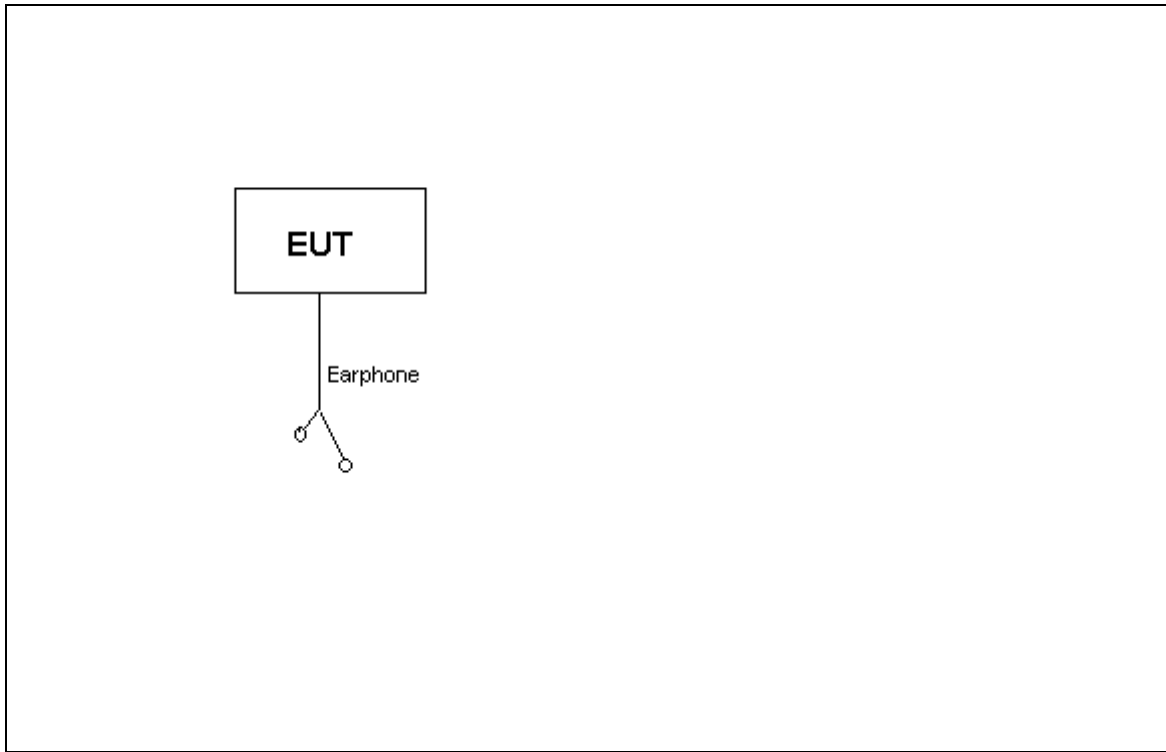

Connection Diagram (Mode 1/Mode 3/Mode 6)

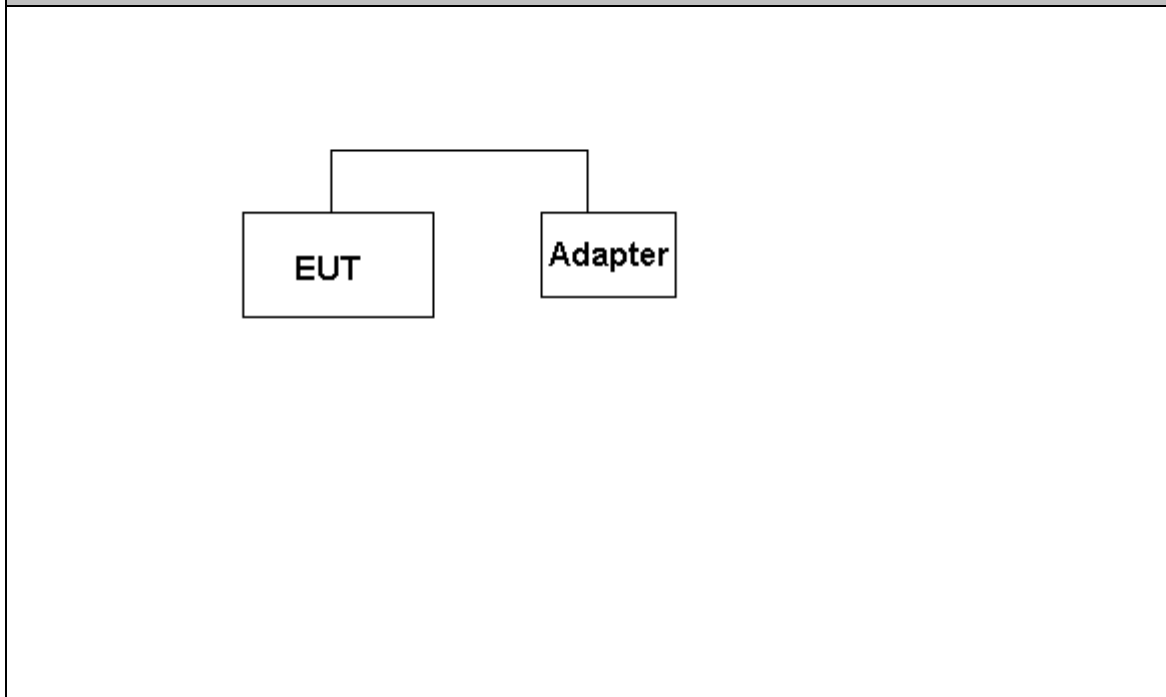

Connection Diagram (Mode 7)

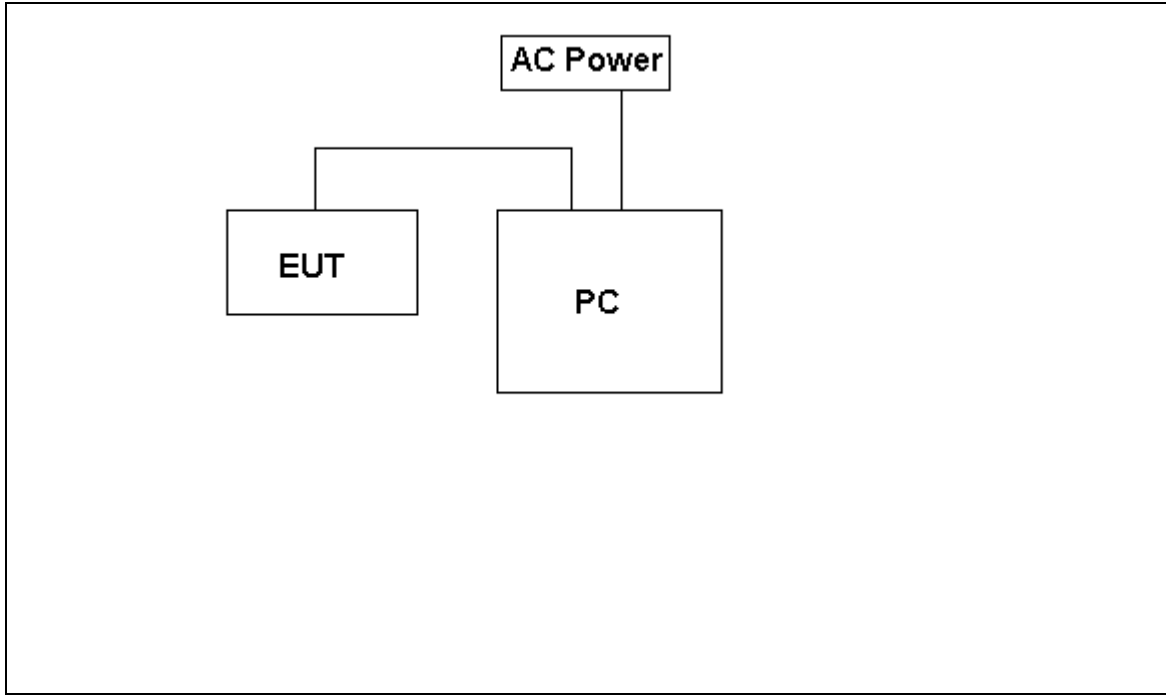

3.3 Cables Used during Test

Cable	Quantity	Length	Type of Cable
USB	1	<3m	Shielded
Earphone	1	<3m	Unshielded

3.4 Associated Equipment Used during Test

Name	Model	Manufacturer	S/N	Calibrated Deadline	Cal interval
Radio Communication Tester	CMU200	R&S	3608082535	2018-03-01	12
Radio Communication Tester	MT8820C	Anritsu	A110518805	2018-05-15	12
Notebook	S3	ThinkPad	A140714638	/	/

4 Electromagnetic Interference (EMI)

4.1 Radiated Disturbance 30MHz to 18GHz

4.1.1 Test Procedure

The test site semi-anechoic chamber has met the requirement of NSA tolerance 4dB according to the standards: ANSI C63.4-2014. The test distance was 3m. The set-up and test methods were according to ANSI C63.4-2014.

A preliminary scan and a final scan of the emissions were made from 30 MHz to 18 GHz by using test script of software; The emissions were measured using Quasi-Peak Detector (30MHz~1GHz) and AV/PK detector (above 1GHz). The maximal emission value was acquired by adjusting the antenna height, polarisation and turntable azimuth in accordance with the software setup. Normally, the height range of antenna was 1m to 4m. The azimuth range of turntable was 0° to 360°. The receiving antenna has two polarizations V and H.

Measurement bandwidth (RBW) for 30MHz to 1000 MHz: 120 kHz;

Measurement bandwidth (RBW) for 1000MHz to 18000 MHz: 1MHz;

EUT was configured in idle mode and the test performed at worst emission state.

4.1.2 Test setup

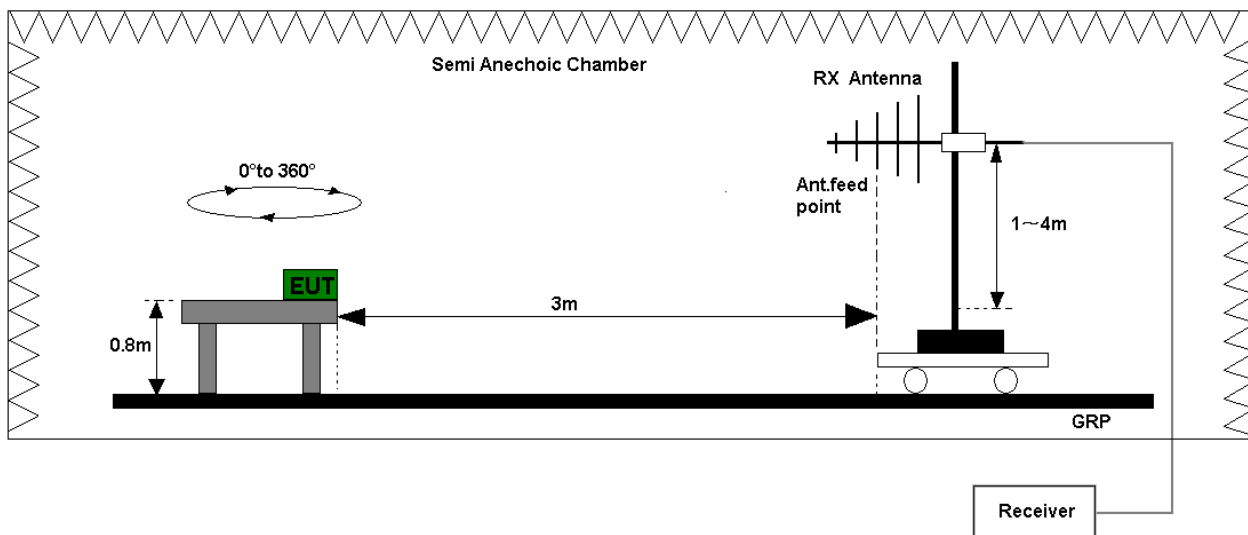

Figure 1. Test set-up of radiated disturbance(30MHz-1GHz)

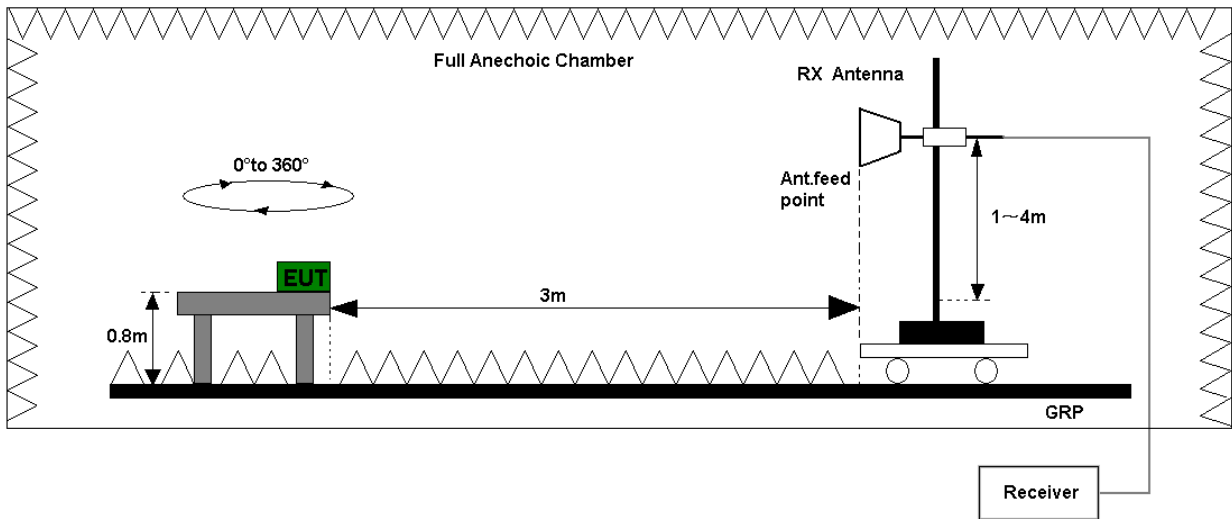

Figure 2. Test set-up of radiated disturbance(above 1GHz)

4.1.3 Test Results

The EUT has met the requirements for Radiated Emission of enclosure port.
Refer to the section 7.1.1 of this report for test data.

Test Limits (Class B)				
Frequency of Emission (MHz)	Radiated Limit			
	Unit(μ V/m)		Unit(dB μ V/m)	
30-88	100		40	
88-216	150		43.5	
216-960	200		46	
Above 960	500		54	
Above 1000	AV	PK	AV	PK
	500	5000	54	74

4.2 Conducted Disturbance 0.15 MHz to 30MHz

4.2.1 Test Procedure

The Table-top EUT was placed upon a non-metallic table 0.8 m above the horizontal metal reference ground plane. EUT was connected to LISN and LISN was connected to reference Ground Plane. EUT was 80cm away from LISN. The set-up and test methods were according to ANSI C63.4-2014. Conducted Disturbance at AC Port measurements were undertaken on the L and N Lines. The emissions were measured using a Quasi-Peak Detector and Average Detector. EUT was communicated with the simulator through Air interface, the simulator controls the EUT to transmitter the maximum power which defined in specification of product. The EUT operated on the typical channel.

Measurement bandwidth (RBW) for 150 kHz to 30 MHz: 9 kHz;

The EUT was set in the shielded chamber and operated under nominal conditions.

4.2.2 Test Setup

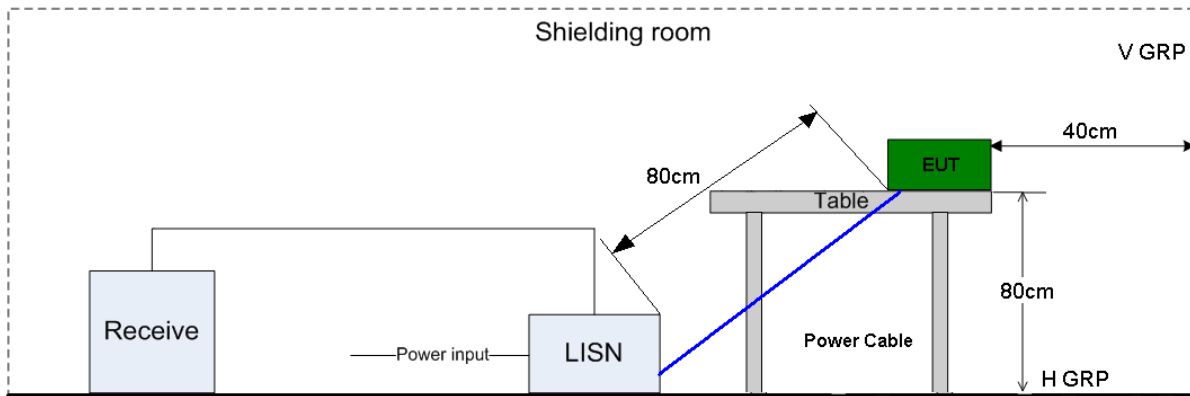

Figure 3. Test Set-up of conducted disturbance

4.2.3 Test Results

The EUT has met requirements for Conducted disturbance of power lines.

Refer to the section 7.2.1 of this report for test data.

Test Limit of AC Power Port		
Frequency range	150kHz ~ 30MHz	
Frequency	Voltage limits	
	QP (dB μ V)	AV (dB μ V)
0.15MHz~0.5MHz	66-56	56-46
0.5MHz-5MHz	56	46
5MHz~30MHz	60	50

5 Main Test Instruments

Main Test Equipments						
Test item	Test Instrument	Model	S/N	Manufacturer	Calibrated Deadline	Cal interval
RE	EMI Test receiver	ESU26	100150	R&S	Jun. 20, 2018	12
	Broadband Antenna	VULB 9163	9163-491	SCHWARZ BECK	Mar. 28, 2019	24
	Horn Antenna	HF906	100683	R&S	Mar. 28, 2019	24
CE	EMI Test receiver	ESU26	100150	R&S	May. 15, 2018	12
	Artificial Mains Network	ENV4200	100134	R&S	May. 15, 2018	12
	Artificial Mains Network	ENV216	100382	R&S	May. 15, 2018	12
Software Information						
Test Item	Software Name	Manufacturer		Version		
RE	EMC32	R&S		V9.25.0		
CE	EMC32	R&S		V9.25.0		

6 System Measurement Uncertainty

For a 95% confidence level, the measurement expanded uncertainties for defined systems, in accordance with the recommendations of ISO 17025 were:

System Measurement Uncertainty		
Items	Extended Uncertainty	
RE(30MHz-1GHz)	Field strength (dB μ V/m)	U=4.1dB; k=2
RE(1GHz-18GHz)	Field strength (dB μ V/m)	U=5.1dB; k=2
CE	Disturbance Voltage (dB μ V)	U=2.5dB; k=2

7 Test Data and Graph

Only the worst test results were shown

7.1 Radiated Disturbance

7.1.1 30MHz~1GHz

Test Mode1:

Full Spectrum



MEASUREMENT RESULT: QP Detector

Frequency MHz	Level dB μ V/m	Transd dB	Limit dB μ V/m	Margin dB	Height cm	Azimuth deg	Polarisation
39.952000	32.70	17.1	40.00	7.30	100.0	265.0	VERTICAL
45.940857	29.89	16.4	40.00	10.11	110.0	224.0	VERTICAL
81.982858	28.74	8.4	40.00	11.26	146.0	45.0	VERTICAL
152.939428	32.50	12.4	43.50	11.00	100.0	301.0	VERTICAL
317.846572	25.78	17.0	46.00	20.22	101.0	25.0	VERTICAL
413.280286	28.85	19.5	46.00	17.15	100.0	144.0	VERTICAL

Note:

Level = Reading level by receiver + Transd (Antenna factor + cable loss – preamplifier gain)
The reading level is calculated by software which is not shown in the sheet.

7.1.2 1GHz~18GHz

Test Mode1:

Full Spectrum

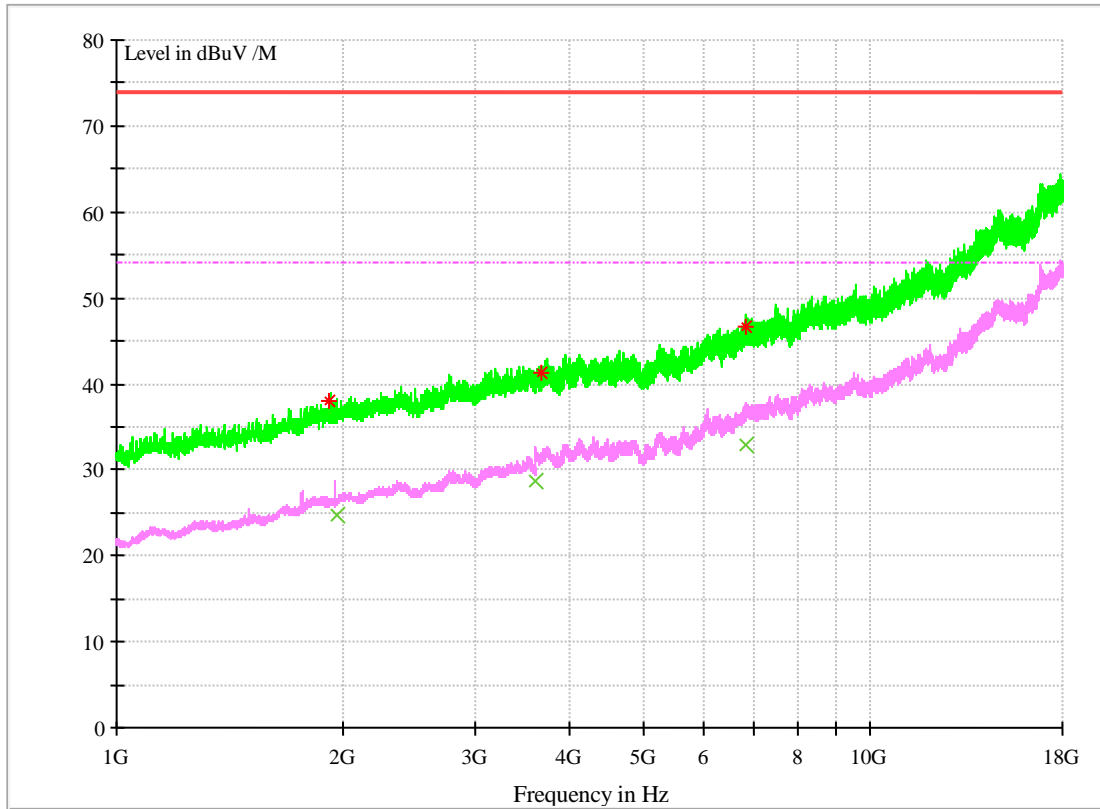

MEASUREMENT RESULT: PK Detector

Frequency MHz	Level dB μ V/m	Transd dB	Limit dB μ V/m	Margin dB	Height cm	Azimuth deg	Polarisation
1912.416667	37.03	-10.0	74.00	36.97	182.0	324.0	HORIZONTAL
3657.913334	42.31	-3.5	74.00	31.69	144.0	23.0	VERTICAL
6846.136000	47.64	3.1	74.00	26.36	194.0	8.0	HORIZONTAL

MEASUREMENT RESULT: AV Detector

Frequency MHz	Level dB μ V/m	Transd dB	Limit dB μ V/m	Margin dB	Height cm	Azimuth deg	Polarisation
1957.816667	25.76	-9.7	54.00	28.24	211.0	272.0	VERTICAL
3603.283334	27.72	-3.6	54.00	26.28	126.0	62.0	VERTICAL
6822.182667	32.88	3.1	54.00	21.12	194.0	39.0	VERTICAL

Note:

Level =Reading level by receiver + Transd (Antenna factor + cable loss – preamplifier gain)
The reading level is calculated by software which is not shown in the sheet.

7.2 Conducted Disturbance

7.2.1 AC Port Test Data

Test Mode1:

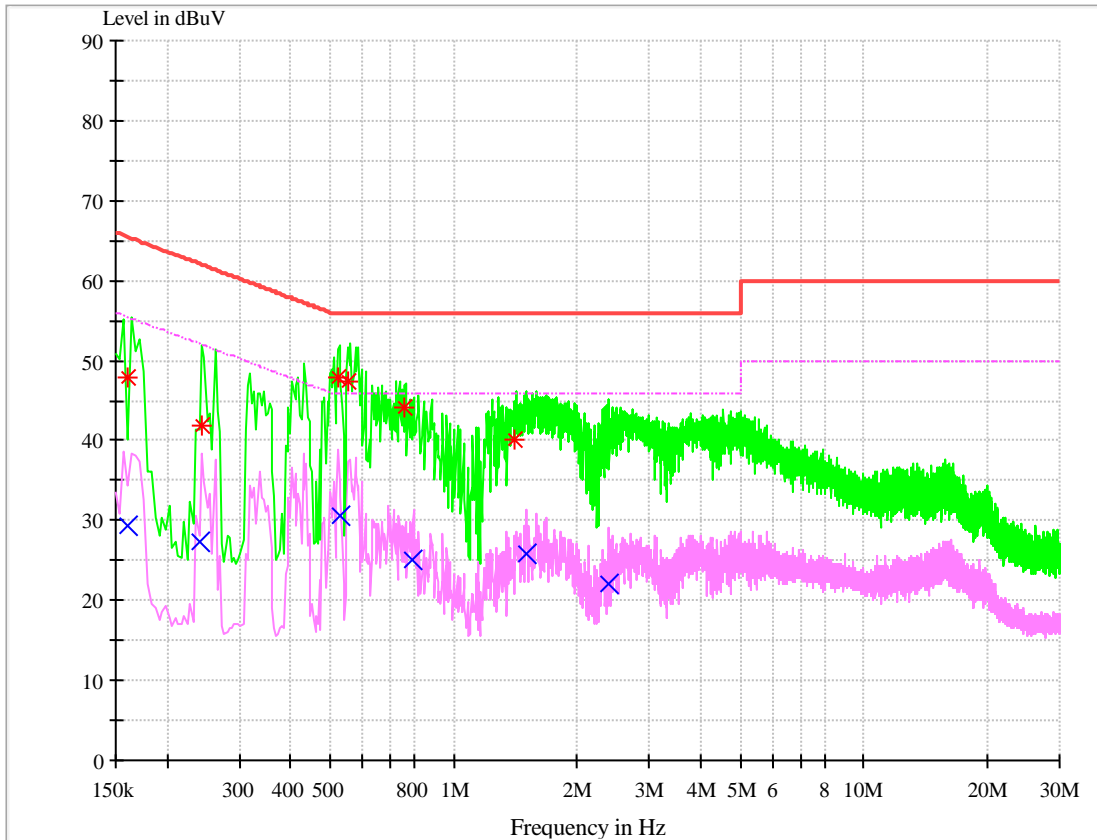

MEASUREMENT RESULT: QP Detector

Frequency MHz	Level dB μ V	Line	Transd dB	Margin dB	Limit dB μ V	PE
0.159843	47.86	L1	9.7	17.61	65.47	FLO
0.243758	41.81	L1	9.7	20.16	61.97	FLO
0.522266	47.94	L1	9.7	8.06	56.00	FLO
0.553778	47.49	N	9.7	8.51	56.00	FLO
0.754451	44.03	L1	9.7	11.97	56.00	FLO
1.414523	40.15	N	9.7	15.85	56.00	FLO

MEASUREMENT RESULT: AV Detector

Frequency MHz	Level dB μ V	Line	Transd dB	Margin dB	Limit dB μ V	PE
0.159581	29.38	N	9.7	26.10	55.49	FLO
0.239726	27.36	N	9.7	24.75	52.11	FLO
0.528660	30.49	N	9.7	15.51	46.00	FLO
0.789923	24.96	N	9.7	21.04	46.00	FLO
1.513530	25.72	N	9.7	20.28	46.00	FLO



2.400180	22.14	N	9.7	23.86	46.00	FLO
----------	-------	---	-----	-------	-------	-----

-----**END**-----