

FCC Radio Test Report

FCC ID: QISBLA-L29

This report concerns (check one): Original Grant Class I Change Class II Change

Project No. : 1709C042
Equipment : Smart Phone
Model Name : BLA-L29
Applicant : Huawei Technologies Co.,Ltd.
Address : Administration Building, Headquarters of Huawei Technologies Co., Ltd., Bantian, Longgang District, Shenzhen, 518129, P.R.C

Date of Receipt : Sep. 07, 2017
Date of Test : Sep. 07, 2017 ~ Oct. 09, 2017
Issued Date : Oct. 09, 2017
Tested by : BTL Inc.

Technical Engineer : Shawn Xiao
(Shawn Xiao)

Authorized Signatory : Steven Lu
(Steven Lu)

B T L I N C .

No.3, Jinshagang 1st Road, Shixia, Dalang Town, Dongguan, Guangdong, China.

TEL: +86-769-8318-3000 FAX: +86-769-8319-6000



Declaration

BTL represents to the client that testing is done in accordance with standard procedures as applicable and that test instruments used has been calibrated with standards traceable to international standard(s) and/or national standard(s).

BTL's reports apply only to the specific samples tested under conditions. It is manufacture's responsibility to ensure that additional production units of this model are manufactured with the identical electrical and mechanical components. **BTL** shall have no liability for any declarations, inferences or generalizations drawn by the client or others from **BTL** issued reports.

BTL's report must not be used by the client to claim product certification, approval, or endorsement by NVLAP, NIST, or any agency of the Federal Government.

This report is the confidential property of the client. As a mutual protection to the clients, the public and **BTL-self**, extracts from the test report shall not be reproduced except in full with **BTL's** authorized written approval.

BTL's laboratory quality assurance procedures are in compliance with the **ISO Guide17025** requirements, and accredited by the conformity assessment authorities listed in this test report.

Limitation

For the use of the authority's logo is limited unless the Test Standard(s)/Scope(s)/Item(s) mentioned in this test report is (are) included in the conformity assessment authorities acceptance respective.

Table of Contents

Page

REPORT ISSUED HISTORY	5
1 . CERTIFICATION	6
2 . SUMMARY OF TEST RESULTS	7
2.1 TEST FACILITY	8
2.2 MEASUREMENT UNCERTAINTY	8
3 . GENERAL INFORMATION	9
3.1 GENERAL DESCRIPTION OF EUT	9
3.2 DESCRIPTION OF TEST MODES AND TEST CONDITION	11
3.3 BLOCK DIGRAM SHOWING THE CONFIGURATION OF SYSTEM TESTED FOR RADIATED	13
3.4 DESCRIPTION OF SUPPORT UNITS	13
4 . TEST RESULT	14
4.1 OUTPUT POWER MEASUREMENT	14
4.1.1 LIMIT	14
4.1.2 TEST PROCEDURE	14
4.1.3 TESTSETUP LAYOUT	14
4.1.4 TEST DEVIATION	14
4.1.5 TEST RESULTS	14
4.2 OCCUPIED BANDWIDTH MEASUREMENT	15
4.2.1 TEST PROCEDURE	15
4.2.2 TEST SETUP LAYOUT	15
4.2.3 TEST DEVIATION	15
4.2.4 TEST RESULTS	15
4.3 CONDUCTED EMISSIONS MEASUREMENT	16
4.3.1 LIMIT	16
4.3.2 TEST PROCEDURES	16
4.3.3 TESTSETUP LAYOUT	16
4.3.4 TESTDEVIATION	16
4.3.5 TEST RESULTS	16
4.4 RADIATED EMISSIONS MEASUREMENT	17
4.4.1 LIMIT	17
4.4.2 TEST PROCEDURES	17
4.4.3 TESTSETUP LAYOUT	18
4.4.4 TESTDEVIATION	18
4.4.5 TEST RESULTS	18
4.5 BAND EDGE MEASUREMENT	19
4.5.1 LIMIT	19

Table of Contents	Page
4.5.2 TEST PROCEDURES	19
4.5.3 TESTSETUP LAYOUT	19
4.5.4 TESTDEVIATION	19
4.5.5 TEST RESULTS	19
4.6 PEAK TO AVERAGE RATIO MEASUREMENT	20
4.6.1 LIMIT	20
4.6.2 TEST PROCEDURES	20
4.6.3 TESTSETUP LAYOUT	20
4.6.4 TESTDEVIATION	20
4.6.5 TEST RESULTS	20
4.7 FREQUENCY STABILITY MEASUREMENT	21
4.7.1 LIMIT	21
4.7.2 TEST PROCEDURES	21
4.7.3 TESTSETUP LAYOUT	21
4.7.4 TESTDEVIATION	21
4.7.5 TEST RESULTS	21
5. LIST OF MEASUREMENT EQUIPMENTS	22
APPENDIX A - OUTPUT POWER	24
APPENDIX B - OCCUPIED BANDWIDTH	31
APPENDIX C - CONDUCTED EMISSIONS	42
APPENDIX D - RADIATED EMISSION	48
APPENDIX E - BAND EDGE	81
APPENDIX F - PEAK TO AVERAGE RATIO	87
APPENDIX G - FREQUENCY STABILITY	93

REPORT ISSUED HISTORY

Issued No.	Description	Issued Date
BTL-FCCP-2-1709C042	Original Issue.	Oct. 09, 2017

1. CERTIFICATION

Equipment : Smart Phone
Brand Name : HUAWEI
Model Name : BLA-L29
Applicant : Huawei Technologies Co.,Ltd.
Manufacturer : Huawei Technologies Co.,Ltd.
Address : Administration Building, Huawei Base, Bantian, Longgang District ,
Shenzhen 518129, P.R.China
Factory : Huawei Technologies Co.,Ltd.
Address : Administration Building, Huawei Base, Bantian, Longgang District ,
Shenzhen 518129, P.R.China
Date of Test : Sep. 07, 2017 ~ Oct. 09, 2017
Test Sample : Engineering Sample
Standard(s) : 47 CFR FCC Part 22 Subpart H
47 CFR FCC Part 2
ANSI/TIA-603-D-2010
KDB 971168 D01 Power Meas License Digital Systems v02r02

The above equipment has been tested and found compliance with the requirement of the relative standards by BTL Inc.

The test data, data evaluation, and equipment configuration contained in our test report (Ref No. BTL-FCCP-2-1709C042) were obtained utilizing the test procedures, test instruments, test sites that has been accredited by the Authority of NVLAP according to the ISO-17025 quality assessment standard and technical standard(s).

Test results included in this report is only for the LTE Band 26 part.

2. SUMMARY OF TEST RESULTS

Test procedures according to the technical standard(s):

FCC Part 22 Subpart H & Part 2			
Standard(s) Section	Test Item	Judgment	Tested By
2.1046 & 22.913(a)	Radiated power	PASS	Paul Li
2.1046 & 22.913(a)	Conducted Output Power	PASS	Paul Li
2.1049(h) & 22.917(a)	Occupied Bandwidth	PASS	Paul Li
2.1051 & 22.917(a)	Conducted Spurious Emissions	PASS	Paul Li
2.1053 & 22.917(a)	Radiated Spurious Emissions	PASS	Paul Li
22.917(a)	Band Edge Measurements	PASS	Paul Li
-	Peak To Average Ratio	PASS	Paul Li
2.1055 & 22.355	Frequency Stability	PASS	Paul Li

Note:

(1) "N/A" denotes test is not applicable to this device.

2.1 TEST FACILITY

The test facilities used to collect the test data in this report is at the location of No.3, Jinshagang 1st Road, Shixia, Dalang Town, Dongguan, Guangdong, China.

BTL's test firm number for FCC: 854385

BTL's designation number for FCC: CN5020

2.2 MEASUREMENT UNCERTAINTY

Where relevant, the following measurement uncertainty levels have been estimated for tests performed on the EUT as specified in CISPR 16-4-2. The BTL measurement uncertainty is less than the CISPR 16-4-2 U_{CISPR} requirement.

The reported uncertainty of measurement $y \pm U$, where expanded uncertainty U is based on a standard uncertainty multiplied by a coverage factor of $k=2$, providing a level of confidence of approximately **95%**.

A. Radiated Measurement :

Test Site	Method	Measurement Frequency Range	Ant. H / V	U,(dB)
DG-CB03 (3m)	CISPR	9KHz ~ 30MHz	V	3.79
		9KHz ~ 30MHz	H	3.57
		30MHz ~ 200MHz	V	3.82
		30MHz ~ 200MHz	H	3.78
		200MHz ~ 1,000MHz	V	4.10
		200MHz ~ 1,000MHz	H	4.06

Test Site	Method	Measurement Frequency Range	Ant. H / V	U,(dB)
DG-CB03 (3m)	CISPR	1GHz ~ 18GHz	V	3.12
		1GHz ~ 18GHz	H	3.68

Note: Unless specifically mentioned, the uncertainty of measurement has not been taken into account to declare the compliance or non-compliance to the specification.

3. GENERAL INFORMATION

3.1 GENERAL DESCRIPTION OF EUT

Equipment	Smart Phone				
Brand Name	HUAWEI				
Model Name	BLA-L29				
Model Difference	N/A				
Modulation Type	QPSK, 16QAM				
Operation Frequency	LTE 26 (Channel Bandwidth: 1.4MHz)	824.7 ~ 848.3 MHz			
	LTE 26 (Channel Bandwidth: 3MHz)	825.5 ~ 847.5 MHz			
	LTE 26 (Channel Bandwidth: 5MHz)	826.5 ~ 846.5 MHz			
	LTE 26 (Channel Bandwidth: 10MHz)	829 ~ 844 MHz			
	LTE 26 (Channel Bandwidth: 15MHz)	831.5 ~ 841.5 MHz			
Max. ERP Power	LTE 26 (Channel Bandwidth: 1.4MHz)	QPSK	19.26	dBm	
		16QAM	18.23	dBm	
	LTE 26 (Channel Bandwidth: 3MHz)	QPSK	18.94	dBm	
		16QAM	18.34	dBm	
	LTE 26 (Channel Bandwidth: 5MHz)	QPSK	19.00	dBm	
		16QAM	18.33	dBm	
	LTE 26 (Channel Bandwidth: 10MHz)	QPSK	19.15	dBm	
		16QAM	18.44	dBm	
	LTE 26 (Channel Bandwidth: 15MHz)	QPSK	19.03	dBm	
		16QAM	18.34	dBm	
	Antenna Type	Fixed Internal Antenna			
	Antenna Gain	-2.07 dBi(Main Ant), -3.02 dBi(Second Ant)			
Hardware Version	HL1BLAM				
Software Version	BLA-L29 8.0.0.69(C432)				
IMEI No. 1	Radiated	866219030013998			
	Conducted	866219030005663			
IMEI No. 2	Radiated	866219030024995			
	Conducted	866219030016660			
Power Source	#1 Supplied from AC/DC adapter. #2 Battery Supplied.				
Power Rating	#1 Input: 100V-240V~50/60Hz, 0.75A Output: 5V --- 2A OR 4.5V --- 5A OR 5V --- 4.5A #2 --- 3.82V 3900mA				

Note:

1. For a more detailed features description, please refer to the manufacturer's specifications or the user's manual.
2. The EUT contains following accessory devices.

Item	Mfr/Brand	Model.
Battery	Sunwoda Electronic Co., LTD	HB436486ECW
	SCUD (FUJIAN) Electronics Co., Ltd	HB436486ECW
	Desay Battery Co., Ltd.	HB436486ECW
USB Cable	LUXSHARE-ICT Co., Ltd.	L99UC018-CS-H
	Chang Shu Honglin Technology Co.,Ltd.	130-27309
		130-27363
Earphone	JIANGXI LIANCHUANG HONGSHENG ELECTRONIC CO., LTD	MEMD1632B729000
	BOLUO COUNTY QUANCHENG ELECTRONIC CO., LTD	MEND1632B729001
		1311-3301-6001-TC-296
	Goer Tek Inc	1311-3301-6001-TC-305
	WINDY-C	
Adapter	MERRY ELECTRONICS (SHENZHEN) CO., LTD.	L99EP003-CS-H
	DONGGUAN PHITEK ELECTRONICS CO.,LTD.	HW-050450E00 (EU) HW-050450U00 (US) HW-050450B00 (UK)
	SHENZHEN HUNTKEY ELECTRONIC CO.,LTD.	
	Salcomp (Shenzhen)Co.,Ltd	
	HUAWEI Technologies Co., Ltd.	HW-050450A00 (AU)
	DONGGUAN PHITEK ELECTRONICS CO.,LTD.	
	SHENZHEN HUNTKEY ELECTRONIC CO.,LTD.	
Salcomp (Shenzhen)Co.,Ltd		

3.2 DESCRIPTION OF TEST MODES AND TEST CONDITION

Following channel(s) was (were) selected for the final test as listed below:

LTE BAND 26					
Test Item	Available Channel	Tested Channel	Channel Bandwidth	Modulation	Mode
ERP	26797 to 27033	26797, 26915, 27033	1.4MHz	QPSK, 16QAM	1 RB / 5 RB Offset
	26805 to 27025	26805, 26915, 27025	3MHz	QPSK, 16QAM	1 RB / 14 RB Offset
	26815 to 27015	26815, 26915, 27015	5MHz	QPSK, 16QAM	1 RB / 24 RB Offset
	26840 to 26990	26840, 26915, 26990	10MHz	QPSK, 16QAM	1 RB / 49 RB Offset
	26865 to 26965	26865, 26915, 26965	15MHz	QPSK, 16QAM	1 RB / 49 RB Offset
Occupied Bandwidth	26797 to 27033	26797, 26915, 27033	1.4MHz	QPSK, 16QAM	1 RB / 0 RB Offset
	26805 to 27025	26805, 26915, 27025	3MHz	QPSK, 16QAM	15 RB / 0 RB Offset
	26815 to 27015	26815, 26915, 27015	5MHz	QPSK, 16QAM	25 RB / 0 RB Offset
	26840 to 26990	26840, 26915, 26990	10MHz	QPSK, 16QAM	50 RB / 0 RB Offset
	26865 to 26965	26865, 26915, 26965	15MHz	QPSK, 16QAM	75 RB / 0 RB Offset
Conducted Emission	26797 to 27033	26915	1.4MHz	QPSK	1 RB / 0 RB Offset
	26805 to 27025	26915	3MHz	QPSK	15 RB / 0 RB Offset
	26815 to 27015	26915	5MHz	QPSK	25 RB / 0 RB Offset
	26840 to 26990	26915	10MHz	QPSK	1 RB / 0 RB Offset
	26865 to 26965	26915	15MHz	QPSK	25 RB / 0 RB Offset
Radiated Emission	26797 to 27033	26797	1.4MHz	QPSK	1 RB / 5 RB Offset
	26865 to 26965	26865	15MHz	QPSK	1 RB / 0 RB Offset
Band Edge	26797 to 27033	26797	1.4MHz	QPSK	1 RB / 0 RB Offset
		27033	1.4MHz	QPSK	6 RB / 0 RB Offset
	26805 to 27025	26805	3MHz	QPSK	1 RB / 5 RB Offset
		27025	3MHz	QPSK	1 RB / 0 RB Offset
	26815 to 27015	26815	5MHz	QPSK	15 RB / 0 RB Offset
		27015	5MHz	QPSK	1 RB / 14 RB Offset
	26840 to 26990	26840	10MHz	QPSK	15 RB / 0 RB Offset
		26990	10MHz	QPSK	1 RB / 0 RB Offset
	26865 to 26965	26865	15MHz	QPSK	25 RB / 0 RB Offset
		26965	15MHz	QPSK	1 RB / 24 RB Offset
	26797 to 27033	26797	1.4MHz	QPSK	25 RB / 0 RB Offset
		27033	1.4MHz	QPSK	1 RB / 0 RB Offset
	26805 to 27025	26805	3MHz	QPSK	1 RB / 5 RB Offset
		27025	3MHz	QPSK	15 RB / 0 RB Offset
26815 to 27015	26815	5MHz	QPSK	1 RB / 14 RB Offset	
	27015	5MHz	QPSK	15 RB / 0 RB Offset	
26840 to 26990	26840	10MHz	QPSK	1 RB / 0 RB Offset	
	26990	10MHz	QPSK	50 RB / 0 RB Offset	
26865 to 26965	26865	15MHz	QPSK	1 RB / 49 RB Offset	
	26965	15MHz	QPSK	50 RB / 0 RB Offset	
26797 to 27033	26797	1.4MHz	QPSK	1 RB / 0 RB Offset	
	27033	1.4MHz	QPSK	75 RB / 0 RB Offset	
26805 to 27025	26805	3MHz	QPSK	1 RB / 74 RB Offset	
	27025	3MHz	QPSK	75 RB / 0 RB Offset	
26815 to 27015	26815	5MHz	QPSK	1 RB / 0 RB Offset	
	27015	5MHz	QPSK	1 RB / 0 RB Offset	
26840 to 26990	26840	10MHz	QPSK	1 RB / 0 RB Offset	
	26990	10MHz	QPSK	1 RB / 0 RB Offset	
26865 to 26965	26865	15MHz	QPSK	1 RB / 0 RB Offset	
	26965	15MHz	QPSK	1 RB / 0 RB Offset	

Peak To Average Ratio	26797 to 27033	26797, 26915, 27033	1.4MHz	QPSK, 16QAM	1 RB / 0 RB Offset
	26805 to 27025	26805, 26915, 27025	3MHz	QPSK, 16QAM	15 RB / 0 RB Offset
	26815 to 27015	26815, 26915, 27015	5MHz	QPSK, 16QAM	25 RB / 0 RB Offset
	26840 to 26990	26840, 26915, 26990	10MHz	QPSK, 16QAM	50 RB / 0 RB Offset
	26865 to 26965	26865, 26915, 26965	15MHz	QPSK, 16QAM	75 RB / 0 RB Offset
Frequency Stability	26797 to 27033	26915	1.4MHz	QPSK	1 RB / 5 RB Offset
	26805 to 27025	26915	3MHz	QPSK	1 RB / 14 RB Offset
	26815 to 27015	26915	5MHz	QPSK	1 RB / 24 RB Offset
	26840 to 26990	26915	10MHz	QPSK	1 RB / 49 RB Offset
	26865 to 26965	26915	15MHz	QPSK	1 RB / 49 RB Offset

EUT TEST CONDITIONS:

Test Item	Environmental Conditions	Test Voltage
ERP	25°C, 60%RH	DC 3.82V
Conducted Output Power	25°C, 65%RH	DC 3.82V
Occupied Bandwidth	25°C, 65%RH	DC 3.82V
Conducted Emission	25°C, 65%RH	DC 3.82V
Radiated Emission	25°C, 60%RH	AC 120V/60Hz
Band Edge	25°C, 65%RH	DC 3.82V
Peak to Average Ratio	25°C, 65%RH	DC 3.82V
Frequency Stability	25°C, 65%RH	DC 3.82V

3.3 BLOCK DIGRAM SHOWING THE CONFIGURATION OF SYSTEM TESTED FOR RADIATED

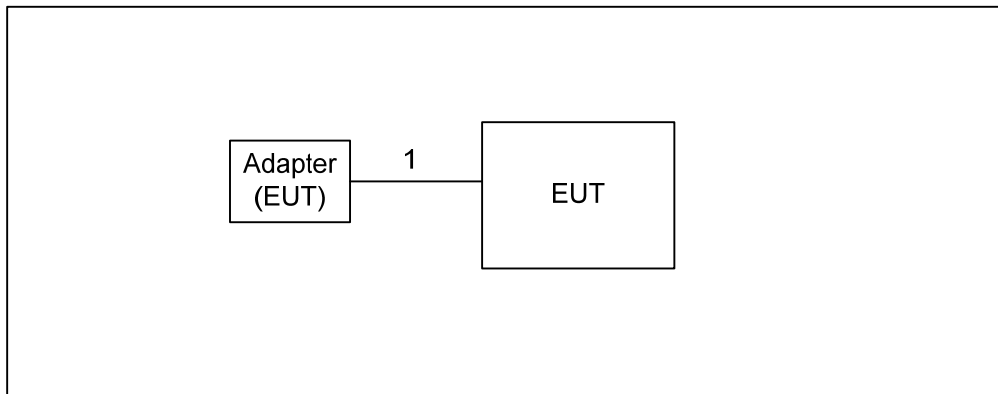

3.4 DESCRIPTION OF SUPPORT UNITS

The EUT has been tested as an independent unit together with other necessary accessories or support units. The following support units or accessories were used to form a representative test configuration during the tests.

Item	Equipment	Mfr/Brand	Model/Type No.	FCC ID	Series No.
-	-	-	-	-	-

Item	Shielded Type	Ferrite Core	Length	Note
1	NO	NO	1.5m	USB cable

4. TEST RESULT

4.1 OUTPUT POWER MEASUREMENT

4.1.1 LIMIT

Mobile / Portable station are limited to 7 watts e.r.p.

4.1.2 TEST PROCEDURE

EIRP/ERP:

1. EIRP= Conducted Power +Antenan gain
ERP power=EIPR power-2.15dBi.

Conducted Power:

The EUT was set up for the maximum power with GSM, GPRS, EDGE, WCDMA and LTE link data modulation and link up with simulator. Set the EUT to transmit under low, middle and high channel and record the power level shown on simulator.

4.1.3 TESTSETUP LAYOUT

Conducted Power Measurement

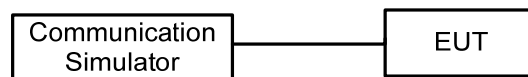

4.1.4 TEST DEVIATION

No deviation

4.1.5 TEST RESULTS

Please refer to the Appendix A.

4.2 OCCUPIED BANDWIDTH MEASUREMENT

4.2.1 TEST PROCEDURE

The EUT makes a call to the communication simulator. All measurements were done at low, middle and high operational frequency range. The communication simulator station system controlled a EUT to export maximum output power under transmission mode and specific channel frequency. Use OBW measurement function of Spectrum analyzer to measure 99 % occupied bandwidth and 26dB bandwidth.

4.2.2 TEST SETUP LAYOUT

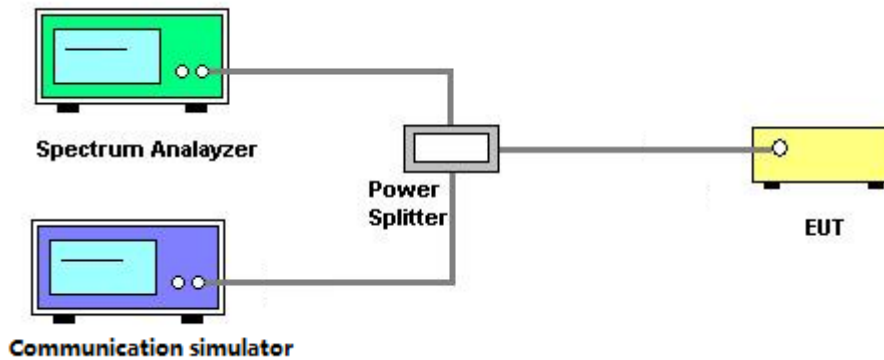

4.2.3 TEST DEVIATION

No deviation

4.2.4 TEST RESULTS

Please refer to the Appendix B.

4.3 CONDUCTED EMISSIONS MEASUREMENT

4.3.1 LIMIT

The power of any emission outside of the authorized operating frequency ranges must be attenuated below the transmitting power (P) by a factor of at least $43 + 10 \log(P)$ dB. The emission limit equal to -13dBm .

4.3.2 TEST PROCEDURES

1. The testing follows FCC KDB 971168 v02r02 Section 6.0.
2. The EUT was connected to spectrum analyzer and system simulator via a power divider.
3. The band edges of low and high channels for the highest RF powers were measured. Set $\text{RBW} \geq 1\%$ EBW in the 1MHz band immediately outside and adjacent to the band edge.
4. Set spectrum analyzer with RMS detector.
5. The RF fundamental frequency should be excluded against the limit line in the operating frequency band.
6. The limit line is derived from $43+10\log(P)\text{dB}$ below the transmitter power P(Watts)

$$= P(W) - [43 + 10\log(P)](\text{dB})$$

$$= [30 + 10\log(P)](\text{dBm}) - [43 + 10\log(P)](\text{dB})$$

$$= -13\text{dBm}$$

4.3.3 TESTSETUP LAYOUT

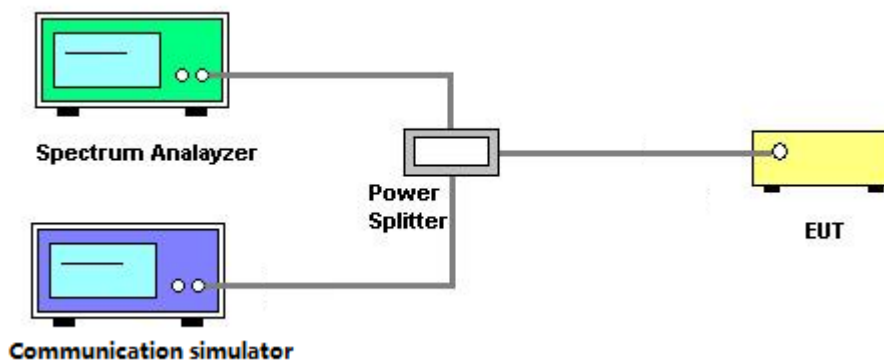

4.3.4 TESTDEVIATION

No deviation

4.3.5 TEST RESULTS

Please refer to the Appendix C.

4.4 RADIATED EMISSIONS MEASUREMENT

4.4.1 LIMIT

The power of any emission outside of the authorized operating frequency ranges must be attenuated below the transmitting power (P) by a factor of at least $43 + 10 \log(P)$ dB. The emission limit equal to -13dBm.

4.4.2 TEST PROCEDURES

1. In the semi-anechoic chamber, EUT placed on the 0.8m height of Turn Table, rotated the table around 360 degrees to search the maximum radiation power and receiver antenna shall be rotated vertical and horizontal polarization and moved height from 1m to 4m to find the maximum polar radiated power. The "Read Value" is the spectrum reading the maximum power value.
2. The substitution horn antenna is substituted for EUT at the same position and signals generator export the CW signal to the substitution antenna via a TX cable. Rotated the Turn Table and moved receiving antenna to find the maximum radiation power. Adjust output power level of S.G to get a Value of spectrum reading equal to "Read Value " of step a. Record the power level of S.G
3. EIRP = Output power level of S.G – TX cable loss + Antenna gain of substitution horn.
4. E.R.P power can be calculated form E.I.R.P power by subtracting the gain of dipole, E.R.P power = E.I.P.R power - 2.15dBi.
5. The resolution bandwidth and video bandwidth of test receiver/spectrum analyzer is 1MHz/3MHz.

4.4.3 TESTSETUP LAYOUT
Below 1G

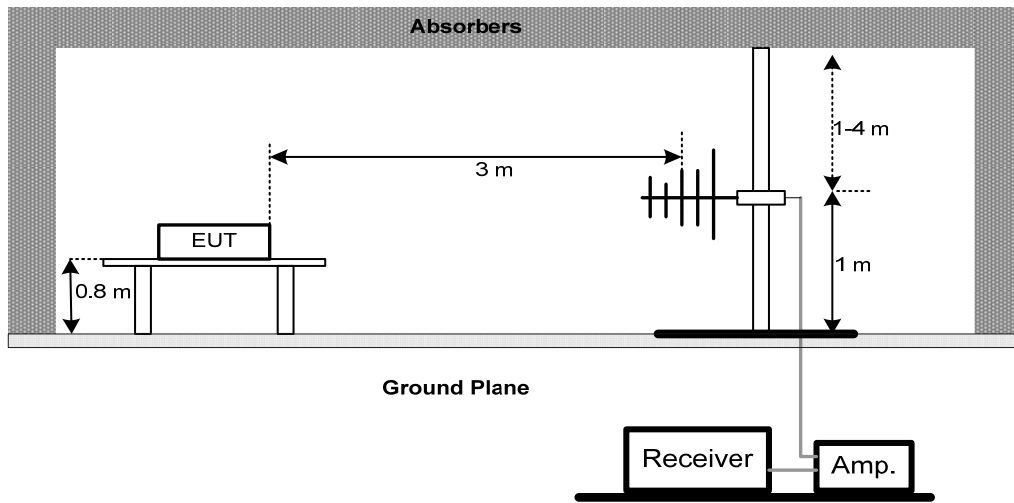

Above 1G

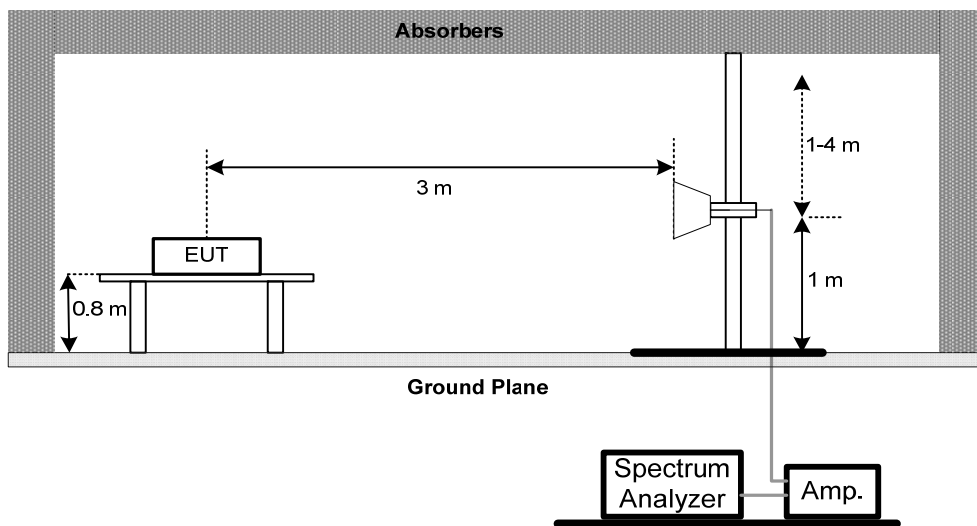

4.4.4 TESTDEVIATION

No deviation

4.4.5 TEST RESULTS

Please refer to the Appendix D.

4.5 BAND EDGE MEASUREMENT

4.5.1 LIMIT

A Power of any emission outside of the authorized operating frequency ranges must be attenuated below the transmitting power (P) by a factor of at least $43 + 10 \log(P)$ dB. In the 1 MHz bands immediately outside and adjacent to the frequency block a resolution bandwidth of at least one percent of the emission bandwidth of the fundamental emission of the transmitter may be employed.

4.5.2 TEST PROCEDURES

1. All measurements were done at low and high operational frequency range.
2. The center frequency of spectrum is the band edge frequency and span is 1MHz. RB of the spectrum is 3kHz and VB of the spectrum is 10kHz (GSM/GPRS/EDGE).
3. The center frequency of spectrum is the band edge frequency and span is 5MHz. RB of the spectrum is 100kHz and VB of the spectrum is 300kHz (WCDMA).
4. The center frequency of spectrum is the band edge frequency and span is 1MHz. RB of the spectrum is 13kHz and VB of the spectrum is 51kHz (LTE Bandwidth 1.4MHz).
5. The center frequency of spectrum is the band edge frequency and span is 1MHz. RB of the spectrum is 30kHz and VB of the spectrum is 100kHz (LTE Bandwidth 3MHz).
6. The center frequency of spectrum is the band edge frequency and span is 1MHz. RB of the spectrum is 100kHz and VB of the spectrum is 300kHz (LTE Bandwidth 5MHz/10MHz).
7. Record the max trace plot into the test report.

4.5.3 TESTSETUP LAYOUT

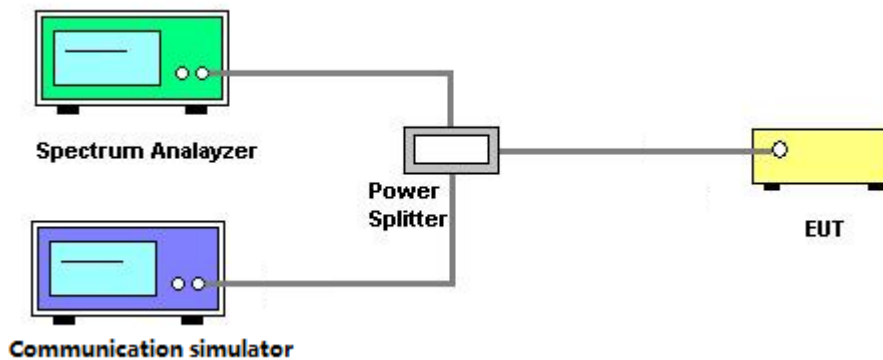

4.5.4 TESTDEVIATION

No deviation

4.5.5 TEST RESULTS

Please refer to the Appendix E.

4.6 PEAK TO AVERAGE RATIO MEASUREMENT

4.6.1 LIMIT

In measuring transmissions in this band using an average power technique, the peak to-average ratio (PAR) of the transmission may not exceed 13 dB.

4.6.2 TEST PROCEDURES

1. Set resolution/measurement bandwidth \geq signal's occupied bandwidth;
2. Set the number of counts to a value that stabilizes the measured CCDF curve;
3. Record the maximum PAPR level associated with a probability of 0.1%.

4.6.3 TESTSETUP LAYOUT

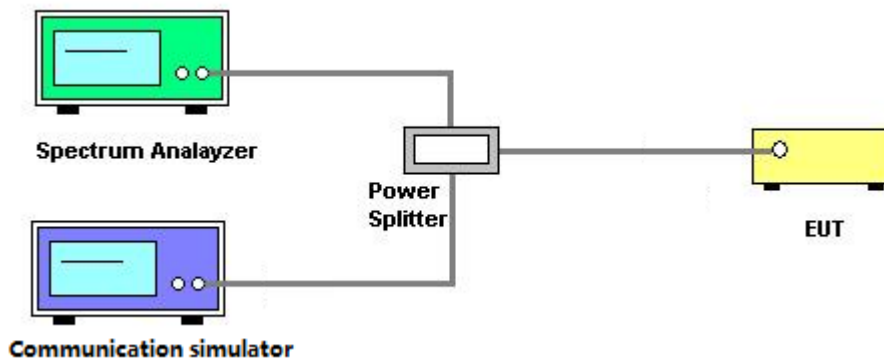

4.6.4 TESTDEVIATION

No deviation

4.6.5 TEST RESULTS

Please refer to the Appendix F.

4.7 FREQUENCY STABILITY MEASUREMENT

4.7.1 LIMIT

1.5 ppm is for base and fixed station. 2.5 ppm is for mobile station.

4.7.2 TEST PROCEDURES

1. Device is placed at the oven room. The oven room could control the temperatures and humidity. Power warm up is at least 15 min and power applied should perform before recording frequency error.
2. EUT is connected the external power supply to control the DC input power. The test voltage range is from minimum to maximum working voltage. Each step shall be record the frequency error rate.
3. The temperature range step is 10 degrees in this test items. All temperature levels shall be hold the $\pm 0.5^{\circ}\text{C}$ during the measurement testing. The each temperature step shall be at least 0.5 hours, consider the EUT could be test under the stability condition.
4. The frequency error was recorded frequency error from the communication simulator.

4.7.3 TESTSETUP LAYOUT

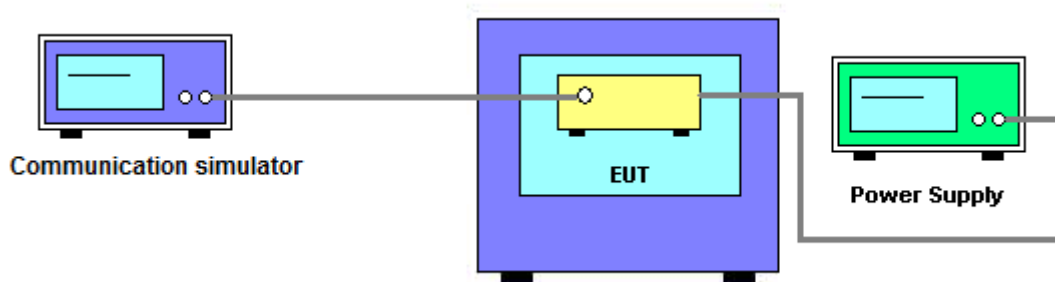

4.7.4 TESTDEVIATION

No deviation

4.7.5 TEST RESULTS

Please refer to the Appendix G.

5. LIST OF MEASUREMENT EQUIPMENTS

Radiated Emission Measurement					
Item	Kind of Equipment	Manufacturer	Type No.	Serial No.	Calibrated until
1	Antenna	Schwarbeck	VULB9160	9160-3232	Mar. 26, 2018
2	Double Ridged Guide Antenna	ETS	3115	75789	Mar. 26, 2018
3	Broad-Band Horn Antenna	Schwarzbeck	BBHA 9170	9170319	Jun. 08, 2018
4	Amplifier	Agilent	8449B	3008A02274	May. 16, 2018
5	Amplifier	HP	8447D	2944A09673	Oct. 20, 2017
6	HighPass Filter	Wairwright Instruments Gmbh	WHK 1.5/15G-10ST	11	Feb. 20, 2018
7	Band Reject Filter	Wairwright Instruments Gmbh	WRCG 1710/1785-1690/180 5-60/12SS	38	Feb. 15, 2018
8	Band Reject Filter	Wairwright Instruments Gmbh	WRCG 824/849-810/863-60/ 9SS	7	Feb. 15, 2018
9	Band Reject Filter	Wairwright Instruments Gmbh	WRCG 880/915-860/935-60/ 9SS	14	Feb. 15, 2018
10	Band Reject Filter	Wairwright Instruments Gmbh	WRCG 1850/1910-1830/193 0-60/10SS	17	Feb. 15, 2018
11	HighPass Filter	Wairwright Instruments Gmbh	WHK3.1/18G-10SS	24	Feb. 20, 2018
12	Wireless Communication Test SET	Agilent	E5515C	MY48364183	Mar. 26, 2018
13	Microwave Preamplifier With Adaptor	EMC INSTRUMENT	EMC2654045	980039 & HA01	Mar. 26, 2018
14	Receiver	Agilent	N9038A	MY52130039	Aug. 20, 2018
15	wideband radio communication tester	R&S	CMW500	152372	Mar. 26, 2018
16	High pass filter	Chengdu kangmaiwei	ZHPF-M3-12.75G-38 69	B201507376 3	Aug. 04, 2018
17	High pass filter	Chengdu kangmaiwei	ZHPF-M1000-4000- 1	B201507376 2	Aug. 04, 2018
18	High pass filter	Chengdu kangmaiwei	ZHPF-M6-186-1727	B201507376 4	Aug. 04, 2018
19	Cable	emci	LMR-400(30MHz-1G Hz)(8m+5m)	N/A	Jun. 26, 2018
20	Cable	emci	EMC104-SM-SM-12 000(12m)	N/A	Jun. 26, 2018
21	Controller	ETS-Lindgren	2090	N/A	N/A
22	Measurement Software	Farad	EZ-EMC Ver.NB-03A1-01	N/A	N/A

Conducted Emission & Band Edge & Occupied Bandwidth Measurement					
Item	Kind of Equipment	Manufacturer	Type No.	Serial No.	Calibrated until
1	Wireless Communication Test SET	Agilent	E5515C	MY48364183	Mar. 26, 2018
2	EXA Spectrum Analyzer	Agilent	N9010A	MY50520044	Mar. 26, 2018
3	POWER SPLITTER	Mini-Circuits	ZFRSC-123-S+	331000910-1	May. 16, 2018
4	wideband radio communication tester	R&S	CMW500	152372	Mar. 26, 2018

Frequency Stability Measurement					
Item	Kind of Equipment	Manufacturer	Type No.	Serial No.	Calibrated until
1	Wireless Communication Test SET	Agilent	E5515C	MY48364183	Mar. 26, 2018
2	Multi-output DC Power Supply	GW Instek	GPC-3030DN	EK880675	Oct. 13, 2017
3	POWER SPLITTER	Mini-Circuits	ZFRSC-123-S+	331000910-1	May. 16, 2018
4	wideband radio communication tester	R&S	CMW500	152372	Mar. 26, 2018
5	Const Temp, & Humidity Chamber	Bell	BTH-50C	20170306001	Mar. 26, 2018

Remark: "N/A" denotes no model name, serial no. or calibration specified.
All calibration period of equipment list is one year.

APPENDIX A - OUTPUT POWER

Conducted Power:

LTE Band / BW	Modulation	RB Sizing	RB Offset	Low CH	Mid CH	High CH
				26797 CH	26915 CH	27033 CH
				824.7 MHz	836.5 MHz	848.3 MHz
26 / 1.4M	QPSK	1	0	23.13	23.17	23.15
		1	2	22.85	23.34	23.17
		1	5	23.04	23.23	23.08
		3	0	23.04	23.09	23.03
		3	1	23.48	22.37	22.97
		3	2	23.37	23.14	23.07
		6	0	22.46	22.19	22.02
	16QAM	1	0	22.45	22.25	22.39
		1	2	22.26	22.04	22.21
		1	5	22.44	22.29	22.39
		3	0	22.15	22.21	22.23
		3	1	22.04	21.97	22.06
		3	2	22.16	21.83	21.83
		6	0	21.14	21.12	21.12

LTE Band / BW	Modulation	RB Sizing	RB Offset	Low CH	Mid CH	High CH
				26805 CH	26915 CH	27025 CH
				825.5 MHz	836.5 MHz	847.5 MHz
26 / 3M	QPSK	1	0	23.05	23.12	23.16
		1	7	22.64	22.91	22.61
		1	14	23.16	23.11	23.04
		8	0	22.16	22.08	22.07
		8	4	22.03	22.11	22.08
		8	7	22.05	21.98	22.04
		15	0	22.15	22.18	22.06
	16QAM	1	0	22.56	22.51	22.43
		1	7	22.05	22.46	22.15
		1	14	22.55	22.52	22.41
		8	0	21.19	21.05	21.06
		8	4	21.04	21.12	21.01
		8	7	21.13	21.01	21.17
		15	0	21.16	21.11	21.02

LTE Band / BW	Modulation	RB Sizing	RB Offset	Low CH	Mid CH	High CH
				26815 CH	26915 CH	27015 CH
				826.5 MHz	836.5 MHz	846.5 MHz
26 / 5M	QPSK	1	0	23.19	23.17	23.00
		1	13	23.09	23.22	23.13
		1	24	23.16	23.15	23.07
		12	0	22.25	22.19	22.22
		12	6	22.22	22.18	22.23
		12	11	22.21	22.10	22.15
	16QAM	25	0	22.23	22.14	22.15
		1	0	22.49	22.27	22.35
		1	13	22.55	22.32	22.42
		1	24	22.46	22.23	22.39
		12	0	21.23	21.17	21.18
		12	6	21.16	21.12	21.13
		12	11	21.17	21.13	21.15
		25	0	21.15	21.07	21.13

LTE Band / BW	Modulation	RB Sizing	RB Offset	Low CH	Mid CH	High CH
				26840 CH	26915 CH	26990 CH
				829.0 MHz	836.5 MHz	844.0 MHz
26 / 10M	QPSK	1	0	23.11	23.07	23.20
		1	25	23.01	23.12	23.37
		1	49	23.17	23.19	23.25
		25	0	22.30	22.25	22.21
		25	13	22.18	22.14	22.16
		25	25	22.25	22.21	22.16
	16QAM	50	0	22.26	22.19	22.22
		1	0	22.47	22.66	22.46
		1	25	22.59	22.31	22.12
		1	49	22.51	22.08	22.41
		25	0	21.22	21.22	21.10
		25	13	21.14	21.13	21.12
		25	25	21.16	21.17	21.13
		50	0	21.13	21.11	21.15

LTE Band / BW	Modulation	RB Sizing	RB Offset	Low CH	Mid CH	High CH
				26865 CH	26915 CH	26965 CH
				831.5 MHz	836.5 MHz	841.5 MHz
26 / 15M	QPSK	1	0	23.25	23.21	23.13
		1	38	23.22	23.21	23.14
		1	74	23.08	23.20	23.01
		36	0	22.25	22.23	22.27
		36	18	22.26	22.19	22.20
		36	39	22.21	22.24	22.25
		75	0	22.21	22.22	22.14
	16QAM	1	0	22.56	22.32	22.36
		1	38	22.56	22.47	22.43
		1	74	22.13	22.18	22.27
		36	0	21.18	21.21	21.13
		36	18	21.20	21.16	21.05
		36	39	21.18	21.15	21.13
		75	0	21.12	21.15	21.11

ERP Power:

LTE Band / BW	Modulation	RB Sizing	RB Offset	Low CH	Mid CH	High CH
				26797 CH	26915 CH	27033 CH
				824.7 MHz	836.5 MHz	848.3 MHz
26 / 1.4M	QPSK	1	0	18.91	18.95	18.93
		1	2	18.63	19.12	18.95
		1	5	18.82	19.01	18.86
		3	0	18.82	18.87	18.81
		3	1	19.26	18.15	18.75
		3	2	19.15	18.92	18.85
		6	0	18.24	17.97	17.80
	16QAM	1	0	18.23	18.03	18.17
		1	2	18.04	17.82	17.99
		1	5	18.22	18.07	18.17
		3	0	17.93	17.99	18.01
		3	1	17.82	17.75	17.84
		3	2	17.94	17.61	17.61
		6	0	16.92	16.90	16.90

LTE Band / BW	Modulation	RB Sizing	RB Offset	Low CH	Mid CH	High CH
				26805 CH	26915 CH	27025 CH
				825.5 MHz	836.5 MHz	847.5 MHz
26 / 3M	QPSK	1	0	18.83	18.90	18.94
		1	7	18.42	18.69	18.39
		1	14	18.94	18.89	18.82
		8	0	17.94	17.86	17.85
		8	4	17.81	17.89	17.86
		8	7	17.83	17.76	17.82
		15	0	17.93	17.96	17.84
	16QAM	1	0	18.34	18.29	18.21
		1	7	17.83	18.24	17.93
		1	14	18.33	18.30	18.19
		8	0	16.97	16.83	16.84
		8	4	16.82	16.90	16.79
		8	7	16.91	16.79	16.95
		15	0	16.94	16.89	16.80

LTE Band / BW	Modulation	RB Sizing	RB Offset	Low CH	Mid CH	High CH
				26815 CH	26915 CH	27015 CH
				826.5 MHz	836.5 MHz	846.5 MHz
26 / 5M	QPSK	1	0	18.97	18.95	18.78
		1	13	18.87	19.00	18.91
		1	24	18.94	18.93	18.85
		12	0	18.03	17.97	18.00
		12	6	18.00	17.96	18.01
		12	11	17.99	17.88	17.93
		25	0	18.01	17.92	17.93
	16QAM	1	0	18.27	18.05	18.13
		1	13	18.33	18.10	18.20
		1	24	18.24	18.01	18.17
		12	0	17.01	16.95	16.96
		12	6	16.94	16.90	16.91
		12	11	16.95	16.91	16.93
		25	0	16.93	16.85	16.91

LTE Band / BW	Modulation	RB Sizing	RB Offset	Low CH	Mid CH	High CH
				26840 CH	26915 CH	26990 CH
				829.0 MHz	836.5 MHz	844.0 MHz
26 / 10M	QPSK	1	0	18.89	18.85	18.98
		1	25	18.79	18.90	19.15
		1	49	18.95	18.97	19.03
		25	0	18.08	18.03	17.99
		25	13	17.96	17.92	17.94
		25	25	18.03	17.99	17.94
		50	0	18.04	17.97	18.00
	16QAM	1	0	18.25	18.44	18.24
		1	25	18.37	18.09	17.90
		1	49	18.29	17.86	18.19
		25	0	17.00	17.00	16.88
		25	13	16.92	16.91	16.90
		25	25	16.94	16.95	16.91
		50	0	16.91	16.89	16.93

LTE Band / BW	Modulation	RB Sizing	RB Offset	Low CH	Mid CH	High CH
				26865 CH	26915 CH	26965 CH
				831.5 MHz	836.5 MHz	841.5 MHz
26 / 15M	QPSK	1	0	19.03	18.99	18.91
		1	38	19.00	18.99	18.92
		1	74	18.86	18.98	18.79
		36	0	18.03	18.01	18.05
		36	18	18.04	17.97	17.98
		36	39	17.99	18.02	18.03
		75	0	17.99	18.00	17.92
	16QAM	1	0	18.34	18.10	18.14
		1	38	18.34	18.25	18.21
		1	74	17.91	17.96	18.05
		36	0	16.96	16.99	16.91
		36	18	16.98	16.94	16.83
		36	39	16.96	16.93	16.91
		75	0	16.90	16.93	16.89

APPENDIX B - OCCUPIED BANDWIDTH

LTE Band 26_1.4M					
QPSK			16QAM		
Channel	Frequency (MHz)	99% Occupied Bandwidth (MHz)	Channel	Frequency (MHz)	99% Occupied Bandwidth (MHz)
26797	824.7	1.0946	26797	824.7	1.0941
26915	836.5	1.0873	26915	836.5	1.0920
27033	848.3	1.0892	27033	848.3	1.0918
Channel	Frequency (MHz)	26dB Bandwidth (MHz)	Channel	Frequency (MHz)	26dB Bandwidth (MHz)
26797	824.7	1.234	26797	824.7	1.234
26915	836.5	1.220	26915	836.5	1.236
27033	848.3	1.232	27033	848.3	1.226

Spectrum Plot

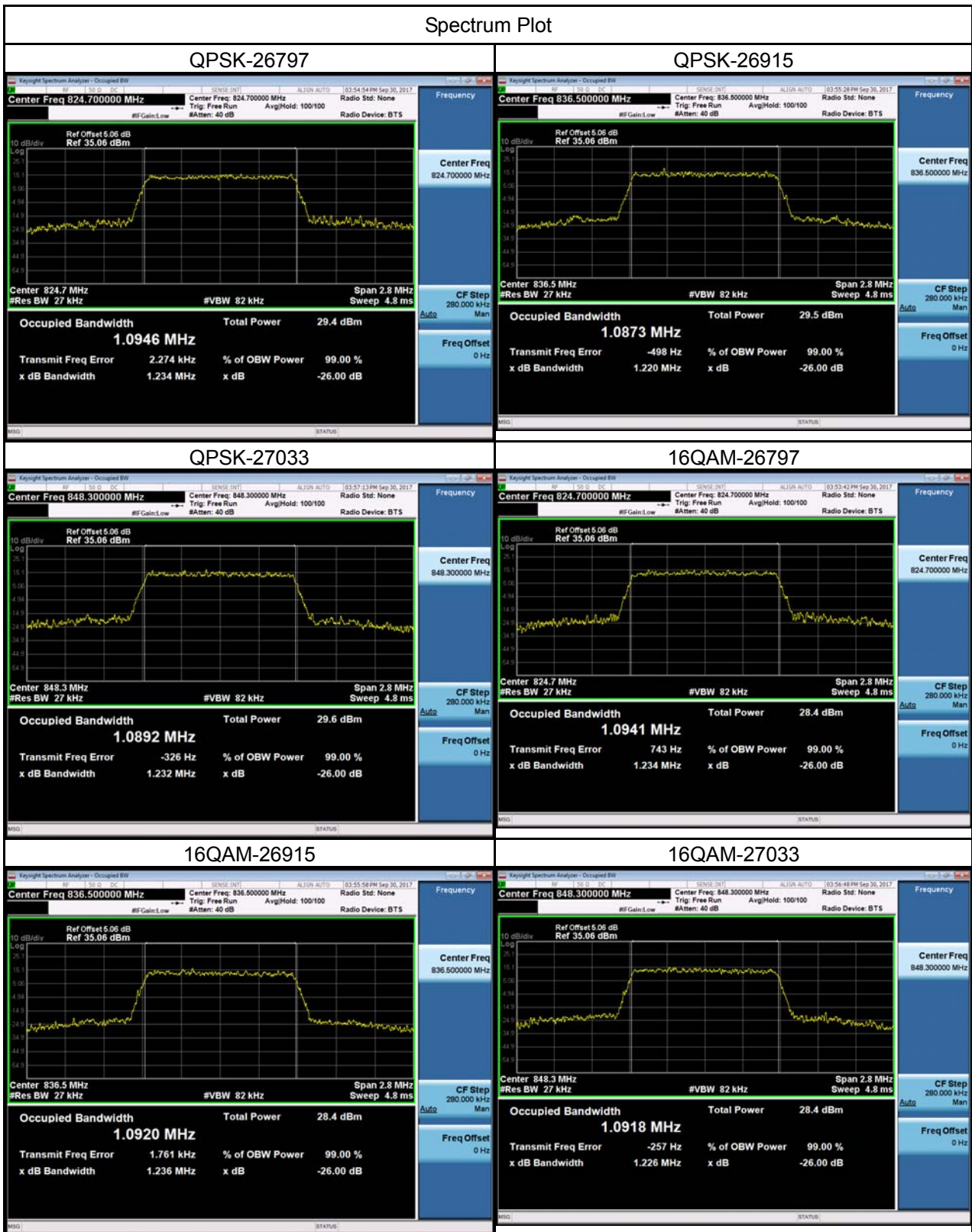

LTE Band 26_3M					
QPSK			16QAM		
Channel	Frequency (MHz)	99% Occupied Bandwidth (MHz)	Channel	Frequency (MHz)	99% Occupied Bandwidth (MHz)
26805	825.5	2.6930	26805	825.5	2.6829
26915	836.5	2.6966	26915	836.5	2.6997
27025	847.5	2.6972	27025	847.5	2.6871
Channel	Frequency (MHz)	26dB Bandwidth (MHz)	Channel	Frequency (MHz)	26dB Bandwidth (MHz)
26805	825.5	2.969	26805	825.5	2.950
26915	836.5	2.978	26915	836.5	2.940
27025	847.5	2.965	27025	847.5	2.934

Spectrum Plot

QPSK-26805

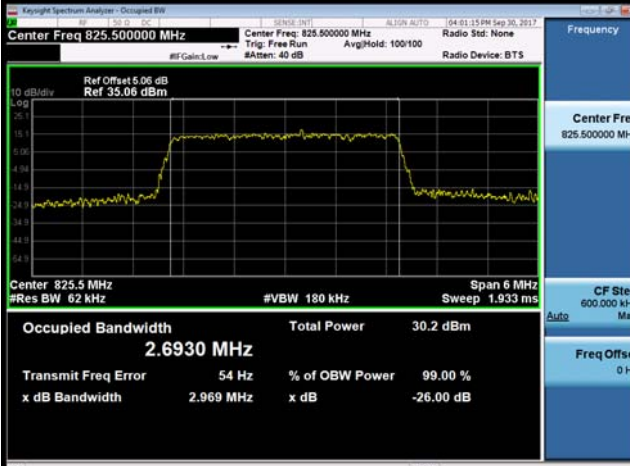

QPSK-26915



QPSK-27025



16QAM-26805



16QAM-26915

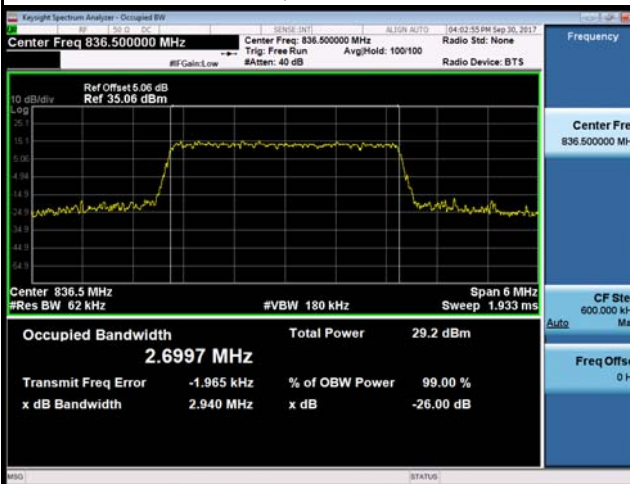

16QAM-27025

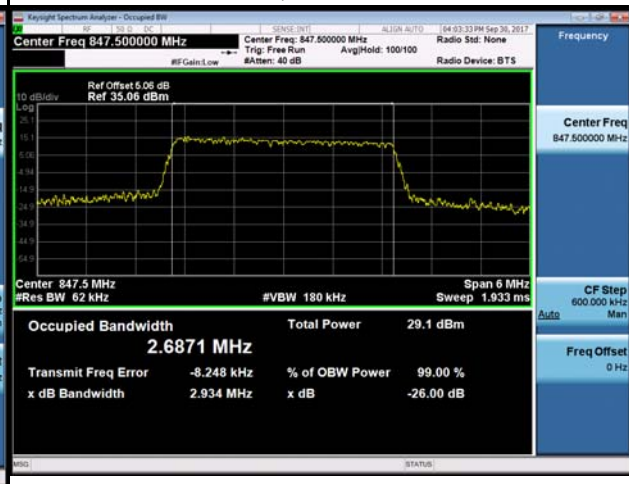

LTE Band 26_5M					
QPSK			16QAM		
Channel	Frequency (MHz)	99% Occupied Bandwidth (MHz)	Channel	Frequency (MHz)	99% Occupied Bandwidth (MHz)
26815	826.5	4.5225	26815	826.5	4.4975
26915	836.5	4.5072	26915	836.5	4.5210
27015	846.5	4.5062	27015	846.5	4.4928
Channel	Frequency (MHz)	26dB Bandwidth (MHz)	Channel	Frequency (MHz)	26dB Bandwidth (MHz)
26815	826.5	4.921	26815	826.5	4.930
26915	836.5	4.943	26915	836.5	4.945
27015	846.5	4.921	27015	846.5	4.935

Spectrum Plot

QPSK-26815

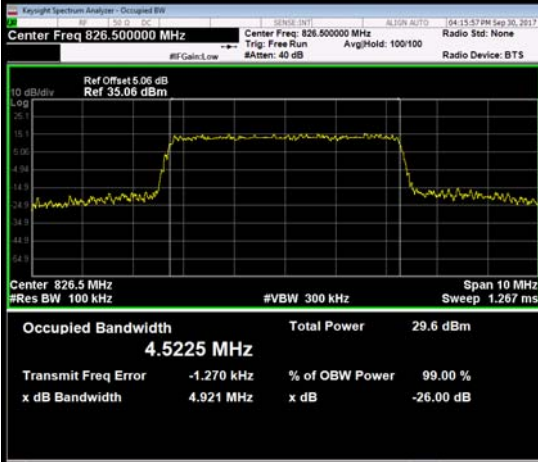

QPSK-26915

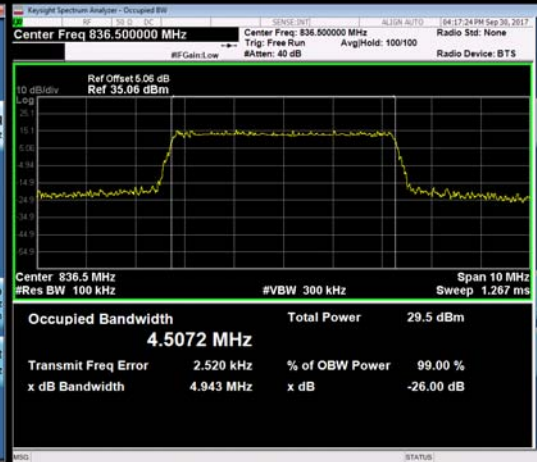

QPSK-27015

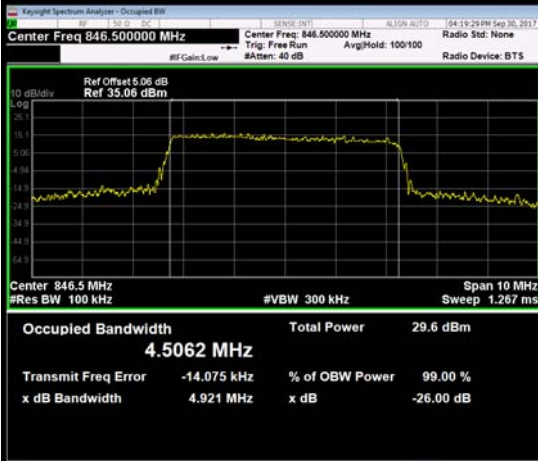

16QAM-26815

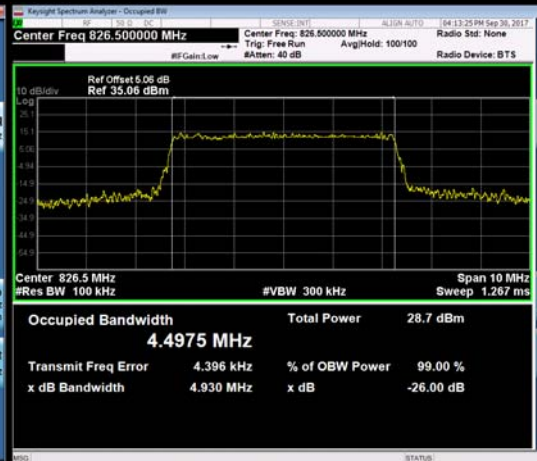

16QAM-26915

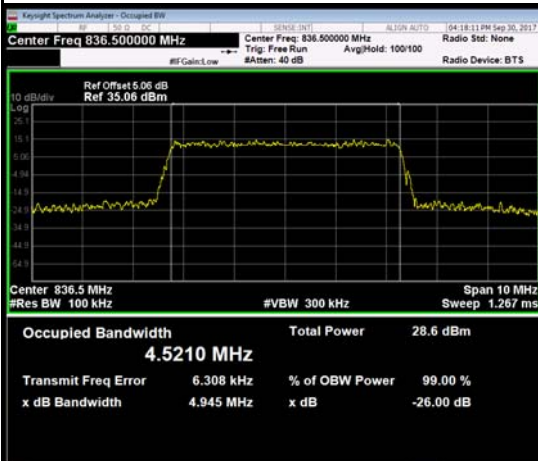

16QAM-27015

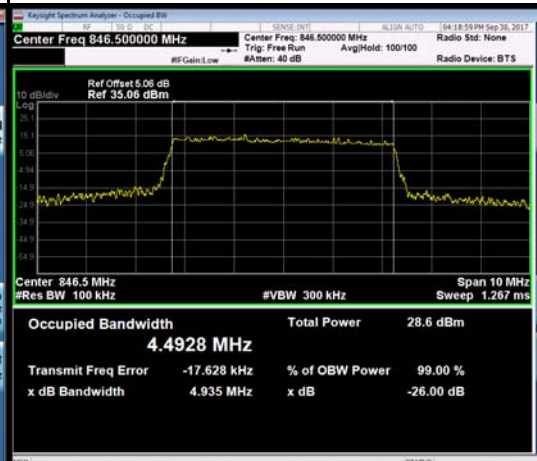

LTE Band 26_10M					
QPSK			16QAM		
Channel	Frequency (MHz)	99% Occupied Bandwidth (MHz)	Channel	Frequency (MHz)	99% Occupied Bandwidth (MHz)
26840	829.0	8.9380	26840	829.0	8.9768
26915	836.5	9.0327	26915	836.5	9.0416
26990	844.0	8.9387	26990	844.0	8.9503
Channel	Frequency (MHz)	26dB Bandwidth (MHz)	Channel	Frequency (MHz)	26dB Bandwidth (MHz)
26840	829.0	9.633	26840	829.0	9.580
26915	836.5	9.720	26915	836.5	9.813
26990	844.0	9.694	26990	844.0	9.685

Spectrum Plot

QPSK-26840

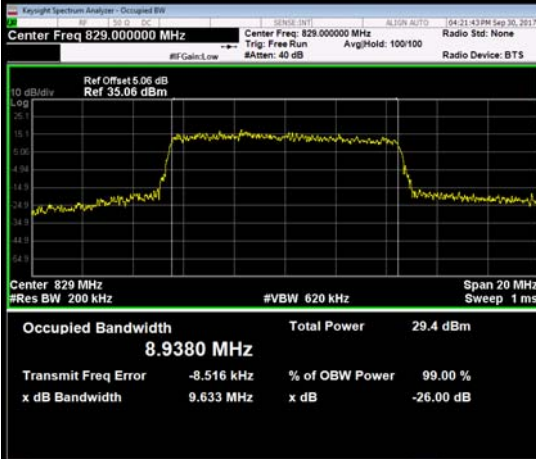

QPSK-26915

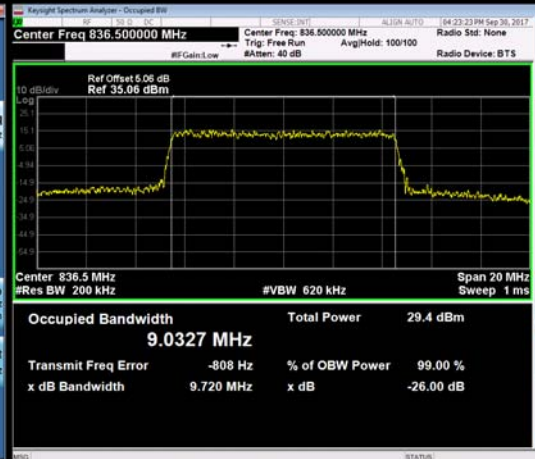

QPSK-26990

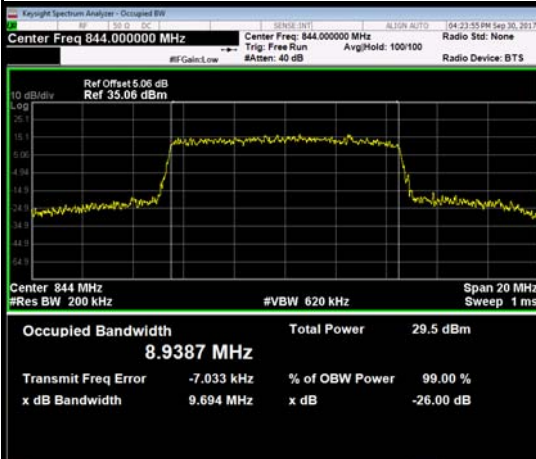

16QAM-26840

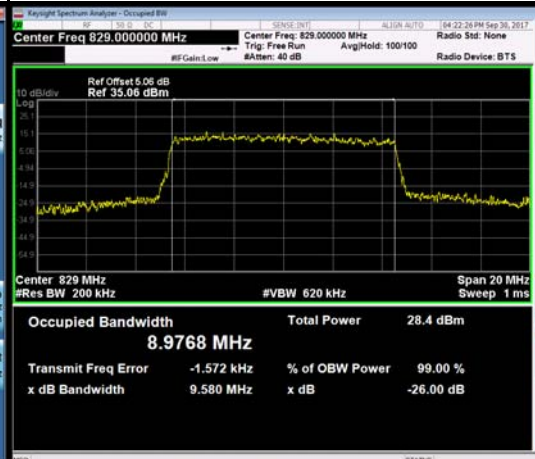

16QAM-26915

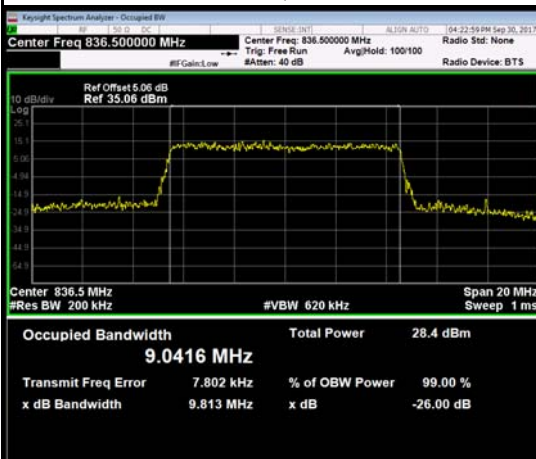

16QAM-26990

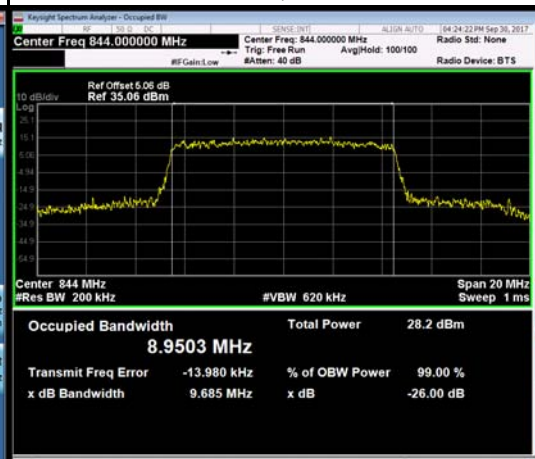

LTE Band 26_15M					
QPSK			16QAM		
Channel	Frequency (MHz)	99% Occupied Bandwidth (MHz)	Channel	Frequency (MHz)	99% Occupied Bandwidth (MHz)
26865	831.5	13.445	26865	831.5	13.482
26915	836.5	13.574	26915	836.5	13.575
26965	841.5	13.574	26965	841.5	13.465
Channel	Frequency (MHz)	26dB Bandwidth (MHz)	Channel	Frequency (MHz)	26dB Bandwidth (MHz)
26865	831.5	14.69	26865	831.5	16.40
26915	836.5	15.01	26915	836.5	14.76
26965	841.5	15.01	26965	841.5	14.42

Spectrum Plot

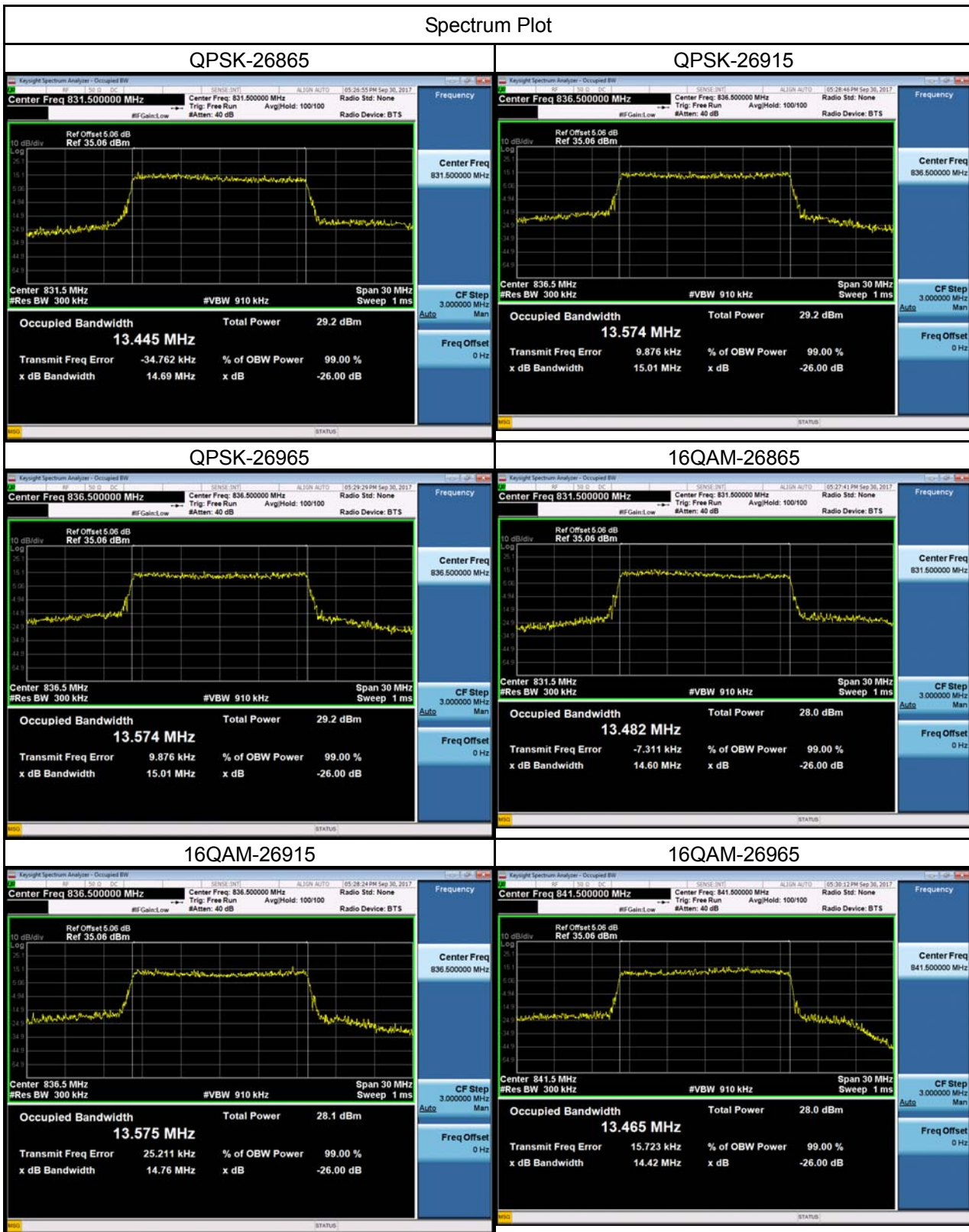

APPENDIX C - CONDUCTED EMISSIONS

LTE Band 26_1.4M

Channel	Frequency(MHz)	Channel	Frequency(MHz)
26915	836.5	26915	836.5
Channel	Frequency(MHz)	-	-
26915	836.5	-	-

LTE Band 26_3M

Channel	Frequency(MHz)	Channel	Frequency(MHz)
26915	836.5	26915	836.5
Channel	Frequency(MHz)	-	-
26915	836.5	-	-

LTE Band 26_5M

Channel	Frequency(MHz)	Channel	Frequency(MHz)
26915	836.5	26915	836.5
Channel	Frequency(MHz)	-	-
26915	836.5	-	-

LTE Band 26_10M

Channel	Frequency(MHz)	Channel	Frequency(MHz)
26915	836.5	26915	836.5
Channel	Frequency(MHz)	-	-
26915	836.5	-	-

LTE Band 26_15M

Channel	Frequency(MHz)	Channel	Frequency(MHz)
26915	836.5	26915	836.5
Channel	Frequency(MHz)	-	-
26915	836.5	-	-

APPENDIX D - RADIATED EMISSION

Test Mode: TX Mode (Adapter: PHITEK)

Ant 0°

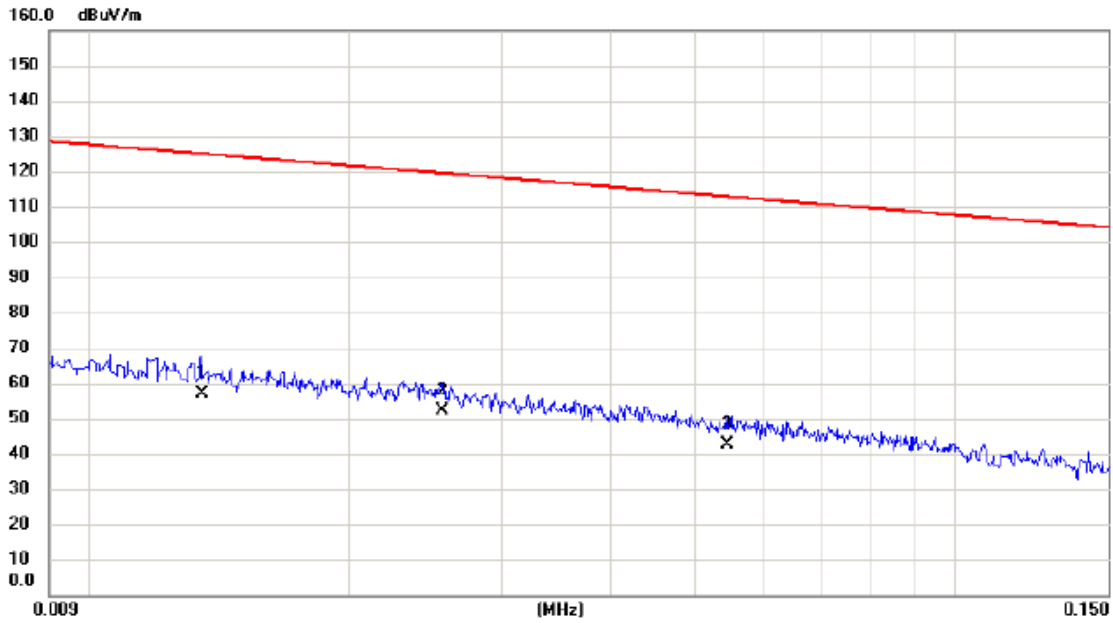

No.	Mk.	Freq. MHz	Reading Level dBuV	Correct Factor dB	Measure- ment dBuV/m	Limit dBuV/m	Margin dB	Detector	Comment
1		0.0135	36.48	20.47	56.95	125.00	-68.05	AVG	
2	*	0.0256	32.63	19.45	52.08	119.44	-67.36	AVG	
3		0.0545	23.94	18.63	42.57	112.88	-70.31	AVG	

Test Mode: TX Mode (Adapter: PHITEK)

Ant 0°

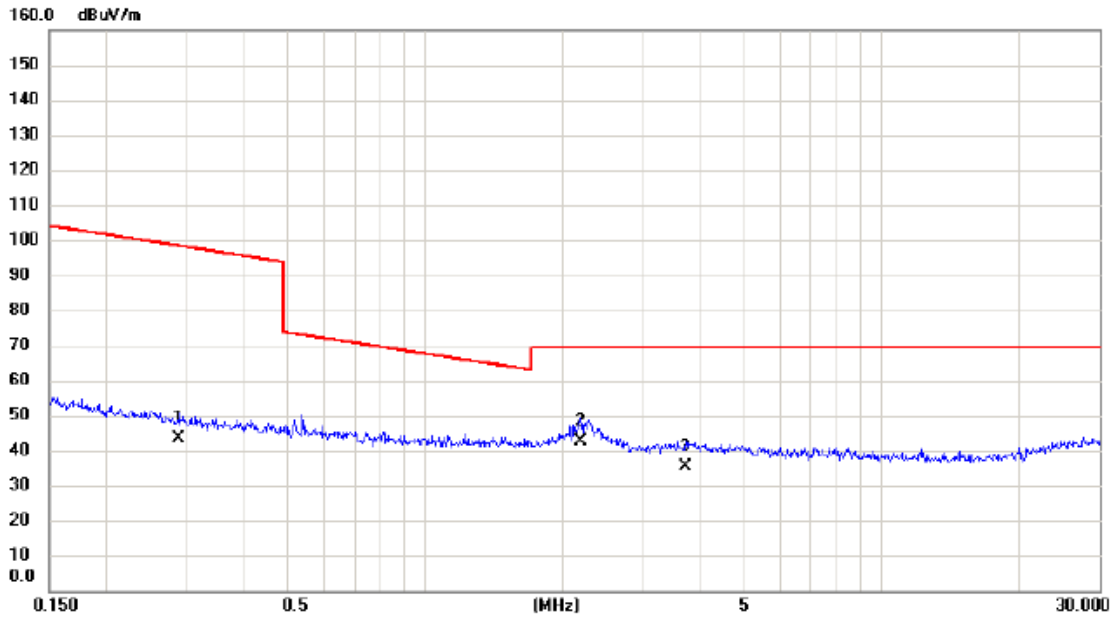

No.	Mk.	Freq. MHz	Reading Level dBuV	Correct Factor dB	Measure- ment dBuV/m	Limit dBuV/m	Margin dB	Detector	Comment
1		0.2893	26.58	16.63	43.21	98.38	-55.17	AVG	
2	*	2.1898	27.18	15.45	42.63	69.54	-26.91	QP	
3		3.7198	20.49	15.02	35.51	69.54	-34.03	QP	

Test Mode: TX Mode (Adapter: PHITEK)

Ant 90°

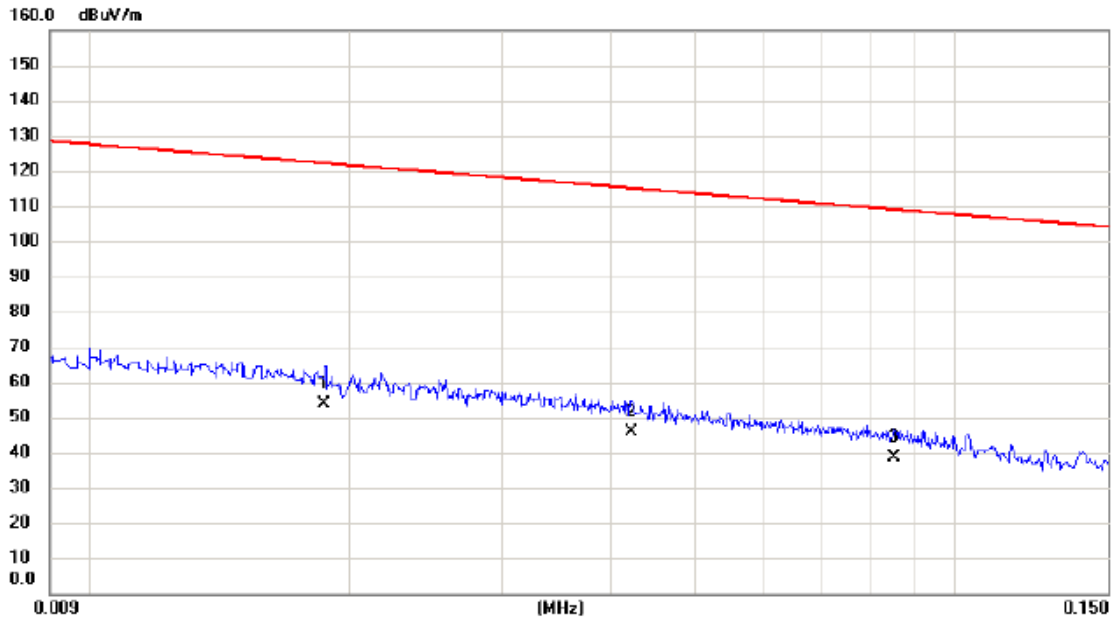

No.	Mk.	Freq.	Reading Level	Correct Factor	Measurement	Limit	Margin	Detector	Comment
		MHz	dBuV	dB	dBuV/m	dBuV/m	dB		
1	*	0.0187	34.06	19.79	53.85	122.17	-68.32	AVG	
2		0.0423	26.75	18.95	45.70	115.08	-69.38	AVG	
3		0.0851	20.49	17.99	38.48	109.01	-70.53	AVG	

Test Mode: TX Mode (Adapter: PHITEK)

Ant 90°

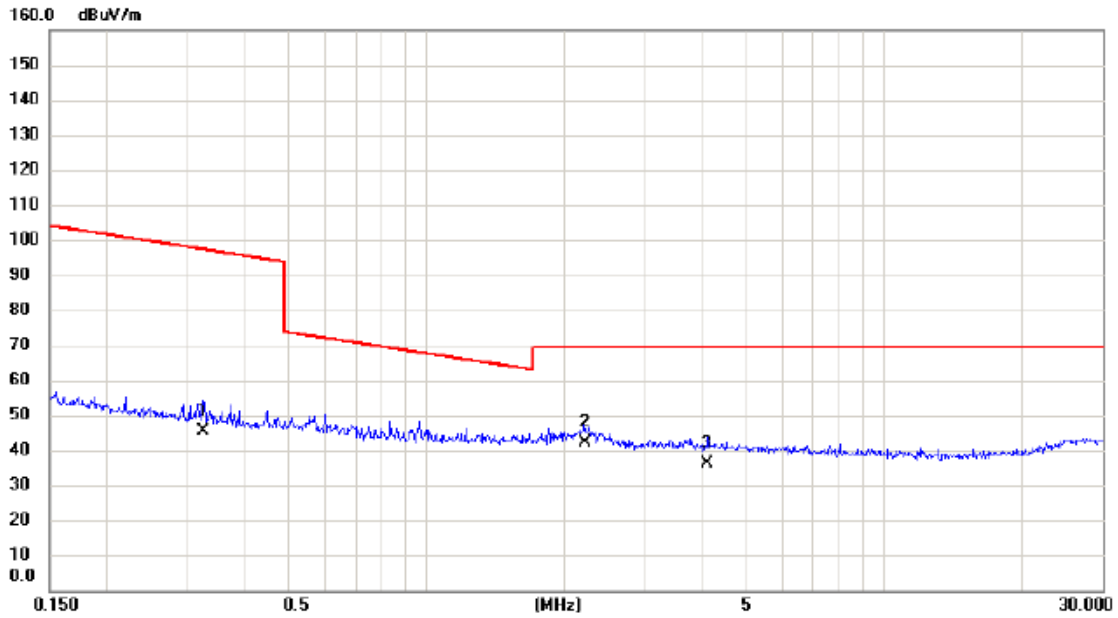

No.	Mk.	Freq. MHz	Reading Level dBuV	Correct Factor dB	Measure- ment dBuV/m	Limit dBuV/m	Margin dB	Detector	Comment
1		0.3251	28.64	16.60	45.24	97.36	-52.12	AVG	
2	*	2.2132	26.57	15.45	42.02	69.54	-27.52	QP	
3		4.1137	21.39	14.88	36.27	69.54	-33.27	QP	

Test Mode: TX Mode (Adapter: HUNTKEY)

Ant 0°

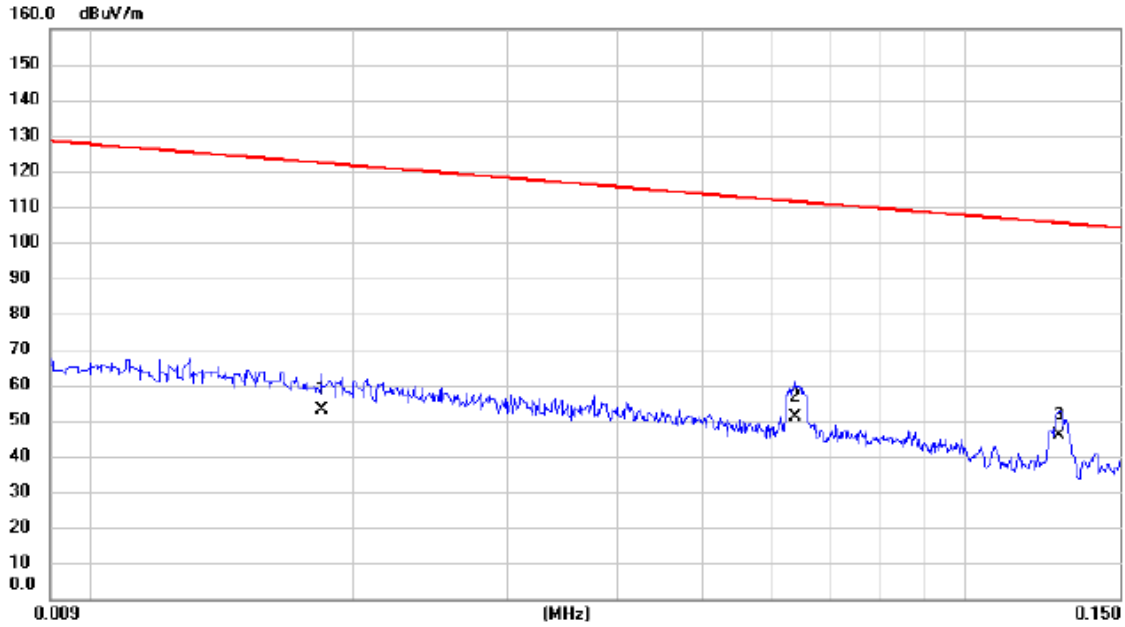

No.	Mk.	Freq. MHz	Reading Level dBuV	Correct Factor dB	Measure- ment dBuV/m	Limit dBuV/m	Margin dB	Detector	Comment
1		0.018	32.99	19.83	52.82	122.31	-69.49	AVG	
2		0.064	32.64	18.45	51.09	111.48	-60.39	AVG	
3	*	0.128	28.49	17.25	45.74	105.46	-59.72	AVG	

Test Mode: TX Mode (Adapter: HUNTKEY)

Ant 0°

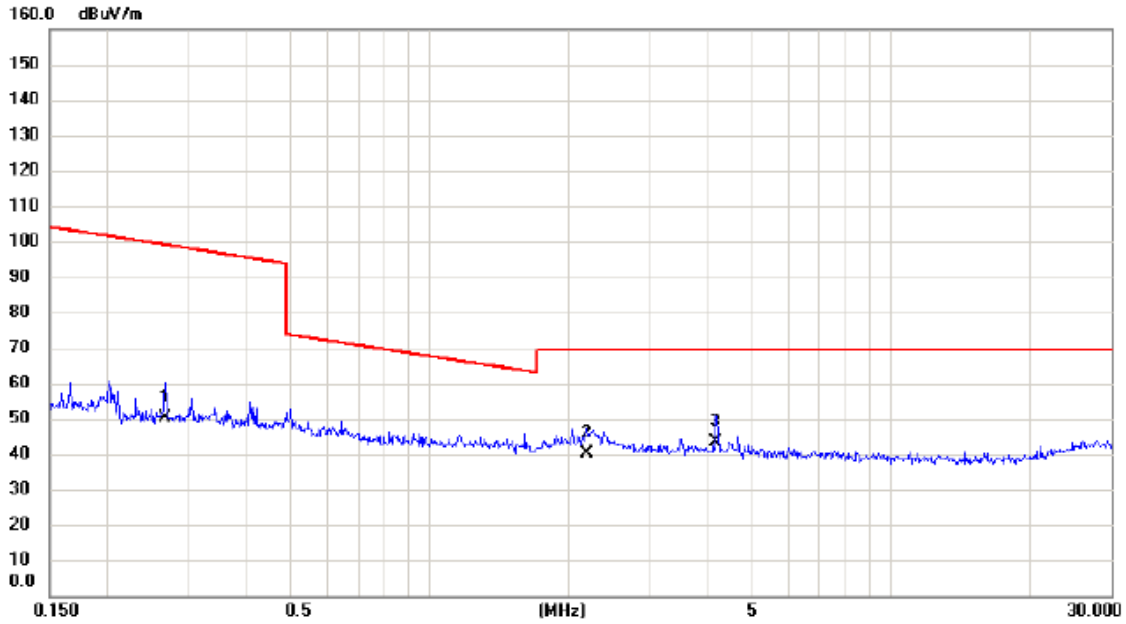

No.	Mk.	Freq. MHz	Reading Level dBuV	Correct Factor dB	Measure- ment dBuV/m	Limit dBuV/m	Margin dB	Detector	Comment
1		0.2672	33.71	16.65	50.36	99.07	-48.71	AVG	
2		2.1898	24.59	15.45	40.04	69.54	-29.50	QP	
3	*	4.1796	28.46	14.84	43.30	69.54	-26.24	QP	

Test Mode: TX Mode (Adapter: HUNTKEY)

Ant 90°

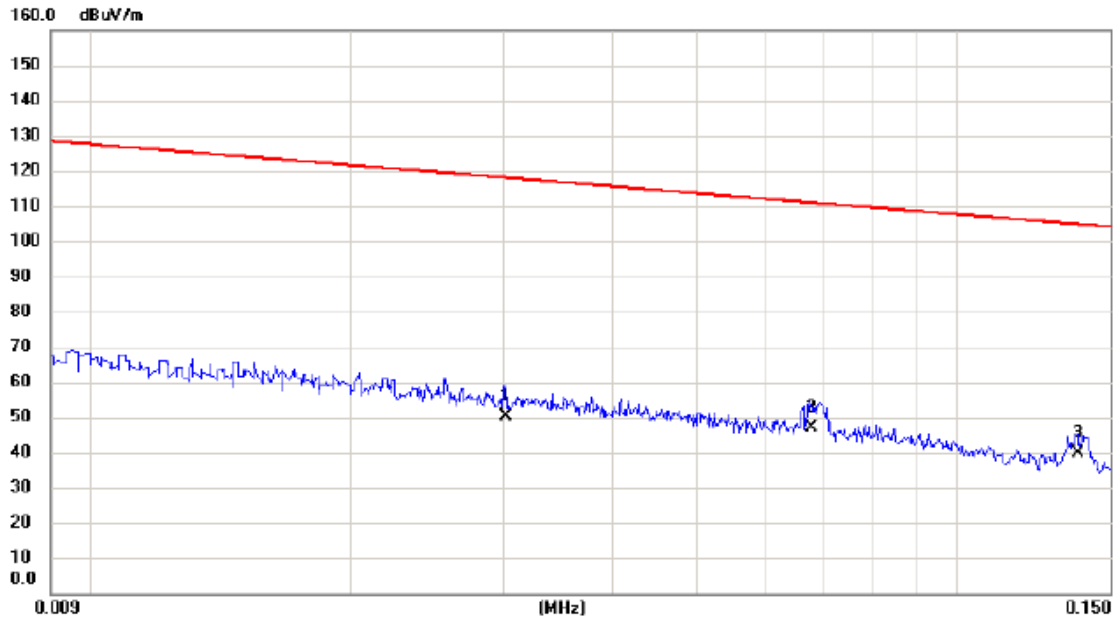

No.	Mk.	Freq. MHz	Reading Level dBuV	Correct Factor dB	Measure- ment dBuV/m	Limit dBuV/m	Margin dB	Detector	Comment
1		0.0302	30.84	19.31	50.15	118.00	-67.85	AVG	
2	*	0.0678	28.49	18.37	46.86	110.98	-64.12	AVG	
3		0.1380	22.75	17.12	39.87	104.81	-64.94	QP	

Test Mode: TX Mode (Adapter: HUNTKEY)

Ant 90°

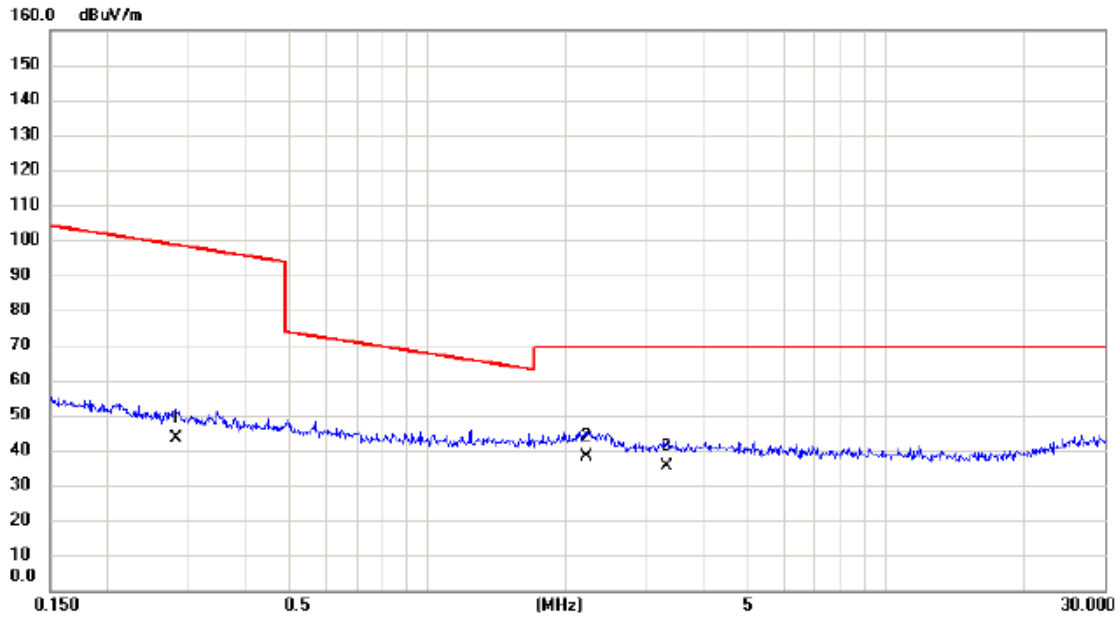

No.	Mk.	Freq. MHz	Reading Level dBuV	Correct Factor dB	Measure- ment dBuV/m	Limit dBuV/m	Margin dB	Detector	Comment
1		0.2818	26.84	16.63	43.47	98.61	-55.14	AVG	
2	*	2.2250	22.65	15.44	38.09	69.54	-31.45	QP	
3		3.3281	20.17	15.14	35.31	69.54	-34.23	QP	

Test Mode: TX Mode (Adapter: Salcomp)

Ant 0°

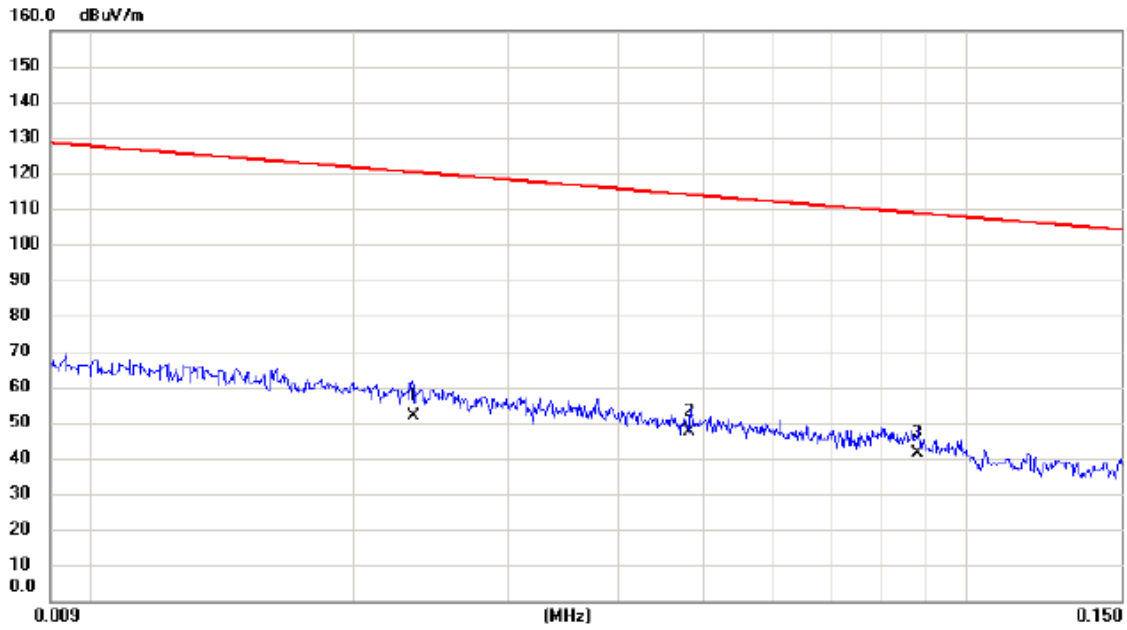

No.	Mk.	Freq. MHz	Reading Level dBuV	Correct Factor dB	Measure- ment dBuV/m	Limit dBuV/m	Margin dB	Detector	Comment
1		0.0234	32.38	19.52	51.90	120.22	-68.32	AVG	
2	*	0.0483	28.49	18.77	47.26	113.93	-66.67	AVG	
3		0.0880	23.67	17.92	41.59	108.72	-67.13	AVG	

Test Mode: TX Mode (Adapter: Salcomp)

Ant 0°

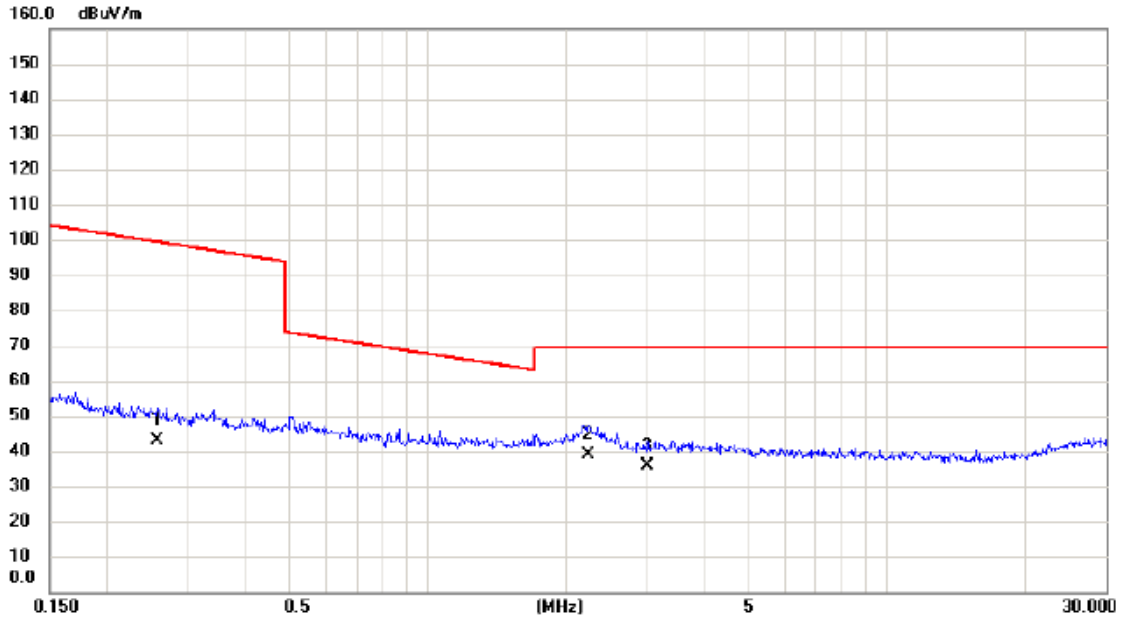

No.	Mk.	Freq. MHz	Reading Level dBuV	Correct Factor dB	Measure- ment dBuV/m	Limit dBuV/m	Margin dB	Detector	Comment
1		0.2575	26.47	16.65	43.12	99.39	-56.27	AVG	
2	*	2.2367	23.58	15.44	39.02	69.54	-30.52	QP	
3		3.0094	20.69	15.23	35.92	69.54	-33.62	QP	

Test Mode: TX Mode (Adapter: Salcomp)

Ant 90°

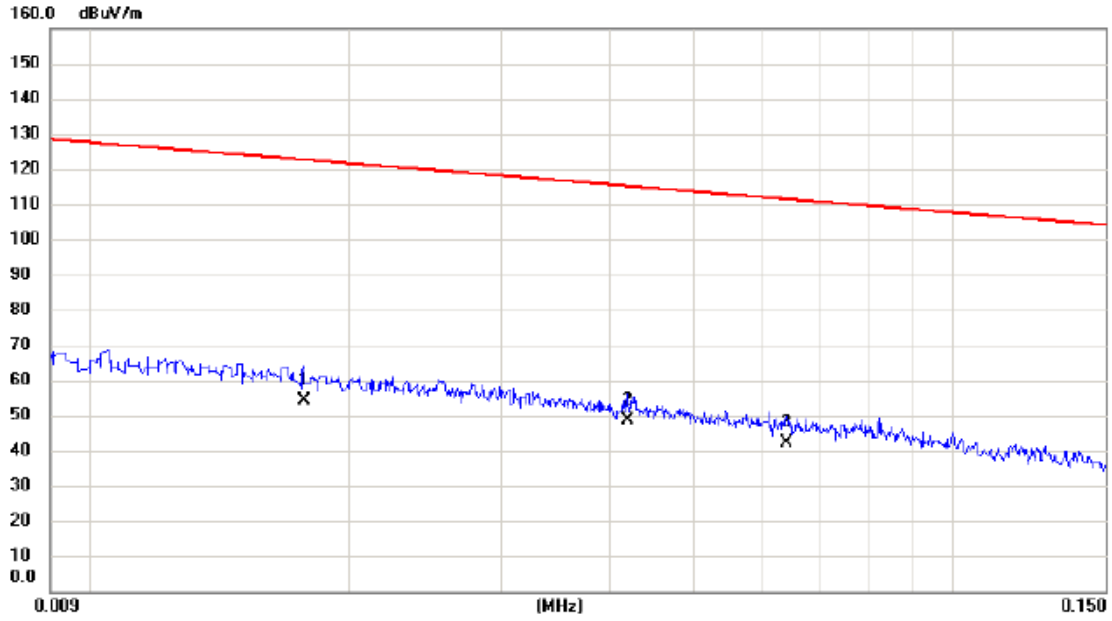

No.	Mk.	Freq. MHz	Reading Level dBuV	Correct Factor dB	Measure- ment dBuV/m	Limit dBuV/m	Margin dB	Detector	Comment
1		0.0177	34.11	19.92	54.03	122.65	-68.62	AVG	
2	*	0.0420	29.47	18.96	48.43	115.14	-66.71	AVG	
3		0.0641	23.58	18.45	42.03	111.47	-69.44	AVG	

Test Mode: TX Mode (Adapter: Salcomp)

Ant 90°

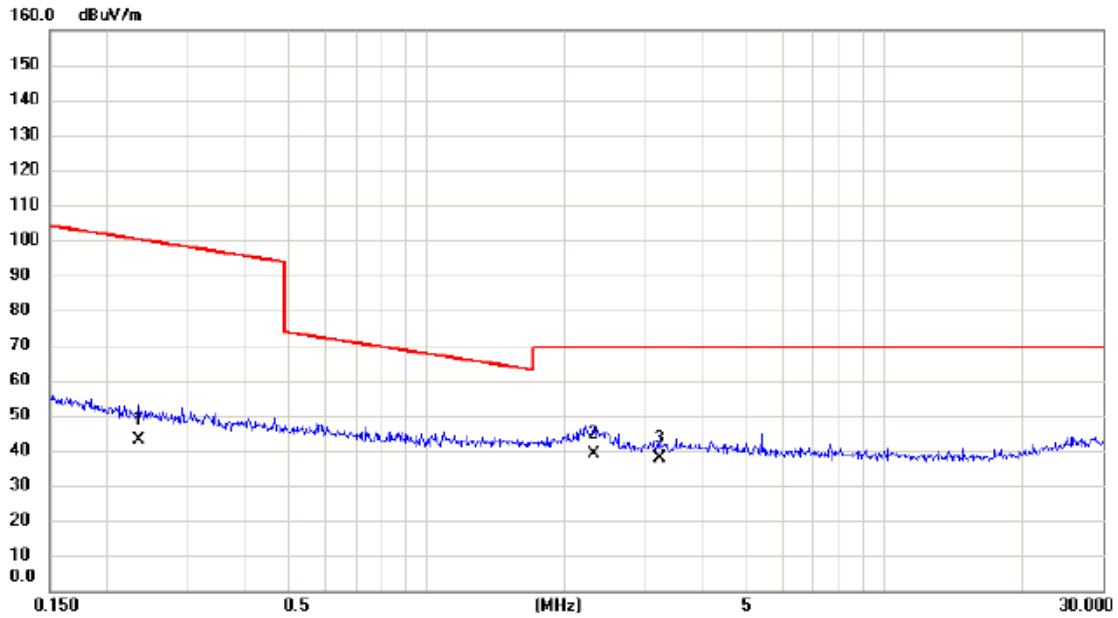

No.	Mk.	Freq. MHz	Reading Level dBuV	Correct Factor dB	Measure- ment dBuV/m	Limit dBuV/m	Margin dB	Detector	Comment
1		0.2341	26.34	16.70	43.04	100.22	-57.18	AVG	
2	*	2.3090	23.58	15.43	39.01	69.54	-30.53	QP	
3		3.2240	22.61	15.16	37.77	69.54	-31.77	QP	

Test Mode: TX Mode (Adapter: HUAWEI)

Ant 0°

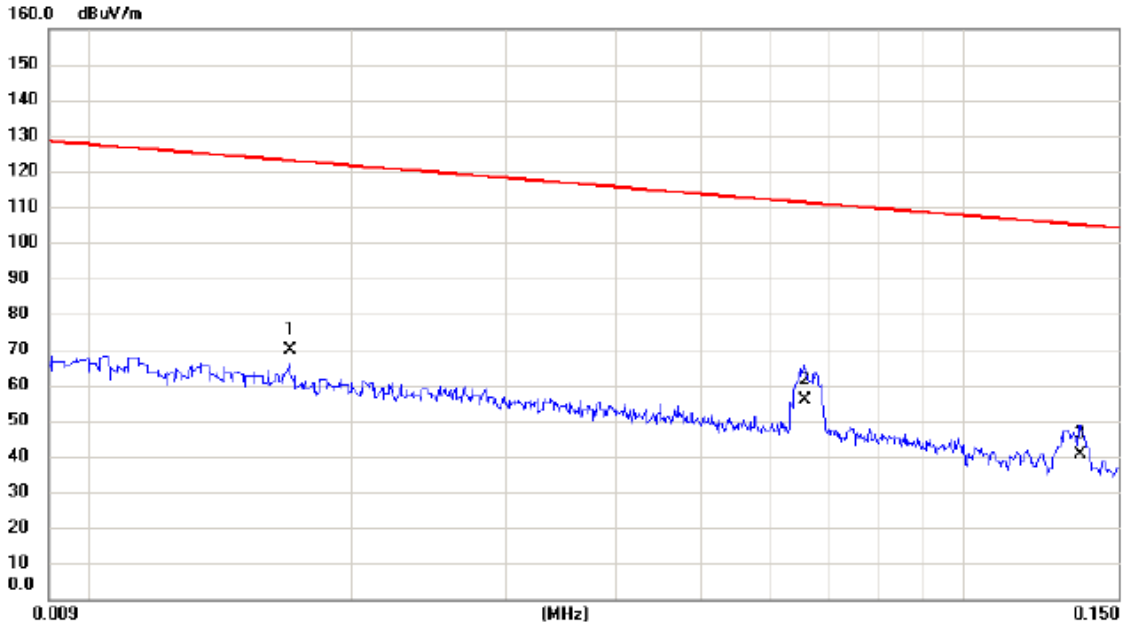

No.	Mk.	Freq.	Reading Level	Correct Factor	Measurement	Limit	Margin	Detector	Comment
		MHz	dBuV	dB	dBuV/m	dBuV/m	dB		
1	*	0.0170	49.63	20.01	69.64	123.00	-53.36	AVG	
2		0.0658	37.22	18.41	55.63	111.24	-55.61	AVG	
3		0.1356	23.66	17.14	40.80	104.96	-64.16	QP	

Test Mode: TX Mode (Adapter: HUAWEI)

Ant 0°

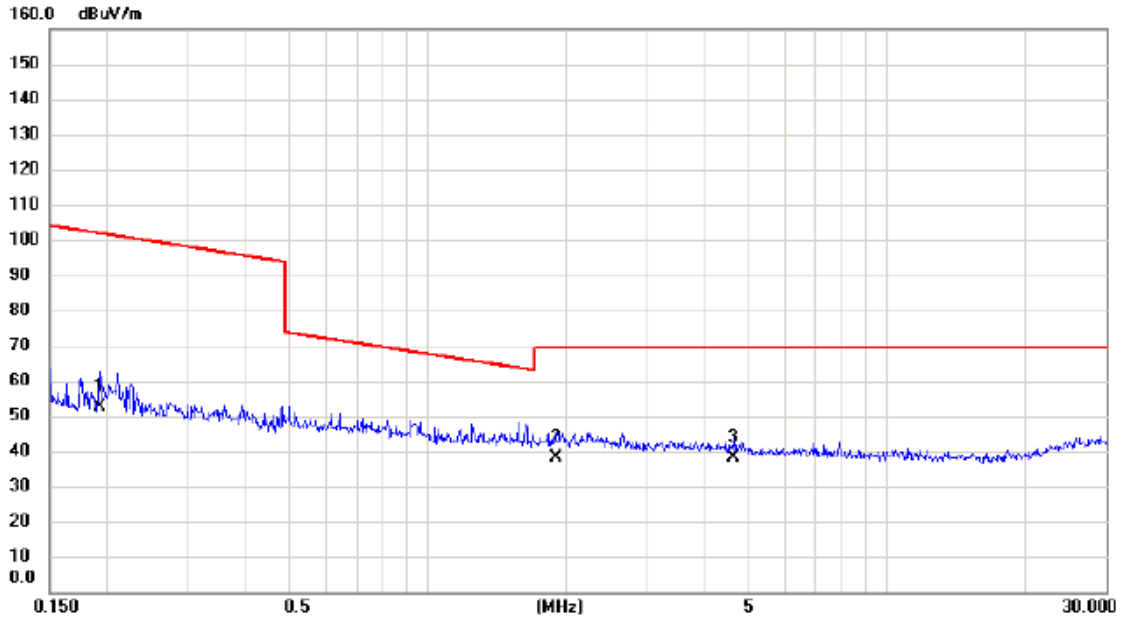

No.	Mk.	Freq. MHz	Reading Level dBuV	Correct Factor dB	Measure- ment dBuV/m	Limit dBuV/m	Margin dB	Detector	Comment
1		0.1924	35.77	16.82	52.59	101.92	-49.33	AVG	
2	*	1.9080	22.61	15.55	38.16	69.54	-31.38	QP	
3		4.6468	23.54	14.57	38.11	69.54	-31.43	QP	

Test Mode: TX Mode (Adapter: HUAWEI)

Ant 90°

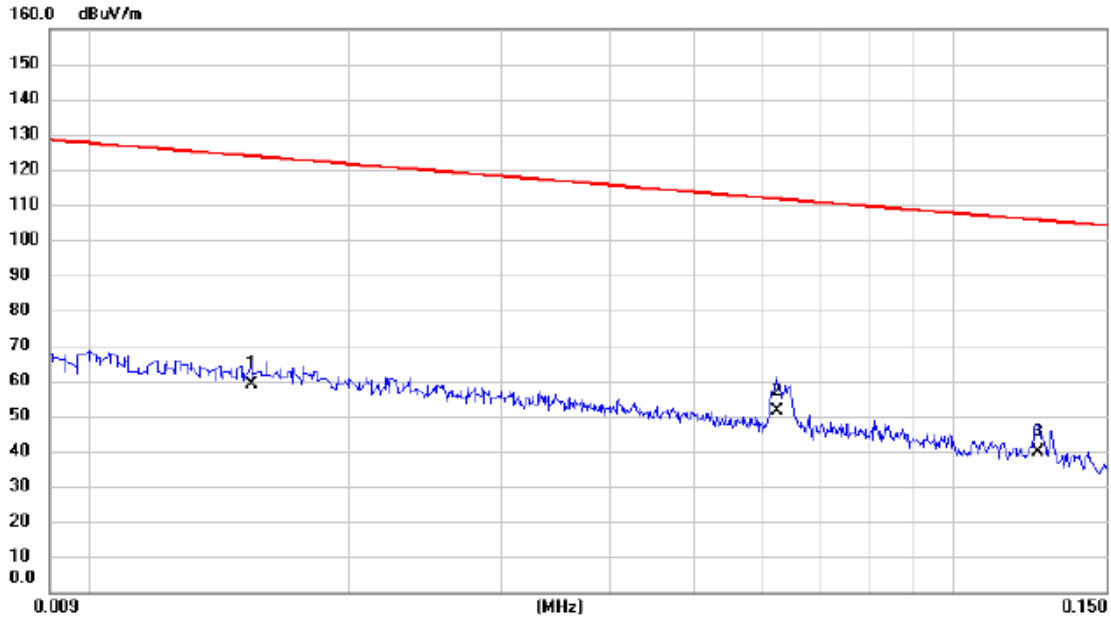

No.	Mk.	Freq. MHz	Reading Level dBuV	Correct Factor dB	Measure- ment dBuV/m	Limit dBuV/m	Margin dB	Detector	Comment
1		0.015	38.76	20.22	58.98	123.85	-64.87	AVG	
2	*	0.062	32.77	18.48	51.25	111.70	-60.45	AVG	
3		0.125	22.64	17.29	39.93	105.67	-65.74	AVG	

Test Mode: TX Mode (Adapter: HUAWEI)

Ant 90°

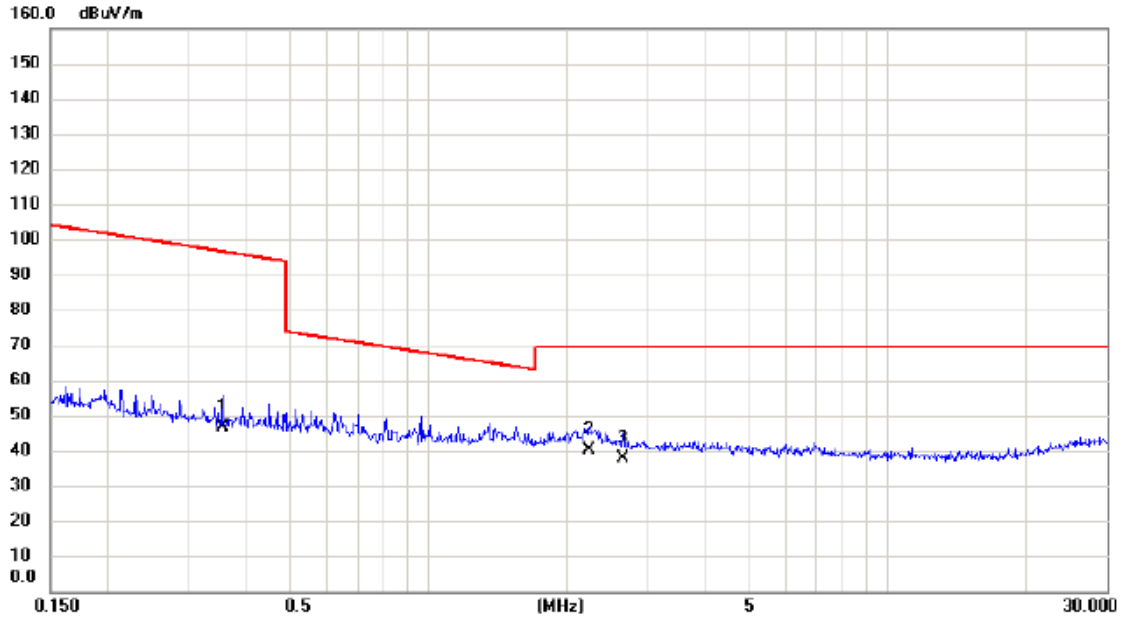

No.	Mk.	Freq. MHz	Reading Level dBuV	Correct Factor dB	Measure- ment dBuV/m	Limit dBuV/m	Margin dB	Detector	Comment
1		0.3558	30.02	16.58	46.60	96.58	-49.98	AVG	
2	*	2.2367	24.76	15.44	40.20	69.54	-29.34	QP	
3		2.6500	22.39	15.33	37.72	69.54	-31.82	QP	

Test Mode: LTE Band 26_TX CH26797_1.4M_Main Ant

Vertical

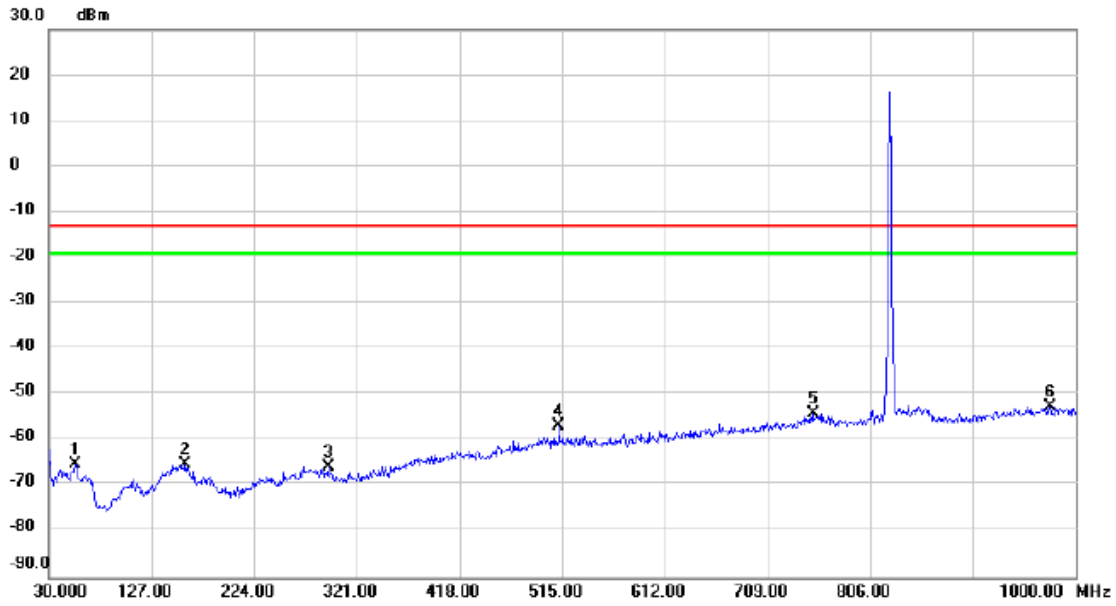

No.	Mk.	Freq. MHz	Reading Level dBm	Correct Factor dB	Measure- ment dBm	Limit dBm	Margin dB	Detector	Comment
1		55.220	-77.77	12.61	-65.16	-13.00	-52.16	peak	
2		159.010	-78.39	13.18	-65.21	-13.00	-52.21	peak	
3		294.810	-77.52	11.62	-65.90	-13.00	-52.90	peak	
4		512.090	-74.52	17.53	-56.99	-13.00	-43.99	peak	
5		751.680	-76.62	22.46	-54.16	-13.00	-41.16	peak	
6	*	975.750	-77.18	24.63	-52.55	-13.00	-39.55	peak	

Test Mode: LTE Band 26_TX CH26797_1.4M_Main Ant

Horizontal



No.	Mk.	Freq. MHz	Reading Level dBm	Correct Factor dB	Measure- ment dBm	Limit dBm	Margin dB	Detector	Comment
1		152.220	-77.68	13.91	-63.77	-13.00	-50.77	peak	
2		234.670	-77.83	12.85	-64.98	-13.00	-51.98	peak	
3		422.850	-77.34	16.56	-60.78	-13.00	-47.78	peak	
4		523.730	-76.22	18.08	-58.14	-13.00	-45.14	peak	
5	*	707.060	-75.75	23.81	-51.94	-13.00	-38.94	peak	
6		975.750	-77.22	24.93	-52.29	-13.00	-39.29	peak	

Test Mode: LTE Band 26_TX CH26797_1.4M_Main Ant

Vertical

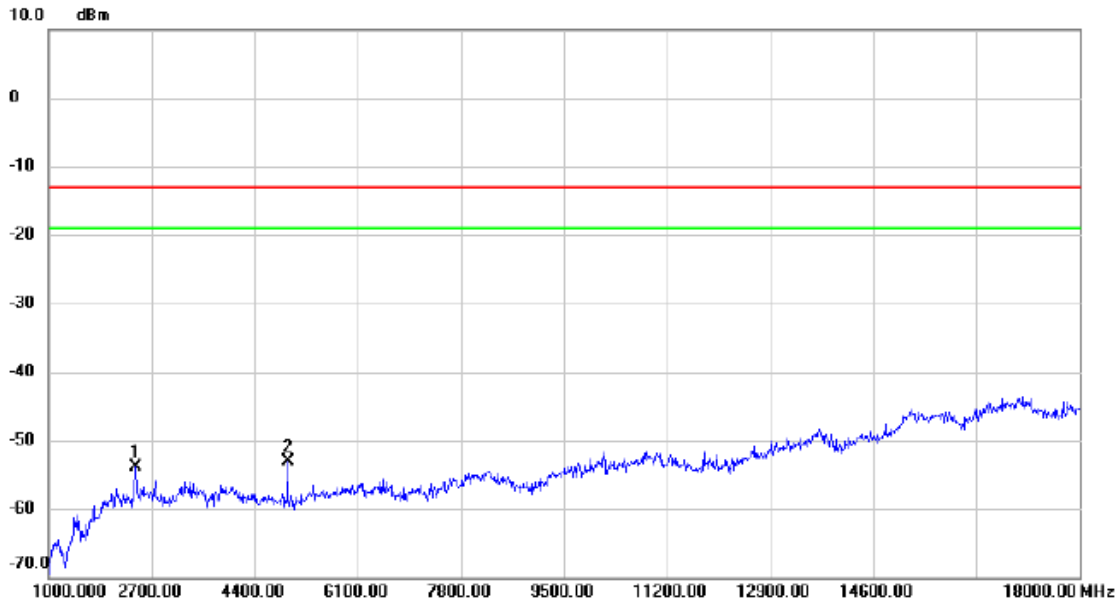

No.	Mk.	Freq. MHz	Reading Level dBm	Correct Factor dB	Measure- ment dBm	Limit dBm	Margin dB	Detector	Comment
1		2428.000	-65.88	12.02	-53.86	-13.00	-40.86	peak	
2	*	4944.000	-67.68	14.56	-53.12	-13.00	-40.12	peak	

Test Mode: LTE Band 26_TX CH26797_1.4M_Main Ant

Horizontal

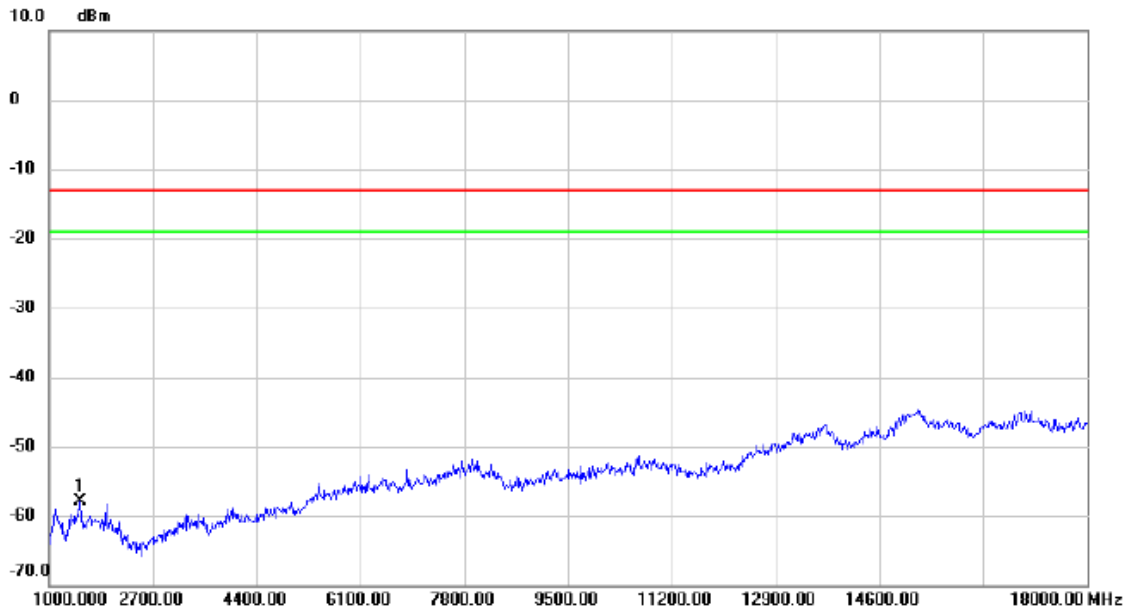

No.	Mk.	Freq. MHz	Reading Level dBm	Correct Factor dB	Measure- ment dBm	Limit dBm	Margin dB	Detector	Comment
1	*	1510.000	-65.98	8.08	-57.90	-13.00	-44.90	peak	

Test Mode: LTE Band 26_TX CH26865_15M_Main Ant

Vertical

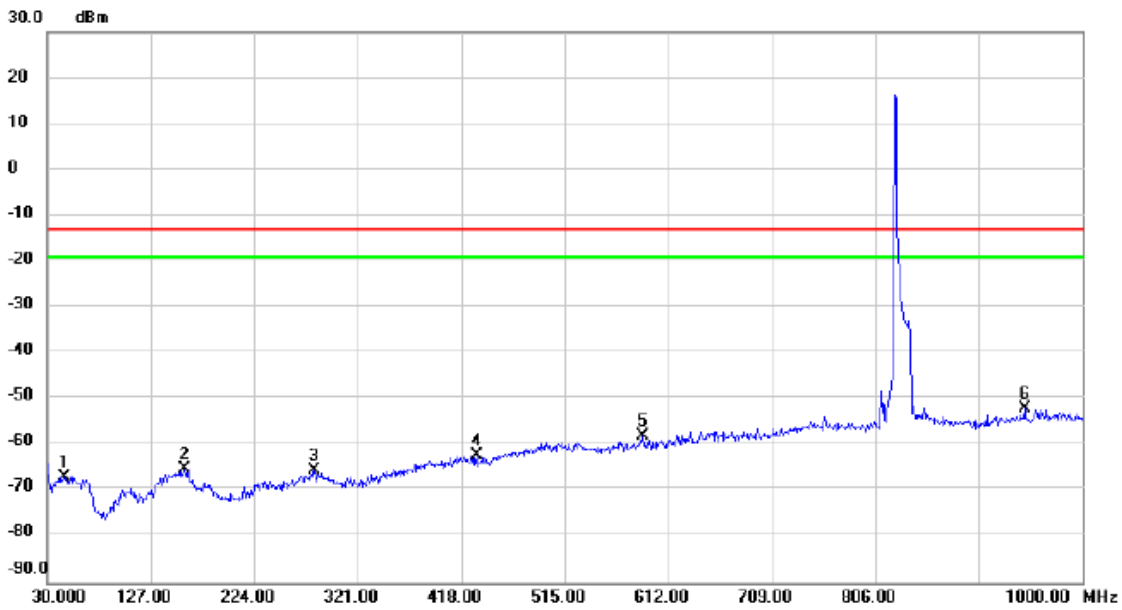

No.	Mk.	Freq. MHz	Reading Level dBm	Correct Factor dB	Measure- ment dBm	Limit dBm	Margin dB	Detector	Comment
1		45.520	-78.77	11.80	-66.97	-13.00	-53.97	peak	
2		158.040	-78.52	13.17	-65.35	-13.00	-52.35	peak	
3		280.260	-78.27	12.64	-65.63	-13.00	-52.63	peak	
4		432.550	-76.66	14.47	-62.19	-13.00	-49.19	peak	
5		587.750	-76.55	18.39	-58.16	-13.00	-45.16	peak	
6	*	945.680	-76.50	24.42	-52.08	-13.00	-39.08	peak	

Test Mode: LTE Band 26_TX CH26865_15M_Main Ant

Horizontal



No.	Mk.	Freq. MHz	Reading Level dBm	Correct Factor dB	Measure- ment dBm	Limit dBm	Margin dB	Detector	Comment
1		147.370	-78.81	13.95	-64.86	-13.00	-51.86	peak	
2		231.760	-77.92	13.10	-64.82	-13.00	-51.82	peak	
3		412.180	-77.61	16.49	-61.12	-13.00	-48.12	peak	
4		521.790	-77.39	18.08	-59.31	-13.00	-46.31	peak	
5		714.820	-76.53	23.62	-52.91	-13.00	-39.91	peak	
6	*	918.520	-76.54	23.68	-52.86	-13.00	-39.86	peak	

Test Mode: LTE Band 26_TX CH26865_15M_Main Ant

Vertical

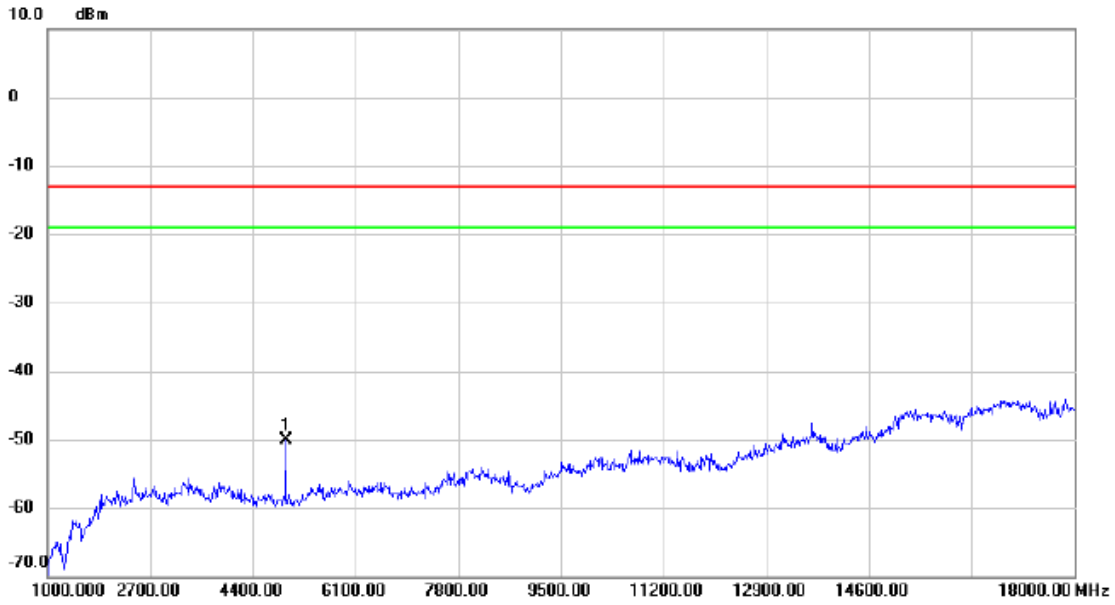

No.	Mk.	Freq. MHz	Reading Level dBm	Correct Factor dB	Measure- ment dBm	Limit dBm	Margin dB	Detector	Comment
1	*	4944.000	-64.67	14.56	-50.11	-13.00	-37.11	peak	

Test Mode: LTE Band 26_TX CH26865_15M_Main Ant

Horizontal

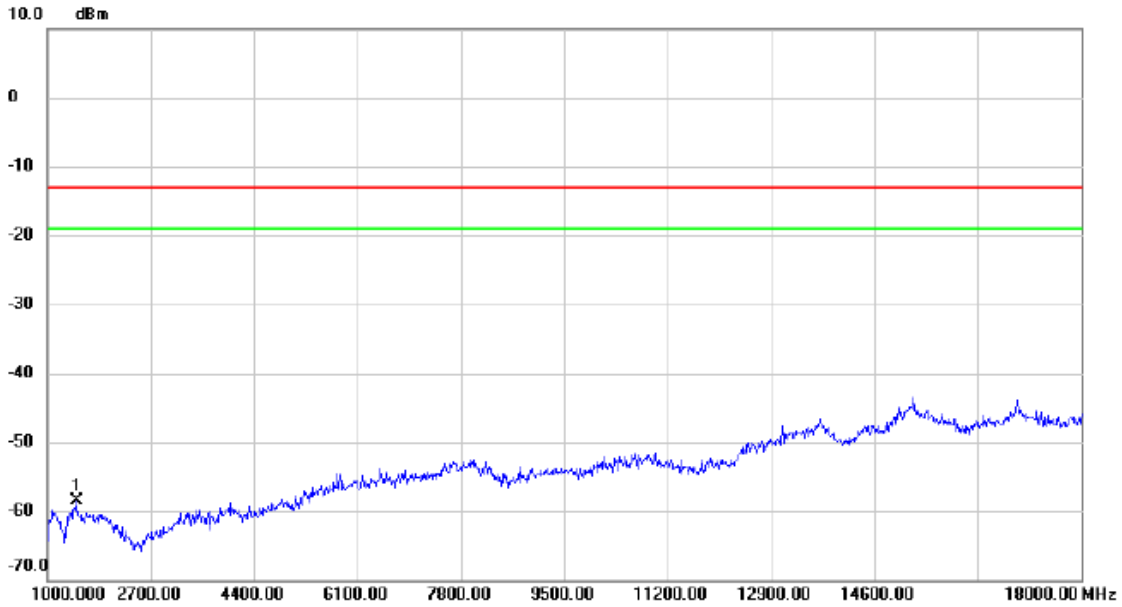

No.	Mk.	Freq. MHz	Reading Level dBm	Correct Factor dB	Measure- ment dBm	Limit dBm	Margin dB	Detector	Comment
1	*	1476.000	-66.44	7.92	-58.52	-13.00	-45.52	peak	

Test Mode: LTE Band 26_TX CH26797_1.4M_Second Ant

Vertical

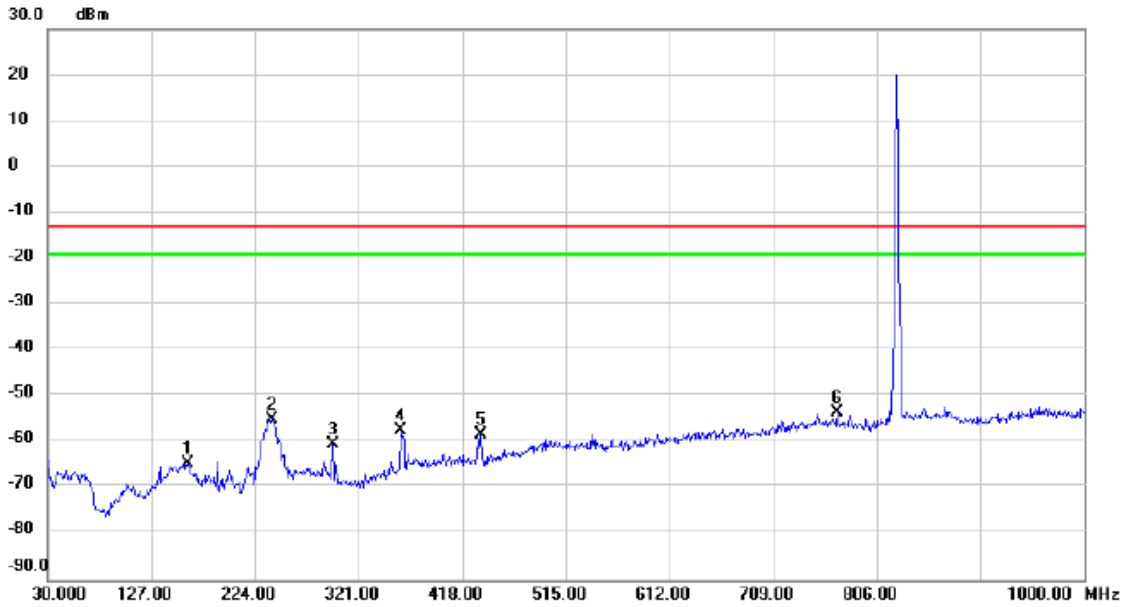

No.	Mk.	Freq. MHz	Reading Level dBm	Correct Factor dB	Measure- ment dBm	Limit dBm	Margin dB	Detector	Comment
1		160.950	-77.65	12.87	-64.78	-13.00	-51.78	peak	
2		239.520	-65.36	10.25	-55.11	-13.00	-42.11	peak	
3		296.750	-71.69	11.38	-60.31	-13.00	-47.31	peak	
4		360.770	-70.17	12.86	-57.31	-13.00	-44.31	peak	
5		435.460	-72.82	14.43	-58.39	-13.00	-45.39	peak	
6	*	769.140	-75.91	22.25	-53.66	-13.00	-40.66	peak	

Test Mode: LTE Band 26_TX CH26797_1.4M_Second Ant

Horizontal



No.	Mk.	Freq. MHz	Reading Level dBm	Correct Factor dB	Measure- ment dBm	Limit dBm	Margin dB	Detector	Comment
1		56.190	-76.49	11.86	-64.63	-13.00	-51.63	peak	
2		134.760	-73.47	11.14	-62.33	-13.00	-49.33	peak	
3		237.580	-74.54	12.61	-61.93	-13.00	-48.93	peak	
4		435.460	-73.69	15.13	-58.56	-13.00	-45.56	peak	
5		533.430	-75.15	18.09	-57.06	-13.00	-44.06	peak	
6	*	696.390	-77.72	23.73	-53.99	-13.00	-40.99	peak	

Test Mode: LTE Band 26_TX CH26797_1.4M_Second Ant

Vertical

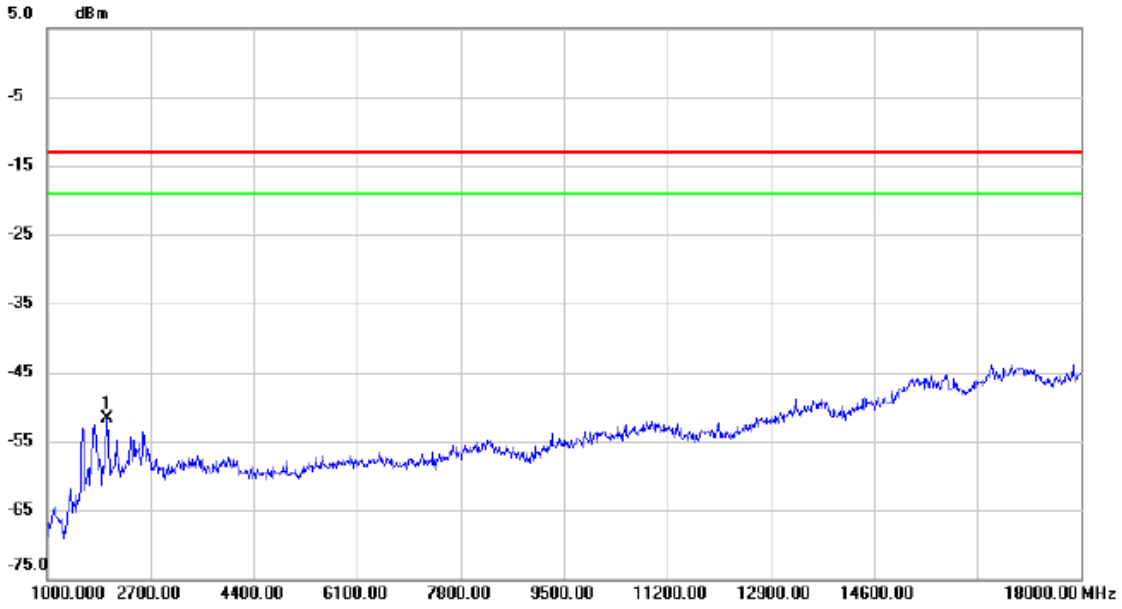

No.	Mk.	Freq. MHz	Reading Level dBm	Correct Factor dB	Measure- ment dBm	Limit dBm	Margin dB	Detector	Comment
1	*	1986.000	-62.47	10.77	-51.70	-13.00	-38.70	peak	

Test Mode: LTE Band 26_TX CH26797_1.4M_Second Ant

Horizontal

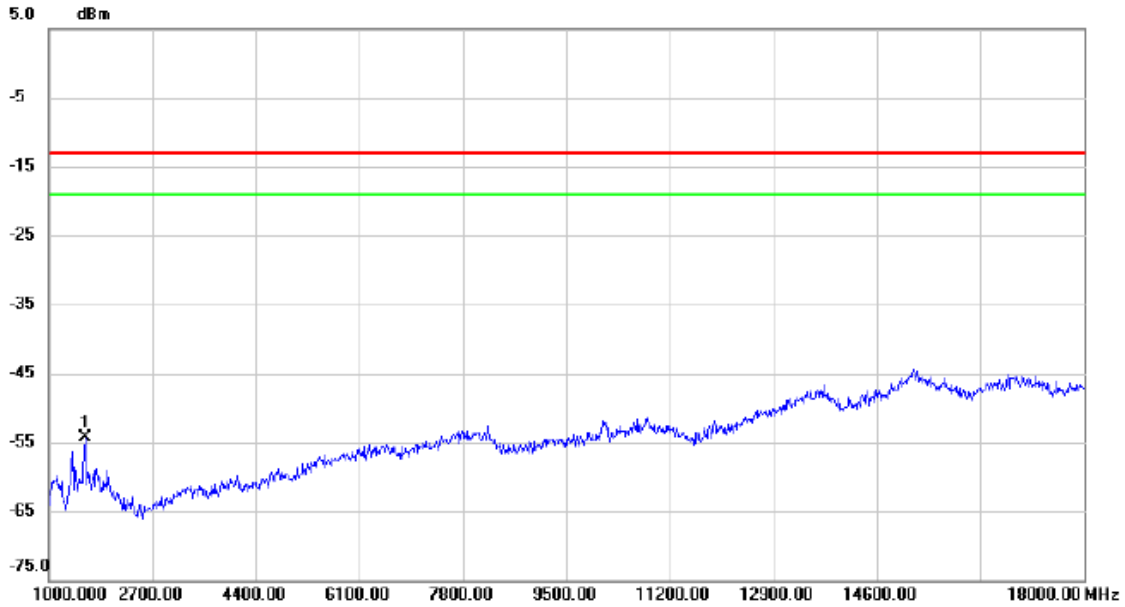

No.	Mk.	Freq. MHz	Reading Level dBm	Correct Factor dB	Measure- ment dBm	Limit dBm	Margin dB	Detector	Comment
1	*	1595.000	-62.36	8.13	-54.23	-13.00	-41.23	peak	

Test Mode: LTE Band 26_TX CH26865_15M_Second Ant

Vertical

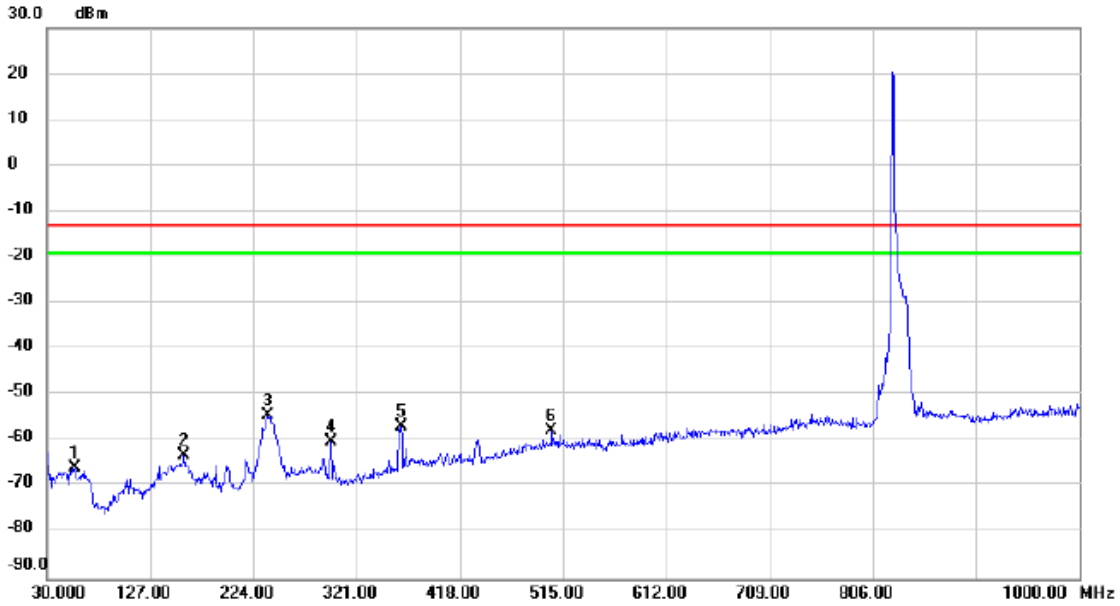

No.	Mk.	Freq. MHz	Reading Level dBm	Correct Factor dB	Measure- ment dBm	Limit dBm	Margin dB	Detector	Comment
1		56.190	-77.99	12.18	-65.81	-13.00	-52.81	peak	
2		159.010	-76.21	13.18	-63.03	-13.00	-50.03	peak	
3	*	237.580	-64.77	10.30	-54.47	-13.00	-41.47	peak	
4		296.750	-71.53	11.38	-60.15	-13.00	-47.15	peak	
5		362.710	-69.76	12.96	-56.80	-13.00	-43.80	peak	
6		504.330	-75.36	17.54	-57.82	-13.00	-44.82	peak	

Test Mode: LTE Band 26_TX CH26865_15M_Second Ant

Horizontal

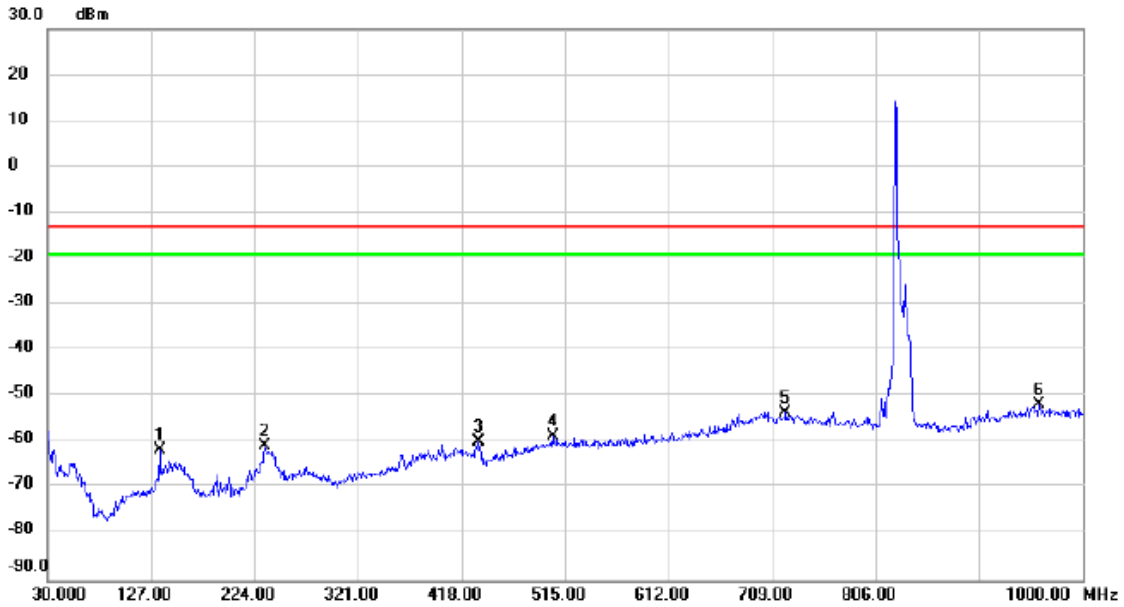

No.	Mk.	Freq. MHz	Reading Level dBm	Correct Factor dB	Measure- ment dBm	Limit dBm	Margin dB	Detector	Comment
1		134.760	-72.70	11.14	-61.56	-13.00	-48.56	peak	
2		233.700	-73.84	12.94	-60.90	-13.00	-47.90	peak	
3		433.520	-75.06	15.35	-59.71	-13.00	-46.71	peak	
4		503.360	-76.82	18.06	-58.76	-13.00	-45.76	peak	
5		721.610	-76.92	23.46	-53.46	-13.00	-40.46	peak	
6	*	959.260	-76.65	24.94	-51.71	-13.00	-38.71	peak	

Test Mode: LTE Band 26_TX CH26865_15M_Second Ant

Vertical

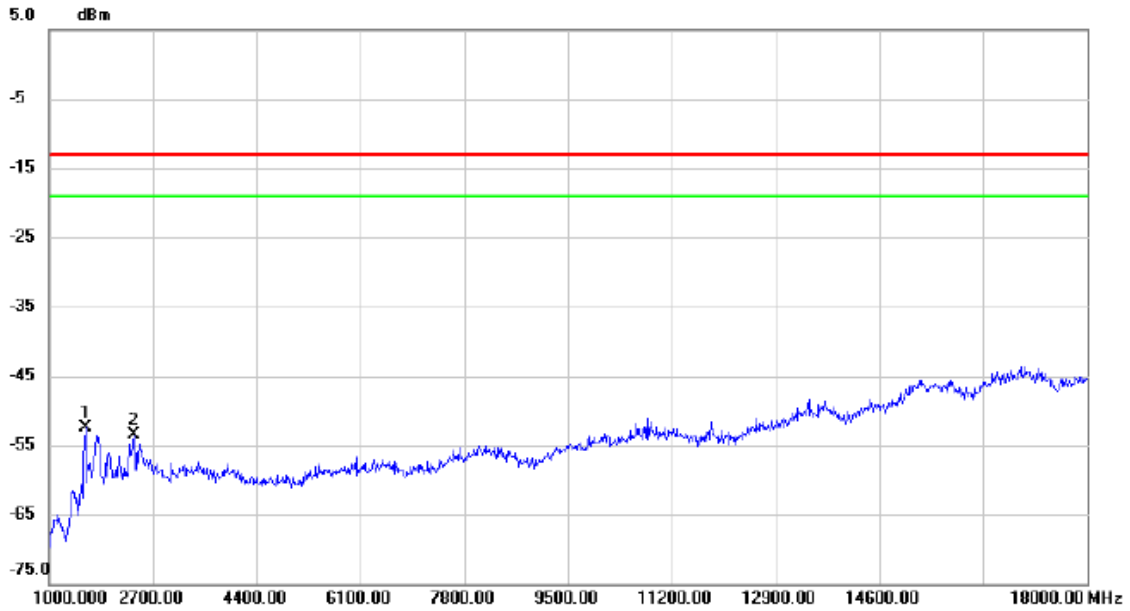

No.	Mk.	Freq. MHz	Reading Level dBm	Correct Factor dB	Measure- ment dBm	Limit dBm	Margin dB	Detector	Comment
1	*	1595.000	-57.83	5.43	-52.40	-13.00	-39.40	peak	
2		2394.000	-65.50	11.94	-53.56	-13.00	-40.56	peak	

Test Mode: LTE Band 26_TX CH26865_15M_Second Ant

Horizontal

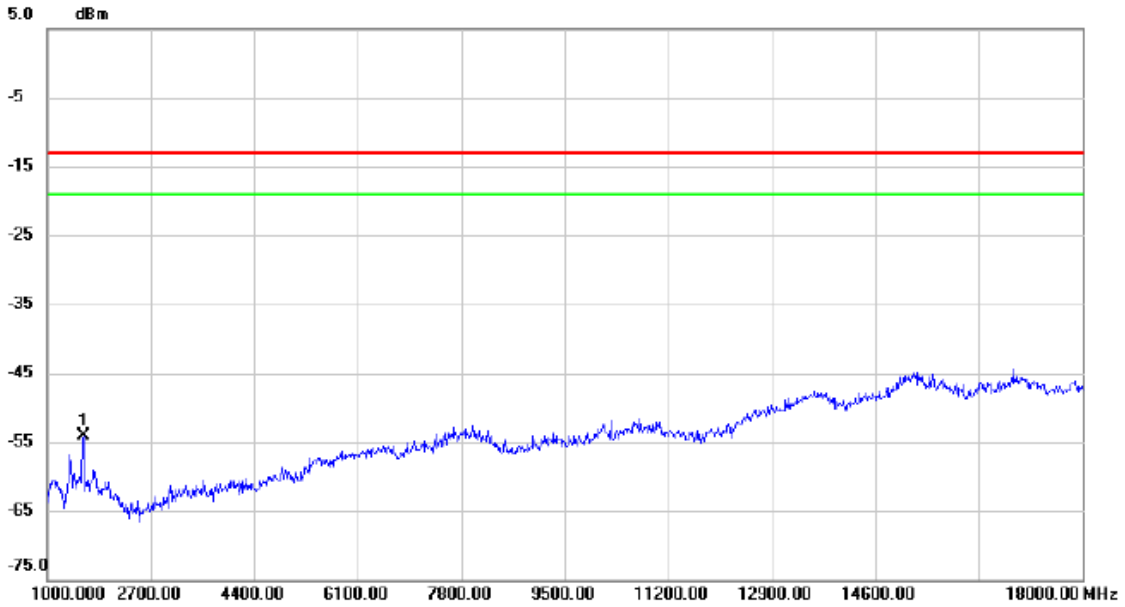

No.	Mk.	Freq. MHz	Reading Level dBm	Correct Factor dB	Measure- ment dBm	Limit dBm	Margin dB	Detector	Comment
1	*	1595.000	-62.15	8.13	-54.02	-13.00	-41.02	peak	

APPENDIX E - BAND EDGE

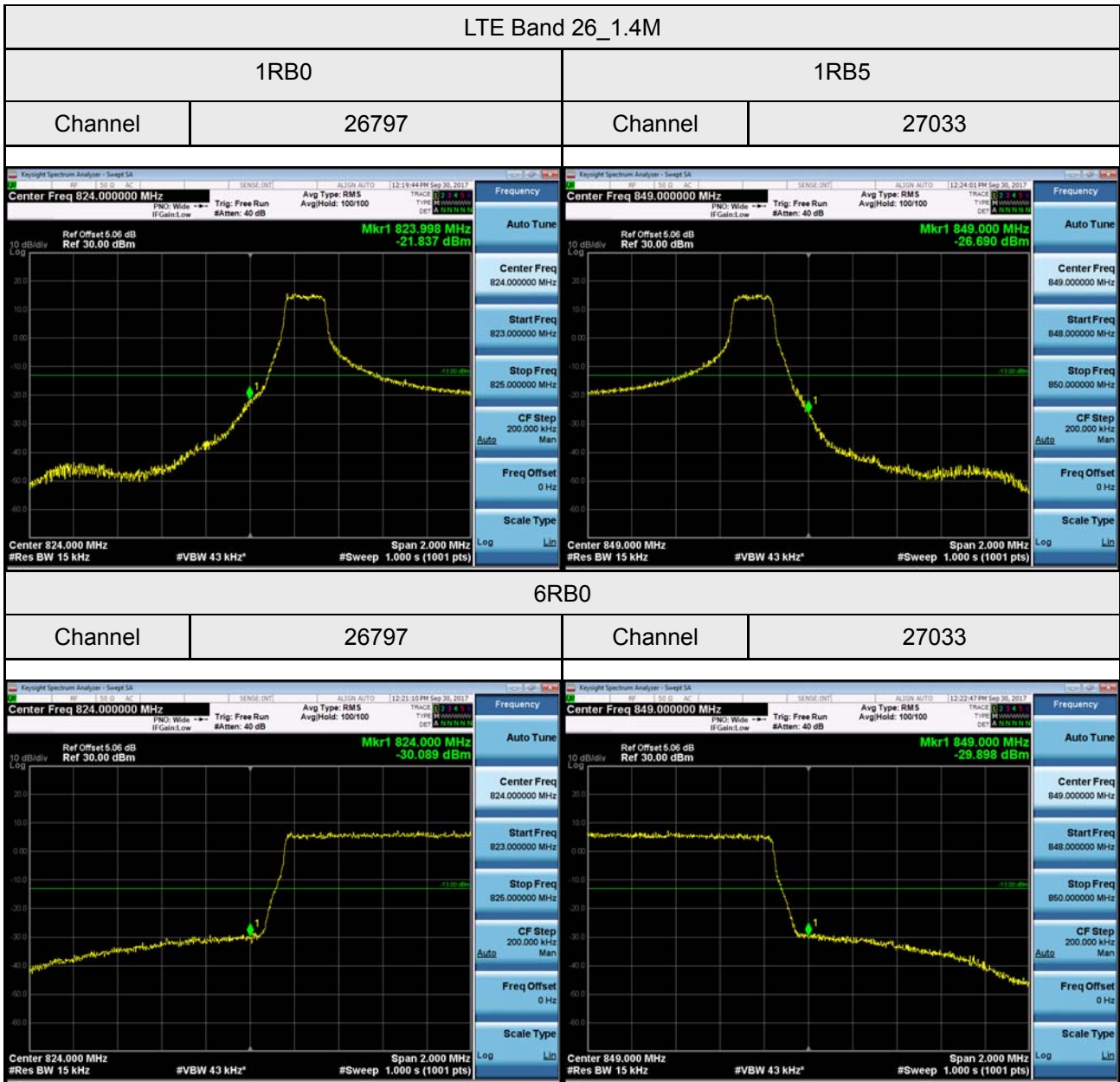

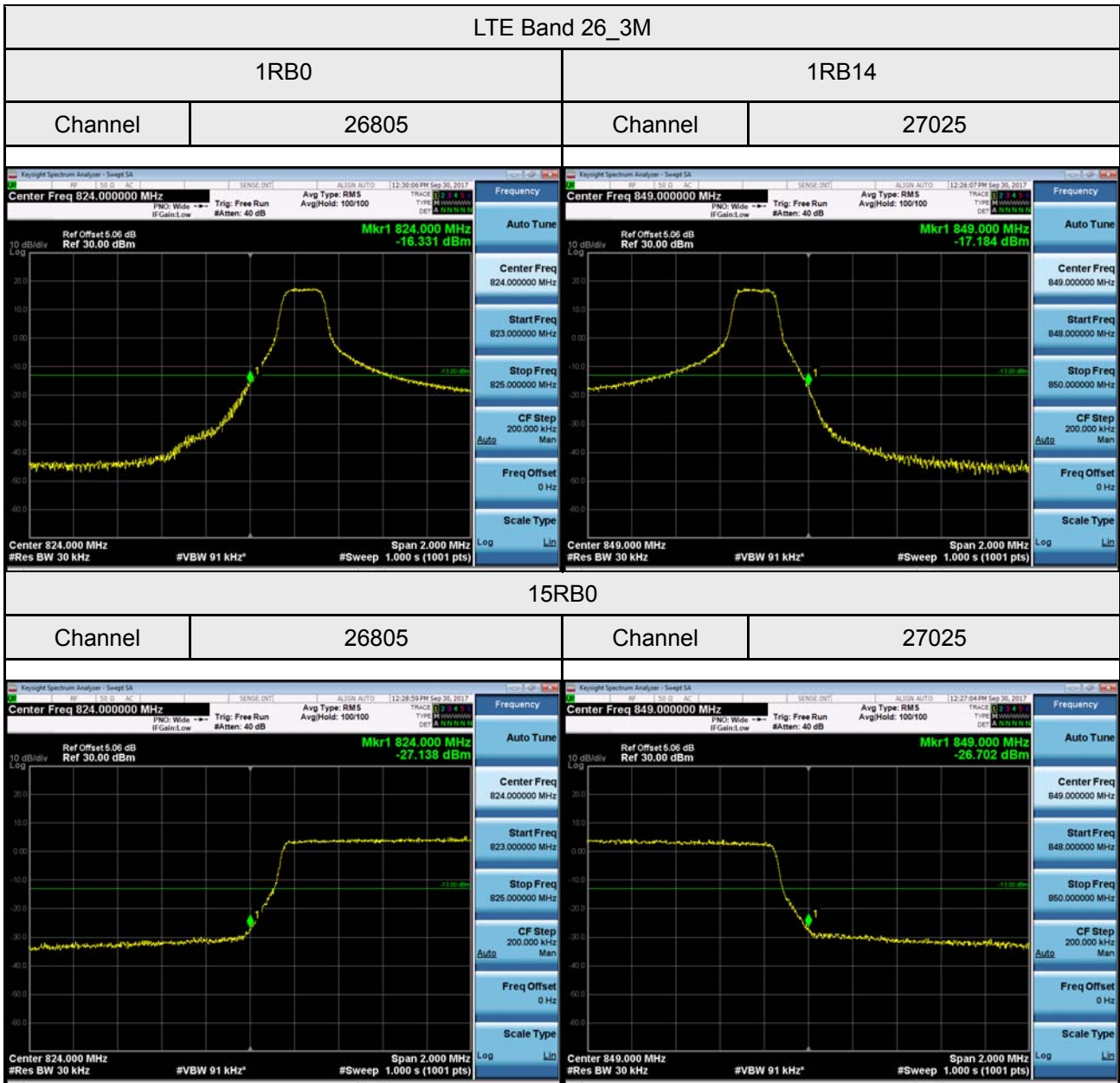

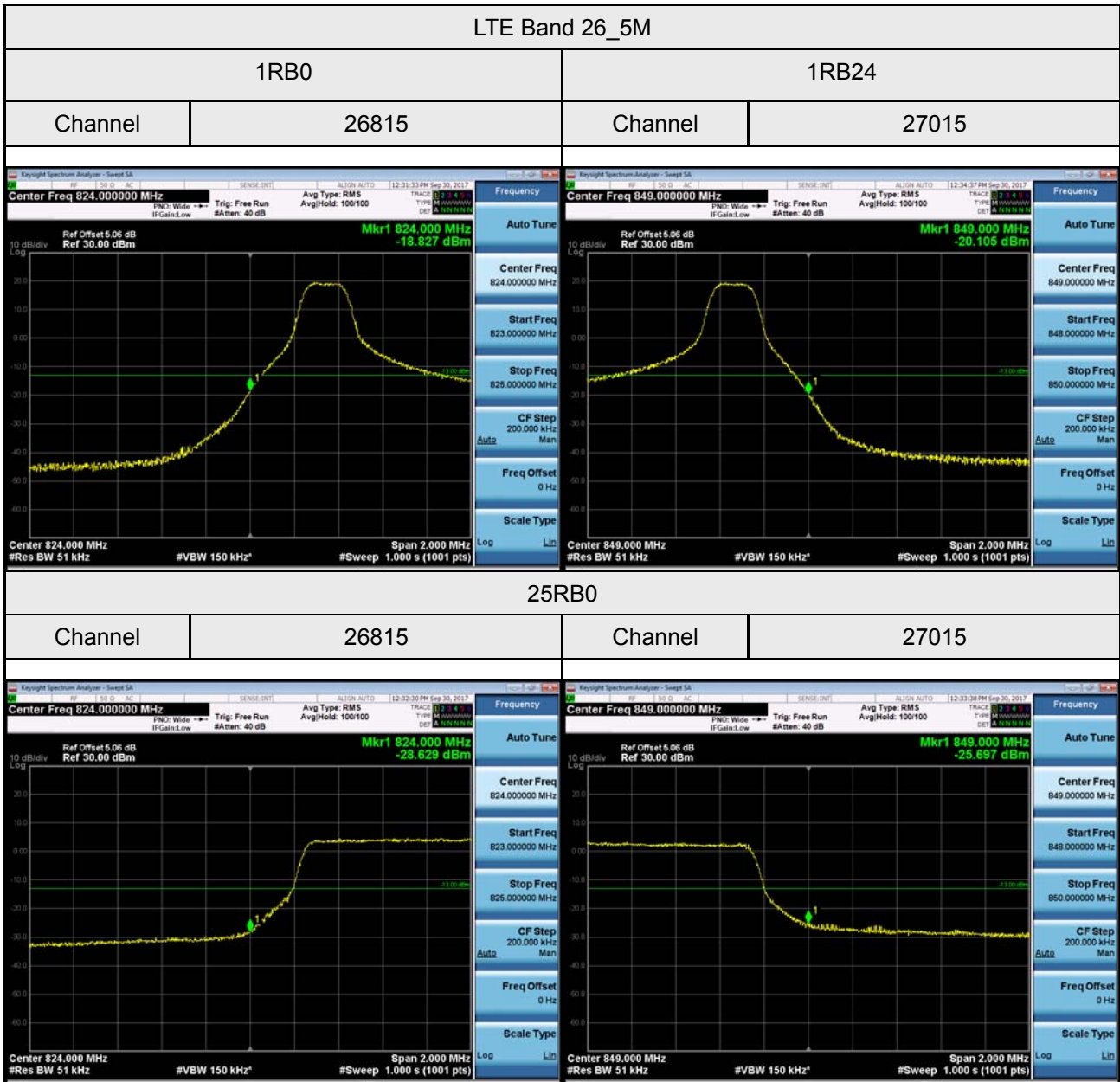

LTE Band 26_10M

1RB0

1RB49

Channel

26840

Channel

26990

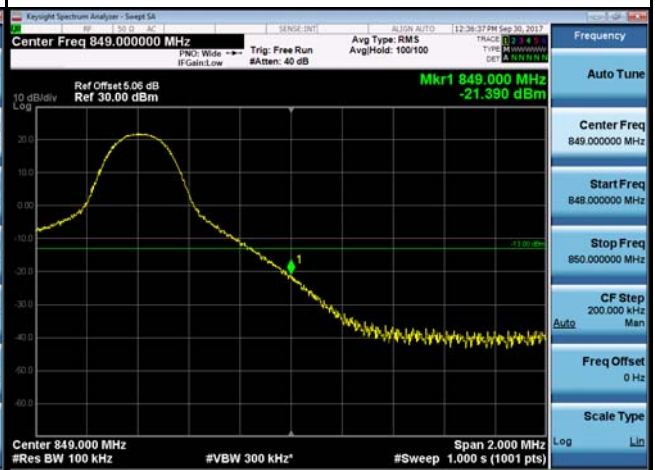
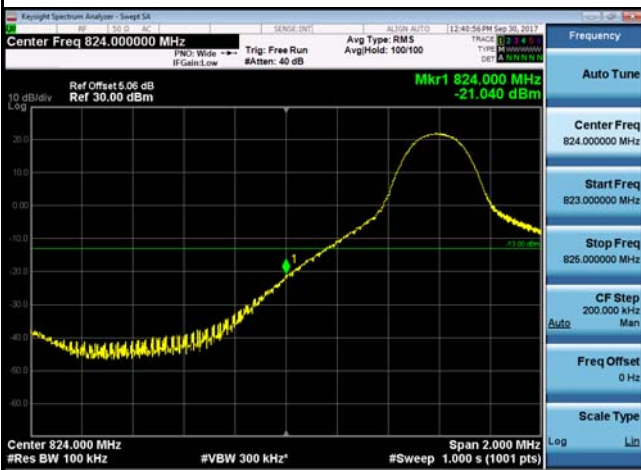

50RB0

Channel

26840

Channel

26990

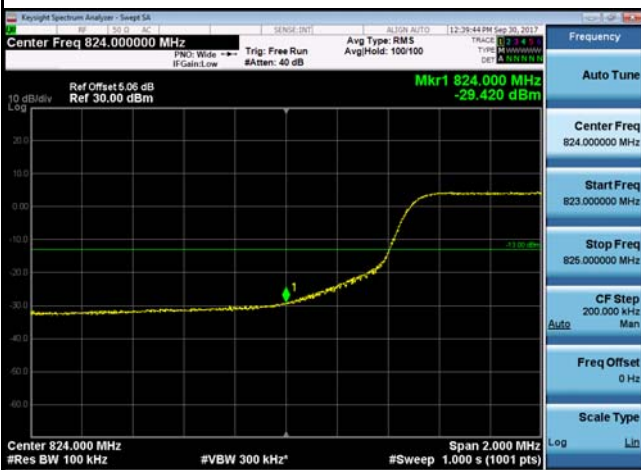

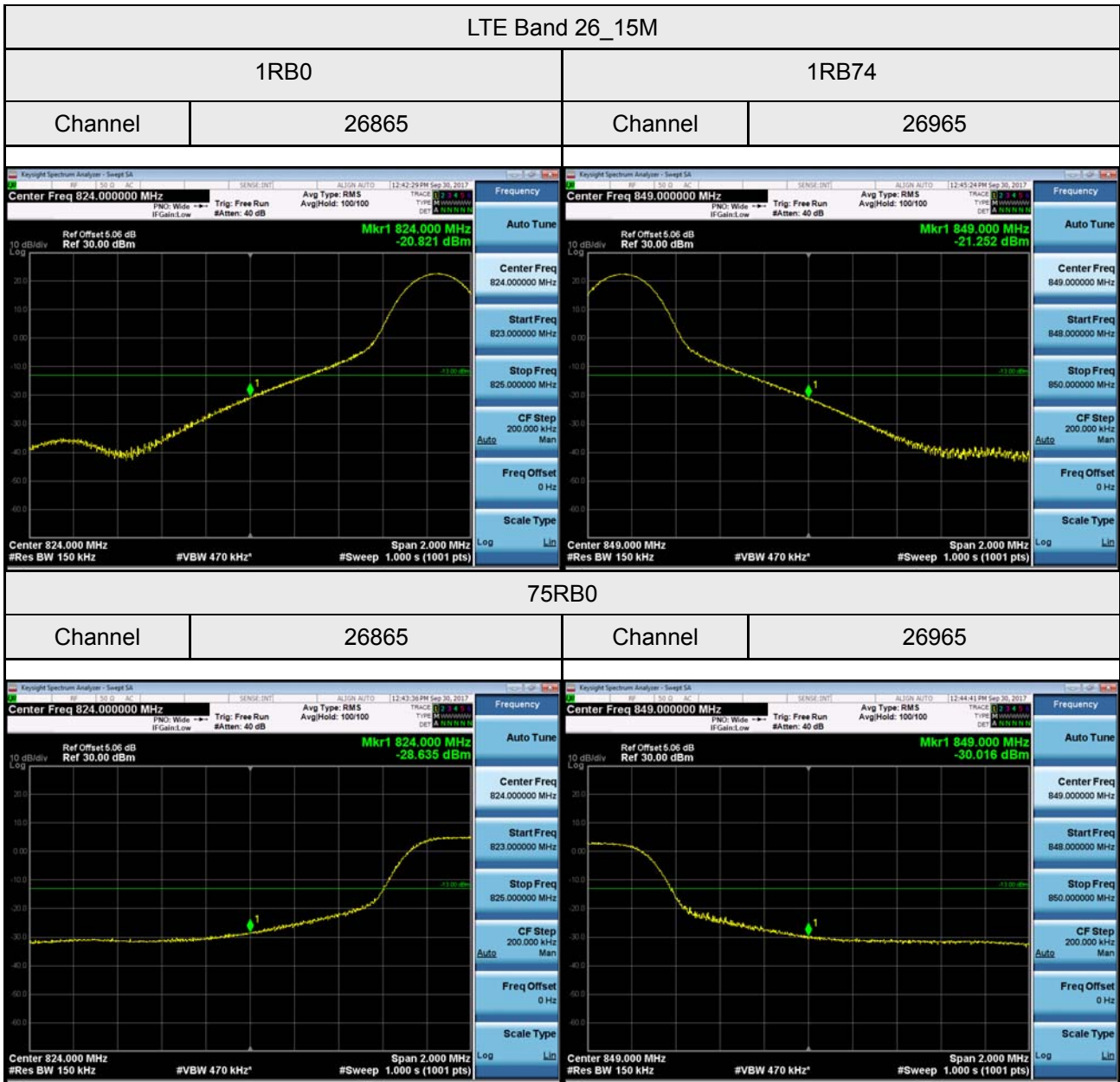

APPENDIX F - PEAK TO AVERAGE RATIO

LTE Band 26 Spectrum Plot_1.4M

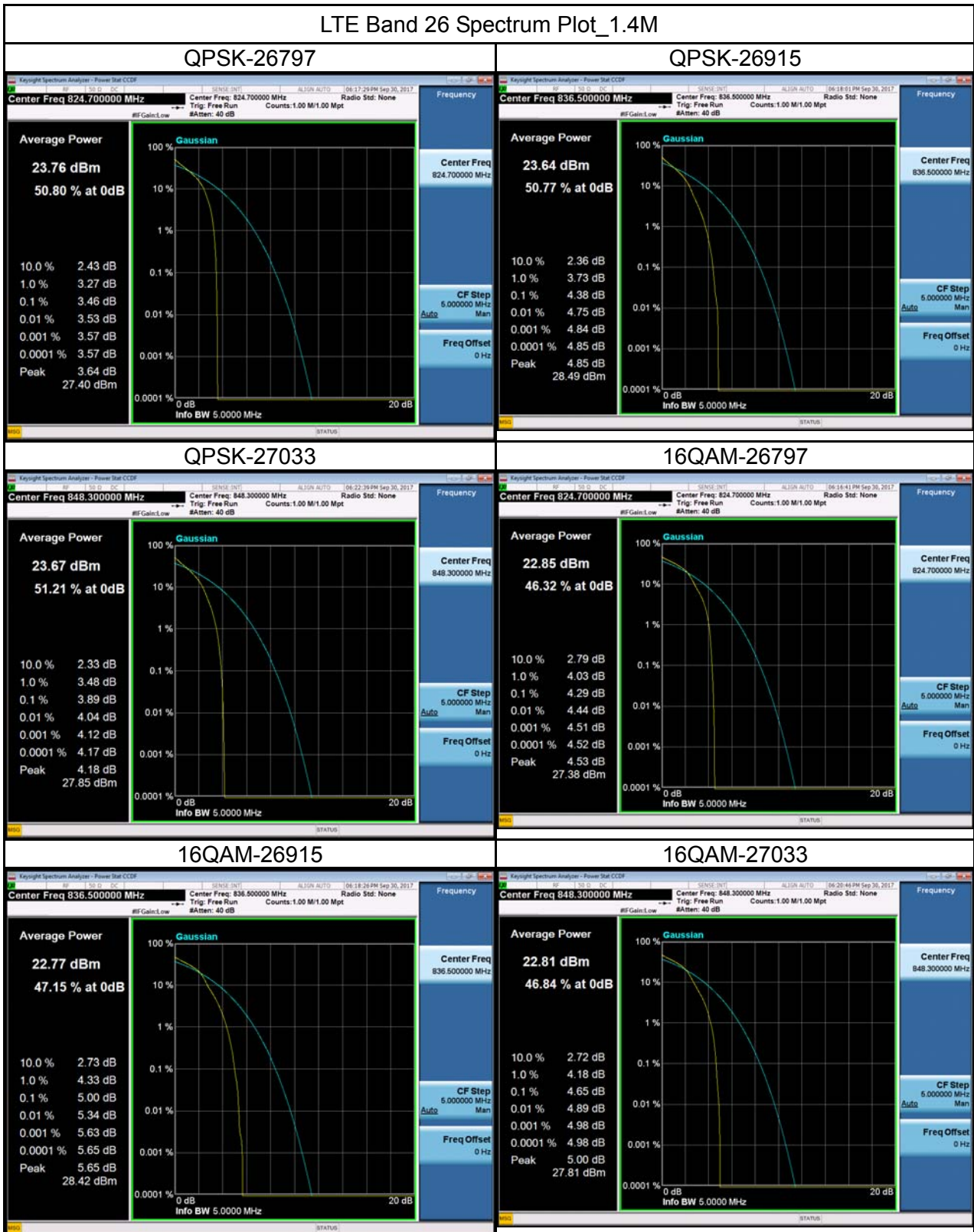

LTE Band 26 Spectrum Plot_3M

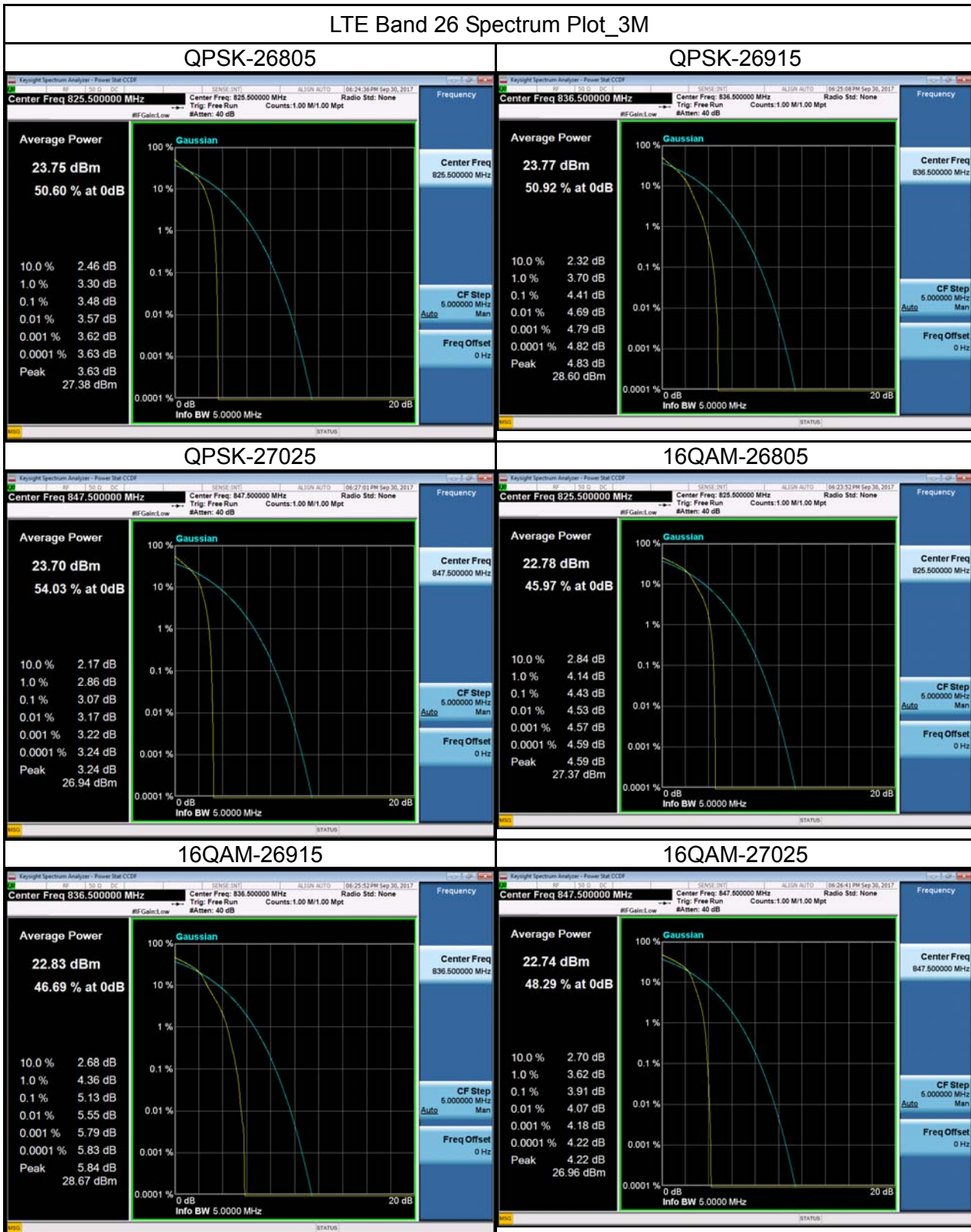

LTE Band 26 Spectrum Plot_5M

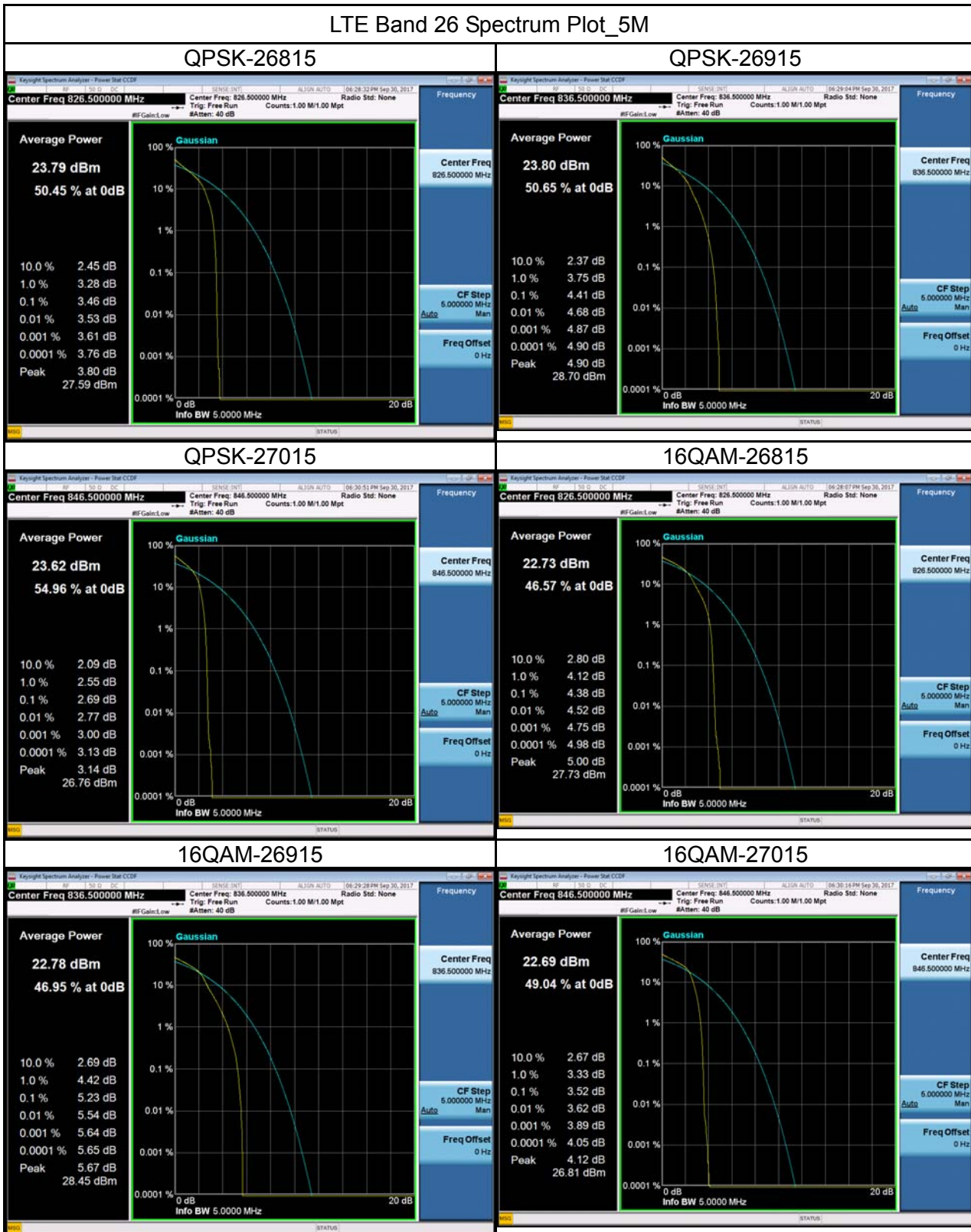

LTE Band 26 Spectrum Plot_10M

QPSK-26840

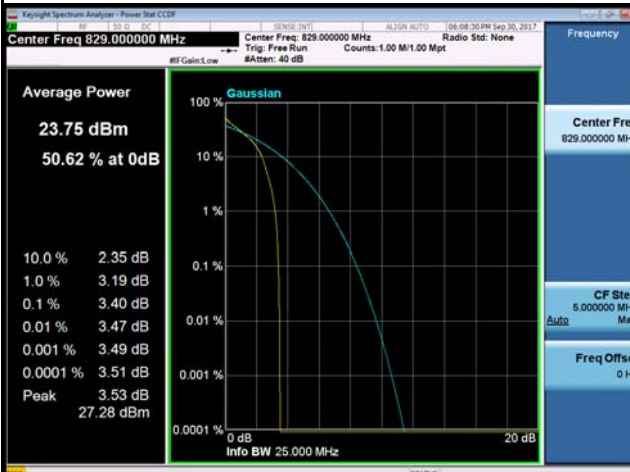

QPSK-26915

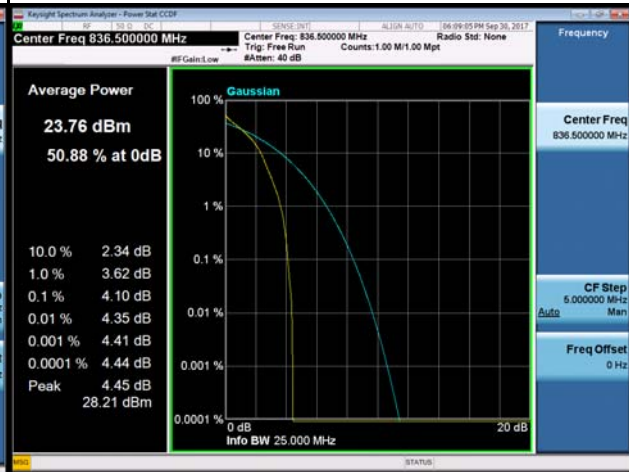

QPSK-26990

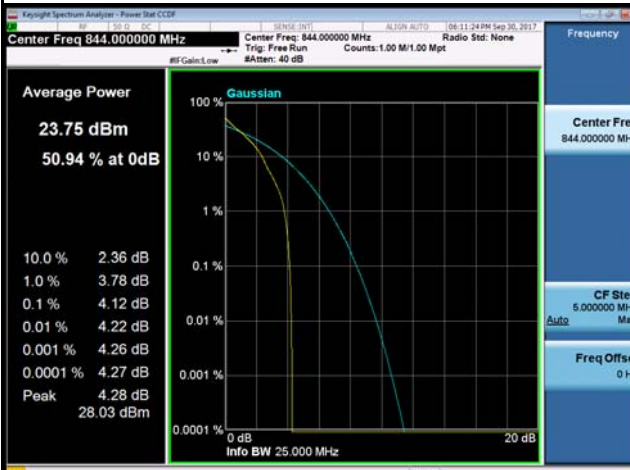

16QAM-26840

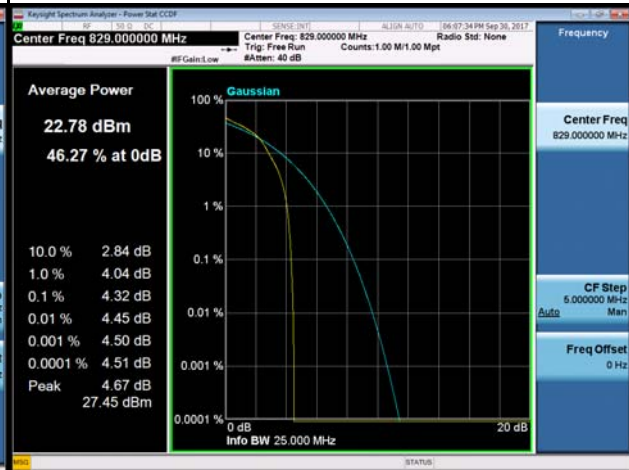

16QAM-26915

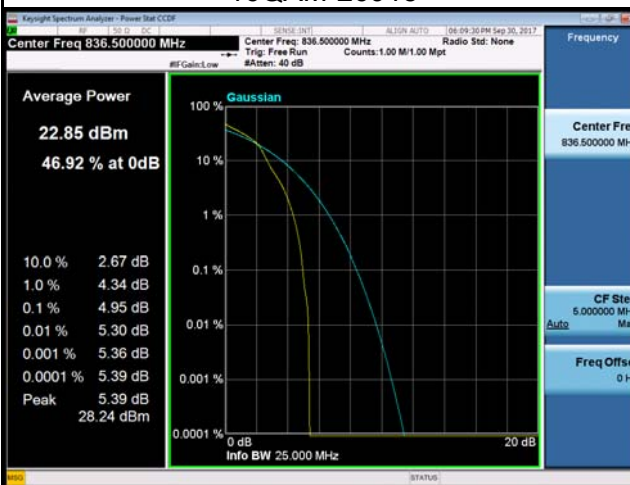

16QAM-26990

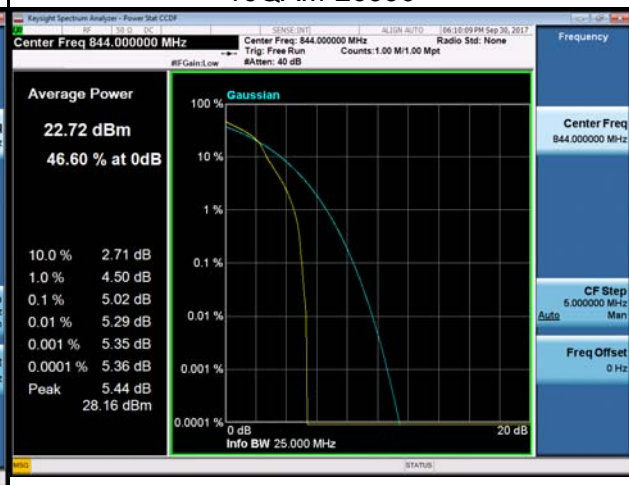

LTE Band 26 Spectrum Plot_15M

QPSK-26865

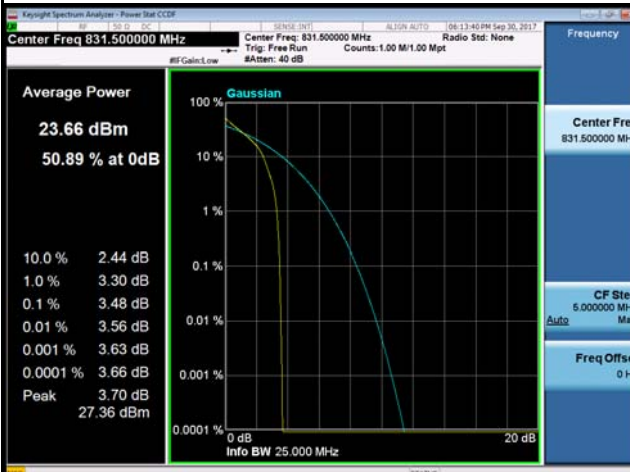

QPSK-26915

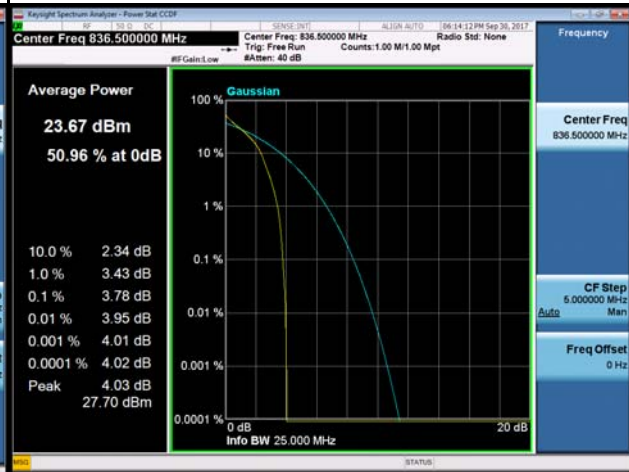

QPSK-26965

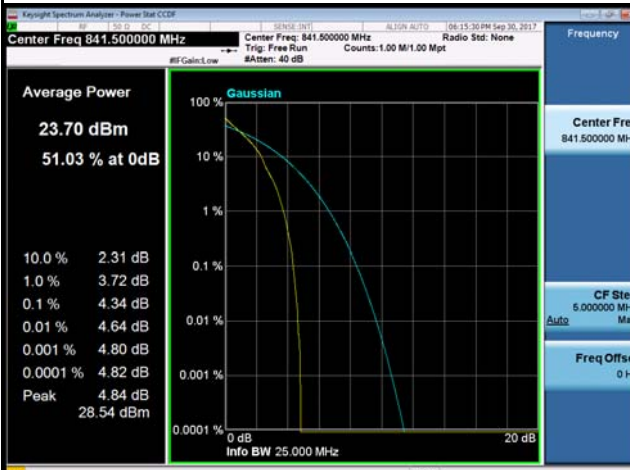

16QAM-26865



16QAM-26915

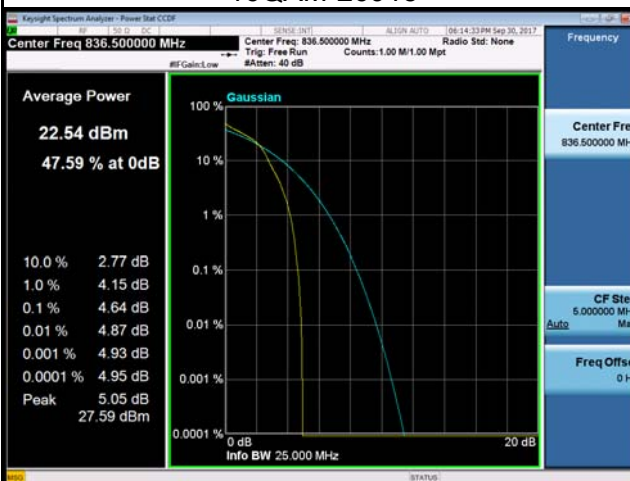

16QAM-26965

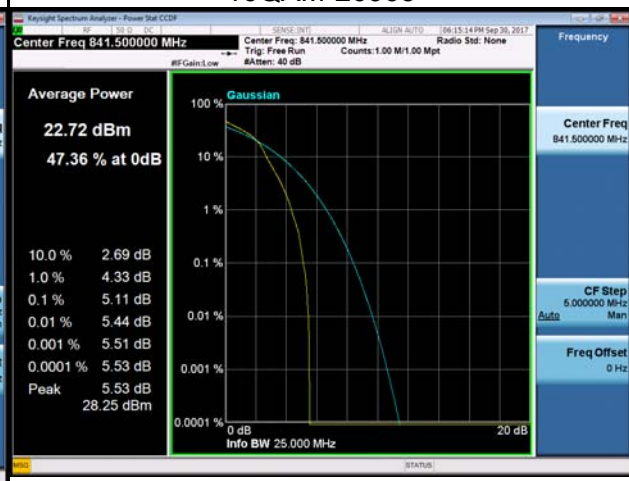

APPENDIX G - FREQUENCY STABILITY

Test Mode:	LTE Band 26_CH26915_1.4M
------------	--------------------------

Temperature vs. Frequency Stability

Temperature(°C)	Frequency Error (Hz)	Frequency Error (ppm)	Limit(ppm)
-30	1.59	0.001900777	2.5
-20	-2.64	0.003156007	2.5
-10	-3.77	0.004506874	2.5
0	2.81	0.003359235	2.5
10	1.90	0.002271369	2.5
20	3.44	0.004112373	2.5
30	-2.86	0.003419008	2.5
40	4.15	0.004961148	2.5
50	2.69	0.003215780	2.5
Max. Deviation (ppm)	4.15	0.004961148	2.5

Voltage vs. Frequency Stability

Voltage(Volts)	Frequency Error (Hz)	Frequency Error (ppm)	Limit(ppm)
3.50	1.81	0.002163778	2.5
3.82	2.06	0.002462642	2.5
4.35	2.54	0.003036461	2.5
Max. Deviation (ppm)	2.54	0.003036461	2.5

Test Mode:	LTE Band 26_CH26915_3M
------------	------------------------

Temperature vs. Frequency Stability

Temperature(°C)	Frequency Error (Hz)	Frequency Error (ppm)	Limit(ppm)
-30	-2.14	0.002558279	2.5
-20	-3.35	0.004004782	2.5
-10	2.73	0.003263598	2.5
0	1.81	0.002163778	2.5
10	-2.66	0.003179916	2.5
20	1.99	0.002378960	2.5
30	-3.84	0.004590556	2.5
40	2.95	0.003526599	2.5
50	3.27	0.003909145	2.5
Max. Deviation (ppm)	3.84	0.004590556	2.5

Voltage vs. Frequency Stability

Voltage(Volts)	Frequency Error (Hz)	Frequency Error (ppm)	Limit(ppm)
3.50	-2.33	0.002785415	2.5
3.82	-2.80	0.003347280	2.5
4.35	3.38	0.004040646	2.5
Max. Deviation (ppm)	3.38	0.004040646	2.5

Test Mode:	LTE Band 26_CH26915_5M
------------	------------------------

Temperature vs. Frequency Stability

Temperature(°C)	Frequency Error (Hz)	Frequency Error (ppm)	Limit(ppm)
-30	2.48	0.002964734	2.5
-20	-3.15	0.003765690	2.5
-10	-4.11	0.004913329	2.5
0	2.59	0.003096234	2.5
10	2.48	0.002964734	2.5
20	-3.18	0.003801554	2.5
30	2.27	0.002713688	2.5
40	1.69	0.002020323	2.5
50	-2.49	0.002976689	2.5
Max. Deviation (ppm)	4.11	0.004913329	2.5

Voltage vs. Frequency Stability

Voltage(Volts)	Frequency Error (Hz)	Frequency Error (ppm)	Limit(ppm)
3.50	2.16	0.002582188	2.5
3.82	1.94	0.002319187	2.5
4.35	-2.66	0.003179916	2.5
Max. Deviation (ppm)	2.66	0.003179916	2.5

Test Mode:	LTE Band 26_CH26915_10M
------------	-------------------------

Temperature vs. Frequency Stability

Temperature(°C)	Frequency Error (Hz)	Frequency Error (ppm)	Limit(ppm)
-30	2.41	0.002881052	2.5
-20	3.67	0.004387328	2.5
-10	2.55	0.003048416	2.5
0	2.90	0.003466826	2.5
10	-3.13	0.003741781	2.5
20	-1.86	0.002223551	2.5
30	1.93	0.002307233	2.5
40	2.43	0.002904961	2.5
50	3.87	0.004626420	2.5
Max. Deviation (ppm)	3.87	0.004626420	2.5

Voltage vs. Frequency Stability

Voltage(Volts)	Frequency Error (Hz)	Frequency Error (ppm)	Limit(ppm)
3.50	3.17	0.003789600	2.5
3.82	2.80	0.003347280	2.5
4.35	3.49	0.004172146	2.5
Max. Deviation (ppm)	3.49	0.004172146	2.5

Test Mode:	LTE Band 26_CH26915_15M
------------	-------------------------

Temperature vs. Frequency Stability

Temperature(°C)	Frequency Error (Hz)	Frequency Error (ppm)	Limit(ppm)
-30	2.21	0.002641961	2.5
-20	3.64	0.004351464	2.5
-10	2.97	0.003550508	2.5
0	-2.48	0.002964734	2.5
10	-3.61	0.004315601	2.5
20	2.51	0.003000598	2.5
30	1.93	0.002307233	2.5
40	2.83	0.003383144	2.5
50	3.36	0.004016736	2.5
Max. Deviation (ppm)	3.64	0.004351464	2.5

Voltage vs. Frequency Stability

Voltage(Volts)	Frequency Error (Hz)	Frequency Error (ppm)	Limit(ppm)
3.50	2.69	0.00321578	2.5
3.82	-3.85	0.00460251	2.5
4.35	2.58	0.00308428	2.5
Max. Deviation (ppm)	3.85	0.00460251	2.5