



中国认可
国际互认
检测
TESTING
CNAS L0310



FCC

RF Test Report

Product Name: Smart Phone

Model Number: BLA-L29

Report No: SYBH(Z-RF)006092017-2005

FCC ID: QISBLA-L29

Reliability Laboratory of Huawei Technologies Co.

(Global Compliance and Testing Center of Huawei Technologies Co., Ltd)

Administration Building, Headquarters of Huawei Technologies Co., Ltd., Bantian, Longgang District,
Shenzhen, 518129, P.R.C

Tel: +86 755 28780808

Fax: +86 755 89652518

Notice

1. The laboratory has Passed the accreditation by China National Accreditation Service for Conformity Assessment (CNAS). The accreditation number is L0310.
2. The laboratory has Passed the accreditation by The American Association for Laboratory Accreditation (A2LA). The accreditation number is 2174.01.
3. The laboratory has been recognized by the US Federal Communications Commission (FCC) to perform compliance testing subject to the Commission's Declaration Of Conformity (DOC) and Certification rules. The Designation Number is CN1173, and the Test Firm Registration Number is 294140.
4. The laboratory has been listed by Industry Canada to perform electromagnetic emission measurements. The recognition numbers of test site are 6369A-1.
5. The test report is invalid if not marked with the signatures of the persons responsible for preparing and approving the test report.
6. The test report is invalid if there is any evidence of erasure and/or falsification.
7. The test report is only valid for the test samples.
8. Content of the test report, in part or in full, cannot be used for publicity and/or promotional purposes without prior written approval from the laboratory.
9. The laboratory (Reliability Lab of Huawei Technologies Co., Ltd) is also named as "Global Compliance and Testing Center of Huawei Technologies Co., Ltd", the both names have coexisted since 2009.



Applicant: Huawei Technologies Co., Ltd.
Address: Administration Building, Headquarters of Huawei Technologies Co., Ltd.,
 Bantian, Longgang District, Shenzhen, 518129, P.R.C

Date of Receipt Sample: 2017-08-28
Start Date of Test: 2017-08-28
End Date of Test: 2017-09-22

Test Result: Pass

Approved by Senior Engineer:	2017-09-25	Roger Zhang	<i>Roger Zhang</i>
	Date	Name	Signature

Prepared by:	2017-09-25	zhoulingbo	<i>zhoulingbo</i>
	Date	Name	Signature



CONTENT

1 General Information..... 5

 1.1 Applied Standard..... 5

 1.2 Test Location..... 5

 1.3 Test Environment Condition 5

2 Test Summary 6

3 Description of the Equipment under Test (EUT)..... 7

 3.1 General Description..... 7

 3.2 EUT Identity 7

 3.3 Technical Description..... 9

4 General Test Conditions / Configurations 10

 4.1 EUT Configurations..... 10

 4.2 Test Environments 11

 4.3 Antenna requirements 11

 4.4 Description of tests..... 12

 4.5 Test Setups..... 15

 4.6 Test Conditions..... 18

5 Main Test Instruments..... 20

6 Appendixes 21

1 General Information

1.1 Applied Standard

Applied Rules: 47 CFR FCC Part 2, Subpart J
47 CFR FCC Part 15, Subpart C

Test Method: FCC PUBLIC NOTICE DA 00-705 Filing and Measurement Guidelines for Frequency Hopping Spread Spectrum Systems (Released March 30, 2000)

ANSI C63.4-2014, American National Standard for Methods of Measurement of Radio-Noise Emissions from Low-Voltage Electrical and Electronic Equipment in the Range of 9 kHz to 40 GHz.

ANSI C63.10-2013, American National Standard for Testing Unlicensed Wireless Devices.

1.2 Test Location

Test Location : Reliability Laboratory of Huawei Technologies Co., Ltd.
Address : Administration Building, Headquarters of Huawei Technologies Co., Ltd., Bantian, Longgang District, Shenzhen, 518129, P.R.C

1.3 Test Environment Condition

Ambient Temperature: 19.5 to 25 °C
Ambient Relative Humidity: 45 to 55 %
Atmospheric Pressure: Not applicable

2 Test Summary

Test Item	FCC Part No.	Requirements	Test Result	Verdict (NOTE)
20dB Emission Bandwidth (EBW)	15.247(a)(1)	No limit.	Appendix A	Pass
Carrier Frequency Separation	15.247(a)(1)	$\geq \text{MAX} \{25\text{kHz}, \text{IFF}\{\text{output power} \leq 125\text{mW}, 2/3 * 20\text{dB EBW}, 20\text{dB EBW}\}\}$.	Appendix B	Pass
Number of Hopping Channel	15.247(a)(1)(iii)	≥ 15 channels.	Appendix C	Pass
Time of Occupancy (Dwell Time)	15.247(a)(1)(iii)	$< 0.4\text{s}$ within a period of $(0.4\text{s} * \text{hopping number})$.	Appendix D	Pass
Maximum Peak Conducted Output Power	15.247(b)(1)	$< 1\text{ W}$ if using ≥ 75 non-overlapping channels.	Appendix E	Pass
Band edge spurious emission	15.247(d)	$< -20\text{ dB}/100\text{ kHz}$ if total peak power \leq power limit.	Appendix F	Pass
Conducted RF Spurious Emission			Appendix G	Pass
Radiated Emissions in the Restricted Bands	15.247(d) 15.209	FCC Part 15.209 field strength limit;	Appendix H	Pass
AC Power Line Conducted Emissions	15.207	FCC Part 15.207 conducted limit;	Appendix I	Pass
NOTE1: For the verdict, the "N/A" denotes "not applicable", the "N/T" denotes "not tested".				



3 Description of the Equipment under Test (EUT)

3.1 General Description

BLA-L29 is subscriber equipment in the LTE/ WCDMA/GSM system. The LTE frequency band is Band 1,Band 2,Band 3,Band 4,Band 5, Band 6, Band 7,Band 8, Band 9,Band 12,Band17, Band 18 ,Band 19, Band 20, Band 26, Band 28, Band 32,Band 34,Band 38,Band39, Band 40 and Band 41. The HSUPA/HSDPA/UMTS frequency band is Band I, Band II, Band IV, Band V, Band VI, Band VIII and Band XIX, The GSM/GPRS/EDGE frequency band includes GSM850 and GSM900 and DCS1800 and PCS1900, The Mobile Phone implements such functions as RF signal receiving/transmitting, LTE/ WCDMA /GSM protocol processing, voice, video, MMS service, GPS, NFC and WIFI etc. Externally it provides earphone port (to provide voice service) and dual USIM card interfaces. It also provides Bluetooth module to synchronize data between a PC and the phone, or to use the built-in modem of the phone to access the Internet with a PC, or to exchange data with other Bluetooth devices..

NOTE: Only Bluetooth test data included in this report.















3.2 EUT Identity

NOTE: Unless otherwise noted in the report, the functional boards installed in the units shall be selected from the below list, but not means all the functional boards listed below shall be installed in one unit.

3.2.1 Board

Board		
Description	Hardware Version	Software Version
Main board	HL1BLAM	BLA-L29 8.0.0.69(C432)

3.2.2 Sub-Assembly

Sub-Assembly			
Sub-Assembly Name	Model	Manufacturer	Description
Adapter	HW-050450B00	Huawei Technologies Co., Ltd.	Input Voltage: 100-240V ~50/60Hz, 0.75A Output Voltage: 5V  2A 4.5V  5A 5V  4.5A Rated Power: 10W/22.5W
Adapter	HW-050450E00	Huawei Technologies Co., Ltd.	Input Voltage: 100-240V ~50/60Hz, 0.75A Output Voltage: 5V  2A 4.5V  5A 5V  4.5A Rated Power: 10W/22.5W
Adapter	HW-050450U00	Huawei Technologies Co., Ltd.	Input Voltage: 100-240V ~50/60Hz, 0.75A Output Voltage: 5V  2A 4.5V  5A 5V  4.5A Rated Power: 10W/22.5W
Adapter	HW-050450A00	Huawei Technologies Co., Ltd.	Input Voltage: 100-240V ~50/60Hz, 0.75A Output Voltage: 5V  2A 4.5V  5A 5V  4.5A Rated Power: 10W/22.5W
Rechargeable Li-ion	HB436486ECW	Huawei Technologies Co., Ltd.	Rated capacity: 3900mAh Nominal Voltage:  +3.82V Charging Voltage:  +4.4V

3.3 Technical Description

Characteristics	Description	
TX/RX Operating Range	2400-2483.5 MHz band	$f_c = 2402 \text{ MHz} + N * 1 \text{ MHz}$, where: <ul style="list-style-type: none">- f_c = "Operating Frequency" in MHz,- N = "Channel Number" with the range from 0 to 78.
Modulation Type	Carrier	Frequency Hopping Spread Spectrum (FHSS)
	Digital	GFSK, $\pi/4$ -DQPSK, 8DPSK
Emission Designator	GFSK: 1M02FXD $\pi/4$ -DQPSK: 1M35GXD 8DPSK: 1M35GXD	
Bluetooth Power Class	Class 1	

4 General Test Conditions / Configurations

4.1 EUT Configurations

4.1.1 General Configurations

Configuration	Description
Test Antenna Ports	Until otherwise specified, <ul style="list-style-type: none"> - All TX tests are performed at all TX antenna ports of the EUT, and - All RX tests are performed at all RX antenna ports of the EUT.
Multiple RF Sources	Other than the tested RF source of the EUT, other RF source(s) are disabled or shutdown during measurements.

4.1.2 Customized Configurations

# EUT Conf.	Signal Description	Operating Frequency
TM1_DH5_Hop	GFSK modulation, package type DH5, hopping on.	---
TM1_DH5_Ch0	GFSK modulation, package type DH5, hopping off.	Ch No. 0 / 2402 MHz
TM1_DH5_Ch39	GFSK modulation, package type DH5, hopping off.	Ch No. 39 / 2441 MHz
TM1_DH5_Ch78	GFSK modulation, package type DH5, hopping off.	Ch No. 78 / 2480 MHz
TM2_2DH5_Hop	$\pi/4$ -DQPSK modulation, package type 2DH5, hopping on.	---
TM2_2DH5_Ch0	$\pi/4$ -DQPSK modulation, package type 2DH5, hopping off.	Ch No. 0 / 2402 MHz
TM2_2DH5_Ch39	$\pi/4$ -DQPSK modulation, package type 2DH5, hopping off.	Ch No. 39 / 2441 MHz
TM2_2DH5_Ch78	$\pi/4$ -DQPSK modulation, package type 2DH5, hopping off.	Ch No. 78 / 2480 MHz
TM3_3DH5_Hop	8DPSK modulation, package type 3DH5, hopping on.	---
TM3_3DH5_Ch0	8DPSK modulation, package type 3DH5, hopping off.	Ch No. 0 / 2402 MHz
TM3_3DH5_Ch39	8DPSK modulation, package type 3DH5, hopping off.	Ch No. 39 / 2441 MHz
TM3_3DH5_Ch78	8DPSK modulation, package type 3DH5, hopping off.	Ch No. 78 / 2480 MHz



4.2 Test Environments

NOTE: The values used in the test report may be stringent than the declared.

Environment Parameter	Selected Values During Tests		
	Temperature	Voltage	Relative Humidity
NT/NV	Ambient	3.82VDC	Ambient

4.3 Antenna requirements

Excerpt from §15.203 of the FCC Rules/Regulations:

“An intentional radiator antenna shall be designed to ensure that no antenna other than that furnished by the responsible party can be used with the device. The use of a permanently attached antenna or of an antenna that uses a unique coupling to the intentional radiator shall be considered sufficient to comply with the provisions of this section.”

The antennas of the **BLA-L29 permanently attached.**

There are no provisions for connection to an external antenna.

Conclusion:

The **Smart Phone FCC ID: QISBLA-L29** unit complies with the requirement of §15.203.

Ch. Frequency (MHz)

Ch.	Frequency (MHz)
00	2402
.	.
.	.
39	2441
.	.
.	.
78	2480

Frequency/ Channel Operations

4.4 Description of tests

4.4.1 Bandwidth measurement

- (a) Connect EUT test port to universal communication tester.
- (b) Set the EUT to transmit maximum output power at 2.4GHz and switch off frequency hopping function, then set the measuring frequency number, finally test the bandwidth with universal communication tester.

4.4.2 Carrier frequency separation measurement

- (a) Connect EUT test port to spectrum analyzer and universal communication tester.
- (b) Set the EUT to transmit maximum output power at 2.4GHz and switch off frequency hopping function, then set the measured frequency number to two adjacent channels separately and test the carrier frequency separation with spectrum analyzer.

4.4.3 Number of hopping channel

- (a) Connect EUT test port to spectrum analyzer and universal communication tester.
- (b) Set the EUT to transmit maximum output power at 2.4GHz and switch on frequency hopping function, then set enough count time (larger than 5000 times) to get all the hopping frequency channel displayed on the screen of spectrum analyzer.
- (c) Count the quantity of peaks to get the number of hopping channels.

4.4.4 Time of occupancy

- (a) Connect test port of EUT to spectrum analyzer and universal communication tester.
- (b) Set the EUT to transmit maximum output power at 2.4GHz and switch on frequency hopping function.
- (c) Set the span of spectrum analyzer to 0 Hz, and set the resolution bandwidth to 1 MHz and the video bandwidth to 1 MHz, then get the time domain measured diagram. and set sweep time to 2 times of one burst occupancy time, and measure the time of occupancy of one burst.
- (d) Set the resolution bandwidth to 1 MHz and the video bandwidth to 3 MHz, and set the sweep time to a period (0.4 seconds multiplied by the number of hopping channels employed), and count the number of the bursts.
- (e) Calculate the time of occupancy in a period with time occupancy of a burst and quantity of bursts

4.4.5 Peak output power

- (a) Connect EUT test port to spectrum analyzer and universal communication tester.
- (b) Set the EUT to transmit maximum output power at 2.4GHz and switch off frequency hopping function.
- (c) Then set the EUT to transmit at high, middle and low frequency and measure the conducted output power separately.

4.4.6 Band edge spurious emission

- (a) Connect EUT test port to spectrum analyzer and universal communication tester
- (b) Set the EUT to transmit maximum output power at 2.4GHz and switch off frequency hopping function.
- (c) Then set the EUT to transmit at high, low frequency and measure the conducted band edge spurious separately.
- (d) Switch on the frequency hopping function, and repeat above measurement.

4.4.7 Conducted RF Spurious

- (a) Connect EUT test port to spectrum analyzer and universal communication tester
- (b) Set the EUT to transmit maximum output power at 2.4GHz and switch off frequency hopping function.
- (c) Then set the EUT to transmit at high, middle and low frequency and measure the conducted spurious separately.
- (d) Switch on the frequency hopping function, and repeat the above measurement.

4.4.8 Radiated spurious emission & spurious in restricted band

The test site semi-anechoic chamber has met the requirement of NSA tolerance 4dB according to the standards: ANSI C63.10 (2013). The EUT was set-up on insulator 80cm above the Ground Plane. The set-up and test methods were according to ANSI C63.10:2013. The Radiated Disturbance measurements were made using a Rohde and Schwarz Test Receiver and control software.

A preliminary scan and a final scan of the emissions were made by using test script of software; the emissions were measured using a Quasi-Peak Detector below 1GHz, Peak Detector and AV detector above 1GHz. The maximal emission value was acquired by adjusting the antenna height, polarisation and turntable azimuth in accordance with the software setup. Normally, the height range of antenna was 1m to 4m, and the azimuth range of turntable was 0° to 360°. The receive antenna has two polarizations V and H.

A portable or small unlicensed wireless device shall be placed on a non-metallic test fixture or other nonmetallic support during testing. The supporting fixture shall permit orientation of the EUT in each of three orthogonal (x, y, z) axis positions such that emissions from the EUT are maximized.

The EUT communicates with the BTS simulator through Air interface. The EUT transmits maximum output power at 2.4GHz and switch off frequency hopping function.

Measurement bandwidth: 30 MHz - 1000 MHz: 120 kHz

Measurement bandwidth: 1000 MHz - 10th Carrier Frequency: 1 MHz

4.4.9 Conducted Emission at Power Port

The Table-top EUT was placed upon a non-metallic table 0.8 m above the horizontal metal reference ground plane. EUT was connected to LISN and LISN was connected to reference Ground Plane. EUT was 80cm from LISN. The set-up and test methods were according to ANSI C63.10: 2013.



Conducted Disturbance at AC Port measurements were undertaken on the L and N Lines. The emissions were measured using a Quasi-Peak Detector and Average Detector.

The EUT communicates with the BTS simulator through Air interface, the BTS simulator controls the EUT to transmitter the maximum power which defined in specification of product. The EUT operated on the typical channel.

Measurement bandwidth (RBW) for 150kHz to 30 MHz: 9 kHz;

4.5 Test Setups

4.5.1 Test Setup 1

The Bluetooth component's antenna ports(s) of the EUT are connected to the measurement instrument per an appropriate attenuator. The EUT is controlled by Bluetooth System Simulator and/or PC/software to emit the specified signals for the purpose of measurements.

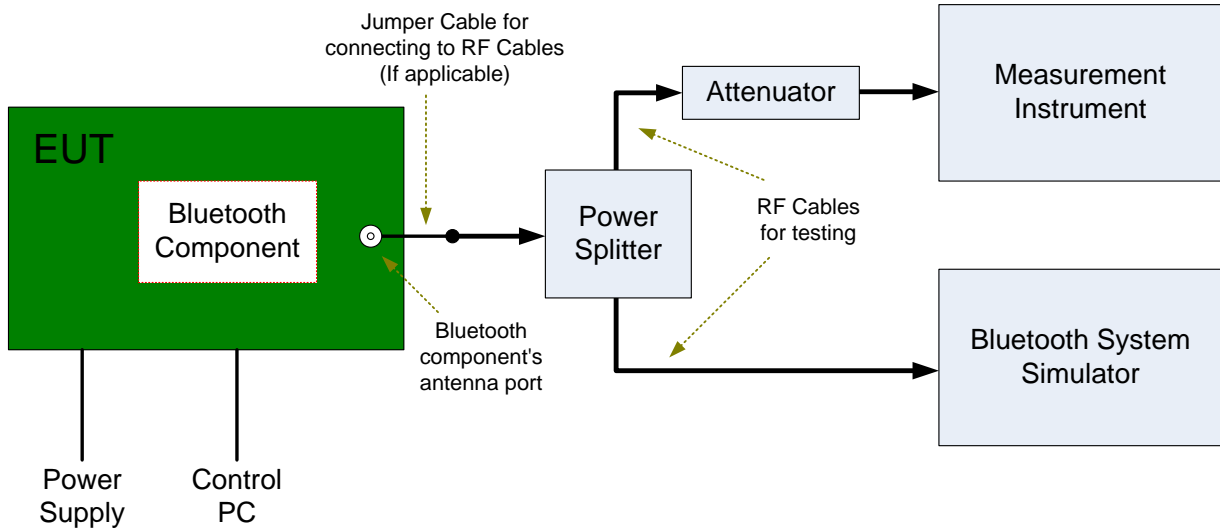

4.5.2 Test Setup 2

The test site semi-anechoic chamber has met the requirement of NSA tolerance 4 dB according to the standards: ANSI C63.4. The test distance is 3m. The setup is according to ANSI C63.4 and CAN/CSA-CEI/IEC CISPR 22.

The maximal emission value is acquired by adjusting the antenna height, polarisation and turntable azimuth. Normally, the height range of antenna is 1 m to 4 m, the azimuth range of turntable is 0° to 360°, and the receive antenna has two polarizations Vertical (V) and Horizontal (H).

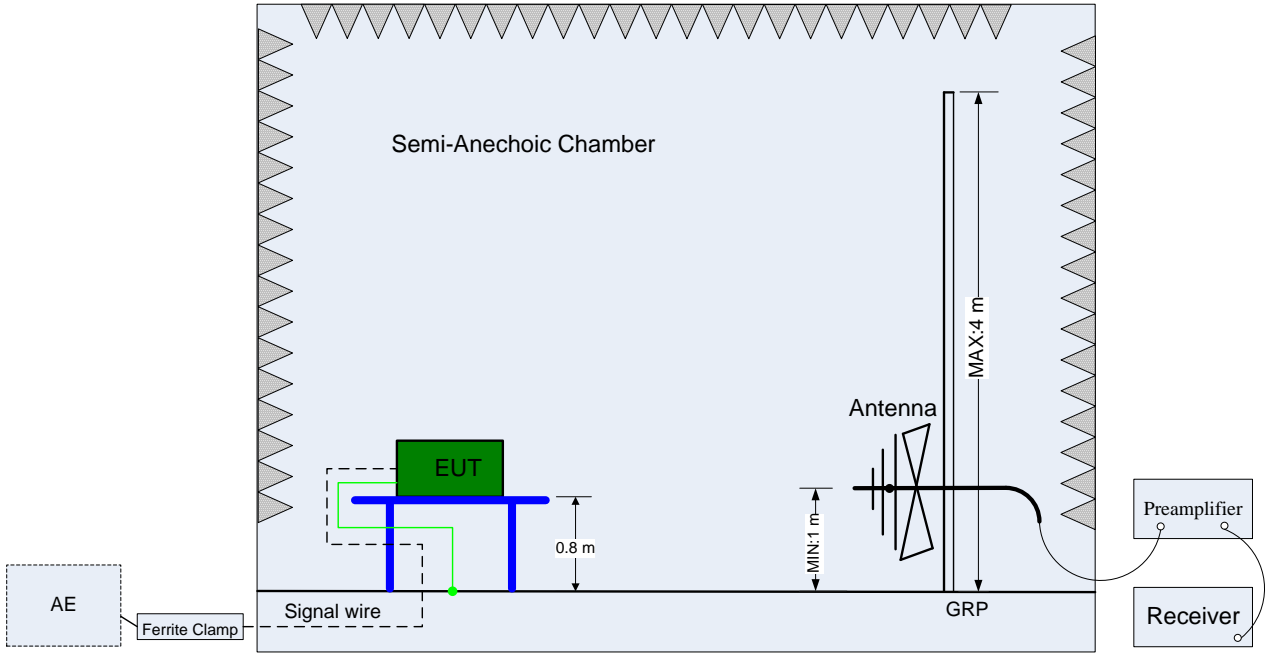

(Below 1 GHz)

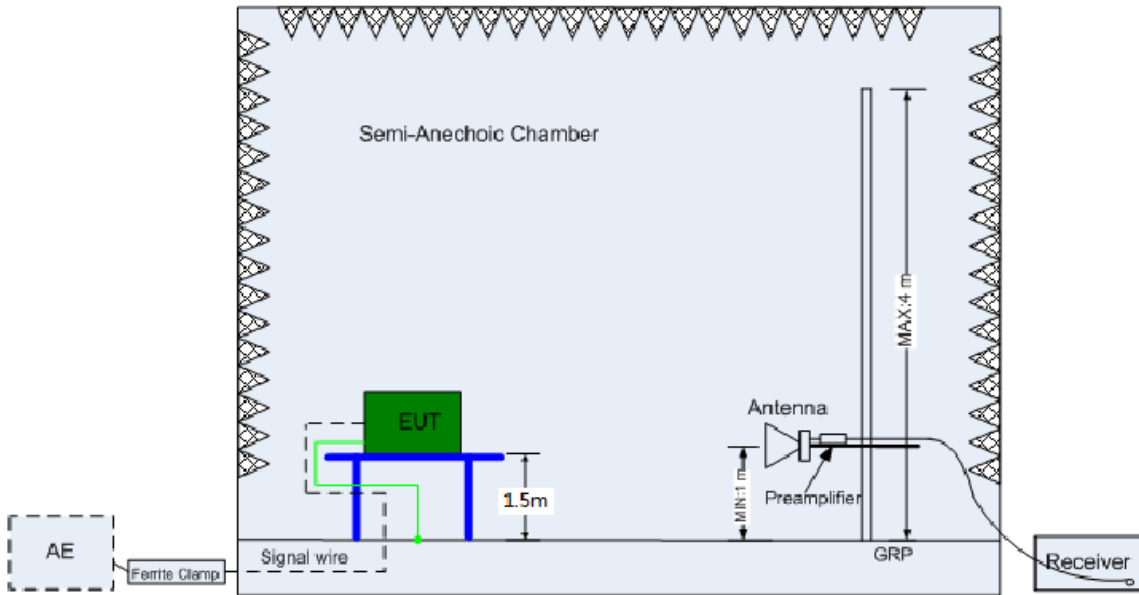

(Above 1 GHz)

4.5.3 Test Setup 3

The mains cable of the EUT (maybe per AC/DC Adapter) must be connected to LISN. The LISN shall be placed 0.8 m from the boundary of EUT and bonded to a ground reference plane for LISN mounted on top of the ground reference plane. This distance is between the closest points of the LISN and the EUT. All other units of the EUT and associated equipment shall be at least 0.8m from the LISN.

Ground connections, where required for safety purposes, shall be connected to the reference ground point of the LISN and, where not otherwise provided or specified by the manufacturer, shall be of same length as the mains cable and run parallel to the mains connection at a separation distance of not more than 0.1 m.

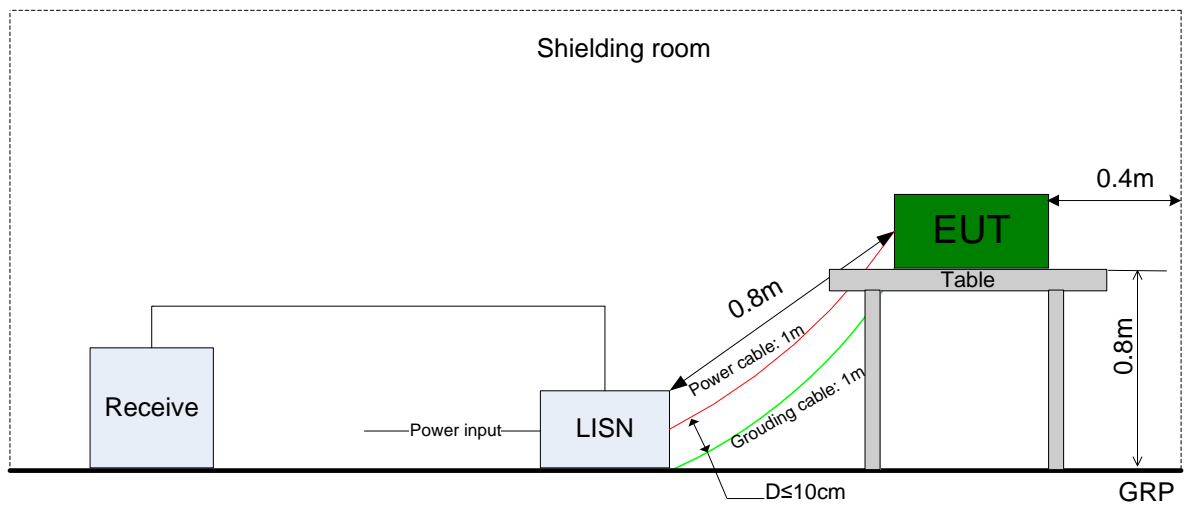

4.6 Test Conditions

Test Case	Test Conditions	
	Configuration	Description
20dB Emission Bandwidth (EBW)	Meas. Method	DA 00-705
	Test Env.	NT/NV
	Test Setup	Test Setup 1
	EUT Conf.	TM1_DH5_Ch0, TM1_DH5_Ch39, TM1_DH5_Ch78, TM2_2DH5_Ch0, TM2_2DH5_Ch39, TM2_2DH5_Ch78, TM3_3DH5_Ch0, TM3_3DH5_Ch39, TM3_3DH5_Ch78.
Carrier Frequency Separation	Meas. Method	DA 00-705
	Test Env.	NT/NV
	Test Setup	Test Setup 1
	EUT Conf.	TM1_DH5_Hop, TM2_2DH5_Hop, TM3_3DH5_Hop.
Number of Hopping Channel	Meas. Method	DA 00-705
	Test Env.	NT/NV
	Test Setup	Test Setup 1
	EUT Conf.	TM1_DH5_Hop, TM2_2DH5_Hop, TM3_3DH5_Hop.
Time of Occupancy (Dwell Time)	Meas. Method	DA 00-705
	Test Env.	NT/NV
	Test Setup	Test Setup 1
	EUT Conf.	TM1_DH5_Ch39, TM2_2DH5_Ch39, TM3_3DH5_Ch39.
Maximum Peak Conducted Output Power	Meas. Method	DA 00-705
	Test Env.	NT/NV
	Test Setup	Test Setup 1
	EUT Conf.	TM1_DH5_Ch0, TM1_DH5_Ch39, TM1_DH5_Ch78, TM2_2DH5_Ch0, TM2_2DH5_Ch39, TM2_2DH5_Ch78, TM3_3DH5_Ch0, TM3_3DH5_Ch39, TM3_3DH5_Ch78.
Band edge spurious emission	Meas. Method	DA 00-705
	Test Env.	NT/NV
	Test Setup	Test Setup 1
	EUT Conf.	TM1_DH5_Ch0, TM1_DH5_Ch78, TM2_2DH5_Ch0, TM2_2DH5_Ch78, TM3_3DH5_Ch0, TM3_3DH5_Ch78.
Conducted RF Spurious Emission	Meas. Method	DA 00-705
	Test Env.	NT/NV

Test Case	Test Conditions		
	Configuration	Description	
	Test Setup	Test Setup 1	
	EUT Conf.	TM1_DH5_Ch0, TM1_DH5_Ch39, TM1_DH5_Ch78, TM2_2DH5_Ch0, TM2_2DH5_Ch39, TM2_2DH5_Ch78, TM3_3DH5_Ch0, TM3_3DH5_Ch39, TM3_3DH5_Ch78.	
	Meas. Method	DA 00-705, C63.4, C63.10. (1) 30 MHz to 1 GHz: Pre: RBW = 100 kHz; VBW = 300 kHz; Det. = Peak. Final: RBW = 120 kHz; Det. = CISPR Quasi-Peak. (2) 1 GHz to 26.5 GHz: Average: RBW = 1 MHz; VBW = 10 Hz; Det. = Peak; Sweep-time = Auto; Trace = Single. Peak: RBW = 1 MHz; VBW = 3 MHz; Det. = Peak; Sweep-time = Auto; Trace ≥ Max Hold * 100.	
	Test Env.	NT/NV	
Radiated Emissions in the Restricted Bands	Test Setup	Test Setup 2	
	EUT Conf.	30 MHz -1 GHz	TM1_DH5_Ch0 (Worst Conf.).
		1-3 GHz	TM1_DH5_Ch0, TM1_DH5_Ch39, TM1_DH5_Ch78, TM2_2DH5_Ch0, TM2_2DH5_Ch39, TM2_2DH5_Ch78, TM3_3DH5_Ch0, TM3_3DH5_Ch39, TM3_3DH5_Ch78.
		3-18 GHz	TM1_DH5_Ch0 (Worse Conf.), TM1_DH5_Ch39 (Worse Conf.), TM1_DH5_Ch78 (Worse Conf.).
		18-26.5 GHz	TM1_DH5_Ch0 (Worst Conf.).
AC Power Line Conducted Emissions	Meas. Method	AC mains conducted. Pre: RBW = 10 kHz; Det. = Peak. Final: RBW = 9 kHz; Det. = CISPR Quasi-Peak & Average.	
	Test Env.	NT/NV	
	Test Setup	Test Setup 3	
	EUT Conf.	TM1_DH5_Ch39.	

**5 Main Test Instruments**

Main Test Equipments					
Equipment Name	Manufacturer	Model	Serial Number	Cal Date	Cal- Due
Power supply	KEITHLEY	2303	1342889	2016/10/13	2017/10/12
Wireless Communication Test set	Agilent	N4010A	MY49081592	2017/7/31	2018/7/30
Universal Radio Communication Tester	R&S	CMU200	123299	2016/11/14	2017/11/13
Spectrum Analyzer	Agilent	N9020A	MY52090652	2017/7/10	2018/7/9
Universal Radio Communication Tester	R & S	CMW500	126854	2016/12/29	2017/12/28
Signal Analyzer	R&S	FSQ31	200021	2017/7/31	2018/7/30
Spectrum Analyzer	Agilent	N9030A	MY49431698	2017/7/31	2018/7/30
Temperature Chamber	WEISS	WKL64	56246002940010	2016/12/21	2017/12/20
Signal generator	Agilent	E8257D	MY49281095	2017/7/31	2018/7/30
Vector Signal Generator	R&S	SMU200A	104162	2017/7/31	2018/7/30
Test receiver	R&S	ESU26	100387	2017/2/21	2018/2/20
Test receiver	R&S	ESCI	101163	2016/11/10	2017/11/9
Spectrum analyzer	R&S	FSU3	200474	2017/2/21	2018/2/20
Spectrum analyzer	R&S	FSU43	100144	2017/2/21	2018/2/20
LOOP Antennas(9kHz-30MHz)	R&S	HFH2-Z2	100262	2017/4/25	2019/4/25
LOOP Antennas(9kHz-30MHz)	R&S	HFH2-Z2	100263	2017/4/25	2019/4/25
Trilog Broadband Antenna (30M~3GHz)	SCHWARZBEC K	VULB 9163	9163-490	2017/3/29	2019/3/29
Trilog Broadband Antenna (30M~3GHz)	SCHWARZBEC K	VULB 9163	9163-521	2017/4/9	2019/4/9
Double-Ridged Waveguide Horn Antenna (1G~18GHz)	R&S	HF907	100304	2017/5/27	2019/5/27
Pyramidal Horn Antenna(18GHz-26.5GHz)	ETS-Lindgren	3160-09	206665	2017/3/24	2018/3/23
Artificial Main Network	R&S	ENV4200	100134	2017/5/15	2018/5/14



Line Impedance Stabilization Network	R&S	ENV216	100382	2017/5/15	2018/5/14
Signal Generator	Agilent	E4438C	MY49071538	2016/12/15	2017/12/14
Power Detecting & Sampling Unit	R&S	OSP-B157	100914	2017/7/31	2018/7/30
Software Information					
Test Item	Software Name		Manufacturer		Version
RE	EMC32		R&S		V9.25.0
CE	EMC32		R&S		V9.25.0

6 Appendixes

Appendix No.	Description
SYBH(Z-RF)006092017-2005-A	Appendix for Bluetooth

END