



中国认可  
国际互认  
检测  
TESTING  
CNAS L0310



# FCC RF Test Report

**Product Name: Smart Phone**

**Model Number: BLA-L09**

**Report No: SYBH(Z-RF)024092017-2003**

**FCC ID: QISBLA-L09**

**Reliability Laboratory of Huawei Technologies Co.**

**(Global Compliance and Testing Center of Huawei Technologies Co., Ltd)**

Administration Building, Headquarters of Huawei Technologies Co., Ltd., Bantian, Longgang District,  
Shenzhen, 518129, P.R.C

Tel: +86 755 28780808

Fax: +86 755 89652518



## Notice

1. The laboratory has Passed the accreditation by China National Accreditation Service for Conformity Assessment (CNAS). The accreditation number is L0310.
2. The laboratory has Passed the accreditation by The American Association for Laboratory Accreditation (A2LA). The accreditation number is 2174.01.
3. The laboratory has been recognized by the US Federal Communications Commission (FCC) to perform compliance testing subject to the Commission's Declaration Of Conformity (DOC) and Certification rules. The Designation Number is CN1173, and the Test Firm Registration Number is 294140.
4. The laboratory has been listed by Industry Canada to perform electromagnetic emission measurements. The recognition numbers of test site are 6369A-1.
5. The test report is invalid if not marked with the signatures of the persons responsible for preparing and approving the test report.
6. The test report is invalid if there is any evidence of erasure and/or falsification.
7. The test report is only valid for the test samples.
8. Content of the test report, in part or in full, cannot be used for publicity and/or promotional purposes without prior written approval from the laboratory.
9. The laboratory (Reliability Lab of Huawei Technologies Co., Ltd) is also named as "Global Compliance and Testing Center of Huawei Technologies Co., Ltd", the both names have coexisted since 2009.



**Applicant:** Huawei Technologies Co., Ltd.  
**Address:** Administration Building, Headquarters of Huawei Technologies Co., Ltd.,  
 Bantian, Longgang District, Shenzhen, 518129, P.R.C

**Date of Receipt Sample:** 2017-08-28  
**Start Date of Test:** 2017-08-28  
**End Date of Test:** 2017-09-22

**Test Result:** Pass

<b>Approved by Senior Engineer:</b>	2017-09-25	Roger Zhang	<i>Roger Zhang</i>
	Date	Name	Signature

<b>Prepared by:</b>	2017-09-25	zhoulingbo	<i>zhoulingbo</i>
	Date	Name	Signature



**CONTENT**

1 General Information..... 5

    1.1 Applied Standard ..... 5

    1.2 Test Location ..... 5

    1.3 Test Environment Condition ..... 5

2 Test Summary ..... 6

    2.1 Measurement Technical Requirements ..... 6

3 Description of the Equipment under Test (EUT)..... 8

    3.1 General Description..... 8

    3.2 EUT Identity ..... 10

    3.3 Technical Description..... 12

4 General Test Conditions / Configurations ..... 14

    4.1 Test Modes ..... 14

    4.2 EUT Configurations ..... 14

    4.3 Test Environments ..... 19

    4.4 Test Setups..... 21

    4.5 Test Conditions..... 22

5 Main Test Instruments..... 23



## 1 General Information

### 1.1 Applied Standard

Applied Rules: 47 CFR FCC Part 2, Subpart J  
47 CFR FCC Part 15, Subpart C  
47 CFR FCC Part 15, Subpart E

Test Method: KDB 789033 D02 General UNII Test Procedures New Rules v01r04  
FCC KDB 558074 D01 DTS Meas Guidance v03r04  
FCC KDB 662911 D01 Multiple Transmitter Output v02  
ANSI C63.10-2013, American National Standard for Testing Unlicensed Wireless Devices

### 1.2 Test Location

Test Location : Reliability Laboratory of Huawei Technologies Co., Ltd.  
Address: Administration Building, Headquarters of Huawei Technologies Co., Ltd., Bantian, Longgang District, Shenzhen, 518129, P.R.C

### 1.3 Test Environment Condition

Temperature: 15 to 30 °C (Ambient)  
Relative Humidity: 20 to 85 % (Ambient)  
Atmospheric Pressure: Not applicable

## 2 Test Summary

### 2.1 Measurement Technical Requirements

#### 2.1.1 U-NII (5150-5250, 5250-5350, 5470-5725 MHz, 5725-5850)

Test Item	Band	FCC Rule	Requirements	Test Result	Verdict
Emission Bandwidth	5150-5250	15.403(i) 15.407(a)(1)	No limit.	Appendix A	refer to No. SYBH(Z-RF)0 06092017-200 3
	5250-5350	15.403(i) 15.407(a)(2)			
	5470-5725	15.403(i) 15.407(a)(2)			
	5725-5850	15.403(i) 15.407(e)	≥ 500 kHz.		
Occupied Bandwidth	5150-5250 5250-5350 5470-5725 5725-5850	KDB 789033 §D	No limit	Appendix B	refer to No. SYBH(Z-RF)0 06092017-200 3
Duty Cycle	--	--	No limit.	Appendix C	refer to No. SYBH(Z-RF)0 06092017-200 3
Maximum Conducted Output Power	5150-5250	15.407(a)(1) 15.407(a)(4)	< 250mW (avg during transmission)	Appendix D	refer to No. SYBH(Z-RF)0 06092017-200 3
	5250-5350	15.407(a)(2) 15.407(a)(4)	<MIN{250mW, 11 dBm+10 *lg(EBW)} (avg during transmission)		
	5470-5725	15.407(a)(2) 15.407(a)(4)	<MIN{250mW, 11 dBm+10 *lg(EBW)} (avg during transmission)		
	5725-5850	15.407(a)(3)	< 1W (avg during transmission)		
maximum Peak Power Spectral Density	5150-5250	15.407(a)(1) 15.407(a)(4)	<11dBm/MHz (avg during transmission)	Appendix E	refer to No. SYBH(Z-RF)0 06092017-200 3
	5250-5350	15.407(a)(2) 15.407(a)(4)	<11dBm/MHz (avg during transmission)		
	5470-5725	15.407(a)(2) 15.407(a)(4)	<11dBm/MHz (avg during transmission)		
	5725-5850	15.407(a)(3) 15.407(a)(4)	<30dBm/500KHz (avg during		



Test Item	Band	FCC Rule	Requirements	Test Result	Verdict
			transmission)		
Frequence Stability	5150-5250 5250-5350 5470-5725 5725-5850	15.407(g)	FCC Part 15.407(g)	Appendix F	refer to No. SYBH(Z-RF)0 06092017-200 3



### 3 Description of the Equipment under Test (EUT)

#### 3.1 General Description

BLA-L09 is subscriber equipment in the LTE/ WCDMA/GSM system. The LTE frequency band is Band 1,Band 2,Band 3,Band 4,Band 5, Band 6, Band 7,Band 8, Band 9,Band 12,Band17, Band 18 ,Band 19, Band 20, Band 26, Band 28, Band 32,Band 34,Band 38,Band39, Band 40 and Band 41. The HSUPA/HSDPA/UMTS frequency band is Band I, Band II, Band IV, Band V, Band VI, Band VIII and Band XIX, The GSM/GPRS/EDGE frequency band includes GSM850 and GSM900 and DCS1800 and PCS1900, The Mobile Phone implements such functions as RF signal receiving/transmitting, LTE/ WCDMA /GSM protocol processing, voice, video, MMS service, GPS, NFC and WIFI etc. Externally it provides earphone port (to provide voice service) and dual USIM card interfaces. It also provides Bluetooth module to synchronize data between a PC and the phone, or to use the built-in modem of the phone to access the Internet with a PC, or to exchange data with other Bluetooth devices

NOTE1: Only 5G WIFI test data included in this report.

NOTE2: We do not test 5G WIFI data of BLA-L09, the test data refer to No. SYBH(Z-RF)006092017-2003 of BLA-L29.

The mobile phone BLA-L29 and BLA-L09 are LTE/UMTS/GSM mobile phone with Bluetooth. The differences between BLA-L29 and BLA-L09 are showed in the following table. BLA-L09 delete one SIM by software. Other parts of the mobile phone are the same, including the appearance, the antenna, Chipset, Bluetooth mode, Wifi mode, Adapter, Battery, and so on.

	BLA-L29	BLA-L09
GSM four bands	B2/B3/B5/B8	B2/B3/B5/B8
WCDMA bands	B1/2/5/8/4/6/19	B1/2/5/8/4/6/19
LTE bands	FDD LTE: B1/2/3/4/5/6/7/8/9/12/17/18/19/20/ B26/28/32 TDD LTE: B34/B38/39/40/41(110M,2545-2655)	FDD LTE: B1/2/3/4/5/6/7/8/9/12/17/18/19/20/ B26/28/32 TDD LTE: B34/B38/39/40/41(110M,2545-2655)
LTE	CA_1C/CA_2C/CA_3C/CA_7C/CA_38	CA_1C/CA_2C/CA_3C/CA_7C/CA_38C/CA





CA(Uplink)	C/CA_39C/CA_40C/CA_41C	_39C/CA_40C/CA_41C
CE bands	GSM900/1800 WB1/B8 LTE B1/B3/B7/B8/B20/B28/B32/B34/B38/B40	GSM900/1800 WB1/B8 LTE B1/B3/B7/B8/B20/B28/B32/B34/B38/B40
SIM card	Two	One
Hardware Version	the same	the same
Software Version	different	different
NFC	the same	the same
External camera	the same	the same
internal camera	the same	the same
FLASH	the same	the same
Mainboard	the same	the same
PCB layout	the same	the same
Appearance	the same	the same
Bluetooth mode	the same	the same
WLAN mode	the same	the same
BT/WLAN antenna	the same	the same
GSM/ WCDMA /LTE	the same	The same



antenna		
Adapter	the same	the same
Battery	the same	the same
Chipset	the same	the same
Memory	the same	the same
RF Parameter	The same RF Parameter in the same band	The same RF Parameter in the same band
Dimension	the same	the same
Main Frequency NV	The same NV in the same band	The same NV in the same band















### 3.2 EUT Identity

NOTE: Unless otherwise noted in the report, the functional boards installed in the units shall be selected from the below list, but not means all the functional boards listed below shall be installed in one unit.

#### 3.2.1 Board

Board		
Description	Hardware Version	Software Version
Main board	HL1BLAM	BLA-L09 8.0.0.68(C432)

### 3.2.2 Sub-Assembly

Sub-Assembly			
Sub-Assembly Name	Model	Manufacturer	Description
Adapter	HW-050450B00	Huawei Technologies Co., Ltd.	Input Voltage: 100-240V ~50/60Hz, 0.75A Output Voltage: 5V  2A 4.5V  5A 5V  4.5A Rated Power: 10W/22.5W
Adapter	HW-050450E00	Huawei Technologies Co., Ltd.	I Input Voltage: 100-240V ~50/60Hz, 0.75A Output Voltage: 5V  2A 4.5V  5A 5V  4.5A Rated Power: 10W/22.5W
Adapter	HW-050450U00	Huawei Technologies Co., Ltd.	I Input Voltage: 100-240V ~50/60Hz, 0.75A Output Voltage: 5V  2A 4.5V  5A 5V  4.5A Rated Power: 10W/22.5W
Adapter	HW-050450A00	Huawei Technologies Co., Ltd.	I Input Voltage: 100-240V ~50/60Hz, 0.75A Output Voltage: 5V  2A 4.5V  5A 5V  4.5A Rated Power: 10W/22.5W
Rechargeable Li-ion	HB436486ECW	Huawei Technologies Co., Ltd.	Rated capacity: 3900mAh Nominal Voltage:  +3.82V Charging Voltage:  +4.4V



### 3.3 Technical Description

Characteristics	Description	
IEEE 802.11 WLAN Mode Supported	<input checked="" type="checkbox"/> 802.11a (20 MHz channel bandwidth), <input checked="" type="checkbox"/> 802.11n (20 MHz channel bandwidth), <input checked="" type="checkbox"/> 802.11n (40 MHz channel bandwidth), <input checked="" type="checkbox"/> 802.11ac (20 MHz channel bandwidth), <input checked="" type="checkbox"/> 802.11ac (40 MHz channel bandwidth), <input checked="" type="checkbox"/> 802.11ac (80 MHz channel bandwidth),	
TX/RX Operating Range	All	$f_c = 5000 \text{ MHz} + N * 5 \text{ MHz}$ , where: - $f_c$ = "Operating Frequency" in MHz, - $N$ = "Channel Number".
	5150-5250 MHz (U-NII)	$N = 36$ to $48$ with step of $4$ for the $20 \text{ MHz}$ channel bandwidth. $N = 38$ to $46$ with step of $4$ for the $40 \text{ MHz}$ channel bandwidth. $N = 42$ for the $80 \text{ MHz}$ channel bandwidth.
	5250-5350 MHz (U-NII)	$N = 52$ to $64$ with step of $4$ for the $20 \text{ MHz}$ channel bandwidth. $N = 54$ to $62$ with step of $4$ for the $40 \text{ MHz}$ channel bandwidth. $N = 58$ for the $80 \text{ MHz}$ channel bandwidth.
	5470-5725 MHz (U-NII)	$N = 100$ to $144$ with step of $4$ for the $20 \text{ MHz}$ channel bandwidth. $N = 102$ to $142$ with step of $4$ for the $40 \text{ MHz}$ channel bandwidth. $N = 138$ for the $80 \text{ MHz}$ channel bandwidth.
	5725-5850 MHz (U-NII)	$N = 149$ to $165$ with step of $4$ for the $20 \text{ MHz}$ channel bandwidth. $N = 151$ to $159$ with step of $4$ for the $40 \text{ MHz}$ channel bandwidth. $N = 155$ for the $80 \text{ MHz}$ channel bandwidth.
Modulation Type	BPSK/QPSK/16QAM/64QAM (OFDM).	
Emission Designator	U-NII(5150-5250, 5250-5350, 5470-5725,)	22M8G7D (for 802.11a mod) 24M7G7D (for 802.11n 20 MHz mode) 40M9G7D (for 802.11n 40 MHz mode) 24M9G7D (for 802.11ac 20 MHz mode) 40M7G7D (for 802.11ac 40 MHz mode) 83M4G7D (for 802.11ac 80 MHz mode)
	U-NII(5725-5850)	16M4G7D (for 802.11a mod) 17M7G7D (for 802.11n 20 MHz mode) 36M4G7D (for 802.11n 40 MHz mode) 17M7G7D (for 802.11ac 20 MHz mode) 36M4G7D (for 802.11ac 40 MHz mode) 76M4G7D (for 802.11ac 80 MHz mode)
TPC	<input type="checkbox"/> Supported, <input checked="" type="checkbox"/> Not Supported	
Antenna	Type	<input type="checkbox"/> External, <input checked="" type="checkbox"/> Integrated
	Ports	<input checked="" type="checkbox"/> Ant 1, <input checked="" type="checkbox"/> Ant 2, <input type="checkbox"/> Ant 3, <input type="checkbox"/> Ant 4
	Smart System	<input checked="" type="checkbox"/> SISO (for 802.11a/n/ac), <input checked="" type="checkbox"/> CDD (for 802.11a), <input checked="" type="checkbox"/> MIMO (for 802.11n/ac), <input type="checkbox"/> Diversity (for 802.11a) : Tx & Rx
	Gain	Ant1:2.68dBi (per antenna port, max.)



Characteristics	Description			
		Ant2: -2.48dBi (per antenna port, max.)		
	Remark	When the EUT is put into service, the practical maximum antenna gain should NOT exceed the value as described above.		
Power Supply	Type	<input checked="" type="checkbox"/> AC/DC Adapter	<input type="checkbox"/> PoE:	<input type="checkbox"/> Other:



## 4 General Test Conditions / Configurations

### 4.1 Test Modes

NOTE: Worst cases for each IEEE 802.11 mode are selected to perform tests.

Test Mode	Test Modes Description
11A	IEEE 802.11a with data rate of 6 Mbps using SISO mode.
11A-CDD	IEEE 802.11a with data rate of 6 Mbps using CDD mode.
11N20	IEEE 802.11n with data rate of MCS0 and bandwidth of 20 MHz using SISO mode.
11N20m	IEEE 802.11n with data rate of MCS8 and bandwidth of 20 MHz using MIMO mode.
11N40	IEEE 802.11n with data rate of MCS0 and bandwidth of 40 MHz using SISO mode.
11N40m	IEEE 802.11n with data rate of MCS8 and bandwidth of 40 MHz using MIMO mode.
11AC20	IEEE 802.11ac with data rate of MCS0 and bandwidth of 20 MHz using SISO mode.
11AC20m	IEEE 802.11ac with data rate of MCS8 and bandwidth of 20 MHz using MIMO mode.
11AC40	IEEE 802.11ac with data rate of MCS0 and bandwidth of 40 MHz using SISO mode.
11AC40m	IEEE 802.11ac with data rate of MCS8 and bandwidth of 40 MHz using MIMO mode.
11AC80	IEEE 802.11ac with data rate of MCS0 and bandwidth of 80 MHz using SISO mode.
11AC80m	IEEE 802.11ac with data rate of MCS8 and bandwidth of 80 MHz using MIMO mode.

### 4.2 EUT Configurations

#### 4.2.1 General Configurations

Configuration	Description
Test Antenna Ports	Until otherwise specified, <ul style="list-style-type: none"> <li>All TX tests are performed at all TX antenna ports of the EUT, and</li> <li>All RX tests are performed at all RX antenna ports of the EUT.</li> </ul>
Multiple RF Sources	Other than the tested RF source of the EUT, other RF source(s) are disabled or shutdown during measurements.

#### 4.2.2 Customized Configurations

##### 4.2.2.1 U-NII

Test Mode	Test Channel	Frequency [MHz]	Antenna Port	Power Conf., per Port	Duty cycle [%]
11A	36	5180	Ant 1	12.5	93
11A	48	5240	Ant 1	12.5	93
11A	52	5260	Ant 1	12.5	93



11A	64	5320	Ant 1	12.5	93
11A	100	5500	Ant 1	12.5	93
11A	140	5700	Ant 1	12.5	93
11A	144	5720	Ant 1	12.5	93
11A	149	5745	Ant 1	12.5	93
11A	165	5825	Ant 1	12.5	93
11A	36	5180	Ant 2	11	93
11A	48	5240	Ant 2	11	93
11A	52	5260	Ant 2	11	93
11A	64	5320	Ant 2	11	93
11A	100	5500	Ant 2	11	93
11A	140	5700	Ant 2	11	93
11A	144	5720	Ant 2	11	93
11A	149	5745	Ant 2	11	93
11A	165	5825	Ant 2	11	93
11A CDD	36	5180	Ant 1	12.5	93
11A CDD	48	5240	Ant 1	12.5	93
11A CDD	52	5260	Ant 1	12.5	93
11A CDD	64	5320	Ant 1	12.5	93
11A CDD	100	5500	Ant 1	12.5	93
11A CDD	140	5700	Ant 1	12.5	93
11A CDD	144	5720	Ant 1	12.5	93
11A CDD	149	5745	Ant 1	12.5	93
11A CDD	165	5825	Ant 1	12.5	93
11A CDD	36,	5180	Ant 2	11	93
11A CDD	48	5240	Ant 2	11	93
11A CDD	52	5260	Ant 2	11	93
11A CDD	64	5320	Ant 2	11	93
11A CDD	100	5500	Ant 2	11	93
11A CDD	140	5700	Ant 2	11	93
11A CDD	144	5720	Ant 2	11	93
11A CDD	149	5745	Ant 2	11	93
11A CDD	165	5825	Ant 1	11	93
11N20	36	5180	Ant 1	12.5	92
11N20	48	5240	Ant 1	12.5	92
11N20	52	5260	Ant 1	12.5	92
11N20	64	5320	Ant 1	12.5	92
11N20	100	5500	Ant 1	12.5	92



11N20	140	5700	Ant 1	12.5	92
11N20	144	5720	Ant 1	12.5	92
11N20	149	5745	Ant 1	12.5	92
11N20	165	5825	Ant 1	12.5	92
11N20	36	5180	Ant 2	11	92
11N20	48	5240	Ant 2	11	92
11N20	52	5260	Ant 2	11	92
11N20	64	5320	Ant 2	11	92
11N20	100	5500	Ant 2	11	92
11N20	140	5700	Ant 2	11	92
11N20	144	5720	Ant 2	11	92
11N20	149	5745	Ant 2	11	92
11N20	165	5825	Ant 2	11	92
11N20M	36	5180	Ant 1	12.5	87
11N20M	48	5240	Ant 1	12.5	87
11N20M	52	5260	Ant 1	12.5	87
11N20M	64	5320	Ant 1	12.5	87
11N20M	100	5500	Ant 1	12.5	87
11N20M	140	5700	Ant 1	12.5	87
11N20M	144	5720	Ant 1	12.5	87
11N20M	149	5745	Ant 1	12.5	87
11N20M	165	5825	Ant 1	12.5	87
11N20M	36	5180	Ant 2	11	86
11N20M	48	5240	Ant 2	11	86
11N20M	52	5260	Ant 2	11	86
11N20M	64	5320	Ant 2	11	86
11N20M	100	5500	Ant 2	11	86
11N20M	140	5700	Ant 2	11	86
11N20M	144	5720	Ant 2	11	86
11N20M	149	5745	Ant 2	11	86
11N20M	165	5825	Ant 2	11	86
11N40	38	5190	Ant 1	10	86
11N40	46	5230	Ant 1	10	86
11N40	54	5270	Ant 1	10	86
11N40	62	5310	Ant 1	10	86
11N40	102	5510	Ant 1	10	86
11N40	134	5670	Ant 1	10	86
11N40	142	5710	Ant 1	10	86
11N40	151	5755	Ant 1	10	86
11N40	159	5795	Ant 1	10	86
11N40	38	5190	Ant 2	8.5	86





11N40	46	5230	Ant 2	8.5	86
11N40	54	5270	Ant 2	8.5	86
11N40	62	5310	Ant 2	8.5	86
11N40	102	5510	Ant 2	8.5	86
11N40	134	5670	Ant 2	8.5	86
11N40	142	5710	Ant 2	8.5	86
11N40	151	5755	Ant 2	8.5	86
11N40	159	5795	Ant 2	8.5	86
11N40M	38	5190	Ant 1	10	78
11N40M	46	5230	Ant 1	10	78
11N40M	54	5270	Ant 1	10	78
11N40M	62	5310	Ant 1	10	78
11N40M	102	5510	Ant 1	10	78
11N40M	134	5670	Ant 1	10	78
11N40M	142	5710	Ant 1	10	78
11N40M	151	5755	Ant 1	10	78
11N40M	159	5795	Ant 1	10	78
11N40M	38	5190	Ant 2	8.5	77
11N40M	46	5230	Ant 2	8.5	77
11N40M	54	5270	Ant 2	8.5	77
11N40M	62	5310	Ant 2	8.5	77
11N40M	102	5510	Ant 2	8.5	77
11N40M	134	5670	Ant 2	8.5	77
11N40M	142	5710	Ant 2	8.5	77
11N40M	151	5755	Ant 2	8.5	77
11N40M	159	5795	Ant 2	8.5	77
11AC20	36	5180	Ant 1	12.5	93
11AC20	48	5240	Ant 1	12.5	93
11AC20	52	5260	Ant 1	12.5	93
11AC20	64	5320	Ant 1	12.5	93
11AC20	100	5500	Ant 1	12.5	93
11AC20	140	5700	Ant 1	12.5	93
11AC20	144	5720	Ant 1	12.5	93
11AC20	149	5745	Ant 1	12.5	93
11AC20	165	5825	Ant 1	12.5	93
11AC20	36	5180	Ant 2	11	93
11AC20	48	5240	Ant 2	11	93
11AC20	52	5260	Ant 2	11	93
11AC20	64	5320	Ant 2	11	93
11AC20	100	5500	Ant 2	11	93
11AC20	140	5700	Ant 2	11	93



11AC20	144	5720	Ant 2	11	93
11AC20	149	5745	Ant 2	11	93
11AC20	165	5825	Ant 2	11	93
11AC20M	36	5180	Ant 1	12.5	86
11AC20M	48	5240	Ant 1	12.5	88
11AC20M	52	5260	Ant 1	12.5	88
11AC20M	64	5320	Ant 1	12.5	88
11AC20M	100	5500	Ant 1	12.5	88
11AC20M	140	5700	Ant 1	12.5	88
11AC20M	144	5720	Ant 1	12.5	88
11AC20M	149	5745	Ant 1	12.5	88
11AC20M	165	5825	Ant 1	12.5	88
11AC20M	36	5180	Ant 2	11	86
11AC20M	48	5240	Ant 2	11	86
11AC20M	52	5260	Ant 2	11	86
11AC20M	64	5320	Ant 2	11	86
11AC20M	100	5500	Ant 2	11	86
11AC20M	140	5700	Ant 2	11	86
11AC20M	144	5720	Ant 2	11	86
11AC20M	149	5745	Ant 2	11	86
11AC20M	165	5825	Ant 2	11	86
11AC40	38	5190	Ant 1	10	86
11AC40	46	5230	Ant 1	10	86
11AC40	54	5270	Ant 1	10	86
11AC40	62	5310	Ant 1	10	86
11AC40	102	5510	Ant 1	10	86
11AC40	134	5670	Ant 1	10	86
11AC40	142	5710	Ant 1	10	86
11AC40	151	5755	Ant 1	10	86
11AC40	159	5795	Ant 1	10	86
11AC40	38	5190	Ant 2	8.5	86
11AC40	46	5230	Ant 2	8.5	86
11AC40	54	5270	Ant 2	8.5	86
11AC40	62	5310	Ant 2	8.5	86
11AC40	102	5510	Ant 2	8.5	86
11AC40	134	5670	Ant 2	8.5	86
11AC40	142	5710	Ant 2	8.5	86
11AC40	151	5755	Ant 2	8.5	86
11AC40	159	5795	Ant 2	8.5	86
11AC40M	38	5190	Ant 1	10	78
11AC40M	46	5230	Ant 1	10	78



11AC40M	54	5270	Ant 1	10	78
11AC40M	62	5310	Ant 1	10	78
11AC40M	102	5510	Ant 1	10	78
11AC40M	134	5670	Ant 1	10	78
11AC40M	142	5710	Ant 1	10	78
11AC40M	151	5755	Ant 1	10	78
11AC40M	159	5795	Ant 1	10	78
11AC40M	38	5190	Ant 2	8.5	77
11AC40M	46	5230	Ant 2	8.5	77
11AC40M	54	5270	Ant 2	8.5	77
11AC40M	62	5310	Ant 2	8.5	77
11AC40M	102	5510	Ant 2	8.5	77
11AC40M	134	5670	Ant 2	8.5	77
11AC40M	142	5710	Ant 2	8.5	77
11AC40M	151	5755	Ant 2	8.5	77
11AC40M	159	5795	Ant 2	8.5	77
11AC80	42	5210	Ant 1	10	76
11AC80	58	5290	Ant 1	10	76
11AC80	106	5530	Ant 1	10	76
11AC80	138	5690	Ant 1	10	76
11AC80	155	5775	Ant 1	10	76
11AC80	42	5210	Ant 2	8.5	76
11AC80	58	5290	Ant 2	8.5	76
11AC80	106	5530	Ant 2	8.5	76
11AC80	138	5690	Ant 2	8.5	76
11AC80	155	5775	Ant 2	8.5	76
11AC80M	42	5210	Ant 1	10	65
11AC80M	58	5290	Ant 1	10	65
11AC80M	106	5530	Ant 1	10	65
11AC80M	138	5690	Ant 1	10	65
11AC80M	155	5775	Ant 1	10	65
11AC80M	42	5210	Ant 2	8.5	65
11AC80M	58	5290	Ant 2	8.5	65
11AC80M	106	5530	Ant 2	8.5	65
11AC80M	138	5690	Ant 2	8.5	65
11AC80M	155	5775	Ant 2	8.5	65

### 4.3 Test Environments

Environment Parameter	Selected Values During Tests
Relative Humidity	Ambient



---

---

Environment Parameter	Selected Values During Tests	
Temperature	TN	Ambient
Voltage	VL	3.6V
	VN	3.82V
	VH	4.35V

NOTE: VL= lower extreme test voltage  
VN= nominal voltage  
VH= upper extreme test voltage  
TN= normal temperature

## 4.4 Test Setups

### 4.4.1 Test Setup 1

The WLAN component's antenna ports(s) of the EUT are connected to the measurement instrument per an appropriate attenuator. The EUT is controlled by PC/software to emit the specified signals for the purpose of measurements.

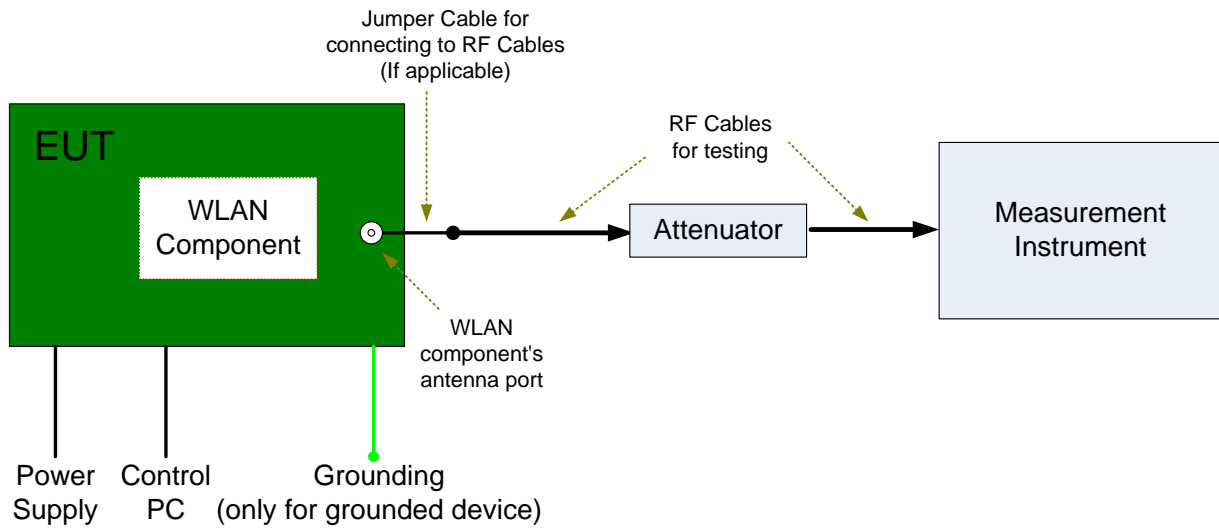



## 4.5 Test Conditions

### 4.5.1 U-NII

Test Case	Test Conditions	
	Configuration	Description
Emission Bandwidth (EBW)	Meas. Method	FCC KDB 789033 §C).
	Test Env.	NT/NV
	Test Setup	Test Setup 1
	EUT Conf.	All EUT conf. with Tx modes.
Occupied Bandwidth (OBW)	Meas. Method	FCC KDB 789033 §D).
	Test Env.	NT/NV
	Test Setup	Test Setup 1
	EUT Conf.	All EUT conf. with Tx modes.
Maximum Conducted Output Power	Meas. Method	FCC KDB 789033 §E)2)b) Method SA-1 and d) Method SA-2.
	Test Env.	NT/NV
	Test Setup	Test Setup 1
	EUT Conf.	All EUT conf. with Tx modes.
Maximum Peak Power Spectral Density	Meas. Method	FCC KDB 789033 §F).
	Test Env.	NT/NV
	Test Setup	Test Setup 1
	EUT Conf.	All EUT conf. with Tx modes.
Frequency Stability	Meas. Method	15.407(g) Frequency Stability
	Test Env.	(1)VL, VN and VH of Rated Voltage at Ambient Climate. (2) -5 °C,5°C,15°C,-25°C,35°C,45°C,50°C
	Test Setup	Test Setup 1
	EUT Conf.	Ch.36,Ch.165



## 5 Main Test Instruments

NOTE: Unless otherwise specified, the calibration intervals for test instruments were Annual (per year). The other intervals, if applicable, are marked with (##y), which denotes ## years calibration interval.

Main Test Equipments					
Equipment Name	Manufacturer	Model	Serial Number	Cal Date	Cal- Due
Power supply	KEITHLEY	2303	1342889	2016/10/13	2017/10/12
Wireless Communication Test set	Agilent	N4010A	MY49081592	2017/7/31	2018/7/30
Universal Radio Communication Tester	R&S	CMU200	123299	2016/11/14	2017/11/13
Spectrum Analyzer	Agilent	N9020A	MY52090652	2017/7/10	2018/7/9
Universal Radio Communication Tester	R & S	CMW500	126854	2016/12/29	2017/12/28
Signal Analyzer	R&S	FSQ31	200021	2017/7/31	2018/7/30
Spectrum Analyzer	Agilent	N9030A	MY49431698	2017/7/31	2018/7/30
Temperature Chamber	WEISS	WKL64	56246002940010	2016/12/21	2017/12/20
Signal generator	Agilent	E8257D	MY49281095	2017/7/31	2018/7/30
Vector Signal Generator	R&S	SMU200A	104162	2017/7/31	2018/7/30
Test receiver	R&S	ESU26	100387	2017/2/21	2018/2/20
Test receiver	R&S	ESCI	101163	2016/11/10	2017/11/9
Spectrum analyzer	R&S	FSU3	200474	2017/2/21	2018/2/20
Spectrum analyzer	R&S	FSU43	100144	2017/2/21	2018/2/20
LOOP Antennas(9kHz-30MHz)	R&S	HFH2-Z2	100262	2017/4/25	2019/4/25
LOOP Antennas(9kHz-30MHz)	R&S	HFH2-Z2	100263	2017/4/25	2019/4/25
Trilog Broadband Antenna (30M~3GHz)	SCHWARZBEC K	VULB 9163	9163-490	2017/3/29	2019/3/29
Trilog Broadband Antenna (30M~3GHz)	SCHWARZBEC K	VULB 9163	9163-521	2017/4/9	2019/4/9
Double-Ridged Waveguide Horn Antenna (1G~18GHz)	R&S	HF907	100304	2017/5/27	2019/5/27



---

---

Pyramidal Horn Antenna(18GHz-26.5GHz)	ETS-Lindgren	3160-09	206665	2017/3/24	2018/3/23
Artificial Main Network	R&S	ENV4200	100134	2017/5/15	2018/5/14
Line Impedance Stabilization Network	R&S	ENV216	100382	2017/5/15	2018/5/14
Signal Generator	Agilent	E4438C	MY49071538	2016/12/15	2017/12/14
Power Detecting & Sampling Unit	R&S	OSP-B157	100914	2017/7/31	2018/7/30

---

END