



中国认可
国际互认
检测
TESTING
CNAS L0310



FCC RF Test Report

Product Name: Smart Phone

Model Number: BLA-L09

Report No: SYBH(Z-RF)024092017-2004

FCC ID: QISBLA-L09

Reliability Laboratory of Huawei Technologies Co.

(Global Compliance and Testing Center of Huawei Technologies Co., Ltd)

Administration Building, Headquarters of Huawei Technologies Co., Ltd., Bantian, Longgang
District, Shenzhen, 518129, P.R.C

Tel: +86 755 28780808 Fax: +86 755 89652518

Notice

1. The laboratory has Passed the accreditation by China National Accreditation Service for Conformity Assessment (CNAS). The accreditation number is L0310.
2. The laboratory has Passed the accreditation by The American Association for Laboratory Accreditation (A2LA). The accreditation number is 2174.01.
3. The laboratory has been recognized by the US Federal Communications Commission (FCC) to perform compliance testing subject to the Commission's Declaration Of Conformity (DOC) and Certification rules. The Designation Number is CN1173, and the Test Firm Registration Number is 294140.
4. The laboratory has been listed by Industry Canada to perform electromagnetic emission measurements. The recognition numbers of test site are 6369A-1.
5. The test report is invalid if not marked with the signatures of the persons responsible for preparing and approving the test report.
6. The test report is invalid if there is any evidence of erasure and/or falsification.
7. The test report is only valid for the test samples.
8. Content of the test report, in part or in full, cannot be used for publicity and/or promotional purposes without prior written approval from the laboratory.
9. The laboratory (Reliability Lab of Huawei Technologies Co., Ltd) is also named as "Global Compliance and Testing Center of Huawei Technologies Co., Ltd", the both names have coexisted since 2009.



Applicant: Huawei Technologies Co., Ltd.
Address: Administration Building, Headquarters of Huawei Technologies Co., Ltd., Bantian, Longgang District, Shenzhen, 518129, P.R.C

Date of Receipt Sample: 2017-08-28
Start Date of Test: 2017-08-28
End Date of Test: 2017-09-22

Test Result: Pass

Approved by Senior Engineer:	2017-09-25	Roger Zhang	<i>Roger Zhang</i>
	Date	Name	Signature

Prepared by:	2017-09-25	zhoulingbo	<i>zhou ling bo</i>
	Date	Name	Signature



CONTENT

1	General Information.....	5
1.1	Applied Standard.....	5
1.2	Test Location.....	5
1.3	Test Environment Condition	5
2	Test Summary	6
3	Description of the Equipment under Test (EUT).....	7
3.1	General Description.....	7
3.2	EUT Identity	9
3.3	Technical Description.....	10
4	General Test Conditions / Configurations	11
4.1	EUT Configurations.....	11
4.2	Test Environments	11
4.3	Test Setups.....	12
4.4	Test Conditions.....	15
5	Main Test Instruments.....	16

1 General Information

1.1 Applied Standard

Applied Rules: 47 CFR FCC Part 2, Subpart J
47 CFR FCC Part 15, Subpart C

Test Method: FCC KDB 558074 D01 DTS Meas Guidance v03r04
ANSI C63.10-2013, American National Standard for Testing Unlicensed
Wireless Devices.

1.2 Test Location

Test Location: Reliability Laboratory of Huawei Technologies Co., Ltd.
Address : Administration Building, Headquarters of Huawei Technologies Co., Ltd.,
Bantian, Longgang District, Shenzhen, 518129, P.R.C

1.3 Test Environment Condition

Ambient Temperature: 19.5to 25 °C
Ambient Relative Humidity: 40 to 55 %
Atmospheric Pressure: Not applicable

2 Test Summary

Test Item	FCC Part No.	Requirements	Test Result	Verdict
DTS (6 dB) Bandwidth	15.247(a)(2)	≥ 500 kHz.	Appendix A	refer to No. SYBH(Z-RF)0060920 17-2004
Occupied Bandwidth	---	---	Appendix B	refer to No. SYBH(Z-RF)0060920 17-2004
Duty Cycle	KDB 558074 (6.0)	No limit	Appendix C	refer to No. SYBH(Z-RF)0060920 17-2004
Maximum Conducted Average Output Power	15.247(b)(3)	For directional gain: < 30 dBm – (G[dBi] – 6 [dB]), Average; Otherwise: < 30 dBm, Average;	Appendix D	refer to No. SYBH(Z-RF)0060920 17-2004
Maximum Power Spectral Density Level	15.247(e)	For directional gain: < 8 dBm/3 kHz – (G[dBi] – 6 [dB]), Average. Otherwise: < 8 dBm/3 kHz, Average.	Appendix E	refer to No. SYBH(Z-RF)0060920 17-2004
Band Edges Compliance	15.247(d)	< -30 dBm/100 kHz if total average power ≤ power limit.	Appendix F	refer to No. SYBH(Z-RF)0060920 17-2004
Unwanted Emissions into Non-Restricted Frequency Bands			Appendix G	refer to No. SYBH(Z-RF)0060920 17-2004
Unwanted Emissions into Restricted Frequency Bands (Radiated)	15.247(d) 15.209 (NOTE 1)	FCC Part 15.209 field strength limit;	Appendix H	refer to No. SYBH(Z-RF)0060920 17-2004
AC Power Line Conducted Emissions	15.207	FCC Part 15.207 conducted limit;	Appendix I	refer to No. SYBH(Z-RF)0060920 17-2004

NOTE 1: According to KDB 558074, antenna-port conducted measurements are acceptable as an alternative to radiated measurements for demonstrating compliance to the limits in the restricted frequency bands. If conducted measurements are performed, then proper impedance matching must be ensured and an additional radiated test for cabinet/case emissions will also be required.

3 Description of the Equipment under Test (EUT)

3.1 General Description

BLA-L09 is subscriber equipment in the LTE/ WCDMA/GSM system. The LTE frequency band is Band 1,Band 2,Band 3,Band 4,Band 5, Band 6, Band 7,Band 8, Band 9,Band 12,Band17, Band 18 ,Band 19, Band 20, Band 26, Band 28, Band 32,Band 34,Band 38,Band39, Band 40 and Band 41. The HSUPA/HSDPA/UMTS frequency band is Band I, Band II, Band IV, Band V, Band VI, Band VIII and Band XIX, The GSM/GPRS/EDGE frequency band includes GSM850 and GSM900 and DCS1800 and PCS1900, The Mobile Phone implements such functions as RF signal receiving/transmitting, LTE/ WCDMA /GSM protocol processing, voice, video, MMS service, GPS, NFC and WIFI etc. Externally it provides earphone port (to provide voice service) and dual USIM card interfaces. It also provides Bluetooth module to synchronize data between a PC and the phone, or to use the built-in modem of the phone to access the Internet with a PC, or to exchange data with other Bluetooth devices

NOTE1: Only Bluetooth BLE test data included in this report.

NOTE2: We do not test Bluetooth BLE data of BLA-L09, the test data refer to No. SYBH(Z-RF)006092017-2004 of BLA-L29.

The mobile phone BLA-L29 and BLA-L09 are LTE/UMTS/GSM mobile phone with Bluetooth. The differences between BLA-L29 and BLA-L09 are showed in the following table. BLA-L09 delete one SIM by software. Other parts of the mobile phone are the same, including the appearance, the antenna, Chipset, Bluetooth mode, Wifi mode, Adapter, Battery, and so on.

	BLA-L29	BLA-L09
GSM four bands	B2/B3/B5/B8	B2/B3/B5/B8
WCDMA bands	B1/2/5/8/4/6/19	B1/2/5/8/4/6/19
LTE bands	FDD LTE: B1/2/3/4/5/6/7/8/9/12/17/18/19/20/ B26/28/32 TDD LTE: B34/B38/39/40/41 (110M,2545-2655)	FDD LTE: B1/2/3/4/5/6/7/8/9/12/17/18/19/20/ B26/28/32 TDD LTE: B34/B38/39/40/41 (110M,2545-2655)
LTE CA(Uplink)	CA_1C/CA_2C/CA_3C/CA_7C/CA_38 C/CA_39C/CA_40C/CA_41C	CA_1C/CA_2C/CA_3C/CA_7C/CA_38C/CA_39C/CA_40C/CA_41C

CE bands	GSM900/1800 WB1/B8 LTE B1/B3/B7/B8/B20/B28/B32/B34/B38/B40	GSM900/1800 WB1/B8 LTE B1/B3/B7/B8/B20/B28/B32/B34/B38/B40
SIM card	Two	One
Hardware Version	the same	the same
Software Version	different	different
NFC	the same	the same
External camera	the same	the same
internal camera	the same	the same
FLASH	the same	the same
Mainboard	the same	the same
PCB layout	the same	the same
Appearance	the same	the same
Bluetooth mode	the same	the same
WLAN mode	the same	the same
BT/WLAN antenna	the same	the same
GSM/WCDMA/LTE antenna	the same	The same
Adapter	the same	the same

Battery	the same	the same
Chipset	the same	the same
Memory	the same	the same
RF Parameter	The same RF Parameter in the same band	The same RF Parameter in the same band
Dimension	the same	the same
Main Frequency NV	The same NV in the same band	The same NV in the same band















3.2 EUT Identity

NOTE: Unless otherwise noted in the report, the functional boards installed in the units shall be selected from the below list, but not means all the functional boards listed below shall be installed in one unit.

3.2.1 Board

Board		
Description	Hardware Version	Software Version
Main board	HL1BLAM	BLA-L09 8.0.0.68(C432)

3.2.2 Sub-Assembly

Sub-Assembly			
Sub-Assembly Name	Model	Manufacturer	Description
Adapter	HW-050450B00	Huawei Technologies Co., Ltd.	Input Voltage: 100-240V ~50/60Hz, 0.75A Output Voltage: 5V  2A 4.5V  5A 5V  4.5A Rated Power: 10W/22.5W
Adapter	HW-050450E00	Huawei Technologies Co., Ltd.	I Input Voltage: 100-240V ~50/60Hz, 0.75A Output Voltage: 5V  2A 4.5V  5A 5V  4.5A Rated Power: 10W/22.5W
Adapter	HW-050450U00	Huawei Technologies Co., Ltd.	I Input Voltage: 100-240V ~50/60Hz, 0.75A Output Voltage: 5V  2A 4.5V  5A 5V  4.5A Rated Power: 10W/22.5W
Adapter	HW-050450A00	Huawei Technologies Co., Ltd.	I Input Voltage: 100-240V ~50/60Hz, 0.75A Output Voltage: 5V  2A 4.5V  5A 5V  4.5A Rated Power: 10W/22.5W
Rechargeable Li-ion	HB436486ECW	Huawei Technologies Co., Ltd.	Rated capacity: 3900mAh Nominal Voltage:  +3.82V Charging Voltage:  +4.4V

3.3 Technical Description

Characteristics	Description	
TX/RX Operating Range	2400-2483.5 MHz band	$f_c = 2402 \text{ MHz} + N * 2 \text{ MHz}$, where: - f_c = "Operating Frequency" in MHz, - N = "Channel Number" with the range from 0 to 39.
Modulation Type	Digital	GFSK,
Emission Designator	GFSK for BT 4.2: 690KFXD	
Bluetooth Power Class	Class 1	



4 General Test Conditions / Configurations

4.1 EUT Configurations

4.1.1 General Configurations

Configuration	Description
Test Antenna Ports	Until otherwise specified, <ul style="list-style-type: none">- All TX tests are performed at all TX antenna ports of the EUT, and- All RX tests are performed at all RX antenna ports of the EUT.
Multiple RF Sources	Other than the tested RF source of the EUT, other RF source(s) are disabled or shutdown during measurements.

4.1.2 Customized Configurations

# EUT Conf.	Signal Description	Operating Frequency	Duty cycle
TM1_Ch0	GFSK for BT 4.2 modulation, package type DH5, hopping off.	Ch No. 0 / 2402 MHz	62%
TM1_Ch19	GFSK for BT 4.2 modulation, package type DH5, hopping off.	Ch No. 19 / 2440 MHz	62%
TM1_Ch39	GFSK for BT 4.2 modulation, package type DH5, hopping off.	Ch No. 39 / 2480 MHz	62%

4.2 Test Environments

NOTE: The values used in the test report may be stringent than the declared.

Environment Parameter	Selected Values During Tests		
	Temperature	Voltage	Relative Humidity
NT/NV	Ambient	3.82 VDC	Ambient

4.3 Test Setups

4.3.1 Test Setup 1

The Bluetooth component's antenna ports(s) of the EUT are connected to the measurement instrument per an appropriate attenuator. The EUT is controlled by Bluetooth System Simulator and/or PC/software to emit the specified signals for the purpose of measurements.

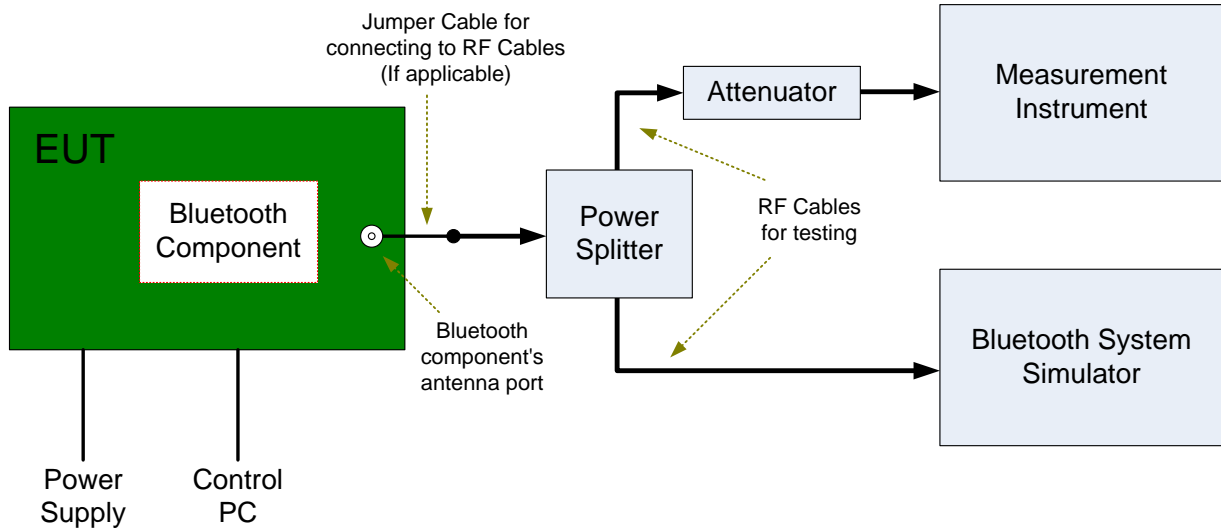

4.3.2 Test Setup 2

The test site semi-anechoic chamber according to the standards: ANSI C63.4. The test distance is 3m. The setup is according to ANSI C63.4 and CAN/CSA-CEI/IEC CISPR 22.

The maximal emission value is acquired by adjusting the antenna height, polarisation and turntable azimuth. Normally, the height range of antenna is 1 m to 4 m, the azimuth range of turntable is 0° to 360°, and the receive antenna has two polarizations Vertical (V) and Horizontal (H).

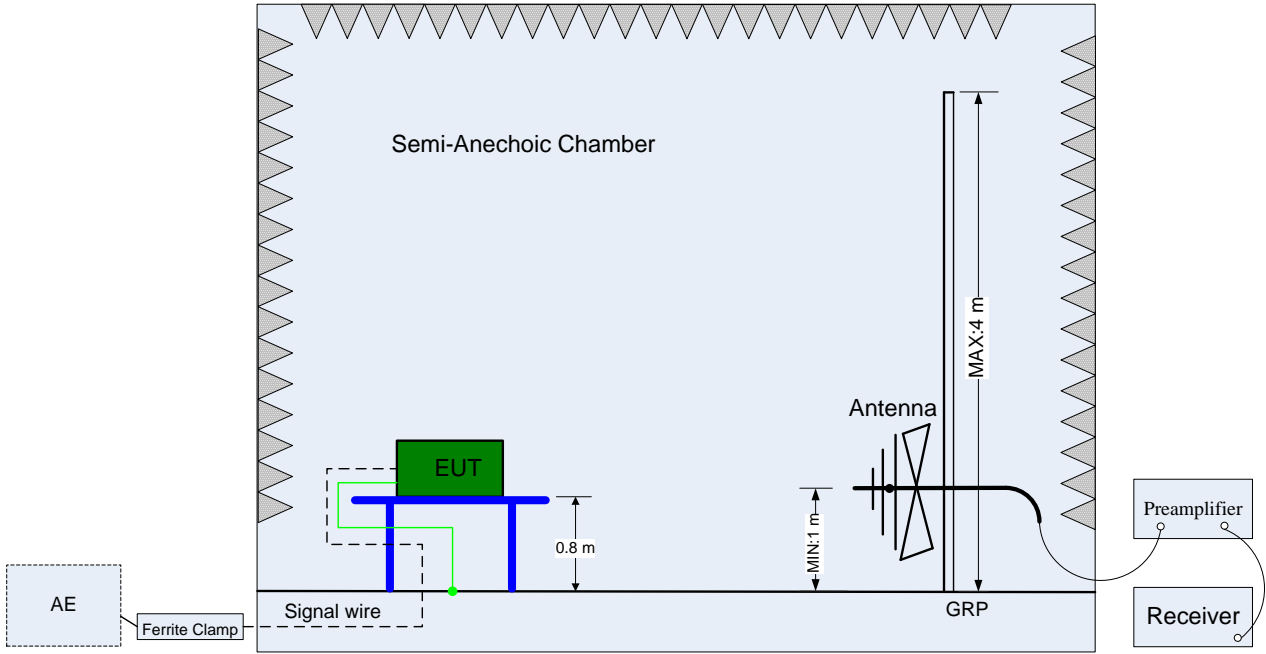

(Below 1 GHz)

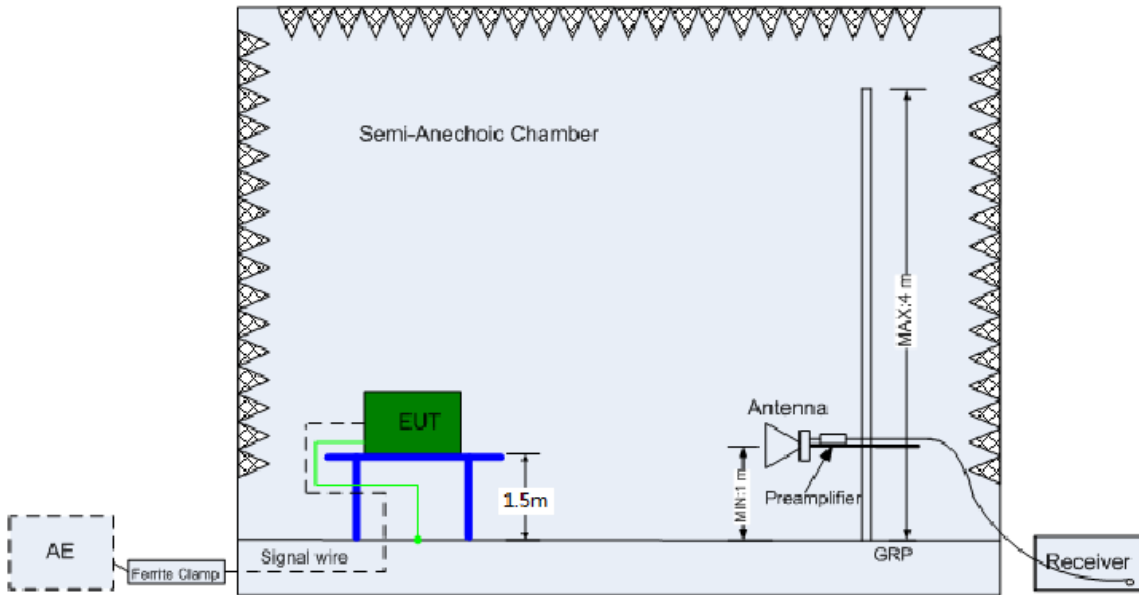

(Above 1 GHz)

4.3.3 Test Setup 3

The mains cable of the EUT (maybe per AC/DC Adapter) must be connected to LISN. The LISN shall be placed 0.8 m from the boundary of EUT and bonded to a ground reference plane for LISN mounted on top of the ground reference plane. This distance is between the closest points of the LISN and the EUT. All other units of the EUT and associated equipment shall be at least 0.8m from the LISN.

Ground connections, where required for safety purposes, shall be connected to the reference ground point of the LISN and, where not otherwise provided or specified by the manufacturer, shall be of same length as the mains cable and run parallel to the mains connection at a separation distance of not more than 0.1 m.

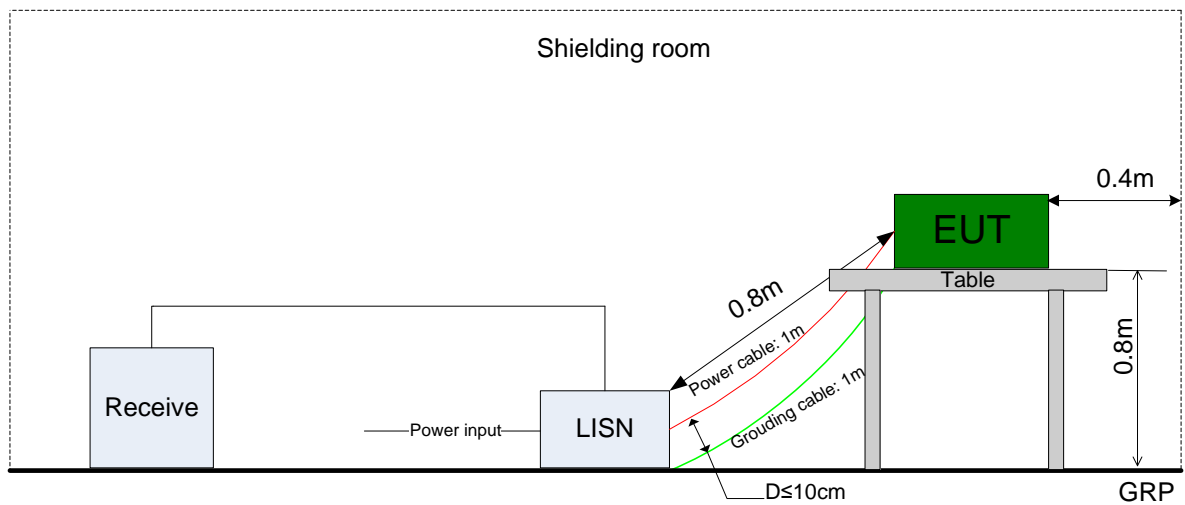

4.4 Test Conditions

Test Case	Test Conditions		
	Configuration	Description	
6dB Emission Bandwidth (EBW)	Meas. Method	FCC KDB 558074 §8.1 Option 2.	
	Test Env.	NT/NV	
	Test Setup	Test Setup 1	
	EUT Conf.	TM1_Ch0, TM1_Ch19, TM1_Ch39.	
Occupied Bandwidth	Meas. Method	FCC KDB 558074 §8.2 Option 2.	
	Test Env.	NT/NV	
	Test Setup	Test Setup 1	
	EUT Conf.	TM1_Ch0, TM1_Ch19, TM1_Ch39.	
Maximum Conducted Average Output Power	Meas. Method	FCC KDB 558074 §9.2 .2. 4	
	Test Env.	NT/NV	
	Test Setup	Test Setup 1	
	EUT Conf.	TM1_Ch0, TM1_Ch19, TM1_Ch39.	
Maximum Power Spectral Density Level	Meas. Method	FCC KDB 558074 §10.1	
	Test Env.	NT/NV	
	Test Setup	Test Setup 1	
	EUT Conf.	TM1_Ch0, TM1_Ch19, TM1_Ch39.	
Band edge spurious emission	Meas. Method	FCC KDB 558074 §13.0.	
	Test Env.	NT/NV	
	Test Setup	Test Setup 1	
	EUT Conf.	TM1_Ch0, TM1_Ch39.	
Unwanted Emissions into Non-Restricted Frequency Bands	Meas. Method	FCC KDB 558074 §11.0	
	Test Env.	NT/NV	
	Test Setup	Test Setup 1	
	EUT Conf.	TM1_Ch0, TM1_Ch19, TM1_Ch39.	
Unwanted Emissions into Restricted Frequency Bands (Radiated)	Meas. Method	ANSI C63.10; FCC KDB 558074 §12.1, Radiated	
	Test Env.	NT/NV	
	Test Setup	Test Setup 2	
	EUT Conf.	30 MHz -1 GHz	TM1_Ch0 (Worst Conf.).
		1-3 GHz	TM1_Ch0, TM1_Ch19, TM1_Ch39.
3-18 GHz		TM1_Ch19 (Worse Conf.),	
18-26.5 GHz		TM1_Ch0 (Worst Conf.).	
AC Power Line Conducted Emissions	Meas. Method	AC mains conducted. Pre: RBW = 10 kHz; Det. = Peak. Final: RBW = 9 kHz; Det. = CISPR Quasi-Peak & Average.	
	Test Env.	NT/NV	
	Test Setup	Test Setup 3	
	EUT Conf.	TM1_Ch39.	

**5 Main Test Instruments**

Main Test Equipments					
Equipment Name	Manufacturer	Model	Serial Number	Cal Date	Cal- Due
Power supply	KEITHLEY	2303	1342889	2016/10/13	2017/10/12
Wireless Communication Test set	Agilent	N4010A	MY49081592	2017/7/31	2018/7/30
Universal Radio Communication Tester	R&S	CMU200	123299	2016/11/14	2017/11/13
Spectrum Analyzer	Agilent	N9020A	MY52090652	2017/7/10	2018/7/9
Universal Radio Communication Tester	R & S	CMW500	126854	2016/12/29	2017/12/28
Signal Analyzer	R&S	FSQ31	200021	2017/7/31	2018/7/30
Spectrum Analyzer	Agilent	N9030A	MY49431698	2017/7/31	2018/7/30
Temperature Chamber	WEISS	WKL64	56246002940010	2016/12/21	2017/12/20
Signal generator	Agilent	E8257D	MY49281095	2017/7/31	2018/7/30
Vector Signal Generator	R&S	SMU200A	104162	2017/7/31	2018/7/30
Test receiver	R&S	ESU26	100387	2017/2/21	2018/2/20
Test receiver	R&S	ESCI	101163	2016/11/10	2017/11/9
Spectrum analyzer	R&S	FSU3	200474	2017/2/21	2018/2/20
Spectrum analyzer	R&S	FSU43	100144	2017/2/21	2018/2/20
LOOP Antennas(9kHz-30MHz)	R&S	HFH2-Z2	100262	2017/4/25	2019/4/25
LOOP Antennas(9kHz-30MHz)	R&S	HFH2-Z2	100263	2017/4/25	2019/4/25
Trilog Broadband Antenna (30M~3GHz)	SCHWARZBEC K	VULB 9163	9163-490	2017/3/29	2019/3/29
Trilog Broadband Antenna (30M~3GHz)	SCHWARZBEC K	VULB 9163	9163-521	2017/4/9	2019/4/9
Double-Ridged Waveguide Horn Antenna (1G~18GHz)	R&S	HF907	100304	2017/5/27	2019/5/27
Pyramidal Horn Antenna(18GHz-26.5GHz)	ETS-Lindgren	3160-09	206665	2017/3/24	2018/3/23
Artificial Main Network	R&S	ENV4200	100134	2017/5/15	2018/5/14



Line Impedance Stabilization Network	R&S	ENV216	100382	2017/5/15	2018/5/14
Signal Generator	Agilent	E4438C	MY49071538	2016/12/15	2017/12/14
Power Detecting & Sampling Unit	R&S	OSP-B157	100914	2017/7/31	2018/7/30
Software Information					
Test Item	Software Name		Manufacturer	Version	
RE	EMC32		R&S	V9.25.0	
CE	EMC32		R&S	V9.25.0	

END