

FCC Radio Test Report

FCC ID: QISB315S-22VERB

This report concerns (check one): Original Grant Class II Change

Project No. : 1802C116
Equipment : LTE CPE
Model Name : B315s-22
Applicant : Huawei Technologies Co.,Ltd.
Address : Administration Building, Headquarters of Huawei Technologies Co., Ltd., Bantian, Longgang District, Shenzhen, 518129, P.R.C

Date of Receipt : Feb. 24, 2018
Date of Test : Feb. 24, 2018 ~ Mar. 24, 2018
Issued Date : Mar. 27, 2018
Tested by : BTL Inc.

Technical Engineer : Shawn Xiao
(Shawn Xiao)

Authorized Signatory : Steven Lu
(Steven Lu)

B T L I N C .

No.3, Jinshagang 1st Road, Shixia, Dalang Town, Dongguan, Guangdong, China.

TEL: +86-769-8318-3000 FAX: +86-769-8319-6000



Declaration

BTL represents to the client that testing is done in accordance with standard procedures as applicable and that test instruments used has been calibrated with standards traceable to international standard(s) and/or national standard(s).

BTL's reports apply only to the specific samples tested under conditions. It is manufacture's responsibility to ensure that additional production units of this model are manufactured with the identical electrical and mechanical components. **BTL** shall have no liability for any declarations, inferences or generalizations drawn by the client or others from **BTL** issued reports.

BTL's report must not be used by the client to claim product certification, approval, or endorsement by NVLAP, NIST, or any agency of the Federal Government.

This report is the confidential property of the client. As a mutual protection to the clients, the public and **BTL-self**, extracts from the test report shall not be reproduced except in full with **BTL's** authorized written approval.

BTL's laboratory quality assurance procedures are in compliance with the **ISO Guide17025** requirements, and accredited by the conformity assessment authorities listed in this test report.

Limitation

For the use of the authority's logo is limited unless the Test Standard(s)/Scope(s)/Item(s) mentioned in this test report is (are) included in the conformity assessment authorities acceptance respective.

Table of Contents

Page

REPORT ISSUED HISTORY	5
1 . CERTIFICATION	6
2 . SUMMARY OF TEST RESULTS	7
2.1 TEST FACILITY	8
2.2 MEASUREMENT UNCERTAINTY	8
3 . GENERAL INFORMATION	9
3.1 GENERAL DESCRIPTION OF EUT	9
3.2 DESCRIPTION OF TEST MODES AND TEST CONDITION	10
3.3 BLOCKDIAGRAMSHOWINGTHECONFIGURATIONOFSYSTEMTESTED	11
3.4 DESCRIPTION OF SUPPORT UNITS	11
4 . TEST RESULT	12
4.1 OUTPUT POWER MEASUREMENT	12
4.1.1 LIMIT	12
4.1.2 TEST PROCEDURE	12
4.1.3 TESTSETUP LAYOUT	12
4.1.4 TEST DEVIATION	12
4.1.5 TEST RESULTS	12
4.2 OCCUPIED BANDWIDTH MEASUREMENT	13
4.2.1 TEST PROCEDURE	13
4.2.2 TEST SETUP LAYOUT	13
4.2.3 TEST DEVIATION	13
4.2.4 TEST RESULTS	13
4.3 CONDUCTED EMISSIONS MEASUREMENT	14
4.3.1 LIMIT	14
4.3.2 TEST PROCEDURES	14
4.3.3 TESTSETUP LAYOUT	14
4.3.4 TESTDEVIATION	14
4.3.5 TEST RESULTS	14
4.4 RADIATED EMISSIONS MEASUREMENT	15
4.4.1 LIMIT	15
4.4.2 TEST PROCEDURES	15
4.4.3 TESTSETUP LAYOUT	15
4.4.4 TESTDEVIATION	16
4.4.5 TEST RESULTS (9KHZ TO 30MHZ)	16
4.4.6 TEST RESULTS (30MHZ TO 1000MHZ)	16
4.4.7 TEST RESULTS (ABOVE 1000MHZ)	16
4.5 BAND EDGE MEASUREMENT	17

Table of Contents

Page

4.5.1 LIMIT	17
4.5.2 TEST PROCEDURES	17
4.5.3 TESTSETUP LAYOUT	17
4.5.4 TESTDEVIATION	17
4.5.5 TEST RESULTS	17
4.6 PEAK TO AVERAGE RATIO MEASUREMENT	18
4.6.1 LIMIT	18
4.6.2 TEST PROCEDURES	18
4.6.3 TESTSETUP LAYOUT	18
4.6.4 TESTDEVIATION	18
4.6.5 TEST RESULTS	18
4.7 FREQUENCY STABILITY MEASUREMENT	19
4.7.1 LIMIT	19
4.7.2 TEST PROCEDURES	19
4.7.3 TESTSETUP LAYOUT	19
4.7.4 TESTDEVIATION	19
4.7.5 TEST RESULTS	19
5. LIST OF MEASUREMENT EQUIPMENTS	20
APPENDIX A - OUTPUT POWER	22
APPENDIX B - OCCUPIED BANDWIDTH	24
APPENDIX C - CONDUCTED EMISSIONS	27
APPENDIX D - RADIATED EMISSION (9KHZ TO 30MHZ)	29
APPENDIX E - RADIATED EMISSION (30MHZ TO 1GHZ)	66
APPENDIX F - RADIATED EMISSION (ABOVE 1GHZ)	79
APPENDIX G - BAND EDGE	116
APPENDIX H - PEAK TO AVERAGE RATIO	118
APPENDIX J - FREQUENCY STABILITY	120

REPORT ISSUED HISTORY

Issued No.	Description	Issued Date
BTL-FCCP-2-1802C116	Original Issue.	Mar. 27, 2018

1. CERTIFICATION

Equipment : LTE CPE
Brand Name : HUAWEI
Model Name : B315s-22
Applicant : Huawei Technologies Co.,Ltd.
Manufacturer : Huawei Technologies Co.,Ltd.
Address : Administration Building, Headquarters of Huawei Technologies Co., Ltd.,
Bantian, Longgang District, Shenzhen, 518129, P.R.C
Factory : Huawei Technologies Co.,Ltd.
Address : Administration Building, Headquarters of Huawei Technologies Co., Ltd.,
Bantian, Longgang District, Shenzhen, 518129, P.R.C
Date of Test : Feb, 24, 2018 ~ Mar, 24, 2018
Test Sample : Engineering Sample
Standard(s) : 47 CFR FCC Part 24 Subpart E
47 CFR FCC Part 2
ANSI/TIA-603-D-2010
KDB 971168 D01 Power Meas License Digital Systems v03

The above equipment has been tested and found compliance with the requirement of the relative standards by BTL Inc.

The test data, data evaluation, and equipment configuration contained in our test report (Ref No. BTL-FCCP-2-1802C116) were obtained utilizing the test procedures, test instruments, test sites that has been accredited by the Authority of NVLAP according to the ISO-17025 quality assessment standard and technical standard(s).

Test results included in this report is only for the PCS1900 part.

2. SUMMARY OF TEST RESULTS

Test procedures according to the technical standard(s):

FCC Part 24 Subpart E & Part 2			
Standard(s) Section	Test Item	Judgment	Tested By
2.1046 24.232(c)	Radiated power	PASS	Paul Li
2.1046 24.232(c)	Conducted Output Power	PASS	Paul Li
2.1049 24.238(a)	Occupied Bandwidth	PASS	Paul Li
2.1051 24.238(a)	Conducted Spurious Emissions	PASS	Paul Li
2.1053 24.238(a)	Radiated Spurious Emissions	PASS	Paul Li
24.238(a)	Band Edge Measurements	PASS	Paul Li
24.232(d)	Peak To Average Ratio	PASS	Paul Li
2.1055 24.235	Frequency Stability	PASS	Paul Li

Note:

(1) "N/A" denotes test is not applicable to this device.

2.1 TEST FACILITY

The test facilities used to collect the test data in this report is at the location of No.3, Jinshagang 1st Road, Shixia, Dalang Town, Dongguan, Guangdong, China.

BTL's test firm number for FCC: 854385

BTL's designation number for FCC: CN5020

2.2 MEASUREMENT UNCERTAINTY

The measurement uncertainty figures shall be calculated according the methods described in the ETSI TR 100 028 and shall correspond to an expansion factor (coverage factor) $k=1.96$ or $k=2$ (which provide confidence levels of respectively 90% and 95.45% in the case where the distributions characterizing the actual measurement uncertainties are normal (Gaussian)).

Measurement Uncertainty for a Level of Confidence of 95 %, $U=2xUc(y)$.

The BTL measurement uncertainty as below table:

A. Radiated Measurement :

Test Site	Method	Measurement Frequency Range	Ant. H / V	U,(dB)
DG-CB03 (3m)	CISPR	9KHz ~ 30MHz	V	3.79
		9KHz ~ 30MHz	H	3.57
		30MHz ~ 200MHz	V	3.82
		30MHz ~ 200MHz	H	3.78
		200MHz ~ 1,000MHz	V	4.10
		200MHz ~ 1,000MHz	H	4.06

Test Site	Method	Measurement Frequency Range	Ant. H / V	U,(dB)
DG-CB03 (3m)	CISPR	1GHz ~ 18GHz	V	3.12
		1GHz ~ 18GHz	H	3.68

Test Site	Method	Measurement Frequency Range	Ant. H / V	U,(dB)
DG-CB03 (1m)	CISPR	18GHz ~ 40GHz	V	4.15
		18GHz ~ 40GHz	H	4.14

Note: Unless specifically mentioned, the uncertainty of measurement has not been taken into account to declare the compliance or non-compliance to the specification.

3. GENERAL INFORMATION

3.1 GENERAL DESCRIPTION OF EUT

Equipment	LTE CPE			
Brand Name	HUAWEI			
Model Name	B315s-22			
Model Difference	N/A			
Modulation Type	GSM/GPRS	GMSK		
	EDGE	GMSK, 8PSK		
Operation Frequency	GSM /EDGE/GPRS	1850.2 ~ 1909.8 MHz		
Max. EIRP Power	GSM/GPRS	GMSK	32.07	dBm
	EDGE	8PSK	27.82	dBm
Antenna Type	Internal Antenna and External Antenna			
Antenna Gain	2.5 dBi for Internal Antenna, 1 dBi and 3 dBi for External Antenna			
Hardware Version	WL1B310I			
Software Version	21.328.03.DM2.00			
IMEI No.	867962031001418			
Power Source	Supplied from AC/DC adapter.			
Power Rating	Input: 100V~240V 50/60 Hz,0.5A Output: 12V --- 1A			

Note:

1. For a more detailed features description, please refer to the manufacturer's specifications or the user's manual.
2. The EUT contains following accessory devices.

Item	Mfr/Brand	Model.
LAN Cable	N/A	N/A
TEL Cable	N/A	N/A
Adapter	Huawei Technologies Co.,Ltd.	HW-120100E01 HW-120100B01 HW-120100U01 HW-120100A6W HW-120100BW HW-120100EW

3.2 DESCRIPTION OF TEST MODES AND TEST CONDITION

Pre-Scan has been conducted to determine the worst-case mode from all possible combinations between available modulations, data rates, XYZ axis and antenna ports
 The worst case was found when positioned on X-plane for EIRP and X-axis for radiated emission.
 Following channel(s) was (were) selected for the final test as listed below:

GSM MODE			
Test Item	Available Channel	Tested Channel	Mode
EIRP	512 to 810	512, 661, 810	GSM, GPRS, EDGE
Conducted Output Power	512 to 810	512, 661, 810	GSM, GPRS, EDGE
Occupied Bandwidth	512 to 810	512, 661, 810	GSM, EDGE
Condcudeted Emission	512 to 810	810	GSM, EDGE
Radiated Emission	512 to 810	810	GSM, EDGE
Band Edge	512 to 810	512, 810	GSM, EDGE
Peak to Average Ratio	512 to 810	512, 661, 810	GSM, EDGE
Frequency Stability	512 to 810	810	GSM

Note: This device was tested under all bandwidths, GSM, GPRS and EDGE. The worst case was found in **GSM CH 810**.

EUT TEST CONDITIONS:

Test Item	Environmental Conditions	Test Voltage
EIRP	25°C, 60%RH	DC 12.00V
Conducted Output Power	25°C, 65%RH	DC 12.00V
Occupied Bandwidth	25°C, 65%RH	DC 12.00V
Conducted Emission	25°C, 65%RH	DC 12.00V
Radiated Emission	25°C, 60%RH	AC 120V/60Hz
Band Edge	25°C, 65%RH	DC 12.00V
Peak to Average Ratio	25°C, 65%RH	DC 12.00V
Frequency Stability	25°C, 65%RH	DC 12.00V, DC 10.80V, DC 13.20V

3.3 BLOCK DIAGRAM SHOWING THE CONFIGURATION OF SYSTEM TESTED

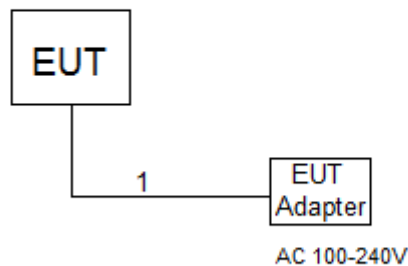

3.4 DESCRIPTION OF SUPPORT UNITS

The EUT has been tested as an independent unit together with other necessary accessories or support units. The following support units or accessories were used to form a representative test configuration during the tests.

Item	Equipment	Mfr/Brand	Model/Type No.	FCC ID	Series No.
-	-	-	-	-	-

Item	Shielded Type	Ferrite Core	Length	Note
1	NO	NO	1.2m	DC cable

4. TEST RESULT

4.1 OUTPUT POWER MEASUREMENT

4.1.1 LIMIT

Mobile / Portable station are limited to 2 watts e.i.r.p.

4.1.2 TEST PROCEDURE

EIRP/ERP:

EIRP= Conducted Power +Antenan gain

ERP power=EIPR power-2.15dBi.

Conducted Power:

The EUT was set up for the maximum power with GSM, GPRS, EDGE data modulation and link up with simulator. Set the EUT to transmit under low, middle and high channel and record the power level shown on simulator.

4.1.3 TESTSETUP LAYOUT

Conducted Power Measurement

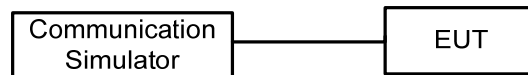

4.1.4 TEST DEVIATION

No deviation

4.1.5 TEST RESULTS

Please refer to the Appendix A.

4.2 OCCUPIED BANDWIDTH MEASUREMENT

4.2.1 TEST PROCEDURE

The EUT makes a call to the communication simulator. All measurements were done at low, middle and high operational frequency range. The communication simulator station system controlled a EUT to export maximum output power under transmission mode and specific channel frequency. Use OBW measurement function of Spectrum analyzer to measure 99 % occupied bandwidth and 26dB bandwidth.

4.2.2 TEST SETUP LAYOUT

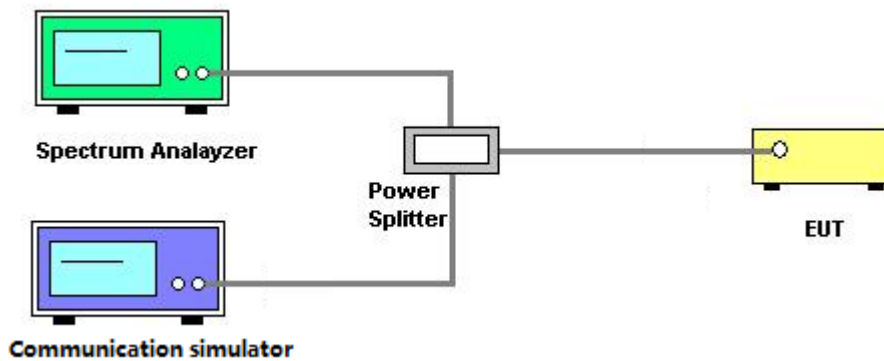

4.2.3 TEST DEVIATION

No deviation

4.2.4 TEST RESULTS

Please refer to the Appendix B.

4.3 CONDUCTED EMISSIONS MEASUREMENT

4.3.1 LIMIT

The power of any emission outside of the authorized operating frequency ranges must be attenuated below the transmitting power (P) by a factor of at least $43 + 10 \log(P)$ dB. The emission limit equal to -13dBm .

4.3.2 TEST PROCEDURES

1. The testing follows FCC KDB 971168 v03 Section 6.0.
2. The EUT was connected to spectrum analyzer and system simulator via a power divider.
3. The band edges of low and high channels for the highest RF powers were measured. Set $\text{RBW} \geq 1\%$ EBW in the 1MHz band immediately outside and adjacent to the band edge.
4. Set spectrum analyzer with RMS detector.
5. The RF fundamental frequency should be excluded against the limit line in the operating frequency band.
6. The limit line is derived from $43+10\log(P)\text{dB}$ below the transmitter power P(Watts)
 $=P(W)-[43+10\log(P)](\text{dB})$
 $=[30+10\log(P)](\text{dBm})-[43+10\log(P)](\text{dB})$
 $=-13\text{dBm}$

4.3.3 TESTSETUP LAYOUT

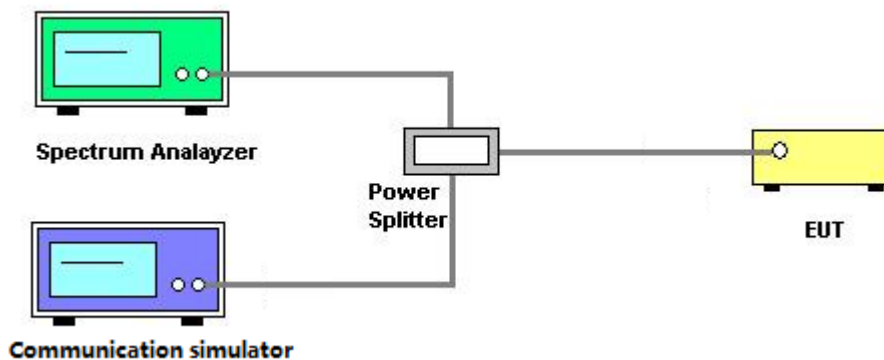

4.3.4 TESTDEVIATION

No deviation

4.3.5 TEST RESULTS

Please refer to the Appendix C.

4.4 RADIATED EMISSIONS MEASUREMENT

4.4.1 LIMIT

The power of any emission outside of the authorized operating frequency ranges must be attenuated below the transmitting power (P) by a factor of at least $43 + 10 \log(P)$ dB. The emission limit equal to -13dBm .

4.4.2 TEST PROCEDURES

1. Substitution method is used for E.I.R.P measurement. In the semi-anechoic chamber, EUT placed on the 0.8m height of Turn Table, rotated the table around 360 degrees to search the maximum radiation power and receiver antenna shall be rotated vertical and horizontal polarization and moved height from 1m to 4m to find the maximum polar radiated power. The "Read Value" is the spectrum reading the maximum power value.
2. The substitution horn antenna is substituted for EUT at the same position and signals generator export the CW signal to the substitution antenna via a TX cable. Rotated the Turn Table and moved receiving antenna to find the maximum radiation power. Adjust output power level of S.G to get a Value of spectrum reading equal to "Read Value " of step a. Record the power level of S.G
3. $\text{EIRP} = \text{Output power level of S.G} - \text{TX cable loss} + \text{Antenna gain of substitution horn}$.
4. E.R.P power can be calculated form E.I.R.P power by subtracting the gain of dipole, $\text{E.R.P power} = \text{E.I.P.R power} - 2.15\text{dBi}$.
5. The resolution bandwidth and video bandwidth of test receiver/spectrum analyzer is 1MHz/3MHz.

4.4.3 TESTSETUP LAYOUT

Below 30MHz

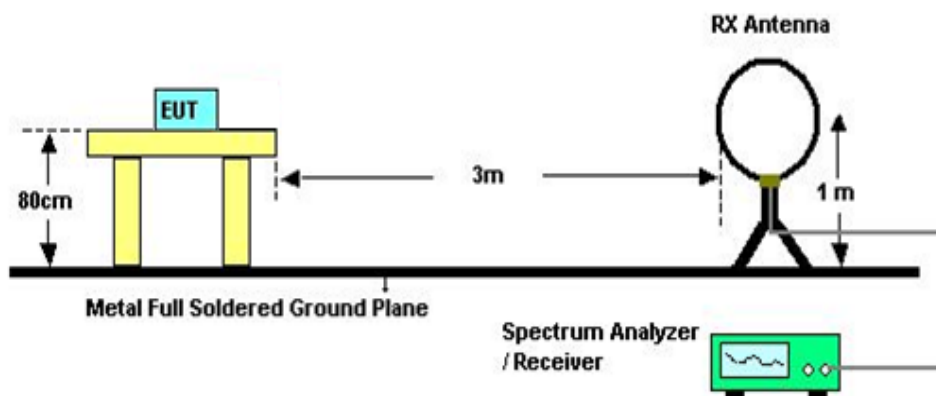

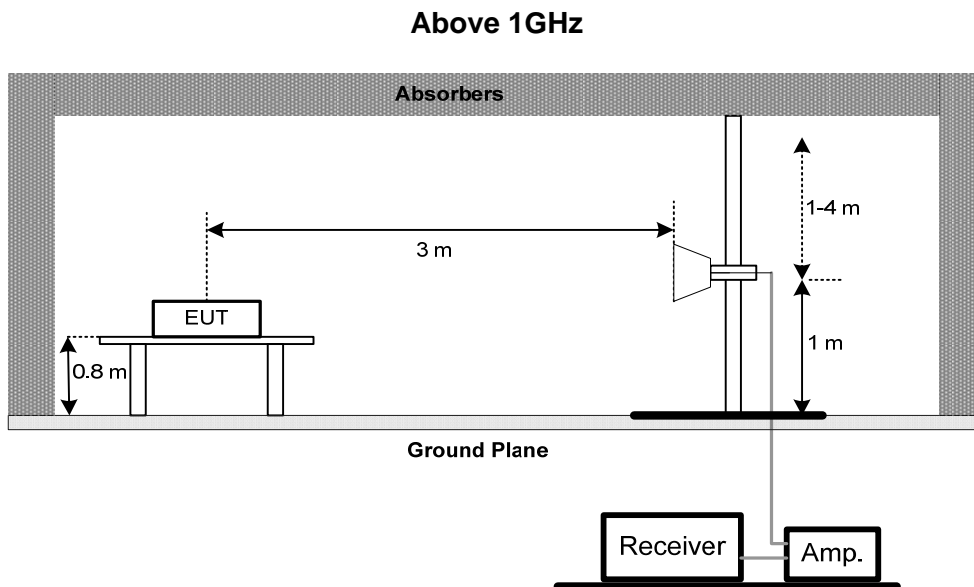
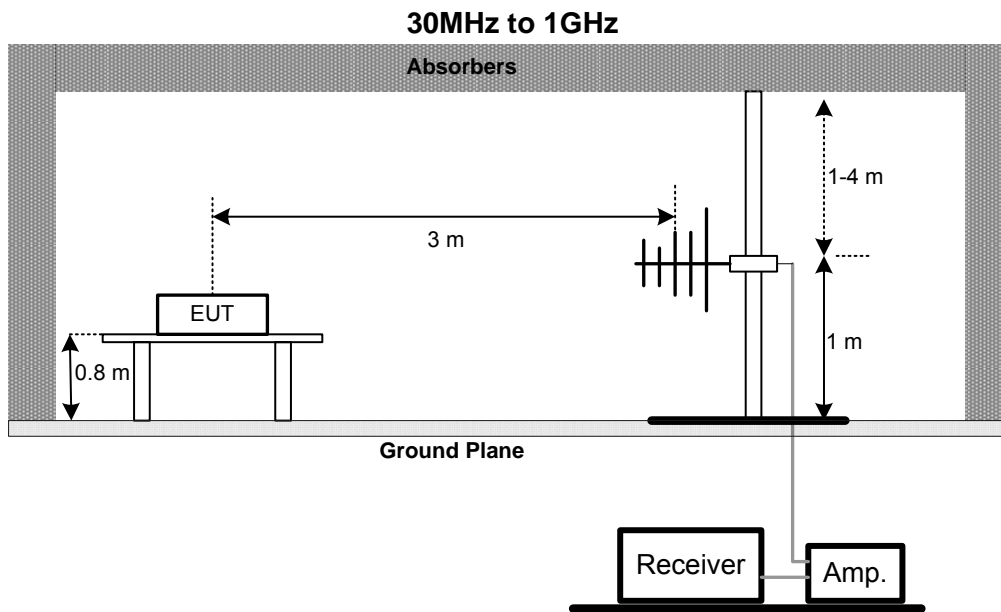

4.4.4 TEST DEVIATION

No deviation

4.4.5 TEST RESULTS (9KHZ TO 30MHZ)

Please refer to the Appendix D.

4.4.6 TEST RESULTS (30MHZ TO 1000MHZ)

Please refer to the Appendix E.

4.4.7 TEST RESULTS (ABOVE 1000MHZ)

Please refer to the Appendix F.

4.5 BAND EDGE MEASUREMENT

4.5.1 LIMIT

A Power of any emission outside of the authorized operating frequency ranges must be attenuated below the transmitting power (P) by a factor of at least $43 + 10 \log(P)$ dB. In the 1 MHz bands immediately outside and adjacent to the frequency block a resolution bandwidth of at least one percent of the emission bandwidth of the fundamental emission of the transmitter may be employed.

4.5.2 TEST PROCEDURES

1. All measurements were done at low and high operational frequency range.
2. The center frequency of spectrum is the band edge frequency and span is 1MHz. RB of the spectrum is 3kHz and VB of the spectrum is 10kHz (GSM/GPRS/EDGE).
3. The center frequency of spectrum is the band edge frequency and span is 5MHz. RB of the spectrum is 100kHz and VB of the spectrum is 300kHz (WCDMA).
4. Record the max trace plot into the test report.

4.5.3 TESTSETUP LAYOUT

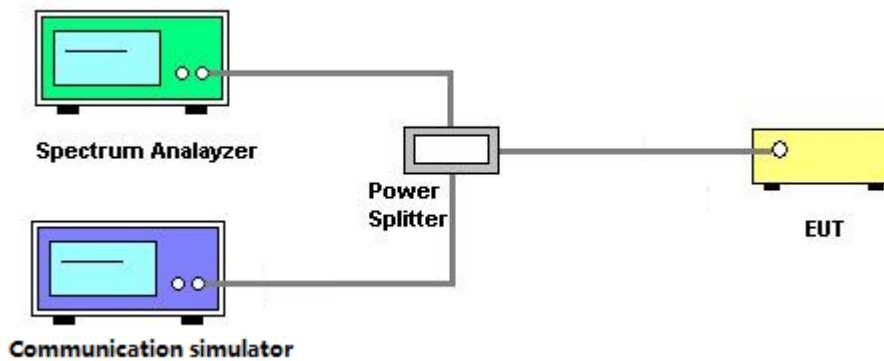

4.5.4 TESTDEVIATION

No deviation

4.5.5 TEST RESULTS

Please refer to the Appendix G.

4.6 PEAK TO AVERAGE RATIO MEASUREMENT

4.6.1 LIMIT

In measuring transmissions in this band using an average power technique, the peak to-average ratio (PAR) of the transmission may not exceed 13 dB.

4.6.2 TEST PROCEDURES

1. Set resolution/measurement bandwidth \geq signal's occupied bandwidth;
2. Set the number of counts to a value that stabilizes the measured CCDF curve;
3. Record the maximum PAPR level associated with a probability of 0.1%.

4.6.3 TESTSETUP LAYOUT

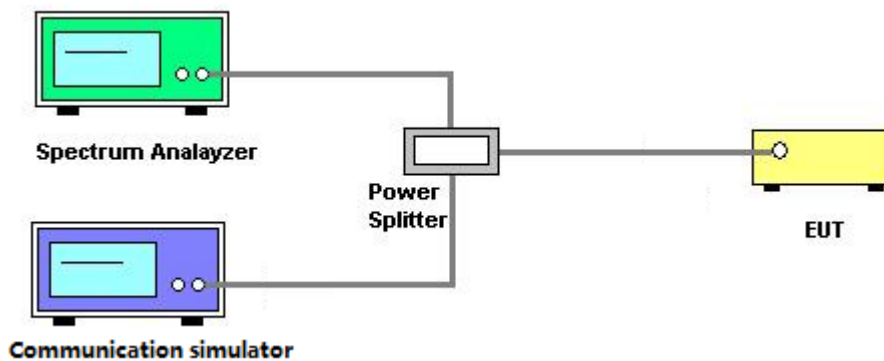

4.6.4 TESTDEVIATION

No deviation

4.6.5 TEST RESULTS

Please refer to the Appendix H.

4.7 FREQUENCY STABILITY MEASUREMENT

4.7.1 LIMIT

1.5 ppm is for base and fixed station. 2.5 ppm is for mobile station.

4.7.2 TEST PROCEDURES

1. Device is placed at the oven room. The oven room could control the temperatures and humidity. Power warm up is at least 15 min and power applied should perform before recording frequency error.
2. EUT is connected the external power supply to control the DC input power. The test voltage range is from minimum to maximum working voltage. Each step shall be record the frequency error rate.
3. The temperature range step is 10 degrees in this test items. All temperature levels shall be hold the $\pm 0.5^{\circ}\text{C}$ during the measurement testing. The each temperature step shall be at least 0.5 hours, consider the EUT could be test under the stability condition.
4. The frequency error was recorded frequency error from the communication simulator.

4.7.3 TESTSETUP LAYOUT

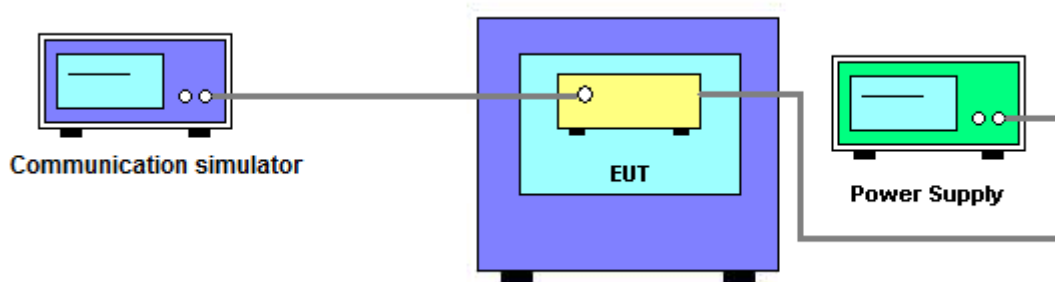

4.7.4 TESTDEVIATION

No deviation

4.7.5 TEST RESULTS

Please refer to the Appendix I.

5. LIST OF MEASUREMENT EQUIPMENTS

Radiated Emission & ERP or EIRP Measurement					
Item	Kind of Equipment	Manufacturer	Type No.	Serial No.	Calibrated until
1	Antenna	Schwarbeck	VULB9160	9160-3232	Mar. 11, 2019
2	Amplifier	Agilent	8449B	3008A02274	Mar. 11, 2019
3	Amplifier	HP	8447D	2944A09673	Oct. 19, 2018
4	HighPass Filter	Wairwright Instruments Gmbh	WHK 1.5/15G-10ST	11	Mar. 11, 2019
5	Band Reject Filter	Wairwright Instruments Gmbh	WRCG 1710/1785-1690/180 5-60/12SS	38	Mar. 11, 2019
6	Band Reject Filter	Wairwright Instruments Gmbh	WRCG 824/849-810/863-60/ 9SS	7	Mar. 11, 2019
7	Band Reject Filter	Wairwright Instruments Gmbh	WRCG 880/915-860/935-60/ 9SS	14	Mar. 11, 2019
8	Band Reject Filter	Wairwright Instruments Gmbh	WRCG 1850/1910-1830/193 0-60/10SS	17	Mar. 11, 2019
9	HighPass Filter	Wairwright Instruments Gmbh	WHK3.1/18G-10SS	24	Mar. 11, 2019
10	Wireless Communication Test SET	Agilent	E5515C	MY48364183	Mar. 11, 2019
11	Microwave Preamplifier With Adaptor	EMC INSTRUMENT	EMC2654045	980039 & HA01	Mar. 11, 2019
12	Receiver	Agilent	N9038A	MY52130039	Aug. 20, 2018
13	wideband radio communication tester	R&S	CMW500	152372	Mar. 11, 2019
14	Cable	emci	LMR-400(30MHz-1G Hz)(8m+5m)	N/A	Jun. 26, 2018
15	Cable	emci	EMC104-SM-SM-12000(12m)	N/A	Jun. 26, 2018
16	Controller	ETS-Lindgren	2090	N/A	N/A
17	Measurement Software	Farad	EZ-EMC Ver.NB-03A1-01	N/A	N/A
18	Antenna	EM	EM-6876-1	230	Feb. 07, 2019
19	Double Ridged Guide Antenna	ETS	3115	75789	Mar. 11, 2019
20	Broad-Band Horn Antenna	Schwarzbeck	BBHA 9170	9170319	Jun. 08, 2018

Conducted Emission & Band Edge & Occupied Bandwidth Measurement					
Item	Kind of Equipment	Manufacturer	Type No.	Serial No.	Calibrated until
1	Wireless Communication Test SET	Agilent	E5515C	MY48364183	Mar. 11, 2019
2	EXA Spectrum Analyzer	Agilent	N9010A	MY50520044	Mar. 11, 2019
3	POWER SPLITTER	Mini-Circuits	ZFRSC-123-S+	331000910-1	Mar. 11, 2019
4	wideband radio communication tester	R&S	CMW500	152372	Mar. 11, 2019
5	Cable	N/A	RG316(0.3m)	N/A	Jul. 05, 2018
6	Spectrum Analyzer	R&S	FSP40	100185	Aug. 20, 2018

Frequency Stability Measurement					
Item	Kind of Equipment	Manufacturer	Type No.	Serial No.	Calibrated until
1	Wireless Communication Test SET	Agilent	E5515C	MY48364183	Mar. 11, 2019
2	Multi-output DC Power Supply	GW Instek	GPC-3030DN	EK880675	Sep. 26, 2020
3	POWER SPLITTER	Mini-Circuits	ZFRSC-123-S+	331000910-1	Mar. 11, 2019
4	wideband radio communication tester	R&S	CMW500	152372	Mar. 11, 2019
5	Const Temp, & Humidity Chamber	Bell	BTH-50C	20170306001	Mar. 26, 2018
6	Cable	N/A	RG316(0.3m)	N/A	Jul. 05, 2018

Remark: "N/A" denotes no model name, serial no. or calibration specified.
 All calibration period of equipment list is one year.

APPENDIX A - OUTPUT POWER

Conducted Power:

PCS1900 (Capsensor Off)		Burst Conducted Power (dBm)		
		512CH	661CH	810CH
		1850.2MHz	1880MHz	1909.8MHz
GSM (CS)		29.05	28.97	29.07
GPRS/EDGE (GMSK)	1 Tx Slot	29.04	28.95	29.02
	2 Tx Slot	26.87	26.88	26.95
	3 Tx Slot	24.76	25.27	24.64
	4 Tx Slot	23.04	22.93	23.06
EDGE (8PSK)	1 Tx Slot	24.54	24.82	24.72
	2 Tx Slot	22.85	22.94	22.85
	3 Tx Slot	20.93	20.87	21.03
	4 Tx Slot	18.97	18.83	18.94

EIRP Power

PCS1900 (Capsensor Off)		EIRP Power (dBm)		
		512CH	661CH	810CH
		1850.2MHz	1880MHz	1909.8MHz
GSM (CS)		32.05	31.97	32.07
GPRS/EDGE (GMSK)	1 Tx Slot	32.04	31.95	32.02
	2 Tx Slot	29.87	29.88	29.95
	3 Tx Slot	27.76	28.27	27.64
	4 Tx Slot	26.04	25.93	26.06
EDGE (8PSK)	1 Tx Slot	27.54	27.82	27.72
	2 Tx Slot	25.85	25.94	25.85
	3 Tx Slot	23.93	23.87	24.03
	4 Tx Slot	21.97	21.83	21.94

APPENDIX B - OCCUPIED BANDWIDTH

PCS1900					
GSM			EDGE		
CS			8PSK		
Channel	Frequency (MHz)	99% Occupied Bandwidth (MHz)	Channel	Frequency (MHz)	99% Occupied Bandwidth (MHz)
512	1850.2	0.243	512	1850.2	0.248
661	1880	0.241	661	1880	0.249
810	1909.8	0.241	810	1909.8	0.248
Channel	Frequency (MHz)	26dB Bandwidth (MHz)	Channel	Frequency (MHz)	26dB Bandwidth (MHz)
512	1850.2	0.314	512	1850.2	0.319
661	1880	0.313	661	1880	0.321
810	1909.8	0.316	810	1909.8	0.314

Spectrum Plot

GSM-512

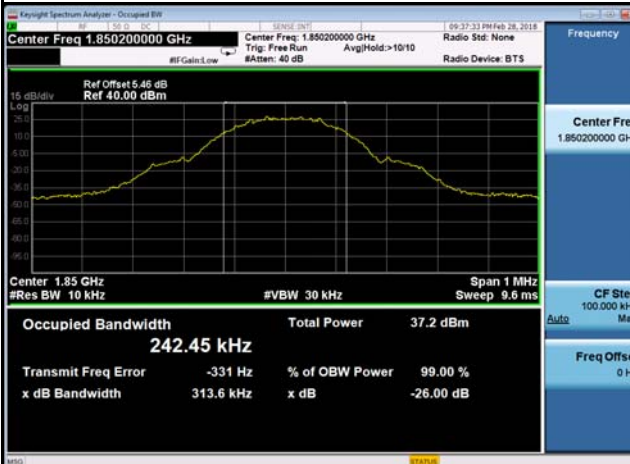

GSM-661

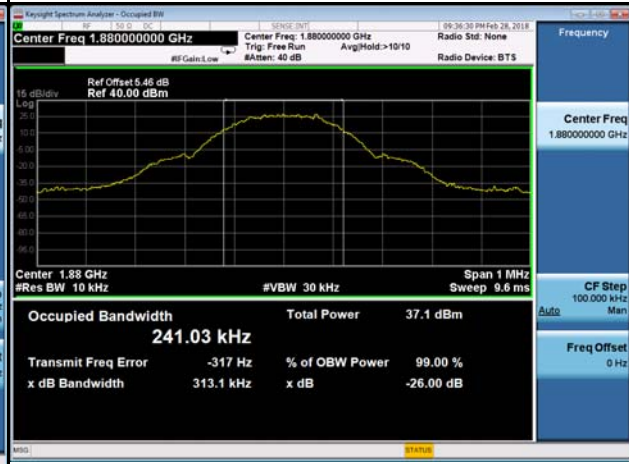

GSM-810

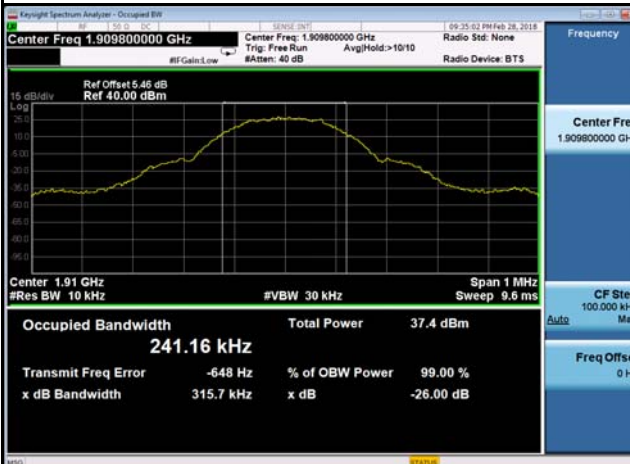

EDGE-512



EDGE-661



EDGE-810



APPENDIX C - CONDUCTED EMISSIONS

PCS1900			
GSM		GSM	
Channel	Frequency(MHz)	Channel	Frequency(MHz)
810	1909.8	810	1909.8
Date: 26.MAR.2018 15:14:02		Date: 26.MAR.2018 15:23:28	
GSM		EDGE	
Channel	Frequency(MHz)	Channel	Frequency(MHz)
810	1909.8	810	1909.8
Date: 20.MAR.2018 18:20:57		Date: 26.MAR.2018 15:14:44	
EDGE		EDGE	
Channel	Frequency(MHz)	Channel	Frequency(MHz)
810	1909.8	810	1909.8
Date: 26.MAR.2018 15:22:08		Date: 20.MAR.2018 17:03:18	

APPENDIX D - RADIATED EMISSION (9KHZ TO 30MHZ)

Test Mode: TX Mode_Adapter: Fuhua_Internal Antenna

Ant 0°

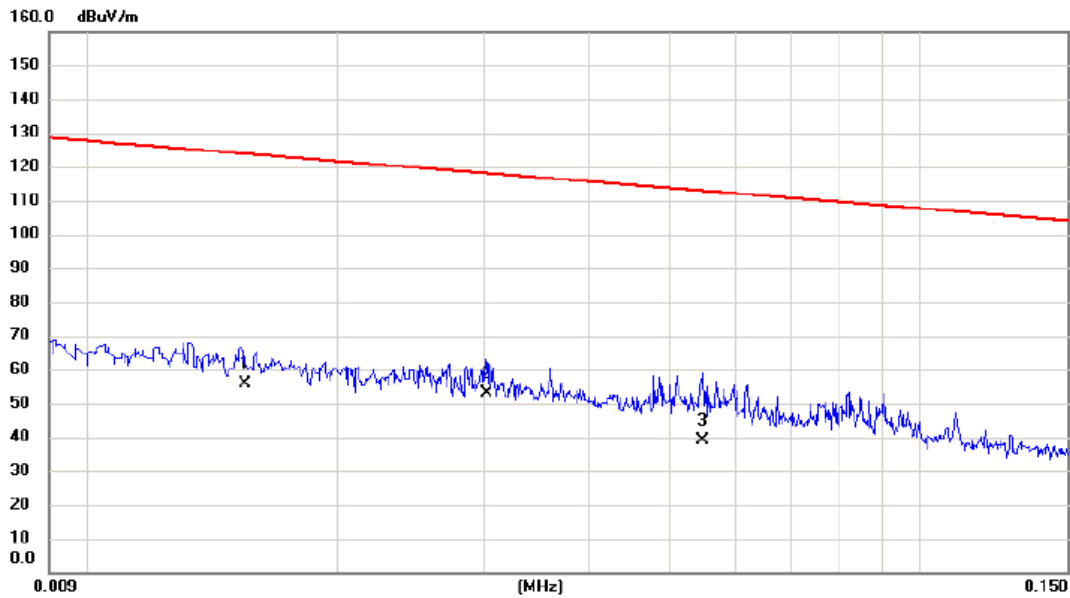

No.	Mk.	Freq. MHz	Reading Level dBuV	Correct Factor dB	Measure- ment dBuV/m	Limit dBuV/m	Margin dB	Detector	Comment
1		0.0155	35.54	20.20	55.74	123.80	-68.06	AVG	
2	*	0.0302	33.63	19.31	52.94	118.00	-65.06	AVG	
3		0.0548	20.34	18.63	38.97	112.83	-73.86	AVG	

Test Mode: TX Mode_Adapter: Fuhua_Internal Antenna

Ant 0°

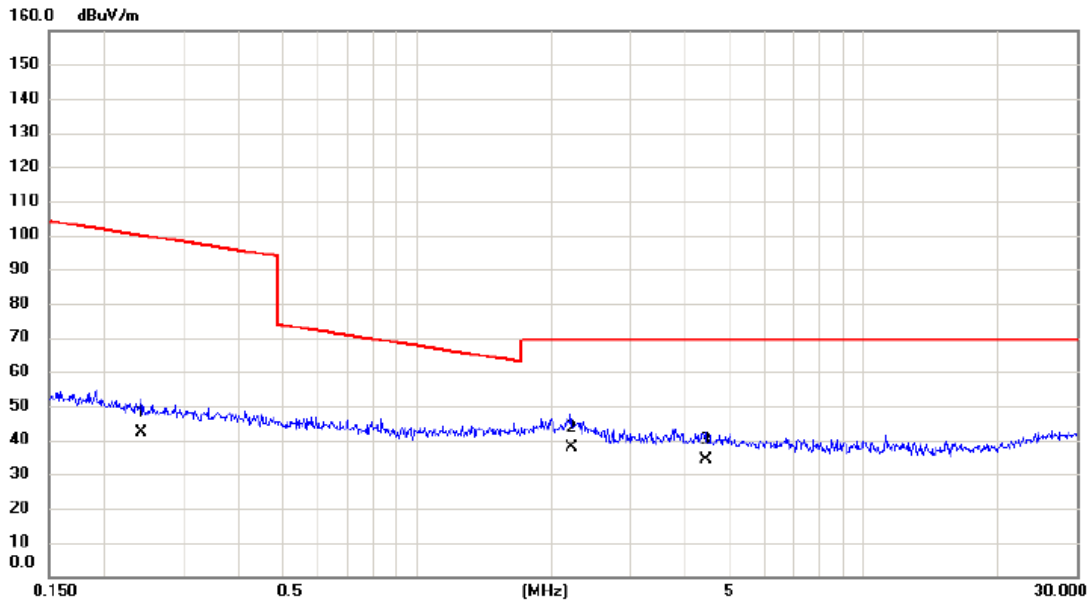

No.	Mk.	Freq. MHz	Reading Level dBuV	Correct Factor dB	Measure- ment dBuV/m	Limit dBuV/m	Margin dB	Detector	Comment
1		0.2416	25.55	16.69	42.24	99.94	-57.70	AVG	
2	*	2.2132	22.24	15.45	37.69	69.54	-31.85	QP	
3		4.4305	19.46	14.70	34.16	69.54	-35.38	QP	

Test Mode: TX Mode _ Adapter: Fuhua_ Internal Antenna

Ant 90°

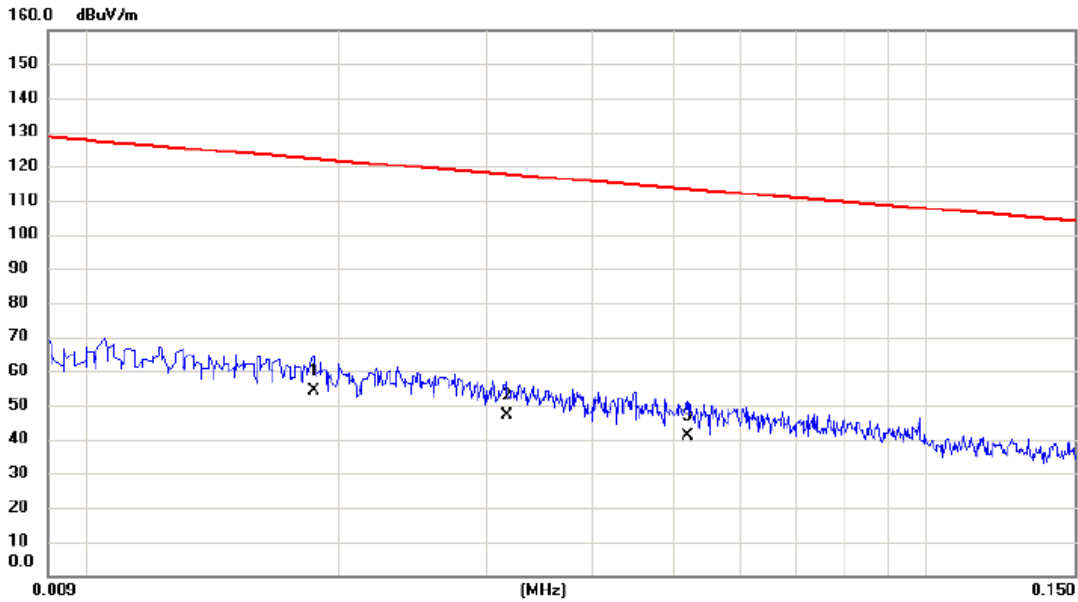

No.	Mk.	Freq. MHz	Reading Level dBuV	Correct Factor dB	Measure- ment dBuV/m	Limit dBuV/m	Margin dB	Detector	Comment
1	*	0.0187	34.38	19.79	54.17	122.17	-68.00	AVG	
2		0.0317	27.69	19.27	46.96	117.58	-70.62	AVG	
3		0.0520	22.35	18.68	41.03	113.28	-72.25	AVG	

Test Mode: TX Mode_Adapter: Fuhua_Internal Antenna

Ant 90°

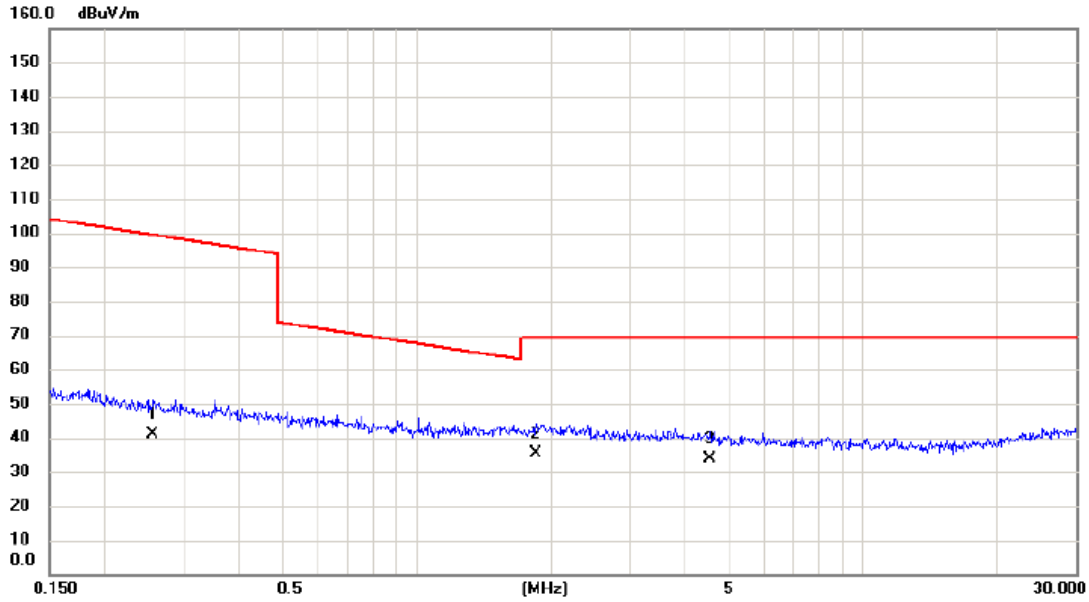

No.	Mk.	Freq. MHz	Reading Level dBuV	Correct Factor dB	Measure- ment dBuV/m	Limit dBuV/m	Margin dB	Detector	Comment
1		0.2562	24.51	16.66	41.17	99.43	-58.26	AVG	
2	*	1.8483	19.76	15.57	35.33	69.54	-34.21	QP	
3		4.5254	18.98	14.64	33.62	69.54	-35.92	QP	

Test Mode: TX Mode _ Adapter: Kuantech_Internal Antenna

Ant 0°

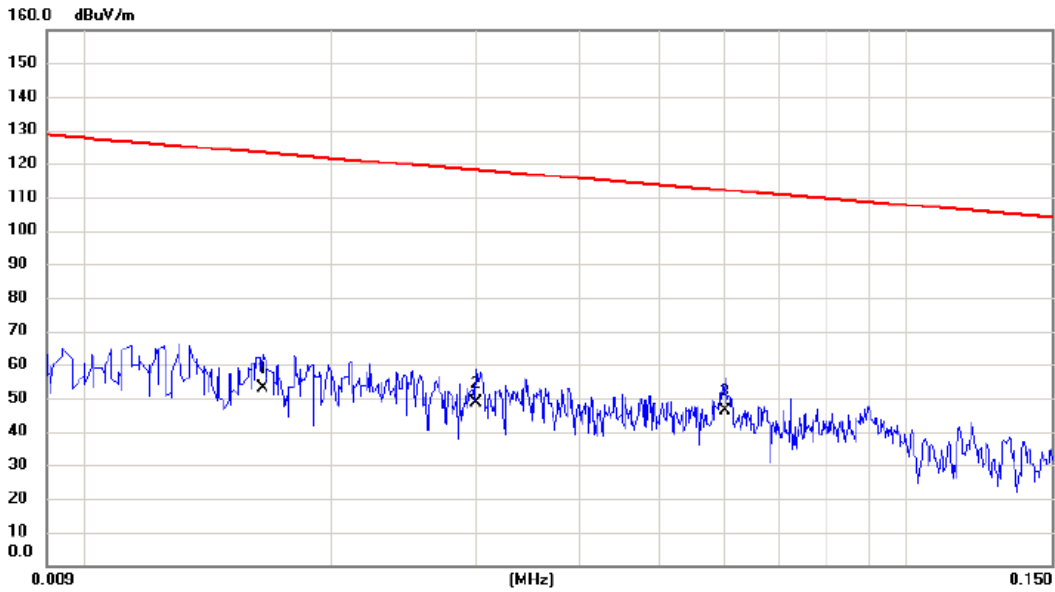

No.	Mk.	Freq. MHz	Reading Level dBuV	Correct Factor dB	Measure- ment dBuV/m	Limit dBuV/m	Margin dB	Detector	Comment
1		0.0165	32.95	20.07	53.02	123.26	-70.24	AVG	
2		0.0300	29.39	19.32	48.71	118.06	-69.35	AVG	
3	*	0.0601	27.65	18.53	46.18	112.03	-65.85	AVG	

Test Mode: TX Mode _ Adapter: Kuantech_Internal Antenna

Ant 0°

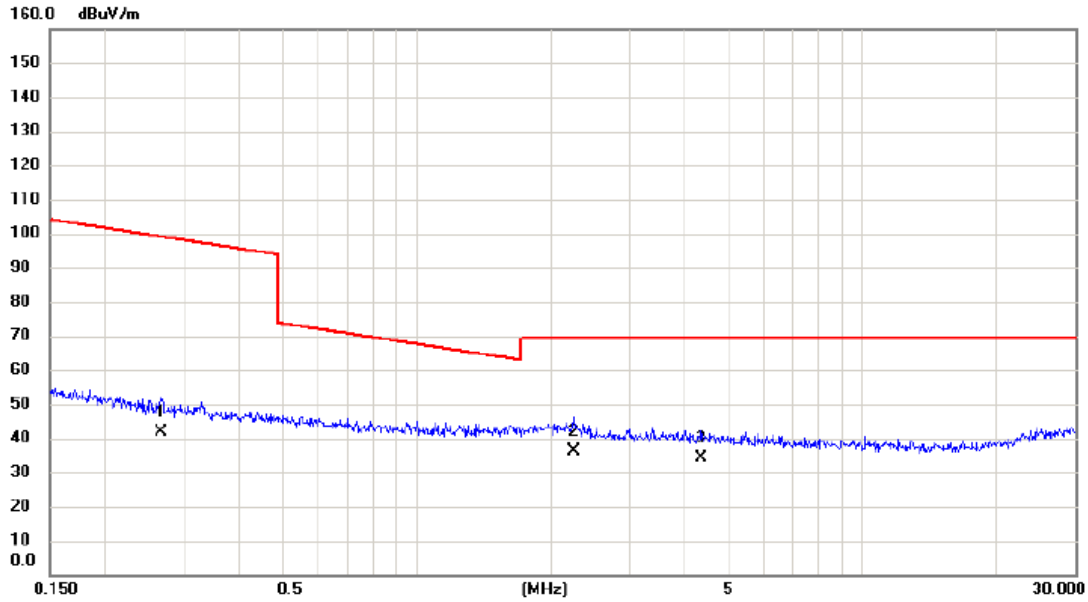

No.	Mk.	Freq. MHz	Reading Level dBuV	Correct Factor dB	Measure- ment dBuV/m	Limit dBuV/m	Margin dB	Detector	Comment
1		0.2672	25.06	16.65	41.71	99.07	-57.36	AVG	
2	*	2.2486	20.67	15.44	36.11	69.54	-33.43	QP	
3		4.3376	19.60	14.76	34.36	69.54	-35.18	QP	

Test Mode: TX Mode _ Adapter: Kuantech_Internal Antenna

Ant 90°

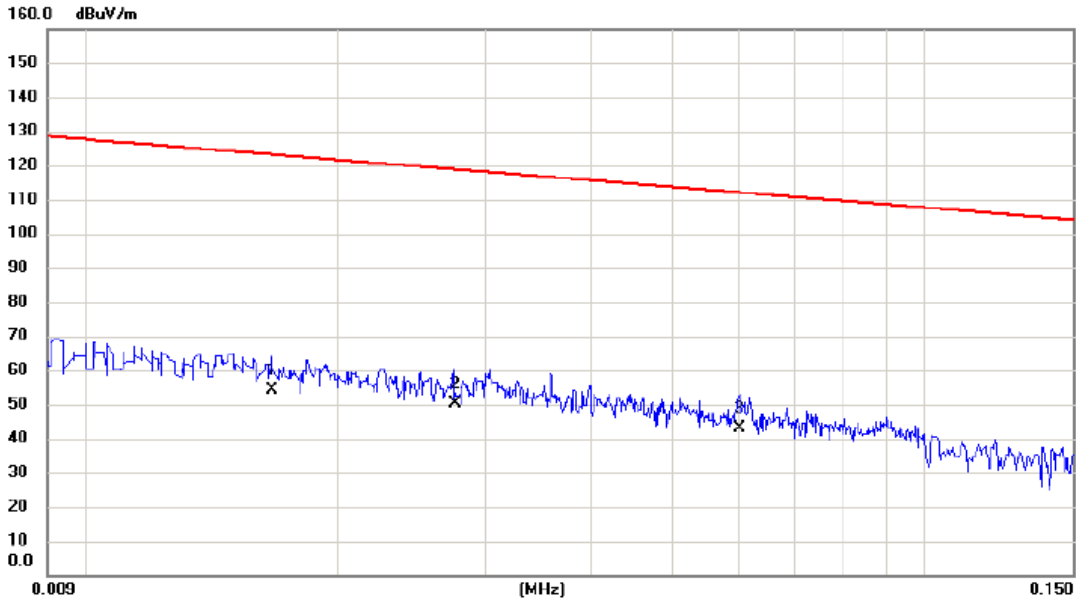

No.	Mk.	Freq. MHz	Reading Level dBuV	Correct Factor dB	Measure- ment dBuV/m	Limit dBUv/m	Margin dB	Detector	Comment
1		0.0167	34.07	20.05	54.12	123.15	-69.03	AVG	
2	*	0.0276	30.96	19.39	50.35	118.79	-68.44	AVG	
3		0.0601	24.49	18.53	43.02	112.03	-69.01	AVG	

Test Mode: TX Mode _ Adapter: Kuantech_Internal Antenna

Ant 90°

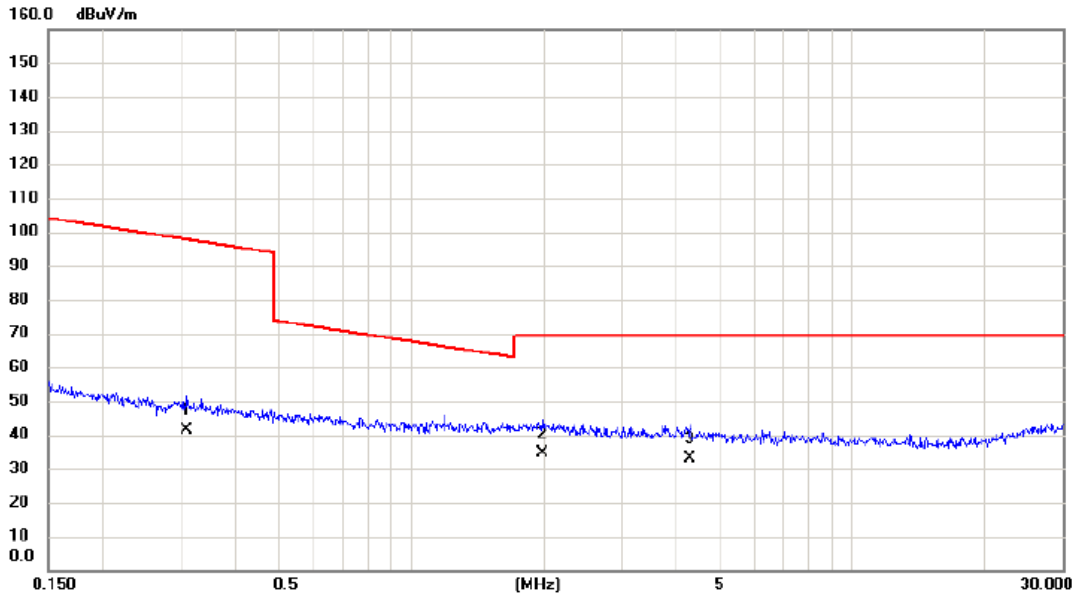

No.	Mk.	Freq. MHz	Reading Level dBuV	Correct Factor dB	Measure- ment dBuV/m	Limit dBuV/m	Margin dB	Detector	Comment
1		0.3100	24.73	16.61	41.34	97.78	-56.44	AVG	
2	*	1.9906	19.03	15.51	34.54	69.54	-35.00	QP	
3		4.2918	18.04	14.78	32.82	69.54	-36.72	QP	

Test Mode: TX Mode _ Adapter: HONOR_ Internal Antenna

Ant 0°

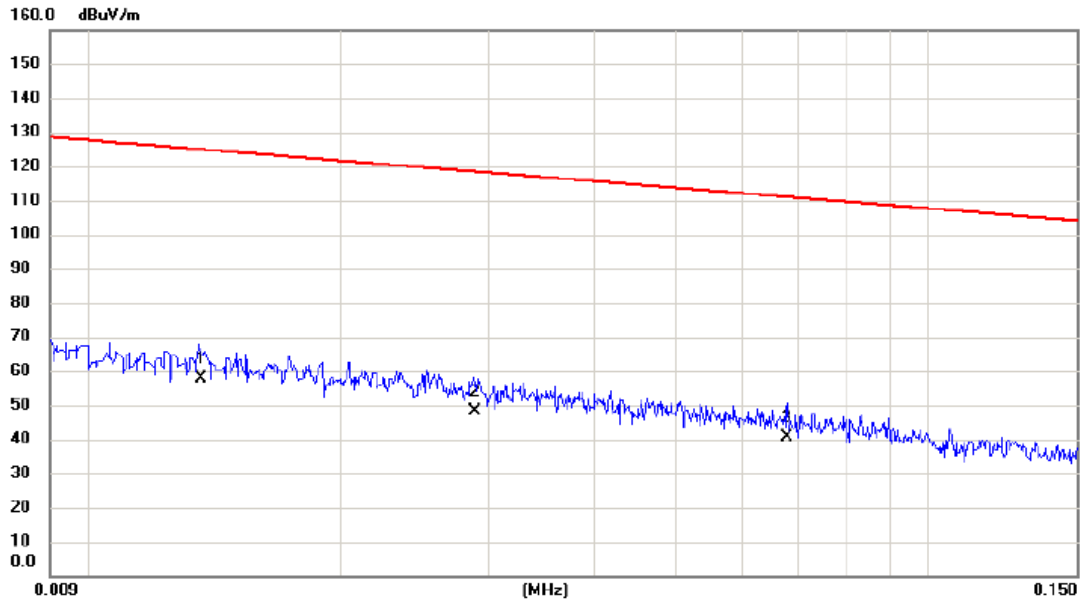

No.	Mk.	Freq. MHz	Reading Level dBuV	Correct Factor dB	Measure- ment dBuV/m	Limit dBuV/m	Margin dB	Detector	Comment
1	*	0.0136	37.20	20.45	57.65	124.93	-67.28	AVG	
2		0.0288	29.00	19.36	48.36	118.42	-70.06	AVG	
3		0.0678	22.28	18.37	40.65	110.98	-70.33	AVG	

Test Mode: TX Mode _ Adapter: HONOR_ Internal Antenna

Ant 0°

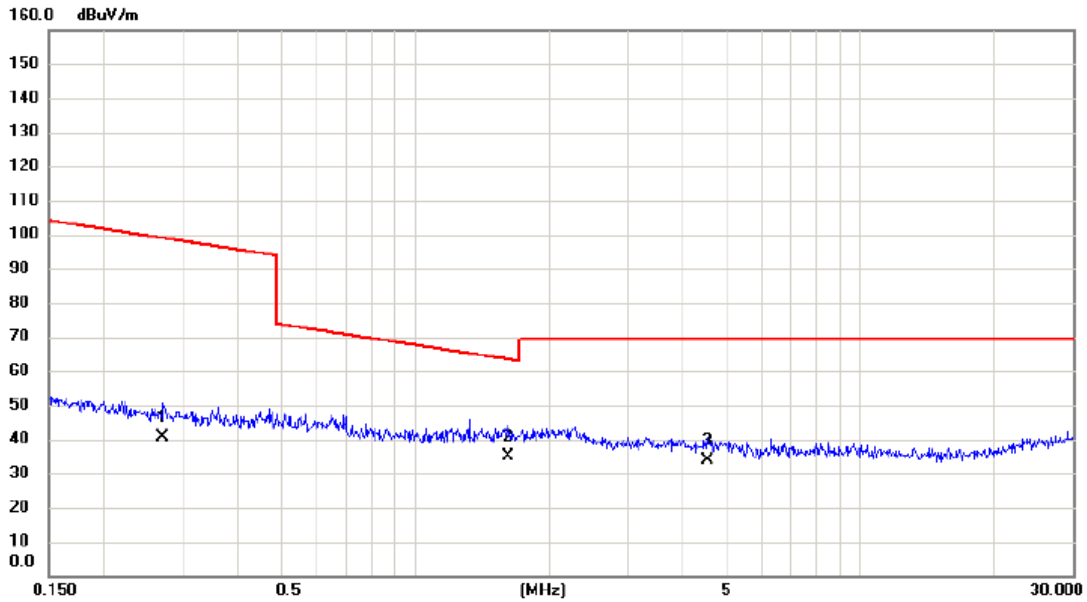

No.	Mk.	Freq. MHz	Reading Level dBuV	Correct Factor dB	Measure- ment dBuV/m	Limit dBuV/m	Margin dB	Detector	Comment
1		0.2714	23.90	16.64	40.54	98.93	-58.39	AVG	
2	*	1.6105	19.39	15.66	35.05	63.47	-28.42	QP	
3		4.5254	18.99	14.64	33.63	69.54	-35.91	QP	

Test Mode: TX Mode _ Adapter: HONOR_ Internal Antenna

Ant 90°

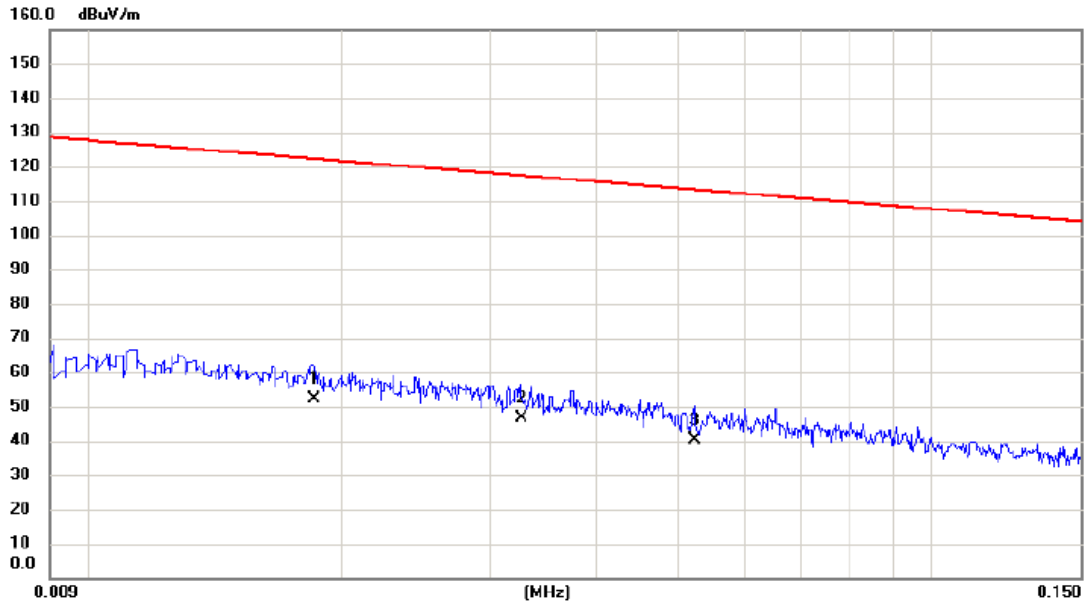

No.	Mk.	Freq.	Reading Level	Correct Factor	Measurement	Limit	Margin	Detector	Comment
		MHz	dBuV	dB	dBuV/m	dBuV/m	dB		
1	*	0.0185	32.35	19.82	52.17	122.26	-70.09	AVG	
2		0.0326	27.51	19.24	46.75	117.34	-70.59	AVG	
3		0.0524	21.47	18.67	40.14	113.22	-73.08	AVG	

Test Mode: TX Mode _ Adapter: HONOR_Internal Antenna

Ant 90°

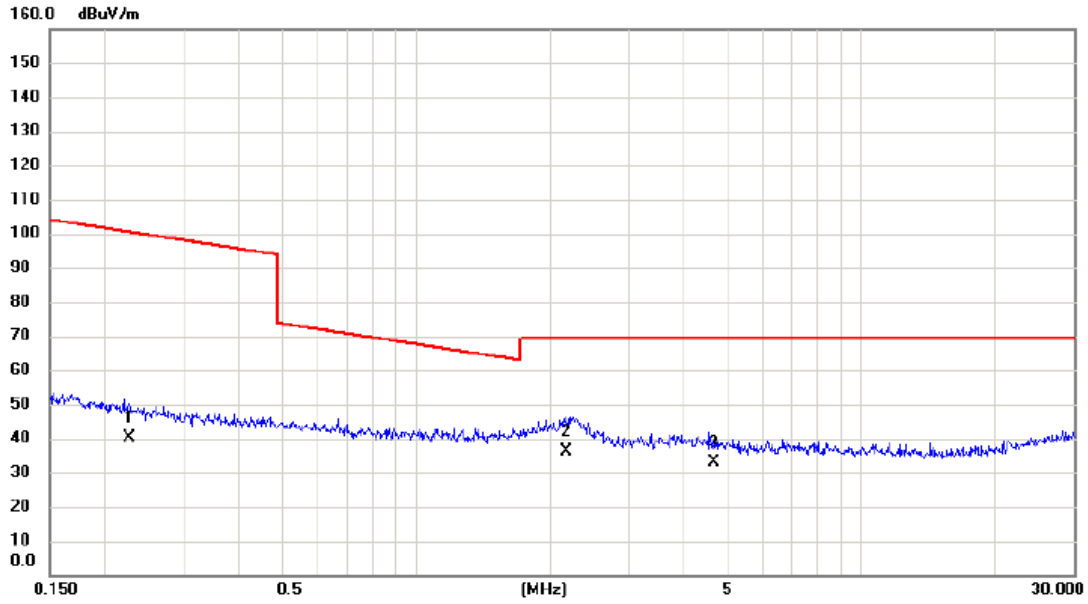

No.	Mk.	Freq. MHz	Reading Level dBuV	Correct Factor dB	Measure- ment dBuV/m	Limit dBuV/m	Margin dB	Detector	Comment
1		0.2268	23.61	16.72	40.33	100.49	-60.16	AVG	
2	*	2.1783	20.82	15.46	36.28	69.54	-33.26	QP	
3		4.6715	18.29	14.56	32.85	69.54	-36.69	QP	

Test Mode: TX Mode_Adapter: Fuhua_External Antenna_1dBi

Ant 0°

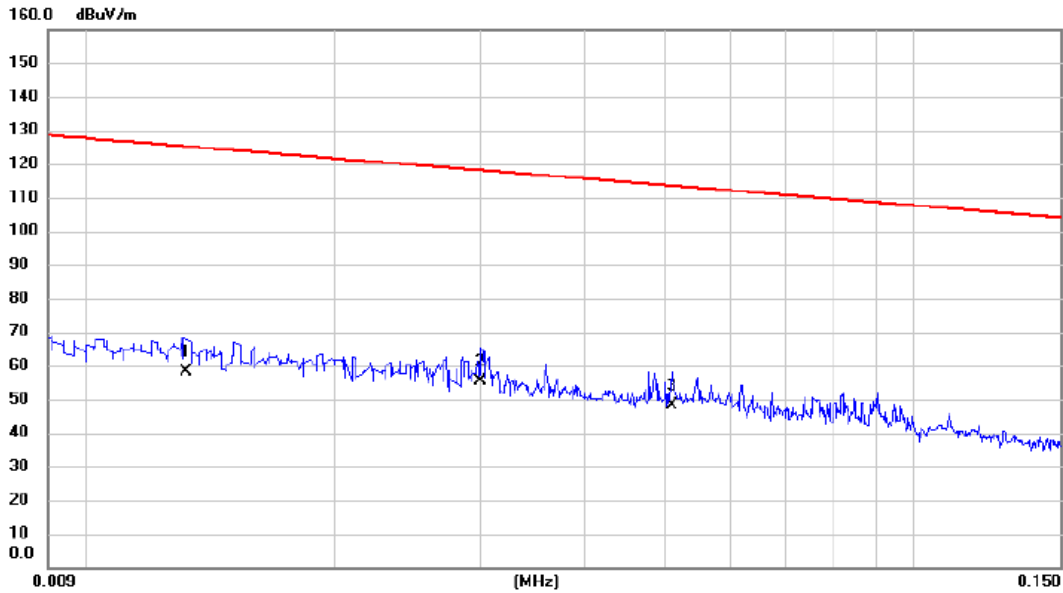

No.	Mk.	Freq. MHz	Reading Level dBuV	Correct Factor dB	Measure- ment dBuV/m	Limit dBuV/m	Margin dB	Detector	Comment
1		0.013	37.85	20.50	58.35	125.19	-66.84	AVG	
2	*	0.030	36.25	19.32	55.57	118.06	-62.49	AVG	
3		0.051	29.58	18.70	48.28	113.45	-65.17	AVG	

Test Mode: TX Mode_Adapter: Fuhua_External Antenna_1dBi

Ant 0°

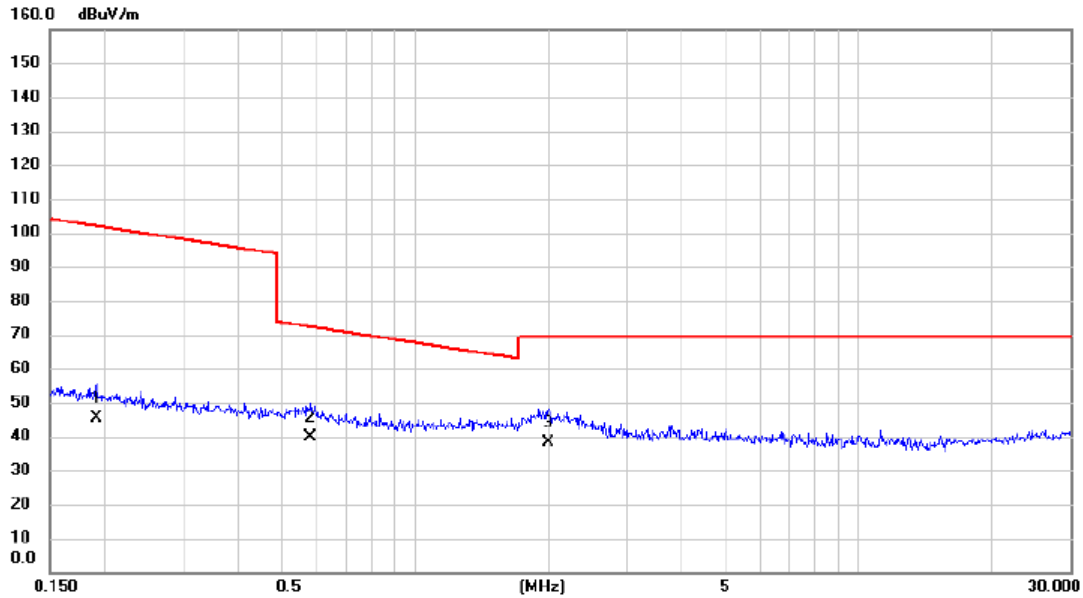

No.	Mk.	Freq.	Reading Level	Correct Factor	Measurement	Limit	Margin	Detector	Comment
		MHz	dBuV	dB	dBuV/m	dBuV/m	dB		
1		0.191	28.38	16.83	45.21	101.98	-56.77	AVG	
2		0.582	23.24	16.37	39.61	72.30	-32.69	QP	
3	*	2.001	22.70	15.51	38.21	69.54	-31.33	QP	

Test Mode: TX Mode _ Adapter: Fuhua_External Antenna_1dBi

Ant 90°

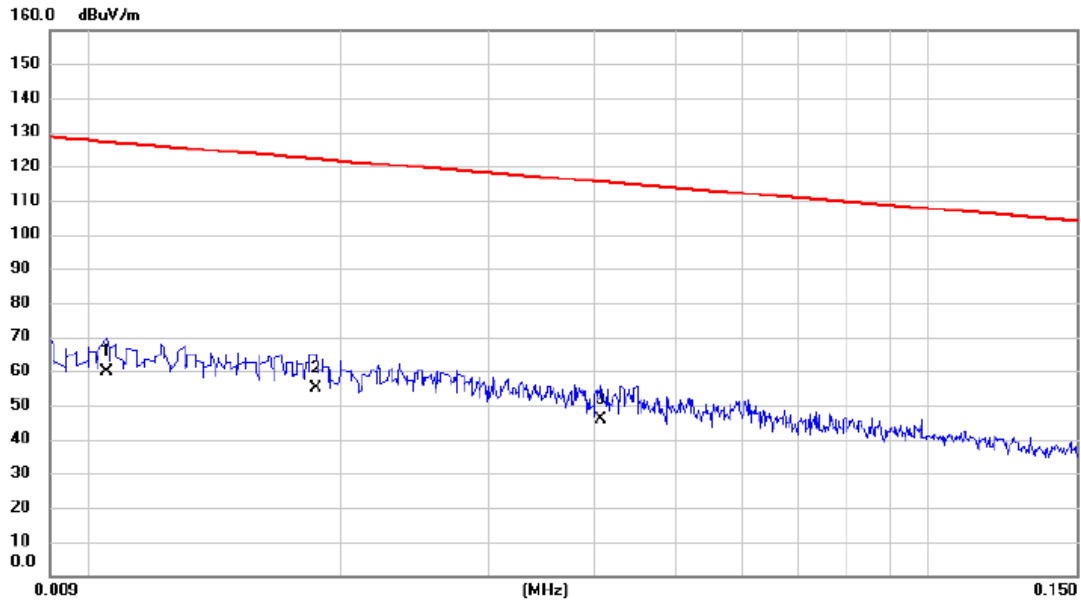

No.	Mk.	Freq. MHz	Reading Level dBuV	Correct Factor dB	Measure- ment dBuV/m	Limit dBuV/m	Margin dB	Detector	Comment
1		0.011	38.86	20.85	59.71	127.18	-67.47	AVG	
2	*	0.019	35.38	19.79	55.17	122.17	-67.00	AVG	
3		0.041	26.67	19.00	45.67	115.39	-69.72	AVG	

Test Mode: TX Mode_Adapter: Fuhua_External Antenna_1dBi

Ant 90°

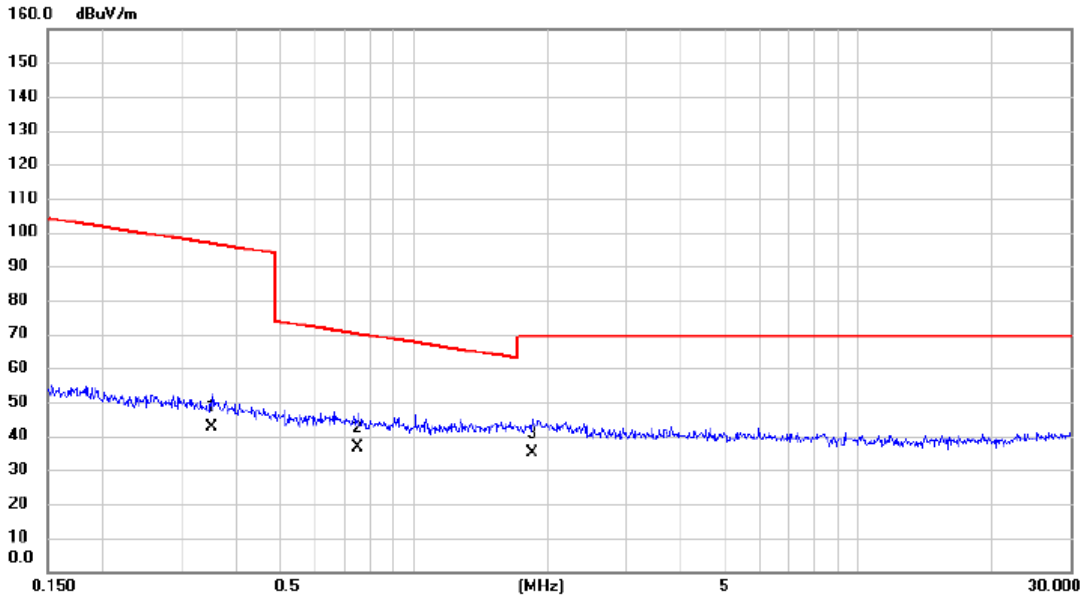

No.	Mk.	Freq. MHz	Reading Level dBuV	Correct Factor dB	Measure- ment dBuV/m	Limit dBuV/m	Margin dB	Detector	Comment
1		0.352	26.04	16.58	42.62	96.67	-54.05	AVG	
2	*	0.747	20.47	16.18	36.65	70.14	-33.49	QP	
3		1.848	19.26	15.57	34.83	69.54	-34.71	QP	

Test Mode: TX Mode _ Adapter: Kuantech_External Antenna_1dBi

Ant 0°

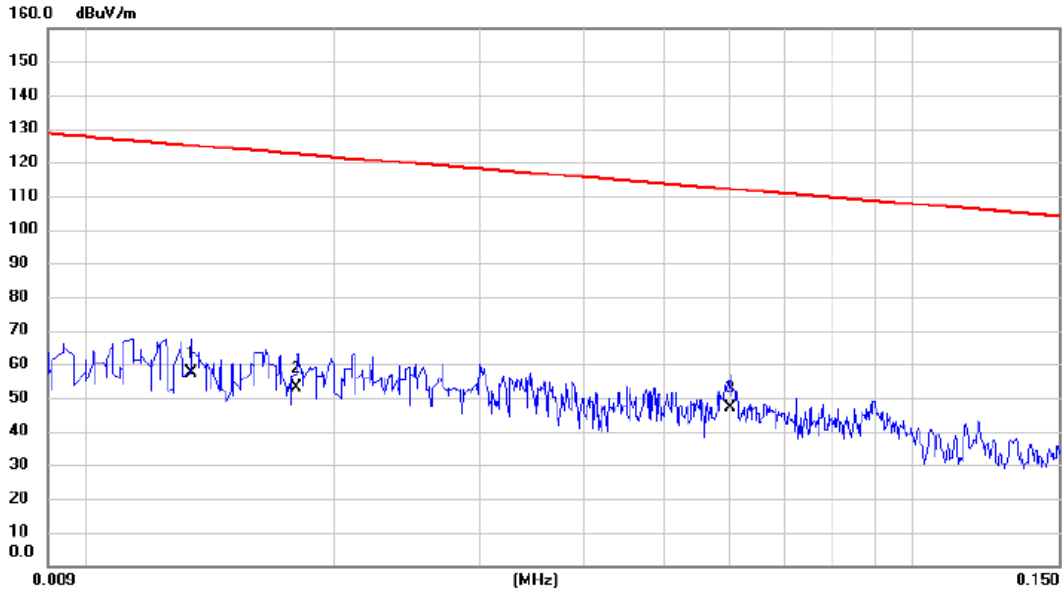

No. Mk.	Freq. MHz	Reading Level dBuV	Correct Factor dB	Measure- ment dBuV/m	Limit dBuV/m	Margin dB	Detector	Comment
1	0.013	37.01	20.48	57.49	125.06	-67.57	AVG	
2	0.018	33.16	19.88	53.04	122.50	-69.46	AVG	
3 *	0.060	28.65	18.53	47.18	112.03	-64.85	AVG	

Test Mode: TX Mode _ Adapter: Kuantech_External Antenna_1dBi

Ant 0°

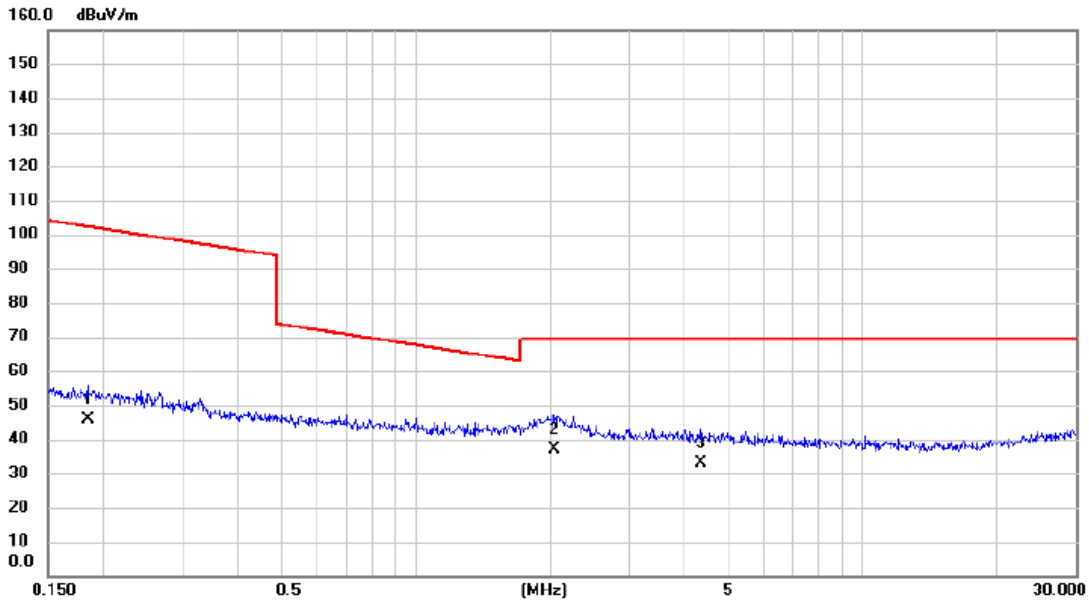

No.	Mk.	Freq. MHz	Reading Level dBuV	Correct Factor dB	Measure- ment dBuV/m	Limit dBuV/m	Margin dB	Detector	Comment
1		0.184	28.98	16.85	45.83	102.29	-56.46	AVG	
2	*	2.044	21.51	15.50	37.01	69.54	-32.53	QP	
3		4.338	18.10	14.76	32.86	69.54	-36.68	QP	

Test Mode: TX Mode _ Adapter: Kuantech_External Antenna_1dBi

Ant 90°

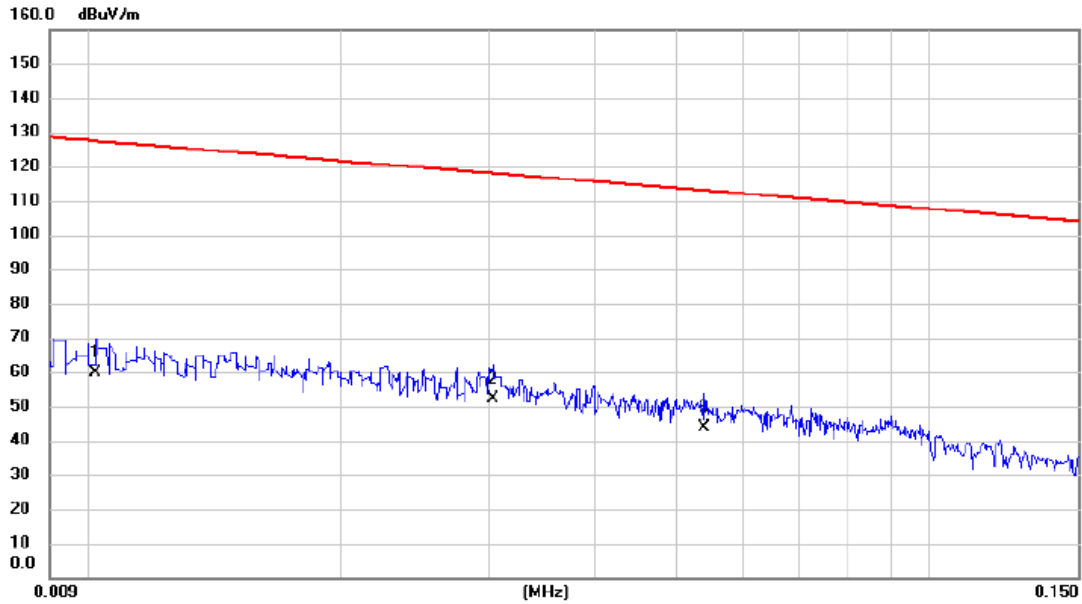

No.	Mk.	Freq. MHz	Reading Level dBuV	Correct Factor dB	Measure- ment dBuV/m	Limit dBuV/m	Margin dB	Detector	Comment
1		0.010	38.72	20.89	59.61	127.43	-67.82	AVG	
2	*	0.030	32.95	19.31	52.26	117.98	-65.72	AVG	
3		0.054	25.27	18.64	43.91	112.96	-69.05	AVG	

Test Mode: TX Mode _ Adapter: Kuantech_External Antenna_1dBi

Ant 90°

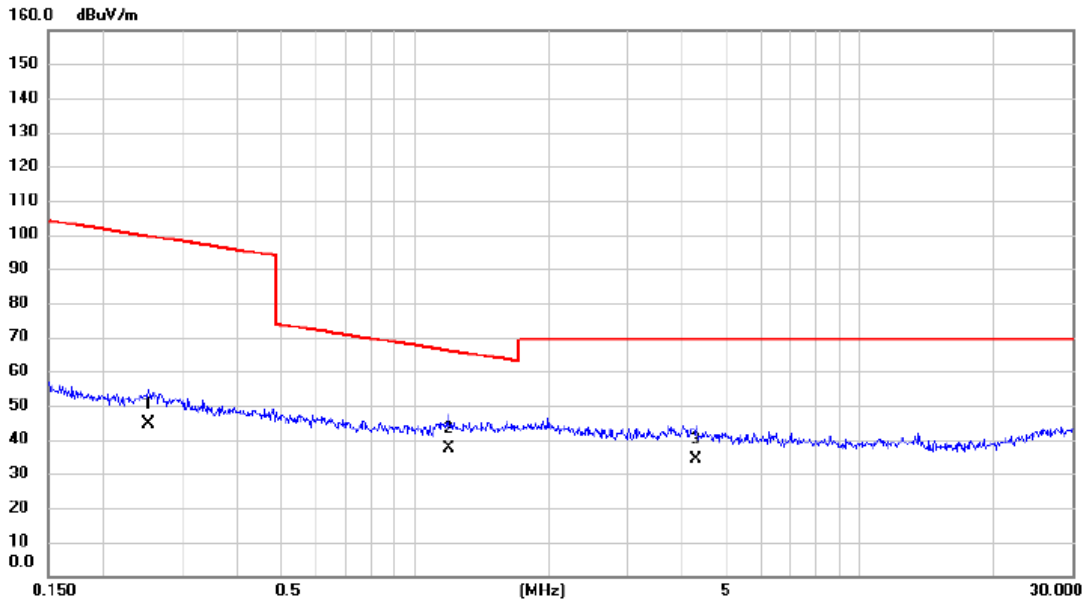

No.	Mk.	Freq. MHz	Reading Level dBuV	Correct Factor dB	Measure- ment dBuV/m	Limit dBuV/m	Margin dB	Detector	Comment
1		0.252	27.76	16.66	44.42	99.58	-55.16	AVG	
2	*	1.191	21.56	15.81	37.37	66.09	-28.72	QP	
3		4.292	19.54	14.78	34.32	69.54	-35.22	QP	

Test Mode: TX Mode _ Adapter: HONOR_External Antenna_1dBi

Ant 0°

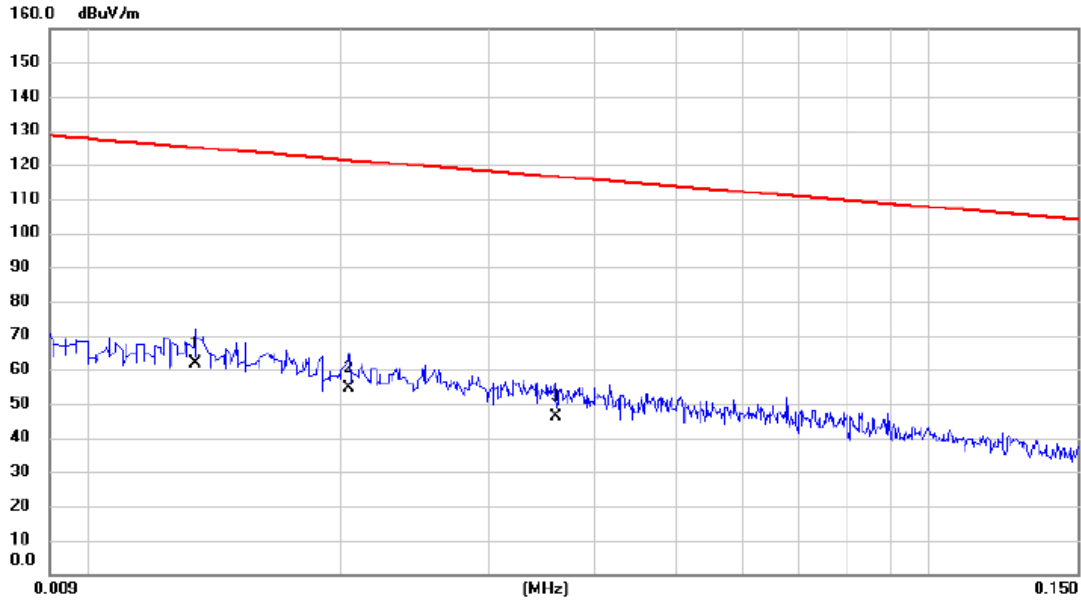

No.	Mk.	Freq. MHz	Reading Level dBuV	Correct Factor dB	Measure- ment dBuV/m	Limit dBuV/m	Margin dB	Detector	Comment
1	*	0.013	41.17	20.48	61.65	125.06	-63.41	AVG	
2		0.020	35.06	19.61	54.67	121.41	-66.74	AVG	
3		0.036	27.24	19.14	46.38	116.48	-70.10	AVG	

Test Mode: TX Mode _ Adapter: HONOR_External Antenna_1dBi

Ant 0°

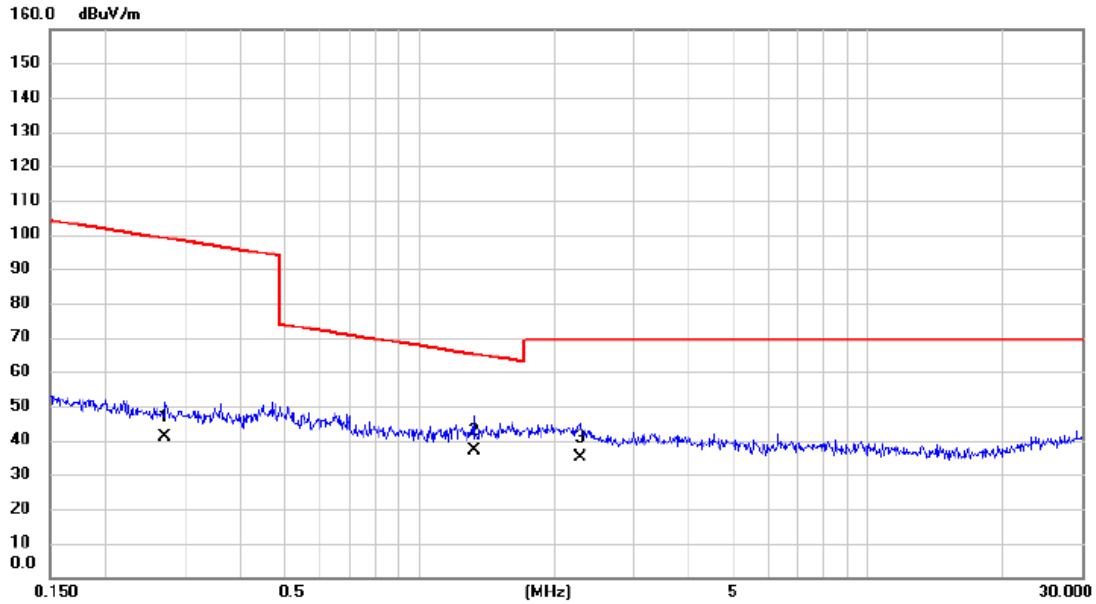

No.	Mk.	Freq. MHz	Reading Level dBuV	Correct Factor dB	Measure- ment dBuV/m	Limit dBuV/m	Margin dB	Detector	Comment
1		0.271	24.40	16.64	41.04	98.93	-57.89	AVG	
2	*	1.324	21.18	15.77	36.95	65.17	-28.22	QP	
3		2.284	19.54	15.43	34.97	69.54	-34.57	QP	

Test Mode: TX Mode _ Adapter: HONOR_External Antenna_1dBi

Ant 90°

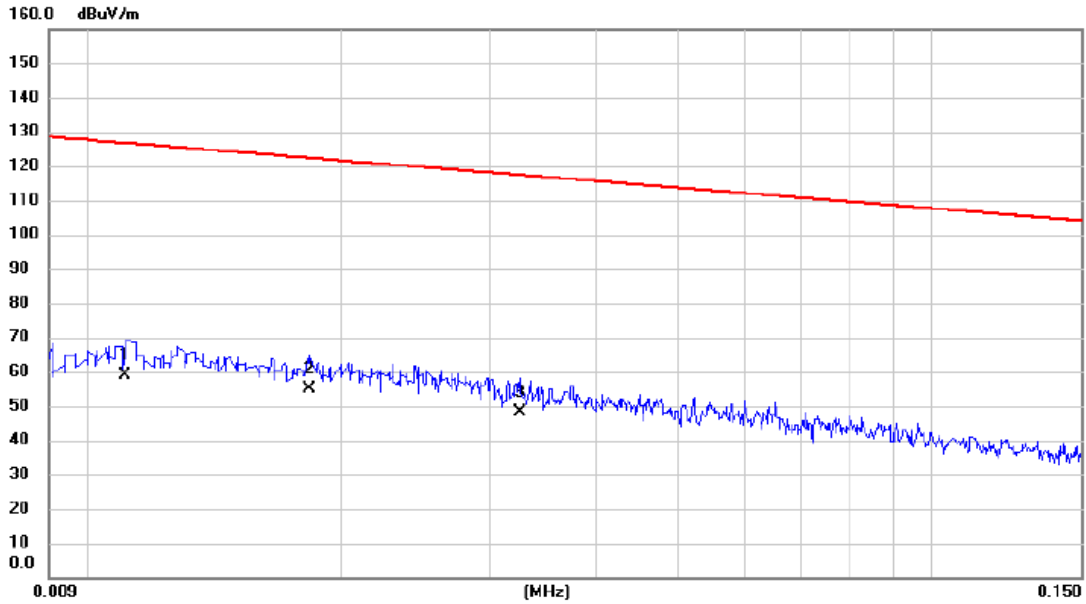

No.	Mk.	Freq. MHz	Reading Level dBuV	Correct Factor dB	Measure- ment dBuV/m	Limit dBuV/m	Margin dB	Detector	Comment
1		0.011	38.18	20.78	58.96	126.70	-67.74	AVG	
2	*	0.018	35.33	19.84	55.17	122.36	-67.19	AVG	
3		0.033	29.00	19.25	48.25	117.37	-69.12	AVG	

Test Mode: TX Mode _ Adapter: HONOR_External Antenna_1dBi

Ant 90°

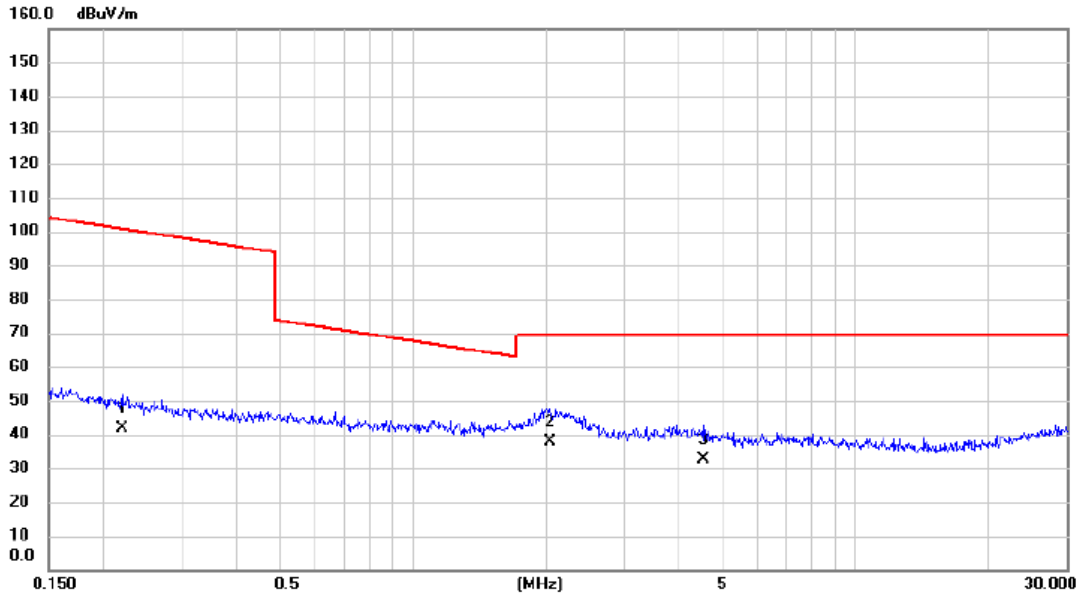

No.	Mk.	Freq. MHz	Reading Level dBuV	Correct Factor dB	Measure- ment dBuV/m	Limit dBuV/m	Margin dB	Detector	Comment
1		0.220	25.22	16.74	41.96	100.77	-58.81	AVG	
2	*	2.044	22.42	15.50	37.92	69.54	-31.62	QP	
3		4.549	18.16	14.63	32.79	69.54	-36.75	QP	

Test Mode: TX Mode_Adapter: Fuhua_External Antenna_3dBi

Ant 0°

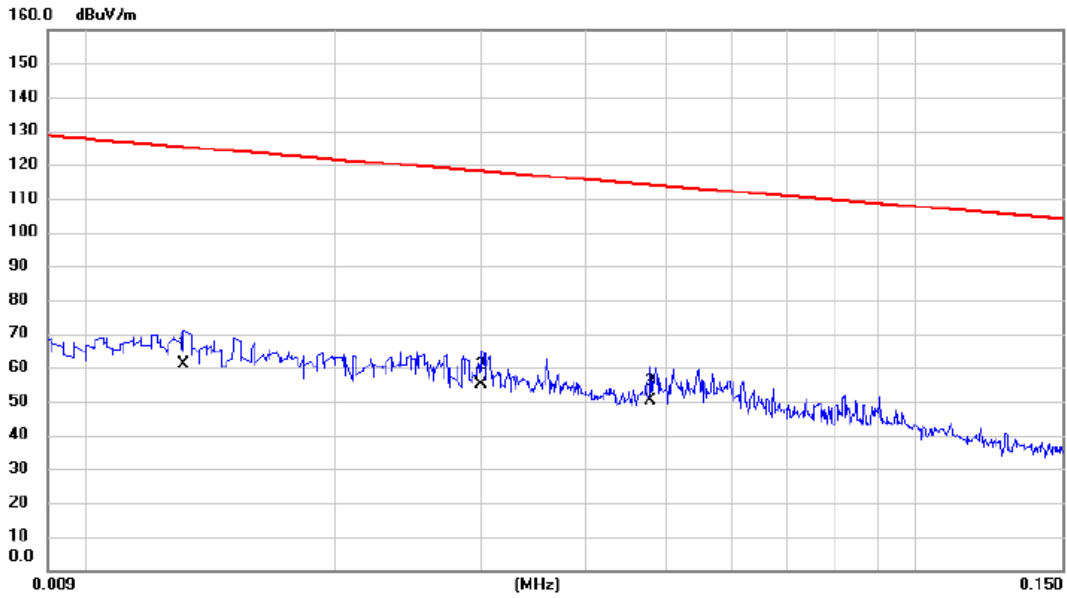

No.	Mk.	Freq. MHz	Reading Level dBuV	Correct Factor dB	Measure- ment dBuV/m	Limit dBuV/m	Margin dB	Detector	Comment
1		0.013	40.33	20.52	60.85	125.26	-64.41	AVG	
2	*	0.030	35.62	19.32	54.94	118.06	-63.12	AVG	
3		0.048	31.30	18.79	50.09	114.02	-63.93	AVG	

Test Mode: TX Mode_Adapter: Fuhua_External Antenna_3dBi

Ant 0°

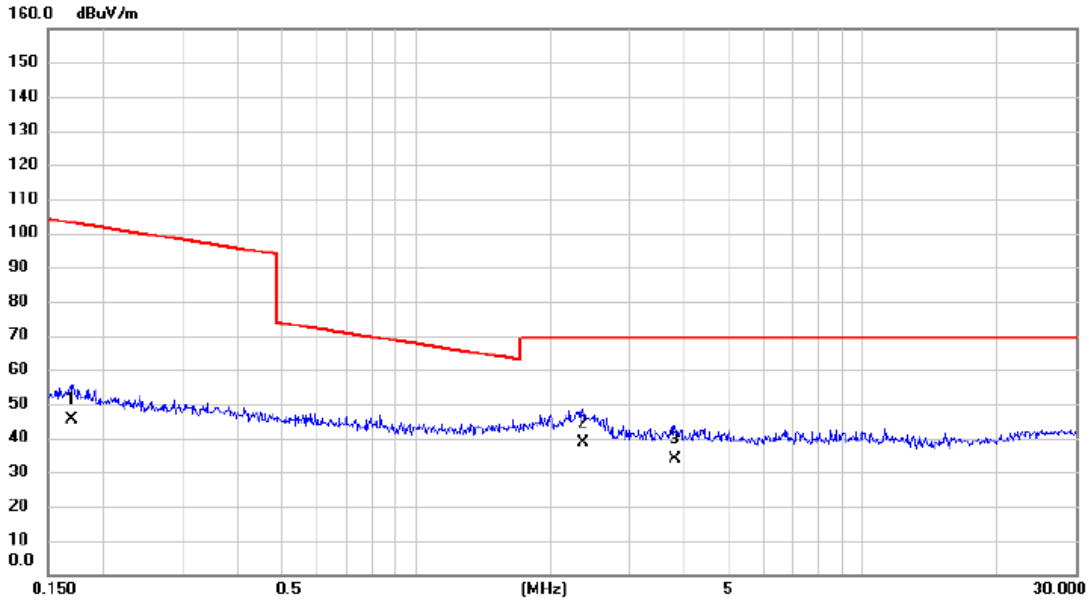

No.	Mk.	Freq. MHz	Reading Level dBuV	Correct Factor dB	Measure- ment dBuV/m	Limit dBuV/m	Margin dB	Detector	Comment
1		0.170	28.41	16.89	45.30	102.98	-57.68	AVG	
2	*	2.371	23.14	15.41	38.55	69.54	-30.99	QP	
3		3.799	18.86	15.01	33.87	69.54	-35.67	QP	

Test Mode: TX Mode _ Adapter: Fuhua_External Antenna_3dBi

Ant 90°

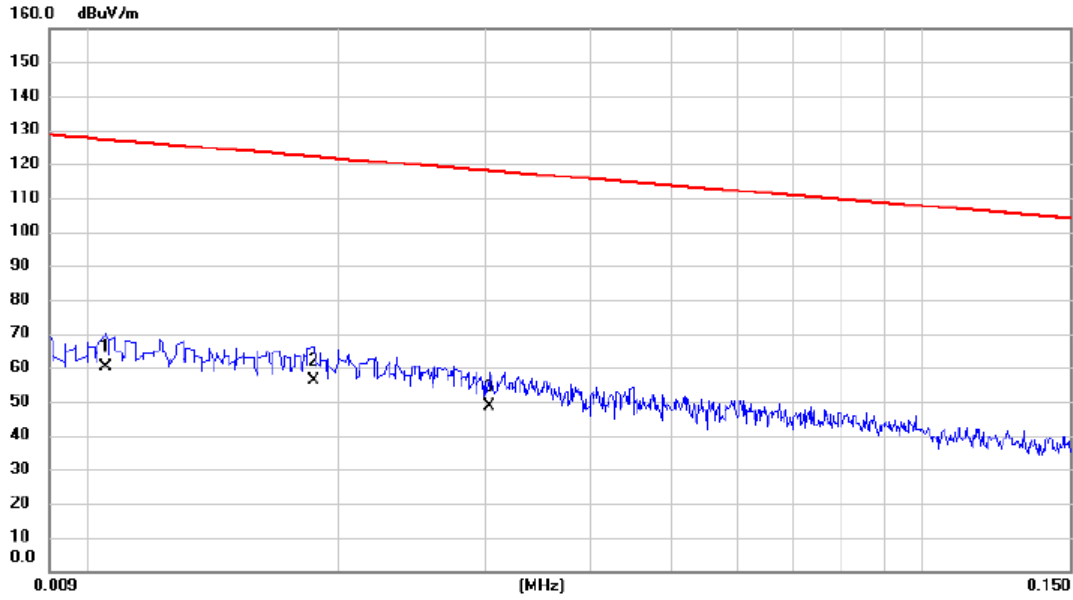

No.	Mk.	Freq. MHz	Reading Level dBuV	Correct Factor dB	Measure- ment dBuV/m	Limit dBuV/m	Margin dB	Detector	Comment
1		0.011	39.36	20.85	60.21	127.18	-66.97	AVG	
2	*	0.019	36.38	19.79	56.17	122.17	-66.00	AVG	
3		0.030	29.48	19.31	48.79	117.98	-69.19	AVG	

Test Mode: TX Mode_Adapter: Fuhua_External Antenna_3dBi

Ant 90°

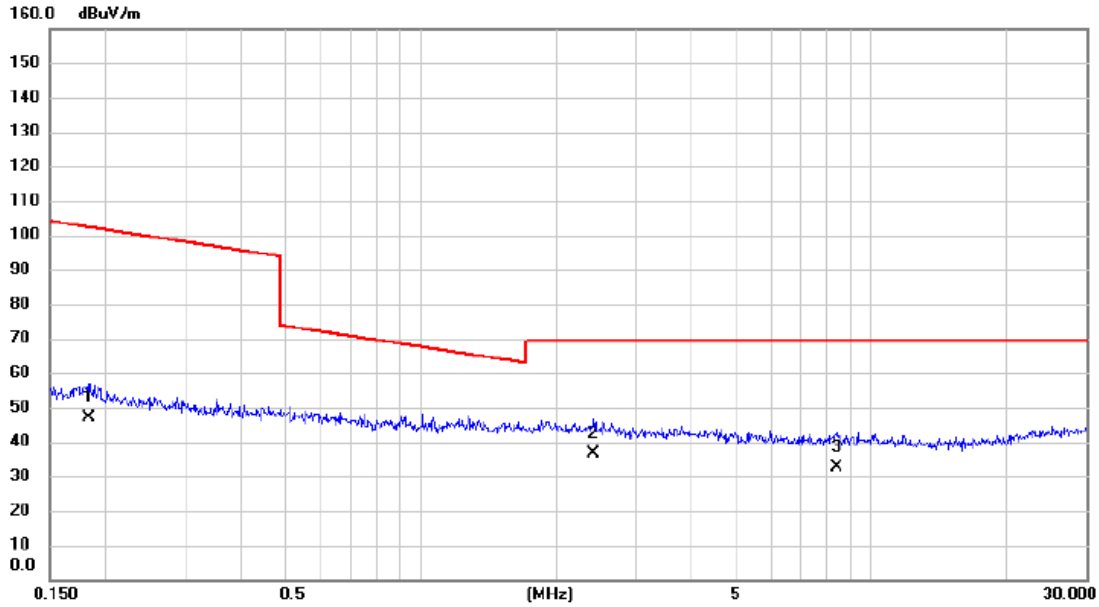

No.	Mk.	Freq. MHz	Reading Level dBuV	Correct Factor dB	Measure- ment dBuV/m	Limit dBuV/m	Margin dB	Detector	Comment
1		0.183	30.31	16.85	47.16	102.34	-55.18	AVG	
2	*	2.422	21.10	15.39	36.49	69.54	-33.05	QP	
3		8.412	18.53	13.94	32.47	69.54	-37.07	QP	

Test Mode: TX Mode _ Adapter: Kuantech_External Antenna_3dBi

Ant 0°

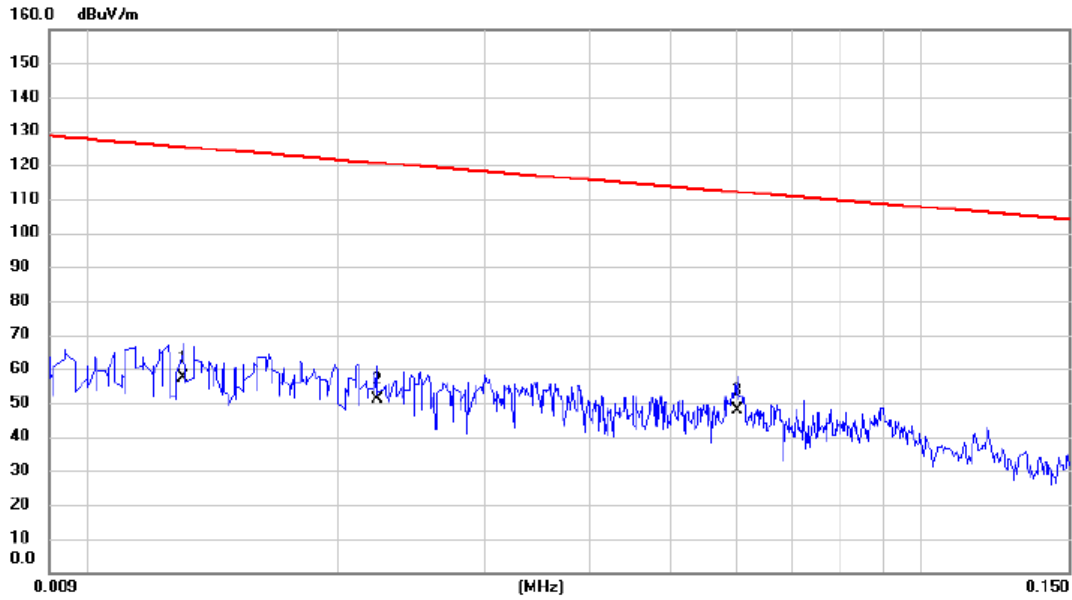

No. Mk.	Freq. MHz	Reading Level dBuV	Correct Factor dB	Measure- ment dBuV/m	Limit dBuV/m	Margin dB	Detector	Comment
1	0.013	36.68	20.53	57.21	125.33	-68.12	AVG	
2	0.022	31.45	19.55	51.00	120.64	-69.64	AVG	
3 *	0.060	29.15	18.53	47.68	112.03	-64.35	AVG	

Test Mode: TX Mode _ Adapter: Kuantech_External Antenna_3dBi

Ant 0°

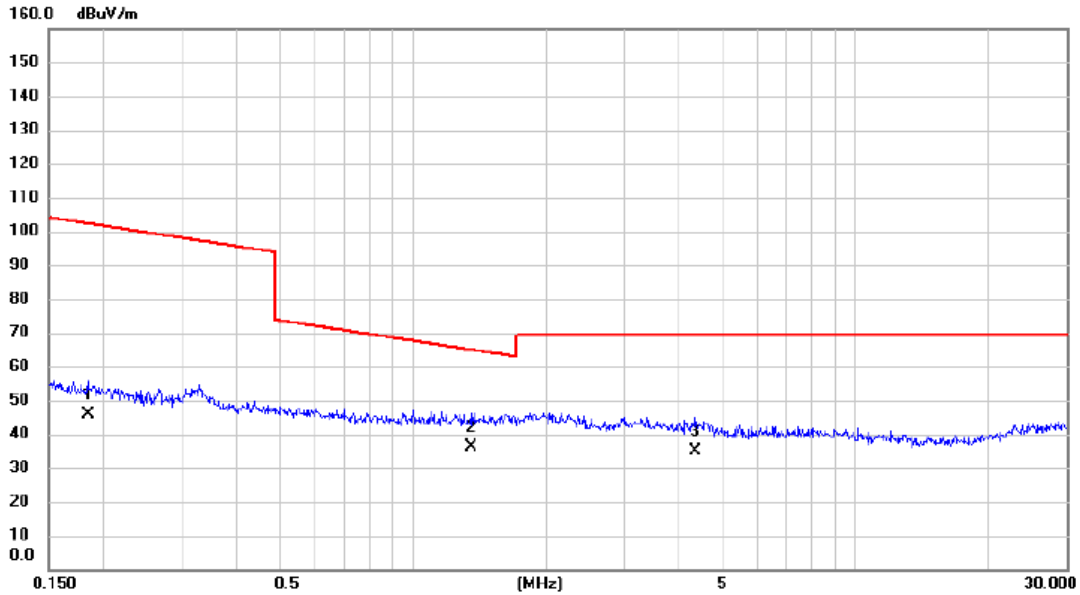

No.	Mk.	Freq. MHz	Reading Level dBuV	Correct Factor dB	Measure- ment dBuV/m	Limit dBuV/m	Margin dB	Detector	Comment
1		0.184	28.98	16.85	45.83	102.29	-56.46	AVG	
2	*	1.352	20.56	15.76	36.32	64.98	-28.66	QP	
3		4.338	20.10	14.76	34.86	69.54	-34.68	QP	

Test Mode: TX Mode _ Adapter: Kuantech_External Antenna_3dBi

Ant 90°

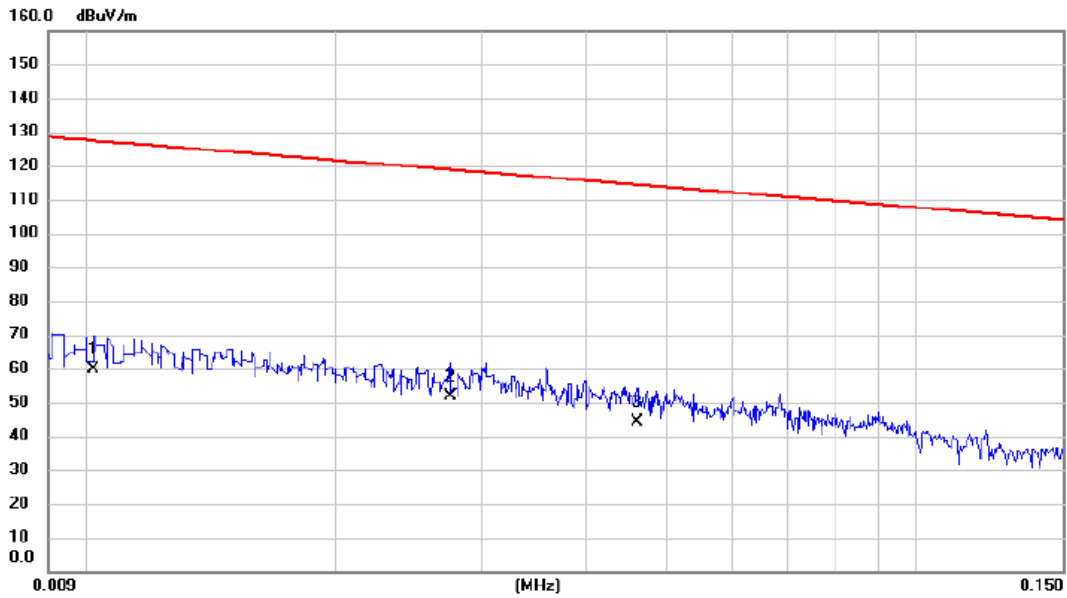

No.	Mk.	Freq. MHz	Reading Level dBuV	Correct Factor dB	Measure- ment dBuV/m	Limit dBuV/m	Margin dB	Detector	Comment
1		0.010	38.72	20.89	59.61	127.43	-67.82	AVG	
2	*	0.028	32.45	19.40	51.85	118.82	-66.97	AVG	
3		0.046	25.49	18.84	44.33	114.33	-70.00	AVG	

Test Mode: TX Mode _ Adapter: Kuantech_External Antenna_3dBi

Ant 90°

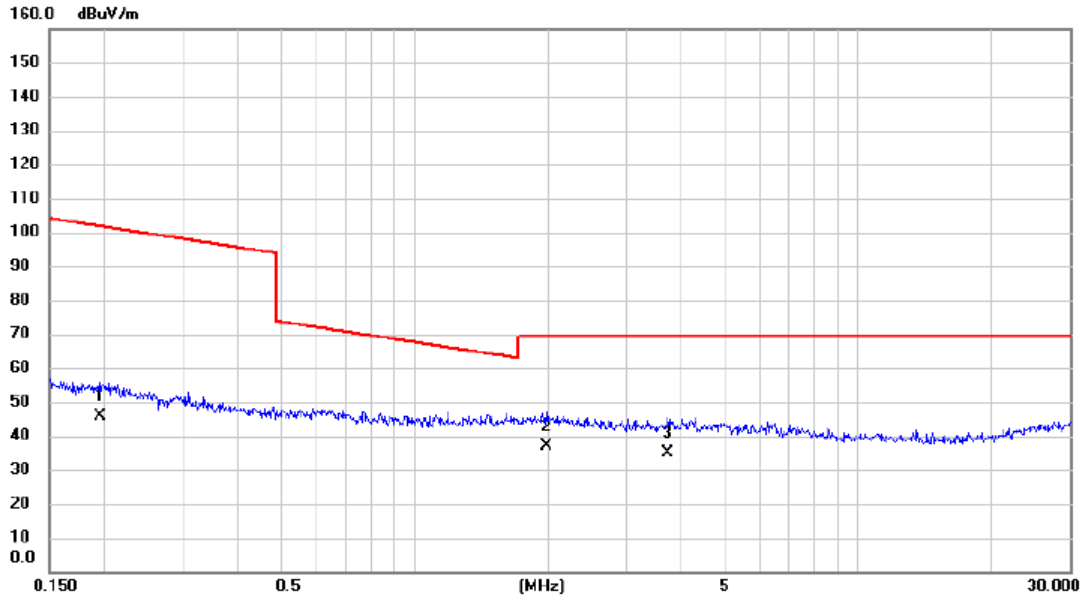

No. Mk.	Freq. MHz	Reading Level dBuV	Correct Factor dB	Measure- ment dBuV/m	Limit dBuV/m	Margin dB	Detector	Comment
1	0.195	28.87	16.81	45.68	101.80	-56.12	AVG	
2 *	1.990	21.53	15.51	37.04	69.54	-32.50	QP	
3	3.720	20.18	15.02	35.20	69.54	-34.34	QP	

Test Mode: TX Mode _ Adapter: HONOR_External Antenna_3dBi

Ant 0°

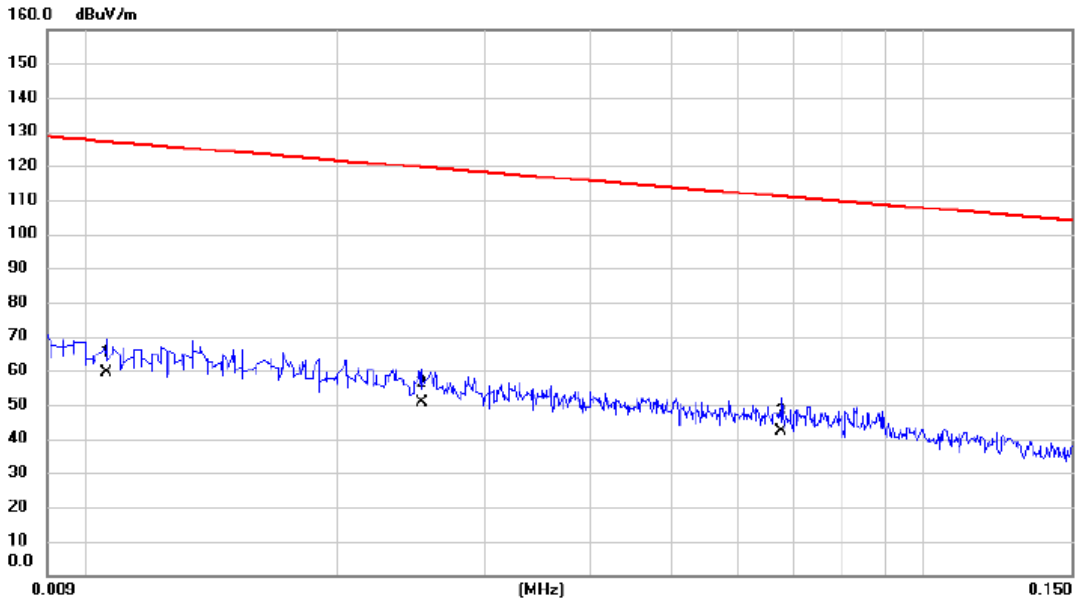

No.	Mk.	Freq. MHz	Reading Level dBuV	Correct Factor dB	Measure- ment dBuV/m	Limit dBuV/m	Margin dB	Detector	Comment
1	*	0.011	38.41	20.84	59.25	127.10	-67.85	AVG	
2		0.025	31.24	19.46	50.70	119.58	-68.88	AVG	
3		0.068	23.77	18.38	42.15	111.01	-68.86	AVG	

Test Mode: TX Mode _ Adapter: HONOR_External Antenna_3dBi

Ant 0°

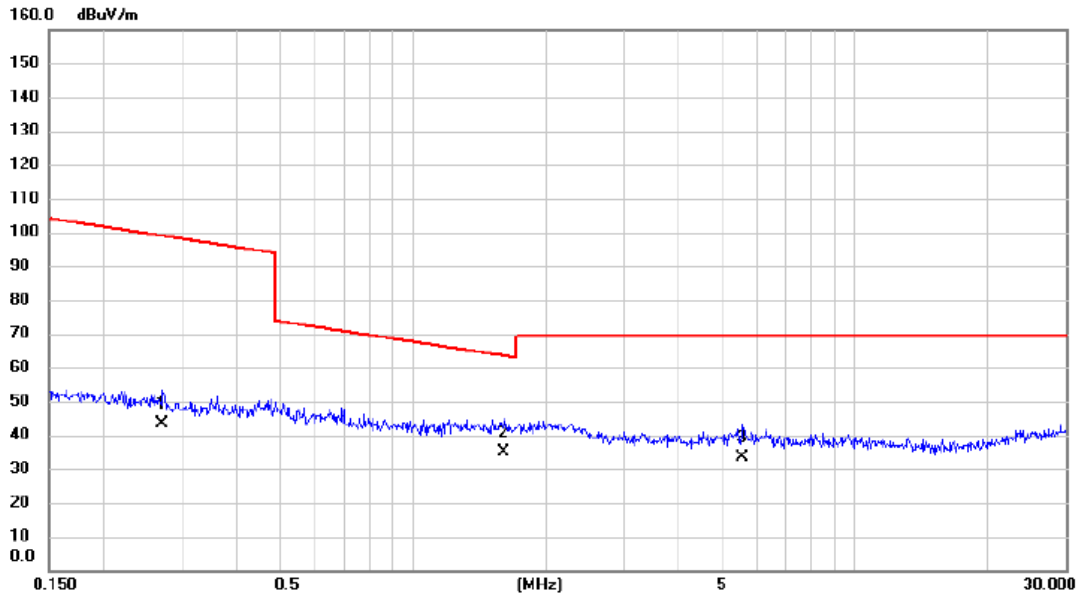

No. Mk.	Freq. MHz	Reading Level dBuV	Correct Factor dB	Measure- ment dBuV/m	Limit dBuV/m	Margin dB	Detector	Comment
1	0.271	26.90	16.64	43.54	98.93	-55.39	AVG	
2 *	1.610	19.39	15.66	35.05	63.47	-28.42	QP	
3	5.564	19.25	14.30	33.55	69.54	-35.99	QP	

Test Mode: TX Mode _ Adapter: HONOR_External Antenna_3dBi

Ant 90°

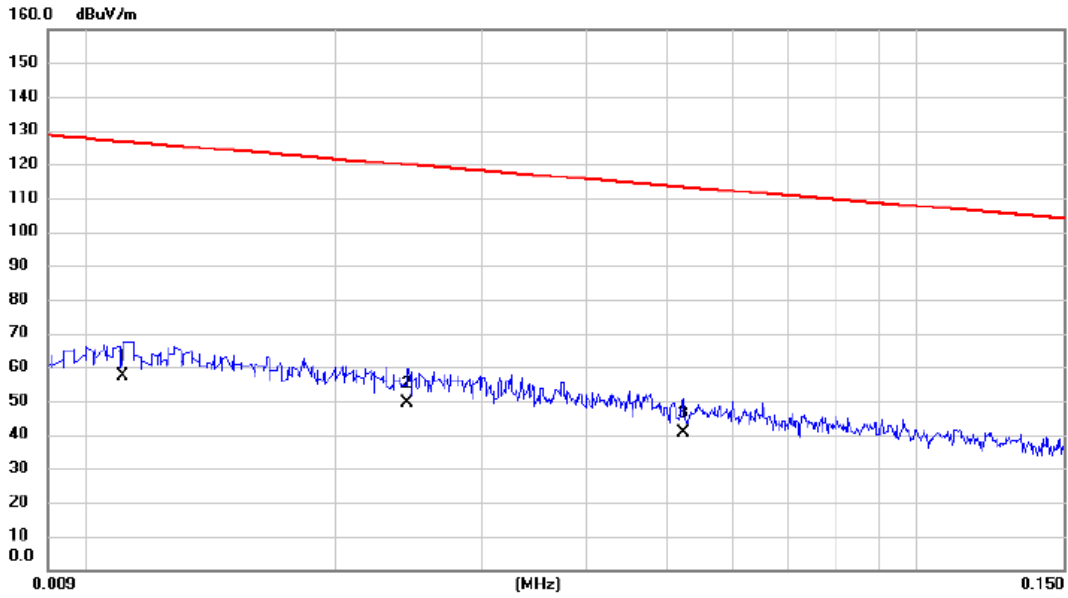

No.	Mk.	Freq.	Reading Level	Correct Factor	Measurement	Limit	Margin	Detector	Comment
		MHz	dBuV	dB	dBuV/m	dBuV/m	dB		
1	*	0.011	36.68	20.78	57.46	126.70	-69.24	AVG	
2		0.024	29.73	19.49	49.22	119.86	-70.64	AVG	
3		0.052	21.97	18.67	40.64	113.22	-72.58	AVG	

Test Mode: TX Mode _ Adapter: HONOR_External Antenna_3dBi

Ant 90°

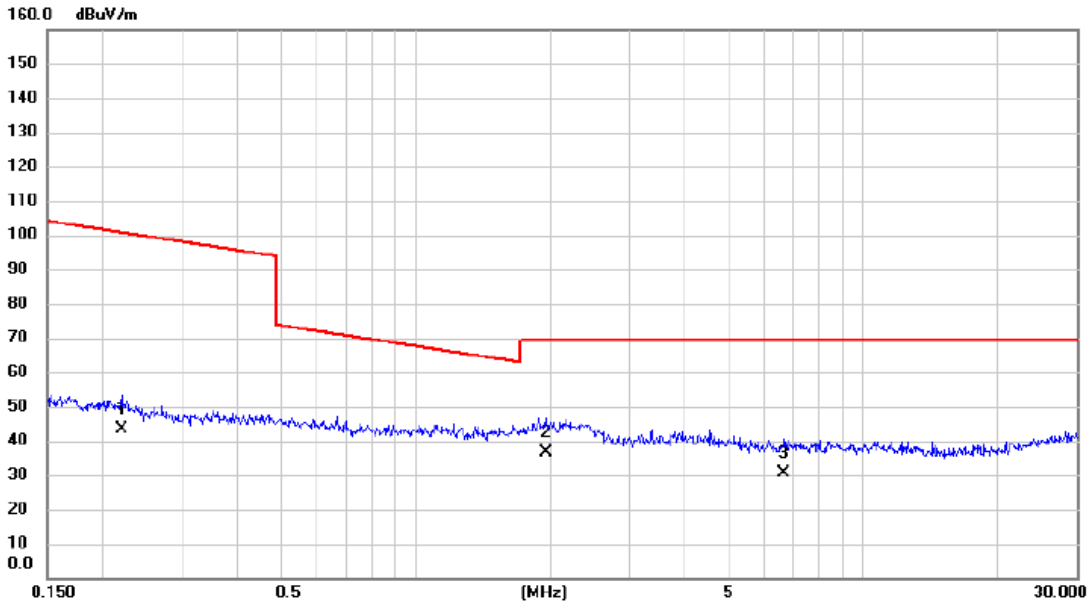

No.	Mk.	Freq. MHz	Reading Level dBuV	Correct Factor dB	Measure- ment dBuV/m	Limit dBuV/m	Margin dB	Detector	Comment
1		0.220	26.72	16.74	43.46	100.77	-57.31	AVG	
2	*	1.949	21.19	15.53	36.72	69.54	-32.82	QP	
3		6.662	16.60	14.17	30.77	69.54	-38.77	QP	

APPENDIX E - RADIATED EMISSION (30MHZ TO 1GHZ)

Test Mode: PCS1900_TX CH810_GSM_Internal Antenna

Vertical

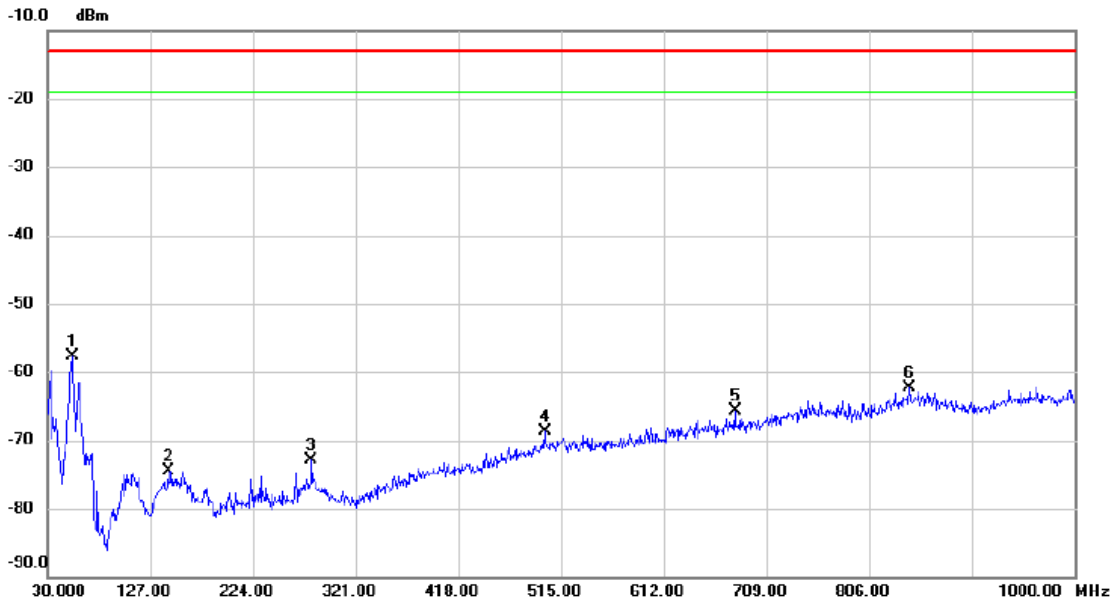

No.	Mk.	Freq. MHz	Reading Level dBm	Correct Factor dB	Measure- ment dBm	Limit dBm	Margin dB	Detector	Comment
1	*	53.280	-59.66	1.99	-57.67	-13.00	-44.67	peak	
2		143.975	-77.00	2.55	-74.45	-13.00	-61.45	peak	
3		279.290	-75.60	2.62	-72.98	-13.00	-59.98	peak	
4		499.965	-76.16	7.55	-68.61	-13.00	-55.61	peak	
5		679.415	-75.98	10.33	-65.65	-13.00	-52.65	peak	
6		844.315	-76.39	14.18	-62.21	-13.00	-49.21	peak	

Test Mode: PCS1900_TX CH810_GSM_Internal Antenna

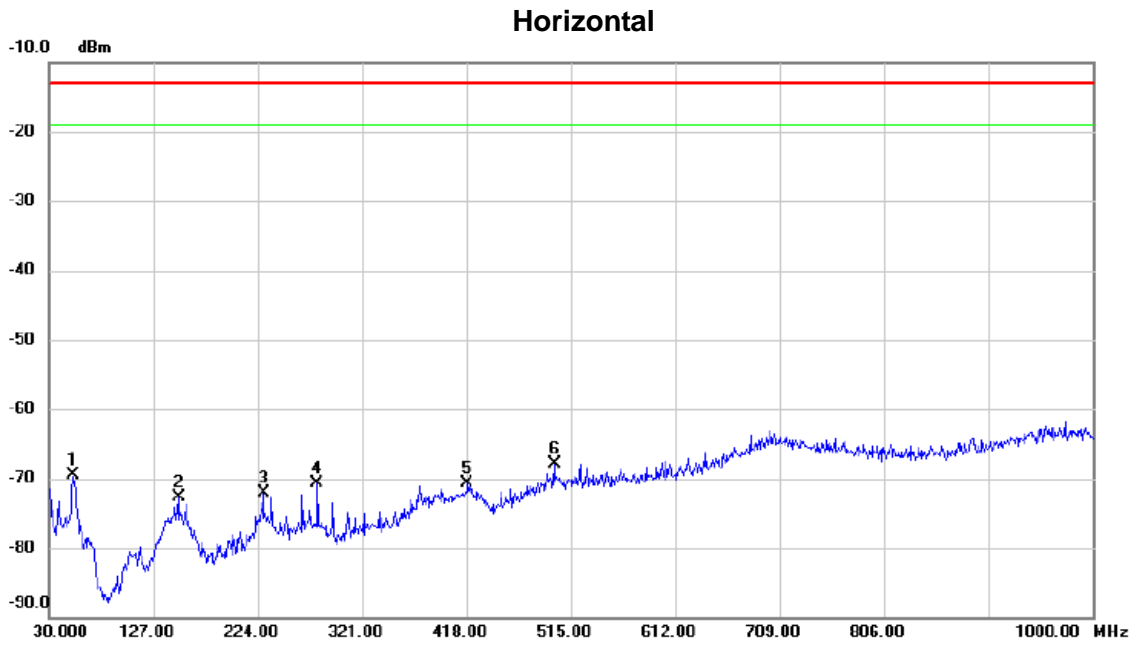

No.	Mk.	Freq. MHz	Reading Level dBm	Correct Factor dB	Measure- ment dBm	Limit dBm	Margin dB	Detector	Comment
1		52.310	-71.52	1.92	-69.60	-13.00	-56.60	peak	
2		150.280	-76.92	4.20	-72.72	-13.00	-59.72	peak	
3		229.335	-75.22	3.07	-72.15	-13.00	-59.15	peak	
4		279.290	-73.18	2.54	-70.64	-13.00	-57.64	peak	
5		418.970	-77.60	6.83	-70.77	-13.00	-57.77	peak	
6	*	499.965	-75.90	8.06	-67.84	-13.00	-54.84	peak	

Test Mode: PCS1900_TX CH810_EDGE_Internal Antenna

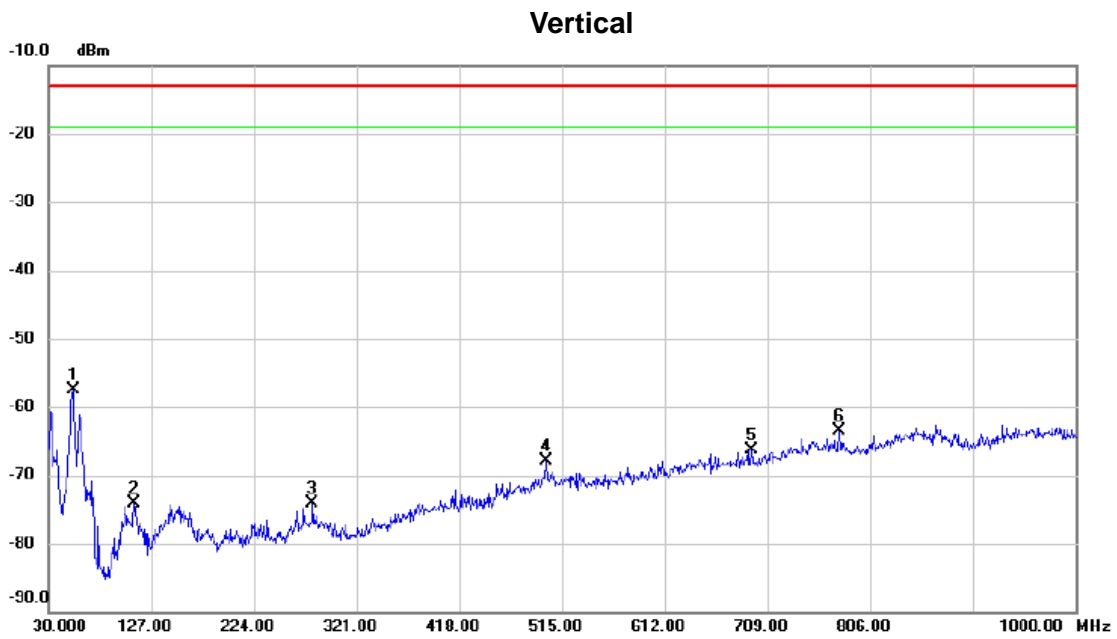

No.	Mk.	Freq. MHz	Reading Level dBm	Correct Factor dB	Measure- ment dBm	Limit dBm	Margin dB	Detector	Comment
1	*	53.280	-59.55	1.99	-57.56	-13.00	-44.56	peak	
2		110.510	-73.06	-1.08	-74.14	-13.00	-61.14	peak	
3		279.290	-76.79	2.62	-74.17	-13.00	-61.17	peak	
4		499.965	-75.42	7.55	-67.87	-13.00	-54.87	peak	
5		693.965	-76.83	10.44	-66.39	-13.00	-53.39	peak	
6		777.385	-75.62	12.15	-63.47	-13.00	-50.47	peak	

Test Mode: PCS1900_TX CH810_EDGE_Internal Antenna

Horizontal

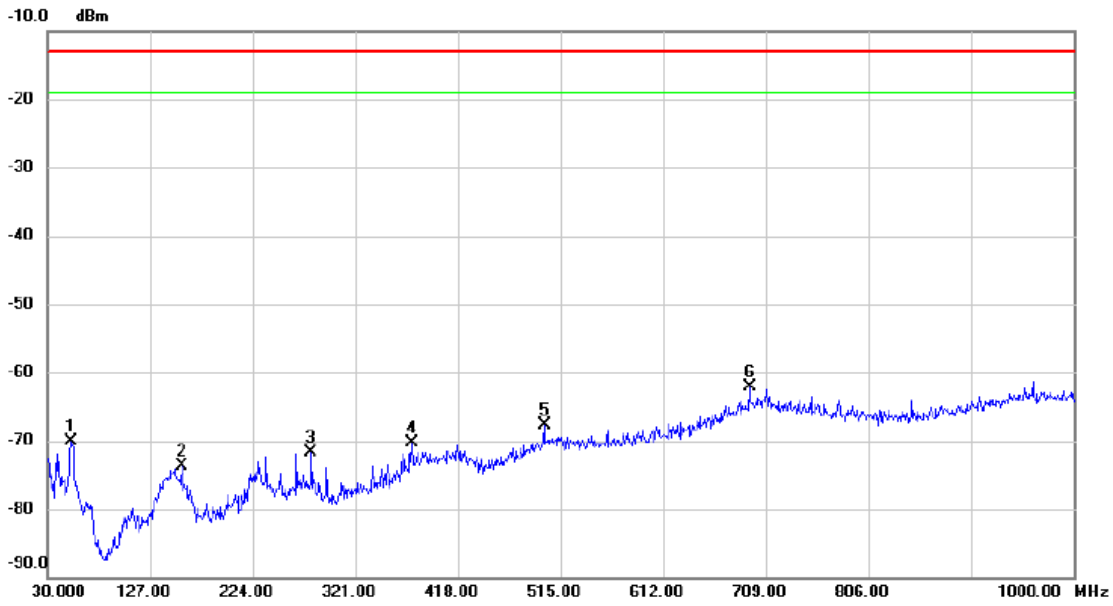

No.	Mk.	Freq. MHz	Reading Level dBm	Correct Factor dB	Measure- ment dBm	Limit dBm	Margin dB	Detector	Comment
1		52.310	-72.06	1.92	-70.14	-13.00	-57.14	peak	
2		157.555	-76.86	3.11	-73.75	-13.00	-60.75	peak	
3		279.290	-74.17	2.54	-71.63	-13.00	-58.63	peak	
4		374.835	-75.72	5.49	-70.23	-13.00	-57.23	peak	
5		499.965	-75.84	8.06	-67.78	-13.00	-54.78	peak	
6	*	693.965	-75.68	13.57	-62.11	-13.00	-49.11	peak	

Test Mode: PCS1900_TX CH810_GSM_External Antenna_1dBi

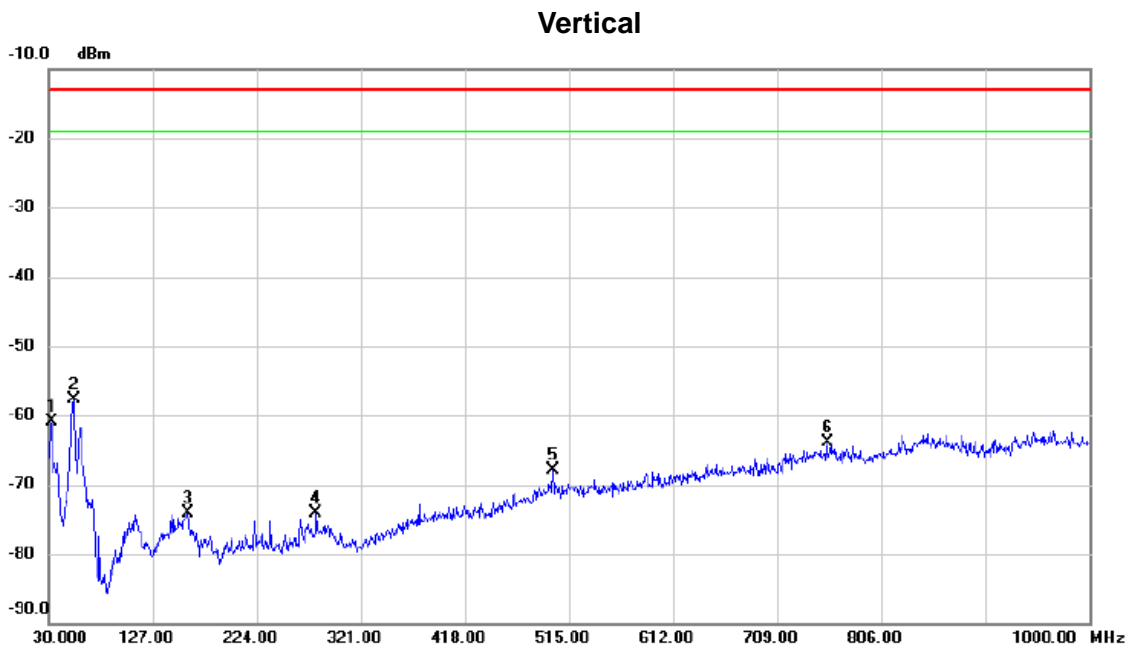

No.	Mk.	Freq. MHz	Reading Level dBm	Correct Factor dB	Measure- ment dBm	Limit dBm	Margin dB	Detector	Comment
1		32.910	-59.87	-0.96	-60.83	-13.00	-47.83	peak	
2	*	53.280	-59.77	1.99	-57.78	-13.00	-44.78	peak	
3		159.980	-77.23	3.18	-74.05	-13.00	-61.05	peak	
4		279.290	-76.68	2.62	-74.06	-13.00	-61.06	peak	
5		499.965	-75.38	7.55	-67.83	-13.00	-54.83	peak	
6		756.045	-76.26	12.41	-63.85	-13.00	-50.85	peak	

Test Mode: PCS1900_TX CH810_GSM_External Antenna_1dBi

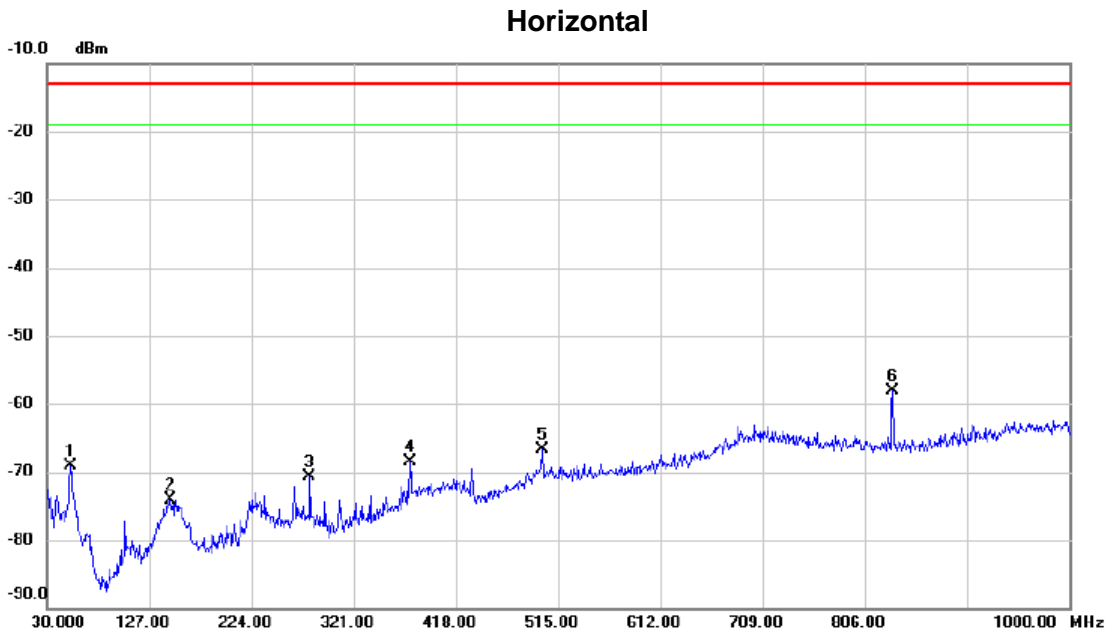

No. Mk.	Freq. MHz	Reading Level dBm	Correct Factor dB	Measure- ment dBm	Limit dBm	Margin dB	Detector	Comment
1	52.795	-71.20	2.05	-69.15	-13.00	-56.15	peak	
2	147.370	-78.01	3.95	-74.06	-13.00	-61.06	peak	
3	279.290	-73.26	2.54	-70.72	-13.00	-57.72	peak	
4	374.835	-74.00	5.49	-68.51	-13.00	-55.51	peak	
5	499.965	-74.75	8.06	-66.69	-13.00	-53.69	peak	
6 *	832.190	-70.02	11.91	-58.11	-13.00	-45.11	peak	

Test Mode: PCS1900_TX CH810_EDGE_External Antenna_1dBi

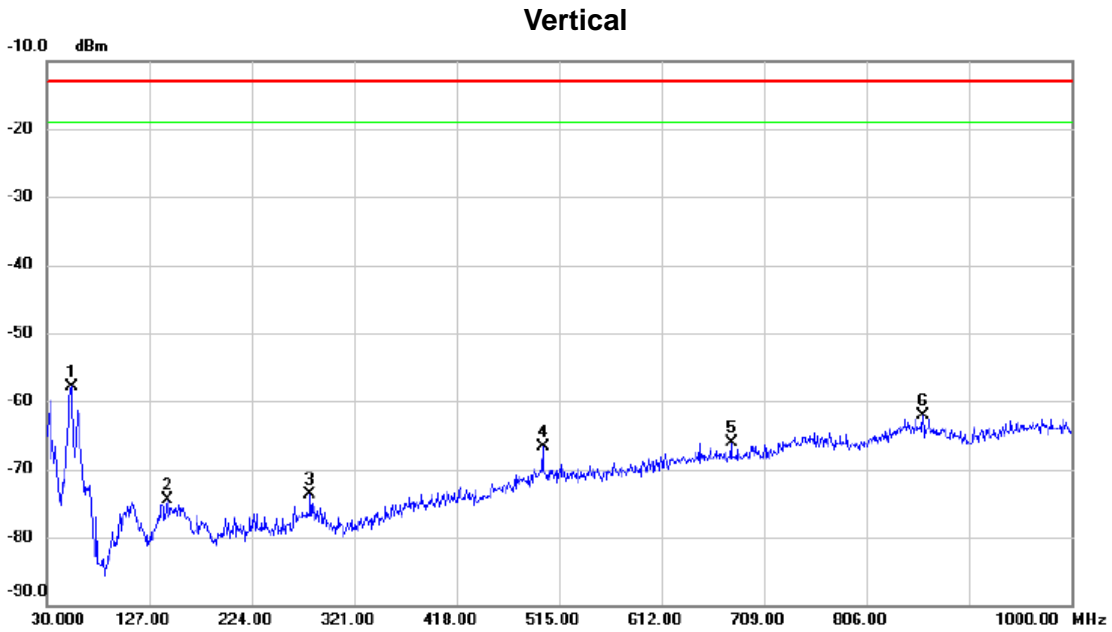

No.	Mk.	Freq. MHz	Reading Level dBm	Correct Factor dB	Measure- ment dBm	Limit dBm	Margin dB	Detector	Comment
1	*	53.280	-59.91	1.99	-57.92	-13.00	-44.92	peak	
2		143.975	-77.15	2.55	-74.60	-13.00	-61.60	peak	
3		279.290	-76.32	2.62	-73.70	-13.00	-60.70	peak	
4		499.965	-74.17	7.55	-66.62	-13.00	-53.62	peak	
5		677.960	-76.45	10.32	-66.13	-13.00	-53.13	peak	
6		859.350	-76.22	14.14	-62.08	-13.00	-49.08	peak	

Test Mode: PCS1900_TX CH810_EDGE_External Antenna_1dBi

Horizontal

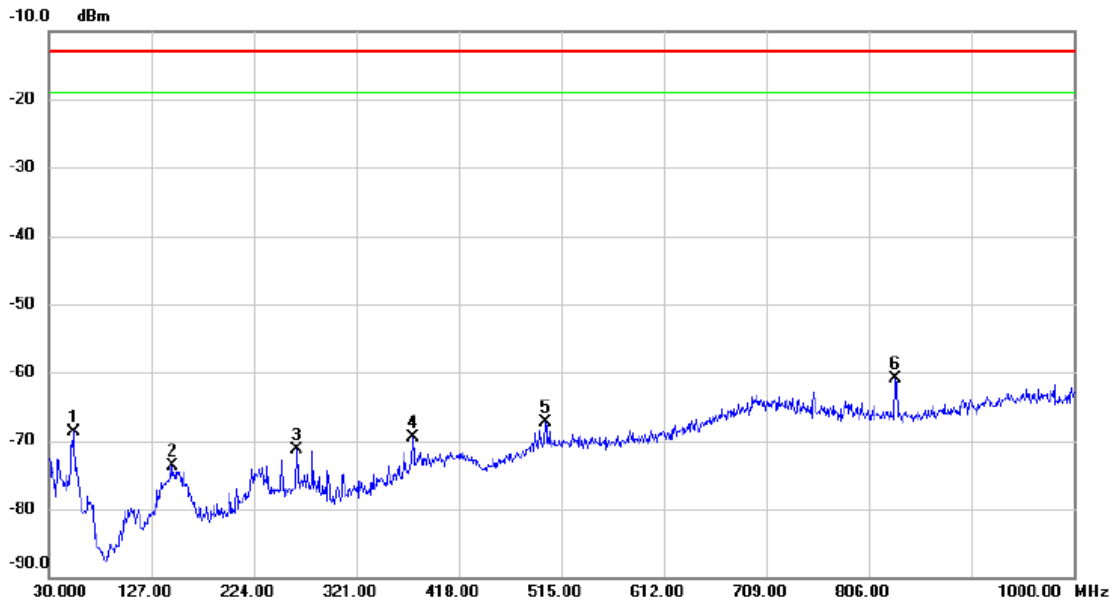

No.	Mk.	Freq. MHz	Reading Level dBm	Correct Factor dB	Measure- ment dBm	Limit dBm	Margin dB	Detector	Comment
1		53.280	-70.90	2.19	-68.71	-13.00	-55.71	peak	
2		147.370	-77.63	3.95	-73.68	-13.00	-60.68	peak	
3		265.225	-73.82	2.50	-71.32	-13.00	-58.32	peak	
4		374.835	-75.06	5.49	-69.57	-13.00	-56.57	peak	
5		499.965	-75.28	8.06	-67.22	-13.00	-54.22	peak	
6	*	831.705	-72.79	11.91	-60.88	-13.00	-47.88	peak	

Test Mode: PCS1900_TX CH810_GSM_External Antenna_3dBi

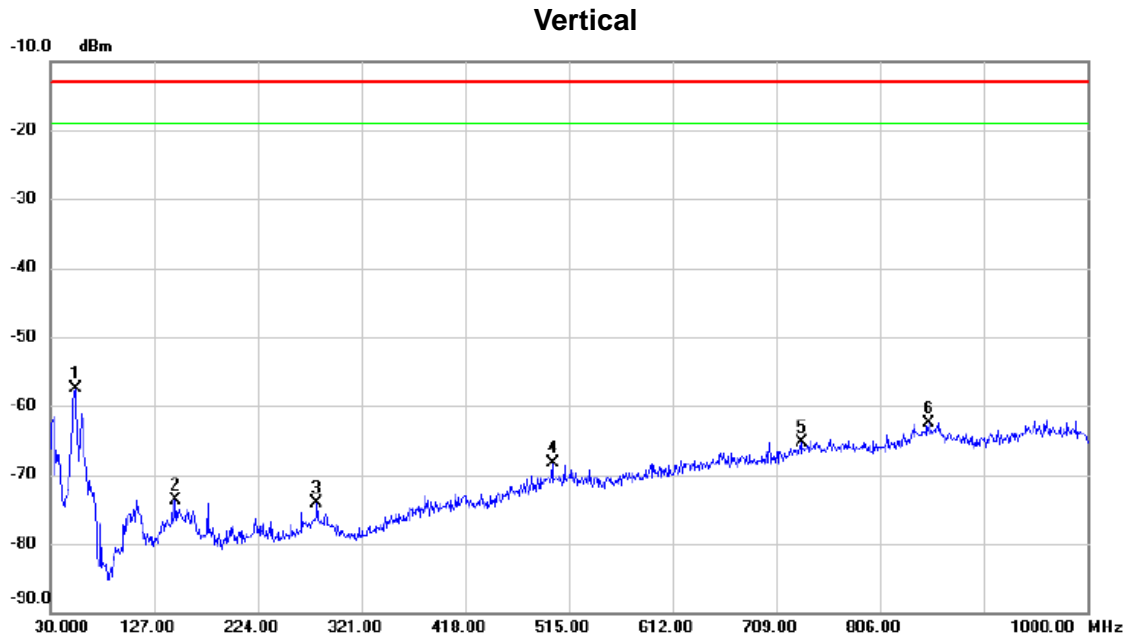

No.	Mk.	Freq. MHz	Reading Level dBm	Correct Factor dB	Measure- ment dBm	Limit dBm	Margin dB	Detector	Comment
1	*	53.280	-59.45	1.99	-57.46	-13.00	-44.46	peak	
2		147.370	-76.55	2.89	-73.66	-13.00	-60.66	peak	
3		279.290	-76.71	2.62	-74.09	-13.00	-61.09	peak	
4		499.965	-75.81	7.55	-68.26	-13.00	-55.26	peak	
5		732.280	-77.08	11.77	-65.31	-13.00	-52.31	peak	
6		851.590	-76.83	14.42	-62.41	-13.00	-49.41	peak	

Test Mode: PCS1900_TX CH810_GSM_External Antenna_3dBi

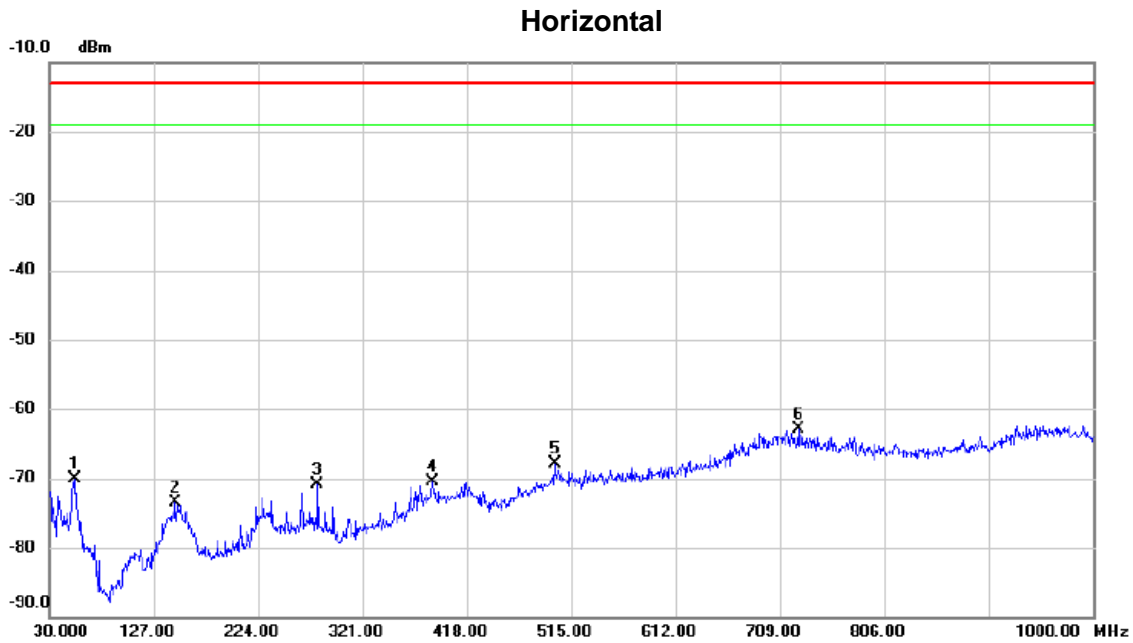

No.	Mk.	Freq. MHz	Reading Level dBm	Correct Factor dB	Measure- ment dBm	Limit dBm	Margin dB	Detector	Comment
1		54.250	-72.50	2.47	-70.03	-13.00	-57.03	peak	
2		147.370	-77.38	3.95	-73.43	-13.00	-60.43	peak	
3		279.290	-73.46	2.54	-70.92	-13.00	-57.92	peak	
4		385.990	-76.51	6.03	-70.48	-13.00	-57.48	peak	
5		499.965	-75.98	8.06	-67.92	-13.00	-54.92	peak	
6	*	725.975	-76.18	13.35	-62.83	-13.00	-49.83	peak	

Test Mode: PCS1900_TX CH810_EDGE_External Antenna_3dBi

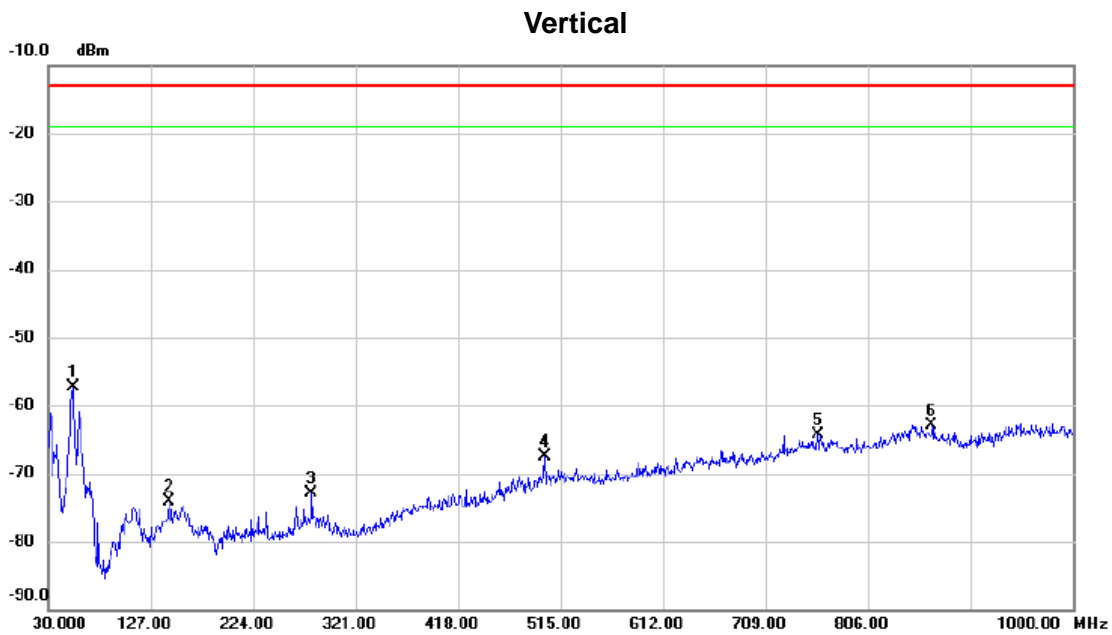

No.	Mk.	Freq. MHz	Reading Level dBm	Correct Factor dB	Measure- ment dBm	Limit dBm	Margin dB	Detector	Comment
1	*	53.280	-59.31	1.99	-57.32	-13.00	-44.32	peak	
2		143.975	-76.67	2.55	-74.12	-13.00	-61.12	peak	
3		279.290	-75.48	2.62	-72.86	-13.00	-59.86	peak	
4		499.965	-75.06	7.55	-67.51	-13.00	-54.51	peak	
5		758.470	-76.76	12.38	-64.38	-13.00	-51.38	peak	
6		866.625	-76.77	13.88	-62.89	-13.00	-49.89	peak	

Test Mode: PCS1900_TX CH810_EDGE_External Antenna_3dBi

Horizontal

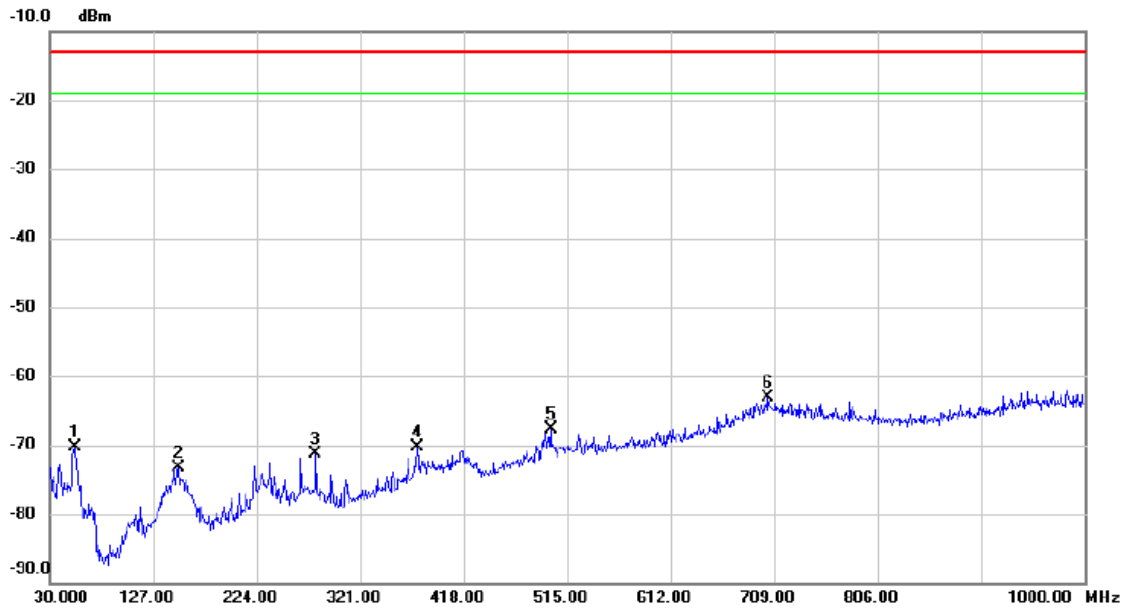

No.	Mk.	Freq. MHz	Reading Level dBm	Correct Factor dB	Measure- ment dBm	Limit dBm	Margin dB	Detector	Comment
1		53.280	-72.57	2.19	-70.38	-13.00	-57.38	peak	
2		150.280	-77.55	4.20	-73.35	-13.00	-60.35	peak	
3		279.290	-73.87	2.54	-71.33	-13.00	-58.33	peak	
4		374.835	-75.87	5.49	-70.38	-13.00	-57.38	peak	
5		499.965	-75.82	8.06	-67.76	-13.00	-54.76	peak	
6	*	703.665	-76.90	13.89	-63.01	-13.00	-50.01	peak	

APPENDIX F - RADIATED EMISSION (ABOVE 1GHZ)

Test Mode: PCS1900_TX CH810_GSM_Internal Antenna

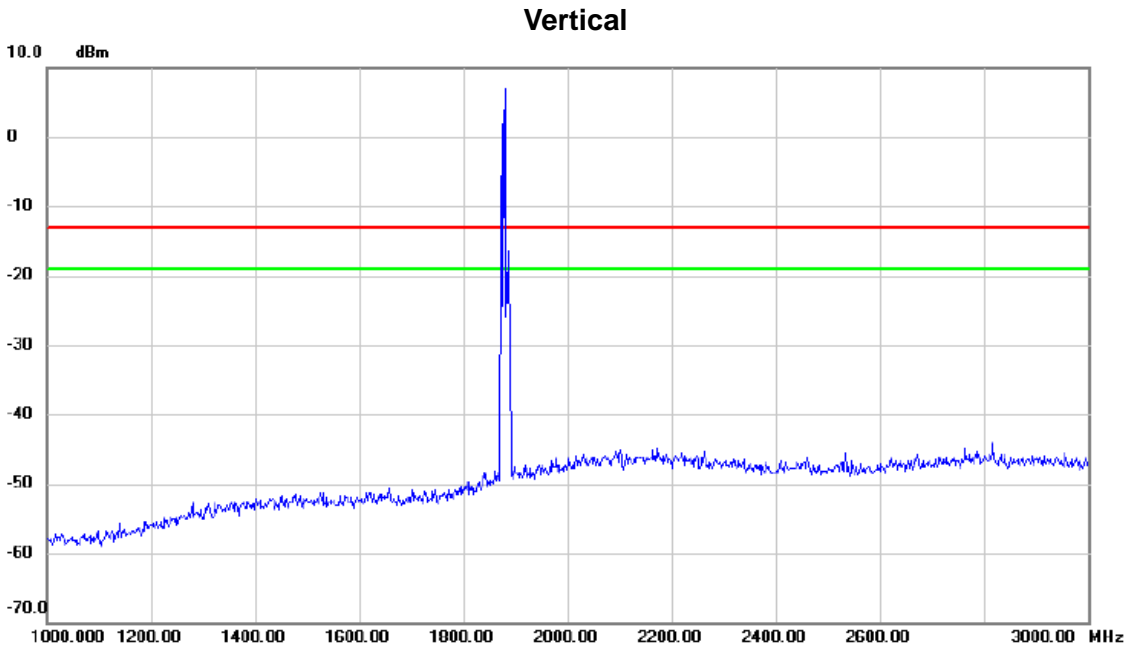

No.	Mk.	Freq.	Reading Level	Correct Factor	Measurement	Limit	Margin	Detector	Comment
		MHz	dBm	dB	dBm	dBm	dB		
		1850.00	5.00	0.00	5.00	-13.00	18.00		

Test Mode: PCS1900_TX CH810_GSM_Internal Antenna

Horizontal

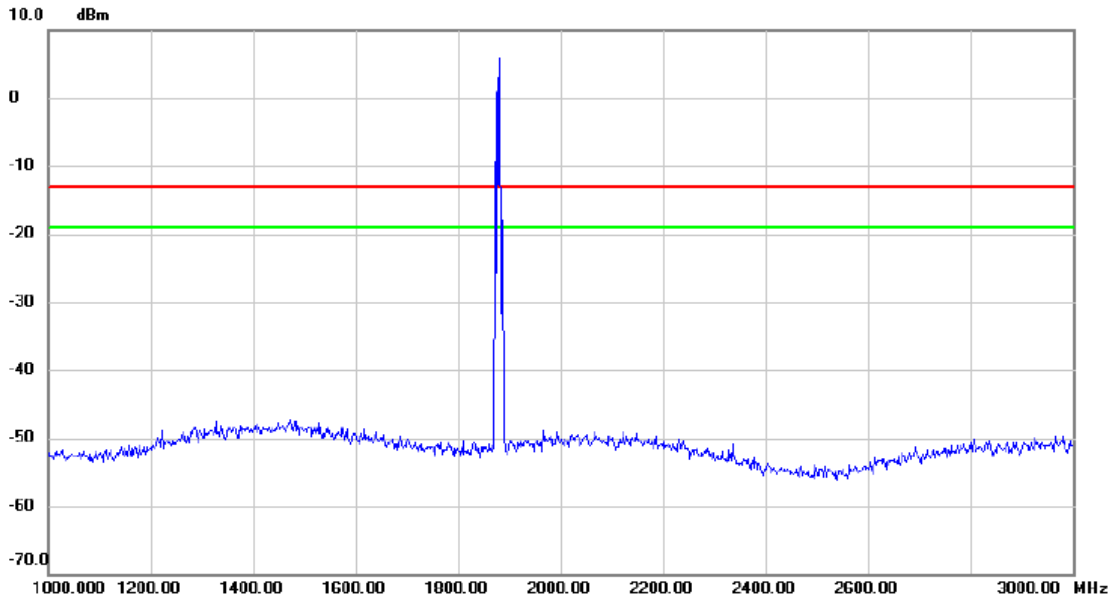

No.	Mk.	Freq. MHz	Reading Level dBm	Correct Factor dB	Measure- ment dBm	Limit dBm	Margin dB	Detector	Comment
-----	-----	--------------	-------------------------	-------------------------	-------------------------	--------------	--------------	----------	---------

Test Mode: PCS1900_TX CH810_GSM_Internal Antenna

Vertical

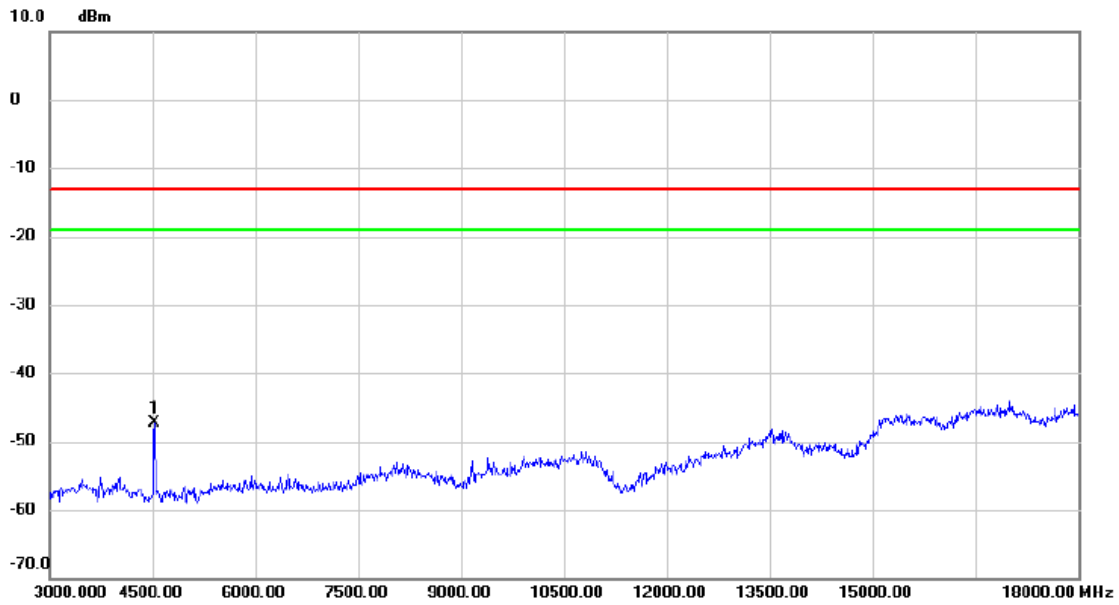

No.	Mk.	Freq. MHz	Reading Level dBm	Correct Factor dB	Measure- ment dBm	Limit dBm	Margin dB	Detector	Comment
1	*	4530.000	-61.64	14.44	-47.20	-13.00	-34.20	peak	

Test Mode: PCS1900_TX CH810_GSM_Internal Antenna

Horizontal

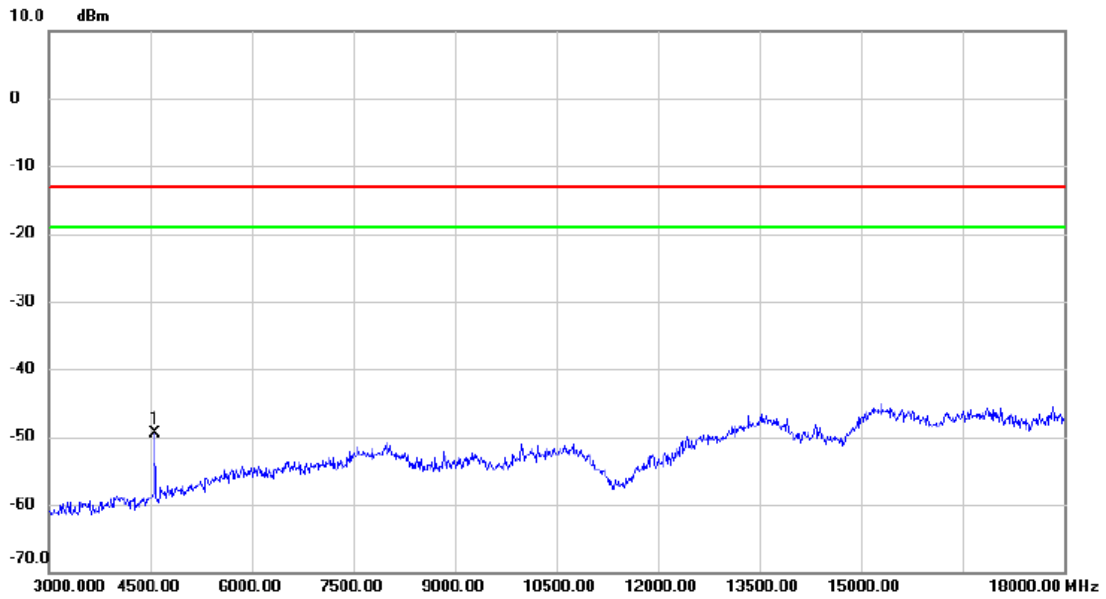

No.	Mk.	Freq. MHz	Reading Level dBm	Correct Factor dB	Measure- ment dBm	Limit dBm	Margin dB	Detector	Comment
1	*	4575.000	-62.86	13.33	-49.53	-13.00	-36.53	peak	

Test Mode: PCS1900_TX CH810_GSM_Internal Antenna

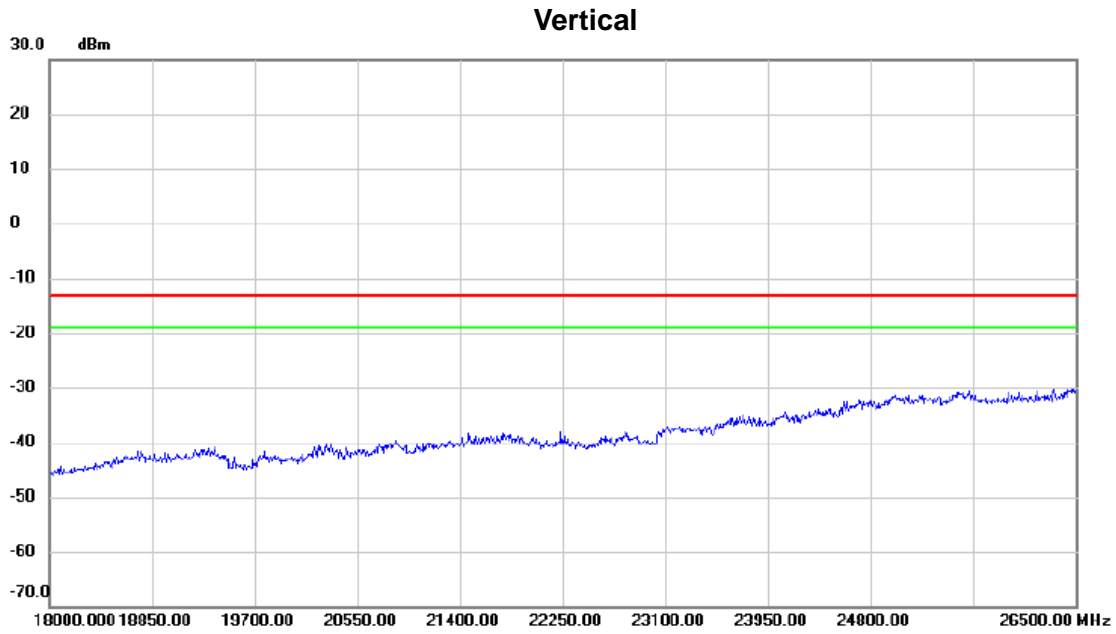

No.	Mk.	Freq. MHz	Reading Level dBm	Correct Factor dB	Measure- ment dBm	Limit dBm	Margin dB	Detector	Comment
-----	-----	--------------	-------------------------	-------------------------	-------------------------	--------------	--------------	----------	---------

Test Mode: PCS1900_TX CH810_GSM_Internal Antenna

Horizontal

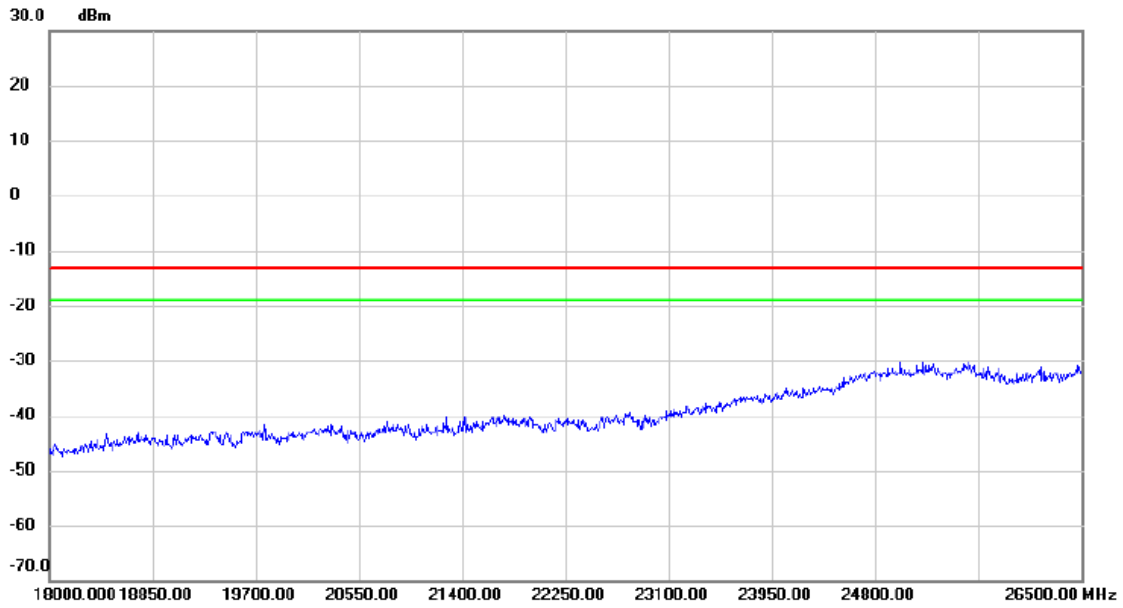

No.	Mk.	Freq. MHz	Reading Level dBm	Correct Factor dB	Measure- ment dBm	Limit dBm	Margin dB	Detector	Comment
-----	-----	--------------	-------------------------	-------------------------	-------------------------	--------------	--------------	----------	---------

Test Mode: PCS1900_TX CH810_EDGE_Internal Antenna

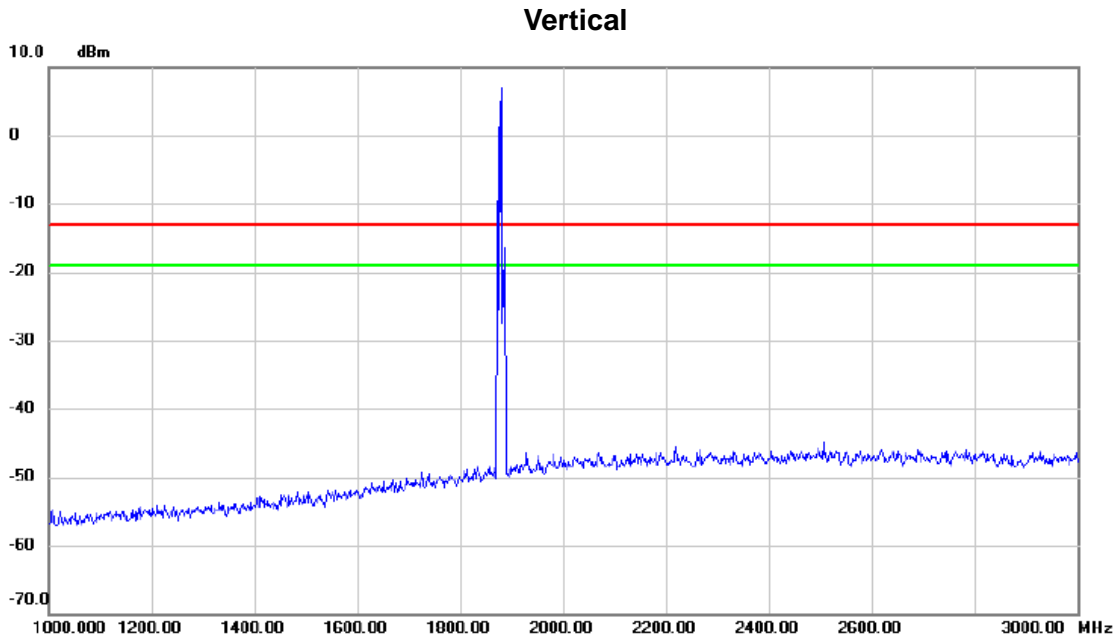

No.	Mk.	Freq. MHz	Reading Level dBm	Correct Factor dB	Measure- ment dBm	Limit dBm	Margin dB	Detector	Comment
		1880.00	5.00	0.00	5.00	-13.50	-18.50		

Test Mode: PCS1900_TX CH810_EDGE_Internal Antenna

Horizontal

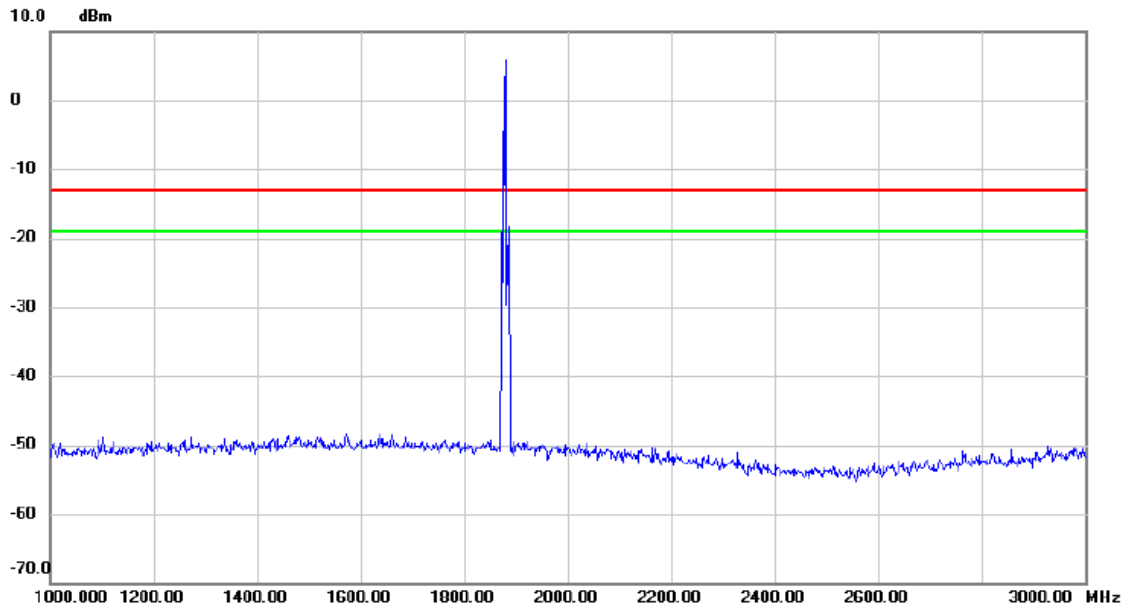

No.	Mk.	Freq. MHz	Reading Level dBm	Correct Factor dB	Measure- ment dBm	Limit dBm	Margin dB	Detector	Comment
		1900.00	5.00	0.00	5.00	-13.00	18.00		

Test Mode: PCS1900_TX CH810_EDGE_Internal Antenna

Vertical

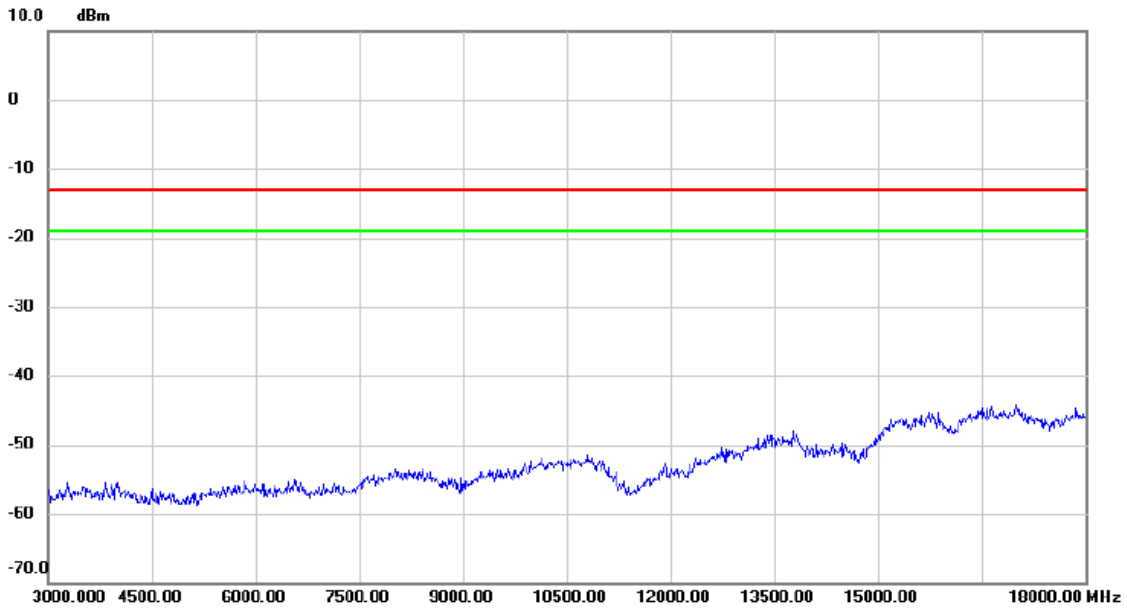

No.	Mk.	Freq.	Reading Level	Correct Factor	Measurement	Limit	Margin	Detector	Comment
		MHz	dBm	dB	dBm	dBm	dB		

Test Mode: PCS1900_TX CH810_EDGE_Internal Antenna

Horizontal

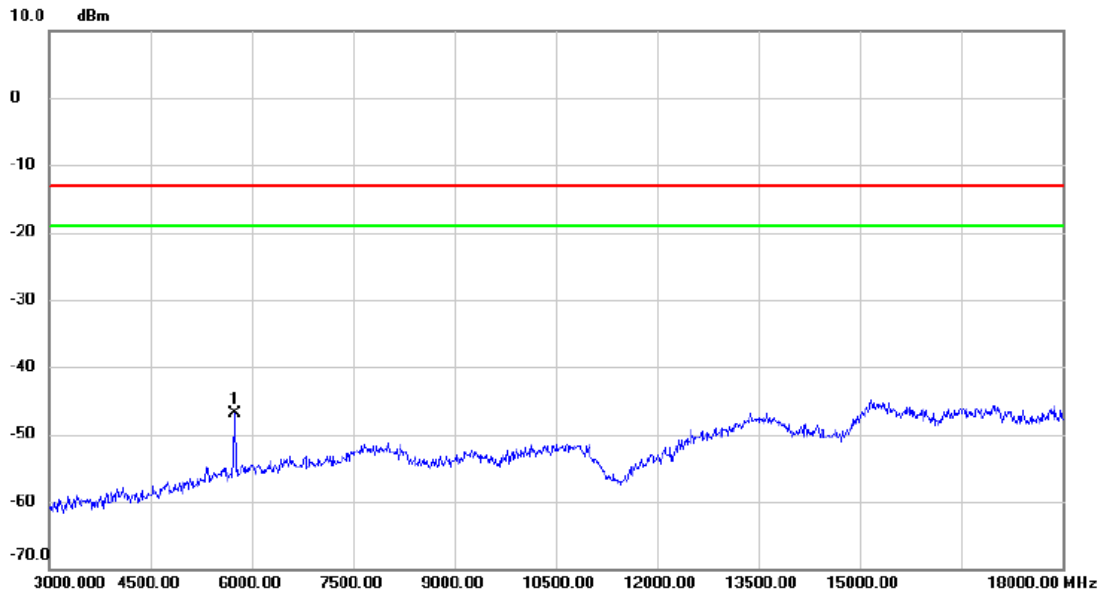

No. Mk.	Freq. MHz	Reading Level dBm	Correct Factor dB	Measure- ment dBm	Limit dBm	Margin dB	Detector	Comment
1 *	5745.000	-64.23	17.38	-46.85	-13.00	-33.85	peak	

Test Mode: PCS1900_TX CH810_EDGE_Internal Antenna

Vertical

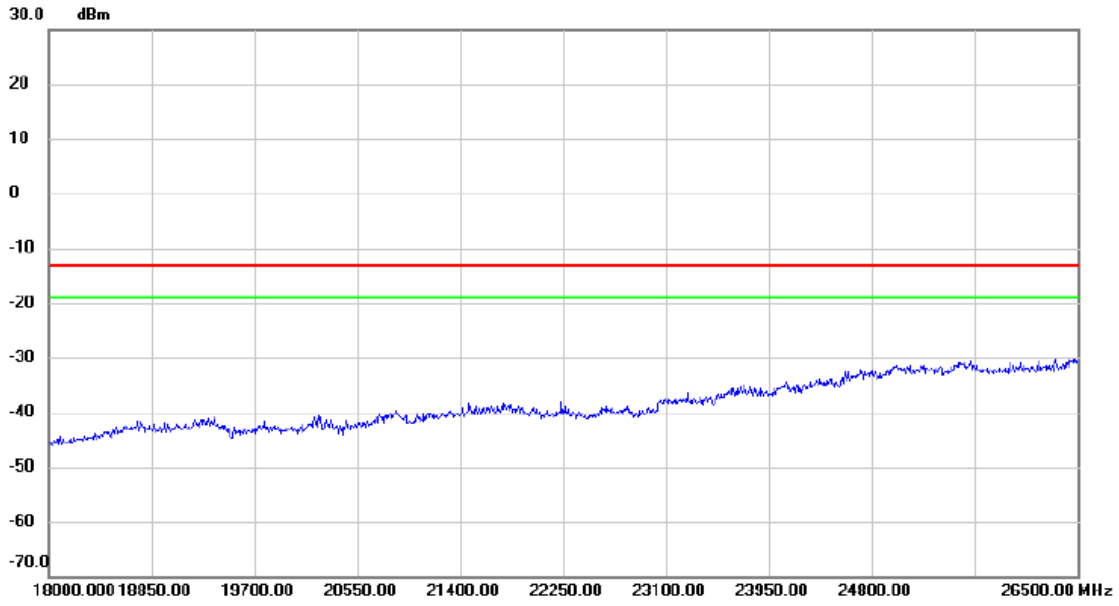

No.	Mk.	Freq.	Reading Level	Correct Factor	Measurement	Limit	Margin	Detector	Comment
		MHz	dBm	dB	dBm	dBm	dB		

Test Mode: PCS1900_TX CH810_EDGE_Internal Antenna

Horizontal

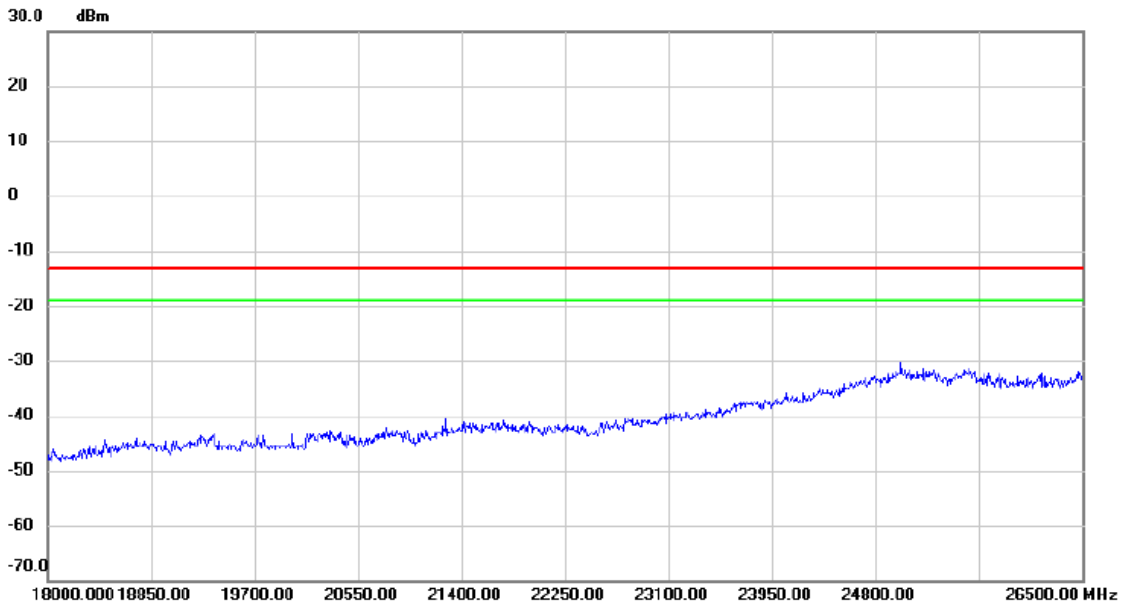

No.	Mk.	Freq. MHz	Reading Level dBm	Correct Factor dB	Measure- ment dBm	Limit dBm	Margin dB	Detector	Comment
-----	-----	--------------	-------------------------	-------------------------	-------------------------	--------------	--------------	----------	---------

Test Mode: PCS1900_TX CH810_GSM_External Antenna_1dBi

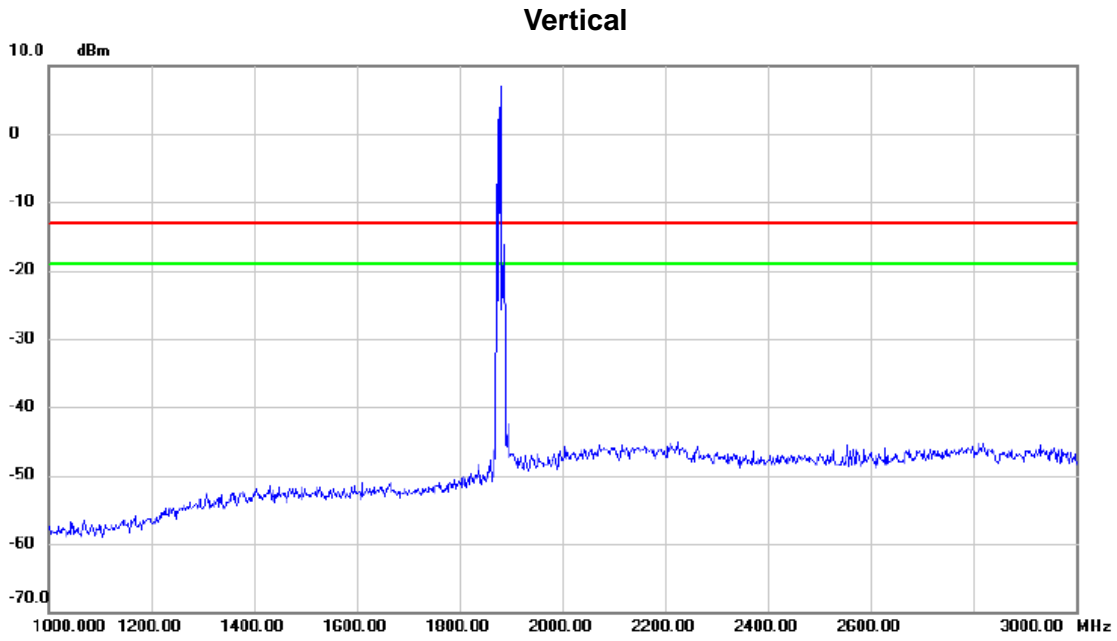

No.	Mk.	Freq.	Reading Level	Correct Factor	Measurement	Limit	Margin	Detector	Comment
		MHz	dBm	dB	dBm	dBm	dB		
		1850.00	5.00	0.00	5.00	-13.00	-18.00		

Test Mode: PCS1900_TX CH810_GSM_External Antenna_1dBi

Horizontal

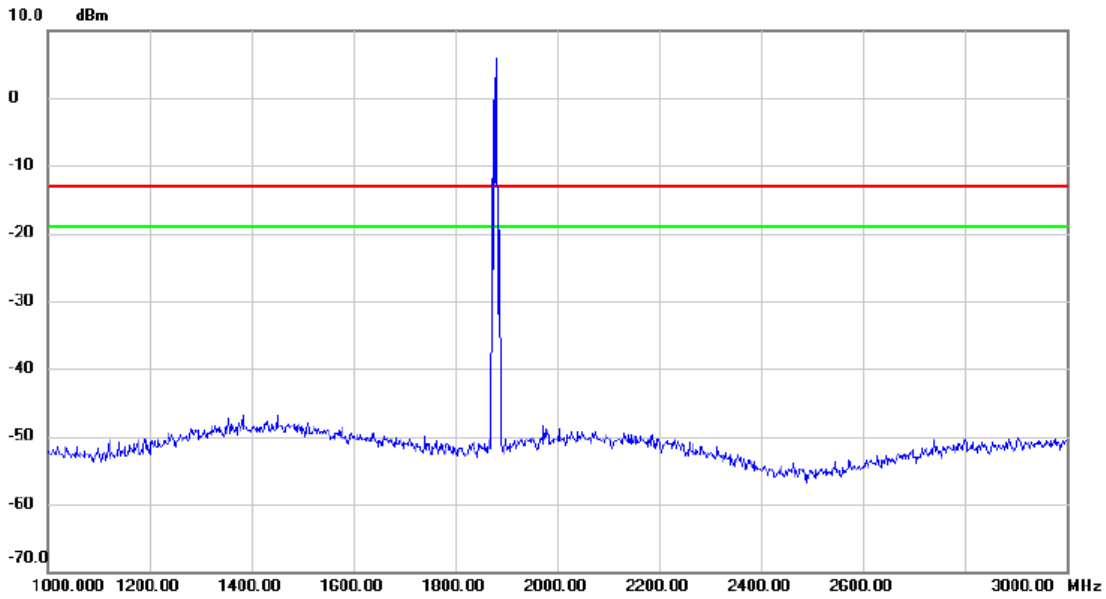

No.	Mk.	Freq.	Reading Level	Correct Factor	Measurement	Limit	Margin	Detector	Comment
		MHz	dBm	dB	dBm	dBm	dB		

Test Mode: PCS1900_TX CH810_GSM_External Antenna_1dBi

Vertical

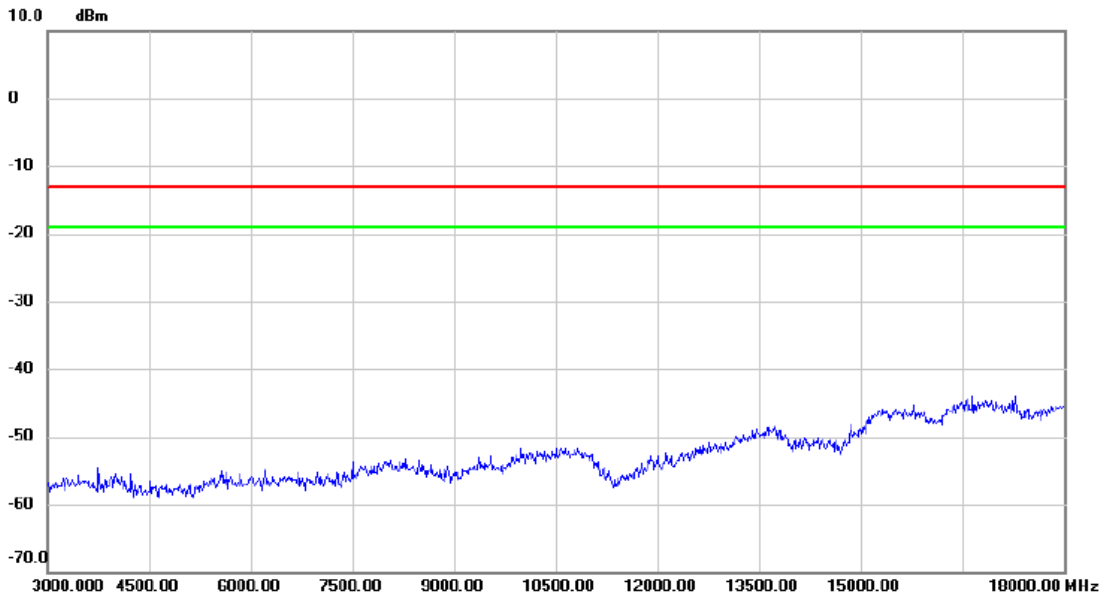

No.	Mk.	Freq. MHz	Reading Level dBm	Correct Factor dB	Measure- ment dBm	Limit dBm	Margin dB	Detector	Comment
-----	-----	--------------	-------------------------	-------------------------	-------------------------	--------------	--------------	----------	---------

Test Mode: PCS1900_TX CH810_GSM_External Antenna_1dBi

Horizontal

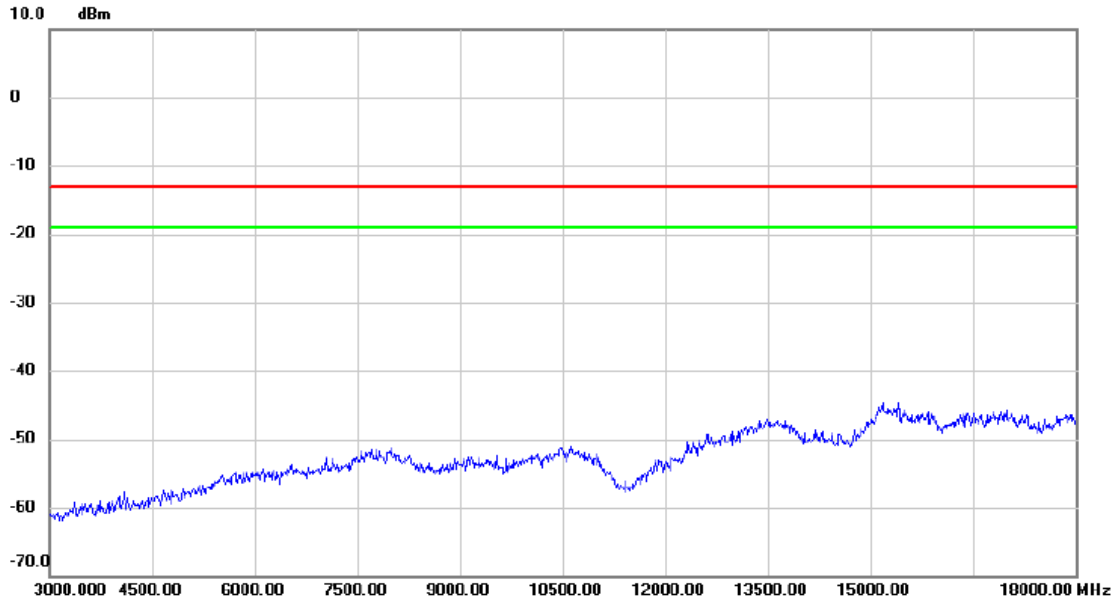

No.	Mk.	Freq.	Reading Level	Correct Factor	Measurement	Limit	Margin	Detector	Comment
		MHz	dBm	dB	dBm	dBm	dB		

Test Mode: PCS1900_TX CH810_GSM_External Antenna_1dBi

Vertical

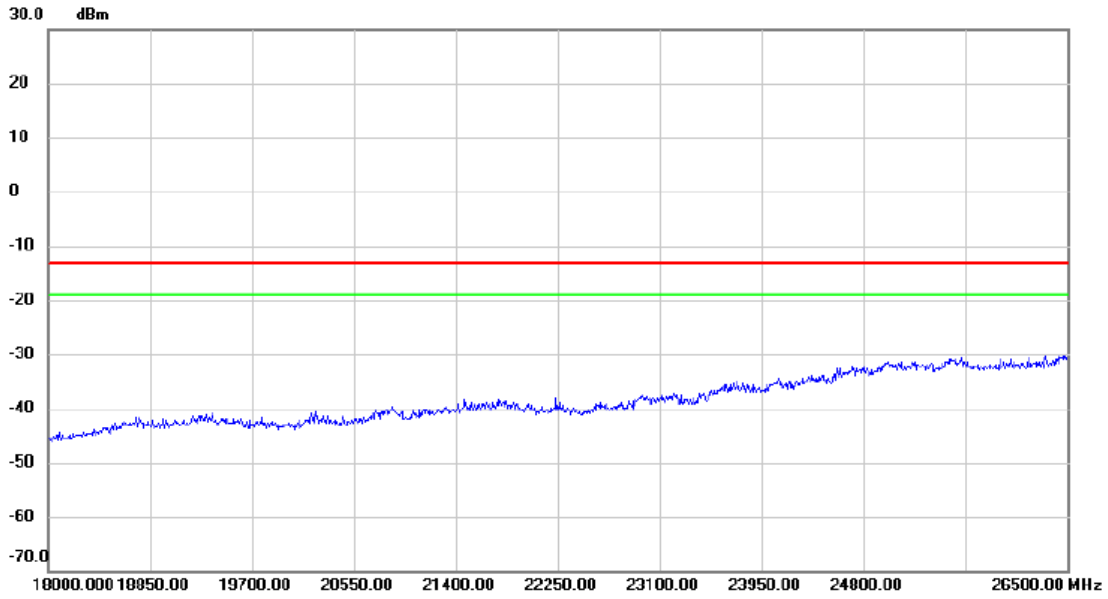

No.	Mk.	Freq. MHz	Reading Level dBm	Correct Factor dB	Measure- ment dBm	Limit dBm	Margin dB	Detector	Comment
-----	-----	--------------	-------------------------	-------------------------	-------------------------	--------------	--------------	----------	---------

Test Mode: PCS1900_TX CH810_GSM_External Antenna_1dBi

Horizontal

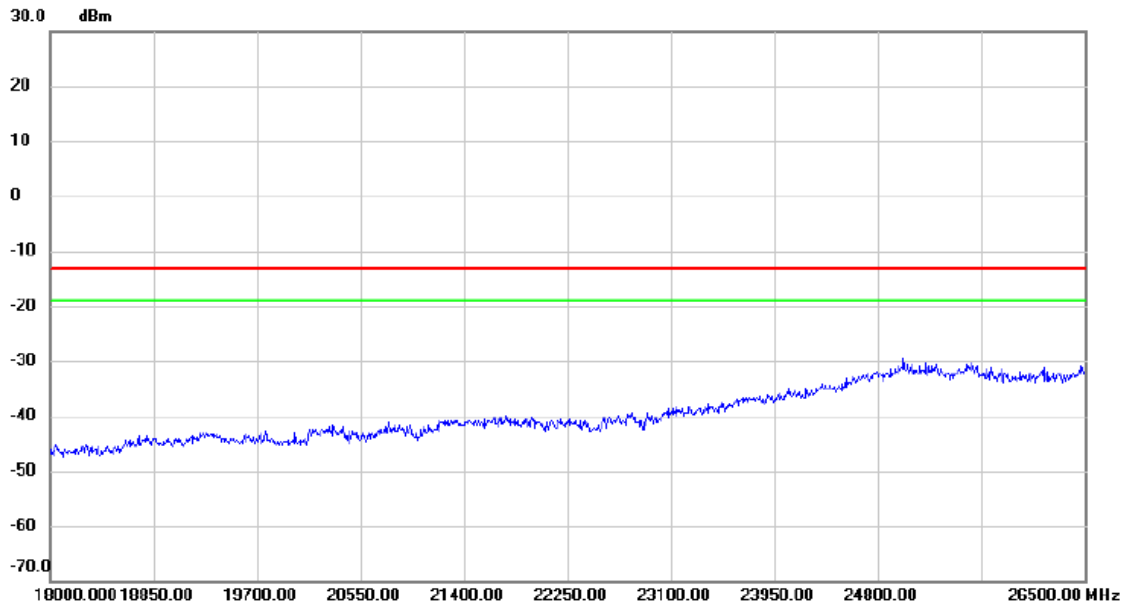

No.	Mk.	Freq.	Reading Level	Correct Factor	Measurement	Limit	Margin	Detector	Comment
		MHz	dBm	dB	dBm	dBm	dB		

Test Mode: PCS1900_TX CH810_EDGE_External Antenna_1dBi

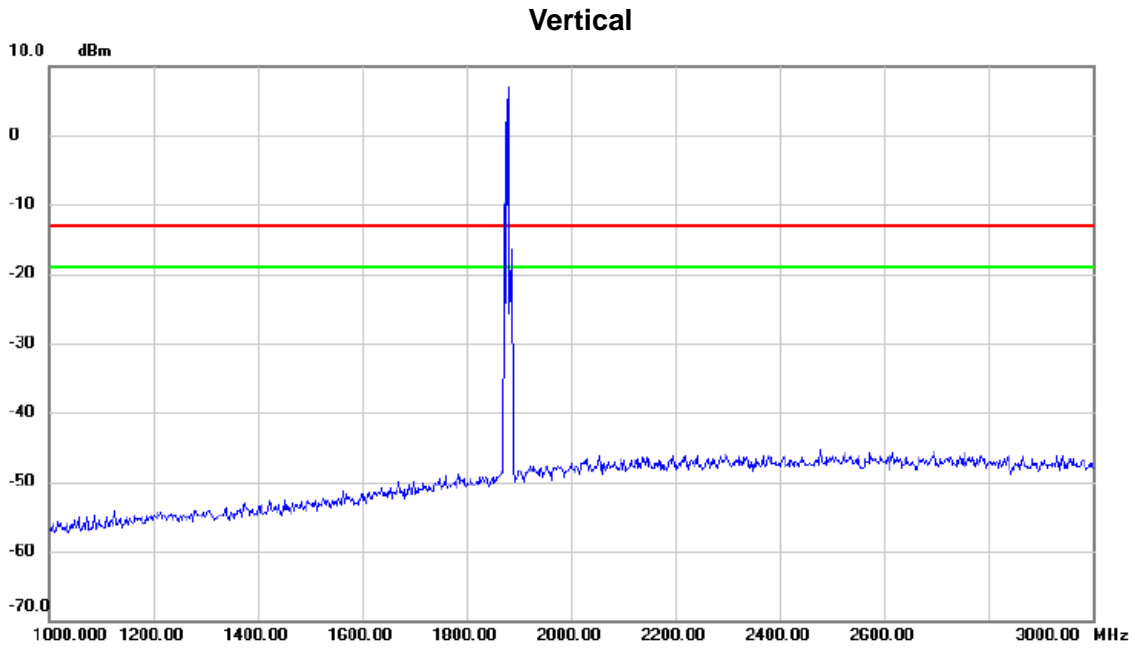

No.	Mk.	Freq.	Reading Level	Correct Factor	Measurement	Limit	Margin	Detector	Comment
		MHz	dBm	dB	dBm	dBm	dB		
		1880.00	5.00	0.00	5.00	-13.00	18.00		

Test Mode: PCS1900_TX CH810_EDGE_External Antenna_1dBi

Horizontal

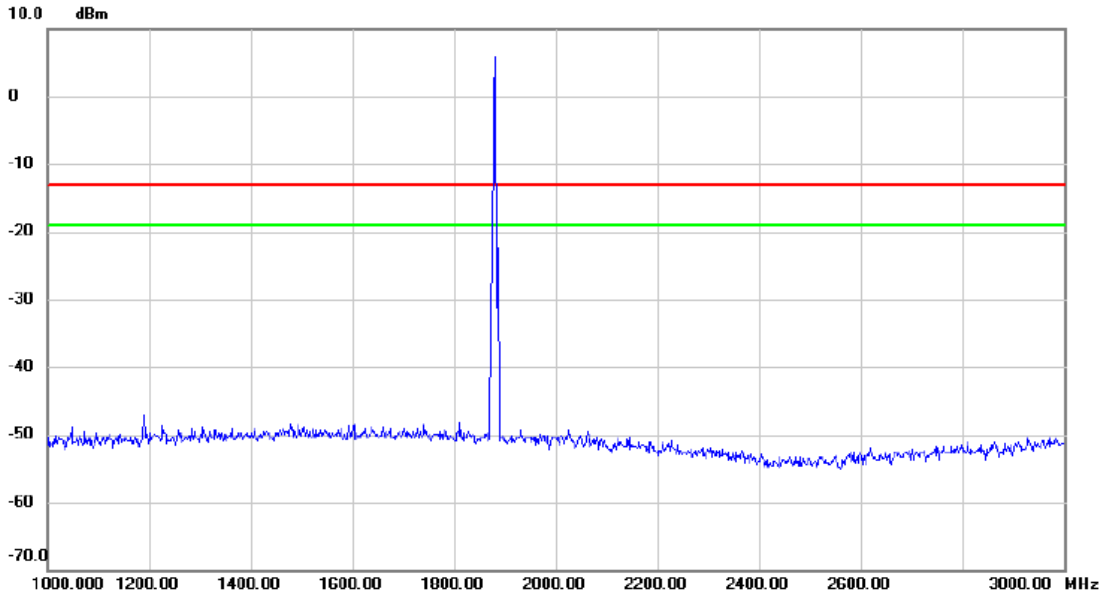

No.	Mk.	Freq.	Reading Level	Correct Factor	Measurement	Limit	Margin	Detector	Comment
		MHz	dBm	dB	dBm	dBm	dB		
		1950.000	5.0	0.0	5.0	-15.0	20.0		

Test Mode: PCS1900_TX CH810_EDGE_External Antenna_1dBi

Vertical

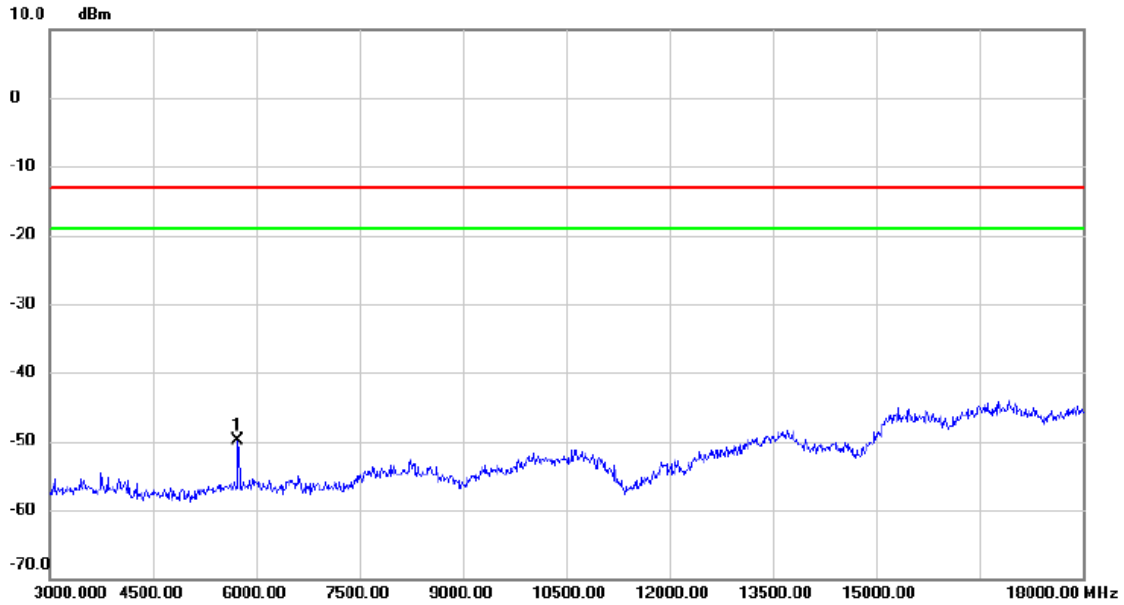

No.	Mk.	Freq. MHz	Reading Level dBm	Correct Factor dB	Measure- ment dBm	Limit dBm	Margin dB	Detector	Comment
1	*	5737.500	-66.35	16.47	-49.88	-13.00	-36.88	peak	

Test Mode: PCS1900_TX CH810_EDGE_External Antenna_1dBi

Horizontal

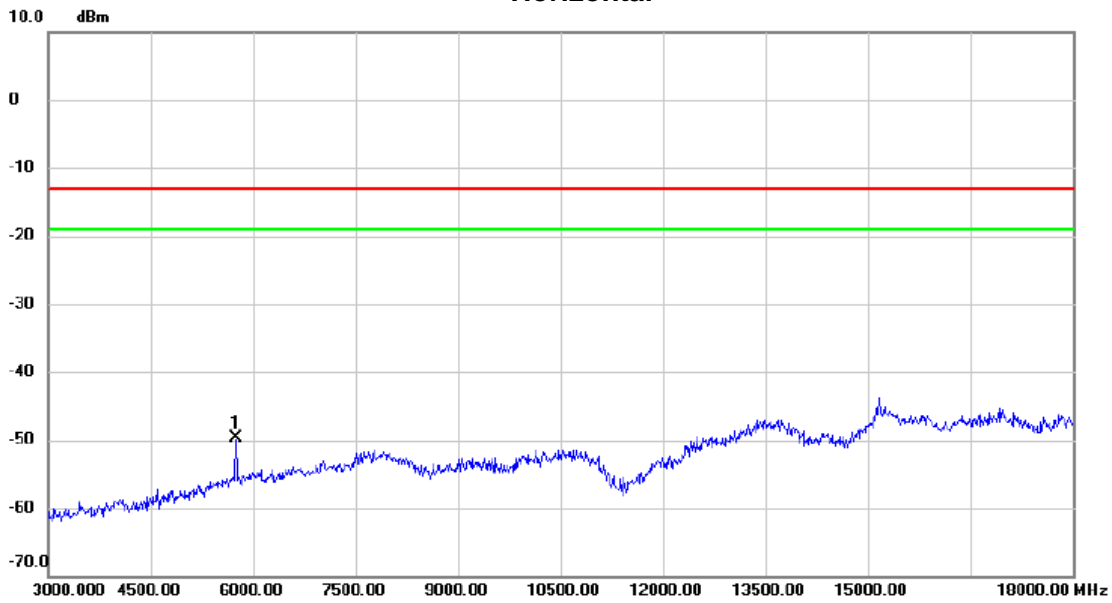

No.	Mk.	Freq. MHz	Reading Level dBm	Correct Factor dB	Measure- ment dBm	Limit dBm	Margin dB	Detector	Comment
1	*	5745.000	-67.18	17.38	-49.80	-13.00	-36.80	peak	

Test Mode: PCS1900_TX CH810_EDGE_External Antenna_1dBi

Vertical

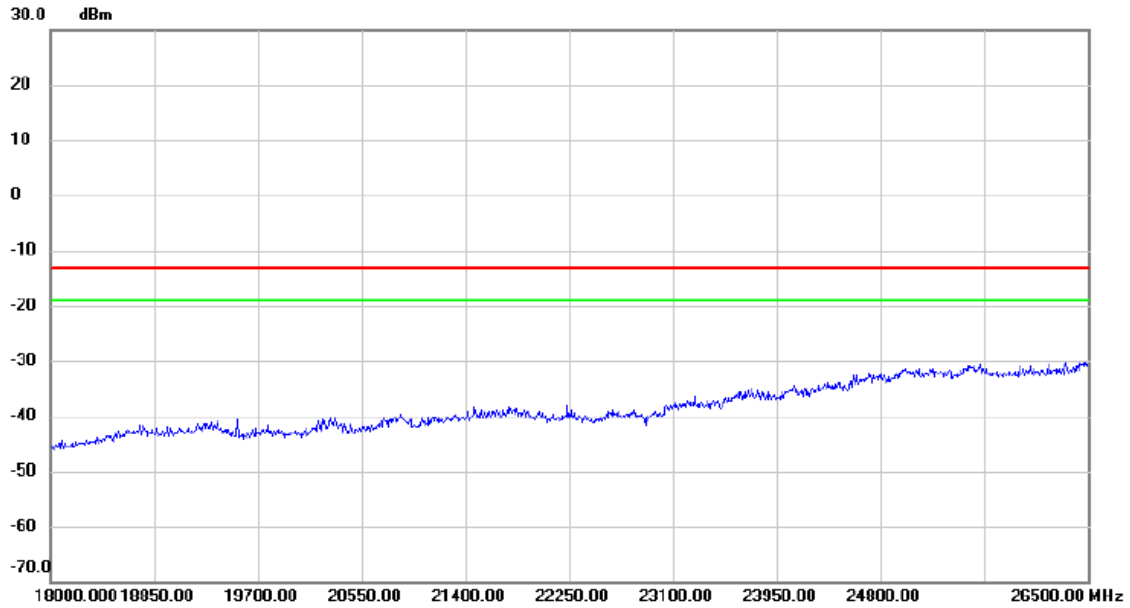

No.	Mk.	Freq. MHz	Reading Level dBm	Correct Factor dB	Measure- ment dBm	Limit dBm	Margin dB	Detector	Comment
-----	-----	--------------	-------------------------	-------------------------	-------------------------	--------------	--------------	----------	---------

Test Mode: PCS1900_TX CH810_EDGE_External Antenna_1dBi

Horizontal

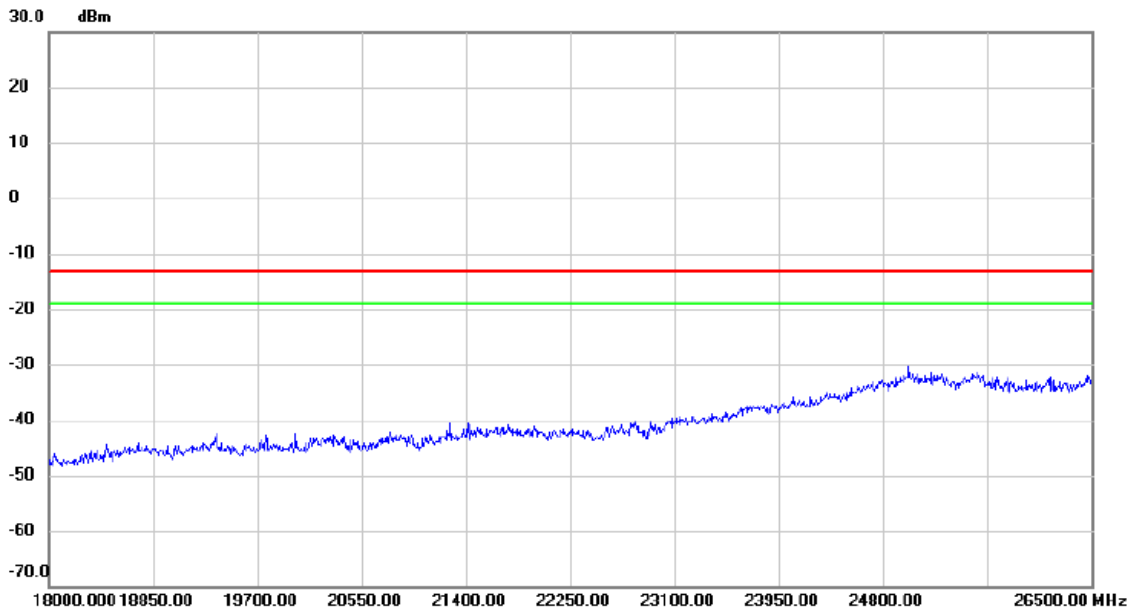

No.	Mk.	Freq.	Reading Level	Correct Factor	Measurement	Limit	Margin	Detector	Comment
		MHz	dBm	dB	dBm	dBm	dB		

Test Mode: PCS1900_TX CH810_GSM_External Antenna_3dBi

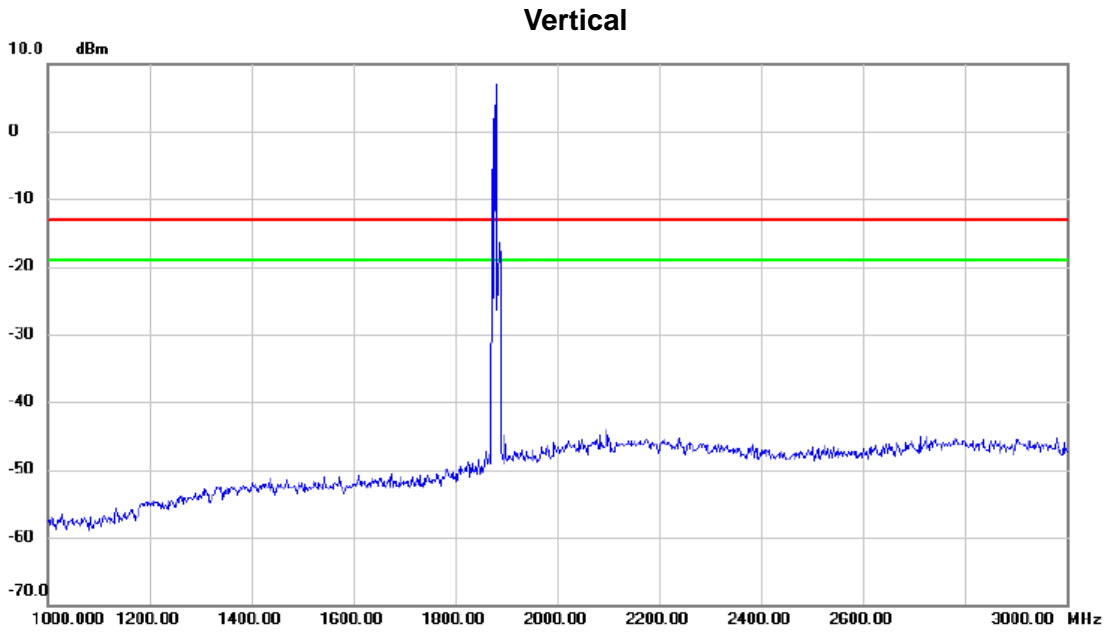

No.	Mk.	Freq. MHz	Reading Level dBm	Correct Factor dB	Measure- ment dBm	Limit dBm	Margin dB	Detector	Comment

Test Mode: PCS1900_TX CH810_GSM_External Antenna_3dBi

Horizontal

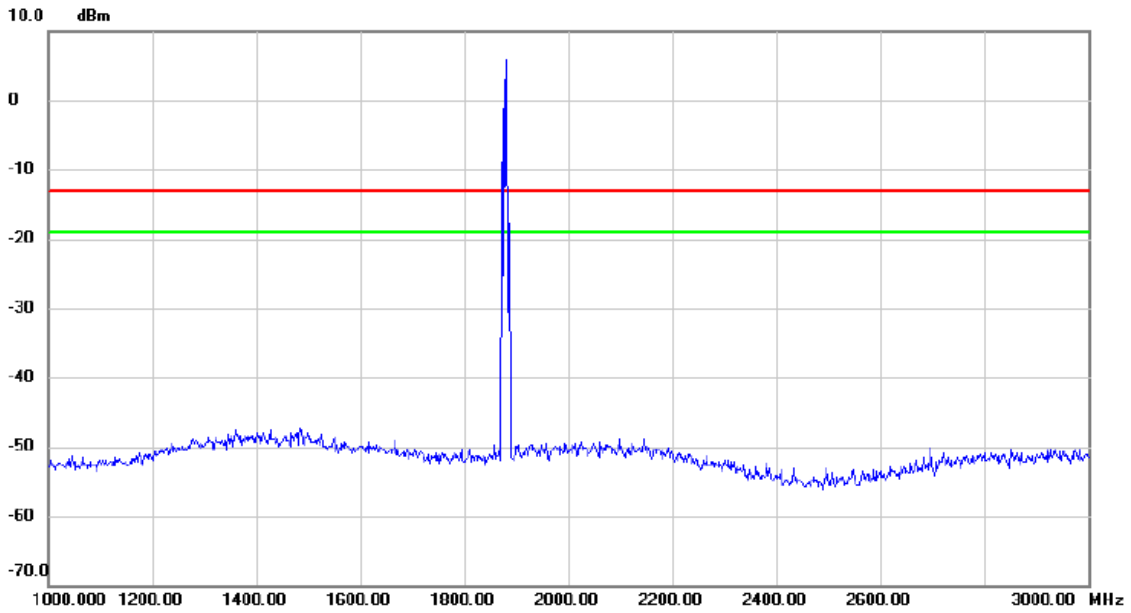

No.	Mk.	Freq.	Reading Level	Correct Factor	Measurement	Limit	Margin	Detector	Comment
		MHz	dBm	dB	dBm	dBm	dB		
		1850.00	10.00	0.00	10.00	-13.00	23.00		

Test Mode: PCS1900_TX CH810_GSM_External Antenna_3dBi

Vertical

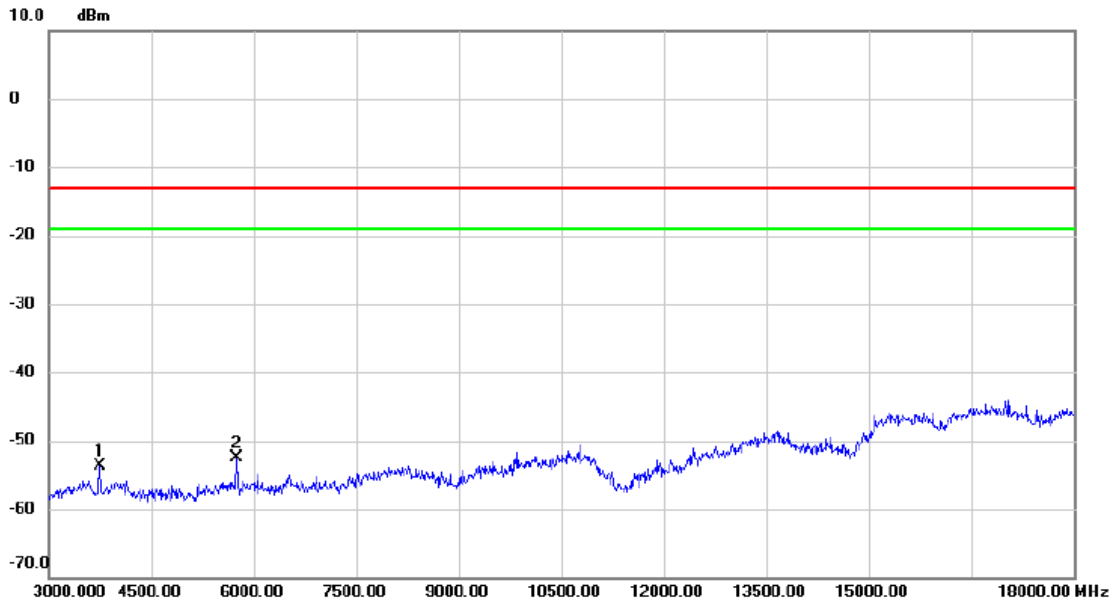

No.	Mk.	Freq. MHz	Reading Level dBm	Correct Factor dB	Measure- ment dBm	Limit dBm	Margin dB	Detector	Comment
1		3757.500	-68.28	14.51	-53.77	-13.00	-40.77	peak	
2	*	5752.500	-68.99	16.50	-52.49	-13.00	-39.49	peak	

Test Mode: PCS1900_TX CH810_GSM_External Antenna_3dBi

Horizontal

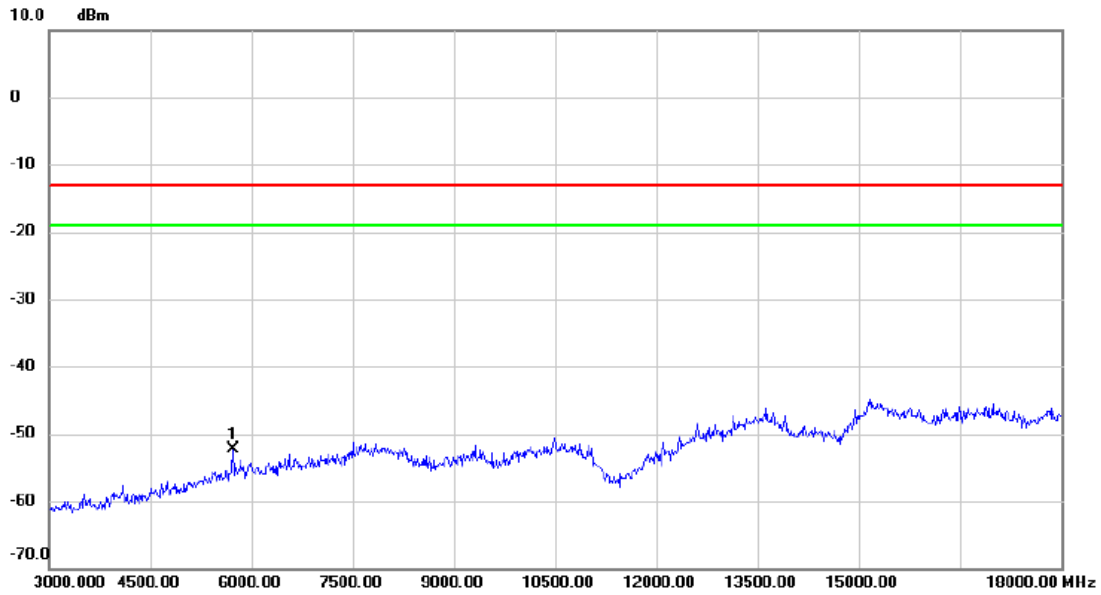

No. Mk.	Freq. MHz	Reading Level dBm	Correct Factor dB	Measure- ment dBm	Limit dBm	Margin dB	Detector	Comment
1 *	5737.500	-69.71	17.35	-52.36	-13.00	-39.36	peak	

Test Mode: PCS1900_TX CH810_GSM_External Antenna_3dBi

Vertical

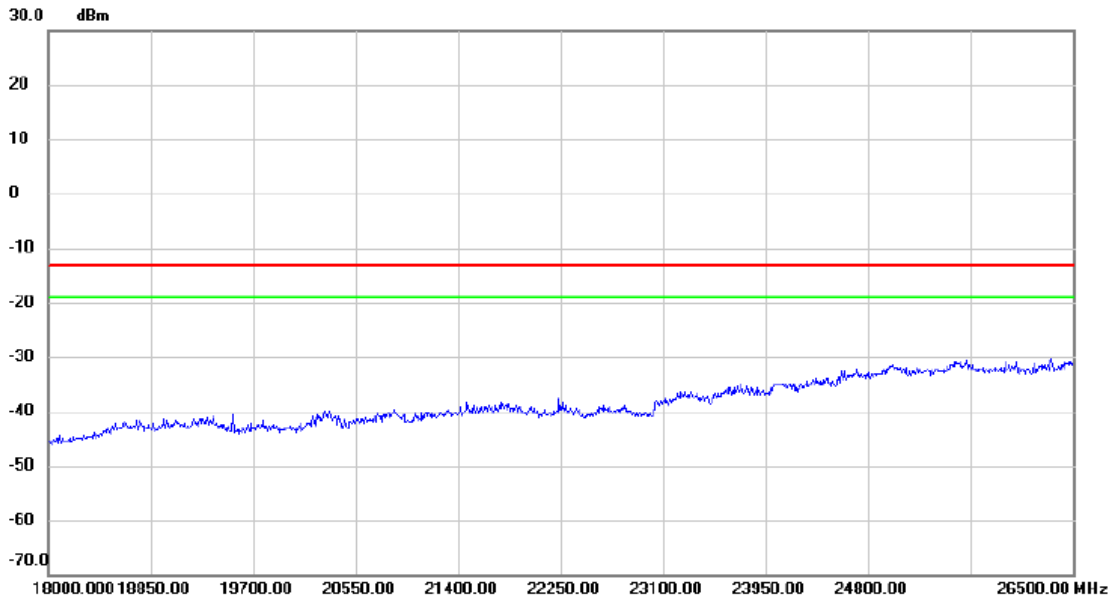

No.	Mk.	Freq.	Reading Level	Correct Factor	Measurement	Limit	Margin	Detector	Comment
		MHz	dBm	dB	dBm	dBm	dB		

Test Mode: PCS1900_TX CH810_GSM_External Antenna_3dBi

Horizontal

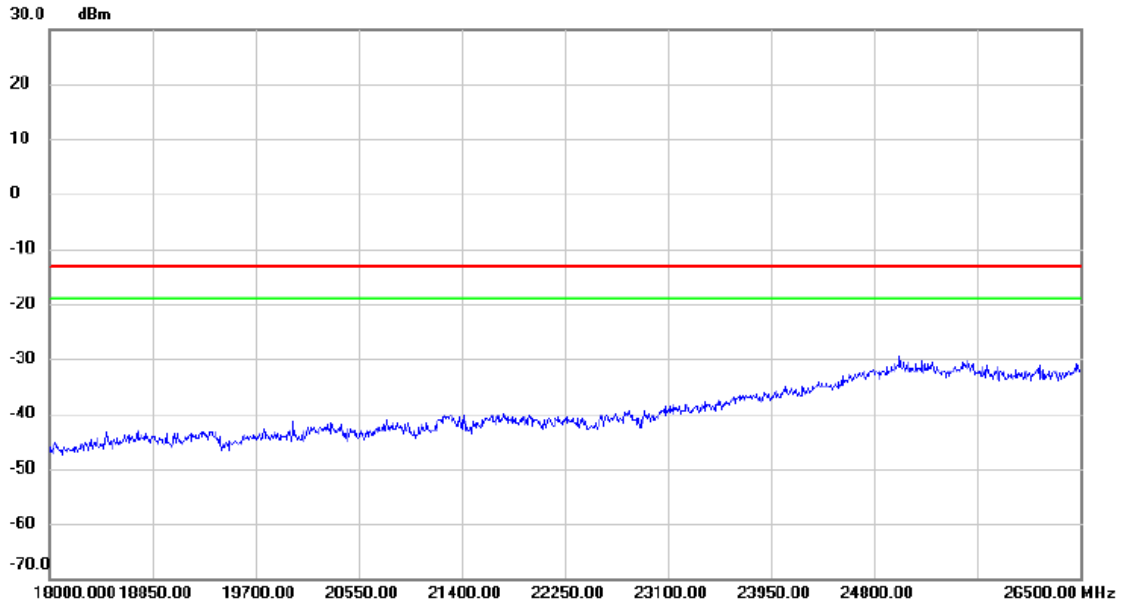

No.	Mk.	Freq.	Reading Level	Correct Factor	Measurement	Limit	Margin	Detector	Comment
		MHz	dBm	dB	dBm	dBm	dB		

Test Mode: PCS1900_TX CH810_EDGE_External Antenna_3dBi

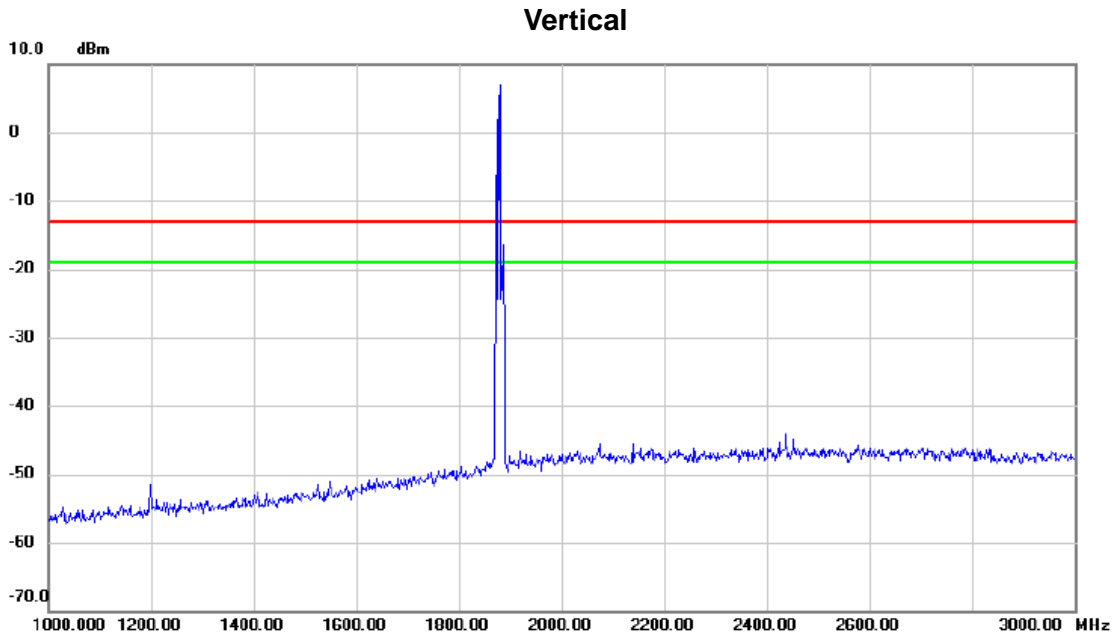

No.	Mk.	Freq.	Reading Level	Correct Factor	Measurement	Limit	Margin	Detector	Comment
		MHz	dBm	dB	dBm	dBm	dB		
		1900.000	5.0		5.0	-13.0	18.0		

Test Mode: PCS1900_TX CH810_EDGE_External Antenna_3dBi

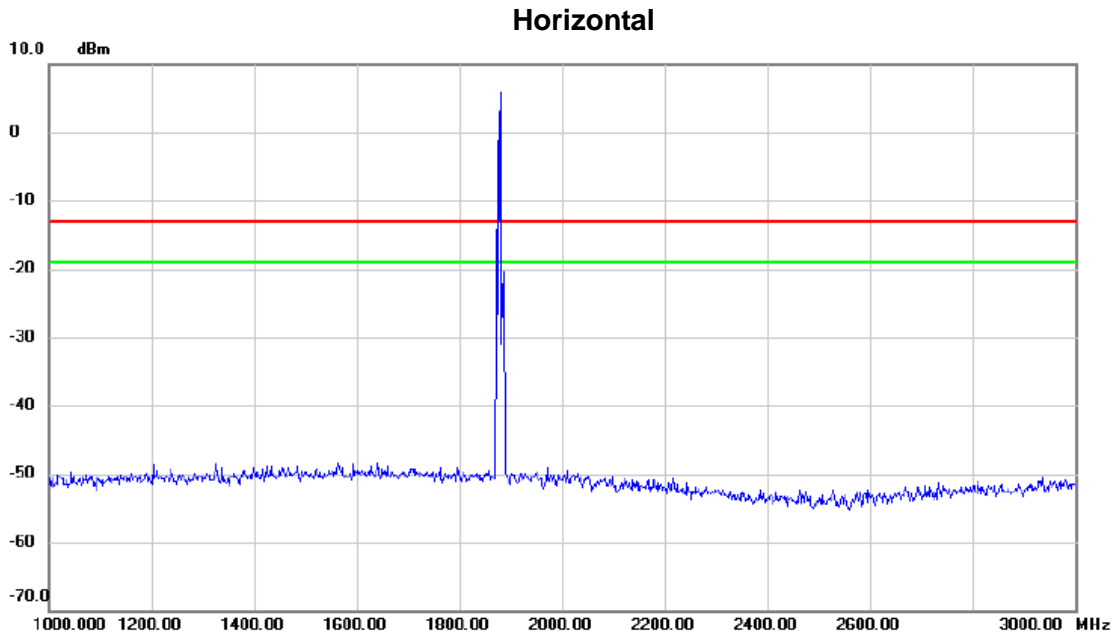

No.	Mk.	Freq.	Reading Level	Correct Factor	Measurement	Limit	Margin	Detector	Comment
		MHz	dBm	dB	dBm	dBm	dB		
		1900.00	5.00	0.00	5.00	-13.00	-18.00		

Test Mode: PCS1900_TX CH810_EDGE_External Antenna_3dBi

Vertical

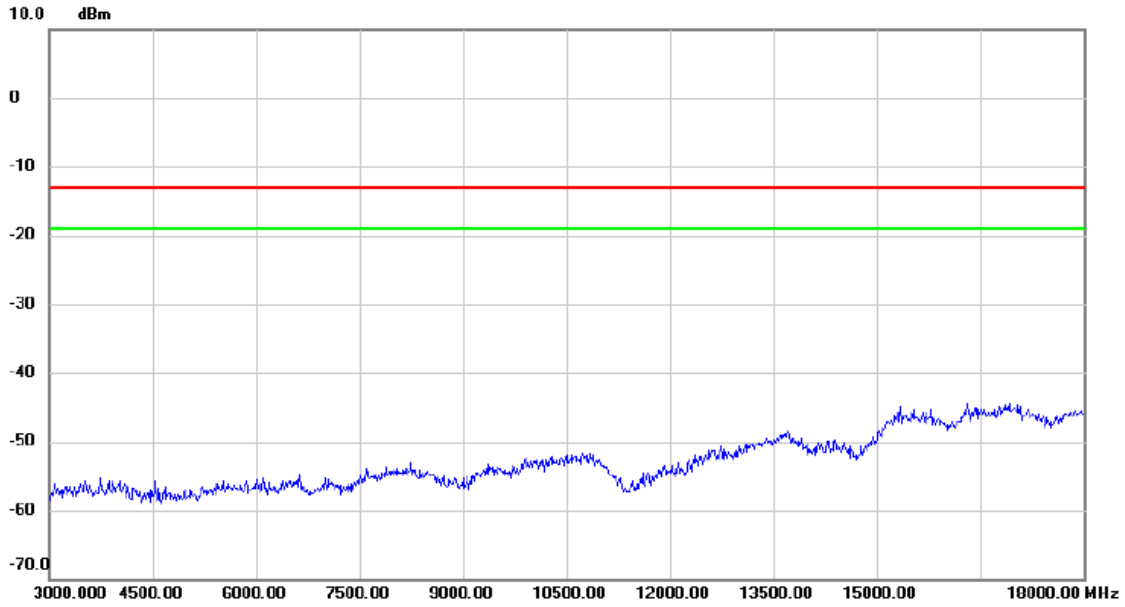

No.	Mk.	Freq. MHz	Reading Level dBm	Correct Factor dB	Measure- ment dBm	Limit dBm	Margin dB	Detector	Comment
-----	-----	--------------	-------------------------	-------------------------	-------------------------	--------------	--------------	----------	---------

Test Mode: PCS1900_TX CH810_EDGE_External Antenna_3dBi

Horizontal

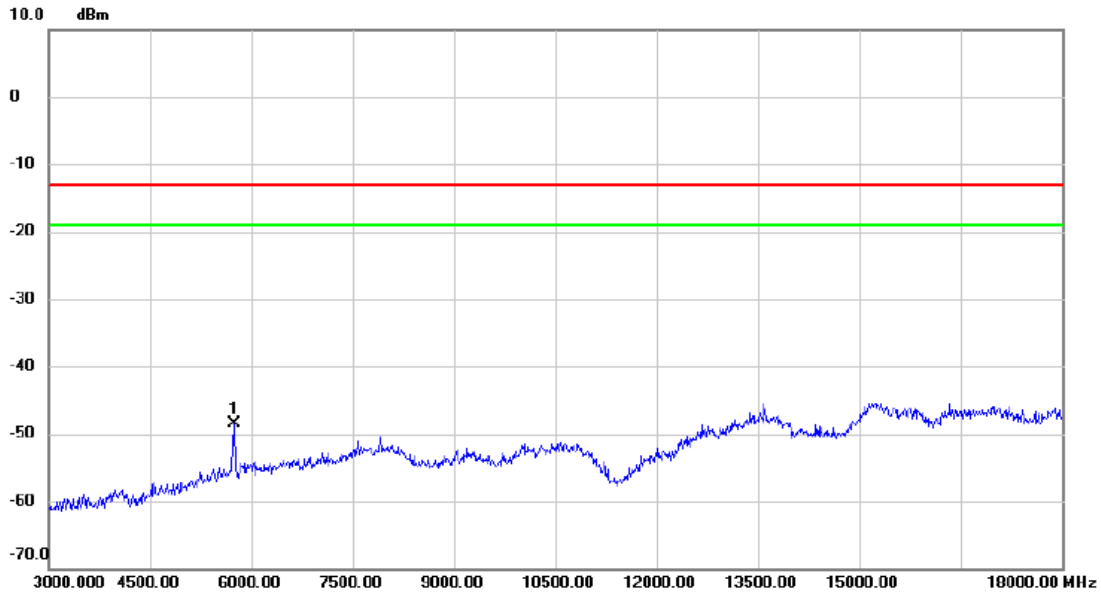

No.	Mk.	Freq. MHz	Reading Level dBm	Correct Factor dB	Measure- ment dBm	Limit dBm	Margin dB	Detector	Comment
1	*	5745.000	-65.81	17.38	-48.43	-13.00	-35.43	peak	

Test Mode: PCS1900_TX CH810_EDGE_External Antenna_3dBi

Vertical

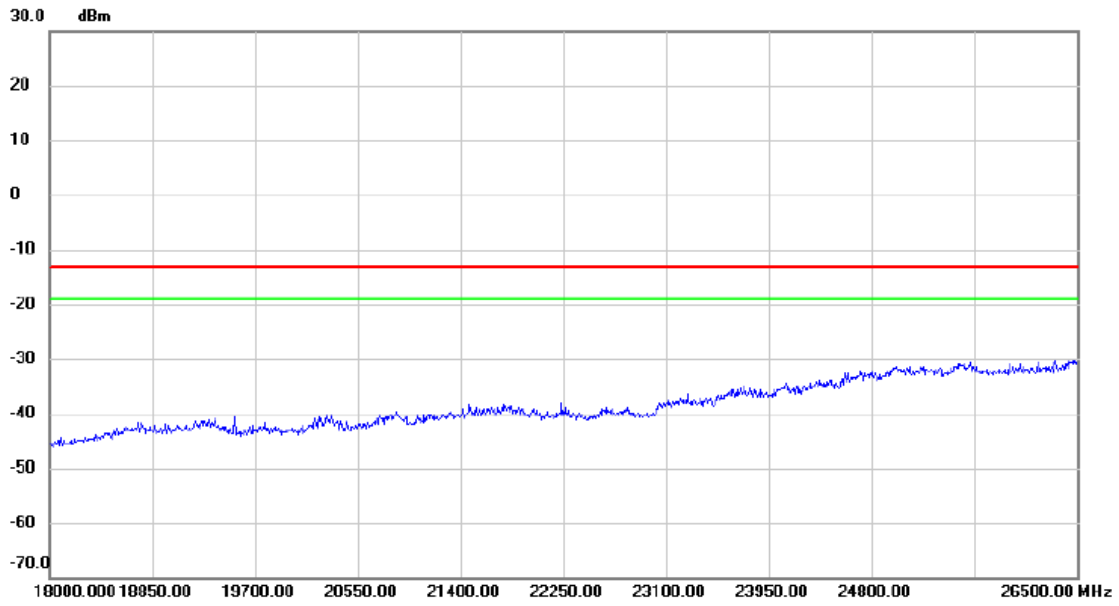

No.	Mk.	Freq.	Reading Level	Correct Factor	Measurement	Limit	Margin	Detector	Comment
		MHz	dBm	dB	dBm	dBm	dB		

Test Mode: PCS1900_TX CH810_EDGE_External Antenna_3dBi

Horizontal

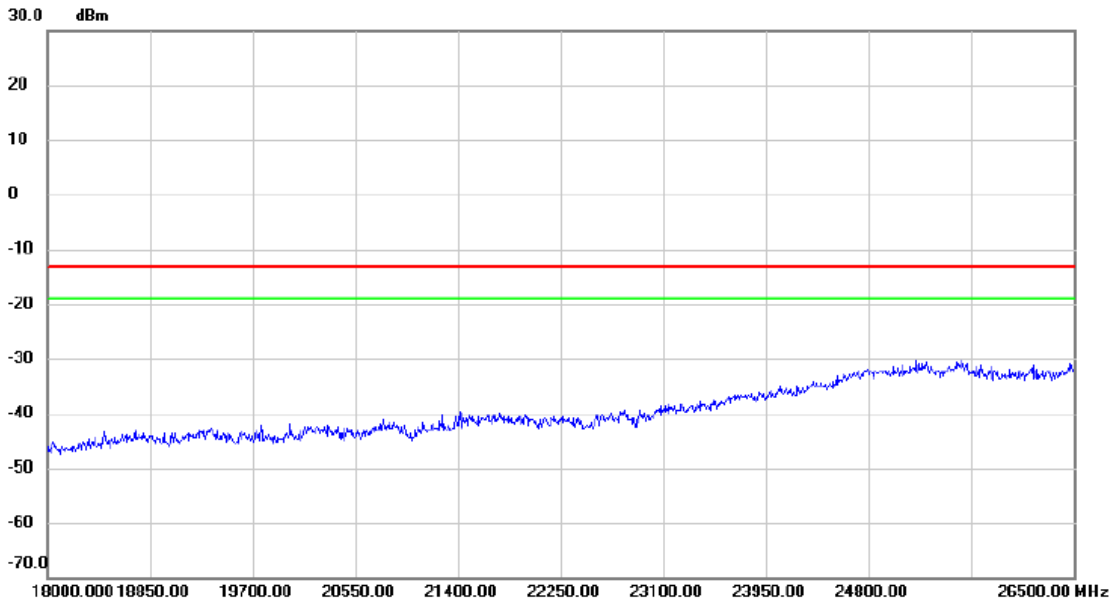

No.	Mk.	Freq.	Reading Level	Correct Factor	Measurement	Limit	Margin	Detector	Comment
		MHz	dBm	dB	dBm	dBm	dB		

APPENDIX G - BAND EDGE

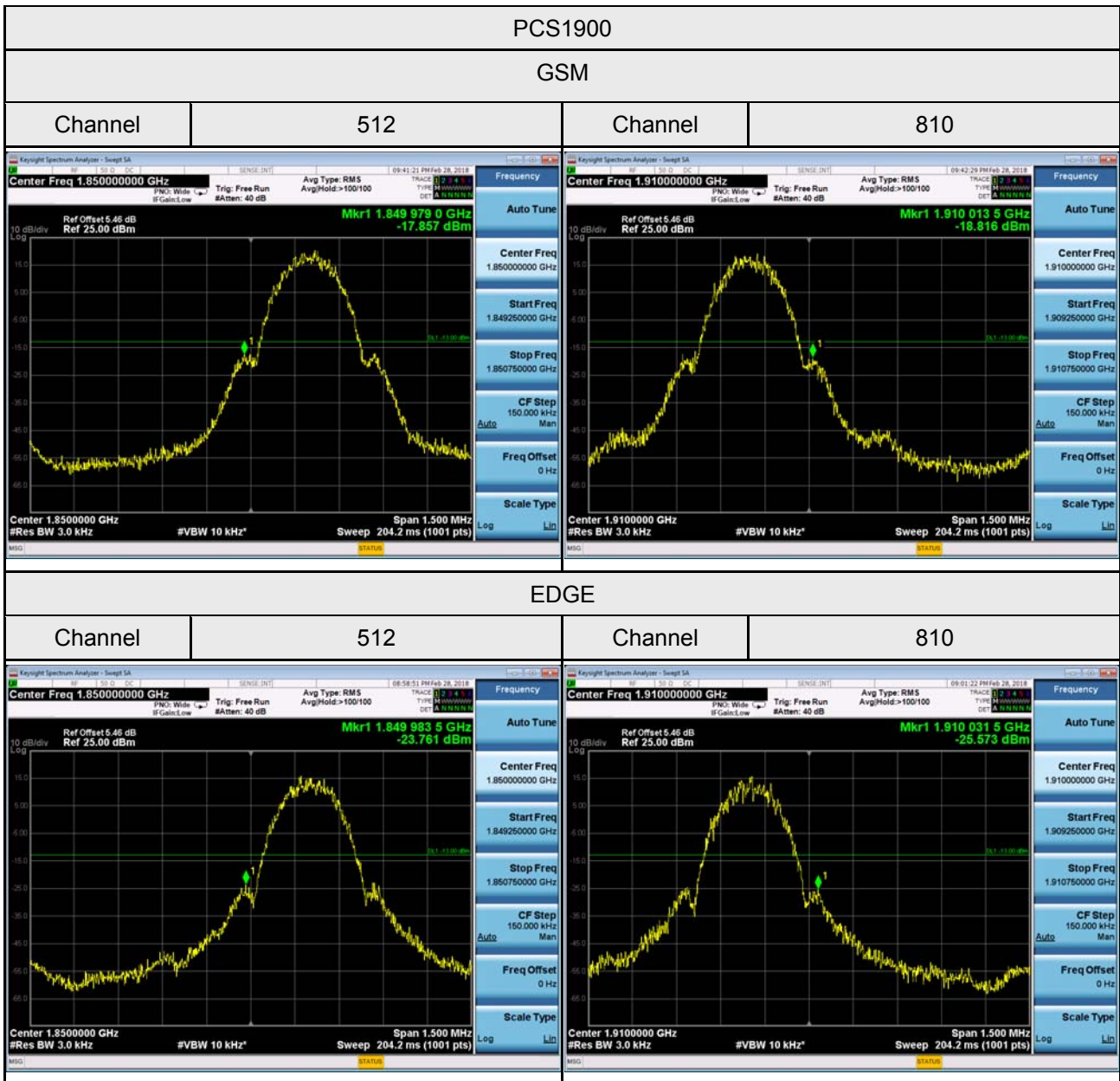

APPENDIX H - PEAK TO AVERAGE RATIO

PCS1900 Spectrum Plot



APPENDIX J - FREQUENCY STABILITY

Test Mode:	PCS1900_CH810
------------	---------------

Temperature vs. Frequency Stability

Temperature(°C)	Frequency Error (Hz)	Frequency Error (ppm)	Limit(ppm)
-30	4.52	0.002442979	2.5
-20	7.46	0.004031997	2.5
-10	6.38	0.003448276	2.5
0	5.41	0.002924008	2.5
10	7.37	0.003983353	2.5
20	5.19	0.002805102	2.5
30	5.88	0.003178035	2.5
40	7.21	0.003896876	2.5
50	3.68	0.001988974	2.5
Max. Deviation (ppm)	7.46	0.004031997	2.5

Voltage vs. Frequency Stability

Voltage(Volts)	Frequency Error (Hz)	Frequency Error (ppm)	Limit(ppm)
10.08V	5.52	0.002983461	2.5
12.00V	4.07	0.002199762	2.5
13.20V	6.03	0.003259107	2.5
Max. Deviation (ppm)	6.03	0.003259107	2.5