



FCC

RF Test Report

Product Name: LTE CPE

Model Number: B310s-518

Report No: SYBH(Z-RF)003122014-2002

FCC ID: QISB310S-518

Reliability Laboratory of Huawei Technologies Co., Ltd.

Administration Building, Headquarters of Huawei Technologies Co., Ltd., Bantian, Longgang District,
Shenzhen, 518129, P.R.C

Tel: +86 755 28780808 Fax: +86 755 89652518



Notice

1. The laboratory has Passed the accreditation by China National Accreditation Service for Conformity Assessment (CNAS). The accreditation number is L0310.
2. The laboratory has Passed the accreditation by The American Association for Laboratory Accreditation (A2LA). The accreditation number is 2174.01.
3. The laboratory has been listed by the US Federal Communications Commission to perform electromagnetic emission measurements. The site recognition number is 97456.
4. The laboratory has been listed by Industry Canada to perform electromagnetic emission measurements. The recognition numbers of test site are 6369A-1 and 6369A-3.
5. The test report is invalid if not marked with the signatures of the persons responsible for preparing and approving the test report.
6. The test report is invalid if there is any evidence of erasure and/or falsification.
7. The test report is only valid for the test samples.
8. Content of the test report, in part or in full, cannot be used for publicity and/or promotional purposes without prior written approval from the laboratory.



Applicant: Huawei Technologies Co., Ltd.
Address: Administration Building, Headquarters of Huawei Technologies Co., Ltd.,
Bantian, Longgang District, Shenzhen, 518129, P.R.C

Date of Receipt Sample: 2014-12-02
Start Date of Test: 2014-12-05
End Date of Test: 2014-12-13

Test Result: Pass

Approved by Senior Engineer:	2014-12-14	Liu Chunlin	
	Date	Name	Signature

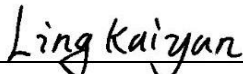
Prepared by:	2014-12-14	Ling Kaiyun	
	Date	Name	Signature



Modification Record

No.	Last Report No.	Modification Description
		First Report



CONTENT

1 General Information6
1.1 Applied Standard.....6
1.2 Test Location6
1.3 Test Environment Condition.....6
2 Test Summary7
3 Description of the Equipment under Test (EUT)8
3.1 General Description8
3.2 EUT Identity8
3.3 Technical Description.....9
4 General Test Conditions / Configurations 10
4.1 Test Modes 10
4.2 EUT Configurations..... 10
4.3 Test Environments 12
4.4 Antenna requirements..... 12
4.5 Description of tests..... 13
4.6 Test Setups..... 15
4.7 Test Conditions 18
5 Main Test Instruments 21



1 General Information

1.1 Applied Standard

Applied Rules: 47 CFR FCC Part 2, Subpart J 2013
47 CFR FCC Part 15, Subpart C 2013

Test Method: FCC KDB 558074 D01 DTS Meas Guidance v03r02
ANSI C63.10-2009, American National Standard for Testing Unlicensed
Wireless Devices.

1.2 Test Location

Test Location 1: Reliability Laboratory of Huawei Technologies Co., Ltd.
Address: Administration Building, Headquarters of Huawei Technologies Co., Ltd.,
Bantian, Longgang District, Shenzhen, 518129, P.R.C

1.3 Test Environment Condition

Ambient Temperature: 19.5to 25 °C
Ambient Relative Humidity: 40 to 55 %
Atmospheric Pressure: Not applicable



2 Test Summary

Test Item	FCC Part No.	Requirements	Test Result	Verdict
DTS (6 dB) Bandwidth	15.247(a)(2)	≥ 500 kHz.	Appendix A	Pass
Occupied Bandwidth	---	---	Appendix B	Pass
Maximum Conducted Average Output Power	15.247(b)(3)	For directional gain: < 30 dBm – (G[dBi] – 6 [dB]), Average; Otherwise: < 30 dBm, Average.	Appendix C	Pass
Maximum Power Spectral Density Level	15.247(e)	For directional gain: < 8 dBm/3 kHz – (G[dBi] – 6 [dB]), Average. Otherwise: < 8 dBm/3 kHz, Average.	Appendix D	Pass
Band Edges Compliance	15.247(d)	< -30 dBm/100 kHz if total peak power \leq power limit.	Appendix E	Pass
Unwanted Emissions into Non-Restricted Frequency Bands			Appendix F	Pass
Unwanted Emissions into Restricted Frequency Bands (Radiated)	15.247(d) 15.209 (NOTE 1)	FCC Part 15.209 field strength limit;	Appendix G	Pass
AC Power Line Conducted Emissions	15.207	FCC Part 15.207 conducted limit;	Appendix H	Pass
NOTE 1: According to KDB 558074, antenna-port conducted measurements are acceptable as an alternative to radiated measurements for demonstrating compliance to the limits in the restricted frequency bands. If conducted measurements are performed, then proper impedance matching must be ensured and an additional radiated test for cabinet/case emissions will also be required.				



3 Description of the Equipment under Test (EUT)

3.1 General Description

B310s-518 LTE/DC-HSDPA/WCDMA/EDGE/GPRS/GSM multi-mode LTE CPE is subscriber equipment in the LTE/UMTS/GSM system and support WLAN 802.11/b/g/n. B310s-518 implement such functions as RF signal receiving/transmitting, LTE/HSPA/WCDMA and EDGE/GPRS/GSM protocol processing, data service etc. It provides USIM card interface, RJ45/RJ11 Ethernet interface and two external antenna interfaces.

3.2 EUT Identity

NOTE: Unless otherwise noted in the report, the functional boards installed in the units shall be selected from the below list, but not means all the functional boards listed below shall be installed in one unit.

3.2.1 Board

Board		
Software Version	Hardware Version	Description
V100R001	WL1B310I	Main Board

3.2.2 Sub-Assembly

Name	Manufacture	Description
Adapter	Huawei Technologies Co., Ltd.	Adapter Model: HW-120100U6W voltage nominal: ~120V Input Voltage :100-240V ~50/60Hz, Output Voltage:  12V 1A Rated Power: 12W



3.3 Technical Description

Characteristics	Description			
IEEE 802.11 WLAN Mode Supported	<input checked="" type="checkbox"/> 802.11b (20 MHz channel bandwidth), <input checked="" type="checkbox"/> 802.11g (20 MHz channel bandwidth) <input checked="" type="checkbox"/> 802.11n (20 MHz channel bandwidth), <input checked="" type="checkbox"/> 802.11n (40 MHz channel bandwidth)			
TX/RX Operating Range	2412-2462 MHz band	fc = 2407 MHz + N * 5 MHz, where: - fc = "Operating Frequency" in MHz, - N = "Channel Number" with the range from 1 to 11 for the 20 MHz channel bandwidth		
Data Rate	802.11b	1 Mbps, 2 Mbps, 5.5 Mbps, 11 Mbps		
	802.11g	6 Mbps, 9 Mbps, 12 Mbps, 18 Mbps, 24 Mbps, 36 Mbps, 48 Mbps, 54 Mbps		
	802.11n (SISO)	MCS 0 to MCS 7		
	802.11n (MIMO)	MCS 8 to MCS 15		
Modulation Type	DBPSK/DQPSK/CCK (DSSS), BPSK/QPSK/16QAM/64QAM (OFDM).			
Emission Designator	10M2G1D (for 802.11b mode), 16M4G7D (for 802.11g mod), 17M5G7D (for 802.11n20 mode) 36M3G7D (for 802.11n40 mode)			
TX Power Control	<input type="checkbox"/> Supported, <input checked="" type="checkbox"/> Not Supported			
Standby Mode	<input type="checkbox"/> Supported, <input checked="" type="checkbox"/> Not Supported			
Equipment Type	<input type="checkbox"/> Stand-alone equipment, <input type="checkbox"/> Plug-in radio device, <input checked="" type="checkbox"/> Combined equipment			
Antenna	Description	Isotropic Antenna		
	Type	<input type="checkbox"/> External, <input checked="" type="checkbox"/> Integrated		
	Ports	<input checked="" type="checkbox"/> Ant 1, <input checked="" type="checkbox"/> Ant 2, <input type="checkbox"/> Ant 3		
	Smart System	<input checked="" type="checkbox"/> SISO (for 802.11b/g/n), <input checked="" type="checkbox"/> MIMO (for 802.11n): 2 Tx & 2 Rx, <input type="checkbox"/> Diversity (for 802.11b/g) : Tx Rx		
	Gain	1 dBi (per antenna port, max.)		
	Remark	When the EUT is put into service, the practical maximum antenna gain should NOT exceed the value as described above.		
Power Supply	Type	<input checked="" type="checkbox"/> AC/DC Adapter	<input type="checkbox"/> PoE:	<input type="checkbox"/> Other:



4 General Test Conditions / Configurations

4.1 Test Modes

NOTE: Worst cases for each IEEE 802.11 mode are selected to perform tests.

Test Mode	Test Modes Description
11B	IEEE 802.11b with data rate of 1 Mbps using SISO mode.
11G	IEEE 802.11g with data rate of 6 Mbps using SISO mode.
11N20	IEEE 802.11n with data rate of MCS0 and bandwidth of 20 MHz using SISO mode.
11N20m	IEEE 802.11n with data rate of MCS8 and bandwidth of 20 MHz using MIMO mode.
11N40	IEEE 802.11n with data rate of MCS0 and bandwidth of 40 MHz using SISO mode.
11N40m	IEEE 802.11n with data rate of MCS8 and bandwidth of 40 MHz using MIMO mode.

4.2 EUT Configurations

4.2.1 General Configurations

Configuration	Description
Test Antenna Ports	Until otherwise specified, <ul style="list-style-type: none"> - All TX tests are performed at all TX antenna ports of the EUT, and - All RX tests are performed at all RX antenna ports of the EUT.
Multiple RF Sources	Other than the tested RF source of the EUT, other RF source(s) are disabled or shutdown during measurements.

4.2.2 Customized Configurations

Test Mode	TX Freq. [MHz]	Duty cycle [%]	G [dBi]
11B	Ant 1: CH1,CH6,CH11 Ant 2: CH1,CH6,CH11	95	1
11G	Ant 1: CH1,CH6,CH11 Ant 2: CH1,CH6,CH11	95	1
11N_20M_SISO	Ant 1: CH1,CH6,CH11 Ant 2: CH1,CH6,CH11	94	1
11N_20M_MIMO	Ant 1: CH1,CH6,CH11 Ant 2: CH1,CH6,CH11	95	1
11N_40M_SISO	Ant 1: CH3,CH6,CH9 Ant 2: CH3,CH6,CH9	90	1
11N_40M_MIMO	Ant 1: CH3,CH6,CH9 Ant 2: CH3,CH6,CH9	91	1



Test Mode	RF Ch.	TX Freq. [MHz]	Antenna Port	RX Freq. [MHz]	Ch. BW [MHz]	Power Conf., per Port
11B	L	Ch No. 1 / 2412 MHz	Ant1	---	20	16
			Ant2	---	20	16
	M	Ch No. 6 / 2437 MHz	Ant1	---	20	16
			Ant2	---	20	16
	H	Ch No. 11 / 2462 MHz	Ant1	---	20	16
			Ant2	---	20	16
11G	L	Ch No. 1 / 2412 MHz	Ant1	---	20	12.5
			Ant2	---	20	12.5
	M	Ch No. 6 / 2437 MHz	Ant1	---	20	12.5
			Ant2	---	20	12.5
	H	Ch No. 11 / 2462 MHz	Ant1	---	20	12.5
			Ant2	---	20	12.5
11N20	L	Ch No. 1 / 2412 MHz	Ant1	---	20	12.5
			Ant2	---	20	12.5
	M	Ch No. 6 / 2437 MHz	Ant1	---	20	12.5
			Ant2	---	20	12.5
	H	Ch No. 11 / 2462 MHz	Ant1	---	20	12.5
			Ant2	---	20	12.5
11N20m	L	Ch No. 1 / 2412 MHz	Ant1	---	20	12.5
			Ant2	---	20	12.5
	M	Ch No. 6 / 2437 MHz	Ant1	---	20	12.5
			Ant2	---	20	12.5
	H	Ch No. 11 / 2462 MHz	Ant1	---	20	12.5
			Ant2	---	20	12.5
11N40	L	Ch No. 3 / 2422 MHz	Ant1	---	40	12.5
			Ant2	---	40	12.5
	M	Ch No. 6 / 2437 MHz	Ant1	---	40	12.5
			Ant2	---	40	12.5
	H	Ch No. 9 / 2452 MHz	Ant1	---	40	12.5
			Ant2	---	40	12.5
11N40m	L	Ch No. 3 / 2422 MHz	Ant1	---	40	12.5
			Ant2	---	40	12.5
	M	Ch No. 6 / 2437 MHz	Ant1	---	40	12.5
			Ant2	---	40	12.5
	H	Ch No. 9 / 2452 MHz	Ant1	---	40	12.5
			Ant2	---	40	12.5



4.3 Test Environments

NOTE: The values used in the test report may be stringent than the declared.

Environment Parameter	Selected Values During Tests		
	Temperature	Voltage	Relative Humidity
NTNV	Ambient	12.0 VDC	Ambient

4.4 Antenna requirements

Excerpt from §15.203 of the FCC Rules/Regulations:

“An intentional radiator antenna shall be designed to ensure that no antenna other than that furnished by the responsible party can be used with the device. The use of a permanently attached antenna or of an antenna that uses a unique coupling to the intentional radiator shall be considered sufficient to comply with the provisions of this section.”

The antennas of the Huawei Mobile Phone are **permanently attached**.
There are no provisions for connection to an external antenna.

Conclusion:

The **EUT FCC ID: QISB310S-518** unit complies with the requirement of §15.203.

Ch. Frequency (MHz)

Ch.	Frequency (MHz)
01	2412
.	.
.	.
06	2437
.	.
.	.
11	2462

Frequency/ Channel Operations

4.5 Description of tests

4.5.1 Bandwidth measurement

- (a) Connect EUT test port to spectrum analyzer.
- (b) Set the EUT to transmit maximum output power at 2.4GHz, then set the measured frequency number and test the bandwidth with spectrum analyzer.

4.5.2 Duty Cycle measurement

- (a) Connect EUT test port to spectrum analyzer.
- (b) Set the EUT to transmit maximum output power at 2.4GHz, then set the measured frequency number and test the Duty Cycle with spectrum analyzer.

4.5.3 Maximum Conducted Average Output Power

- (a) Connect EUT test port to spectrum analyzer.
- (b) Set the EUT to transmit maximum output power at 2.4GHz.
- (c) Then set the EUT to transmit at high, middle and low frequency and measure the conducted output power separately.

4.5.4 Band edge spurious emission

- (a) Connect EUT test port to spectrum analyzer
- (b) Set the EUT to transmit maximum output power at 2.4GHz.
- (c) Then set the EUT to transmit at high, low frequency and measure the conducted band edge spurious separately.

4.5.5 Conducted RF spurious

- (a) Connect EUT test port to spectrum analyzer
- (b) Set the EUT to transmit maximum output power at 2.4GHz.
- (c) Then set the EUT to transmit at high, middle and low frequency and measure the conducted spurious separately.

4.5.6 Power spectral density

- (a) Connect EUT test port to spectrum analyzer
- (b) Set the EUT to transmit maximum output power at 2.4GHz.
- (c) Then set the EUT to transmit at high, middle and low frequency and measure the conducted power spectral density.

4.5.7 Radiated spurious emission & spurious in restricted band

The test site semi-anechoic chamber has met the requirement of NSA tolerance 4dB according to the standards: ANSI C63.10 (2009). The EUT was set-up on insulator 80cm above the Ground Plane. The set-up and test methods were according to ANSI C63.10:2009. The Radiated Disturbance measurements were made using a Rohde and Schwarz Test Receiver and control software.

A preliminary scan and a final scan of the emissions were made by using test script of software; the emissions were measured using a Quasi-Peak Detector below 1GHz, Peak Detector and AV Detector

above 1GHz. The maximal emission value was acquired by adjusting the antenna height, polarisation and turntable azimuth in accordance with the software setup. Normally, the height range of antenna was 1m to 4m, and the azimuth range of turntable was 0° to 360°. The receive antenna has two polarizations V and H.

A portable or small unlicensed wireless device shall be placed on a non-metallic test fixture or other nonmetallic support during testing. The supporting fixture shall permit orientation of the EUT in each of three orthogonal (x, y, z) axis positions such that emissions from the EUT are maximized.

The EUT communicates with the BTS simulator through Air interface. The EUT operated on the typical channel.

Measurement bandwidth: 30 MHz – 1000 MHz: 120 kHz

Measurement bandwidth: 1000 MHz – 10th Carrier Frequency: 1 MHz

4.5.8 Conducted Emission at Power Port

The Table-top EUT was placed upon a non-metallic table 0.8 m above the horizontal metal reference ground plane. EUT was connected to LISN and LISN was connected to reference Ground Plane. EUT was 80cm from LISN. The set-up and test methods were according to ANSI C63.10: 2009.

Conducted Disturbance at AC Port measurements were undertaken on the L and N Lines. The emissions were measured using a Quasi-Peak Detector and Average Detector.

The EUT communicates with the BTS simulator through Air interface, the BTS simulator controls the Wireless Modem to transmit the maximum power which defined in specification of product. The Wireless Modem operated on the typical channel.

Measurement bandwidth (RBW) for 150kHz to 30 MHz: 9 kHz;

4.6 Test Setups

4.6.1 Test Setup 1

The WLAN component's antenna port(s) of the EUT are connected to the measurement instrument per an appropriate attenuator. The EUT is controlled by PC/software to emit the specified signals for the purpose of measurements.

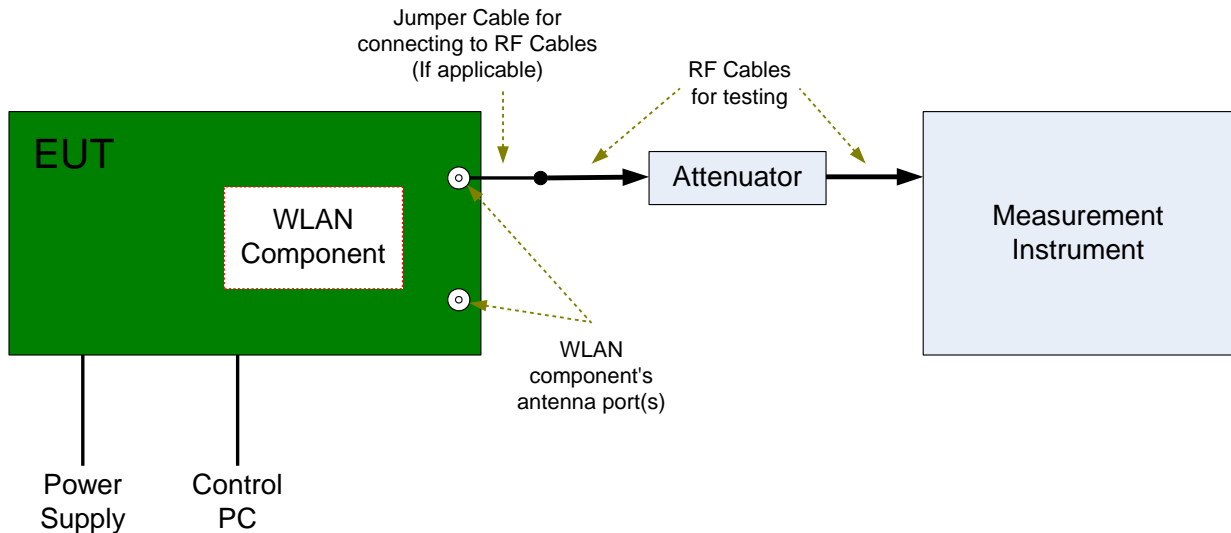

4.6.2 Test Setup 2

The test site semi-anechoic chamber has met the requirement of NSA tolerance 4 dB according to the standards: ANSI C63.4. The test distance is 3m. The setup is according to ANSI C63.4 and CAN/CSA-CEI/IEC CISPR 22.

The maximal emission value is acquired by adjusting the antenna height, polarisation and turntable azimuth. Normally, the height range of antenna is 1 m to 4 m, the azimuth range of turntable is 0° to 360°, and the receive antenna has two polarizations Vertical (V) and Horizontal (H).

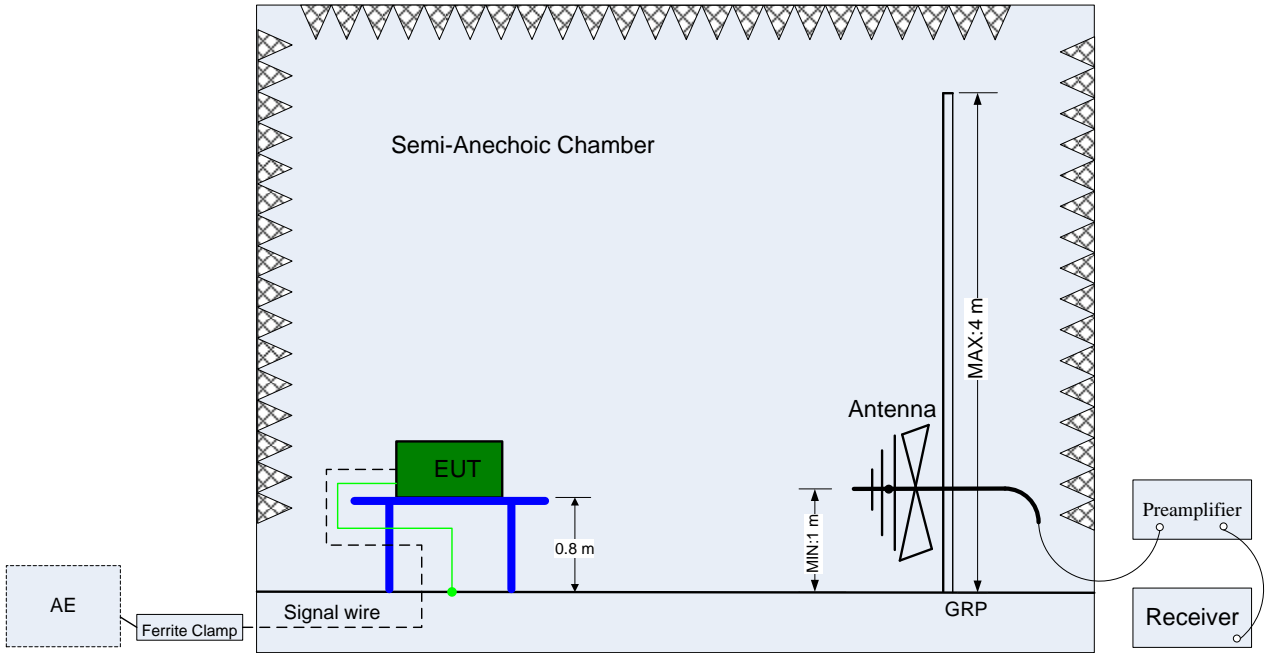

(Below 1 GHz)

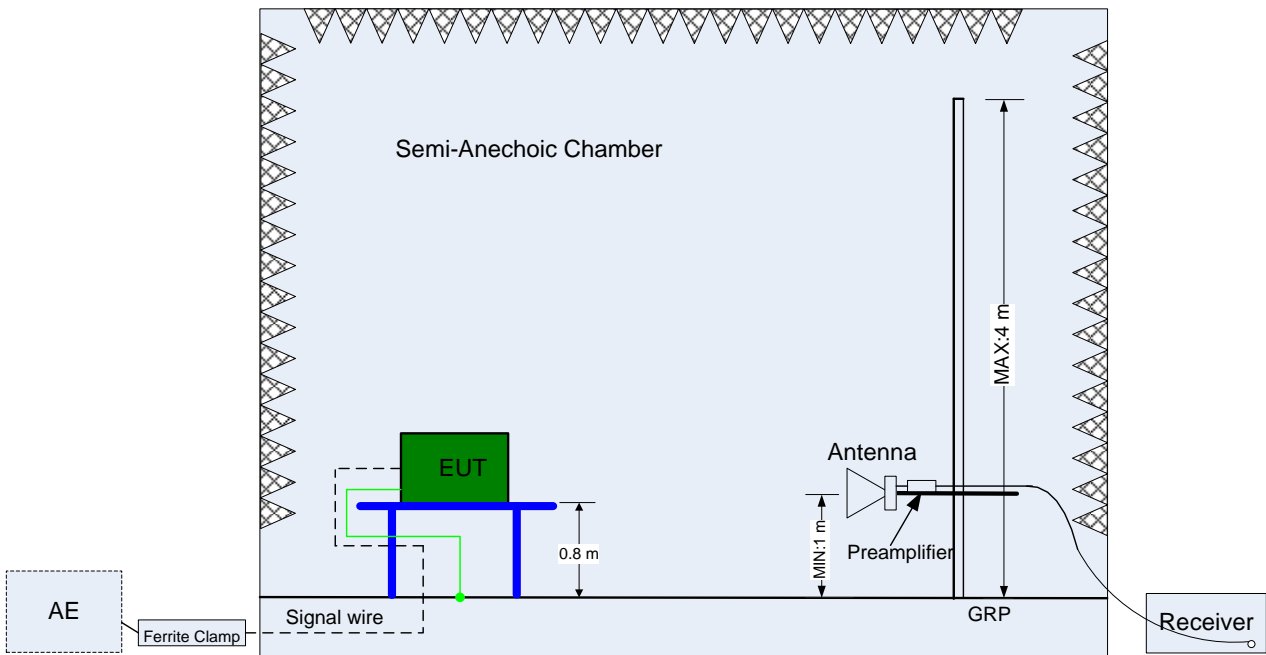

(Above 1 GHz)

4.6.3 Test Setup 3

The mains cable of the EUT (maybe per AC/DC Adapter) must be connected to LISN. The LISN shall be placed 0.8 m from the boundary of EUT and bonded to a ground reference plane for LISN mounted on top of the ground reference plane. This distance is between the closest points of the LISN and the EUT. All other units of the EUT and associated equipment shall be at least 0.8 m from the LISN.

Ground connections, where required for safety purposes, shall be connected to the reference ground point of the LISN and, where not otherwise provided or specified by the manufacturer, shall be of same length as the mains cable and run parallel to the mains connection at a separation distance of not more than 0.1 m.

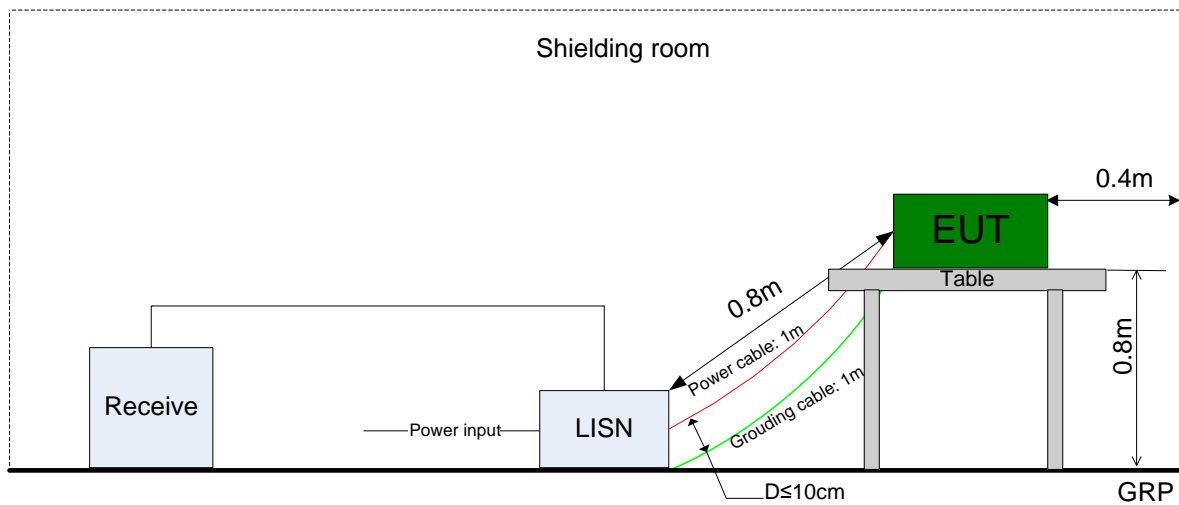

4.7 Test Conditions

Test Case	Test Conditions	
	Configuration	Description
DTS (6 dB) Bandwidth	Measurement Method	FCC KDB 558074 §8.2 Option 2.
	Test Environment	NTNV
	Test Setup	Test Setup 1
	EUT Configuration	11B_L@Ant1, 11B_L@Ant2, 11B_M@Ant1, 11B_M@Ant2, 11B_H@Ant1, 11B_H@Ant2, 11G_L@Ant1, 11G_L@Ant2, 11G_M@Ant1, 11G_M@Ant2, 11G_H@Ant1, 11G_H@Ant2, 11N20_L@Ant1, 11N20_L@Ant2, 11N20_M@Ant1, 11N20_M@Ant2, 11N20_H@Ant1, 11N20_H@Ant2, 11N20m_L@Ant1, 11N20m_L@Ant2, 11N20m_M@Ant1, 11N20m_M@Ant2, 11N20m_H@Ant1, 11N20m_H@Ant2, 11N40_L@Ant1, 11N40_L@Ant2, 11N40_M@Ant1, 11N40_M@Ant2, 11N40_H@Ant1, 11N40_H@Ant2, 11N40m_L@Ant1, 11N40m_L@Ant2, 11N40m_M@Ant1, 11N40m_M@Ant2, 11N40m_H@Ant1, 11N40m_H@Ant2
Maximum Conducted Average Output Power	Measurement Method	FCC KDB 558074 §9.2 .2. 4
	Test Environment	NTNV
	Test Setup	Test Setup 1
	EUT Configuration	11B_L@Ant1, 11B_L@Ant2, 11B_M@Ant1, 11B_M@Ant2, 11B_H@Ant1, 11B_H@Ant2, 11G_L@Ant1, 11G_L@Ant2, 11G_M@Ant1, 11G_M@Ant2, 11G_H@Ant1, 11G_H@Ant2, 11N20_L@Ant1, 11N20_L@Ant2, 11N20_M@Ant1, 11N20_M@Ant2, 11N20_H@Ant1, 11N20_H@Ant2, 11N20m_L@Ant1, 11N20m_L@Ant2, 11N20m_M@Ant1, 11N20m_M@Ant2, 11N20m_H@Ant1, 11N20m_H@Ant2, 11N40_L@Ant1, 11N40_L@Ant2, 11N40_M@Ant1, 11N40_M@Ant2, 11N40_H@Ant1, 11N40_H@Ant2, 11N40m_L@Ant1, 11N40m_L@Ant2, 11N40m_M@Ant1, 11N40m_M@Ant2, 11N40m_H@Ant1, 11N40m_H@Ant2
Maximum Power Spectral Density Level	Measurement Method	FCC KDB 558074 §10.5
	Test Environment	NTNV
	Test Setup	Test Setup 1
	EUT Configuration	11B_L@Ant1, 11B_L@Ant2, 11B_M@Ant1, 11B_M@Ant2, 11B_H@Ant1, 11B_H@Ant2, 11G_L@Ant1, 11G_L@Ant2, 11G_M@Ant1, 11G_M@Ant2, 11G_H@Ant1, 11G_H@Ant2, 11N20_L@Ant1, 11N20_L@Ant2, 11N20_M@Ant1, 11N20_M@Ant2, 11N20_H@Ant1, 11N20_H@Ant2,

Test Case	Test Conditions	
	Configuration	Description
		11N20m_L@Ant1, 11N20m_L@Ant2, 11N20m_M@Ant1, 11N20m_M@Ant2, 11N20m_H@Ant1, 11N20m_H@Ant2, 11N40_L@Ant1, 11N40_L@Ant2, 11N40_M@Ant1, 11N40_M@Ant2, 11N40_H@Ant1, 11N40_H@Ant2, 11N40m_L@Ant1, 11N40m_L@Ant2, 11N40m_M@Ant1, 11N40m_M@Ant2, 11N40m_H@Ant1, 11N40m_H@Ant2
Band Edges Compliance	Measurement Method	FCC KDB 558074 §13.0.
	Test Environment	NTNV
	Test Setup	Test Setup 1
	EUT Configuration	11B_L@Ant1, 11B_L@Ant2, 11B_H@Ant1, 11B_H@Ant2, 11G_L@Ant1, 11G_L@Ant2, 11G_H@Ant1, 11G_H@Ant2, 11N20_L@Ant1, 11N20_L@Ant2, 11N20_H@Ant1, 11N20_H@Ant2, 11N20m_L@Ant1, 11N20m_L@Ant2, 11N20m_H@Ant1, 11N20m_H@Ant2, 11N40_L@Ant1, 11N40_L@Ant2, 11N40_H@Ant1, 11N40_H@Ant2, 11N40m_L@Ant1, 11N40m_L@Ant2, 11N40m_H@Ant1, 11N40m_H@Ant2
Unwanted Emissions into Non-Restricted Frequency Bands	Measurement Method	FCC KDB 558074 §11.0
	Test Environment	NTNV
	Test Setup	Test Setup 1
	EUT Configuration	11B_L@Ant1, 11B_L@Ant2, 11B_M@Ant1, 11B_M@Ant2, 11B_H@Ant1, 11B_H@Ant2, 11G_L@Ant1, 11G_L@Ant2, 11G_M@Ant1, 11G_M@Ant2, 11G_H@Ant1, 11G_H@Ant2, 11N20_L@Ant1, 11N20_L@Ant2, 11N20_M@Ant1, 11N20_M@Ant2, 11N20_H@Ant1, 11N20_H@Ant2, 11N20m_L@Ant1, 11N20m_L@Ant2, 11N20m_M@Ant1, 11N20m_M@Ant2, 11N20m_H@Ant1, 11N20m_H@Ant2, 11N40_L@Ant1, 11N40_L@Ant2, 11N40_M@Ant1, 11N40_M@Ant2, 11N40_H@Ant1, 11N40_H@Ant2, 11N40m_L@Ant1, 11N40m_L@Ant2, 11N40m_M@Ant1, 11N40m_M@Ant2, 11N40m_H@Ant1, 11N40m_H@Ant2
Unwanted Emissions into Restricted Frequency Bands (Radiated)	Measurement Method	ANSI C63.10; FCC KDB 558074 §12.1, Radiated
	Test Environment	NTNV
	Test Setup	Test Setup 2
	EUT Placement	<input type="checkbox"/> Flatwise, <input type="checkbox"/> Upright, <input type="checkbox"/> Hung
	EUT Configuration	((1) 30 MHz to 1 GHz: 11B_L@Ant1 (Worst Conf.). (2) 1 GHz to 3 GHz: 11B_L@Ant1, 11B_L@Ant2, 11B_H@Ant1, 11B_H@Ant2, 11G_L@Ant1, 11G_L@Ant2, 11G_H@Ant1, 11G_H@Ant2,



Test Case	Test Conditions	
	Configuration	Description
		11N20_L@Ant1, 11N20_L@Ant2, 11N20_H@Ant1, 11N20_H@Ant2, 11N20m_L@Ant1, 11N20m_L@Ant2, 11N20m_H@Ant1, 11N20m_H@Ant2, 11N40_L@Ant1, 11N40_L@Ant2, 11N40_H@Ant1, 11N40_H@Ant2, 11N40m_L@Ant1, 11N40m_L@Ant2, 11N40m_H@Ant1, 11N40m_H@Ant2, (3) 3 GHz to 18 GHz: 11B_L@Ant1 (Worse Conf.), 11B_H@Ant1 (Worse Conf.). (4) 18 GHz to 26.5 GHz: 11B_L@Ant1 (Worse Conf.), 11B_H@Ant1 (Worse Conf.).
AC Power Line Conducted Emissions	Measurement Method	AC mains conducted.
	Test Environment	NTNV
	Test Setup	Test Setup 3
	EUT Configuration	11B_L@Ant1 (Worst Conf.).

**5 Main Test Instruments**

Equipment Name	Manufacturer	Model	Serial Number	Cal Date	Cal- Due
Power supply	KEITHLEY	2303	A120714713	2014-08-07	2016-08-06
Wireless Communication Test set	Agilent	N4010A	MY49081592	2014-11-04	2015-11-03
Universal Radio Communication Tester	R&S	CMU200	117341	2014-02-25	2015-02-24
Spectrum Analyzer	Agilent	N9020A	MY52090652	2014-07-11	2015-07-10
Universal Radio Communication Tester	R & S	CMW500	126855	2013-08-08	2015-08-09
Spectrum Analyzer	Agilent	E4440A	MY48250119	2014-07-11	2015-07-10
Signal Analyzer	R&S	FSQ31	200021	2014-11-04	2015-11-03
Spectrum Analyzer	Agilent	N9030A	MY49431698	2014-11-04	2015-11-03
Temperature Chamber	WEISS	WKL64	56246002940010	2014-02-25	2015-02-24
Temperature Chamber	ESPEC	MW3030	06114003	2014-05-09	2015-05-08
Signal generator	Agilent	E8257D	MY51500314	2014-05-09	2015-05-08
Vector Signal Generator	R&S	SMU200A	104162	2014-11-04	2015-11-03
Test receiver	R&S	ESU26	100150	2014-05-09	2015-05-08
Spectrum analyzer	R&S	FSU3	200474	2014-11-04	2015-11-03
Spectrum analyzer	R&S	FSU43	100144	2014-11-04	2015-11-03
Double-Ridged Waveguide Horn Antenna (1G~18GHz)	R&S	HF907	100304	2013-02-02	2015-02-01
Trilog Broadband Antenna (30M~3GHz)	SCHWARZBECK	VULB 9163	9163-490	2013-02-02	2015-02-01
LOOP Antennas(9kHz-30MHz)	R&S	HFH2-Z2	100262	2013-03-23	2015-03-22
Pyramidal Horn Antenna(18GHz-26-5GHz)	ETS-LINDGREN	3160-09	5140299	2013-03-05	2015-03-04
Artificial Mains Network	R&S	ENV4200	100134	2014-11-04	2015-11-03
Artificial Mains Network	R&S	ENV216	100382	2014-11-04	2015-11-03

END