



RF TEST REPORT

Applicant Huawei Technologies Co., Ltd
FCC ID QISATU-L21
Product Smart Phone
Model ATU-L21
Report No. R1802H0029-R5
Issue Date March 16, 2018

TA Technology (Shanghai) Co., Ltd. tested the above equipment in accordance with the requirements in **FCC CFR47 Part 15C (2018)**. The test results show that the equipment tested is capable of demonstrating compliance with the requirements as documented in this report.

Performed by: Xianqing Li

Approved by: Kai Xu

TA Technology (Shanghai) Co., Ltd.

No.145, Jintang Rd, Tangzhen Industry Park, Pudong Shanghai, China

TEL: +86-021-50791141/2/3

FAX: +86-021-50791141/2/3-8000

Table of Contents

1	Test Laboratory.....	4
1.1	Notes of the Test Report.....	4
1.2	Test facility.....	4
1.3	Testing Location.....	5
2	General Description of Equipment under Test.....	6
3	Applied Standards.....	9
4	Information about the FHSS characteristics.....	10
4.1	Frequency Hopping System Requirement.....	10
4.2	Pseudorandom Frequency Hopping Sequence.....	11
4.3	Equal Hopping Frequency Use.....	12
4.4	System Receiver Input Bandwidth.....	12
4.5	Test Configuration.....	12
5	Test Case Results.....	13
5.1	Peak Power Output –Conducted.....	13
5.2	Occupied Bandwidth (20dB).....	15
5.3	Frequency Separation.....	19
5.4	Time of Occupancy (Dwell Time).....	21
5.5	Band Edge Compliance.....	23
5.6	Spurious Radiated Emissions in the Restricted Band.....	26
5.7	Number of hopping Frequency.....	29
5.8	Spurious RF Conducted Emissions.....	31
5.9	Radiates Emission.....	35
5.10	Conducted Emission.....	51
6	Main Test Instruments.....	53
	ANNEX A: Product Change Description.....	54

Summary of Measurement Results

Number	Summary of measurements of results	Clause in FCC rules	Verdict
1	Peak Power Output -Conducted	15.247(b)(1)	PASS
2	Occupied Bandwidth (20dB)	15.247(a)(1)	PASS
3	Frequency Separation	15.247(a)(1)	PASS
4	Time of Occupancy (Dwell Time)	15.247(a)(1)(iii)	PASS
5	Band Edge Compliance	15.247(d)	PASS
6	Spurious Radiated Emissions in the restricted band	15.247(d), 15.205, 15.209	PASS
7	Number of Hopping Frequency	15.247(a)(1)(iii)	PASS
8	Spurious RF Conducted Emissions	15.247(d)	PASS
9	Radiates Emission	15.247(d), 15.205, 15.209	PASS
10	AC Power Line Conducted Emission	15.207	PASS
11	Frequency Hopping System	15.247 (g), (h)	PASS
Date of Testing: February 24, 2018 ~ March 6, 2018			

1 Test Laboratory

1.1 Notes of the Test Report

This report shall not be reproduced in full or partial, without the written approval of **TA technology (shanghai) co., Ltd.** The results documented in this report apply only to the tested sample, under the conditions and modes of operation as described herein .Measurement Uncertainties were not taken into account and are published for informational purposes only. This report is written to support regulatory compliance of the applicable standards stated above.

1.2 Test facility

CNAS (accreditation number: L2264)

TA Technology (Shanghai) Co., Ltd. has obtained the accreditation of China National Accreditation Service for Conformity Assessment (CNAS).

FCC (Designation number: CN1179, Test Firm Registration Number: 446626)

TA Technology (Shanghai) Co., Ltd. has been listed on the US Federal Communications Commission list of test facilities recognized to perform electromagnetic emissions measurements.

IC (recognition number is 8510A)

TA Technology (Shanghai) Co., Ltd. has been listed by industry Canada to perform electromagnetic emission measurement.

VCCI (recognition number is C-4595, T-2154, R-4113, G-10766)

TA Technology (Shanghai) Co., Ltd. has been listed by industry Japan to perform electromagnetic emission measurement.

A2LA (Certificate Number: 3857.01)

TA Technology (Shanghai) Co., Ltd. has been listed by American Association for Laboratory Accreditation to perform electromagnetic emission measurement.

1.3 Testing Location

Company: TA Technology (Shanghai) Co., Ltd.
Address: No.145, Jintang Rd, Tangzhen Industry Park, Pudong Shanghai, China
City: Shanghai
Post code: 201201
Country: P. R. China
Contact: Xu Kai
Telephone: +86-021-50791141/2/3
Fax: +86-021-50791141/2/3-8000
Website: <http://www.ta-shanghai.com>
E-mail: xukai@ta-shanghai.com

2 General Description of Equipment under Test

Client Information

Applicant	Huawei Technologies Co., Ltd.
Applicant address	Administration Building, Headquarters of Huawei Technologies Co., Ltd., Bantian, Longgang District, Shenzhen, 518129, P.R.China.
Manufacturer	Huawei Technologies Co., Ltd.
Manufacturer address	Administration Building, Headquarters of Huawei Technologies Co., Ltd., Bantian, Longgang District, Shenzhen, 518129, P.R.China.

General information

EUT Description			
Model	ATU-L21		
IMEI	SIM 1: 867267030032749 SIM 2: 867267030032756		
Hardware Version	HL1ATUM		
Software Version	ATU-L21 8.0.1.44(SP1C900)		
Power Supply	Battery/AC adapter		
Antenna Type	Internal Antenna		
Antenna Connector	A permanently attached antenna (meet with the standard FCC Part 15.203 requirement)		
Antenna Gain	-1.5 dBi		
Test Mode(s)	Basic Rate	Enhanced Data Rate(EDR)	
Modulation Type	Frequency Hopping Spread Spectrum (FHSS)		
	GFSK	$\pi/4$ DQPSK	8DPSK
Packet Type (Maximum Payload)	DH5	2DH5	3DH5
Max. Conducted Power	11.95dBm		
Operating Frequency Range(s)	2400 ~ 2483.5 MHz		

EUT Accessory	
Adapter 1- EU	Manufacturer: SHENZHEN HUNTKEY ELECTRIC CO., LTD Model: HW-050100E01
Adapter 2- EU	Manufacturer: HUIZHOU BYD ELECTRONIC CO., LTD. Model: HW-050100E01
Adapter 3- EU	Manufacturer: DONG GUAN PHITEK ELECTRONICS CO., LTD. Model: HW-050100E01
Adapter 4- UK	Manufacturer: SHENZHEN HUNTKEY ELECTRIC CO., LTD Model: HW-050100B01
Adapter 5- UK	Manufacturer: HUIZHOU BYD ELECTRONIC CO., LTD. Model: HW-050100B01
Adapter 6- UK	Manufacturer: DONG GUAN PHITEK ELECTRONICS CO., LTD. Model: HW-050100B01
Adapter 7- US	Manufacturer: SHENZHEN HUNTKEY ELECTRIC CO., LTD Model: HW-050100U01
Adapter 8- US	Manufacturer: HUIZHOU BYD ELECTRONIC CO., LTD. Model: HW-050100U01
Adapter 9- US	Manufacturer: DONG GUAN PHITEK ELECTRONICS CO., LTD. Model: HW-050100U01
Adapter 10- AU	Manufacturer: SHENZHEN HUNTKEY ELECTRIC CO., LTD Model: HW-050100A01
Adapter 11- AU	Manufacturer: HUIZHOU BYD ELECTRONIC CO., LTD. Model: HW-050100A01
Adapter 12- AU	Manufacturer: DONG GUAN PHITEK ELECTRONICS CO., LTD. Model: HW-050100A01
Battery 1	Manufacturer: SCUD(FUJIAN) Electronics Co.,Ltd Model: HB366481ECW-11
Battery 2	Manufacturer: Sunwoda Electronics Co.,Ltd Model: HB366481ECW-11
Battery 3	Manufacturer: Desay battery Co.,LTD Model: HB366481ECW-11
Earphone 1	Manufacturer: BOLUO COUNTY QUANCHENG ELECTRONIC CO.,LTD Model: 1293-3283-3.5MM-300
Earphone 2	Manufacturer: GoerTek Inc Model: HA1-3W
Earphone 3	Manufacturer: Jiangxi Lianchuang Hongsheng Electronic Co.,LTD Model: MEMD1532B528A00
Earphone 4	Manufacturer: BOLUO COUNTY QUANCHENG ELECTRONIC CO.,LTD Model: 1293#+3283# 3.5MM-150
Earphone 5	Manufacturer: GoerTek Inc



	Model: HA1-3
Earphone 6	Manufacturer: Jiangxi Lianchuang Hongsheng Electronic Co.,LTD Model: MEMD1532B528000
Earphone 7	Manufacturer: FOXCONN Model: EPAB542-2WH03-DH
USB Extend Cable	100cm Cable, Shielded
Note: 1.The information of the EUT is declared by the manufacturer. 2. There are more than one Adapters, Batteries, Earphones; each one should be applied throughout the compliance test respectively, however, only the worst case (Adapter 5, Battery 1, Earphone 2) will be recorded in this report.	

ATU-L21 (R1802H0029-R5) is a variant model of ATU-L11 (R1802H0028-R6). Test values duplicated from Original for variant. The detailed product change description please refers to the ANNEX A.

3 Applied Standards

According to the specifications of the manufacturer, it must comply with the requirements of the following standards:

Test standards

- **FCC CFR47 Part 15C (2018) Radio Frequency Devices**
- **ANSI C63.10 (2013)**
- **DA00-705 Filing and Frequency Measurement Guidelines For Frequency Hopping Spread Spectrum System (2000).**

4 Information about the FHSS characteristics

4.1 Frequency Hopping System Requirement

Standard requirement:

(g) Frequency hopping spread spectrum systems are not required to employ all available hopping channels during each transmission. However, the system, consisting of both the transmitter and the receiver, must be designed to comply with all of the regulations in this section should the transmitter be presented with a continuous data (or information) stream. In addition, a system employing short transmission bursts must comply with the definition of a frequency hopping system and must distribute its transmissions over the minimum number of hopping channels specified in this section.

(h) The incorporation of intelligence within a frequency hopping spread spectrum system that permits the system to recognize other users within the spectrum band so that it individually and independently chooses and adapts its hopsets to avoid hopping on occupied channels is permitted. The coordination of frequency hopping systems in any other manner for the express purpose of avoiding the simultaneous occupancy of individual hopping frequencies by multiple transmitters is not permitted.

Compliance for section 15.247(g):

According to Bluetooth Core Specification, the Bluetooth system transmits the packets with the pseudorandom hopping frequency with a continuous data and short burst transmission from the Bluetooth system is also transmitted under the frequency hopping system with the pseudorandom hopping frequency system.

Compliance for section 15.247(h):

According to Bluetooth Core Specification, the Bluetooth system incorporates with an adaptive system to detect other user within the spectrum band so that it individually and independently to avoid hopping on the occupied channels.

According to Bluetooth Core Specification, the Bluetooth system is designed not have the ability to coordinate with other FHSS System in an effort to avoid the simultaneous occupancy of individual hopping frequencies by multiple transmitter.

4.2 Pseudorandom Frequency Hopping Sequence

Frequency Hopping Systems. A spread spectrum system in which the carrier is modulated with the coded information in a conventional manner causing a conventional spreading of the RF energy about the frequency carrier. The frequency of the carrier is not fixed but changes at fixed intervals under the direction of a coded sequence. The wide RF bandwidth needed by such a system is not required by spreading of the RF energy about the carrier but rather to accommodate the range of frequencies to which the carrier frequency can hop. The test of a frequency hopping system is that the near term distribution of hops appears random, the long term distribution appears evenly distributed over the hop set, and sequential hops are randomly distributed in both direction and magnitude of change in the hop set.

The selection scheme chooses a segment of 32 hop frequencies spanning about 64 MHz and visits these hops in a pseudo-random order. Next, a different 32-hop segment is chosen, etc. In the page, master page response, slave page response, page scan, inquiry, inquiry response and inquiry scan hopping sequences, the same 32-hop segment is used all the time (the segment is selected by the address; different devices will have different paging segments).

When the basic channel hopping sequence is selected, the output constitutes a pseudo-random sequence that slides through the 79 hops. The principle is depicted in the figure below.

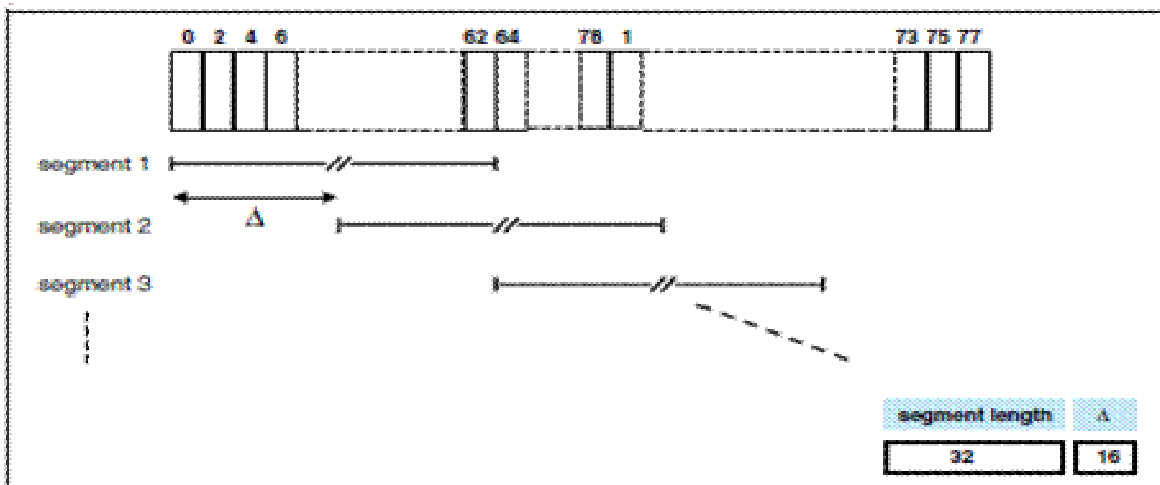

Hop selection scheme in CONNECTION state.

Pseudorandom Frequency Hopping Sequence Table as below:

Channel: 08, 24, 40, 56, 40, 56, 72, 09, 01, 09, 33, 41, 33, 41, 65, 73, 53, 69, 06, 22, 04, 20, 36, 52, 38, 46, 70, 78, 68, 76, 21, 29, 10, 26, 42, 58, 44, 60, 76, 13, 03, 11, 35, 43, 37, 45, 69, 77, 55, 71, 08, 24, 08, 24, 40, 56, 40, 48, 72, 01, 72, 01, 25, 33, 12, 28, 44, 60, 42, 58, 74, 11, 05, 13, 37, 45, etc.

Each frequency used equally on the average by each transmitter.

The system receiver have input bandwidths that match the hopping channel bandwidths of their corresponding transmitters and shift frequencies in synchronization with the transmitted signals.

4.3 Equal Hopping Frequency Use

All Bluetooth units participating in the Pico net are time and hop-synchronized to the channel. Each new transmission event begins on the next channel in the hopping sequence after the final channel used in the previous transmission event.

4.4 System Receiver Input Bandwidth

Each channel bandwidth is 1MHz. The system receivers have input bandwidths that match the hopping channel bandwidths of their corresponding transmitters and shift frequencies in synchronization with the transmitted signals.

4.5 Test Configuration

The EUT has been associated with peripherals and configuration operated in a manner tended to maximize its emission characteristics in a typical application.

The radiated emission was measured in the following position: EUT stand-up position (Z axis), lie-down position (X, Y axis). The worst emission was found in lie-down position (X axis) and the worst case was recorded.

Test Cases	Test Modes
Peak Power Output -Conducted	DH5/2DH5/3DH5
Occupied Bandwidth (20dB)	DH5/2DH5/3DH5
Frequency Separation	DH5/2DH5/3DH5
Time of Occupancy (Dwell Time)	DH5/2DH5/3DH5
Band Edge Compliance	DH5/2DH5/3DH5
Spurious Radiated Emissions in the restricted band	DH5/3DH5
Number of Hopping Frequency	DH5/2DH5/3DH5
Spurious RF Conducted Emissions	DH5/3DH5
Radiates Emission	DH5/3DH5
Conducted Emission	3DH5

5 Test Case Results

5.1 Peak Power Output –Conducted

Ambient condition

Temperature	Relative humidity	Pressure
23°C ~25°C	45%~50%	101.5kPa

Methods of Measurement

During the process of the testing, The EUT was connected to the spectrum analyzer and Bluetooth test set via a power splitter with a known loss. The EUT is controlled by the Bluetooth test set to ensure max power transmission with proper modulation. The peak detector is used. RBW is set to 2 MHz; VBW is set to 6 MHz. These measurements have been tested at following channels: 0, 39, and 78.

Test Setup

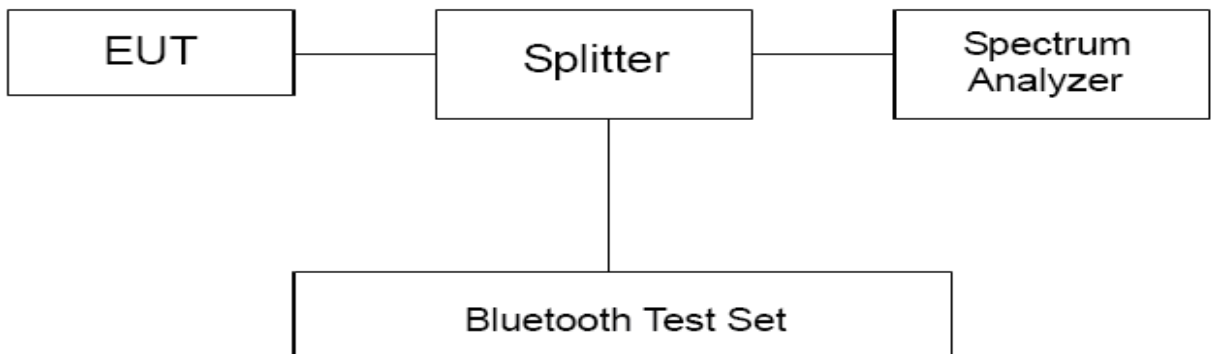

Limits

Rule Part 15.247 (b) (1) specifies that " For frequency hopping systems operating in the 2400–2483.5 MHz band employing at least 75 non-overlapping hopping channels, and all frequency hopping systems in the 5725–5850 MHz band: 1 watt. For all other frequency hopping systems in the 2400–2483.5 MHz band: 0.125 watts."

Peak Output Power	≤ 0.125W (21dBm)
-------------------	------------------

Measurement Uncertainty

The assessed measurement uncertainty to ensure 95% confidence level for the normal distribution is with the coverage factor $k = 2$, $U=0.44$ dB.

**Test Results**

Channel	Frequency (MHz)	Peak Output Power (dBm)			Conclusion
		DH5	2DH5	3DH5	
0	2402	10.34	11.19	11.50	PASS
39	2441	10.74	11.63	11.95	PASS
78	2480	9.88	10.77	11.09	PASS

Note: The measured power density (dBm) has the offset with cable loss already.

5.2 Occupied Bandwidth (20dB)

Ambient condition

Temperature	Relative humidity	Pressure
23°C ~25°C	45%~50%	101.5kPa

Method of Measurement

The EUT was connected to the spectrum analyzer and Bluetooth test set via a power splitter with a known loss. The occupied bandwidth is measured using spectrum analyzer. RBW is set to 20kHz and VBW is set to 62kHz on spectrum analyzer. -20dB occupied bandwidths are recorded.

Test Setup

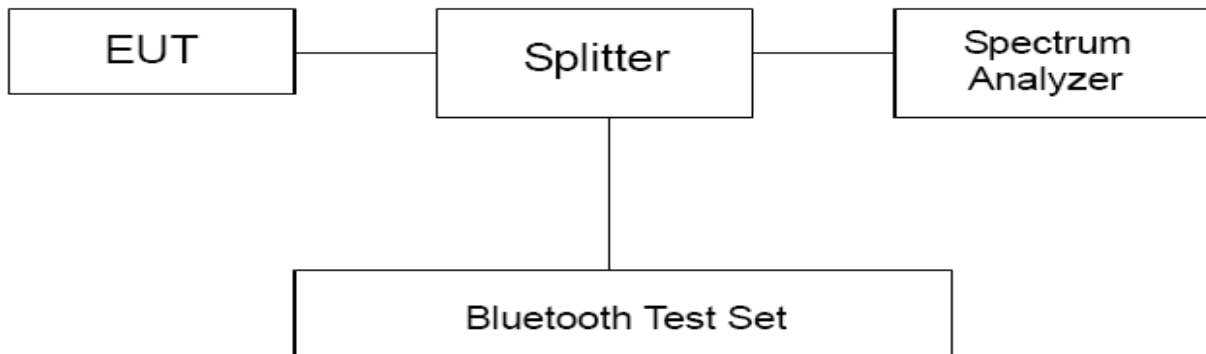

Limits

No specific occupied bandwidth requirements in part 15.247(a) (1).

Measurement Uncertainty

The assessed measurement uncertainty to ensure 95% confidence level for the normal distribution is with the coverage factor $k = 2$, $U=936$ Hz.

Test Results

Mode		Channel	Frequency (MHz)	99% bandwidth(kHz)	20dB Bandwidth(kHz)
BT	DH5	0	2402	901.79	950.4
		39	2441	900.74	949.8
		78	2480	899.88	949.4
	2DH5	0	2402	1174.8	1279
		39	2441	1173.9	1279
		78	2480	1172.8	1279
	3DH5	0	2402	1175.4	1286
		39	2441	1174.8	1285
		78	2480	1174.4	1282

BT DH5 CH0, Carrier frequency (MHz): 2402

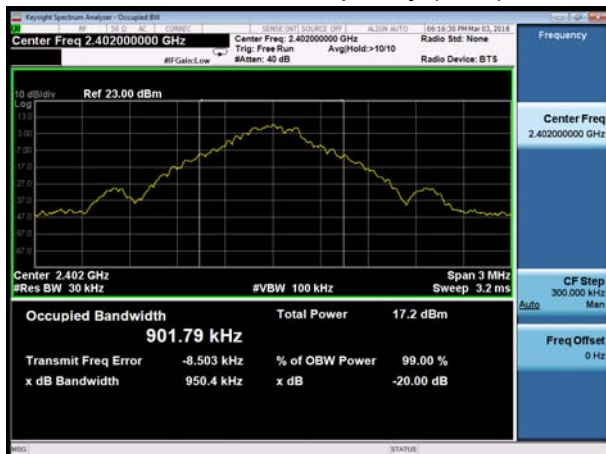

BT 2DH5 CH0, Carrier frequency (MHz): 2402

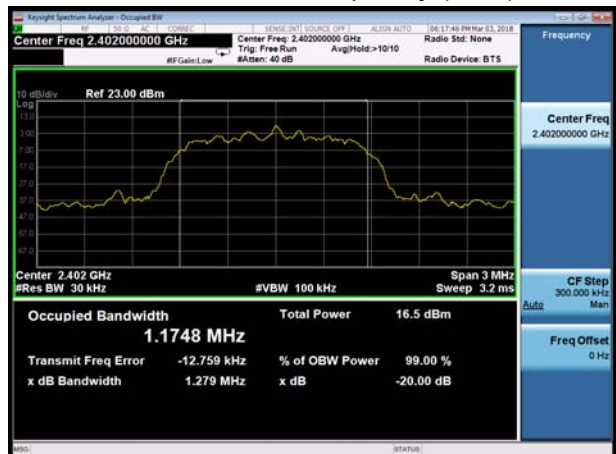

BT DH5 CH39, Carrier frequency (MHz): 2441



BT 2DH5 CH39, Carrier frequency (MHz): 2441

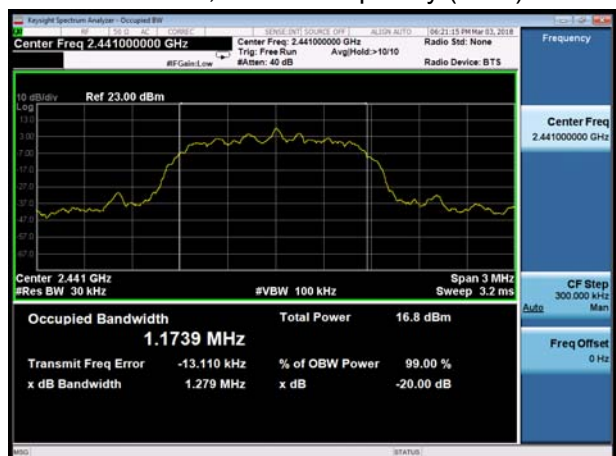

BT DH5 CH78, Carrier frequency (MHz): 2480



BT 2DH5 CH78, Carrier frequency (MHz): 2480

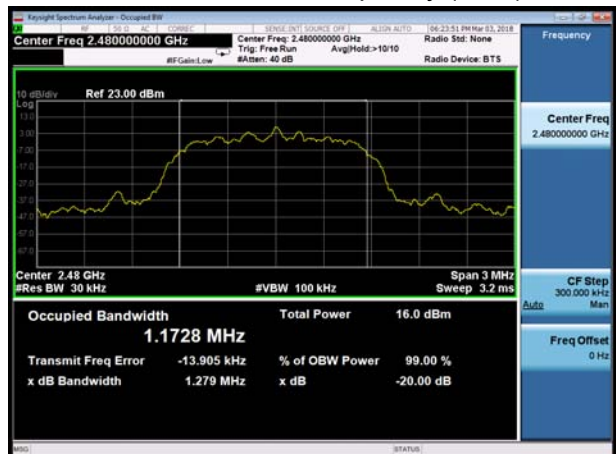



BT 3DH5 CH0, Carrier frequency (MHz): 2402

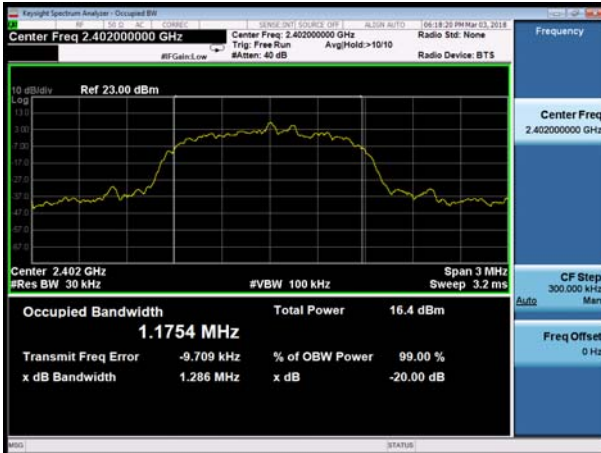

BT 3DH5 CH39, Carrier frequency (MHz): 2441



BT 3DH5 CH78, Carrier frequency (MHz): 2480



5.3 Frequency Separation

Ambient condition

Temperature	Relative humidity	Pressure
23°C ~25°C	45%~50%	101.5kPa

Method of Measurement

The EUT was connected to the spectrum analyzer and Bluetooth test set via a power splitter with a known loss. RBW is set to 30 kHz and VBW is set to 100 kHz on spectrum analyzer. Set EUT on Hopping on mode.

Test setup

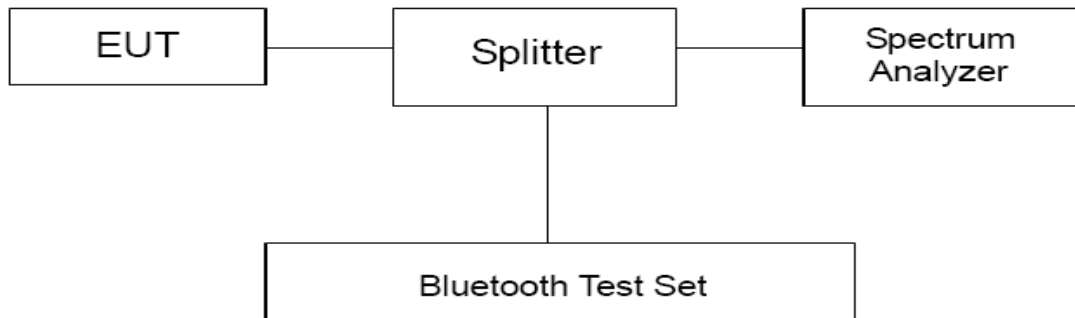

Limits

Rule Part 15.247(a)(1) specifies that “Frequency hopping systems shall have hopping channel carrier frequencies separated by a minimum of 25 kHz or the 20 dB bandwidth of the hopping channel, whichever is greater. Alternatively, frequency hopping systems operating in the 2400–2483.5 MHz band may have hopping channel carrier frequencies that are separated by 25 kHz or two-thirds of the 20 dB bandwidth of the hopping channel, whichever is greater, provided the systems operate with an output power no greater than 125 mW. ”

Note: The value of two-thirds of 20 dB bandwidth is always greater than 25 kHz.

Measurement Uncertainty

The assessed measurement uncertainty to ensure 95% confidence level for the normal distribution is with the coverage factor $k = 2$, $U=936$ Hz.

Test Results:

Packet type	Carrier frequency (MHz)	Carrier frequency separation(kHz)	20dB Bandwidth(kHz)	Limit (kHz)	Conclusion
DH5	2441	999	949.8	633.2	PASS
2DH5	2441	999	1279.0	852.7	PASS
3DH5	2441	999	1285.0	856.7	PASS

Note: The limit is two-thirds of 20 dB bandwidth.

BT DH5 CH39, Carrier frequency (MHz): 2441



BT 2DH5 CH39, Carrier frequency (MHz): 2441



BT 3DH5 CH39, Carrier frequency (MHz): 2441



5.4 Time of Occupancy (Dwell Time)

Ambient condition

Temperature	Relative humidity	Pressure
23°C ~25°C	45%~50%	101.5kPa

Methods of Measurement

The EUT was connected to the spectrum analyzer and Bluetooth test set via a power splitter with a known loss. RBW is set to 1MHz and VBW is set to 1MHz on spectrum analyzer. The dwell time is calculated by:

Dwell time = time slot length * hop rate * 0.4s with:

The selected EUT Packet type uses a slot type of DH5 packet and a hopping rate of 1600(ch*hop/s) for all channels. So the final hopping rate for all channel is 1600/5=320(ch*hop/s)

Test Setup

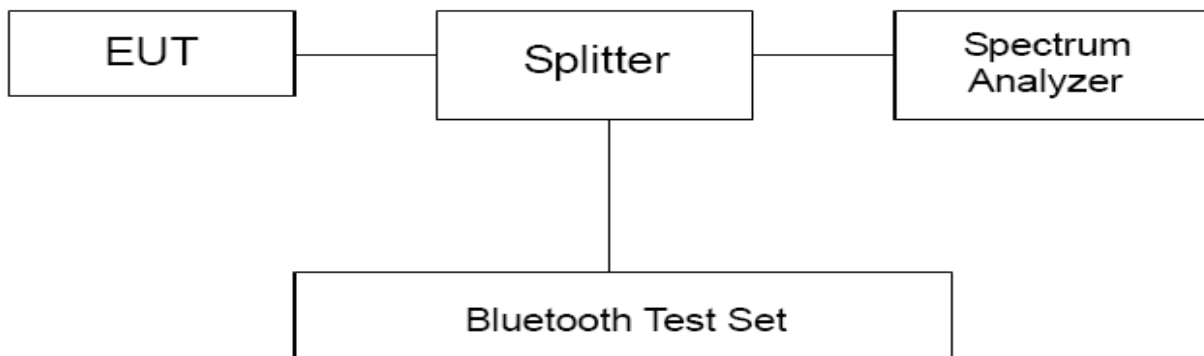

Limits

Rule Part15.247(a) specifies that " Frequency hopping systems in the 2400–2483.5 MHz band shall use at least 15 channels. The average time of occupancy on any channel shall not be greater than 0.4 seconds within a period of 0.4 seconds multiplied by the number of hopping channels employed."

Dwell time	≤ 400ms
------------	---------

Measurement Uncertainty

The assessed measurement uncertainty to ensure 95% confidence level for the normal distribution is with the coverage factor $k = 2$.

Requirements	Uncertainty					
Dwell Time	DH5	$U=0.70ms$	2DH5	$U=0.70ms$	3DH5	$U=0.70ms$

Test Results:

Channel 39					
Packet type	hop rate (1/s)	Time slot length(ms)	Dwell time (ms)	Limit (ms)	Conclusion
DH5	320	2.880	368.64	400	PASS
2DH5	320	2.890	369.92	400	PASS
3DH5	320	2.890	369.92	400	PASS

Note: Dwell time = time slot length * hop rate * 0.4s

BT DH5 CH39, Carrier frequency (MHz): 2441

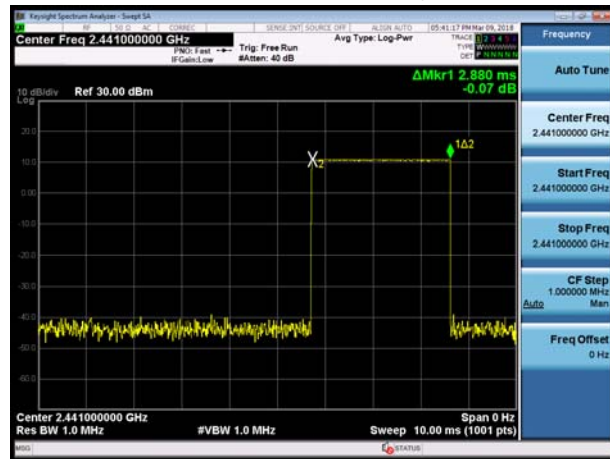

BT 2DH5 CH39, Carrier frequency (MHz): 2441

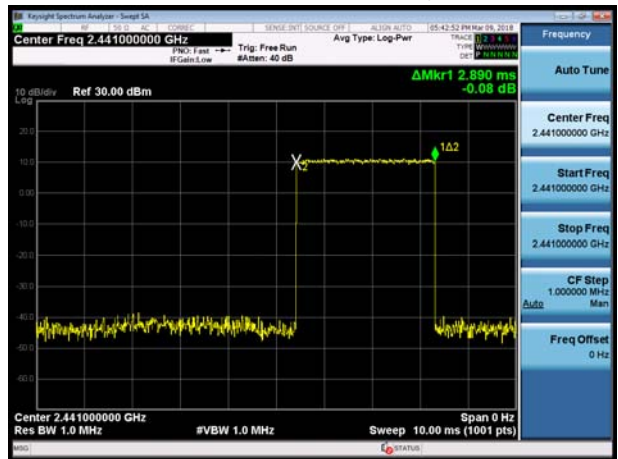

BT 3DH5 CH39, Carrier frequency (MHz): 2441

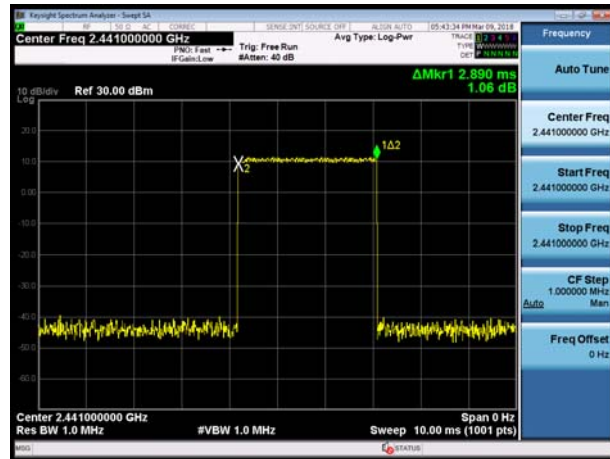

5.5 Band Edge Compliance

Ambient condition

Temperature	Relative humidity	Pressure
23°C ~25°C	45%~50%	101.5kPa

Method of Measurement

The EUT was connected to the spectrum analyzer and Bluetooth test set via a power splitter with a known loss. The lowest and highest channels were measured. The peak detector is used. RBW is set to 100 kHz and VBW is set to 300 kHz on spectrum analyzer. EUT test for Hopping On mode and Hopping Off mode.

Test Setup

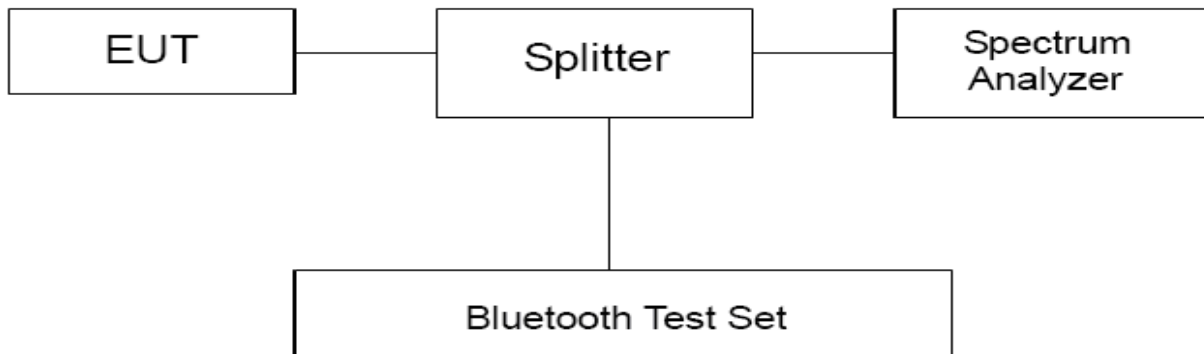

Limits

Rule Part 15.247(d) specifies that “In any 100 kHz bandwidth outside the frequency band in which the spread spectrum or digitally modulated intentional radiator is operating, the radio frequency power that is produced by the intentional radiator shall be at least 20 dB below that in the 100 kHz bandwidth within the band that contains the highest level of the desired power, based on either an RF conducted or a radiated measurement, provided the transmitter demonstrates compliance with the peak conducted power limits.”

Measurement Uncertainty

The assessed measurement uncertainty to ensure 95% confidence level for the normal distribution is with the coverage factor $k = 1.96$.

Frequency	Uncertainty
2GHz-3GHz	1.407 dB

Test Results
Hopping On

BT DH5 CH0, Carrier frequency (MHz): 2402

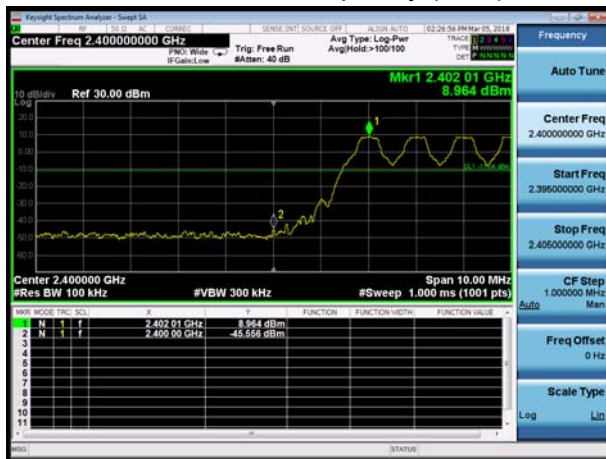

BT DH5 CH78, Carrier frequency (MHz): 2480

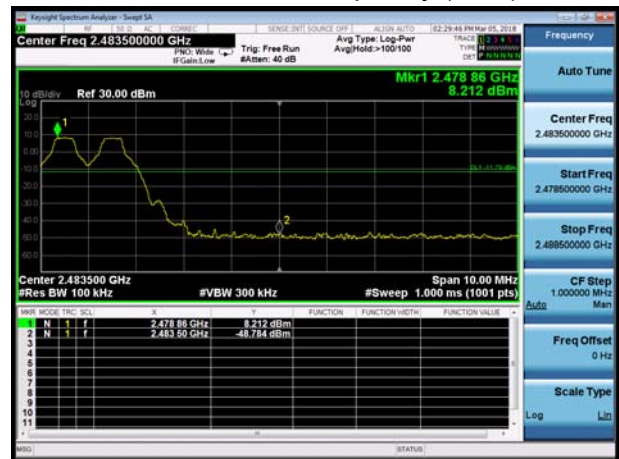

BT 2DH5 CH0, Carrier frequency (MHz): 2402



BT 2DH5 CH78, Carrier frequency (MHz): 2480



BT 3DH5 CH0, Carrier frequency (MHz): 2402

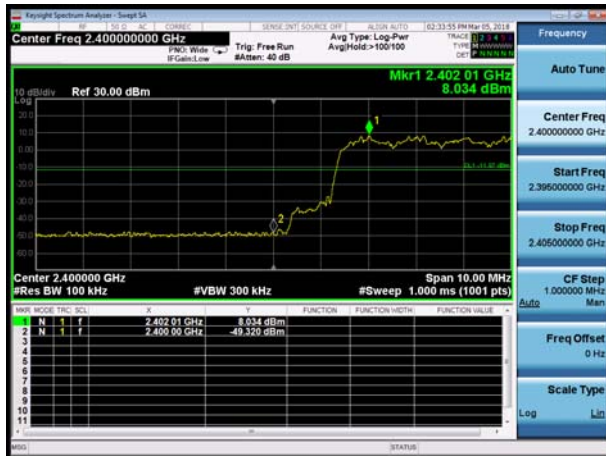

BT 3DH5 CH78, Carrier frequency (MHz): 2480



Hopping Off

BT DH5 CH0, Carrier frequency (MHz): 2402

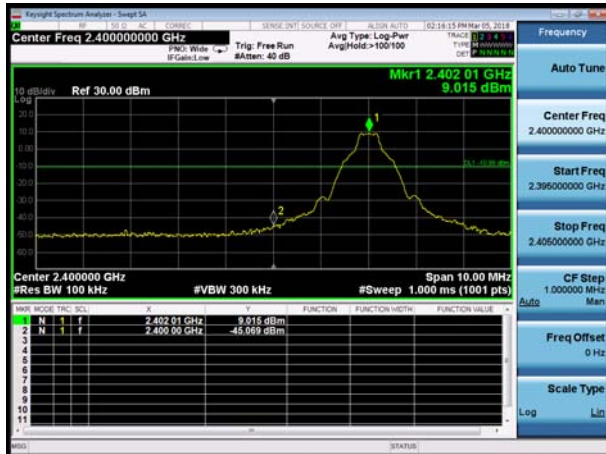

BT DH5 CH78, Carrier frequency (MHz): 2480

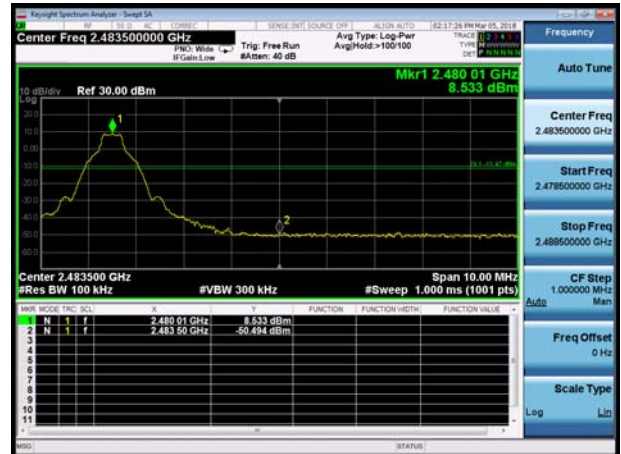

BT 2DH5 CH0, Carrier frequency (MHz): 2402

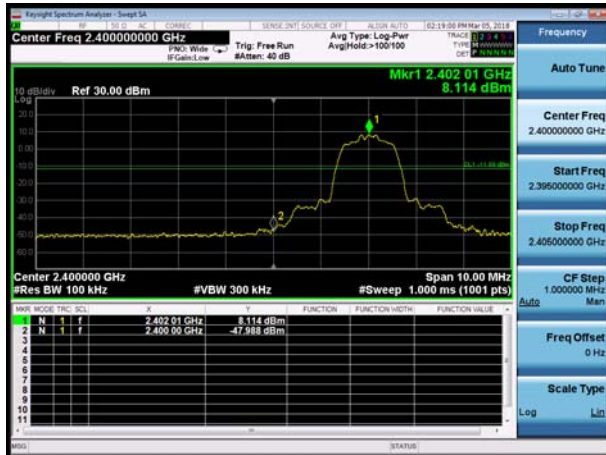

BT 2DH5 CH78, Carrier frequency (MHz): 2480



BT 3DH5 CH0, Carrier frequency (MHz): 2402

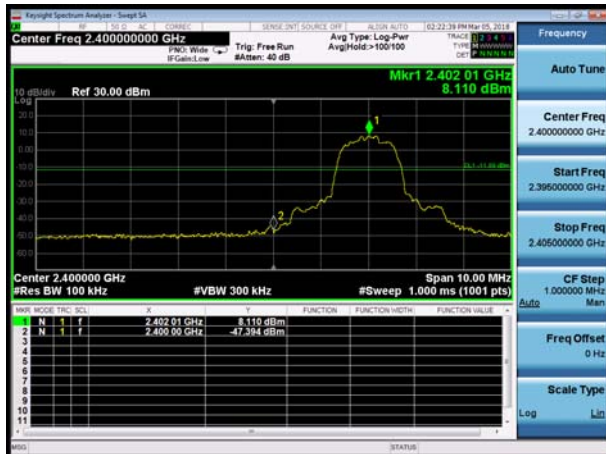

BT 3DH5 CH78, Carrier frequency (MHz): 2480

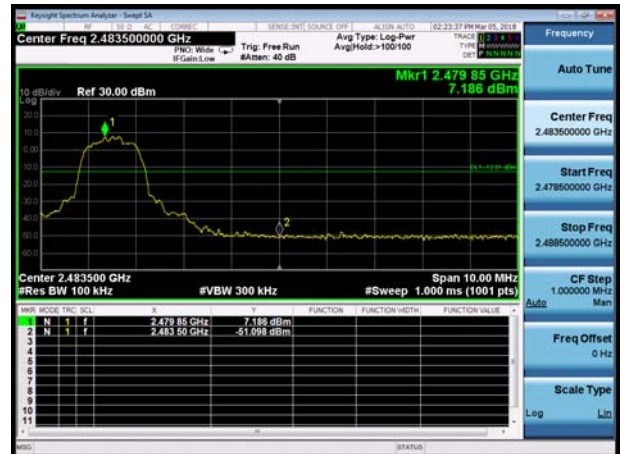

5.6 Spurious Radiated Emissions in the Restricted Band

Ambient condition

Temperature	Relative humidity	Pressure
23°C ~25°C	45%~50%	101.5kPa

The Equipment Under Test (EUT) was set up on a non-conductive table in the semi-anechoic chamber. The test was performed at the distance of 3 m between the EUT and the receiving antenna. The turntable shall be rotated from 0 to 360 degrees for detecting the maximum of radiated spurious signal level. The measurements shall be repeated with orthogonal polarization of the test antenna. The data of cable loss and antenna factor has been calibrated in full testing frequency range before the testing.

Set the spectrum analyzer in the following:

- (a) PEAK: RBW=1MHz; VBW=3MHz / Sweep=AUTO
- (b) The dwell time per channel of the hopping signal is less than 100 ms, then the reading obtained with the 10 Hz VBW may be further adjusted by a “duty cycle correction factor”, derived from $20\log(\text{dwell time}/100 \text{ ms})$, in an effort to demonstrate compliance with the 15.209 limit. If the emission is pulsed, modify the unit for continuous operation; use the settings shown above, then correct the reading by subtracting the peak- average correction factor, derived from the appropriate duty cycle calculation.

This setting method can refer to **DA00-705**.

The test is in transmitting mode. The field strength of spurious emission was measured in the following position: EUT stand-up position (Z axis), lie-down position (X, Y axis) and docking mode. The worst emission was found in stand-up position (Y axis) and the worst case was recorded.

Test setup

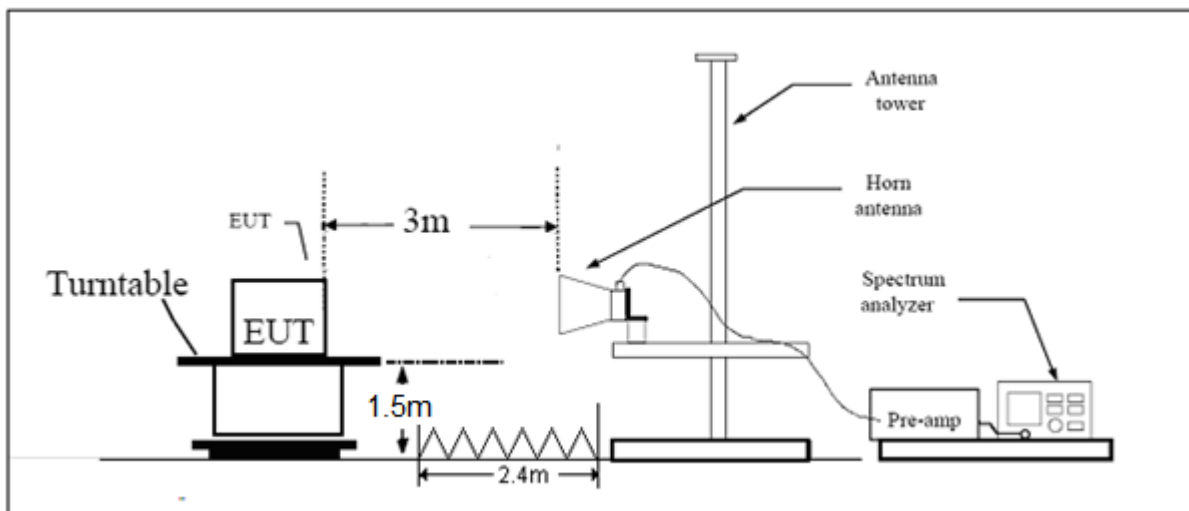

Note: Area side: 2.4mX3.6m

Limits

Spurious Radiated Emissions are permitted in any of the frequency bands listed below:

MHz	MHz	MHz	GHz
0.090 - 0.110	16.42 - 16.423	399.9 - 410	4.5 - 5.15
¹ 0.495 - 0.505	16.69475 - 16.69525	608 - 614	5.35 - 5.46
2.1735 - 2.1905	16.80425 - 16.80475	960 - 1240	7.25 - 7.75
4.125 - 4.128	25.5 - 25.67	1300 - 1427	8.025 - 8.5
4.17725 - 4.17775	37.5 - 38.25	1435 - 1626.5	9.0 - 9.2
4.20725 - 4.20775	73 - 74.6	1645.5 - 1646.5	9.3 - 9.5
6.215 - 6.218	74.8 - 75.2	1660 - 1710	10.6 - 12.7
6.26775 - 6.26825	108 - 121.94	1718.8 - 1722.2	13.25 - 13.4
6.31175 - 6.31225	123 - 138	2200 - 2300	14.47 - 14.5
8.291 - 8.294	149.9 - 150.05	2310 - 2390	15.35 - 16.2
8.362 - 8.366	156.52475 - 156.52525	2483.5 - 2500	17.7 - 21.4
8.37625 - 8.38675	156.7 - 156.9	2690 - 2900	22.01 - 23.12
8.41425 - 8.41475	162.0125 - 167.17	3260 - 3267	23.6 - 24.0
12.29 - 12.293	167.72 - 173.2	3332 - 3339	31.2 - 31.8
12.51975 - 12.52025	240 - 285	3345.8 - 3358	36.43 - 36.5
12.57675 - 12.57725	322 - 335.4	3600 - 4400	(²)
13.36 - 13.41			

Limit in restricted band

Frequency of emission (MHz)	Field strength(uV/m)	Field strength(dBuV/m)
30-88	100	40
88-216	150	43.5
216-960	200	46
Above960	500	54

§15.35(b)

There is also a limit on the radio frequency emissions, as measured using instrumentation with a peak detector function, corresponding to 20 dB above the maximum permitted average limit.

Peak Limit=74dBuV/m

Average Limit=54dBuV/m

Measurement Uncertainty

The assessed measurement uncertainty to ensure 95% confidence level for the normal distribution is with the coverage factor $k = 1.96$, $U = 3.55$ dB.

Test Results:
The signal beyond the limit is carrier.

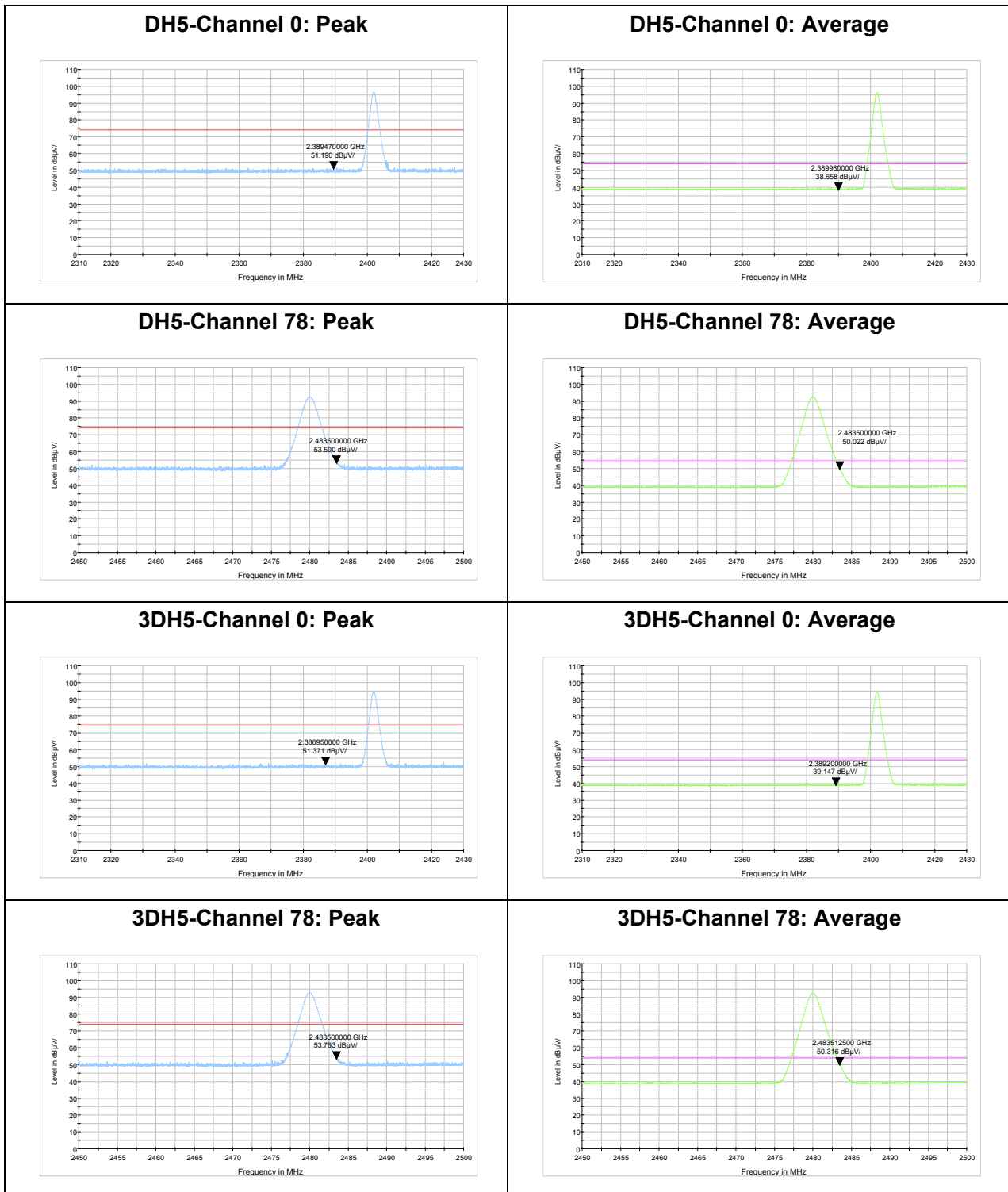

5.7 Number of hopping Frequency

Ambient condition

Temperature	Relative humidity	Pressure
23°C ~25°C	45%~50%	101.5kPa

Method of Measurement

The EUT was connected to the spectrum analyzer and Bluetooth test set via a power splitter with a known loss. RBW is set to 1MHz and VBW is set to 1 MHz on spectrum analyzer. Set EUT on Hopping on mode.

Test setup

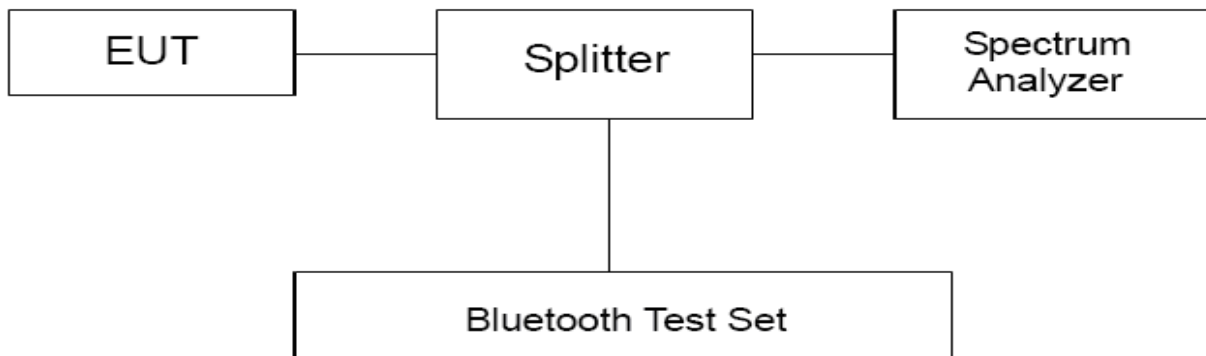

Limits

Rule Part 15.247(a) (1) (iii) specifies that” Frequency hopping systems in the 2400–2483.5 MHz band shall use at least 15 channels.”

Limits	≥ 15 channels
--------	---------------



Test Results:

Mode		Number of hopping channels	conclusion
BT	DH5	79	PASS
	2DH5	79	PASS
	3DH5	79	PASS

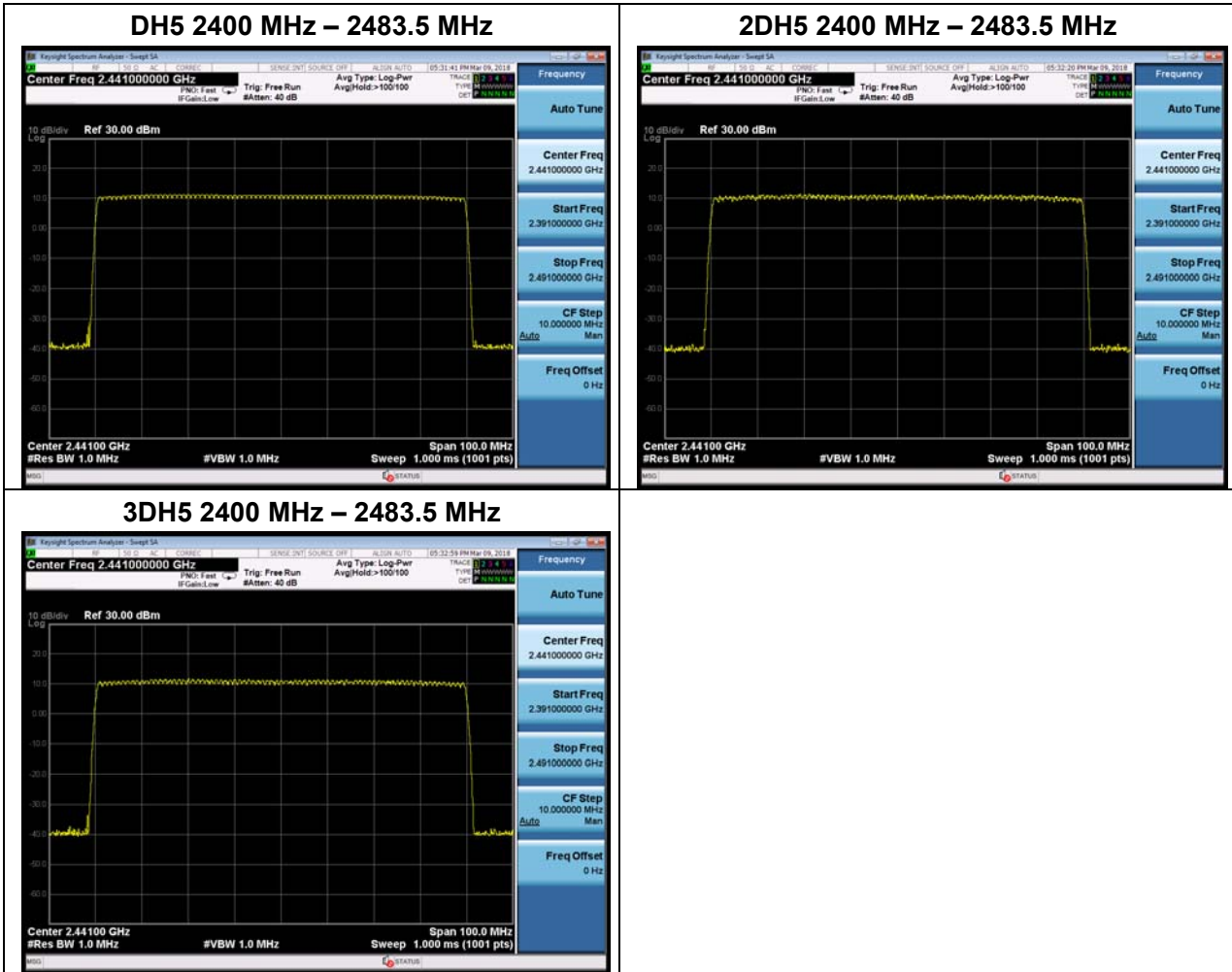

5.8 Spurious RF Conducted Emissions

Ambient condition

Temperature	Relative humidity	Pressure
23°C ~25°C	45%~50%	101.5kPa

Method of Measurement

The EUT was connected to the spectrum analyzer and Bluetooth test set via a power splitter with a known loss. The spectrum analyzer scans from 30MHz to the 10th harmonic of the carrier. The peak detector is used. Set RBW 100kHz and VBW 300 kHz, Sweep is set to ATUO.

The test is in transmitting mode.

Test setup

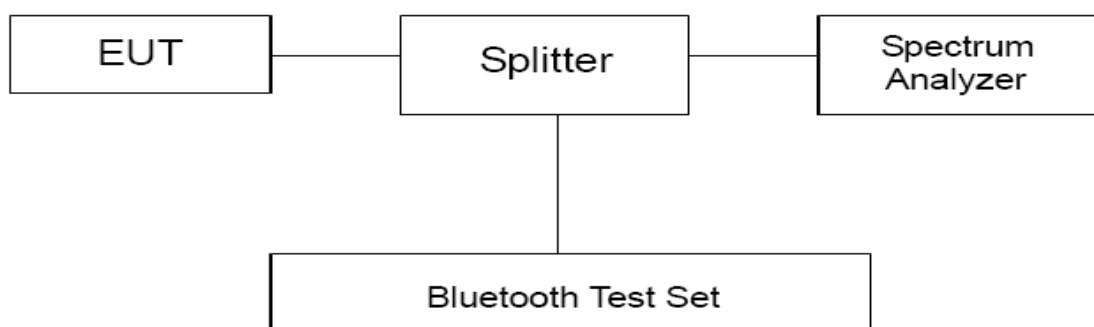

Limits

Rule Part 15.247(d) specifies that “In any 100 kHz bandwidth outside the frequency band in which the spread spectrum intentional radiator is operating, the radio frequency power that is produced by the intentional radiator shall be at least 20 dB below that in the 100 kHz bandwidth within the band that contains the highest level of the desired power.”

Mode	Carrier frequency (MHz)	Reference value (dBm)	Limit
GFSK (DH5)	2402	8.54	-11.46
	2441	9.04	-10.97
	2480	8.17	-11.83
GFSK (2DH5)	2402	7.40	-12.60
	2441	8.16	-11.84
	2480	7.44	-12.56
EDR (3DH5)	2402	7.63	-12.37
	2441	7.60	-12.40
	2480	7.39	-12.61

**Measurement Uncertainty**

The assessed measurement uncertainty to ensure 95% confidence level for the normal distribution is with the coverage factor $k = 1.96$.

Frequency	Uncertainty
100kHz-2GHz	0.684 dB
2GHz-26GHz	1.407 dB

Test Results:

The signal beyond the limit is carrier.

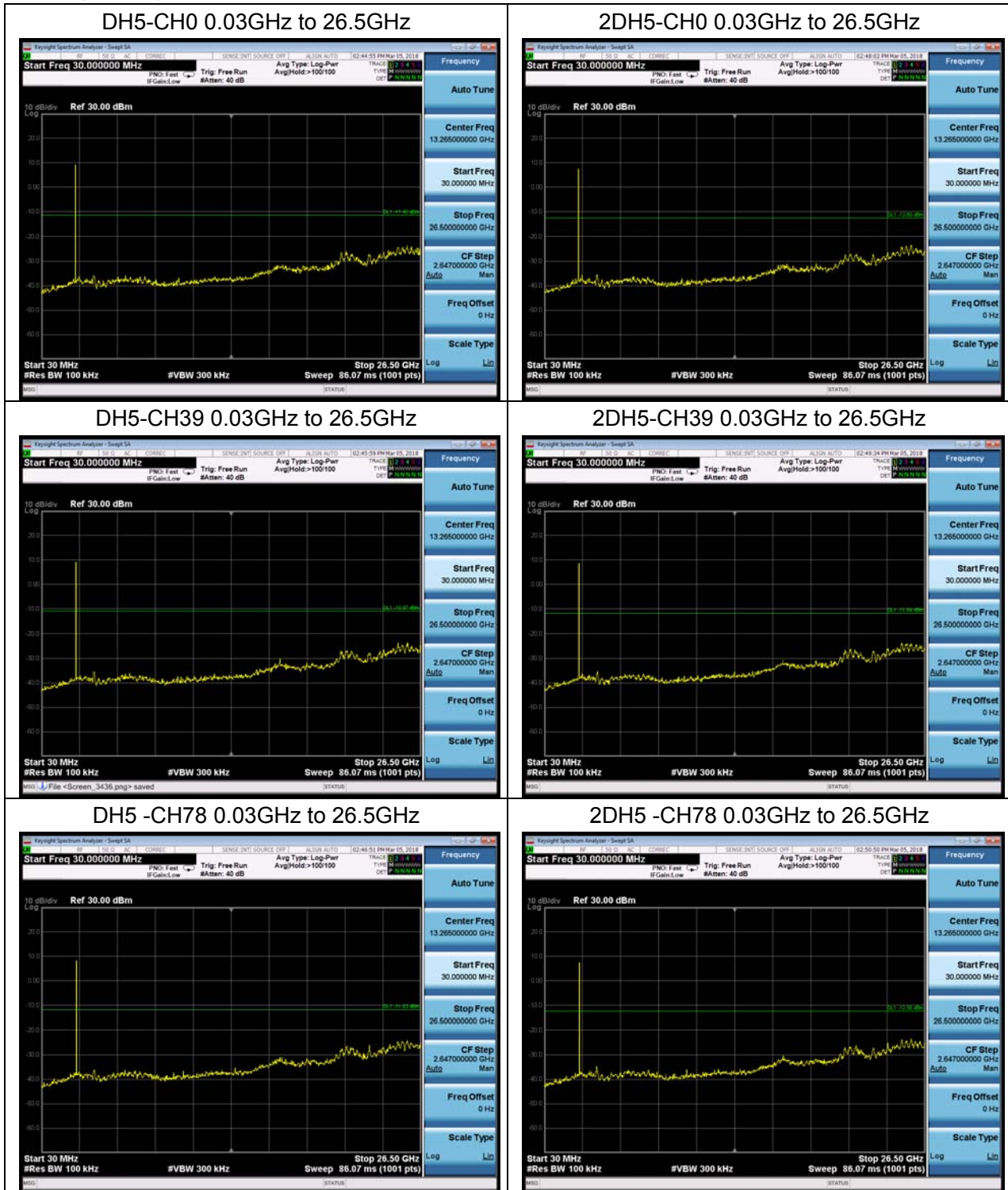

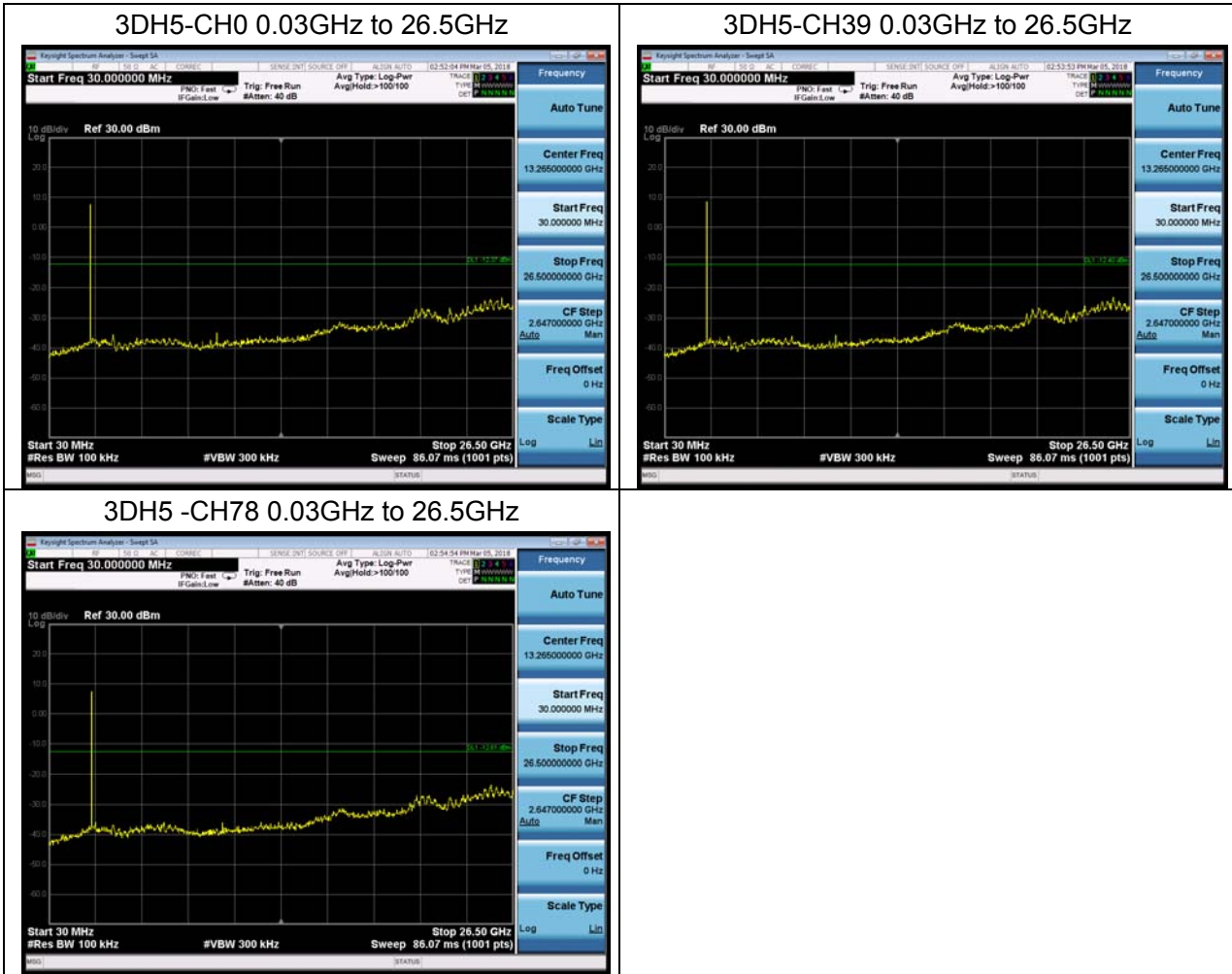

5.9 Radiates Emission

Ambient condition

Temperature	Relative humidity	Pressure
23°C ~25°C	45%~50%	101.5kPa

Method of Measurement

The test set-up was made in accordance to the general provisions of ANSI C63.10-2013. The Equipment Under Test (EUT) was set up on a non-conductive table in the semi-anechoic chamber. The test was performed at the distance of 3 m between the EUT and the receiving antenna. The radiated emissions measurements were made in a typical installation configuration.

Sweep the whole frequency band through the range from 9 kHz to the 10th harmonic of the carrier, and the emissions less than 20 dB below the permissible value are reported.

During the test, below 30MHz, the center of the loop shall be 1 meters; above 30MHz, the height of receive antenna shall be moved from 1 to 4 meters, and the antenna shall be performed under horizontal and vertical polarization. The turntable shall be rotated from 0 to 360 degrees for detecting the maximum of radiated spurious signal level. The measurements shall be repeated with orthogonal polarization of the test antenna. The data of cable loss and antenna factor has been calibrated in full testing frequency range before the testing.

Set the spectrum analyzer in the following:

Below 1GHz (detector: Peak and Quasi-Peak)

RBW=100kHz / VBW=300kHz / Sweep=AUTO

Above 1GHz(detector: Peak):

(a) PEAK: RBW=1MHz VBW=3MHz/ Sweep=AUTO

(b) AVERAGE: RBW=1MHz / VBW=10Hz / Sweep=AUTO

The radiated emission was measured in the following position: EUT stand-up position (Z axis), lie-down position (X, Y axis). The worst emission was found in lie-down position (X axis) and the worst case was recorded. Then this mode was measured in the following mode: EUT with cradle and EUT without cradle. The worst emission was found in EUT with cradle mode and the worst case was recorded.

The test is in transmitting mode.

Test setup
9KHz ~ 30MHz

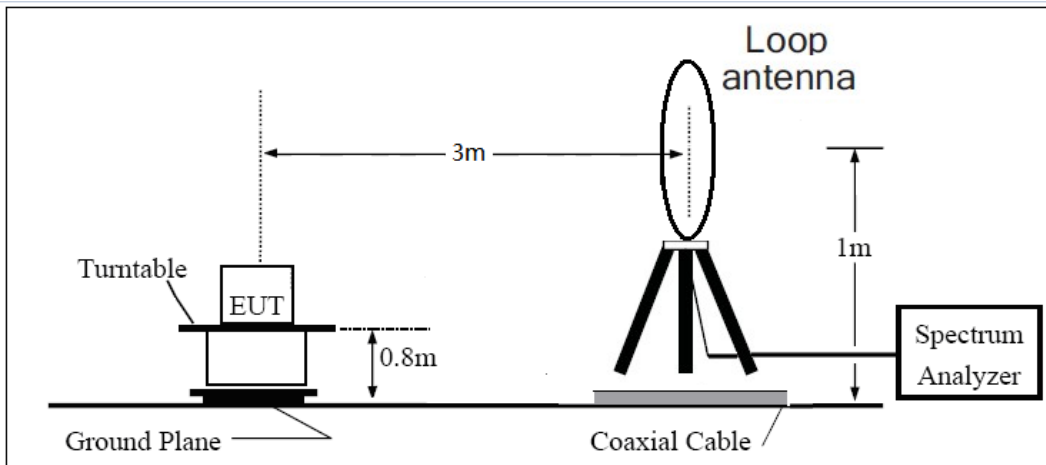

30MHz ~ 1GHz

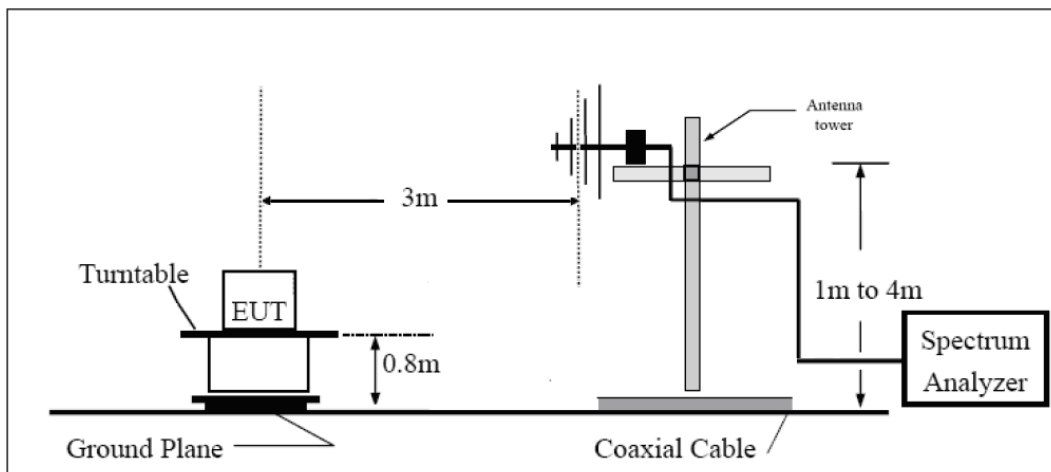

Above 1GHz

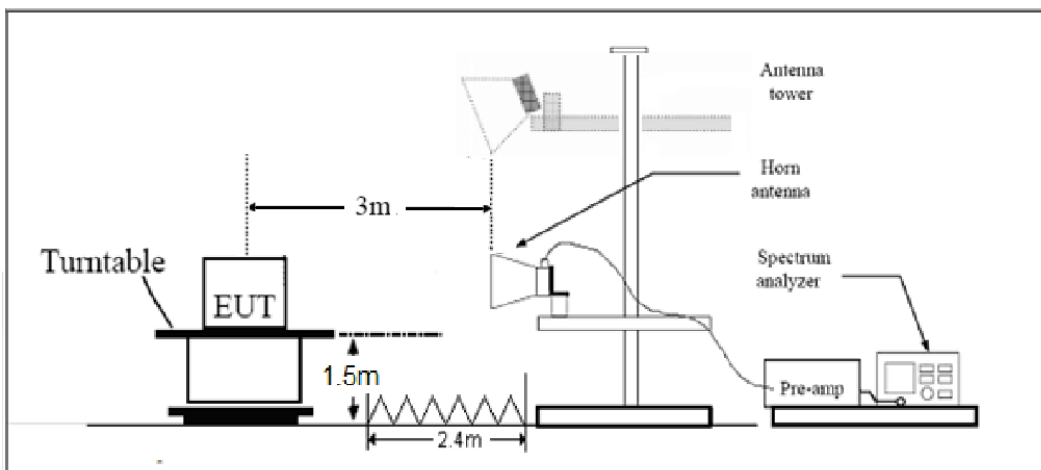

Limits

Rule Part 15.247(d) specifies that “In addition, radiated emissions which fall in the restricted bands, as defined in § 15.205(a), must also comply with the radiated emission limits specified in § 15.209(a) (see § 15.205(c)).”

Limit in restricted band

Frequency of emission (MHz)	Field strength(uV/m)	Field strength(dBuV/m)
0.009–0.490	2400/F(kHz)	/
0.490–1.705	24000/F(kHz)	/
1.705–30.0	30	/
30-88	100	40
88-216	150	43.5
216-960	200	46
Above960	500	54

§15.35(b)

There is also a limit on the radio frequency emissions, as measured using instrumentation with a peak detector function, corresponding to 20 dB above the maximum permitted average limit.

Measurement Uncertainty

The assessed measurement uncertainty to ensure 95% confidence level for the normal distribution is with the coverage factor $k = 1.96$.

Frequency	Uncertainty
9KHz-30MHz	3.55 dB
30MHz-200MHz	4.19 dB
200MHz-1GHz	3.63 dB
Above 1GHz	3.68 dB

Test result

Sweep from 9 kHz to 30MHz, and the emissions more than 20 dB below the permissible value are not reported.

The following graphs display the maximum values of horizontal and vertical by software.

For above 1GHz, Blue trace uses the peak detection, Green trace uses the average detection.

During the test, the Radiates Emission from 30MHz to 1GHz was performed in all modes with all channels, BT **GFSK Channel 78** are selected as the worst condition. The test data of the worst-case condition was recorded in this report.

Continuous TX mode:

FCC RE 0.03-1GHz QP Class B

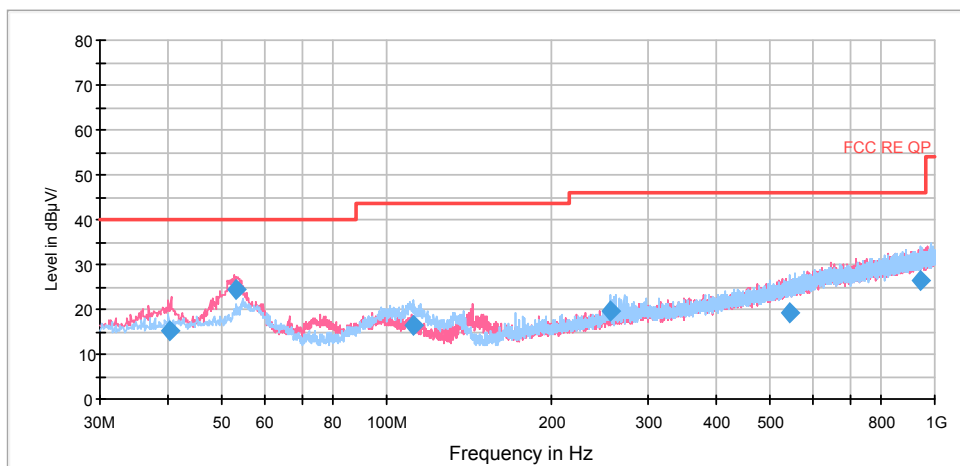

Radiates Emission from 30MHz to 1GHz

Frequency (MHz)	Quasi-Peak (dBuV/m)	Reading value (dBuV/m)	Height (cm)	Polarization	Azimuth (deg)	Correct Factor (dB)	Margin (dB)	Limit (dBuV/m)
40.107500	15.0	1.7	100.0	V	117.0	13.3	25.0	40.0
53.315000	24.3	11.5	100.0	V	188.0	12.8	15.7	40.0
111.607500	16.4	4.3	225.0	H	38.0	12.1	27.1	43.5
256.453750	19.7	5.1	113.0	H	245.0	14.6	26.3	46.0
543.978750	19.1	-2.5	225.0	H	344.0	21.6	26.9	46.0
943.745000	26.4	-0.8	125.0	H	22.0	27.2	19.6	46.0

Remark: 1. Quasi-Peak = Reading value + Correction factor

2. Correction Factor = Antenna factor+ Insertion loss(cable loss+amplifier gain)

3. Margin = Limit – Quasi-Peak

GFSK-Channel 0

FCC RE 1G-3GHz PK+AV Class B

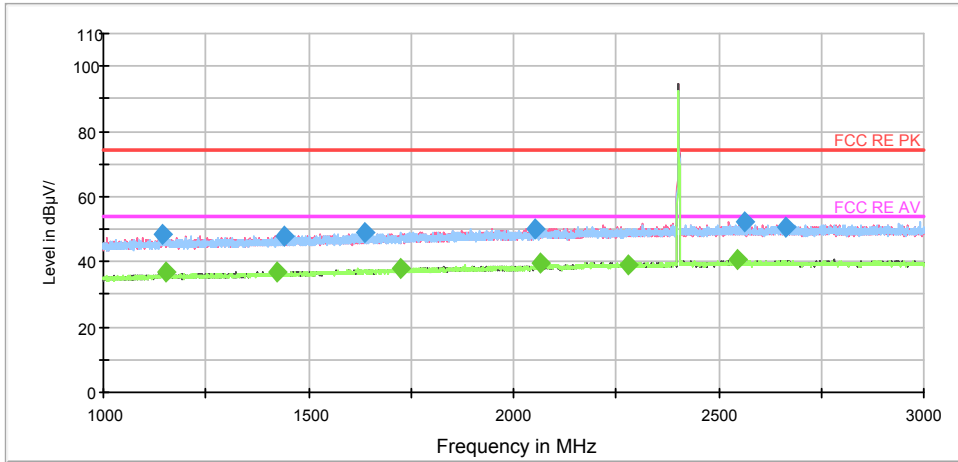

Note: The signal beyond the limit is carrier.
Radiates Emission from 1GHz to 3GHz

RE 3-18GHz PK+AV

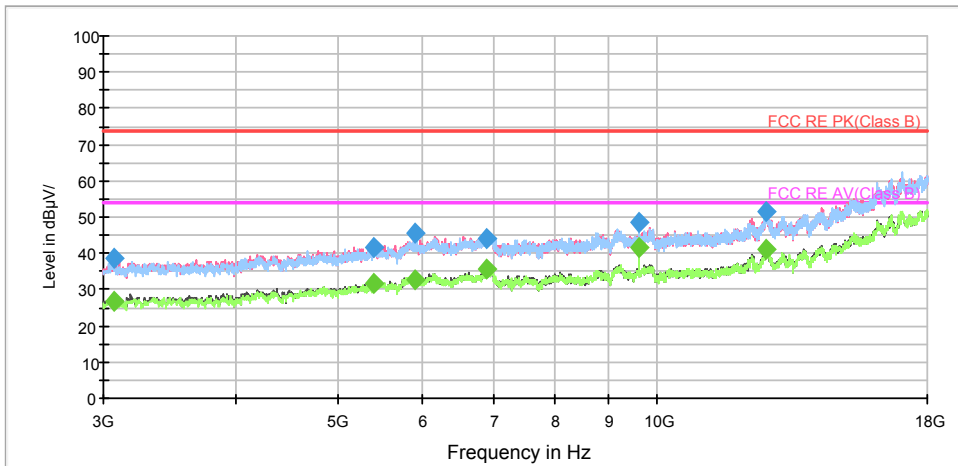

Radiates Emission from 3GHz to 18GHz

BELL_RE 18-26.5GHz PK+AV

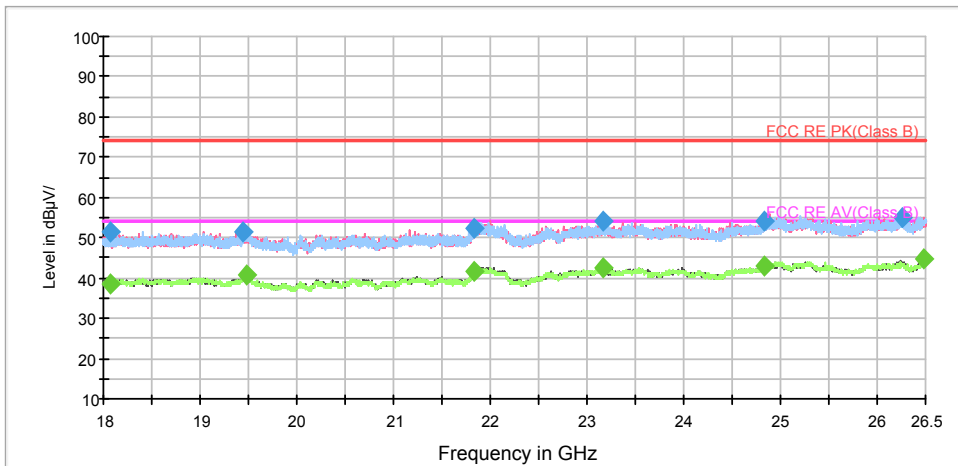

Radiates Emission from 18GHz to 26.5GHz



Frequency (MHz)	Peak (dBuV/m)	Height (cm)	Polarization	Azimuth (deg)	Reading value (dBuV/m)	Correct Factor (dB)	Margin (dB)	Limit (dBuV/m)
1144.250000	48.5	100.0	H	0.0	46.2	2.3	25.5	74
1441.750000	47.9	100.0	H	82.0	44.7	3.2	26.1	74
1639.500000	48.7	100.0	V	158.0	44.8	3.9	25.3	74
2054.250000	50.3	100.0	H	92.0	44.9	5.4	23.7	74
2564.750000	52.3	100.0	V	273.0	45.1	7.2	21.7	74
2664.000000	50.6	100.0	V	0.0	43.3	7.3	23.4	74

Remark: 1. Correction Factor = Antenna factor+ Insertion loss (cable loss + amplifier gain)

Frequency (MHz)	Average (dBuV/m)	Height (cm)	Polarization	Azimuth (deg)	Reading value (dBuV/m)	Correct Factor (dB)	Margin (dB)	Limit (dBuV/m)
1153.000000	36.7	100.0	H	150.0	34.4	2.3	17.3	54
1422.250000	36.8	100.0	H	173.0	33.7	3.1	17.2	54
1724.750000	38.2	100.0	V	262.0	34.0	4.2	15.8	54
2063.500000	39.3	100.0	H	71.0	33.8	5.5	14.7	54
2279.250000	39.3	100.0	V	0.0	33.0	6.3	14.7	54
2544.500000	40.6	100.0	V	318.0	33.4	7.2	13.4	54

Remark: 1. Correction Factor = Antenna factor+ Insertion loss (cable loss + amplifier gain)

GFSK-Channel 39

FCC RE 1G-3GHz PK+AV Class B

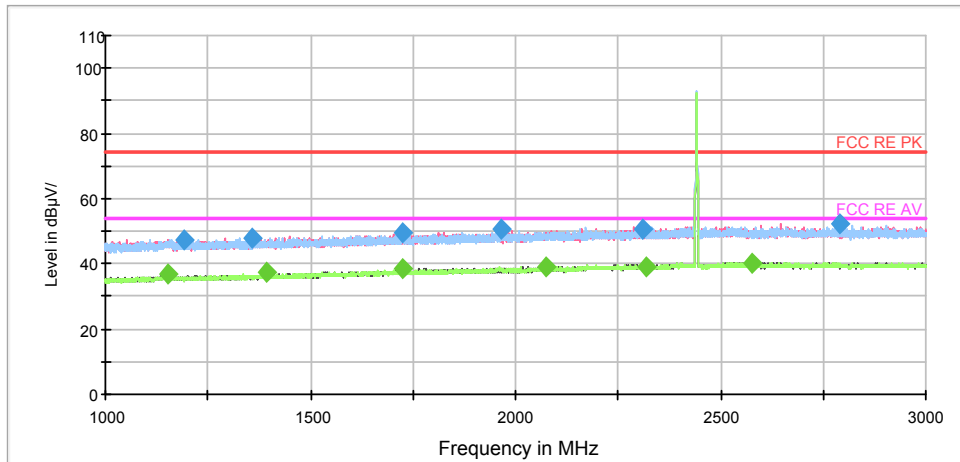

Note: The signal beyond the limit is carrier.
Radiates Emission from 1GHz to 3GHz

RE 3-18GHz PK+AV

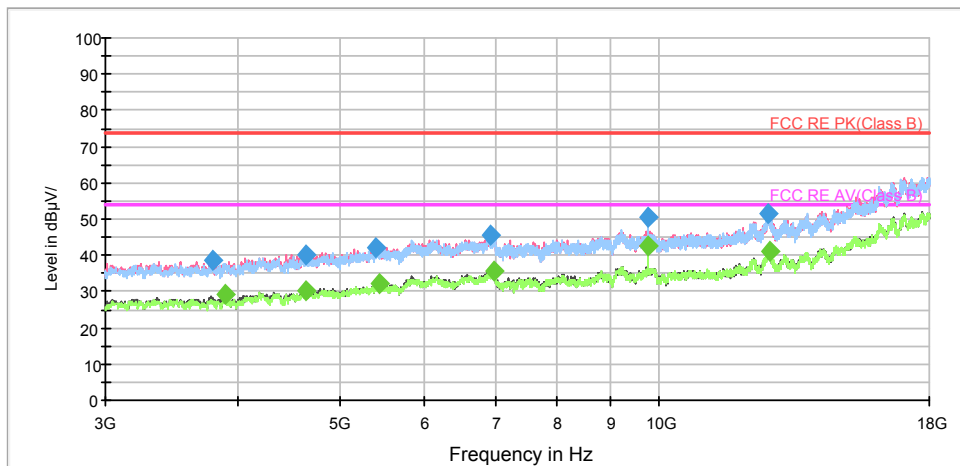

Radiates Emission from 3GHz to 18GHz

BELL_RE 18-26.5GHz PK+AV

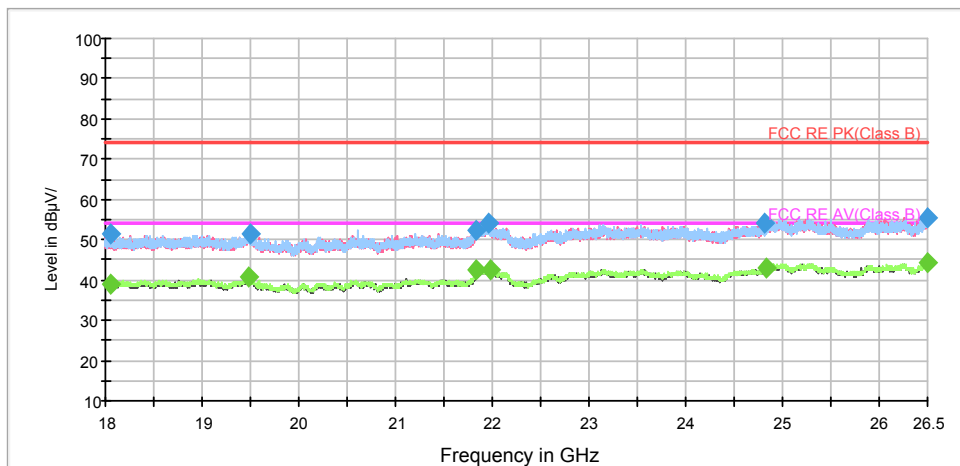

Radiates Emission from 18GHz to 26.5GHz



Frequency (MHz)	Peak (dBuV/m)	Height (cm)	Polarization	Azimuth (deg)	Reading value (dBuV/m)	Correct Factor (dB)	Margin (dB)	Limit (dBuV/m)
1193.250000	47.4	100.0	H	0.0	45.0	2.4	26.6	74
1357.750000	48.1	100.0	V	165.0	45.2	2.9	25.9	74
1725.000000	49.4	100.0	V	349.0	45.2	4.2	24.6	74
1963.750000	50.4	100.0	H	34.0	45.3	5.1	23.6	74
2309.500000	50.8	100.0	V	291.0	44.3	6.5	23.2	74
2790.250000	52.4	100.0	H	264.0	45.0	7.4	21.6	74

Remark: 1. Correction Factor = Antenna factor+ Insertion loss (cable loss + amplifier gain)

Frequency (MHz)	Average (dBuV/m)	Height (cm)	Polarization	Azimuth (deg)	Reading value (dBuV/m)	Correct Factor (dB)	Margin (dB)	Limit (dBuV/m)
1154.500000	36.7	100.0	H	55.0	34.4	2.3	17.3	54
1393.500000	37.1	100.0	V	323.0	34.1	3.0	16.9	54
1725.000000	38.3	100.0	H	146.0	34.1	4.2	15.7	54
2073.750000	39.1	100.0	V	323.0	33.6	5.5	14.9	54
2319.750000	39.2	100.0	V	165.0	32.7	6.5	14.8	54
2575.500000	40.4	100.0	V	257.0	33.2	7.2	13.6	54

Remark: 1. Correction Factor = Antenna factor+ Insertion loss (cable loss + amplifier gain)

GFSK-Channel 78

FCC RE 1G-3GHz PK+AV Class B

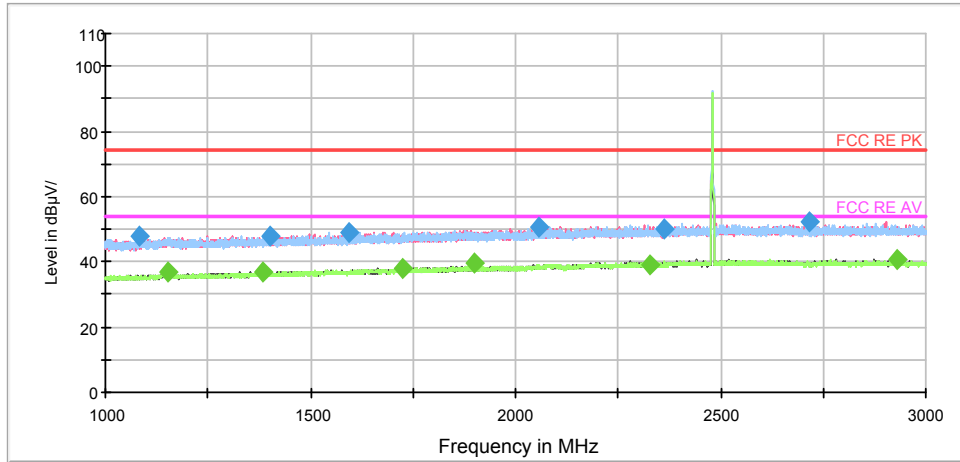

Note: The signal beyond the limit is carrier.
Radiates Emission from 1GHz to 3GHz

RE 3-18GHz PK+AV

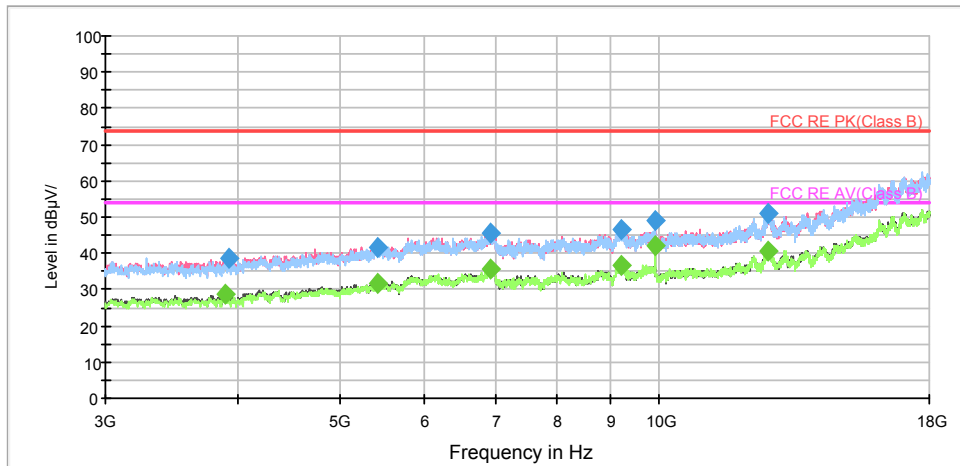

Radiates Emission from 3GHz to 18GHz

BELL_RE 18-26.5GHz PK+AV

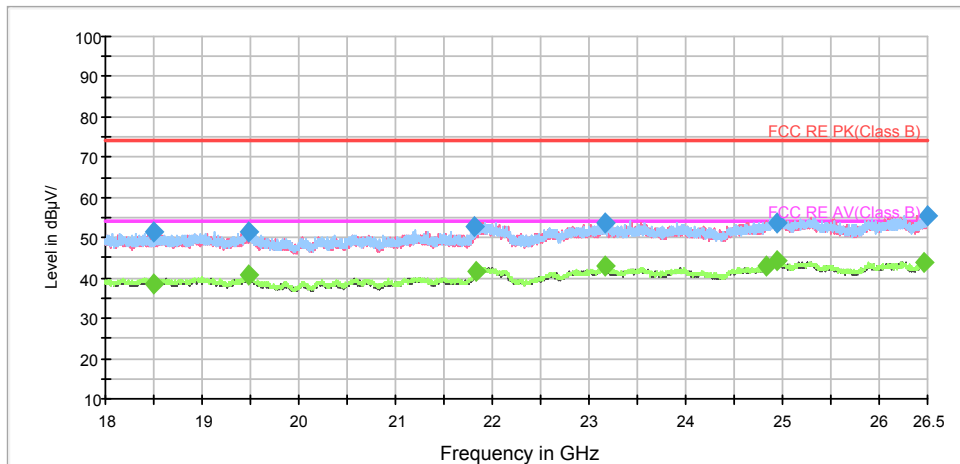

Radiates Emission from 18GHz to 26.5GHz



Frequency (MHz)	Peak (dBuV/m)	Height (cm)	Polarization	Azimuth (deg)	Reading value (dBuV/m)	Correct Factor (dB)	Margin (dB)	Limit (dBuV/m)
1083.500000	47.6	100.0	H	1.0	45.5	2.1	26.4	74
1403.750000	48.0	100.0	H	37.0	44.9	3.1	26.0	74
1595.000000	49.1	100.0	V	0.0	45.4	3.7	24.9	74
2058.750000	50.9	100.0	H	173.0	45.5	5.4	23.1	74
2362.500000	49.8	100.0	H	220.0	43.1	6.7	24.2	74
2715.250000	52.5	100.0	V	289.0	45.2	7.3	21.5	74

Remark: 1. Correction Factor = Antenna factor+ Insertion loss (cable loss + amplifier gain)

Frequency (MHz)	Average (dBuV/m)	Height (cm)	Polarization	Azimuth (deg)	Reading value (dBuV/m)	Correct Factor (dB)	Margin (dB)	Limit (dBuV/m)
1154.500000	36.7	100.0	V	352.0	34.4	2.3	17.3	54
1385.500000	36.9	100.0	H	115.0	33.9	3.0	17.1	54
1725.250000	38.2	100.0	V	301.0	34.0	4.2	15.8	54
1897.500000	39.8	100.0	V	278.0	35.0	4.8	14.2	54
2325.500000	39.3	100.0	V	0.0	32.8	6.5	14.7	54
2932.000000	40.7	100.0	V	359.0	33.2	7.5	13.3	54

Remark: 1. Correction Factor = Antenna factor+ Insertion loss (cable loss + amplifier gain)

EDR-Channel 0

FCC RE 1G-3GHz PK+AV Class B

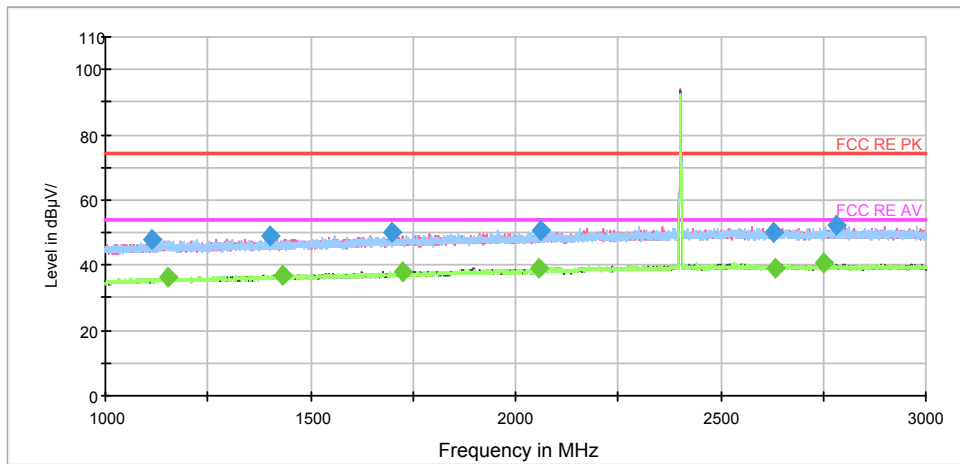

Note: The signal beyond the limit is carrier.

Radiates Emission from 1GHz to 3GHz

RE 3-18GHz PK+AV

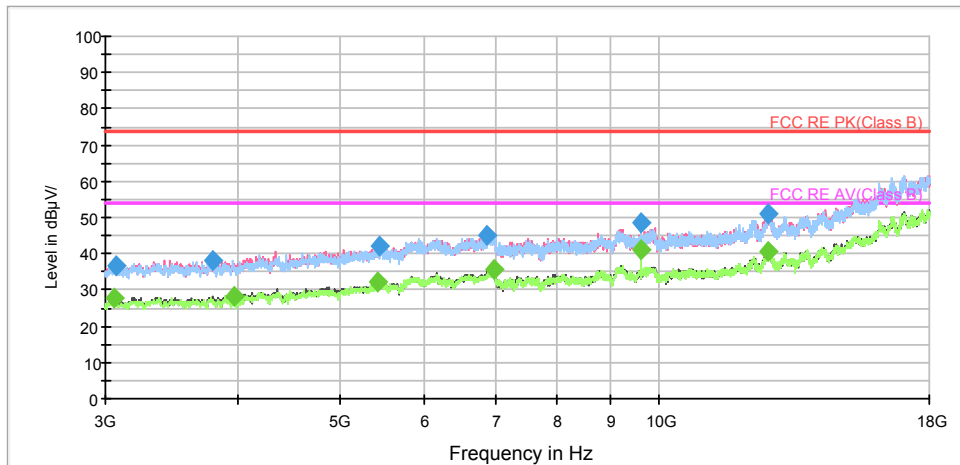

Radiates Emission from 3GHz to 18GHz

BELL_RE 18-26.5GHz PK+AV

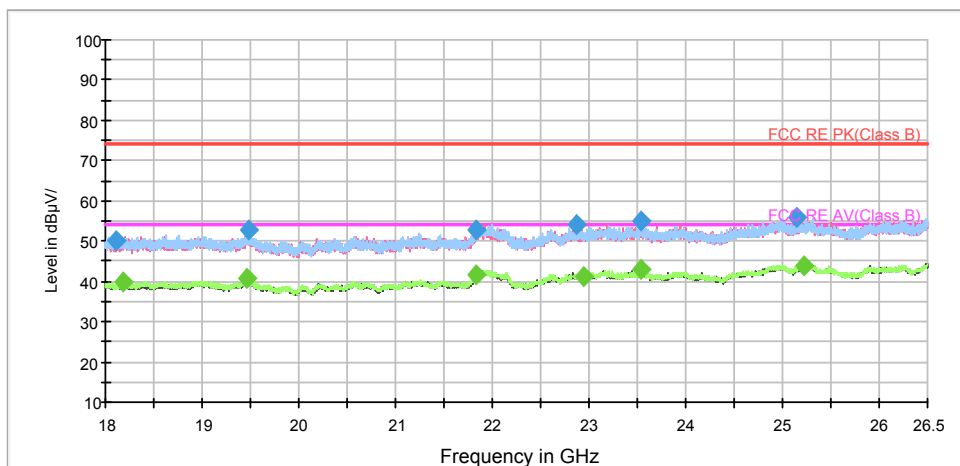

Radiates Emission from 18GHz to 26.5GHz



Frequency (MHz)	Peak (dBuV/m)	Height (cm)	Polarization	Azimuth (deg)	Reading value (dBuV/m)	Correct Factor (dB)	Margin (dB)	Limit (dBuV/m)
1111.500000	47.8	100.0	H	15.0	45.6	2.2	26.2	74
1401.250000	48.9	100.0	H	184.0	45.8	3.1	25.1	74
1698.750000	49.9	100.0	H	317.0	45.8	4.1	24.1	74
2062.000000	50.8	100.0	V	352.0	45.3	5.5	23.2	74
2628.500000	49.8	100.0	V	0.0	42.5	7.3	24.2	74
2780.750000	52.2	100.0	V	352.0	44.8	7.4	21.8	74

Remark: 1. Correction Factor = Antenna factor+ Insertion loss (cable loss + amplifier gain)

Frequency (MHz)	Average (dBuV/m)	Height (cm)	Polarization	Azimuth (deg)	Reading value (dBuV/m)	Correct Factor (dB)	Margin (dB)	Limit (dBuV/m)
1150.750000	36.6	100.0	V	304.0	34.3	2.3	17.4	54
1431.000000	37.1	100.0	H	68.0	33.9	3.2	16.9	54
1725.000000	38.1	100.0	V	224.0	33.9	4.2	15.9	54
2056.250000	38.9	100.0	H	102.0	33.5	5.4	15.1	54
2633.000000	39.3	100.0	V	0.0	32.0	7.3	14.7	54
2752.500000	40.5	100.0	V	118.0	33.1	7.4	13.5	54

Remark: 1. Correction Factor = Antenna factor+ Insertion loss (cable loss + amplifier gain)

FCC RE 1G-3GHz PK+AV Class B

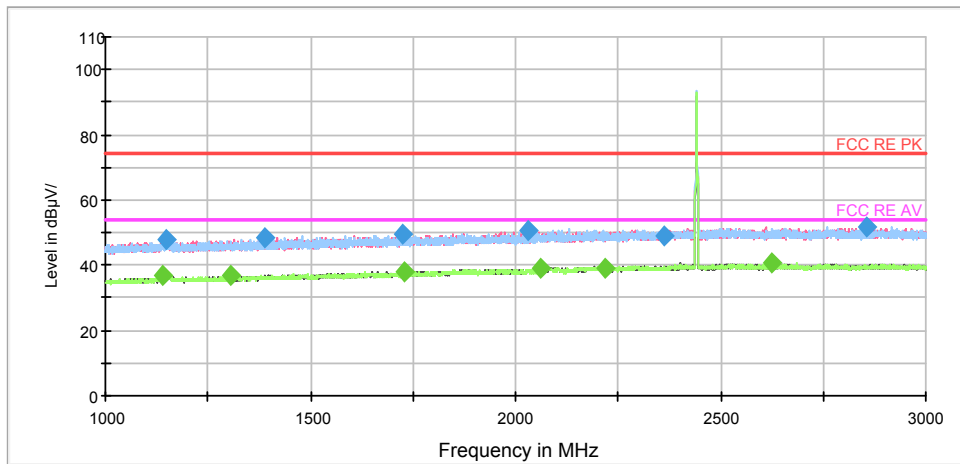

Note: The signal beyond the limit is carrier.

Radiates Emission from 1GHz to 3GHz

RE 3-18GHz PK+AV

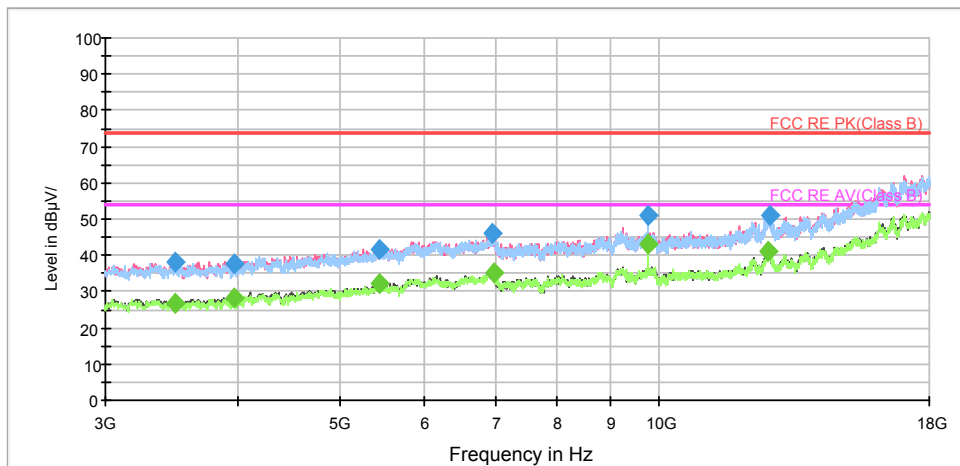

Radiates Emission from 3GHz to 18GHz

BELL_RE 18-26.5GHz PK+AV

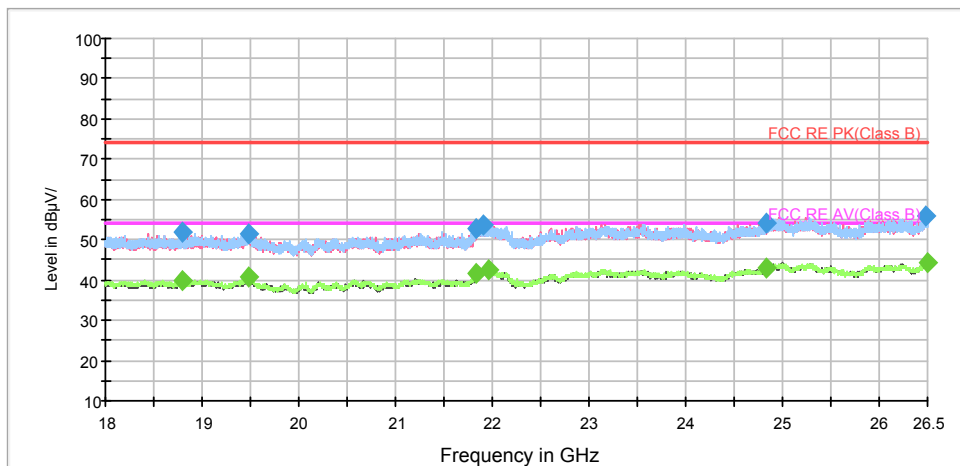

Radiates Emission from 18GHz to 26.5GHz



Frequency (MHz)	Peak (dBuV/m)	Height (cm)	Polarization	Azimuth (deg)	Reading value (dBuV/m)	Correct Factor (dB)	Margin (dB)	Limit (dBuV/m)
1148.750000	48.1	100.0	H	268.0	45.8	2.3	25.9	74
1387.750000	48.4	100.0	H	48.0	45.4	3.0	25.6	74
1727.000000	49.3	100.0	H	0.0	45.1	4.2	24.7	74
2032.500000	50.8	100.0	H	3.0	45.5	5.3	23.2	74
2362.000000	48.8	100.0	V	355.0	42.2	6.6	25.2	74
2855.000000	51.8	100.0	H	8.0	44.3	7.5	22.2	74

Remark: 1. Correction Factor = Antenna factor+ Insertion loss (cable loss + amplifier gain)

Frequency (MHz)	Average (dBuV/m)	Height (cm)	Polarization	Azimuth (deg)	Reading value (dBuV/m)	Correct Factor (dB)	Margin (dB)	Limit (dBuV/m)
1140.500000	36.7	100.0	H	3.0	34.4	2.3	17.3	54
1306.000000	37.0	100.0	V	0.0	34.2	2.8	17.0	54
1728.250000	37.9	100.0	V	292.0	33.7	4.2	16.1	54
2061.250000	39.3	100.0	V	177.0	33.8	5.5	14.7	54
2219.250000	39.3	100.0	H	2.0	33.2	6.1	14.7	54
2625.250000	40.7	100.0	V	355.0	33.4	7.3	13.3	54

Remark: 1. Correction Factor = Antenna factor+ Insertion loss (cable loss + amplifier gain)

EDR-Channel 78

FCC RE 1G-3GHz PK+AV Class B

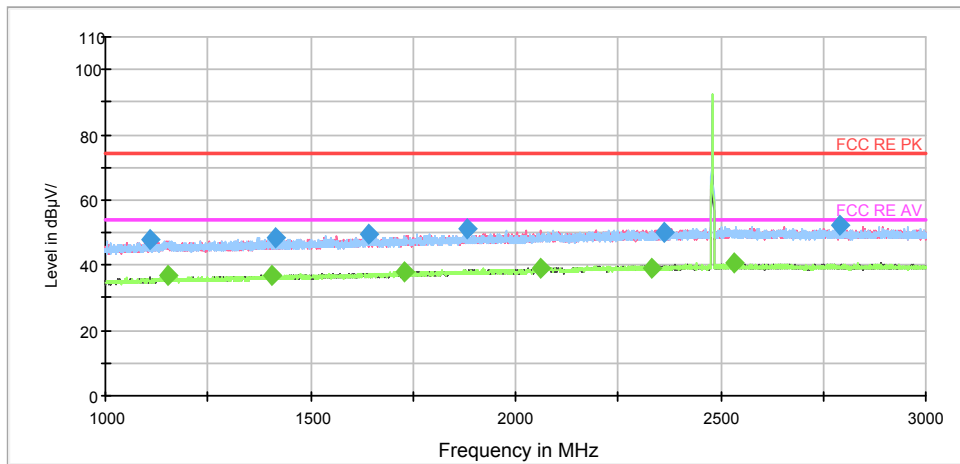

Note: The signal beyond the limit is carrier.

Radiates Emission from 1GHz to 3GHz

RE 3-18GHz PK+AV

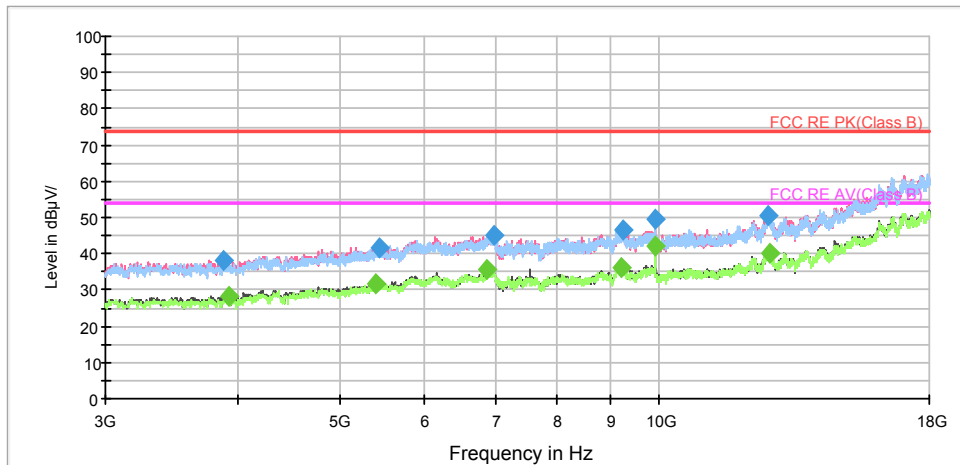

Radiates Emission from 3GHz to 18GHz

BELL_RE 18-26.5GHz PK+AV

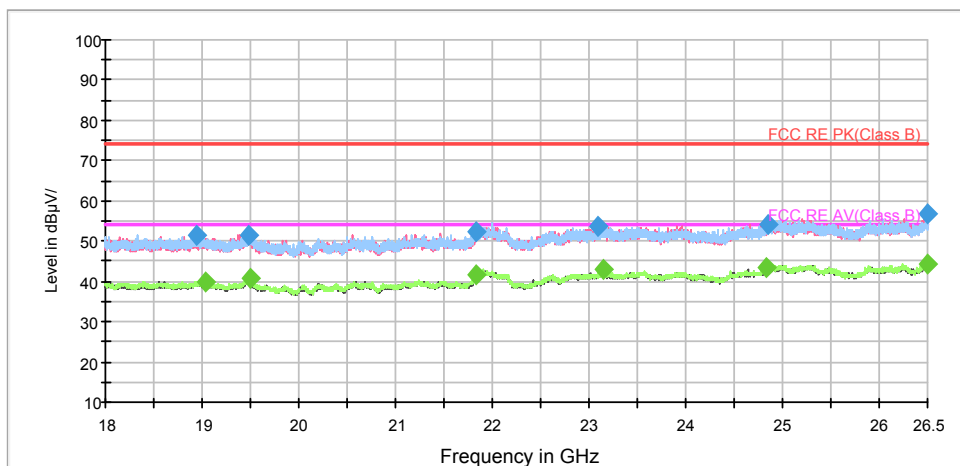

Radiates Emission from 18GHz to 26.5GHz



Frequency (MHz)	Peak (dBuV/m)	Height (cm)	Polarization	Azimuth (deg)	Reading value (dBuV/m)	Correct Factor (dB)	Margin (dB)	Limit (dBuV/m)
1111.250000	47.9	100.0	H	2.0	45.7	2.2	26.1	74
1416.750000	48.4	100.0	H	113.0	45.3	3.1	25.6	74
1639.750000	49.6	100.0	V	345.0	45.7	3.9	24.4	74
1883.250000	51.2	100.0	H	0.0	46.4	4.8	22.8	74
2362.500000	49.9	100.0	V	0.0	43.2	6.7	24.1	74
2791.250000	52.0	100.0	H	6.0	44.6	7.4	22.0	74

Remark: 1. Correction Factor = Antenna factor+ Insertion loss (cable loss + amplifier gain)

Frequency (MHz)	Average (dBuV/m)	Height (cm)	Polarization	Azimuth (deg)	Reading value (dBuV/m)	Correct Factor (dB)	Margin (dB)	Limit (dBuV/m)
1155.000000	36.7	100.0	H	113.0	34.4	2.3	17.3	54
1405.250000	36.9	100.0	H	148.0	33.8	3.1	17.1	54
1728.000000	37.9	100.0	V	0.0	33.7	4.2	16.1	54
2061.500000	39.3	100.0	V	324.0	33.8	5.5	14.7	54
2333.250000	39.3	100.0	V	358.0	32.8	6.5	14.7	54
2534.250000	40.6	100.0	V	315.0	33.4	7.2	13.4	54

Remark: 1. Correction Factor = Antenna factor+ Insertion loss (cable loss + amplifier gain)

5.10 Conducted Emission

Ambient condition

Temperature	Relative humidity	Pressure
23°C ~25°C	45%~50%	101.5kPa

Methods of Measurement

The EUT is placed on a non-metallic table of 80cm height above the horizontal metal reference ground plane. During the test, the EUT was operating in its typical mode. The test method is according to ANSI C63.10-2013. Connect the AC power line of the EUT to the L.I.S.N. Use EMI receiver to detect the average and Quasi-peak value. RBW is set to 9 kHz, VBW is set to 30kHz. The measurement result should include both L line and N line.

The test is in transmitting mode.

Test Setup

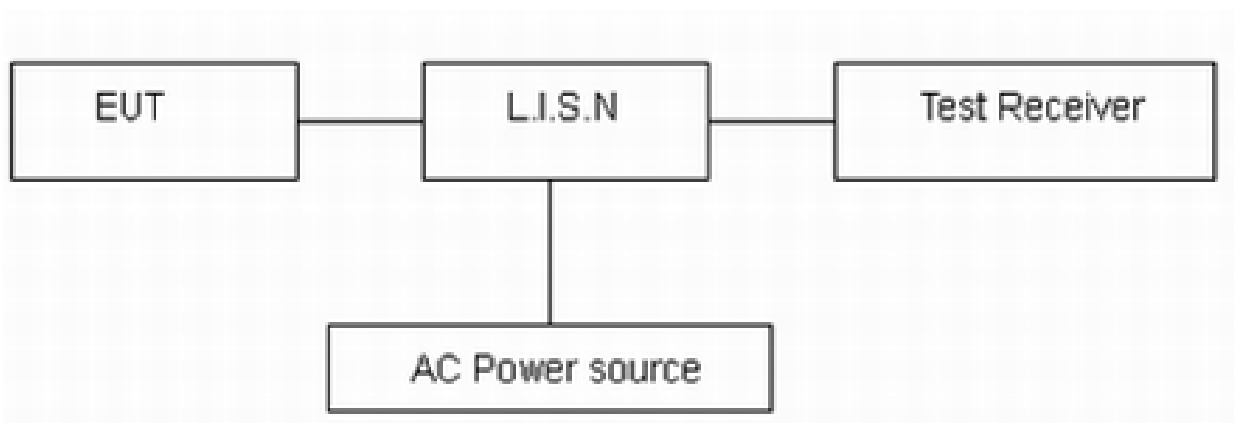

Note: AC Power source is used to 120V/60Hz.

Limits

Frequency (MHz)	Conducted Limits(dBμV)	
	Quasi-peak	Average
0.15 - 0.5	66 to 56 *	56 to 46 *
0.5 - 5	56	46
5 - 30	60	50

*: Decreases with the logarithm of the frequency.

Measurement Uncertainty

The assessed measurement uncertainty to ensure 95% confidence level for the normal distribution is with the coverage factor $k = 1.96$, $U=2.69$ dB.

Test Results:

Following plots, Blue trace uses the peak detection, Green trace uses the average detection. During the test, the Conducted Emission was performed in all modes with all channels, BT **GFSK channel 78**, are selected as the worst condition. The test data of the worst-case condition was recorded in this report.

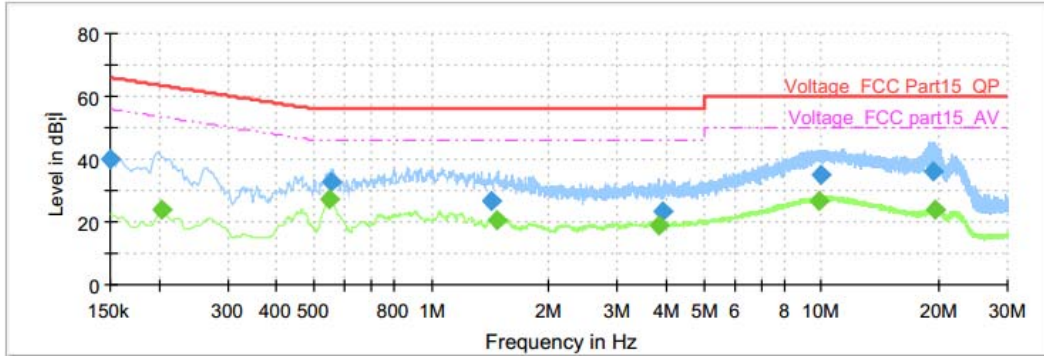

Final Result

Frequency (MHz)	QuasiPeak (dB; i V)	Average (dB; i V)	Limit (dB; i V)	Margin (dB)	Meas. Time (ms)	Bandwidth (kHz)	Line	Filter	Corr. (dB)
0.150000	40.19	---	66.00	25.81	1000.0	9.000	L1	ON	19.6
0.204000	---	24.12	53.45	29.33	1000.0	9.000	L1	ON	19.7
0.548250	---	27.22	46.00	18.78	1000.0	9.000	L1	ON	19.6
0.552750	32.51	---	56.00	23.49	1000.0	9.000	L1	ON	19.6
1.421250	26.91	---	56.00	29.09	1000.0	9.000	L1	ON	19.6
1.473000	---	20.36	46.00	25.64	1000.0	9.000	L1	ON	19.6
3.813000	---	18.78	46.00	27.22	1000.0	9.000	L1	ON	19.6
3.912000	23.29	---	56.00	32.71	1000.0	9.000	L1	ON	19.6
9.820500	---	26.83	50.00	23.17	1000.0	9.000	L1	ON	19.9
9.919500	35.25	---	60.00	24.75	1000.0	9.000	L1	ON	19.9
19.380750	36.26	---	60.00	23.74	1000.0	9.000	L1	ON	20.1
19.466250	---	23.90	50.00	26.10	1000.0	9.000	L1	ON	20.1

BT_L_0.15-30Mhz

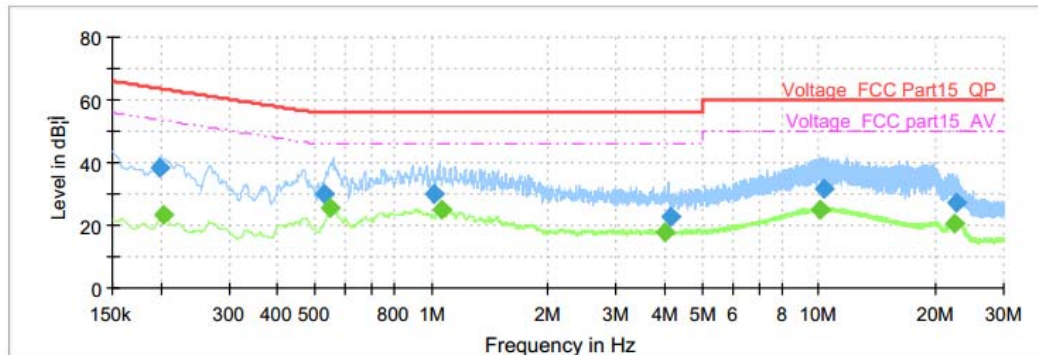

Final Result

Frequency (MHz)	QuasiPeak (dB; i V)	Average (dB; i V)	Limit (dB; i V)	Margin (dB)	Meas. Time (ms)	Bandwidth (kHz)	Line	Filter	Corr. (dB)
0.199500	38.37	---	63.63	25.27	1000.0	9.000	N	ON	19.7
0.204000	---	23.54	53.45	29.90	1000.0	9.000	N	ON	19.7
0.528000	29.92	---	56.00	26.08	1000.0	9.000	N	ON	19.6
0.548250	---	25.42	46.00	20.58	1000.0	9.000	N	ON	19.6
1.011750	30.21	---	56.00	25.79	1000.0	9.000	N	ON	19.6
1.056750	---	24.97	46.00	21.03	1000.0	9.000	N	ON	19.6
3.993000	---	17.88	46.00	28.12	1000.0	9.000	N	ON	19.6
4.134750	23.00	---	56.00	33.00	1000.0	9.000	N	ON	19.6
10.050000	---	24.89	50.00	25.11	1000.0	9.000	N	ON	19.9
10.250250	31.55	---	60.00	28.45	1000.0	9.000	N	ON	19.9
22.290000	---	20.61	50.00	29.39	1000.0	9.000	N	ON	19.9
22.578000	27.01	---	60.00	32.99	1000.0	9.000	N	ON	19.9

BT_N_0.15-30Mhz

6 Main Test Instruments

Name	Manufacturer	Type	Serial Number	Calibration Date	Expiration Date
BT Base Station Simulator	R&S	CBT	100271	2017-05-14	2018-05-13
Loop Antenna	SCHWARZBECK	FMZB1519	1519-047	2017-02-18	2020-02-17
EMI Test Receiver	R&S	ESR	101667	2017-09-06	2018-09-05
LISN	R&S	ENV216	101171	2016-12-16	2019-12-15
Signal Analyzer	R&S	FSV30	100815	2017-12-17	2018-12-16
EMI Test Receiver	R&S	ESCI	100948	2017-05-20	2018-05-19
TRILOG Broadband Antenna	Schwarzbeck	VULB 9163	9163-201	2017-11-18	2020-11-17
Double Ridged Waveguide Horn Antenna	R&S	HF907	100126	2014-12-06	2019-12-05
Spectrum Analyzer	Agilent	N9010A	MY47191109	2017-05-20	2018-05-19
Standard Gain Horn	ETS-Lindgren	3160-09	00102644	2015-01-30	2020-01-29
RF Cable	Agilent	SMA 15cm	0001	/	/
Power Splitter	Hua Xiang	SHX-GF2-2-13	10120101	/	/
Software (CE)	R&S	EMC32	9.26.0	/	/
Software (RE/RSE)	R&S	EMC32	8.52.0	/	/

*****END OF REPORT *****

ANNEX A: Product Change Description

Huawei Technologies Co.,Ltd.

Difference Declaration Letter

Article 1: Difference description:

The difference between model ATU-L21 and ATU-L11 is show in the below table:

		Model: ATU-L21	Model: ATU-L11
Licensed Frequency	LTE BAND	B5/B7	B5/B7
	UMTS BAND	B2/B5	B2/B5
	GSM	B2/B5	B2/B5
	Antenna	Same	Same
Unlicensed Frequency	Bluetooth	4.2	4.2
	2.4G Wi-Fi	Same	Same
	NFC	Not support	Support
	Antenna	Same	Same
Hardware	Ram / Rom	Same	Same
	PCB	Same	Same
	USB Port	Same	Same
Appearance	Dimension	152.4*73*7.8	152.4*73*8.05
Accessory	Battery	Same	Same
	ExternalCharger	Same	Same
	USB label	Same	Same
	Earphone	Same	Same
others	fingerprint	Not support	Not support
	Camera	Same	Same