

FCC DFS Test Report

FCC ID: QISAP8130DN

This report concerns (check one): Original Grant Class I Change Class II Change

Project No. : 1407C034V
Equipment : Outdoor Wireless LAN Access Point
Model Name : AP8130DN
Applicant : Huawei Technologies Co.,Ltd.
Address : Administration Building, Huawei Base, Bantian,
Longgang District ,Shenzhen 518129, P.R.China

Date of Receipt : Mar. 09, 2015
Date of Test : Mar. 09, 2015 ~ Jun. 08, 2015
Issued Date : Apr. 11, 2016
Tested by : BTL Inc.

Testing Engineer : Shawn Xiao
(Shawn Xiao)

Technical Manager : David Mao
(David Mao)

Authorized Signatory : Steven Lu
(Steven Lu)

B T L I N C .

No.3,Jinshagang 1st Road, Shixia,Dalang Town, Dongguan,
Guangdong, China.

TEL: +86-769-8318-3000FAX: +86-769-8319-6000

Declaration

BTL represents to the client that testing is done in accordance with standard procedures as applicable and that test instruments used has been calibrated with standards traceable to international standard(s) and/or national standard(s).

BTL's reports apply only to the specific samples tested under conditions. It is manufacture's responsibility to ensure that additional production units of this model are manufactured with the identical electrical and mechanical components. **BTL** shall have no liability for any declarations, inferences or generalizations drawn by the client or others from **BTL** issued reports.

BTL's report must not be used by the client to claim product certification, approval, or endorsement by NVLAP, NIST, or any agency of the Federal Government.

This report is the confidential property of the client. As a mutual protection to the clients, the public and **BTL-self**, extracts from the test report shall not be reproduced except in full with **BTL's** authorized written approval.

BTL's laboratory quality assurance procedures are in compliance with the **ISO Guide17025** requirements, and accredited by the conformity assessment authorities listed in this test report.

Limitation

For the use of the authority's logo is limited unless the Test Standard(s)/Scope(s)/Item(s) mentioned in this test report is (are) included in the conformity assessment authorities acceptance respective.

Table of Contents	Page
1 . CERTIFICATION	5
2 . EUT INFORMATION	6
2.1 EUT SPECIFICATION TABLE	6
2.4 EUT MAXIMUM AND MINIMUM E.I.R.P. POWER	8
3 .U-NII DFS RULE REQUIREMENTS	9
3.1 WORKING MODES AND REQUIRED TEST ITEMS	9
3.2 TEST LIMITS AND RADAR SIGNAL PARAMETERS	10
4 . TEST INSTRUMENTS	13
5 .EMC EMISSION TEST	14
5.1 DFS MEASUREMENT SYSTEM:	14
5.2 CALIBRATION OF DFS DETECTION THRESHOLD LEVEL:	16
5.3 DEVIATION FROM TEST STANDARD	16
6 . TEST RESULTS	17
6.1 SUMMARY OF TEST RESULT	17
6.2 DETELED TEST RESULTS	18
6.2.1 TEST MODE: DEVICE OPERATING IN MASTER MODE.	18
6.2.2 DFS DETECTION THRESHOLD	18
6.2.3 CHANNEL AVAILABILITY CHECK TIME	24
6.2.4CHANNEL CLOSING TRANSMISSION AND CHANNEL MOVE TIME WLAN TRAFFIC	33
6.2.5 NON- OCCUPANCY PERIOD	60
6.2.6 UNIFORM SPREADING	62
6.2.7 U-NII DETECTION BANDWIDTH	62

REPORT ISSUED HISTORY

Issued No.	Description	Issued Date
BTL-FCCP-5-1407C034B	Original Report.	Jun. 10, 2015
BTL-FCCP-5-1407C034V	Compared with previous report (BTL-FCCP-5-1407C034B), the antennas are added, which does not affect the test results, the rest are kept the same.	Apr. 11, 2016

1. CERTIFICATION

Equipment : Outdoor Wireless LAN Access Point
Brand Name : HUAWEI
Model Name : AP8130DN
Applicant : Huawei Technologies Co.,Ltd.
Manufacturer : Huawei Technologies Co.,Ltd.
Address : Administration Building, Huawei Base, Bantian, Longgang District ,Shenzhen 518129, P.R.China
Factory : Huawei Technologies Co.,Ltd.
Address : Huawei Base, Bantian, Longgang District, Shenzhen 518129, P.R.China
Date of Test: : Mar. 09, 2015 ~ Jun. 08, 2015
Test Sample : ENGINEERING SAMPLE
Standard(s) : FCC Part 15, Subpart E (Section 15.407)
FCC KDB 789033 D02 General UNII Test Procedures New Rules v01

The above equipment has been tested and found compliance with the requirement of the relative standards by BTL Inc.

The test data, data evaluation, and equipment configuration contained in our test report (Ref No. BTL-FCCP-5-1407C034V) were obtained utilizing the test procedures, test instruments, test sites that has been accredited by the Authority of TAF according to the ISO-17025 quality assessment standard and technical standard(s).

Test result included in this report is only for the 5GHz module which is support 5GHz only.

2. EUT INFORMATION

2.1 EUT SPECIFICATION TABLE

Table 1: Specification of EUT

Product name	Outdoor Wireless LAN Access Point
Brand Name	HUAWEI
Model	AP8130DN
FCC ID	QISAP8130DN
Operational Mode	Master
Operating Frequency Range	5260~5320MHz&5500~5700MHz
Modulation	OFDM

Note: This device was functioned as a Master Slave device during the DF
This device supports bridge mode and mesh mode.

2.2 DESCRIPTION OF AVAILABLE ANTENNAS TO THE EUT

Antenna Specification:

Ant.	Manufacturer	Model Name	Antenna Type	Connector	Gain (dBi)	Note
1	Shenglu	SL12845A	External Antenna	N-type	8	5GHz
2	Shenglu	SL12845A	External Antenna	N-type	8	5GHz

Note:

1. The EUT incorporates a MIMO function. Physically, the EUT provides two completed transmitters and receivers (2T2R).

2.3 CONDUCTED OUTPUT POWER AND EIRP POWER

TABLE 3: THE CONDUCTED OUTPUT POWER LIST

TX (11a)

FREQUENCY BAND (MHz)	MAX. POWER	
	OUTPUT POWER(dBm)	OUTPUT POWER(mW)
5260~5320	21.94	156.32
5500~5700	22.00	158.49

TX (11n 40MHz)

FREQUENCY BAND (MHz)	MAX. POWER	
	OUTPUT POWER(dBm)	OUTPUT POWER(mW)
5270~5310	20.06	101.39
5510~5670	20.17	103.99

TX (11ac 80 MHz)

FREQUENCY BAND (MHz)	MAX. POWER	
	OUTPUT POWER(dBm)	OUTPUT POWER(mW)
5290	14.44	27.80
5530	21.53	142.23

2.4 EUT MAXIMUM AND MINIMUM E.I.R.P. POWER

TABLE 4: THE MAX EIRP LIST

TX (11a)

FREQUENCY BAND (MHz)	MAX. POWER	
	OUTPUT POWER(dBm)	OUTPUT POWER(mW)
5260~5320	29.94	986.28
5500~5700	30.00	1000

TX (11n40MHz)

FREQUENCY BAND (MHz)	MAX. POWER	
	OUTPUT POWER(dBm)	OUTPUT POWER(mW)
5270~5310	28.06	639.74
5510~5670	28.17	656.15

TX (11ac 80 MHz)

FREQUENCY BAND (MHz)	MAX. POWER	
	OUTPUT POWER(dBm)	OUTPUT POWER(mW)
5290	22.44	175.39
5530	29.53	897.43

3.U-NII DFS RULE REQUIREMENTS

3.1 WORKING MODES AND REQUIRED TEST ITEMS

The manufacturer shall state whether the UUT is capable of operating as a Master and/or a Client. If the UUT is capable of operating in more than one operating mode then each operating mode shall be tested separately. See tables 1 and 2 for the applicability of DFS requirements for each of the operational modes.

Table 5: Applicability of DFS requirements prior to use a channel

Requirement	Operational Mode		
	Master	Client without radar detection	Client with radar detection
Non-Occupancy Period	✓	Not required	✓
DFS Detection Threshold	✓	Not required	✓
Channel Availability Check Time	✓	Not required	Not required
Uniform Spreading	✓	Not required	Not required
U-NII Detection Bandwidth	✓	Not required	✓

Table 6: Applicability of DFS requirements during normal operation.

Requirement	Operational Mode		
	Master	Client without radar detection	Client with radar detection
DFS Detection Threshold	✓	Not required	✓
Channel Closing Transmission Time	✓	✓	✓
Channel Move Time	✓	✓	✓
U-NII Detection Bandwidth	✓	Not required	✓

3.2 TEST LIMITS AND RADAR SIGNAL PARAMETERS

DETECTION THRESHOLD VALUES

Table 7: DFS Detection Thresholds for Master Devices and Client Devices With Radar Detection.

Maximum Transmit Power	Value (See Notes 1 and 2)
EIRP \geq 200 milliwatt	-64 dBm
EIRP < 200 milliwatt and power spectral density < 10 dBm/MHz	-62 dBm
EIRP < 200 milliwatt that do not meet the power spectral density requirement	-64 dBm

Note 1: This is the level at the input of the receiver assuming a 0 dBi receive antenna.

Note 2: Throughout these test procedures an additional 1 dB has been added to the amplitude of the test transmission waveforms to account for variations in measurement equipment. This will ensure that the test signal is at or above the detection threshold level to trigger a DFS response.

Note 3: EIRP is based on the highest antenna gain. For MIMO devices refer to KDB Publication 662911D01.

Table 8: DFS Response Requirement Values

Parameter	Value
Non-occupancy period	Minimum 30 minutes
Channel Availability Check Time	60 seconds
Channel Move Time	10 seconds See Note 1.
Channel Closing Transmission Time	200 milliseconds + an aggregate of 60 milliseconds over remaining 10 second period. See Notes 1 and 2.
U-NII Detection Bandwidth	Minimum 100% of the UNII 99% transmission power bandwidth. See Note 3.

Note 1: Channel Move Time and the Channel Closing Transmission Time should be performed with Radar Type 0. The measurement timing begins at the end of the Radar Type 0 burst.

Note 2: The Channel Closing Transmission Time is comprised of 200 milliseconds starting at the beginning of the Channel Move Time plus any additional intermittent control signals required to facilitate a Channel move (an aggregate of 60 milliseconds) during the remainder of the 10 second period. The aggregate duration of control signals will not count quiet periods in between transmissions.

Note 3: During the U-NII Detection Bandwidth detection test, radar type 0 should be used. For each frequency step the minimum percentage of detection is 90 percent. Measurements are performed with no data traffic.

PARAMETERS OF DFS TEST SIGNALS

Step intervals of 0.1 microsecond for Pulse Width, 1 microsecond for PRI, 1 MHz for chirp width and 1 for the number of pulses will be utilized for the random determination of specific test waveforms.

Table 9: Short Pulse Radar Test Waveforms.

Radar Type	Pulse Width (μsec)	PRI (μsec)	Number of Pulses	Minimum Percentage of Successful Detection	Minimum Number of Trials
0	1	1428	18	See Note 1	See Note 1
1	1	Test A: 15 unique PRI values randomly selected from the list of 23 PRI values in Table 5a	Roundup $\left\{ \begin{array}{l} \left(\frac{1}{360} \right) \cdot \\ \left(\frac{19 \cdot 10^6}{\text{PRI}_{\mu\text{sec}}} \right) \end{array} \right\}$	60%	30
		Test B: 15 unique PRI values randomly selected within the range of 518-3066 μsec, with a minimum increment of 1 μsec, excluding PRI values selected in Test A			
2	1-5	150-230	23-29	60%	30
3	6-10	200-500	16-18	60%	30
4	11-20	200-500	12-16	60%	30
Aggregate (Radar Types 1-4)				80%	120
Note 1: Short Pulse Radar Type 0 should be used for the detection bandwidth test, channel move time, and channel closing time tests.					

A minimum of 30 unique waveforms are required for each of the Short Pulse Radar Types 2 through 4. If more than 30 waveforms are used for Short Pulse Radar Types 2 through 4, then each additional waveform must also be unique and not repeated from the previous waveforms. If more than 30 waveforms are used for Short Pulse Radar Type 1, then each additional waveform is generated with Test B and must also be unique and not repeated from the previous waveforms in Tests A or B.

Table 10: Long Pulse Radar Test Waveform

Radar Type	Pulse Width (μsec)	Chirp Width (MHz)	PRI (μsec)	Number of Pulses per Burst	Number of Bursts	Minimum Percentage of Successful Detection	Minimum Number of Trials
5	50-100	5-20	1000-2000	1-3	8-20	80%	30

Table 11: Frequency Hopping Radar Test Waveform

Radar Type	Pulse Width (μsec)	Chirp Width (MHz)	PRI (μsec)	Number of Pulses per Burst	Number of Bursts	Minimum Percentage of Successful Detection	Minimum Number of Trials
6	1	333	9	0.333	300	70%	30

4. TEST INSTRUMENTS

Table 1: Test instruments list.

DESCRIPTION	MANUFACTURER	MODEL NO.	Serial No	Calibration Until
EXA Spectrum Analyzer	Agilent	N9010A	MY50520044	Mar. 28, 2016
Signal Generator	Agilent	E4438C	MY49071316	Mar. 28, 2016
POWER SPLITTER	Mini-Circuits	ZFRSC-123-S+	331000910-1	Mar. 17, 2016
POWER SPLITTER	Mini-Circuits	ZN4PD1-63-S+	SF9335D1045-1	Mar.04, 2016
Attenuator	WOKEN	6SM3502	VAS1214NL	Mar. 10, 2016
Spectrum Analyzer	R&S	FSL 6	100423	Nov. 02, 2015

Note: Calibration interval of instruments listed above is one year.

5. EMC EMISSION TEST

5.1 DFS MEASUREMENT SYSTEM:

CONDUCTED METHOD SYSTEM BLOCK DIAGRAM

Master Conducted Measurement

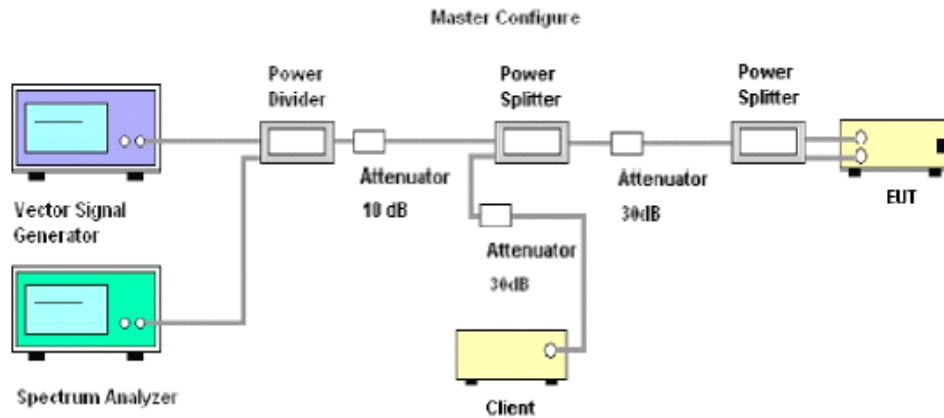

SYSTEM OVERVIEW

The short pulse and long pulse signal generating system utilizes the NTIA software. The Vector Signal Generator has been validated by the NTIA. The hopping signal generating system utilizes the CCS simulated hopping method and system, which has been validated by the DoD, FCC and NTIA. The software selects waveform parameters from within the bounds of the signal type on a random basis using uniform distribution.

The short pulse types 2, 3 and 4, and the long pulse type 5 parameters are randomized at run-time.

The hopping type 6 pulse parameters are fixed while the hopping sequence is based on the August 2005 NTIA Hopping Frequency List. The initial starting point randomized at run-time and each subsequent starting point is incremented by 475. Each frequency in the 100-length segment is compared to the boundaries of the EUT Detection Bandwidth and the software creates a hopping burst pattern in accordance with Section 7.4.1.3 Method #2 Simulated Frequency Hopping Radar Waveform Generating Subsystem of FCC 06-96. The frequency of the signal generator is incremented in 1 MHz steps from FL to FH for each successive trial. This incremental sequence is repeated as required to generate a minimum of 30 total trials and to maintain a uniform frequency distribution over the entire Detection Bandwidth.

The signal monitoring equipment consists of a spectrum analyzer set to display 8001 bins on the horizontal axis. The time-domain resolution is 2 msec / bin with a 16 second sweep time, meeting the 10 second short pulse reporting criteria. The aggregate ON time is calculated by multiplying the number of bins above a threshold during a particular observation period by the dwell time per bin, with the analyzer set to peak detection and max hold.

Should multiple RF ports be utilized for the Master and/or Slave devices (for example, for diversity or MIMO implementations), additional combiner/dividers are inserted between the Master Combiner/Divider and the pad connected to the Master Device (and/or between the Slave Combiner/Divider and the pad connected to the Slave Device). Additional pads are utilized such that there is one pad at each RF port on each EUT.

5.2 CALIBRATION OF DFS DETECTION THRESHOLD LEVEL:

A 50 ohm load is connected in place of the spectrum analyzer, and the spectrum analyzer is connected in place of the master device and the signal generator is set to CW mode. The amplitude of the signal generator is adjusted to yield a level of -62 dBm as measured on the spectrum analyzer.

Without changing any of the instrument settings, the spectrum analyzer is reconnected to the Common port of the Spectrum Analyzer Combiner/Divider. Measure the amplitude and calculate the difference from -62 dBm. Adjust the Reference Level Offset of the spectrum analyzer to this difference.

The spectrum analyzer displays the level of the signal generator as received at the antenna ports of the Master Device. The interference detection threshold may be varied from the calibrated value of -62 dBm and the spectrum analyzer will still indicate the level as received by the Master Device.

Set the signal generator to produce a radar waveform, trigger a burst manually and measure the level on the spectrum analyzer. Readjust the amplitude of the signal generator as required so that the peak level of the waveform is at a displayed level equal to the required or desired interference detection threshold. Separate signal generator amplitude settings are determined as required for each radar type.

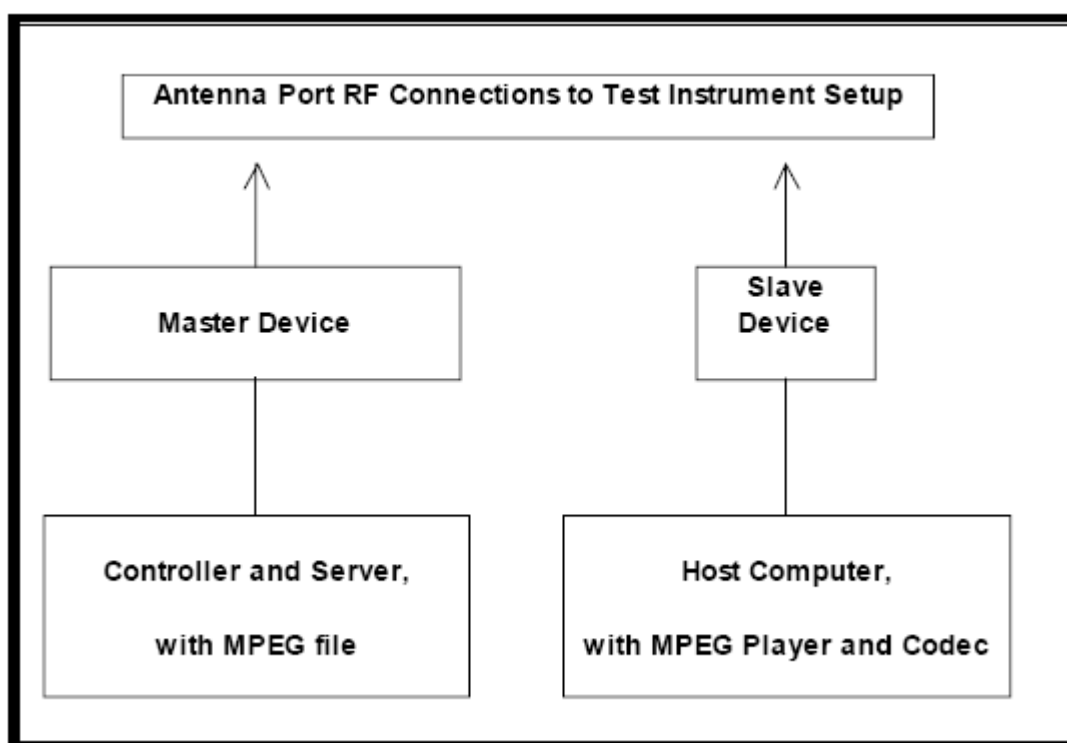

5.3 DEVIATION FROM TEST STANDARD

No deviation.

6. TEST RESULTS

6.1 SUMMARY OF TEST RESULT

Clause	Test Parameter	Remarks	Pass/Fail
15.407	DFS Detection Threshold	Applicable	Pass
15.407	Channel Availability Check Time	Applicable	Pass
15.407	Channel Move Time	Applicable	Pass
15.407	Channel Closing Transmission Time	Applicable	Pass
15.407	Non- Occupancy Period	Applicable	Pass
15.407	Uniform Spreading	Applicable	Pass
15.407	U-NII Detection Bandwidth	Applicable	Pass

6.2 DETELED TEST RESULTS

Clause	Test Parameter	Remarks	Pass/Fail
15.407	DFS Detection Threshold	Applicable	Pass
15.407	Channel Availability Check Time	Applicable	Pass
15.407	Channel Move Time	Applicable	Pass
15.407	Channel Closing Transmission Time	Applicable	Pass
15.407	Non- Occupancy Period	Applicable	Pass
15.407	Uniform Spreading	Applicable	Pass
15.407	U-NII Detection Bandwidth	Applicable	Pass

6.2.1 TEST MODE: DEVICE OPERATING IN MASTER MODE.

Master with injection at the Master. (Radar Test Waveforms are injected into the Master)

6.2.2 DFS DETECTION THRESHOLD

Calibration:

For a detection threshold level of -64dBm and the Master antenna gain is 8dBi, required detection threshold is -56 dBm ($= -64+8$).

Note: Maximum Transmit Power is more than 200 milliwatt in this report, so detection threshold level is -64dBm (please refer to Table 7 [page 9]).

Radar Signal 0

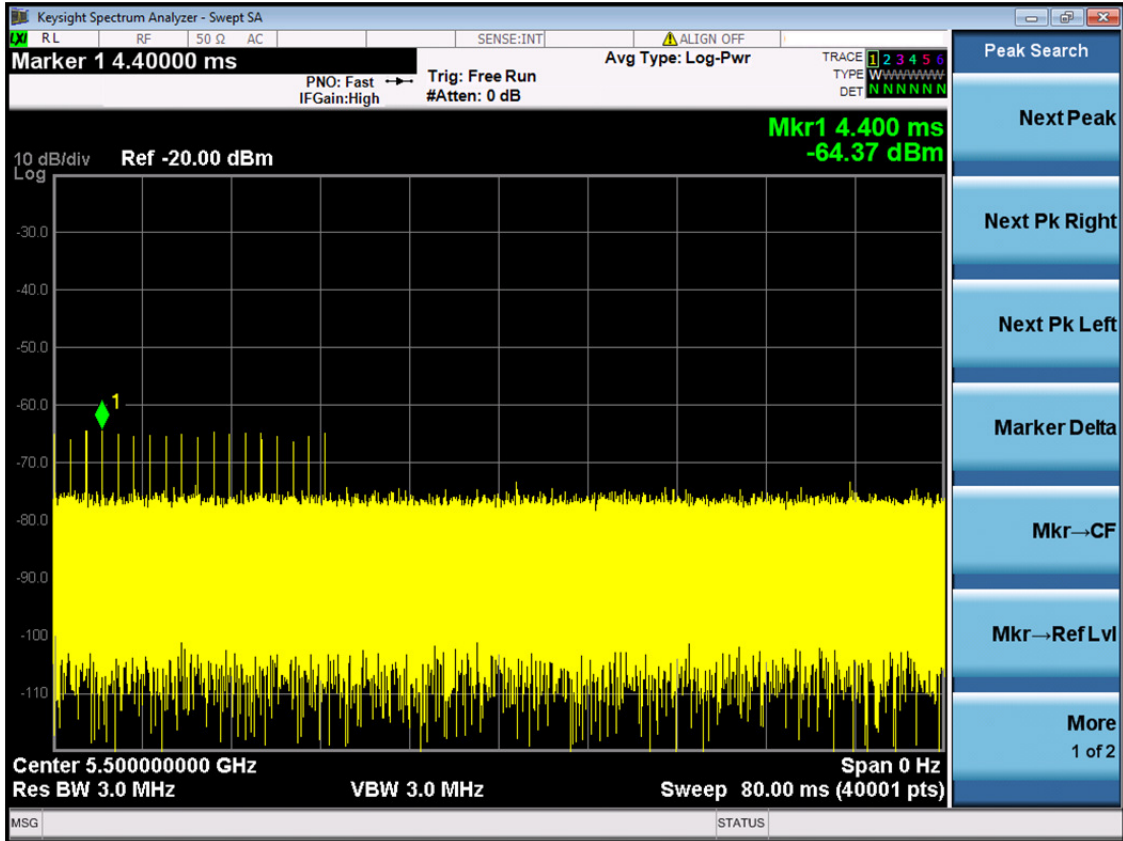

Radar Signal 1-A

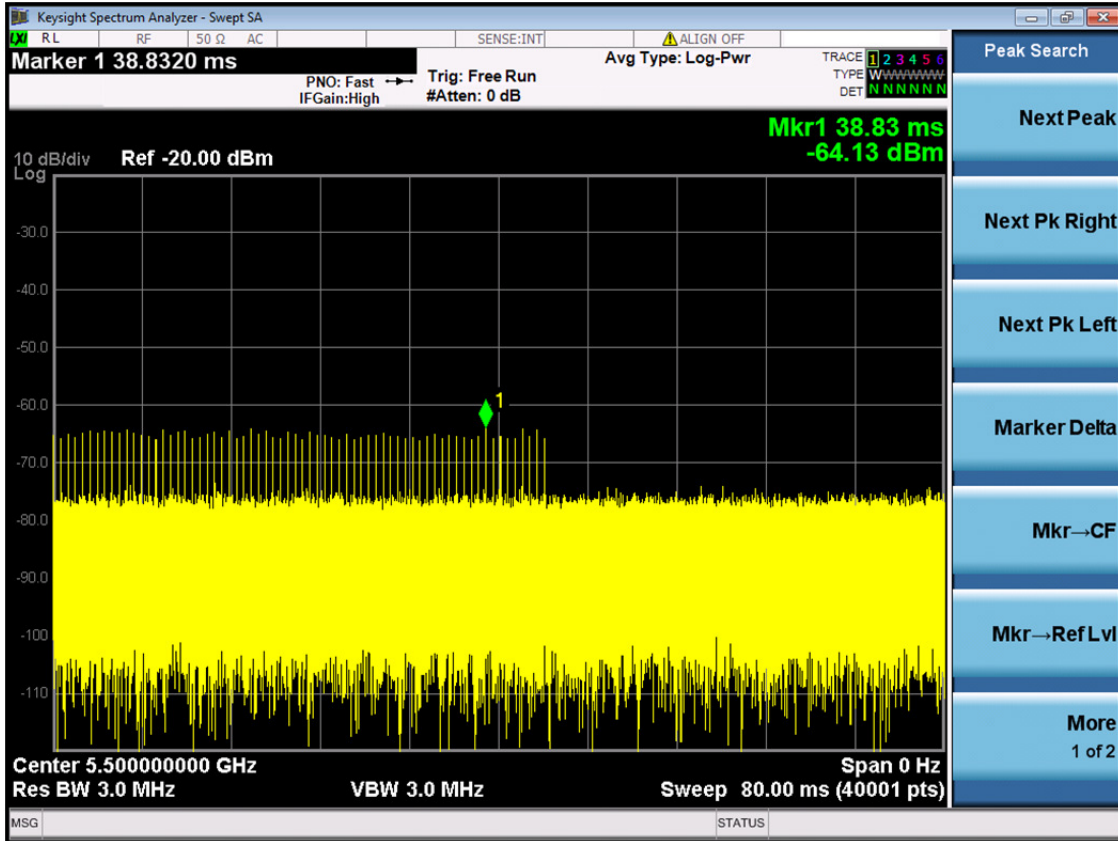

Radar Signal 1-B

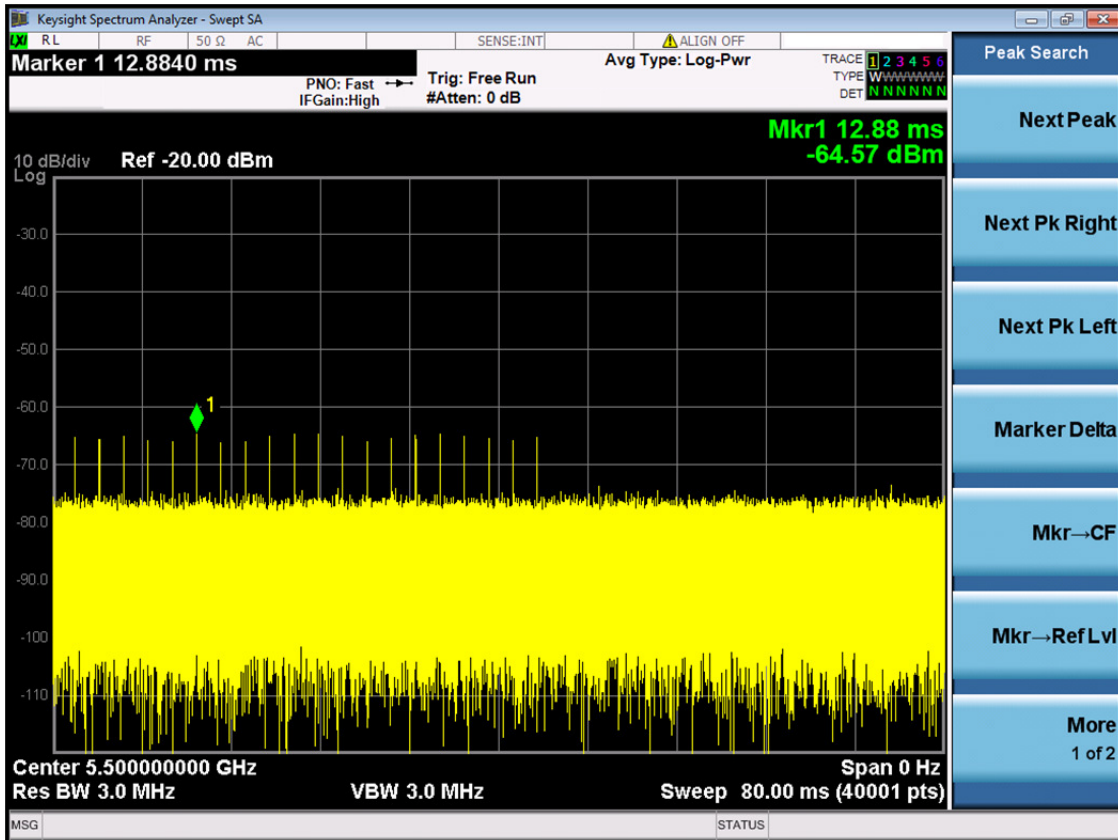

Radar Signal 2

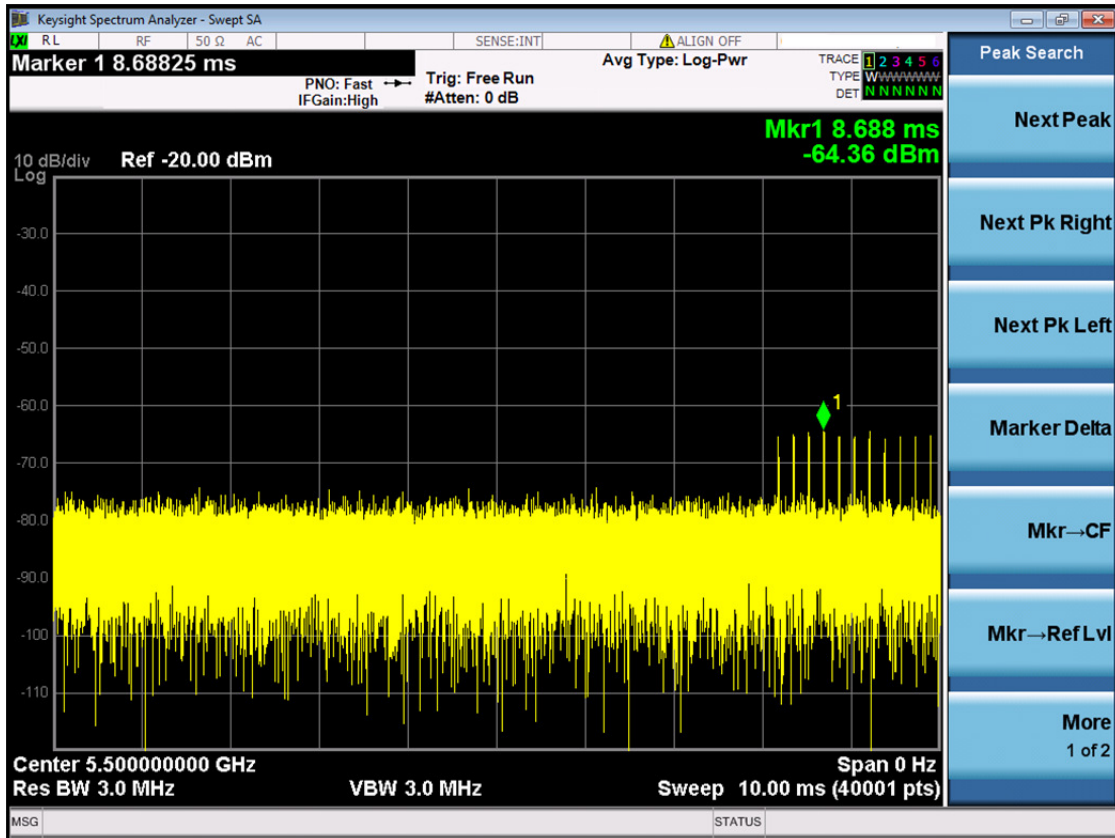

Radar Signal 3

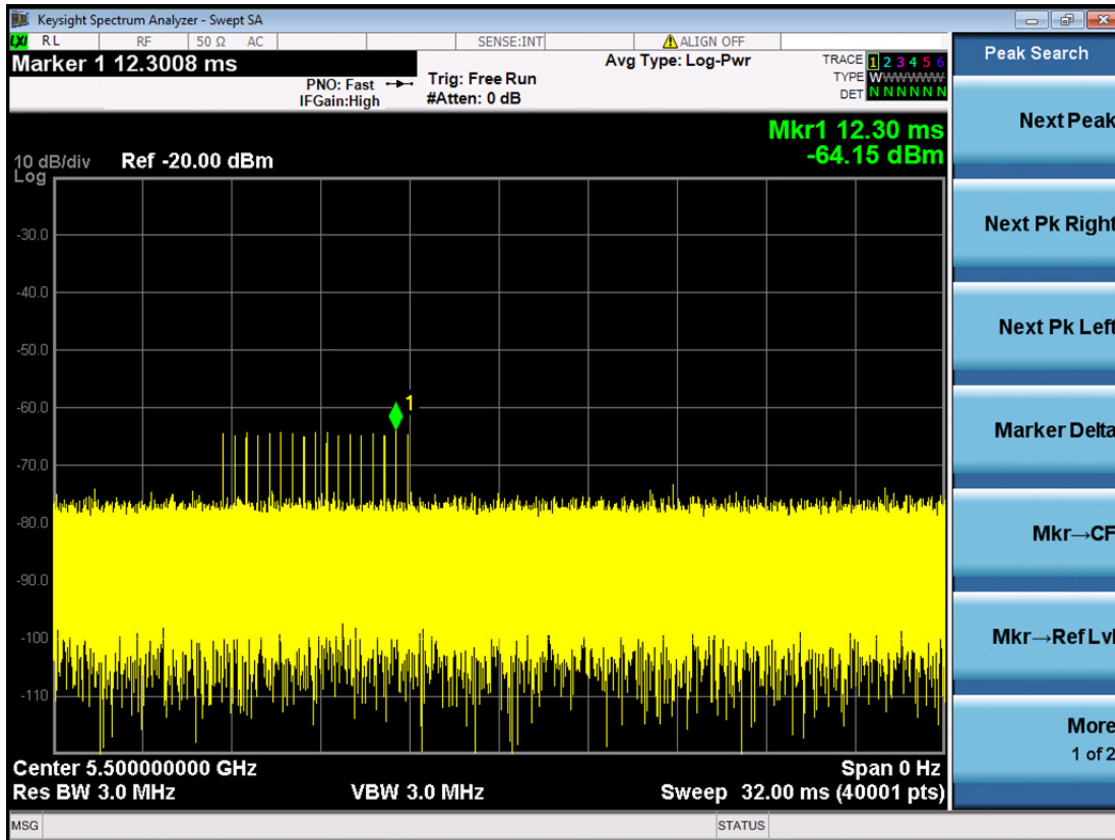

Radar Signal 4

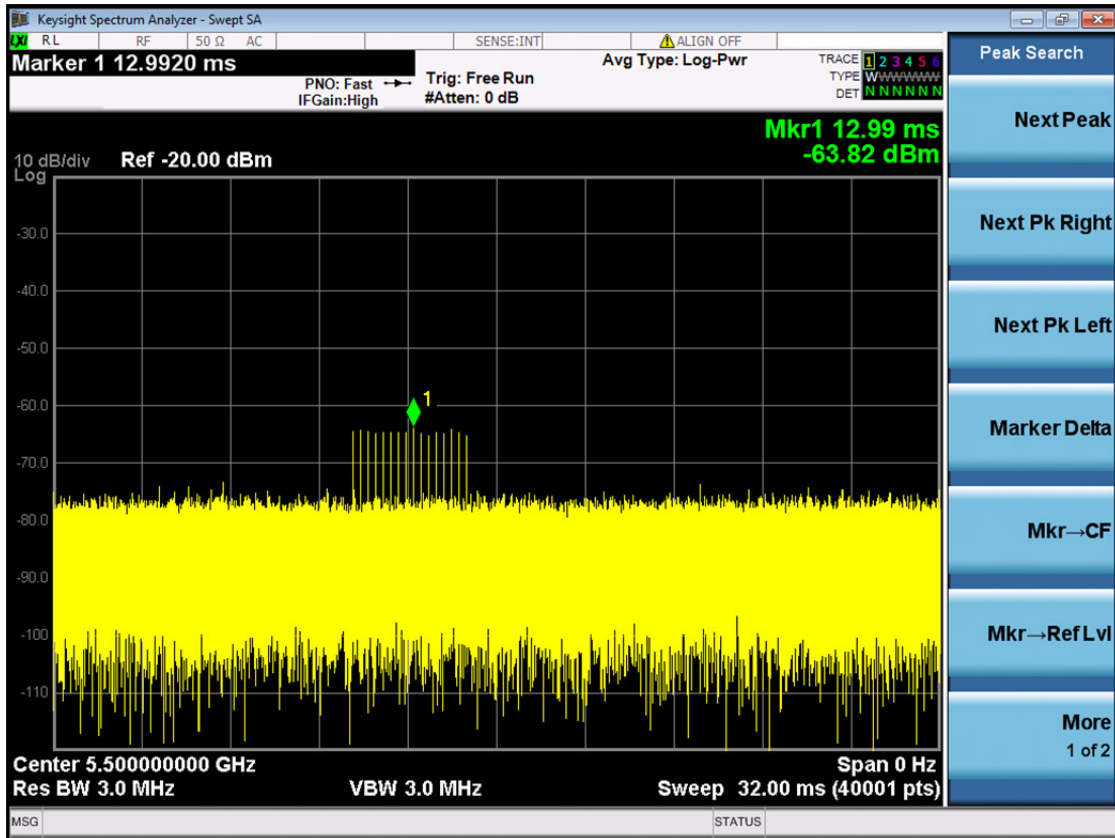

Radar Signal 5

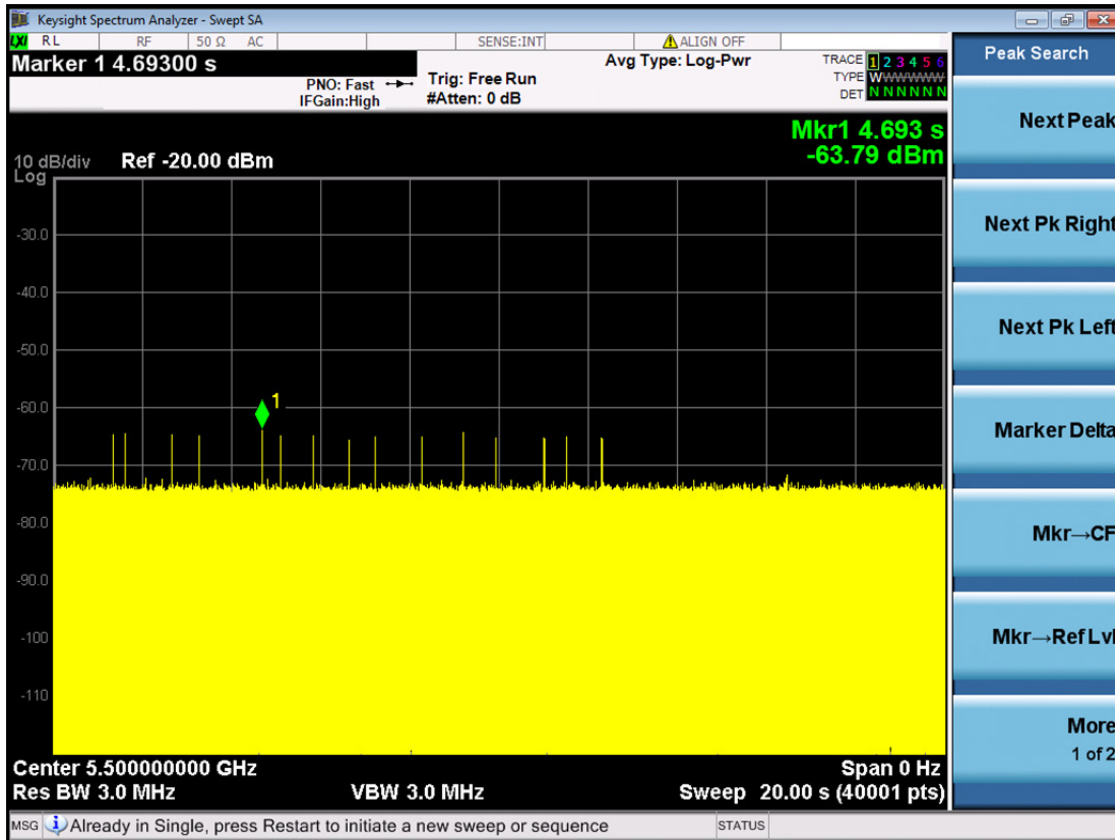

6.2.3 CHANNEL AVAILABILITY CHECK TIME

If the UUT successfully detected the radar burst, it should be observed as the UUT has no transmissions occurred until the UUT starts transmitting on another channel.

11aMode

Initial Channel Availability Check Time

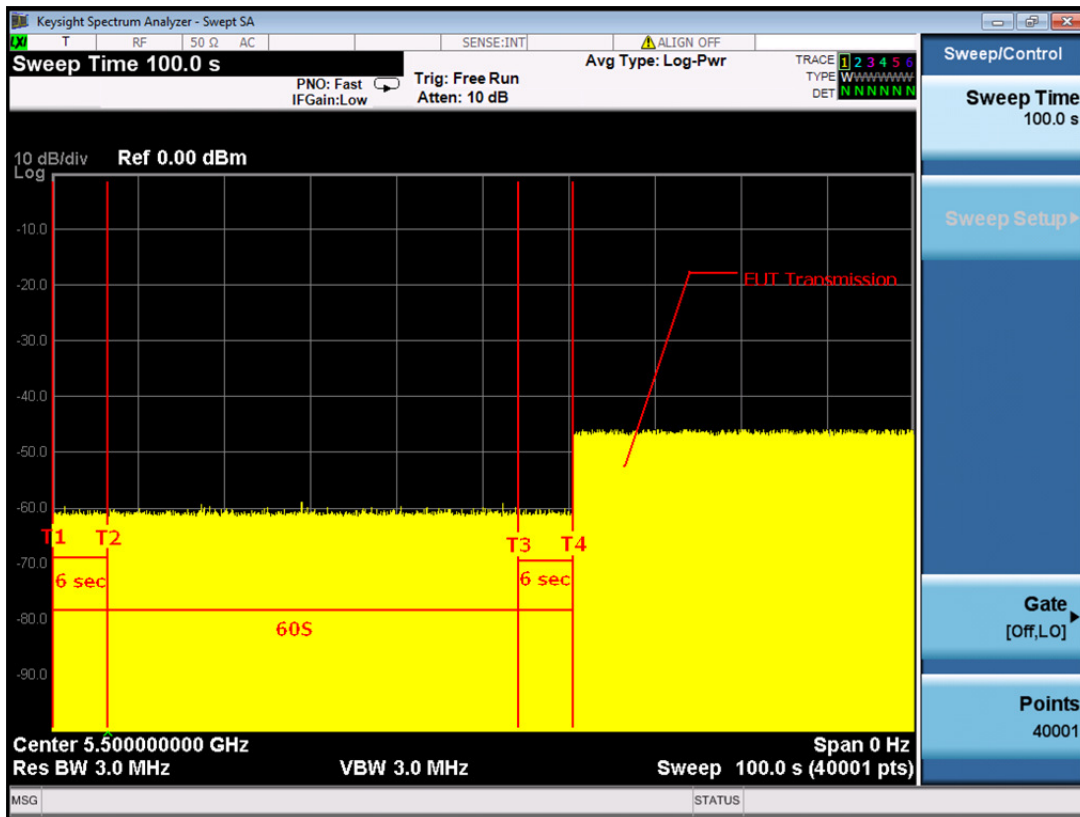

Note: T1 denotes the end of power-up time period is 6 second.

T4 denotes the end of Channel Availability Check time is 66 second. Channel Availability Check time is equal to (T4 – T1) 60 seconds.

11a Mode

Radar Burst at the Beginning of the Channel Availability Check Time

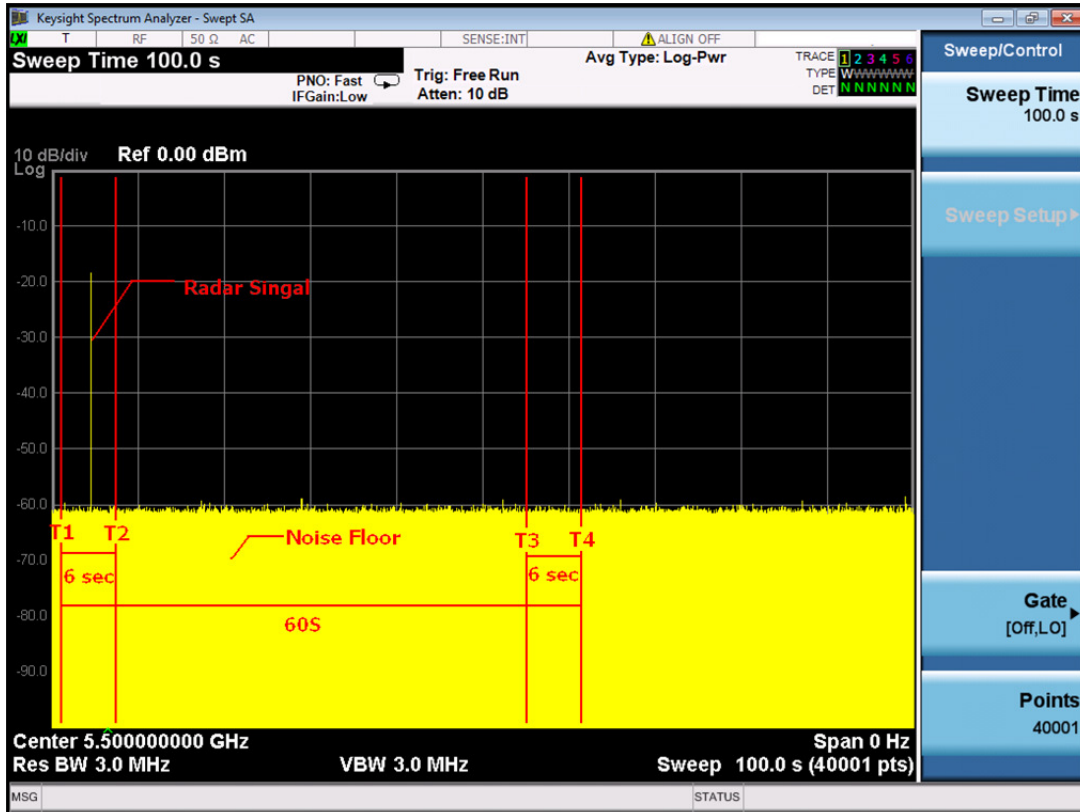

Note: T1 denotes the end of power up time period is 6 second.
T2 denotes 12 second. the radar burst was commenced within a 6 second window starting from the end of power-up sequence.
T4 denotes the 66 second.

11a Mode

Radar Burst at the End of the Channel Availability Check Time

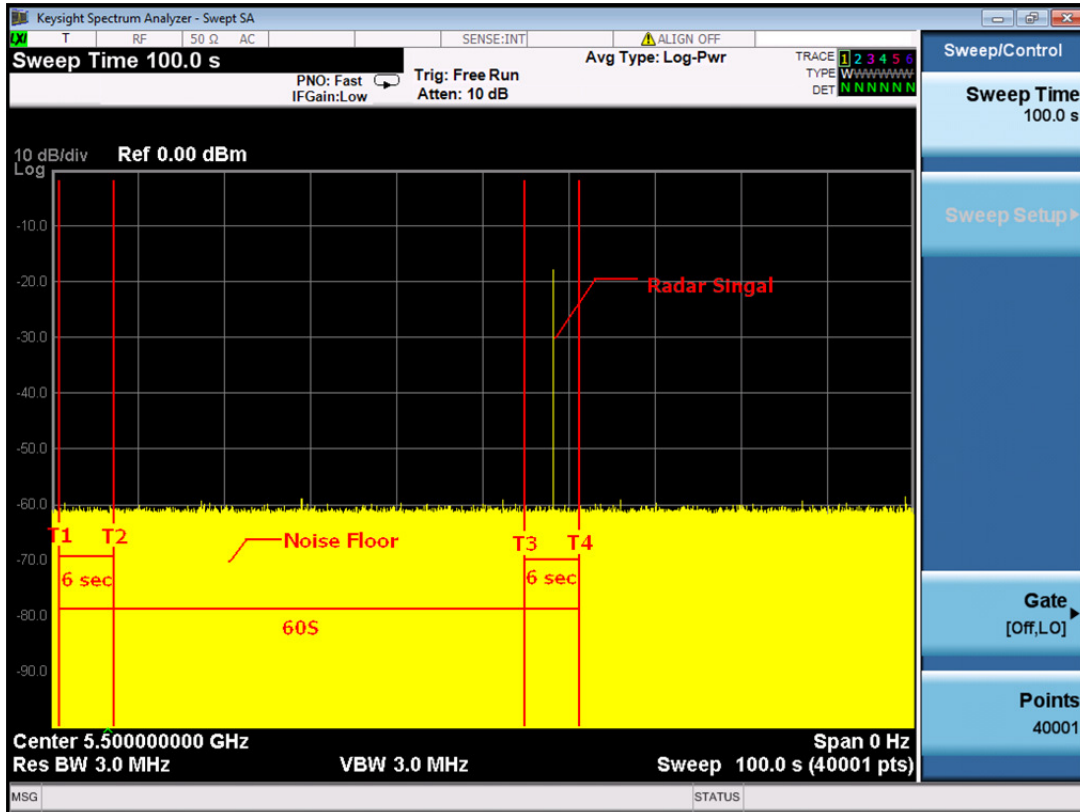

Note: T1 denotes the end of power up time period is 6 second.
 T3 denotes 66 second and radar burst was commenced within 54thsecond to 60thsecond window starting from the end of power-up sequence.
 T4 denotes the 66 second

11n 40MHz Mode

Initial Channel Availability Check Time

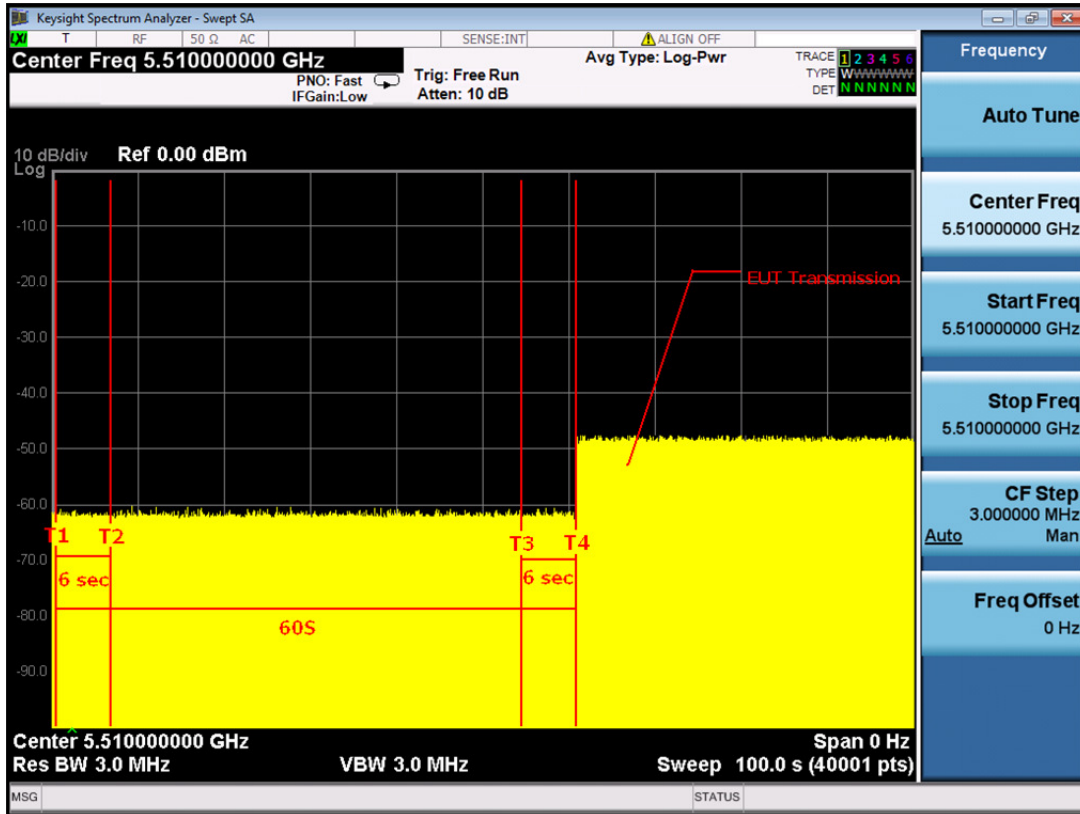

Note: T1 denotes the end of power-up time period is 6 second.
T4 denotes the end of Channel Availability Check time is 66 second. Channel Availability Check time is equal to (T4 – T1) 60 seconds.

11n 40MHz Mode

Radar Burst at the Beginning of the Channel Availability Check Time

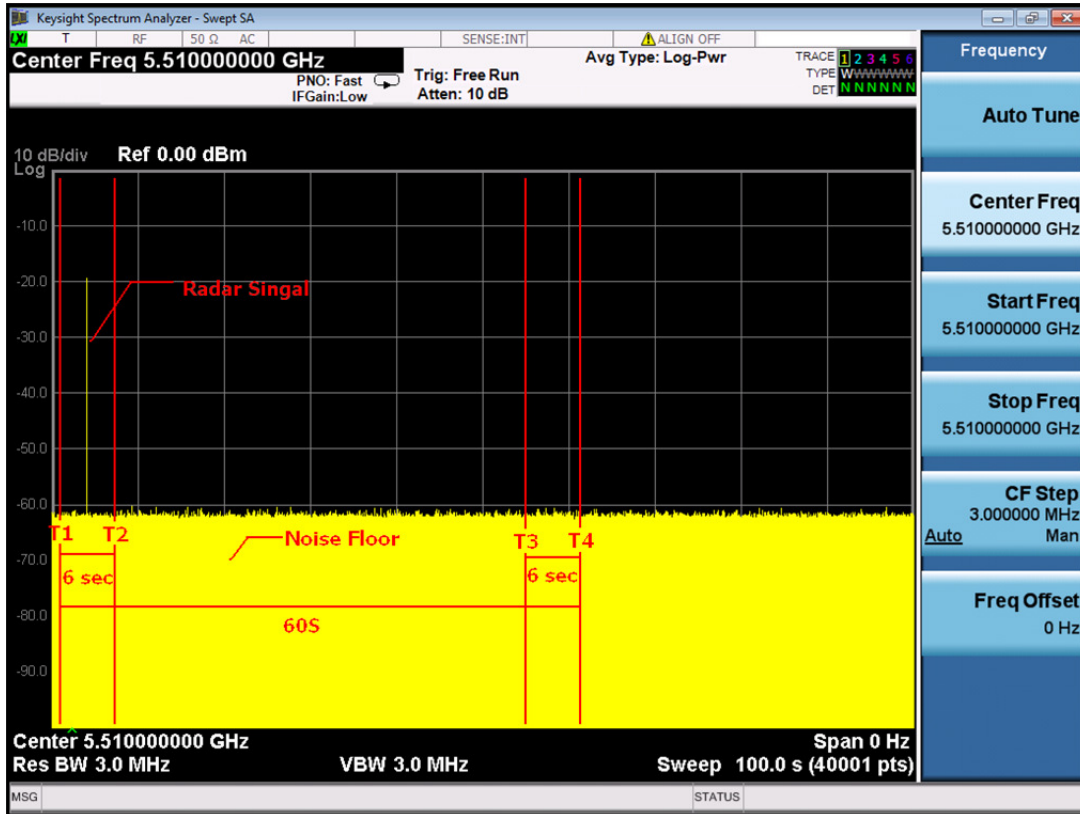

Note: T1 denotes the end of power up time period is 6 second.
 T2 denotes 12 second. the radar burst was commenced within a 6 second window starting from the end of power-up sequence.
 T4 denotes the 66 second.

11n 40MHz Mode

Radar Burst at the End of the Channel Availability Check Time

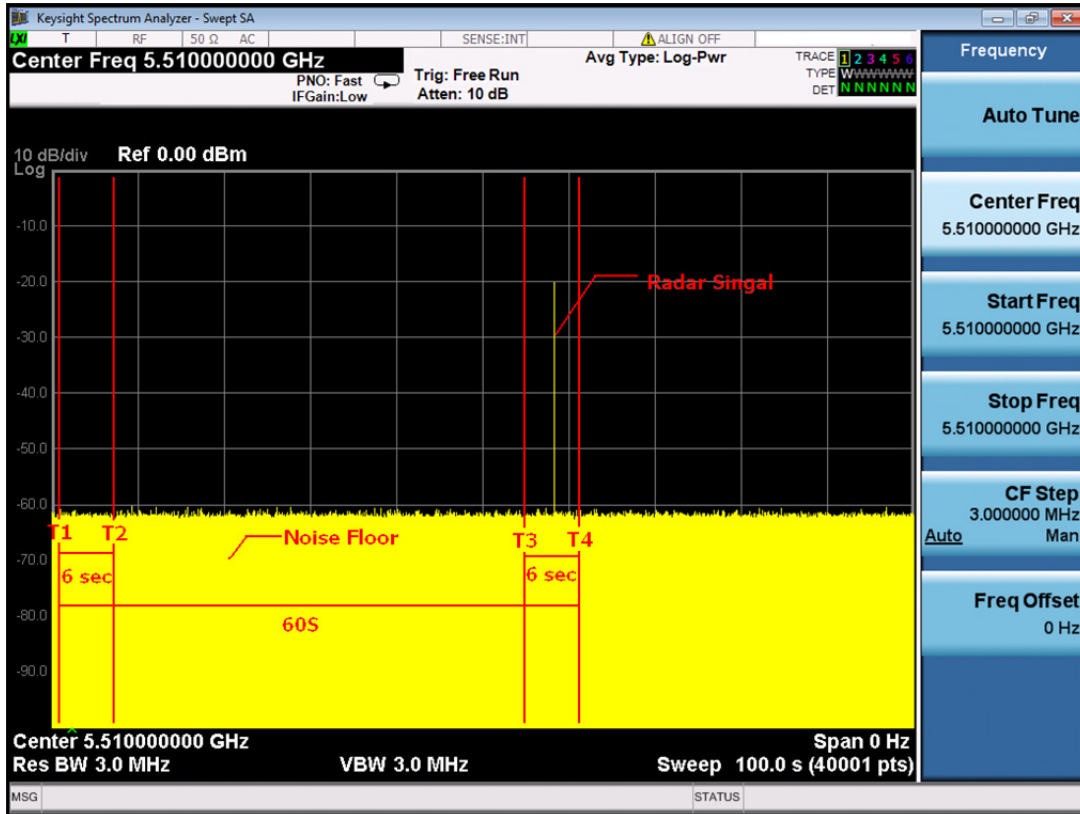

Note: T1 denotes the end of power up time period is 6 second.
 T3 denotes 66 second and radar burst was commenced within 54thsecond to 60thsecond window starting from the end of power-up sequence.
 T4 denotes the 66 second

11ac 80MHz Mode

Initial Channel Availability Check Time

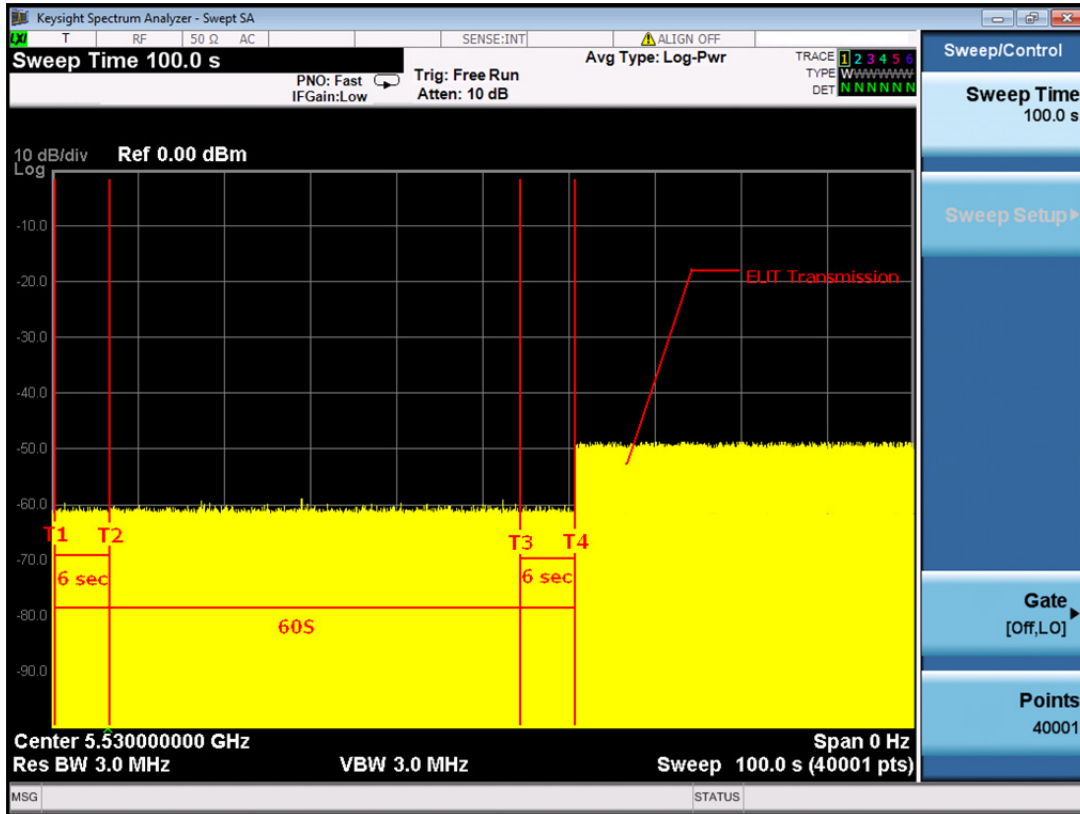

Note: T1 denotes the end of power-up time period is 6 second.
T4 denotes the end of Channel Availability Check time is 66 second. Channel Availability Check time is equal to (T4 – T1) 60 seconds.

11ac 80MHz Mode

Radar Burst at the Beginning of the Channel Availability Check Time

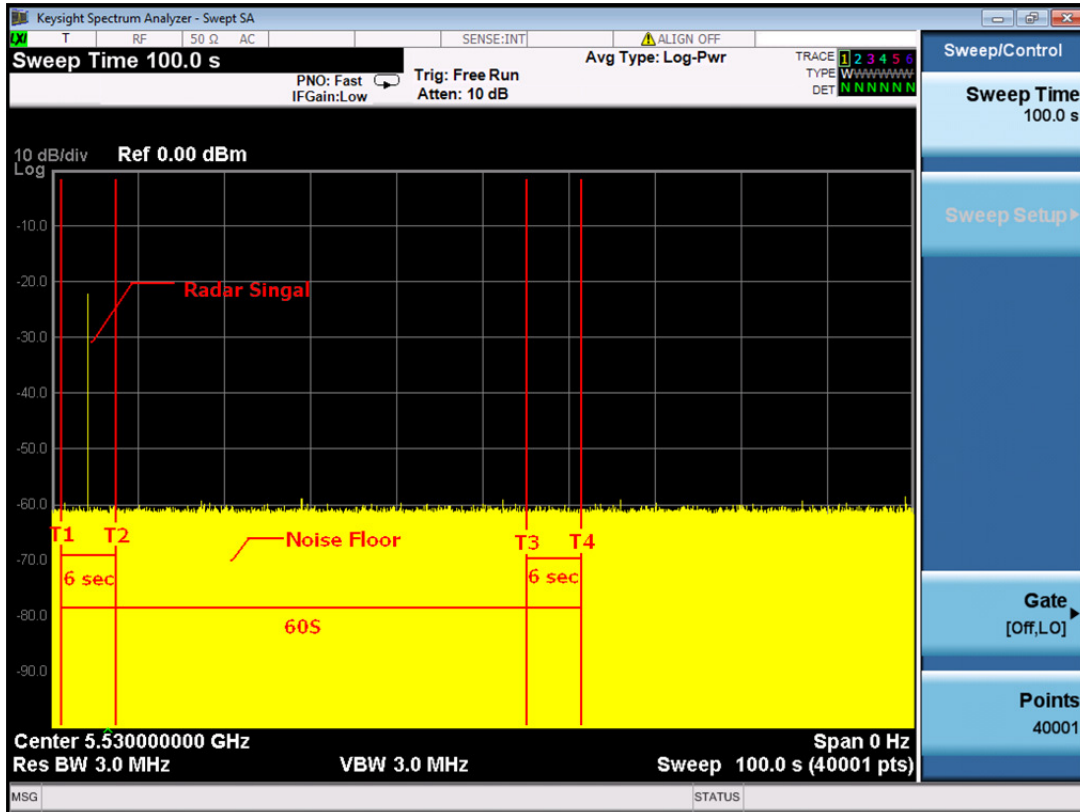

Note: T1 denotes the end of power up time period is 6 second.
 T2 denotes 12 second. the radar burst was commenced within a 6 second window starting from the end of power-up sequence.
 T4 denotes the 66 second.

11ac 80MHz Mode

Radar Burst at the End of the Channel Availability Check Time

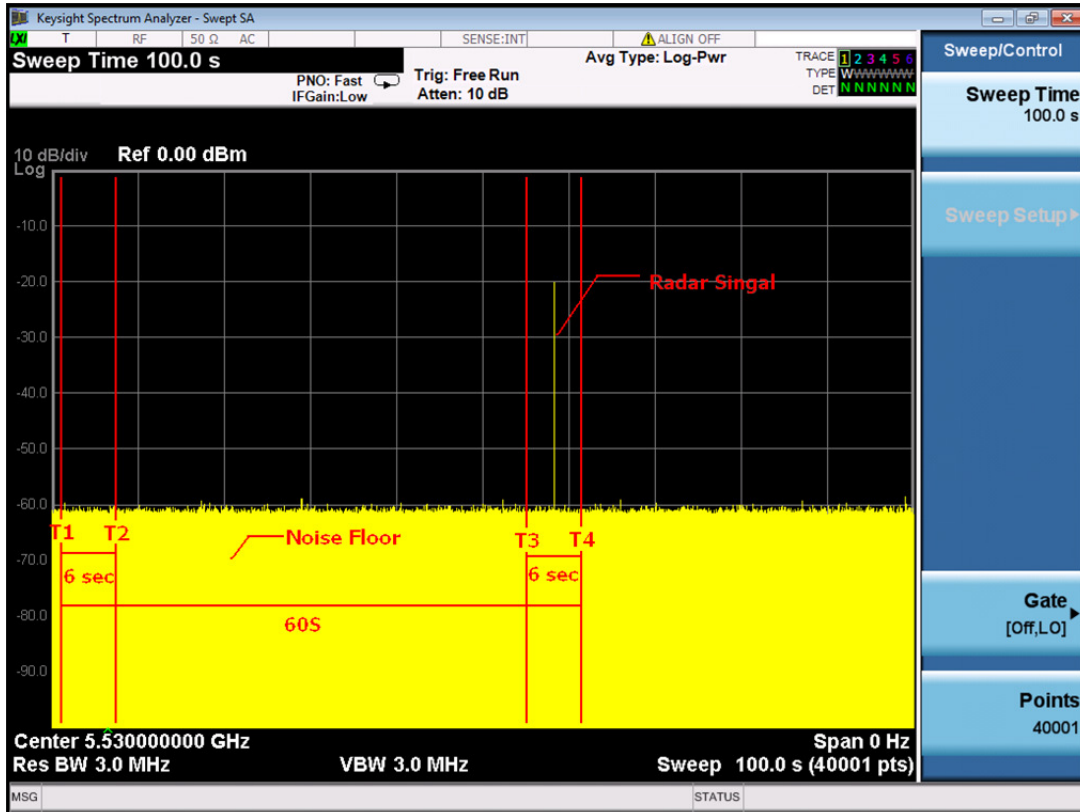

Note: T1 denotes the end of power up time period is 6 second.
 T3 denotes 66 second and radar burst was commenced within 54thsecond to 60thsecond window starting from the end of power-up sequence.
 T4 denotes the 66 second

6.2.4 CHANNEL CLOSING TRANSMISSION AND CHANNEL MOVE TIME WLAN TRAFFIC

TX (11a Mode)

Table 1: Short Pulse Radar Test Waveforms.

Radar Type	Pulse Width (µsec)	PRI (µsec)	Number of Pulses	Pass times	Fail times	Percentage of Successful Detection (%)
0	1	1428	18	30	0	100
1	1	Test A: 15 unique PRI values randomly selected from the list of 23 PRI values in Table 5a Test B: 15 unique PRI values randomly selected within the range of 518-3066 µsec, with a minimum increment of 1 µsec, excluding PRI values selected in Test A	$\text{Roundup} \left\{ \begin{array}{l} \left(\frac{1}{360} \right) \\ \left(\frac{19 \cdot 10^6}{\text{PRI}_{\mu\text{sec}}} \right) \end{array} \right\}$	27	3	90
2	1-5	150-230	23-29	28	2	93
3	6-10	200-500	16-18	26	4	87
4	11-20	200-500	12-16	27	3	90
Aggregate (Radar Types 1-4)			-	108	12	90

Table 2: Long Pulse Radar Test Waveform

Radar Type	Pulse Width (µsec)	Chirp Width (MHz)	PRI (µsec)	Number of Pulses Per Burst	Number of Bursts	Pass times	Fail times	Percentage of Successful Detection (%)
5	50-100	5-20	1000-2000	1-3	8-20	26	4	87

Table 3: Frequency Hopping Radar Test Waveform

Radar Type	Pulse Width (µsec)	PRI (µsec)	Pulses per Hop	Hopping Rate (kHz)	Hopping Sequence Length (msec)	Pass times	Fail times	Percentage of Successful Detection (%)
6	1	333	9	0.333	300	27	3	90

Table 4: Short Pulse Radar Test Waveforms.– Bridge Mode

Radar Type	Pulse Width (μsec)	PRI (μsec)	Number of Pulses	Pass times	Fail times	Percentage of Successful Detection (%)
0	1	1428	18	30	0	100

Table 5: Short Pulse Radar Test Waveforms.– Mesh Mode

Radar Type	Pulse Width (μsec)	PRI (μsec)	Number of Pulses	Pass times	Fail times	Percentage of Successful Detection (%)
0	1	1428	18	30	0	100

TX (11a Mode)

Radar signal 0

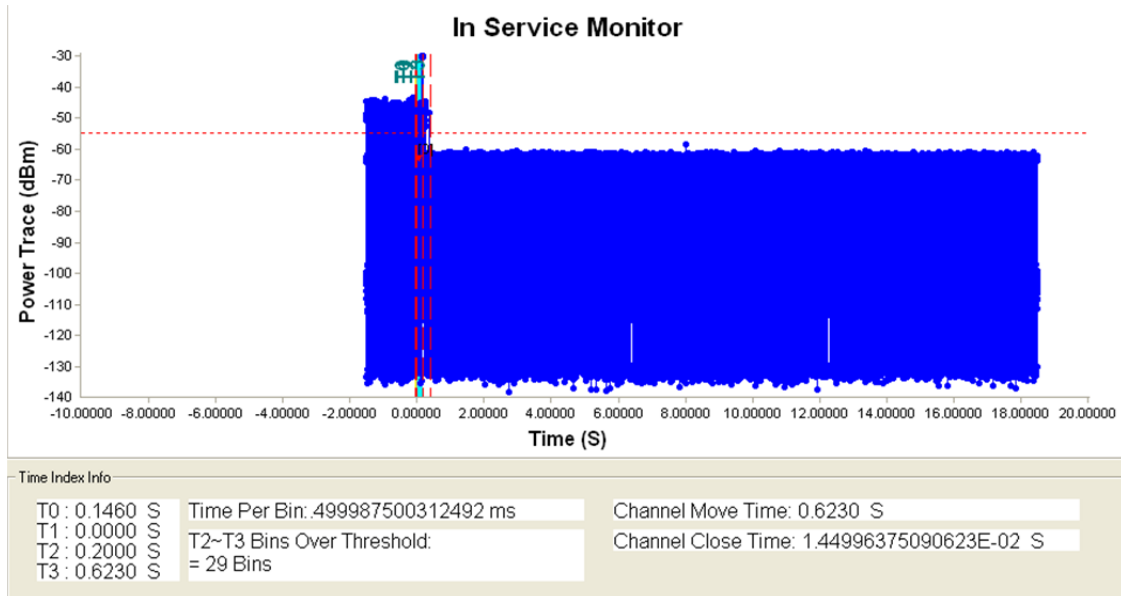

Note: T0 denotes the start of Channel Move Time upon the end of the last Radar burst.
 T1 denotes the data transmission time of 200ms from T0.
 T2 denotes the end of Channel Move Time.
 T3 denotes the 10 second from T0 to observe the aggregate duration of transmissions.

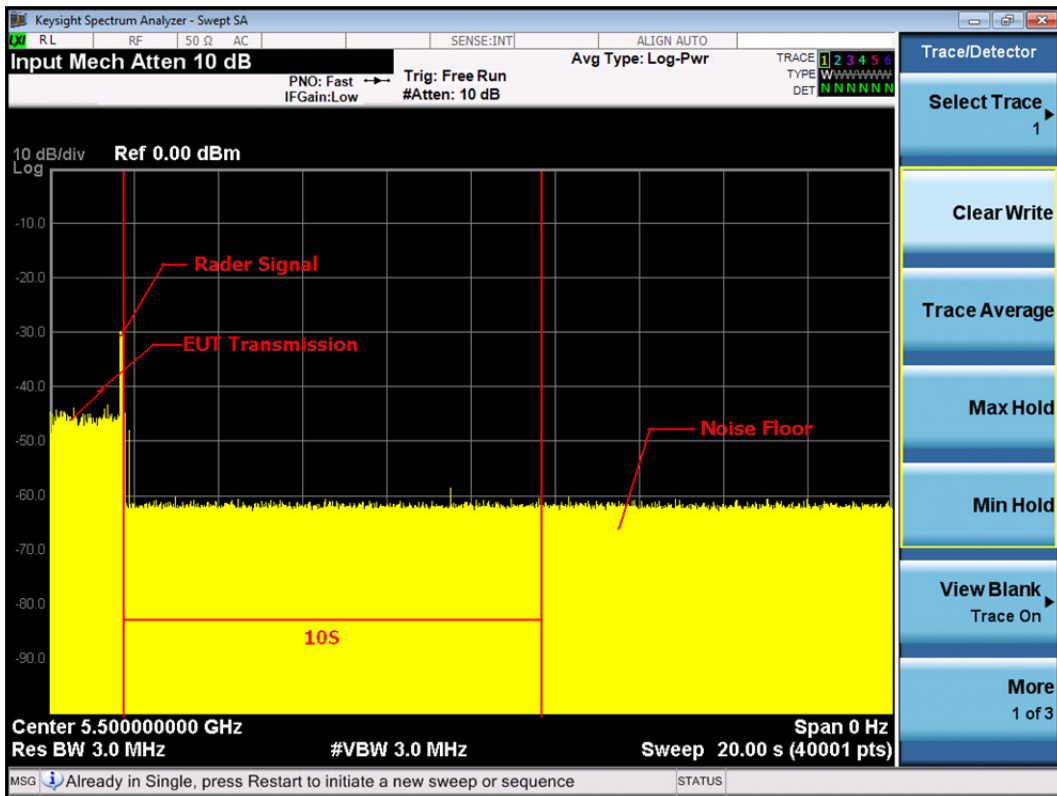

Note: An expanded plot for the device vacates the channel in the required 500ms

TX (11a Mode)

Radar1 Static Performances				
Trial #	Pluse per Burst	Pluse Width(us)	PRI(us)	Detection(YES / No)
1	18	1.0u	1.428	YES
2	18	1.0u	1.428	YES
3	18	1.0u	1.428	YES
4	18	1.0u	1.428	YES
5	18	1.0u	1.428	NO
6	18	1.0u	1.428	YES
7	18	1.0u	1.428	YES
8	18	1.0u	1.428	YES
9	18	1.0u	1.428	YES
10	18	1.0u	1.428	YES
11	18	1.0u	1.428	YES
12	18	1.0u	1.428	NO
13	18	1.0u	1.428	YES
14	18	1.0u	1.428	YES
15	18	1.0u	1.428	YES
16	18	1.0u	1.428	YES
17	18	1.0u	1.428	YES
18	18	1.0u	1.428	YES
19	18	1.0u	1.428	YES
20	18	1.0u	1.428	YES
21	18	1.0u	1.428	YES
22	18	1.0u	1.428	YES
23	18	1.0u	1.428	YES
24	18	1.0u	1.428	YES
25	18	1.0u	1.428	NO
26	18	1.0u	1.428	YES
27	18	1.0u	1.428	YES
28	18	1.0u	1.428	YES
29	18	1.0u	1.428	YES
30	18	1.0u	1.428	YES
Detection Rate :				90 %

Radar2 Statical Performances				
Trial #	Pluse per Burst	Pluse Width(us)	PRI(us)	Detection(YES / No)
1	28	4.3u	208	YES
2	28	2.8u	160	YES
3	26	2.9u	184	YES
4	24	2.7u	190	YES
5	28	3.4u	172	YES
6	28	4.0u	170	YES
7	27	1.3u	220	YES
8	28	1.4u	168	YES
9	25	4.5u	209	YES
10	24	3.3u	204	NO
11	26	2.4u	229	YES
12	27	3.8u	224	YES
13	23	2.7u	207	YES
14	24	3.3u	204	YES
15	26	2.4u	229	YES
16	27	3.8u	224	NO
17	29	2.7u	226	YES
18	29	2.9u	210	YES
19	27	1.8u	190	YES
20	26	2.0u	198	YES
21	23	1.2u	151	YES
22	25	1.4u	168	YES
23	25	1.5u	193	YES
24	27	2.6u	228	YES
25	26	1.7u	216	YES
26	23	4.8u	225	YES
27	28	1.9u	221	YES
28	26	4.1u	227	YES
29	26	3.1u	169	YES
30	27	2.2u	208	YES
Detection Rate 93%				

Radar3 Statical Performances				
Trial #	Pluse per Burst	Pluse Width(s)	PRI(us)	Detection(YES / No)
1	18	8.6u	405	YES
2	18	8.4u	410	YES
3	16	9.3u	398	NO
4	16	8.0u	364	YES
5	17	9.6u	366	YES
6	18	8.0u	258	YES
7	16	9.3u	268	NO
8	16	8.2u	477	YES
9	18	8.7u	206	YES
10	18	9.0u	213	YES
11	16	9.8u	482	YES
12	17	7.9u	436	YES
13	17	7.0u	447	YES
14	16	7.6u	410	YES
15	16	8.2u	300	YES
16	18	7.4u	336	YES
17	16	9.3u	492	YES
18	17	7.5u	471	YES
19	17	7.9u	481	NO
20	18	8.0u	492	YES
21	16	9.9u	463	YES
22	17	8.5u	445	YES
23	17	8.0u	250	YES
24	16	8.0u	364	YES
25	17	7.2u	435	YES
26	18	6.5u	336	YES
27	18	6.8u	480	YES
28	17	7.2u	435	NO
29	18	6.5u	336	YES
30	18	6.8u	480	YES
				Detection Rate 87%

Radar4 Statical Performances				
Trial #	Pluse per Burst	Pluse Width(us)	PRI(us)	Detection(YES / No)
1	13	13.8u	482	YES
2	15	14.9u	436	YES
3	15	15.8u	447	YES
4	15	14.6u	410	YES
5	14	13.9u	481	YES
6	14	16.0u	492	YES
7	15	17.0u	463	YES
8	12	17.5u	445	YES
9	12	16.0u	442	YES
10	13	13.6u	405	YES
11	16	14.4u	440	YES
12	16	15.3u	398	YES
13	13	14.0u	364	YES
14	16	13.2u	477	YES
15	12	12.7u	206	NO
16	13	12.0u	213	YES
17	15	19.0u	300	YES
18	13	11.4u	336	YES
19	16	12.5u	330	YES
20	13	16.6u	463	YES
21	13	18.8u	445	YES
22	15	19.0u	442	YES
23	15	14.8u	405	YES
24	15	18.6u	409	YES
25	15	18.2u	441	YES
26	12	20.0u	332	YES
27	14	14.8u	478	YES
28	13	15.6u	367	YES
29	14	17.0u	258	NO
30	15	19.3u	270	YES
				Detection Rate 93%

Radar5 Statical Performances		
Trial #	Test Signal name	Detection(YES / No)
1	LP_Signal_01	Yes
2	LP_Signal_02	Yes
3	LP_Signal_03	Yes
4	LP_Signal_04	Yes
5	LP_Signal_05	Yes
6	LP_Signal_06	Yes
7	LP_Signal_07	Yes
8	LP_Signal_08	Yes
9	LP_Signal_09	Yes
10	LP_Signal_10	Yes
11	LP_Signal_11	Yes
12	LP_Signal_12	Yes
13	LP_Signal_13	Yes
14	LP_Signal_14	Yes
15	LP_Signal_15	Yes
16	LP_Signal_16	Yes
17	LP_Signal_17	Yes
18	LP_Signal_18	Yes
19	LP_Signal_19	Yes
20	LP_Signal_20	Yes
21	LP_Signal_21	Yes
22	LP_Signal_22	Yes
23	LP_Signal_23	Yes
24	LP_Signal_24	Yes
25	LP_Signal_25	Yes
26	LP_Signal_26	Yes
27	LP_Signal_27	Yes
28	LP_Signal_28	Yes
29	LP_Signal_29	Yes
30	LP_Signal_30	Yes
		Detection Rate 100%

Radar6 Statical Performances		
Trial #	Hoping Frequency Sequence Name	Detection(YES / No)
1	HOP_FREQ_SEQ_01	Yes
2	HOP_FREQ_SEQ_02	Yes
3	HOP_FREQ_SEQ_03	Yes
4	HOP_FREQ_SEQ_04	NO
5	HOP_FREQ_SEQ_05	Yes
6	HOP_FREQ_SEQ_06	Yes
7	HOP_FREQ_SEQ_07	Yes
8	HOP_FREQ_SEQ_08	Yes
9	HOP_FREQ_SEQ_09	Yes
10	HOP_FREQ_SEQ_10	Yes
11	HOP_FREQ_SEQ_11	Yes
12	HOP_FREQ_SEQ_12	NO
13	HOP_FREQ_SEQ_13	Yes
14	HOP_FREQ_SEQ_14	Yes
15	HOP_FREQ_SEQ_15	NO
16	HOP_FREQ_SEQ_16	Yes
17	HOP_FREQ_SEQ_17	Yes
18	HOP_FREQ_SEQ_18	Yes
19	HOP_FREQ_SEQ_19	Yes
20	HOP_FREQ_SEQ_20	Yes
21	HOP_FREQ_SEQ_21	Yes
22	HOP_FREQ_SEQ_22	Yes
23	HOP_FREQ_SEQ_23	Yes
24	HOP_FREQ_SEQ_24	Yes
25	HOP_FREQ_SEQ_25	Yes
26	HOP_FREQ_SEQ_26	Yes
27	HOP_FREQ_SEQ_27	Yes
28	HOP_FREQ_SEQ_28	Yes
29	HOP_FREQ_SEQ_29	Yes
30	HOP_FREQ_SEQ_30	Yes
		Detection Rate 90%

TX (11n 40MHz Mode)

Table 1: Short Pulse Radar Test Waveforms.

Radar Type	Pulse Width (µsec)	PRI (µsec)	Number of Pulses	Pass times	Fail times	Percentage of Successful Detection (%)
0	1	1428	18	30	0	100
1	1	Test A: 15 unique PRI values randomly selected from the list of 23 PRI values in Table 5a Test B: 15 unique PRI values randomly selected within the range of 518-3066 µsec, with a minimum increment of 1 µsec, excluding PRI values selected in Test A	$\text{Roundup} \left\{ \frac{\left(\frac{1}{360} \right) \cdot 19 \cdot 10^6}{\text{PRI}_{\mu\text{sec}}} \right\}$	28	2	93
2	1-5	150-230	23-29	27	3	90
3	6-10	200-500	16-18	25	5	83
4	11-20	200-500	12-16	27	3	90
Aggregate (Radar Types 1-4)			-	107	13	89

Table 2: Long Pulse Radar Test Waveform

Rad ar Type	Pulse Width (µsec)	PRI (µsec)	Pulses per Hop	Hopping Rate (kHz)	Hopping Sequence Length (msec)	Pass times	Fail times	Percentage of Successful Detection (%)
5	1	333	9	0.333	300	26	4	87

Table 3: Frequency Hopping Radar Test Waveform

Rad ar Type	Pulse Width (µsec)	PRI (µsec)	Pulses per Hop	Hopping Rate (kHz)	Hopping Sequence Length (msec)	Pass times	Fail times	Percentage of Successful Detection (%)
6	1	333	9	0.333	300	27	3	90

Table 4: Short Pulse Radar Test Waveforms.– Bridge Mode

Radar Type	Pulse Width (μsec)	PRI (μsec)	Number of Pulses	Pass times	Fail times	Percentage of Successful Detection (%)
0	1	1428	18	29	1	97

Table 5: Short Pulse Radar Test Waveforms.– Mesh Mode

Radar Type	Pulse Width (μsec)	PRI (μsec)	Number of Pulses	Pass times	Fail times	Percentage of Successful Detection (%)
0	1	1428	18	30	0	100

TX (11n 40MHz Mode)

Radar signal 0

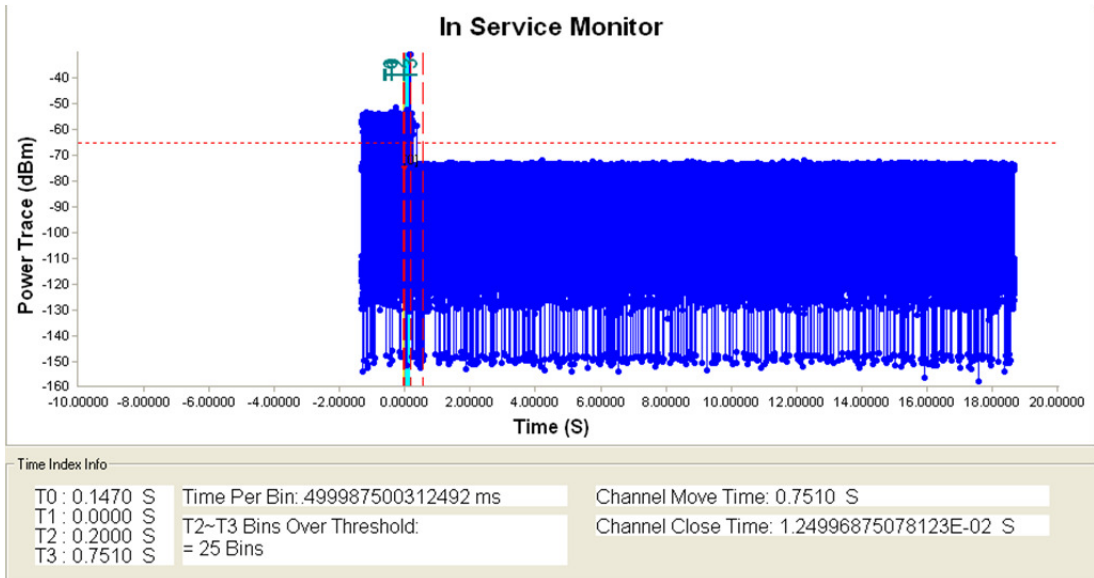

Note: T0 denotes the start of Channel Move Time upon the end of the last Radar burst.
 T1 denotes the data transmission time of 200ms from T0.
 T2 denotes the end of Channel Move Time.
 T3 denotes the 10 second from T0 to observe the aggregate duration of transmissions.

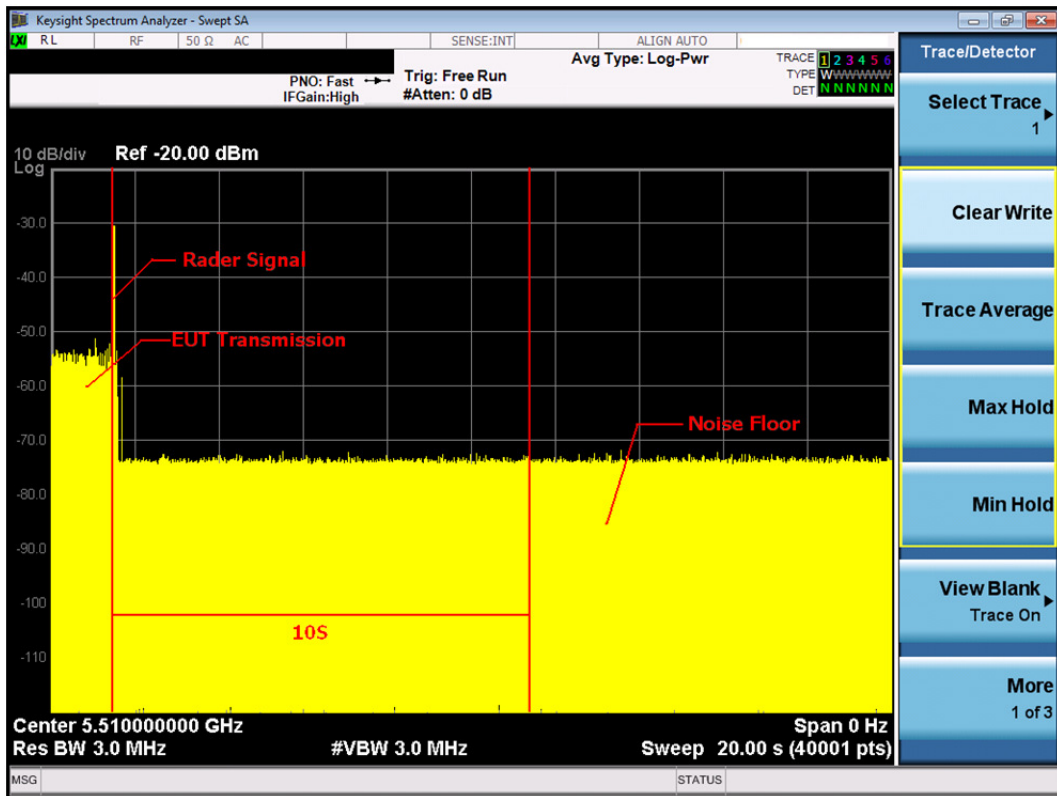

Note: An expanded plot for the device vacates the channel in the required 500ms

TX (11n 40MHz Mode)

Radar1 Statical Performances				
Trial #	Pluse per Burst	Pluse Width(us)	PRI(us)	Detection(YES / No)
1	18	1.0u	1.428	YES
2	18	1.0u	1.428	YES
3	18	1.0u	1.428	YES
4	18	1.0u	1.428	YES
5	18	1.0u	1.428	NO
6	18	1.0u	1.428	YES
7	18	1.0u	1.428	YES
8	18	1.0u	1.428	YES
9	18	1.0u	1.428	YES
10	18	1.0u	1.428	YES
11	18	1.0u	1.428	YES
12	18	1.0u	1.428	NO
13	18	1.0u	1.428	YES
14	18	1.0u	1.428	YES
15	18	1.0u	1.428	YES
16	18	1.0u	1.428	YES
17	18	1.0u	1.428	YES
18	18	1.0u	1.428	YES
19	18	1.0u	1.428	YES
20	18	1.0u	1.428	YES
21	18	1.0u	1.428	YES
22	18	1.0u	1.428	YES
23	18	1.0u	1.428	YES
24	18	1.0u	1.428	YES
25	18	1.0u	1.428	NO
26	18	1.0u	1.428	YES
27	18	1.0u	1.428	YES
28	18	1.0u	1.428	YES
29	18	1.0u	1.428	YES
30	18	1.0u	1.428	YES
Detection Rate 90%				

Radar2 Statical Performances				
Trial #	Pluse per Burst	Pluse Width(us)	PRI(us)	Detection(YES / No)
1	28	4.3u	208	YES
2	28	2.8u	160	YES
3	26	2.9u	184	YES
4	24	2.7u	190	YES
5	28	3.4u	172	YES
6	28	4.0u	170	YES
7	27	1.3u	220	YES
8	28	1.4u	168	YES
9	25	4.5u	209	YES
10	24	3.3u	204	NO
11	26	2.4u	229	YES
12	27	3.8u	224	YES
13	23	2.7u	207	YES
14	24	3.3u	204	YES
15	26	2.4u	229	YES
16	27	3.8u	224	NO
17	29	2.7u	226	YES
18	29	2.9u	210	YES
19	27	1.8u	190	YES
20	26	2.0u	198	YES
21	23	1.2u	151	YES
22	25	1.4u	168	YES
23	25	1.5u	193	YES
24	27	2.6u	228	YES
25	26	1.7u	216	YES
26	23	4.8u	225	YES
27	28	1.9u	221	YES
28	26	4.1u	227	YES
29	26	3.1u	169	YES
30	27	2.2u	208	YES
Detection Rate 93%				

Radar3 Statical Performances				
Trial #	Pluse per Burst	Pluse Width(s)	PRI(us)	Detection(YES / No)
1	18	8.6u	405	YES
2	18	8.4u	410	YES
3	16	9.3u	398	NO
4	16	8.0u	364	YES
5	17	9.6u	366	YES
6	18	8.0u	258	YES
7	16	9.3u	268	NO
8	16	8.2u	477	YES
9	18	8.7u	206	YES
10	18	9.0u	213	YES
11	16	9.8u	482	YES
12	17	7.9u	436	YES
13	17	7.0u	447	YES
14	16	7.6u	410	YES
15	16	8.2u	300	YES
16	18	7.4u	336	YES
17	16	9.3u	492	YES
18	17	7.5u	471	YES
19	17	7.9u	481	NO
20	18	8.0u	492	YES
21	16	9.9u	463	YES
22	17	8.5u	445	YES
23	17	8.0u	250	YES
24	16	8.0u	364	YES
25	17	7.2u	435	YES
26	18	6.5u	336	YES
27	18	6.8u	480	YES
28	17	7.2u	435	NO
29	18	6.5u	336	YES
30	18	6.8u	480	YES
Detection Rate 87%				

Radar4 Statical Performances				
Trial #	Pluse per Burst	Pluse Width(us)	PRI(us)	Detection(YES / No)
1	13	13.8u	482	YES
2	15	14.9u	436	YES
3	15	15.8u	447	YES
4	15	14.6u	410	YES
5	14	13.9u	481	YES
6	14	16.0u	492	YES
7	15	17.0u	463	YES
8	12	17.5u	445	YES
9	12	16.0u	442	YES
10	13	13.6u	405	YES
11	16	14.4u	440	YES
12	16	15.3u	398	YES
13	13	14.0u	364	YES
14	16	13.2u	477	YES
15	12	12.7u	206	NO
16	13	12.0u	213	YES
17	15	19.0u	300	YES
18	13	11.4u	336	YES
19	16	12.5u	330	YES
20	13	16.6u	463	YES
21	13	18.8u	445	YES
22	15	19.0u	442	YES
23	15	14.8u	405	YES
24	15	18.6u	409	YES
25	15	18.2u	441	YES
26	12	20.0u	332	YES
27	14	14.8u	478	YES
28	13	15.6u	367	YES
29	14	17.0u	258	NO
30	15	19.3u	270	YES
Detection Rate 93%				

Radar5 Statical Performances		
Trial #	Test Signal name	Detection(YES / No)
1	LP_Signal_01	Yes
2	LP_Signal_02	Yes
3	LP_Signal_03	Yes
4	LP_Signal_04	Yes
5	LP_Signal_05	Yes
6	LP_Signal_06	Yes
7	LP_Signal_07	Yes
8	LP_Signal_08	Yes
9	LP_Signal_09	Yes
10	LP_Signal_10	Yes
11	LP_Signal_11	Yes
12	LP_Signal_12	Yes
13	LP_Signal_13	Yes
14	LP_Signal_14	Yes
15	LP_Signal_15	Yes
16	LP_Signal_16	Yes
17	LP_Signal_17	Yes
18	LP_Signal_18	Yes
19	LP_Signal_19	Yes
20	LP_Signal_20	Yes
21	LP_Signal_21	Yes
22	LP_Signal_22	Yes
23	LP_Signal_23	Yes
24	LP_Signal_24	Yes
25	LP_Signal_25	Yes
26	LP_Signal_26	Yes
27	LP_Signal_27	Yes
28	LP_Signal_28	Yes
29	LP_Signal_29	Yes
30	LP_Signal_30	Yes
Detection Rate100%		

Radar6 Statical Performances		
Trial #	Hoping Frequency Sequence Name	Detection(YES / No)
1	HOP_FREQ_SEQ_01	Yes
2	HOP_FREQ_SEQ_02	Yes
3	HOP_FREQ_SEQ_03	Yes
4	HOP_FREQ_SEQ_04	NO
5	HOP_FREQ_SEQ_05	Yes
6	HOP_FREQ_SEQ_06	Yes
7	HOP_FREQ_SEQ_07	Yes
8	HOP_FREQ_SEQ_08	Yes
9	HOP_FREQ_SEQ_09	Yes
10	HOP_FREQ_SEQ_10	Yes
11	HOP_FREQ_SEQ_11	Yes
12	HOP_FREQ_SEQ_12	NO
13	HOP_FREQ_SEQ_13	Yes
14	HOP_FREQ_SEQ_14	Yes
15	HOP_FREQ_SEQ_15	NO
16	HOP_FREQ_SEQ_16	Yes
17	HOP_FREQ_SEQ_17	Yes
18	HOP_FREQ_SEQ_18	Yes
19	HOP_FREQ_SEQ_19	Yes
20	HOP_FREQ_SEQ_20	Yes
21	HOP_FREQ_SEQ_21	Yes
22	HOP_FREQ_SEQ_22	Yes
23	HOP_FREQ_SEQ_23	Yes
24	HOP_FREQ_SEQ_24	Yes
25	HOP_FREQ_SEQ_25	Yes
26	HOP_FREQ_SEQ_26	Yes
27	HOP_FREQ_SEQ_27	Yes
28	HOP_FREQ_SEQ_28	Yes
29	HOP_FREQ_SEQ_29	Yes
30	HOP_FREQ_SEQ_30	Yes
Detection Rate 90%		

TX (11ac 80MHz Mode)

Table 1: Short Pulse Radar Test Waveforms.

Radar Type	Pulse Width (µsec)	PRI (µsec)	Number of Pulses	Pass times	Fail times	Percentage of Successful Detection (%)
0	1	1428	18	29	1	97
1	1	Test A: 15 unique PRI values randomly selected from the list of 23 PRI values in Table 5a Test B: 15 unique PRI values randomly selected within the range of 518-3066 µsec, with a minimum increment of 1 µsec, excluding PRI values selected in Test A	$\text{Roundup} \left\{ \frac{\left(\frac{1}{360} \right) \cdot \left(19 \cdot 10^6 \right)}{\text{PRI}_{\mu\text{sec}}} \right\}$	28	2	93
2	1-5	150-230	23-29	27	3	90
3	6-10	200-500	16-18	26	4	87
4	11-20	200-500	12-16	28	2	93
Aggregate (Radar Types 1-4)			-	109	11	91

Table 2: Long Pulse Radar Test Waveform

Radar Type	Pulse Width (µsec)	Chirp Width (MHz)	PRI (µsec)	Number of Pulses Per Burst	Number of Bursts	Pass times	Fail times	Percentage of Successful Detection (%)
5	50-100	5-20	1000-2000	1-3	8-20	27	3	90

Table 3: Frequency Hopping Radar Test Waveform

Radar Type	Pulse Width (µsec)	PRI (µsec)	Pulses per Hop	Hopping Rate (kHz)	Hopping Sequence Length (msec)	Pass times	Fail times	Percentage of Successful Detection (%)
6	1	333	9	0.333	300	26	4	87

Table 4: Short Pulse Radar Test Waveforms.– Bridge Mode

Radar Type	Pulse Width (μsec)	PRI (μsec)	Number of Pulses	Pass times	Fail times	Percentage of Successful Detection (%)
0	1	1428	18	28	2	93

Table 5: Short Pulse Radar Test Waveforms.– Mesh Mode

Radar Type	Pulse Width (μsec)	PRI (μsec)	Number of Pulses	Pass times	Fail times	Percentage of Successful Detection (%)
0	1	1428	18	29	1	97

TX (11ac 80MHz Mode)
 Radar signal 0

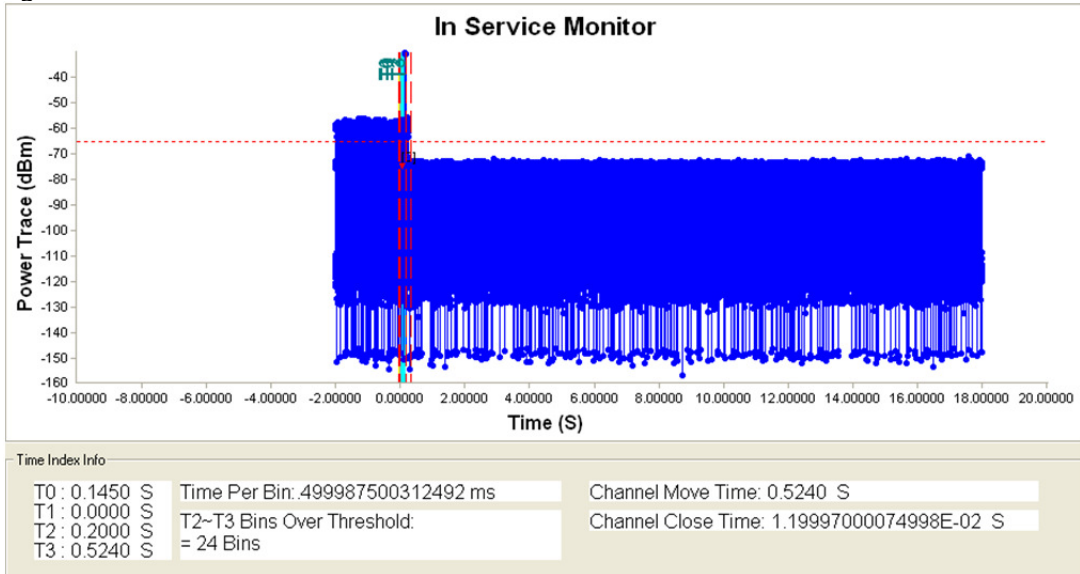

Note: T0 denotes the start of Channel Move Time upon the end of the last Radar burst.
 T1 denotes the data transmission time of 200ms from T0.
 T2 denotes the end of Channel Move Time.
 T3 denotes the 10 second from T0 to observe the aggregate duration of transmissions.

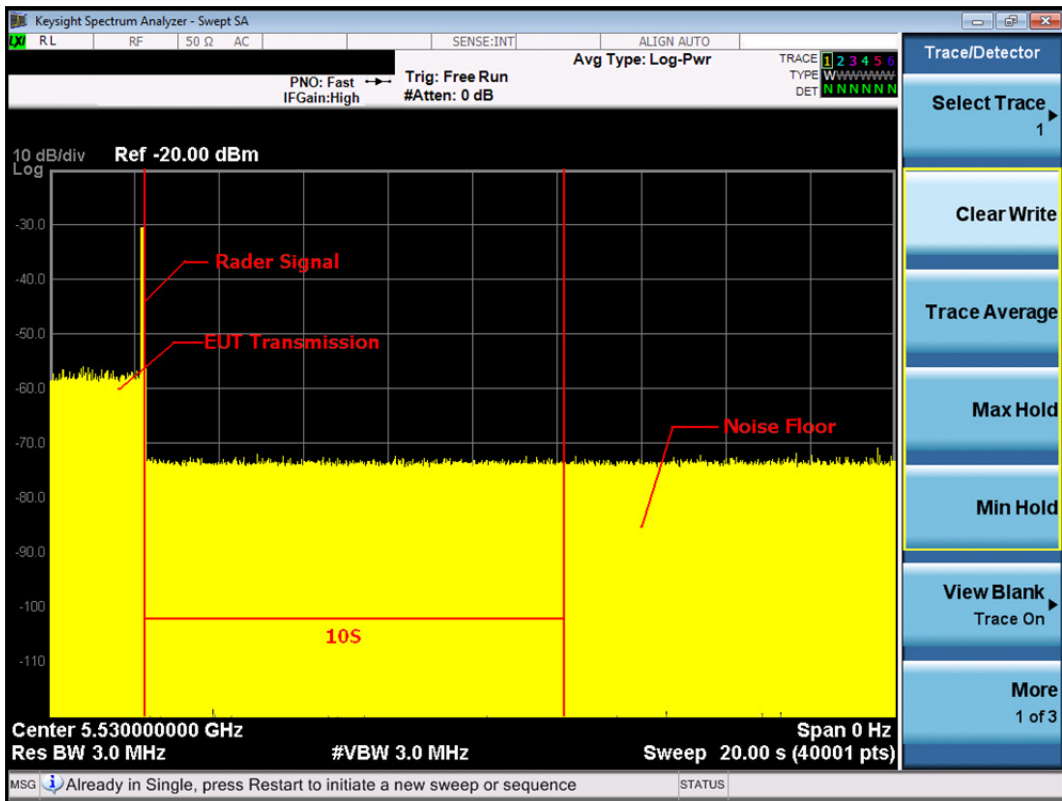

Note: An expanded plot for the device vacates the channel in the required 500ms

TX (11n 40MHz Mode)

Radar1 Static Performances				
Trial #	Pluse per Burst	Pluse Width(us)	PRI(us)	Detection(YES / No)
1	18	1.0u	1.428	YES
2	18	1.0u	1.428	YES
3	18	1.0u	1.428	YES
4	18	1.0u	1.428	YES
5	18	1.0u	1.428	NO
6	18	1.0u	1.428	YES
7	18	1.0u	1.428	YES
8	18	1.0u	1.428	YES
9	18	1.0u	1.428	YES
10	18	1.0u	1.428	YES
11	18	1.0u	1.428	YES
12	18	1.0u	1.428	NO
13	18	1.0u	1.428	YES
14	18	1.0u	1.428	YES
15	18	1.0u	1.428	YES
16	18	1.0u	1.428	YES
17	18	1.0u	1.428	YES
18	18	1.0u	1.428	YES
19	18	1.0u	1.428	YES
20	18	1.0u	1.428	YES
21	18	1.0u	1.428	YES
22	18	1.0u	1.428	YES
23	18	1.0u	1.428	YES
24	18	1.0u	1.428	YES
25	18	1.0u	1.428	NO
26	18	1.0u	1.428	YES
27	18	1.0u	1.428	YES
28	18	1.0u	1.428	YES
29	18	1.0u	1.428	YES
30	18	1.0u	1.428	YES
Detection Rate 90%				

Radar2 Statical Performances				
Trial #	Pluse per Burst	Pluse Width(us)	PRI(us)	Detection(YES / No)
1	28	4.3u	208	YES
2	28	2.8u	160	YES
3	26	2.9u	184	YES
4	24	2.7u	190	YES
5	28	3.4u	172	YES
6	28	4.0u	170	YES
7	27	1.3u	220	YES
8	28	1.4u	168	YES
9	25	4.5u	209	YES
10	24	3.3u	204	NO
11	26	2.4u	229	YES
12	27	3.8u	224	YES
13	23	2.7u	207	YES
14	24	3.3u	204	YES
15	26	2.4u	229	YES
16	27	3.8u	224	NO
17	29	2.7u	226	YES
18	29	2.9u	210	YES
19	27	1.8u	190	YES
20	26	2.0u	198	YES
21	23	1.2u	151	YES
22	25	1.4u	168	YES
23	25	1.5u	193	YES
24	27	2.6u	228	YES
25	26	1.7u	216	YES
26	23	4.8u	225	YES
27	28	1.9u	221	YES
28	26	4.1u	227	YES
29	26	3.1u	169	YES
30	27	2.2u	208	YES
Detection Rate 93%				

Radar3 Statical Performances				
Trial #	Pluse per Burst	Pluse Width(s)	PRI(us)	Detection(YES / No)
1	18	8.6u	405	YES
2	18	8.4u	410	YES
3	16	9.3u	398	NO
4	16	8.0u	364	YES
5	17	9.6u	366	YES
6	18	8.0u	258	YES
7	16	9.3u	268	NO
8	16	8.2u	477	YES
9	18	8.7u	206	YES
10	18	9.0u	213	YES
11	16	9.8u	482	YES
12	17	7.9u	436	YES
13	17	7.0u	447	YES
14	16	7.6u	410	YES
15	16	8.2u	300	YES
16	18	7.4u	336	YES
17	16	9.3u	492	YES
18	17	7.5u	471	YES
19	17	7.9u	481	NO
20	18	8.0u	492	YES
21	16	9.9u	463	YES
22	17	8.5u	445	YES
23	17	8.0u	250	YES
24	16	8.0u	364	YES
25	17	7.2u	435	YES
26	18	6.5u	336	YES
27	18	6.8u	480	YES
28	17	7.2u	435	NO
29	18	6.5u	336	YES
30	18	6.8u	480	YES
Detection Rate 87%				

Radar4 Statical Performances				
Trial #	Pluse per Burst	Pluse Width(us)	PRI(us)	Detection(YES / No)
1	13	13.8u	482	YES
2	15	14.9u	436	YES
3	15	15.8u	447	YES
4	15	14.6u	410	YES
5	14	13.9u	481	YES
6	14	16.0u	492	YES
7	15	17.0u	463	YES
8	12	17.5u	445	YES
9	12	16.0u	442	YES
10	13	13.6u	405	YES
11	16	14.4u	440	YES
12	16	15.3u	398	YES
13	13	14.0u	364	YES
14	16	13.2u	477	YES
15	12	12.7u	206	NO
16	13	12.0u	213	YES
17	15	19.0u	300	YES
18	13	11.4u	336	YES
19	16	12.5u	330	YES
20	13	16.6u	463	YES
21	13	18.8u	445	YES
22	15	19.0u	442	YES
23	15	14.8u	405	YES
24	15	18.6u	409	YES
25	15	18.2u	441	YES
26	12	20.0u	332	YES
27	14	14.8u	478	YES
28	13	15.6u	367	YES
29	14	17.0u	258	NO
30	15	19.3u	270	YES
Detection Rate 93%				

Radar5 Statical Performances		
Trial #	Test Signal name	Detection(YES / No)
1	LP_Signal_01	Yes
2	LP_Signal_02	Yes
3	LP_Signal_03	Yes
4	LP_Signal_04	Yes
5	LP_Signal_05	Yes
6	LP_Signal_06	Yes
7	LP_Signal_07	Yes
8	LP_Signal_08	Yes
9	LP_Signal_09	Yes
10	LP_Signal_10	Yes
11	LP_Signal_11	Yes
12	LP_Signal_12	Yes
13	LP_Signal_13	Yes
14	LP_Signal_14	Yes
15	LP_Signal_15	Yes
16	LP_Signal_16	Yes
17	LP_Signal_17	Yes
18	LP_Signal_18	Yes
19	LP_Signal_19	Yes
20	LP_Signal_20	Yes
21	LP_Signal_21	Yes
22	LP_Signal_22	Yes
23	LP_Signal_23	Yes
24	LP_Signal_24	Yes
25	LP_Signal_25	Yes
26	LP_Signal_26	Yes
27	LP_Signal_27	Yes
28	LP_Signal_28	Yes
29	LP_Signal_29	Yes
30	LP_Signal_30	Yes
Detection Rate100%		

Radar6 Statical Performances		
Trial #	Hoping Frequency Sequence Name	Detection(YES / No)
1	HOP_FREQ_SEQ_01	Yes
2	HOP_FREQ_SEQ_02	Yes
3	HOP_FREQ_SEQ_03	Yes
4	HOP_FREQ_SEQ_04	NO
5	HOP_FREQ_SEQ_05	Yes
6	HOP_FREQ_SEQ_06	Yes
7	HOP_FREQ_SEQ_07	Yes
8	HOP_FREQ_SEQ_08	Yes
9	HOP_FREQ_SEQ_09	Yes
10	HOP_FREQ_SEQ_10	Yes
11	HOP_FREQ_SEQ_11	Yes
12	HOP_FREQ_SEQ_12	NO
13	HOP_FREQ_SEQ_13	Yes
14	HOP_FREQ_SEQ_14	Yes
15	HOP_FREQ_SEQ_15	NO
16	HOP_FREQ_SEQ_16	Yes
17	HOP_FREQ_SEQ_17	Yes
18	HOP_FREQ_SEQ_18	Yes
19	HOP_FREQ_SEQ_19	Yes
20	HOP_FREQ_SEQ_20	Yes
21	HOP_FREQ_SEQ_21	Yes
22	HOP_FREQ_SEQ_22	Yes
23	HOP_FREQ_SEQ_23	Yes
24	HOP_FREQ_SEQ_24	Yes
25	HOP_FREQ_SEQ_25	Yes
26	HOP_FREQ_SEQ_26	Yes
27	HOP_FREQ_SEQ_27	Yes
28	HOP_FREQ_SEQ_28	Yes
29	HOP_FREQ_SEQ_29	Yes
30	HOP_FREQ_SEQ_30	Yes
Detection Rate 90%		

6.2.5NON- OCCUPANCY PERIOD

During the 30 minutes observation time, UUT did not make any transmissions on a channel after a radar signal was detected on that channel by either the Channel Availability Check or the In-Service Monitoring.

5500 Non-Occupancy period

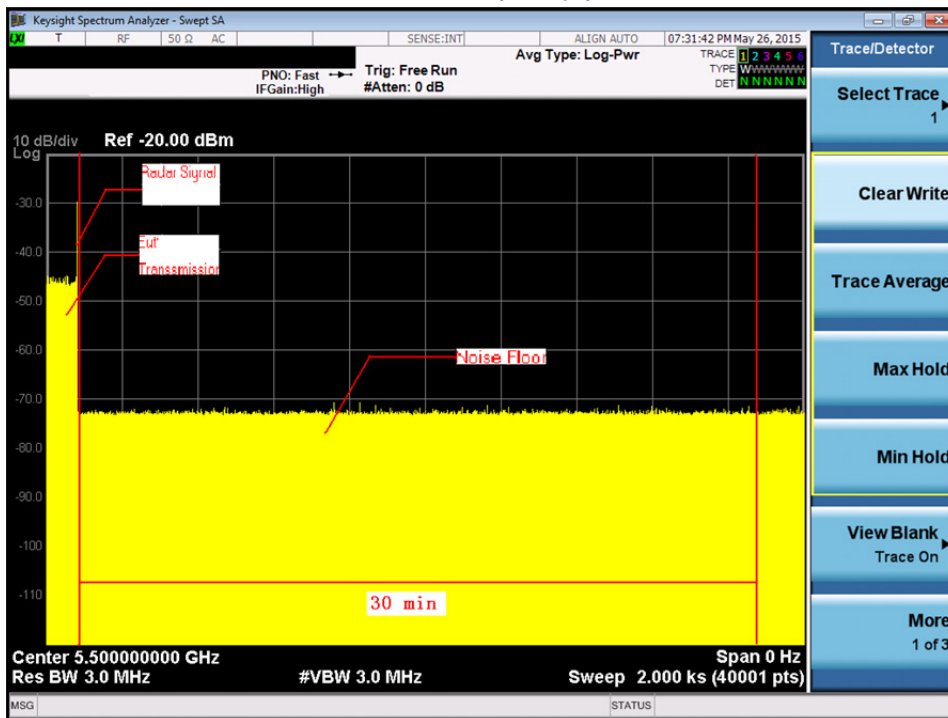

5510 Non-Occupancy period

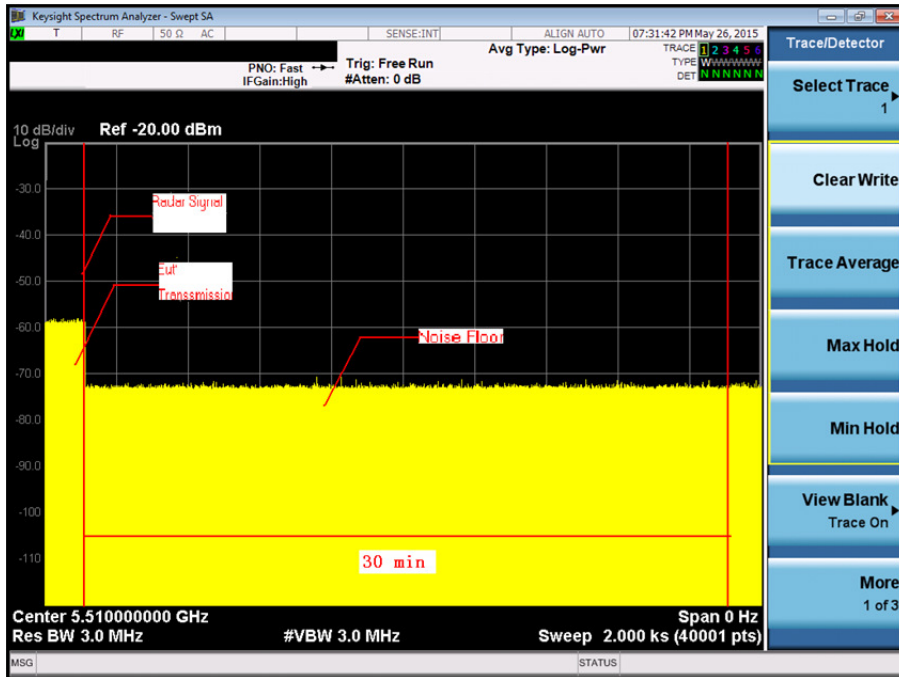

5530 Non-Occupancy period

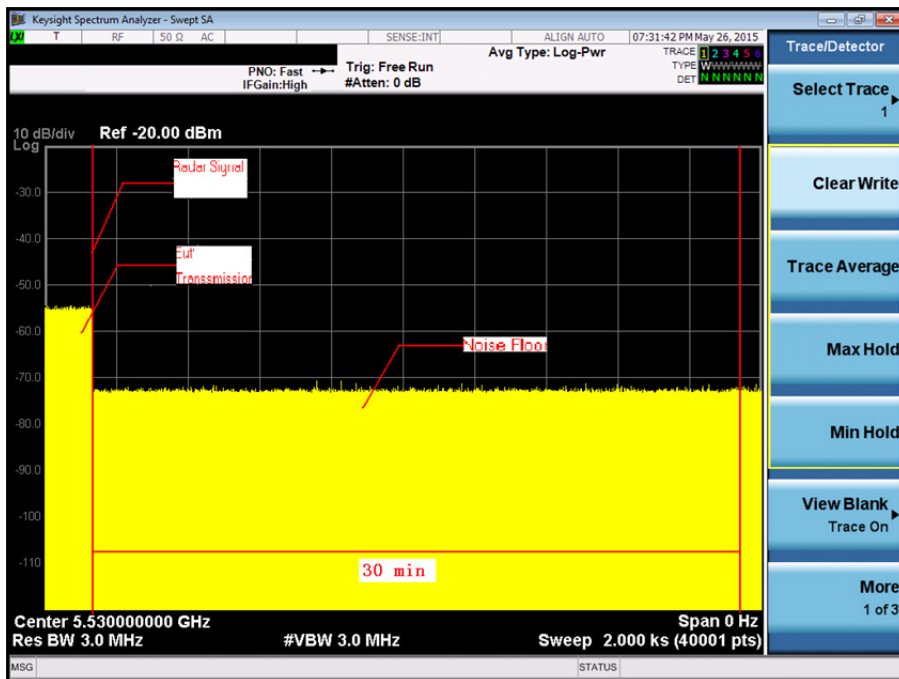

6.2.6 UNIFORM SPREADING

The intention of the uniform spreading is to provide, on aggregate, a uniform loading of the spectrum. The UUT using the bands 5250 to 5350MHz and 5470 to 5600 MHz channels so that the probability of selecting a given channel shall be the same for channels. The UUT will select channel by random mode and remember this channel when detect radar signal, so that will select unused channel by random mode.

6.2.7 U-NII DETECTION BANDWIDTH

