

FCC Radio Test Report

FCC ID: QISAP8130DN

This report concerns (check one): Original Grant Class I Change Class II Change

Project No. : 1407C034V
Equipment : Outdoor Wireless LAN Access Point
Model Name : AP8130DN
Applicant : Huawei Technologies Co.,Ltd.
Address : Administration Building, Huawei Base, Bantian,
Longgang District ,Shenzhen 518129, P.R.China

Date of Receipt : Mar. 09, 2015
Mar. 07, 2016
Date of Test : Mar. 09, 2015 ~ Jun. 08, 2015
Mar. 07, 2016 ~ Apr. 08, 2016
Issued Date : Apr. 11, 2016
Tested by : BTL Inc.

Testing Engineer : Shawn Xiao
(Shawn Xiao)

Technical Manager : David Mao
(David Mao)

Authorized Signatory : Steven Lu
(Steven Lu)

B T L I N C .

No.3, Jinshagang 1st Road, Shixia, Dalang Town, Dongguan,
Guangdong, China.

TEL: +86-769-8318-3000 FAX: +86-769-8319-6000

Declaration

BTL represents to the client that testing is done in accordance with standard procedures as applicable and that test instruments used has been calibrated with standards traceable to international standard(s) and/or national standard(s).

BTL's reports apply only to the specific samples tested under conditions. It is manufacture's responsibility to ensure that additional production units of this model are manufactured with the identical electrical and mechanical components. **BTL** shall have no liability for any declarations, inferences or generalizations drawn by the client or others from **BTL** issued reports.

BTL's report must not be used by the client to claim product certification, approval, or endorsement by NVLAP, NIST, or any agency of the Federal Government.

This report is the confidential property of the client. As a mutual protection to the clients, the public and **BTL-self**, extracts from the test report shall not be reproduced except in full with **BTL's** authorized written approval.

BTL's laboratory quality assurance procedures are in compliance with the **ISO Guide 17025** requirements, and accredited by the conformity assessment authorities listed in this test report.

Limitation

For the use of the authority's logo is limited unless the Test Standard(s)/Scope(s)/Item(s) mentioned in this test report is (are) included in the conformity assessment authorities acceptance respective.

Table of Contents	Page
1 . CERTIFICATION	7
2 . SUMMARY OF TEST RESULTS	8
2.1 TEST FACILITY	9
2.2 MEASUREMENT UNCERTAINTY	9
3 . GENERAL INFORMATION	10
3.1 GENERAL DESCRIPTION OF EUT	10
3.2 DESCRIPTION OF TEST MODES	14
3.3 TABLE OF PARAMETERS OF TEST SOFTWARE SETTING	16
3.4 BLOCK DIAGRAM SHOWING THE CONFIGURATION OF SYSTEM TESTED	20
3.5 DESCRIPTION OF SUPPORT UNITS	20
4 . EMC EMISSION TEST	21
4.1 CONDUCTED EMISSION MEASUREMENT	21
4.1.1 POWER LINE CONDUCTED EMISSION LIMITS	21
4.1.2 TEST PROCEDURE	21
4.1.3 DEVIATION FROM TEST STANDARD	21
4.1.4 TEST SETUP	22
4.1.5 EUT OPERATING CONDITIONS	22
4.1.6 EUT TEST CONDITIONS	22
4.1.7 TEST RESULTS	22
4.2 RADIATED EMISSION MEASUREMENT	23
4.2.1 Radiated Emission Limits	23
4.2.2 TEST PROCEDURE	24
4.2.3 DEVIATION FROM TEST STANDARD	24
4.2.4 TEST SETUP	24
4.2.5 EUT OPERATING CONDITIONS	25
4.2.6 EUT TEST CONDITIONS	25
4.2.7 TEST RESULTS (9Khz to 30MHz)	26
4.2.8 TEST RESULTS (30mhz to 1000 MHz)	26
4.2.9 TEST RESULTS (Above 1000 MHz)	26
5 . 26dB SPECTRUM BANDWIDTH	27
5.1 APPLIED PROCEDURES / LIMIT	27
5.1.1 TEST PROCEDURE	27
5.1.2 DEVIATION FROM STANDARD	27
5.1.3 TEST SETUP	27
5.1.4 EUT OPERATION CONDITIONS	27
5.1.5 EUT TEST CONDITIONS	28
5.1.6 TEST RESULTS	28
6 . MAXIMUM CONDUCTED OUTPUT POWER	29

Table of Contents	Page
6.1 APPLIED PROCEDURES / LIMIT	29
6.1.1 TEST PROCEDURE	29
6.1.2 DEVIATION FROM STANDARD	30
6.1.3 TEST SETUP	30
6.1.4 EUT OPERATION CONDITIONS	30
6.1.5 EUT TEST CONDITIONS	30
6.1.6 TEST RESULTS	30
7 . ANTENNA CONDUCTED SPURIOUS EMISSION	31
7.1 APPLIED PROCEDURES / LIMIT	31
7.1.1 TEST PROCEDURE	31
7.1.2 DEVIATION FROM STANDARD	31
7.1.3 TEST SETUP	31
7.1.4 EUT OPERATION CONDITIONS	31
7.1.5 EUT TEST CONDITIONS	31
7.1.6 TEST RESULTS	31
8 . POWER SPECTRAL DENSITY TEST	32
8.1 APPLIED PROCEDURES / LIMIT	32
8.1.1 TEST PROCEDURE	32
8.1.1 DEVIATION FROM STANDARD	33
8.1.2 TEST SETUP	33
8.1.3 EUT OPERATION CONDITIONS	33
8.1.4 EUT TEST CONDITIONS	33
8.1.5 TEST RESULTS	33
9 . FREQUENCY STABILITY MEASUREMENT	34
9.1 APPLIED PROCEDURES / LIMIT	34
9.1.1 TEST PROCEDURE	34
9.1.2 DEVIATION FROM STANDARD	34
9.1.3 TEST SETUP	35
9.1.4 EUT OPERATION CONDITIONS	35
9.1.5 EUT TEST CONDITIONS	35
9.1.6 TEST RESULTS	35
10 . MEASUREMENT INSTRUMENTS LIST	36
11 . EUT TEST PHOTOS	38
ATTACHMENT A - CONDUCTED EMISSION	42
ATTACHMENT B - RADIATED EMISSION (9KHZ TO 30MHZ)	45
ATTACHMENT C - RADIATED EMISSION (30MHZ TO 1000MHZ)	47
ATTACHMENT D - RADIATED EMISSION (ABOVE 1000MHZ)	72
ATTACHMENT E - BANDWIDTH	315

Table of Contents

Page

ATTACHMENT F - MAXIMUM OUTPUT POWER	361
ATTACHMENT G - ANTENNA CONDUCTED SPURIOUS EMISSION	394
ATTACHMENT H - POWER SPECTRAL DENSITY	467
ATTACHMENT I - FREQUENCY STABILITY	627

REPORT ISSUED HISTORY

Issued No.	Description	Issued Date
BTL-FCCP-3-1407C034B	Original Report.	Jun. 10, 2015
BTL-FCCP-3-1407C034V	Compared with previous report (BTL-FCCP-3-1407C034B), the antennas are added, Conducted Emission and Radiated Emissions have been re-evaluated and recorded in the test report, the rest are kept the same.	Apr. 11, 2016

1. CERTIFICATION

Equipment : Outdoor Wireless LAN Access Point
Brand Name : HUAWEI
Model Name : AP8130DN
Applicant : Huawei Technologies Co.,Ltd.
Manufacturer : Huawei Technologies Co.,Ltd.
Address : Administration Building, Huawei Base, Bantian, Longgang District ,Shenzhen
518129, P.R.China
Factory : Huawei Technologies Co.,Ltd.
Address : Huawei Base, Bantian, Longgang District, Shenzhen 518129, P.R.China
Date of Test : Mar. 09, 2015 ~ Jun. 08, 2015
Mar. 07, 2016 ~ Apr. 08, 2016
Test Sample : Engineering Sample
Standard(s) : FCC Part15, Subpart E(15.407) / ANSI C63.10-2013

The above equipment has been tested and found compliance with the requirement of the relative standards by BTL Inc.

The test data, data evaluation, and equipment configuration contained in our test report (Ref No. BTL-FCCP-3-1407C034V) were obtained utilizing the test procedures, test instruments, test sites that has been accredited by the Authority of TAF according to the ISO-17025 quality assessment standard and technical standard(s).

Test result included in this report is only for the 5GHz module which is support 5GHz only.

2. SUMMARY OF TEST RESULTS

Test procedures according to the technical standard(s):

FCC Part15, Subpart E			
Standard(s) Section	Test Item	Judgment	Remark
15.207	AC Power Line Conducted Emissions	PASS	
15.407(a)	26dB Spectrum Bandwidth	PASS	
15.407(a)	Maximum Conducted Output Power	PASS	
15.407(a)	Power Spectral Density	PASS	
15.407(a)	Radiated Emissions	PASS	
15.407(b)	Band Edge Emissions	PASS	
15.407(g)	Frequency Stability	PASS	
15.203	Antenna Requirements	PASS	

NOTE:

(1) "N/A" denotes test is not applicable in this test report.

2.1 TEST FACILITY

The test facilities used to collect the test data in this report is at the location of No.3, Jinshagang 1st Road, Shixia, Dalang Town, Dongguan, Guangdong, China.
BTL's test firm number for FCC: 319330

2.2 MEASUREMENT UNCERTAINTY

Where relevant, the following measurement uncertainty levels have been estimated for tests performed on the EUT as specified in CISPR 16-4-2. The BTL measurement uncertainty is less than the CISPR 16-4-2 U_{CISPR} requirement.

The reported uncertainty of measurement $y \pm U$, where expanded uncertainty U is based on a standard uncertainty multiplied by a coverage factor of $k=2$, providing a level of confidence of approximately 95 %.

A. Conducted Measurement:

Test Site	Method	Measurement Frequency Range	U, (dB)
DG-C02	CISPR	150 KHz ~ 30MHz	2.32

B. Radiated Measurement:

Test Site	Method	Measurement Frequency Range	Ant. H / V	U, (dB)
DG-CB03	CISPR	9KHz~30MHz	V	3.79
		9KHz~30MHz	H	3.57
		30MHz ~ 200MHz	V	3.82
		30MHz ~ 200MHz	H	3.78
		200MHz ~ 1,000MHz	V	4.10
		200MHz ~ 1,000MHz	H	4.06
		1GHz~18GHz	V	3.12
		1GHz~18GHz	H	3.68
		18GHz~40GHz	V	4.15
		18GHz~40GHz	H	4.14

Note: Unless specifically mentioned, the uncertainty of measurement has not been taken into account to declare the compliance or non-compliance to the specification.

3. GENERAL INFORMATION

3.1 GENERAL DESCRIPTION OF EUT

Equipment	Outdoor Wireless LAN Access Point	
Brand Name	HUAWEI	
Model Name	AP8130DN	
Mode Different	NA	
Product Description	Operation Frequency	UNII-1: 5150-5250MHz UNII-2A: 5250-5350MHz UNII-2C: 5470-5725MHz UNII-3: 5725-5850MHz
	Modulation Type	OFDM
	Bit Rate of Transmitter	300Mbps
Power Source	DC voltage supplied from PoE. Model: PoE 35-54A	
Power Rating	I/P: AC 100-240V 50/60Hz 1.0A MAX O/P: DC 5V 0.65A	

Output Power	Output Power (Max.)for UNII-1 (1TX)	802.11a: 19.60 dBm 802.11n (20M): 15.69 dBm 802.11n (40M): 15.58 dBm 802.11ac (20M): 15.73 dBm 802.11ac (40M): 15.47 dBm 802.11ac (80M): 9.71 dBm
	Output Power (Max.)for UNII-2A (1TX)	802.11a: 19.55 dBm 802.11n (20M): 15.73 dBm 802.11n (40M): 15.46 dBm 802.11ac (20M): 15.71 dBm 802.11ac (40M): 15.36 dBm 802.11ac (80M): 9.73 dBm
	Output Power (Max.)for UNII-2C (1TX)	802.11a: 19.59 dBm 802.11n (20M): 15.82 dBm 802.11n (40M): 15.73 dBm 802.11ac (20M): 15.74 dBm 802.11ac (40M): 15.59 dBm 802.11ac (80M): 16.75 dBm
	Output Power (Max.)for UNII-3 (1TX)	802.11a: 19.61 dBm 802.11n (20M): 15.73 dBm 802.11n (40M): 15.71 dBm 802.11ac (20M): 15.78 dBm 802.11ac (40M): 16.38 dBm 802.11ac (80M): 11.73 dBm

Output Power	Output Power (Max.)for UNII-1 (2TX)	802.11a: 21.04 dBm 802.11n (20M): 18.69 dBm 802.11n (40M): 18.57 dBm 802.11ac (20M): 18.78 dBm 802.11ac (40M): 18.55 dBm 802.11ac (80M): 12.81 dBm
	Output Power (Max.)for UNII-2A (2TX)	802.11a: 21.00 dBm 802.11n (20M): 18.74 dBm 802.11n (40M): 18.51 dBm 802.11ac (20M): 18.72 dBm 802.11ac (40M): 18.04 dBm 802.11ac (80M): 12.71 dBm
	Output Power (Max.)for UNII-2C (2TX)	802.11a: 21.05 dBm 802.11n (20M): 18.71 dBm 802.11n (40M): 18.72 dBm 802.11ac (20M): 18.75 dBm 802.11ac (40M): 18.27 dBm 802.11ac (80M): 19.72 dBm
	Output Power (Max.)for UNII-3 (2TX)	802.11a: 21.11 dBm 802.11n (20M): 18.71 dBm 802.11n (40M): 18.62 dBm 802.11ac (20M): 18.79 dBm 802.11ac (40M): 18.64 dBm 802.11ac (80M): 14.74 dBm

Note:

1. For a more detailed features description, please refer to the manufacturer's specifications or the user's manual.

2. Channel List:

UNII-1		UNII-1		UNII-1	
Channel	Frequency (MHz)	Channel	Frequency (MHz)	Channel	Frequency (MHz)
36	5180	38	5190	42	5210
40	5200	46	5230		
44	5220				
48	5240				

UNII-2A		UNII-2A		UNII-2A	
Channel	Frequency (MHz)	Channel	Frequency (MHz)	Channel	Frequency (MHz)
52	5260	54	5270	58	5290
56	5280	62	5310		
60	5300				
64	5320				

UNII-2C		UNII-2C		UNII-2C	
Channel	Frequency (MHz)	Channel	Frequency (MHz)	Channel	Frequency (MHz)
100	5500	102	5510	106	5530
104	5520	110	5550	122	5610
108	5540	118	5590		
112	5560	126	5630		
116	5580	134	5670		
120	5600				
124	5620				
128	5640				
132	5660				
136	5680				
140	5700				

UNII-3		UNII-3		UNII-3	
Channel	Frequency (MHz)	Channel	Frequency (MHz)	Channel	Frequency (MHz)
149	5745	151	5755	155	5775
153	5765	159	5795		
157	5785				
161	5805				
165	5825				

3. Antenna Specification:

Ant.	Manufacturer	Model Name	Antenna Type	Connector	Gain (dBi)	Note
1	Shenglu	SL12845A	External Antenna	N-type	8	5GHz
2	Shenglu	SL12845A	External Antenna	N-type	8	5GHz

Note:

1. The EUT incorporates a MIMO function. Physically, the EUT provides two completed transmitters and receivers (2T2R).

2. ANT 2 for 1TX was found to be the worst case and recorded.

3. A 12dB attenuator is epoxied to the antenna to be one part of antenna.

Remark:

the UNII-2A, UNII-2C Output Power limit is $24-8+6=22$ dBm, the UNII-1, UNII-3 Output Power limit is $30-8+6 = 28$.

The UNII-1 PSD limit is $17-8+6=15$ dBm/MHz, the UNII-2A, UNII-2C PSD limit is $11-8+6=9$ dBm/MHz, the UNII-3 PSD limit is $30-8+6=28$ dBm/500kHz.

4. Operating Mode

Operating Mode	1TX	2TX
TX Mode		
802.11a	V (ANT 2)	V (ANT 1+ANT 2)
802.11n (20MHz)	V (ANT 2)	V (ANT 1+ANT 2)
802.11n (40MHz)	V (ANT 2)	V (ANT 1+ANT 2)
802.11ac (20MHz)	V (ANT 2)	V (ANT 1+ANT 2)
802.11ac (40MHz)	V (ANT 2)	V (ANT 1+ANT 2)
802.11ac (80MHz)	V (ANT 2)	V (ANT 1+ANT 2)

3.2 DESCRIPTION OF TEST MODES

To investigate the maximum EMI emission characteristics generates from EUT, the test system was pre-scanning tested base on the consideration of following EUT operation mode or test configuration mode which possible have effect on EMI emission level. Each of these EUT operation mode(s) or test configuration mode(s) mentioned above was evaluated respectively.

Pretest Mode	Description
Mode 1	TX A Mode / CH36, CH40, CH48 (UNII-1)
Mode 2	TX N20 Mode / CH36, CH40, CH48 (UNII-1)
Mode 3	TX N40 Mode / CH38, CH46 (UNII-1)
Mode 4	TX AC20 Mode / CH36, CH40, CH48 (UNII-1)
Mode 5	TX AC40 Mode / CH38, CH46 (UNII-1)
Mode 6	TX AC80 Mode / CH42 (UNII-1)
Mode 7	TX A Mode / CH52, CH60, CH64 (UNII-2A)
Mode 8	TX N20 Mode / CH52, CH60, CH64 (UNII-2A)
Mode 9	TX N40 Mode / CH54, CH62 (UNII-2A)
Mode 10	TX AC20 Mode / CH52, CH60, CH64 (UNII-2A)
Mode 11	TX AC40 Mode / CH54, CH62 (UNII-2A)
Mode 12	TX AC80 Mode / CH58 (UNII-2A)
Mode 13	TX A Mode / CH100, CH116, CH140 (UNII-2C)
Mode 14	TX N20 Mode / CH100, CH116, CH140 (UNII-2C)
Mode 15	TX N40 Mode / CH102, CH110, CH134 (UNII-2C)
Mode 16	TX AC20 Mode / CH100, CH116, CH140 (UNII-2C)
Mode 17	TX AC40 Mode / CH102, CH110, CH134 (UNII-2C)
Mode 18	TX AC80 Mode / CH106, CH122 (UNII-2C)
Mode 19	TX A Mode / CH149,CH157,CH165 (UNII-3)
Mode 20	TX N20 Mode / CH149,CH157,CH165 (UNII-3)
Mode 21	TX N40 Mode / CH151,CH159 (UNII-3)
Mode 22	TX AC20 Mode / CH149,CH157,CH165 (UNII-3)
Mode 23	TX AC40 Mode / CH151,CH159 (UNII-3)
Mode 24	TX AC80 Mode / CH155 (UNII-3)
Mode 25	TX Mode

The EUT system operated these modes were found to be the worst case during the pre-scanning test as following:

For Conducted Test	
Final Test Mode	Description
Mode 25	TX Mode

For Radiated Test	
Final Test Mode	Description
Mode 1	TX A Mode / CH36, CH40, CH48 (UNII-1)
Mode 2	TX N20 Mode / CH36, CH40, CH48 (UNII-1)
Mode 3	TX N40 Mode / CH38, CH46 (UNII-1)
Mode 4	TX AC20 Mode / CH36, CH40, CH48 (UNII-1)
Mode 5	TX AC40 Mode / CH38, CH46 (UNII-1)
Mode 6	TX AC80 Mode / CH42 (UNII-1)
Mode 7	TX A Mode / CH52, CH60, CH64 (UNII-2A)
Mode 8	TX N20 Mode / CH52, CH60, CH64 (UNII-2A)
Mode 9	TX N40 Mode / CH54, CH62 (UNII-2A)
Mode 10	TX AC20 Mode / CH52, CH60, CH64 (UNII-2A)
Mode 11	TX AC40 Mode / CH54, CH62 (UNII-2A)
Mode 12	TX AC80 Mode / CH58 (UNII-2A)
Mode 13	TX A Mode / CH100, CH116, CH140 (UNII-2C)
Mode 14	TX N20 Mode / CH100, CH116, CH140 (UNII-2C)
Mode 15	TX N40 Mode / CH102, CH110, CH134 (UNII-2C)
Mode 16	TX AC20 Mode / CH100, CH116, CH140 (UNII-2C)
Mode 17	TX AC40 Mode / CH102, CH110, CH134 (UNII-2C)
Mode 18	TX AC80 Mode / CH106, CH122 (UNII-2C)
Mode 19	TX A Mode / CH149,CH157,CH165 (UNII-3)
Mode 20	TX N20 Mode / CH149,CH157,CH165 (UNII-3)
Mode 21	TX N40 Mode / CH151,CH159 (UNII-3)
Mode 22	TX AC20 Mode / CH149,CH157,CH165 (UNII-3)
Mode 23	TX AC40 Mode / CH151,CH159 (UNII-3)
Mode 24	TX AC80 Mode / CH155 (UNII-3)

Note:

(1) For radiated below 1GHz test, the 802.11a mode is found to be the worst case and recorded.

3.3 TABLE OF PARAMETERS OF TEST SOFTWARE SETTING

During testing channel & power controlling software provided by the customer was used to control the operating channel as well as the output power level. The RF output power selection is for the setting of RF output power expected by the customer and is going to be fixed on the firmware of the final end product

UNII-1 - 1TX			
Test Software Version	cart		
Frequency (MHz)	5180	5200	5240
A Mode	20	20	20
N20 Mode	18	18	18
AC20 Mode	18	18	18
Frequency (MHz)	5190	5230	
N40 Mode	17	17	
AC40 Mode	17	17	
Frequency (MHz)	5210		
AC80 Mode	15		

UNII-2A - 1TX			
Test Software Version	cart		
Frequency (MHz)	5260	5300	5320
A Mode	20	20	20
N20 Mode	18	18	18
AC20 Mode	18	18	18
Frequency (MHz)	5270	5310	
N40 Mode	17	17	
AC40 Mode	17	17	
Frequency (MHz)	5290		
AC80 Mode	15		

UNII-2C - 1TX			
Test Software Version	cart		
Frequency (MHz)	5500	5580	5700
A Mode	20	20	20
N20 Mode	18	18	18
AC20 Mode	18	18	18
Frequency (MHz)	5510	5550	5670
N40 Mode	17	16	17
AC40 Mode	17	16	17
Frequency (MHz)	5530	5610	
AC80 Mod	11	17	

UNII-3 - 1TX			
Test Software Version	cart		
Frequency (MHz)	5745	5785	5825
A Mode	20	20	20
N20 Mode	18	18	18
AC20 Mode	18	18	15
Frequency (MHz)	5755	5795	
N40 Mode	17	17	
AC40 Mode	17	17	
Frequency (MHz)	5775		
AC80 Mode	12		

UNII-1 - 2TX			
Test Software Version	cart		
Frequency (MHz)	5180	5200	5240
A Mode	16	16	16
N20 Mode	16	16	16
AC20 Mode	16	16	16
Frequency (MHz)	5190	5230	
N40 Mode	14	16	
AC40 Mode	14	16	
Frequency (MHz)	5210		
AC80 Mode	12		

UNII-2A - 2TX			
Test Software Version	cart		
Frequency (MHz)	5260	5300	5320
A Mode	16	16	16
N20 Mode	16	16	16
AC20 Mode	16	16	16
Frequency (MHz)	5270	5310	
N40 Mode	16	14	
AC40 Mode	16	14	
Frequency (MHz)	5290		
AC80 Mode	12		

UNII-2C - 2TX			
Test Software Version	cart		
Frequency (MHz)	5500	5580	5700
A Mode	16	16	16
N20 Mode	16	16	16
AC20 Mode	16	16	16
Frequency (MHz)	5510	5550	5670
N40 Mode	16	16	16
AC40 Mode	16	16	16
Frequency (MHz)	5530	5610	
AC80 Mod	12	17	

UNII-3 - 2TX			
Test Software Version	cart		
Frequency (MHz)	5745	5785	5825
A Mode	16	16	16
N20 Mode	16	16	16
AC20 Mode	16	16	16
Frequency (MHz)	5755	5795	
N40 Mode	16	16	
AC40 Mode	15	16	
Frequency (MHz)	5775		
AC80 Mode	12		

3.4 BLOCK DIAGRAM SHOWING THE CONFIGURATION OF SYSTEM TESTED

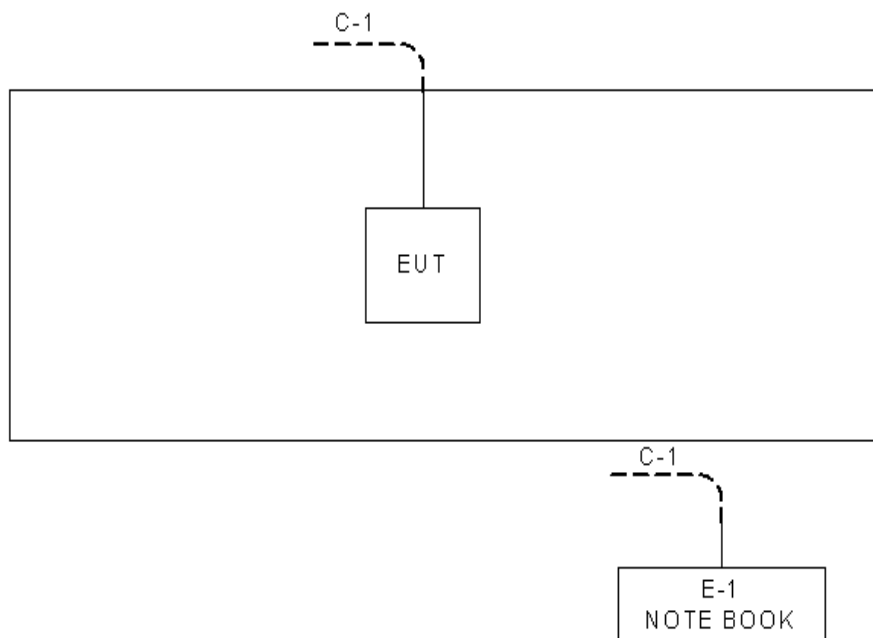

3.5 DESCRIPTION OF SUPPORT UNITS

The EUT has been tested as an independent unit together with other necessary accessories or support units. The following support units or accessories were used to form a representative test configuration during the tests.

Item	Equipment	Mfr/Brand	Model/Type No.	FCC ID	Series No.
E-1	NOTEBOOK	DELL	H2510	DOC	SS07999198

Item	Shielded Type	Ferrite Core	Length	Note
C-1	NA	NA	10m	RJ45 cable

4. EMC EMISSION TEST

4.1 CONDUCTED EMISSION MEASUREMENT

4.1.1 POWER LINE CONDUCTED EMISSION LIMITS (Frequency Range 150KHz-30MHz)

Frequency of Emission (MHz)	Conducted Limit (dB μ V)	
	Quasi-peak	Average
0.15 -0.50	66 to 56*	56 to 46*
0.50 -5.0	56	46
5.0 -30.0	60	50

Note:

- (1) The limit of " * " decreases with the logarithm of the frequency
- (2) The test result calculated as following:
 Measurement Value = Reading Level + Correct Factor
 Correct Factor = Insertion Loss + Cable Loss + Attenuator Factor(if use)
 Margin Level = Measurement Value - Limit Value

The following table is the setting of the receiver

Receiver Parameters	Setting
Attenuation	10 dB
Start Frequency	0.15 MHz
Stop Frequency	30 MHz
IF Bandwidth	9 KHz

4.1.2 TEST PROCEDURE

- a. The EUT was placed 0.8 meters from the horizontal ground plane with EUT being connected to the power mains through a line impedance stabilization network (LISN). All other support equipments powered from additional LISN(s). The LISN provide 50 Ohm/ 50uH of coupling impedance for the measuring instrument.
- b. Interconnecting cables that hang closer than 40 cm to the ground plane shall be folded back and forth in the center forming a bundle 30 to 40 cm long.
- c. I/O cables that are not connected to a peripheral shall be bundled in the center. The end of the cable may be terminated, if required, using the correct terminating impedance. The overall length shall not exceed 1 m.
- d. LISN at least 80 cm from nearest part of EUT chassis.
- e. For the actual test configuration, please refer to the related Item –EUT Test Photos.

4.1.3 DEVIATION FROM TEST STANDARD

No deviation

4.1.4 TEST SETUP

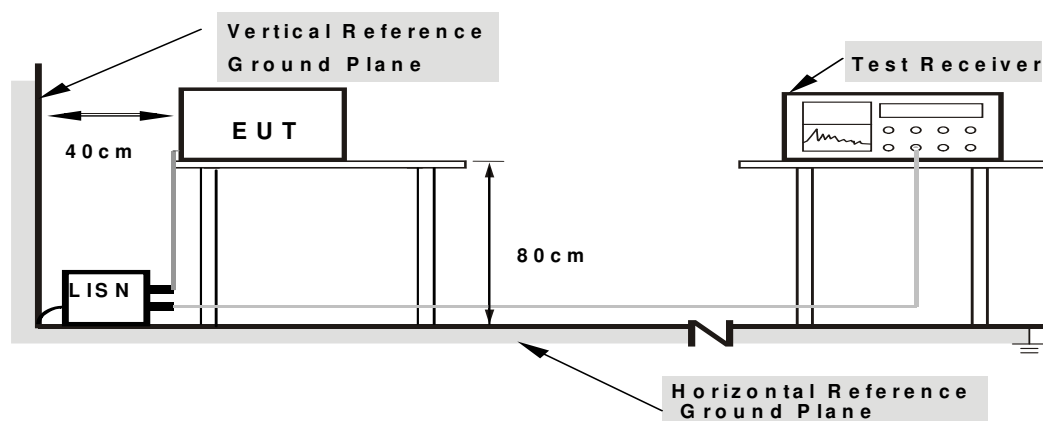

- Note: 1.Support units were connected to second LISN.
 2.Both of LISNs (AMN) are 80 cm from EUT and at least 80 from other units and other metal planes

4.1.5 EUT OPERATING CONDITIONS

The EUT was placed on the test table and programmed in normal function.

4.1.6 EUT TEST CONDITIONS

Temperature: 25°C Relative Humidity: 55% Test Voltage: AC 120V/60Hz

4.1.7 TEST RESULTS

Please refer to the Attachment A.

4.2 RADIATED EMISSION MEASUREMENT

4.2.1 Radiated Emission Limits

In case the emission fall within the restricted band specified on 15.205(a), then the 15.209(a) limit in the table below has to be followed.

LIMITS OF RADIATED EMISSION MEASUREMENT (9KHz-1000MHz)

Frequency (MHz)	Field Strength (microvolts/meter)	Measurement Distance (meters)
0.009~0.490	2400/F(KHz)	300
0.490~1.705	24000/F(KHz)	30
1.705~30.0	30	30
30~88	100	3
88~216	150	3
216~960	200	3
960~1000	500	3

LIMITS OF RADIATED EMISSION MEASUREMENT (Above 1000MHz)

Frequency (MHz)	(dBuV/m) (at 3 meters)	
	PEAK	AVERAGE
Above 1000	74	54

Notes:

- (1) The limit for radiated test was performed according to FCC PART 15C.
- (2) The tighter limit applies at the band edges.
- (3) Emission level (dBuV/m)=20log Emission level (uV/m).
- (4) The test result calculated as following:
 Measurement Value = Reading Level + Correct Factor
 Correct Factor = Antenna Factor + Cable Loss - Amplifier Gain(if use)
 Margin Level = Measurement Value - Limit Value

LIMITS OF UNWANTED EMISSION OUT OF THE RESTRICTED BANDS

Frequencies (MHz)	EIRP Limit (dBm)	Equivalent Field Strength at 3m (dBuV/m)
5150-5250	-27	68.3
5250-5350	-27	68.3
5470-5725	-27	68.3
5725-5850	-27 (beyond 10MHz of the band edge)	68.3
	-17 (within 10 MHz of band edge)	78.3

Note: The following formula is used to convert the equipment isotropic radiated power (eirp) to field

strength: $E = \frac{1000000 \sqrt{30P}}{3} \mu\text{V/m}$, where P is the eirp (Watts)

4.2.2 TEST PROCEDURE

- a. The measuring distance of 3 m shall be used for measurements. The EUT was placed on the top of a rotating table 0.8 meter above the ground at a 3 meter semi-anechoic chamber. The table was rotated 360 degrees to determine the position of the highest radiation.(below 1GHz)
- b. The measuring distance of 3 m shall be used for measurements. The EUT was placed on the top of a rotating table 1.5 meter above the ground at a 3 meter semi-anechoic chamber. The table was rotated 360 degrees to determine the position of the highest radiation.(above 1GHz)
- c. The height of the equipment or of the substitution antenna shall be 0.8 m or 1.5m, the height of the test antenna shall vary between 1 m to 4 m. Both horizontal and vertical polarizations of the antenna are set to make the measurement.
- d. The initial step in collecting radiated emission data is a receiver peak detector mode pre-scanning the measurement frequency range. Significant peaks are then marked and then Quasi Peak detector mode re-measured.
- e. All readings are Peak unless otherwise stated QP in column of Note. Peak denotes that the Peak reading compliance with the QP Limits and then QP Mode measurement didn't perform. (below 1GHz)
- f. All readings are Peak Mode value unless otherwise stated AVG in column of Note. If the Peak Mode Measured value compliance with the Peak Limits and lower than AVG Limits, the EUT shall be deemed to meet both Peak & AVG Limits and then only Peak Mode was measured, but AVG Mode didn't perform. (above 1GHz)
- g. For the actual test configuration, please refer to the related Item –EUT Test Photos.

4.2.3 DEVIATION FROM TEST STANDARD

No deviation

4.2.4 TEST SETUP

(A)Radiated Emission Test Set-Up Frequency Below 1GHz

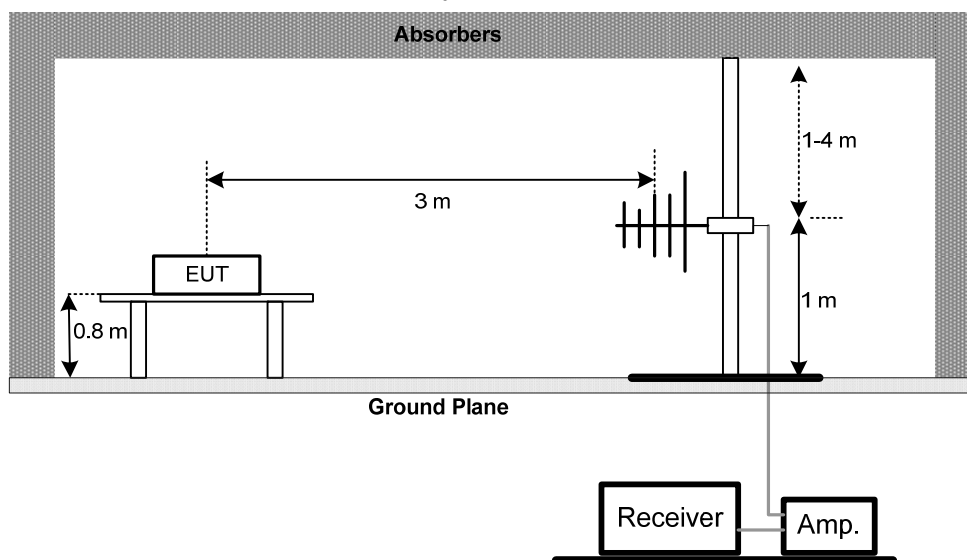

(B) Radiated Emission Test Set-Up Frequency Above 1 GHz

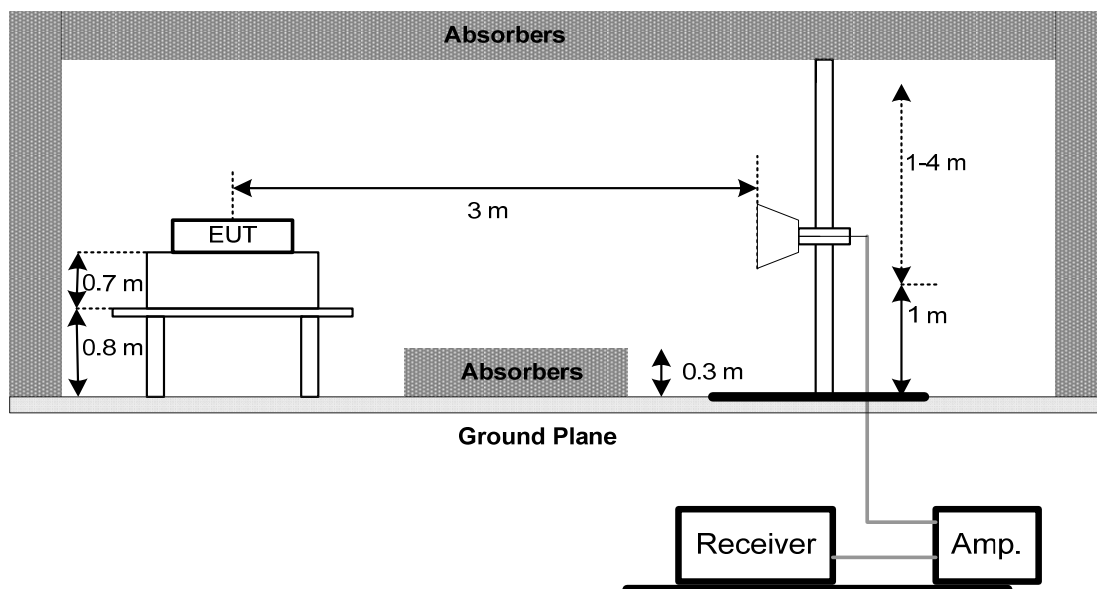

(C) Radiated emissions below 30MHz

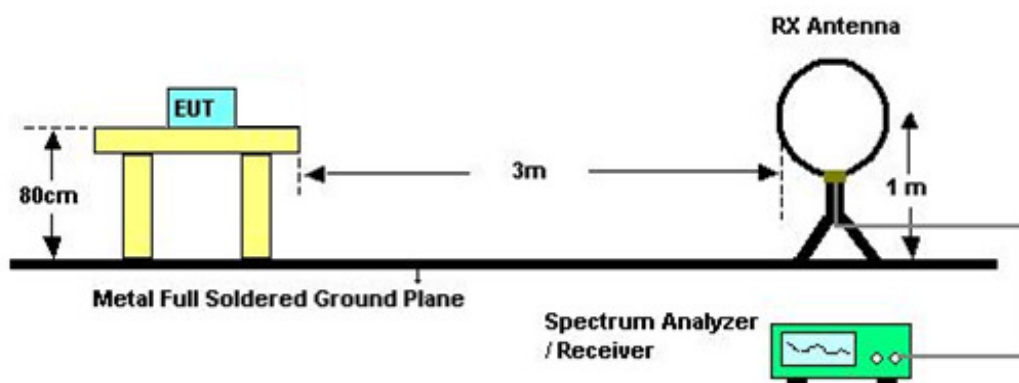

4.2.5 EUT OPERATING CONDITIONS

The EUT tested system was configured as the statements of 4.1.5 unless otherwise a special operating condition is specified in the follows during the testing.

4.2.6 EUT TEST CONDITIONS

Temperature: 25°C Relative Humidity: 55% Test Voltage: AC 120V/60Hz

4.2.7 TEST RESULTS (9Khz to 30MHz)

Please refer to the Attachment B

Remark:

- (1) The amplitude of spurious emissions which are attenuated by more than 20 dB below the permissible value has no need to be reported.
- (2) Distance extrapolation factor = $40 \log(\text{specific distance} / \text{test distance})$ (dB).
- (3) Limit line = specific limits (dBuV) + distance extrapolation factor.

4.2.8 TEST RESULTS (30mhz to 1000 MHz)

Please refer to the Attachment C.

4.2.9 TEST RESULTS (Above 1000 MHz)

Please refer to the Attachment D.

Remark:

- (1) No limit: This is fundamental signal, the judgment is not applicable.
For fundamental signal judgment was referred to Peak output test.

5. 26dB SPECTRUM BANDWIDTH

5.1 APPLIED PROCEDURES / LIMIT

FCC Part15, Subpart E			
Test Item	Limit	Frequency Range (MHz)	Result
Bandwidth	26 dB Bandwidth	5150-5250	PASS
	26 dB Bandwidth	5250-5350	PASS
	26 dB Bandwidth	5470-5725	PASS
	Minimum 500kHz 6dB Bandwidth	5725-5850	PASS

5.1.1 TEST PROCEDURE

a. The EUT was directly connected to the spectrum analyzer and antenna output port as show in the block diagram below,

b.

Spectrum Parameters	Setting
Attenuation	Auto
Span Frequency	> 26dB Bandwidth
RBW	300 kHz
VBW	1000 kHz
Detector	Peak
Trace	Max Hold
Sweep Time	Auto

c. Measured the spectrum width with power higher than 26dB below carrier

5.1.2 DEVIATION FROM STANDARD

No deviation.

5.1.3 TEST SETUP



5.1.4 EUT OPERATION CONDITIONS

The EUT tested system was configured as the statements of 4.1.5 unless otherwise a special operating condition is specified in the follows during the testing.

5.1.5 EUT TEST CONDITIONS

Temperature: 22°C Relative Humidity: 56% Test Voltage: AC 120V/60Hz

5.1.6 TEST RESULTS

Please refer to the Attachment E.

6. MAXIMUM CONDUCTED OUTPUT POWER

6.1 APPLIED PROCEDURES / LIMIT

FCC Part15, Subpart E			
Test Item	Limit	Frequency Range (MHz)	Result
Conducted Output Power	Fixed:1 Watt (30dBm) Mobile and portable: 250mW (24dBm)	5150-5250	PASS
	250mW (24dBm)	5250-5350	PASS
	250mW (24dBm)	5470-5725	PASS
	1 Watt (30dBm)	5725-5850	PASS
Note: The maximum e.i.r.p at anyelevation angle above 30 degrees as measured from the horizon must not exceed 125mW(21dBm)			

6.1.1 TEST PROCEDURE

a. The EUT was directly connected to the power meter and antenna output port as show in the block diagram below,

b.

Spectrum Parameter	Setting
Attenuation	Auto
Span Frequency	Encompass the entire emissions bandwidth (EBW) of the signal
RBW	= 1MHz.
VBW	\geq 3MHz.
Detector	RMS
Trace	Max Hold
Sweep Time	auto

c. Test was performed in accordance with method of KDB 789033 D02.

6.1.2 DEVIATION FROM STANDARD

No deviation.

6.1.3 TEST SETUP



6.1.4 EUT OPERATION CONDITIONS

The EUT tested system was configured as the statements of 4.1.5 unless otherwise a special operating condition is specified in the follows during the testing.

6.1.5 EUT TEST CONDITIONS

Temperature: 22°C Relative Humidity: 56% Test Voltage: AC 120V/60Hz

6.1.6 TEST RESULTS

Please refer to the Attachment F.

7. ANTENNA CONDUCTED SPURIOUS EMISSION

7.1 APPLIED PROCEDURES / LIMIT

FCC Part15, Subpart E			
Test Item	Limit	Frequency Range (MHz)	Result
Antenna conducted Spurious Emission	-27dBm/MHz	5150-5250	PASS
	-27dBm/MHz	5250-5350	PASS
	-27dBm/MHz	5470-5725	PASS
	Below -17dBm/MHz within 10MHz of band edge, below -27dBm/MHz beyond 10MHz of the band edge	5725-5850	PASS

7.1.1 TEST PROCEDURE

a. The EUT was directly connected to the spectrum analyzer and antenna output port as show in the block diagram below,

b.

Spectrum Parameter	Setting
Attenuation	Auto
RBW	1000kHz
VBW	1000kHz
Trace	Max Hold
Sweep Time	Auto

7.1.2 DEVIATION FROM STANDARD

No deviation.

7.1.3 TEST SETUP

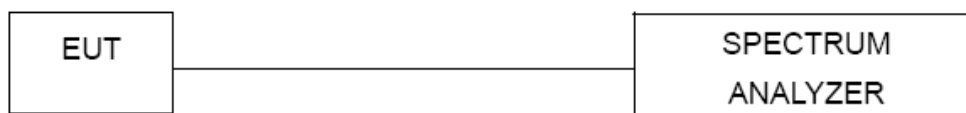

7.1.4 EUT OPERATION CONDITIONS

The EUT tested system was configured as the statements of 4.1.5 unless otherwise a special operating condition is specified in the follows during the testing.

7.1.5 EUT TEST CONDITIONS

Temperature: 22°C Relative Humidity: 56% Test Voltage: AC 120V/60Hz

7.1.6 TEST RESULTS

Please refer to the Attachment G.

8. POWER SPECTRAL DENSITY TEST

8.1 APPLIED PROCEDURES / LIMIT

FCC Part15, Subpart E			
Test Item	Limit	Frequency Range (MHz)	Result
Power Spectral Density	Other then Mobile and portable:17dBm/MHz Mobile and portable:11dBm/MHz	5150-5250	PASS
	11dBm/MHz	5250-5350	PASS
	11dBm/MHz	5470-5725	PASS
	30dBm/500kHz	5725-5850	PASS

8.1.1 TEST PROCEDURE

a. The EUT was directly connected to the spectrum analyzer and antenna output port as show in the block diagram below,

b.

Spectrum Parameter	Setting
Attenuation	Auto
Span Frequency	Encompass the entire emissions bandwidth (EBW) of the signal
RBW	= 1MHz.
VBW	≥ 3MHz.
Detector	RMS
Trace average	100 trace
Sweep Time	Auto

Note:

1. For UNII-3, according to KDB publication 789033 D02 General UNII Test Procedures New Rules v01, section II.F.5., it is acceptable to set RBW at 1MHz and VBW at 3MHz if the spectrum analyzer does not have 500kHz RBW.
2. The value measured with RBW=1MHz is to be added with $10\log(500\text{kHz}/1\text{MHz})$ which is -3dB. For example, if the measured value is +10dBm using RBW=1MHz (that is +10dBm/MHz), then the converted value will be +7dBm/500kHz.

8.1.1 DEVIATION FROM STANDARD

No deviation.

8.1.2 TEST SETUP



8.1.3 EUT OPERATION CONDITIONS

The EUT tested system was configured as the statements of 4.1.5 unless otherwise a special operating condition is specified in the follows during the testing.

8.1.4 EUT TEST CONDITIONS

Temperature: 22°C Relative Humidity: 56% Test Voltage: AC 120V/60Hz

8.1.5 TEST RESULTS

Please refer to the Attachment H.

9. FREQUENCY STABILITY MEASUREMENT

9.1 APPLIED PROCEDURES / LIMIT

FCC Part15, Subpart E			
Test Item	Limit	Frequency Range (MHz)	Result
Frequency Stability	Specified in the user's manual	5150-5250	PASS
		5250-5350	PASS
		5470-5725	PASS
		5725-5850	PASS

9.1.1 TEST PROCEDURE

a. The EUT was directly connected to the spectrum analyzer and antenna output port as show in the block diagram below,

b.

Spectrum Parameter	Setting
Attenuation	Auto
Span Frequency	Entire absence of modulation emissions bandwidth
RBW	10 kHz
VBW	10 kHz
Sweep Time	Auto

c. The test extreme voltage is to change the primary supply voltage from 85 to 115 percent of the nominal value.

d. User manual temperature is -40°C~60°C.

9.1.2 DEVIATION FROM STANDARD

No deviation.

9.1.3 TEST SETUP

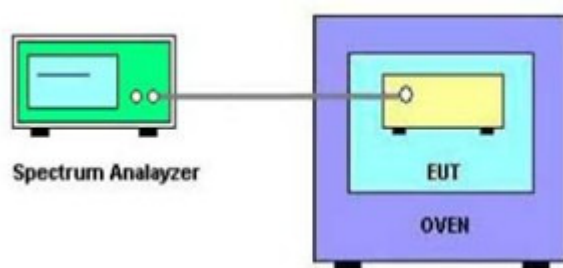

9.1.4 EUT OPERATION CONDITIONS

The EUT tested system was configured as the statements of 4.1.5 unless otherwise a special operating condition is specified in the follows during the testing.

9.1.5 EUT TEST CONDITIONS

Temperature: 25°C Relative Humidity: 55% Test Voltage: AC 120V/60Hz

9.1.6 TEST RESULTS

Please refer to the Attachment I.

10. MEASUREMENT INSTRUMENTS LIST

Conducted Emission Measurement					
Item	Kind of Equipment	Manufacturer	Type No.	Serial No.	Calibrated until
1	LISN	EMCO	3816/2	0052765	Mar. 27, 2017
2	LISN	R&S	ENV216	101447	Mar. 27, 2017
3	Test Cable	emci	RG223(9KHz-30 MHz)	C_17	Mar. 10, 2017
4	EMI Test Receiver	R&S	ESCI	100382	Mar. 27, 2017
5	50Ω Terminator	SHX	TF2-3G-A	08122901	Mar. 27, 2017
6	Measurement Software	Farad	EZ-EMC Ver.NB-03A1-01	N/A	N/A

Radiated Emission Measurement					
Item	Kind of Equipment	Manufacturer	Type No.	Serial No.	Calibrated until
1	Antenna	Schwarbeck	VULB9160	9160-3232	Mar. 27, 2017
2	Amplifier	HP	8447D	2944A09673	Nov. 09, 2016
3	Receiver	AGILENT	N9038A	MY52130039	Oct. 11, 2016
4	Test Cable	emci	LMR-400(30MHz-1GHz)	C-01	Jun. 28, 2016
5	Controller	CT	SC100	N/A	N/A
6	Antenna	ETS	3115	00075789	Mar. 27, 2017
7	Amplifier	Agilent	8449B	3008A02274	Nov. 01, 2016
8	Receiver	AGILENT	N9038A	MY52130039	Oct. 11, 2016
9	Test Cable	emci	EMC104-SM-SM-10000(1GHz – 26.5GHz)	C-68	Jun. 28, 2016
10	Controller	CT	SC100	N/A	N/A
11	Broad-Band Horn Antenna	Schwarzbeck	BBHA 9170	9170319	Mar. 27, 2017
12	Microwave Pre-amplifier With Adaptor	EMC INSTRUMENT	EMC2654045	980039 & HA01	Mar. 27, 2017
13	Active Loop Antenna	R&S	HFH2-Z2	830749/020	Sep. 07, 2016
14	Measurement Software	Farad	EZ-EMC Ver.NB-03A1-01	N/A	N/A

Spectrum Bandwidth Measurement					
Item	Kind of Equipment	Manufacturer	Type No.	Serial No.	Calibrated until
1	Spectrum Analyzer	R&S	FSP 40	100185	Nov. 02, 2015
2	Test Cable	emci	EMC104-SM-SM-9000(0.01GHz – 26.5GHz)	C-100	N/A

Maximum Conducted Output Power Measurement					
Item	Kind of Equipment	Manufacturer	Type No.	Serial No.	Calibrated until
1	P-series Power meter	Agilent	N1911A	MY45100473	Mar. 29, 2015
2	Wireband Power sensor	Agilent	N1921A	MY51100041	Mar. 29, 2015

Antenna Conducted Spurious Emission Measurement					
Item	Kind of Equipment	Manufacturer	Type No.	Serial No.	Calibrated until
1	Spectrum Analyzer	R&S	FSP 40	100185	Nov. 02, 2015
2	Test Cable	emci	EMC104-SM-SM-9000(0.01GHz – 26.5GHz)	C-100	N/A

Power Spectral Density Measurement					
Item	Kind of Equipment	Manufacturer	Type No.	Serial No.	Calibrated until
1	Spectrum Analyzer	R&S	FSP 40	100185	Nov. 02, 2015
2	Test Cable	emci	EMC104-SM-SM-9000(0.01GHz – 26.5GHz)	C-100	N/A

Frequency Stability Measurement					
Item	Kind of Equipment	Manufacturer	Type No.	Serial No.	Calibrated until
1	Spectrum Analyzer	R&S	FSP 40	100185	Nov. 02, 2015
2	Precision Oven Tester	HOLINK	H-T-1F-D	BA03101701	May 23, 2016

Remark: "N/A" denotes no model name, serial no. or calibration specified.
 All calibration period of equipment list is one year.

11. EUT TEST PHOTOS

Conducted Measurement Photos



Radiated Measurement Photos

9kHz to 30MHz

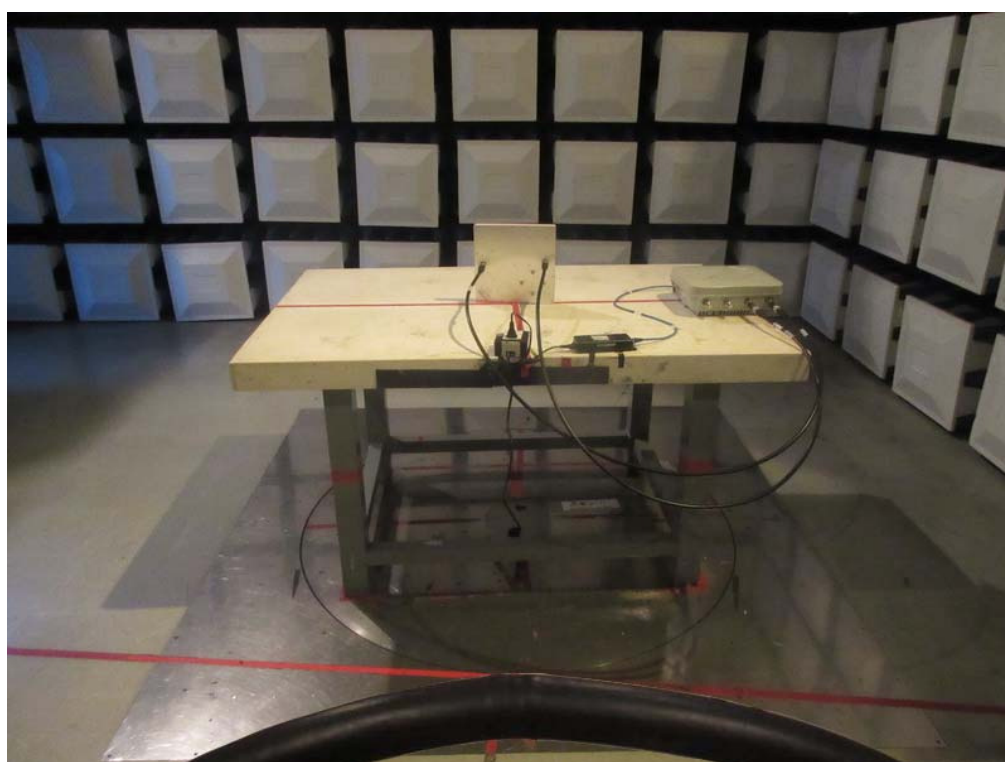
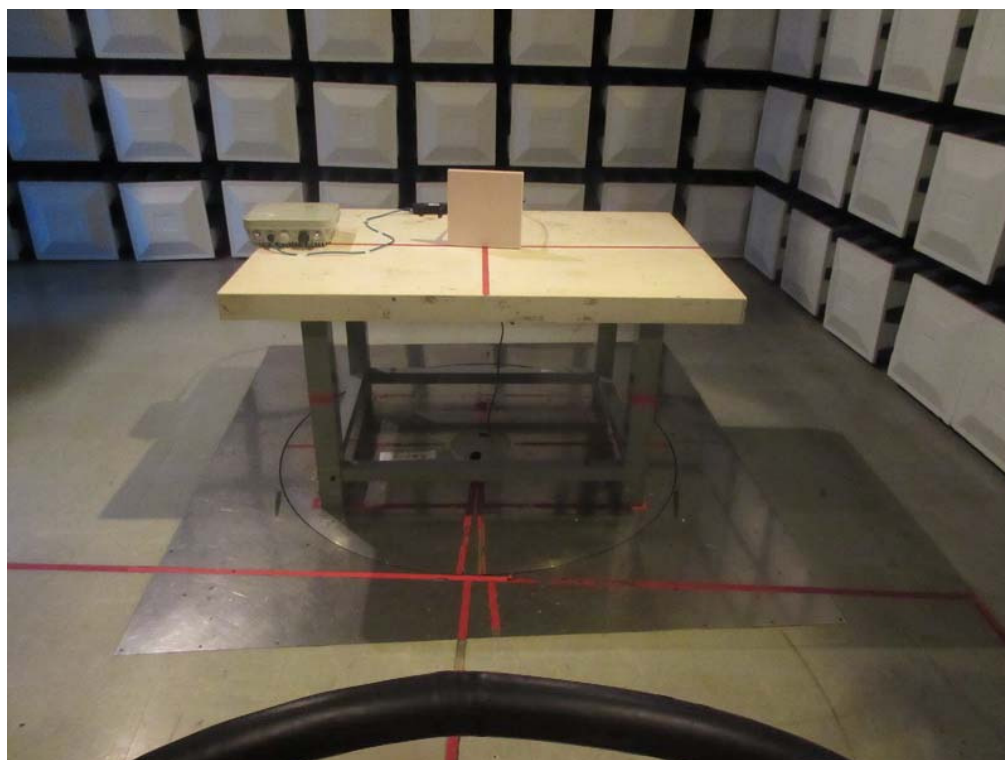

Radiated Measurement Photos

30MHz to 1000MHz

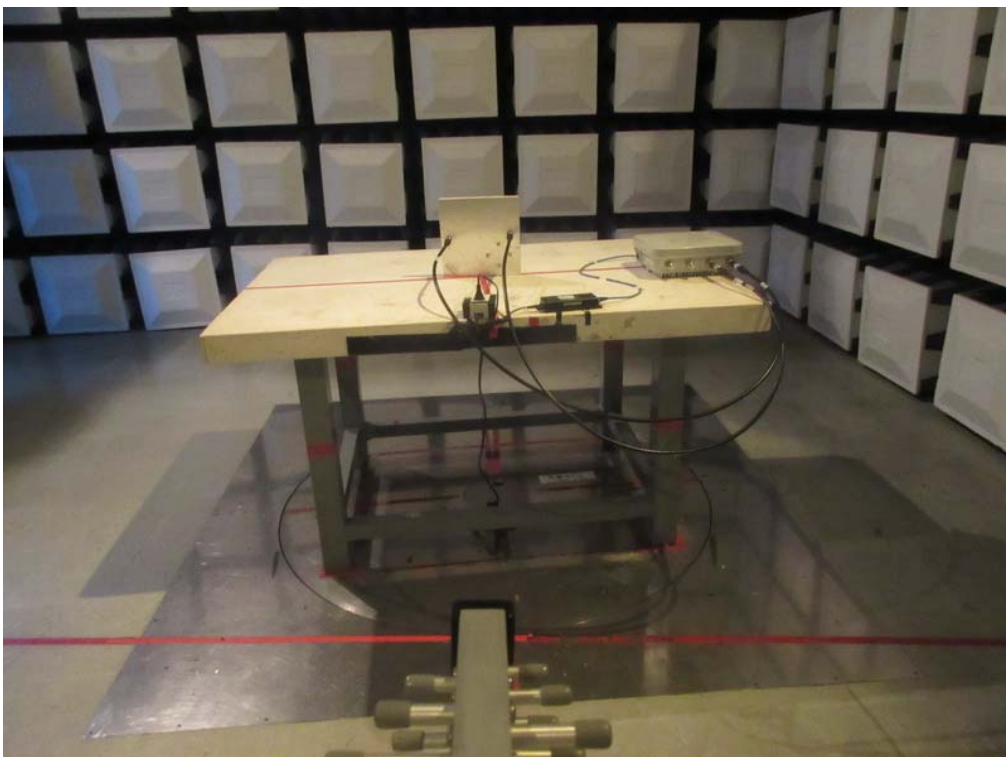
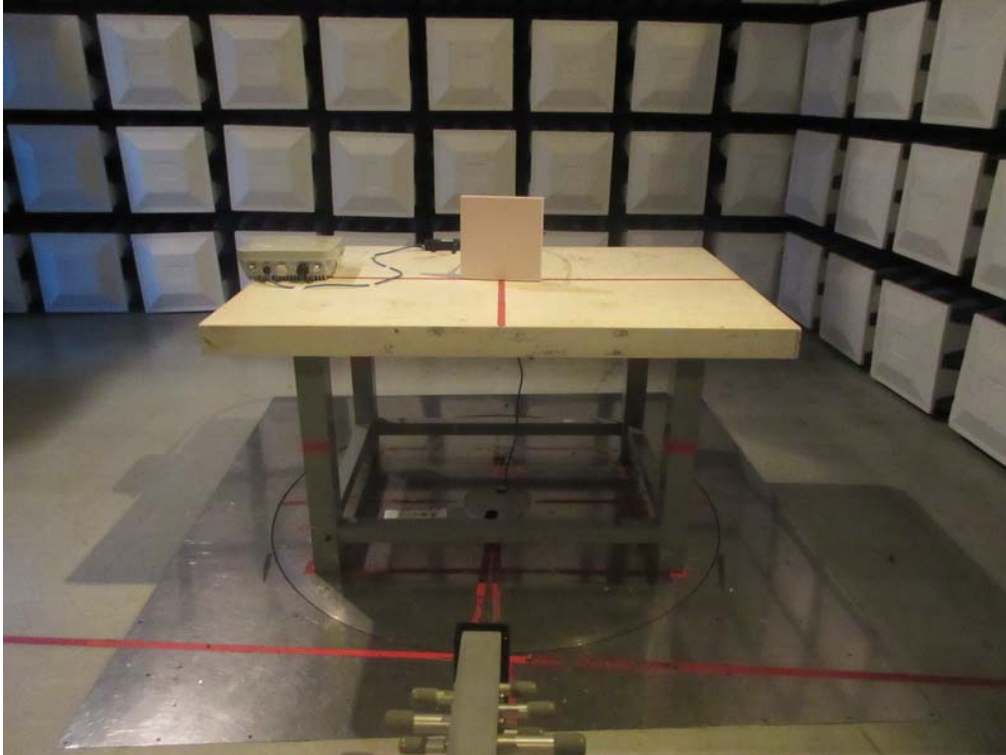

Radiated Measurement Photos

Above 1000MHz

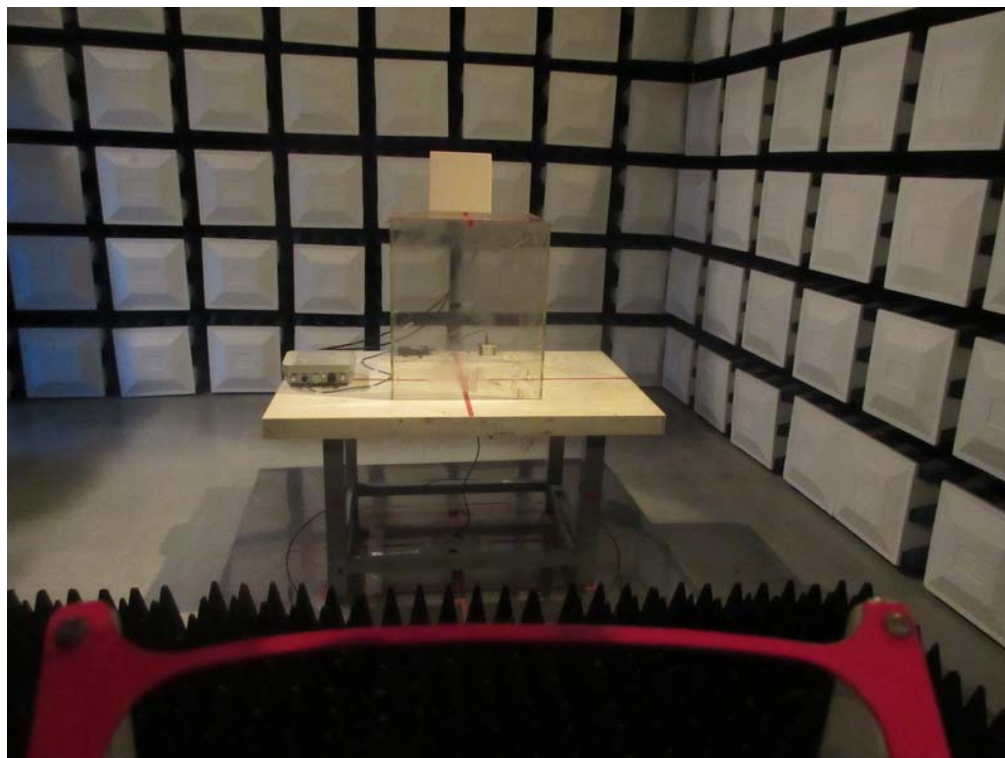

ATTACHMENT A - CONDUCTED EMISSION

Test Mode: TX MODE

Line

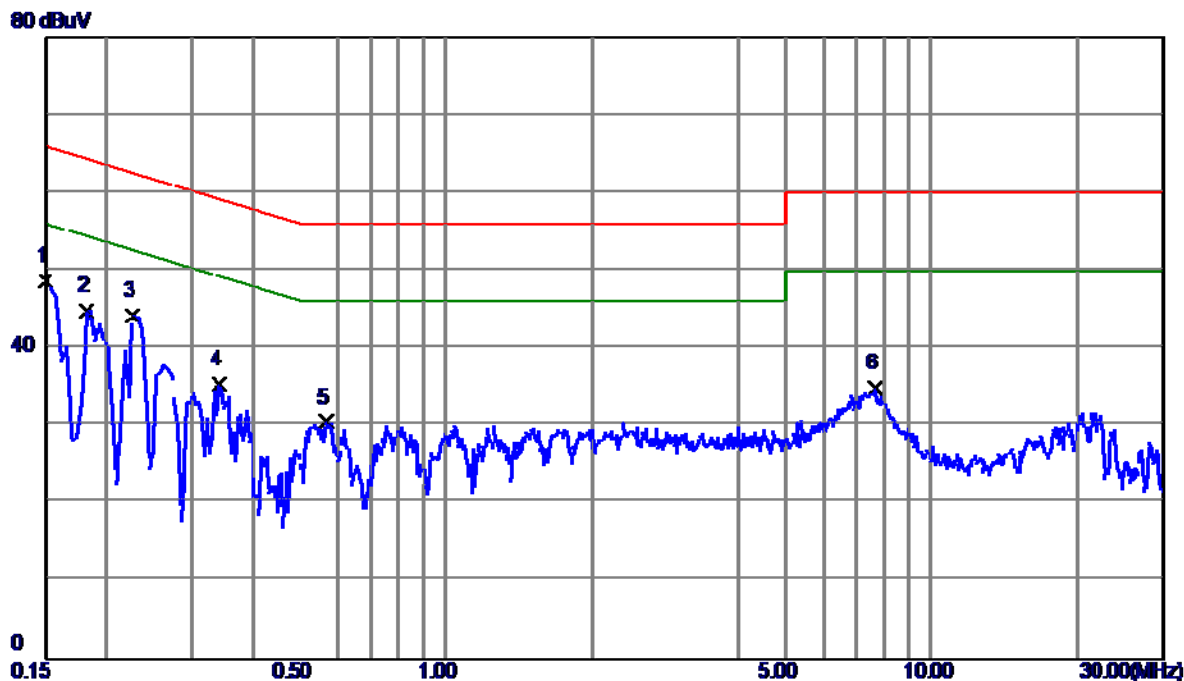

No.	Freq. MHz	Reading Level dBuV	Correct Factor dB	Measure ment dBuV	Limit dBuV	Margin dB	Detector	Comment
1	0.1500	39.19	9.52	48.71	66.00	-17.29	Peak	
2	0.1819	35.24	9.55	44.79	64.40	-19.61	Peak	
3	0.2260	34.58	9.58	44.16	62.60	-18.44	Peak	
4	0.3420	25.74	9.63	35.37	59.15	-23.78	Peak	
5	0.5660	20.78	9.70	30.48	56.00	-25.52	Peak	
6	7.6540	25.04	9.90	34.94	60.00	-25.06	Peak	

Note : The test result has included the cable loss.

Test Mode:	TX MODE
------------	---------

Neutral

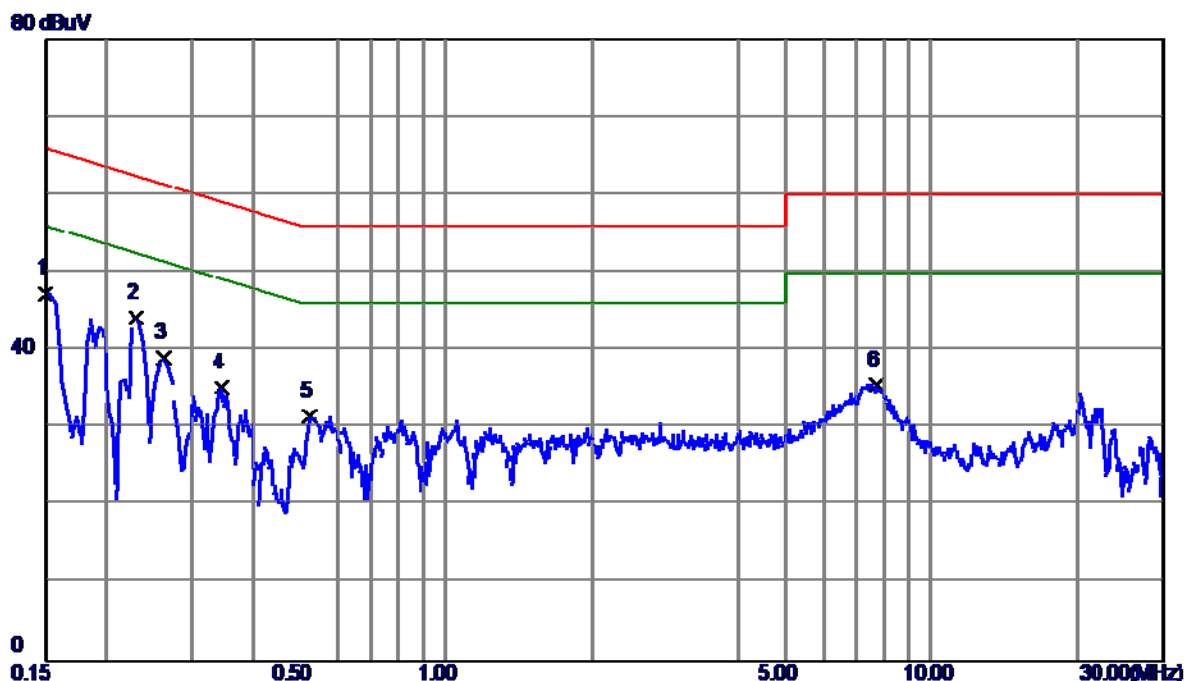

No.	Freq. MHz	Reading Level dBuV	Correct Factor dB	Measure ment dBuV	Limit dBuV	Margin dB	Detector	Comment
1	0.1500	37.81	9.47	47.28	66.00	-18.72	Peak	
2	0.2300	34.61	9.50	44.11	62.45	-18.34	Peak	
3	0.2620	29.48	9.50	38.98	61.37	-22.39	Peak	
4	0.3460	25.72	9.52	35.24	59.06	-23.82	Peak	
5	0.5260	21.94	9.55	31.49	56.00	-24.51	Peak	
6	7.7140	25.71	9.84	35.55	60.00	-24.45	Peak	

Note : The test result has included the cable loss.

ATTACHMENT B - RADIATED EMISSION (9KHZ TO 30MHZ)

Test Mode:	TX MODE
------------	---------

Frequency (MHz)	Ant 0°/90°	Read level dBuV/m	Factor (dB)	Measured(FS) (dBuV/m)	Limit (dBuV/m)	Margin (dB)	Note
0.0097	0°	13.31	24.9523	38.2623	127.8688	-89.6065	AVG
0.0097	0°	14.982	24.9523	39.9343	147.8688	-107.9345	PEAK
0.0295	0°	6.12	23.6983	29.8183	118.2078	-88.3895	AVG
0.0295	0°	8.21	23.6983	31.9083	138.2078	-106.2995	PEAK
0.0345	0°	3.62	23.3817	27.0017	116.8478	-89.8462	AVG
0.0345	0°	5.5	23.3817	28.8817	136.8478	-107.9662	PEAK
0.0574	0°	1.57	22.2520	23.8220	112.4260	-88.6040	AVG
0.0574	0°	2.52	22.2520	24.7720	132.4260	-107.6540	PEAK
0.5061	0°	19.63	19.8195	39.4495	73.5195	-34.0700	QP
1.9538	0°	23.12	19.5046	42.6246	69.5400	-26.9154	QP

Frequency (MHz)	Ant 0°/90°	Read level dBuV/m	Factor (dB)	Measured(FS) (dBuV/m)	Limit (dBuV/m)	Margin (dB)	Note
0.0126	90°	13.55	24.3000	37.8500	125.5968	-87.7468	AVG
0.0126	90°	14.11	24.3000	38.4100	145.5968	-107.1868	PEAK
0.0267	90°	7.82	23.8757	31.6957	119.0740	-87.3783	AVG
0.0267	90°	8.35	23.8757	32.2257	139.0740	-106.8483	PEAK
0.0478	90°	5.5	22.5393	28.0393	114.0157	-85.9763	AVG
0.0478	90°	6.95	22.5393	29.4893	134.0157	-104.5263	PEAK
0.0541	90°	1.88	22.3180	24.1980	112.9403	-88.7423	AVG
0.0541	90°	2.58	22.3180	24.8980	132.9403	-108.0423	PEAK
0.626	90°	22.23	20.2032	42.4332	71.6727	-29.2395	QP
2.0524	90°	24.19	19.4686	43.6586	69.5400	-25.8814	QP

ATTACHMENT C - RADIATED EMISSION (30MHZ TO 1000MHZ)

Test Mode: UNII-1/TX A Mode 5180MHz

Vertical

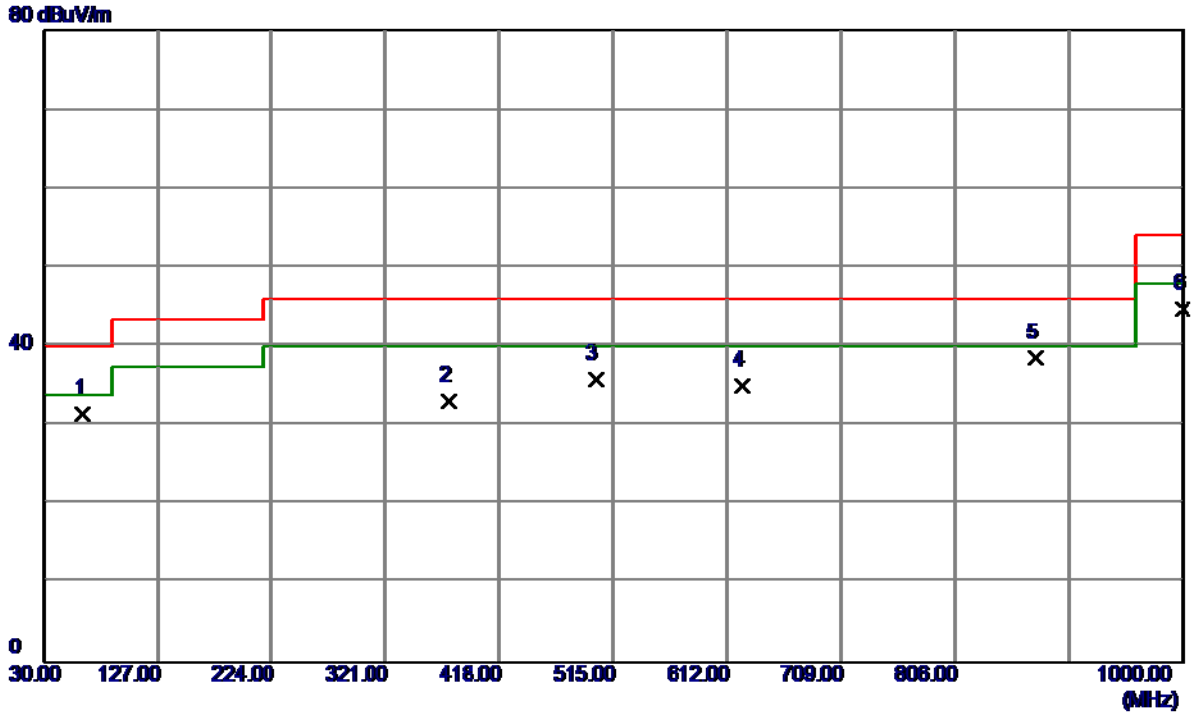

No.	Freq. MHz	Reading Level dBuV/m	Correct Factor dB	Measure ment dBuV/m	Limit dBuV/m	Margin dB	Detector	Comment
1	63.9500	45.70	-14.22	31.48	40.00	-8.52	Peak	
2	375.3200	42.93	-9.78	33.15	46.00	-12.85	Peak	
3	500.4500	43.00	-7.15	35.85	46.00	-10.15	Peak	
4	624.6100	39.87	-4.77	35.10	46.00	-10.90	Peak	
5	874.8700	38.69	-0.20	38.49	46.00	-7.51	Peak	
6	1000.0000	42.74	2.09	44.83	54.00	-9.17	Peak	

Test Mode: UNII-1/TX A Mode 5180MHz

Horizontal

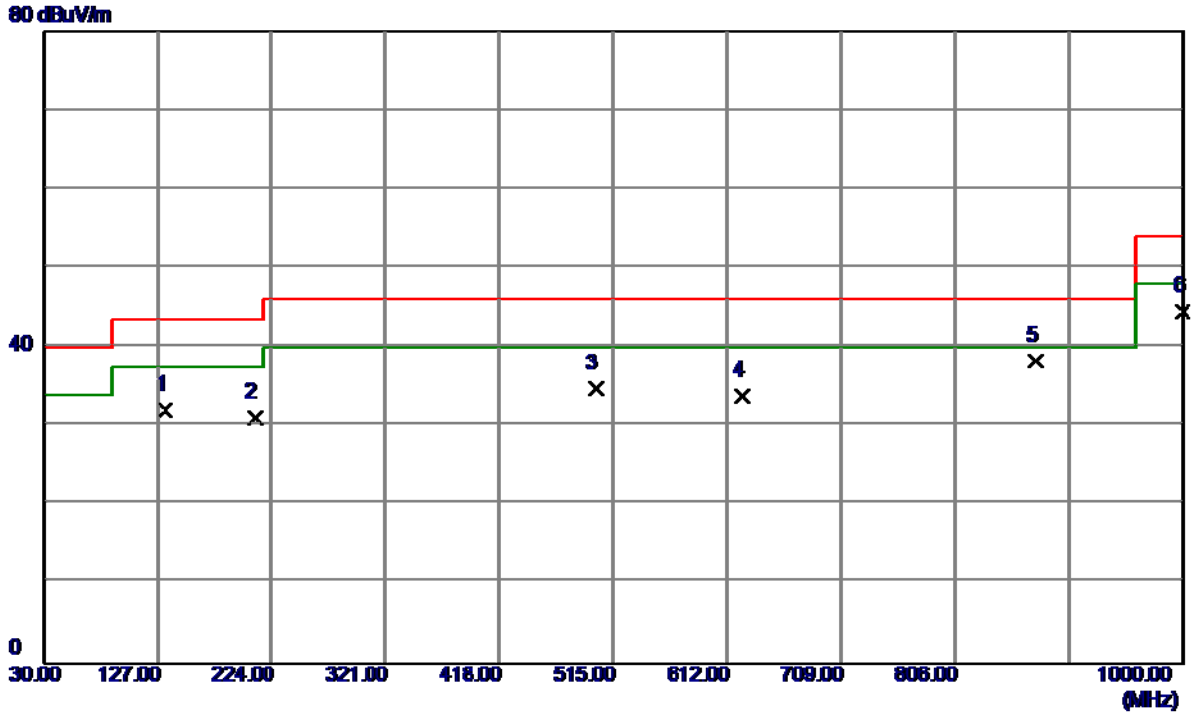

No.	Freq. MHz	Reading Level dBuV/m	Correct Factor dB	Measure ment dBuV/m	Limit dBuV/m	Margin dB	Detector	Comment
1	133.7899	45.72	-13.79	31.93	43.50	-11.57	Peak	
2	209.4500	46.79	-15.70	31.09	43.50	-12.41	Peak	
3	500.4500	41.85	-7.15	34.70	46.00	-11.30	Peak	
4	624.6100	38.55	-4.77	33.78	46.00	-12.22	Peak	
5	874.8700	38.47	-0.20	38.27	46.00	-7.73	Peak	
6	1000.0000	42.35	2.09	44.44	54.00	-9.56	Peak	

Test Mode: UNII-1/TX A Mode 5200MHz

Vertical

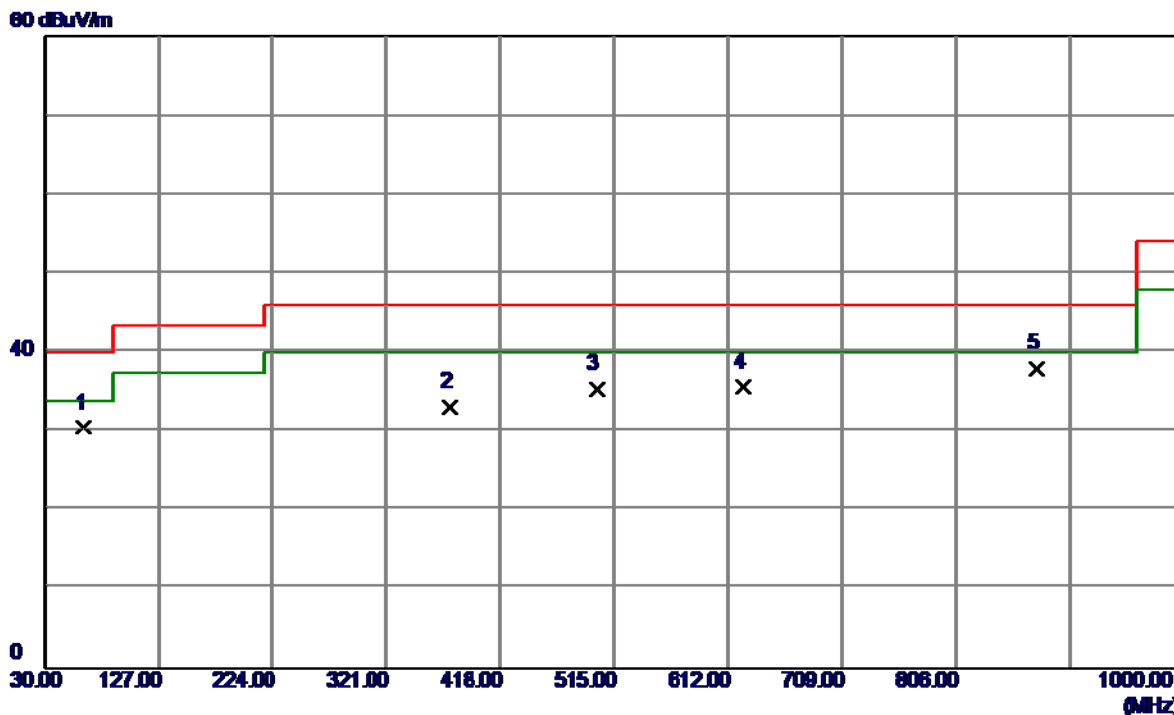

No.	Freq. MHz	Reading Level dBuV/m	Correct Factor dB	Measure ment dBuV/m	Limit dBuV/m	Margin dB	Detector	Comment
1	63.9500	44.70	-14.22	30.48	40.00	-9.52	Peak	
2	375.3200	42.93	-9.78	33.15	46.00	-12.85	Peak	
3	500.4500	42.50	-7.15	35.35	46.00	-10.65	Peak	
4	624.6100	40.37	-4.77	35.60	46.00	-10.40	Peak	
5	874.8700	38.19	-0.20	37.99	46.00	-8.01	Peak	
6	1000.0000	41.74	2.09	43.83	54.00	-10.17	Peak	

Test Mode: UNII-1/TX A Mode 5200MHz

Horizontal

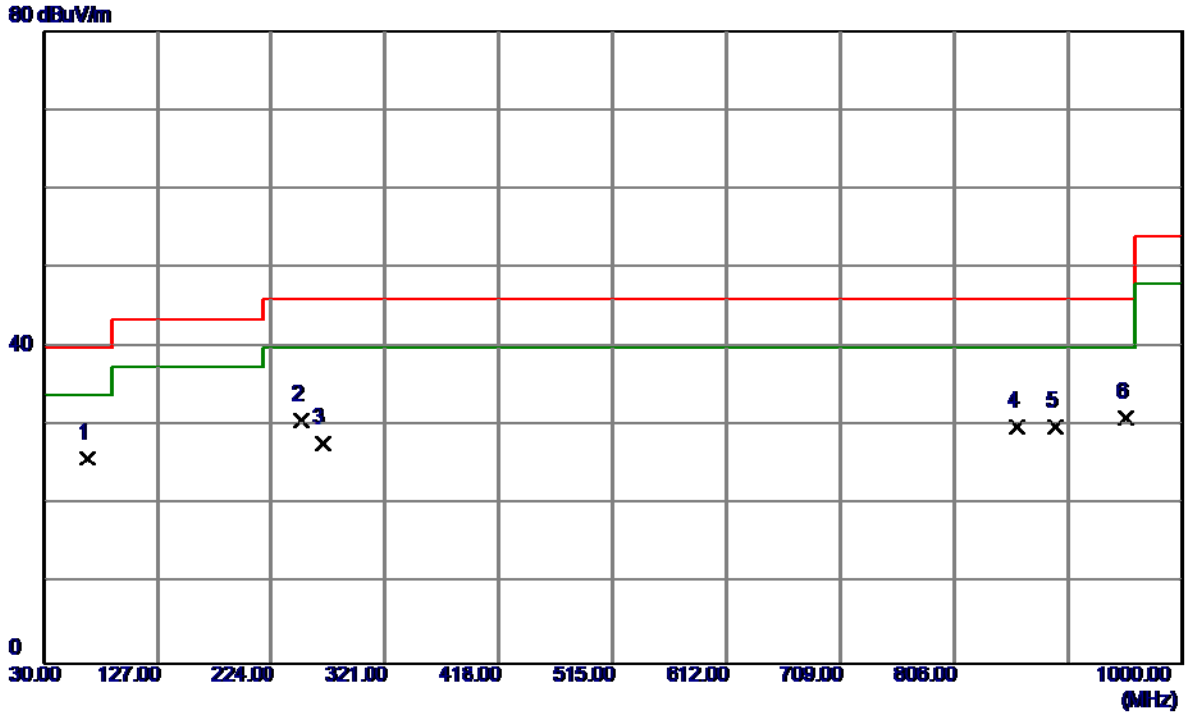

No.	Freq. MHz	Reading Level dBuV/m	Correct Factor dB	Measure ment dBuV/m	Limit dBuV/m	Margin dB	Detector	Comment
1	67.8300	40.65	-14.79	25.86	40.00	-14.14	Peak	
2	250.1900	44.16	-13.37	30.79	46.00	-15.21	Peak	
3	267.6500	40.45	-12.54	27.91	46.00	-18.09	Peak	
4	860.3200	30.51	-0.56	29.95	46.00	-16.05	Peak	
5	892.3300	29.63	0.24	29.87	46.00	-16.13	Peak	
6	952.4700	29.20	1.78	30.98	46.00	-15.02	Peak	

Test Mode: UNII-1/TX A Mode 5240MHz

Vertical

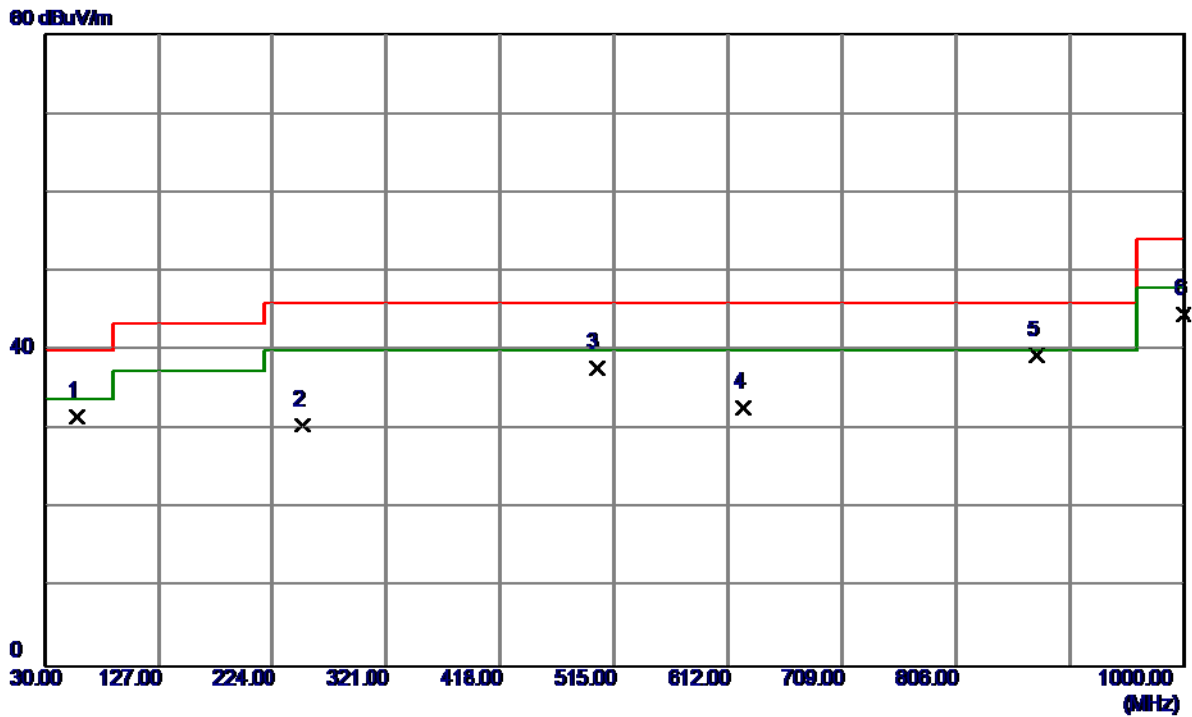

No.	Freq. MHz	Reading Level dBuV/m	Correct Factor dB	Measure ment dBuV/m	Limit dBuV/m	Margin dB	Detector	Comment
1	58.1300	45.17	-13.55	31.62	40.00	-8.38	Peak	
2	250.1900	43.99	-13.37	30.62	46.00	-15.38	Peak	
3	500.4500	44.87	-7.15	37.72	46.00	-8.28	Peak	
4	624.6100	37.52	-4.77	32.75	46.00	-13.25	Peak	
5	874.8700	39.59	-0.20	39.39	46.00	-6.61	Peak	
6	1000.0000	42.48	2.09	44.57	54.00	-9.43	Peak	

Test Mode: UNII-1/TX A Mode 5240MHz

Horizontal

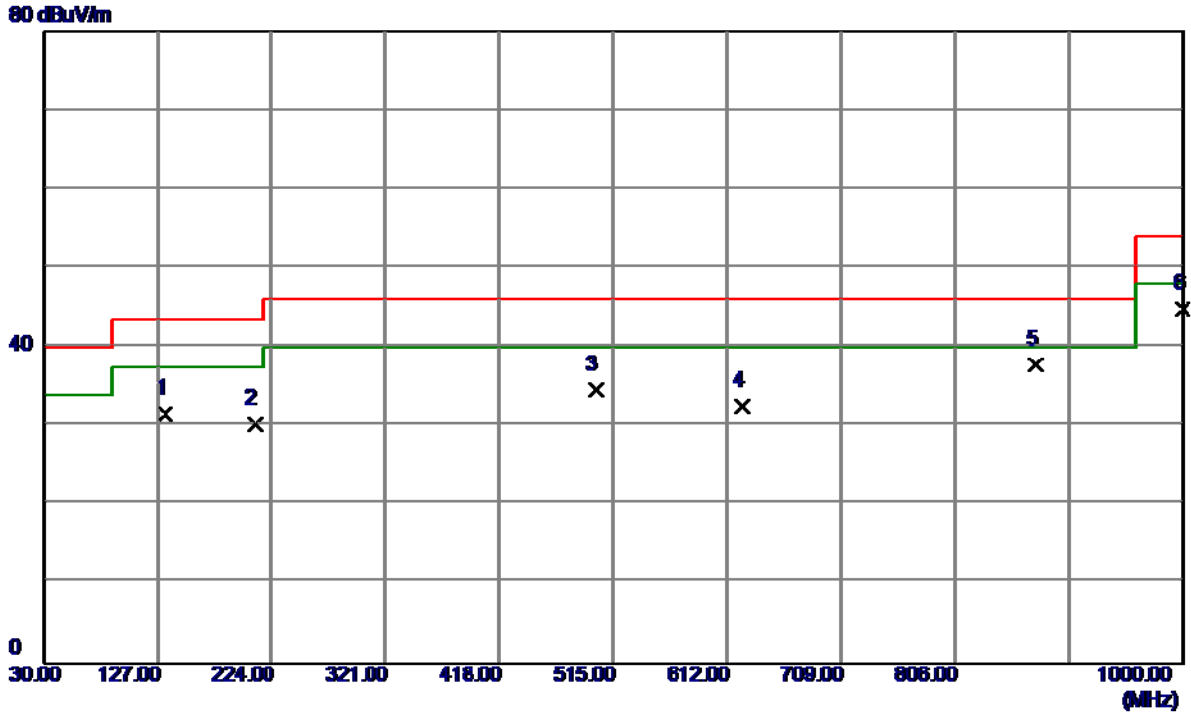

No.	Freq. MHz	Reading Level dBuV/m	Correct Factor dB	Measure ment dBuV/m	Limit dBuV/m	Margin dB	Detector	Comment
1	133.7899	45.34	-13.79	31.55	43.50	-11.95	Peak	
2	209.4500	45.92	-15.70	30.22	43.50	-13.28	Peak	
3	500.4500	41.68	-7.15	34.53	46.00	-11.47	Peak	
4	624.6100	37.30	-4.77	32.53	46.00	-13.47	Peak	
5	874.8700	37.94	-0.20	37.74	46.00	-8.26	Peak	
6	1000.0000	42.75	2.09	44.84	54.00	-9.16	Peak	

Test Mode: UNII-2A/TX A Mode 5260MHz

Vertical

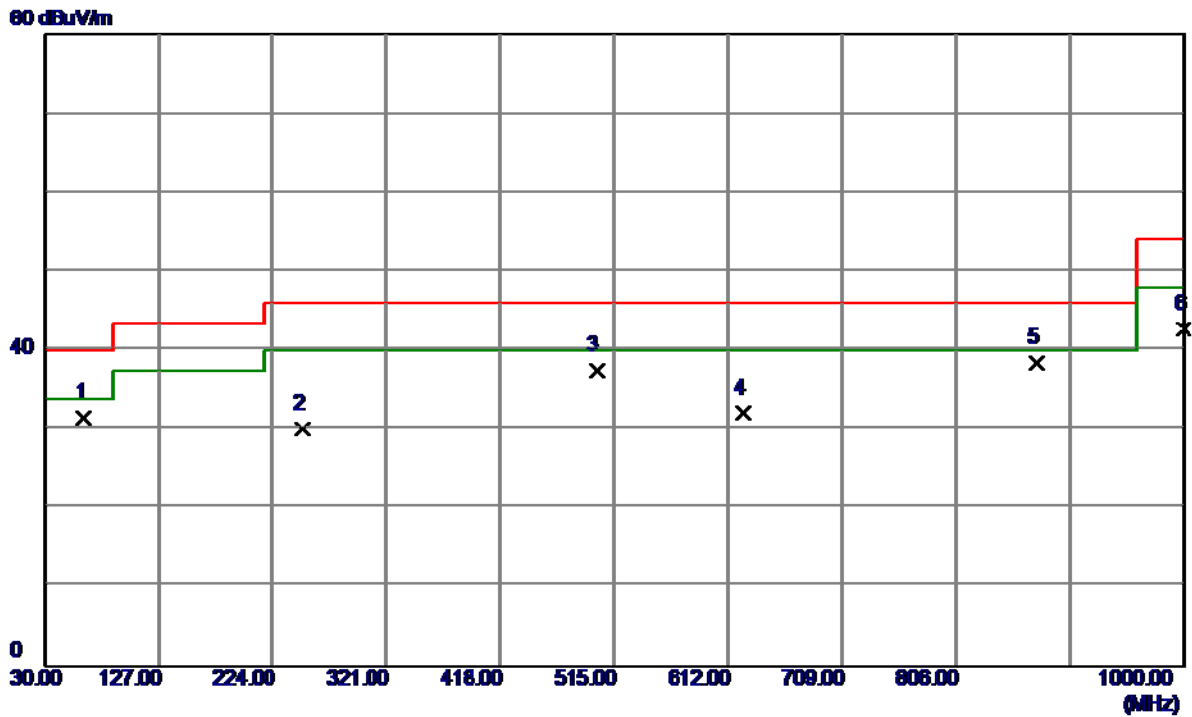

No.	Freq. MHz	Reading Level dBuV/m	Correct Factor dB	Measure ment dBuV/m	Limit dBuV/m	Margin dB	Detector	Comment
1	63.9500	45.74	-14.22	31.52	40.00	-8.48	Peak	
2	250.1900	43.47	-13.37	30.10	46.00	-15.90	Peak	
3	500.4500	44.64	-7.15	37.49	46.00	-8.51	Peak	
4	624.6100	36.85	-4.77	32.08	46.00	-13.92	Peak	
5	874.8700	38.65	-0.20	38.45	46.00	-7.55	Peak	
6	1000.0000	40.59	2.09	42.68	54.00	-11.32	Peak	

Test Mode: UNII-2A/TX A Mode 5260MHz

Horizontal

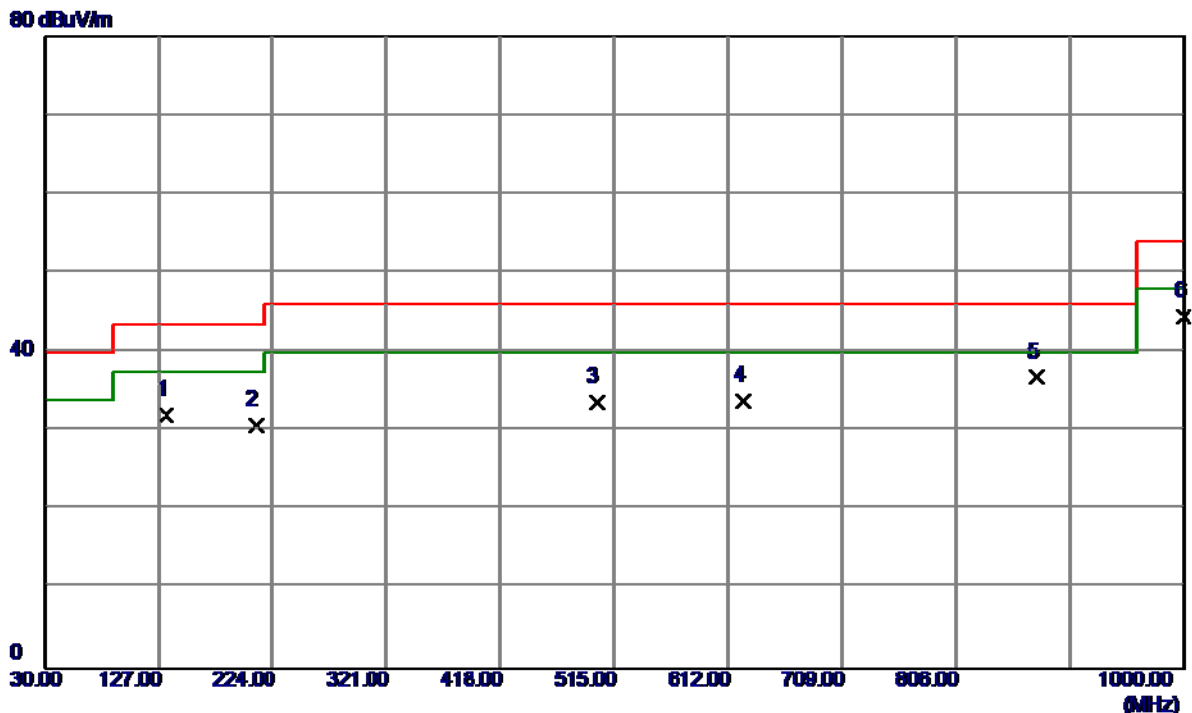

No.	Freq. MHz	Reading Level dBuV/m	Correct Factor dB	Measure ment dBuV/m	Limit dBuV/m	Margin dB	Detector	Comment
1	133.7899	45.77	-13.79	31.98	43.50	-11.52	Peak	
2	209.4500	46.36	-15.70	30.66	43.50	-12.84	Peak	
3	500.4500	40.80	-7.15	33.65	46.00	-12.35	Peak	
4	624.6100	38.54	-4.77	33.77	46.00	-12.23	Peak	
5	874.8700	37.04	-0.20	36.84	46.00	-9.16	Peak	
6	1000.0000	42.40	2.09	44.49	54.00	-9.51	Peak	

Test Mode: UNII-2A/TX A Mode 5300MHz

Vertical

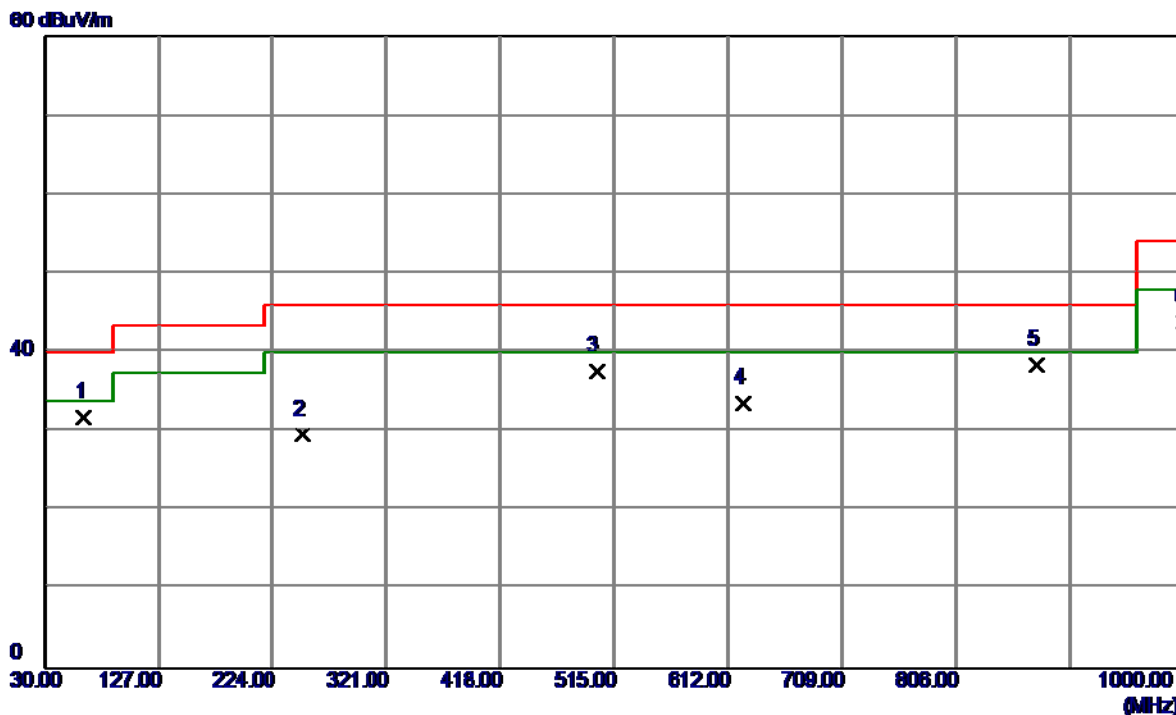

No.	Freq. MHz	Reading Level dBuV/m	Correct Factor dB	Measure ment dBuV/m	Limit dBuV/m	Margin dB	Detector	Comment
1	63.9500	46.02	-14.22	31.80	40.00	-8.20	Peak	
2	250.1900	42.98	-13.37	29.61	46.00	-16.39	Peak	
3	500.4500	44.80	-7.15	37.65	46.00	-8.35	Peak	
4	624.6100	38.30	-4.77	33.53	46.00	-12.47	Peak	
5	874.8700	38.67	-0.20	38.47	46.00	-7.53	Peak	
6	1000.0000	41.69	2.09	43.78	54.00	-10.22	Peak	

Test Mode: UNII-2A/TX A Mode 5300MHz

Horizontal

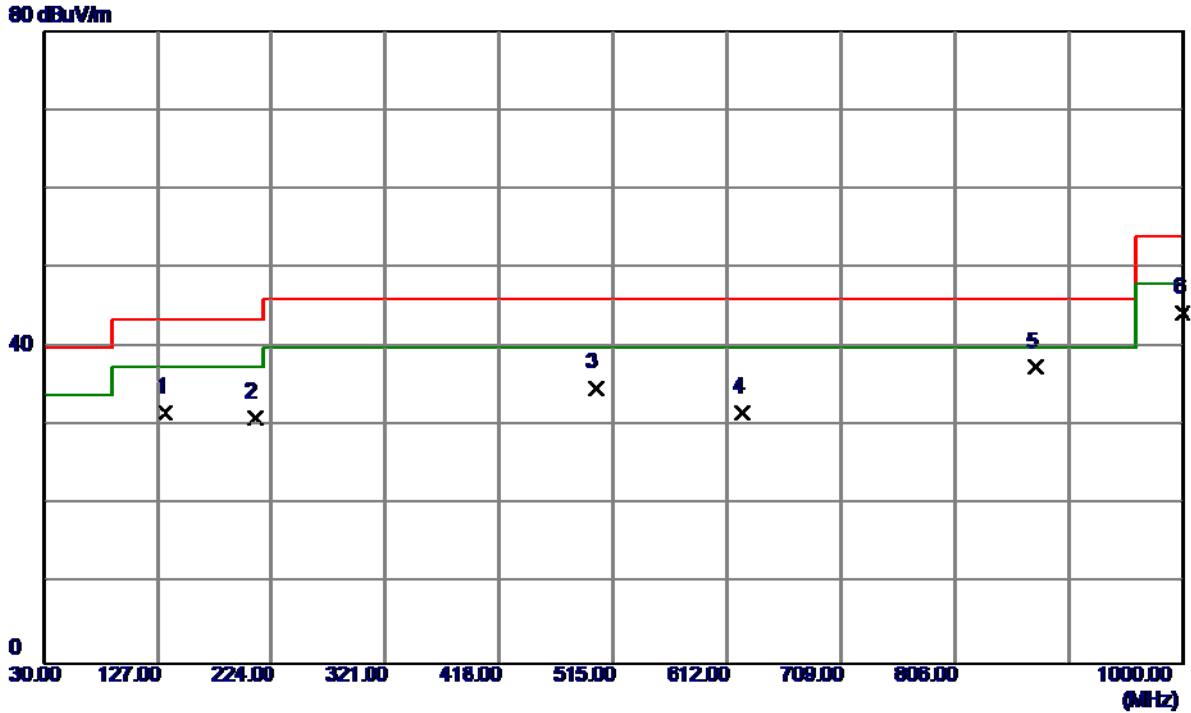

No.	Freq. MHz	Reading Level dBuV/m	Correct Factor dB	Measure ment dBuV/m	Limit dBuV/m	Margin dB	Detector	Comment
1	133.7899	45.43	-13.79	31.64	43.50	-11.86	Peak	
2	209.4500	46.72	-15.70	31.02	43.50	-12.48	Peak	
3	500.4500	41.95	-7.15	34.80	46.00	-11.20	Peak	
4	624.6100	36.50	-4.77	31.73	46.00	-14.27	Peak	
5	874.8700	37.63	-0.20	37.43	46.00	-8.57	Peak	
6	1000.0000	42.24	2.09	44.33	54.00	-9.67	Peak	

Test Mode: UNII-2A/TX A Mode 5320MHz

Vertical

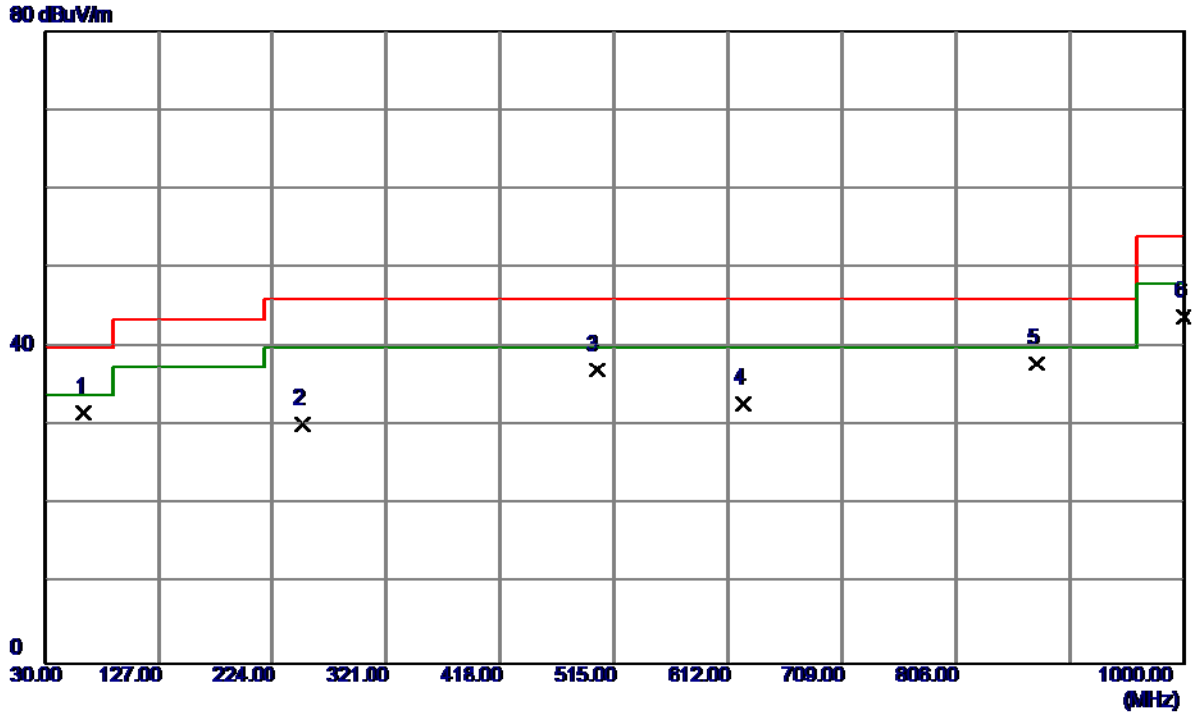

No.	Freq. MHz	Reading Level dBuV/m	Correct Factor dB	Measure ment dBuV/m	Limit dBuV/m	Margin dB	Detector	Comment
1	63.9500	45.86	-14.22	31.64	40.00	-8.36	Peak	
2	250.1900	43.58	-13.37	30.21	46.00	-15.79	Peak	
3	500.4500	44.20	-7.15	37.05	46.00	-8.95	Peak	
4	624.6100	37.64	-4.77	32.87	46.00	-13.13	Peak	
5	874.8700	38.19	-0.20	37.99	46.00	-8.01	Peak	
6	1000.0000	41.74	2.09	43.83	54.00	-10.17	Peak	

Test Mode: UNII-2A/TX A Mode 5320MHz

Horizontal

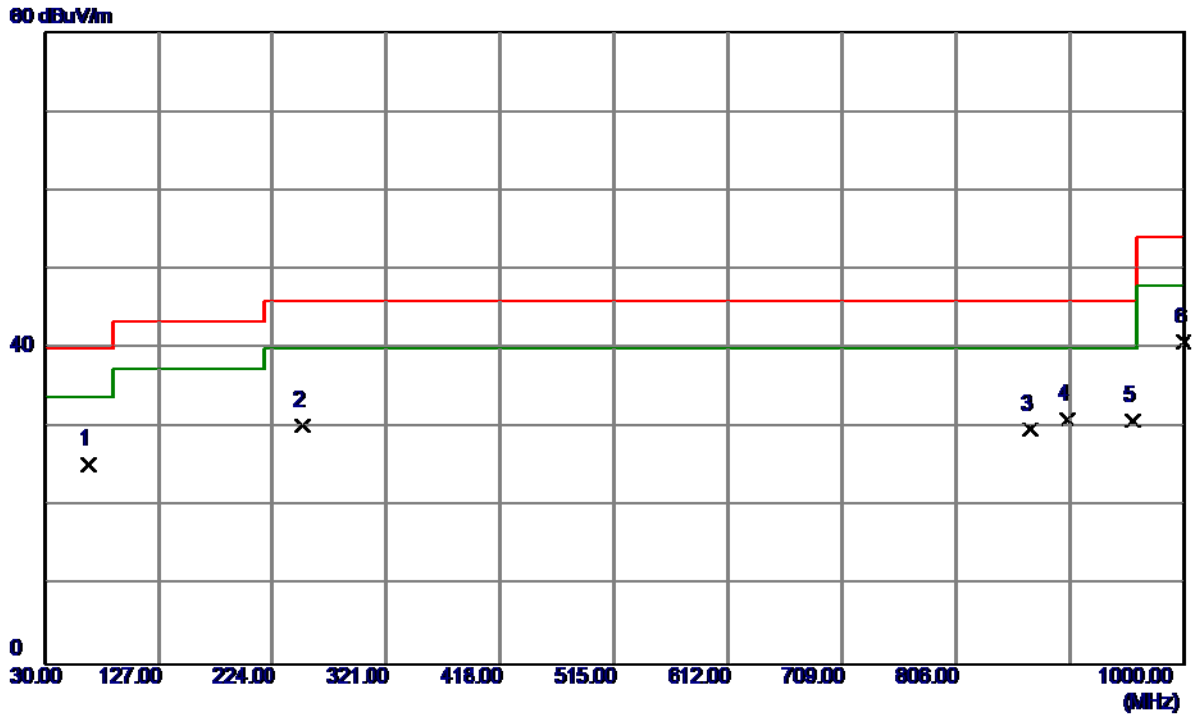

No.	Freq. MHz	Reading Level dBuV/m	Correct Factor dB	Measure ment dBuV/m	Limit dBuV/m	Margin dB	Detector	Comment
1	67.8300	40.09	-14.79	25.30	40.00	-14.70	Peak	
2	250.1900	43.61	-13.37	30.24	46.00	-15.76	Peak	
3	870.0200	30.11	-0.32	29.79	46.00	-16.21	Peak	
4	901.0600	30.65	0.46	31.11	46.00	-14.89	Peak	
5	957.3200	29.11	1.81	30.92	46.00	-15.08	Peak	
6	1000.0000	38.65	2.09	40.74	54.00	-13.26	Peak	

Test Mode: UNII-2C/TX A Mode 5500MHz

Vertical

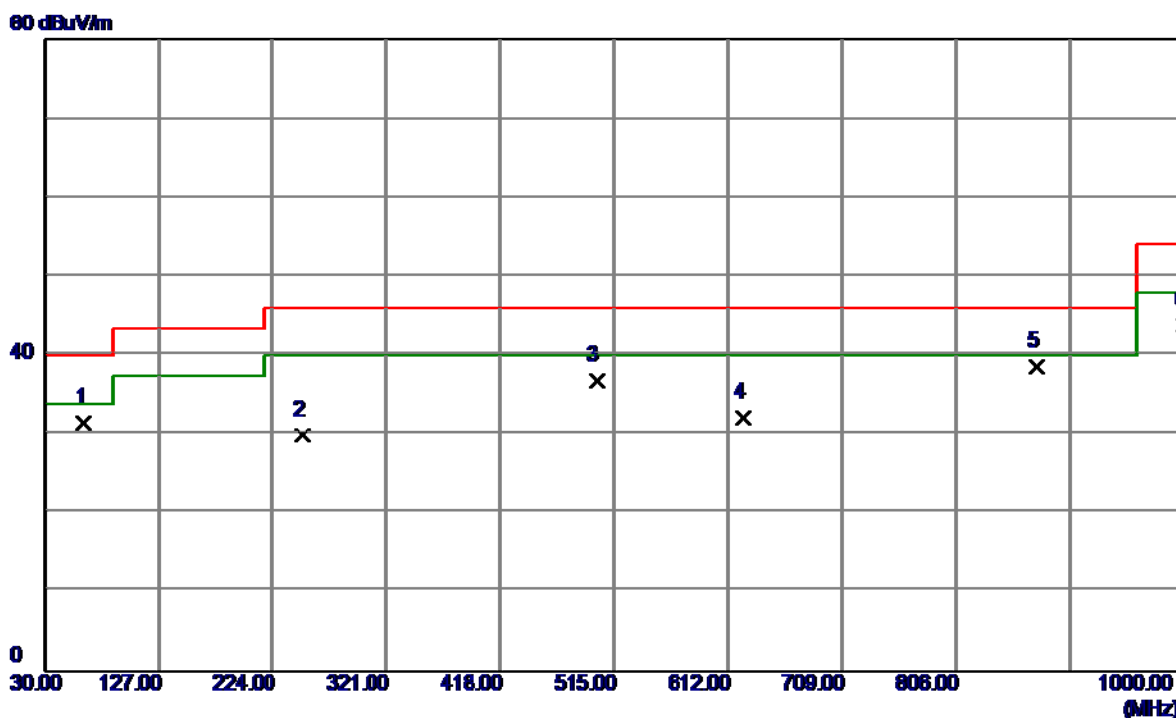

No.	Freq. MHz	Reading Level dBuV/m	Correct Factor dB	Measure ment dBuV/m	Limit dBuV/m	Margin dB	Detector	Comment
1	63.9500	45.77	-14.22	31.55	40.00	-8.45	Peak	
2	250.1900	43.23	-13.37	29.86	46.00	-16.14	Peak	
3	500.4500	43.96	-7.15	36.81	46.00	-9.19	Peak	
4	624.6100	36.95	-4.77	32.18	46.00	-13.82	Peak	
5	874.8700	38.81	-0.20	38.61	46.00	-7.39	Peak	
6	1000.0000	41.73	2.09	43.82	54.00	-10.18	Peak	

Test Mode: UNII-2C/TX A Mode 5500MHz

Horizontal

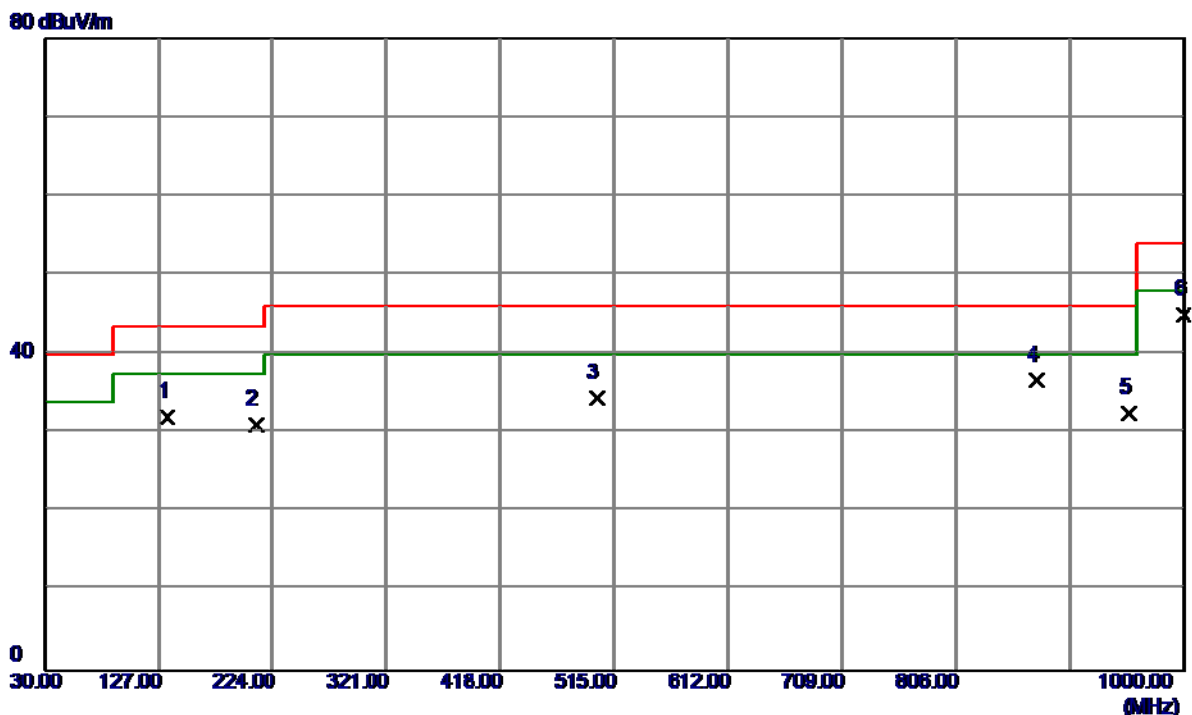

No.	Freq. MHz	Reading Level dBuV/m	Correct Factor dB	Measure ment dBuV/m	Limit dBuV/m	Margin dB	Detector	Comment
1	134.7600	45.66	-13.70	31.96	43.50	-11.54	Peak	
2	209.4500	46.80	-15.70	31.10	43.50	-12.40	Peak	
3	500.4500	41.57	-7.15	34.42	46.00	-11.58	Peak	
4	874.8700	36.77	-0.20	36.57	46.00	-9.43	Peak	
5	953.4400	30.73	1.78	32.51	46.00	-13.49	Peak	
6	1000.0000	42.83	2.09	44.92	54.00	-9.08	Peak	

Test Mode: UNII-2C/TX A Mode 5580MHz

Vertical

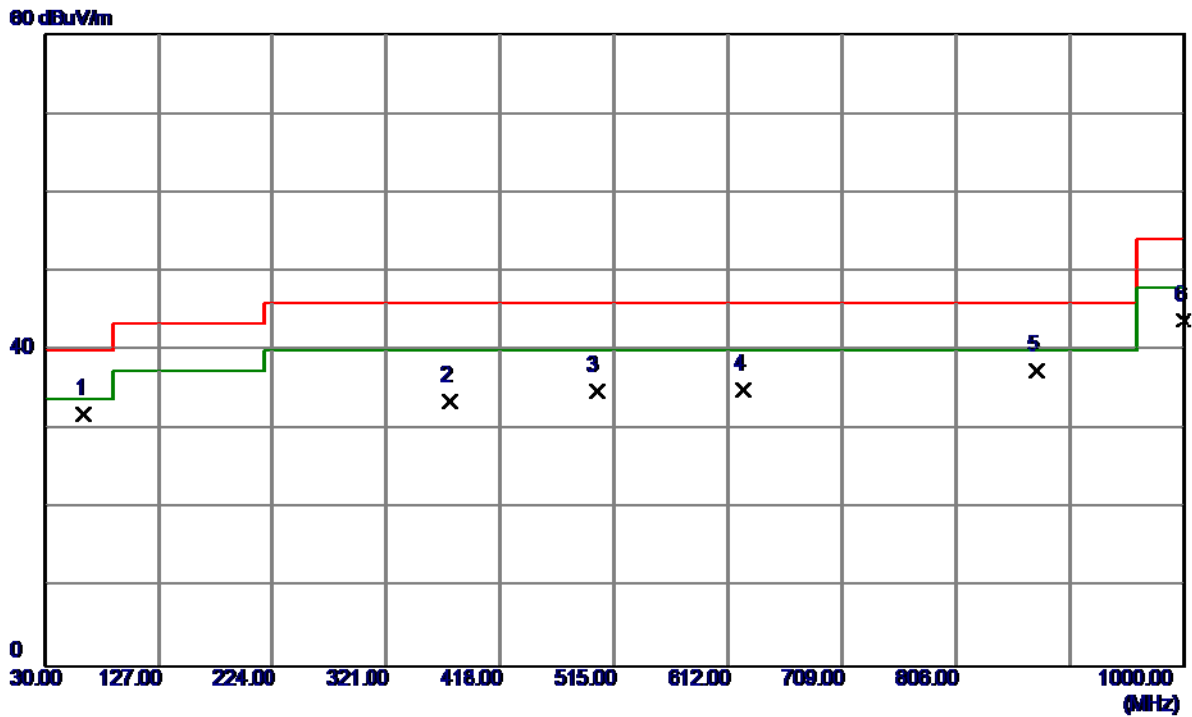

No.	Freq. MHz	Reading Level dBuV/m	Correct Factor dB	Measure ment dBuV/m	Limit dBuV/m	Margin dB	Detector	Comment
1	63.9500	46.20	-14.22	31.98	40.00	-8.02	Peak	
2	375.3200	43.43	-9.78	33.65	46.00	-12.35	Peak	
3	500.4500	42.00	-7.15	34.85	46.00	-11.15	Peak	
4	624.6100	39.87	-4.77	35.10	46.00	-10.90	Peak	
5	874.8700	37.69	-0.20	37.49	46.00	-8.51	Peak	
6	1000.0000	41.74	2.09	43.83	54.00	-10.17	Peak	

Test Mode: UNII-2C/TX A Mode 5580MHz

Horizontal

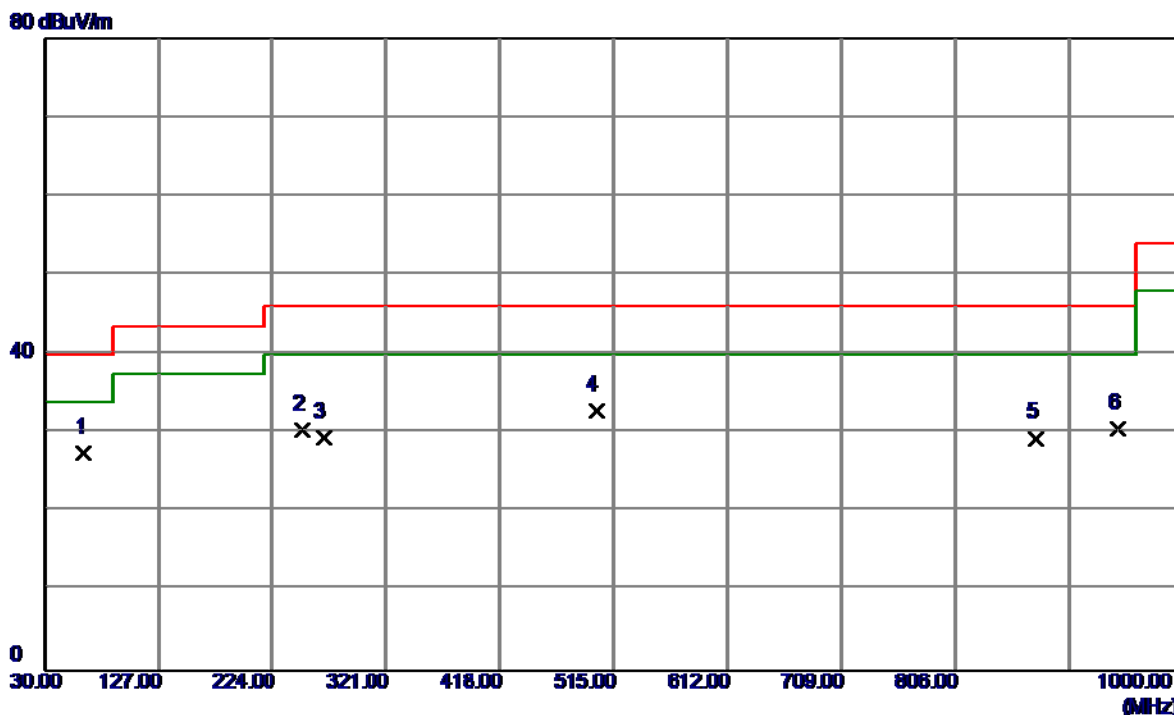

No.	Freq. MHz	Reading Level dBuV/m	Correct Factor dB	Measure ment dBuV/m	Limit dBuV/m	Margin dB	Detector	Comment
1	63.9500	41.67	-14.22	27.45	40.00	-12.55	Peak	
2	250.1900	43.81	-13.37	30.44	46.00	-15.56	Peak	
3	267.6500	42.05	-12.54	29.51	46.00	-16.49	Peak	
4	500.4500	39.89	-7.15	32.74	46.00	-13.26	Peak	
5	874.8700	29.56	-0.20	29.36	46.00	-16.64	Peak	
6	944.7100	28.98	1.62	30.60	46.00	-15.40	Peak	

Test Mode: UNII-2C/TX A Mode 5700MHz

Vertical

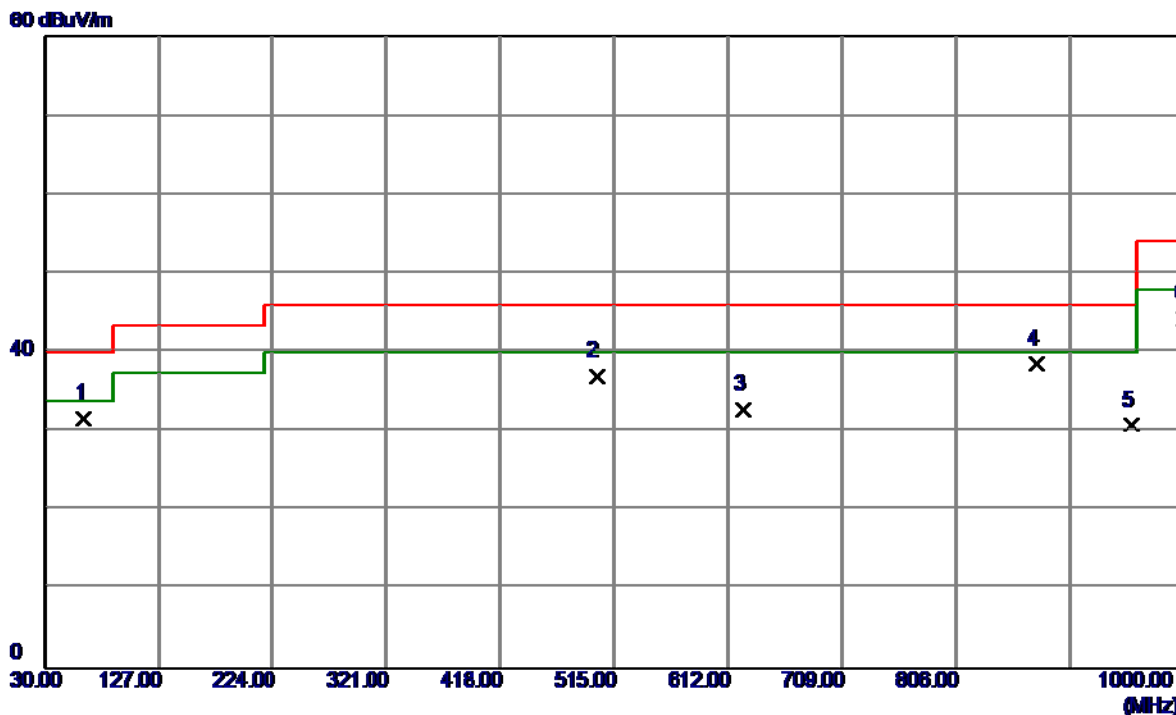

No.	Freq. MHz	Reading Level dBuV/m	Correct Factor dB	Measure ment dBuV/m	Limit dBuV/m	Margin dB	Detector	Comment
1	63.9500	45.88	-14.22	31.66	40.00	-8.34	Peak	
2	500.4500	44.10	-7.15	36.95	46.00	-9.05	Peak	
3	624.6100	37.61	-4.77	32.84	46.00	-13.16	Peak	
4	874.8700	38.68	-0.20	38.48	46.00	-7.52	Peak	
5	955.3800	29.00	1.80	30.80	46.00	-15.20	Peak	
6	1000.0000	42.17	2.09	44.26	54.00	-9.74	Peak	

Test Mode: UNII-2C/TX A Mode 5700MHz

Horizontal

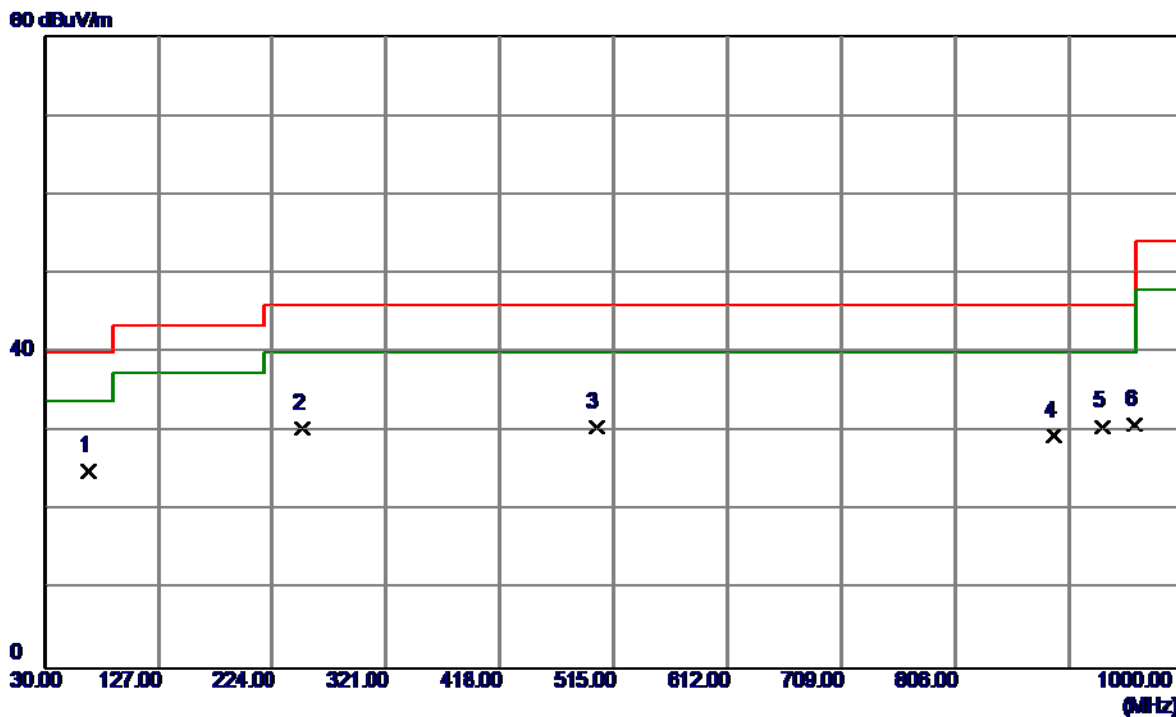

No.	Freq. MHz	Reading Level dBuV/m	Correct Factor dB	Measure ment dBuV/m	Limit dBuV/m	Margin dB	Detector	Comment
1	67.8300	39.71	-14.79	24.92	40.00	-15.08	Peak	
2	250.1900	43.73	-13.37	30.36	46.00	-15.64	Peak	
3	500.4500	37.66	-7.15	30.51	46.00	-15.49	Peak	
4	890.3900	29.29	0.19	29.48	46.00	-16.52	Peak	
5	932.1000	29.35	1.29	30.64	46.00	-15.36	Peak	
6	959.2600	29.00	1.82	30.82	46.00	-15.18	Peak	

Test Mode: UNII-3/TX A Mode 5745MHz

Vertical

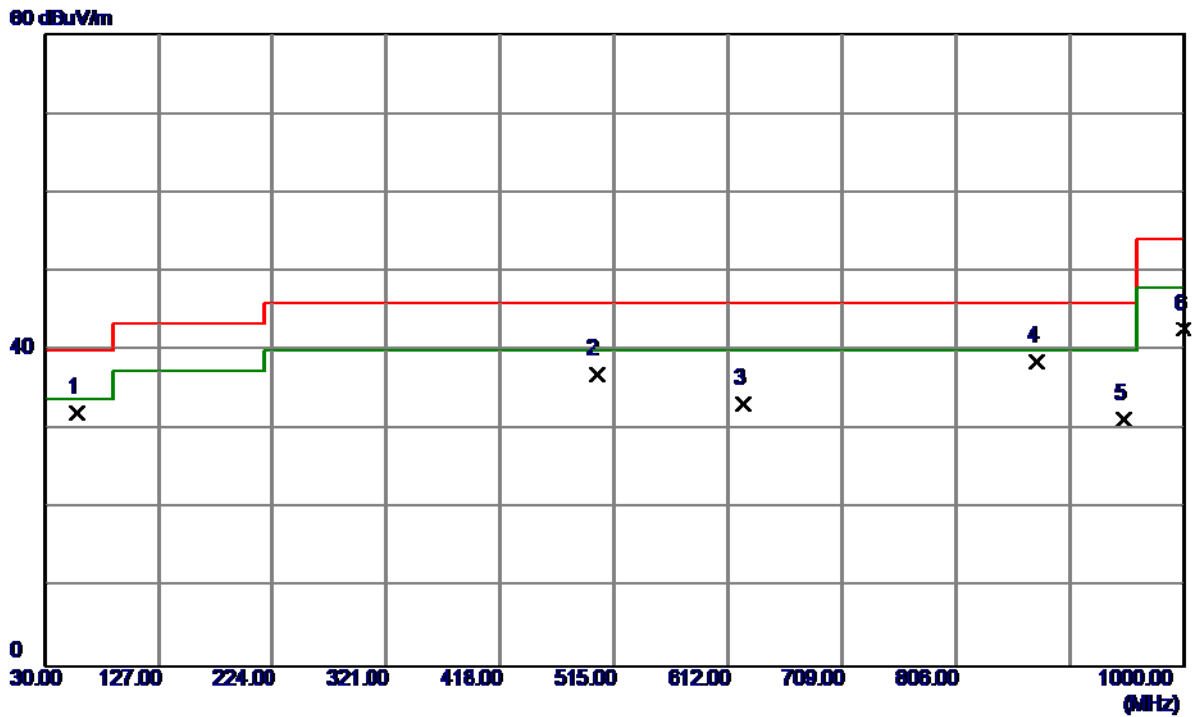

No.	Freq. MHz	Reading Level dBuV/m	Correct Factor dB	Measure ment dBuV/m	Limit dBuV/m	Margin dB	Detector	Comment
1	58.1300	45.66	-13.55	32.11	40.00	-7.89	Peak	
2	500.4500	44.18	-7.15	37.03	46.00	-8.97	Peak	
3	624.6100	38.09	-4.77	33.32	46.00	-12.68	Peak	
4	874.8700	38.73	-0.20	38.53	46.00	-7.47	Peak	
5	949.5600	29.58	1.75	31.33	46.00	-14.67	Peak	
6	1000.0000	40.70	2.09	42.79	54.00	-11.21	Peak	

Test Mode: UNII-3/TX A Mode 5745MHz

Horizontal

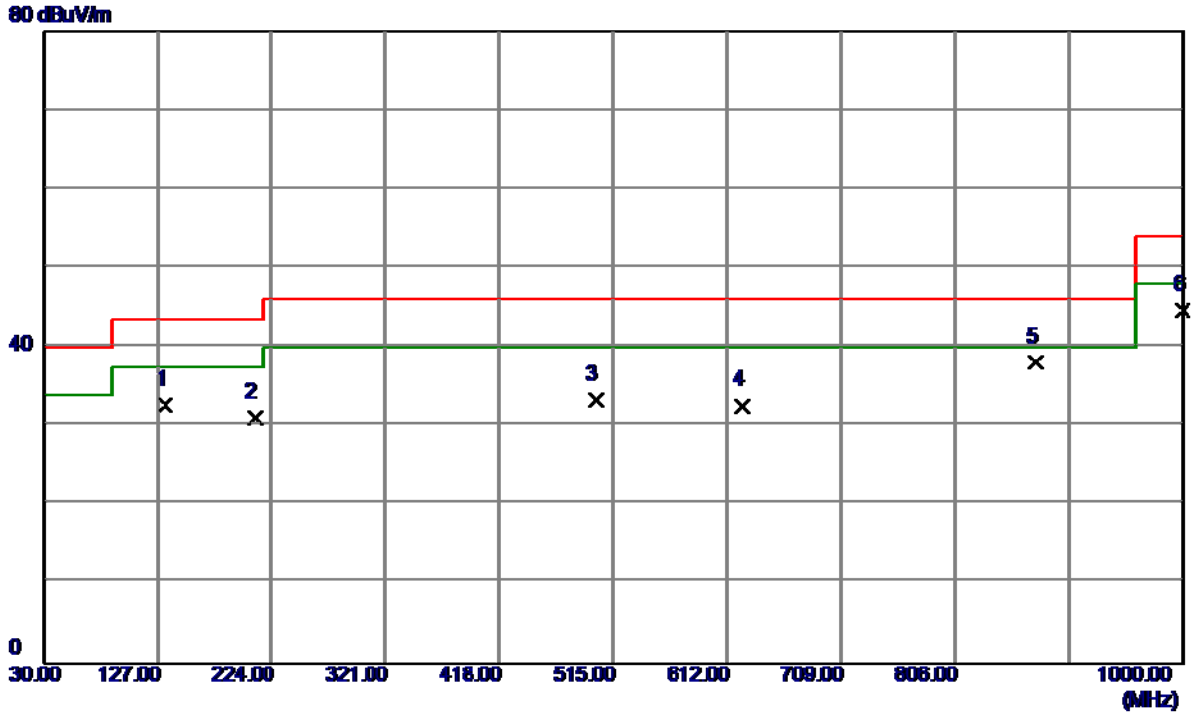

No.	Freq. MHz	Reading Level dBuV/m	Correct Factor dB	Measurement dBuV/m	Limit dBuV/m	Margin dB	Detector	Comment
1	133.7899	46.38	-13.79	32.59	43.50	-10.91	Peak	
2	209.4500	46.68	-15.70	30.98	43.50	-12.52	Peak	
3	500.4500	40.43	-7.15	33.28	46.00	-12.72	Peak	
4	624.6100	37.33	-4.77	32.56	46.00	-13.44	Peak	
5	874.8700	38.29	-0.20	38.09	46.00	-7.91	Peak	
6	1000.0000	42.51	2.09	44.60	54.00	-9.40	Peak	

Test Mode: UNII-3/TX A Mode 5785MHz

Vertical

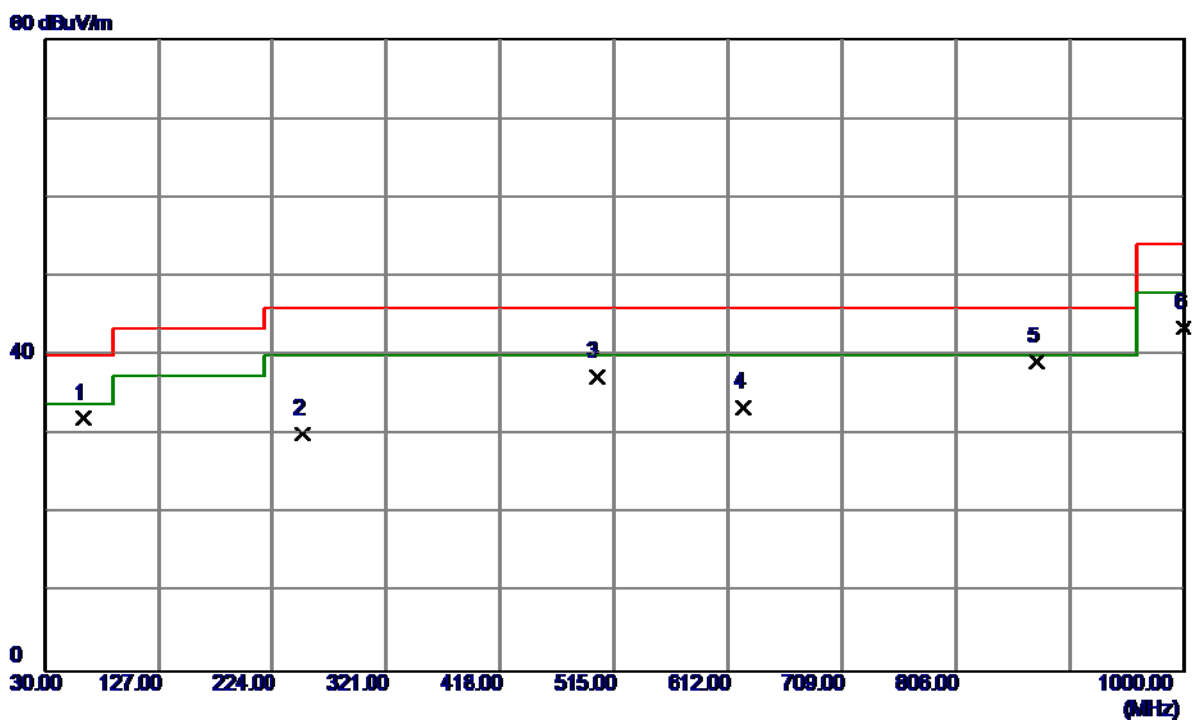

No.	Freq. MHz	Reading Level dBuV/m	Correct Factor dB	Measure ment dBuV/m	Limit dBuV/m	Margin dB	Detector	Comment
1	62.9800	46.16	-14.08	32.08	40.00	-7.92	Peak	
2	250.1900	43.40	-13.37	30.03	46.00	-15.97	Peak	
3	500.4500	44.38	-7.15	37.23	46.00	-8.77	Peak	
4	624.6100	38.18	-4.77	33.41	46.00	-12.59	Peak	
5	874.8700	39.46	-0.20	39.26	46.00	-6.74	Peak	
6	1000.0000	41.44	2.09	43.53	54.00	-10.47	Peak	

Test Mode: UNII-3/TX A Mode 5785MHz

Horizontal

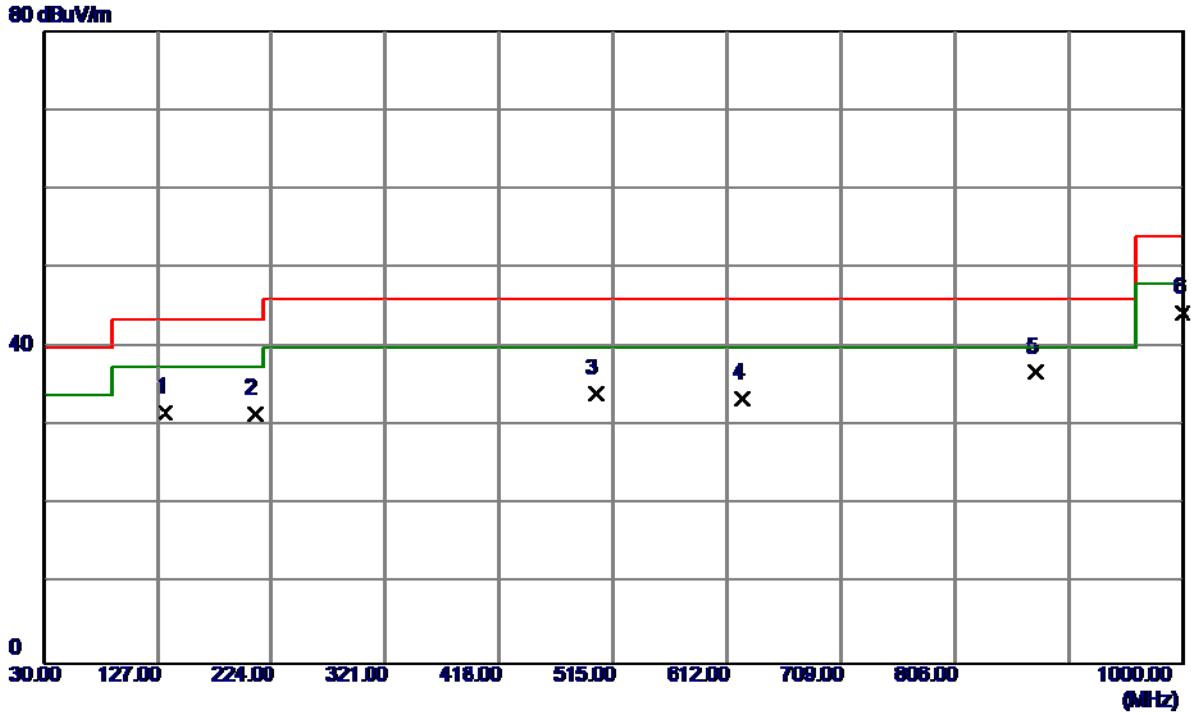

No.	Freq. MHz	Reading Level dBuV/m	Correct Factor dB	Measure ment dBuV/m	Limit dBuV/m	Margin dB	Detector	Comment
1	133.7899	45.48	-13.79	31.69	43.50	-11.81	Peak	
2	209.4500	47.22	-15.70	31.52	43.50	-11.98	Peak	
3	500.4500	41.17	-7.15	34.02	46.00	-11.98	Peak	
4	624.6100	38.16	-4.77	33.39	46.00	-12.61	Peak	
5	874.8700	37.02	-0.20	36.82	46.00	-9.18	Peak	
6	1000.0000	42.16	2.09	44.25	54.00	-9.75	Peak	

Test Mode: UNII-3/TX A Mode 5825MHz

Vertical

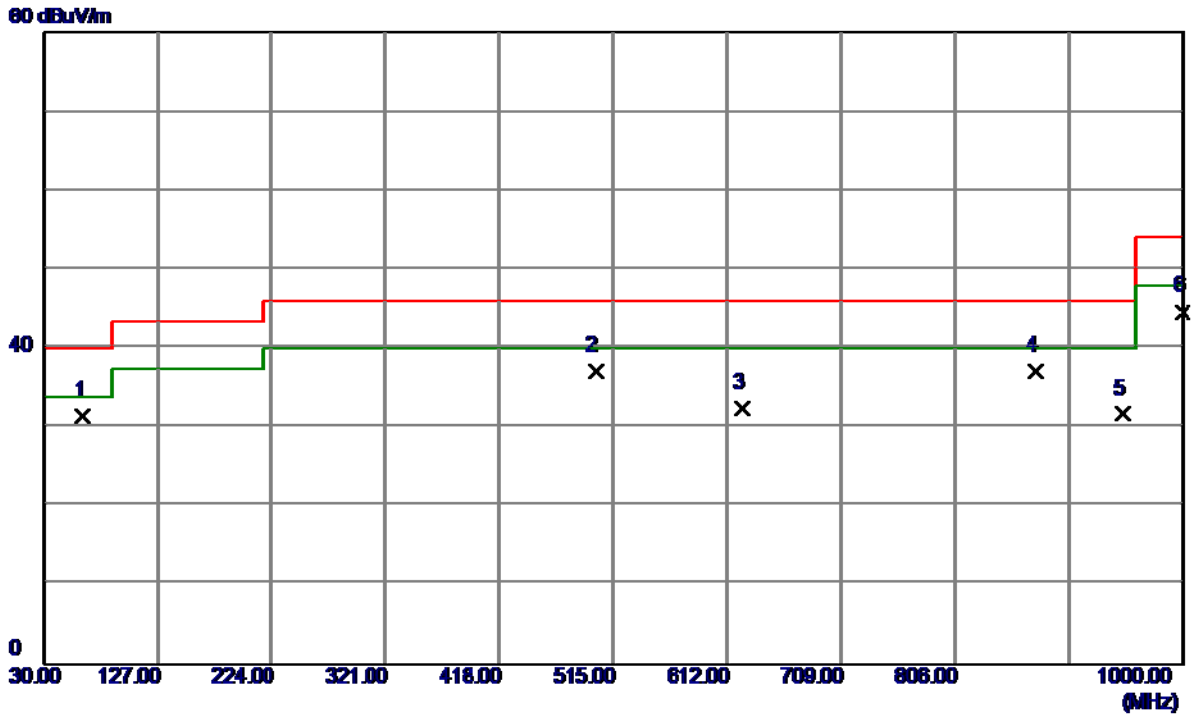

No.	Freq. MHz	Reading Level dBuV/m	Correct Factor dB	Measure ment dBuV/m	Limit dBuV/m	Margin dB	Detector	Comment
1	63.9500	45.76	-14.22	31.54	40.00	-8.46	Peak	
2	500.4500	44.22	-7.15	37.07	46.00	-8.93	Peak	
3	624.6100	37.23	-4.77	32.46	46.00	-13.54	Peak	
4	874.8700	37.28	-0.20	37.08	46.00	-8.92	Peak	
5	949.5600	30.01	1.75	31.76	46.00	-14.24	Peak	
6	1000.0000	42.63	2.09	44.72	54.00	-9.28	Peak	

Test Mode: UNII-3/TX A Mode 5825MHz

Horizontal

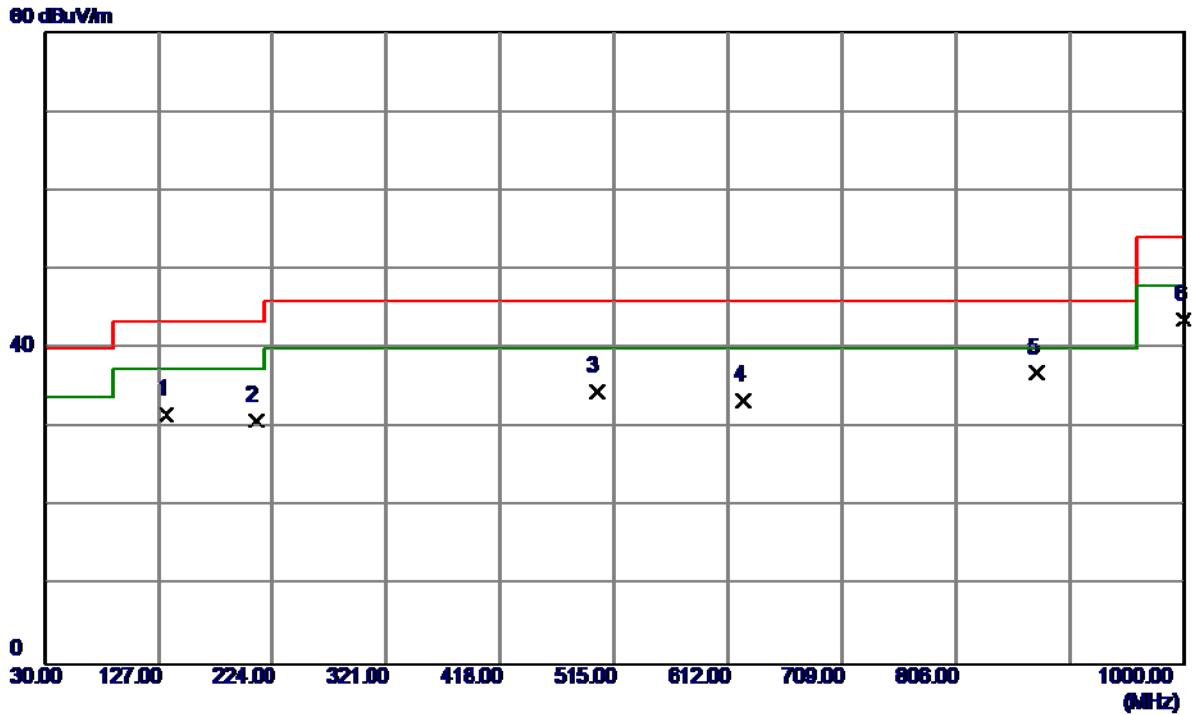

No.	Freq. MHz	Reading Level dBuV/m	Correct Factor dB	Measure ment dBuV/m	Limit dBuV/m	Margin dB	Detector	Comment
1	133.7899	45.42	-13.79	31.63	43.50	-11.87	Peak	
2	209.4500	46.61	-15.70	30.91	43.50	-12.59	Peak	
3	500.4500	41.78	-7.15	34.63	46.00	-11.37	Peak	
4	624.6100	38.16	-4.77	33.39	46.00	-12.61	Peak	
5	874.8700	37.08	-0.20	36.88	46.00	-9.12	Peak	
6	1000.0000	41.57	2.09	43.66	54.00	-10.34	Peak	

ATTACHMENT D - RADIATED EMISSION (ABOVE 1000MHZ)

Orthogonal Axis:	X
Test Mode:	UNII-1/ TX A Mode 5180MHz

Vertical

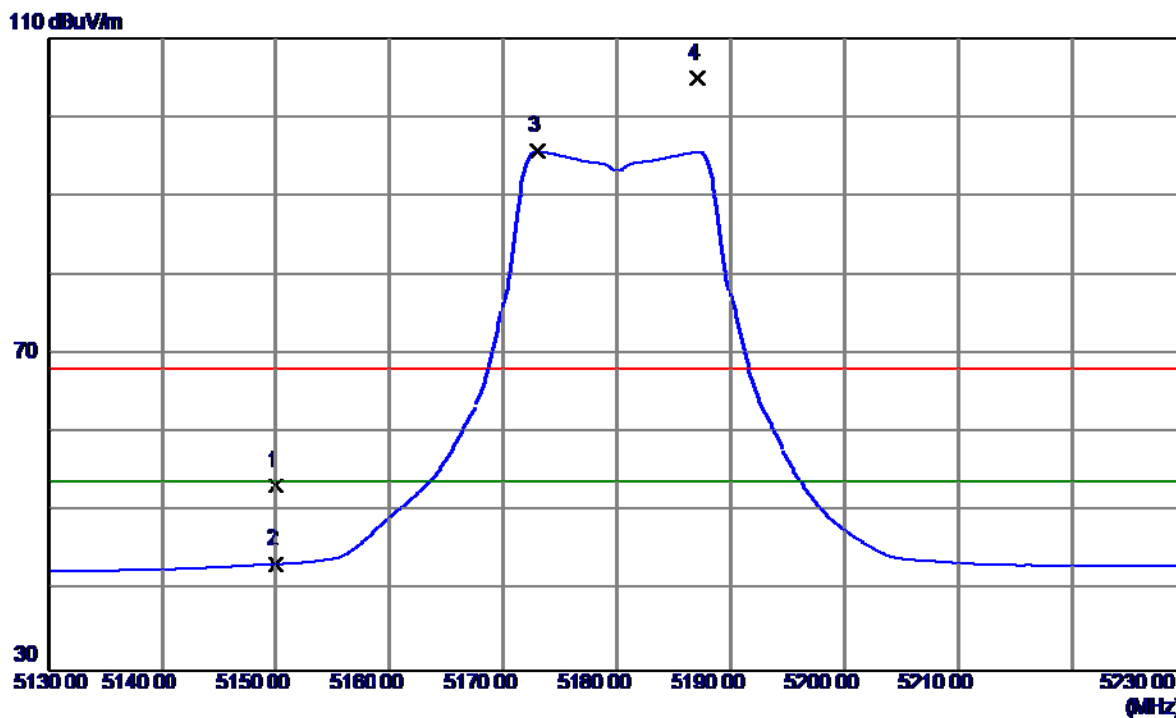

No.	Freq. MHz	Reading Level dBuV/m	Correct Factor dB	Measure ment dBuV/m	Limit dBuV/m	Margin dB	Detector	Comment
1	5150.0000	13.10	40.22	53.32	68.30	-14.98	Peak	
2	5150.0000	3.25	40.22	43.47	54.00	-10.53	AVG	
3	5173.0000	55.42	40.27	95.69	54.00	41.69	AVG	No Limit
4	5187.1000	64.61	40.30	104.91	68.30	36.61	Peak	No Limit

Orthogonal Axis:	X
Test Mode:	UNII-1/ TX A Mode 5180MHz

Vertical

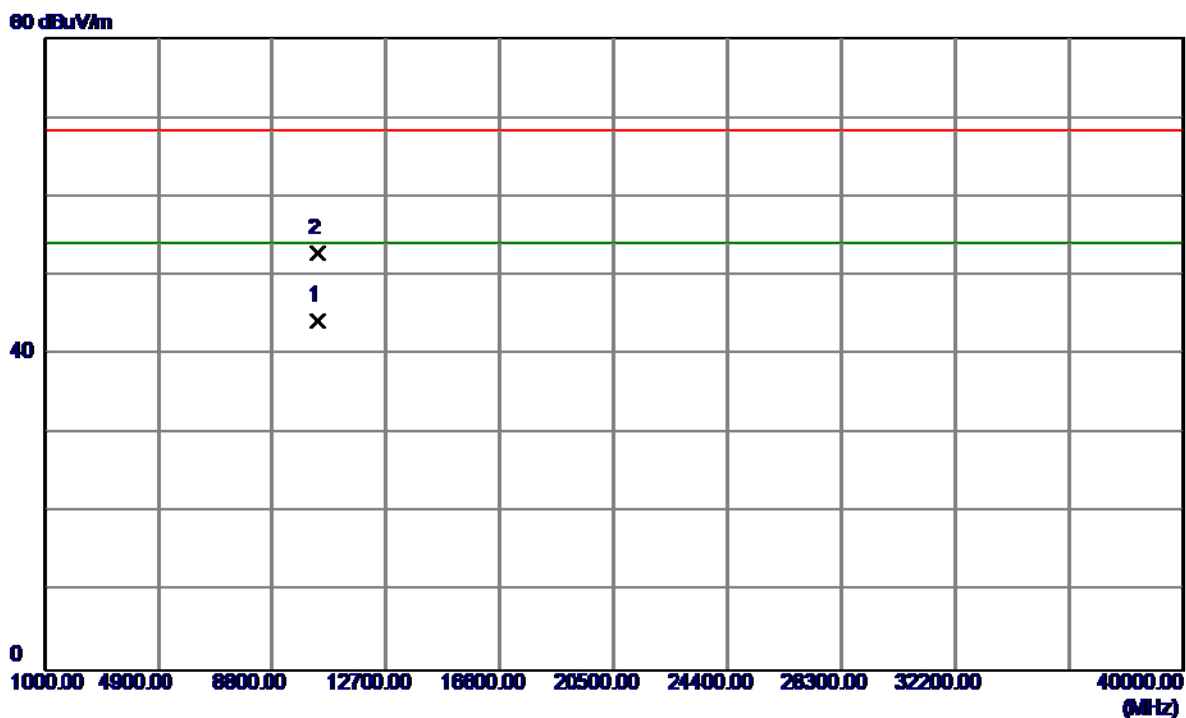

No.	Freq. MHz	Reading Level dBuV/m	Correct Factor dB	Measure ment dBuV/m	Limit dBuV/m	Margin dB	Detector	Comment
1	10360.3600	30.47	13.86	44.33	54.00	-9.67	AVG	
2	10360.4620	38.93	13.86	52.79	68.30	-15.51	Peak	

Orthogonal Axis:	X
Test Mode:	UNII-1/ TX A Mode 5180MHz

Horizontal

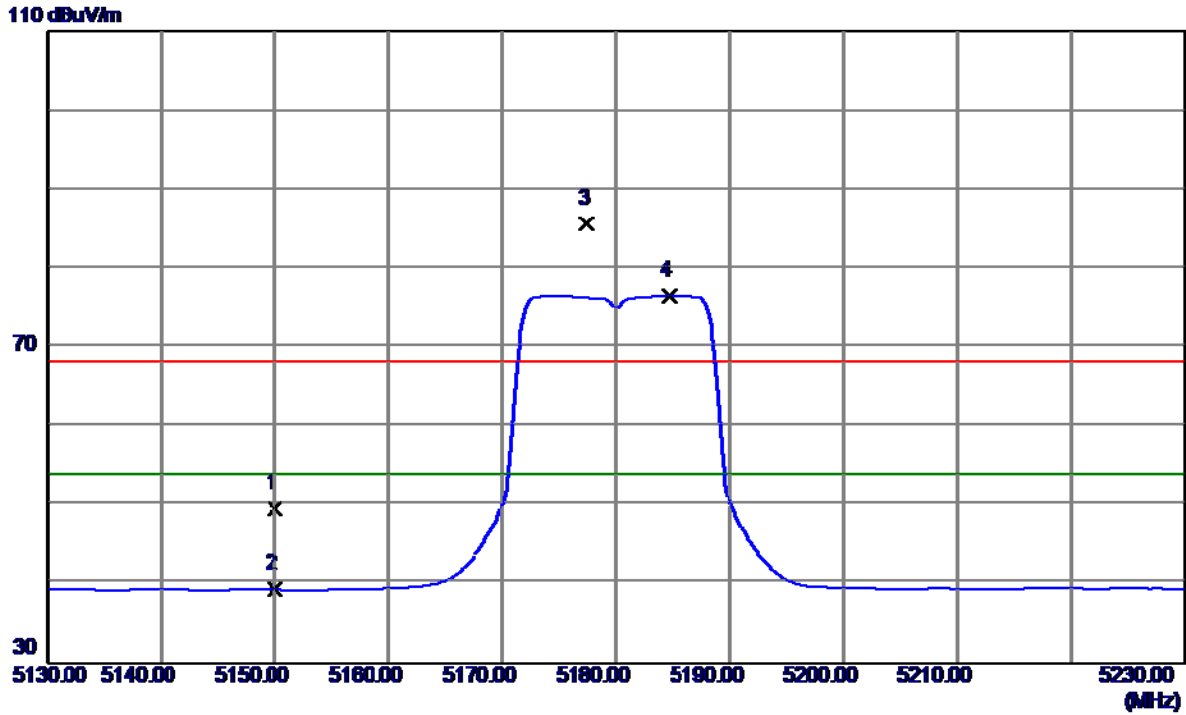

No.	Freq. MHz	Reading Level dBuV/m	Correct Factor dB	Measure ment dBuV/m	Limit dBuV/m	Margin dB	Detector	Comment
1	5150.0000	9.39	40.22	49.61	68.30	-18.69	Peak	
2	5150.0000	-0.84	40.22	39.38	54.00	-14.62	AVG	
3	5177.5000	45.43	40.28	85.71	68.30	17.41	Peak	No Limit
4	5184.7000	36.31	40.29	76.60	54.00	22.60	AVG	No Limit

Orthogonal Axis:	X
Test Mode:	UNII-1/ TX A Mode 5180MHz

Horizontal

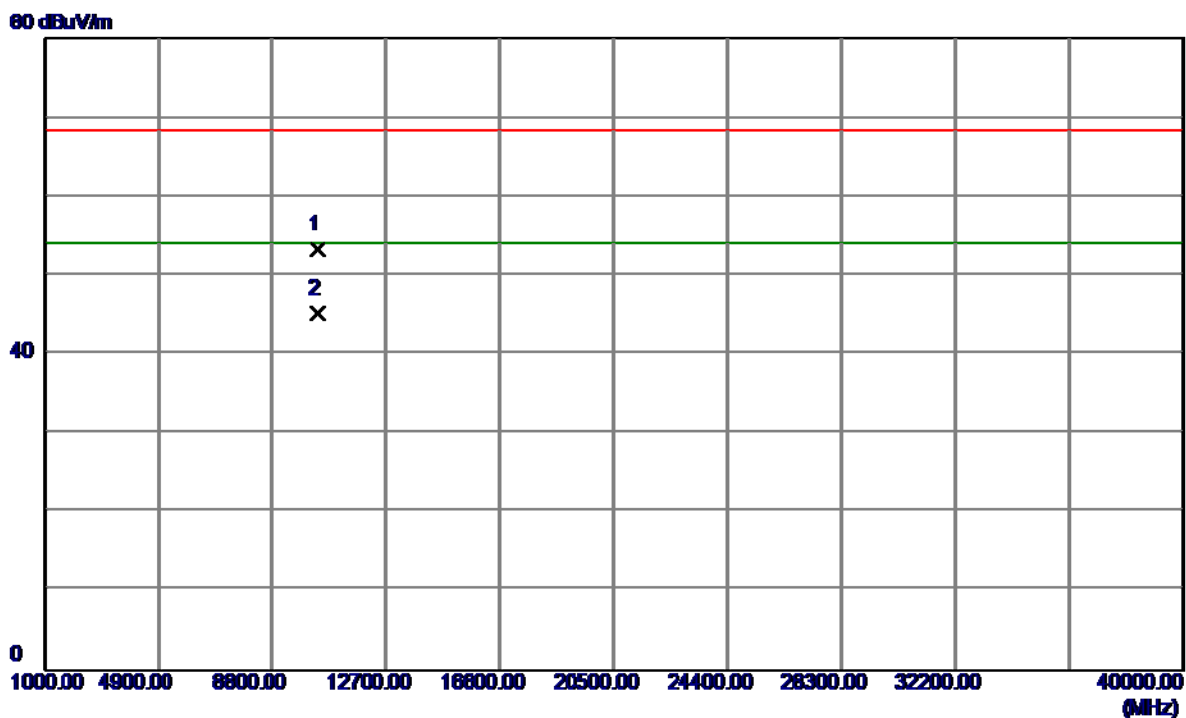

No.	Freq. MHz	Reading Level dBuV/m	Correct Factor dB	Measure ment dBuV/m	Limit dBuV/m	Margin dB	Detector	Comment
1	10360.0000	39.41	13.86	53.27	68.30	-15.03	Peak	
2	10360.6000	31.34	13.86	45.20	54.00	-8.80	AVG	

Orthogonal Axis:	X
Test Mode:	UNII-1/ TX A Mode 5200MHz

Vertical

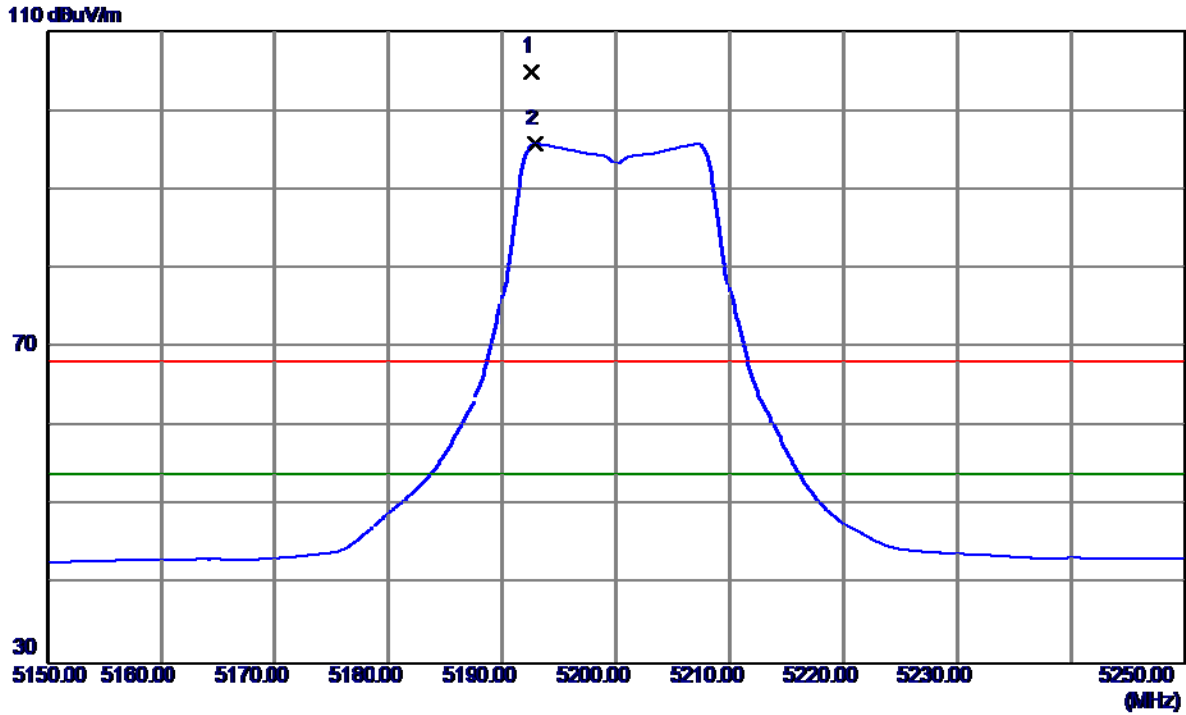

No.	Freq. MHz	Reading Level dBuV/m	Correct Factor dB	Measure ment dBuV/m	Limit dBuV/m	Margin dB	Detector	Comment
1	5192.6000	64.56	40.31	104.87	68.30	36.57	Peak	No Limit
2	5192.9000	55.41	40.31	95.72	54.00	41.72	AVG	No Limit

Orthogonal Axis:	X
Test Mode:	UNII-1/ TX A Mode 5200MHz

Vertical

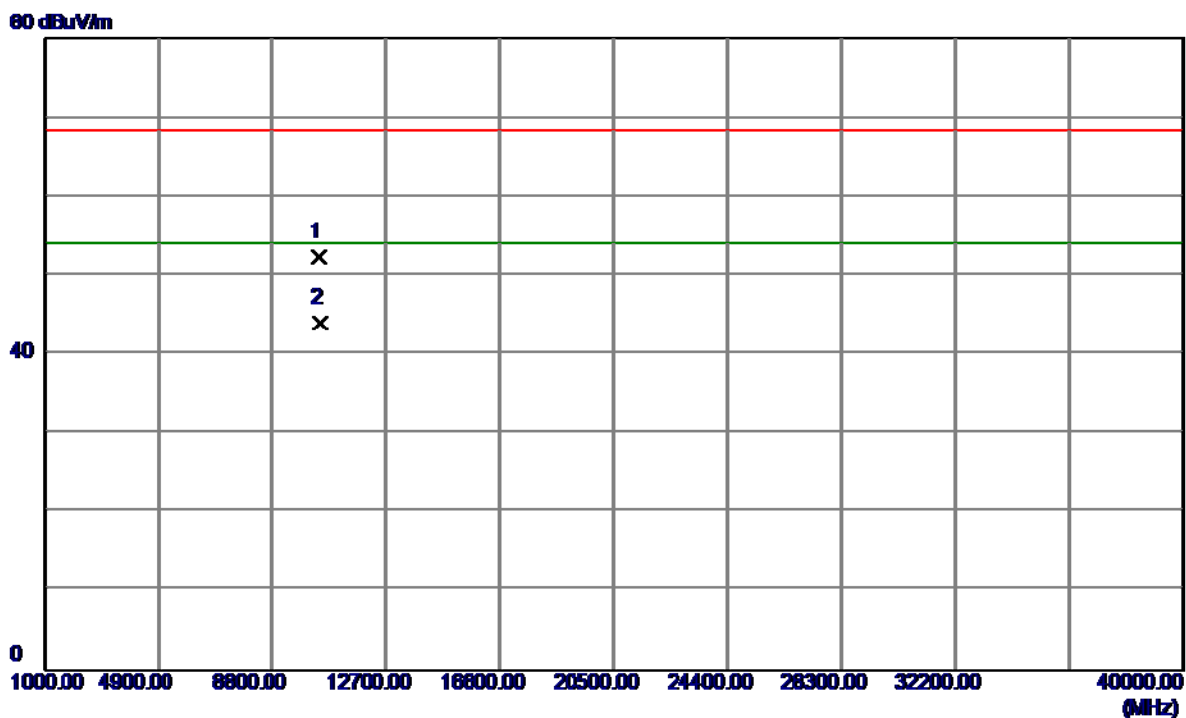

No.	Freq. MHz	Reading Level dBuV/m	Correct Factor dB	Measure ment dBuV/m	Limit dBuV/m	Margin dB	Detector	Comment
1	10400.6700	38.50	13.80	52.30	68.30	-16.00	Peak	
2	10440.6700	30.19	13.75	43.94	54.00	-10.06	AVG	

Orthogonal Axis:	X
Test Mode:	UNII-1/ TX A Mode 5200MHz

Horizontal

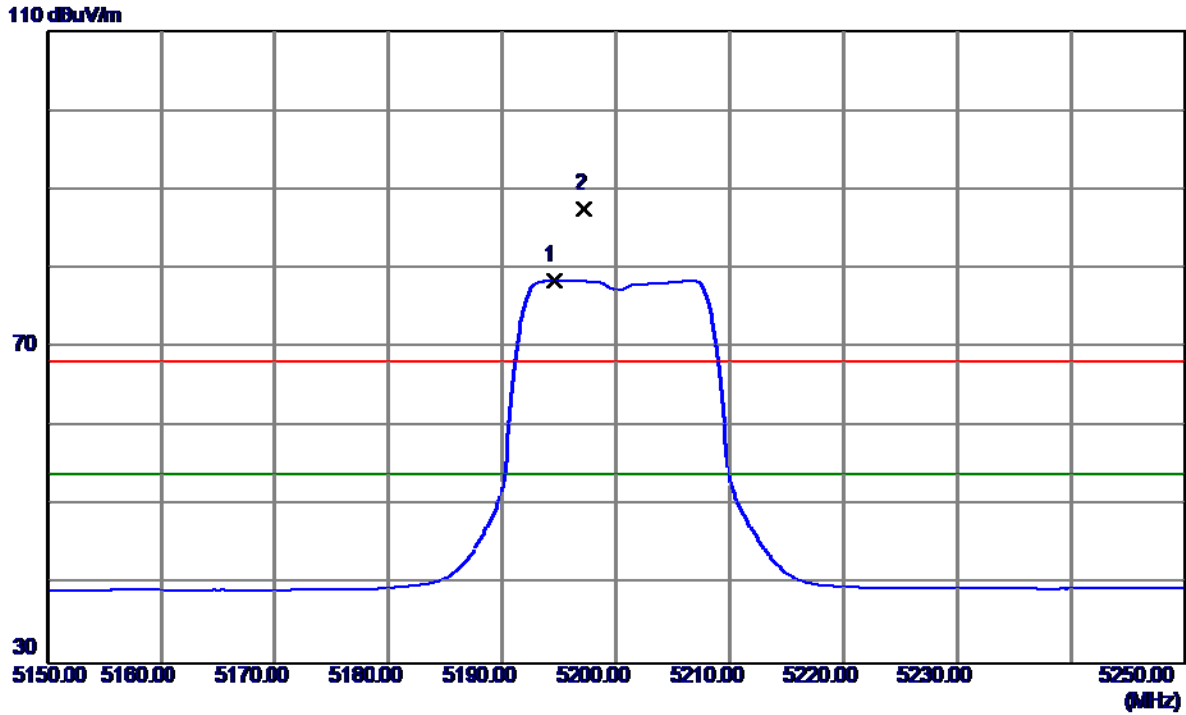

No.	Freq. MHz	Reading Level dBuV/m	Correct Factor dB	Measure ment dBuV/m	Limit dBuV/m	Margin dB	Detector	Comment
1	5194.5000	38.23	40.31	78.54	54.00	24.54	AVG	No Limit
2	5197.2000	47.21	40.32	87.53	68.30	19.23	Peak	No Limit

Orthogonal Axis:	X
Test Mode:	UNII-1/ TX A Mode 5200MHz

Horizontal

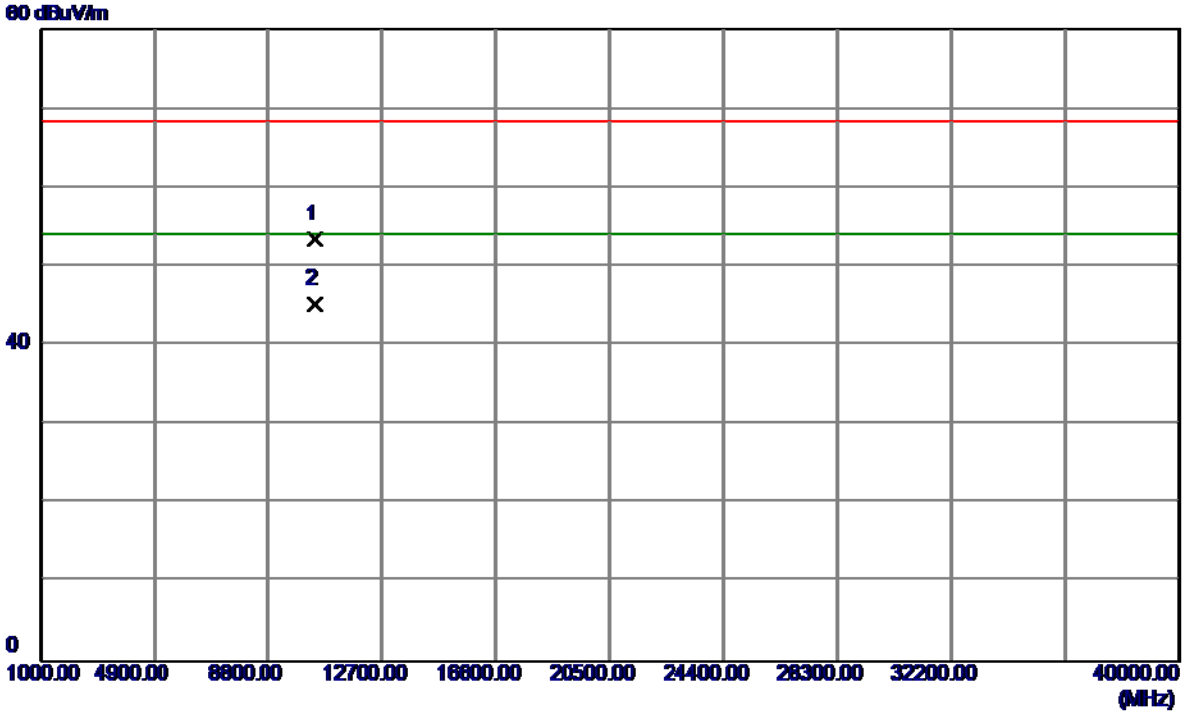

No.	Freq. MHz	Reading Level dBuV/m	Correct Factor dB	Measure ment dBuV/m	Limit dBuV/m	Margin dB	Detector	Comment
1	10399.9000	39.62	13.80	53.42	68.30	-14.88	Peak	
2	10399.9000	31.43	13.80	45.23	54.00	-8.77	AVG	

Orthogonal Axis:	X
Test Mode:	UNII-1/ TX A Mode 5240MHz

Vertical

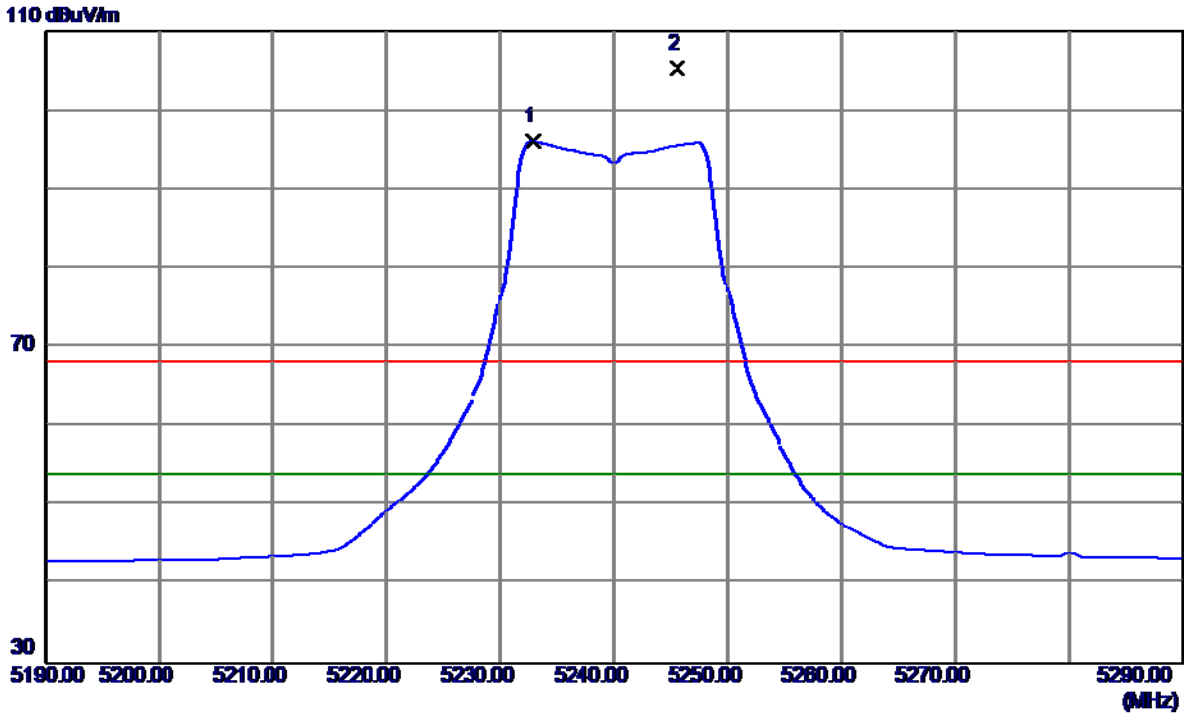

No.	Freq. MHz	Reading Level dBuV/m	Correct Factor dB	Measure ment dBuV/m	Limit dBuV/m	Margin dB	Detector	Comment
1	5232.9000	55.63	40.39	96.02	54.00	42.02	AVG	No Limit
2	5245.6000	64.86	40.42	105.28	68.30	36.98	Peak	No Limit

Orthogonal Axis:	X
Test Mode:	UNII-1/ TX A Mode 5240MHz

Vertical

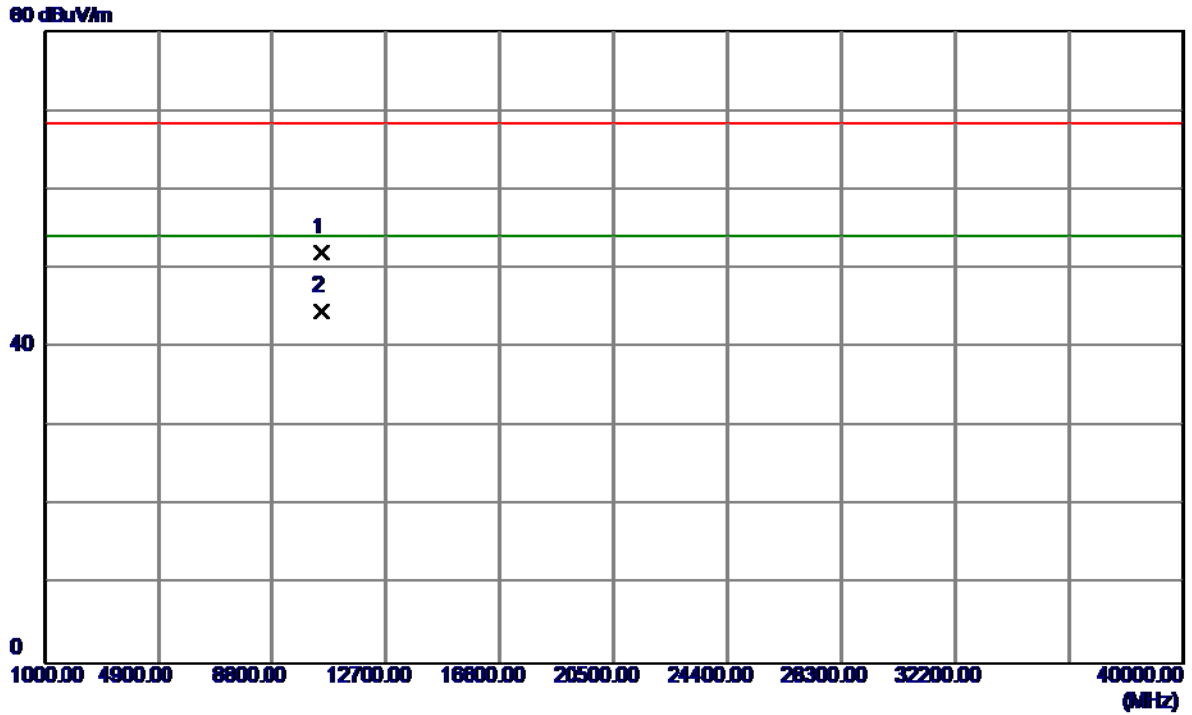

No.	Freq. MHz	Reading Level dBuV/m	Correct Factor dB	Measure ment dBuV/m	Limit dBuV/m	Margin dB	Detector	Comment
1	10480.8610	38.28	13.69	51.97	68.30	-16.33	Peak	
2	10481.0400	30.92	13.69	44.61	54.00	-9.39	AVG	

Orthogonal Axis:	X
Test Mode:	UNII-1/ TX A Mode 5240MHz

Horizontal

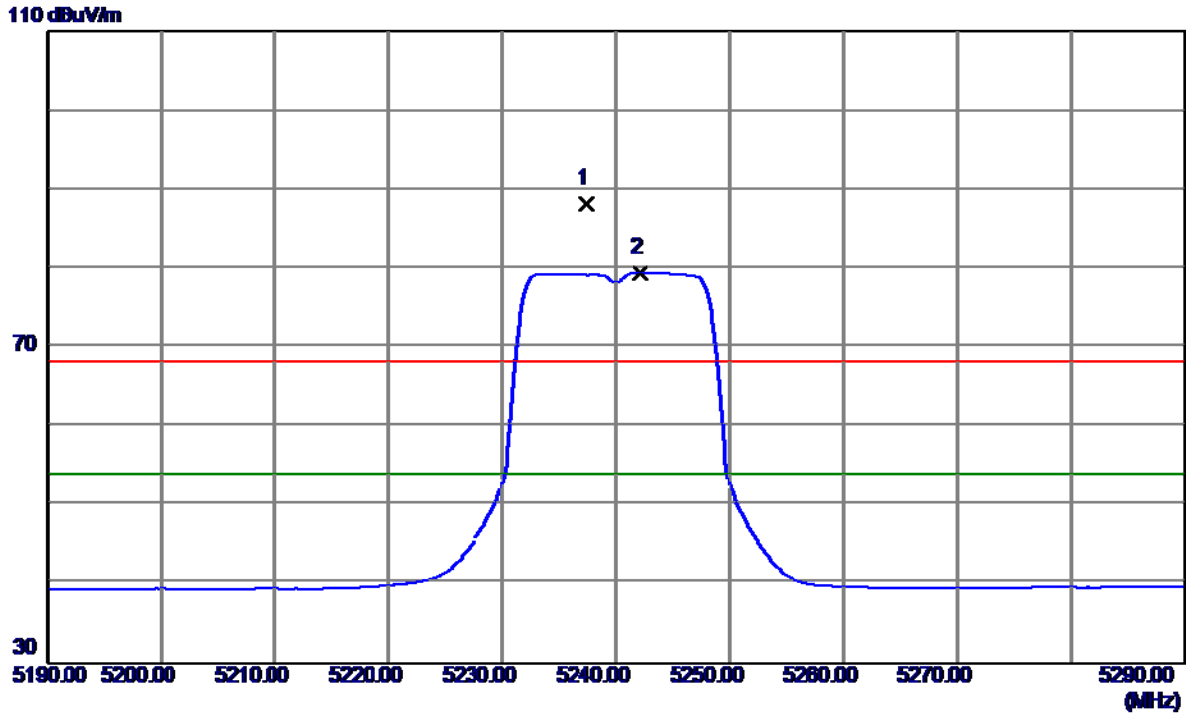

No.	Freq. MHz	Reading Level dBuV/m	Correct Factor dB	Measure ment dBuV/m	Limit dBuV/m	Margin dB	Detector	Comment
1	5237.4000	47.89	40.40	88.29	68.30	19.99	Peak	No Limit
2	5242.1000	39.07	40.41	79.48	54.00	25.48	AVG	No Limit

Orthogonal Axis:	X
Test Mode:	UNII-1/ TX A Mode 5240MHz

Horizontal

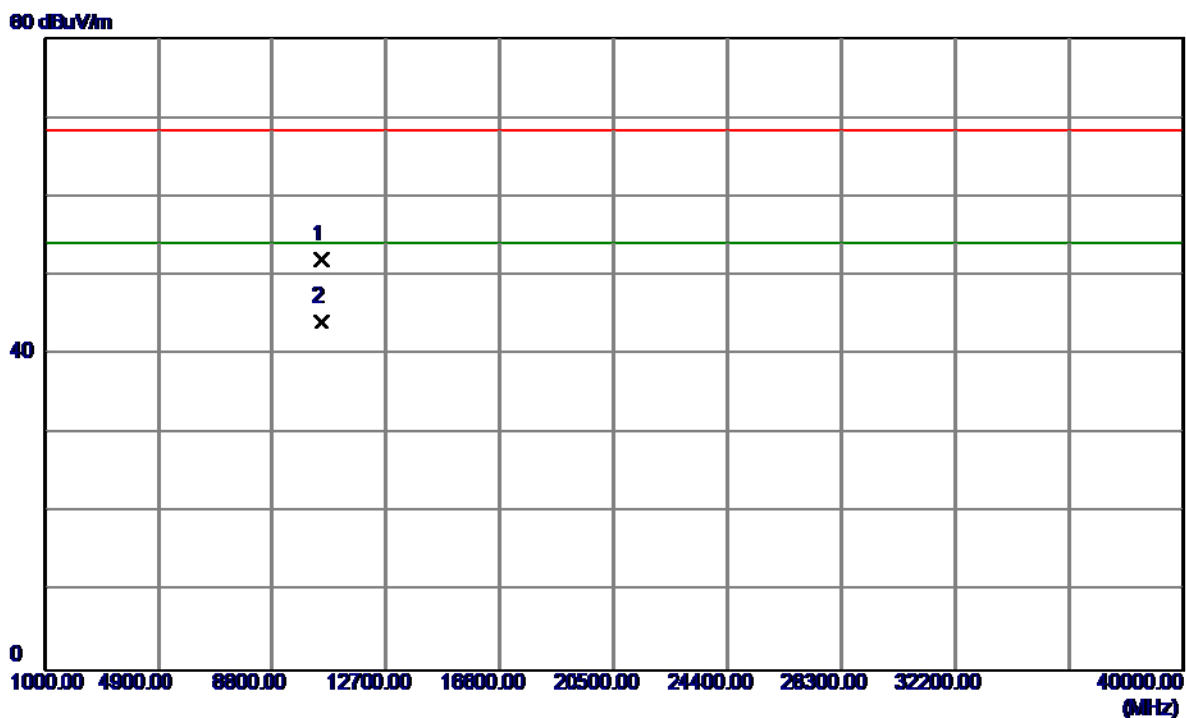

No.	Freq. MHz	Reading Level dBuV/m	Correct Factor dB	Measure ment dBuV/m	Limit dBuV/m	Margin dB	Detector	Comment
1	10480.3570	38.25	13.69	51.94	68.30	-16.36	Peak	
2	10480.6470	30.54	13.69	44.23	54.00	-9.77	AVG	

Orthogonal Axis:	X
Test Mode:	UNII-1/ TX N20 Mode 5180MHz

Vertical

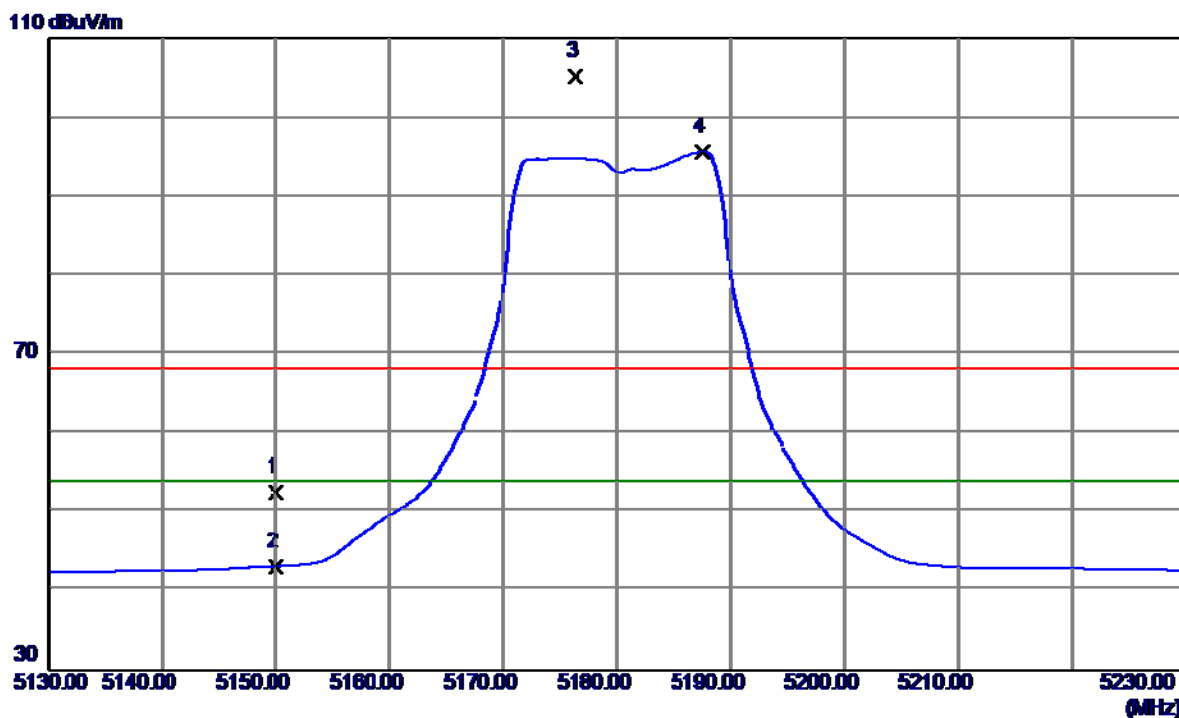

No.	Freq. MHz	Reading Level dBuV/m	Correct Factor dB	Measure ment dBuV/m	Limit dBuV/m	Margin dB	Detector	Comment
1	5150.0000	12.30	40.22	52.52	68.30	-15.78	Peak	
2	5150.0000	2.96	40.22	43.18	54.00	-10.82	AVG	
3	5176.3000	64.87	40.27	105.14	68.30	36.84	Peak	No Limit
4	5187.6000	55.29	40.30	95.59	54.00	41.59	AVG	No Limit

Orthogonal Axis:	X
Test Mode:	UNII-1/ TX N20 Mode 5180MHz

Vertical

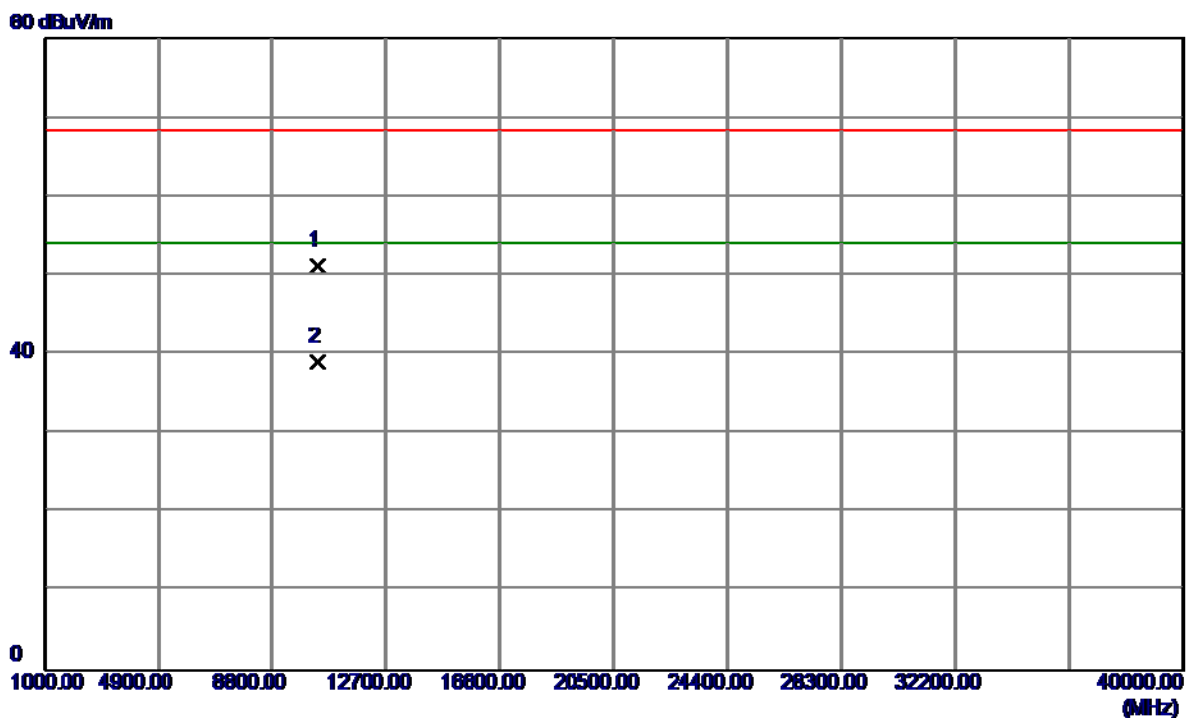

No.	Freq. MHz	Reading Level dBuV/m	Correct Factor dB	Measure ment dBuV/m	Limit dBuV/m	Margin dB	Detector	Comment
1	10360.0199	37.34	13.86	51.20	68.30	-17.10	Peak	
2	10360.0800	25.11	13.86	38.97	54.00	-15.03	AVG	

Orthogonal Axis:	X
Test Mode:	UNII-1/ TX N20 Mode 5180MHz

Horizontal

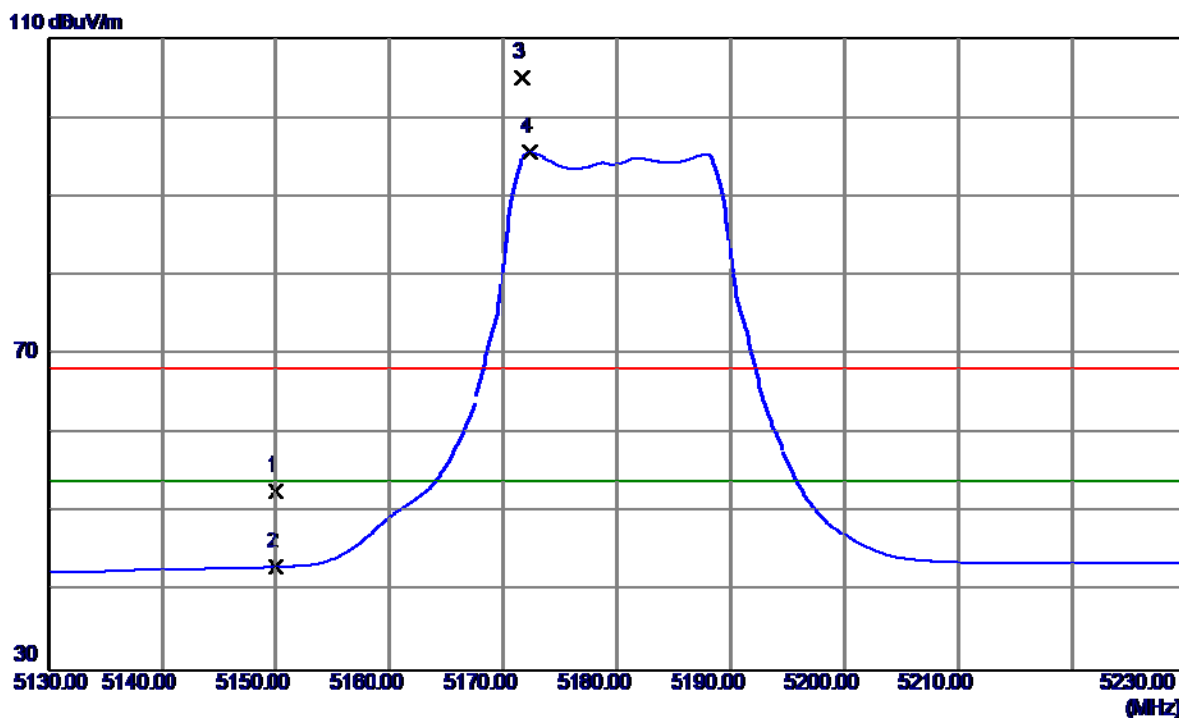

No.	Freq. MHz	Reading Level dBuV/m	Correct Factor dB	Measure ment dBuV/m	Limit dBuV/m	Margin dB	Detector	Comment
1	5150.0000	12.48	40.22	52.70	68.30	-15.60	Peak	
2	5150.0000	2.87	40.22	43.09	54.00	-10.91	AVG	
3	5171.7000	64.74	40.26	105.00	68.30	36.70	Peak	No Limit
4	5172.3000	55.30	40.27	95.57	54.00	41.57	AVG	No Limit

Orthogonal Axis:	X
Test Mode:	UNII-1/ TX N20 Mode 5180MHz

Horizontal

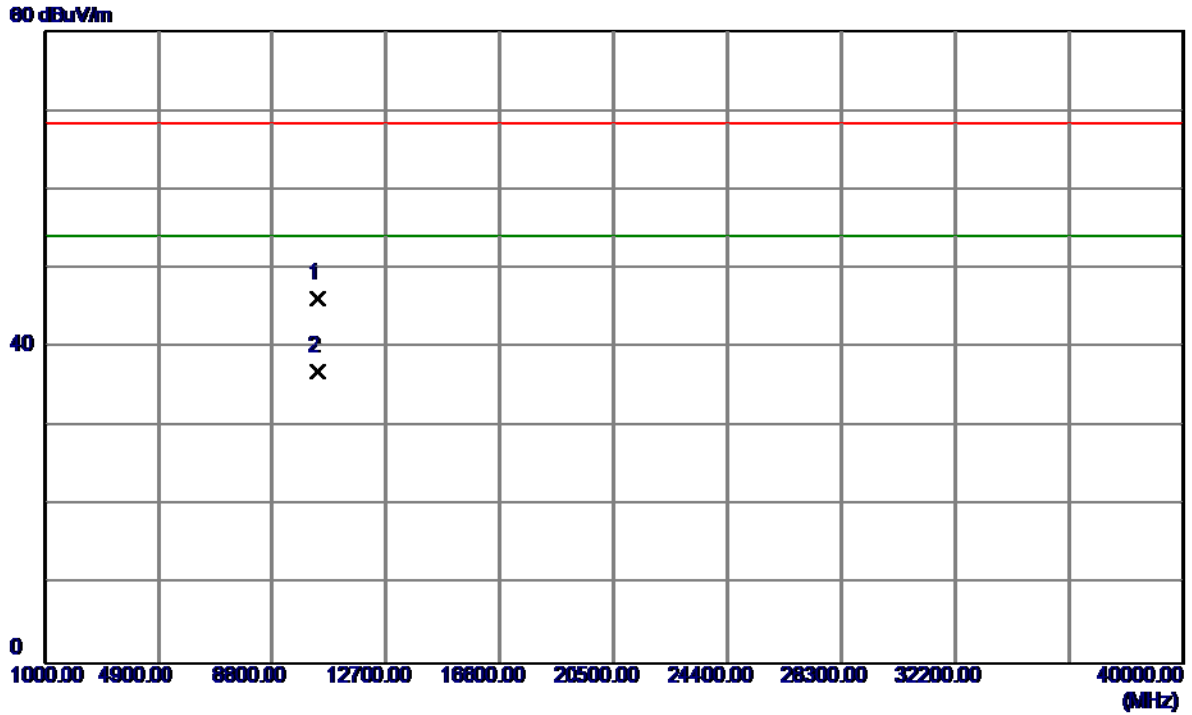

No.	Freq. MHz	Reading Level dBuV/m	Correct Factor dB	Measure ment dBuV/m	Limit dBuV/m	Margin dB	Detector	Comment
1	10360.2590	32.34	13.86	46.20	68.30	-22.10	Peak	
2	10360.3500	23.14	13.86	37.00	54.00	-17.00	AVG	

Orthogonal Axis:	X
Test Mode:	UNII-1/ TX N20 Mode 5200MHz

Vertical

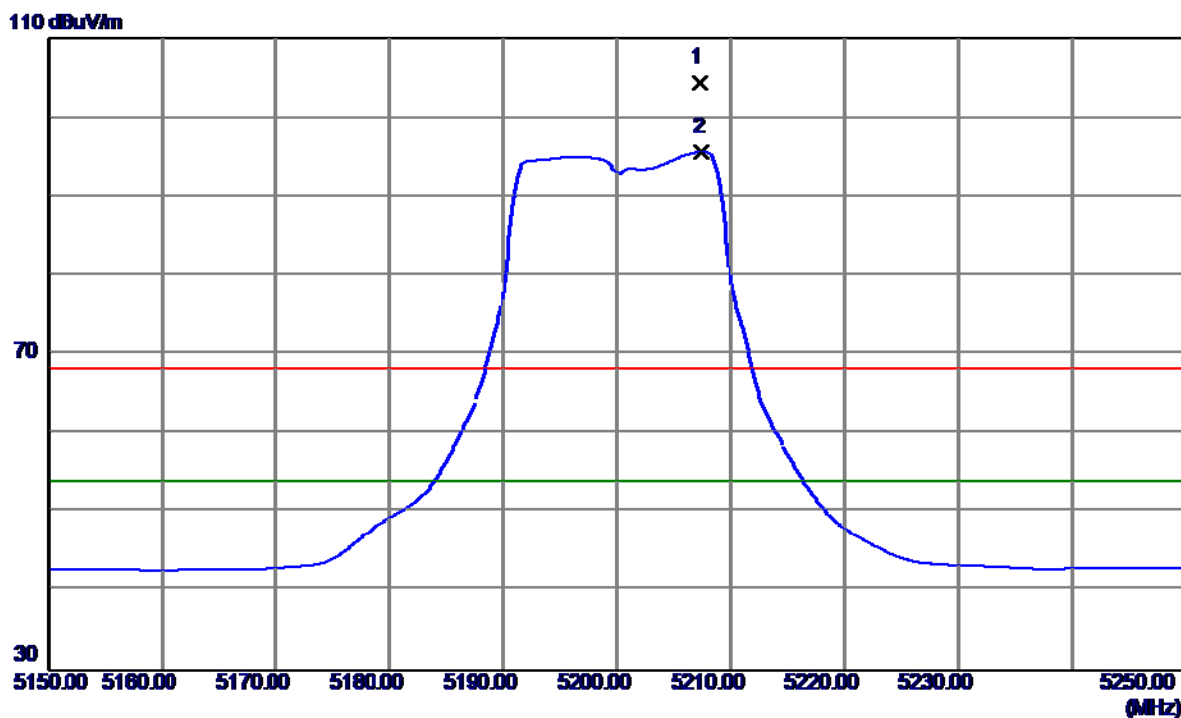

No.	Freq. MHz	Reading Level dBuV/m	Correct Factor dB	Measure ment dBuV/m	Limit dBuV/m	Margin dB	Detector	Comment
1	5207.3000	64.11	40.34	104.45	68.30	36.15	Peak	No Limit
2	5207.5000	55.26	40.34	95.60	54.00	41.60	AVG	No Limit

Orthogonal Axis:	X
Test Mode:	UNII-1/ TX N20 Mode 5200MHz

Vertical

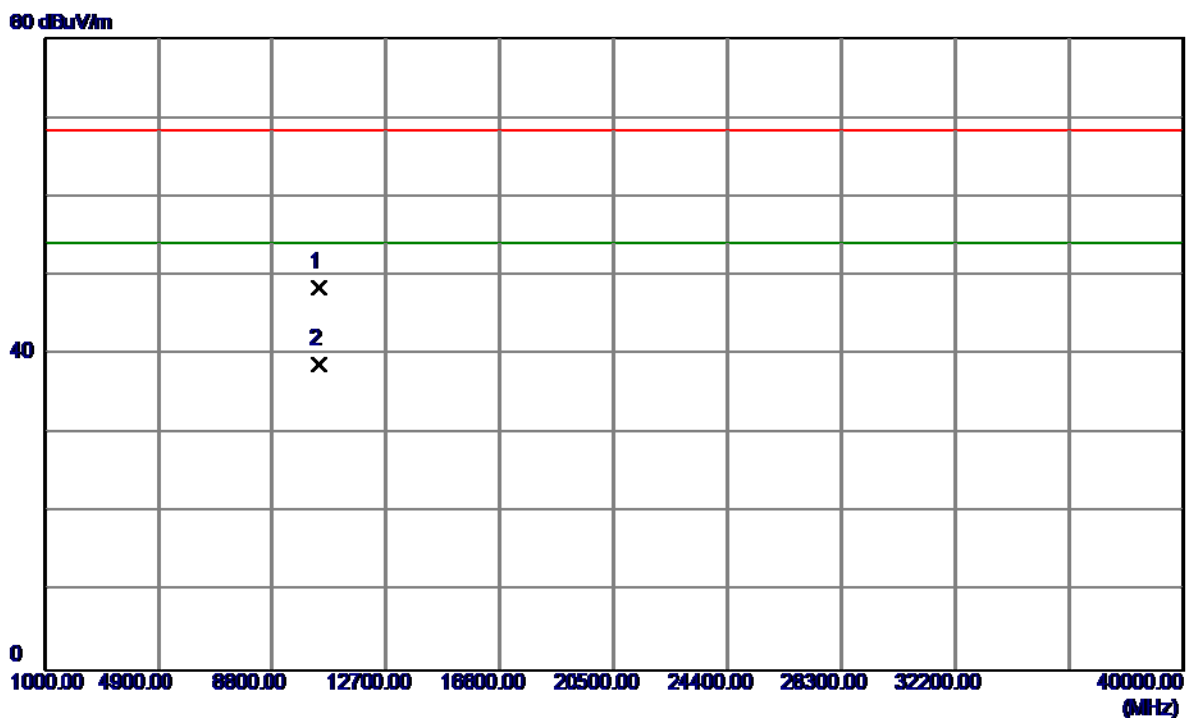

No.	Freq. MHz	Reading Level dBuV/m	Correct Factor dB	Measure ment dBuV/m	Limit dBuV/m	Margin dB	Detector	Comment
1	10400.3530	34.65	13.80	48.45	68.30	-19.85	Peak	
2	10400.1730	24.87	13.80	38.67	54.00	-15.33	AVG	

Orthogonal Axis:	X
Test Mode:	UNII-1/ TX N20 Mode 5200MHz

Horizontal

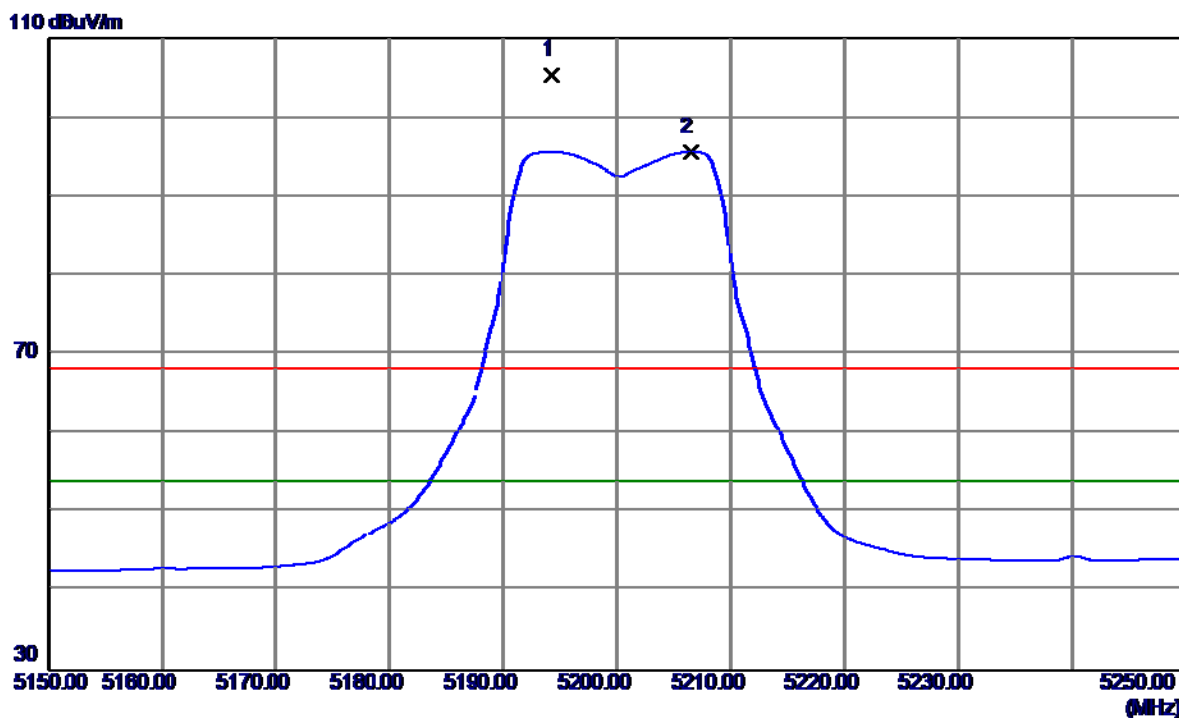

No.	Freq. MHz	Reading Level dBuV/m	Correct Factor dB	Measure ment dBuV/m	Limit dBuV/m	Margin dB	Detector	Comment
1	5194.2000	65.06	40.31	105.37	68.30	37.07	Peak	No Limit
2	5206.5000	55.30	40.34	95.64	54.00	41.64	AVG	No Limit

Orthogonal Axis:	X
Test Mode:	UNII-1/ TX N20 Mode 5200MHz

Horizontal

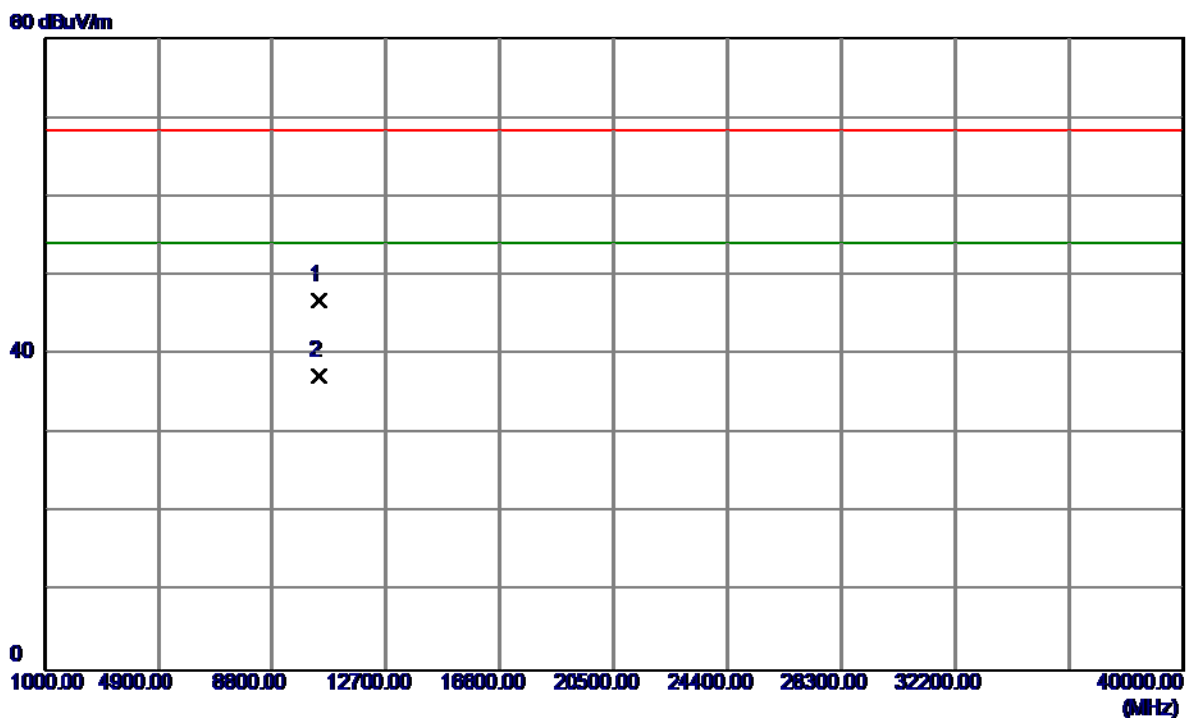

No.	Freq. MHz	Reading Level dBuV/m	Correct Factor dB	Measure ment dBuV/m	Limit dBuV/m	Margin dB	Detector	Comment
1	10400.2200	33.02	13.80	46.82	68.30	-21.48	Peak	
2	10400.2200	23.54	13.80	37.34	54.00	-16.66	AVG	

Orthogonal Axis:	X
Test Mode:	UNII-1/ TX N20 Mode 5240MHz

Vertical

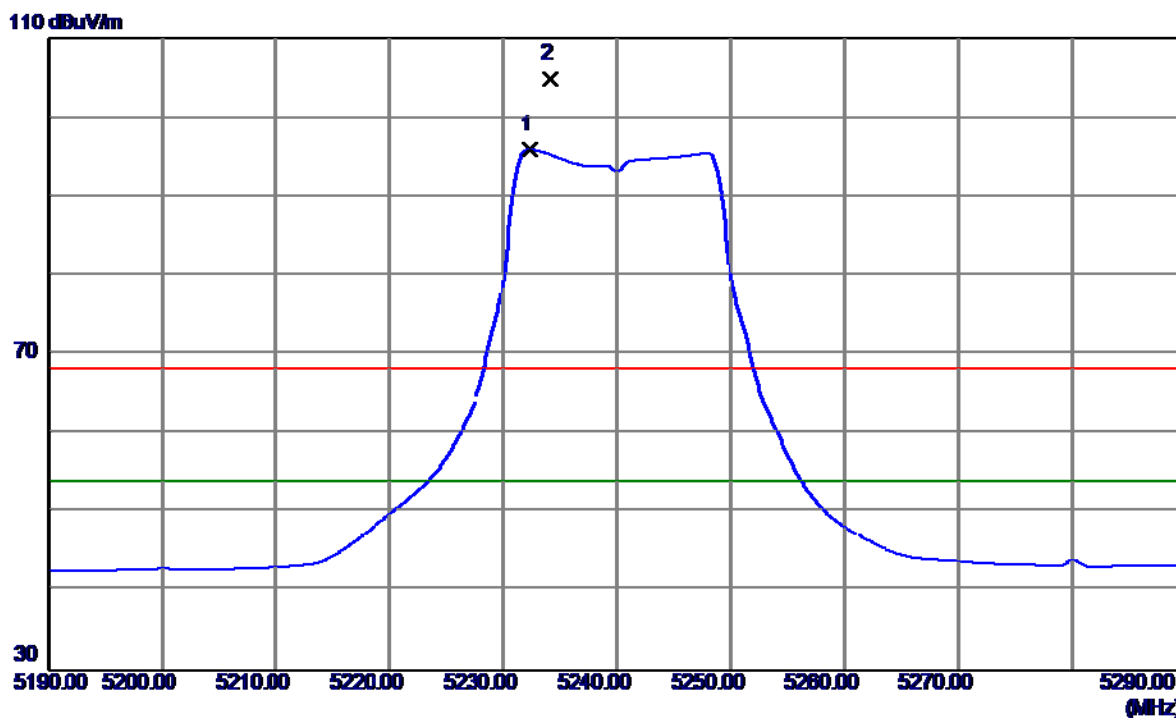

No.	Freq. MHz	Reading Level dBuV/m	Correct Factor dB	Measure ment dBuV/m	Limit dBuV/m	Margin dB	Detector	Comment
1	5232.3000	55.50	40.39	95.89	54.00	41.89	AVG	No Limit
2	5234.1000	64.43	40.40	104.83	68.30	36.53	Peak	No Limit

Orthogonal Axis:	X
Test Mode:	UNII-1/ TX N20 Mode 5240MHz

Vertical

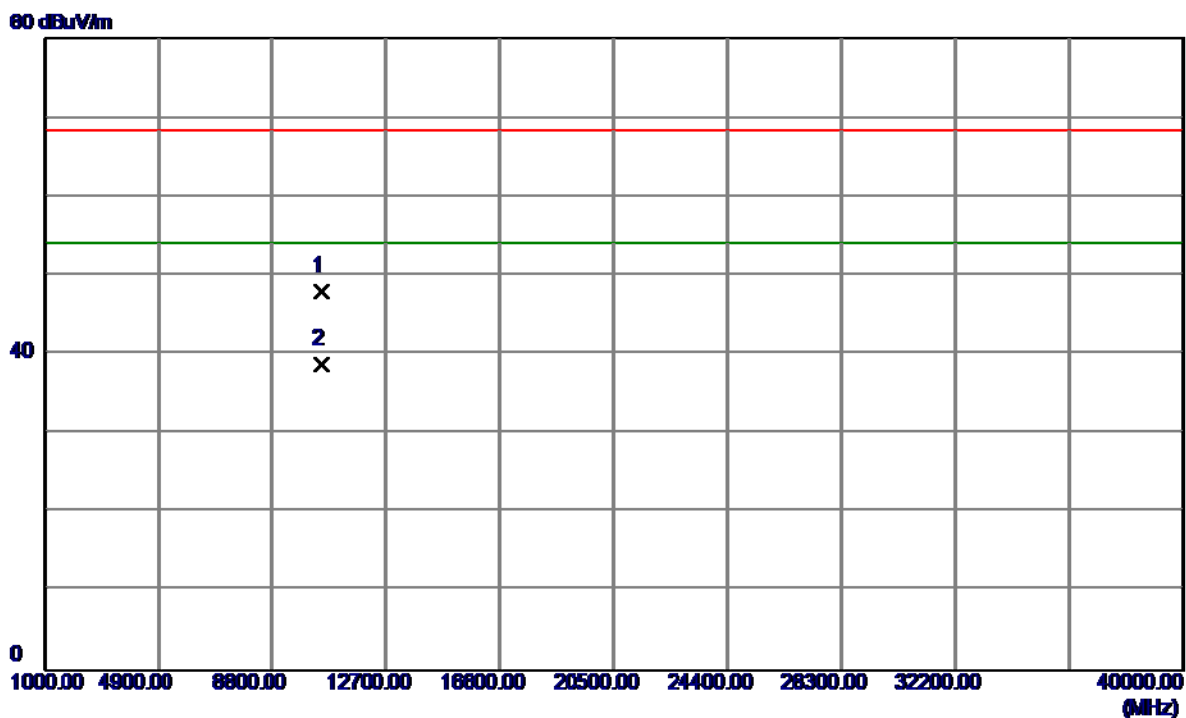

No.	Freq. MHz	Reading Level dBuV/m	Correct Factor dB	Measure ment dBuV/m	Limit dBuV/m	Margin dB	Detector	Comment
1	10480.3099	34.34	13.69	48.03	68.30	-20.27	Peak	
2	10480.3099	25.10	13.69	38.79	54.00	-15.21	AVG	

Orthogonal Axis:	X
Test Mode:	UNII-1/ TX N20 Mode 5240MHz

Horizontal

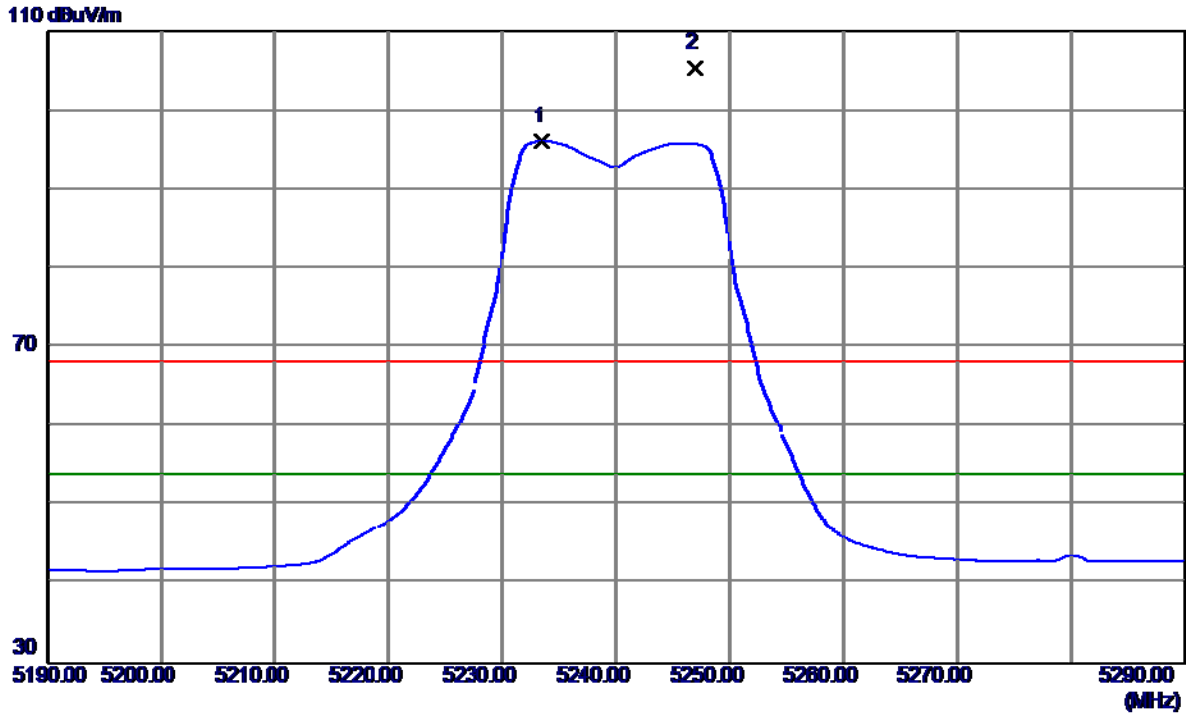

No.	Freq. MHz	Reading Level dBuV/m	Correct Factor dB	Measure ment dBuV/m	Limit dBuV/m	Margin dB	Detector	Comment
1	5233.5000	55.69	40.39	96.08	54.00	42.08	AVG	No Limit
2	5247.0000	64.96	40.42	105.38	68.30	37.08	Peak	No Limit

Orthogonal Axis:	X
Test Mode:	UNII-1/ TX N20 Mode 5240MHz

Horizontal

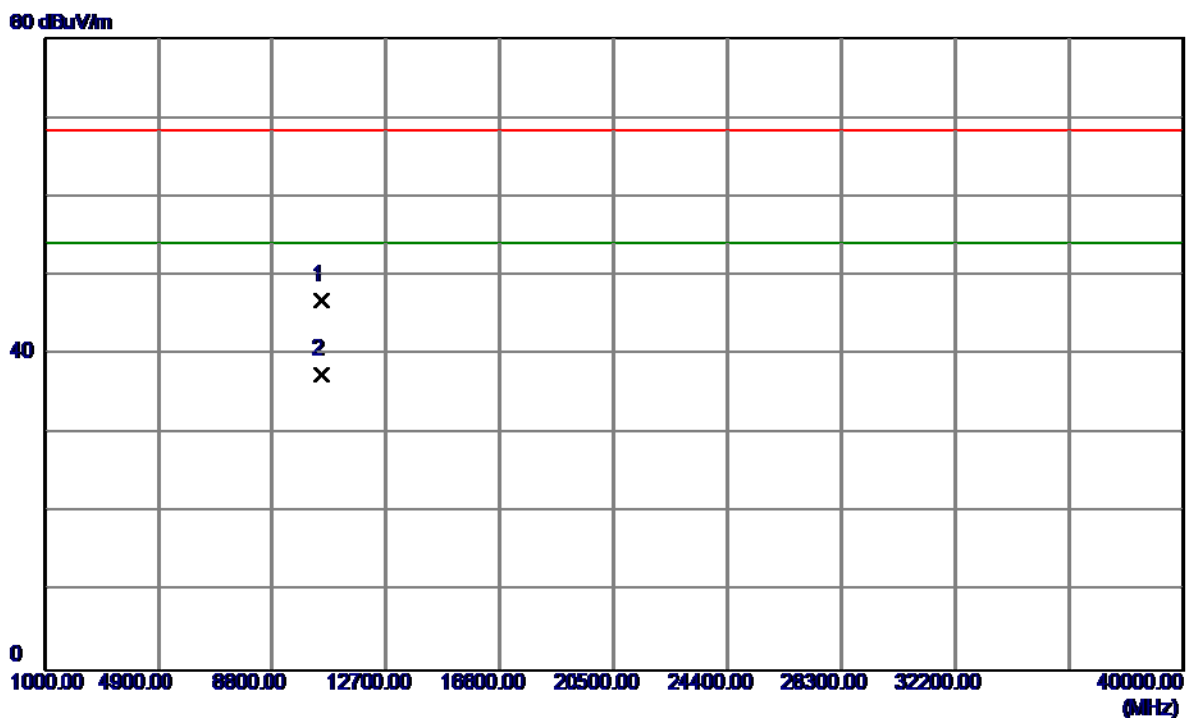

No.	Freq. MHz	Reading Level dBuV/m	Correct Factor dB	Measure ment dBuV/m	Limit dBuV/m	Margin dB	Detector	Comment
1	10480.3680	33.22	13.69	46.91	68.30	-21.39	Peak	
2	10480.6600	23.71	13.69	37.40	54.00	-16.60	AVG	

Orthogonal Axis:	X
Test Mode:	UNII-1/ TX N40 Mode 5190MHz

Vertical

110 dBuV/m

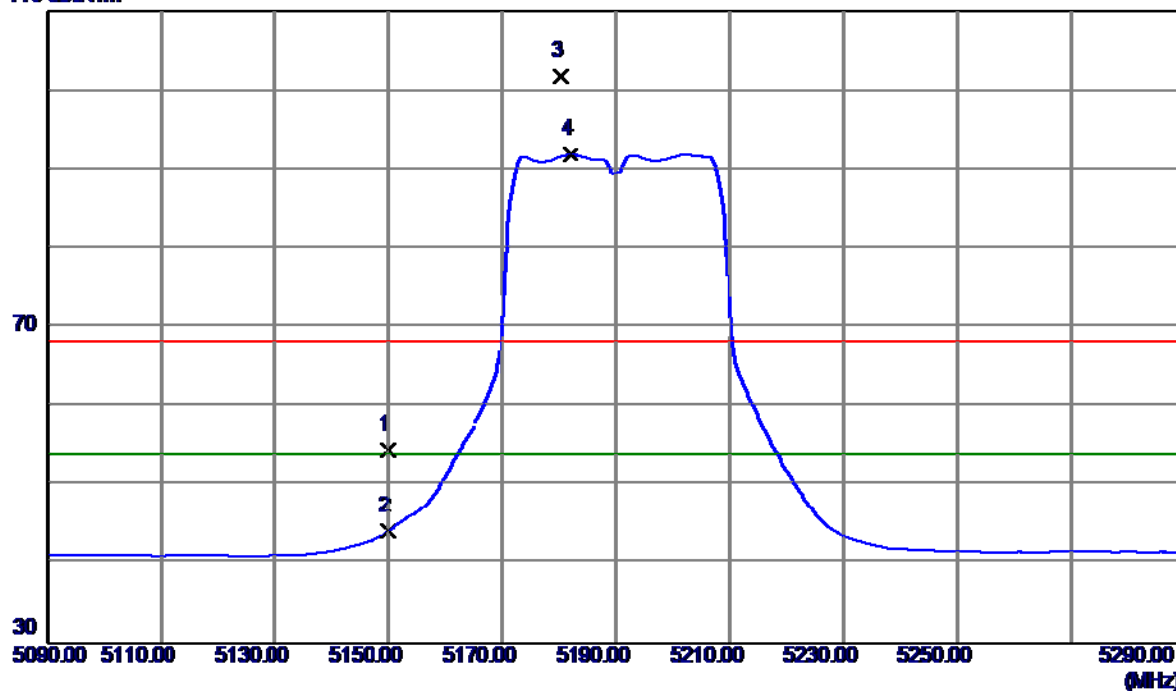

No.	Freq. MHz	Reading Level dBuV/m	Correct Factor dB	Measure ment dBuV/m	Limit dBuV/m	Margin dB	Detector	Comment
1	5150.0000	14.27	40.22	54.49	68.30	-13.81	Peak	
2	5150.0000	3.99	40.22	44.21	54.00	-9.79	AVG	
3	5180.2000	61.57	40.28	101.85	68.30	33.55	Peak	No Limit
4	5182.0000	51.67	40.29	91.96	54.00	37.96	AVG	No Limit

Orthogonal Axis:	X
Test Mode:	UNII-1/ TX N40 Mode 5190MHz

Vertical

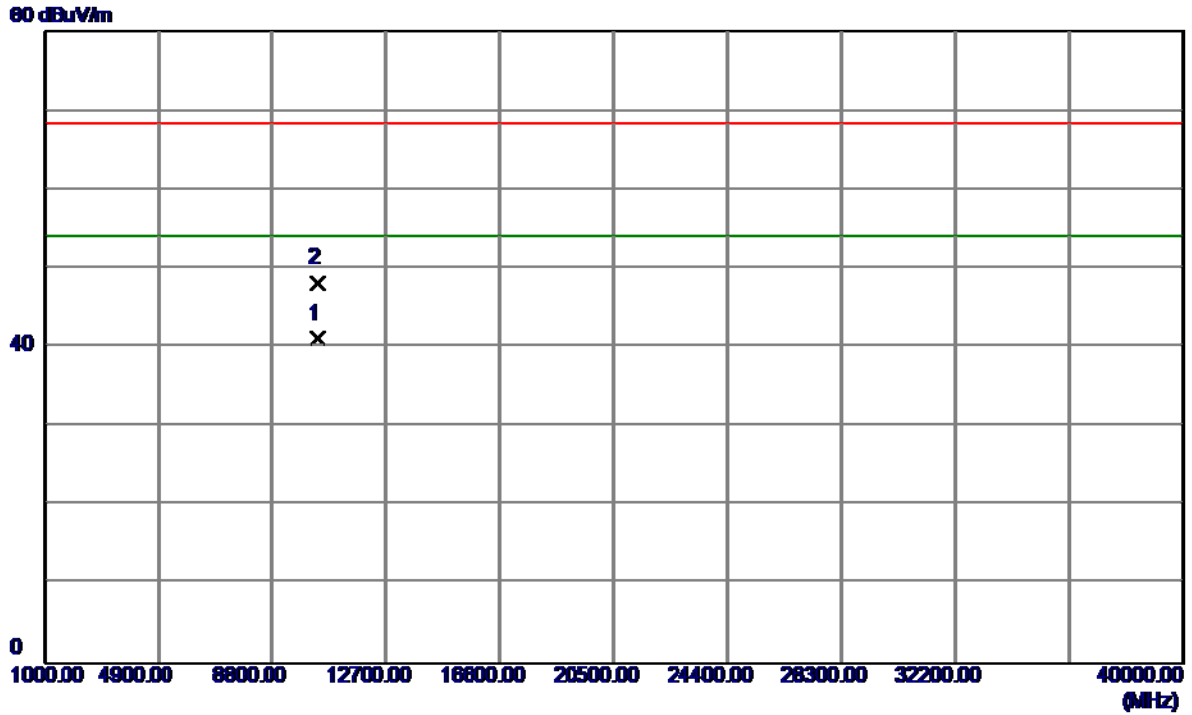

No.	Freq. MHz	Reading Level dBuV/m	Correct Factor dB	Measure ment dBuV/m	Limit dBuV/m	Margin dB	Detector	Comment
1	10380.3000	27.32	13.83	41.15	54.00	-12.85	AVG	
2	10381.3700	34.35	13.83	48.18	68.30	-20.12	Peak	

Orthogonal Axis:	X
Test Mode:	UNII-1/ TX N40 Mode 5190MHz

Horizontal

110 dBuV/m

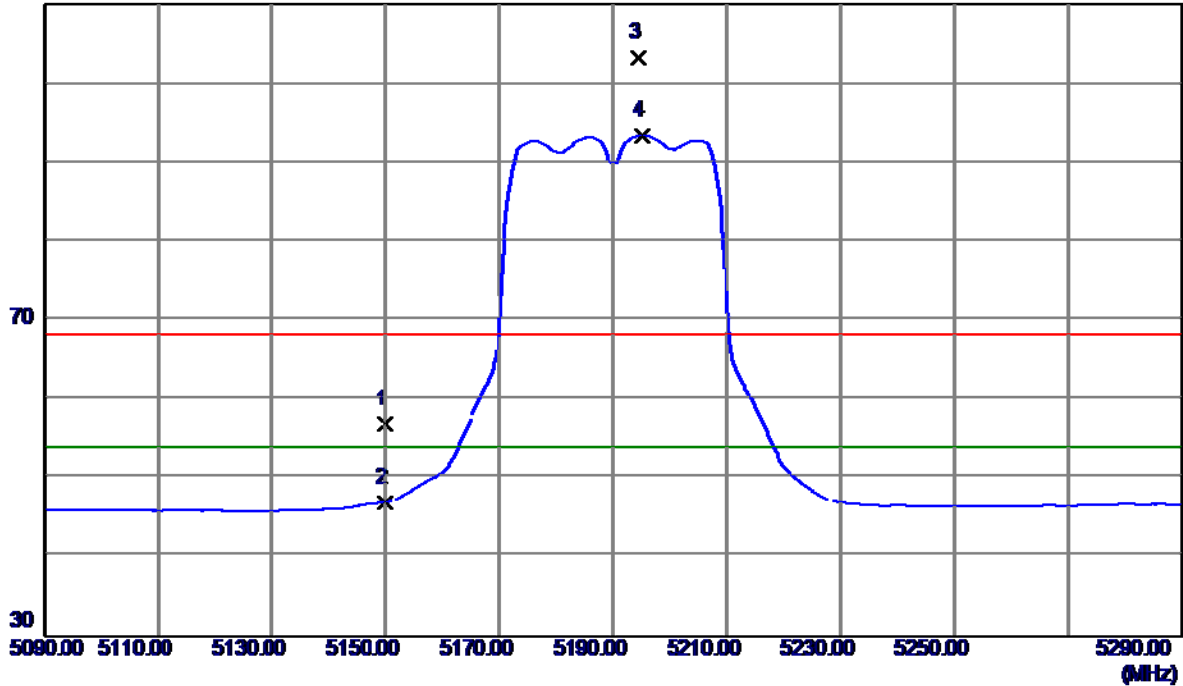

No.	Freq. MHz	Reading Level dBuV/m	Correct Factor dB	Measure ment dBuV/m	Limit dBuV/m	Margin dB	Detector	Comment
1	5150.0000	16.71	40.22	56.93	68.30	-11.37	Peak	
2	5150.0000	6.76	40.22	46.98	54.00	-7.02	AVG	
3	5194.4000	62.98	40.31	103.29	68.30	34.99	Peak	No Limit
4	5195.2000	53.08	40.31	93.39	54.00	39.39	AVG	No Limit

Orthogonal Axis:	X
Test Mode:	UNII-1/ TX N40 Mode 5190MHz

Horizontal

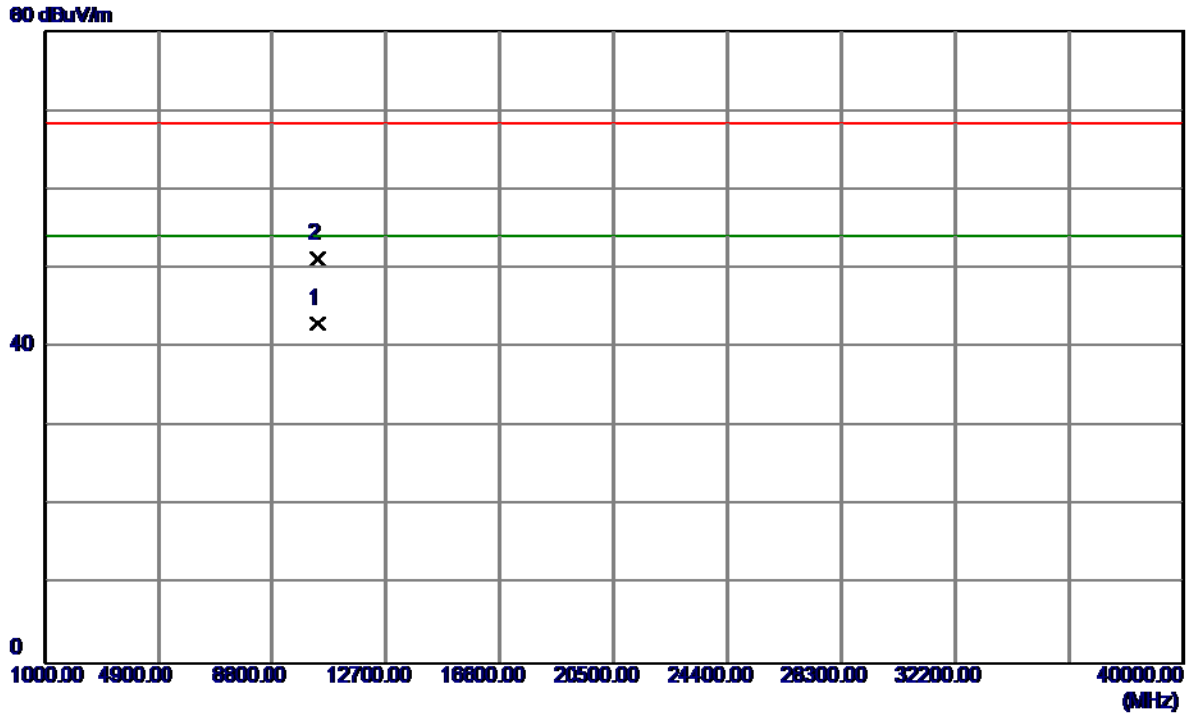

No.	Freq. MHz	Reading Level dBuV/m	Correct Factor dB	Measure ment dBuV/m	Limit dBuV/m	Margin dB	Detector	Comment
1	10380.3720	29.23	13.83	43.06	54.00	-10.94	AVG	
2	10380.3880	37.43	13.83	51.26	68.30	-17.04	Peak	

Orthogonal Axis:	X
Test Mode:	UNII-1/ TX N40 Mode 5230MHz

Vertical

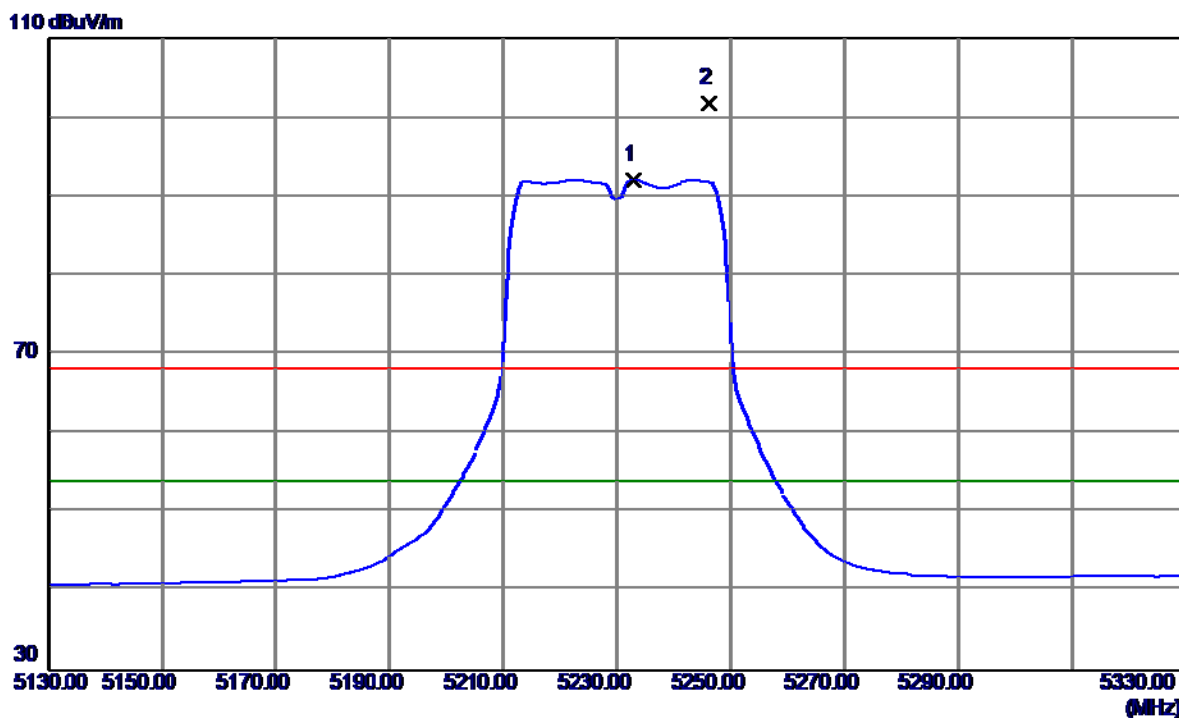

No.	Freq. MHz	Reading Level dBuV/m	Correct Factor dB	Measure ment dBuV/m	Limit dBuV/m	Margin dB	Detector	Comment
1	5232.8000	51.74	40.39	92.13	54.00	38.13	AVG	No Limit
2	5246.2000	61.49	40.42	101.91	68.30	33.61	Peak	No Limit

Orthogonal Axis:	X
Test Mode:	UNII-1/ TX N40 Mode 5230MHz

Vertical

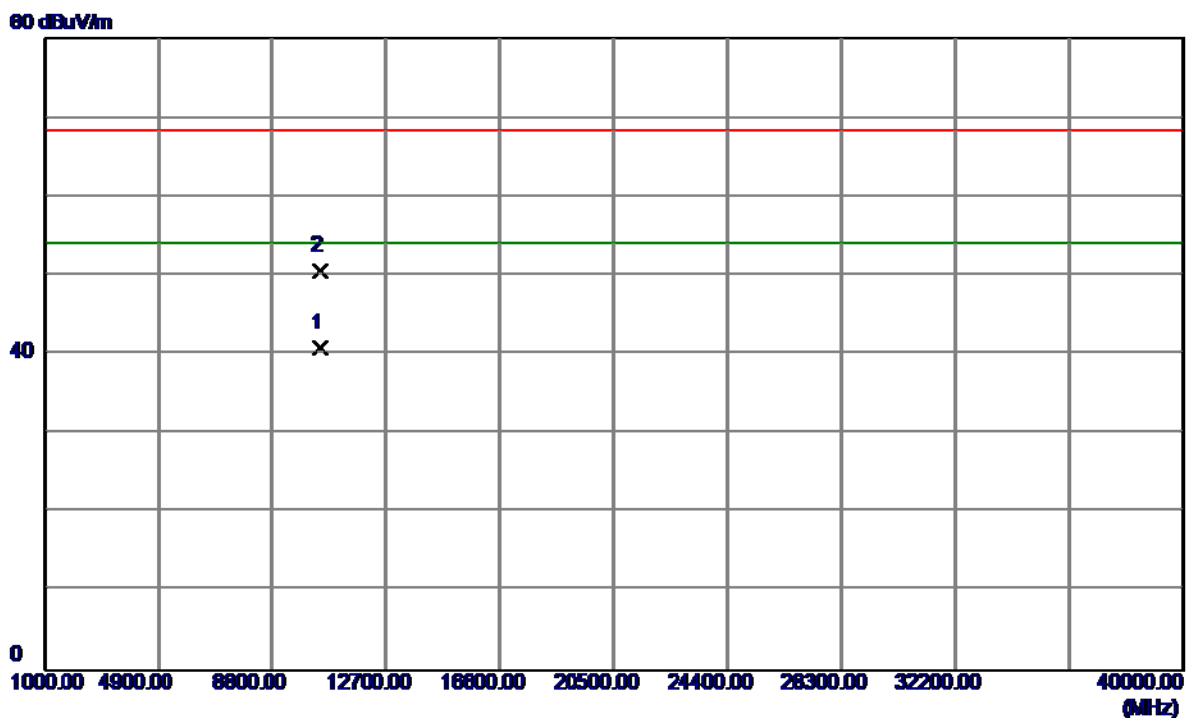

No.	Freq. MHz	Reading Level dBuV/m	Correct Factor dB	Measure ment dBuV/m	Limit dBuV/m	Margin dB	Detector	Comment
1	10460.1260	27.15	13.72	40.87	54.00	-13.13	AVG	
2	10460.6100	36.88	13.72	50.60	68.30	-17.70	Peak	

Orthogonal Axis:	X
Test Mode:	UNII-1/ TX N40 Mode 5230MHz

Horizontal

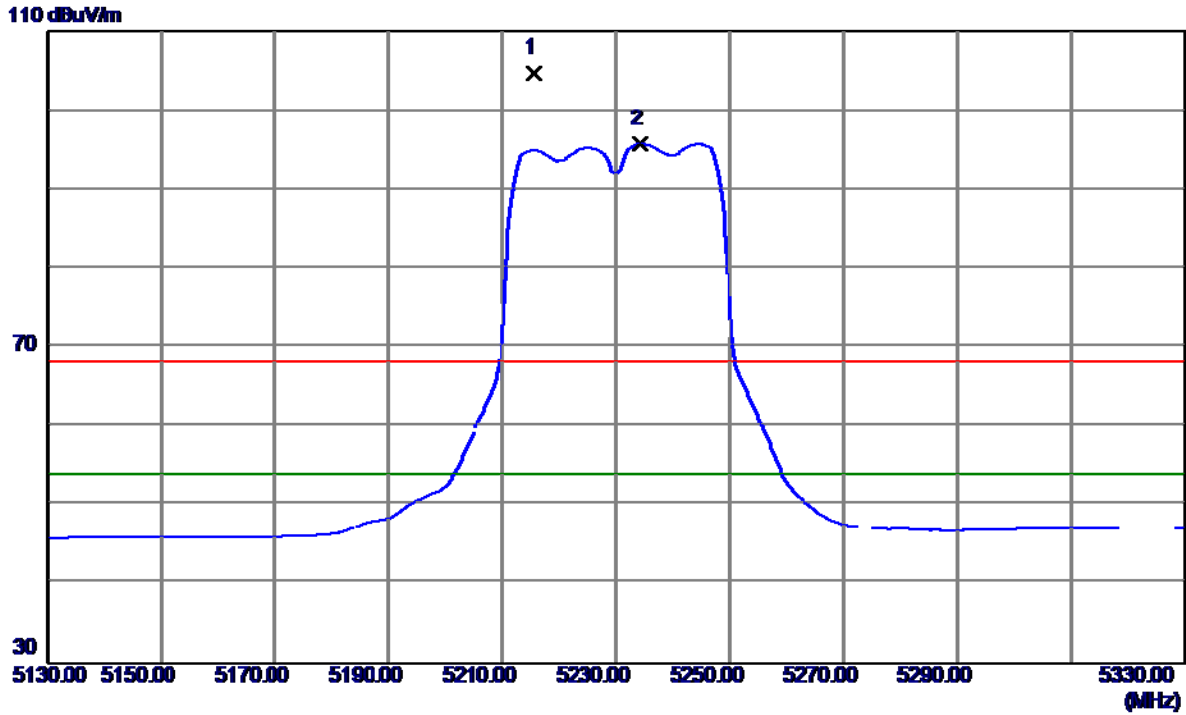

No.	Freq. MHz	Reading Level dBuV/m	Correct Factor dB	Measure ment dBuV/m	Limit dBuV/m	Margin dB	Detector	Comment
1	5215.6000	64.41	40.36	104.77	68.30	36.47	Peak	No Limit
2	5234.2000	55.33	40.40	95.73	54.00	41.73	AVG	No Limit

Orthogonal Axis:	X
Test Mode:	UNII-1/ TX N40 Mode 5230MHz

Horizontal

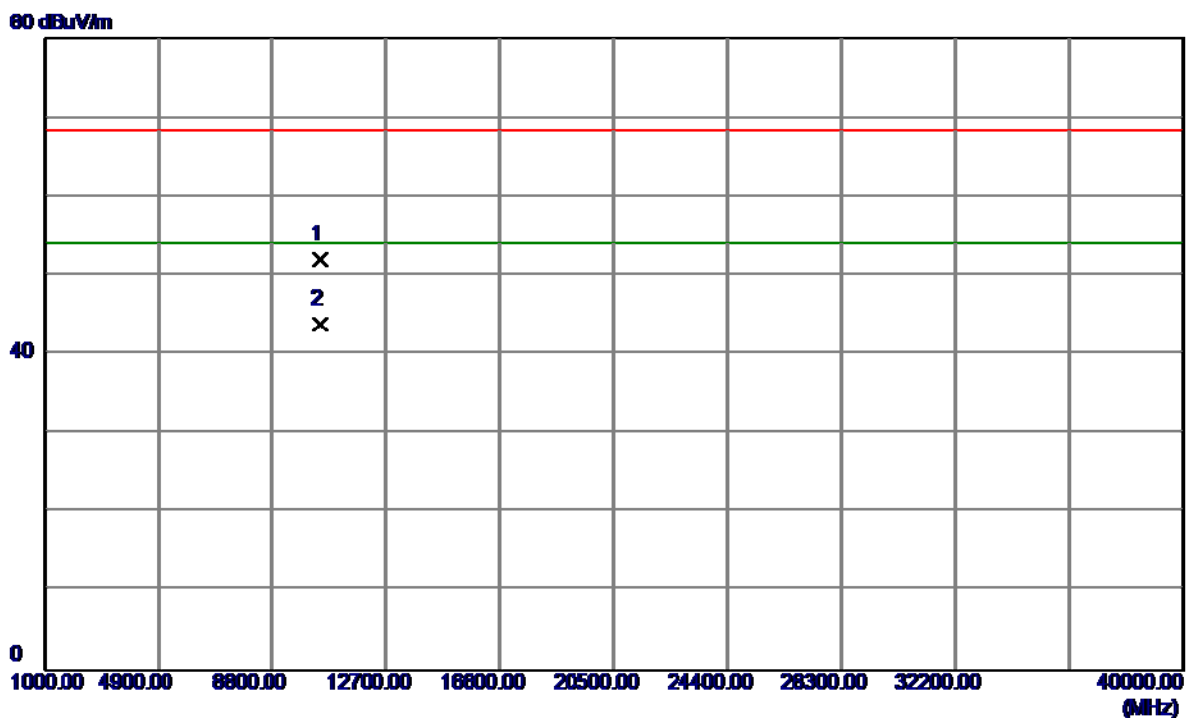

No.	Freq. MHz	Reading Level dBuV/m	Correct Factor dB	Measure ment dBuV/m	Limit dBuV/m	Margin dB	Detector	Comment
1	10460.4500	38.31	13.72	52.03	68.30	-16.27	Peak	
2	10460.8300	30.15	13.72	43.87	54.00	-10.13	AVG	

Orthogonal Axis :	X
Test Mode :	UNII-2A/ TX A Mode 5260MHz

Vertical

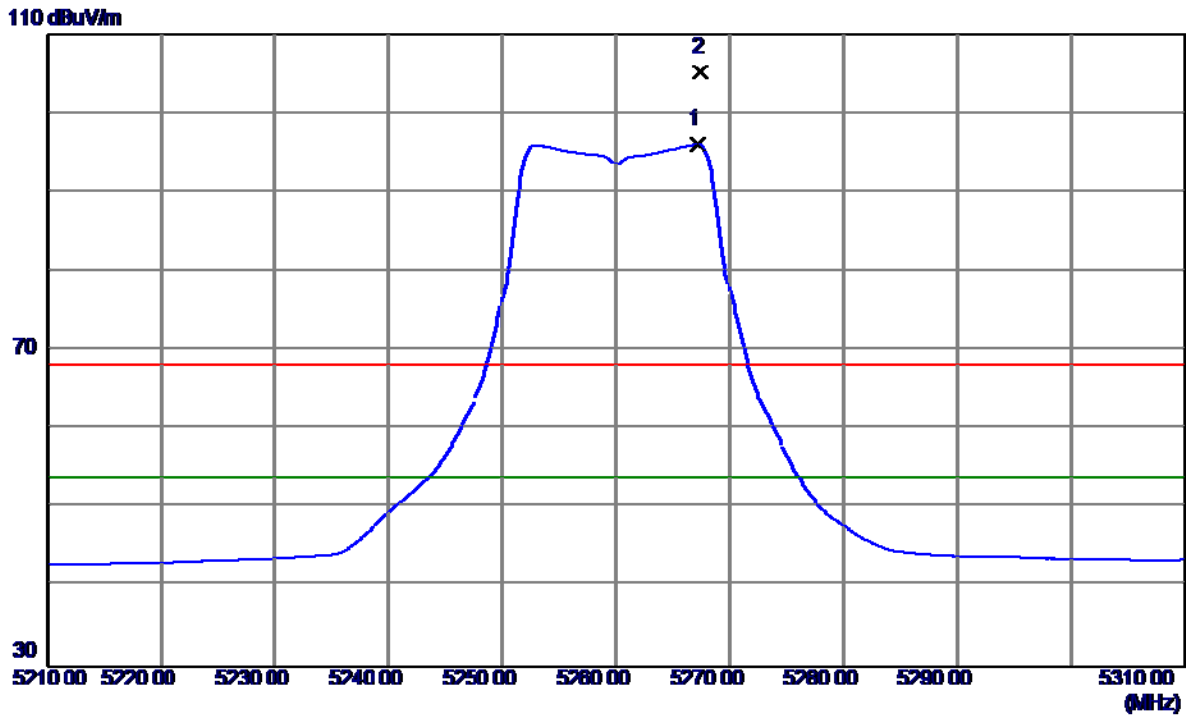

No.	Freq. MHz	Reading Level dBuV/m	Correct Factor dB	Measure ment dBuV/m	Limit dBuV/m	Margin dB	Detector	Comment
1	5267.2000	55.57	40.47	96.04	54.00	42.04	AVG	No Limit
2	5267.5000	64.74	40.47	105.21	68.30	36.91	Peak	No Limit

Orthogonal Axis :	X
Test Mode :	UNII-2A/ TX A Mode 5260MHz

Vertical

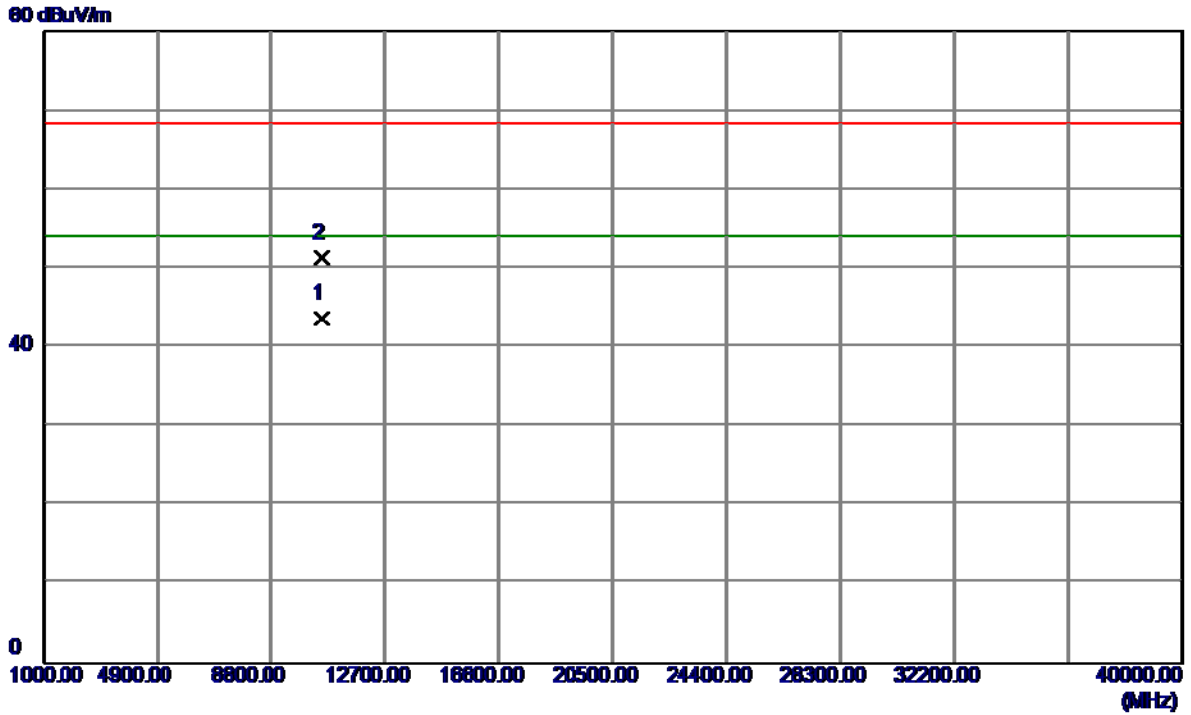

No.	Freq. MHz	Reading Level dBuV/m	Correct Factor dB	Measure ment dBuV/m	Limit dBuV/m	Margin dB	Detector	Comment
1	10520.3000	29.94	13.75	43.69	54.00	-10.31	AVG	
2	10520.3600	37.53	13.75	51.28	68.30	-17.02	Peak	

Orthogonal Axis :	X
Test Mode :	UNII-2A/ TX A Mode 5260MHz

Horizontal

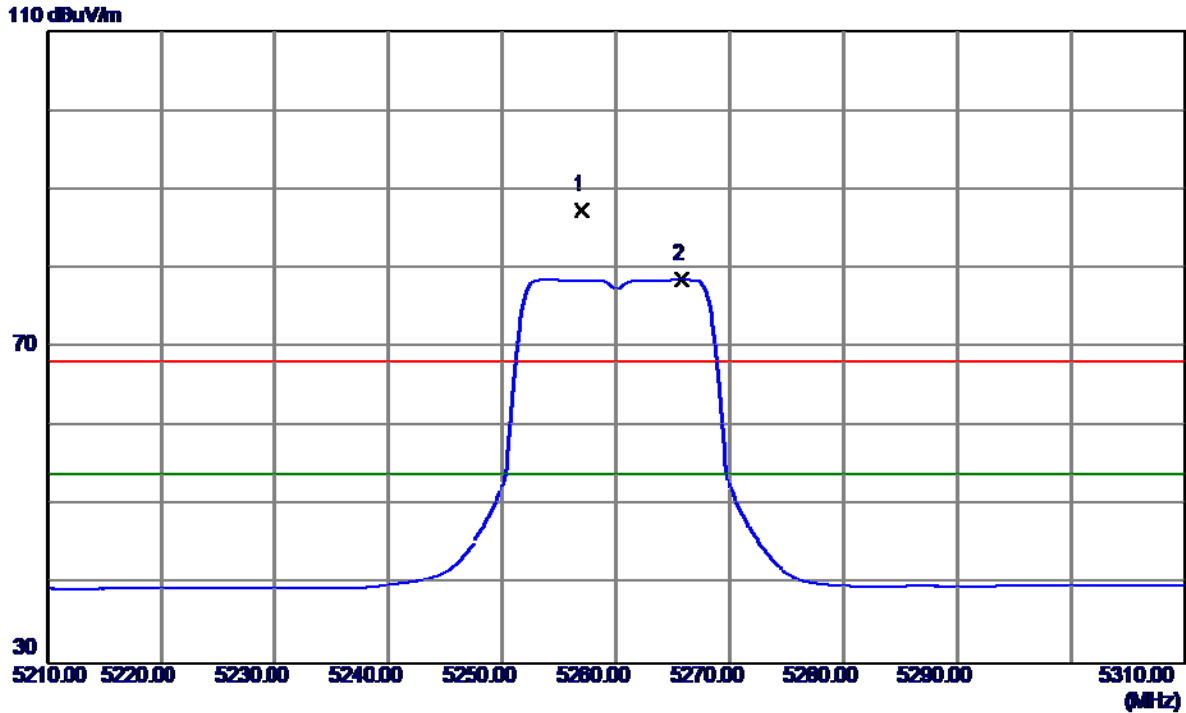

No.	Freq. MHz	Reading Level dBuV/m	Correct Factor dB	Measure ment dBuV/m	Limit dBuV/m	Margin dB	Detector	Comment
1	5257.0000	46.96	40.44	87.40	68.30	19.10	Peak	No Limit
2	5265.8000	38.15	40.46	78.61	54.00	24.61	AVG	No Limit

Orthogonal Axis :	X
Test Mode :	UNII-2A/ TX A Mode 5260MHz

Horizontal

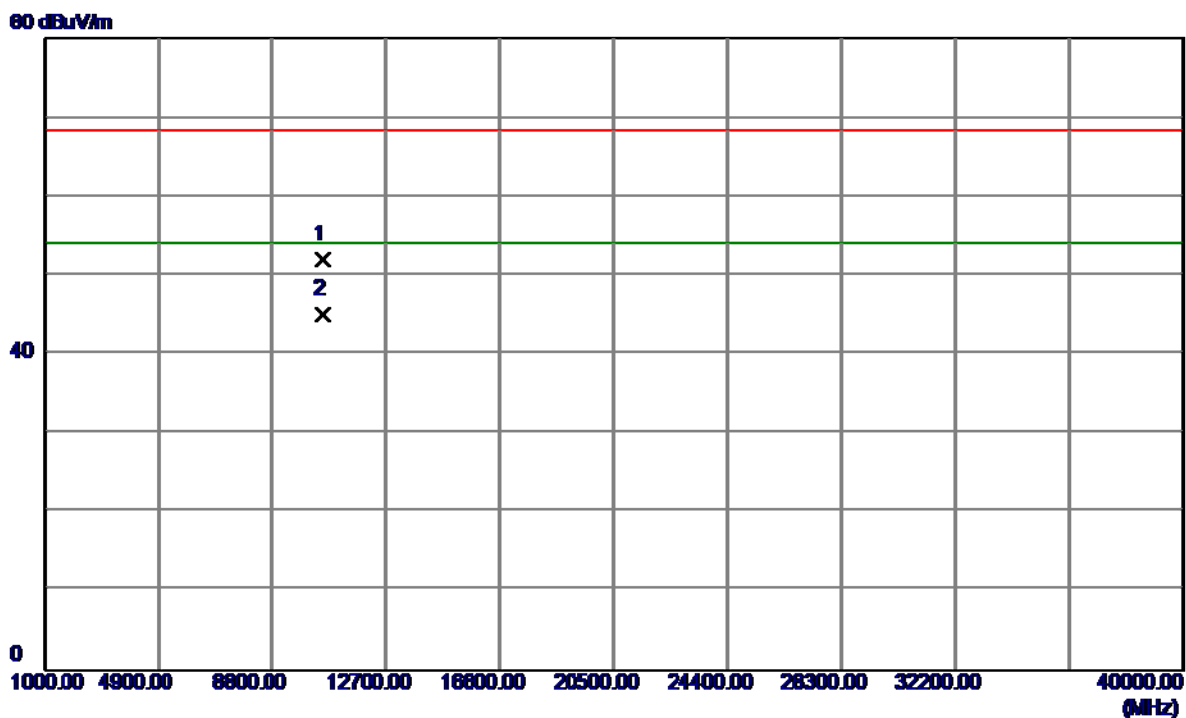

No.	Freq. MHz	Reading Level dBuV/m	Correct Factor dB	Measure ment dBuV/m	Limit dBuV/m	Margin dB	Detector	Comment
1	10520.1600	38.26	13.75	52.01	68.30	-16.29	Peak	
2	10520.2500	31.41	13.75	45.16	54.00	-8.84	AVG	

Orthogonal Axis :	X
Test Mode :	UNII-2A/ TX A Mode 5300MHz

Vertical

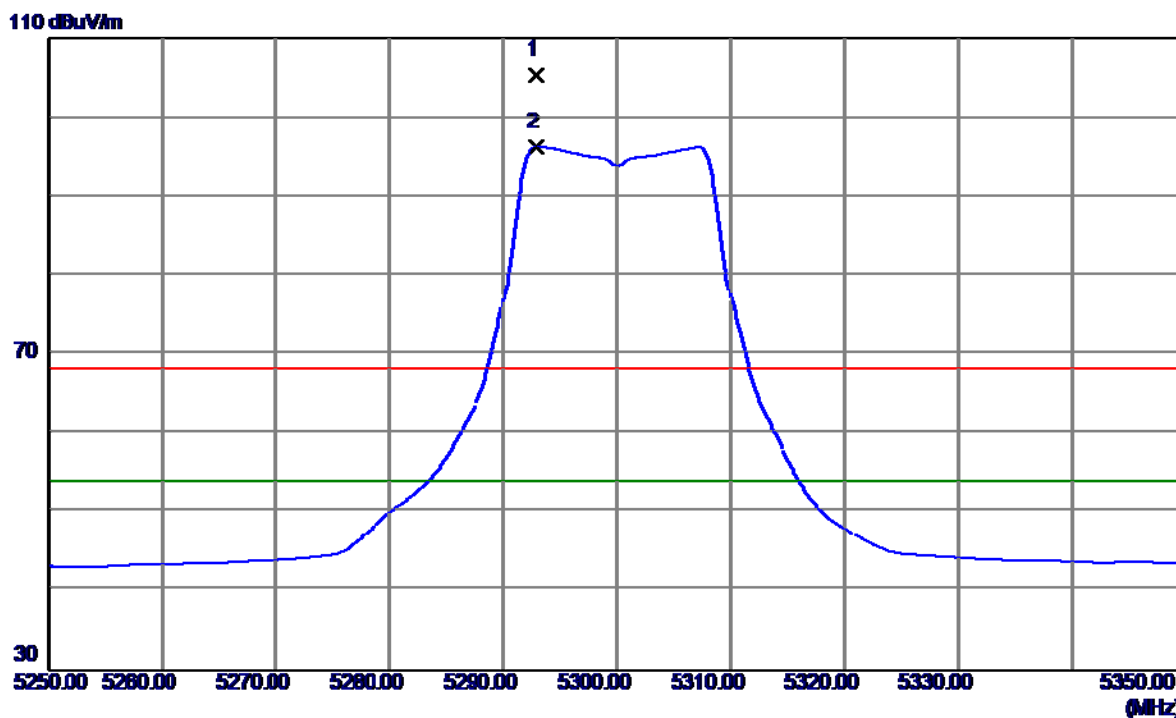

No.	Freq. MHz	Reading Level dBuV/m	Correct Factor dB	Measure ment dBuV/m	Limit dBuV/m	Margin dB	Detector	Comment
1	5292.9000	64.83	40.52	105.35	68.30	37.05	Peak	No Limit
2	5292.9000	55.74	40.52	96.26	54.00	42.26	AVG	No Limit

Orthogonal Axis :	X
Test Mode :	UNII-2A/ TX A Mode 5300MHz

Vertical

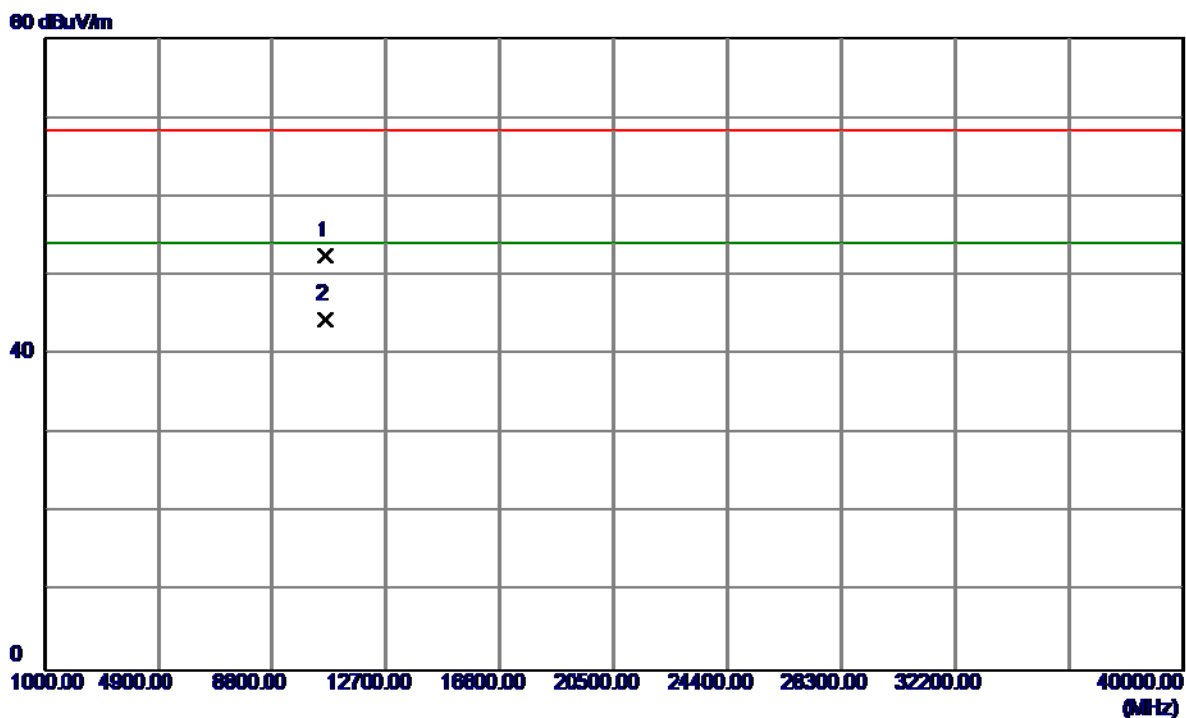

No.	Freq. MHz	Reading Level dBuV/m	Correct Factor dB	Measure ment dBuV/m	Limit dBuV/m	Margin dB	Detector	Comment
1	10600.5199	38.33	14.08	52.41	68.30	-15.89	Peak	
2	10600.6000	30.47	14.08	44.55	54.00	-9.45	AVG	

Orthogonal Axis :	X
Test Mode :	UNII-2A/ TX A Mode 5300MHz

Horizontal

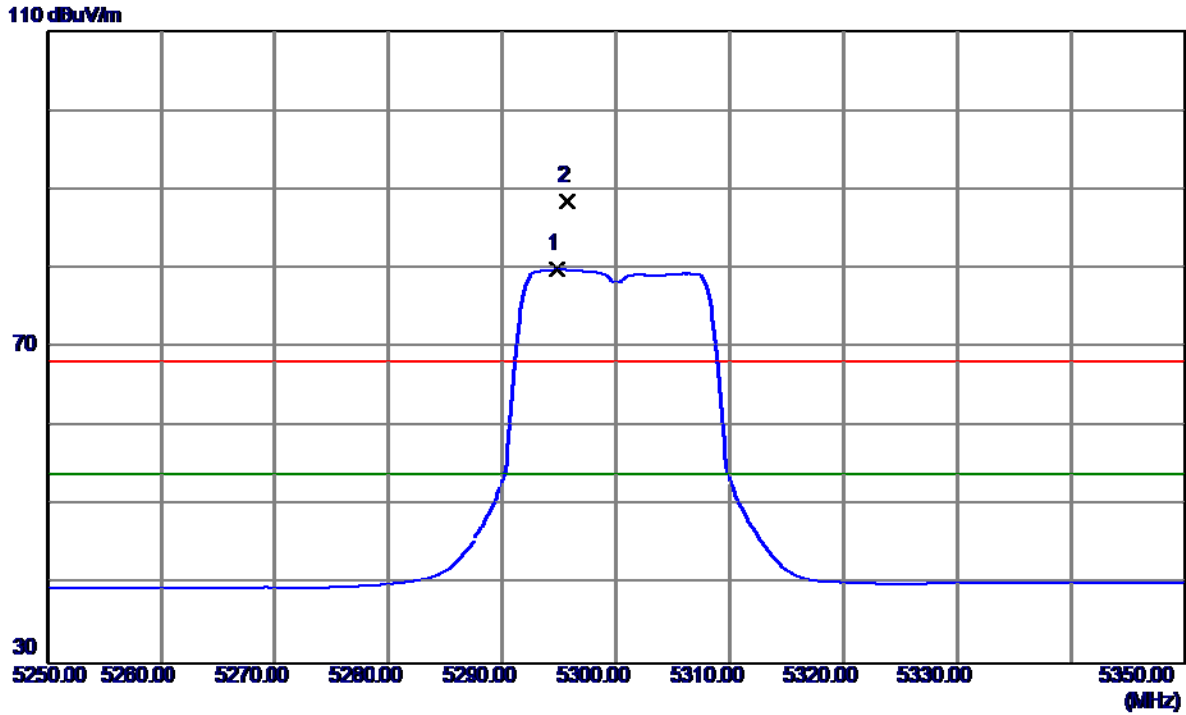

No.	Freq. MHz	Reading Level dBuV/m	Correct Factor dB	Measure ment dBuV/m	Limit dBuV/m	Margin dB	Detector	Comment
1	5294.8000	39.33	40.52	79.85	54.00	25.85	AVG	No Limit
2	5295.7000	48.00	40.53	88.53	68.30	20.23	Peak	No Limit

Orthogonal Axis :	X
Test Mode :	UNII-2A/ TX A Mode 5300MHz

Horizontal

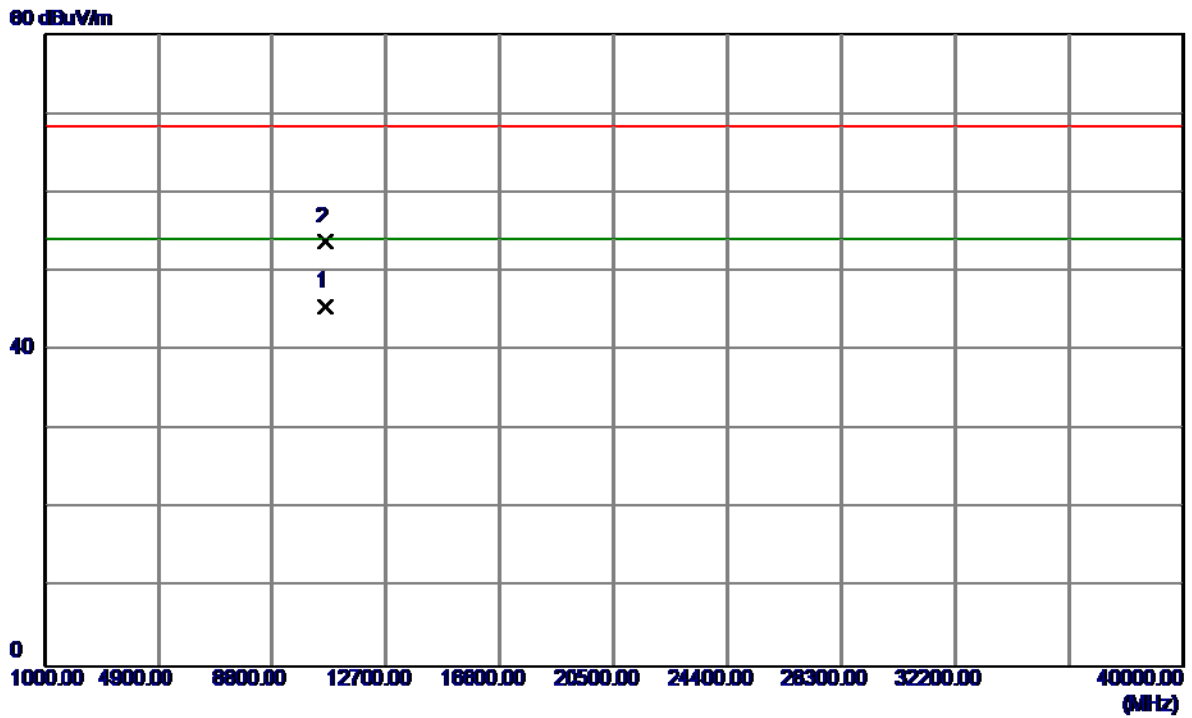

No.	Freq. MHz	Reading Level dBuV/m	Correct Factor dB	Measure ment dBuV/m	Limit dBuV/m	Margin dB	Detector	Comment
1	10600.1100	31.56	14.08	45.64	54.00	-8.36	AVG	
2	10600.2600	39.74	14.08	53.82	68.30	-14.48	Peak	

Orthogonal Axis :	X
Test Mode :	UNII-2A/ TX A Mode 5320MHz

Vertical

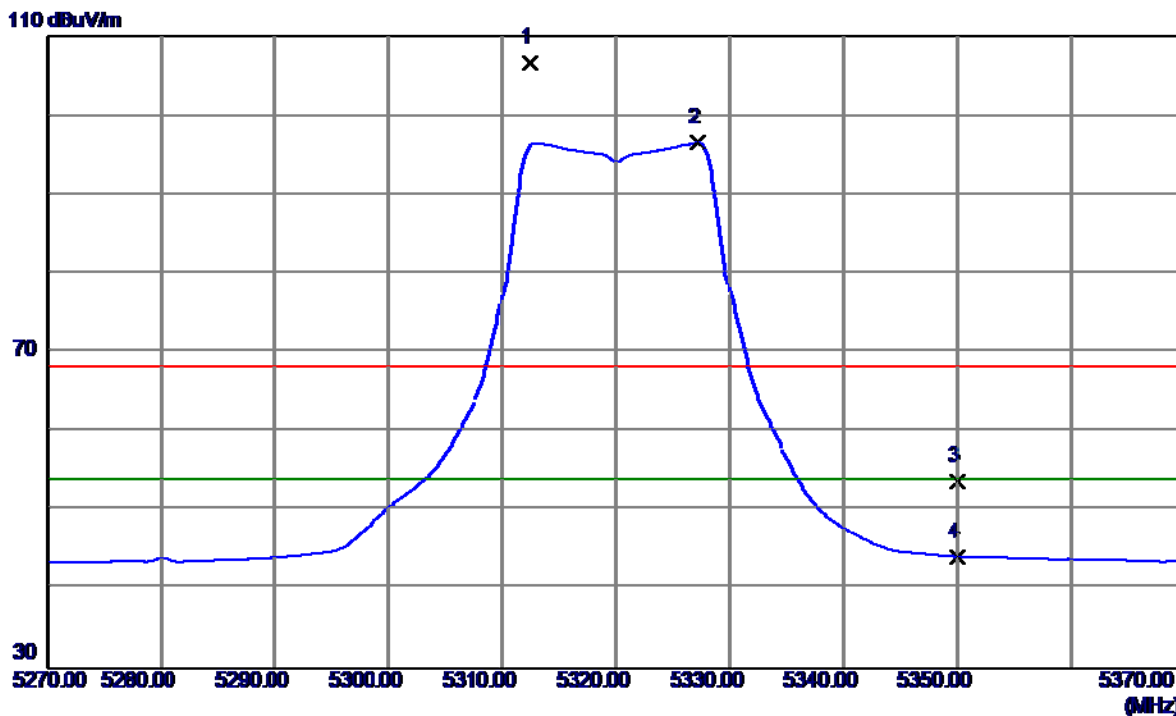

No.	Freq. MHz	Reading Level dBuV/m	Correct Factor dB	Measure ment dBuV/m	Limit dBuV/m	Margin dB	Detector	Comment
1	5312.4000	66.03	40.56	106.59	68.30	38.29	Peak	No Limit
2	5327.2000	55.92	40.59	96.51	54.00	42.51	AVG	No Limit
3	5350.0000	13.04	40.64	53.68	68.30	-14.62	Peak	
4	5350.0000	3.49	40.64	44.13	54.00	-9.87	AVG	

Orthogonal Axis :	X
Test Mode :	UNII-2A/ TX A Mode 5320MHz

Vertical

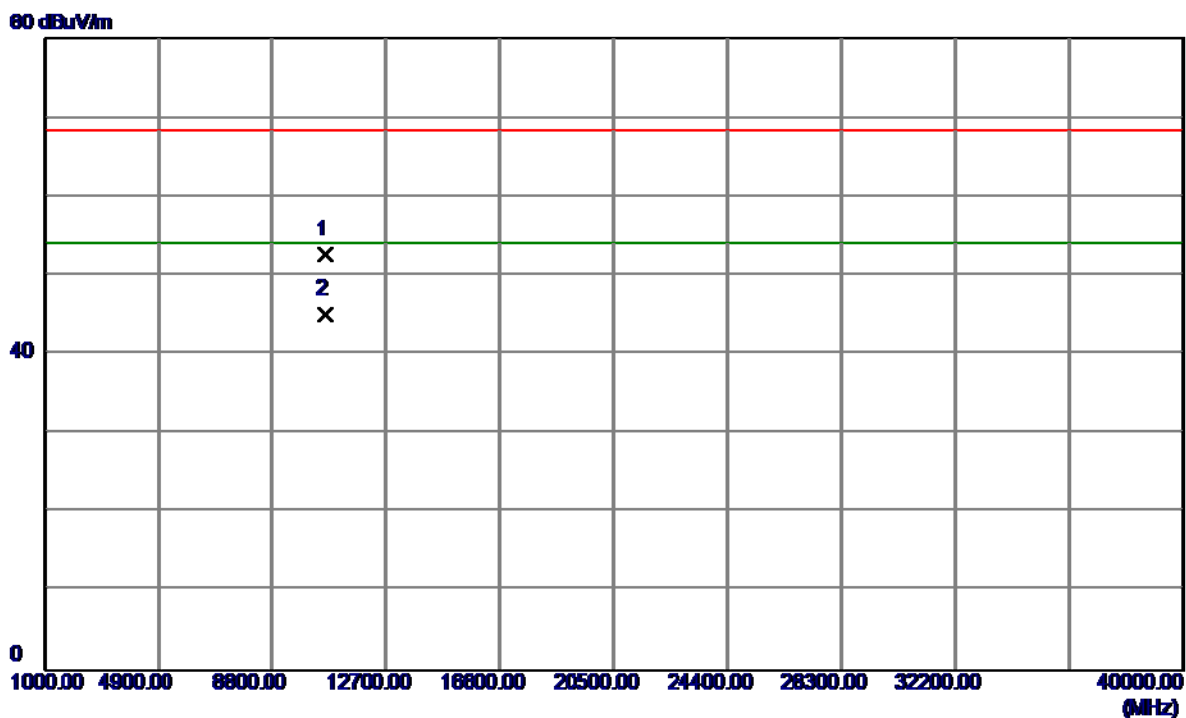

No.	Freq. MHz	Reading Level dBuV/m	Correct Factor dB	Measure ment dBuV/m	Limit dBuV/m	Margin dB	Detector	Comment
1	10640.3500	38.37	14.25	52.62	68.30	-15.68	Peak	
2	10640.3500	30.84	14.25	45.09	54.00	-8.91	AVG	

Orthogonal Axis :	X
Test Mode :	UNII-2A/ TX A Mode 5320MHz

Horizontal

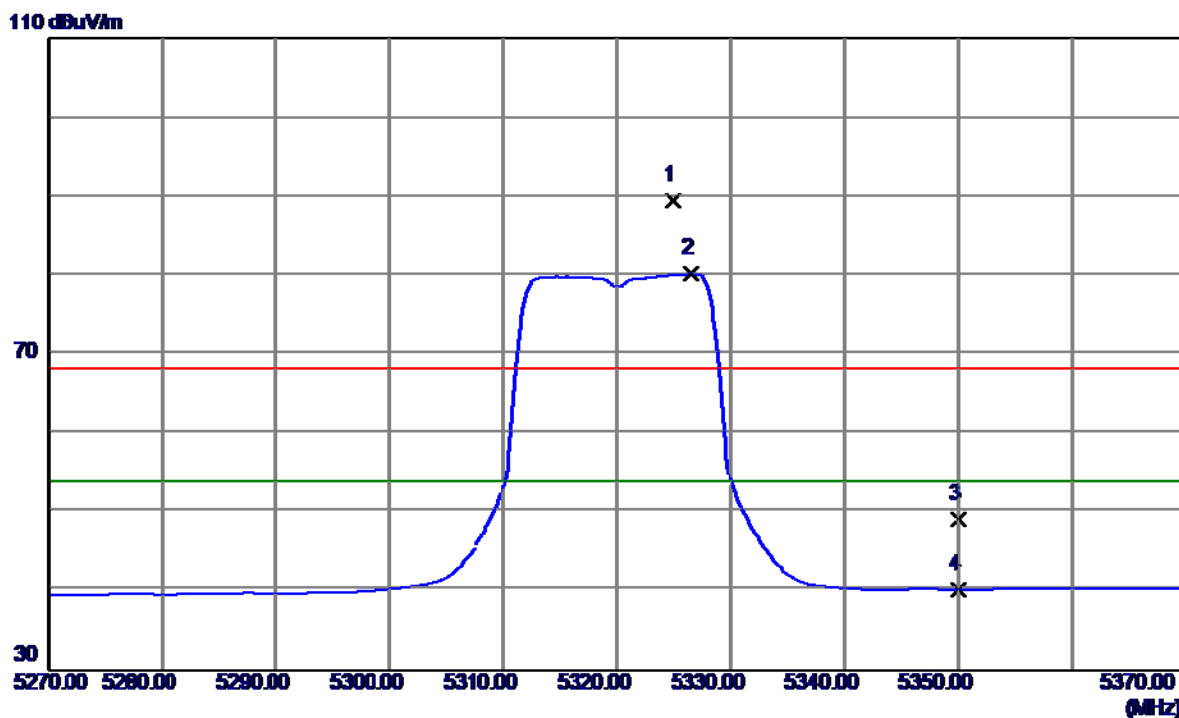

No.	Freq. MHz	Reading Level dBuV/m	Correct Factor dB	Measure ment dBuV/m	Limit dBuV/m	Margin dB	Detector	Comment
1	5324.9000	48.92	40.59	89.51	68.30	21.21	Peak	No Limit
2	5326.6000	39.58	40.59	80.17	54.00	26.17	AVG	No Limit
3	5350.0000	8.52	40.64	49.16	68.30	-19.14	Peak	
4	5350.0000	-0.36	40.64	40.28	54.00	-13.72	AVG	

Orthogonal Axis :	X
Test Mode :	UNII-2A/ TX A Mode 5320MHz

Horizontal

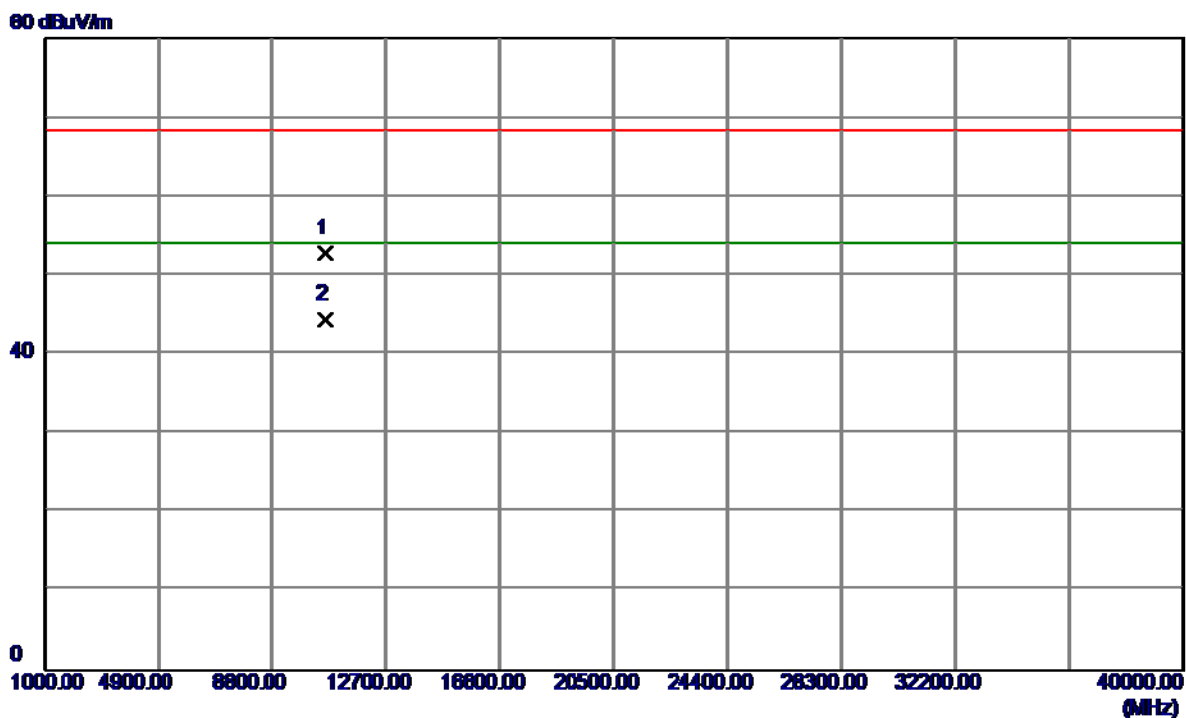

No.	Freq. MHz	Reading Level dBuV/m	Correct Factor dB	Measure ment dBuV/m	Limit dBuV/m	Margin dB	Detector	Comment
1	10640.2500	38.62	14.25	52.87	68.30	-15.43	Peak	
2	10640.3800	30.26	14.25	44.51	54.00	-9.49	AVG	

Orthogonal Axis :	X
Test Mode :	UNII-2A/ TX N20 Mode 5260MHz

Vertical

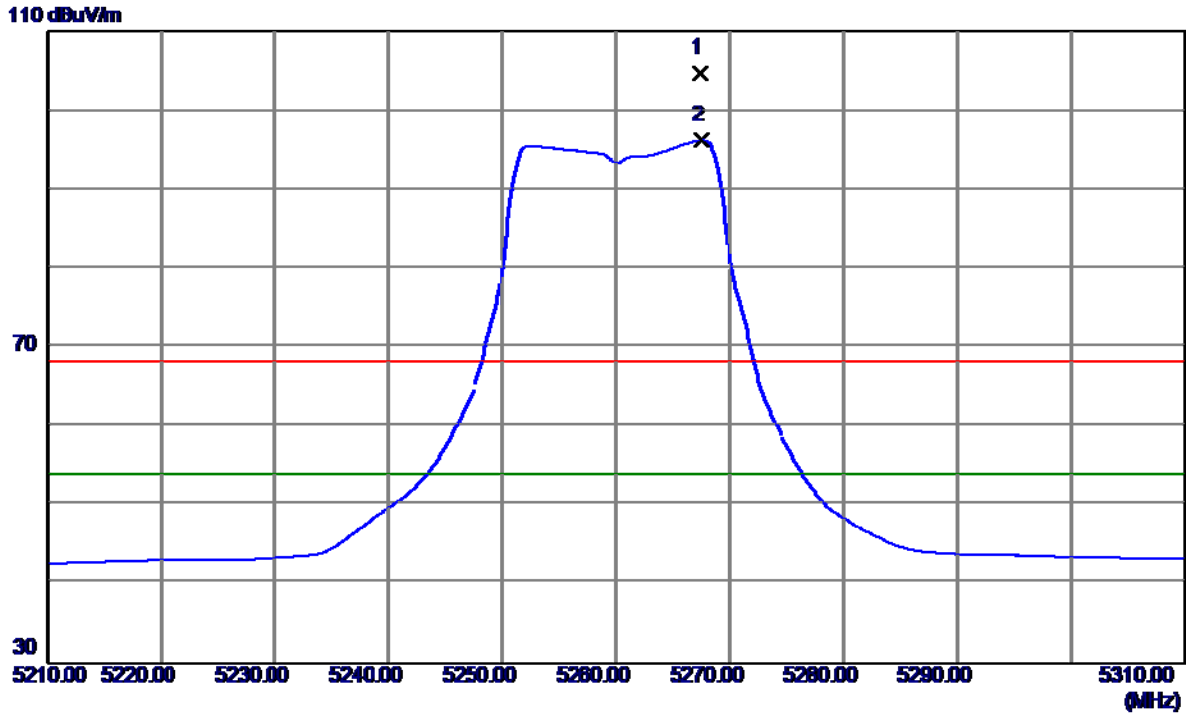

No.	Freq. MHz	Reading Level dBuV/m	Correct Factor dB	Measure ment dBuV/m	Limit dBuV/m	Margin dB	Detector	Comment
1	5267.4000	64.26	40.47	104.73	68.30	36.43	Peak	No Limit
2	5267.6000	55.70	40.47	96.17	54.00	42.17	AVG	No Limit

Orthogonal Axis :	X
Test Mode :	UNII-2A/ TX N20 Mode 5260MHz

Vertical

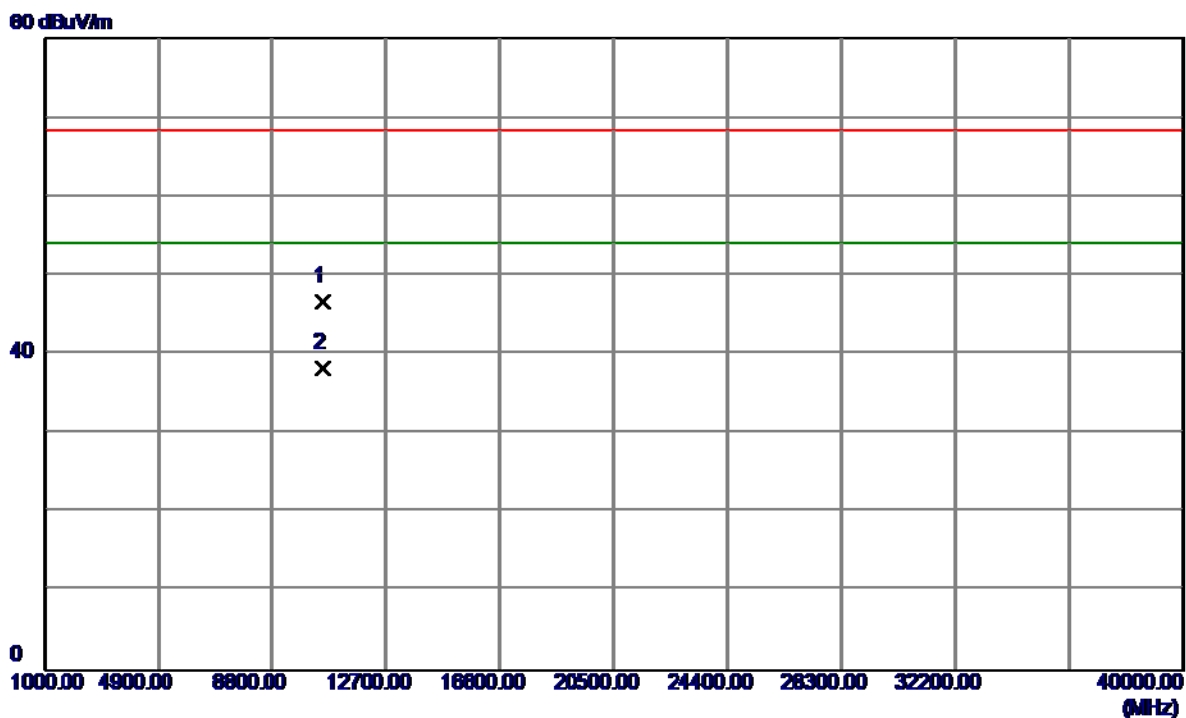

No.	Freq. MHz	Reading Level dBuV/m	Correct Factor dB	Measure ment dBuV/m	Limit dBuV/m	Margin dB	Detector	Comment
1	10520.3120	33.03	13.75	46.78	68.30	-21.52	Peak	
2	10520.2580	24.46	13.75	38.21	54.00	-15.79	AVG	

Orthogonal Axis :	X
Test Mode :	UNII-2A/ TX N20 Mode 5260MHz

Horizontal

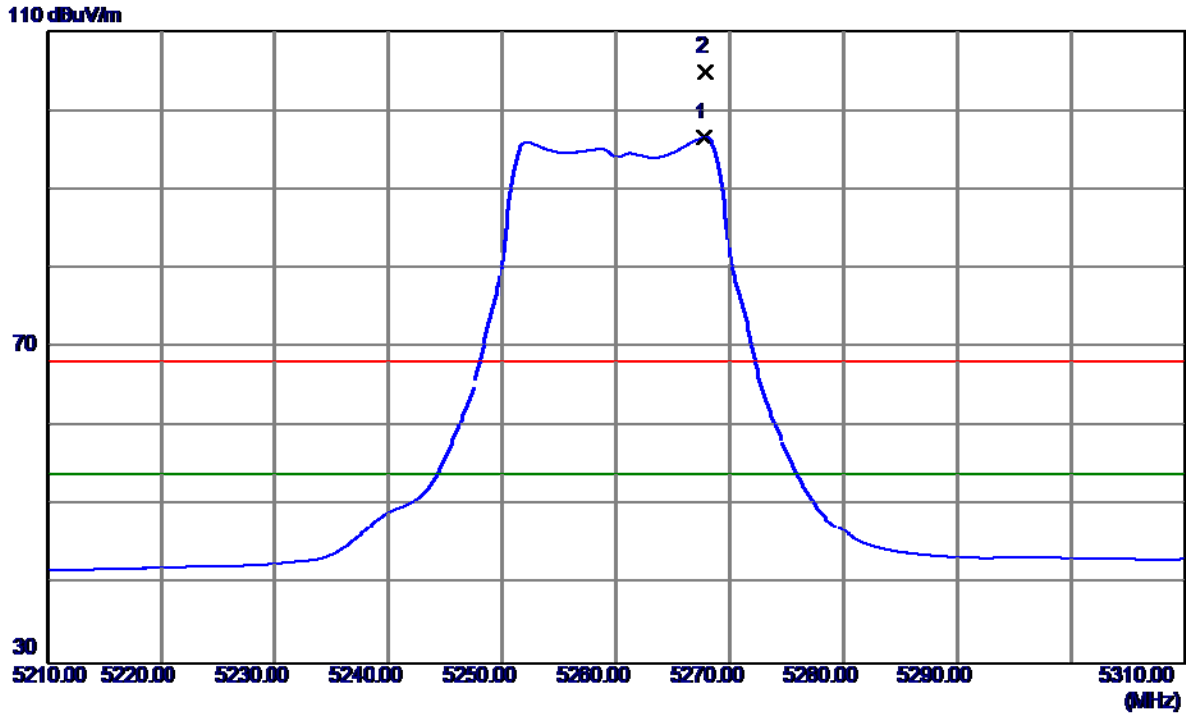

No.	Freq. MHz	Reading Level dBuV/m	Correct Factor dB	Measure ment dBuV/m	Limit dBuV/m	Margin dB	Detector	Comment
1	5267.8000	56.11	40.47	96.58	54.00	42.58	AVG	No Limit
2	5267.9000	64.38	40.47	104.85	68.30	36.55	Peak	No Limit

Orthogonal Axis :	X
Test Mode :	UNII-2A/ TX N20 Mode 5260MHz

Horizontal

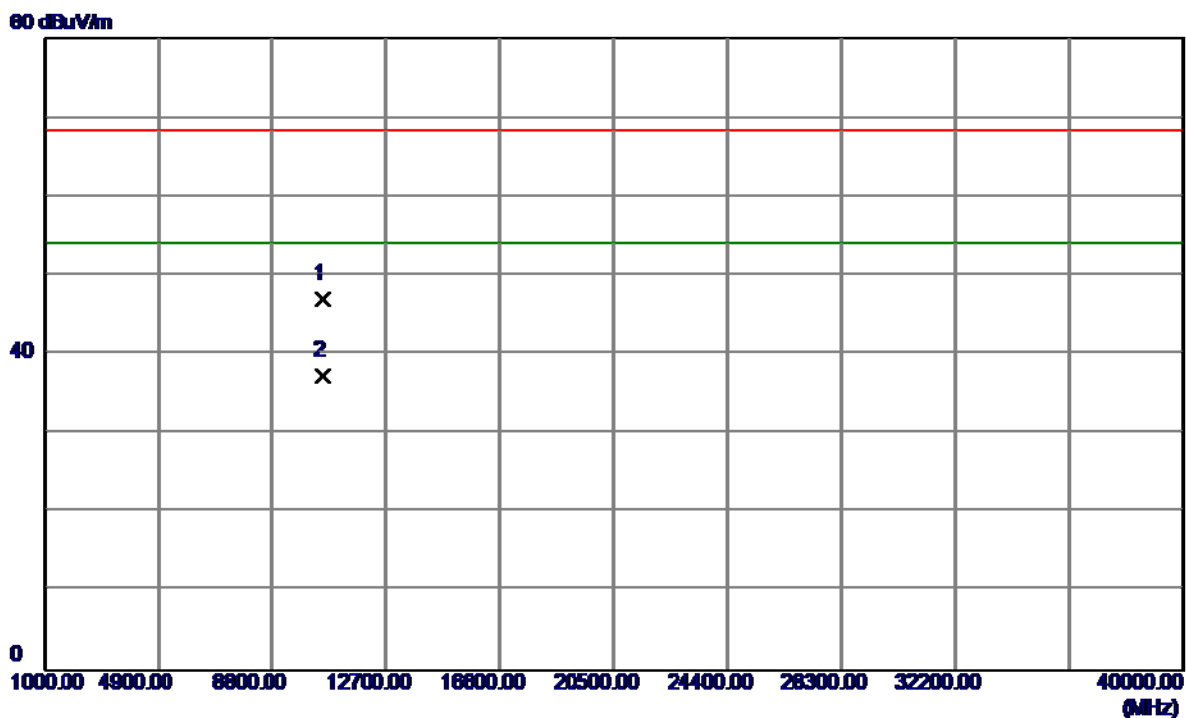

No.	Freq. MHz	Reading Level dBuV/m	Correct Factor dB	Measure ment dBuV/m	Limit dBuV/m	Margin dB	Detector	Comment
1	10520.0900	33.22	13.75	46.97	68.30	-21.33	Peak	
2	10520.0900	23.51	13.75	37.26	54.00	-16.74	AVG	

Orthogonal Axis :	X
Test Mode :	UNII-2A/ TX N20 Mode 5300MHz

Vertical

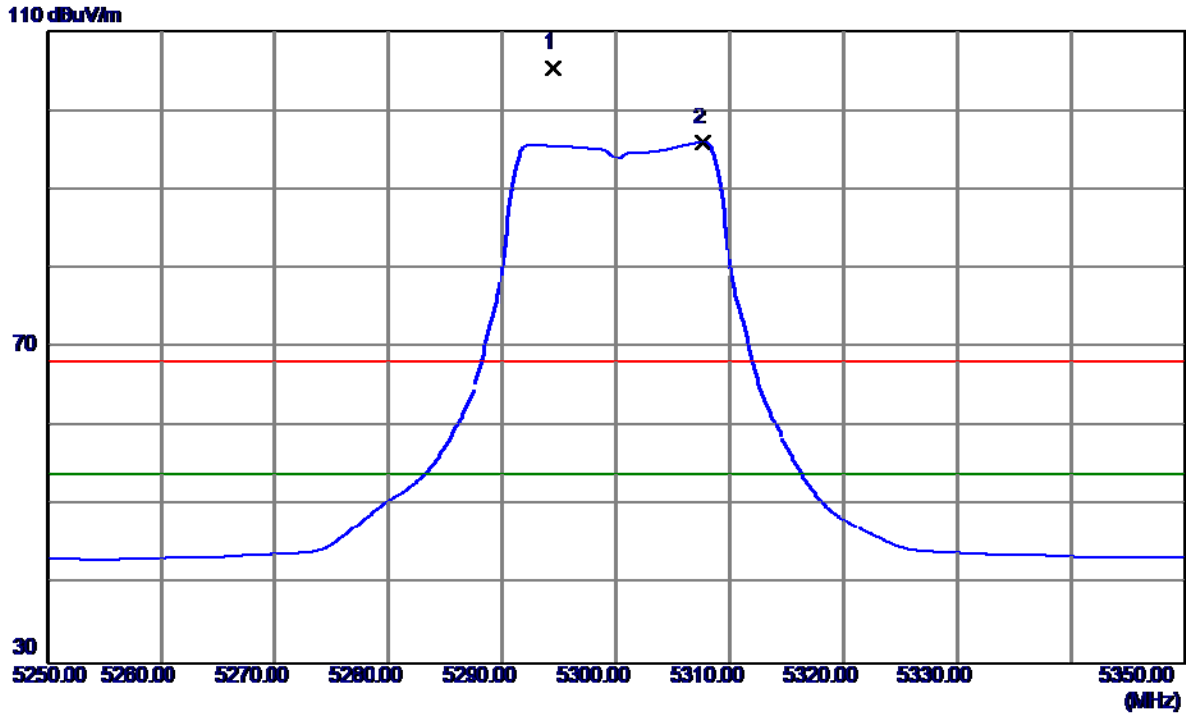

No.	Freq. MHz	Reading Level dBuV/m	Correct Factor dB	Measure ment dBuV/m	Limit dBuV/m	Margin dB	Detector	Comment
1	5294.4000	64.79	40.52	105.31	68.30	37.01	Peak	No Limit
2	5307.7000	55.38	40.55	95.93	54.00	41.93	AVG	No Limit

Orthogonal Axis :	X
Test Mode :	UNII-2A/ TX N20 Mode 5300MHz

Vertical

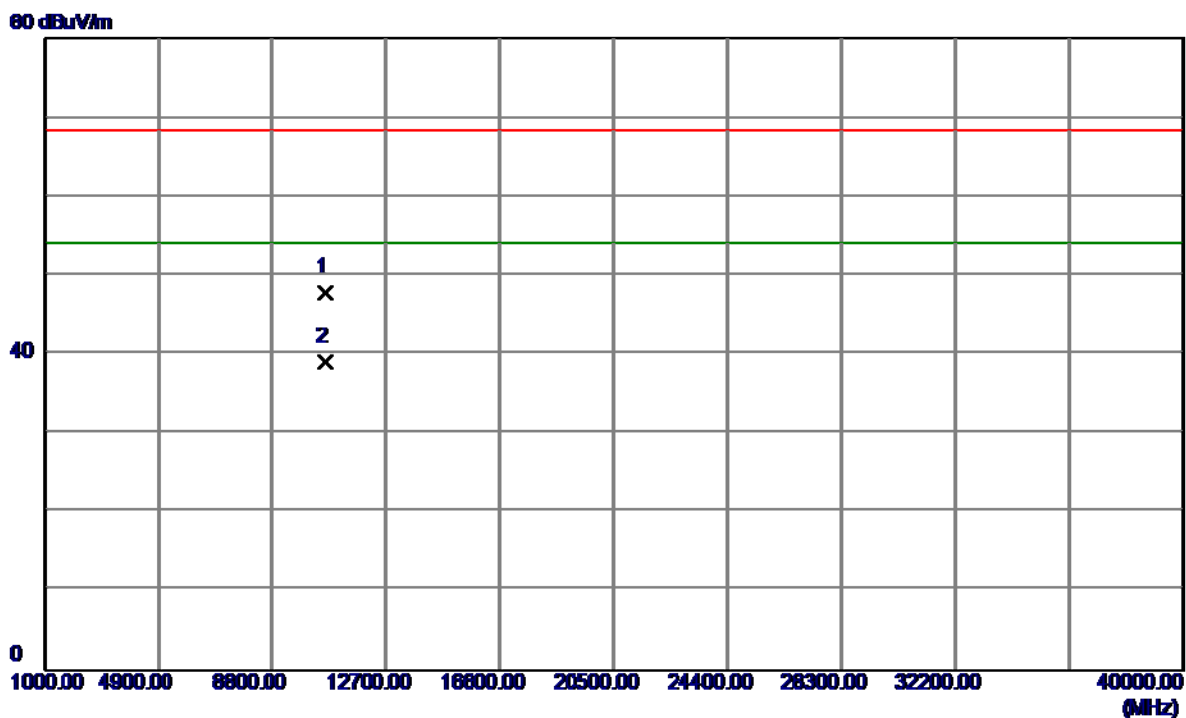

No.	Freq. MHz	Reading Level dBuV/m	Correct Factor dB	Measure ment dBuV/m	Limit dBuV/m	Margin dB	Detector	Comment
1	10600.2300	33.82	14.08	47.90	68.30	-20.40	Peak	
2	10600.2300	24.95	14.08	39.03	54.00	-14.97	AVG	

Orthogonal Axis :	X
Test Mode :	UNII-2A/ TX N20 Mode 5300MHz

Horizontal

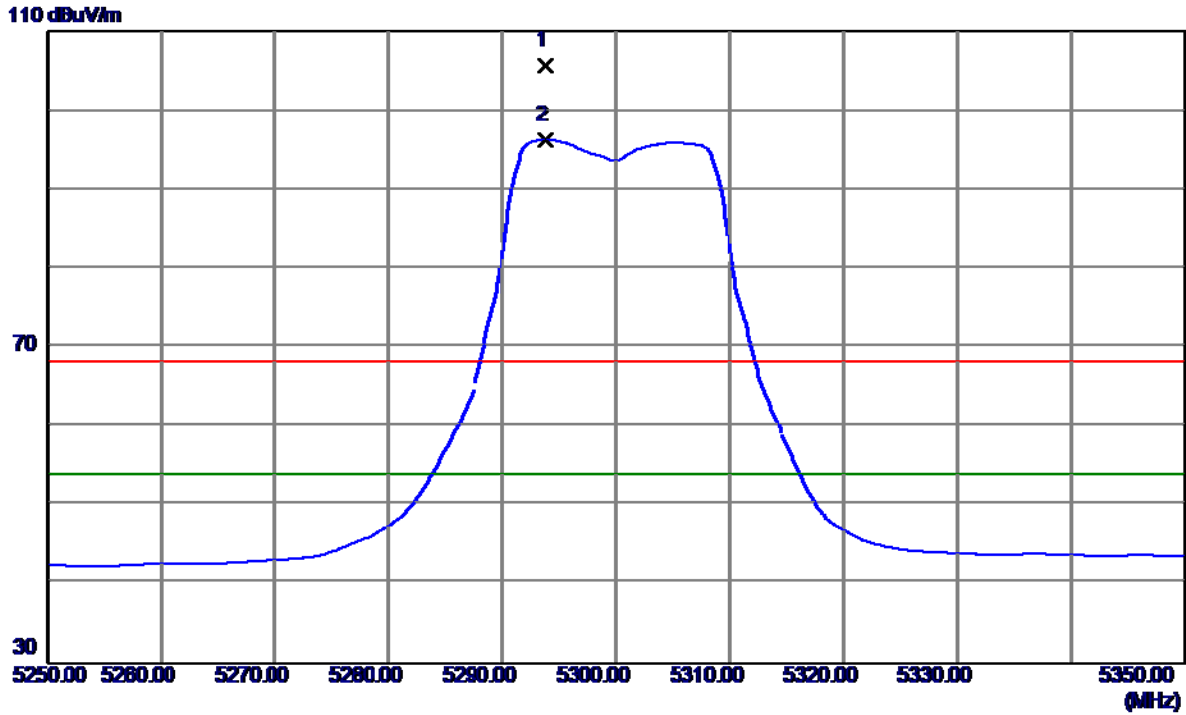

No.	Freq. MHz	Reading Level dBuV/m	Correct Factor dB	Measure ment dBuV/m	Limit dBuV/m	Margin dB	Detector	Comment
1	5293.8000	65.13	40.52	105.65	68.30	37.35	Peak	No Limit
2	5293.8000	55.74	40.52	96.26	54.00	42.26	AVG	No Limit

Orthogonal Axis :	X
Test Mode :	UNII-2A/ TX N20 Mode 5300MHz

Horizontal

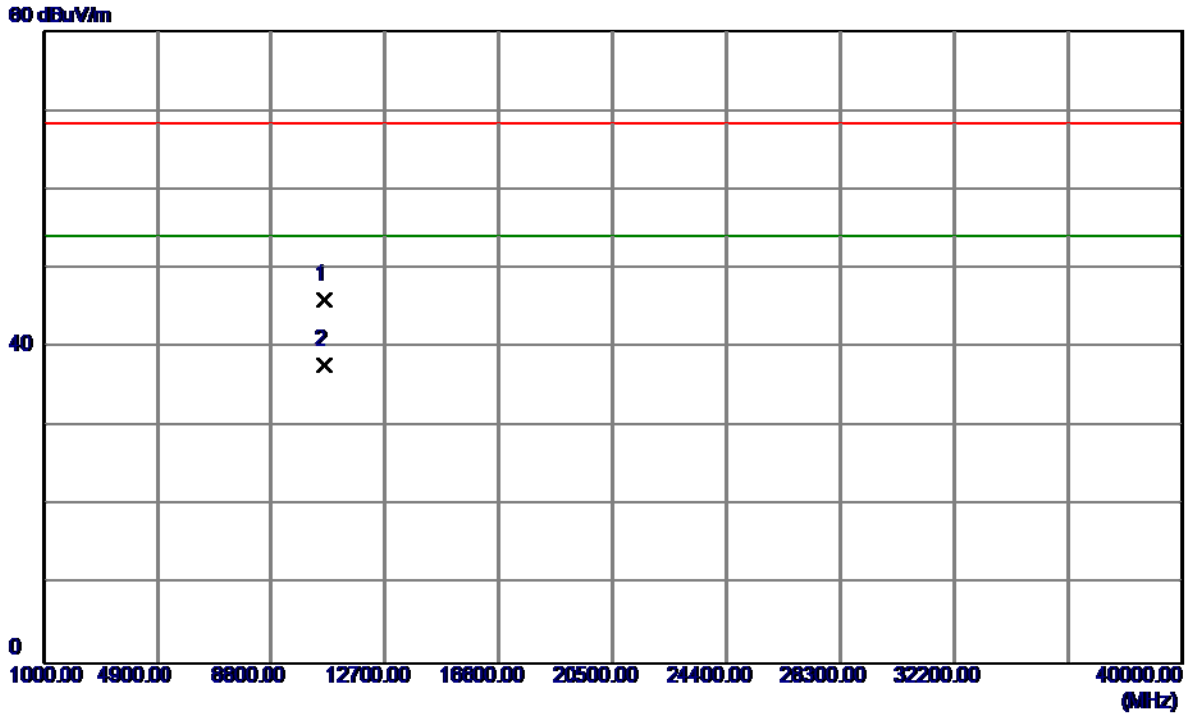

No.	Freq. MHz	Reading Level dBuV/m	Correct Factor dB	Measure ment dBuV/m	Limit dBuV/m	Margin dB	Detector	Comment
1	10600.3339	32.02	14.08	46.10	68.30	-22.20	Peak	
2	10600.5700	23.73	14.08	37.81	54.00	-16.19	AVG	

Orthogonal Axis :	X
Test Mode :	UNII-2A/ TX N20 Mode 5320MHz

Vertical

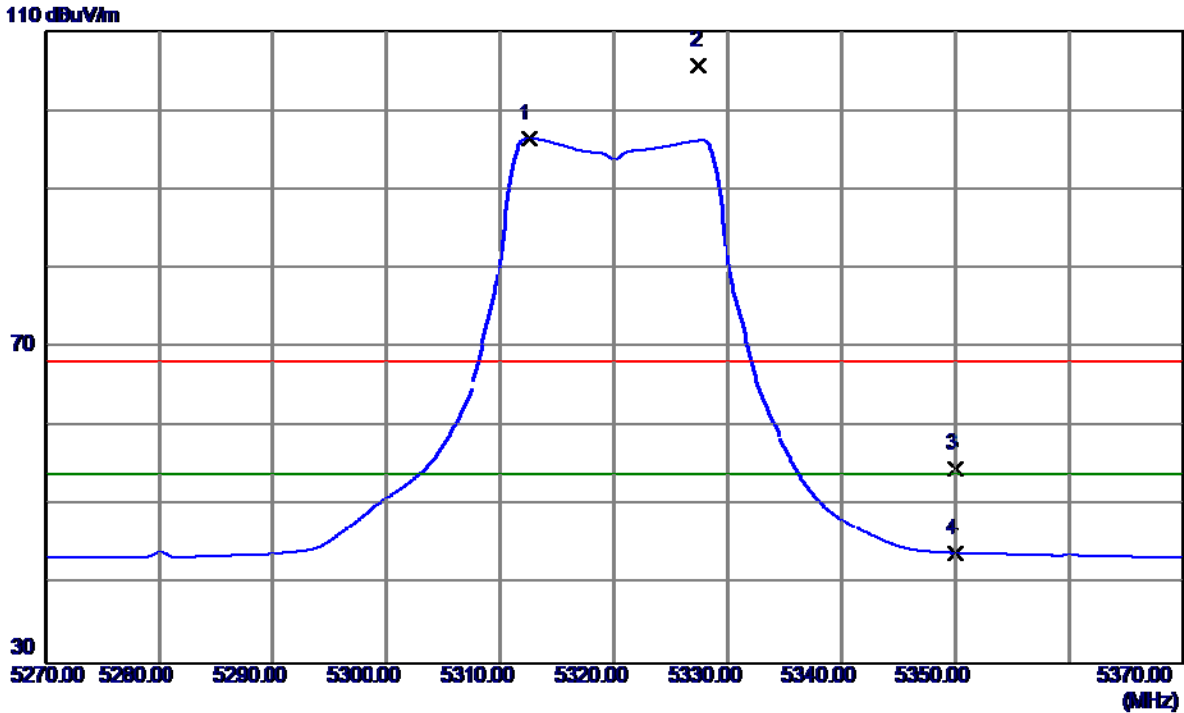

No.	Freq. MHz	Reading Level dBuV/m	Correct Factor dB	Measure ment dBuV/m	Limit dBuV/m	Margin dB	Detector	Comment
1	5312.5000	55.89	40.56	96.45	54.00	42.45	AVG	No Limit
2	5327.5000	65.02	40.59	105.61	68.30	37.31	Peak	No Limit
3	5350.0000	13.95	40.64	54.59	68.30	-13.71	Peak	
4	5350.0000	3.33	40.64	43.97	54.00	-10.03	AVG	

Orthogonal Axis :	X
Test Mode :	UNII-2A/ TX N20 Mode 5320MHz

Vertical

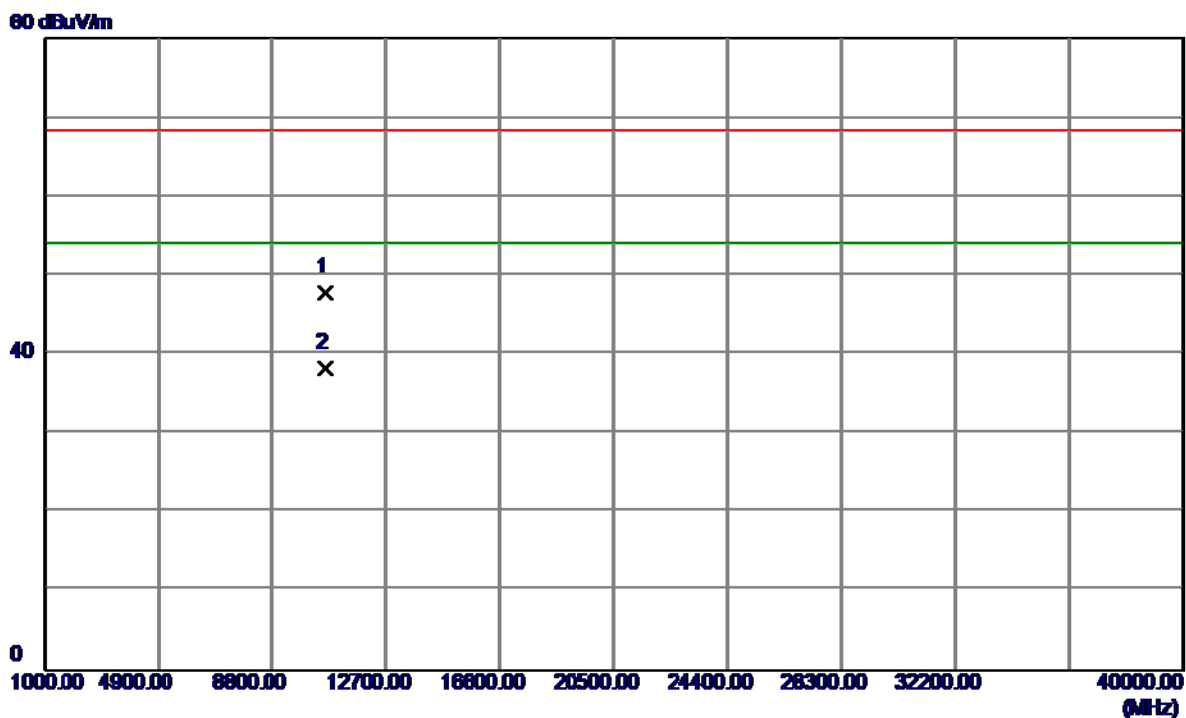

No.	Freq. MHz	Reading Level dBuV/m	Correct Factor dB	Measure ment dBuV/m	Limit dBuV/m	Margin dB	Detector	Comment
1	10640.5510	33.57	14.25	47.82	68.30	-20.48	Peak	
2	10640.1660	24.04	14.25	38.29	54.00	-15.71	AVG	

Orthogonal Axis :	X
Test Mode :	UNII-2A/ TX N20 Mode 5320MHz

Horizontal

110 dBuV/m

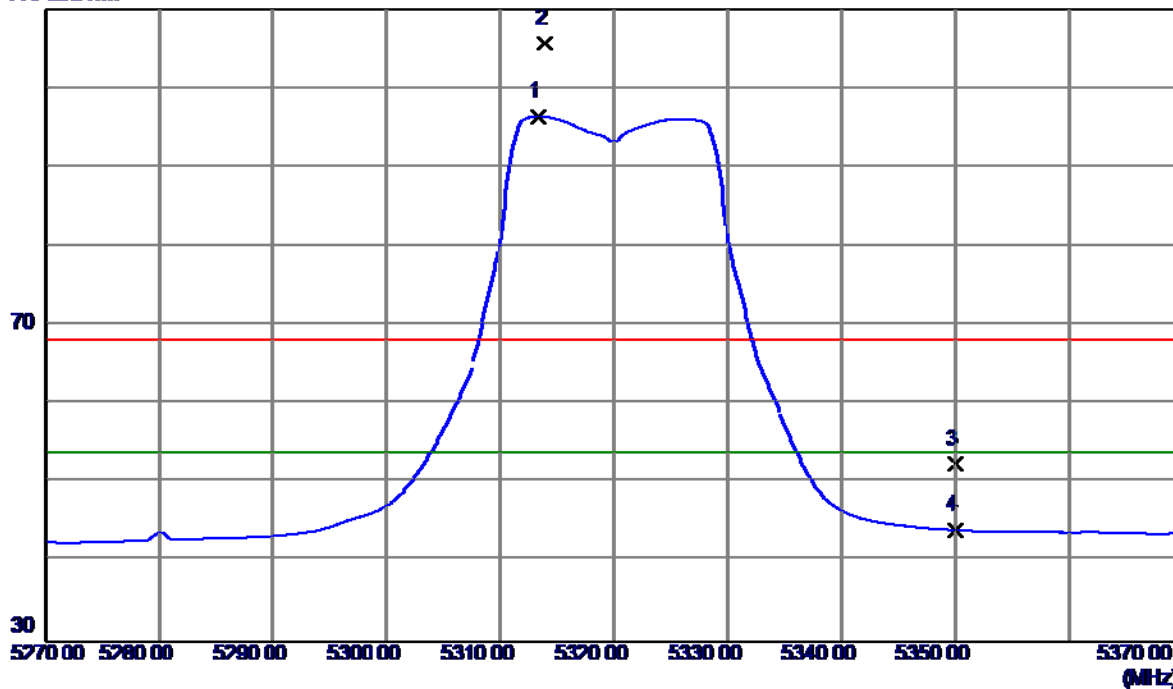

No.	Freq. MHz	Reading Level dBuV/m	Correct Factor dB	Measure ment dBuV/m	Limit dBuV/m	Margin dB	Detector	Comment
1	5313.3000	55.87	40.56	96.43	54.00	42.43	AVG	No Limit
2	5313.9000	65.17	40.57	105.74	68.30	37.44	Peak	No Limit
3	5350.0000	11.75	40.64	52.39	68.30	-15.91	Peak	
4	5350.0000	3.45	40.64	44.09	54.00	-9.91	AVG	

Orthogonal Axis :	X
Test Mode :	UNII-2A/ TX N20 Mode 5320MHz

Horizontal

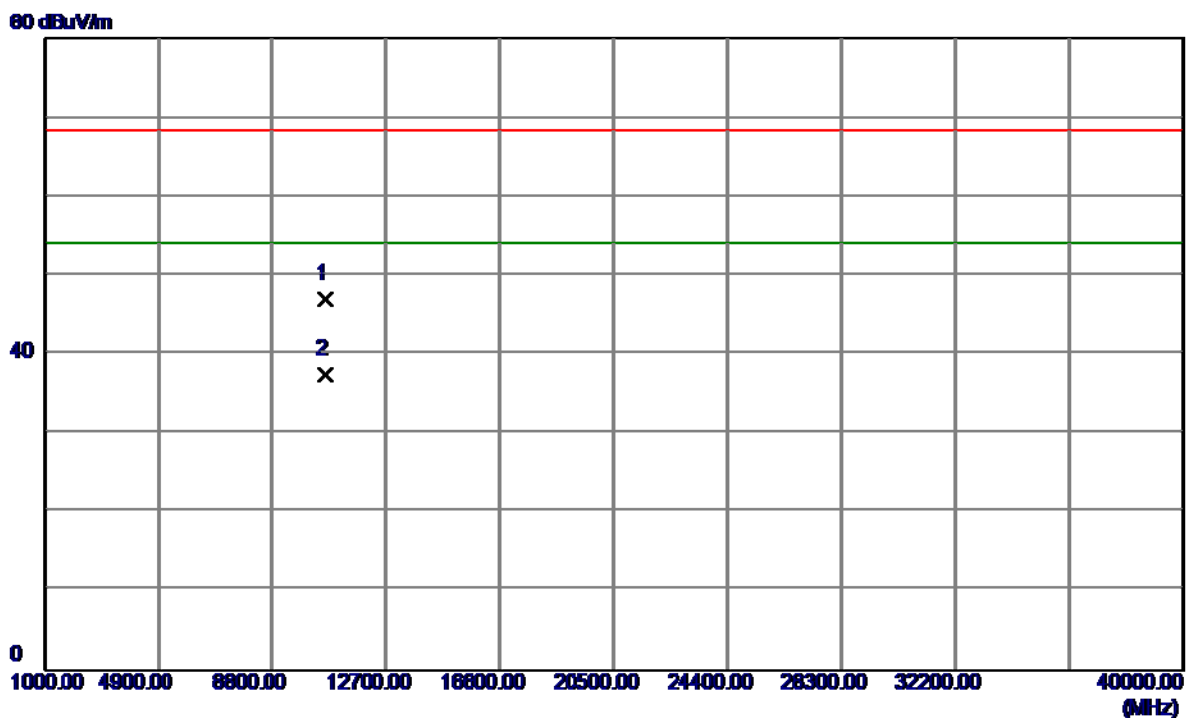

No.	Freq. MHz	Reading Level dBuV/m	Correct Factor dB	Measure ment dBuV/m	Limit dBuV/m	Margin dB	Detector	Comment
1	10640.5800	32.80	14.25	47.05	68.30	-21.25	Peak	
2	10640.5800	23.21	14.25	37.46	54.00	-16.54	AVG	

Orthogonal Axis :	X
Test Mode :	UNII-2A/ TX N40 Mode 5270MHz

Vertical

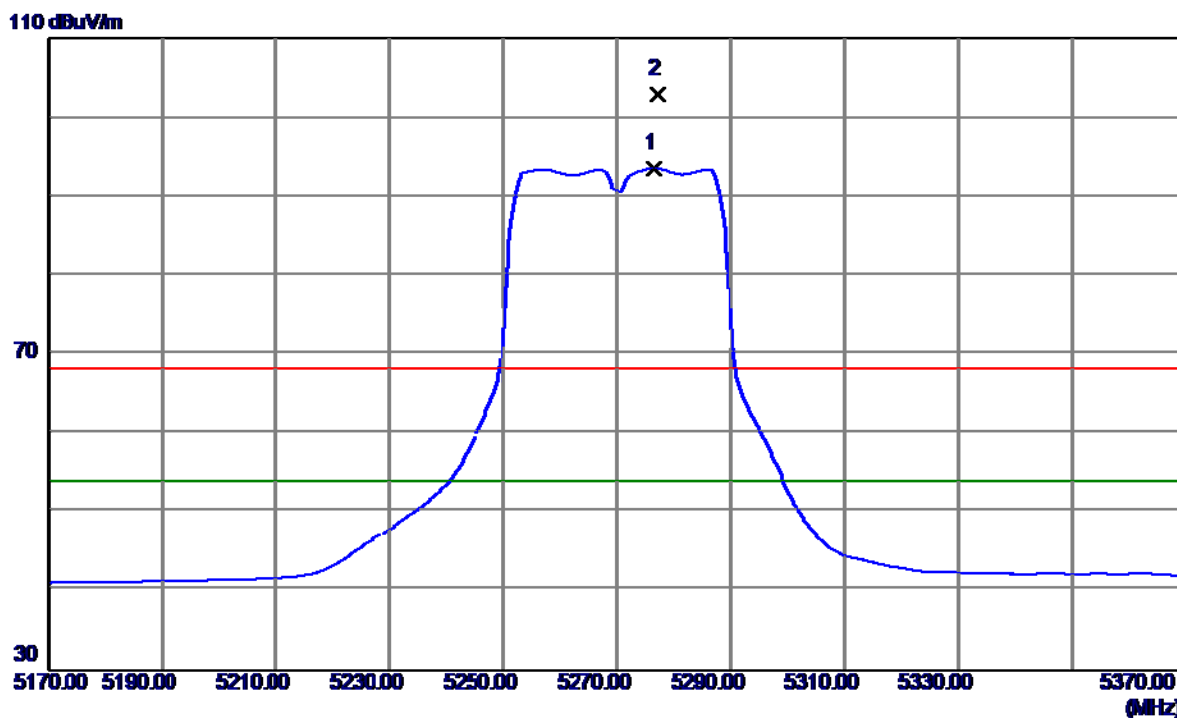

No.	Freq. MHz	Reading Level dBuV/m	Correct Factor dB	Measure ment dBuV/m	Limit dBuV/m	Margin dB	Detector	Comment
1	5276.4000	53.05	40.49	93.54	54.00	39.54	AVG	No Limit
2	5277.2000	62.42	40.49	102.91	68.30	34.61	Peak	No Limit

Orthogonal Axis :	X
Test Mode :	UNII-2A/ TX N40 Mode 5270MHz

Vertical

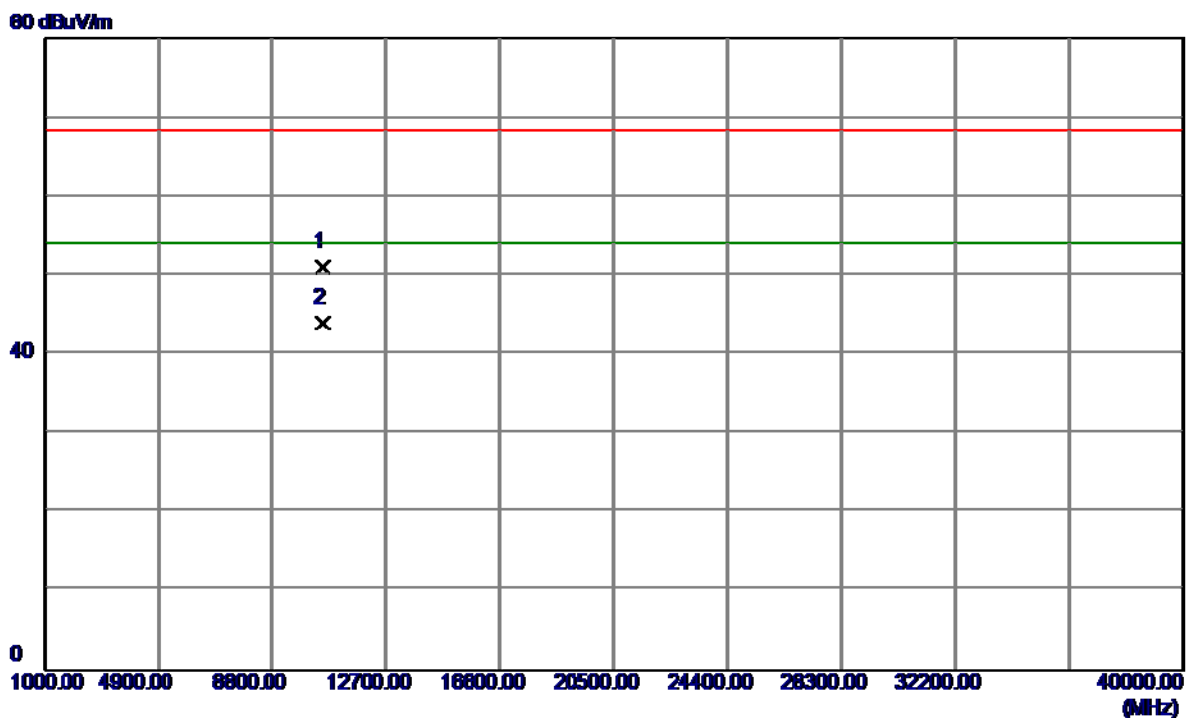

No.	Freq. MHz	Reading Level dBuV/m	Correct Factor dB	Measure ment dBuV/m	Limit dBuV/m	Margin dB	Detector	Comment
1	10541.2670	37.23	13.84	51.07	68.30	-17.23	Peak	
2	10541.9300	30.15	13.84	43.99	54.00	-10.01	AVG	

Orthogonal Axis :	X
Test Mode :	UNII-2A/ TX N40 Mode 5270MHz

Horizontal

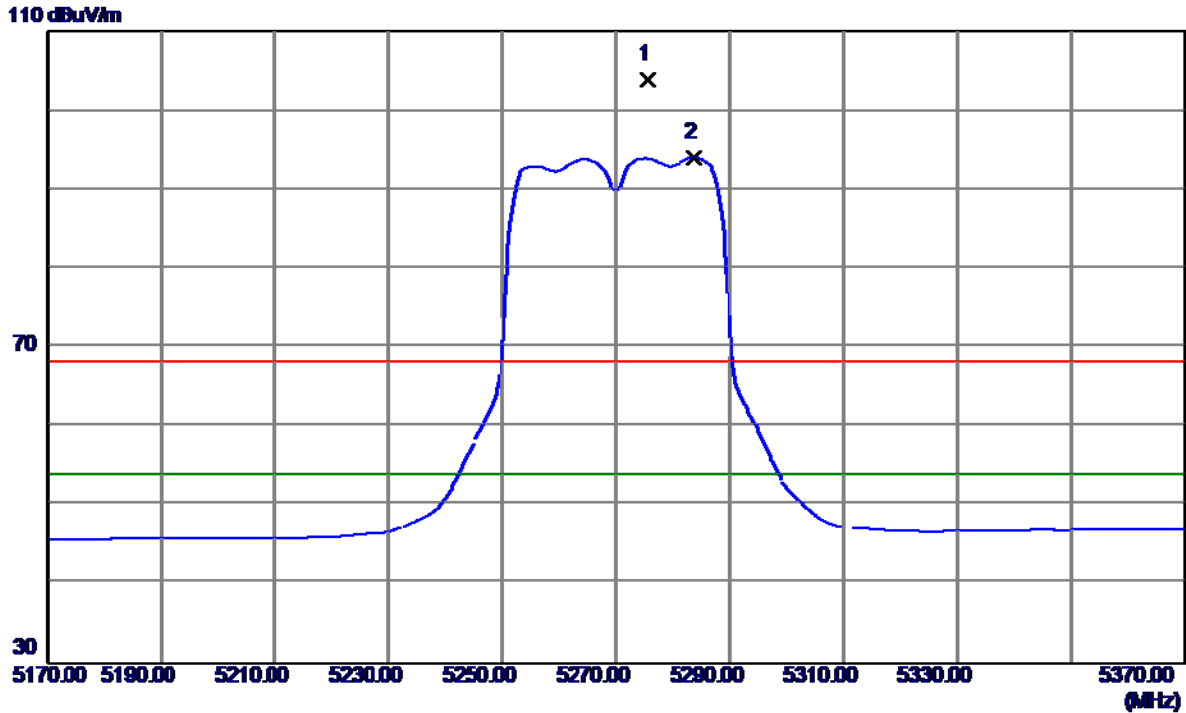

No.	Freq. MHz	Reading Level dBuV/m	Correct Factor dB	Measure ment dBuV/m	Limit dBuV/m	Margin dB	Detector	Comment
1	5275.6000	63.42	40.48	103.90	68.30	35.60	Peak	No Limit
2	5283.8000	53.53	40.50	94.03	54.00	40.03	AVG	No Limit

Orthogonal Axis :	X
Test Mode :	UNII-2A/ TX N40 Mode 5270MHz

Horizontal

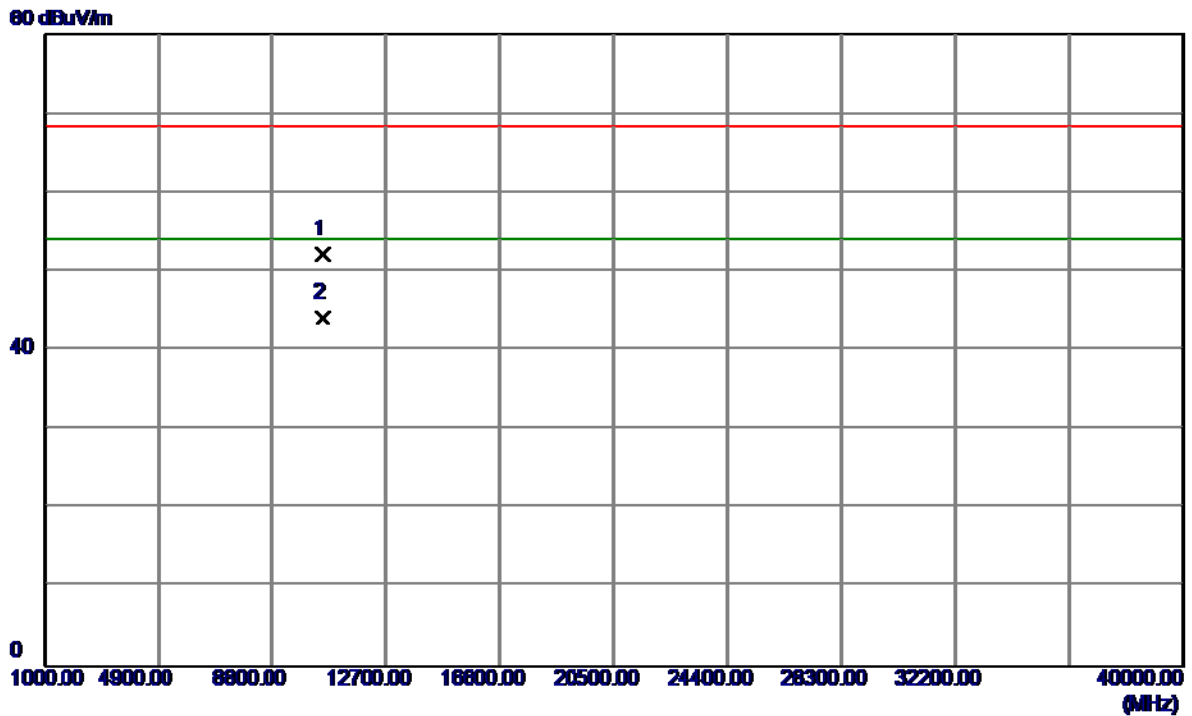

No.	Freq. MHz	Reading Level dBuV/m	Correct Factor dB	Measure ment dBuV/m	Limit dBuV/m	Margin dB	Detector	Comment
1	10540.7630	38.28	13.83	52.11	68.30	-16.19	Peak	
2	10540.4320	30.36	13.83	44.19	54.00	-9.81	AVG	

Orthogonal Axis :	X
Test Mode :	UNII-2A/ TX N40 Mode 5310MHz

Vertical

110 dBuV/m

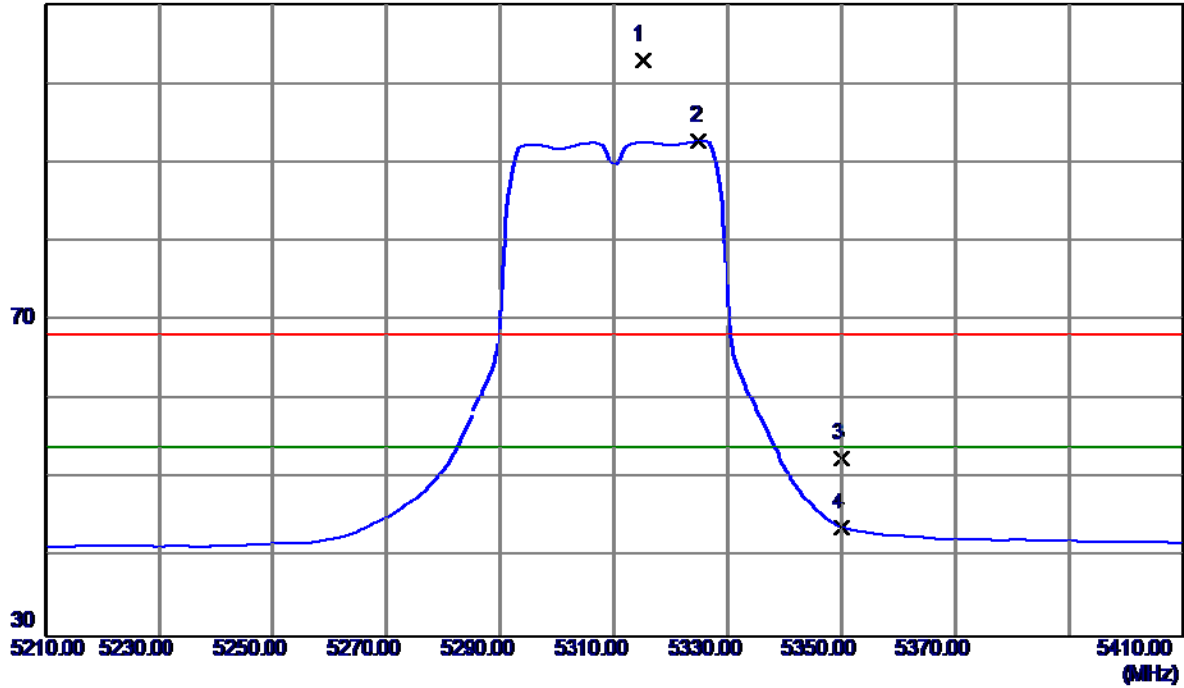

No.	Freq. MHz	Reading Level dBuV/m	Correct Factor dB	Measure ment dBuV/m	Limit dBuV/m	Margin dB	Detector	Comment
1	5315.0000	62.34	40.57	102.91	68.30	34.61	Peak	No Limit
2	5325.0000	52.10	40.59	92.69	54.00	38.69	AVG	No Limit
3	5350.0000	11.91	40.64	52.55	68.30	-15.75	Peak	
4	5350.0000	3.17	40.64	43.81	54.00	-10.19	AVG	

Orthogonal Axis :	X
Test Mode :	UNII-2A/ TX N40 Mode 5310MHz

Vertical

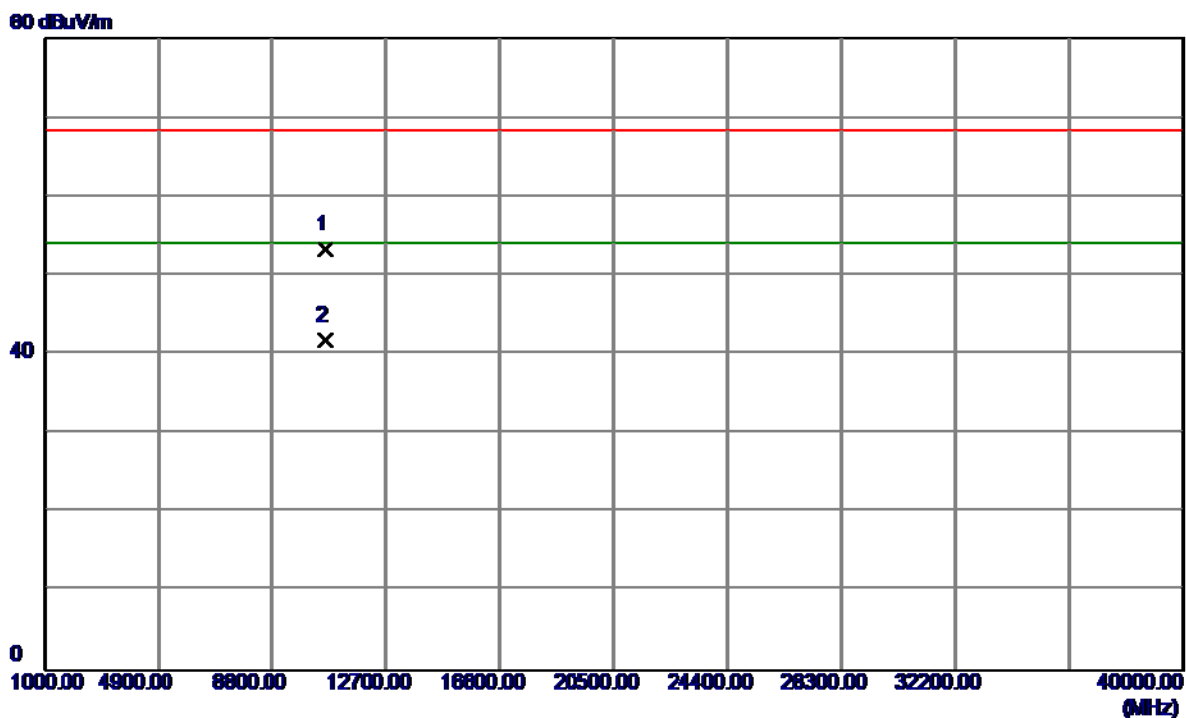

No.	Freq. MHz	Reading Level dBuV/m	Correct Factor dB	Measure ment dBuV/m	Limit dBuV/m	Margin dB	Detector	Comment
1	10620.0000	39.13	14.17	53.30	68.30	-15.00	Peak	
2	10620.3200	27.63	14.17	41.80	54.00	-12.20	AVG	

Orthogonal Axis :	X
Test Mode :	UNII-2A/ TX N40 Mode 5310MHz

Horizontal

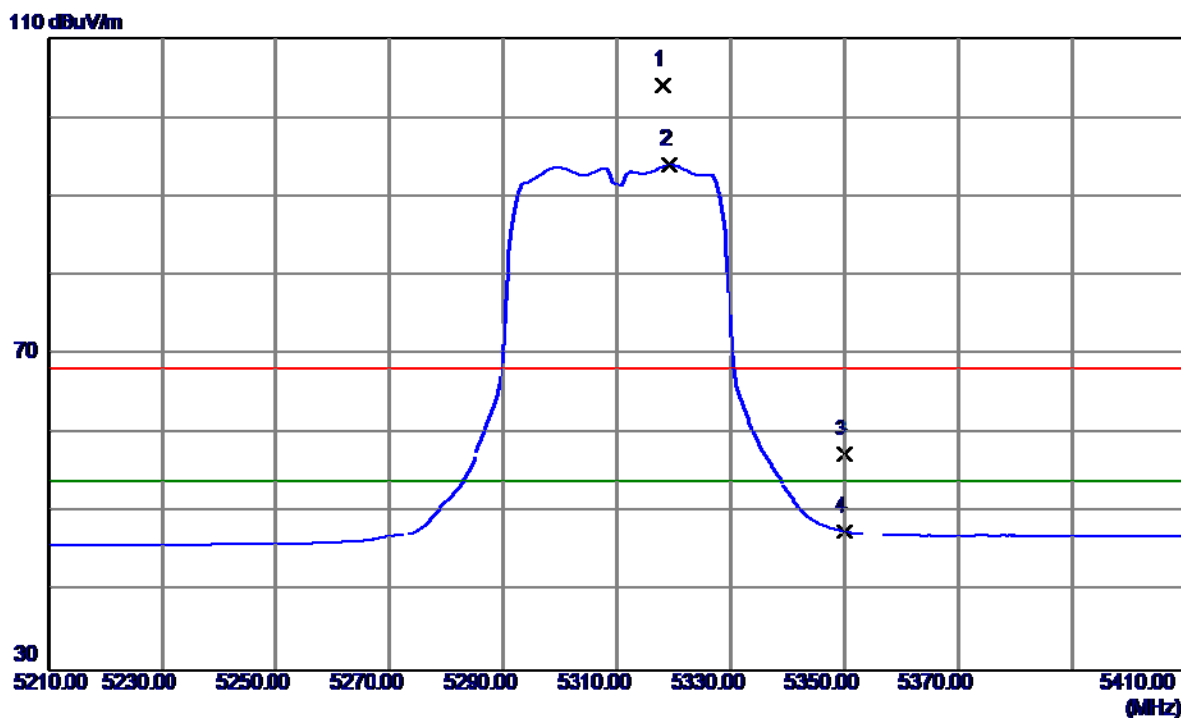

No.	Freq. MHz	Reading Level dBuV/m	Correct Factor dB	Measure ment dBuV/m	Limit dBuV/m	Margin dB	Detector	Comment
1	5318.0000	63.57	40.57	104.14	68.30	35.84	Peak	No Limit
2	5319.2000	53.35	40.58	93.93	54.00	39.93	AVG	No Limit
3	5350.0000	16.68	40.64	57.32	68.30	-10.98	Peak	
4	5350.0000	7.01	40.64	47.65	54.00	-6.35	AVG	

Orthogonal Axis :	X
Test Mode :	UNII-2A/ TX N40 Mode 5310MHz

Horizontal

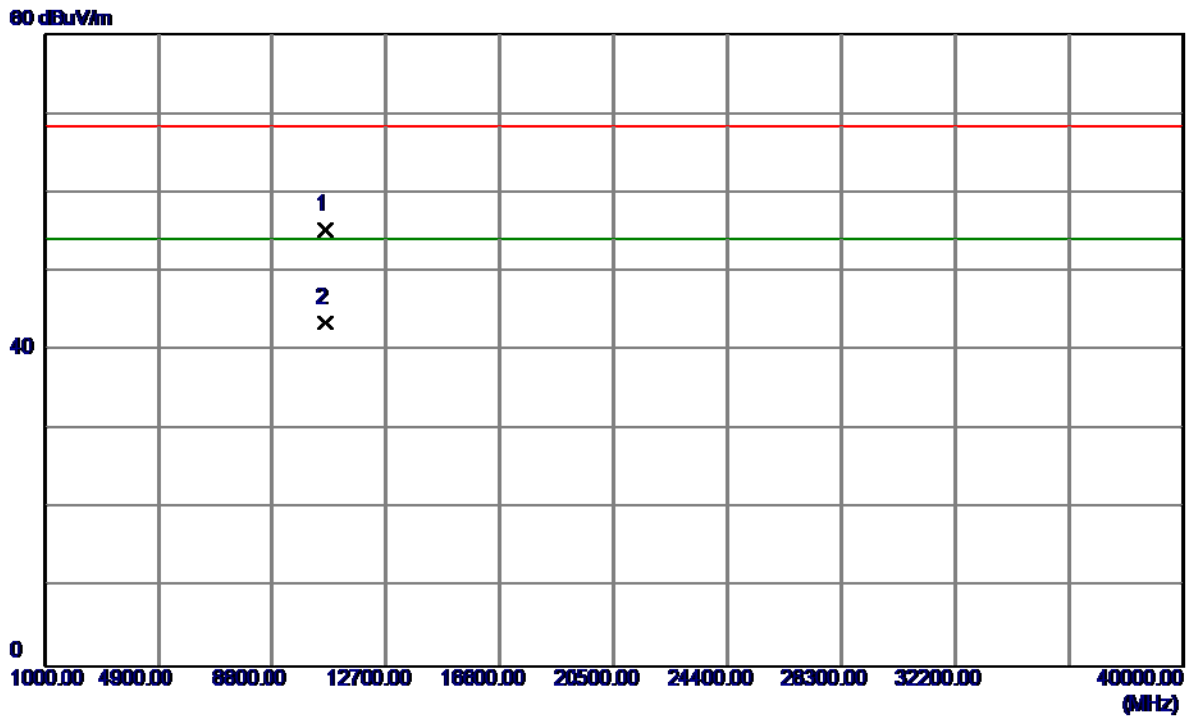

No.	Freq. MHz	Reading Level dBuV/m	Correct Factor dB	Measure ment dBuV/m	Limit dBuV/m	Margin dB	Detector	Comment
1	10621.3240	41.11	14.17	55.28	68.30	-13.02	Peak	
2	10621.5430	29.32	14.17	43.49	54.00	-10.51	AVG	

Orthogonal Axis :	X
Test Mode :	UNII-2C/ TX A Mode 5500MHz

Vertical

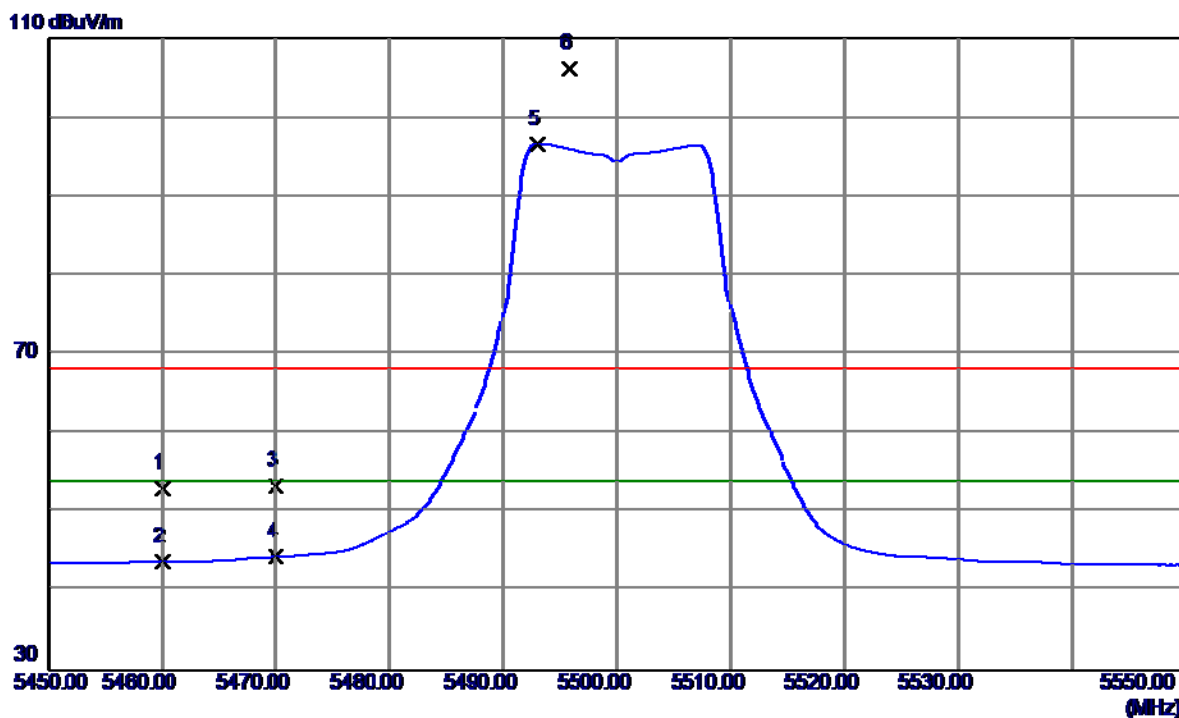

No.	Freq. MHz	Reading Level dBuV/m	Correct Factor dB	Measure ment dBuV/m	Limit dBuV/m	Margin dB	Detector	Comment
1	5460.0000	12.16	40.88	53.04	68.30	-15.26	Peak	
2	5460.0000	2.91	40.88	43.79	54.00	-10.21	AVG	
3	5470.0000	12.53	40.90	53.43	68.30	-14.87	Peak	
4	5470.0000	3.48	40.90	44.38	54.00	-9.62	AVG	
5	5493.0000	55.68	40.95	96.63	54.00	42.63	AVG	No Limit
6	5495.8000	65.16	40.95	106.11	68.30	37.81	Peak	No Limit

Orthogonal Axis :	X
Test Mode :	UNII-2C/ TX A Mode 5500MHz

Vertical

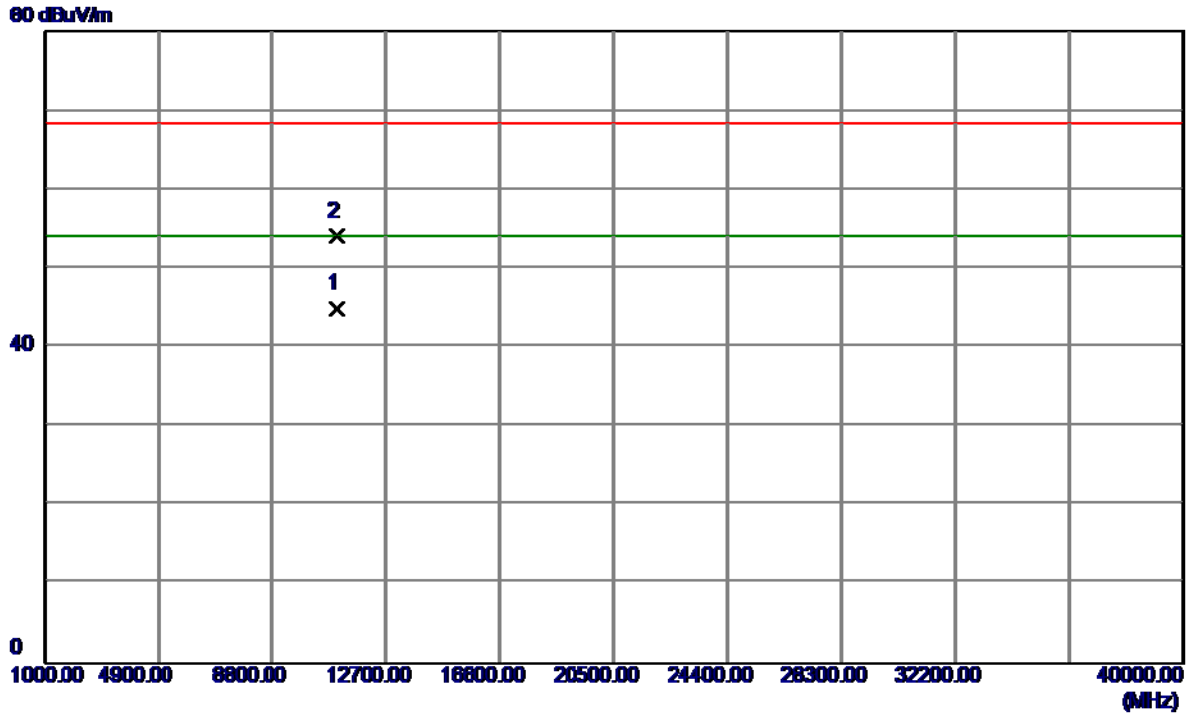

No.	Freq. MHz	Reading Level dBuV/m	Correct Factor dB	Measure ment dBuV/m	Limit dBuV/m	Margin dB	Detector	Comment
1	11000.1340	29.27	15.75	45.02	54.00	-8.98	AVG	
2	11000.2240	38.27	15.75	54.02	68.30	-14.28	Peak	

Orthogonal Axis :	X
Test Mode :	UNII-2C/ TX A Mode 5500MHz

Horizontal

110 dBuV/m

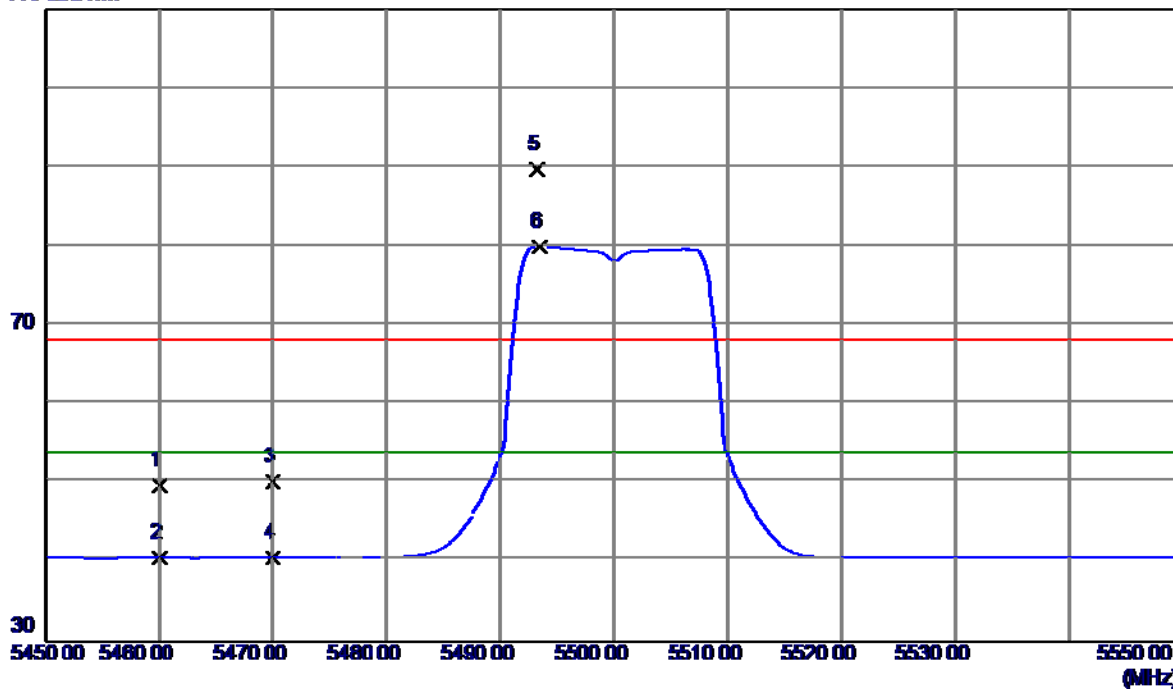

No.	Freq. MHz	Reading Level dBuV/m	Correct Factor dB	Measure ment dBuV/m	Limit dBuV/m	Margin dB	Detector	Comment
1	5460.0000	8.78	40.88	49.66	68.30	-18.64	Peak	
2	5460.0000	-0.31	40.88	40.57	54.00	-13.43	AVG	
3	5470.0000	9.33	40.90	50.23	68.30	-18.07	Peak	
4	5470.0000	-0.32	40.90	40.58	54.00	-13.42	AVG	
5	5493.2000	48.72	40.95	89.67	68.30	21.37	Peak	No Limit
6	5493.4000	38.93	40.95	79.88	54.00	25.88	AVG	No Limit

Orthogonal Axis :	X
Test Mode :	UNII-2C/ TX A Mode 5500MHz

Horizontal

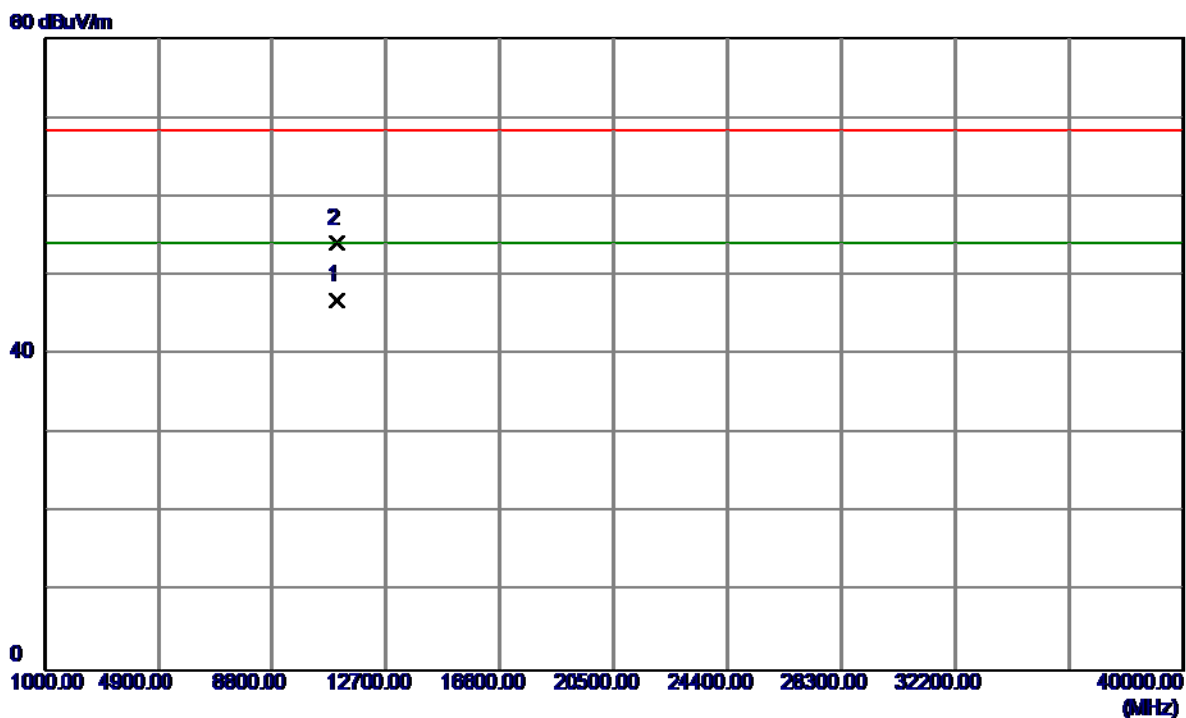

No.	Freq. MHz	Reading Level dBuV/m	Correct Factor dB	Measure ment dBuV/m	Limit dBuV/m	Margin dB	Detector	Comment
1	11000.3840	31.11	15.75	46.86	54.00	-7.14	AVG	
2	11000.5510	38.35	15.75	54.10	68.30	-14.20	Peak	

Orthogonal Axis :	X
Test Mode :	UNII-2C/ TX A Mode 5580MHz

Vertical

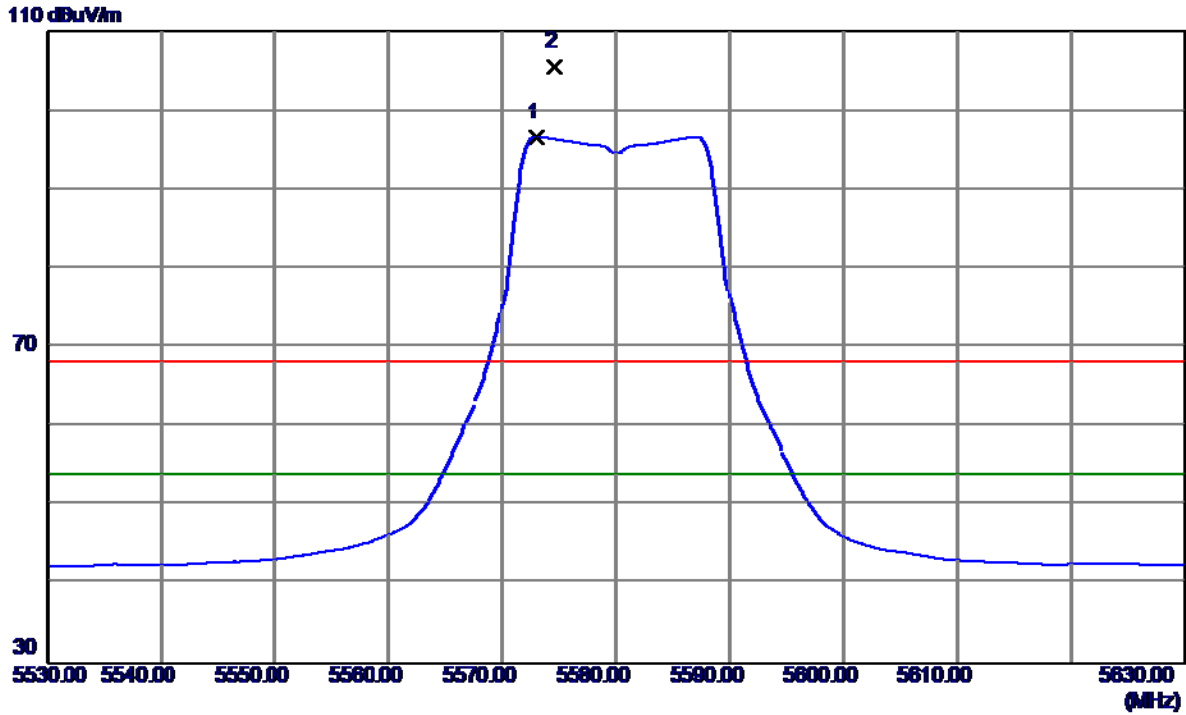

No.	Freq. MHz	Reading Level dBuV/m	Correct Factor dB	Measure ment dBuV/m	Limit dBuV/m	Margin dB	Detector	Comment
1	5573.0000	55.54	41.06	96.60	54.00	42.60	AVG	No Limit
2	5574.6000	64.53	41.06	105.59	68.30	37.29	Peak	No Limit

Orthogonal Axis :	X
Test Mode :	UNII-2C/ TX A Mode 5580MHz

Vertical

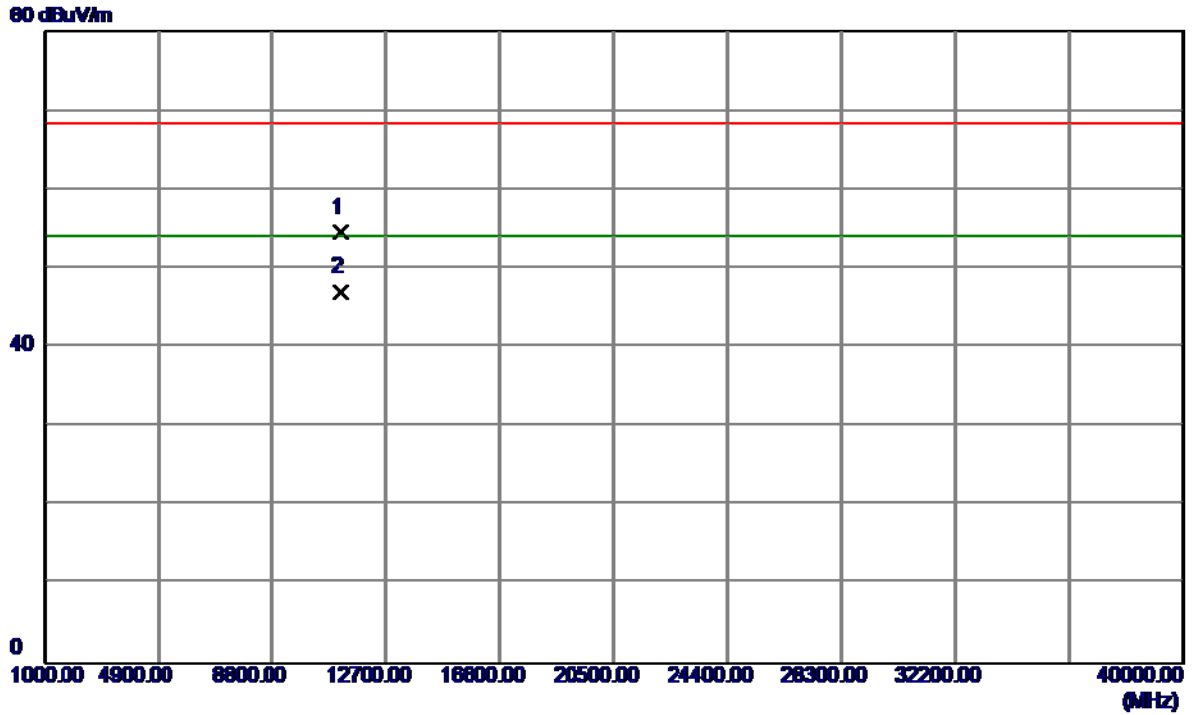

No.	Freq. MHz	Reading Level dBuV/m	Correct Factor dB	Measure ment dBuV/m	Limit dBuV/m	Margin dB	Detector	Comment
1	11160.1420	38.47	16.13	54.60	68.30	-13.70	Peak	
2	11160.3780	30.89	16.13	47.02	54.00	-6.98	AVG	

Orthogonal Axis :	X
Test Mode :	UNII-2C/ TX A Mode 5580MHz

Horizontal

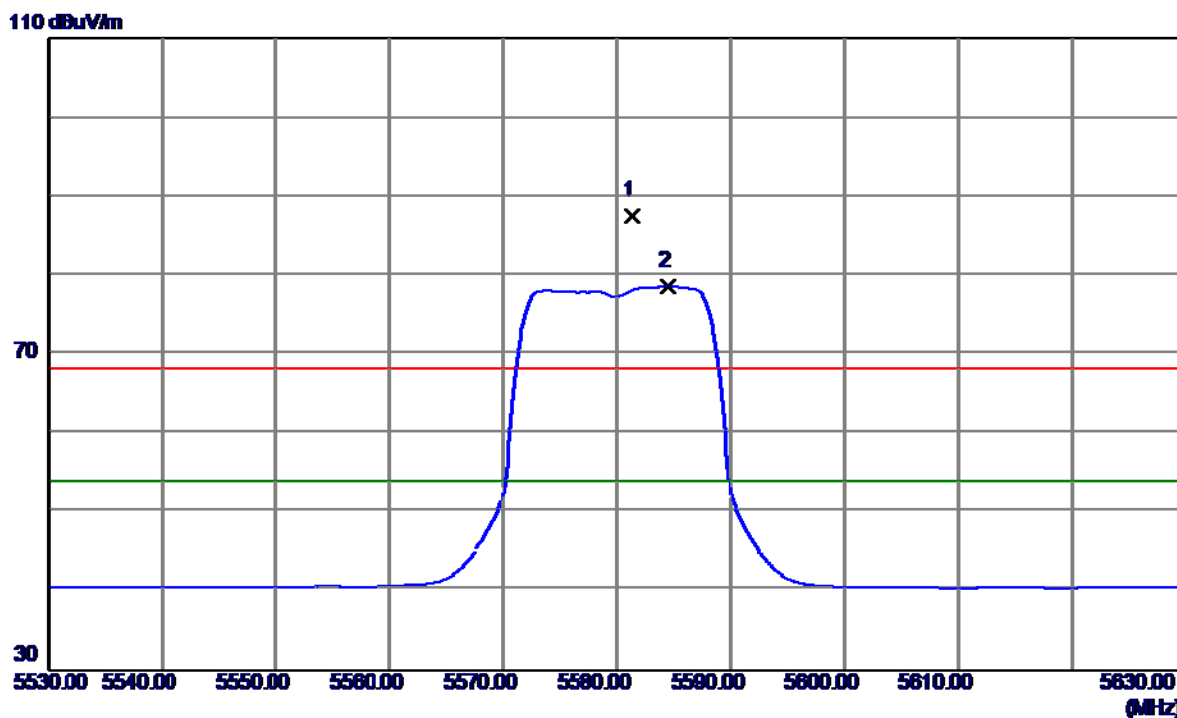

No.	Freq. MHz	Reading Level dBuV/m	Correct Factor dB	Measure ment dBuV/m	Limit dBuV/m	Margin dB	Detector	Comment
1	5581.3000	46.49	41.07	87.56	68.30	19.26	Peak	No Limit
2	5584.4000	37.52	41.07	78.59	54.00	24.59	AVG	No Limit

Orthogonal Axis :	X
Test Mode :	UNII-2C/ TX A Mode 5580MHz

Horizontal

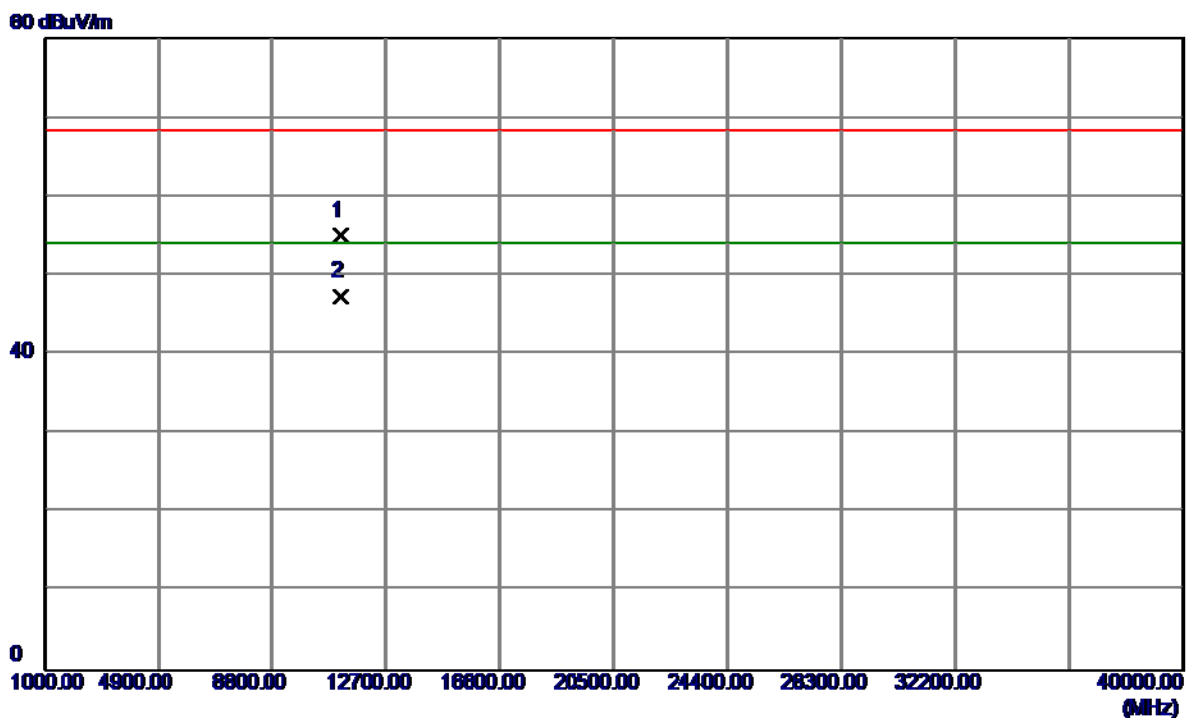

No.	Freq. MHz	Reading Level dBuV/m	Correct Factor dB	Measure ment dBuV/m	Limit dBuV/m	Margin dB	Detector	Comment
1	11160.3570	38.89	16.13	55.02	68.30	-13.28	Peak	
2	11160.2890	31.25	16.13	47.38	54.00	-6.62	AVG	

Orthogonal Axis :	X
Test Mode :	UNII-2C/ TX A Mode 5700MHz

Vertical

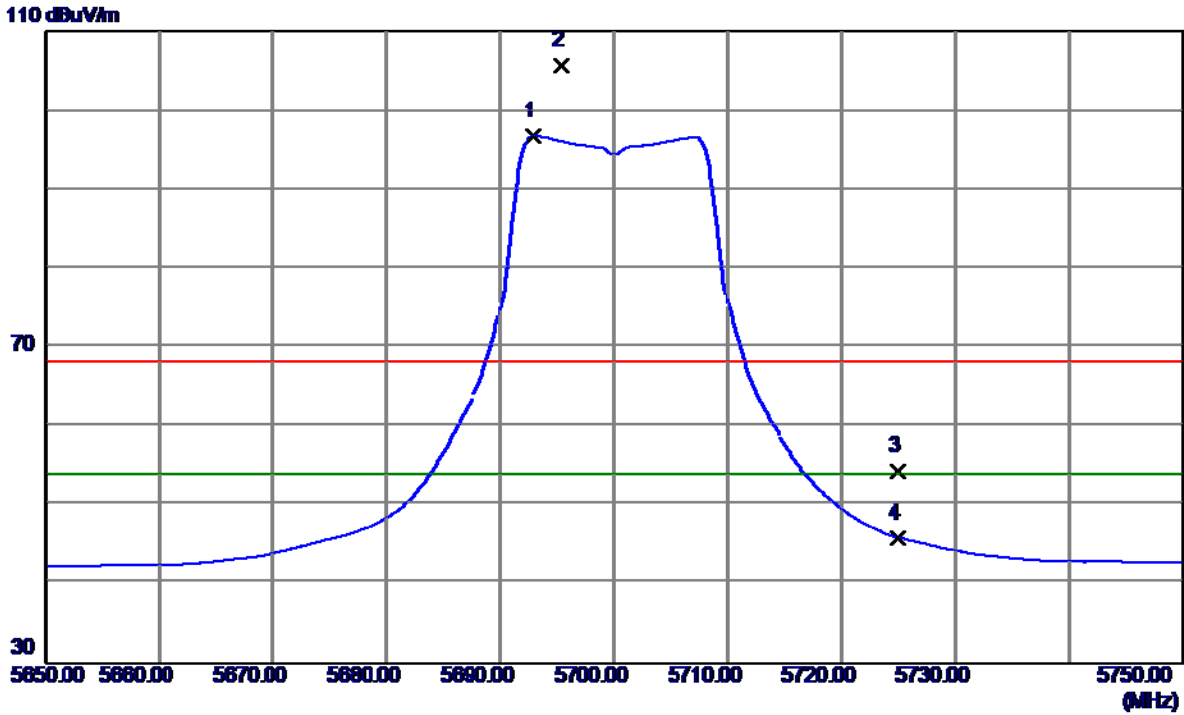

No.	Freq. MHz	Reading Level dBuV/m	Correct Factor dB	Measure ment dBuV/m	Limit dBuV/m	Margin dB	Detector	Comment
1	5692.9000	55.49	41.22	96.71	54.00	42.71	AVG	No Limit
2	5695.3000	64.47	41.23	105.70	68.30	37.40	Peak	No Limit
3	5725.0000	13.09	41.27	54.36	68.30	-13.94	Peak	
4	5725.0000	4.63	41.27	45.90	54.00	-8.10	AVG	

Orthogonal Axis :	X
Test Mode :	UNII-2C/ TX A Mode 5700MHz

Vertical

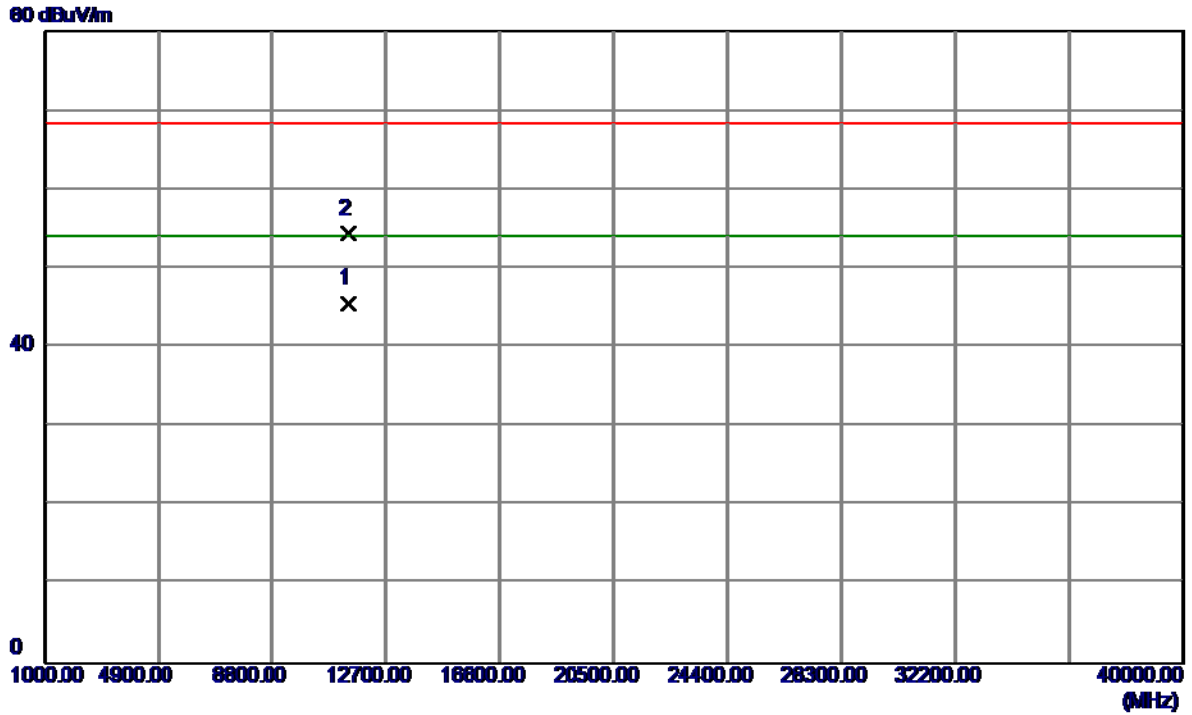

No.	Freq. MHz	Reading Level dBuV/m	Correct Factor dB	Measure ment dBuV/m	Limit dBuV/m	Margin dB	Detector	Comment
1	11400.1480	28.84	16.70	45.54	54.00	-8.46	AVG	
2	11400.4930	37.72	16.70	54.42	68.30	-13.88	Peak	

Orthogonal Axis :	X
Test Mode :	UNII-2C/ TX A Mode 5700MHz

Horizontal

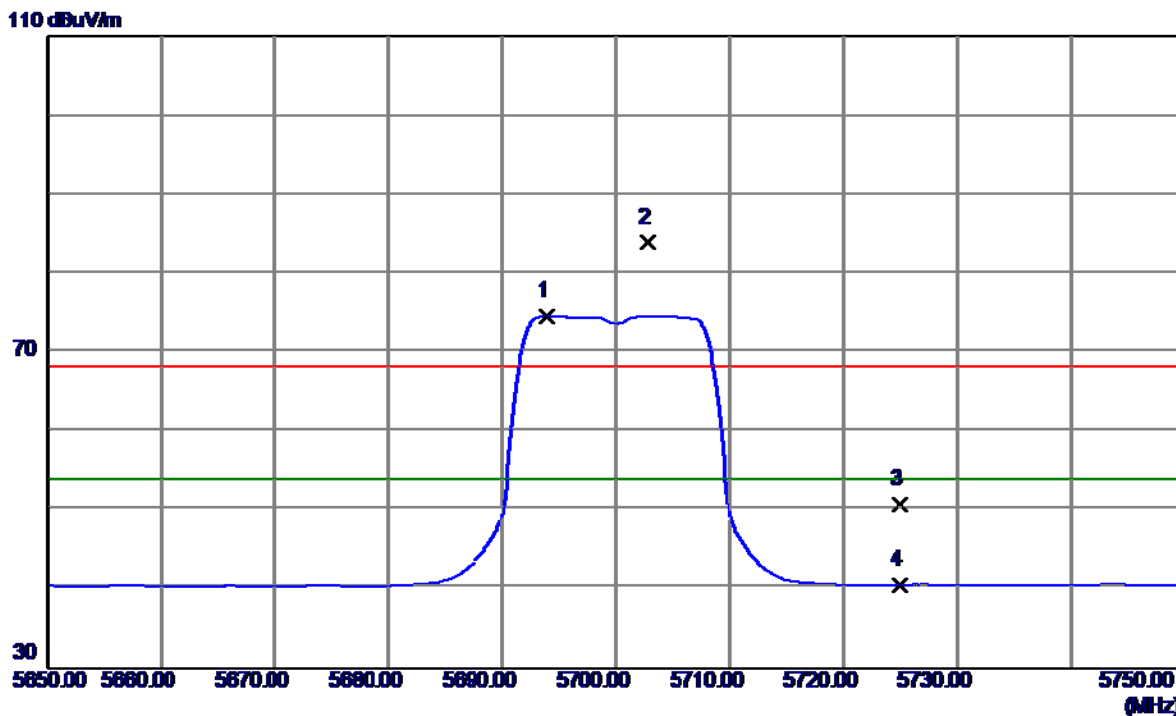

No.	Freq. MHz	Reading Level dBuV/m	Correct Factor dB	Measure ment dBuV/m	Limit dBuV/m	Margin dB	Detector	Comment
1	5693.9000	33.40	41.22	74.62	54.00	20.62	AVG	No Limit
2	5702.8000	42.61	41.24	83.85	68.30	15.55	Peak	No Limit
3	5725.0000	9.54	41.27	50.81	68.30	-17.49	Peak	
4	5725.0000	-0.65	41.27	40.62	54.00	-13.38	AVG	

Orthogonal Axis :	X
Test Mode :	UNII-2C/ TX A Mode 5700MHz

Horizontal

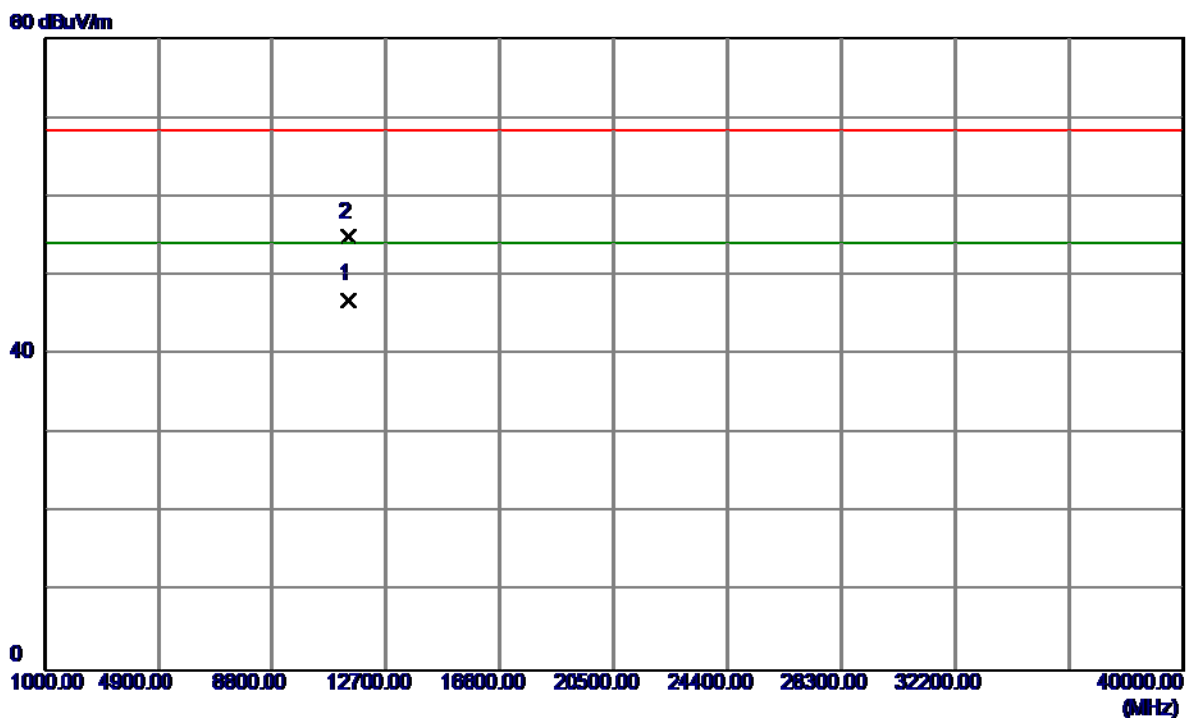

No.	Freq. MHz	Reading Level dBuV/m	Correct Factor dB	Measure ment dBuV/m	Limit dBuV/m	Margin dB	Detector	Comment
1	11400.3480	30.26	16.70	46.96	54.00	-7.04	AVG	
2	11400.3290	38.23	16.70	54.93	68.30	-13.37	Peak	

Orthogonal Axis :	X
Test Mode :	UNII-2C/ TX N20 Mode 5500MHz

Vertical

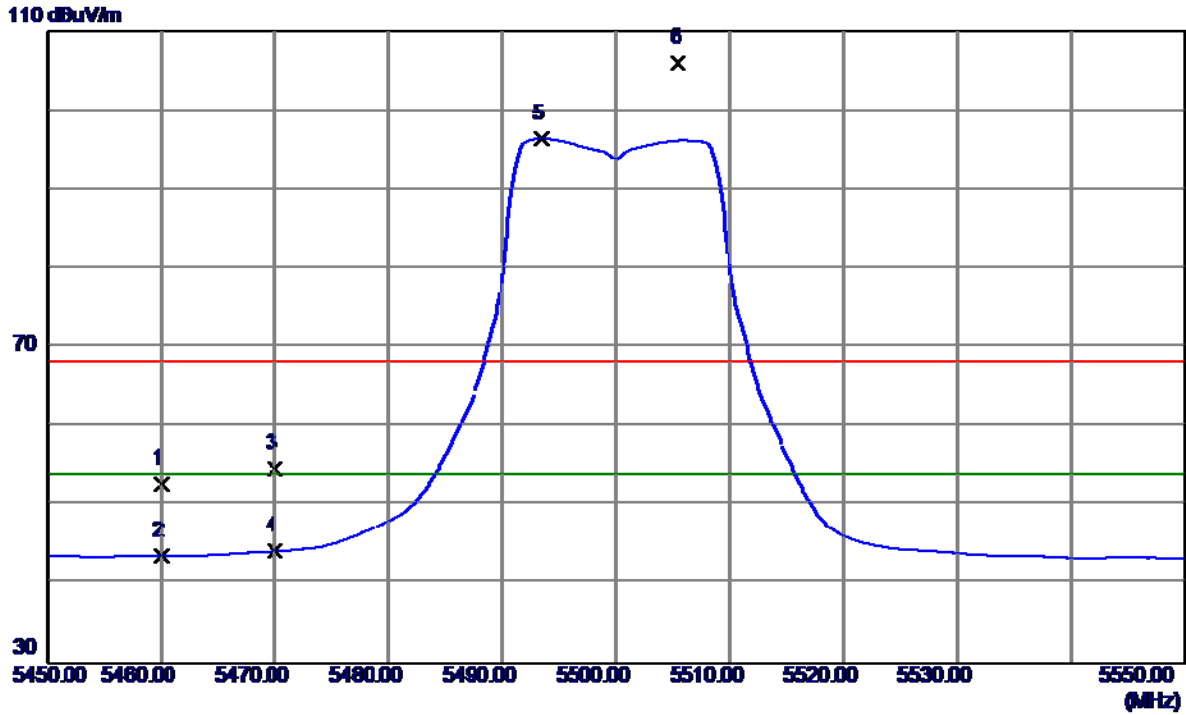

No.	Freq. MHz	Reading Level dBuV/m	Correct Factor dB	Measure ment dBuV/m	Limit dBuV/m	Margin dB	Detector	Comment
1	5460.0000	11.86	40.88	52.74	68.30	-15.56	Peak	
2	5460.0000	2.77	40.88	43.65	54.00	-10.35	AVG	
3	5470.0000	13.81	40.90	54.71	68.30	-13.59	Peak	
4	5470.0000	3.29	40.90	44.19	54.00	-9.81	AVG	
5	5493.4000	55.41	40.95	96.36	54.00	42.36	AVG	No Limit
6	5505.5000	64.97	40.97	105.94	68.30	37.64	Peak	No Limit

Orthogonal Axis :	X
Test Mode :	UNII-2C/ TX N20 Mode 5500MHz

Vertical

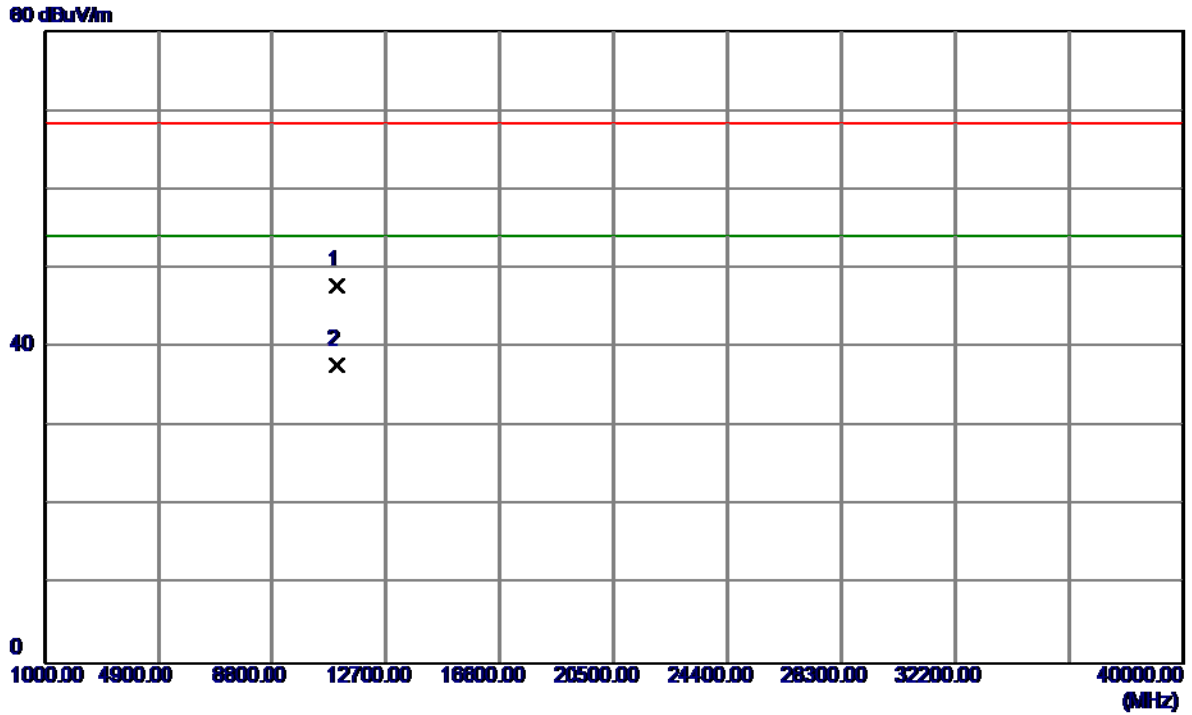

No.	Freq. MHz	Reading Level dBuV/m	Correct Factor dB	Measure ment dBuV/m	Limit dBuV/m	Margin dB	Detector	Comment
1	11000.1870	32.02	15.75	47.77	68.30	-20.53	Peak	
2	11000.3570	22.01	15.75	37.76	54.00	-16.24	AVG	

Orthogonal Axis :	X
Test Mode :	UNII-2C/ TX N20 Mode 5500MHz

Horizontal

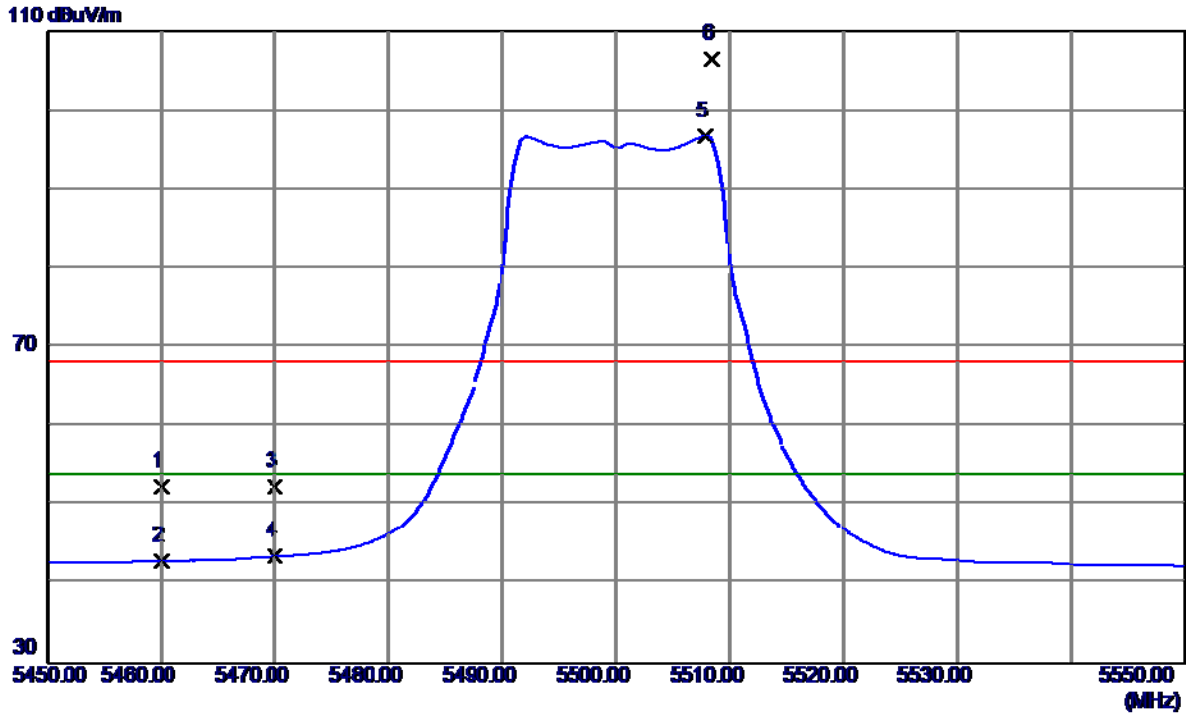

No.	Freq. MHz	Reading Level dBuV/m	Correct Factor dB	Measure ment dBuV/m	Limit dBuV/m	Margin dB	Detector	Comment
1	5460.0000	11.51	40.88	52.39	68.30	-15.91	Peak	
2	5460.0000	2.08	40.88	42.96	54.00	-11.04	AVG	
3	5470.0000	11.46	40.90	52.36	68.30	-15.94	Peak	
4	5470.0000	2.66	40.90	43.56	54.00	-10.44	AVG	
5	5507.9000	55.79	40.97	96.76	54.00	42.76	AVG	No Limit
6	5508.4000	65.44	40.97	106.41	68.30	38.11	Peak	No Limit

Orthogonal Axis :	X
Test Mode :	UNII-2C/ TX N20 Mode 5500MHz

Horizontal

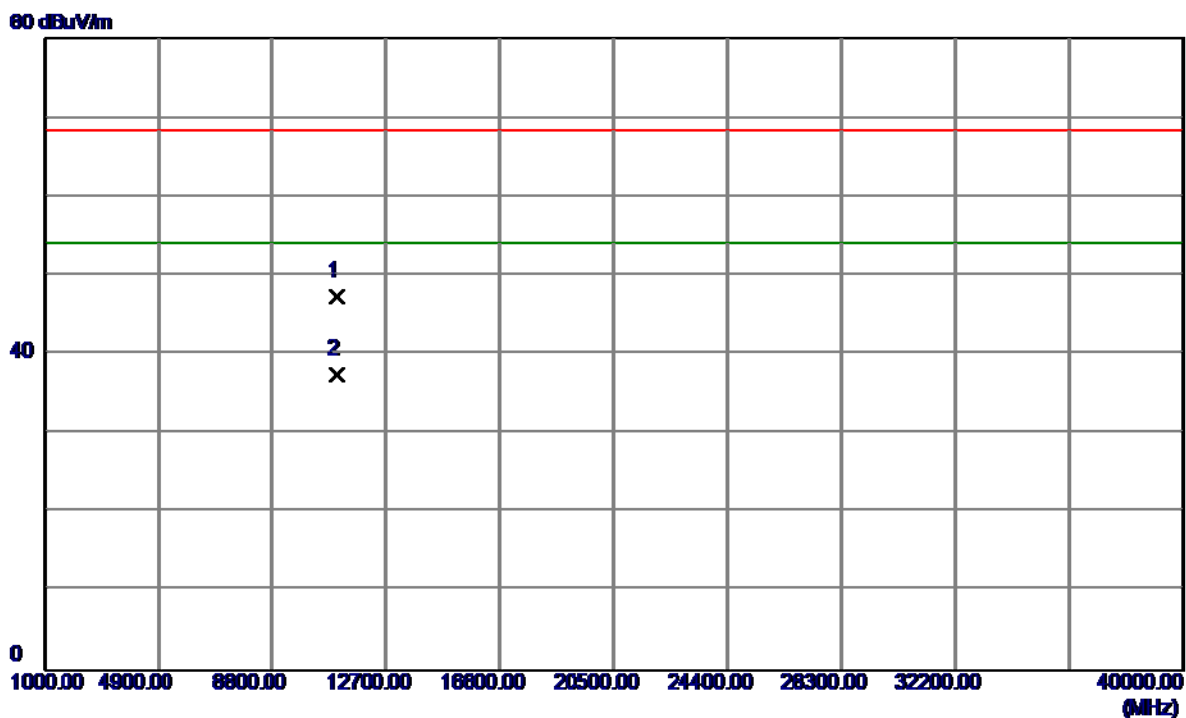

No.	Freq. MHz	Reading Level dBuV/m	Correct Factor dB	Measure ment dBuV/m	Limit dBuV/m	Margin dB	Detector	Comment
1	11000.0599	31.56	15.75	47.31	68.30	-20.99	Peak	
2	11000.0599	21.66	15.75	37.41	54.00	-16.59	AVG	

Orthogonal Axis :	X
Test Mode :	UNII-2C/ TX N20 Mode 5580MHz

Vertical

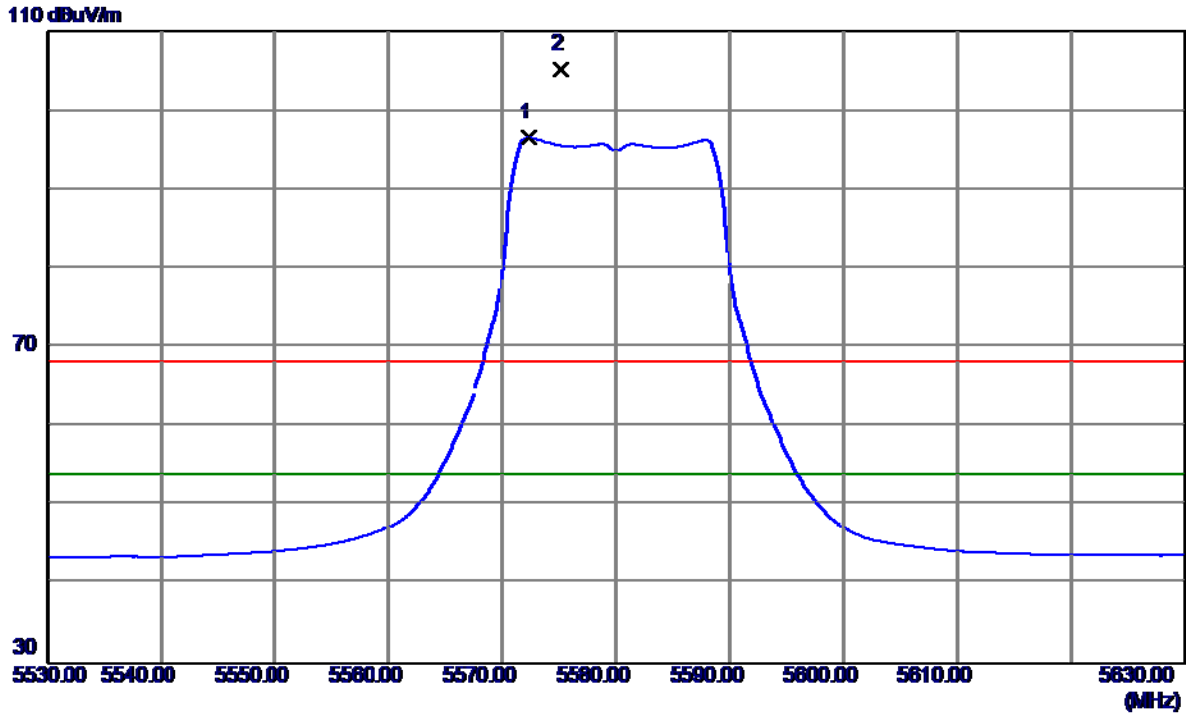

No.	Freq. MHz	Reading Level dBuV/m	Correct Factor dB	Measure ment dBuV/m	Limit dBuV/m	Margin dB	Detector	Comment
1	5572.3000	55.44	41.06	96.50	54.00	42.50	AVG	No Limit
2	5575.1000	64.13	41.06	105.19	68.30	36.89	Peak	No Limit

Orthogonal Axis :	X
Test Mode :	UNII-2C/ TX N20 Mode 5580MHz

Vertical

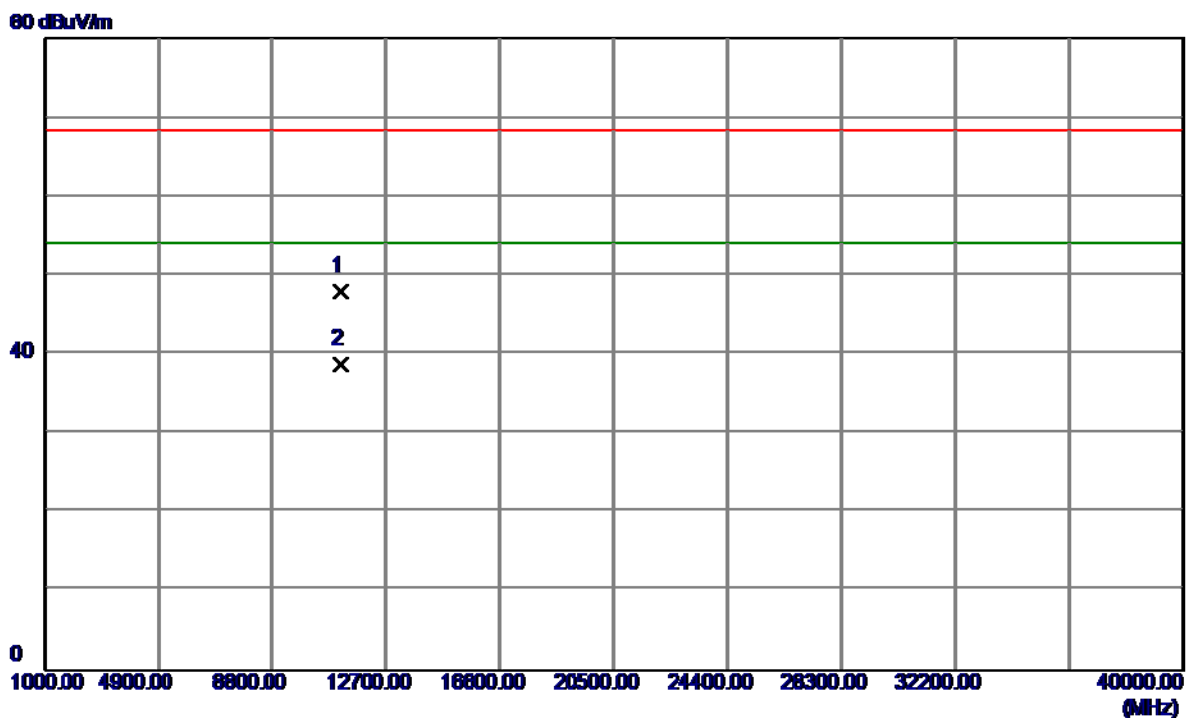

No.	Freq. MHz	Reading Level dBuV/m	Correct Factor dB	Measure ment dBuV/m	Limit dBuV/m	Margin dB	Detector	Comment
1	11160.1700	31.89	16.13	48.02	68.30	-20.28	Peak	
2	11160.1700	22.66	16.13	38.79	54.00	-15.21	AVG	

Orthogonal Axis :	X
Test Mode :	UNII-2C/ TX N20 Mode 5580MHz

Horizontal

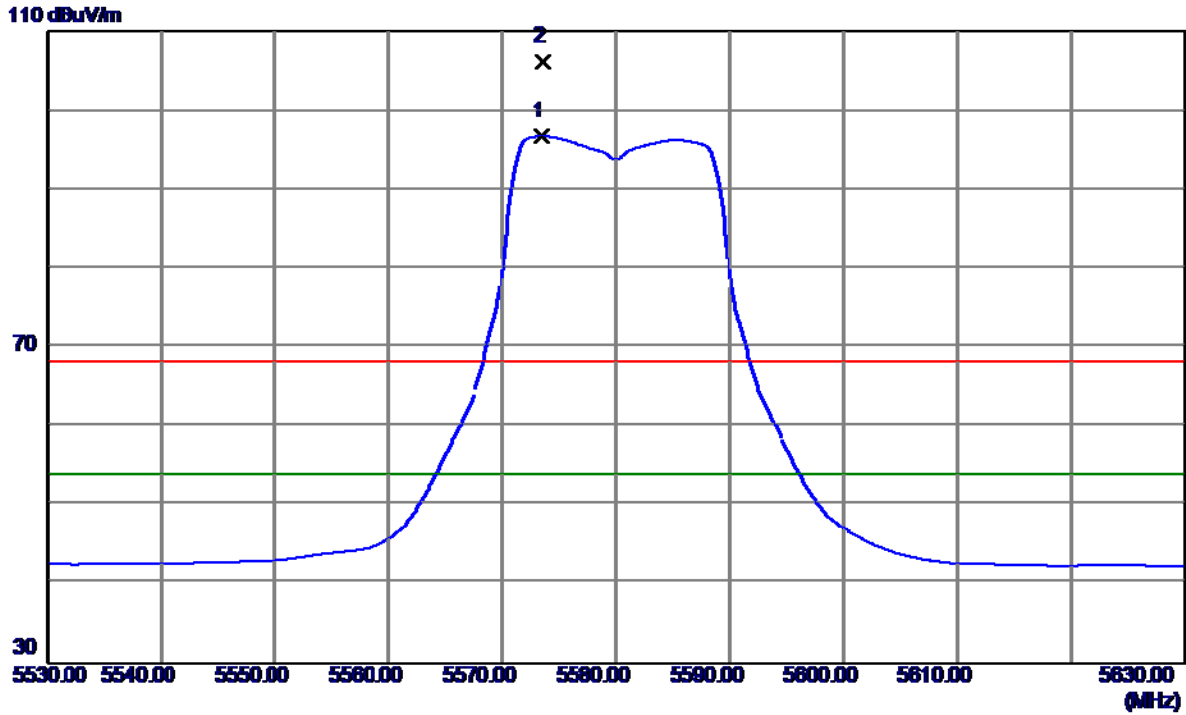

No.	Freq. MHz	Reading Level dBuV/m	Correct Factor dB	Measure ment dBuV/m	Limit dBuV/m	Margin dB	Detector	Comment
1	5573.4000	55.62	41.06	96.68	54.00	42.68	AVG	No Limit
2	5573.6000	65.18	41.06	106.24	68.30	37.94	Peak	No Limit

Orthogonal Axis :	X
Test Mode :	UNII-2C/ TX N20 Mode 5580MHz

Horizontal

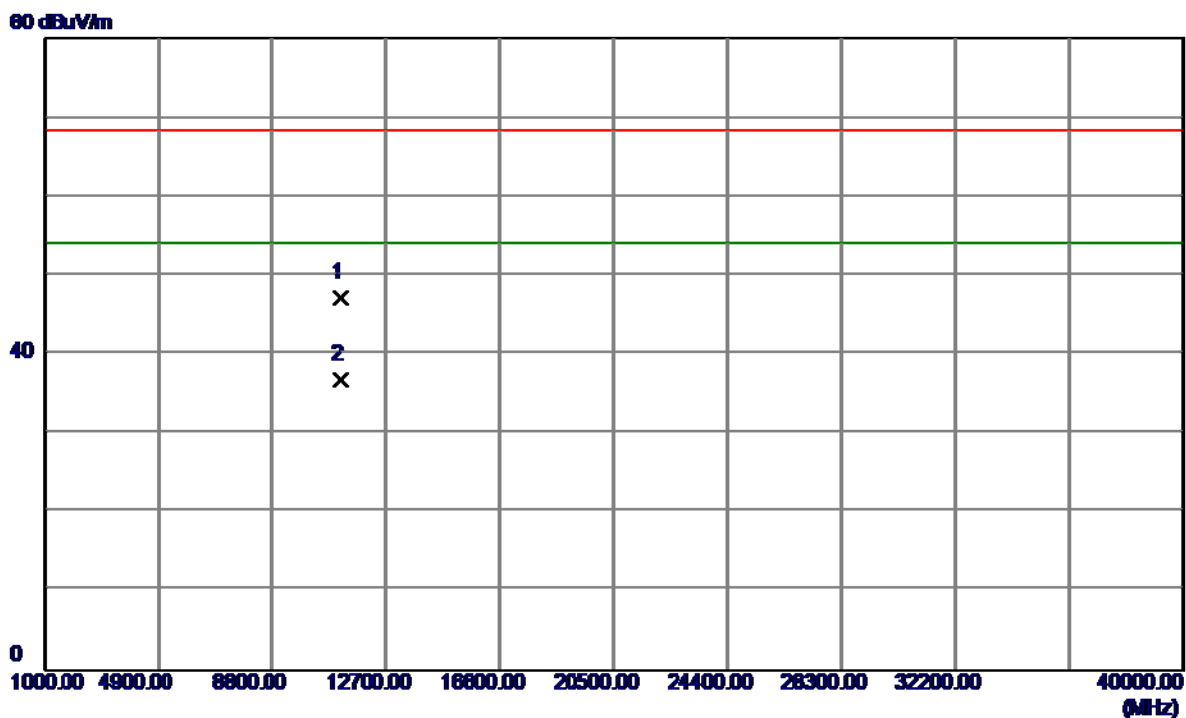

No.	Freq. MHz	Reading Level dBuV/m	Correct Factor dB	Measure ment dBuV/m	Limit dBuV/m	Margin dB	Detector	Comment
1	11160.3770	31.06	16.13	47.19	68.30	-21.11	Peak	
2	11160.3840	20.67	16.13	36.80	54.00	-17.20	AVG	

Orthogonal Axis :	X
Test Mode :	UNII-2C/ TX N20 Mode 5700MHz

Vertical

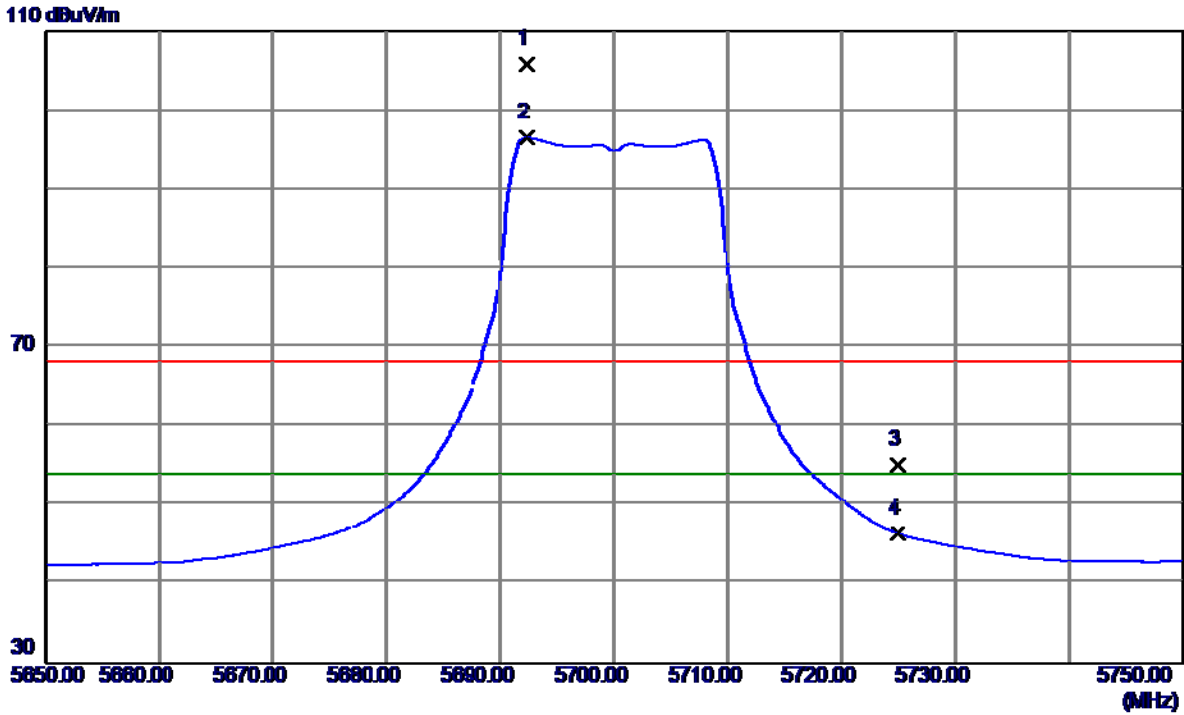

No.	Freq. MHz	Reading Level dBuV/m	Correct Factor dB	Measure ment dBuV/m	Limit dBuV/m	Margin dB	Detector	Comment
1	5692.3000	64.63	41.22	105.85	68.30	37.55	Peak	No Limit
2	5692.3000	55.31	41.22	96.53	54.00	42.53	AVG	No Limit
3	5725.0000	13.84	41.27	55.11	68.30	-13.19	Peak	
4	5725.0000	5.14	41.27	46.41	54.00	-7.59	AVG	

Orthogonal Axis :	X
Test Mode :	UNII-2C/ TX N20 Mode 5700MHz

Vertical

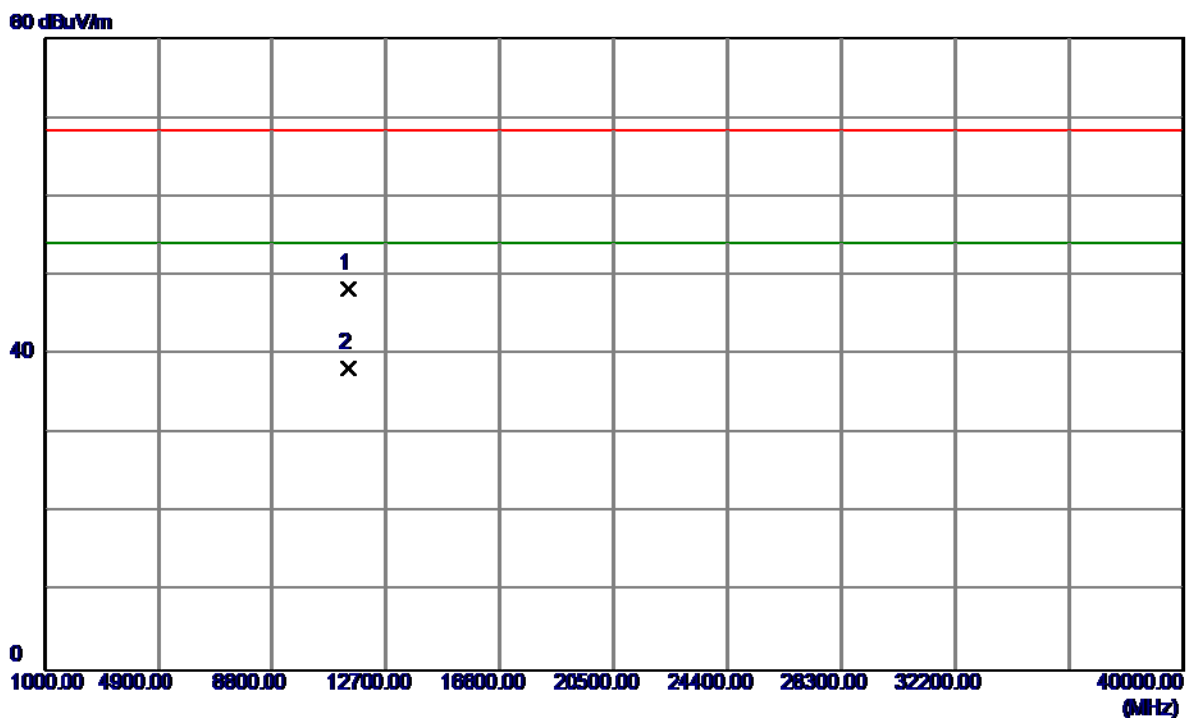

No.	Freq. MHz	Reading Level dBuV/m	Correct Factor dB	Measure ment dBuV/m	Limit dBuV/m	Margin dB	Detector	Comment
1	11400.6330	31.67	16.70	48.37	68.30	-19.93	Peak	
2	11400.0050	21.50	16.70	38.20	54.00	-15.80	AVG	

Orthogonal Axis :	X
Test Mode :	UNII-2C/ TX N20 Mode 5700MHz

Horizontal

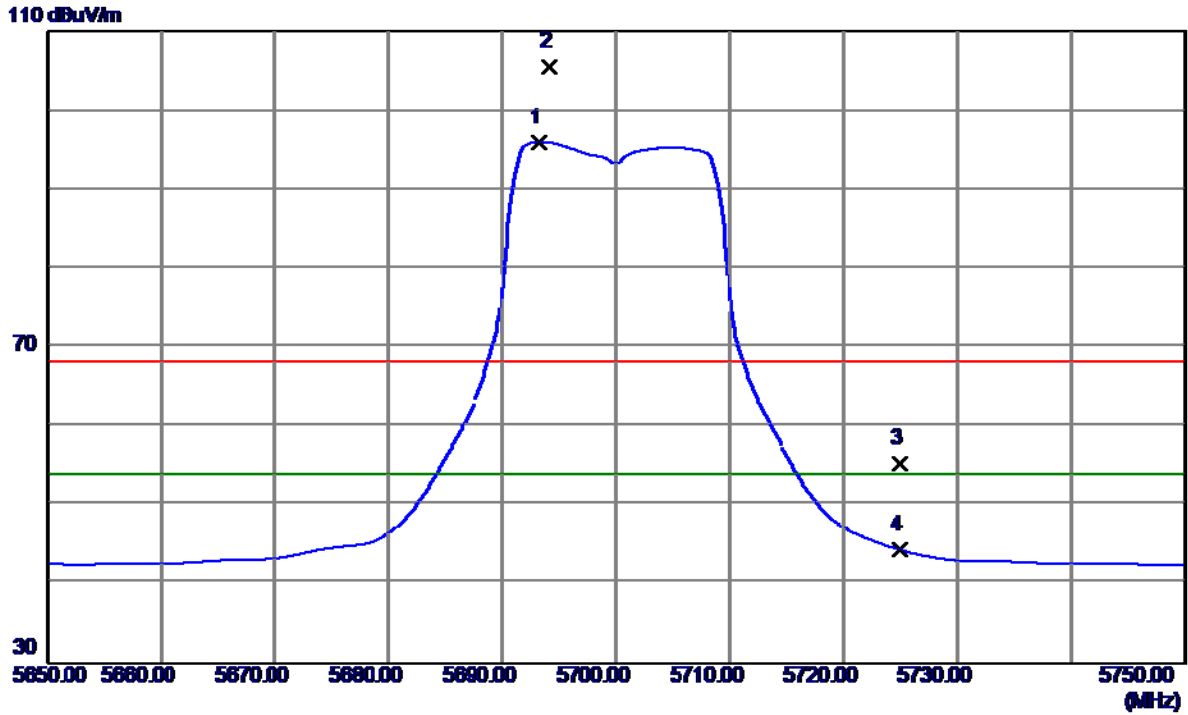

No.	Freq. MHz	Reading Level dBuV/m	Correct Factor dB	Measure ment dBuV/m	Limit dBuV/m	Margin dB	Detector	Comment
1	5693.2000	54.77	41.22	95.99	54.00	41.99	AVG	No Limit
2	5694.1000	64.26	41.22	105.48	68.30	37.18	Peak	No Limit
3	5725.0000	13.96	41.27	55.23	68.30	-13.07	Peak	
4	5725.0000	3.09	41.27	44.36	54.00	-9.64	AVG	

Orthogonal Axis :	X
Test Mode :	UNII-2C/ TX N20 Mode 5700MHz

Horizontal

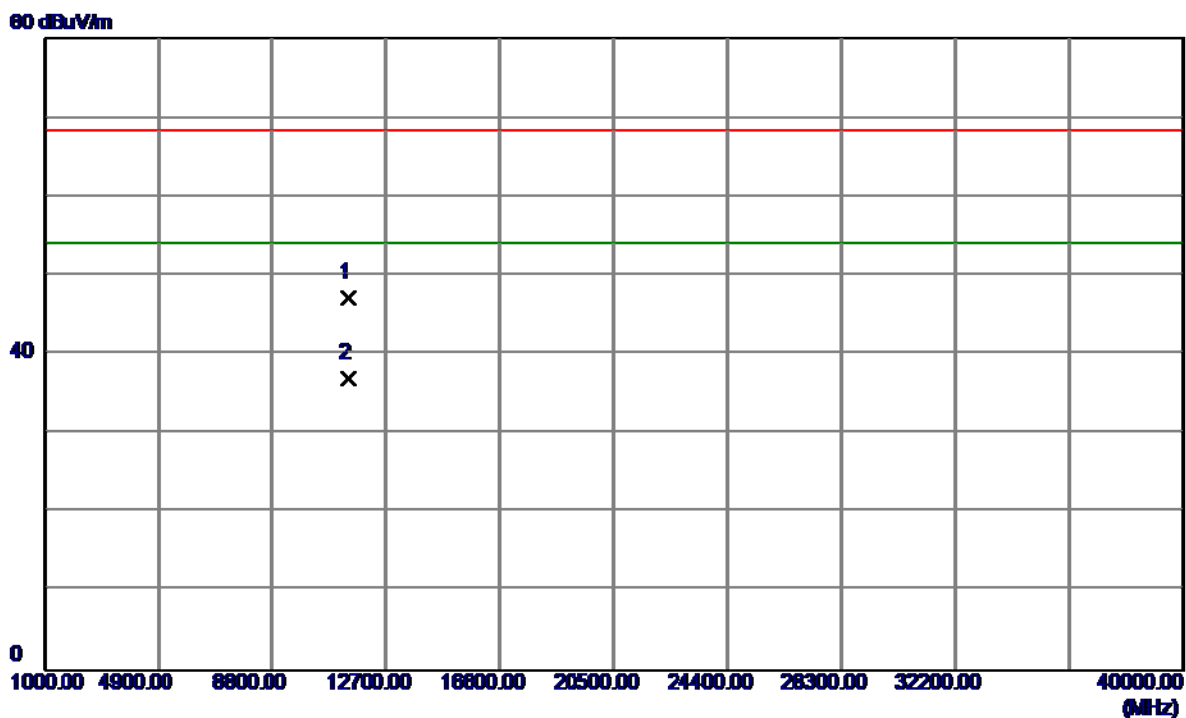

No.	Freq. MHz	Reading Level dBuV/m	Correct Factor dB	Measure ment dBuV/m	Limit dBuV/m	Margin dB	Detector	Comment
1	11400.2800	30.43	16.70	47.13	68.30	-21.17	Peak	
2	11400.2800	20.21	16.70	36.91	54.00	-17.09	AVG	

Orthogonal Axis :	X
Test Mode :	UNII-2C/ TX N40 Mode 5510MHz

Vertical

110 dBuV/m

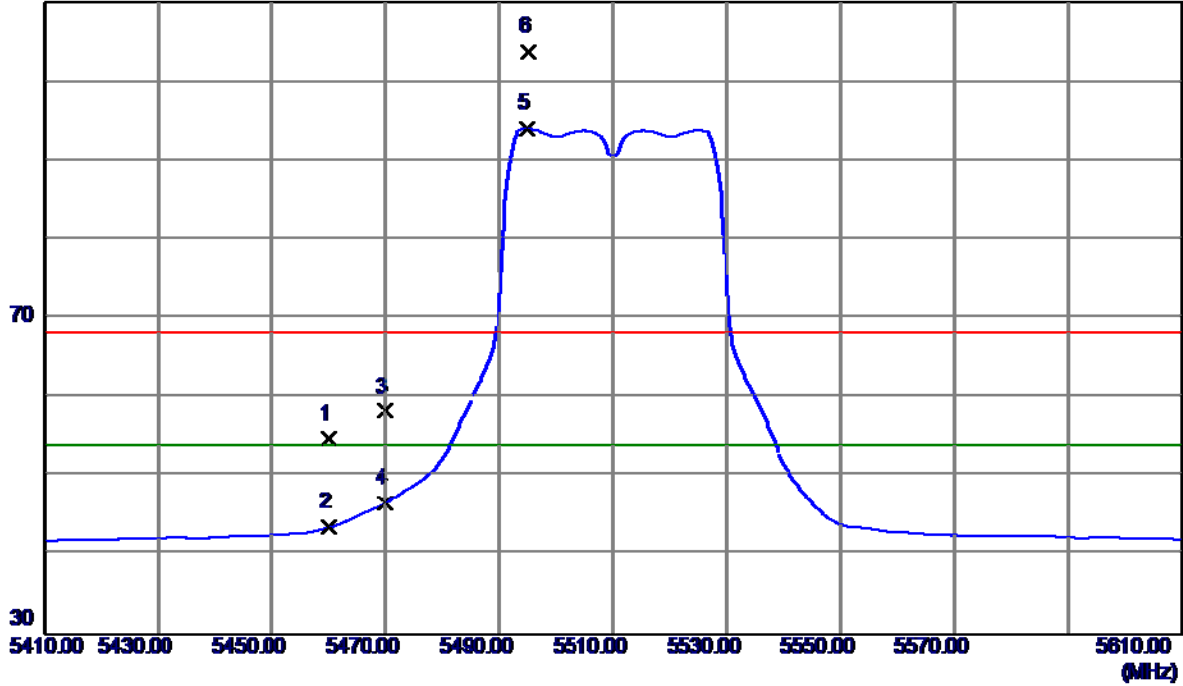

No.	Freq. MHz	Reading Level dBuV/m	Correct Factor dB	Measure ment dBuV/m	Limit dBuV/m	Margin dB	Detector	Comment
1	5460.0000	13.84	40.88	54.72	68.30	-13.58	Peak	
2	5460.0000	2.65	40.88	43.53	54.00	-10.47	AVG	
3	5470.0000	17.34	40.90	58.24	68.30	-10.06	Peak	
4	5470.0000	5.67	40.90	46.57	54.00	-7.43	AVG	
5	5494.8000	53.05	40.95	94.00	54.00	40.00	AVG	No Limit
6	5495.2000	62.74	40.95	103.69	68.30	35.39	Peak	No Limit

Orthogonal Axis :	X
Test Mode :	UNII-2C/ TX N40 Mode 5510MHz

Vertical

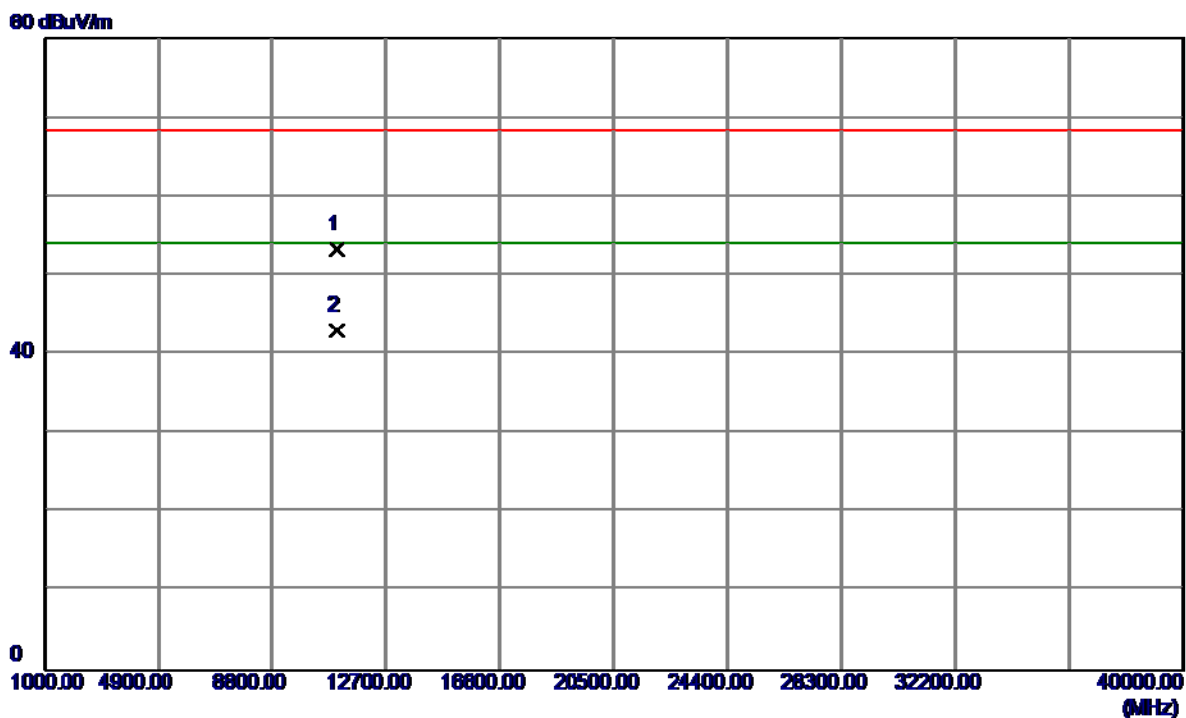

No.	Freq. MHz	Reading Level dBuV/m	Correct Factor dB	Measure ment dBuV/m	Limit dBuV/m	Margin dB	Detector	Comment
1	11020.1420	37.52	15.80	53.32	68.30	-14.98	Peak	
2	11020.1270	27.23	15.80	43.03	54.00	-10.97	AVG	

Orthogonal Axis :	X
Test Mode :	UNII-2C/ TX N40 Mode 5510MHz

Horizontal

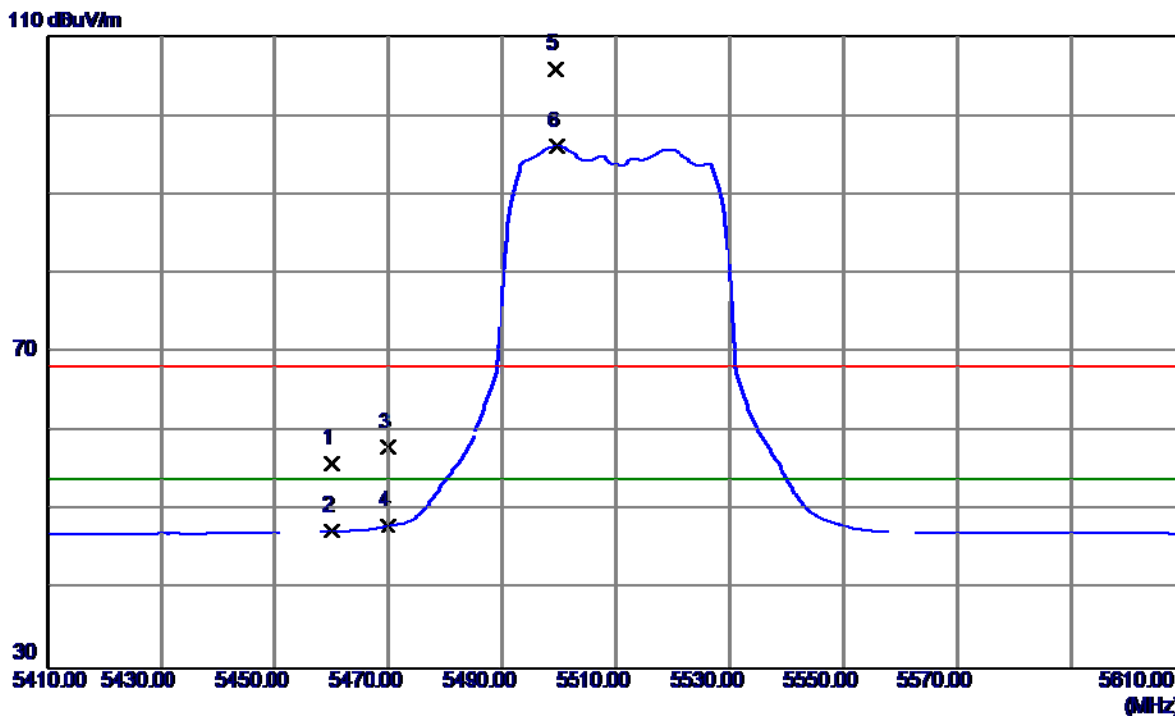

No.	Freq. MHz	Reading Level dBuV/m	Correct Factor dB	Measure ment dBuV/m	Limit dBuV/m	Margin dB	Detector	Comment
1	5460.0000	15.08	40.88	55.96	68.30	-12.34	Peak	
2	5460.0000	6.55	40.88	47.43	54.00	-6.57	AVG	
3	5470.0000	17.08	40.90	57.98	68.30	-10.32	Peak	
4	5470.0000	7.23	40.90	48.13	54.00	-5.87	AVG	
5	5499.4000	64.91	40.96	105.87	68.30	37.57	Peak	No Limit
6	5499.6000	55.11	40.96	96.07	54.00	42.07	AVG	No Limit

Orthogonal Axis :	X
Test Mode :	UNII-2C/ TX N40 Mode 5510MHz

Horizontal

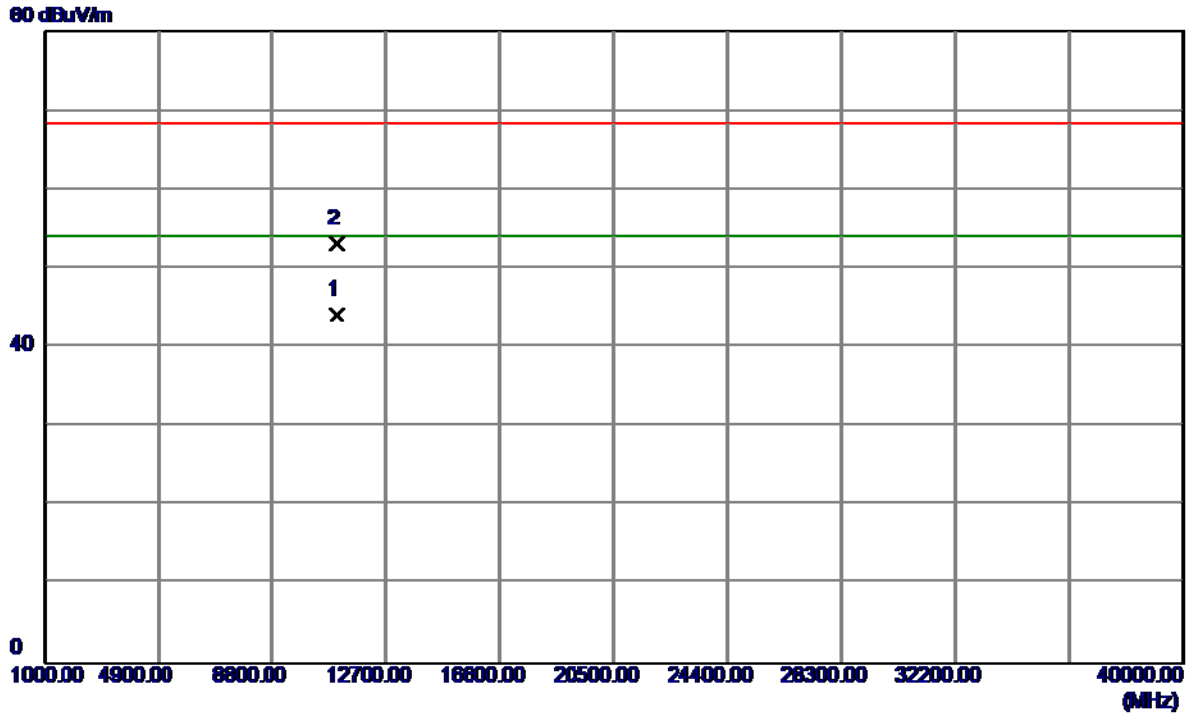

No.	Freq. MHz	Reading Level dBuV/m	Correct Factor dB	Measure ment dBuV/m	Limit dBuV/m	Margin dB	Detector	Comment
1	11020.7800	28.34	15.80	44.14	54.00	-9.86	AVG	
2	11020.5870	37.37	15.80	53.17	68.30	-15.13	Peak	

Orthogonal Axis :	X
Test Mode :	UNII-2C/ TX N40 Mode 5550MHz

Vertical

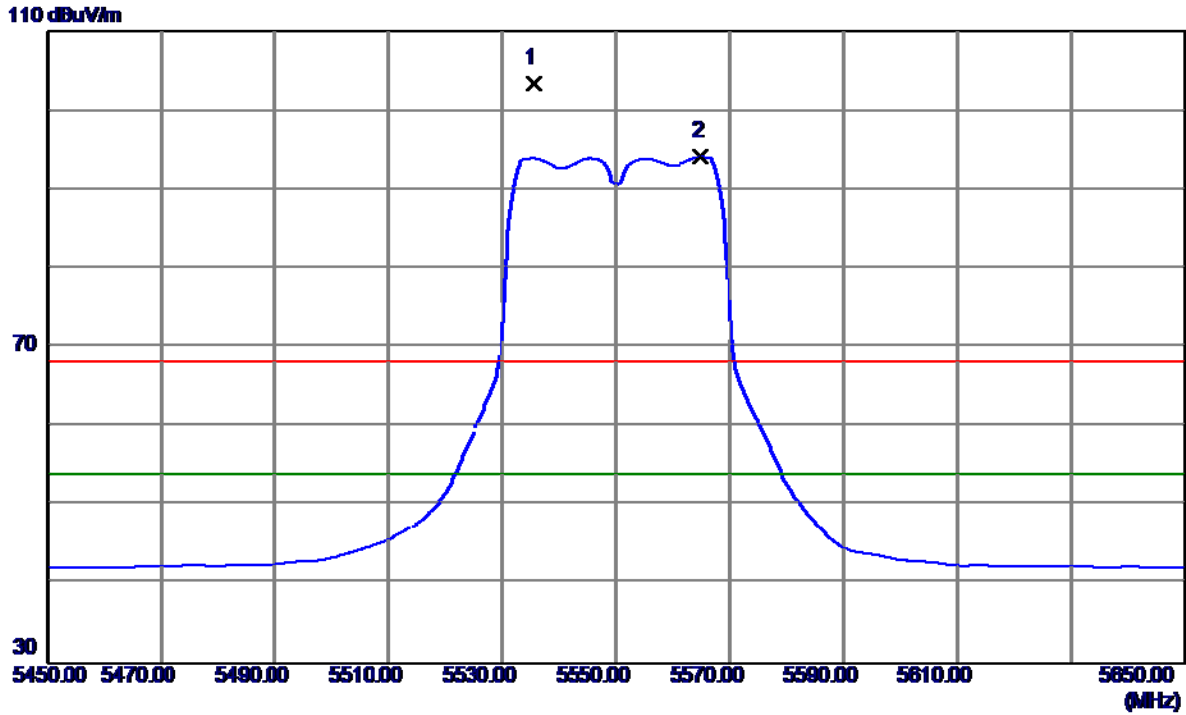

No.	Freq. MHz	Reading Level dBuV/m	Correct Factor dB	Measure ment dBuV/m	Limit dBuV/m	Margin dB	Detector	Comment
1	5535.6000	62.49	41.01	103.50	68.30	35.20	Peak	No Limit
2	5565.0000	53.05	41.05	94.10	54.00	40.10	AVG	No Limit

Orthogonal Axis :	X
Test Mode :	UNII-2C/ TX N40 Mode 5550MHz

Vertical

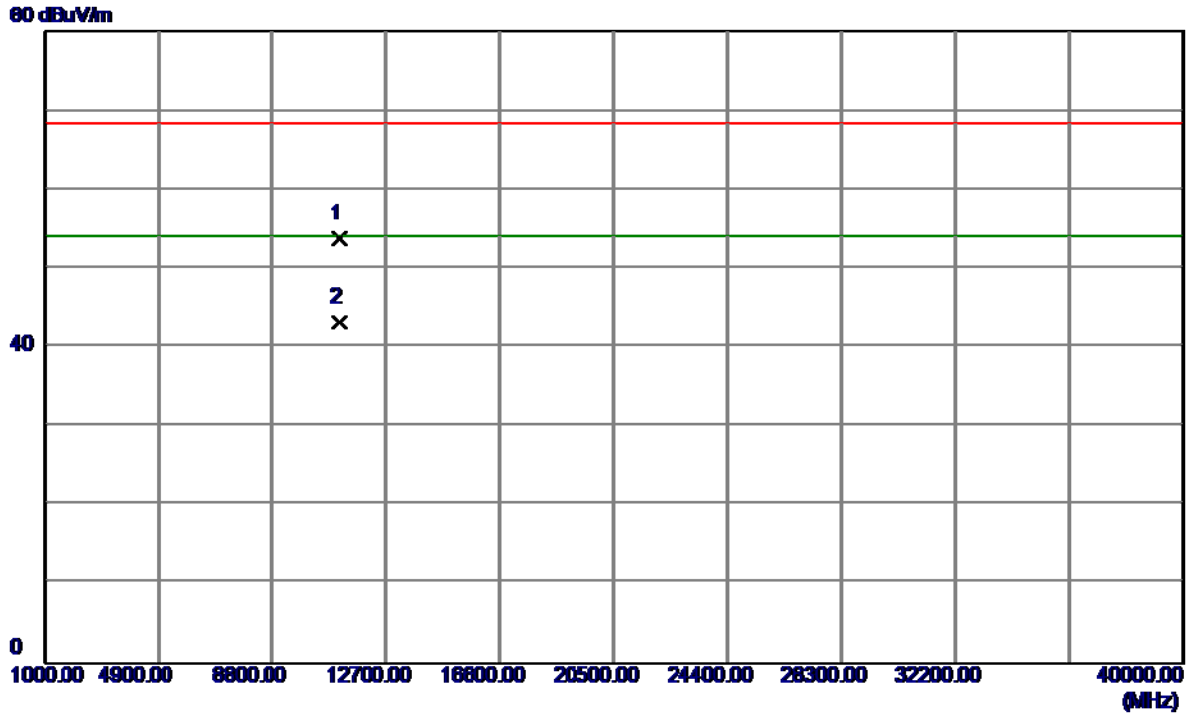

No.	Freq. MHz	Reading Level dBuV/m	Correct Factor dB	Measure ment dBuV/m	Limit dBuV/m	Margin dB	Detector	Comment
1	11100.5370	37.83	15.99	53.82	68.30	-14.48	Peak	
2	11100.3990	27.14	15.99	43.13	54.00	-10.87	AVG	

Orthogonal Axis :	X
Test Mode :	UNII-2C/ TX N40 Mode 5550MHz

Horizontal

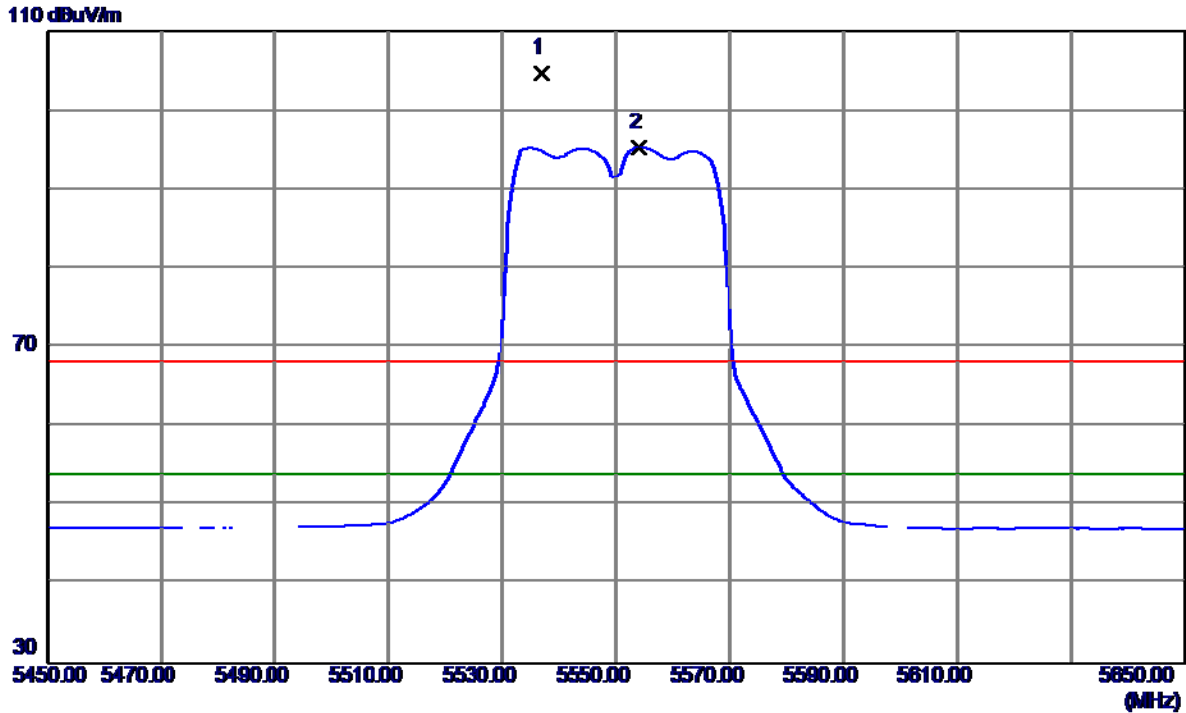

No.	Freq. MHz	Reading Level dBuV/m	Correct Factor dB	Measure ment dBuV/m	Limit dBuV/m	Margin dB	Detector	Comment
1	5536.8000	63.76	41.01	104.77	68.30	36.47	Peak	No Limit
2	5554.0000	54.32	41.03	95.35	54.00	41.35	AVG	No Limit

Orthogonal Axis :	X
Test Mode :	UNII-2C/ TX N40 Mode 5550MHz

Horizontal

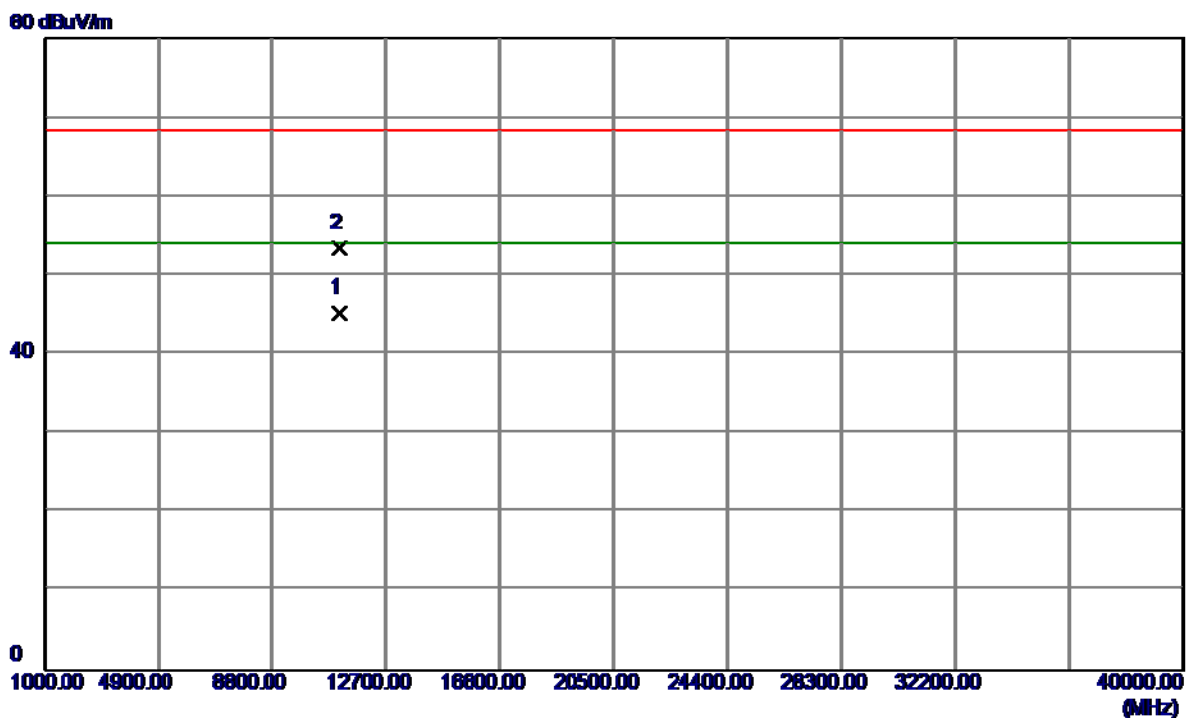

No.	Freq. MHz	Reading Level dBuV/m	Correct Factor dB	Measure ment dBuV/m	Limit dBuV/m	Margin dB	Detector	Comment
1	11100.1350	29.26	15.99	45.25	54.00	-8.75	AVG	
2	11100.6380	37.47	15.99	53.46	68.30	-14.84	Peak	

Orthogonal Axis :	X
Test Mode :	UNII-2C/ TX N40 Mode 5670MHz

Vertical

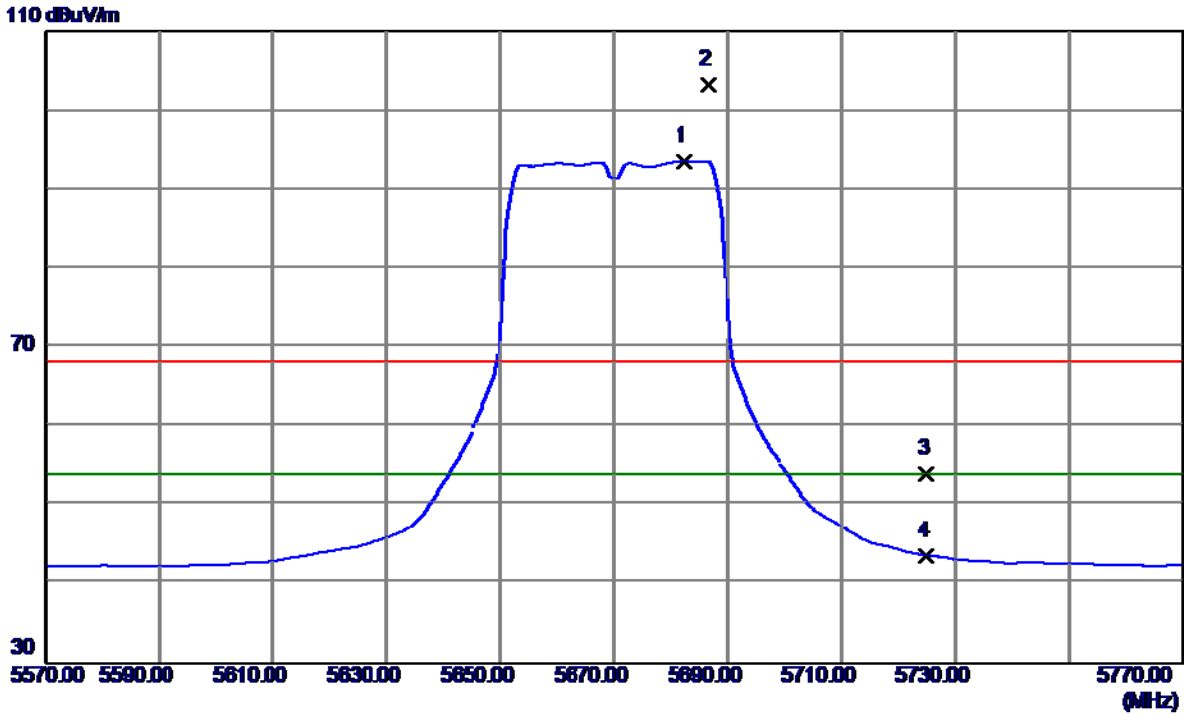

No.	Freq. MHz	Reading Level dBuV/m	Correct Factor dB	Measure ment dBuV/m	Limit dBuV/m	Margin dB	Detector	Comment
1	5682.4000	52.35	41.21	93.56	54.00	39.56	AVG	No Limit
2	5686.6000	62.08	41.21	103.29	68.30	34.99	Peak	No Limit
3	5725.0000	12.69	41.27	53.96	68.30	-14.34	Peak	
4	5725.0000	2.38	41.27	43.65	54.00	-10.35	AVG	

Orthogonal Axis :	X
Test Mode :	UNII-2C/ TX N40 Mode 5670MHz

Vertical

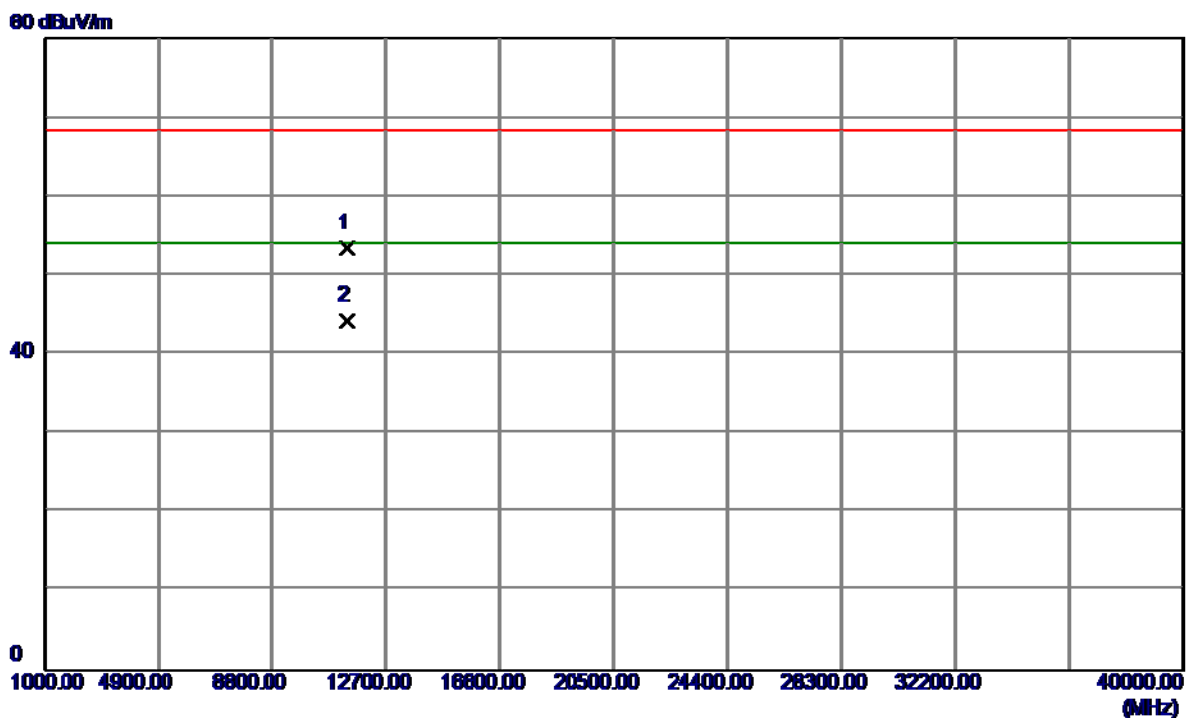

No.	Freq. MHz	Reading Level dBuV/m	Correct Factor dB	Measure ment dBuV/m	Limit dBuV/m	Margin dB	Detector	Comment
1	11340.2500	36.85	16.56	53.41	68.30	-14.89	Peak	
2	11340.4870	27.78	16.56	44.34	54.00	-9.66	AVG	

Orthogonal Axis :	X
Test Mode :	UNII-2C/ TX N40 Mode 5670MHz

Horizontal

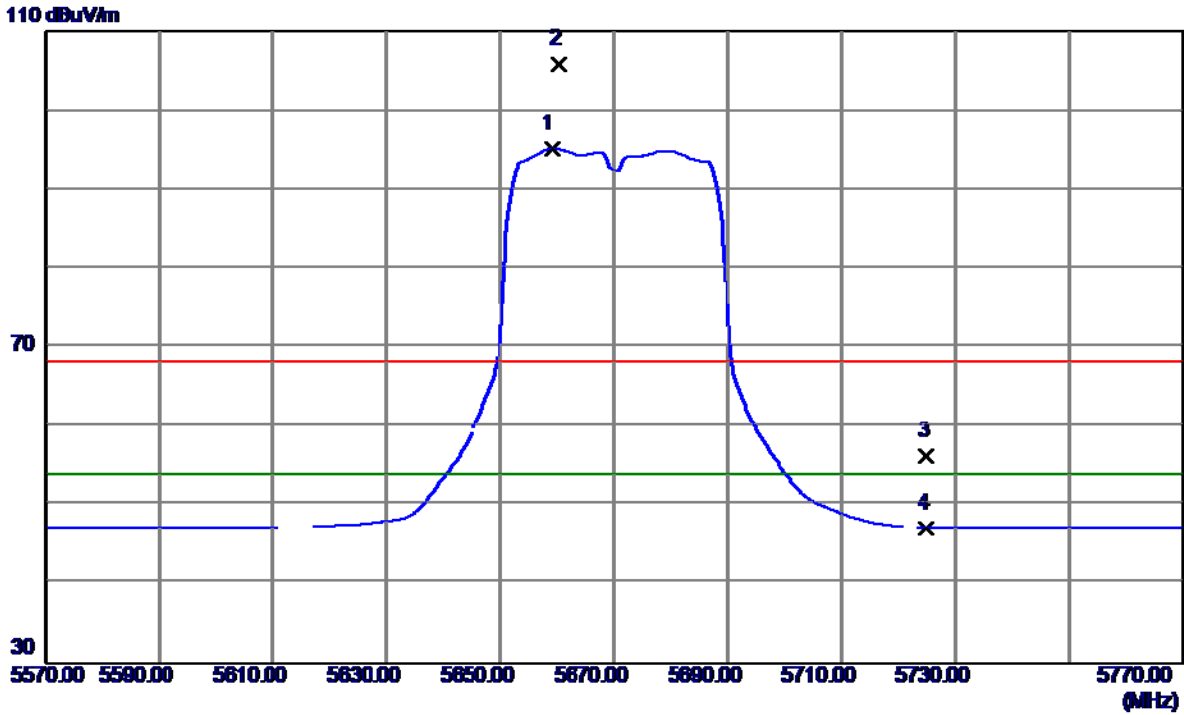

No.	Freq. MHz	Reading Level dBuV/m	Correct Factor dB	Measure ment dBuV/m	Limit dBuV/m	Margin dB	Detector	Comment
1	5659.0000	53.93	41.18	95.11	54.00	41.11	AVG	No Limit
2	5660.2000	64.63	41.18	105.81	68.30	37.51	Peak	No Limit
3	5725.0000	15.02	41.27	56.29	68.30	-12.01	Peak	
4	5725.0000	5.88	41.27	47.15	54.00	-6.85	AVG	

Orthogonal Axis :	X
Test Mode :	UNII-2C/ TX N40 Mode 5670MHz

Horizontal

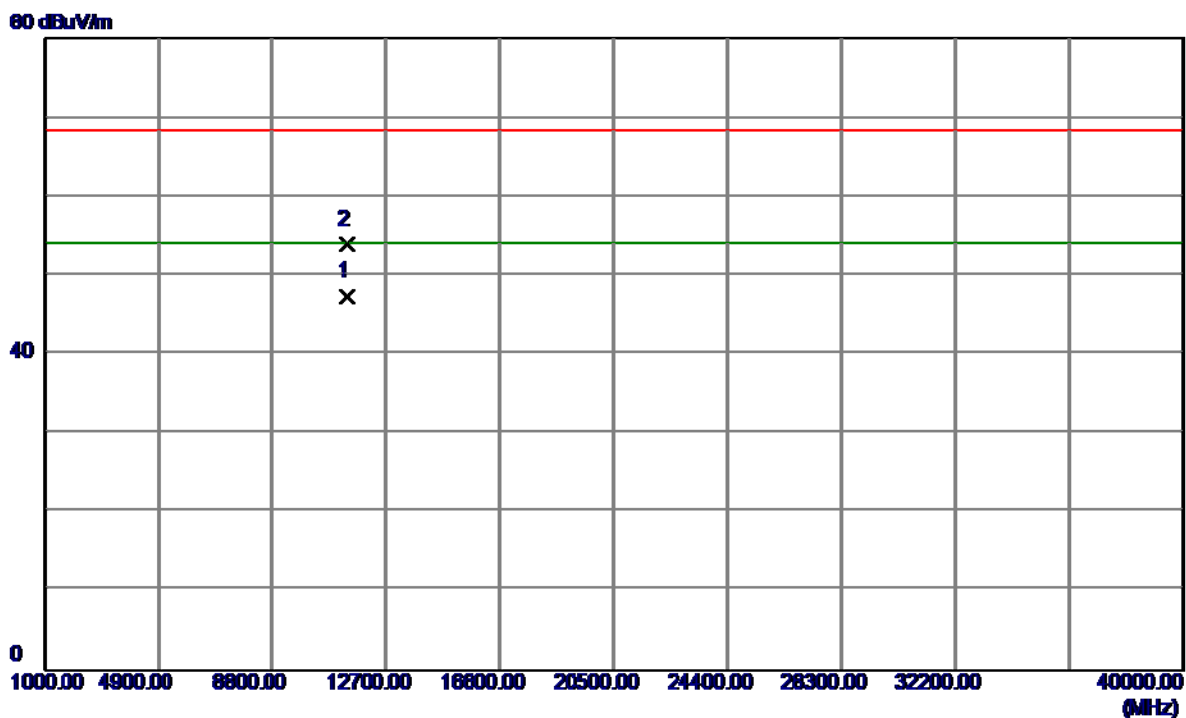

No.	Freq. MHz	Reading Level dBuV/m	Correct Factor dB	Measure ment dBuV/m	Limit dBuV/m	Margin dB	Detector	Comment
1	11340.3890	30.76	16.56	47.32	54.00	-6.68	AVG	
2	11340.8300	37.33	16.56	53.89	68.30	-14.41	Peak	

Orthogonal Axis:	X
Test Mode:	UNII-3/TX A Mode 5745MHz

Vertical

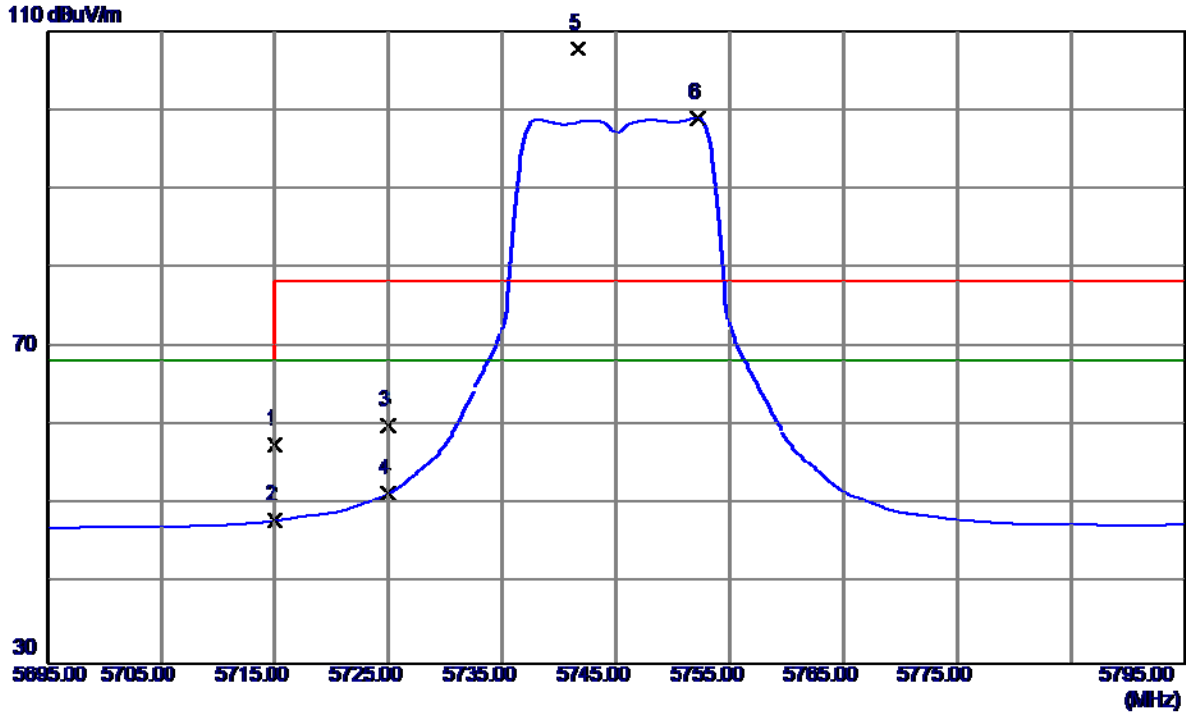

No.	Freq. MHz	Reading Level dBuV/m	Correct Factor dB	Measure ment dBuV/m	Limit dBuV/m	Margin dB	Detector	Comment
1	5715.0000	16.48	41.25	57.73	68.30	-10.57	Peak	
2	5715.0000	6.77	41.25	48.02	68.30	-20.28	AVG	
3	5725.0000	18.77	41.27	60.04	78.30	-18.26	Peak	
4	5725.0000	10.13	41.27	51.40	68.30	-16.90	AVG	
5	5741.7000	66.48	41.29	107.77	78.30	29.47	Peak	No Limit
6	5752.2000	57.70	41.30	99.00	68.30	30.70	AVG	No Limit

Orthogonal Axis:	X
Test Mode:	UNII-3/TX A Mode 5745MHz

Vertical

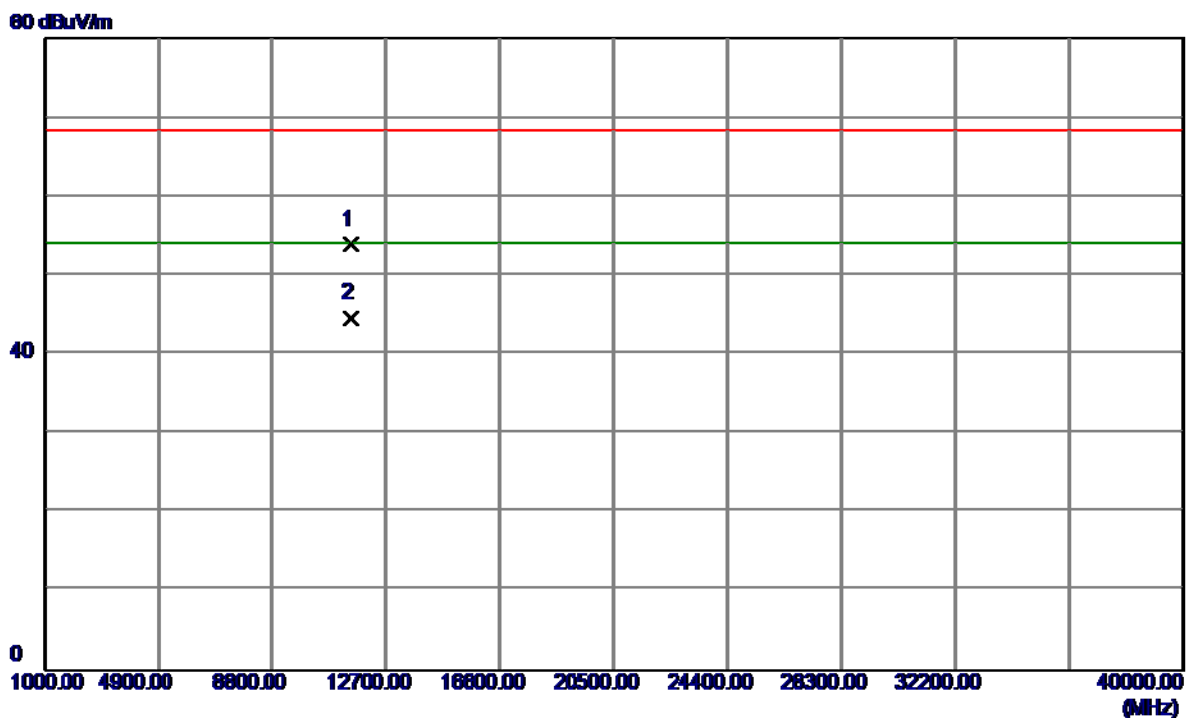

No.	Freq. MHz	Reading Level dBuV/m	Correct Factor dB	Measure ment dBuV/m	Limit dBuV/m	Margin dB	Detector	Comment
1	11490.5000	36.99	16.91	53.90	68.30	-14.40	Peak	
2	11490.1100	27.76	16.91	44.67	54.00	-9.33	AVG	

Orthogonal Axis:	X
Test Mode:	UNII-3/TX A Mode 5745MHz

Horizontal

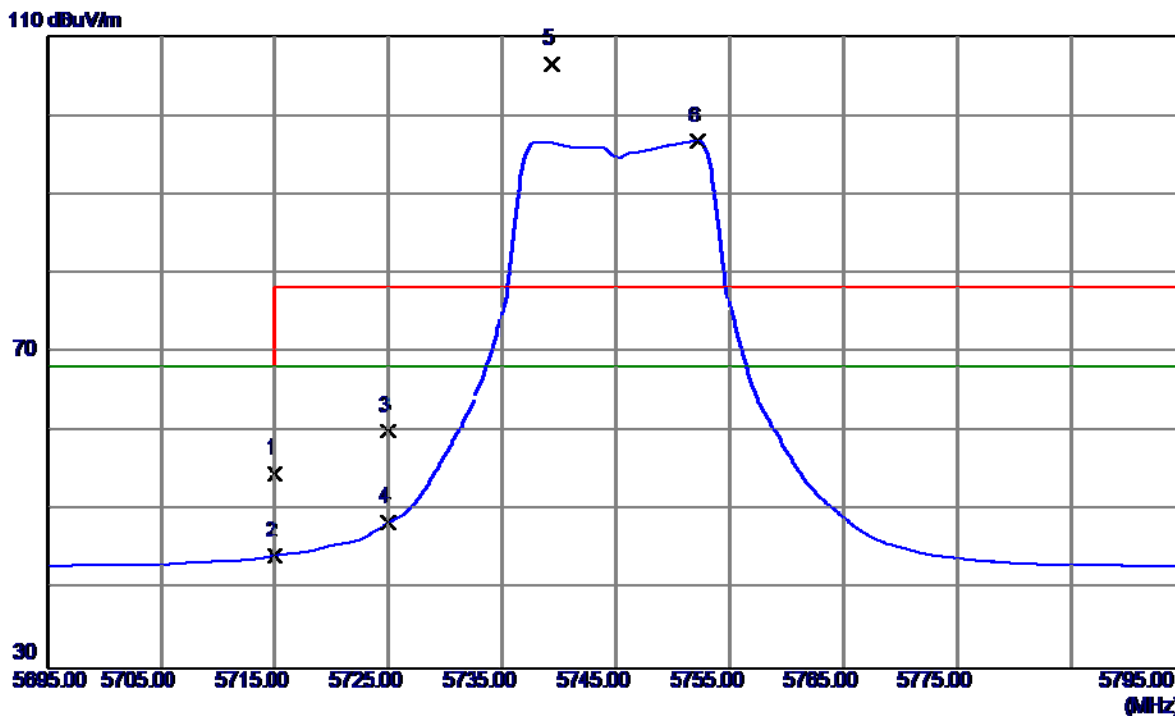

No.	Freq. MHz	Reading Level dBuV/m	Correct Factor dB	Measure ment dBuV/m	Limit dBuV/m	Margin dB	Detector	Comment
1	5715.0000	13.39	41.25	54.64	68.30	-13.66	Peak	
2	5715.0000	3.02	41.25	44.27	68.30	-24.03	AVG	
3	5725.0000	18.77	41.27	60.04	78.30	-18.26	Peak	
4	5725.0000	7.23	41.27	48.50	68.30	-19.80	AVG	
5	5739.3000	65.26	41.29	106.55	78.30	28.25	Peak	No Limit
6	5752.2000	55.45	41.30	96.75	68.30	28.45	AVG	No Limit

Orthogonal Axis:	X
Test Mode:	UNII-3/TX A Mode 5745MHz

Horizontal

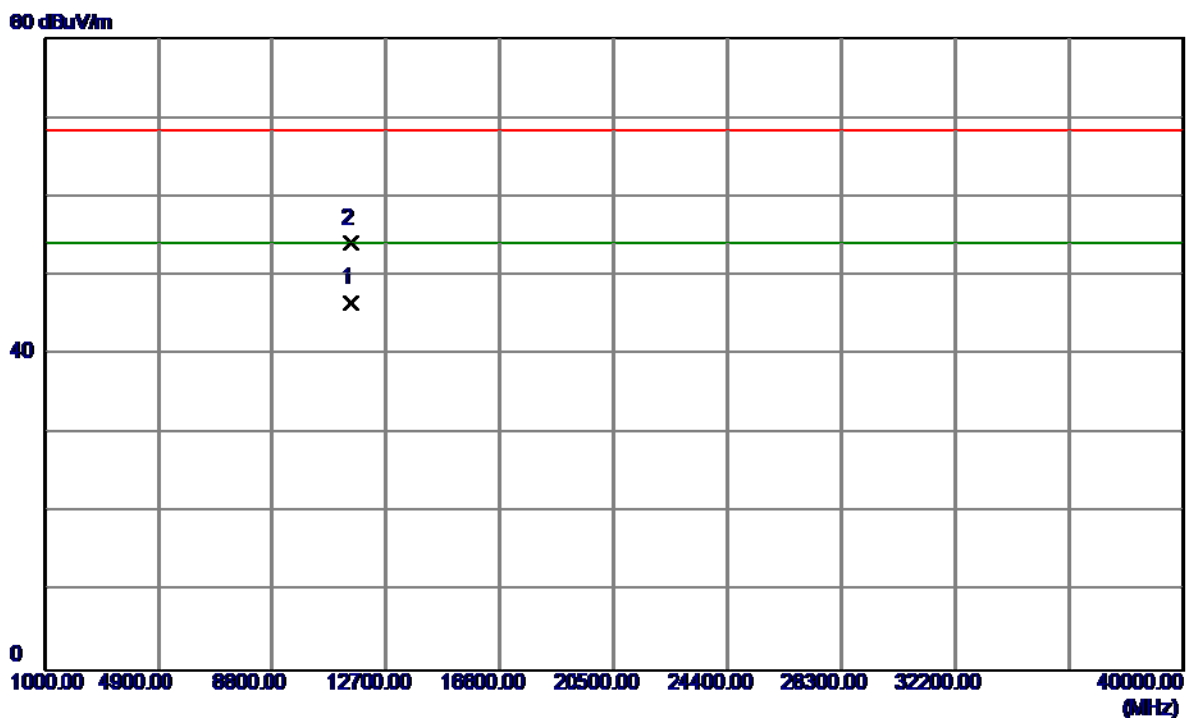

No.	Freq. MHz	Reading Level dBuV/m	Correct Factor dB	Measure ment dBuV/m	Limit dBuV/m	Margin dB	Detector	Comment
1	11490.2800	29.62	16.91	46.53	54.00	-7.47	AVG	
2	11490.6360	37.17	16.91	54.08	68.30	-14.22	Peak	

Orthogonal Axis:	X
Test Mode:	UNII-3/TX A Mode 5785MHz

Vertical

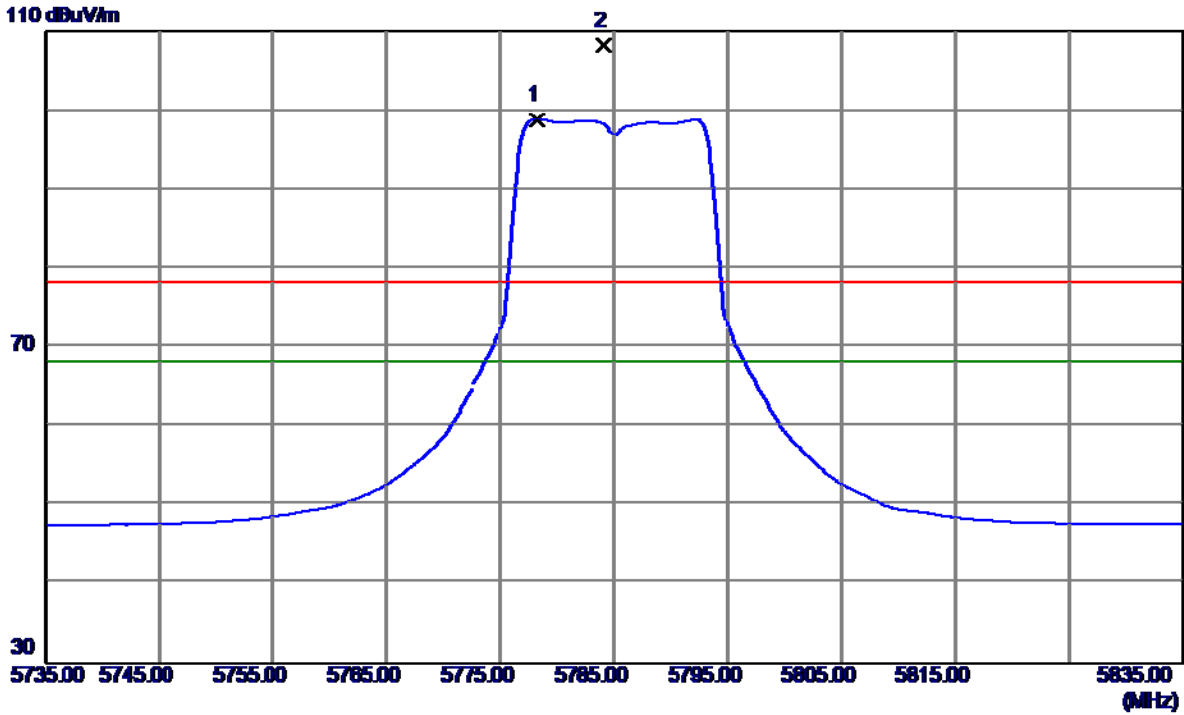

No.	Freq. MHz	Reading Level dBuV/m	Correct Factor dB	Measure ment dBuV/m	Limit dBuV/m	Margin dB	Detector	Comment
1	5778.2000	57.52	41.34	98.86	68.30	30.56	AVG	No Limit
2	5784.1000	66.81	41.35	108.16	78.30	29.86	Peak	No Limit

Orthogonal Axis:	X
Test Mode:	UNII-3/TX A Mode 5785MHz

Vertical

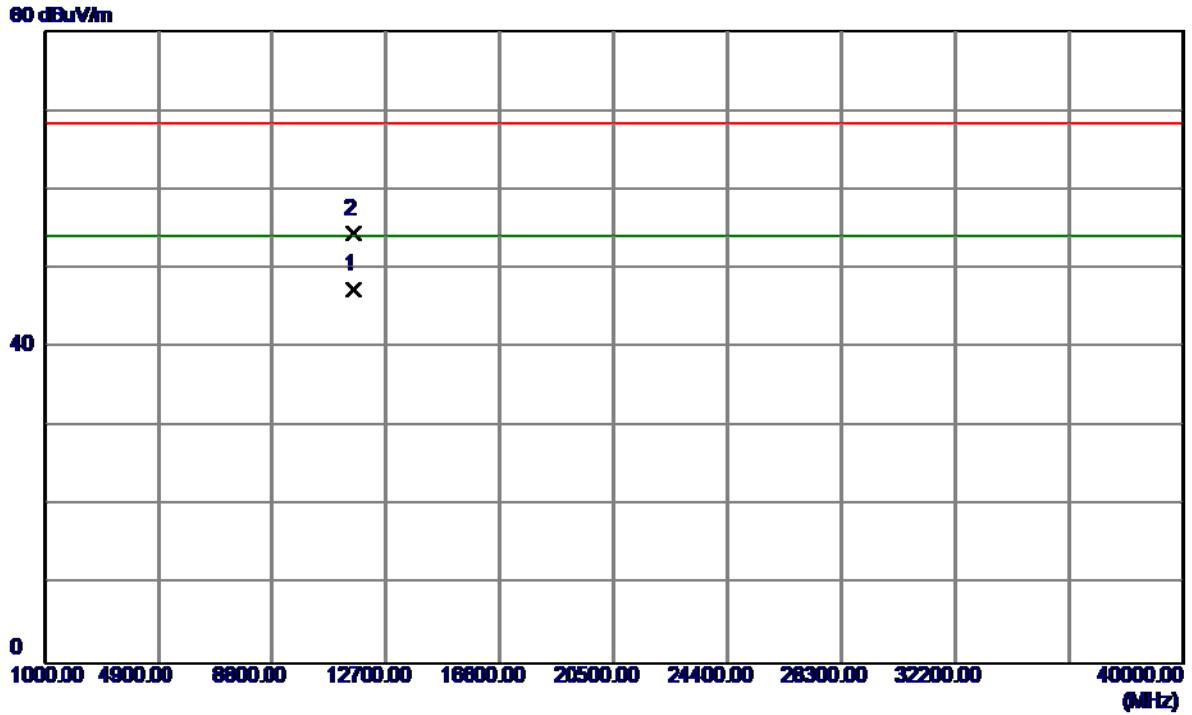

No.	Freq. MHz	Reading Level dBuV/m	Correct Factor dB	Measure ment dBuV/m	Limit dBuV/m	Margin dB	Detector	Comment
1	11570.3470	30.36	17.05	47.41	54.00	-6.59	AVG	
2	11570.3700	37.38	17.05	54.43	68.30	-13.87	Peak	

Orthogonal Axis:	X
Test Mode:	UNII-3/TX A Mode 5785MHz

Horizontal

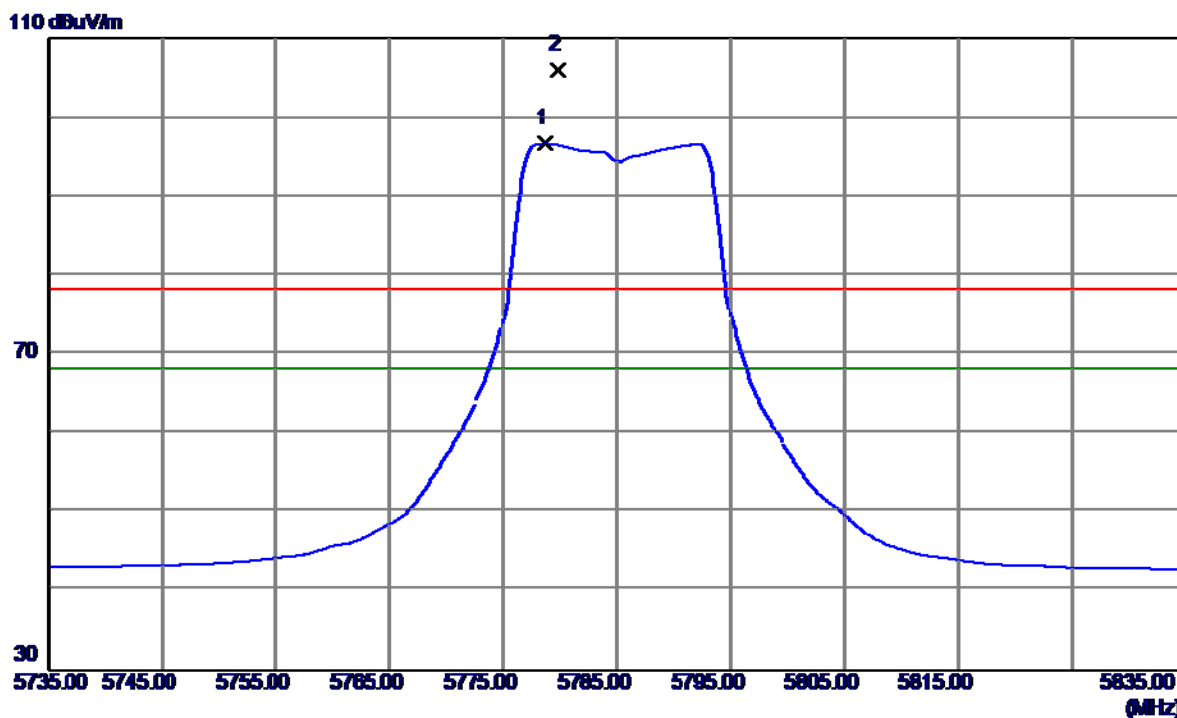

No.	Freq. MHz	Reading Level dBuV/m	Correct Factor dB	Measure ment dBuV/m	Limit dBuV/m	Margin dB	Detector	Comment
1	5778.7000	55.31	41.34	96.65	68.30	28.35	AVG	No Limit
2	5779.8000	64.71	41.34	106.05	78.30	27.75	Peak	No Limit

Orthogonal Axis:	X
Test Mode:	UNII-3/TX A Mode 5785MHz

Horizontal

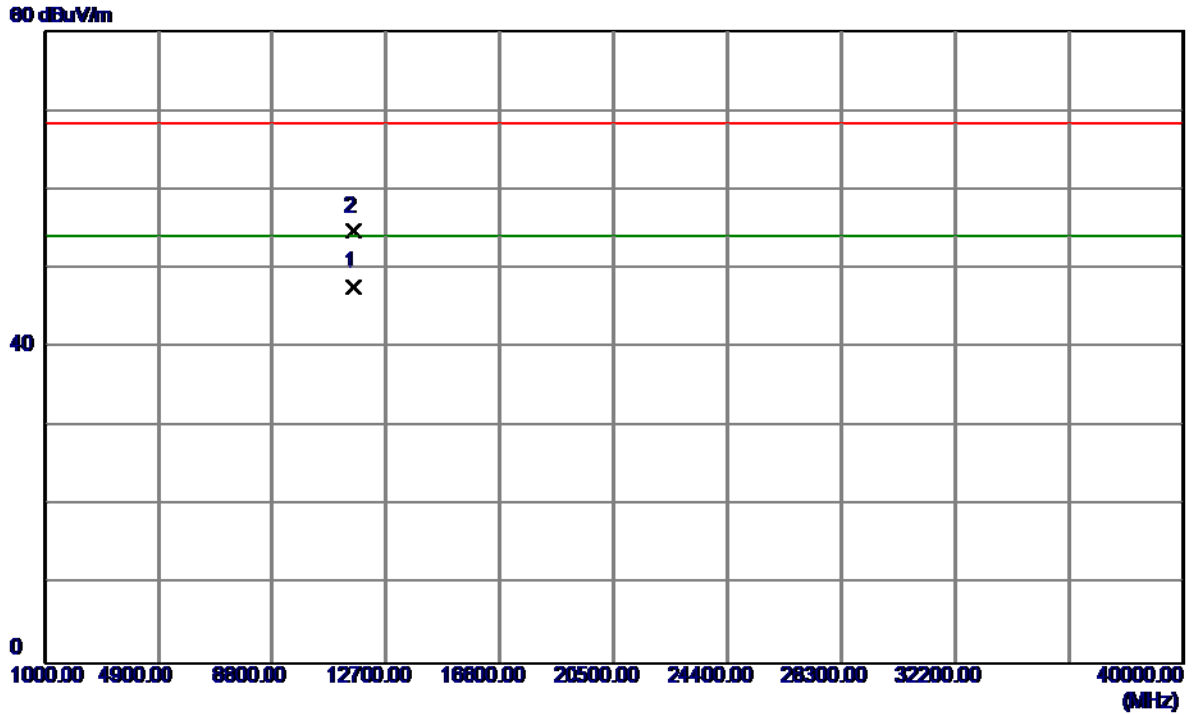

No.	Freq. MHz	Reading Level dBuV/m	Correct Factor dB	Measure ment dBuV/m	Limit dBuV/m	Margin dB	Detector	Comment
1	11570.3800	30.64	17.05	47.69	54.00	-6.31	AVG	
2	11570.2280	37.72	17.05	54.77	68.30	-13.53	Peak	

Orthogonal Axis:	X
Test Mode:	UNII-3/TX A Mode 5825MHz

Vertical

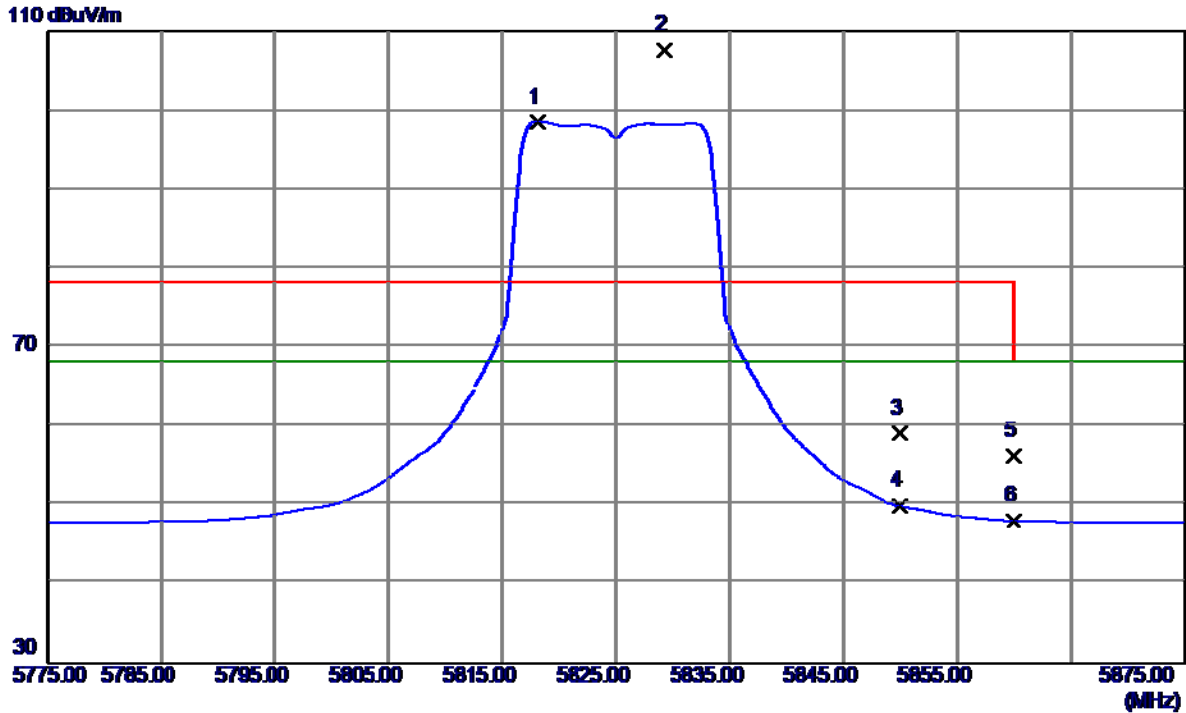

No.	Freq. MHz	Reading Level dBuV/m	Correct Factor dB	Measure ment dBuV/m	Limit dBuV/m	Margin dB	Detector	Comment
1	5818.1000	57.14	41.39	98.53	68.30	30.23	AVG	No Limit
2	5829.2000	66.21	41.41	107.62	78.30	29.32	Peak	No Limit
3	5850.0000	17.71	41.44	59.15	78.30	-19.15	Peak	
4	5850.0000	8.51	41.44	49.95	68.30	-18.35	AVG	
5	5860.0000	14.83	41.45	56.28	78.30	-22.02	Peak	
6	5860.0000	6.63	41.45	48.08	68.30	-20.22	AVG	

Orthogonal Axis:	X
Test Mode:	UNII-3/TX A Mode 5825MHz

Vertical

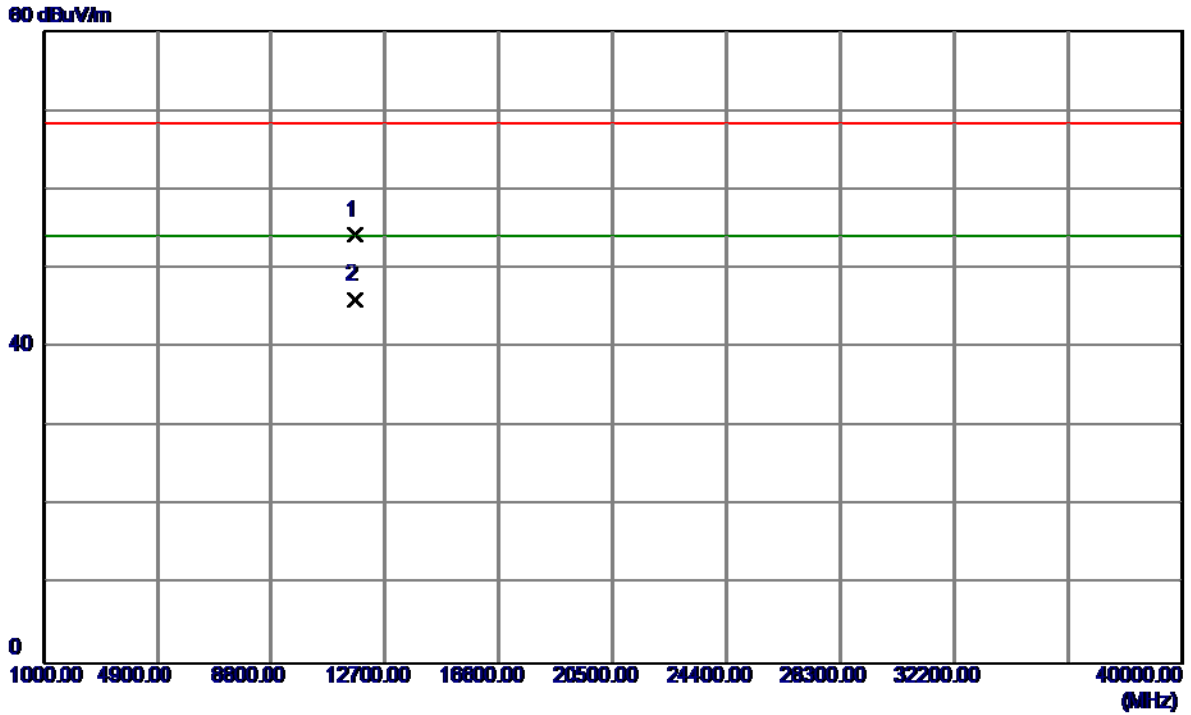

No.	Freq. MHz	Reading Level dBuV/m	Correct Factor dB	Measure ment dBuV/m	Limit dBuV/m	Margin dB	Detector	Comment
1	11650.4780	37.08	17.17	54.25	68.30	-14.05	Peak	
2	11650.1300	28.89	17.17	46.06	54.00	-7.94	AVG	

Orthogonal Axis:	X
Test Mode:	UNII-3/TX A Mode 5825MHz

Horizontal

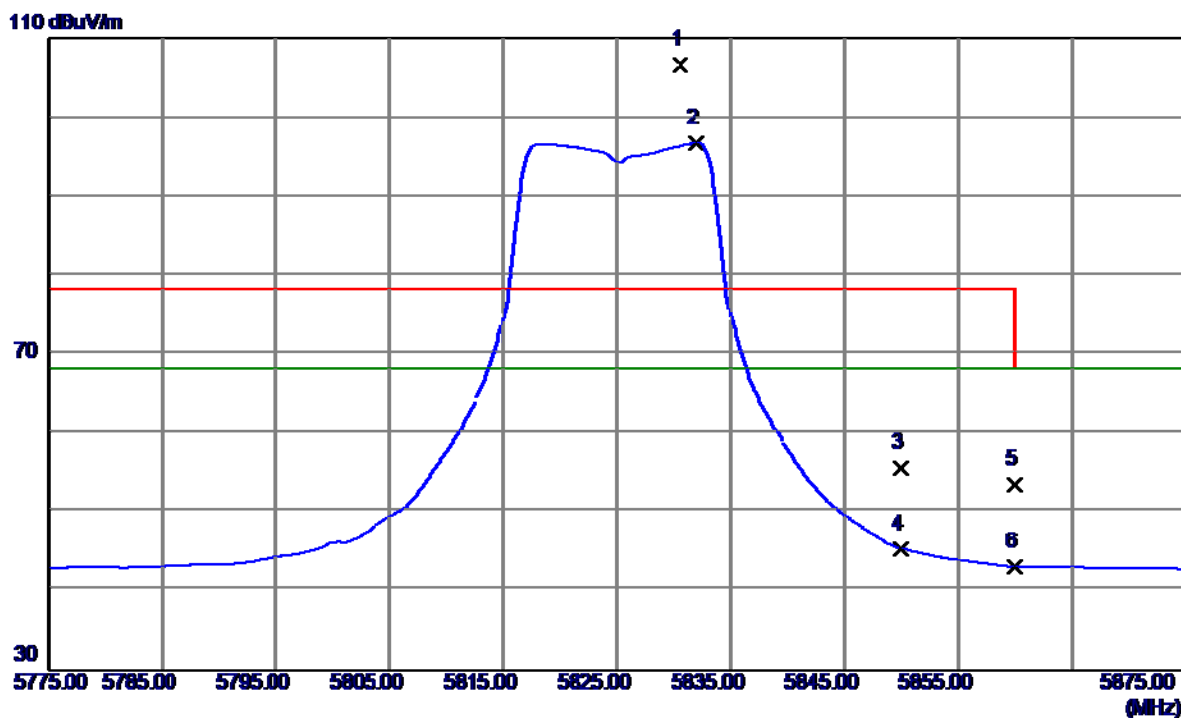

No.	Freq. MHz	Reading Level dBuV/m	Correct Factor dB	Measure ment dBuV/m	Limit dBuV/m	Margin dB	Detector	Comment
1	5830.6000	65.18	41.41	106.59	78.30	28.29	Peak	No Limit
2	5832.0000	55.28	41.41	96.69	68.30	28.39	AVG	No Limit
3	5850.0000	14.16	41.44	55.60	78.30	-22.70	Peak	
4	5850.0000	3.99	41.44	45.43	68.30	-22.87	AVG	
5	5860.0000	12.08	41.45	53.53	78.30	-24.77	Peak	
6	5860.0000	1.67	41.45	43.12	68.30	-25.18	AVG	

Orthogonal Axis:	X
Test Mode:	UNII-3/TX A Mode 5825MHz

Horizontal

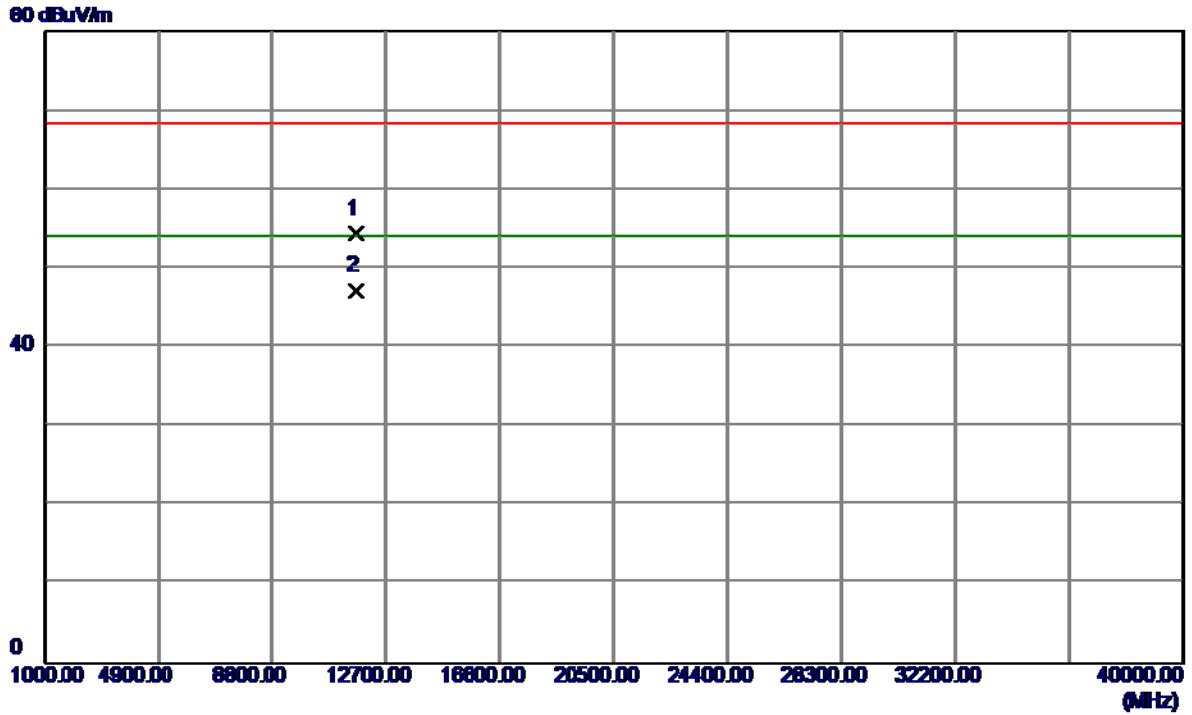

No.	Freq. MHz	Reading Level dBuV/m	Correct Factor dB	Measure ment dBuV/m	Limit dBuV/m	Margin dB	Detector	Comment
1	11650.3660	37.17	17.17	54.34	68.30	-13.96	Peak	
2	11650.6000	30.07	17.17	47.24	54.00	-6.76	AVG	

Orthogonal Axis:	X
Test Mode:	UNII-3/TX N20 Mode 5745MHz

Vertical

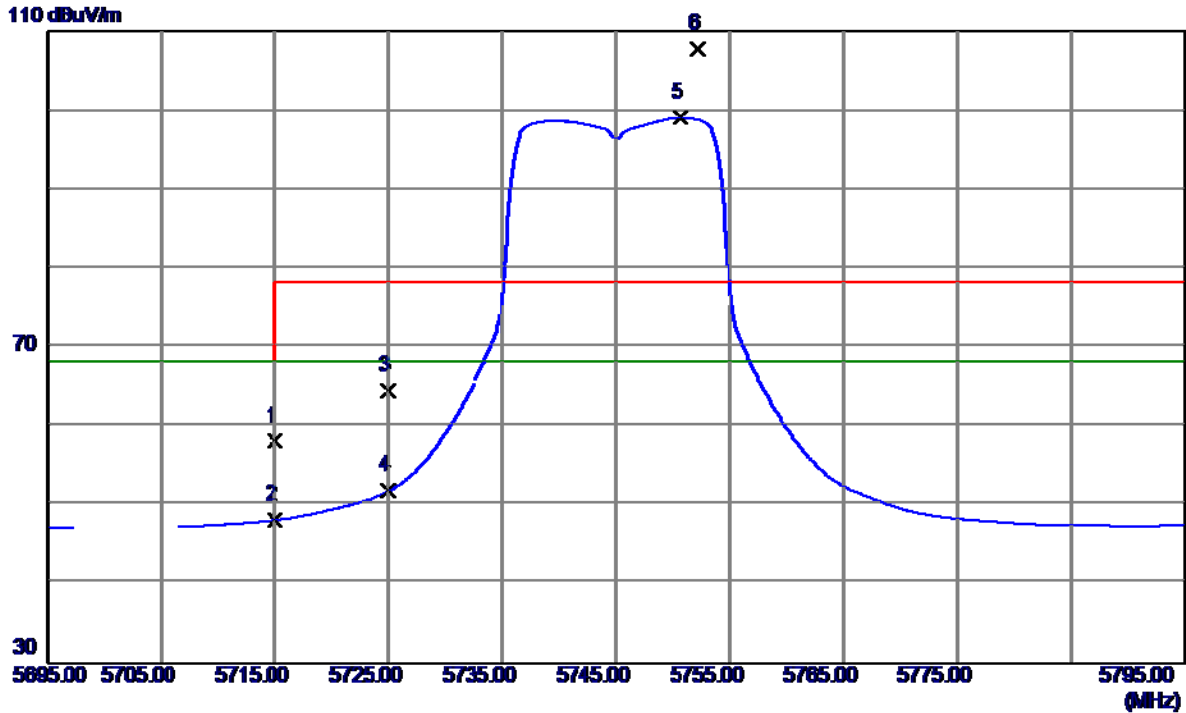

No.	Freq. MHz	Reading Level dBuV/m	Correct Factor dB	Measure ment dBuV/m	Limit dBuV/m	Margin dB	Detector	Comment
1	5715.0000	16.95	41.25	58.20	68.30	-10.10	Peak	
2	5715.0000	6.98	41.25	48.23	68.30	-20.07	AVG	
3	5725.0000	23.24	41.27	64.51	78.30	-13.79	Peak	
4	5725.0000	10.58	41.27	51.85	68.30	-16.45	AVG	
5	5750.7000	57.74	41.30	99.04	68.30	30.74	AVG	No Limit
6	5752.2000	66.42	41.30	107.72	78.30	29.42	Peak	No Limit

Orthogonal Axis:	X
Test Mode:	UNII-3/TX N20 Mode 5745MHz

Vertical

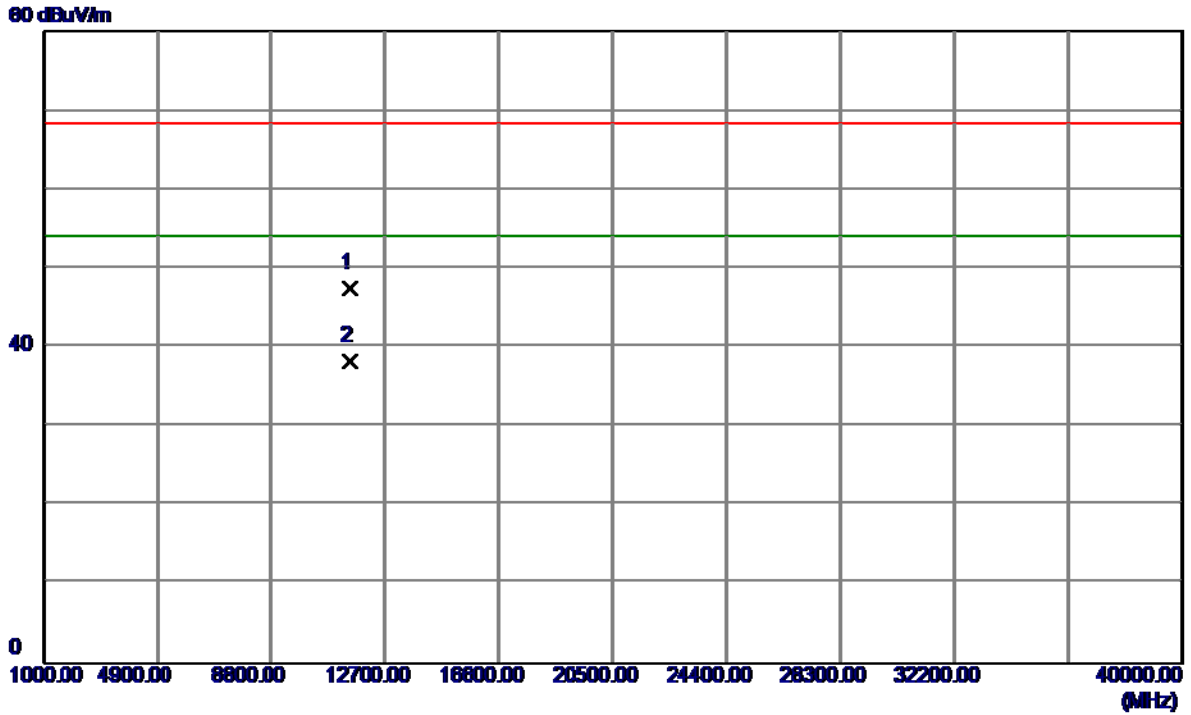

No.	Freq. MHz	Reading Level dBuV/m	Correct Factor dB	Measure ment dBuV/m	Limit dBuV/m	Margin dB	Detector	Comment
1	11490.1300	30.65	16.91	47.56	68.30	-20.74	Peak	
2	11490.1300	21.26	16.91	38.17	54.00	-15.83	AVG	

Orthogonal Axis:	X
Test Mode:	UNII-3/TX N20 Mode 5745MHz

Horizontal

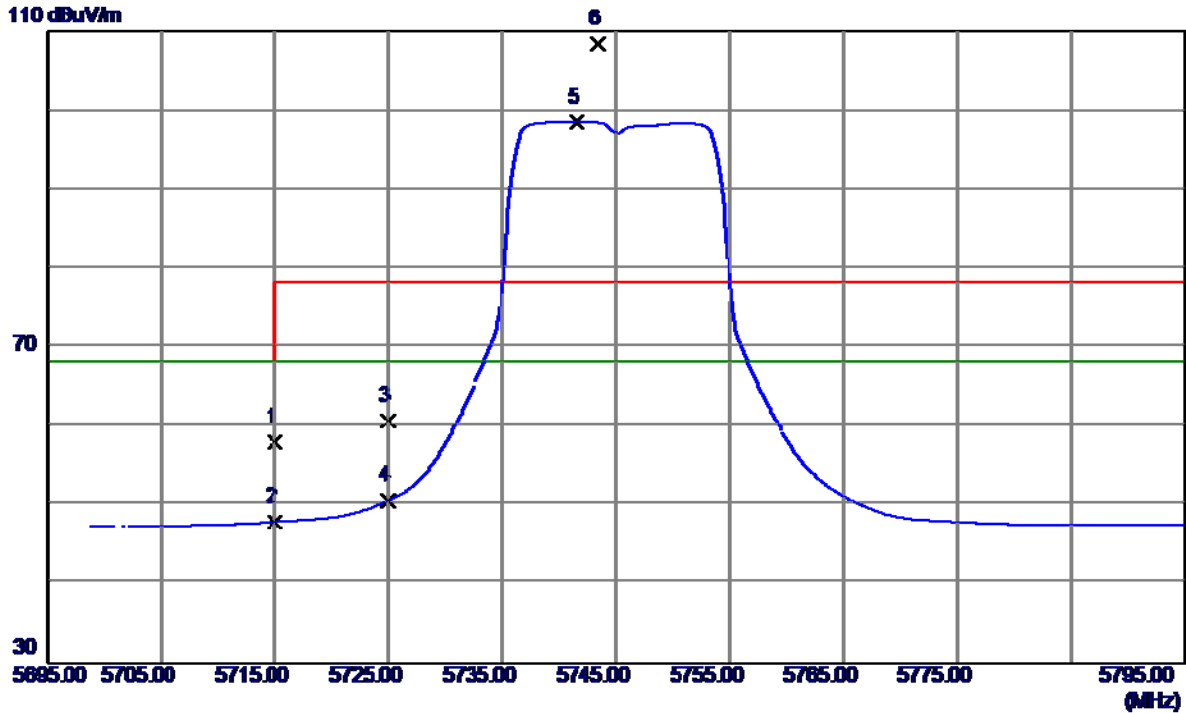

No.	Freq. MHz	Reading Level dBuV/m	Correct Factor dB	Measure ment dBuV/m	Limit dBuV/m	Margin dB	Detector	Comment
1	5715.0000	16.76	41.25	58.01	68.30	-10.29	Peak	
2	5715.0000	6.73	41.25	47.98	68.30	-20.32	AVG	
3	5725.0000	19.42	41.27	60.69	78.30	-17.61	Peak	
4	5725.0000	9.42	41.27	50.69	68.30	-17.61	AVG	
5	5741.6000	57.26	41.29	98.55	68.30	30.25	AVG	No Limit
6	5743.4000	67.15	41.29	108.44	78.30	30.14	Peak	No Limit

Orthogonal Axis:	X
Test Mode:	UNII-3/TX N20 Mode 5745MHz

Horizontal

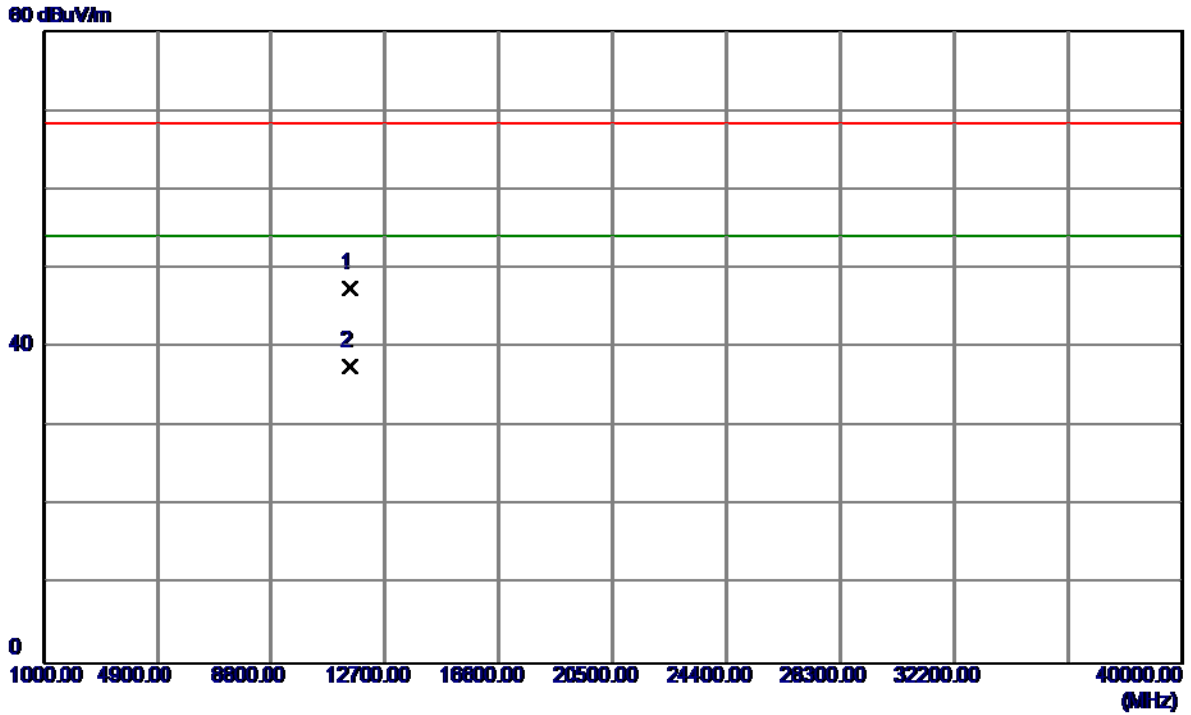

No.	Freq. MHz	Reading Level dBuV/m	Correct Factor dB	Measure ment dBuV/m	Limit dBuV/m	Margin dB	Detector	Comment
1	11490.7720	30.54	16.91	47.45	68.30	-20.85	Peak	
2	11490.3450	20.64	16.91	37.55	54.00	-16.45	AVG	

Orthogonal Axis:	X
Test Mode:	UNII-3/TX N20 Mode 5785MHz

Vertical

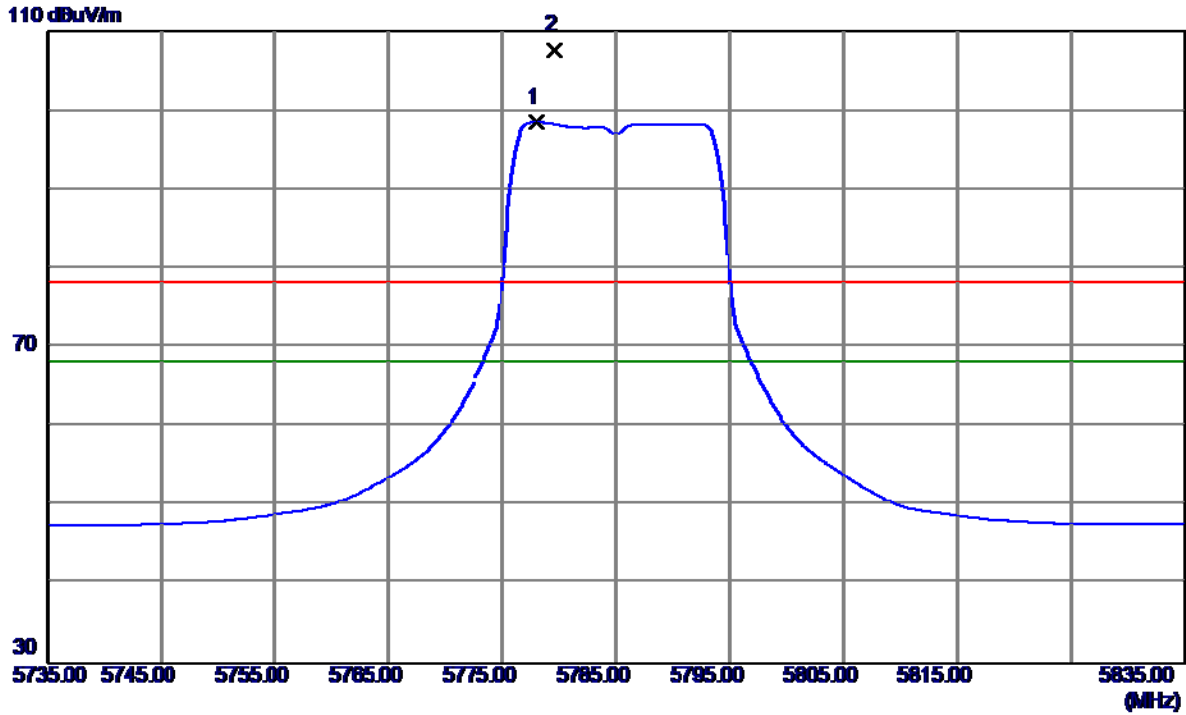

No.	Freq. MHz	Reading Level dBuV/m	Correct Factor dB	Measure ment dBuV/m	Limit dBuV/m	Margin dB	Detector	Comment
1	5778.0000	57.12	41.34	98.46	68.30	30.16	AVG	No Limit
2	5779.6000	66.25	41.34	107.59	78.30	29.29	Peak	No Limit

Orthogonal Axis:	X
Test Mode:	UNII-3/TX N20 Mode 5785MHz

Vertical

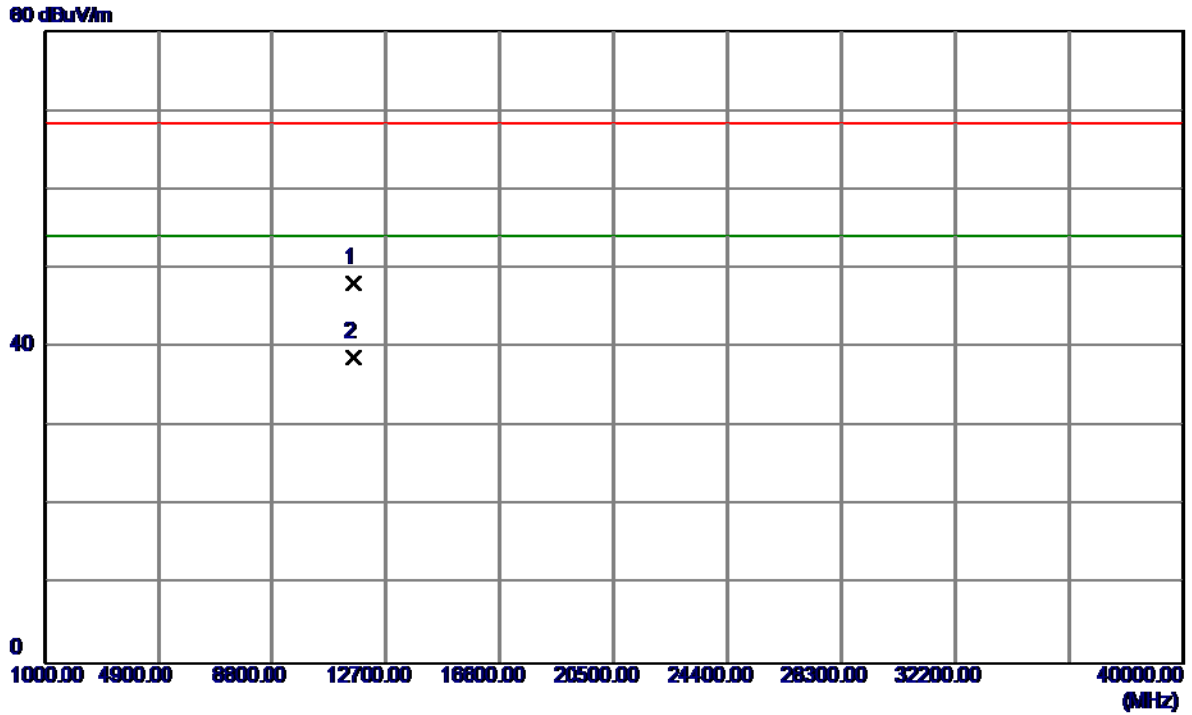

No.	Freq. MHz	Reading Level dBuV/m	Correct Factor dB	Measure ment dBuV/m	Limit dBuV/m	Margin dB	Detector	Comment
1	11570.6910	31.04	17.05	48.09	68.30	-20.21	Peak	
2	11570.6640	21.66	17.05	38.71	54.00	-15.29	AVG	

Orthogonal Axis:	X
Test Mode:	UNII-3/TX N20 Mode 5785MHz

Horizontal

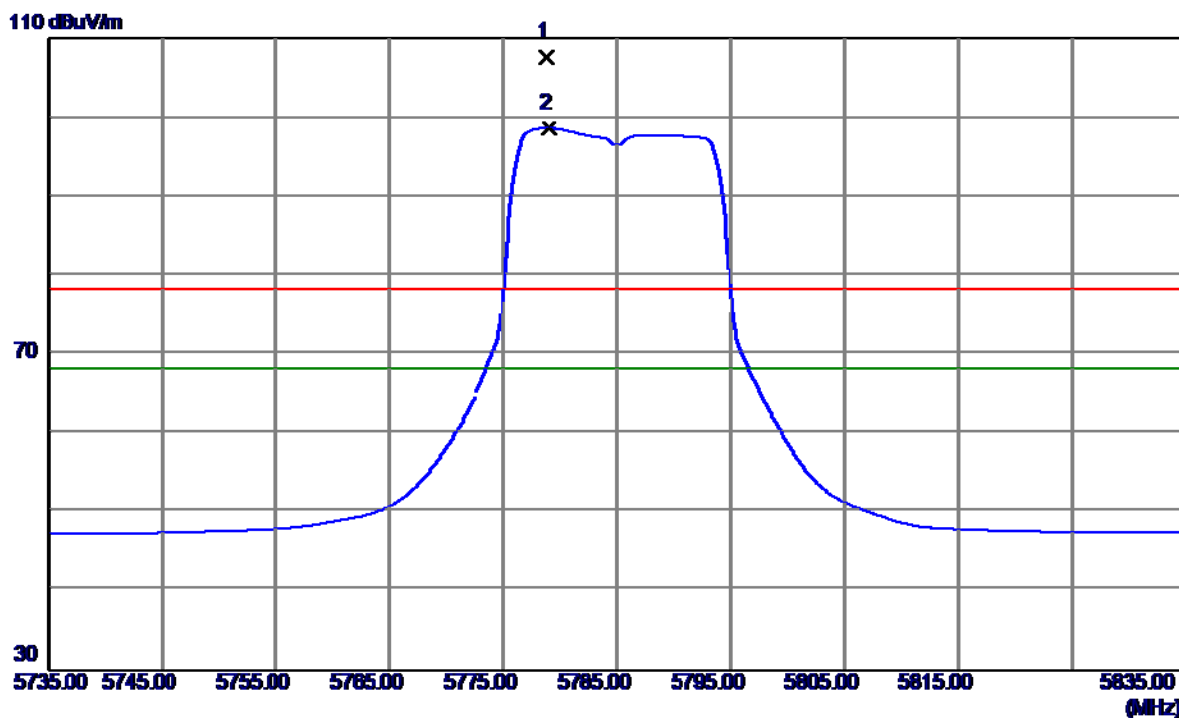

No.	Freq. MHz	Reading Level dBuV/m	Correct Factor dB	Measure ment dBuV/m	Limit dBuV/m	Margin dB	Detector	Comment
1	5778.8000	66.33	41.34	107.67	78.30	29.37	Peak	No Limit
2	5779.0000	57.28	41.34	98.62	68.30	30.32	AVG	No Limit

Orthogonal Axis:	X
Test Mode:	UNII-3/TX N20 Mode 5785MHz

Horizontal

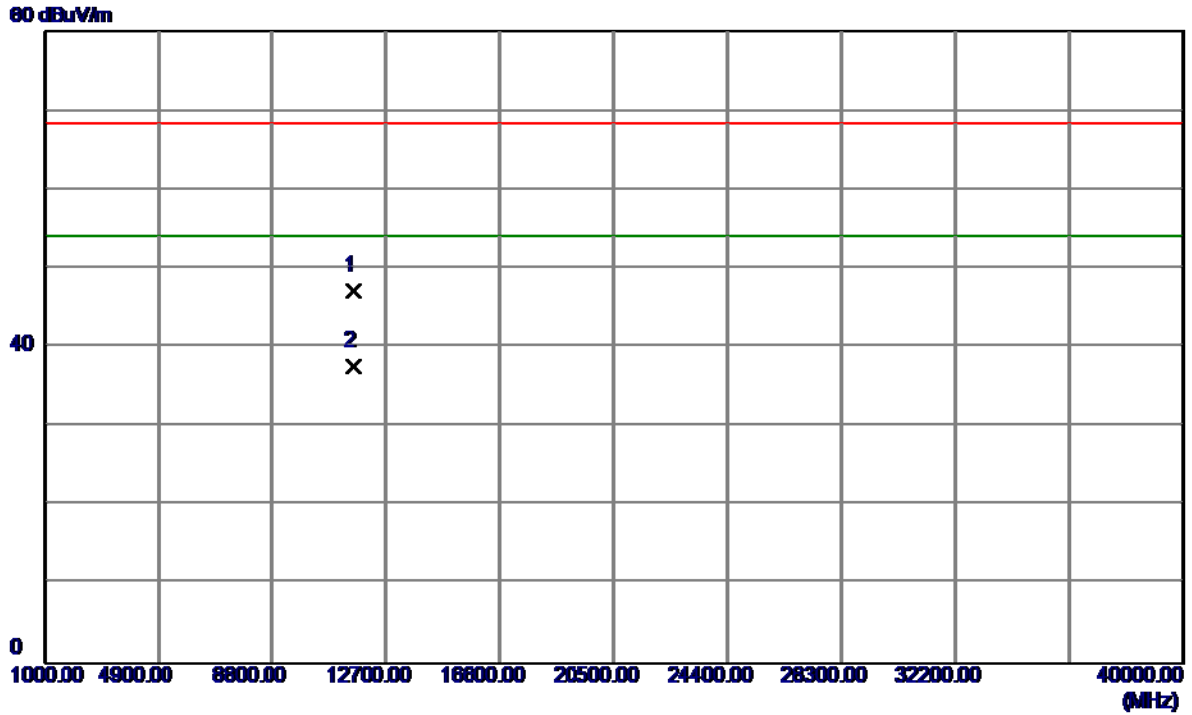

No.	Freq. MHz	Reading Level dBuV/m	Correct Factor dB	Measure ment dBuV/m	Limit dBuV/m	Margin dB	Detector	Comment
1	11570.1800	30.13	17.05	47.18	68.30	-21.12	Peak	
2	11570.1800	20.61	17.05	37.66	54.00	-16.34	AVG	

Orthogonal Axis:	X
Test Mode:	UNII-3/TX N20 Mode 5825MHz

Vertical

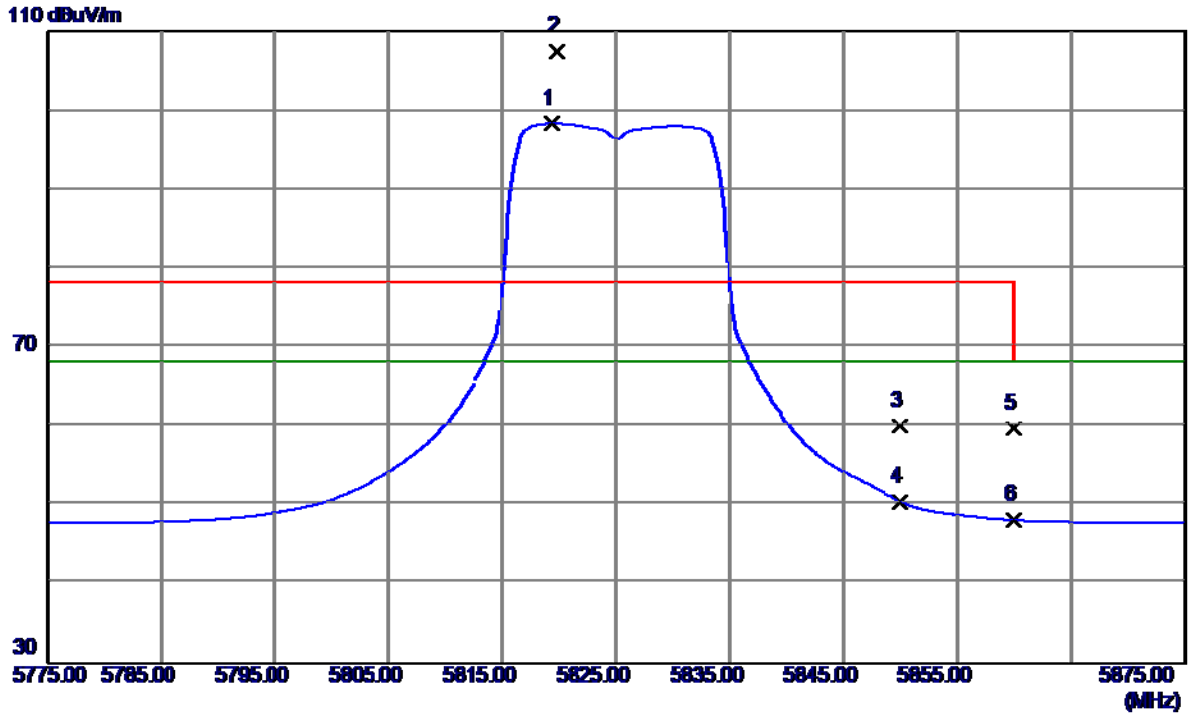

No.	Freq. MHz	Reading Level dBuV/m	Correct Factor dB	Measure ment dBuV/m	Limit dBuV/m	Margin dB	Detector	Comment
1	5819.3000	56.92	41.39	98.31	68.30	30.01	AVG	No Limit
2	5819.8000	66.03	41.39	107.42	78.30	29.12	Peak	No Limit
3	5850.0000	18.69	41.44	60.13	78.30	-18.17	Peak	
4	5850.0000	9.09	41.44	50.53	68.30	-17.77	AVG	
5	5860.0000	18.36	41.45	59.81	78.30	-18.49	Peak	
6	5860.0000	6.76	41.45	48.21	68.30	-20.09	AVG	

Orthogonal Axis:	X
Test Mode:	UNII-3/TX N20 Mode 5825MHz

Vertical

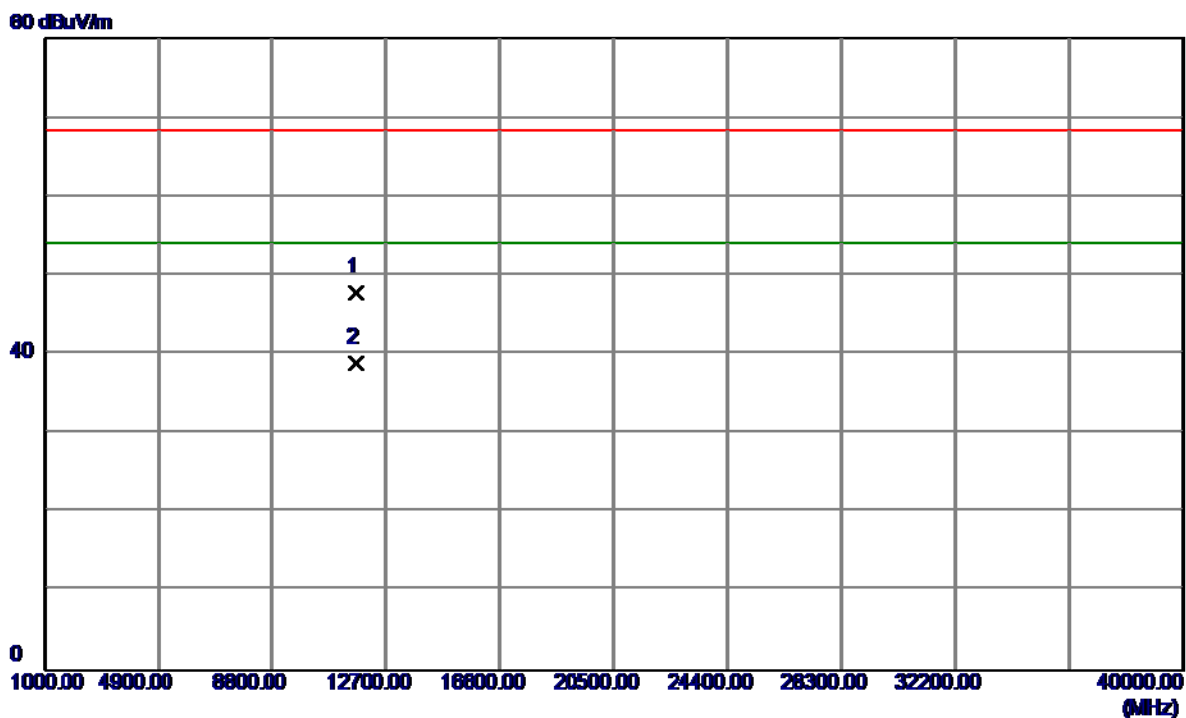

No.	Freq. MHz	Reading Level dBuV/m	Correct Factor dB	Measure ment dBuV/m	Limit dBuV/m	Margin dB	Detector	Comment
1	11650.1800	30.69	17.17	47.86	68.30	-20.44	Peak	
2	11650.1800	21.77	17.17	38.94	54.00	-15.06	AVG	

Orthogonal Axis:	X
Test Mode:	UNII-3/TX N20 Mode 5825MHz

Horizontal

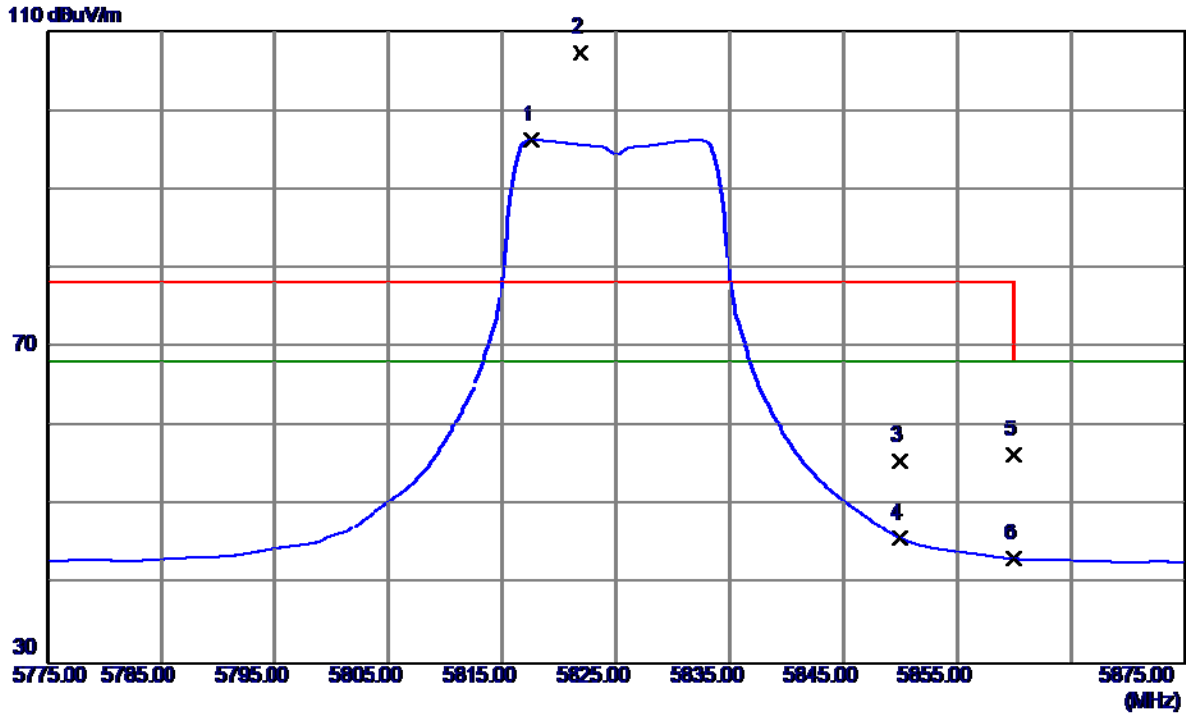

No.	Freq. MHz	Reading Level dBuV/m	Correct Factor dB	Measure ment dBuV/m	Limit dBuV/m	Margin dB	Detector	Comment
1	5817.6000	54.84	41.39	96.23	68.30	27.93	AVG	No Limit
2	5821.9000	65.90	41.40	107.30	78.30	29.00	Peak	No Limit
3	5850.0000	14.10	41.44	55.54	78.30	-22.76	Peak	
4	5850.0000	4.41	41.44	45.85	68.30	-22.45	AVG	
5	5860.0000	14.92	41.45	56.37	78.30	-21.93	Peak	
6	5860.0000	1.79	41.45	43.24	68.30	-25.06	AVG	

Orthogonal Axis:	X
Test Mode:	UNII-3/TX N20 Mode 5825MHz

Horizontal

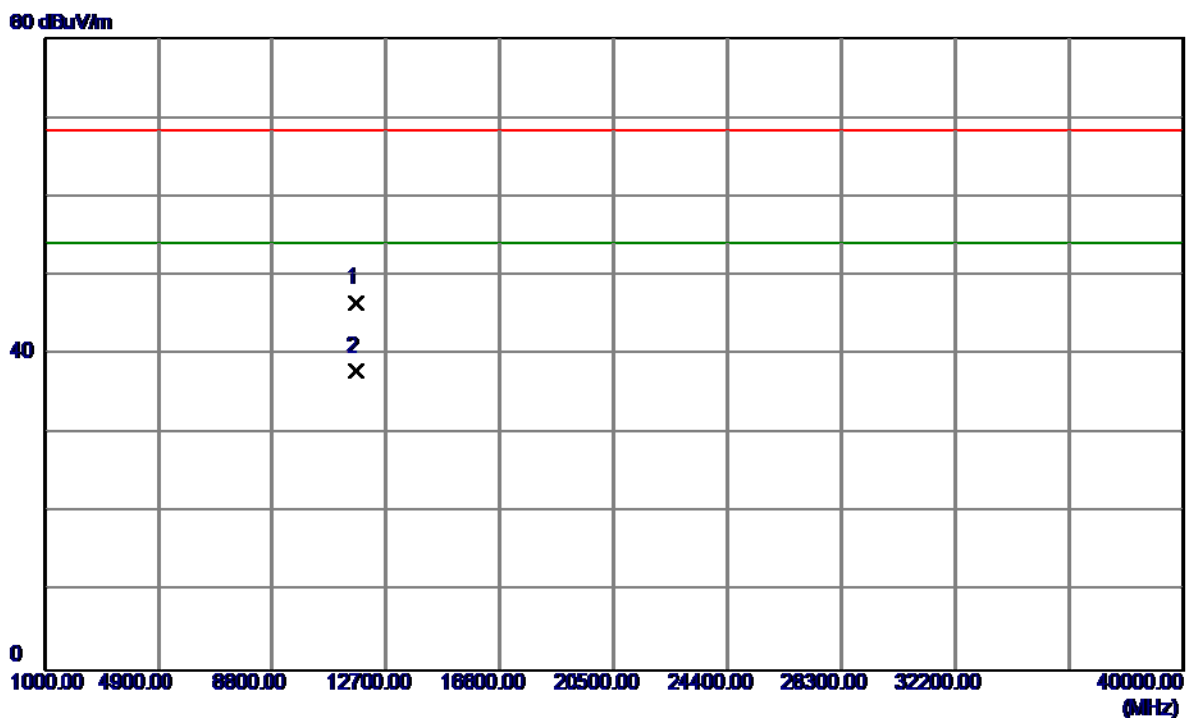

No.	Freq. MHz	Reading Level dBuV/m	Correct Factor dB	Measure ment dBuV/m	Limit dBuV/m	Margin dB	Detector	Comment
1	11650.1140	29.37	17.17	46.54	68.30	-21.76	Peak	
2	11650.4720	20.67	17.17	37.84	54.00	-16.16	AVG	

Orthogonal Axis:	X
Test Mode:	UNII-3/TX N40 Mode 5755MHz

Vertical

110 dBuV/m

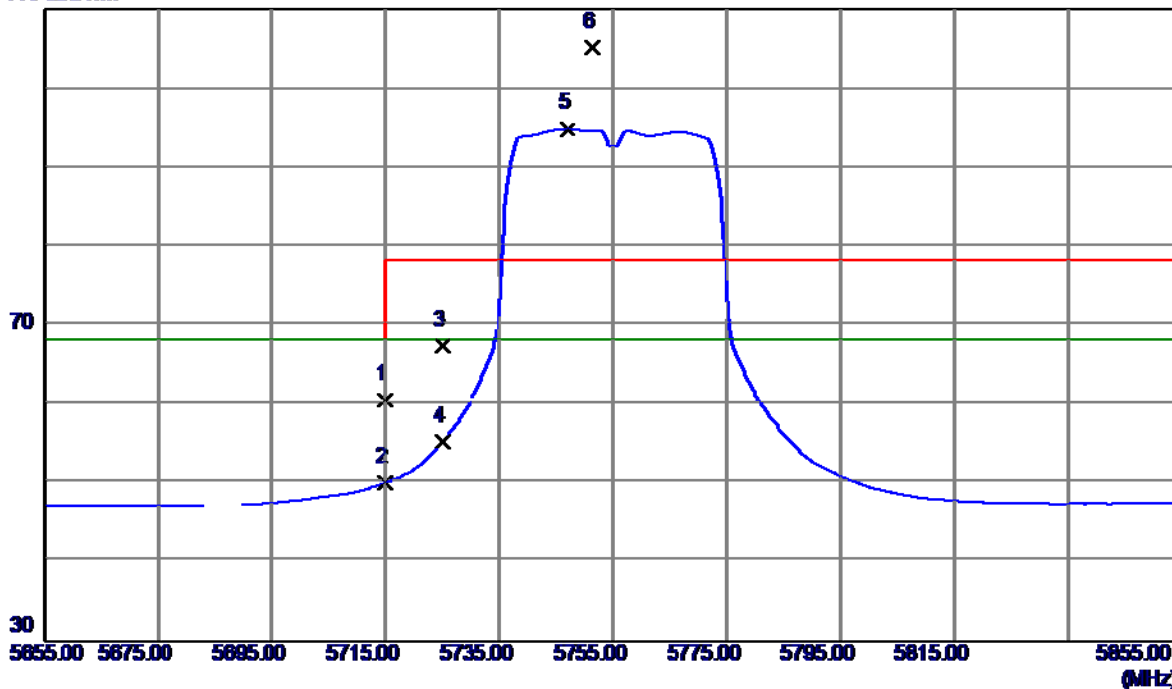

No.	Freq. MHz	Reading Level dBuV/m	Correct Factor dB	Measure ment dBuV/m	Limit dBuV/m	Margin dB	Detector	Comment
1	5715.0000	19.39	41.25	60.64	68.30	-7.66	Peak	
2	5715.0000	8.93	41.25	50.18	68.30	-18.12	AVG	
3	5725.0000	26.16	41.27	67.43	78.30	-10.87	Peak	
4	5725.0000	14.04	41.27	55.31	68.30	-12.99	AVG	
5	5747.0000	53.58	41.30	94.88	68.30	26.58	AVG	No Limit
6	5751.4000	63.85	41.30	105.15	78.30	26.85	Peak	No Limit

Orthogonal Axis:	X
Test Mode:	UNII-3/TX N40 Mode 5755MHz

Vertical

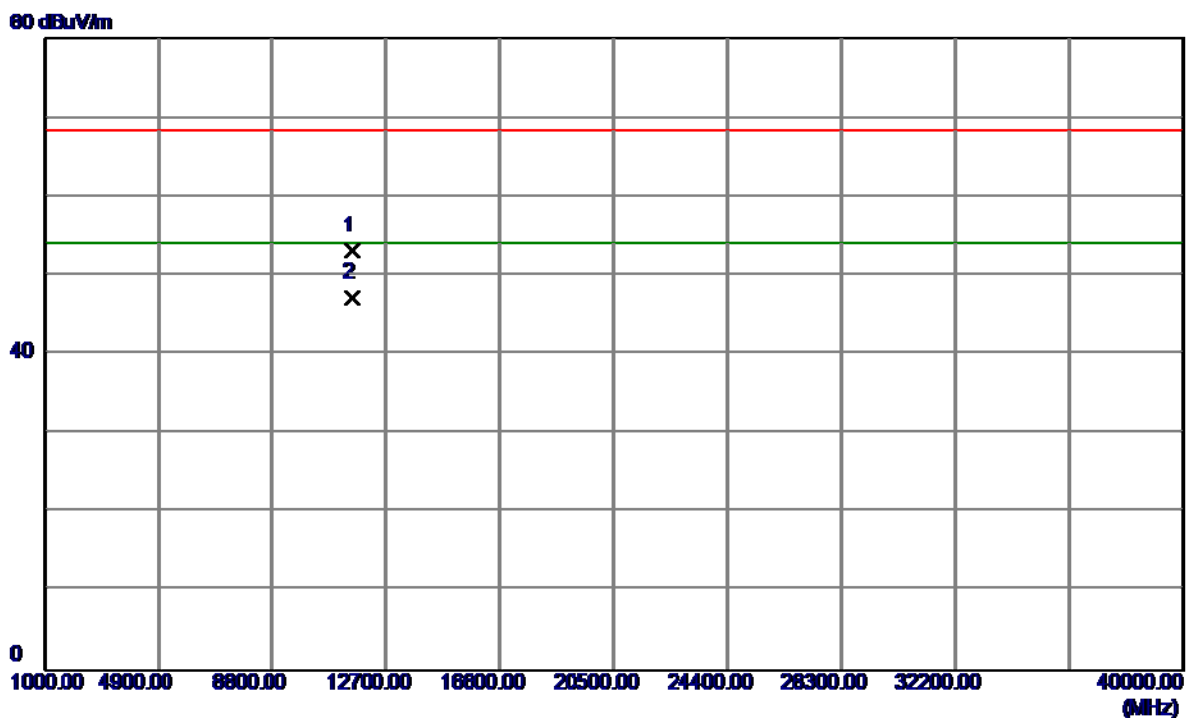

No.	Freq. MHz	Reading Level dBuV/m	Correct Factor dB	Measure ment dBuV/m	Limit dBuV/m	Margin dB	Detector	Comment
1	11510.7200	36.24	16.95	53.19	68.30	-15.11	Peak	
2	11510.4340	30.30	16.95	47.25	54.00	-6.75	AVG	

Orthogonal Axis:	X
Test Mode:	UNII-3/TX N40 Mode 5755MHz

Horizontal

110 dBuV/m

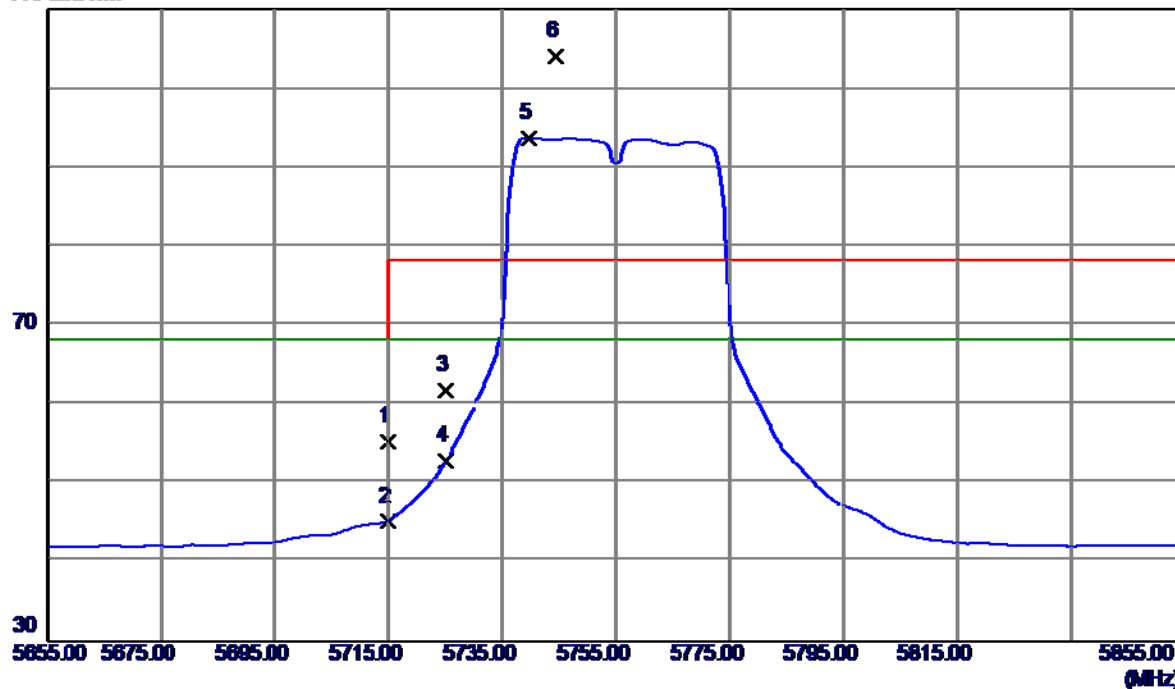

No.	Freq. MHz	Reading Level dBuV/m	Correct Factor dB	Measure ment dBuV/m	Limit dBuV/m	Margin dB	Detector	Comment
1	5715.0000	14.03	41.25	55.28	68.30	-13.02	Peak	
2	5715.0000	4.02	41.25	45.27	68.30	-23.03	AVG	
3	5725.0000	20.54	41.27	61.81	78.30	-16.49	Peak	
4	5725.0000	11.57	41.27	52.84	68.30	-15.46	AVG	
5	5739.6000	52.39	41.29	93.68	68.30	25.38	AVG	No Limit
6	5744.4000	62.84	41.29	104.13	78.30	25.83	Peak	No Limit

Orthogonal Axis:	X
Test Mode:	UNII-3/TX N40 Mode 5755MHz

Horizontal

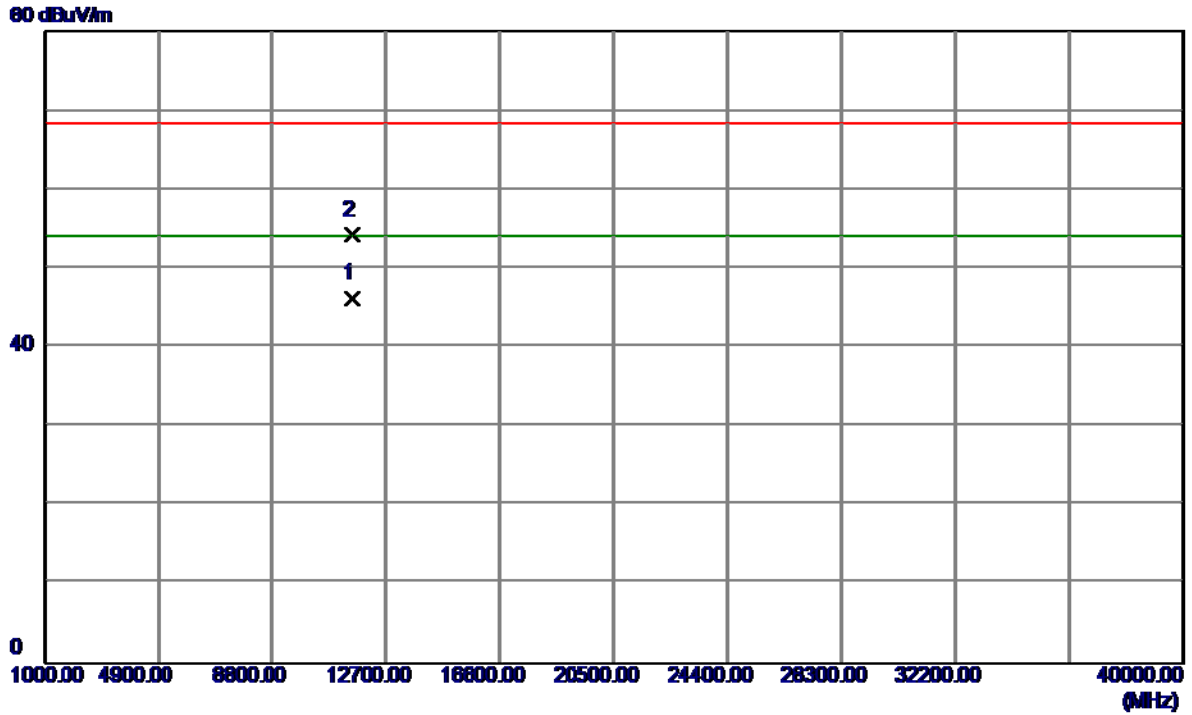

No.	Freq. MHz	Reading Level dBuV/m	Correct Factor dB	Measure ment dBuV/m	Limit dBuV/m	Margin dB	Detector	Comment
1	11510.4470	29.34	16.95	46.29	54.00	-7.71	AVG	
2	11510.2880	37.23	16.95	54.18	68.30	-14.12	Peak	

Orthogonal Axis:	X
Test Mode:	UNII-3/TX N40 Mode 5795MHz

Vertical

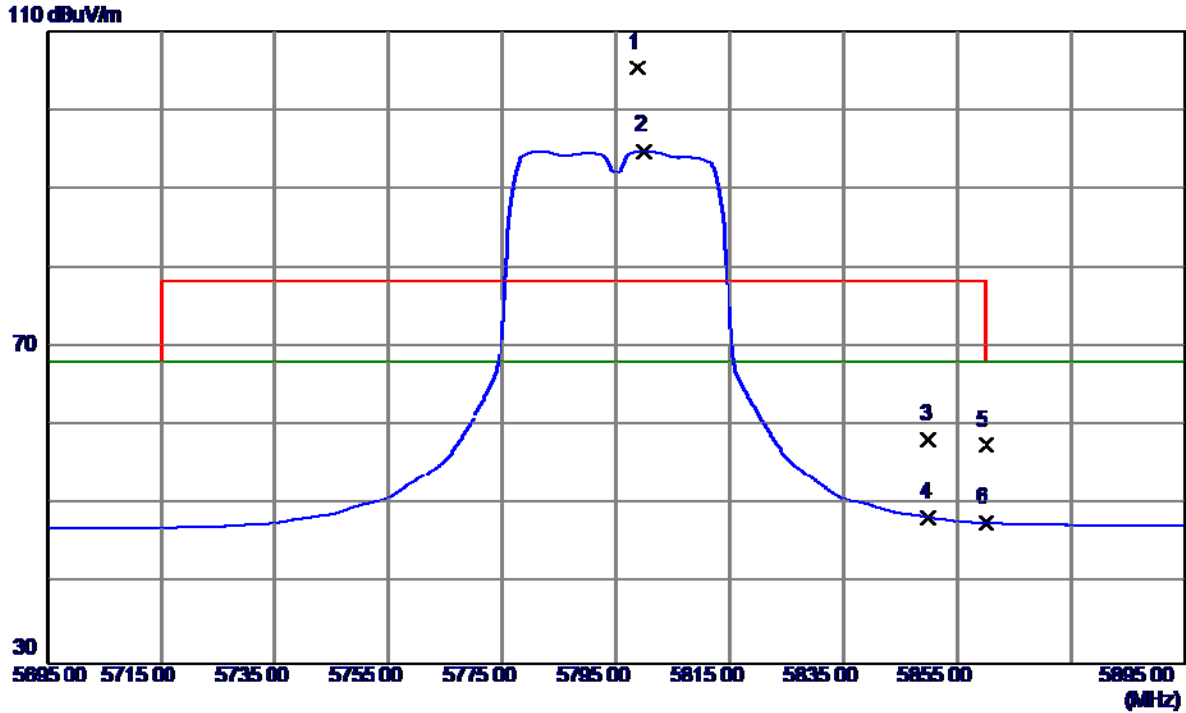

No.	Freq. MHz	Reading Level dBuV/m	Correct Factor dB	Measure ment dBuV/m	Limit dBuV/m	Margin dB	Detector	Comment
1	5798.8000	64.05	41.37	105.42	78.30	27.12	Peak	No Limit
2	5799.8000	53.51	41.37	94.88	68.30	26.58	AVG	No Limit
3	5850.0000	16.82	41.44	58.26	78.30	-20.04	Peak	
4	5850.0000	6.99	41.44	48.43	68.30	-19.87	AVG	
5	5860.0000	16.15	41.45	57.60	78.30	-20.70	Peak	
6	5860.0000	6.29	41.45	47.74	68.30	-20.56	AVG	

Orthogonal Axis:	X
Test Mode:	UNII-3/TX N40 Mode 5795MHz

Vertical

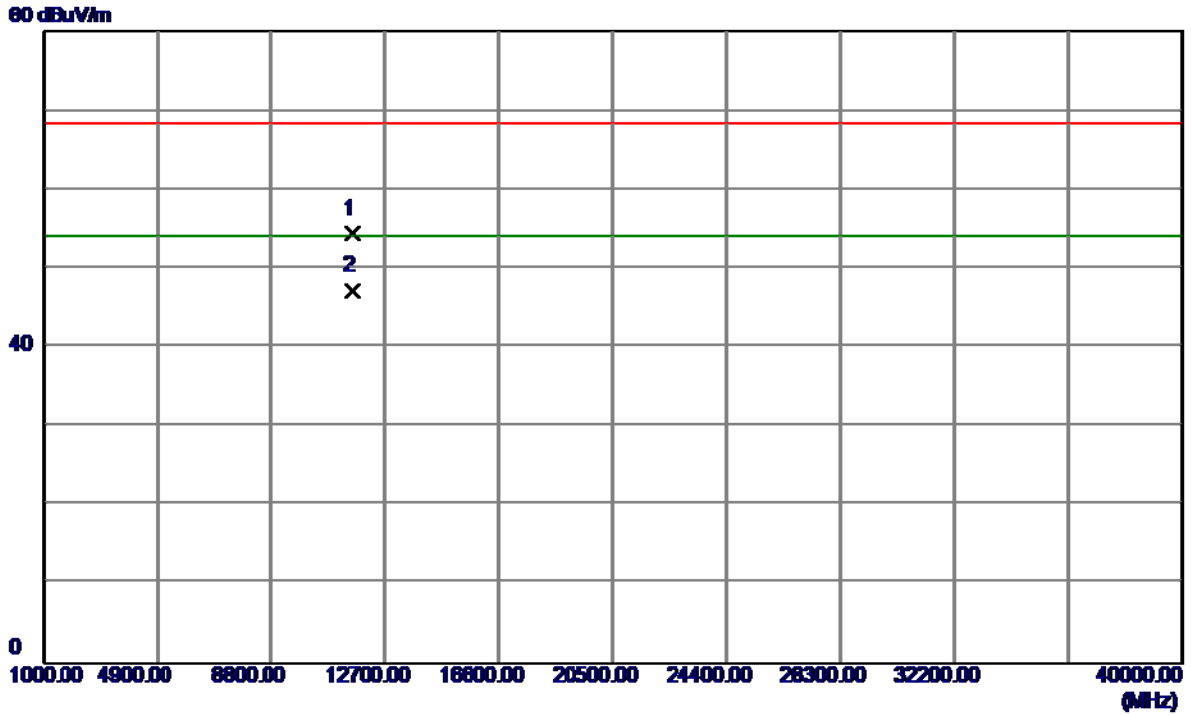

No.	Freq. MHz	Reading Level dBuV/m	Correct Factor dB	Measure ment dBuV/m	Limit dBuV/m	Margin dB	Detector	Comment
1	11590.2619	37.25	17.08	54.33	68.30	-13.97	Peak	
2	11590.8920	30.16	17.08	47.24	54.00	-6.76	AVG	

Orthogonal Axis:	X
Test Mode:	UNII-3/TX N40 Mode 5795MHz

Horizontal

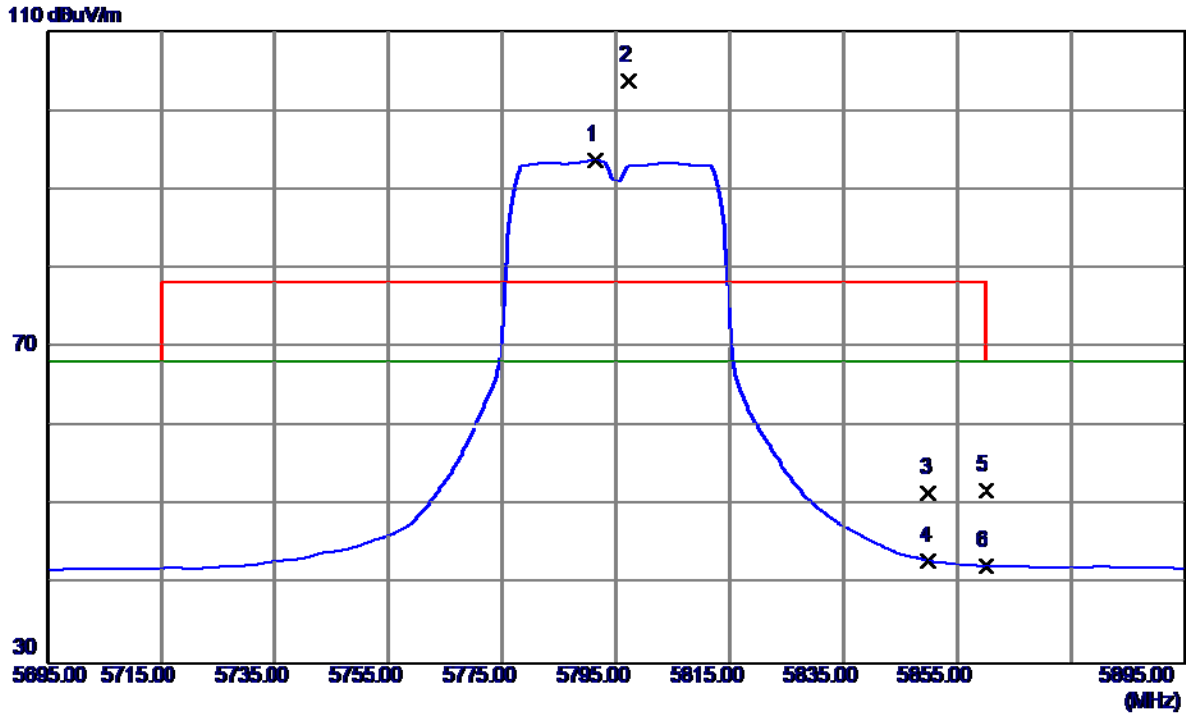

No.	Freq. MHz	Reading Level dBuV/m	Correct Factor dB	Measure ment dBuV/m	Limit dBuV/m	Margin dB	Detector	Comment
1	5791.4000	52.30	41.36	93.66	68.30	25.36	AVG	No Limit
2	5797.2000	62.41	41.36	103.77	78.30	25.47	Peak	No Limit
3	5850.0000	10.12	41.44	51.56	78.30	-26.74	Peak	
4	5850.0000	1.54	41.44	42.98	68.30	-25.32	AVG	
5	5860.0000	10.44	41.45	51.89	78.30	-26.41	Peak	
6	5860.0000	0.86	41.45	42.31	68.30	-25.99	AVG	

Orthogonal Axis:	X
Test Mode:	UNII-3/TX N40 Mode 5795MHz

Horizontal

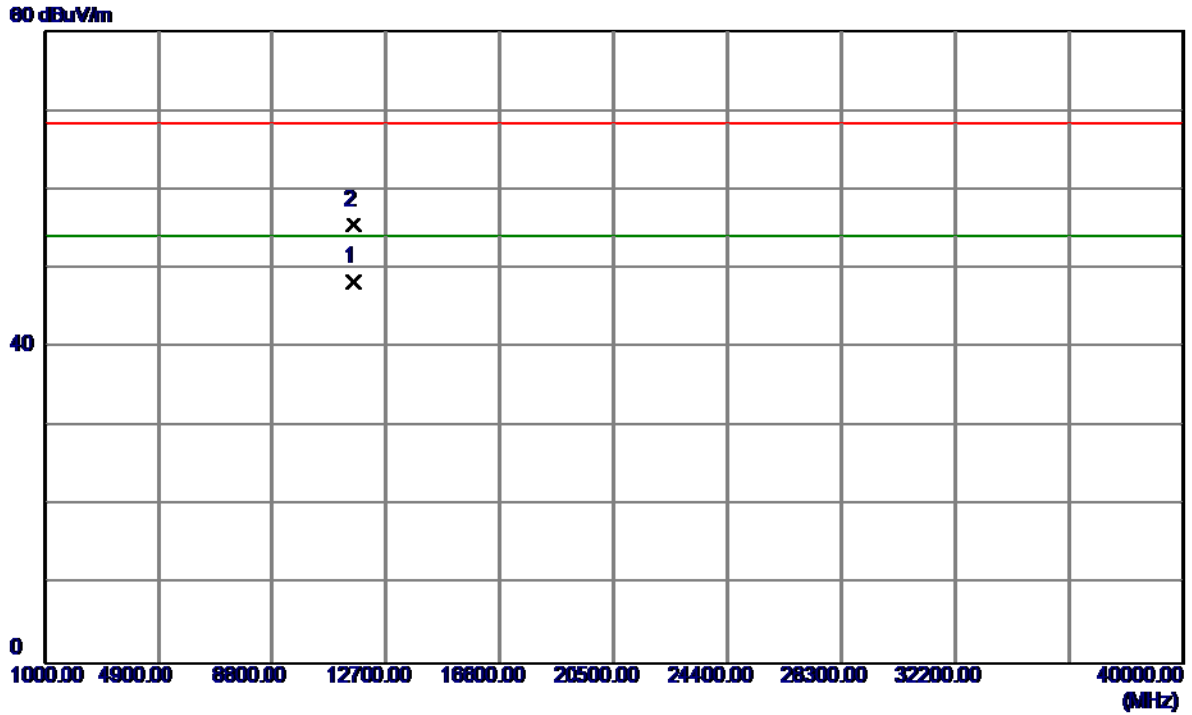

No.	Freq. MHz	Reading Level dBuV/m	Correct Factor dB	Measure ment dBuV/m	Limit dBuV/m	Margin dB	Detector	Comment
1	11590.4620	31.23	17.08	48.31	54.00	-5.69	AVG	
2	11590.6260	38.42	17.08	55.50	68.30	-12.80	Peak	

Orthogonal Axis:	X
Test Mode:	UNII-1/ TX AC20 Mode 5180MHz

Vertical

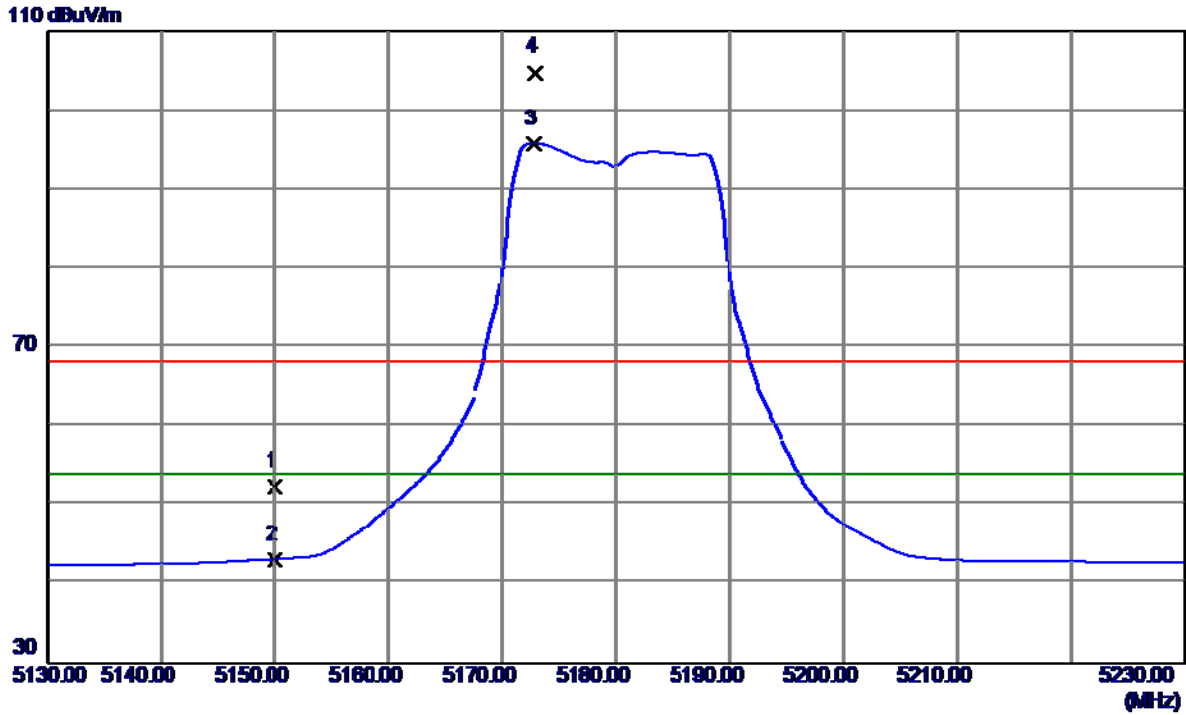

No.	Freq. MHz	Reading Level dBuV/m	Correct Factor dB	Measure ment dBuV/m	Limit dBuV/m	Margin dB	Detector	Comment
1	5150.0000	12.16	40.22	52.38	68.30	-15.92	Peak	
2	5150.0000	2.96	40.22	43.18	54.00	-10.82	AVG	
3	5172.8000	55.56	40.27	95.83	54.00	41.83	AVG	No Limit
4	5172.9000	64.53	40.27	104.80	68.30	36.50	Peak	No Limit

Orthogonal Axis:	X
Test Mode:	UNII-1/ TX AC20 Mode 5180MHz

Vertical

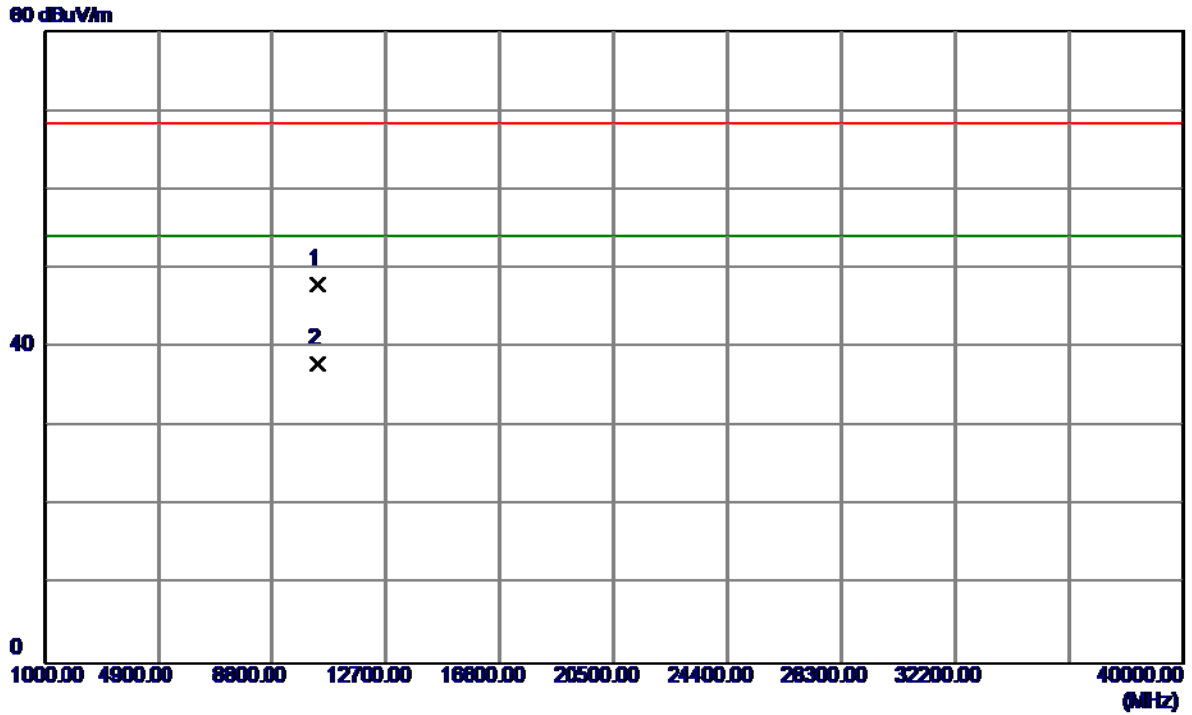

No.	Freq. MHz	Reading Level dBuV/m	Correct Factor dB	Measure ment dBuV/m	Limit dBuV/m	Margin dB	Detector	Comment
1	10360.1210	34.07	13.86	47.93	68.30	-20.37	Peak	
2	10360.3280	24.01	13.86	37.87	54.00	-16.13	AVG	

Orthogonal Axis:	X
Test Mode:	UNII-1/ TX AC20 Mode 5180MHz

Horizontal

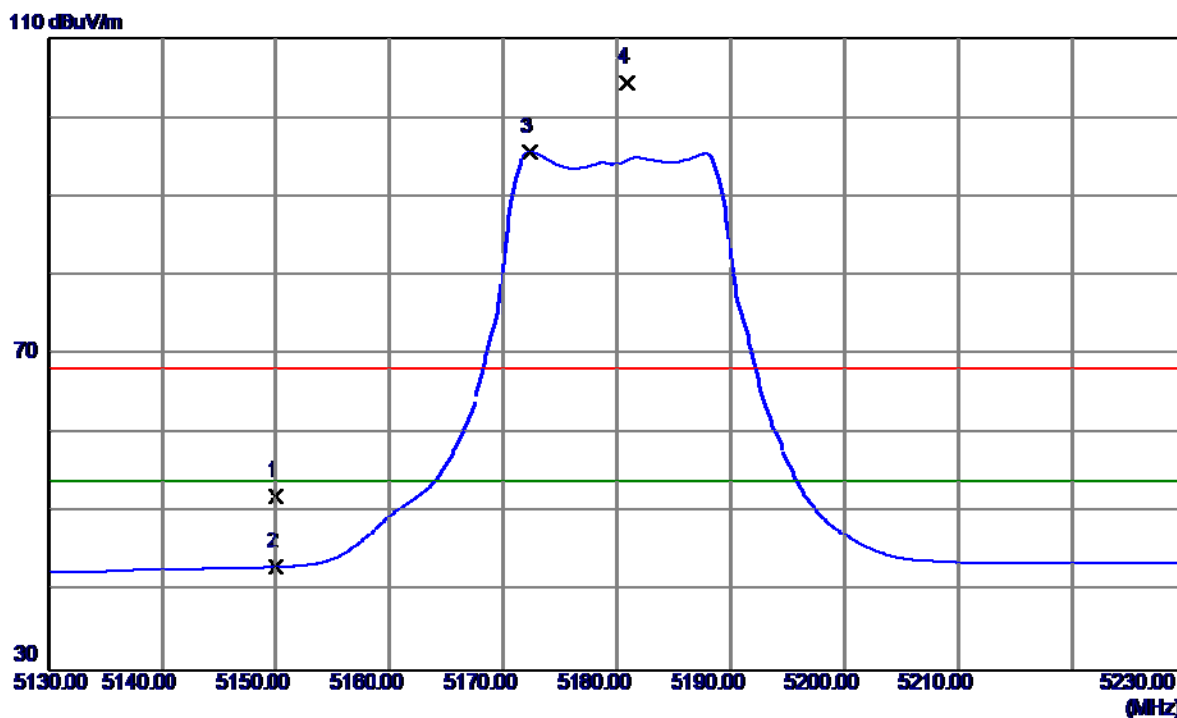

No.	Freq. MHz	Reading Level dBuV/m	Correct Factor dB	Measure ment dBuV/m	Limit dBuV/m	Margin dB	Detector	Comment
1	5150.0000	11.92	40.22	52.14	68.30	-16.16	Peak	
2	5150.0000	2.88	40.22	43.10	54.00	-10.90	AVG	
3	5172.3000	55.34	40.27	95.61	54.00	41.61	AVG	No Limit
4	5180.9000	64.17	40.28	104.45	68.30	36.15	Peak	No Limit

Orthogonal Axis:	X
Test Mode:	UNII-1/ TX AC20 Mode 5180MHz

Horizontal

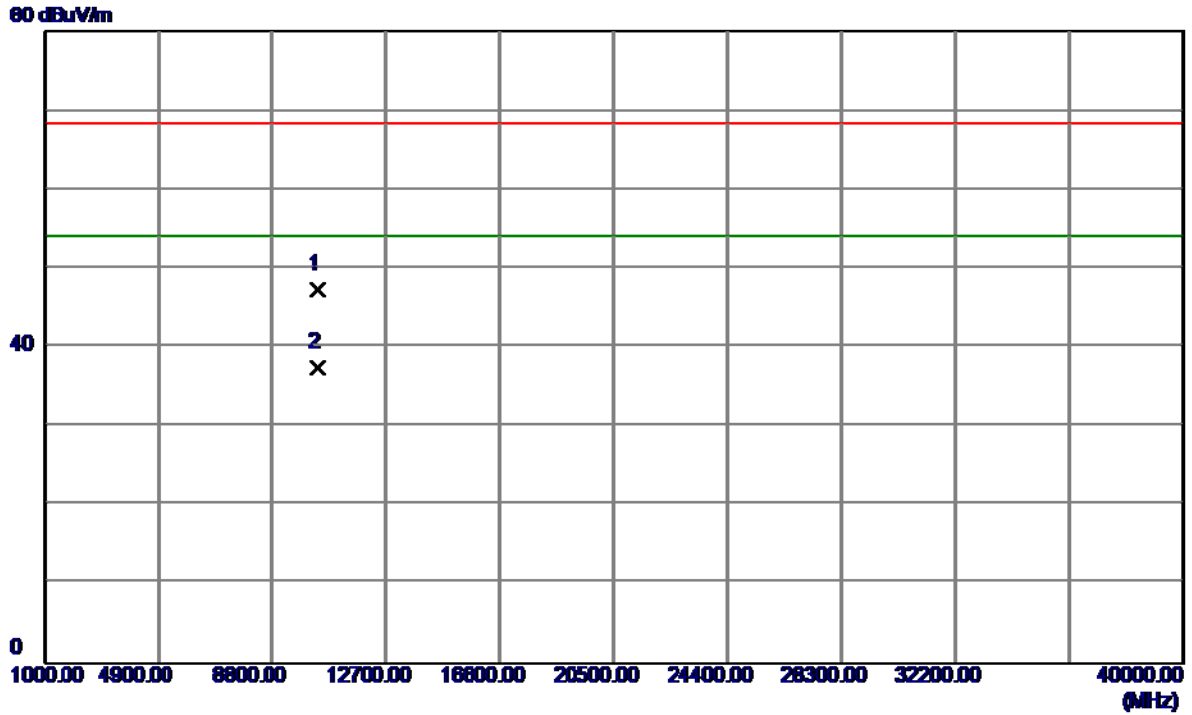

No.	Freq. MHz	Reading Level dBuV/m	Correct Factor dB	Measure ment dBuV/m	Limit dBuV/m	Margin dB	Detector	Comment
1	10360.0100	33.55	13.86	47.41	68.30	-20.89	Peak	
2	10360.0100	23.57	13.86	37.43	54.00	-16.57	AVG	

Orthogonal Axis:	X
Test Mode:	UNII-1/ TX AC20 Mode 5200MHz

Vertical

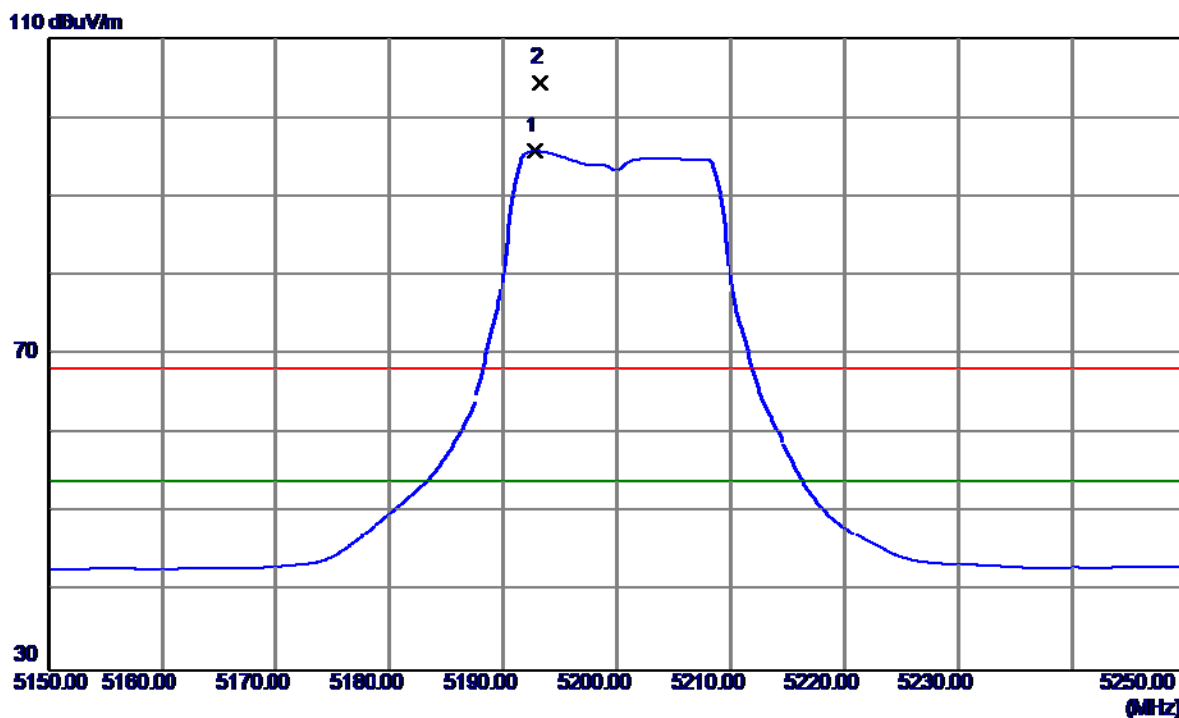

No.	Freq. MHz	Reading Level dBuV/m	Correct Factor dB	Measure ment dBuV/m	Limit dBuV/m	Margin dB	Detector	Comment
1	5192.8000	55.41	40.31	95.72	54.00	41.72	AVG	No Limit
2	5193.2000	64.13	40.31	104.44	68.30	36.14	Peak	No Limit

Orthogonal Axis:	X
Test Mode:	UNII-1/ TX AC20 Mode 5200MHz

Vertical

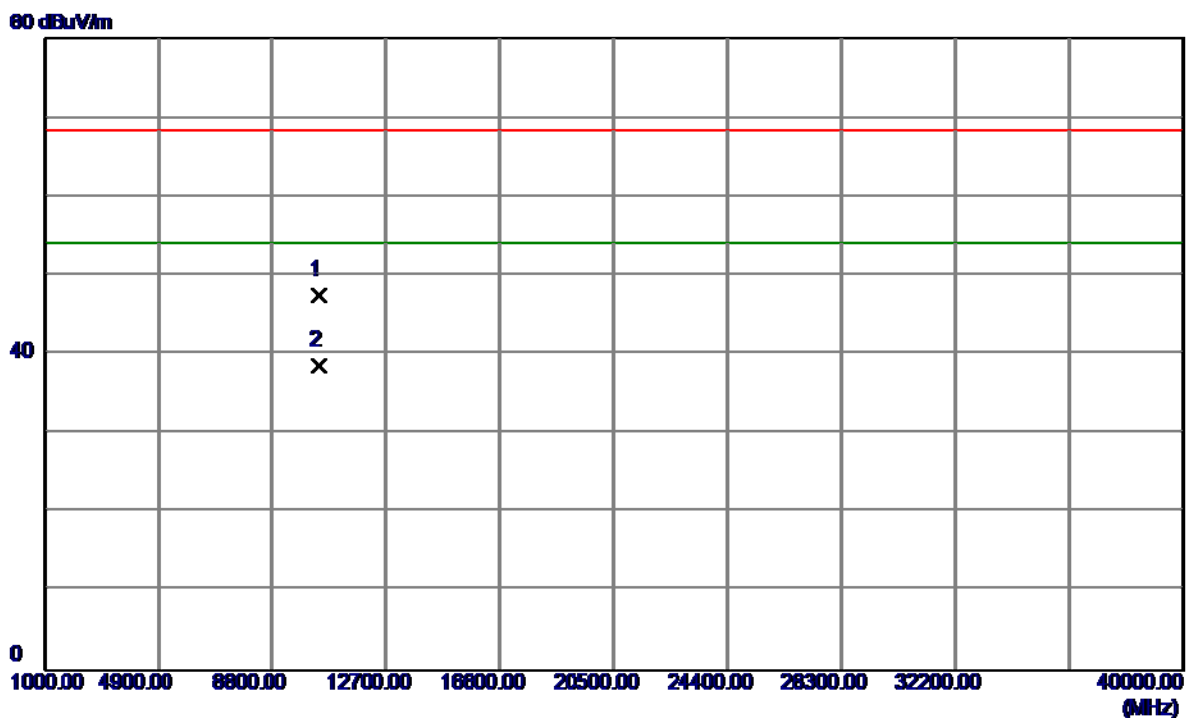

No.	Freq. MHz	Reading Level dBuV/m	Correct Factor dB	Measure ment dBuV/m	Limit dBuV/m	Margin dB	Detector	Comment
1	10400.3500	33.78	13.80	47.58	68.30	-20.72	Peak	
2	10400.3500	24.81	13.80	38.61	54.00	-15.39	AVG	

Orthogonal Axis:	X
Test Mode:	UNII-1/ TX AC20 Mode 5200MHz

Horizontal

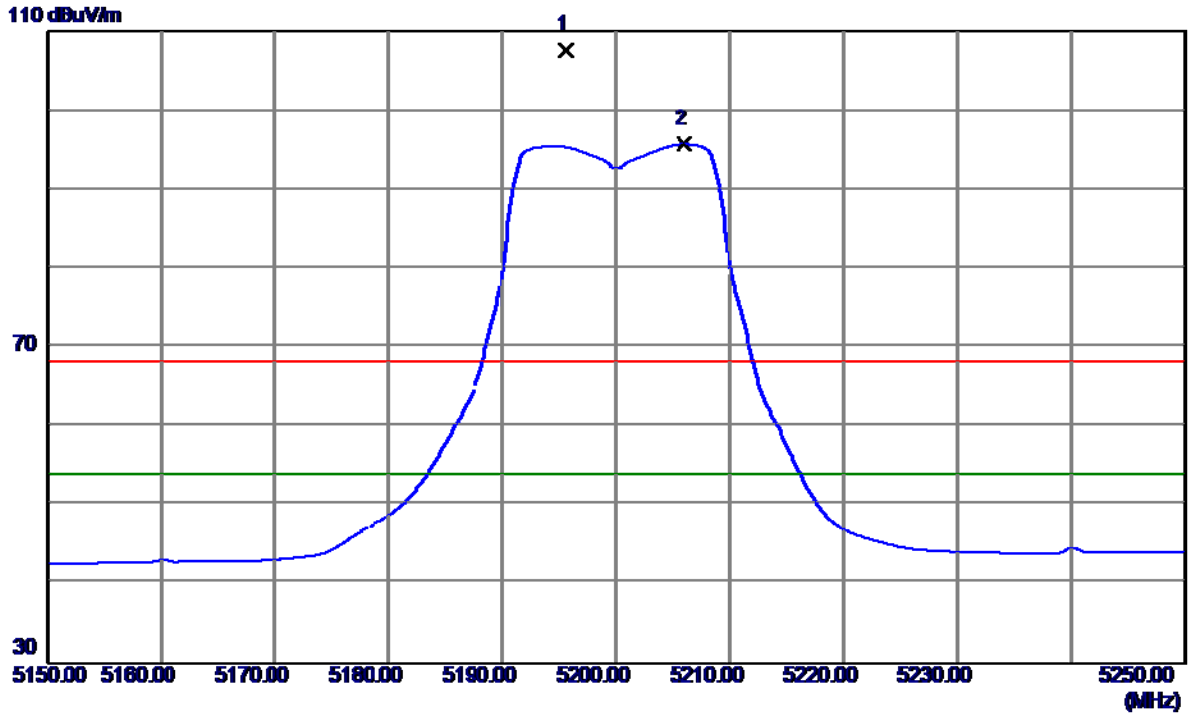

No.	Freq. MHz	Reading Level dBuV/m	Correct Factor dB	Measure ment dBuV/m	Limit dBuV/m	Margin dB	Detector	Comment
1	5195.6000	67.23	40.31	107.54	68.30	39.24	Peak	No Limit
2	5206.0000	55.35	40.34	95.69	54.00	41.69	AVG	No Limit

Orthogonal Axis:	X
Test Mode:	UNII-1/ TX AC20 Mode 5200MHz

Horizontal

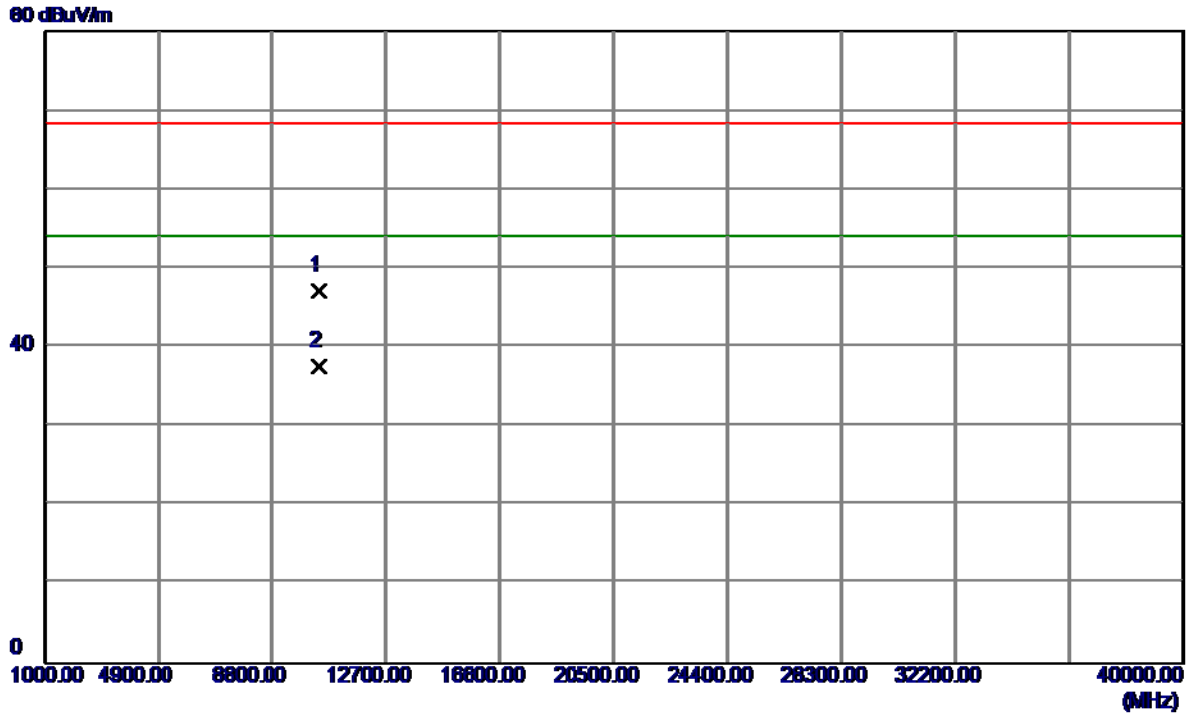

No.	Freq. MHz	Reading Level dBuV/m	Correct Factor dB	Measure ment dBuV/m	Limit dBuV/m	Margin dB	Detector	Comment
1	10400.6210	33.33	13.80	47.13	68.30	-21.17	Peak	
2	10400.5540	23.74	13.80	37.54	54.00	-16.46	AVG	

Orthogonal Axis:	X
Test Mode:	UNII-1/ TX AC20 Mode 5240MHz

Vertical

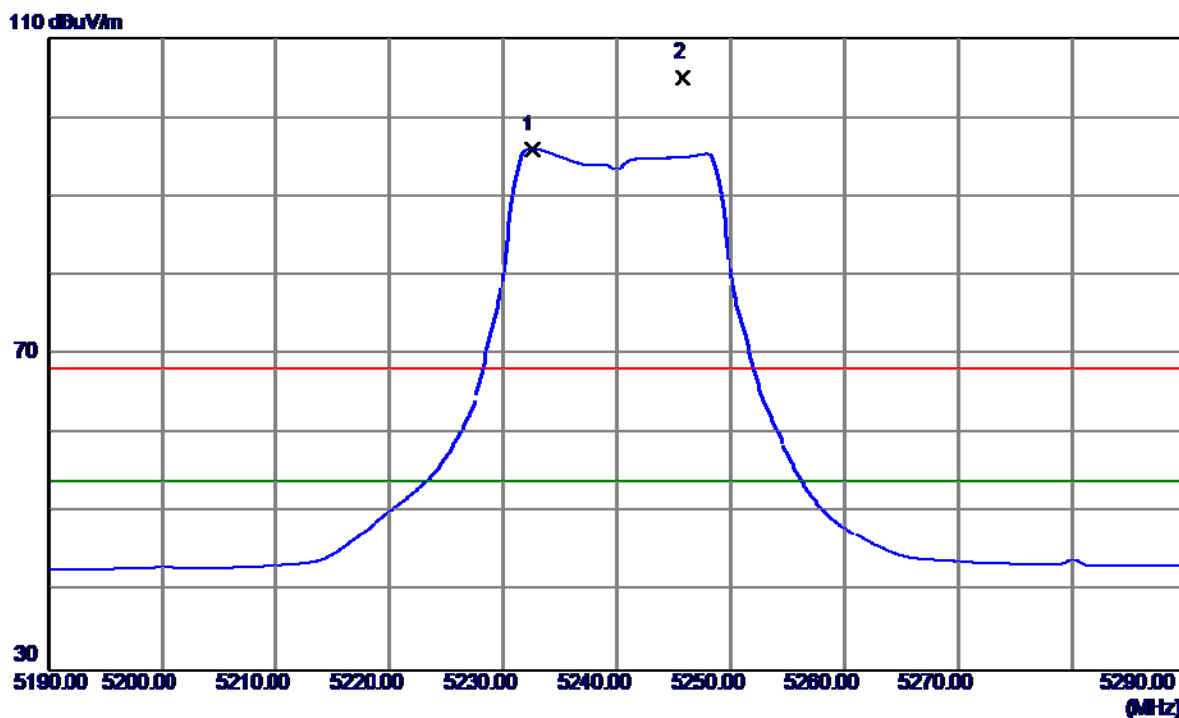

No.	Freq. MHz	Reading Level dBuV/m	Correct Factor dB	Measure ment dBuV/m	Limit dBuV/m	Margin dB	Detector	Comment
1	5232.5000	55.59	40.39	95.98	54.00	41.98	AVG	No Limit
2	5245.8000	64.55	40.42	104.97	68.30	36.67	Peak	No Limit

Orthogonal Axis:	X
Test Mode:	UNII-1/ TX AC20 Mode 5240MHz

Vertical

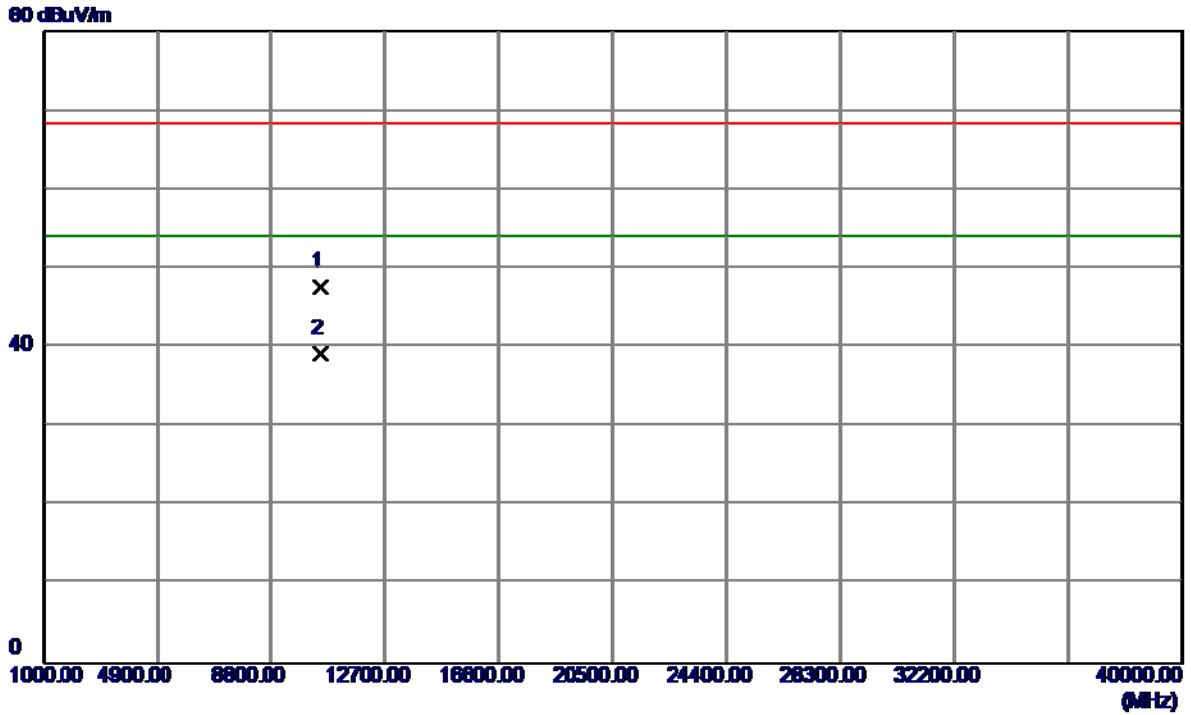

No.	Freq. MHz	Reading Level dBuV/m	Correct Factor dB	Measure ment dBuV/m	Limit dBuV/m	Margin dB	Detector	Comment
1	10480.6220	34.01	13.69	47.70	68.30	-20.60	Peak	
2	10480.1230	25.47	13.69	39.16	54.00	-14.84	AVG	

Orthogonal Axis:	X
Test Mode:	UNII-1/ TX AC20 Mode 5240MHz

Horizontal

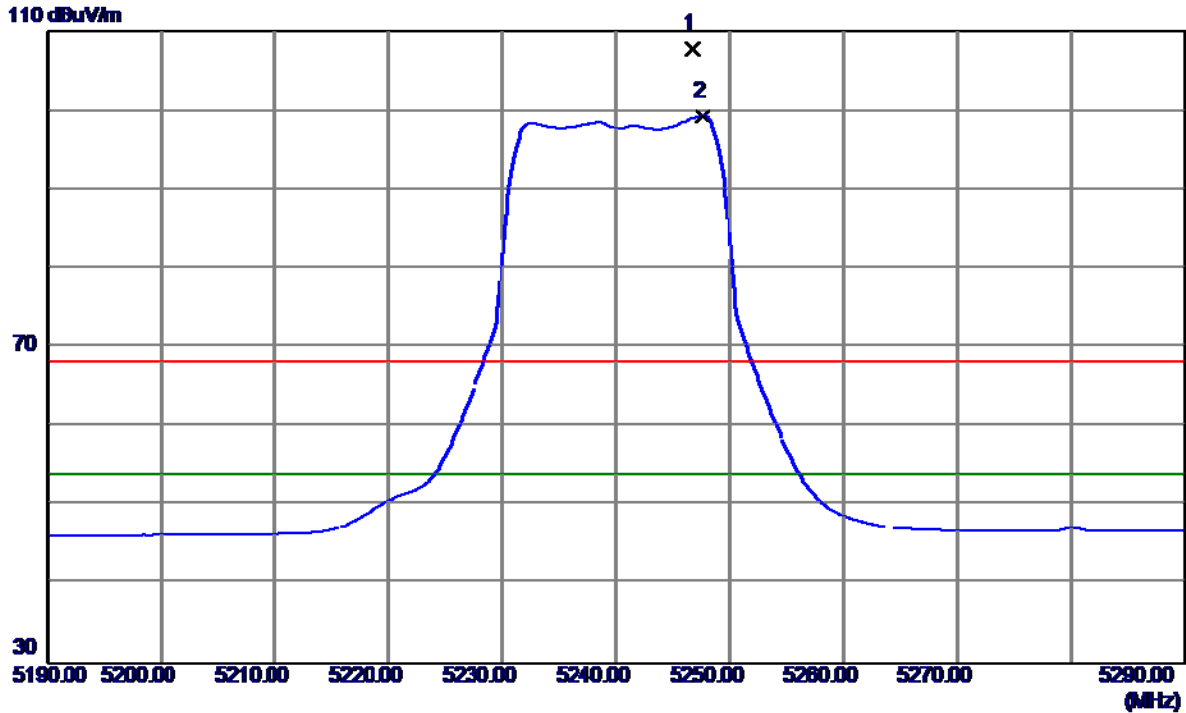

No.	Freq. MHz	Reading Level dBuV/m	Correct Factor dB	Measure ment dBuV/m	Limit dBuV/m	Margin dB	Detector	Comment
1	5246.8000	67.33	40.42	107.75	68.30	39.45	Peak	No Limit
2	5247.7000	58.84	40.43	99.27	54.00	45.27	AVG	No Limit

Orthogonal Axis:	X
Test Mode:	UNII-1/ TX AC20 Mode 5240MHz

Horizontal

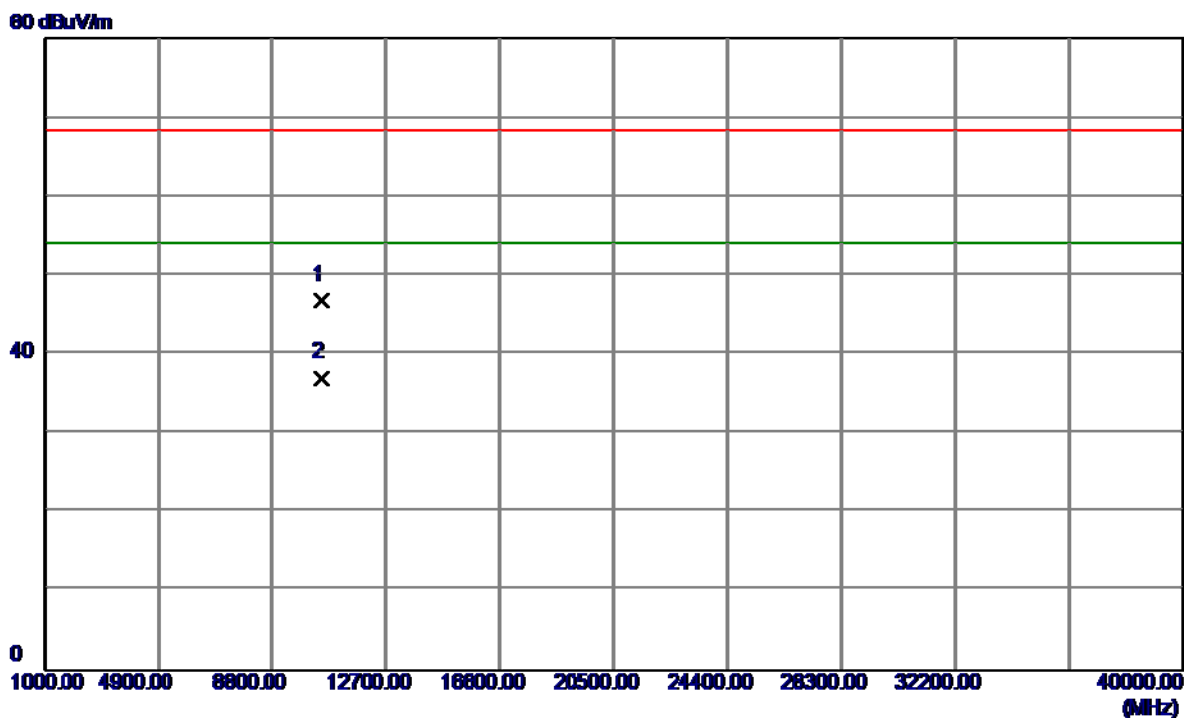

No.	Freq. MHz	Reading Level dBuV/m	Correct Factor dB	Measure ment dBuV/m	Limit dBuV/m	Margin dB	Detector	Comment
1	10480.3400	33.12	13.69	46.81	68.30	-21.49	Peak	
2	10480.3400	23.35	13.69	37.04	54.00	-16.96	AVG	

Orthogonal Axis:	X
Test Mode:	UNII-1/ TX AC40 Mode 5190MHz

Vertical

110 dBuV/m

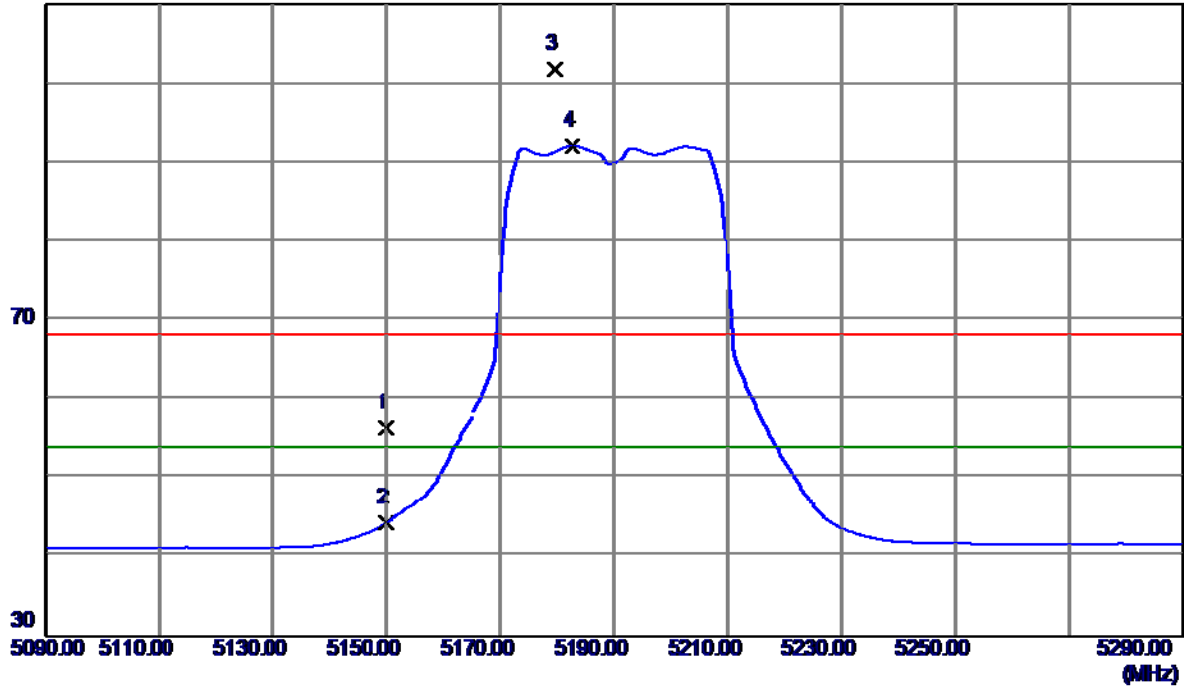

No.	Freq. MHz	Reading Level dBuV/m	Correct Factor dB	Measure ment dBuV/m	Limit dBuV/m	Margin dB	Detector	Comment
1	5150.0000	16.11	40.22	56.33	68.30	-11.97	Peak	
2	5150.0000	4.16	40.22	44.38	54.00	-9.62	AVG	
3	5179.6000	61.54	40.28	101.82	68.30	33.52	Peak	No Limit
4	5182.6000	51.85	40.29	92.14	54.00	38.14	AVG	No Limit

Orthogonal Axis:	X
Test Mode:	UNII-1/ TX AC40 Mode 5190MHz

Vertical

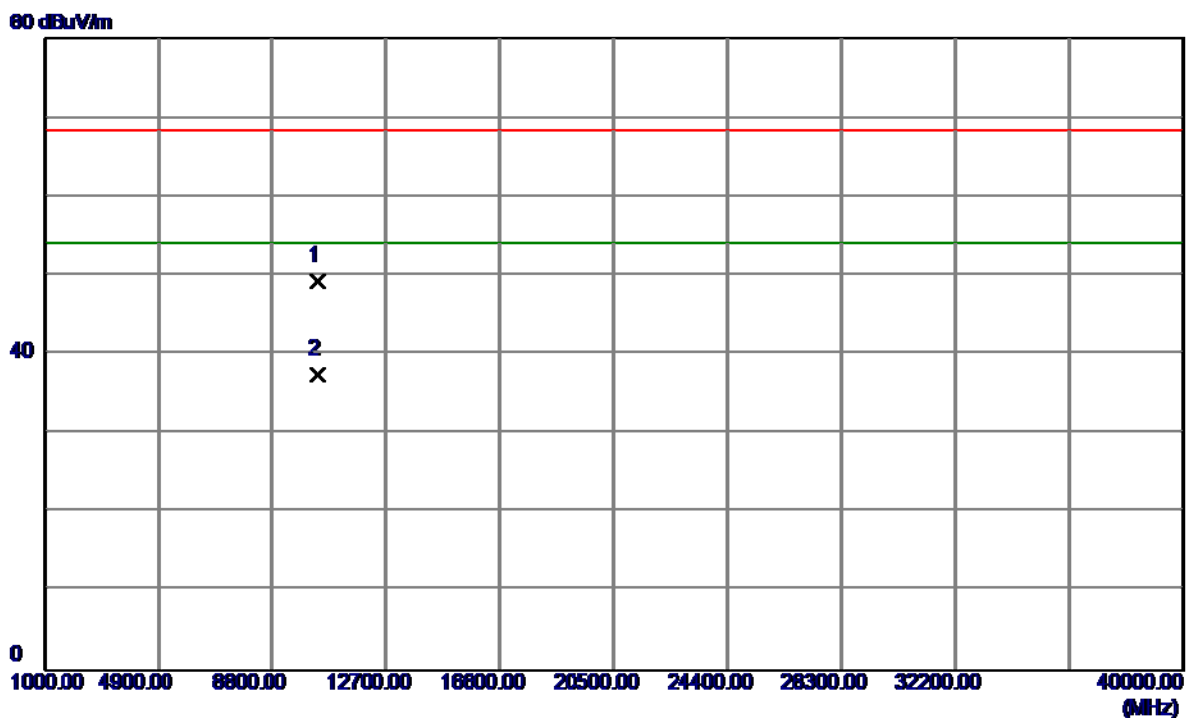

No.	Freq. MHz	Reading Level dBuV/m	Correct Factor dB	Measure ment dBuV/m	Limit dBuV/m	Margin dB	Detector	Comment
1	10380.3099	35.45	13.83	49.28	68.30	-19.02	Peak	
2	10380.3099	23.63	13.83	37.46	54.00	-16.54	AVG	

Orthogonal Axis:	X
Test Mode:	UNII-1/ TX AC40 Mode 5190MHz

Horizontal

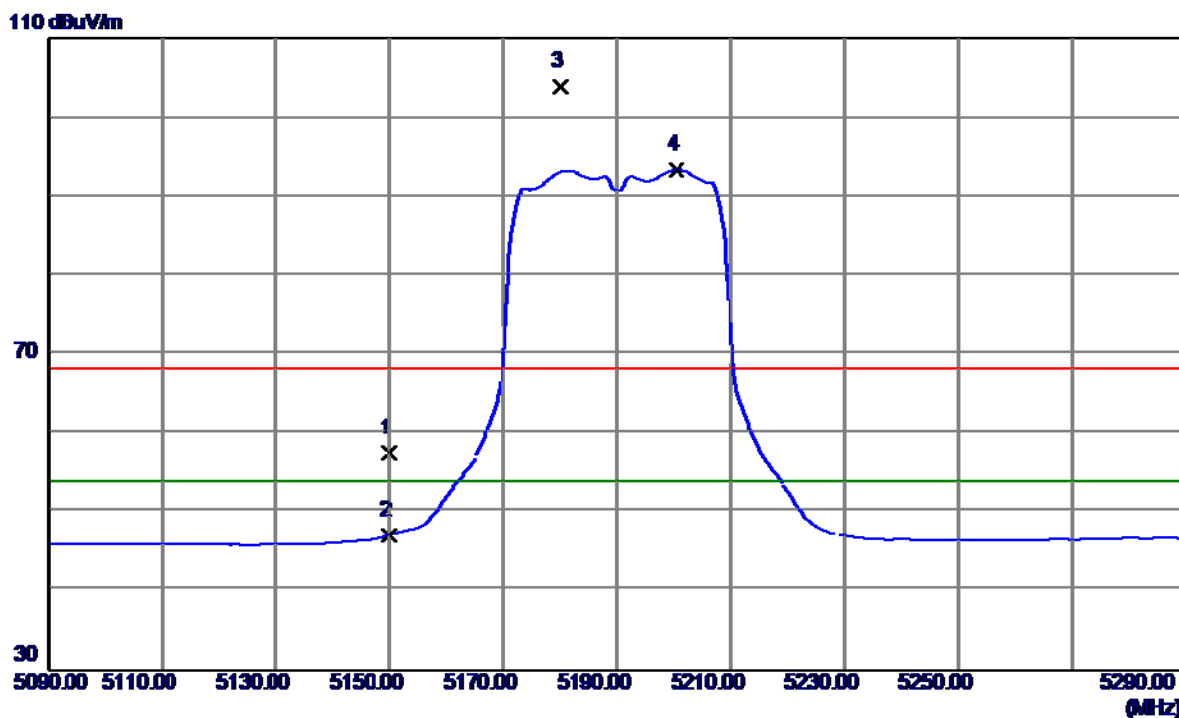

No.	Freq. MHz	Reading Level dBuV/m	Correct Factor dB	Measure ment dBuV/m	Limit dBuV/m	Margin dB	Detector	Comment
1	5150.0000	17.24	40.22	57.46	68.30	-10.84	Peak	
2	5150.0000	6.96	40.22	47.18	54.00	-6.82	AVG	
3	5180.0000	63.60	40.28	103.88	68.30	35.58	Peak	No Limit
4	5200.4000	53.07	40.32	93.39	54.00	39.39	AVG	No Limit

Orthogonal Axis:	X
Test Mode:	UNII-1/ TX AC40 Mode 5190MHz

Horizontal

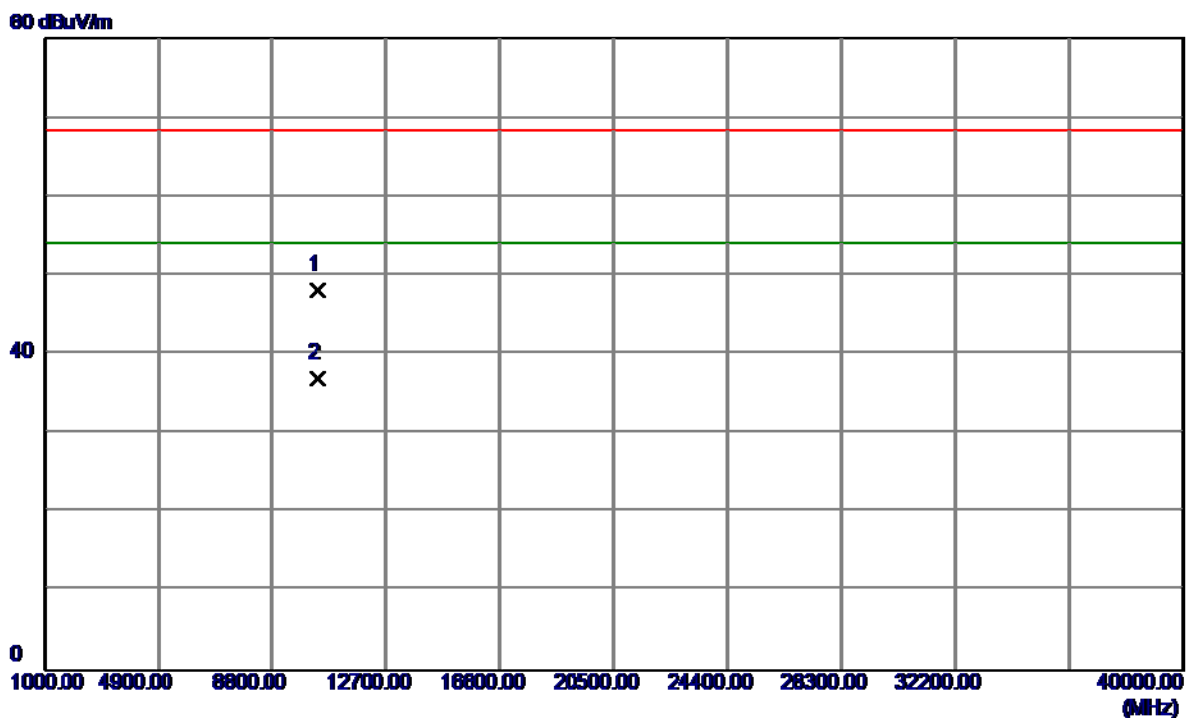

No.	Freq. MHz	Reading Level dBuV/m	Correct Factor dB	Measure ment dBuV/m	Limit dBuV/m	Margin dB	Detector	Comment
1	10381.5199	34.40	13.83	48.23	68.30	-20.07	Peak	
2	10381.5199	23.06	13.83	36.89	54.00	-17.11	AVG	

Orthogonal Axis:	X
Test Mode:	UNII-1/ TX AC40 Mode 5230MHz

Vertical

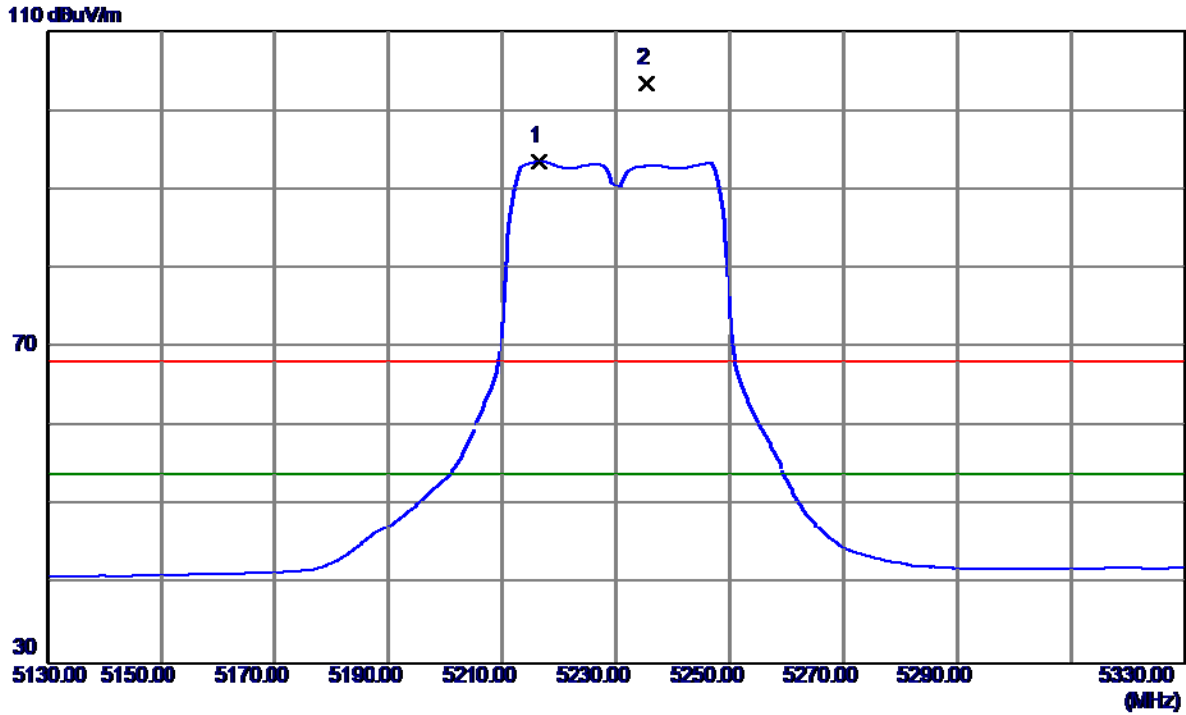

No.	Freq. MHz	Reading Level dBuV/m	Correct Factor dB	Measure ment dBuV/m	Limit dBuV/m	Margin dB	Detector	Comment
1	5216.4000	53.17	40.36	93.53	54.00	39.53	AVG	No Limit
2	5235.4000	63.11	40.40	103.51	68.30	35.21	Peak	No Limit

Orthogonal Axis:	X
Test Mode:	UNII-1/ TX AC40 Mode 5230MHz

Vertical

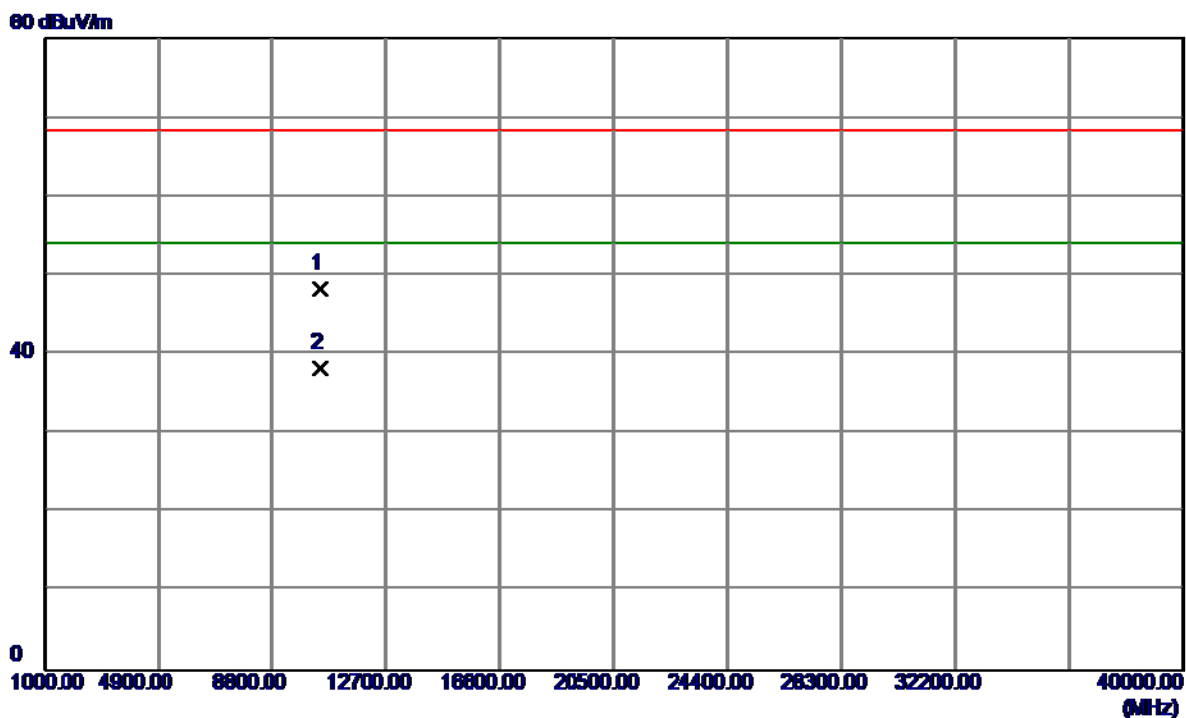

No.	Freq. MHz	Reading Level dBuV/m	Correct Factor dB	Measure ment dBuV/m	Limit dBuV/m	Margin dB	Detector	Comment
1	10460.1449	34.56	13.72	48.28	68.30	-20.02	Peak	
2	10460.5670	24.46	13.72	38.18	54.00	-15.82	AVG	

Orthogonal Axis:	X
Test Mode:	UNII-1/ TX AC40 Mode 5230MHz

Horizontal

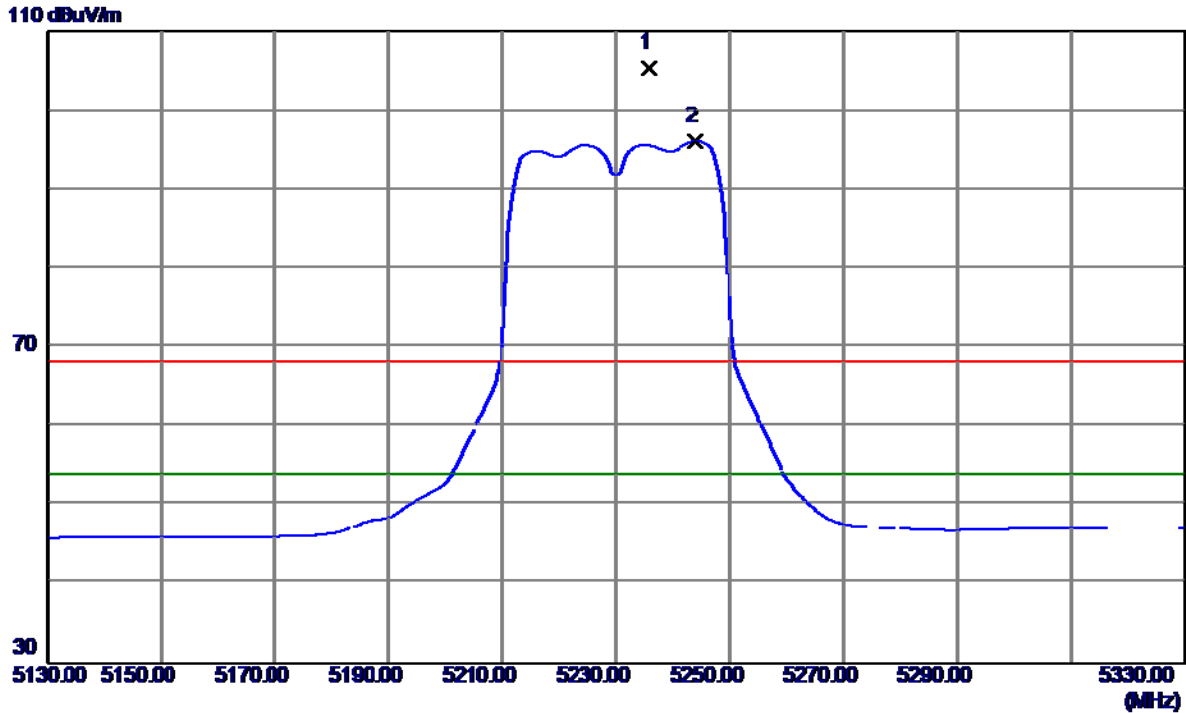

No.	Freq. MHz	Reading Level dBuV/m	Correct Factor dB	Measure ment dBuV/m	Limit dBuV/m	Margin dB	Detector	Comment
1	5235.8000	64.97	40.40	105.37	68.30	37.07	Peak	No Limit
2	5244.0000	55.67	40.42	96.09	54.00	42.09	AVG	No Limit

Orthogonal Axis:	X
Test Mode:	UNII-1/ TX AC40 Mode 5230MHz

Horizontal

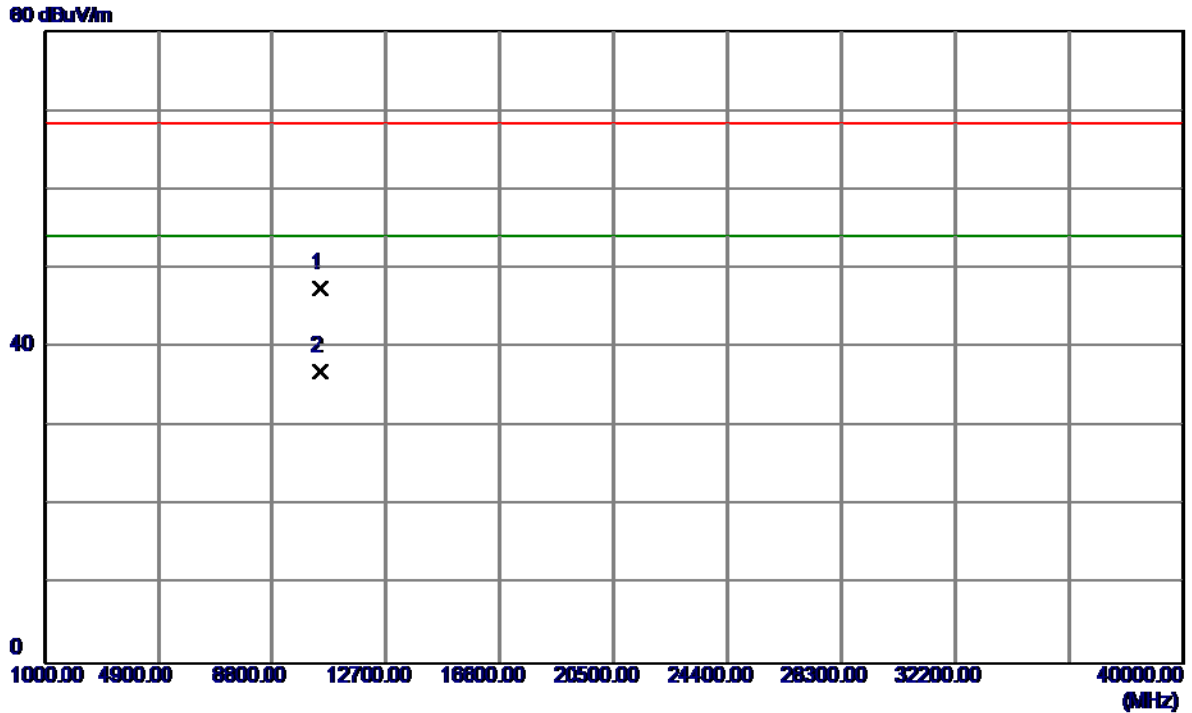

No.	Freq. MHz	Reading Level dBuV/m	Correct Factor dB	Measure ment dBuV/m	Limit dBuV/m	Margin dB	Detector	Comment
1	10460.1800	33.83	13.72	47.55	68.30	-20.75	Peak	
2	10460.1800	23.24	13.72	36.96	54.00	-17.04	AVG	

Orthogonal Axis:	X
Test Mode:	UNII-1/ TX AC80 Mode 5210MHz

Vertical

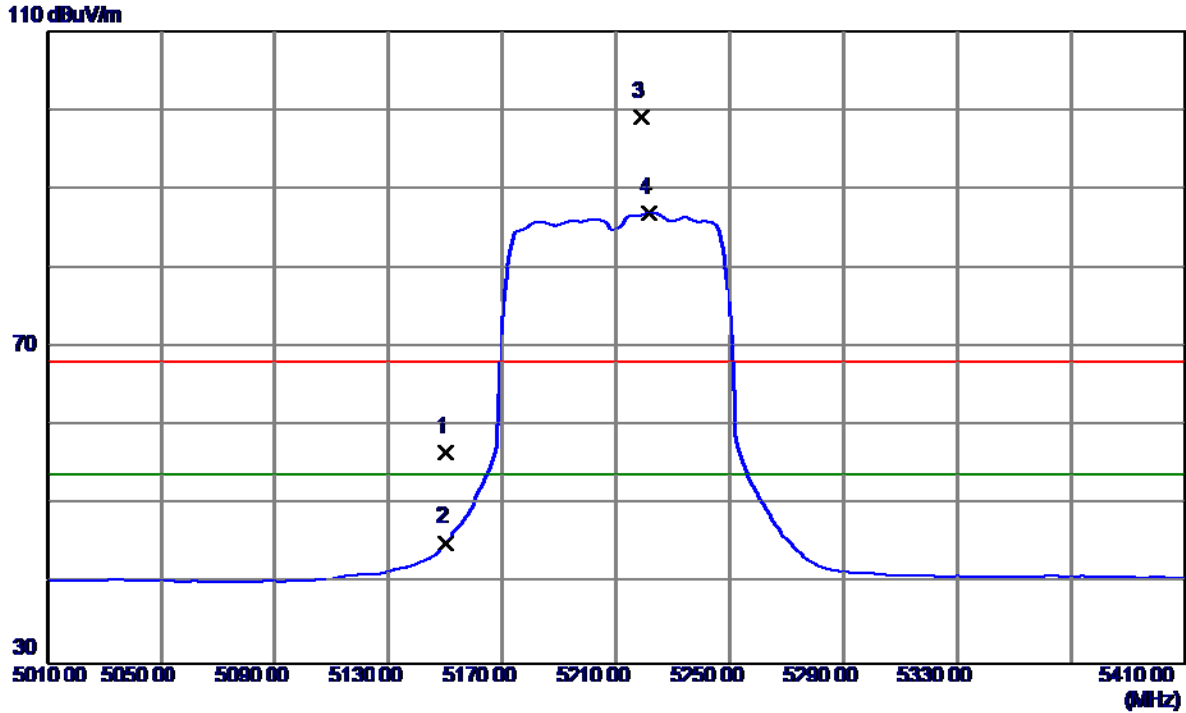

No.	Freq. MHz	Reading Level dBuV/m	Correct Factor dB	Measure ment dBuV/m	Limit dBuV/m	Margin dB	Detector	Comment
1	5150.0000	16.55	40.22	56.77	68.30	-11.53	Peak	
2	5150.0000	5.06	40.22	45.28	54.00	-8.72	AVG	
3	5218.8000	58.68	40.36	99.04	68.30	30.74	Peak	No Limit
4	5221.6000	46.60	40.37	86.97	54.00	32.97	AVG	No Limit

Orthogonal Axis:	X
Test Mode:	UNII-1/ TX AC80 Mode 5210MHz

Vertical

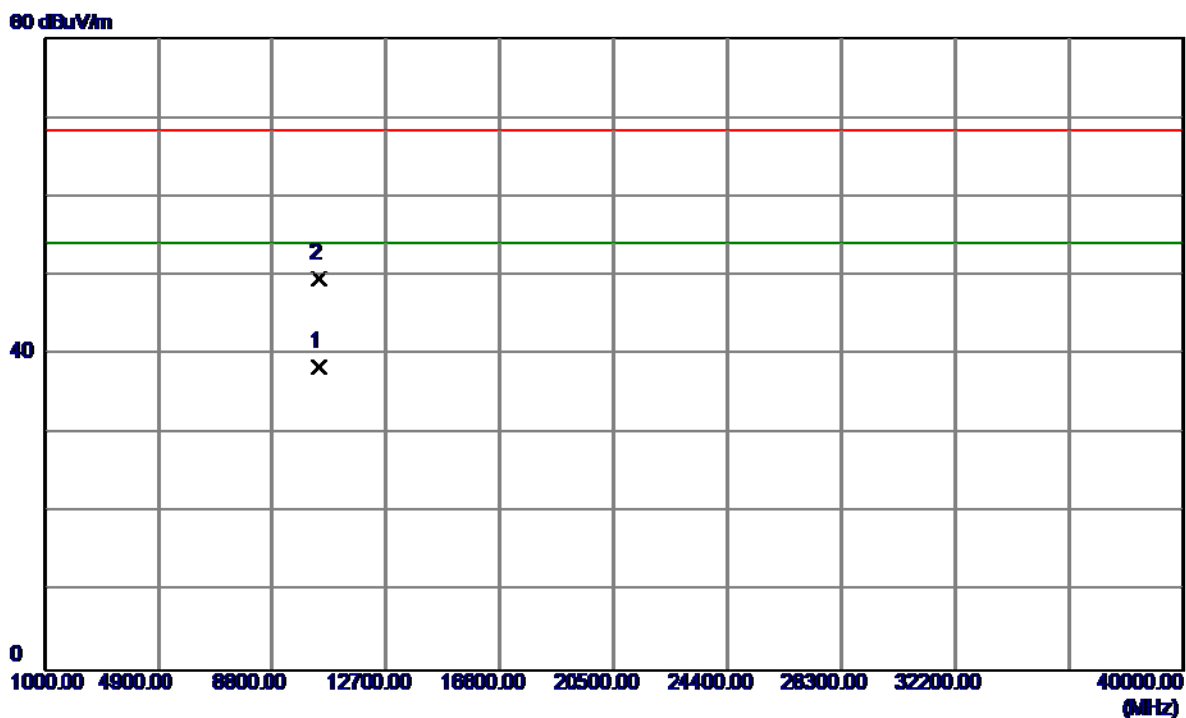

No.	Freq. MHz	Reading Level dBuV/m	Correct Factor dB	Measure ment dBuV/m	Limit dBuV/m	Margin dB	Detector	Comment
1	10422.6000	24.57	13.77	38.34	54.00	-15.66	AVG	
2	10422.7000	35.79	13.77	49.56	68.30	-18.74	Peak	

Orthogonal Axis:	X
Test Mode:	UNII-1/ TX AC80 Mode 5210MHz

Horizontal

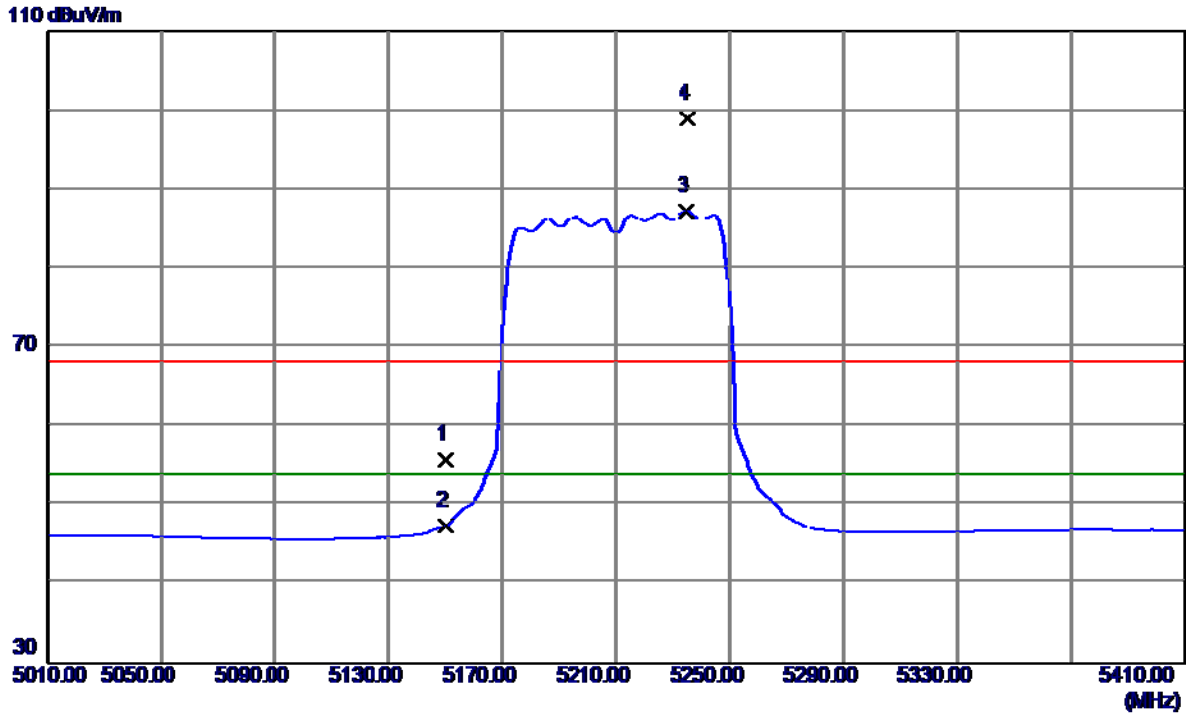

No.	Freq. MHz	Reading Level dBuV/m	Correct Factor dB	Measure ment dBuV/m	Limit dBuV/m	Margin dB	Detector	Comment
1	5150.0000	15.54	40.22	55.76	68.30	-12.54	Peak	
2	5150.0000	7.26	40.22	47.48	54.00	-6.52	AVG	
3	5234.8000	46.93	40.40	87.33	54.00	33.33	AVG	No Limit
4	5235.2000	58.57	40.40	98.97	68.30	30.67	Peak	No Limit

Orthogonal Axis:	X
Test Mode:	UNII-1/ TX AC80 Mode 5210MHz

Horizontal

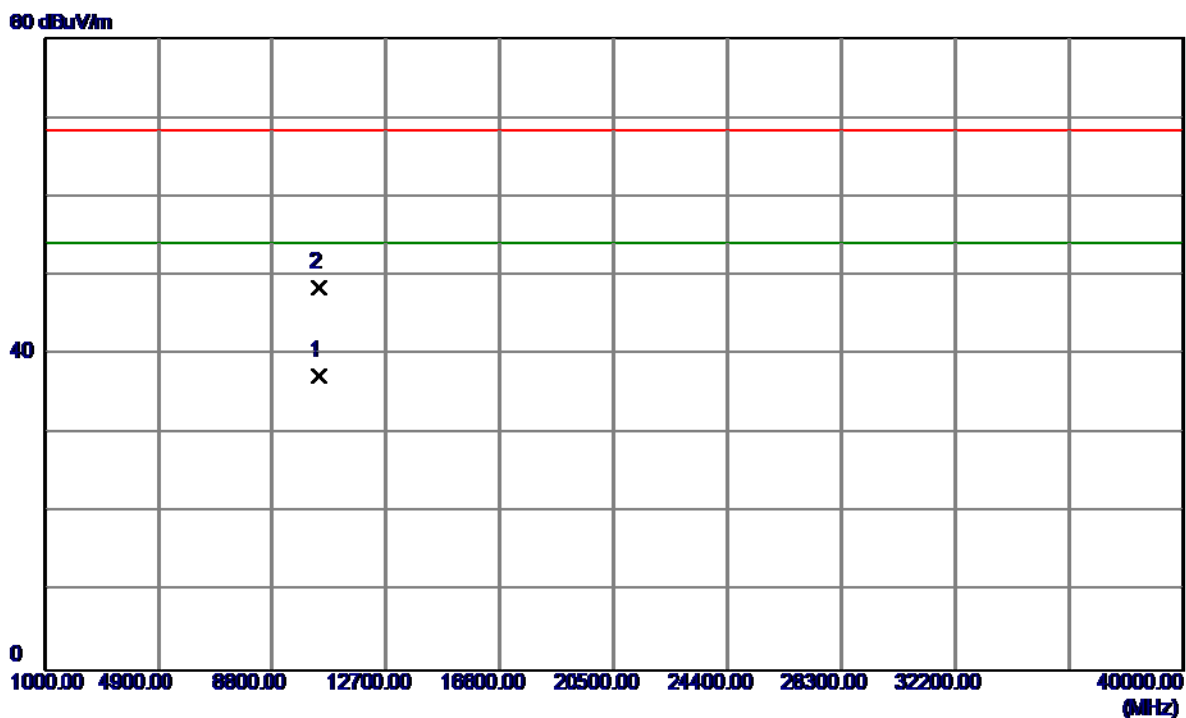

No.	Freq. MHz	Reading Level dBuV/m	Correct Factor dB	Measure ment dBuV/m	Limit dBuV/m	Margin dB	Detector	Comment
1	10421.1200	23.57	13.77	37.34	54.00	-16.66	AVG	
2	10421.5630	34.74	13.77	48.51	68.30	-19.79	Peak	

Orthogonal Axis :	X
Test Mode :	UNII-2A/ TX AC20 Mode 5260MHz

Vertical

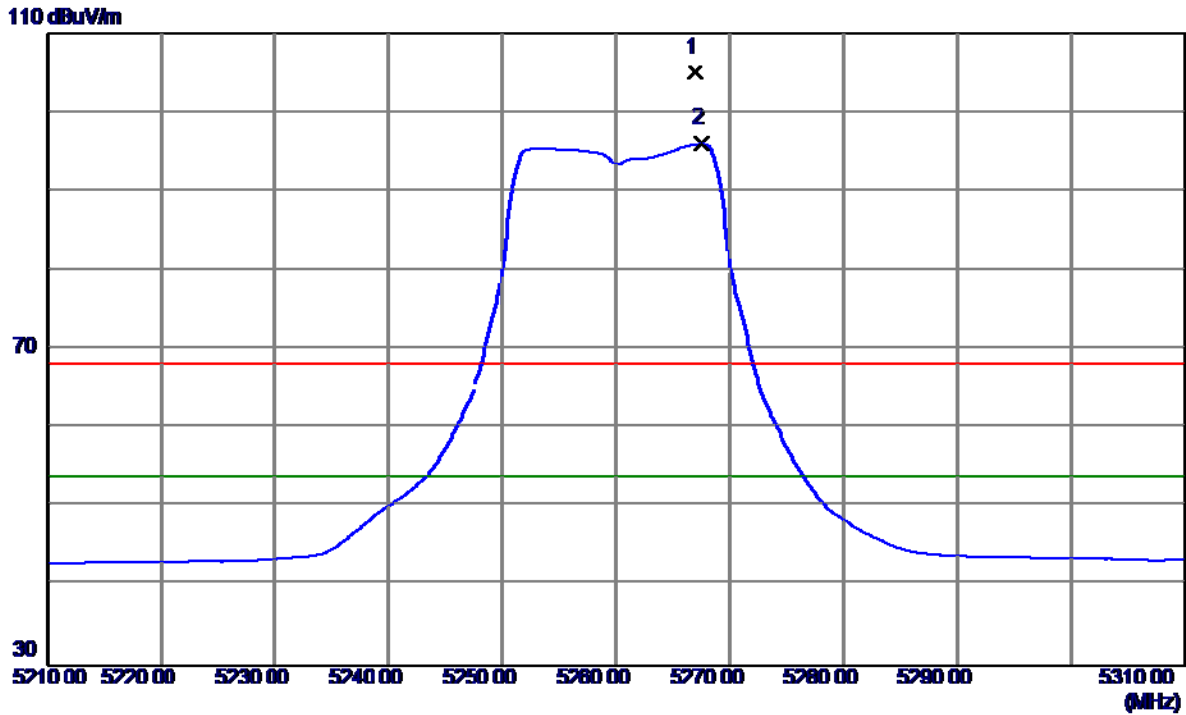

No.	Freq. MHz	Reading Level dBuV/m	Correct Factor dB	Measure ment dBuV/m	Limit dBuV/m	Margin dB	Detector	Comment
1	5267.0000	64.60	40.47	105.07	68.30	36.77	Peak	No Limit
2	5267.6000	55.55	40.47	96.02	54.00	42.02	AVG	No Limit

Orthogonal Axis :	X
Test Mode :	UNII-2A/ TX AC20 Mode 5260MHz

Vertical

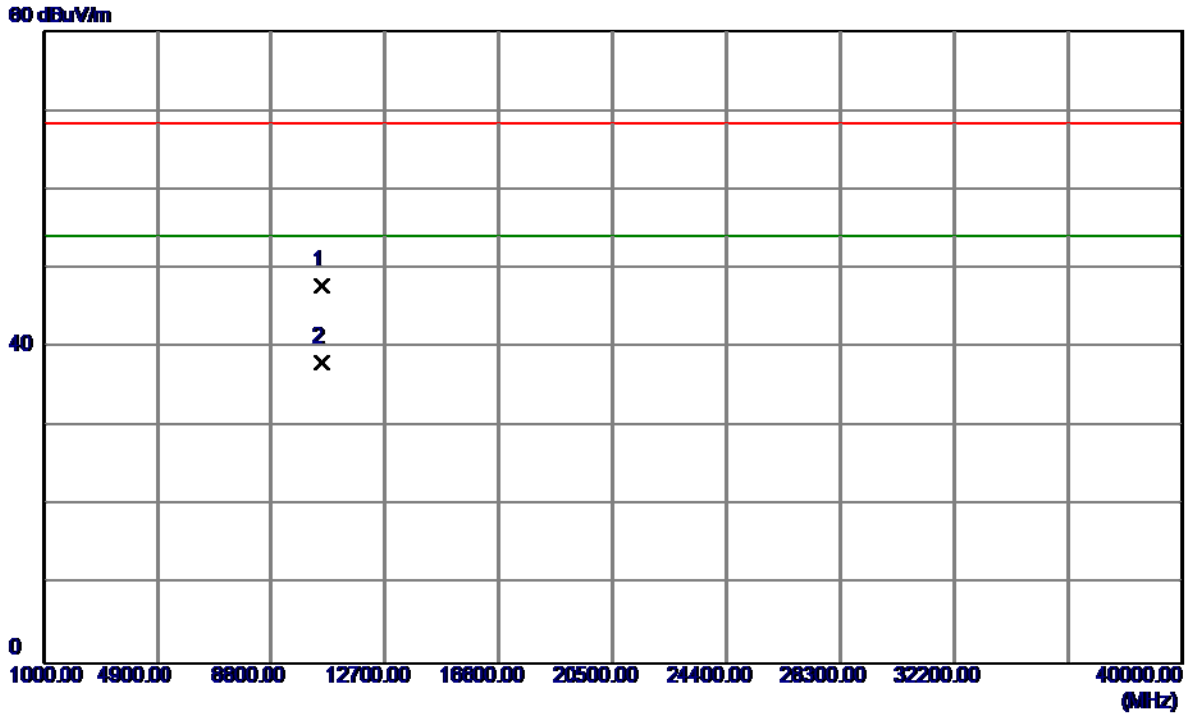

No.	Freq. MHz	Reading Level dBuV/m	Correct Factor dB	Measure ment dBuV/m	Limit dBuV/m	Margin dB	Detector	Comment
1	10520.3400	34.10	13.75	47.85	68.30	-20.45	Peak	
2	10520.3400	24.37	13.75	38.12	54.00	-15.88	AVG	

Orthogonal Axis :	X
Test Mode :	UNII-2A/ TX AC20 Mode 5260MHz

Horizontal

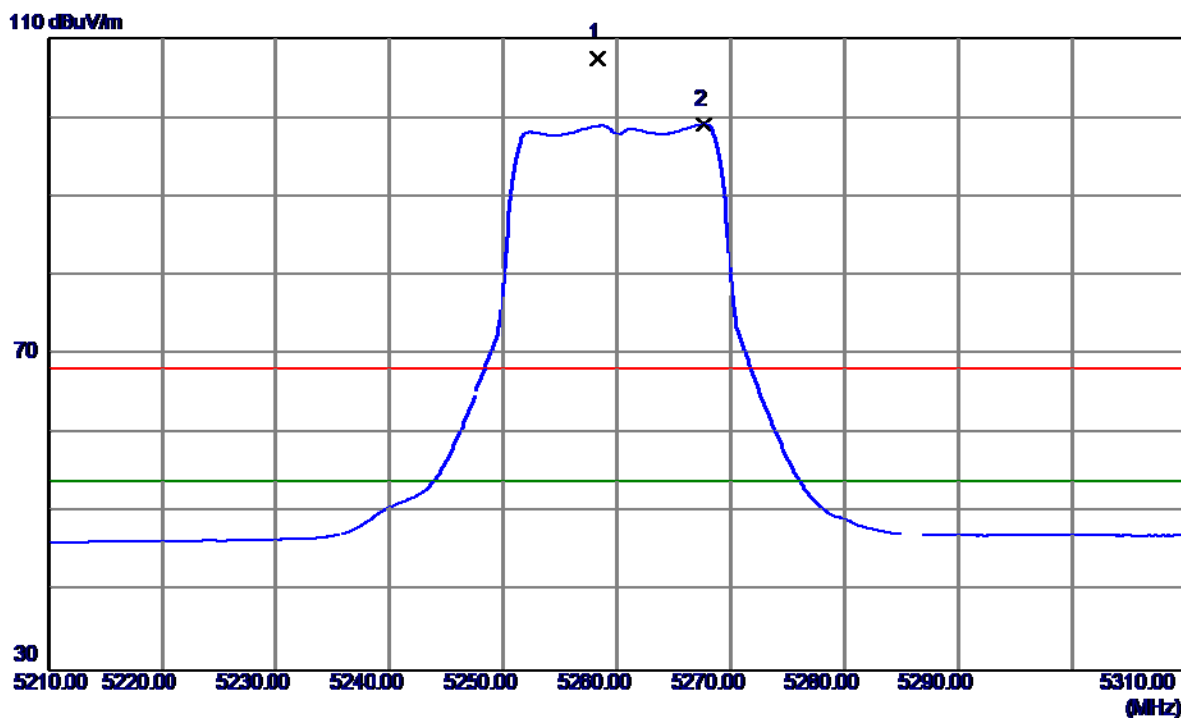

No.	Freq. MHz	Reading Level dBuV/m	Correct Factor dB	Measure ment dBuV/m	Limit dBuV/m	Margin dB	Detector	Comment
1	5258.3000	67.05	40.45	107.50	68.30	39.20	Peak	No Limit
2	5267.7000	58.58	40.47	99.05	54.00	45.05	AVG	No Limit

Orthogonal Axis :	X
Test Mode :	UNII-2A/ TX AC20 Mode 5260MHz

Horizontal

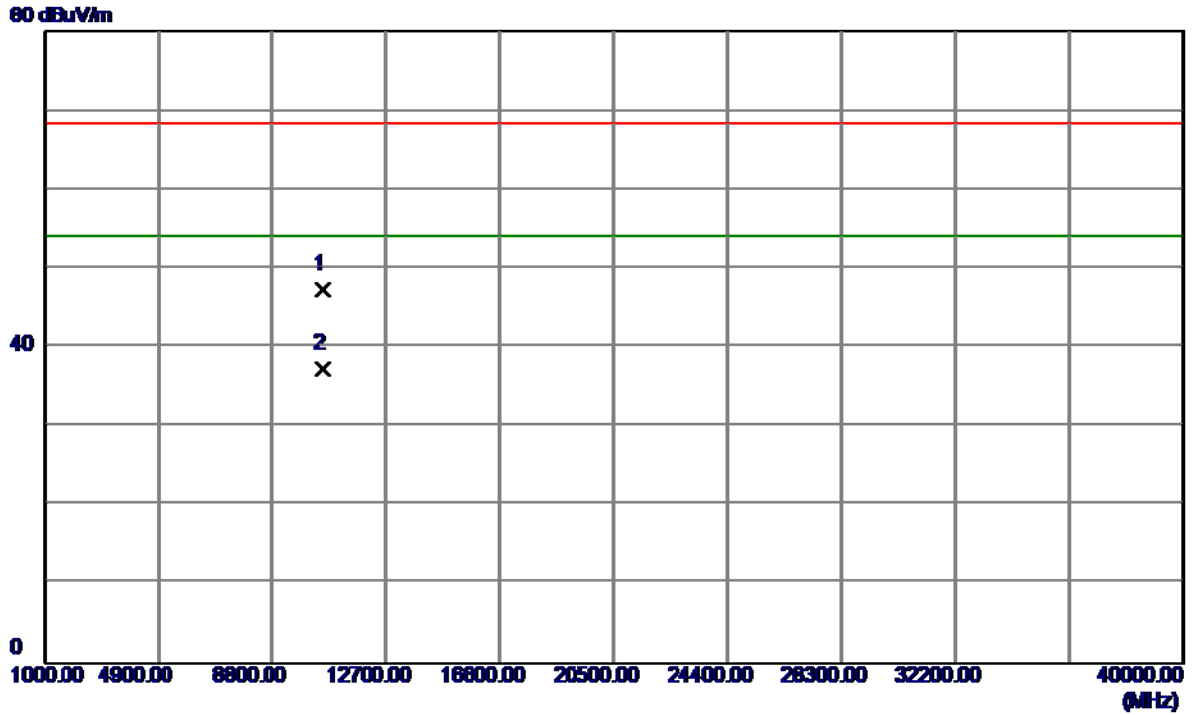

No.	Freq. MHz	Reading Level dBuV/m	Correct Factor dB	Measure ment dBuV/m	Limit dBuV/m	Margin dB	Detector	Comment
1	10520.6689	33.68	13.75	47.43	68.30	-20.87	Peak	
2	10520.5500	23.53	13.75	37.28	54.00	-16.72	AVG	

Orthogonal Axis :	X
Test Mode :	UNII-2A/ TX AC20 Mode 5300MHz

Vertical

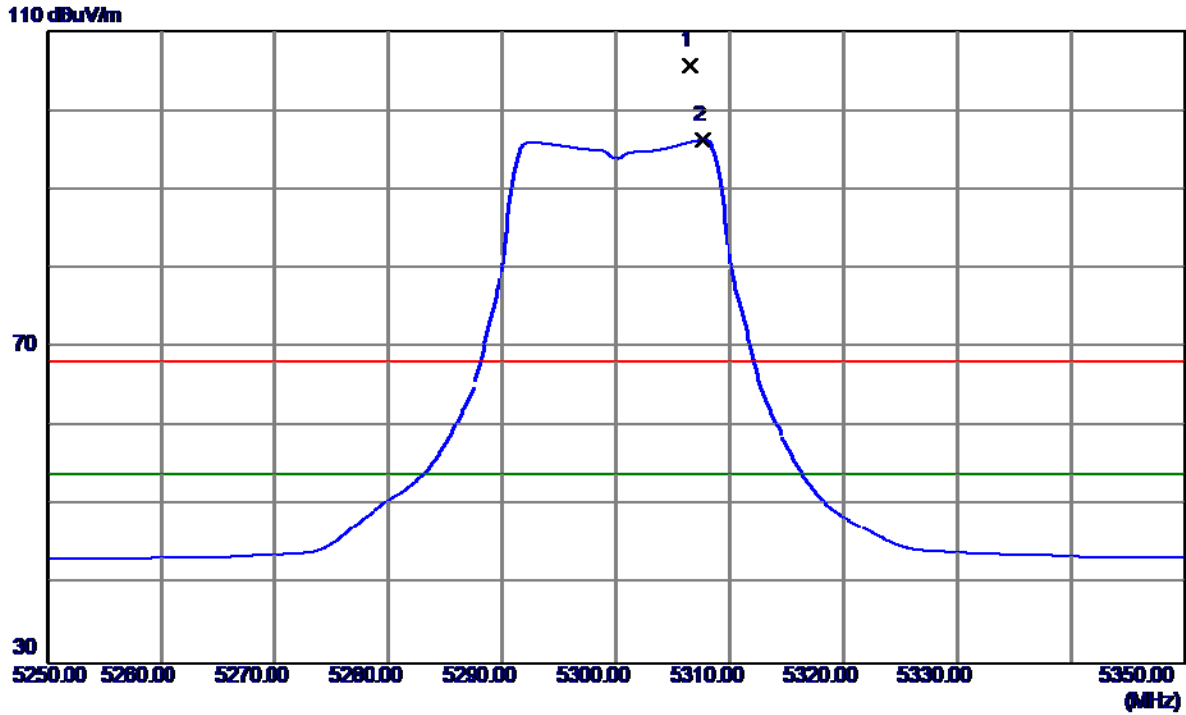

No.	Freq. MHz	Reading Level dBuV/m	Correct Factor dB	Measure ment dBuV/m	Limit dBuV/m	Margin dB	Detector	Comment
1	5306.6000	65.19	40.55	105.74	68.30	37.44	Peak	No Limit
2	5307.7000	55.71	40.55	96.26	54.00	42.26	AVG	No Limit

Orthogonal Axis :	X
Test Mode :	UNII-2A/ TX AC20 Mode 5300MHz

Vertical

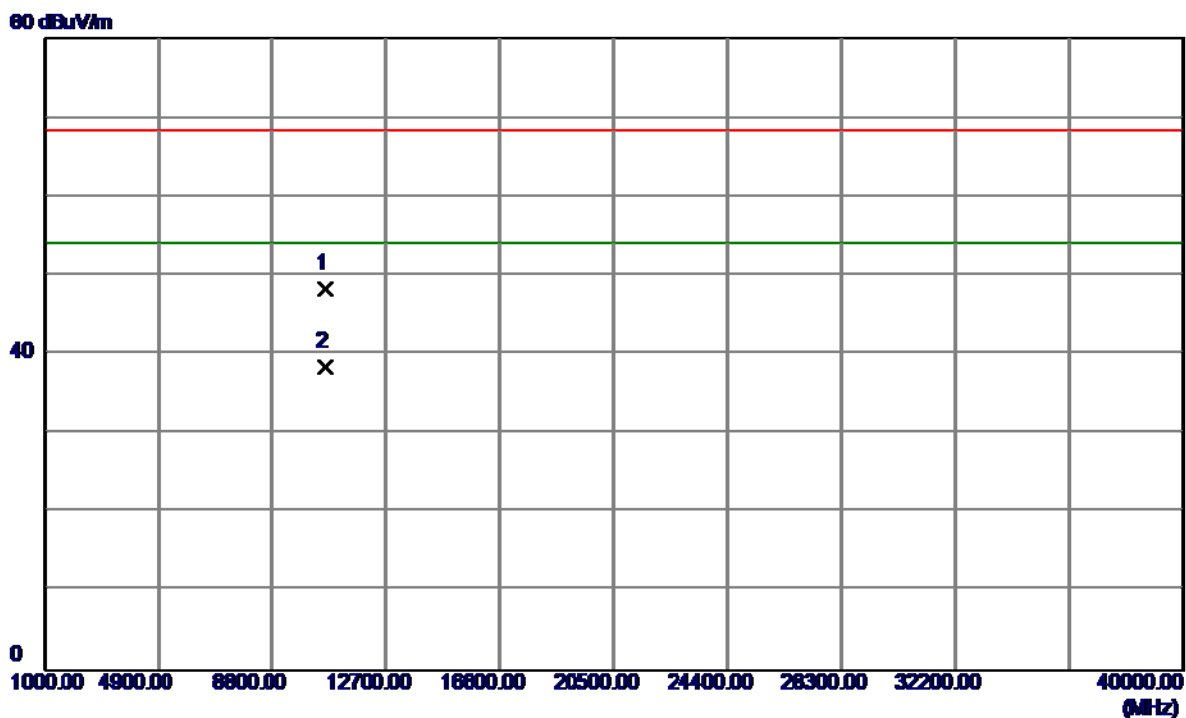

No.	Freq. MHz	Reading Level dBuV/m	Correct Factor dB	Measure ment dBuV/m	Limit dBuV/m	Margin dB	Detector	Comment
1	10600.3339	34.25	14.08	48.33	68.30	-19.97	Peak	
2	10600.1710	24.37	14.08	38.45	54.00	-15.55	AVG	

Orthogonal Axis :	X
Test Mode :	UNII-2A/ TX AC20 Mode 5300MHz

Horizontal

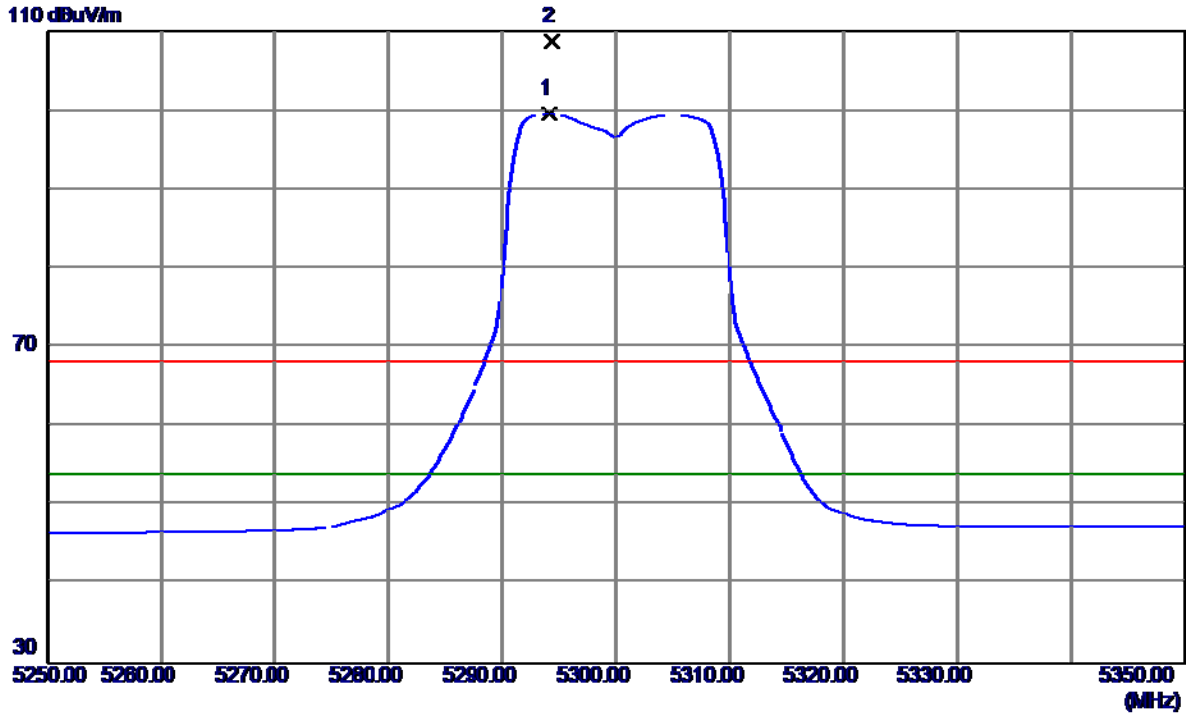

No.	Freq. MHz	Reading Level dBuV/m	Correct Factor dB	Measure ment dBuV/m	Limit dBuV/m	Margin dB	Detector	Comment
1	5294.1000	59.04	40.52	99.56	54.00	45.56	AVG	No Limit
2	5294.3000	68.23	40.52	108.75	68.30	40.45	Peak	No Limit

Orthogonal Axis :	X
Test Mode :	UNII-2A/ TX AC20 Mode 5300MHz

Horizontal

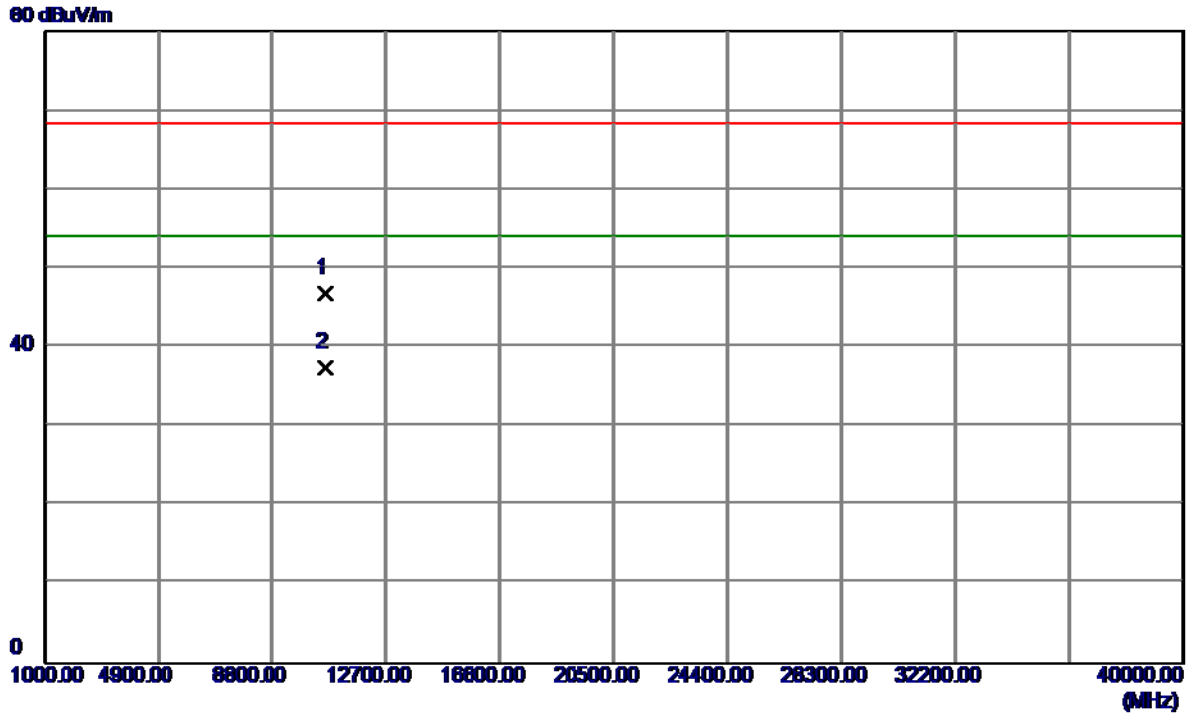

No.	Freq. MHz	Reading Level dBuV/m	Correct Factor dB	Measure ment dBuV/m	Limit dBuV/m	Margin dB	Detector	Comment
1	10600.7100	32.79	14.08	46.87	68.30	-21.43	Peak	
2	10600.7100	23.38	14.08	37.46	54.00	-16.54	AVG	

Orthogonal Axis :	X
Test Mode :	UNII-2A/ TX AC20 Mode 5320MHz

Vertical

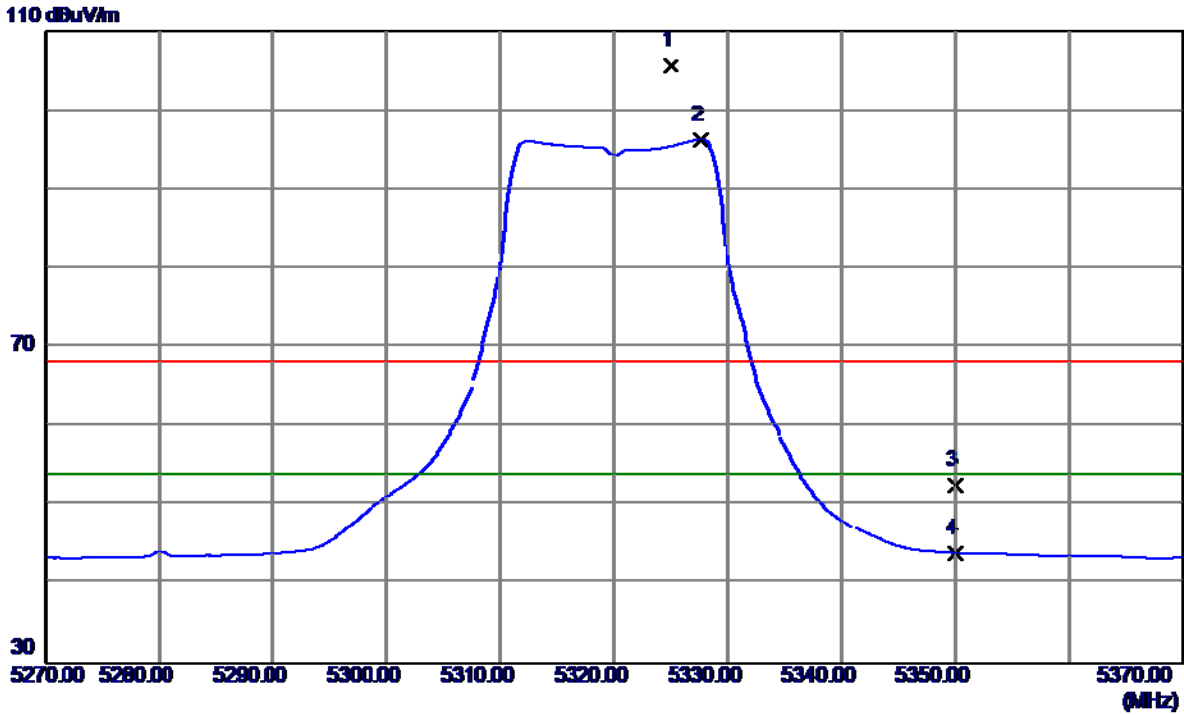

No.	Freq. MHz	Reading Level dBuV/m	Correct Factor dB	Measure ment dBuV/m	Limit dBuV/m	Margin dB	Detector	Comment
1	5325.0000	65.13	40.59	105.72	68.30	37.42	Peak	No Limit
2	5327.7000	55.71	40.59	96.30	54.00	42.30	AVG	No Limit
3	5350.0000	11.85	40.64	52.49	68.30	-15.81	Peak	
4	5350.0000	3.33	40.64	43.97	54.00	-10.03	AVG	

Orthogonal Axis :	X
Test Mode :	UNII-2A/ TX AC20 Mode 5320MHz

Vertical

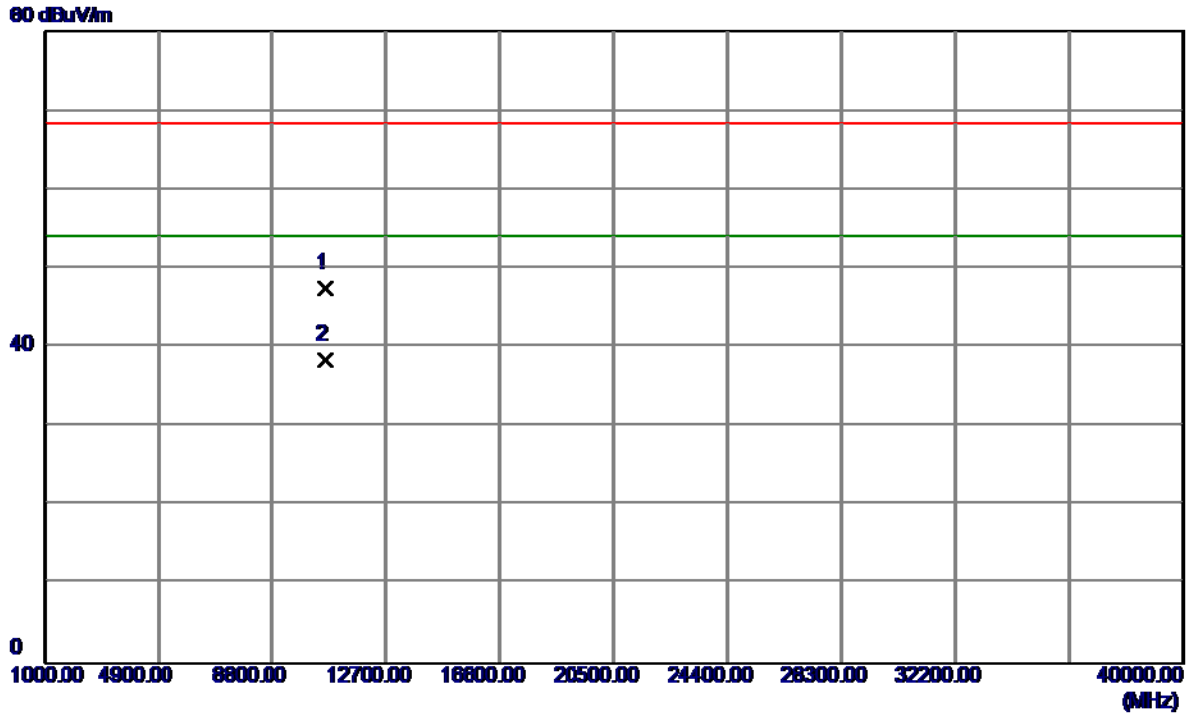

No.	Freq. MHz	Reading Level dBuV/m	Correct Factor dB	Measure ment dBuV/m	Limit dBuV/m	Margin dB	Detector	Comment
1	10640.2800	33.31	14.25	47.56	68.30	-20.74	Peak	
2	10640.2800	24.09	14.25	38.34	54.00	-15.66	AVG	

Orthogonal Axis :	X
Test Mode :	UNII-2A/ TX AC20 Mode 5320MHz

Horizontal

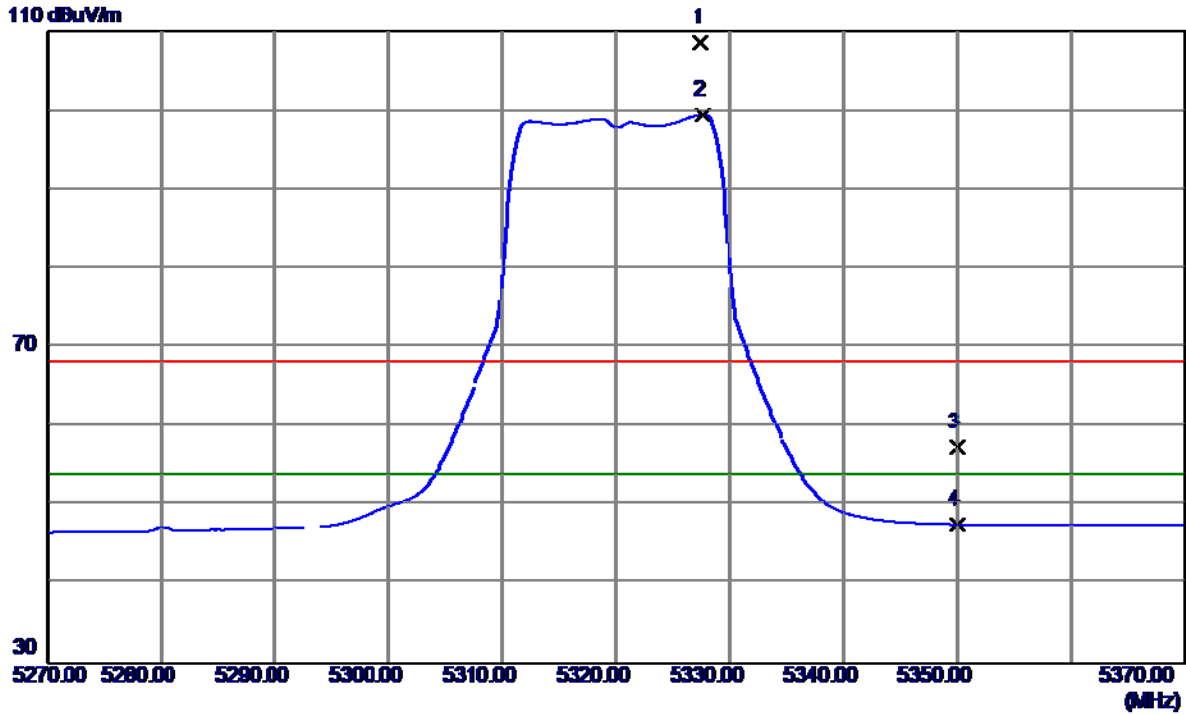

No.	Freq. MHz	Reading Level dBuV/m	Correct Factor dB	Measure ment dBuV/m	Limit dBuV/m	Margin dB	Detector	Comment
1	5327.5000	67.92	40.59	108.51	68.30	40.21	Peak	No Limit
2	5327.7000	58.79	40.59	99.38	54.00	45.38	AVG	No Limit
3	5350.0000	16.73	40.64	57.37	68.30	-10.93	Peak	
4	5350.0000	7.01	40.64	47.65	54.00	-6.35	AVG	

Orthogonal Axis :	X
Test Mode :	UNII-2A/ TX AC20 Mode 5320MHz

Horizontal

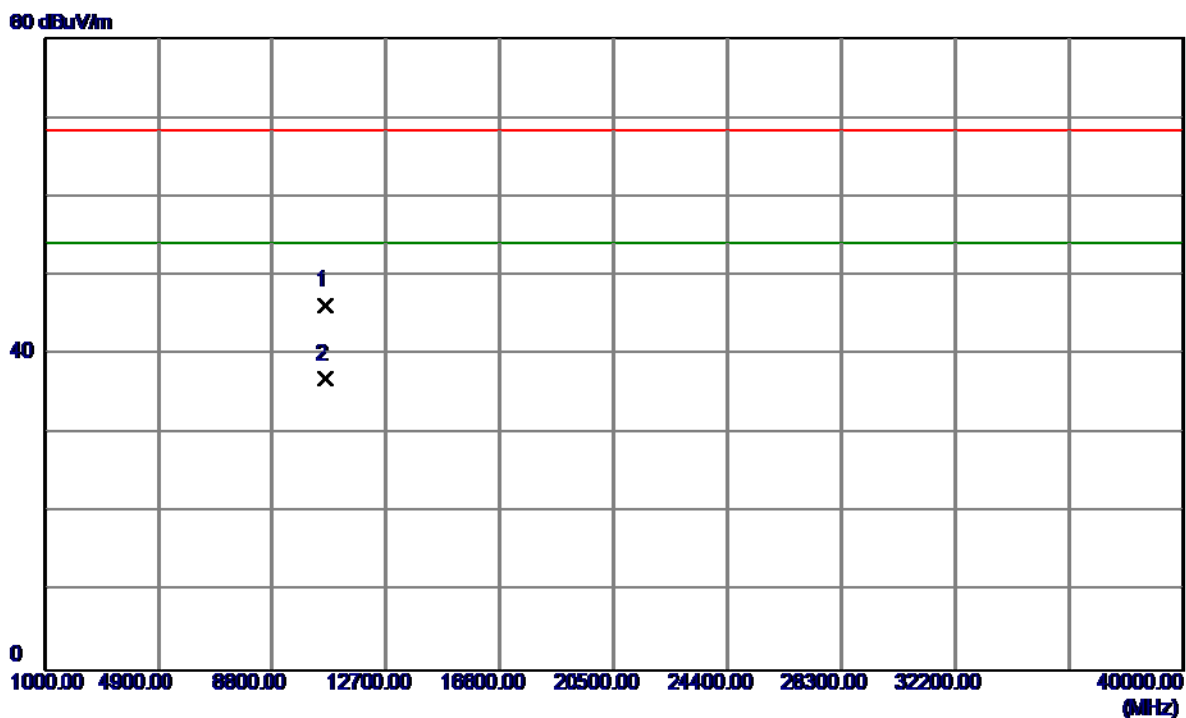

No.	Freq. MHz	Reading Level dBuV/m	Correct Factor dB	Measure ment dBuV/m	Limit dBuV/m	Margin dB	Detector	Comment
1	10640.1140	32.02	14.25	46.27	68.30	-22.03	Peak	
2	10640.5880	22.63	14.25	36.88	54.00	-17.12	AVG	

Orthogonal Axis :	X
Test Mode :	UNII-2A/ TX AC40 Mode 5270MHz

Vertical

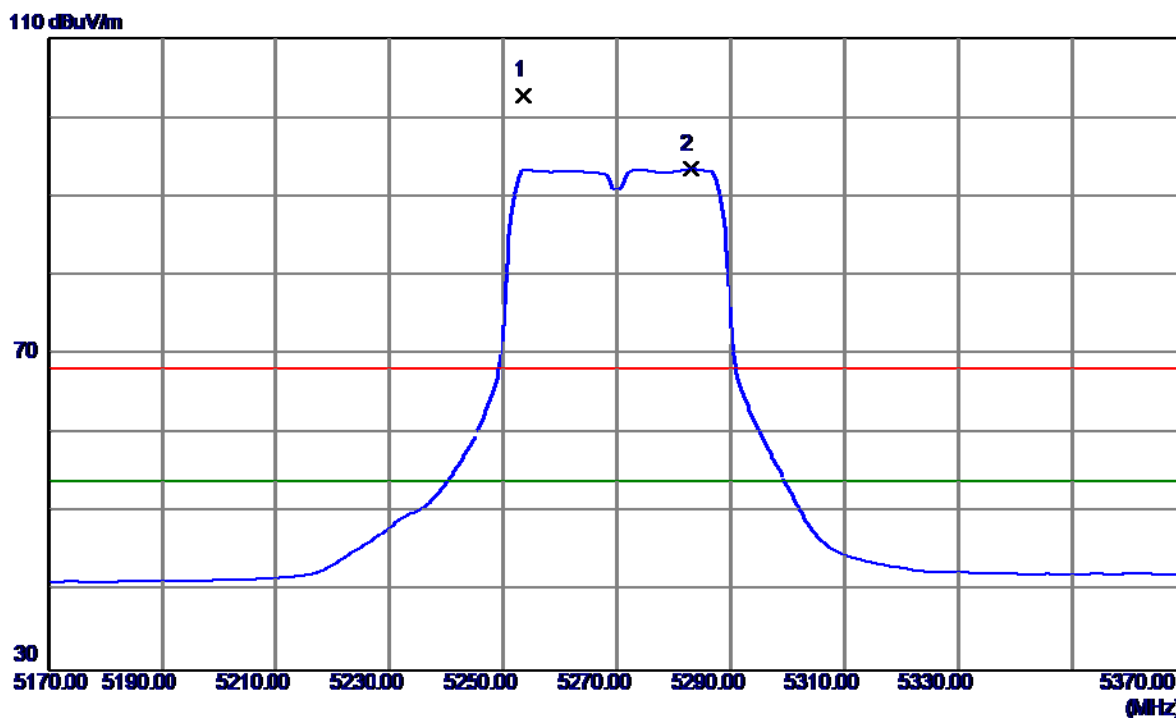

No.	Freq. MHz	Reading Level dBuV/m	Correct Factor dB	Measure ment dBuV/m	Limit dBuV/m	Margin dB	Detector	Comment
1	5253.6000	62.37	40.44	102.81	68.30	34.51	Peak	No Limit
2	5283.0000	52.94	40.50	93.44	54.00	39.44	AVG	No Limit

Orthogonal Axis :	X
Test Mode :	UNII-2A/ TX AC40 Mode 5270MHz

Vertical

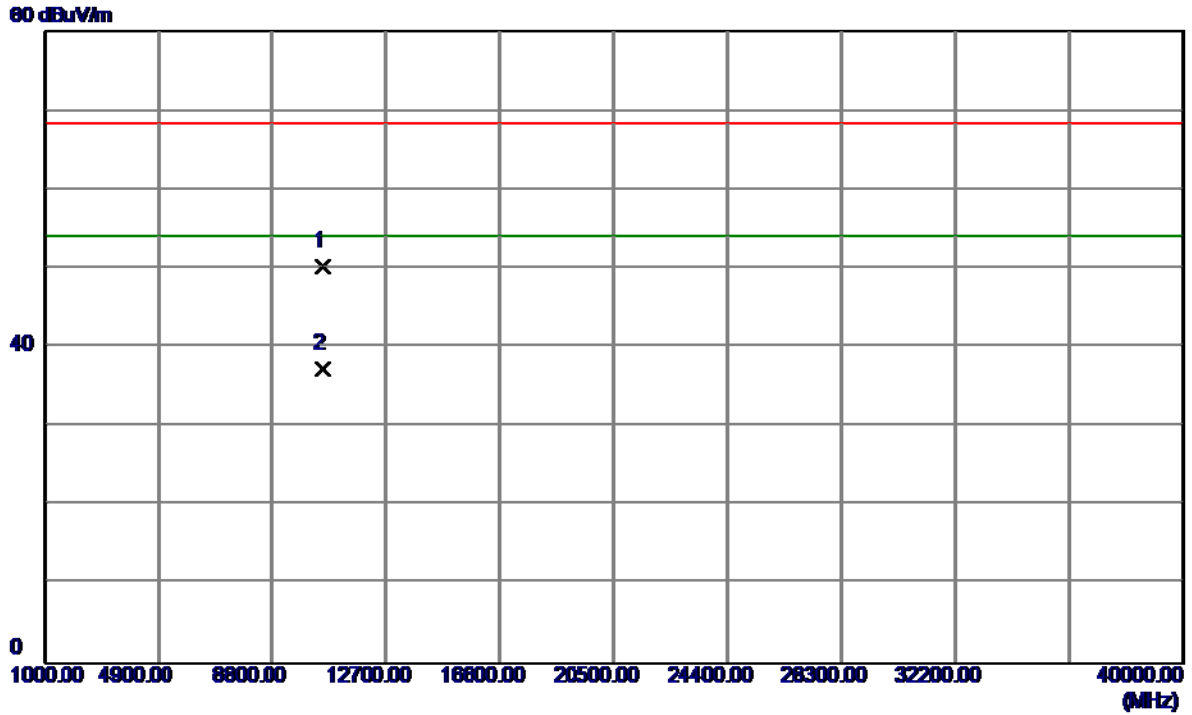

No.	Freq. MHz	Reading Level dBuV/m	Correct Factor dB	Measure ment dBuV/m	Limit dBuV/m	Margin dB	Detector	Comment
1	10540.2570	36.46	13.83	50.29	68.30	-18.01	Peak	
2	10540.6550	23.47	13.83	37.30	54.00	-16.70	AVG	

Orthogonal Axis :	X
Test Mode :	UNII-2A/ TX AC40 Mode 5270MHz

Horizontal

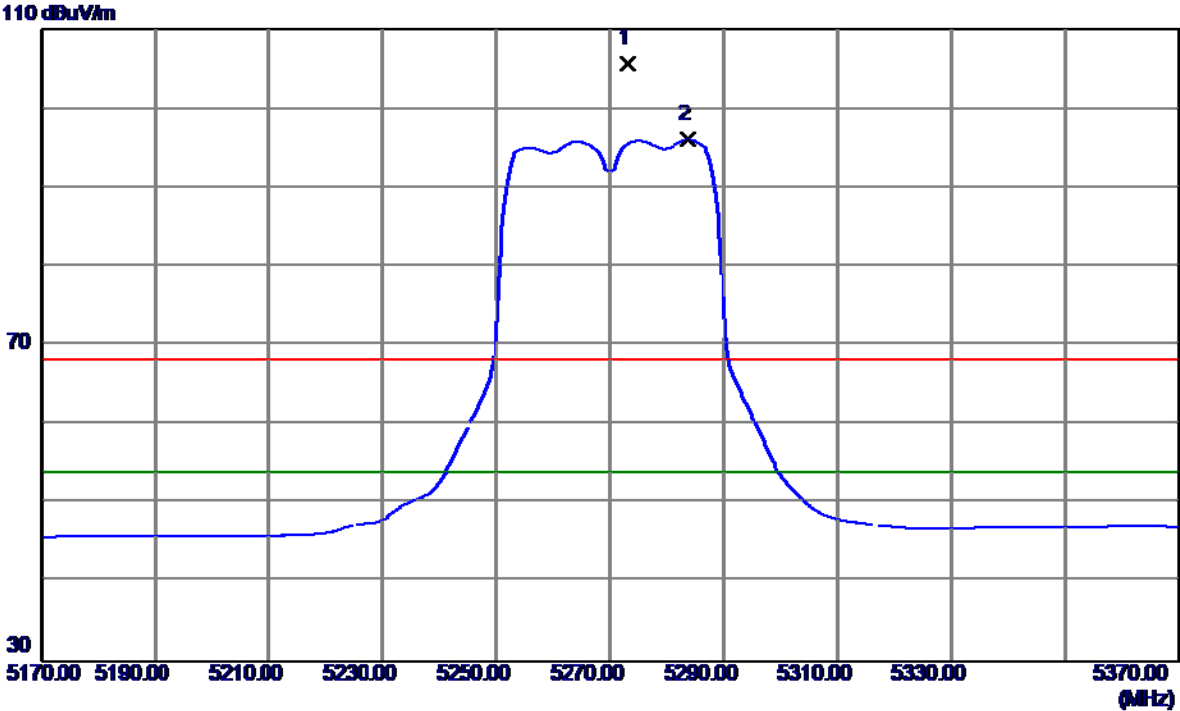

No.	Freq. MHz	Reading Level dBuV/m	Correct Factor dB	Measure ment dBuV/m	Limit dBuV/m	Margin dB	Detector	Comment
1	5273.2000	65.24	40.48	105.72	68.30	37.42	Peak	No Limit
2	5283.8000	55.51	40.50	96.01	54.00	42.01	AVG	No Limit

Orthogonal Axis :	X
Test Mode :	UNII-2A/ TX AC40 Mode 5270MHz

Horizontal

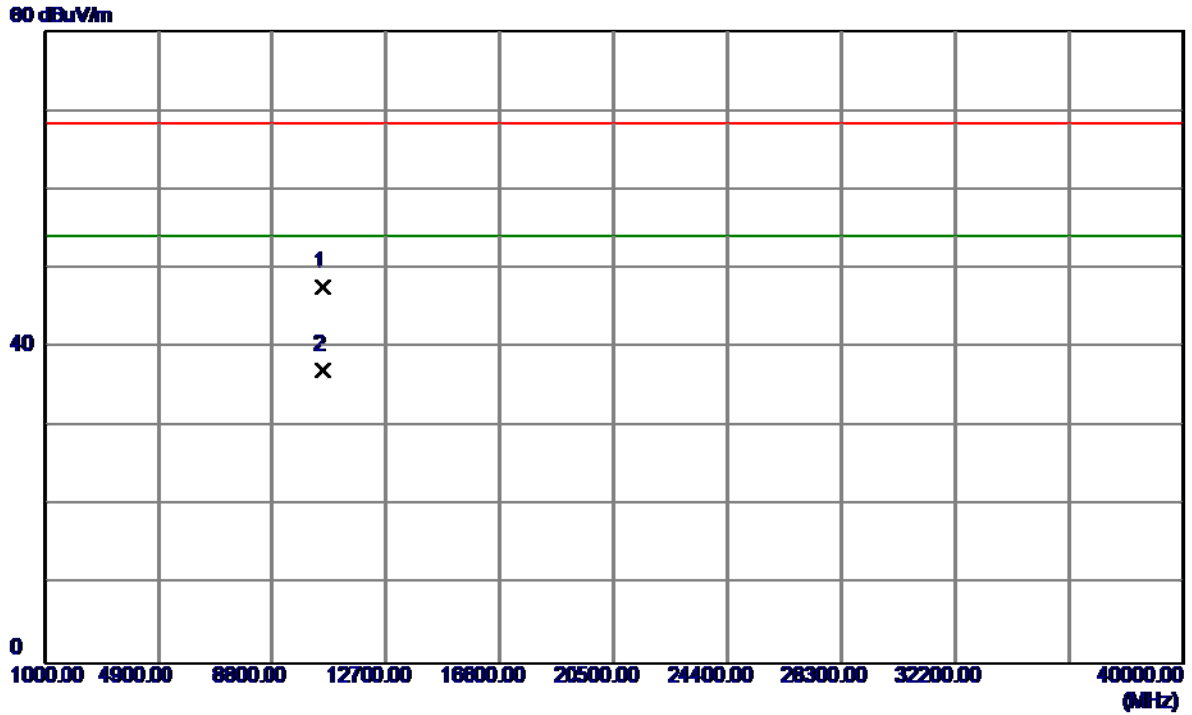

No.	Freq. MHz	Reading Level dBuV/m	Correct Factor dB	Measure ment dBuV/m	Limit dBuV/m	Margin dB	Detector	Comment
1	10540.8700	33.85	13.84	47.69	68.30	-20.61	Peak	
2	10540.8700	23.28	13.84	37.12	54.00	-16.88	AVG	

Orthogonal Axis :	X
Test Mode :	UNII-2A/ TX AC40 Mode 5310MHz

Vertical

110 dBuV/m

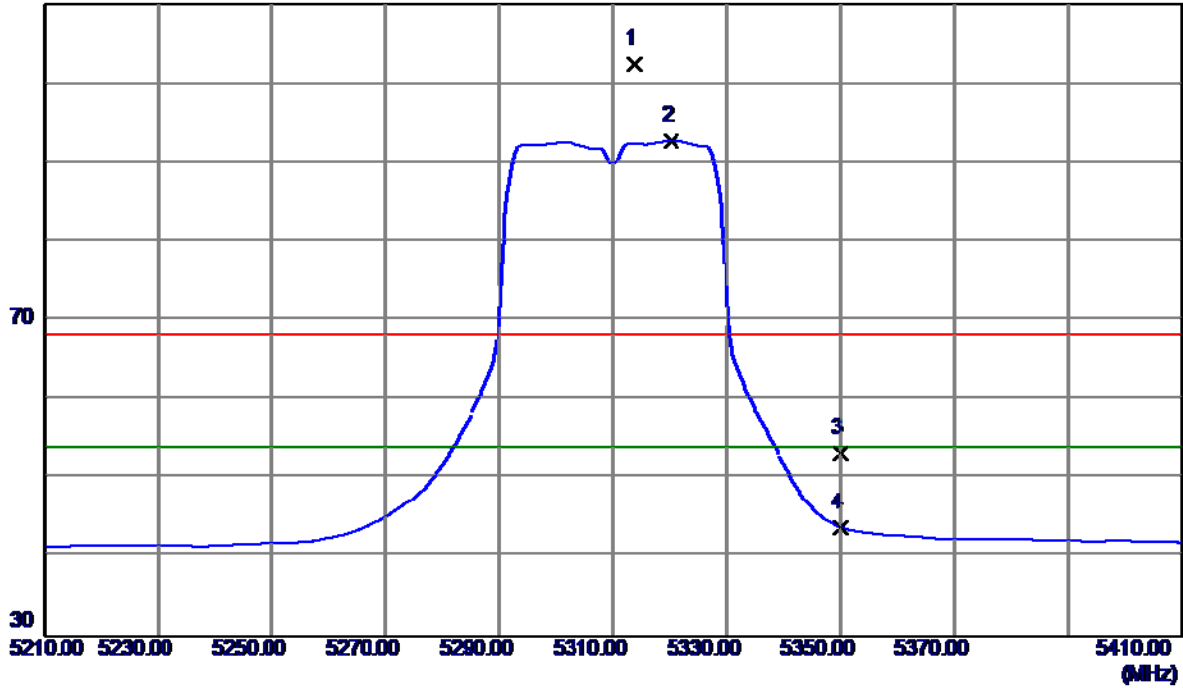

No.	Freq. MHz	Reading Level dBuV/m	Correct Factor dB	Measure ment dBuV/m	Limit dBuV/m	Margin dB	Detector	Comment
1	5313.8000	61.85	40.57	102.42	68.30	34.12	Peak	No Limit
2	5320.2000	52.18	40.58	92.76	54.00	38.76	AVG	No Limit
3	5350.0000	12.50	40.64	53.14	68.30	-15.16	Peak	
4	5350.0000	3.17	40.64	43.81	54.00	-10.19	AVG	

Orthogonal Axis :	X
Test Mode :	UNII-2A/ TX AC40 Mode 5310MHz

Vertical

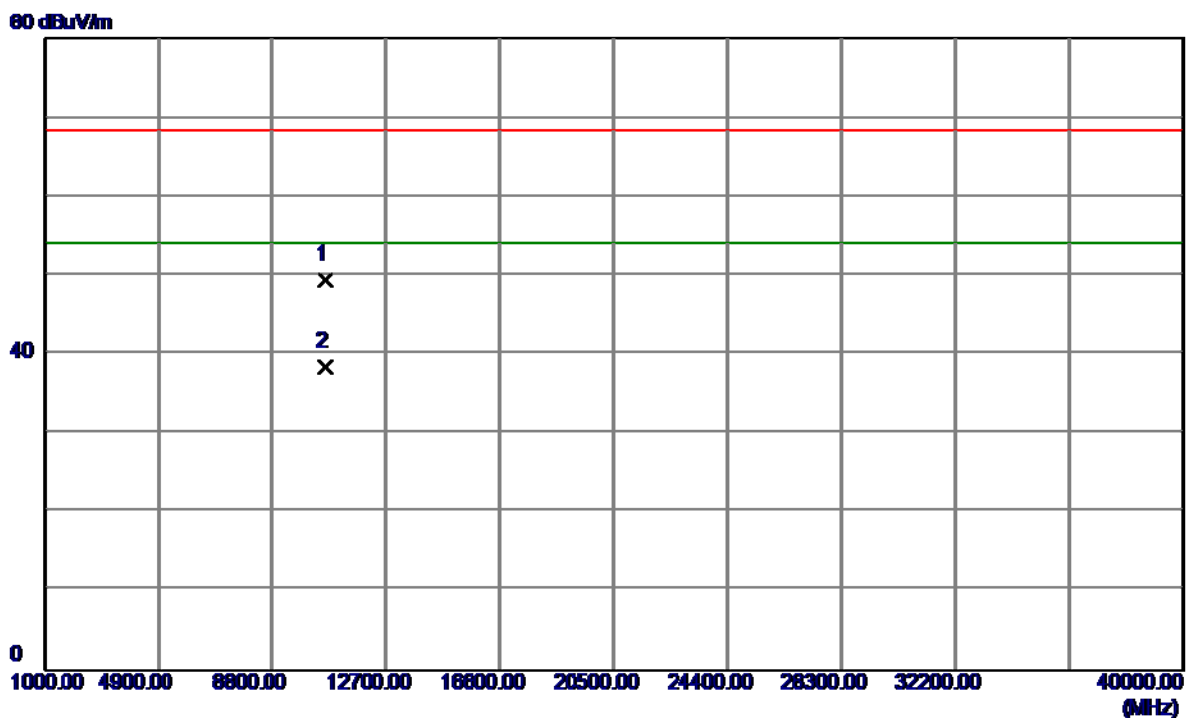

No.	Freq. MHz	Reading Level dBuV/m	Correct Factor dB	Measure ment dBuV/m	Limit dBuV/m	Margin dB	Detector	Comment
1	10620.2500	35.21	14.17	49.38	68.30	-18.92	Peak	
2	10620.2500	24.30	14.17	38.47	54.00	-15.53	AVG	

Orthogonal Axis :	X
Test Mode :	UNII-2A/ TX AC40 Mode 5310MHz

Horizontal

110 dBuV/m

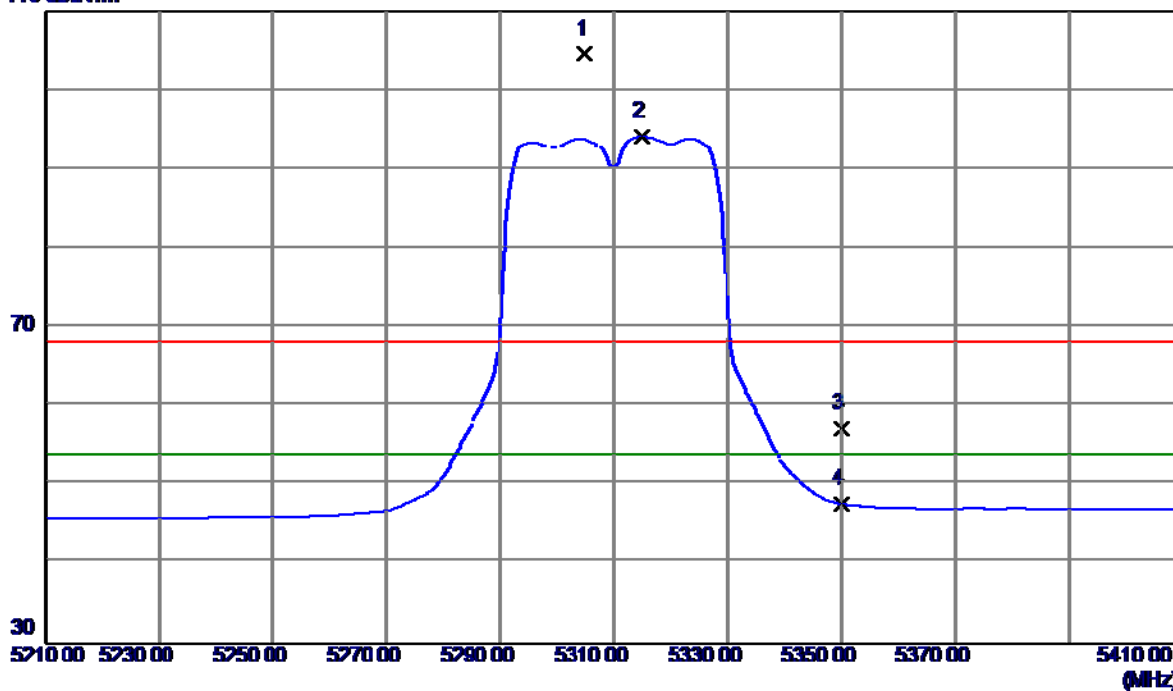

No.	Freq. MHz	Reading Level dBuV/m	Correct Factor dB	Measure ment dBuV/m	Limit dBuV/m	Margin dB	Detector	Comment
1	5305.0000	63.95	40.55	104.50	68.30	36.20	Peak	No Limit
2	5314.8000	53.58	40.57	94.15	54.00	40.15	AVG	No Limit
3	5350.0000	16.56	40.64	57.20	68.30	-11.10	Peak	
4	5350.0000	6.95	40.64	47.59	54.00	-6.41	AVG	

Orthogonal Axis :	X
Test Mode :	UNII-2A/ TX AC40 Mode 5310MHz

Horizontal

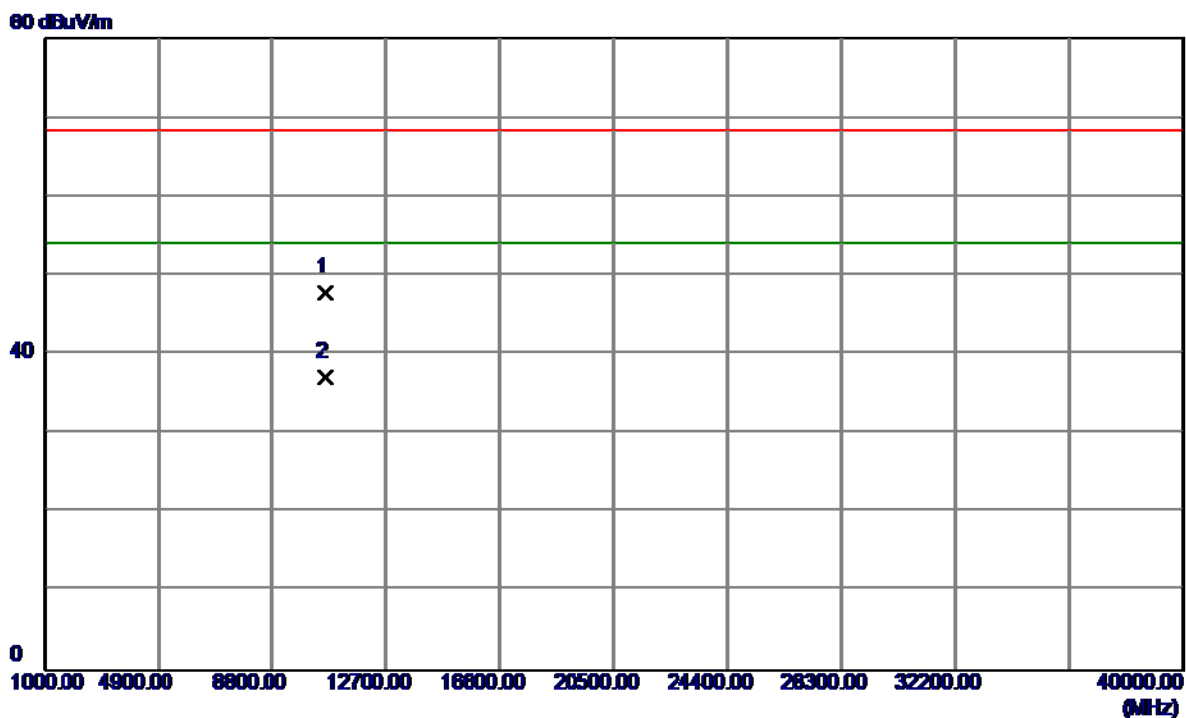

No.	Freq. MHz	Reading Level dBuV/m	Correct Factor dB	Measure ment dBuV/m	Limit dBuV/m	Margin dB	Detector	Comment
1	10620.3700	33.69	14.17	47.86	68.30	-20.44	Peak	
2	10620.3700	22.99	14.17	37.16	54.00	-16.84	AVG	

Orthogonal Axis :	X
Test Mode :	UNII-2A/ TX AC80 Mode 5290MHz

Vertical

110 dBuV/m

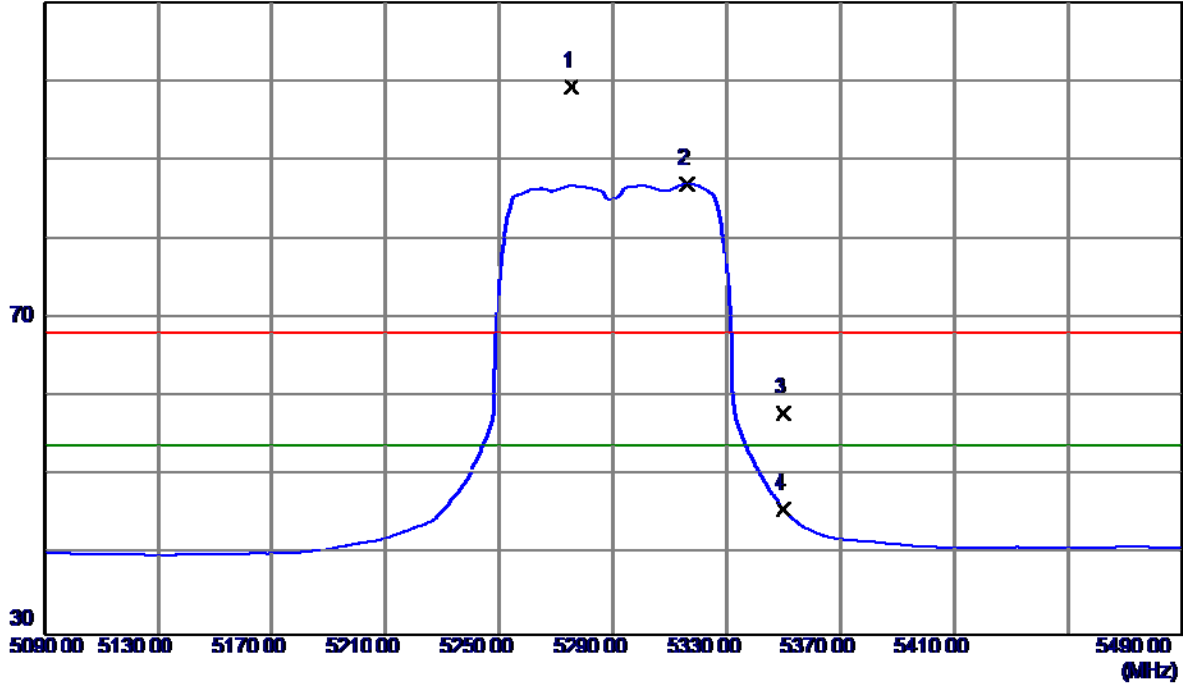

No.	Freq. MHz	Reading Level dBuV/m	Correct Factor dB	Measure ment dBuV/m	Limit dBuV/m	Margin dB	Detector	Comment
1	5275.2000	58.82	40.48	99.30	68.30	31.00	Peak	No Limit
2	5316.4000	46.40	40.57	86.97	54.00	32.97	AVG	No Limit
3	5350.0000	17.40	40.64	58.04	68.30	-10.26	Peak	
4	5350.0000	5.20	40.64	45.84	54.00	-8.16	AVG	

Orthogonal Axis :	X
Test Mode :	UNII-2A/ TX AC80 Mode 5290MHz

Vertical

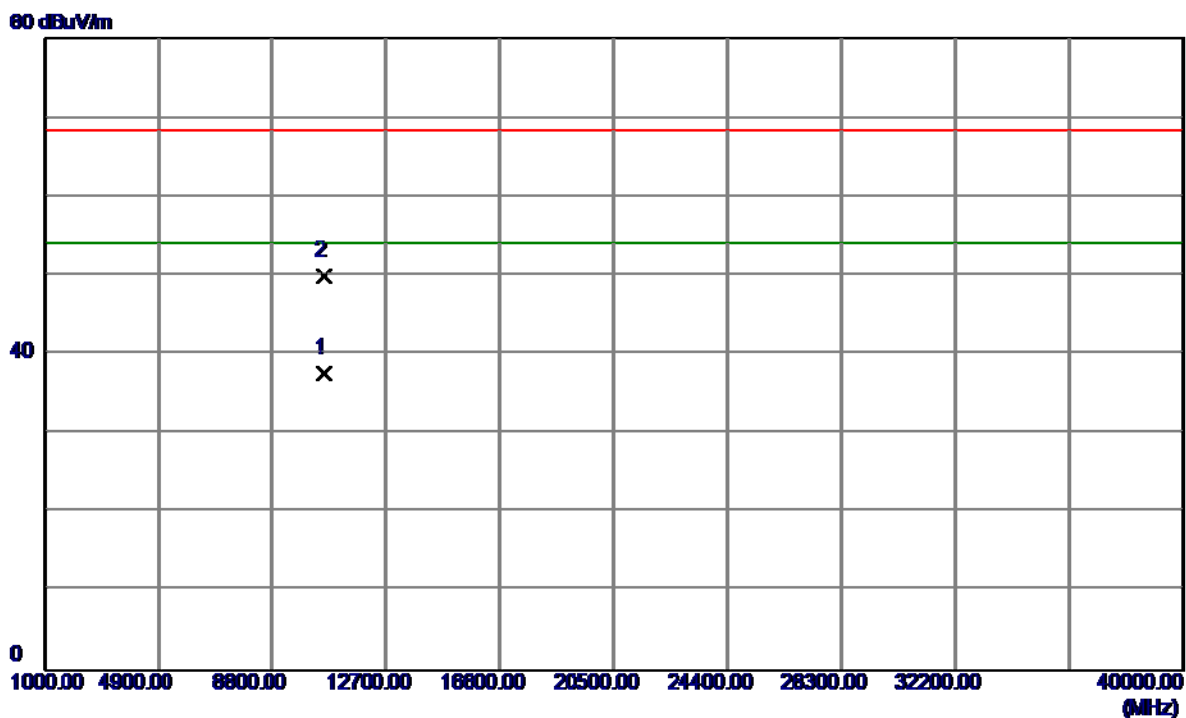

No.	Freq. MHz	Reading Level dBuV/m	Correct Factor dB	Measure ment dBuV/m	Limit dBuV/m	Margin dB	Detector	Comment
1	10581.3400	23.58	14.00	37.58	54.00	-16.42	AVG	
2	10581.3900	35.86	14.00	49.86	68.30	-18.44	Peak	

Orthogonal Axis :	X
Test Mode :	UNII-2A/ TX AC80 Mode 5290MHz

Horizontal

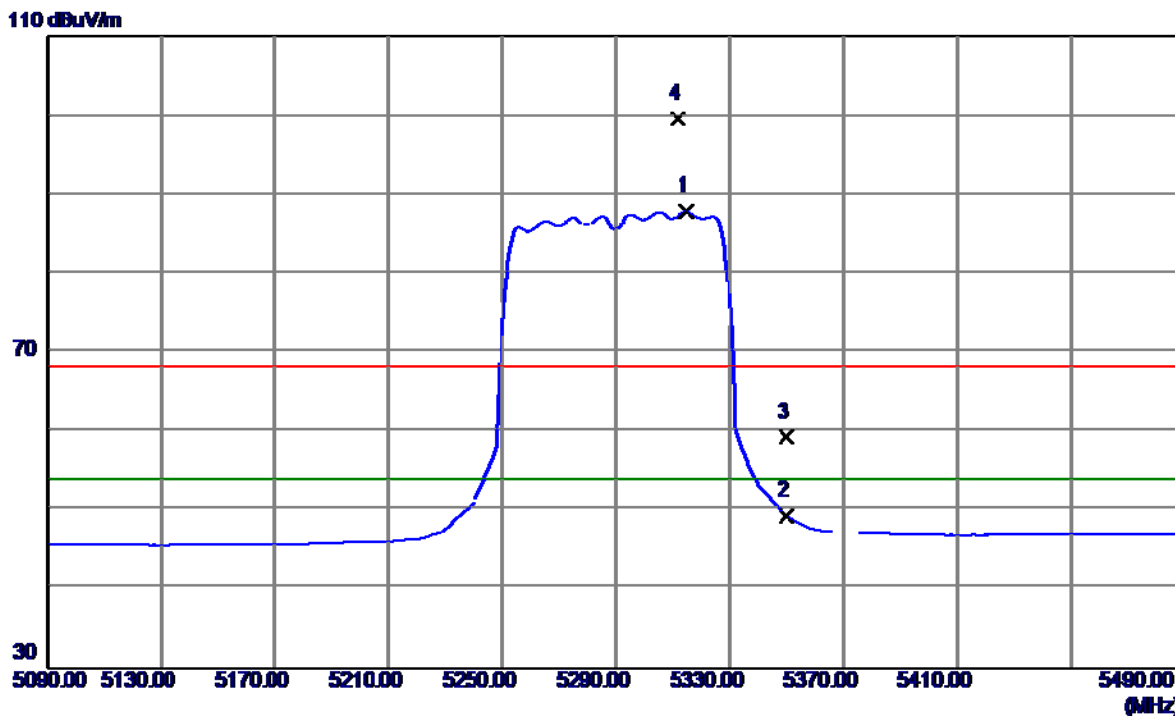

No.	Freq. MHz	Reading Level dBuV/m	Correct Factor dB	Measure ment dBuV/m	Limit dBuV/m	Margin dB	Detector	Comment
1	5314.8000	47.36	40.57	87.93	54.00	33.93	AVG	No Limit
2	5350.0000	8.75	40.64	49.39	54.00	-4.61	AVG	
3	5350.0000	18.66	40.64	59.30	68.30	-9.00	Peak	
4	5311.6000	58.99	40.56	99.55	68.30	31.25	Peak	No Limit

Orthogonal Axis :	X
Test Mode :	UNII-2A/ TX AC80 Mode 5290MHz

Horizontal

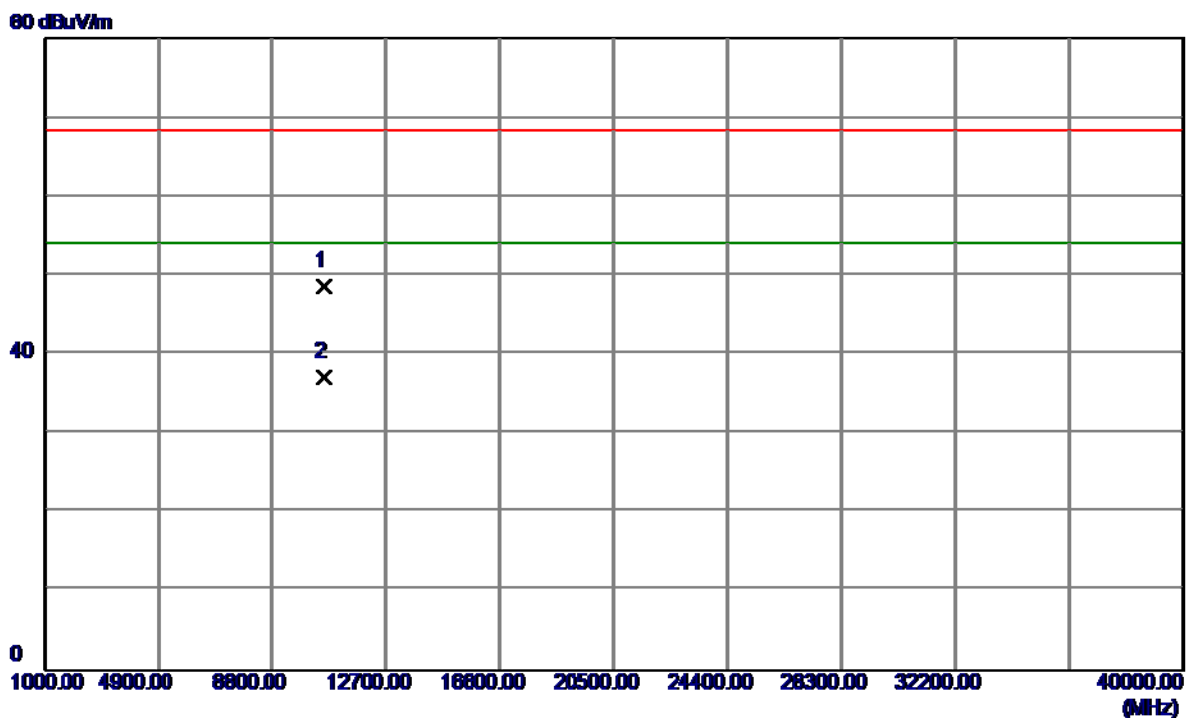

No.	Freq. MHz	Reading Level dBuV/m	Correct Factor dB	Measure ment dBuV/m	Limit dBuV/m	Margin dB	Detector	Comment
1	10580.9900	34.57	14.00	48.57	68.30	-19.73	Peak	
2	10580.9900	23.14	14.00	37.14	54.00	-16.86	AVG	

Orthogonal Axis :	X
Test Mode :	UNII-2C/ TX AC20 Mode 5500MHz

Vertical

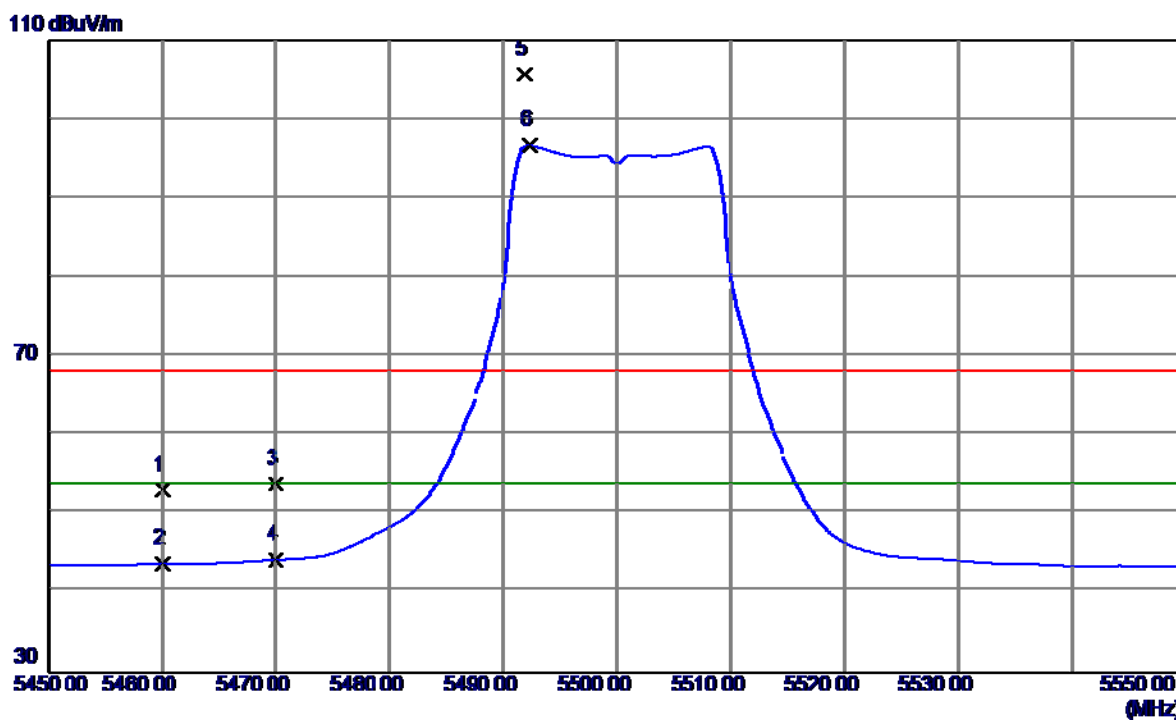

No.	Freq. MHz	Reading Level dBuV/m	Correct Factor dB	Measure ment dBuV/m	Limit dBuV/m	Margin dB	Detector	Comment
1	5460.0000	12.21	40.88	53.09	68.30	-15.21	Peak	
2	5460.0000	2.87	40.88	43.75	54.00	-10.25	AVG	
3	5470.0000	12.95	40.90	53.85	68.30	-14.45	Peak	
4	5470.0000	3.35	40.90	44.25	54.00	-9.75	AVG	
5	5491.9000	64.73	40.94	105.67	68.30	37.37	Peak	No Limit
6	5492.3000	55.74	40.94	96.68	54.00	42.68	AVG	No Limit

Orthogonal Axis :	X
Test Mode :	UNII-2C/ TX AC20 Mode 5500MHz

Vertical

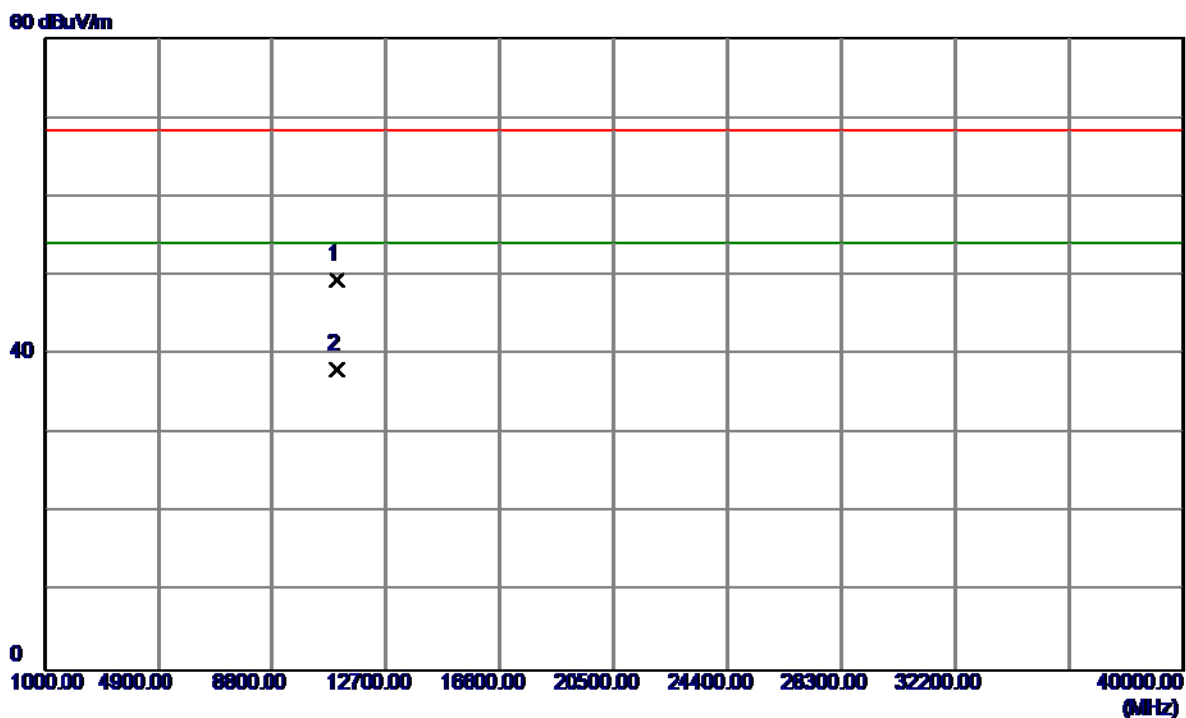

No.	Freq. MHz	Reading Level dBuV/m	Correct Factor dB	Measure ment dBuV/m	Limit dBuV/m	Margin dB	Detector	Comment
1	11000.6700	33.65	15.75	49.40	68.30	-18.90	Peak	
2	11000.6200	22.36	15.75	38.11	54.00	-15.89	AVG	

Orthogonal Axis :	X
Test Mode :	UNII-2C/ TX AC20 Mode 5500MHz

Horizontal

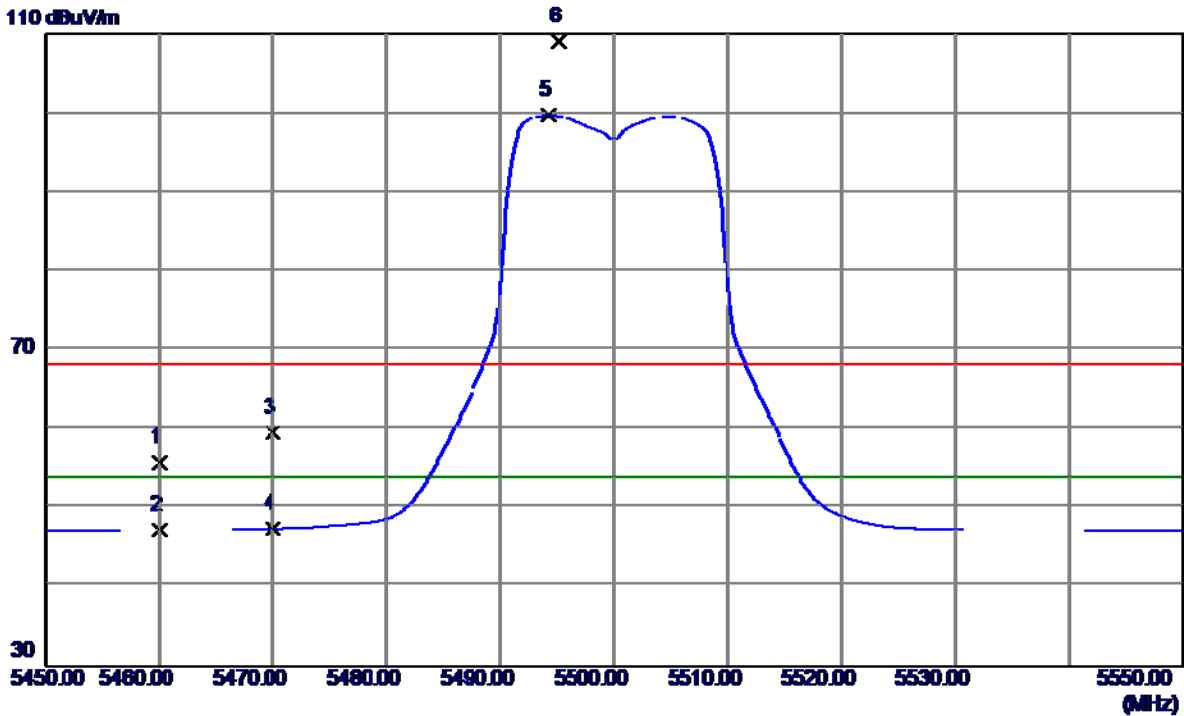

No.	Freq. MHz	Reading Level dBuV/m	Correct Factor dB	Measure ment dBuV/m	Limit dBuV/m	Margin dB	Detector	Comment
1	5460.0000	14.89	40.88	55.77	68.30	-12.53	Peak	
2	5460.0000	6.36	40.88	47.24	54.00	-6.76	AVG	
3	5470.0000	18.66	40.90	59.56	68.30	-8.74	Peak	
4	5470.0000	6.58	40.90	47.48	54.00	-6.52	AVG	
5	5494.2000	58.80	40.95	99.75	54.00	45.75	AVG	No Limit
6	5495.1000	68.03	40.95	108.98	68.30	40.68	Peak	No Limit

Orthogonal Axis :	X
Test Mode :	UNII-2C/ TX AC20 Mode 5500MHz

Horizontal

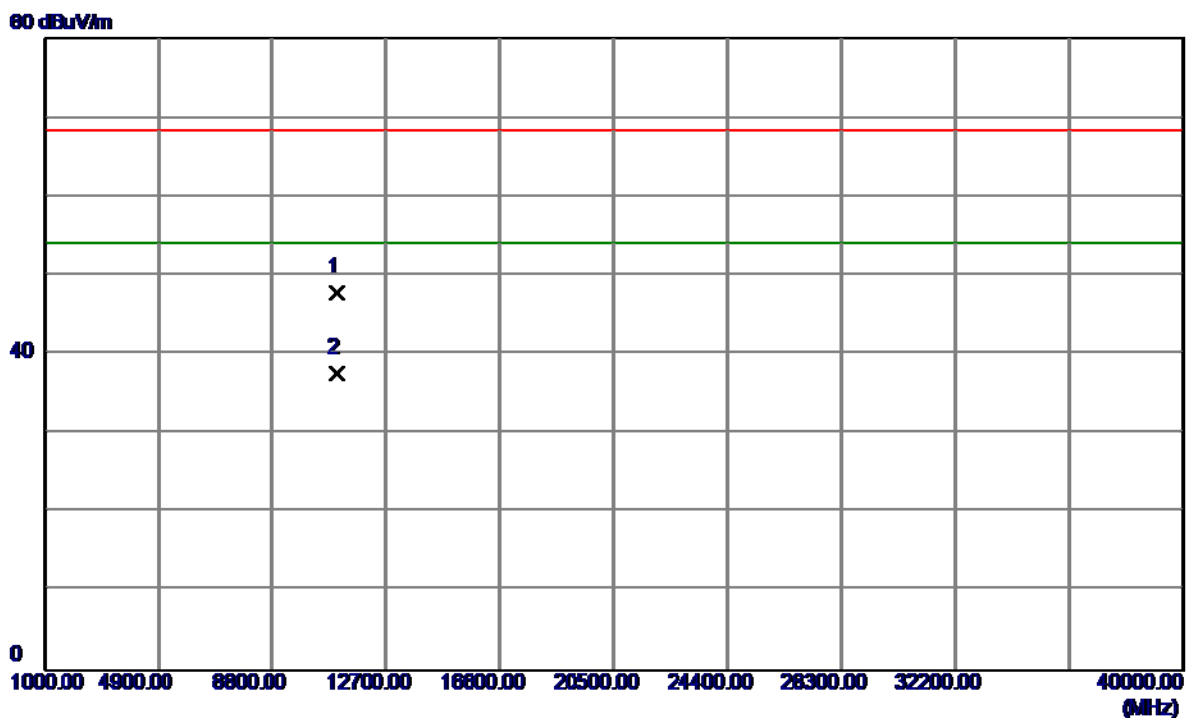

No.	Freq. MHz	Reading Level dBuV/m	Correct Factor dB	Measure ment dBuV/m	Limit dBuV/m	Margin dB	Detector	Comment
1	11000.0800	32.07	15.75	47.82	68.30	-20.48	Peak	
2	11000.0800	21.90	15.75	37.65	54.00	-16.35	AVG	

Orthogonal Axis :	X
Test Mode :	UNII-2C/ TX AC20 Mode 5580MHz

Vertical

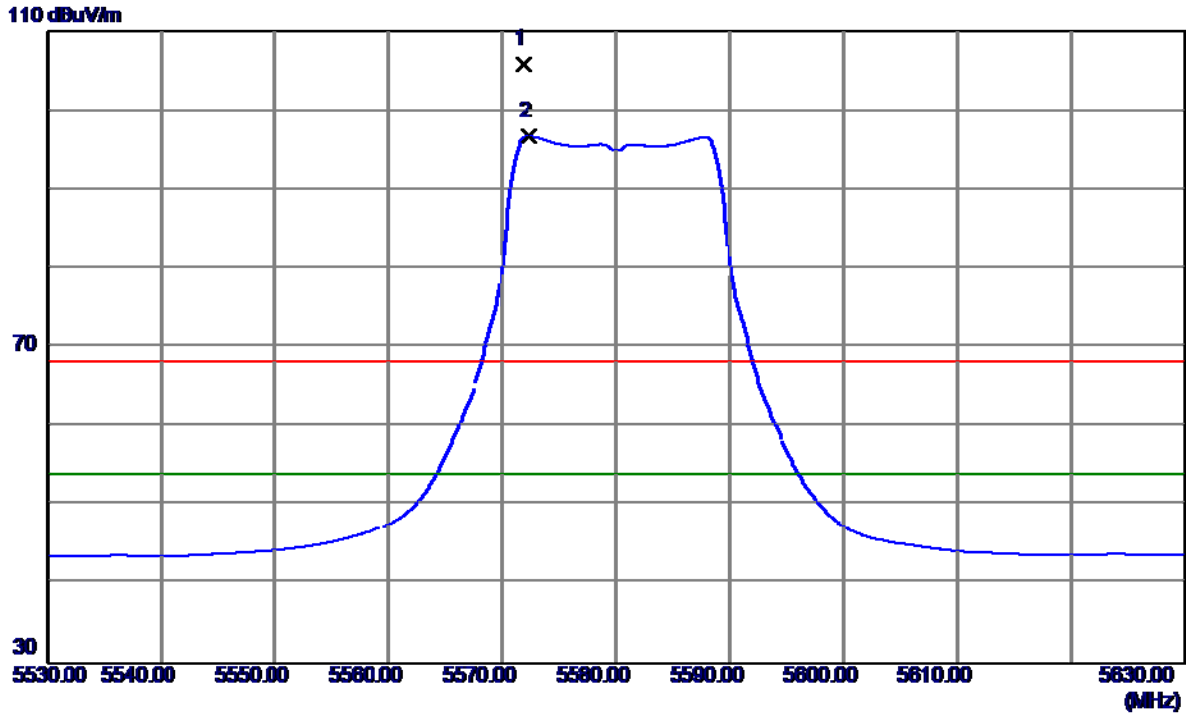

No.	Freq. MHz	Reading Level dBuV/m	Correct Factor dB	Measure ment dBuV/m	Limit dBuV/m	Margin dB	Detector	Comment
1	5571.9000	64.84	41.06	105.90	68.30	37.60	Peak	No Limit
2	5572.3000	55.66	41.06	96.72	54.00	42.72	AVG	No Limit

Orthogonal Axis :	X
Test Mode :	UNII-2C/ TX AC20 Mode 5580MHz

Vertical

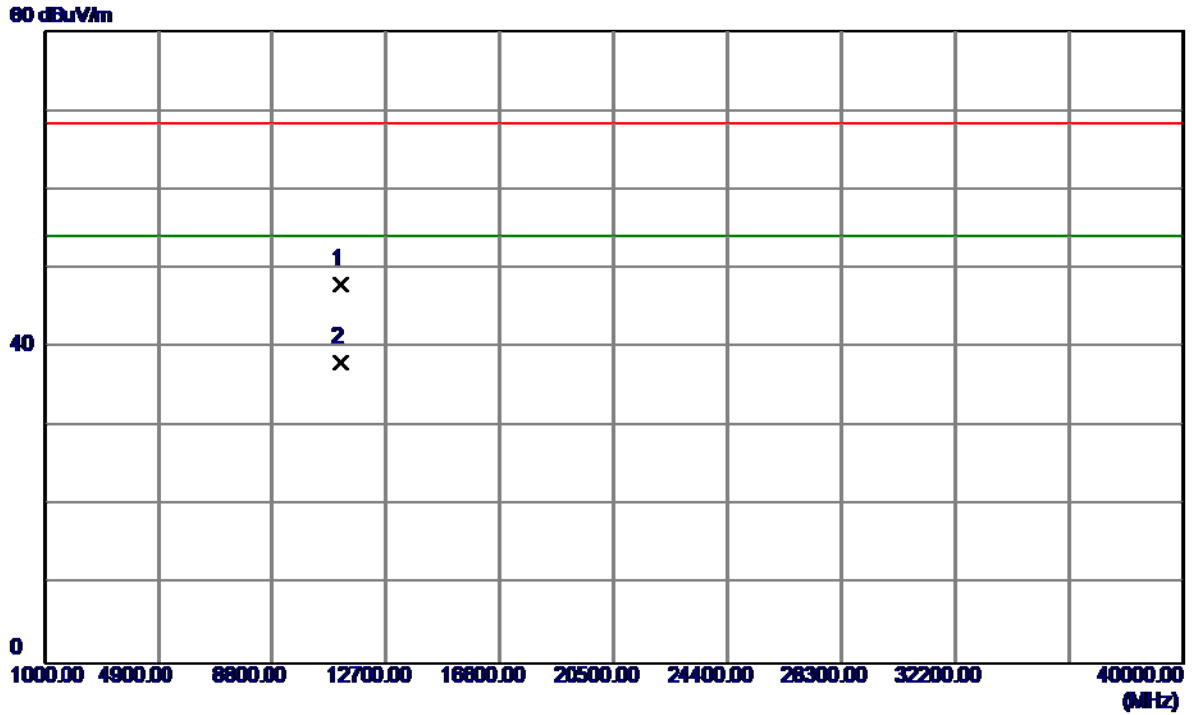

No.	Freq. MHz	Reading Level dBuV/m	Correct Factor dB	Measure ment dBuV/m	Limit dBuV/m	Margin dB	Detector	Comment
1	11160.7100	31.89	16.13	48.02	68.30	-20.28	Peak	
2	11160.7100	21.88	16.13	38.01	54.00	-15.99	AVG	

Orthogonal Axis :	X
Test Mode :	UNII-2C/ TX AC20 Mode 5580MHz

Horizontal

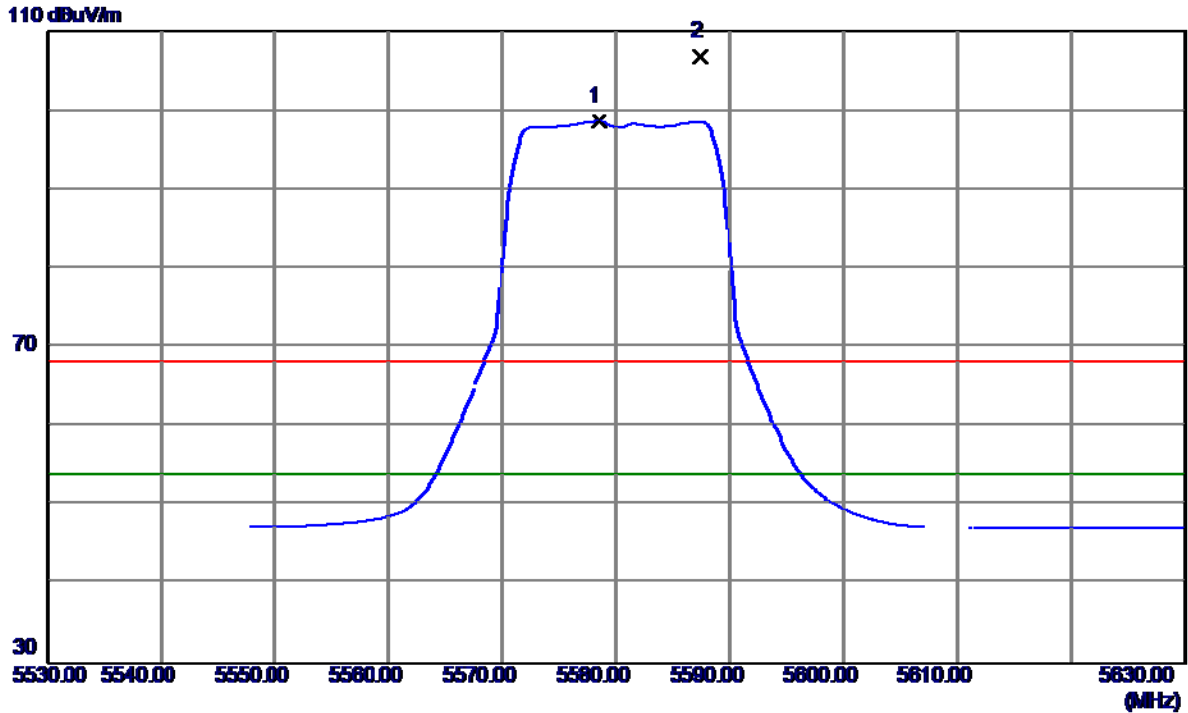

No.	Freq. MHz	Reading Level dBuV/m	Correct Factor dB	Measure ment dBuV/m	Limit dBuV/m	Margin dB	Detector	Comment
1	5578.5000	57.54	41.07	98.61	54.00	44.61	AVG	No Limit
2	5587.4000	65.79	41.08	106.87	68.30	38.57	Peak	No Limit

Orthogonal Axis :	X
Test Mode :	UNII-2C/ TX AC20 Mode 5580MHz

Horizontal

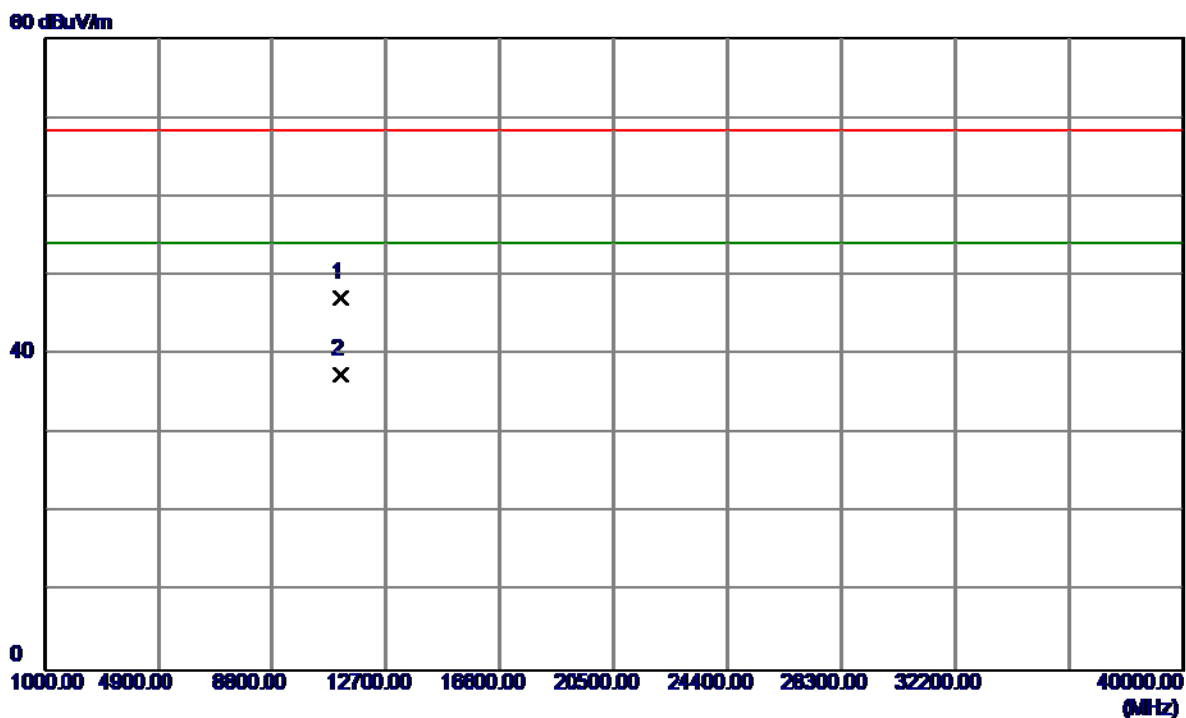

No.	Freq. MHz	Reading Level dBuV/m	Correct Factor dB	Measure ment dBuV/m	Limit dBuV/m	Margin dB	Detector	Comment
1	11160.0300	31.10	16.13	47.23	68.30	-21.07	Peak	
2	11160.0300	21.29	16.13	37.42	54.00	-16.58	AVG	

Orthogonal Axis :	X
Test Mode :	UNII-2C/ TX AC20 Mode 5700MHz

Vertical

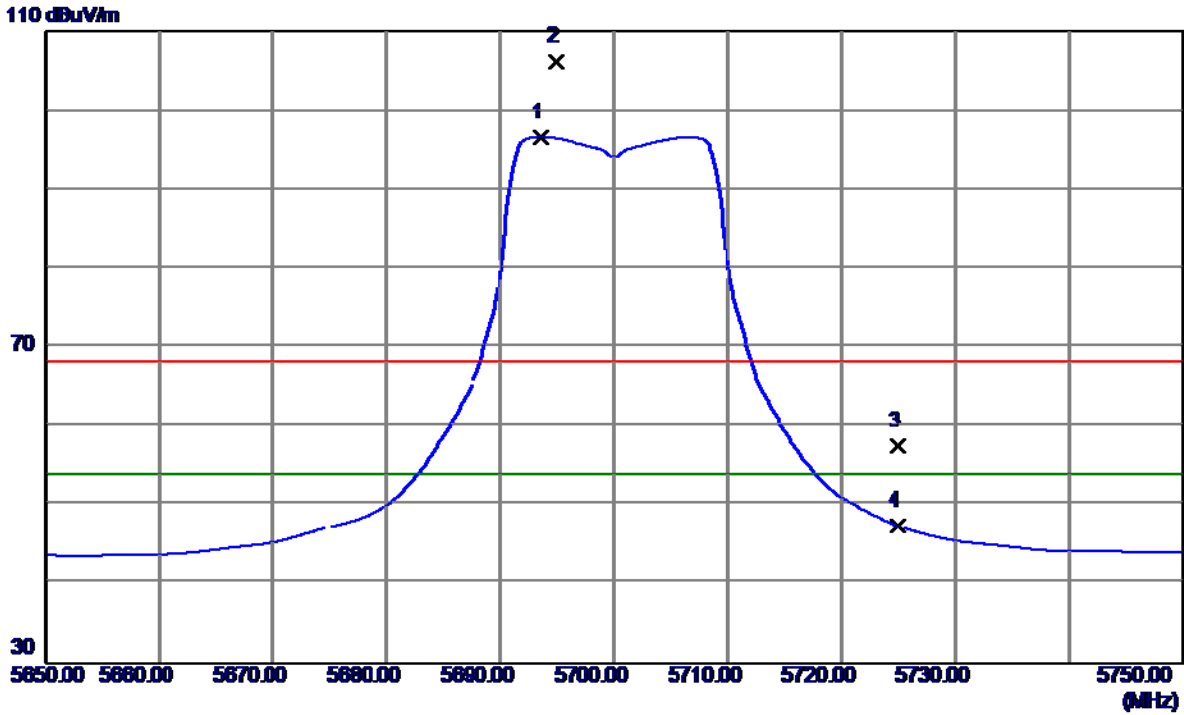

No.	Freq. MHz	Reading Level dBuV/m	Correct Factor dB	Measure ment dBuV/m	Limit dBuV/m	Margin dB	Detector	Comment
1	5693.6000	55.40	41.22	96.62	54.00	42.62	AVG	No Limit
2	5694.9000	64.97	41.23	106.20	68.30	37.90	Peak	No Limit
3	5725.0000	16.24	41.27	57.51	68.30	-10.79	Peak	
4	5725.0000	6.16	41.27	47.43	54.00	-6.57	AVG	

Orthogonal Axis :	X
Test Mode :	UNII-2C/ TX AC20 Mode 5700MHz

Vertical

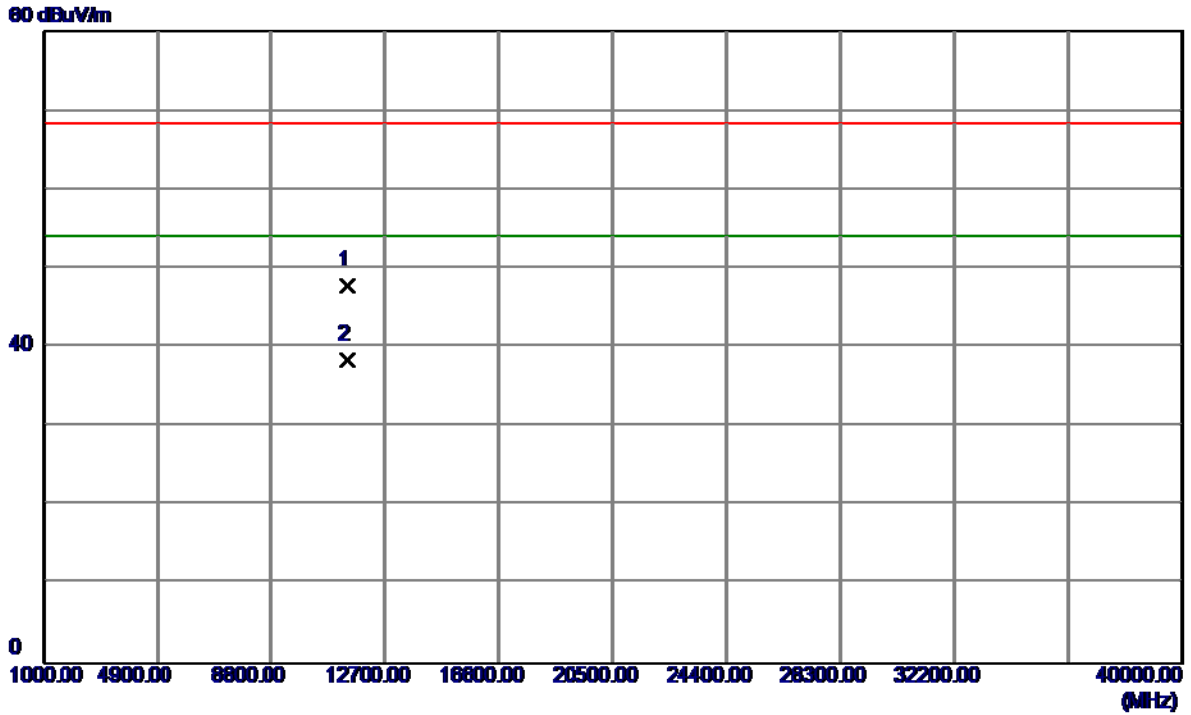

No.	Freq. MHz	Reading Level dBuV/m	Correct Factor dB	Measure ment dBuV/m	Limit dBuV/m	Margin dB	Detector	Comment
1	11400.7900	31.21	16.70	47.91	68.30	-20.39	Peak	
2	11400.7900	21.63	16.70	38.33	54.00	-15.67	AVG	

Orthogonal Axis :	X
Test Mode :	UNII-2C/ TX AC20 Mode 5700MHz

Horizontal

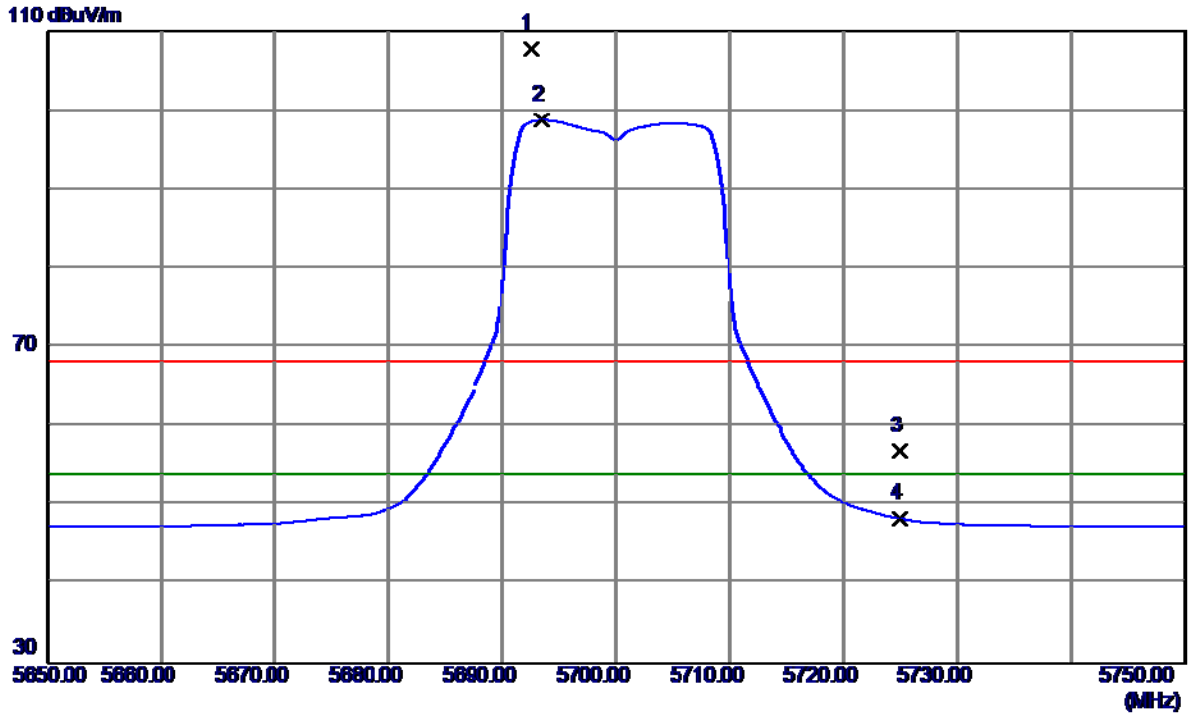

No.	Freq. MHz	Reading Level dBuV/m	Correct Factor dB	Measure ment dBuV/m	Limit dBuV/m	Margin dB	Detector	Comment
1	5692.5000	66.50	41.22	107.72	68.30	39.42	Peak	No Limit
2	5693.4000	57.53	41.22	98.75	54.00	44.75	AVG	No Limit
3	5725.0000	15.55	41.27	56.82	68.30	-11.48	Peak	
4	5725.0000	7.13	41.27	48.40	54.00	-5.60	AVG	

Orthogonal Axis :	X
Test Mode :	UNII-2C/ TX AC20 Mode 5700MHz

Horizontal

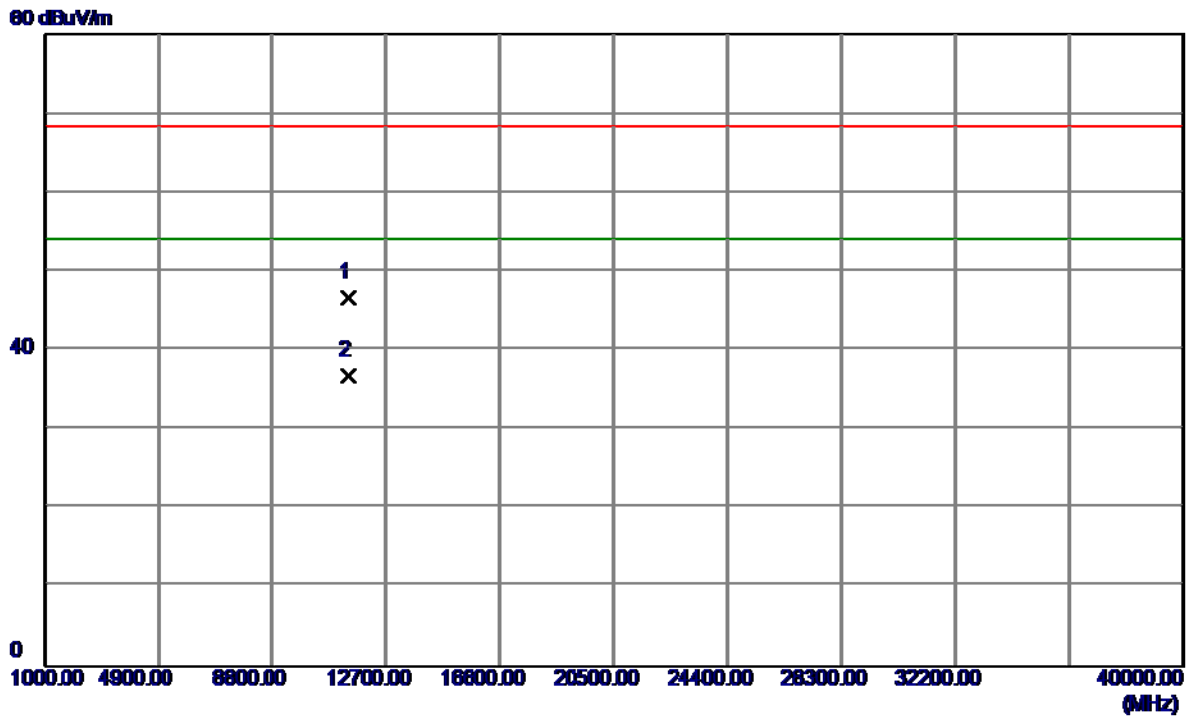

No.	Freq. MHz	Reading Level dBuV/m	Correct Factor dB	Measure ment dBuV/m	Limit dBuV/m	Margin dB	Detector	Comment
1	11400.6300	30.07	16.70	46.77	68.30	-21.53	Peak	
2	11400.2200	20.14	16.70	36.84	54.00	-17.16	AVG	

Orthogonal Axis :	X
Test Mode :	UNII-2C/ TX AC40 Mode 5510MHz

Vertical

110 dBuV/m

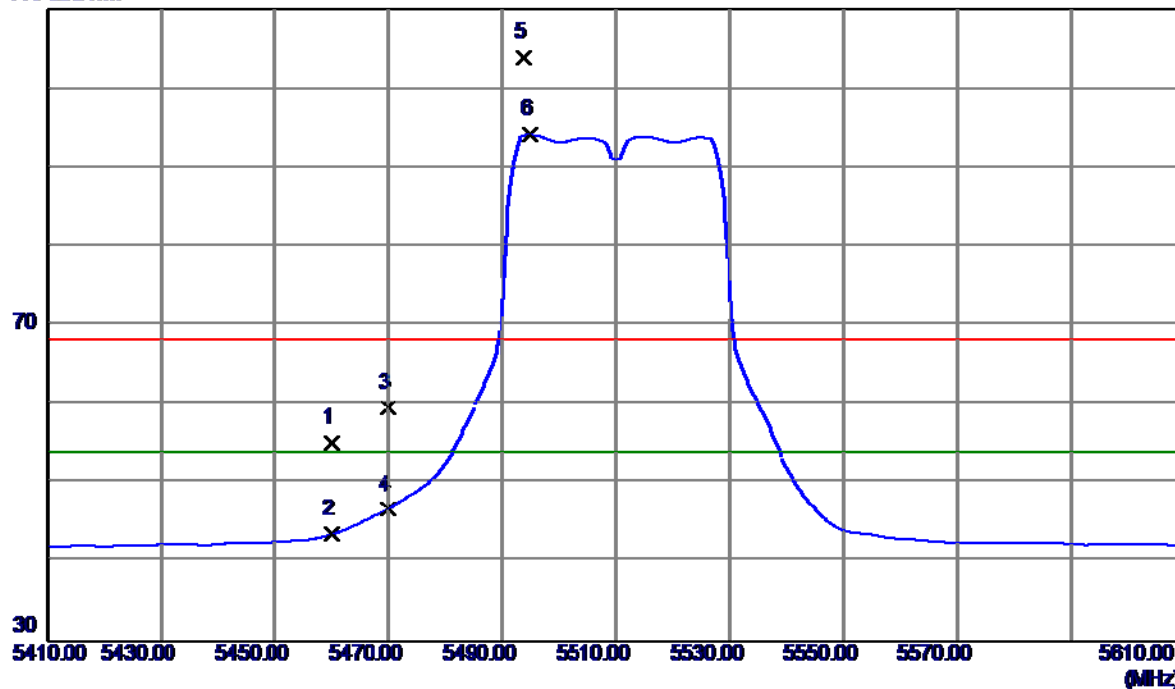

No.	Freq. MHz	Reading Level dBuV/m	Correct Factor dB	Measure ment dBuV/m	Limit dBuV/m	Margin dB	Detector	Comment
1	5460.0000	14.30	40.88	55.18	68.30	-13.12	Peak	
2	5460.0000	2.67	40.88	43.55	54.00	-10.45	AVG	
3	5470.0000	18.64	40.90	59.54	68.30	-8.76	Peak	
4	5470.0000	5.82	40.90	46.72	54.00	-7.28	AVG	
5	5493.8000	62.98	40.95	103.93	68.30	35.63	Peak	No Limit
6	5494.8000	53.16	40.95	94.11	54.00	40.11	AVG	No Limit

Orthogonal Axis :	X
Test Mode :	UNII-2C/ TX AC40 Mode 5510MHz

Vertical

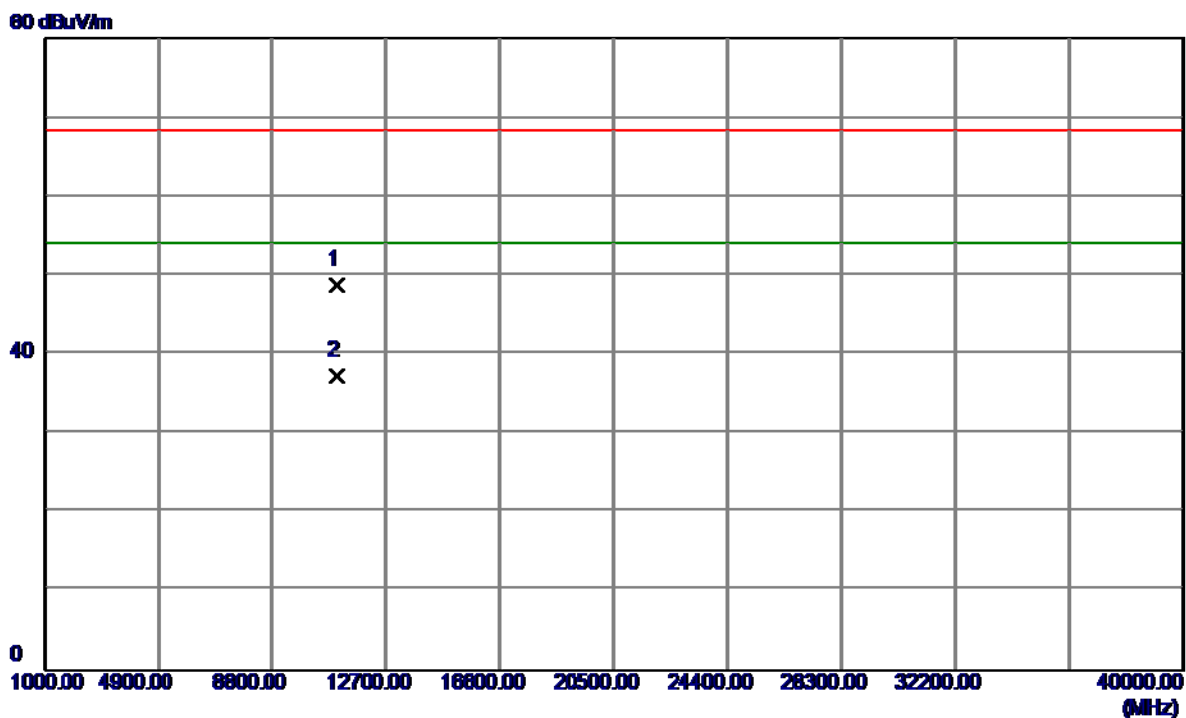

No.	Freq. MHz	Reading Level dBuV/m	Correct Factor dB	Measure ment dBuV/m	Limit dBuV/m	Margin dB	Detector	Comment
1	11020.0300	32.95	15.80	48.75	68.30	-19.55	Peak	
2	11020.0300	21.54	15.80	37.34	54.00	-16.66	AVG	

Orthogonal Axis :	X
Test Mode :	UNII-2C/ TX AC40 Mode 5510MHz

Horizontal

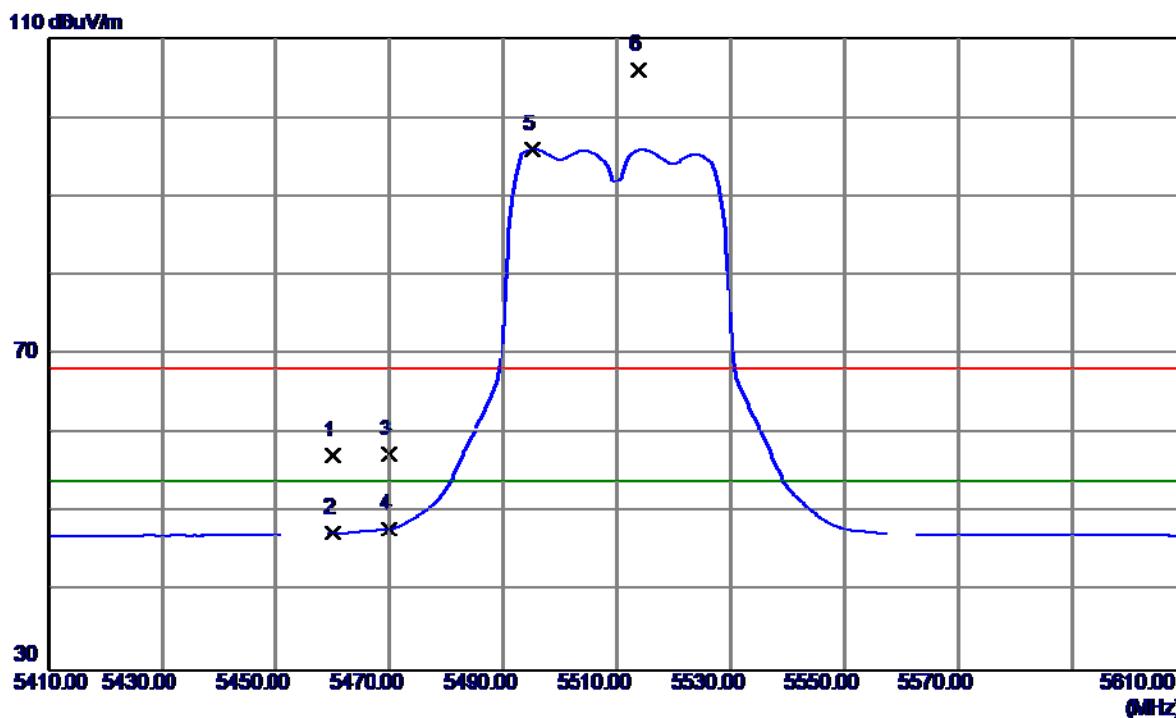

No.	Freq. MHz	Reading Level dBuV/m	Correct Factor dB	Measure ment dBuV/m	Limit dBuV/m	Margin dB	Detector	Comment
1	5460.0000	16.25	40.88	57.13	68.30	-11.17	Peak	
2	5460.0000	6.50	40.88	47.38	54.00	-6.62	AVG	
3	5470.0000	16.39	40.90	57.29	68.30	-11.01	Peak	
4	5470.0000	7.05	40.90	47.95	54.00	-6.05	AVG	
5	5495.2000	54.98	40.95	95.93	54.00	41.93	AVG	No Limit
6	5513.8000	64.97	40.98	105.95	68.30	37.65	Peak	No Limit

Orthogonal Axis :	X
Test Mode :	UNII-2C/ TX AC40 Mode 5510MHz

Horizontal

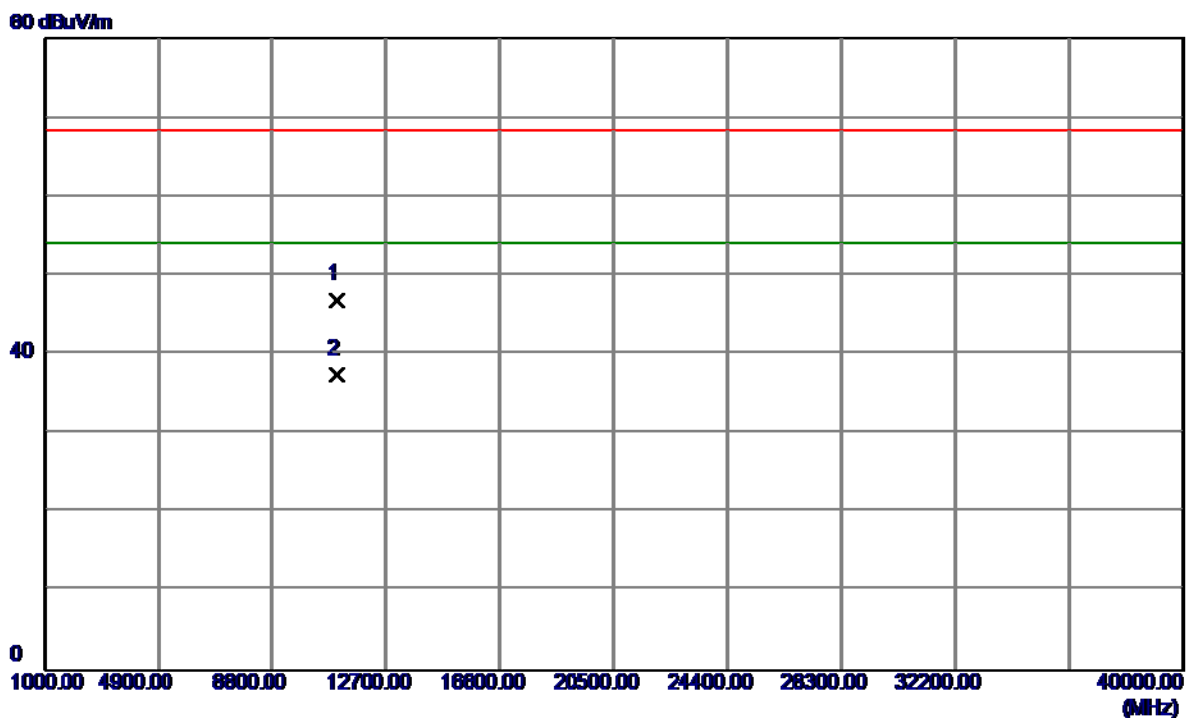

No.	Freq. MHz	Reading Level dBuV/m	Correct Factor dB	Measure ment dBuV/m	Limit dBuV/m	Margin dB	Detector	Comment
1	11020.4560	31.16	15.80	46.96	68.30	-21.34	Peak	
2	11020.2440	21.65	15.80	37.45	54.00	-16.55	AVG	

Orthogonal Axis :	X
Test Mode :	UNII-2C/ TX AC40 Mode 5550MHz

Vertical

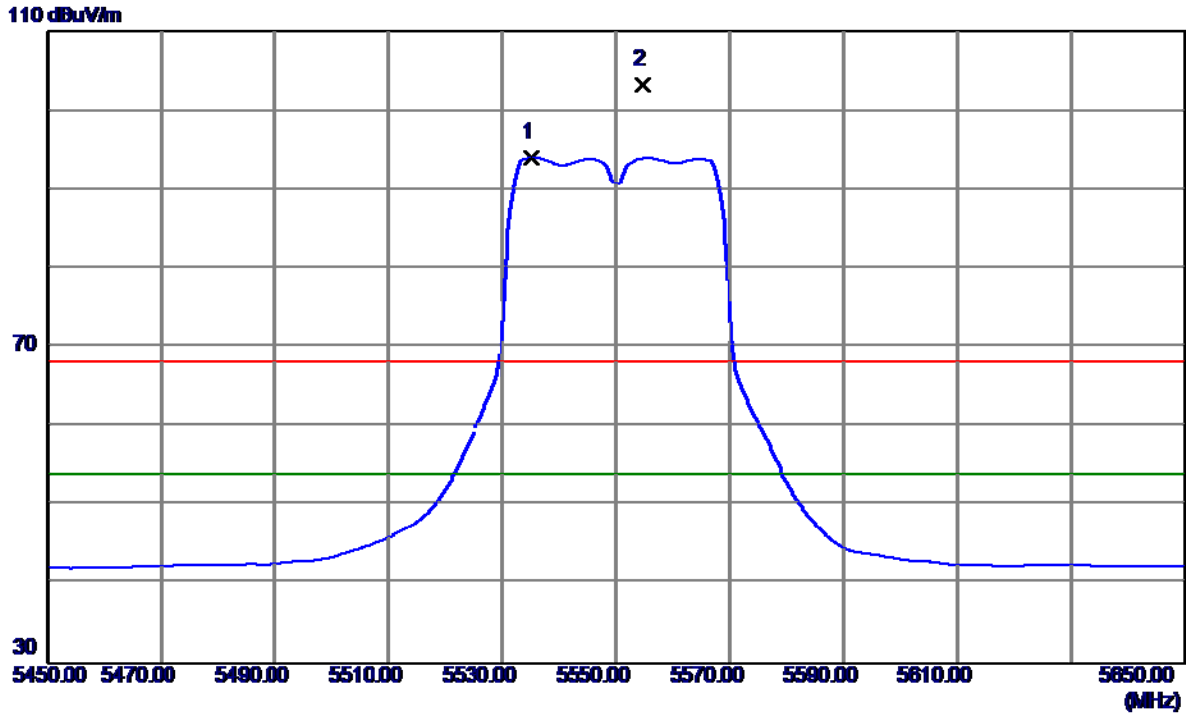

No.	Freq. MHz	Reading Level dBuV/m	Correct Factor dB	Measure ment dBuV/m	Limit dBuV/m	Margin dB	Detector	Comment
1	5535.2000	53.01	41.01	94.02	54.00	40.02	AVG	No Limit
2	5554.6000	62.19	41.03	103.22	68.30	34.92	Peak	No Limit

Orthogonal Axis :	X
Test Mode :	UNII-2C/ TX AC40 Mode 5550MHz

Vertical

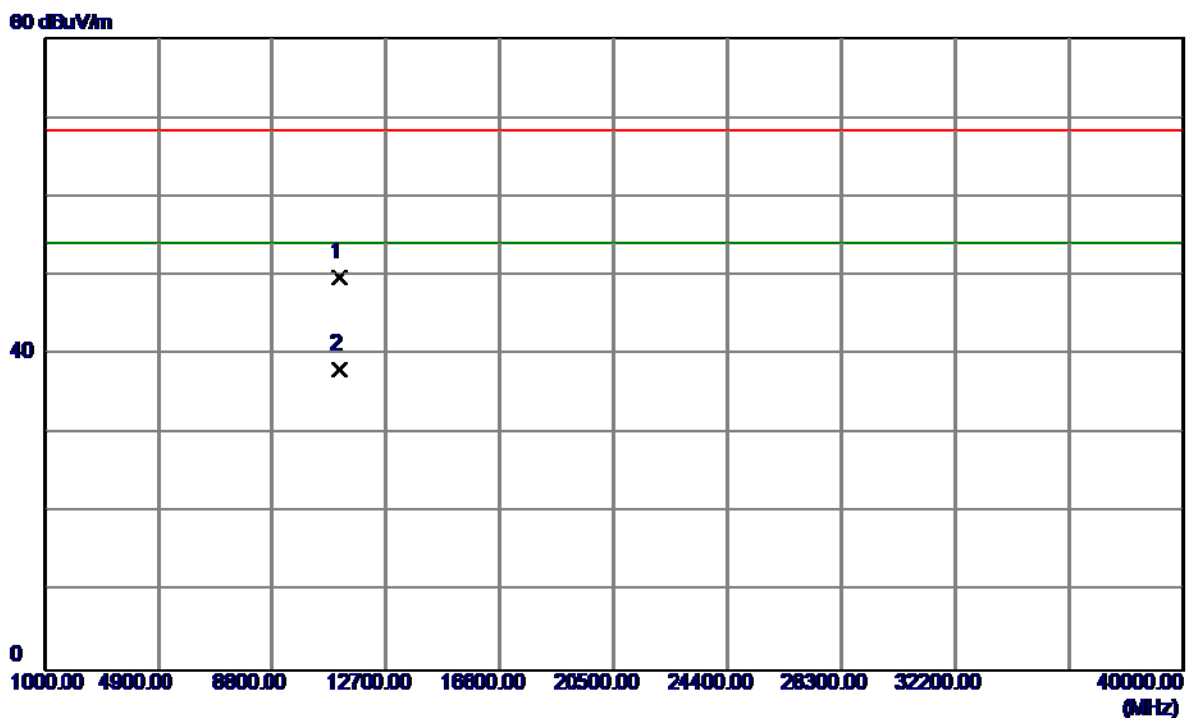

No.	Freq. MHz	Reading Level dBuV/m	Correct Factor dB	Measure ment dBuV/m	Limit dBuV/m	Margin dB	Detector	Comment
1	11100.5800	33.75	15.99	49.74	68.30	-18.56	Peak	
2	11100.5800	22.14	15.99	38.13	54.00	-15.87	AVG	

Orthogonal Axis :	X
Test Mode :	UNII-2C/ TX AC40 Mode 5550MHz

Horizontal

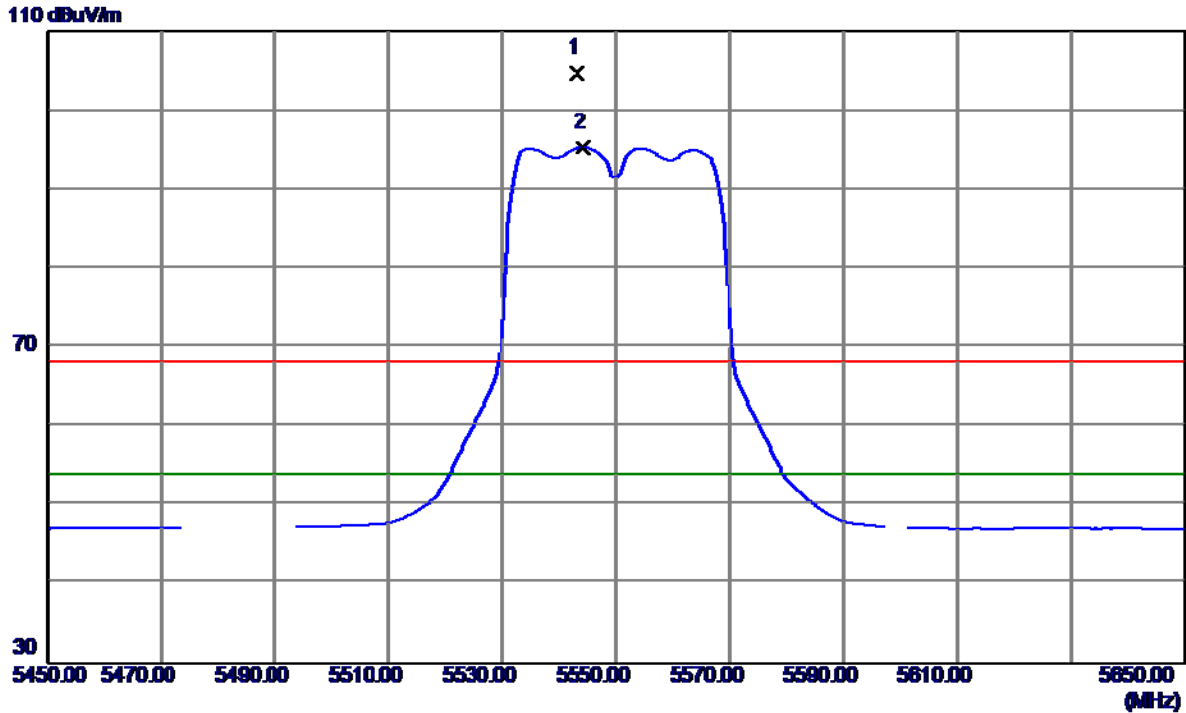

No.	Freq. MHz	Reading Level dBuV/m	Correct Factor dB	Measure ment dBuV/m	Limit dBuV/m	Margin dB	Detector	Comment
1	5543.2000	63.72	41.02	104.74	68.30	36.44	Peak	No Limit
2	5544.2000	54.31	41.02	95.33	54.00	41.33	AVG	No Limit

Orthogonal Axis :	X
Test Mode :	UNII-2C/ TX AC40 Mode 5550MHz

Horizontal

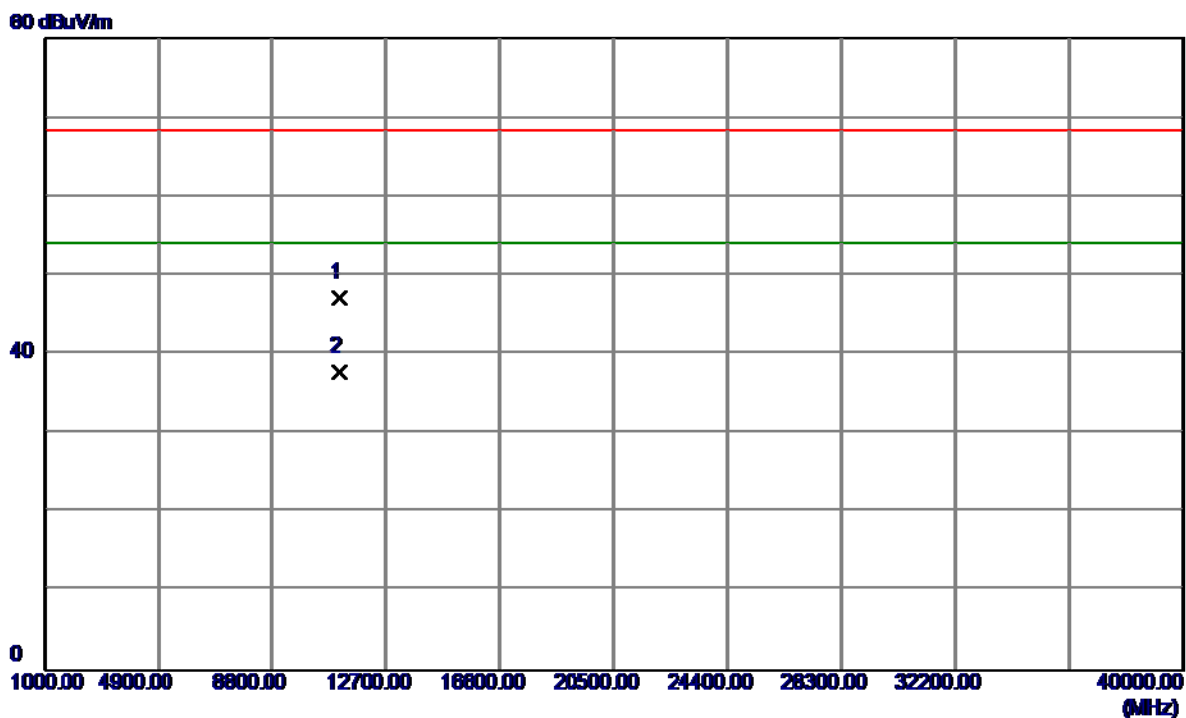

No.	Freq. MHz	Reading Level dBuV/m	Correct Factor dB	Measure ment dBuV/m	Limit dBuV/m	Margin dB	Detector	Comment
1	11100.7870	31.14	15.99	47.13	68.30	-21.17	Peak	
2	11100.1460	21.75	15.99	37.74	54.00	-16.26	AVG	

Orthogonal Axis :	X
Test Mode :	UNII-2C/ TX AC40 Mode 5670MHz

Vertical

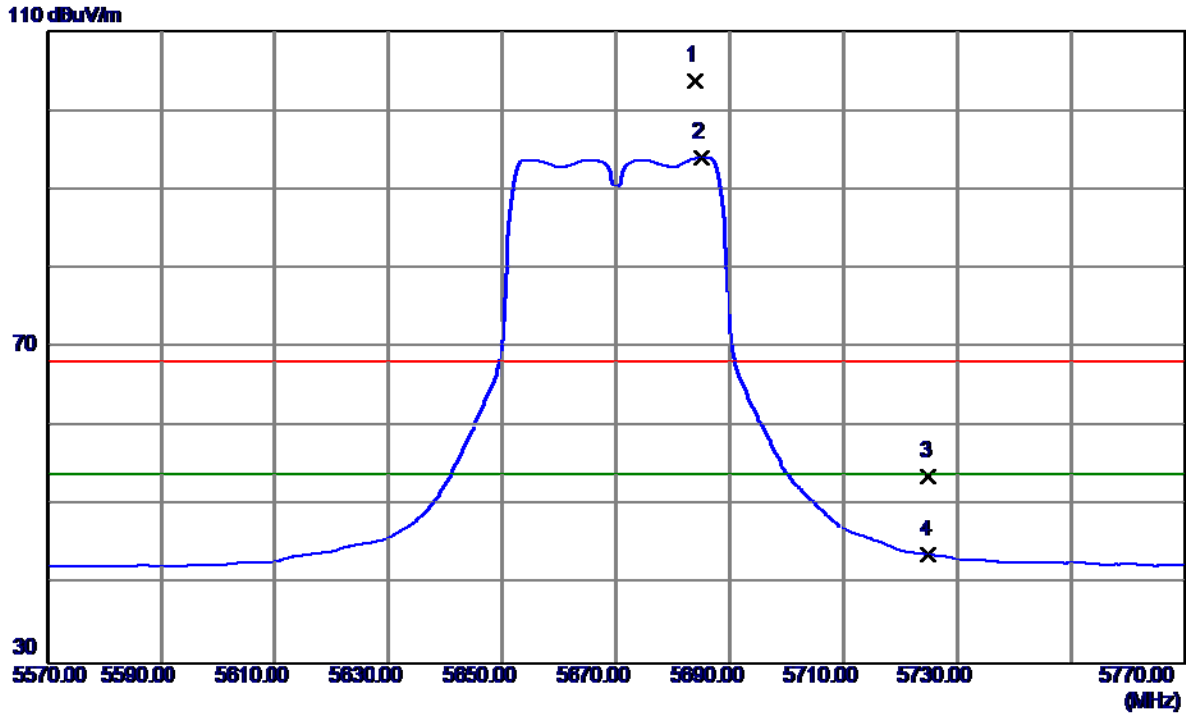

No.	Freq. MHz	Reading Level dBuV/m	Correct Factor dB	Measure ment dBuV/m	Limit dBuV/m	Margin dB	Detector	Comment
1	5684.0000	62.52	41.21	103.73	68.30	35.43	Peak	No Limit
2	5685.2000	52.82	41.21	94.03	54.00	40.03	AVG	No Limit
3	5725.0000	12.36	41.27	53.63	68.30	-14.67	Peak	
4	5725.0000	2.48	41.27	43.75	54.00	-10.25	AVG	

Orthogonal Axis :	X
Test Mode :	UNII-2C/ TX AC40 Mode 5670MHz

Vertical

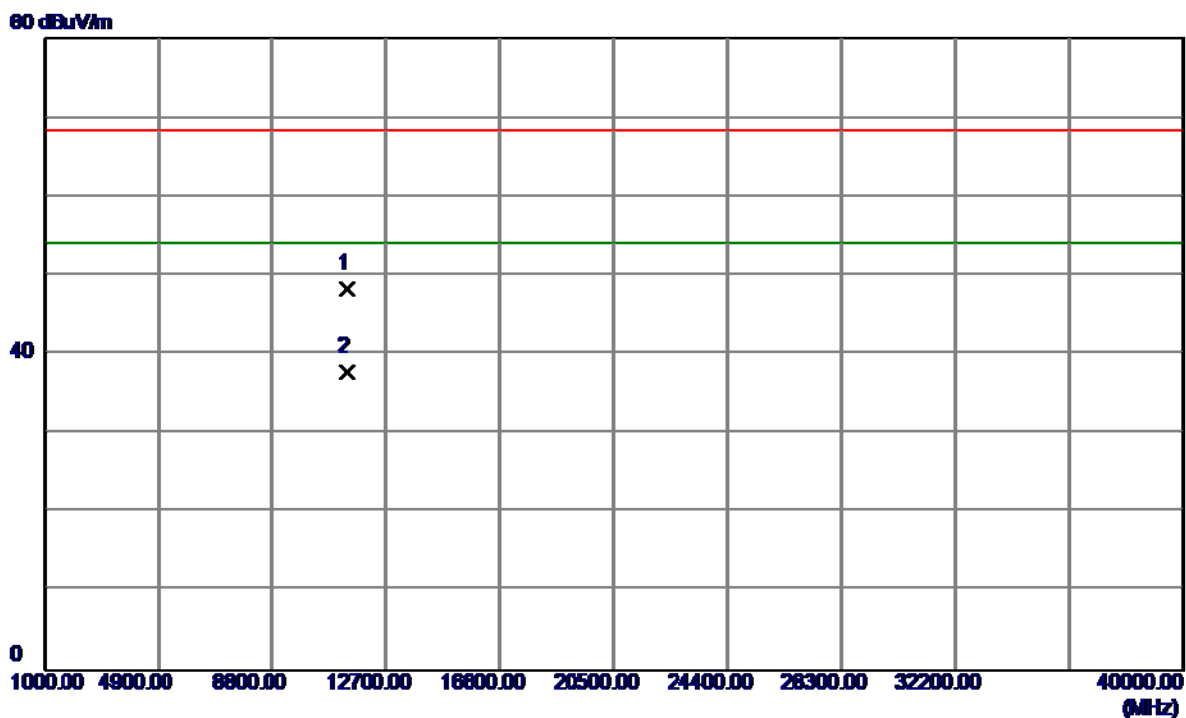

No.	Freq. MHz	Reading Level dBuV/m	Correct Factor dB	Measure ment dBuV/m	Limit dBuV/m	Margin dB	Detector	Comment
1	11341.2300	31.79	16.56	48.35	68.30	-19.95	Peak	
2	11341.2300	21.26	16.56	37.82	54.00	-16.18	AVG	

Orthogonal Axis :	X
Test Mode :	UNII-2C/ TX AC40 Mode 5670MHz

Horizontal

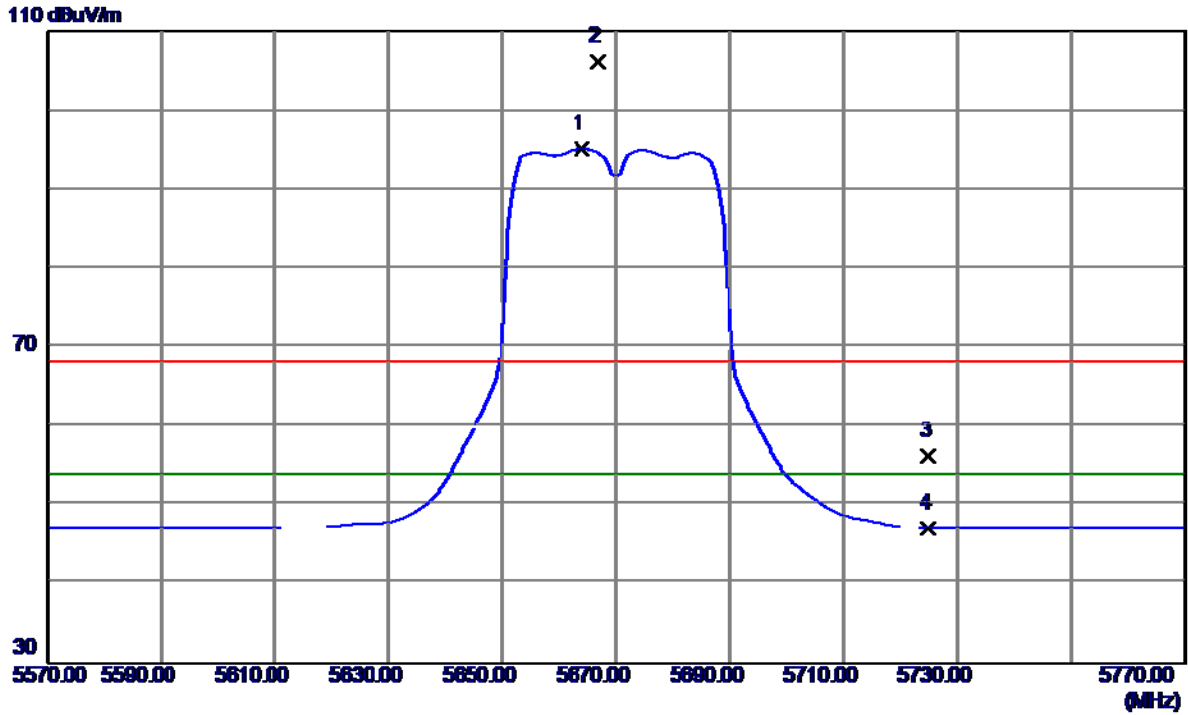

No.	Freq. MHz	Reading Level dBuV/m	Correct Factor dB	Measure ment dBuV/m	Limit dBuV/m	Margin dB	Detector	Comment
1	5664.0000	53.97	41.18	95.15	54.00	41.15	AVG	No Limit
2	5666.8000	64.99	41.19	106.18	68.30	37.88	Peak	No Limit
3	5725.0000	14.99	41.27	56.26	68.30	-12.04	Peak	
4	5725.0000	5.90	41.27	47.17	54.00	-6.83	AVG	

Orthogonal Axis :	X
Test Mode :	UNII-2C/ TX AC40 Mode 5670MHz

Horizontal

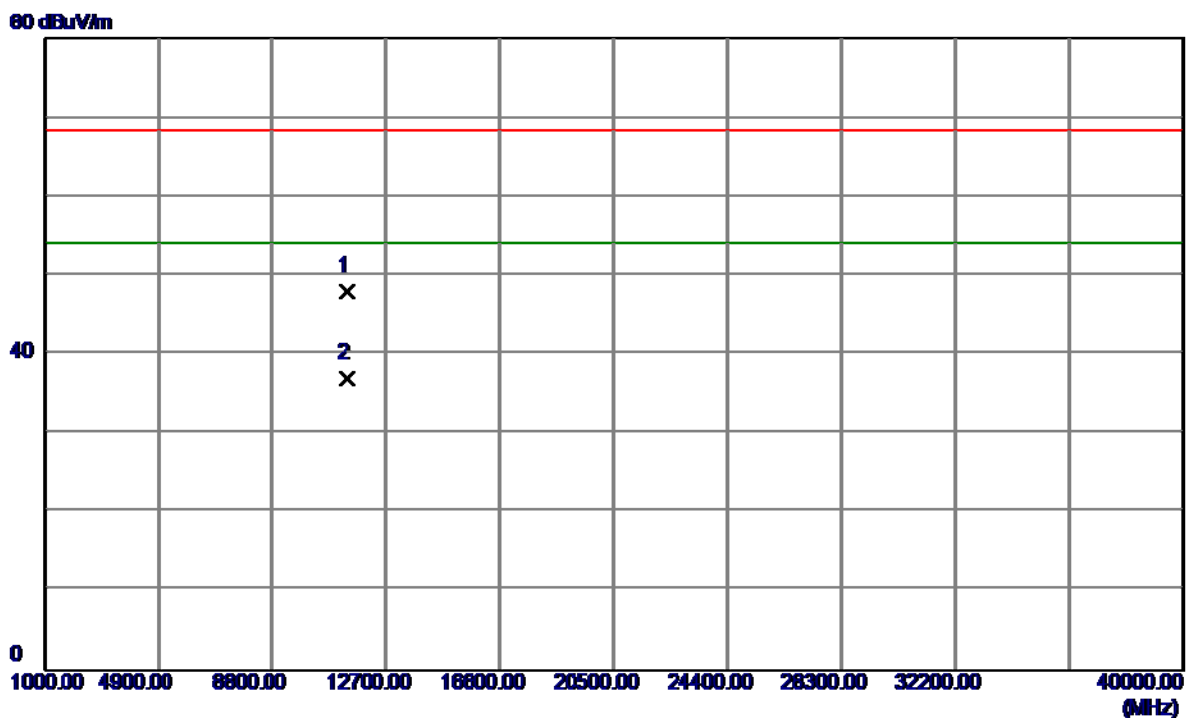

No.	Freq. MHz	Reading Level dBuV/m	Correct Factor dB	Measure ment dBuV/m	Limit dBuV/m	Margin dB	Detector	Comment
1	11340.5199	31.47	16.56	48.03	68.30	-20.27	Peak	
2	11340.5199	20.45	16.56	37.01	54.00	-16.99	AVG	

Orthogonal Axis :	X
Test Mode :	UNII-2C/ TX AC80 Mode 5530MHz

Vertical

110 dBuV/m

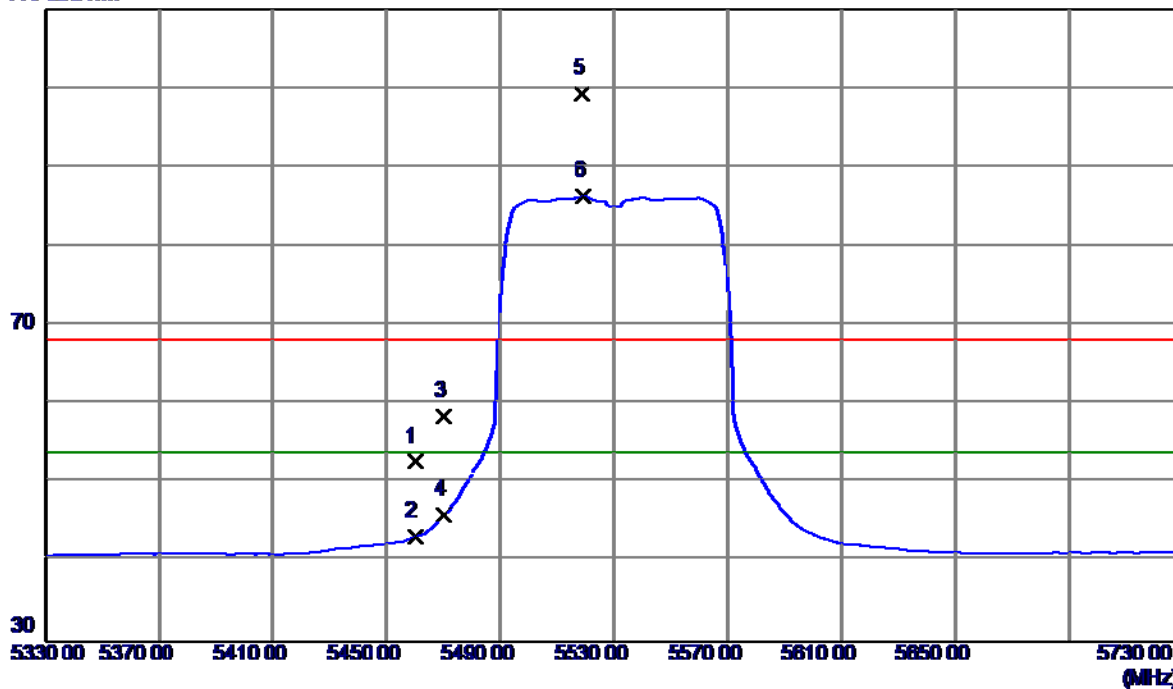

No.	Freq. MHz	Reading Level dBuV/m	Correct Factor dB	Measure ment dBuV/m	Limit dBuV/m	Margin dB	Detector	Comment
1	5460.0000	11.84	40.88	52.72	68.30	-15.58	Peak	
2	5460.0000	2.36	40.88	43.24	54.00	-10.76	AVG	
3	5470.0000	17.63	40.90	58.53	68.30	-9.77	Peak	
4	5470.0000	5.05	40.90	45.95	54.00	-8.05	AVG	
5	5518.8000	58.28	40.99	99.27	68.30	30.97	Peak	No Limit
6	5519.2000	45.29	40.99	86.28	54.00	32.28	AVG	No Limit

Orthogonal Axis :	X
Test Mode :	UNII-2C/ TX AC80 Mode 5530MHz

Vertical

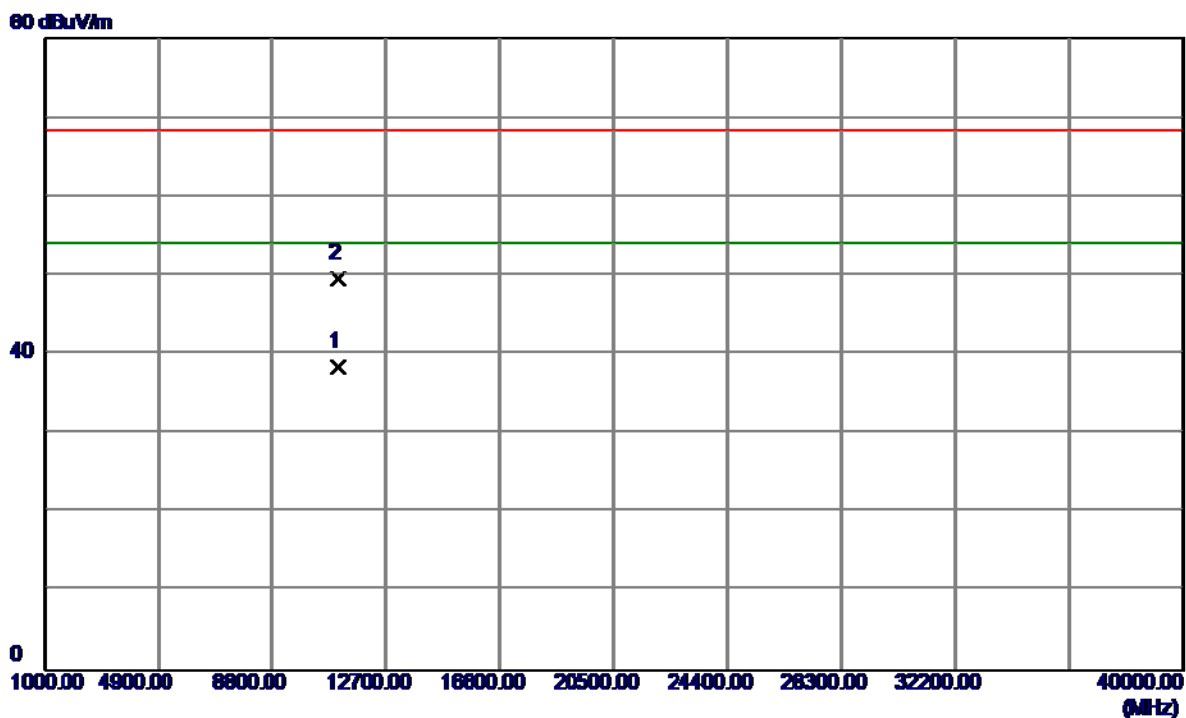

No.	Freq. MHz	Reading Level dBuV/m	Correct Factor dB	Measure ment dBuV/m	Limit dBuV/m	Margin dB	Detector	Comment
1	11062.1760	22.52	15.90	38.42	54.00	-15.58	AVG	
2	11062.3380	33.75	15.90	49.65	68.30	-18.65	Peak	

Orthogonal Axis :	X
Test Mode :	UNII-2C/ TX AC80 Mode 5530MHz

Horizontal

110 dBuV/m

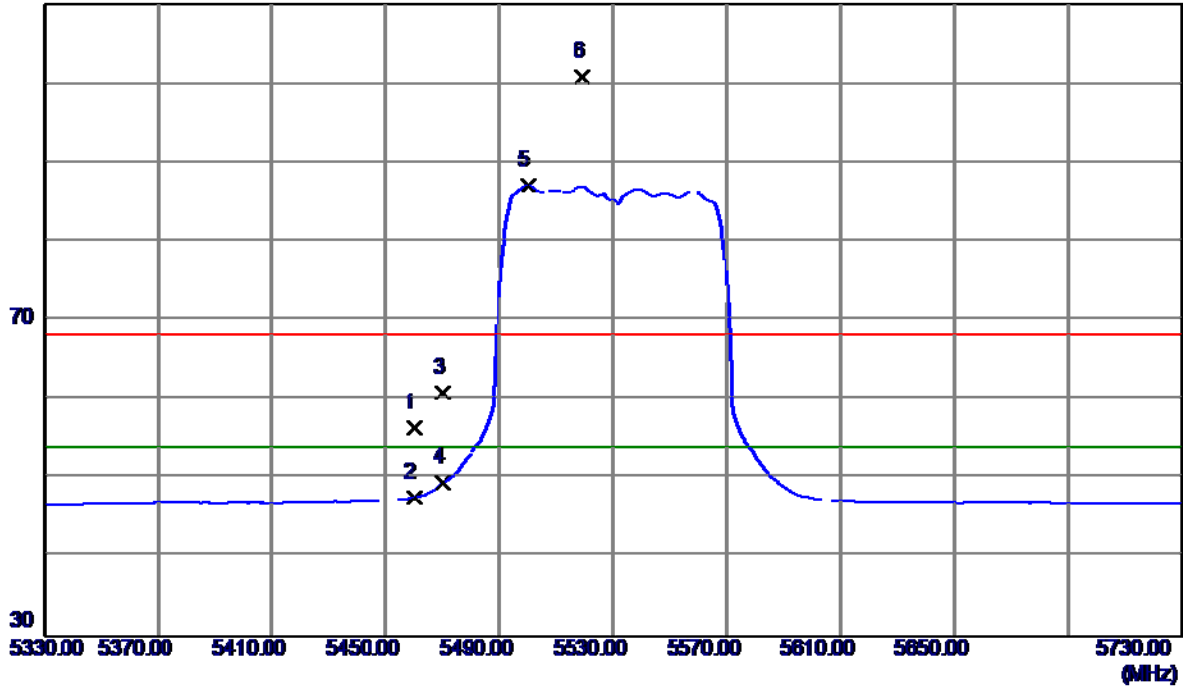

No.	Freq. MHz	Reading Level dBuV/m	Correct Factor dB	Measure ment dBuV/m	Limit dBuV/m	Margin dB	Detector	Comment
1	5460.0000	15.54	40.88	56.42	68.30	-11.88	Peak	
2	5460.0000	6.78	40.88	47.66	54.00	-6.34	AVG	
3	5470.0000	19.99	40.90	60.89	68.30	-7.41	Peak	
4	5470.0000	8.60	40.90	49.50	54.00	-4.50	AVG	
5	5500.0000	46.15	40.96	87.11	54.00	33.11	AVG	No Limit
6	5519.2000	59.88	40.99	100.87	68.30	32.57	Peak	No Limit

Orthogonal Axis :	X
Test Mode :	UNII-2C/ TX AC80 Mode 5530MHz

Horizontal

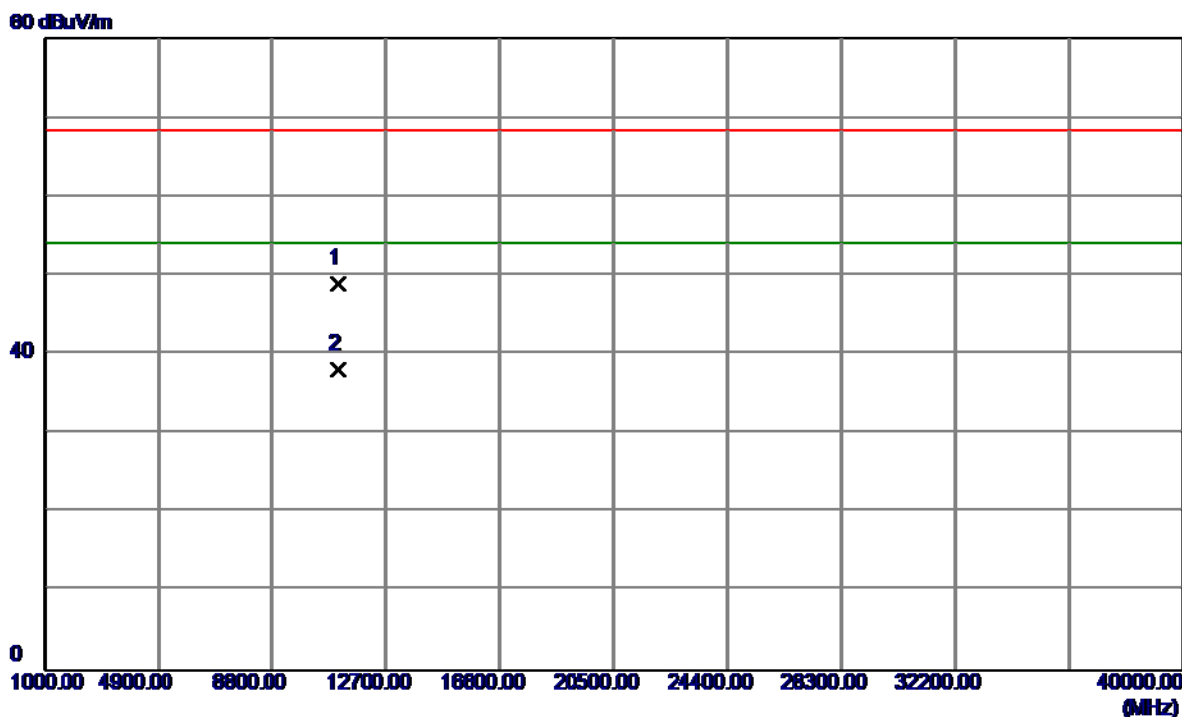

No.	Freq. MHz	Reading Level dBuV/m	Correct Factor dB	Measure ment dBuV/m	Limit dBuV/m	Margin dB	Detector	Comment
1	11059.3600	33.11	15.89	49.00	68.30	-19.30	Peak	
2	11059.8700	22.14	15.89	38.03	54.00	-15.97	AVG	

Orthogonal Axis :	X
Test Mode :	UNII-2C/ TX AC80 Mode 5610MHz

Vertical

110 dBuV/m

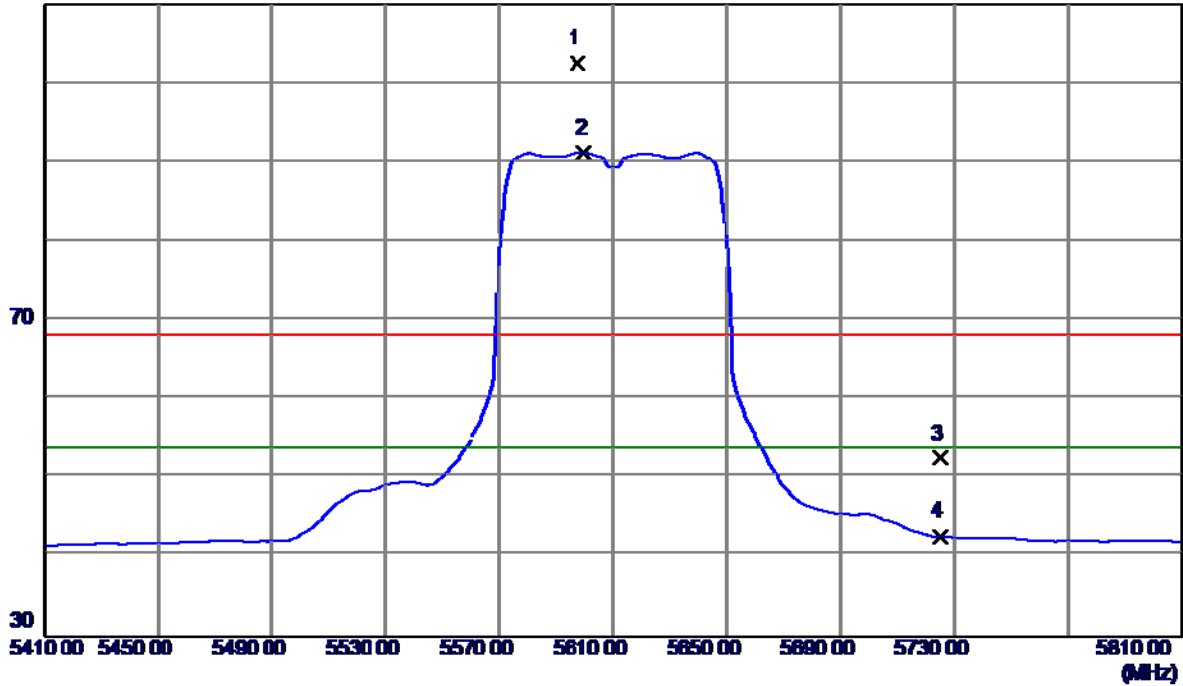

No.	Freq. MHz	Reading Level dBuV/m	Correct Factor dB	Measure ment dBuV/m	Limit dBuV/m	Margin dB	Detector	Comment
1	5597.6000	61.45	41.09	102.54	68.30	34.24	Peak	No Limit
2	5600.0000	50.01	41.10	91.11	54.00	37.11	AVG	No Limit
3	5725.0000	11.21	41.27	52.48	68.30	-15.82	Peak	
4	5725.0000	1.32	41.27	42.59	54.00	-11.41	AVG	

Orthogonal Axis :	X
Test Mode :	UNII-2C/ TX AC80 Mode 5610MHz

Vertical

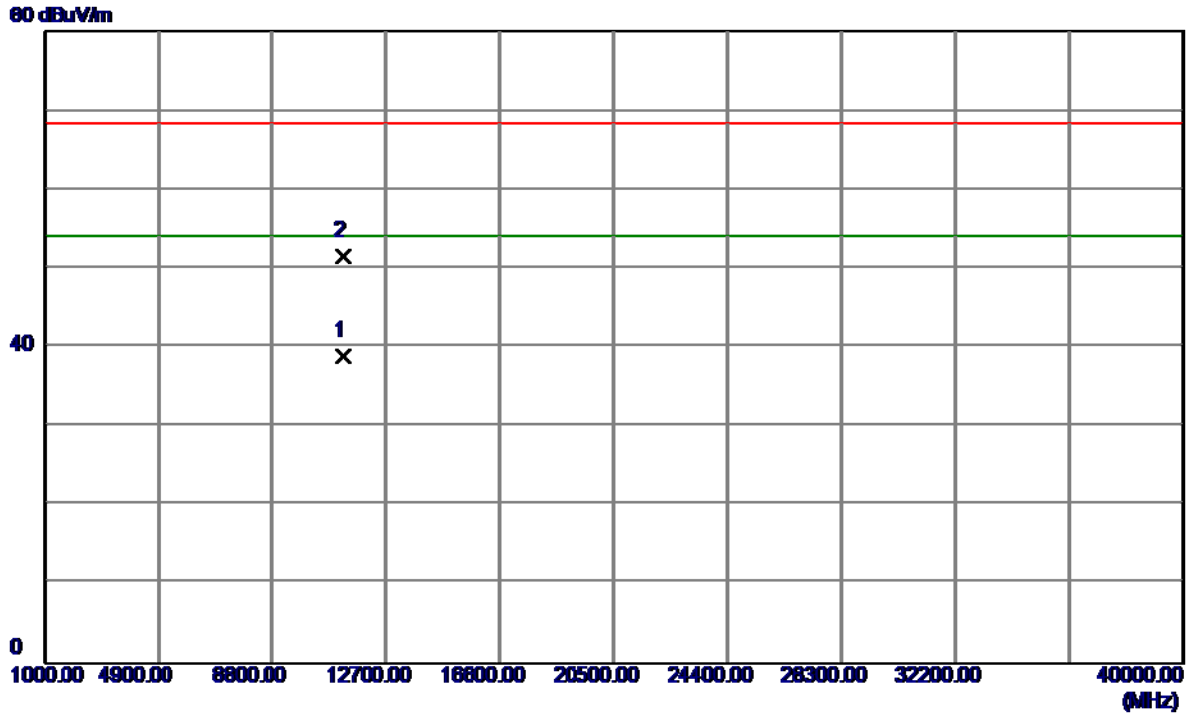

No.	Freq. MHz	Reading Level dBuV/m	Correct Factor dB	Measure ment dBuV/m	Limit dBuV/m	Margin dB	Detector	Comment
1	11221.3259	22.63	16.27	38.90	54.00	-15.10	AVG	
2	11221.5519	35.21	16.28	51.49	68.30	-16.81	Peak	

Orthogonal Axis :	X
Test Mode :	UNII-2C/ TX AC80 Mode 5610MHz

Horizontal

110 dBuV/m

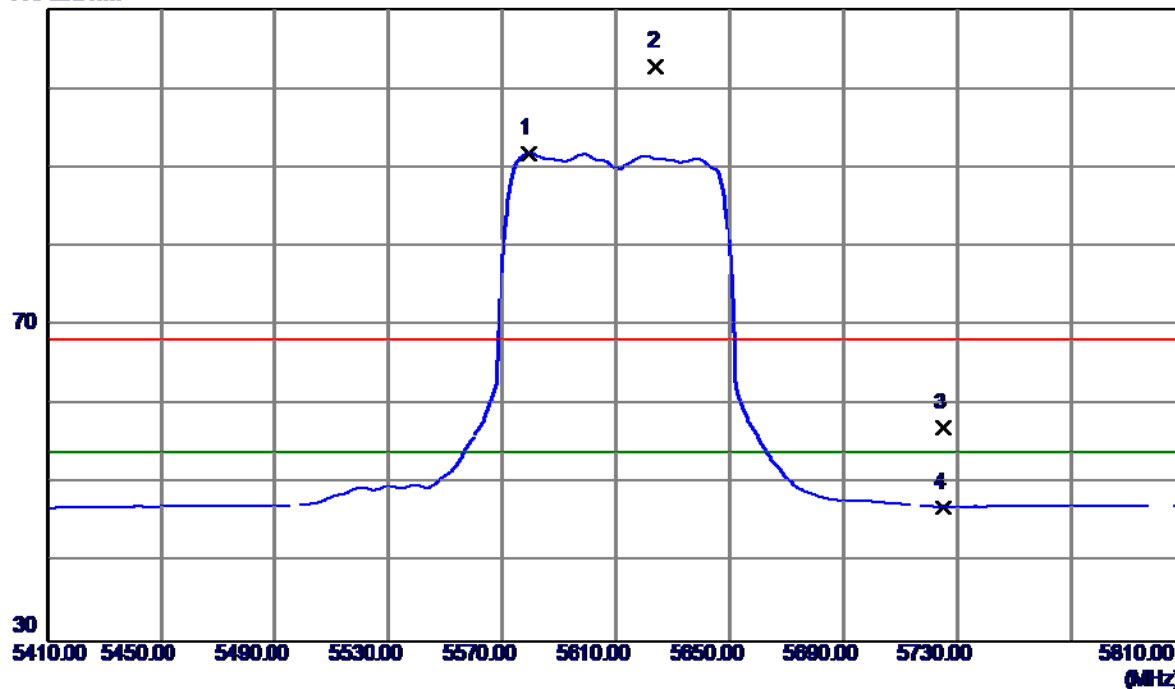

No.	Freq. MHz	Reading Level dBuV/m	Correct Factor dB	Measure ment dBuV/m	Limit dBuV/m	Margin dB	Detector	Comment
1	5579.2000	50.77	41.07	91.84	54.00	37.84	AVG	No Limit
2	5624.0000	61.63	41.13	102.76	68.30	34.46	Peak	No Limit
3	5725.0000	15.71	41.27	56.98	68.30	-11.32	Peak	
4	5725.0000	5.72	41.27	46.99	54.00	-7.01	AVG	

Orthogonal Axis :	X
Test Mode :	UNII-2C/ TX AC80 Mode 5610MHz

Horizontal

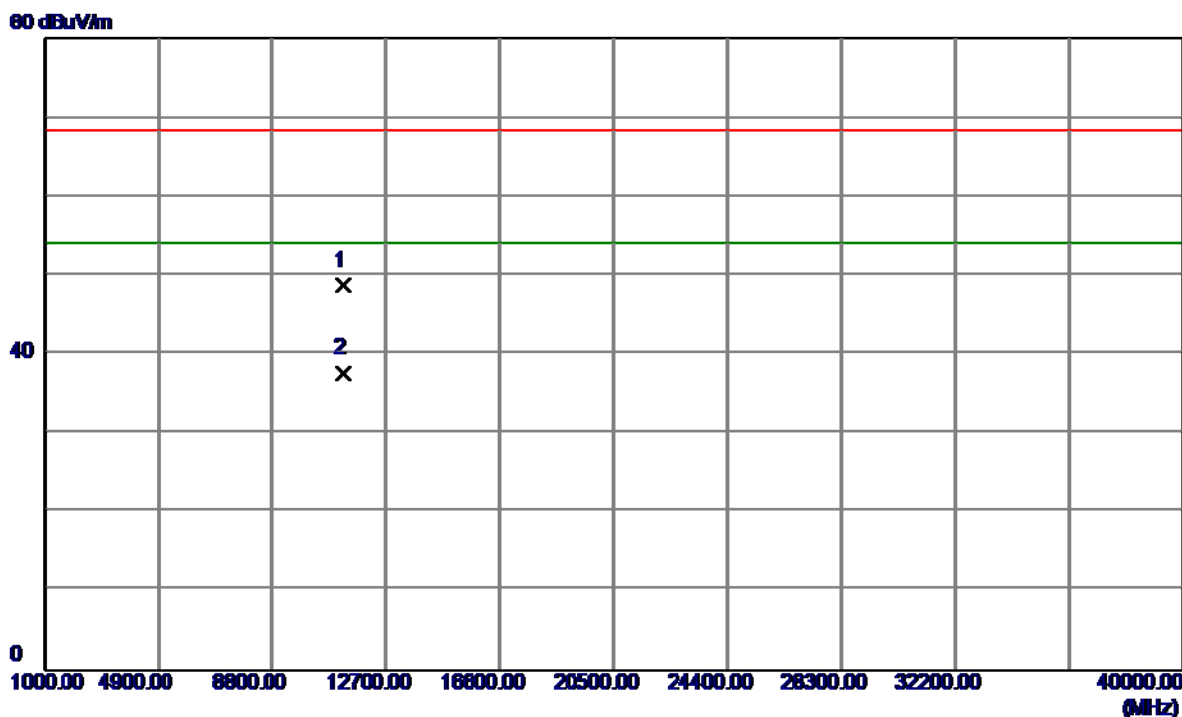

No.	Freq. MHz	Reading Level dBuV/m	Correct Factor dB	Measure ment dBuV/m	Limit dBuV/m	Margin dB	Detector	Comment
1	11220.4500	32.45	16.27	48.72	68.30	-19.58	Peak	
2	11220.5599	21.36	16.27	37.63	54.00	-16.37	AVG	

Orthogonal Axis:	X
Test Mode:	UNII-3/TX AC20 Mode 5745MHz

Vertical

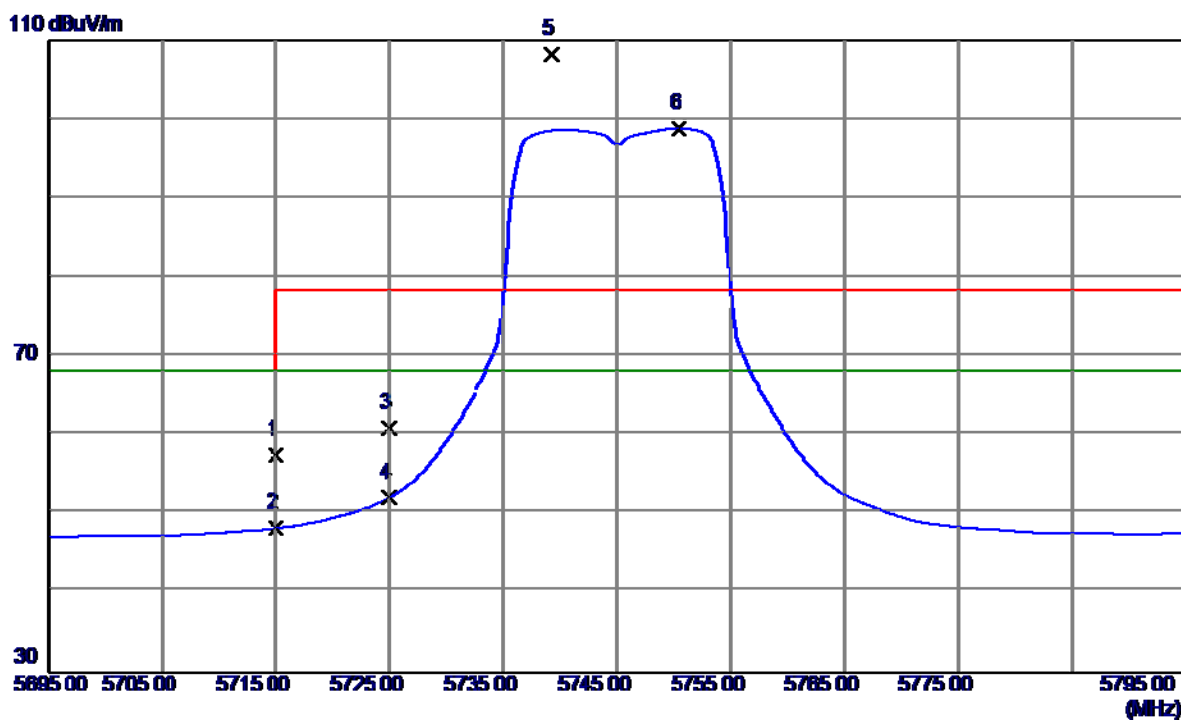

No.	Freq. MHz	Reading Level dBuV/m	Correct Factor dB	Measure ment dBuV/m	Limit dBuV/m	Margin dB	Detector	Comment
1	5715.0000	16.21	41.25	57.46	68.30	-10.84	Peak	
2	5715.0000	6.93	41.25	48.18	68.30	-20.12	AVG	
3	5725.0000	19.58	41.27	60.85	78.30	-17.45	Peak	
4	5725.0000	10.76	41.27	52.03	68.30	-16.27	AVG	
5	5739.2000	66.94	41.29	108.23	78.30	29.93	Peak	No Limit
6	5750.4000	57.57	41.30	98.87	68.30	30.57	AVG	No Limit

Orthogonal Axis:	X
Test Mode:	UNII-3/TX AC20 Mode 5745MHz

Vertical

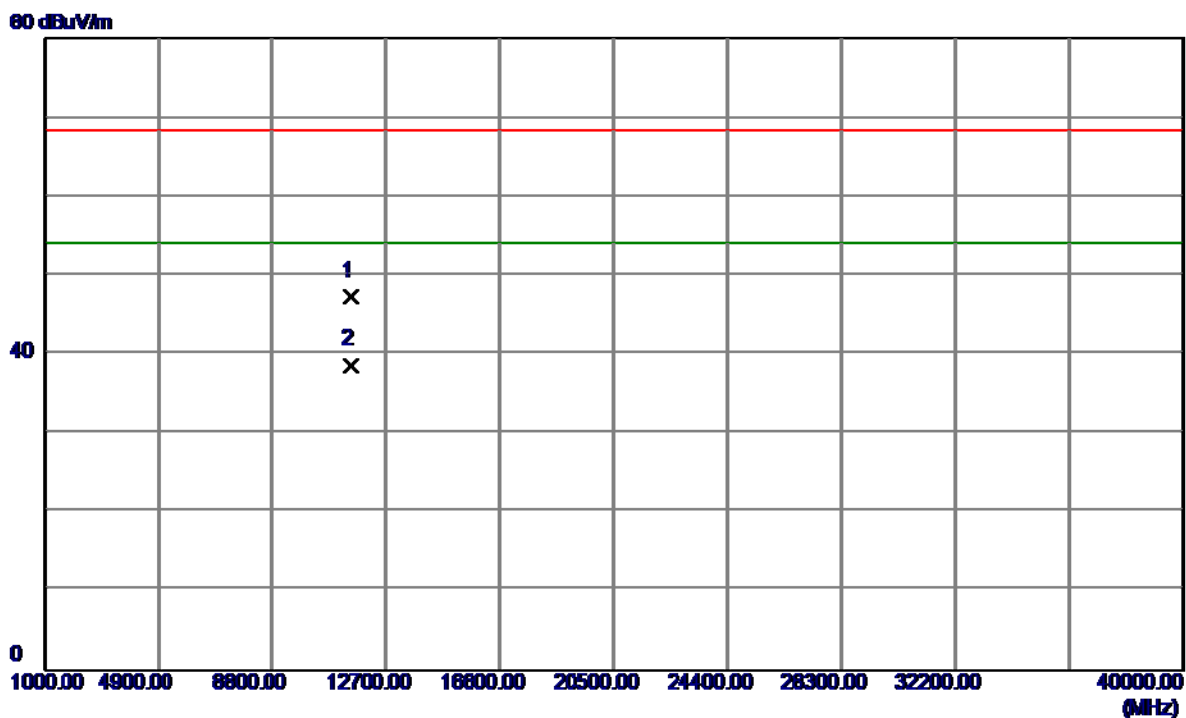

No.	Freq. MHz	Reading Level dBuV/m	Correct Factor dB	Measure ment dBuV/m	Limit dBuV/m	Margin dB	Detector	Comment
1	11490.7100	30.41	16.91	47.32	68.30	-20.98	Peak	
2	11490.7100	21.73	16.91	38.64	54.00	-15.36	AVG	

Orthogonal Axis:	X
Test Mode:	UNII-3/TX AC20 Mode 5745MHz

Horizontal

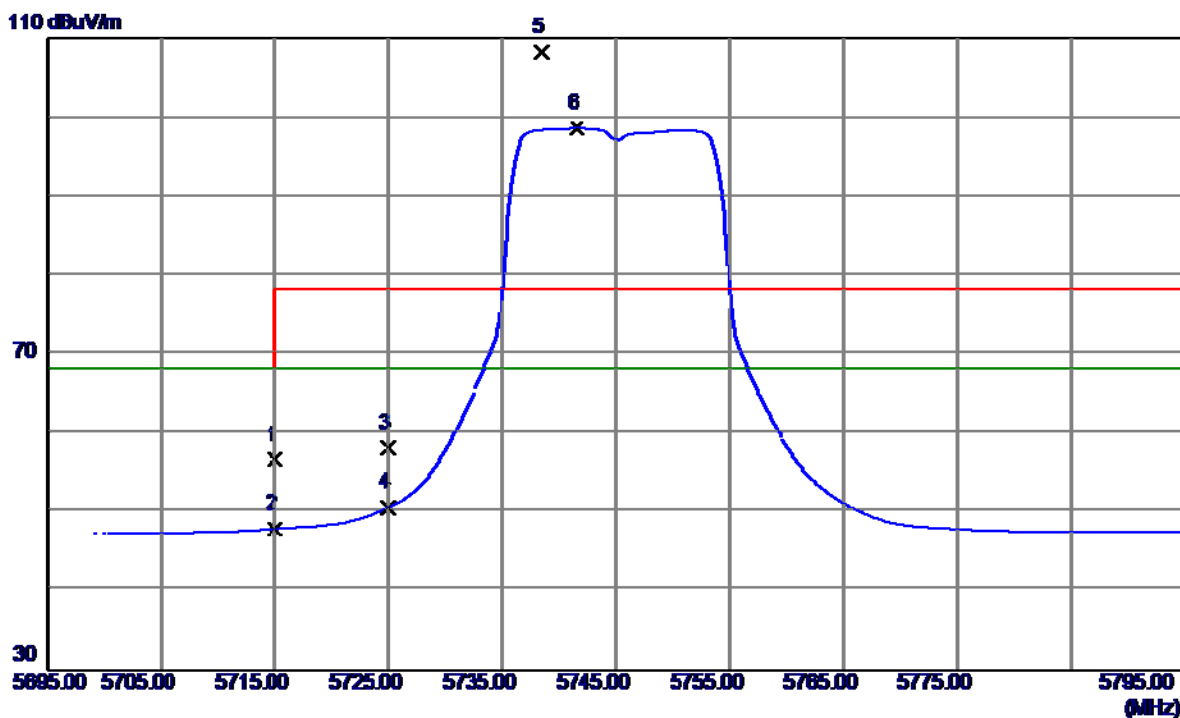

No.	Freq. MHz	Reading Level dBuV/m	Correct Factor dB	Measure ment dBuV/m	Limit dBuV/m	Margin dB	Detector	Comment
1	5715.0000	15.39	41.25	56.64	68.30	-11.66	Peak	
2	5715.0000	6.72	41.25	47.97	68.30	-20.33	AVG	
3	5725.0000	16.90	41.27	58.17	78.30	-20.13	Peak	
4	5725.0000	9.44	41.27	50.71	68.30	-17.59	AVG	
5	5738.4000	66.98	41.28	108.26	78.30	29.96	Peak	No Limit
6	5741.6000	57.28	41.29	98.57	68.30	30.27	AVG	No Limit

Orthogonal Axis:	X
Test Mode:	UNII-3/TX AC20 Mode 5745MHz

Horizontal

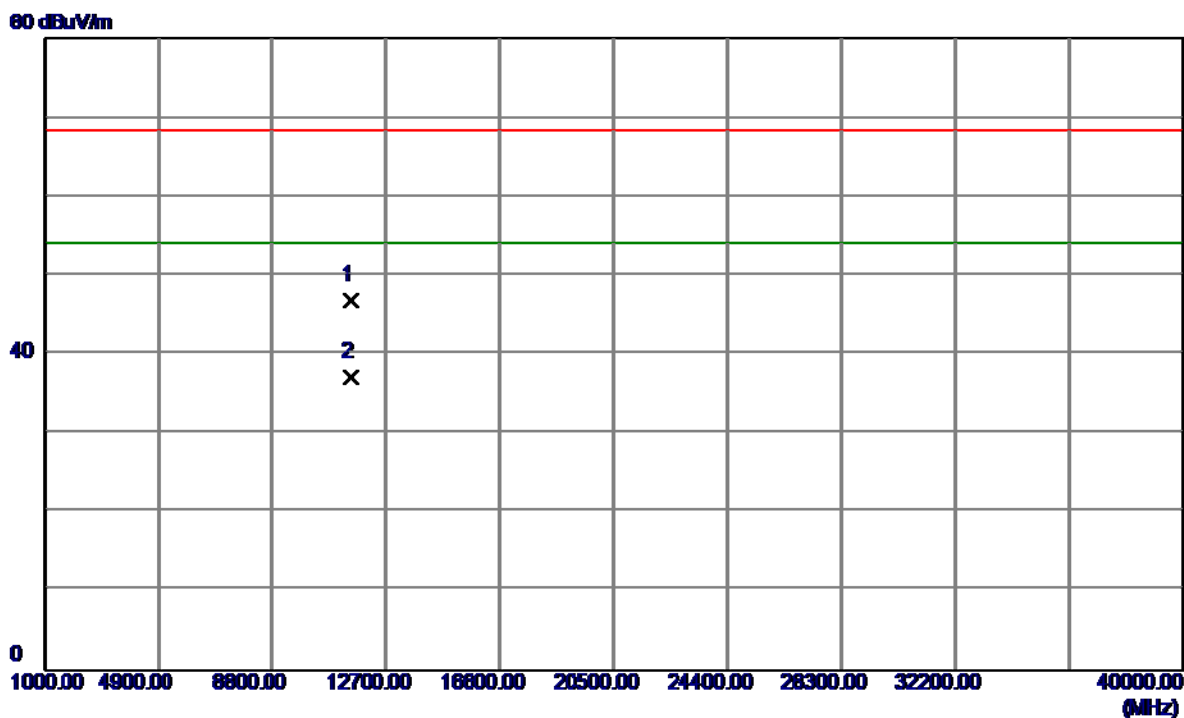

No.	Freq. MHz	Reading Level dBuV/m	Correct Factor dB	Measure ment dBuV/m	Limit dBuV/m	Margin dB	Detector	Comment
1	11490.3400	29.92	16.91	46.83	68.30	-21.47	Peak	
2	11490.3400	20.21	16.91	37.12	54.00	-16.88	AVG	

Orthogonal Axis:	X
Test Mode:	UNII-3/TX AC20 Mode 5785MHz

Vertical

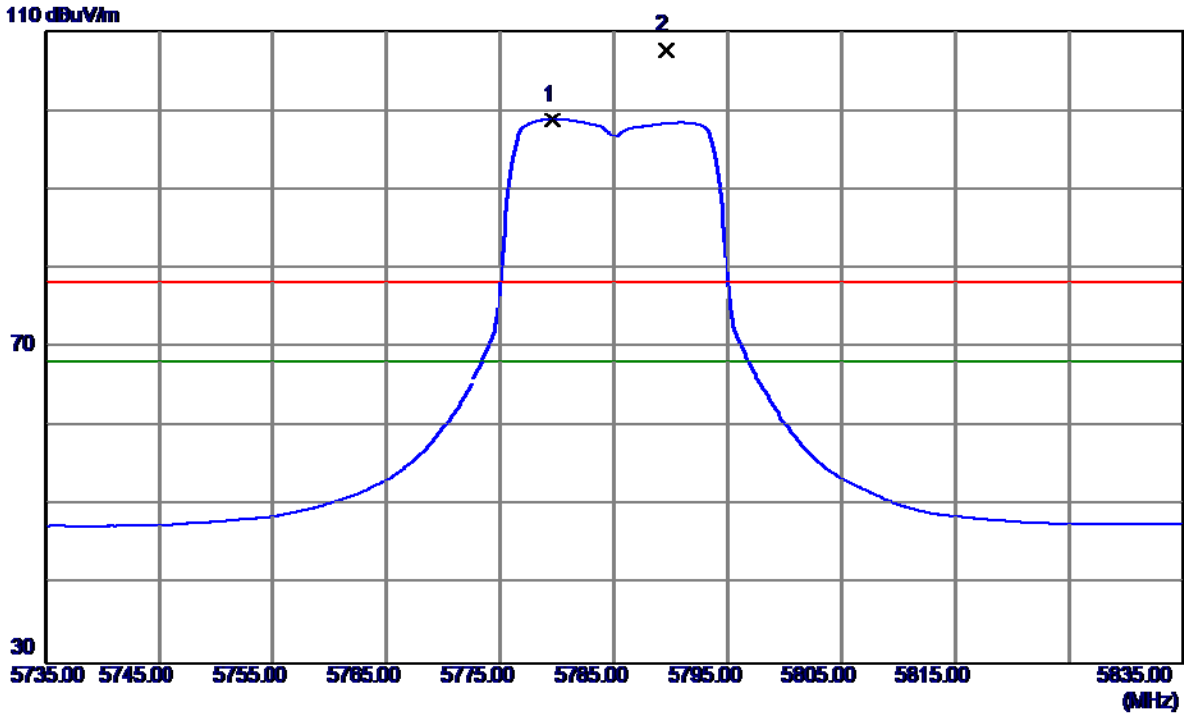

No.	Freq. MHz	Reading Level dBuV/m	Correct Factor dB	Measure ment dBuV/m	Limit dBuV/m	Margin dB	Detector	Comment
1	5779.6000	57.51	41.34	98.85	68.30	30.55	AVG	No Limit
2	5789.5000	66.25	41.35	107.60	78.30	29.30	Peak	No Limit

Orthogonal Axis:	X
Test Mode:	UNII-3/TX AC20 Mode 5785MHz

Vertical

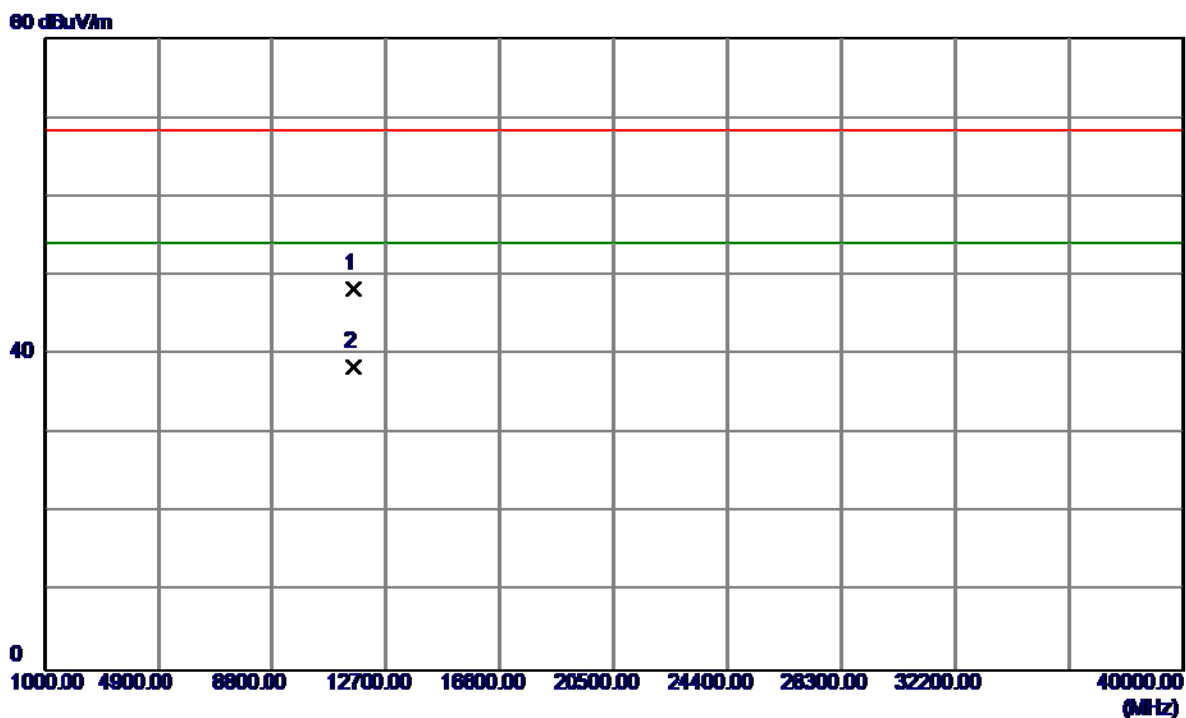

No.	Freq. MHz	Reading Level dBuV/m	Correct Factor dB	Measure ment dBuV/m	Limit dBuV/m	Margin dB	Detector	Comment
1	11570.3640	31.34	17.05	48.39	68.30	-19.91	Peak	
2	11570.1230	21.41	17.05	38.46	54.00	-15.54	AVG	

Orthogonal Axis:	X
Test Mode:	UNII-3/TX AC20 Mode 5785MHz

Horizontal

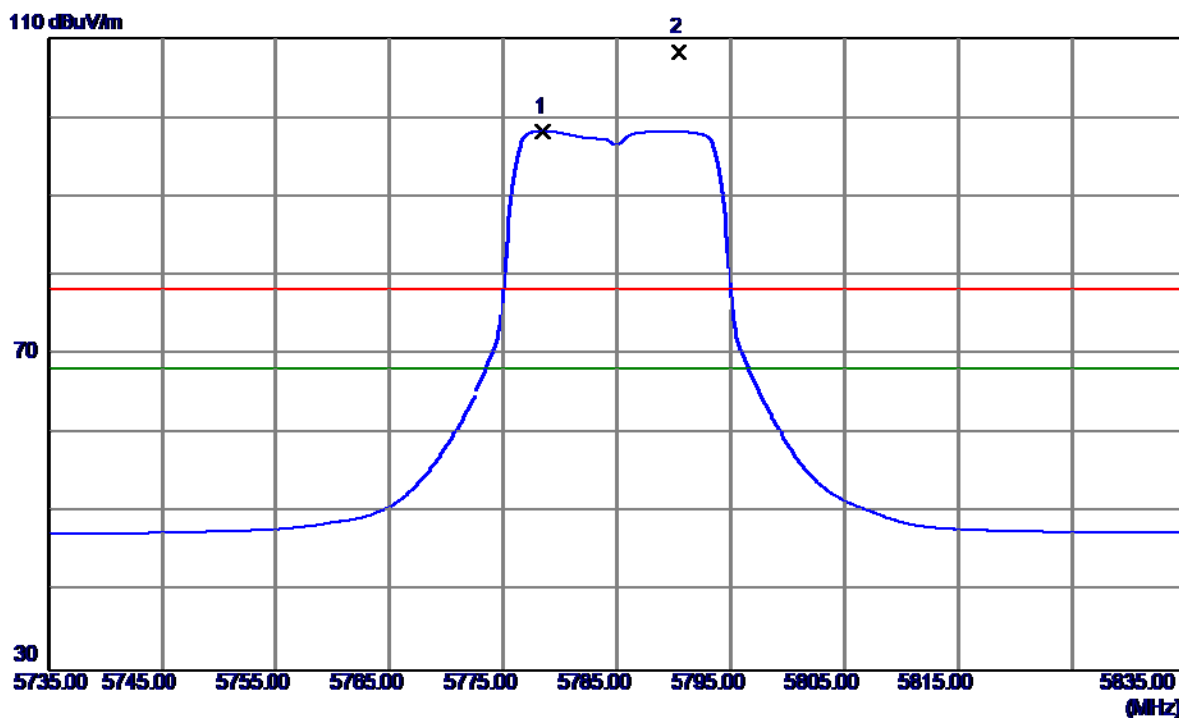

No.	Freq. MHz	Reading Level dBuV/m	Correct Factor dB	Measure ment dBuV/m	Limit dBuV/m	Margin dB	Detector	Comment
1	5778.5000	56.90	41.34	98.24	68.30	29.94	AVG	No Limit
2	5790.4000	66.92	41.35	108.27	78.30	29.97	Peak	No Limit

Orthogonal Axis:	X
Test Mode:	UNII-3/TX AC20 Mode 5785MHz

Horizontal

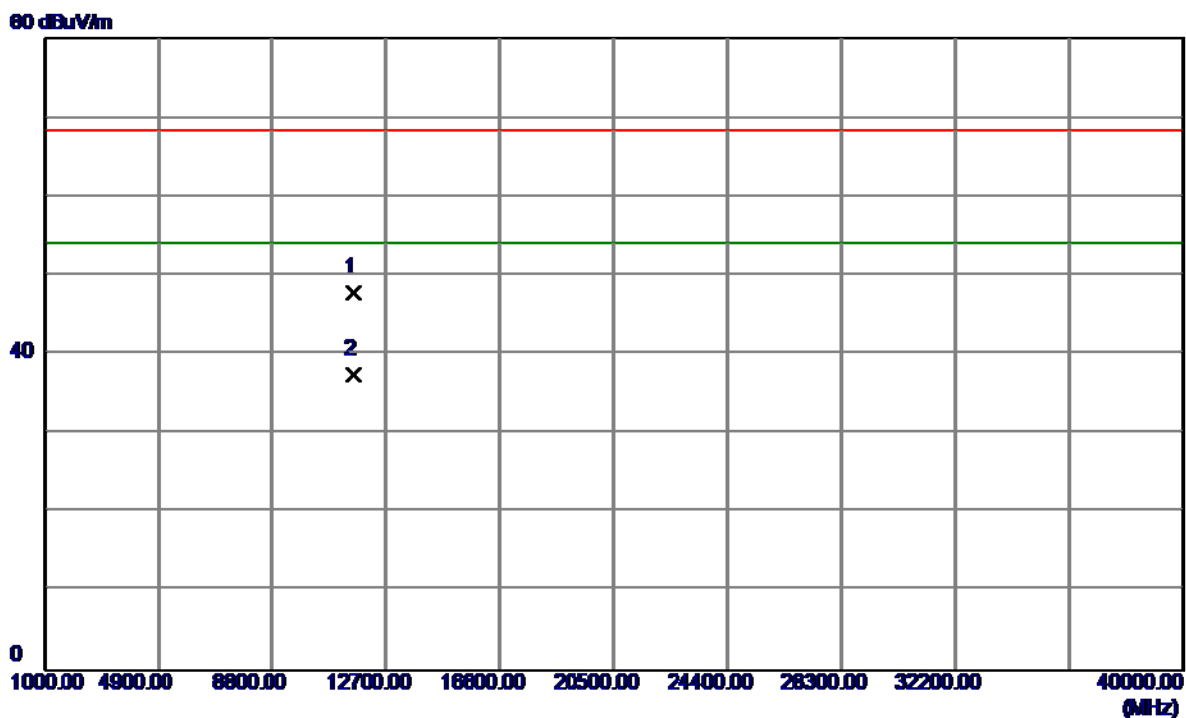

No.	Freq. MHz	Reading Level dBuV/m	Correct Factor dB	Measure ment dBuV/m	Limit dBuV/m	Margin dB	Detector	Comment
1	11570.1700	30.80	17.05	47.85	68.30	-20.45	Peak	
2	11570.1700	20.41	17.05	37.46	54.00	-16.54	AVG	

Orthogonal Axis:	X
Test Mode:	UNII-3/TX AC20 Mode 5825MHz

Vertical

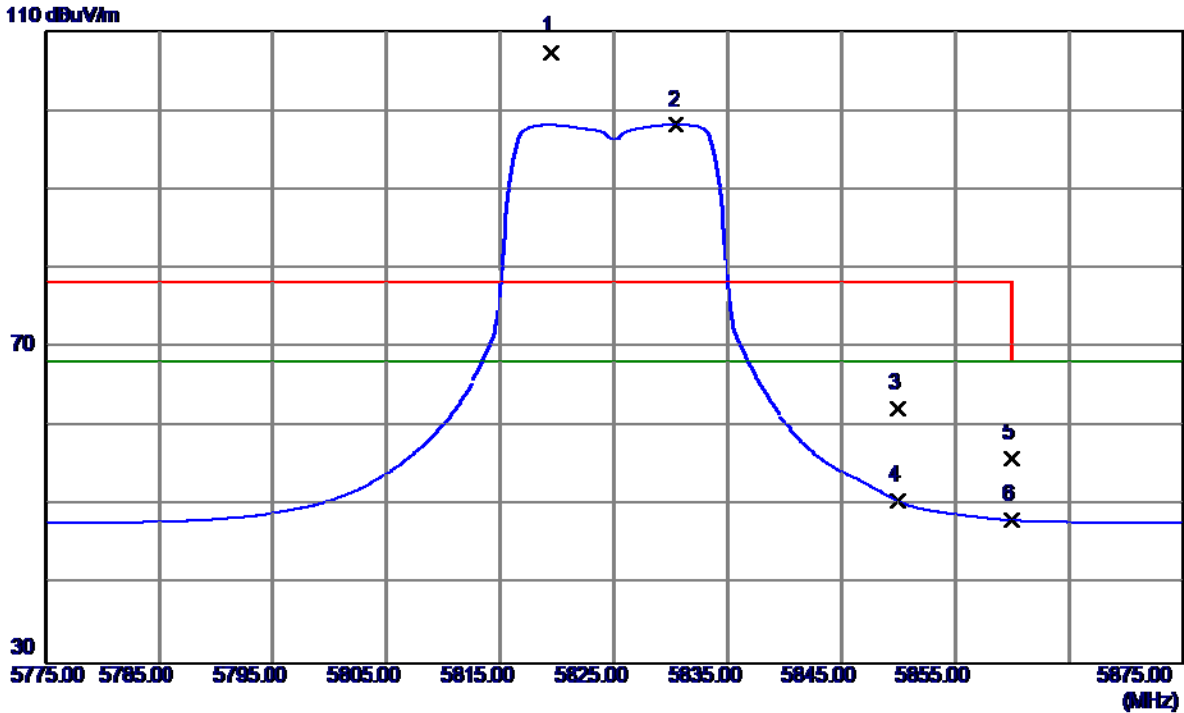

No.	Freq. MHz	Reading Level dBuV/m	Correct Factor dB	Measure ment dBuV/m	Limit dBuV/m	Margin dB	Detector	Comment
1	5819.4000	65.97	41.39	107.36	78.30	29.06	Peak	No Limit
2	5830.5000	56.78	41.41	98.19	68.30	29.89	AVG	No Limit
3	5850.0000	20.84	41.44	62.28	78.30	-16.02	Peak	
4	5850.0000	9.17	41.44	50.61	68.30	-17.69	AVG	
5	5860.0000	14.46	41.45	55.91	78.30	-22.39	Peak	
6	5860.0000	6.77	41.45	48.22	68.30	-20.08	AVG	

Orthogonal Axis:	X
Test Mode:	UNII-3/TX AC20 Mode 5825MHz

Vertical

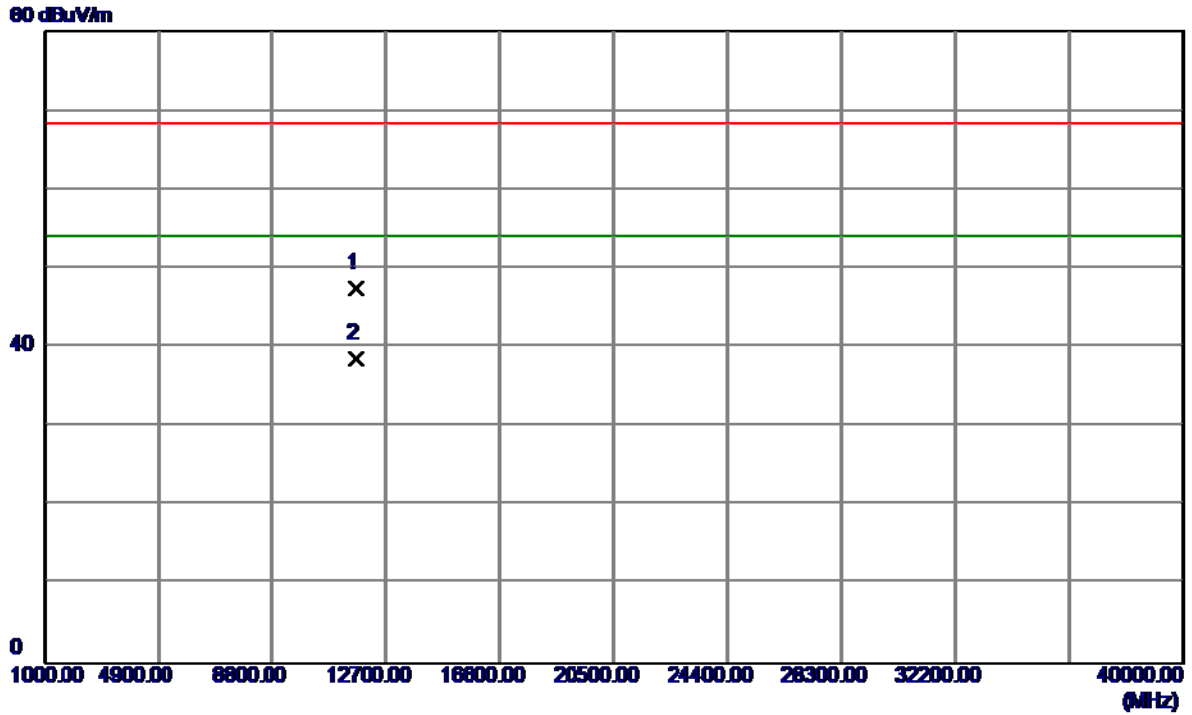

No.	Freq. MHz	Reading Level dBuV/m	Correct Factor dB	Measure ment dBuV/m	Limit dBuV/m	Margin dB	Detector	Comment
1	11650.1300	30.38	17.17	47.55	68.30	-20.75	Peak	
2	11650.1300	21.44	17.17	38.61	54.00	-15.39	AVG	

Orthogonal Axis:	X
Test Mode:	UNII-3/TX AC20 Mode 5825MHz

Horizontal

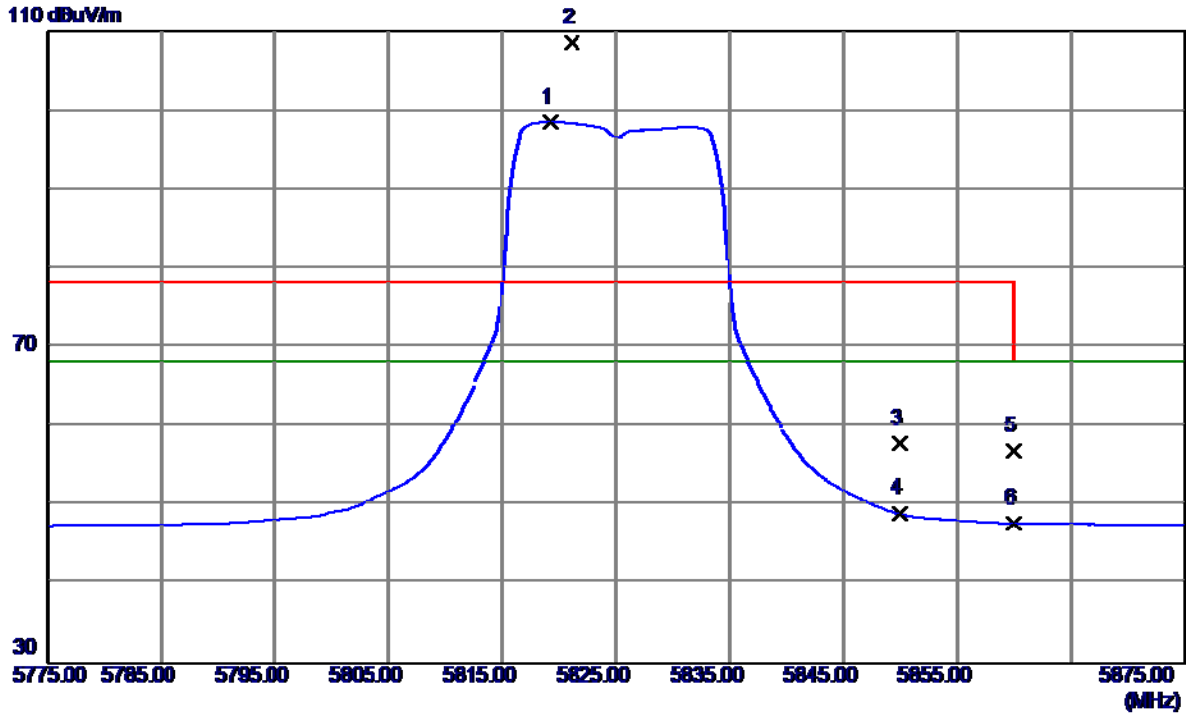

No.	Freq. MHz	Reading Level dBuV/m	Correct Factor dB	Measure ment dBuV/m	Limit dBuV/m	Margin dB	Detector	Comment
1	5819.2000	57.11	41.39	98.50	68.30	30.20	AVG	No Limit
2	5821.1000	67.17	41.40	108.57	78.30	30.27	Peak	No Limit
3	5850.0000	16.41	41.44	57.85	78.30	-20.45	Peak	
4	5850.0000	7.53	41.44	48.97	68.30	-19.33	AVG	
5	5860.0000	15.36	41.45	56.81	78.30	-21.49	Peak	
6	5860.0000	6.32	41.45	47.77	68.30	-20.53	AVG	

Orthogonal Axis:	X
Test Mode:	UNII-3/TX AC20 Mode 5825MHz

Horizontal

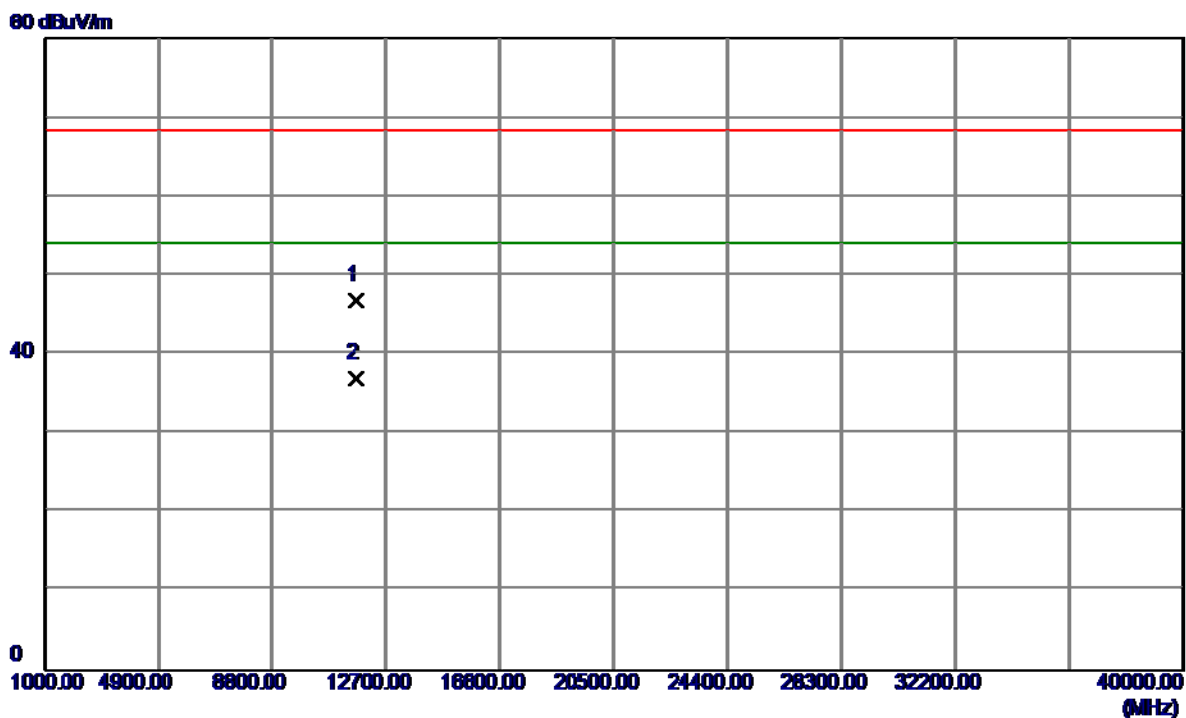

No.	Freq. MHz	Reading Level dBuV/m	Correct Factor dB	Measure ment dBuV/m	Limit dBuV/m	Margin dB	Detector	Comment
1	11650.3400	29.71	17.17	46.88	68.30	-21.42	Peak	
2	11650.3400	19.85	17.17	37.02	54.00	-16.98	AVG	

Orthogonal Axis:	X
Test Mode:	UNII-3/TX AC40 Mode 5755MHz

Vertical

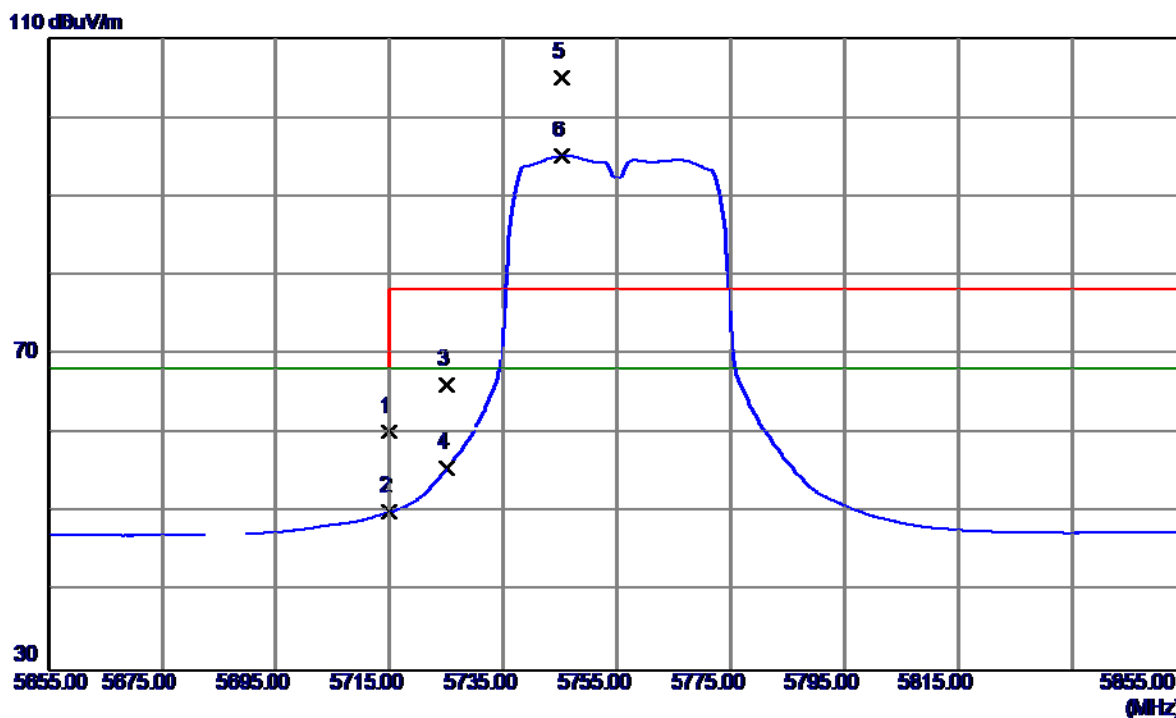

No.	Freq. MHz	Reading Level dBuV/m	Correct Factor dB	Measure ment dBuV/m	Limit dBuV/m	Margin dB	Detector	Comment
1	5715.0000	19.00	41.25	60.25	68.30	-8.05	Peak	
2	5715.0000	8.84	41.25	50.09	68.30	-18.21	AVG	
3	5725.0000	24.93	41.27	66.20	78.30	-12.10	Peak	
4	5725.0000	14.27	41.27	55.54	68.30	-12.76	AVG	
5	5745.2000	63.69	41.29	104.98	78.30	26.68	Peak	No Limit
6	5745.2000	53.77	41.29	95.06	68.30	26.76	AVG	No Limit

Orthogonal Axis:	X
Test Mode:	UNII-3/TX AC40 Mode 5755MHz

Vertical

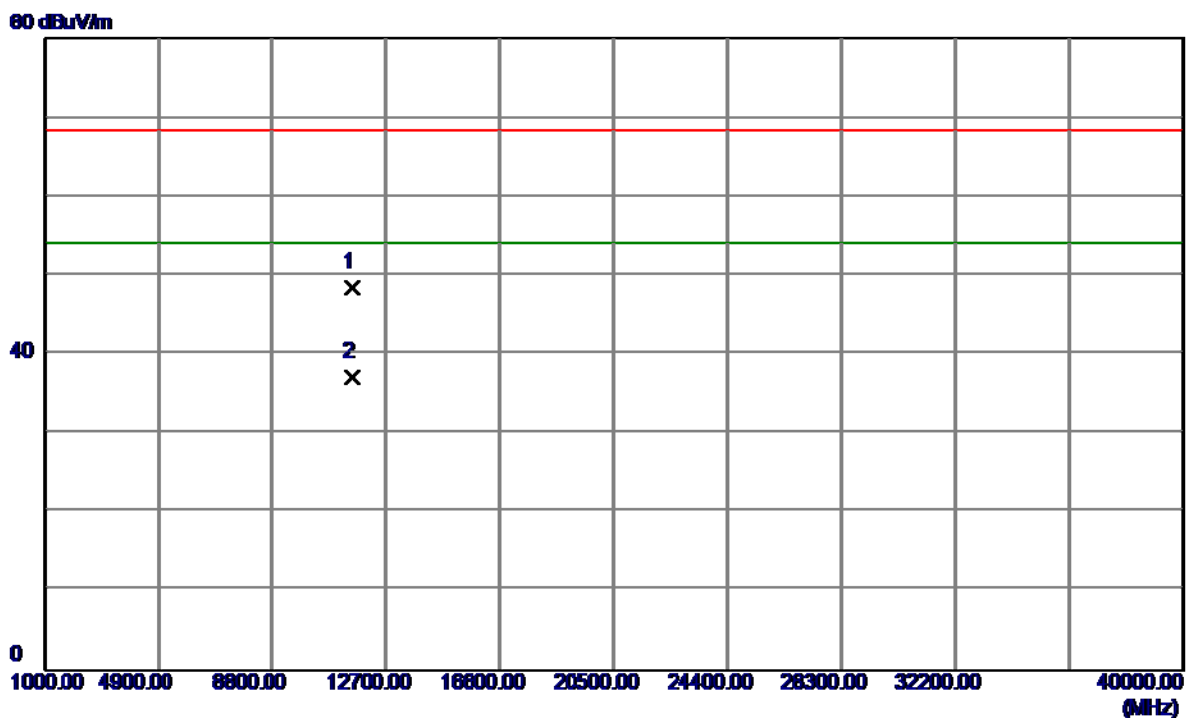

No.	Freq. MHz	Reading Level dBuV/m	Correct Factor dB	Measure ment dBuV/m	Limit dBuV/m	Margin dB	Detector	Comment
1	11510.7730	31.57	16.95	48.52	68.30	-19.78	Peak	
2	11510.2730	20.16	16.95	37.11	54.00	-16.89	AVG	

Orthogonal Axis:	X
Test Mode:	UNII-3/TX AC40 Mode 5755MHz

Horizontal

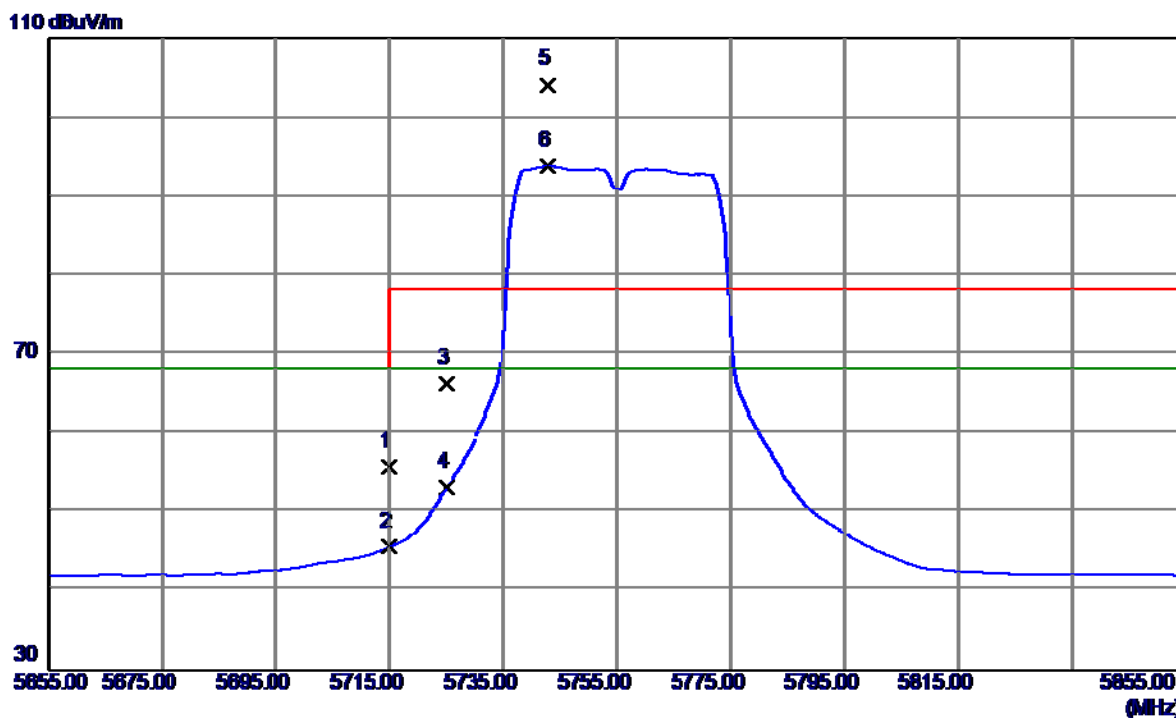

No.	Freq. MHz	Reading Level dBuV/m	Correct Factor dB	Measure ment dBuV/m	Limit dBuV/m	Margin dB	Detector	Comment
1	5715.0000	14.48	41.25	55.73	68.30	-12.57	Peak	
2	5715.0000	4.36	41.25	45.61	68.30	-22.69	AVG	
3	5725.0000	25.03	41.27	66.30	78.30	-12.00	Peak	
4	5725.0000	11.93	41.27	53.20	68.30	-15.10	AVG	
5	5742.8000	62.87	41.29	104.16	78.30	25.86	Peak	No Limit
6	5742.8000	52.55	41.29	93.84	68.30	25.54	AVG	No Limit

Orthogonal Axis:	X
Test Mode:	UNII-3/TX AC40 Mode 5755MHz

Horizontal

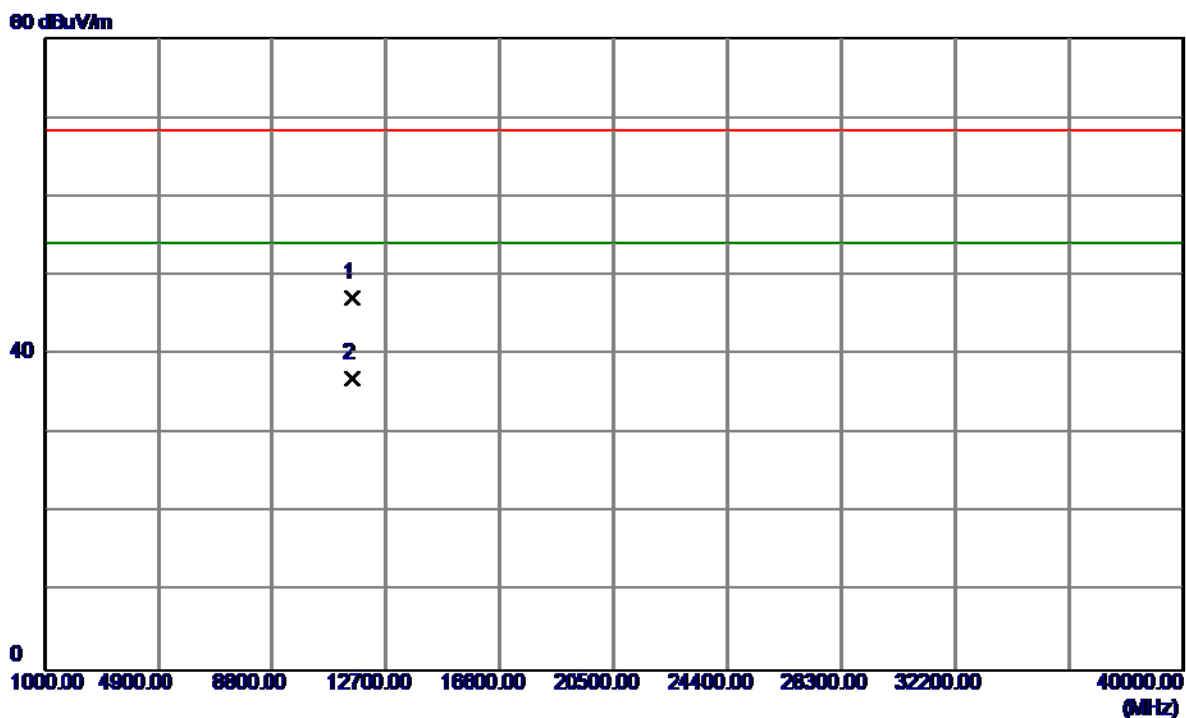

No.	Freq. MHz	Reading Level dBuV/m	Correct Factor dB	Measure ment dBuV/m	Limit dBuV/m	Margin dB	Detector	Comment
1	11510.2699	30.29	16.95	47.24	68.30	-21.06	Peak	
2	11510.2699	20.08	16.95	37.03	54.00	-16.97	AVG	

Orthogonal Axis:	X
Test Mode:	UNII-3/TX AC40 Mode 5795MHz

Vertical

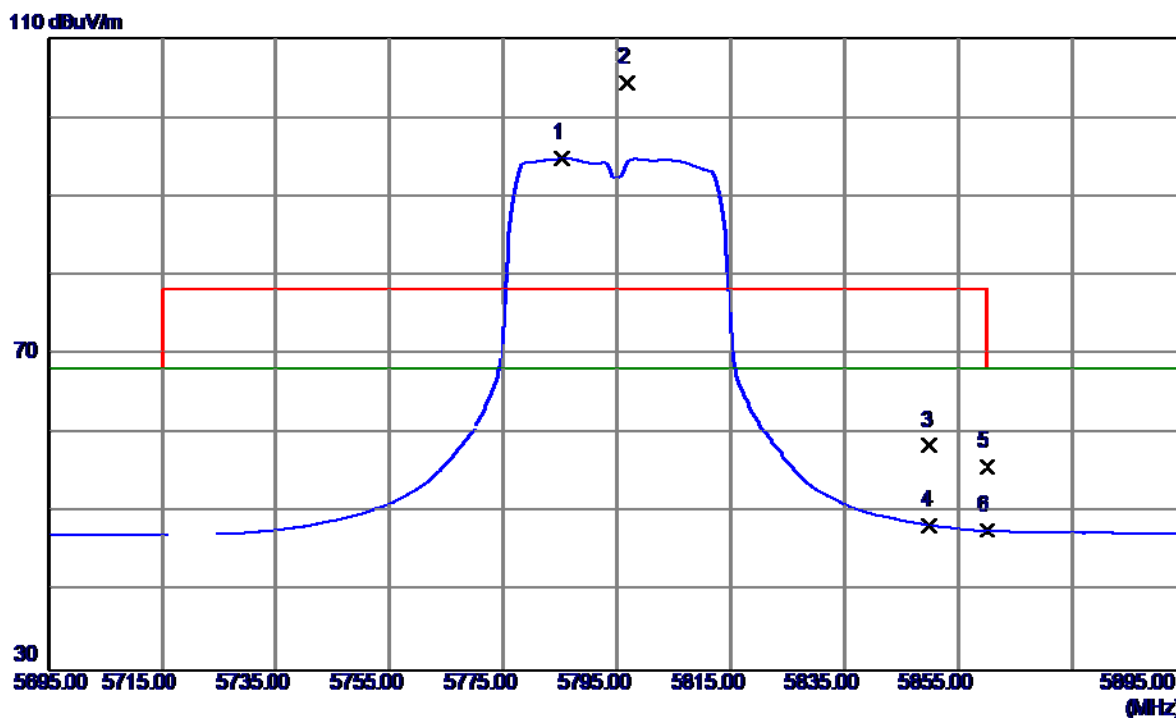

No.	Freq. MHz	Reading Level dBuV/m	Correct Factor dB	Measure ment dBuV/m	Limit dBuV/m	Margin dB	Detector	Comment
1	5785.2000	53.41	41.35	94.76	68.30	26.46	AVG	No Limit
2	5796.8000	63.03	41.36	104.39	78.30	26.09	Peak	No Limit
3	5850.0000	17.10	41.44	58.54	78.30	-19.76	Peak	
4	5850.0000	7.00	41.44	48.44	68.30	-19.86	AVG	
5	5860.0000	14.36	41.45	55.81	78.30	-22.49	Peak	
6	5860.0000	6.29	41.45	47.74	68.30	-20.56	AVG	

Orthogonal Axis:	X
Test Mode:	UNII-3/TX AC40 Mode 5795MHz

Vertical

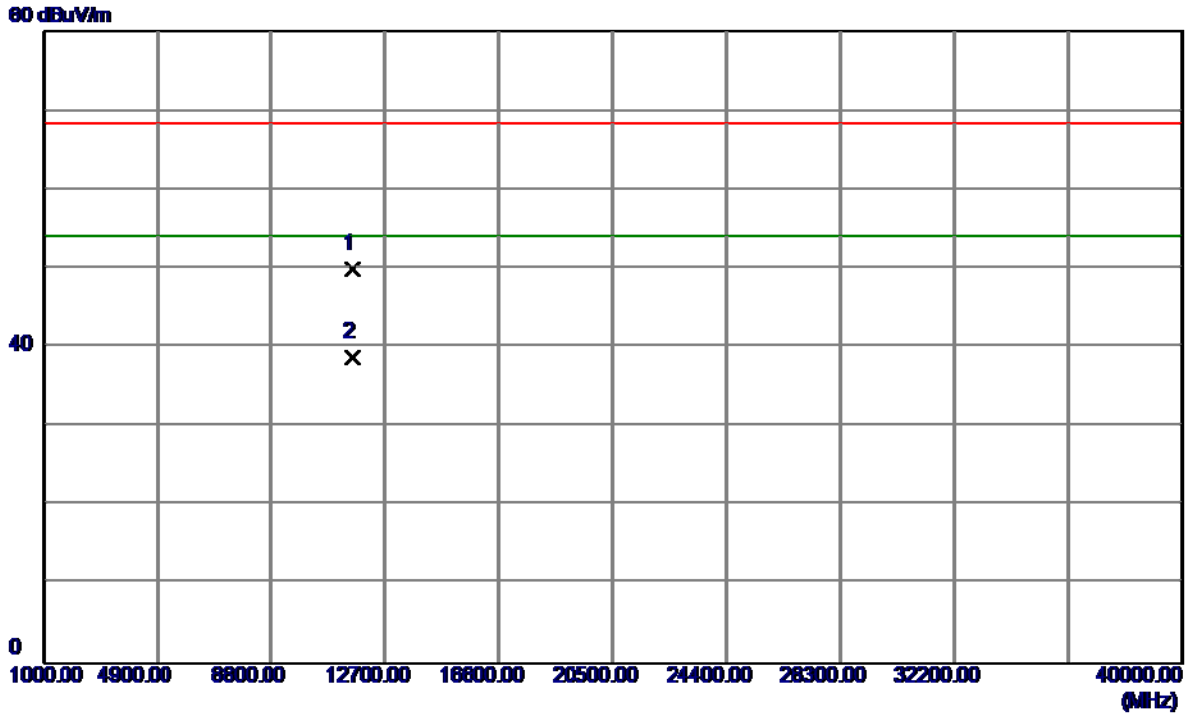

No.	Freq. MHz	Reading Level dBuV/m	Correct Factor dB	Measure ment dBuV/m	Limit dBuV/m	Margin dB	Detector	Comment
1	11590.0300	32.80	17.08	49.88	68.30	-18.42	Peak	
2	11590.0300	21.58	17.08	38.66	54.00	-15.34	AVG	

Orthogonal Axis:	X
Test Mode:	UNII-3/TX AC40 Mode 5795MHz

Horizontal

110 dBuV/m

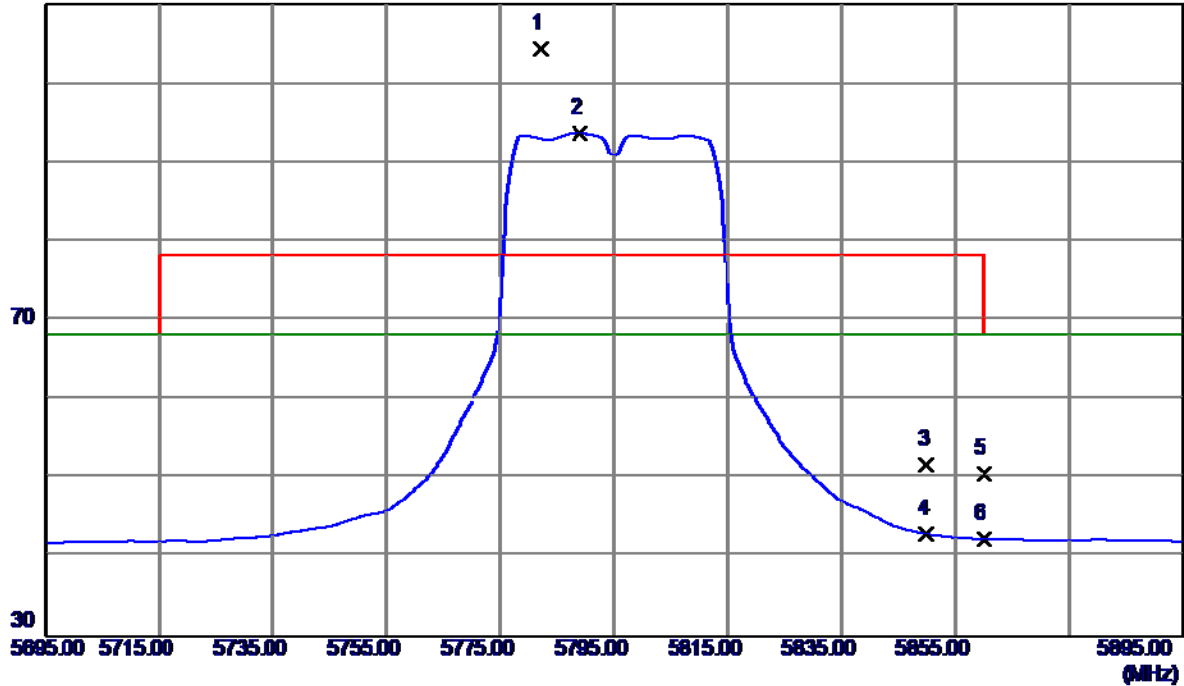

No.	Freq. MHz	Reading Level dBuV/m	Correct Factor dB	Measure ment dBuV/m	Limit dBuV/m	Margin dB	Detector	Comment
1	5782.2000	63.07	41.34	104.41	78.30	26.11	Peak	No Limit
2	5789.0000	52.36	41.35	93.71	68.30	25.41	AVG	No Limit
3	5850.0000	10.32	41.44	51.76	78.30	-26.54	Peak	
4	5850.0000	1.50	41.44	42.94	68.30	-25.36	AVG	
5	5860.0000	9.23	41.45	50.68	78.30	-27.62	Peak	
6	5860.0000	0.85	41.45	42.30	68.30	-26.00	AVG	

Orthogonal Axis:	X
Test Mode:	UNII-3/TX AC40 Mode 5795MHz

Horizontal

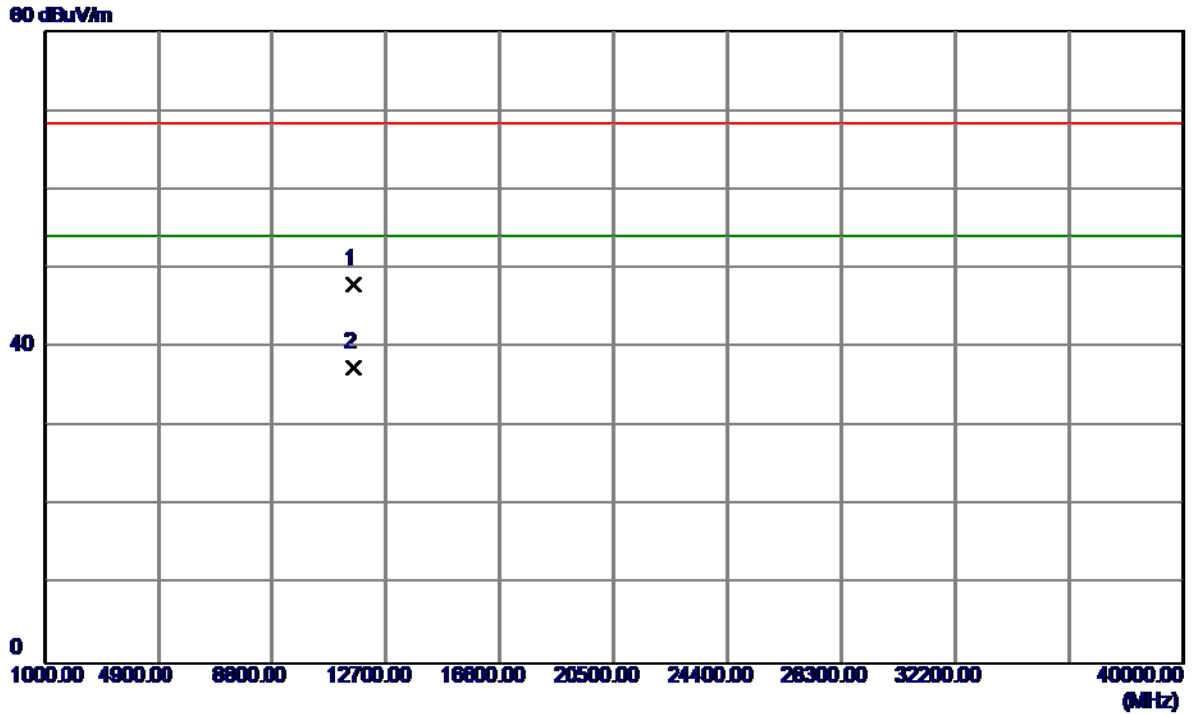

No.	Freq. MHz	Reading Level dBuV/m	Correct Factor dB	Measure ment dBuV/m	Limit dBuV/m	Margin dB	Detector	Comment
1	11590.7400	30.94	17.08	48.02	68.30	-20.28	Peak	
2	11590.7400	20.38	17.08	37.46	54.00	-16.54	AVG	

Orthogonal Axis:	X
Test Mode:	UNII-3/TX AC80 Mode 5775MHz

Vertical

110 dBuV/m

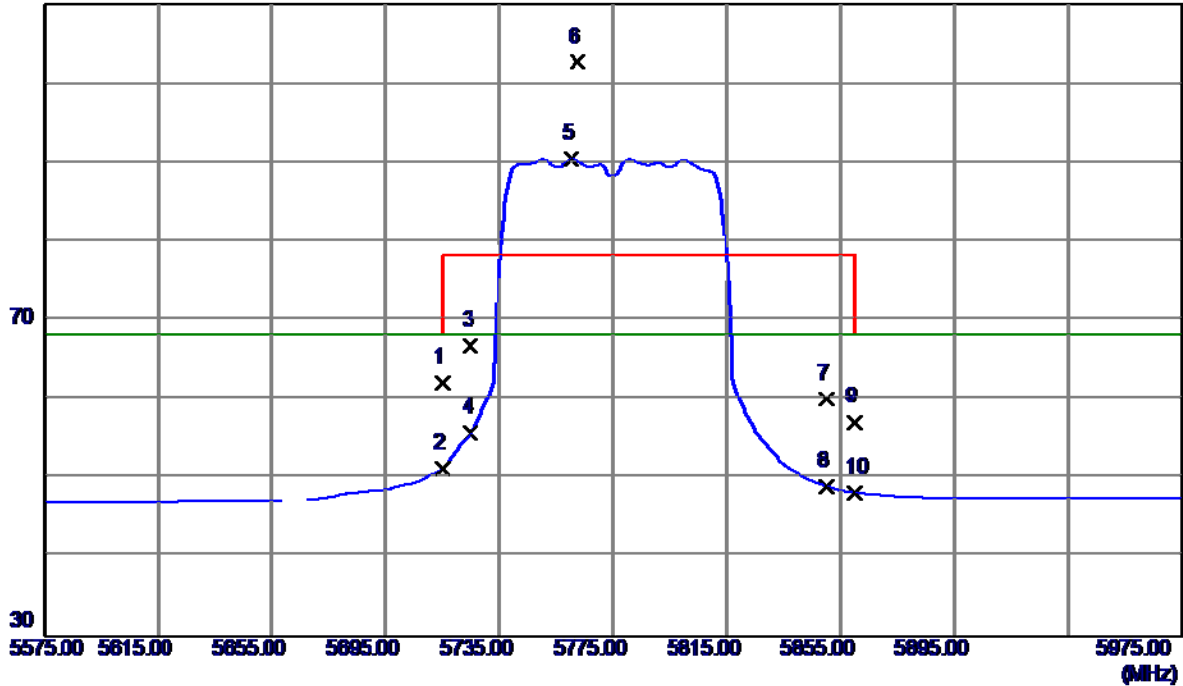

No.	Freq. MHz	Reading Level dBuV/m	Correct Factor dB	Measure ment dBuV/m	Limit dBuV/m	Margin dB	Detector	Comment
1	5715.0000	20.92	41.25	62.17	68.30	-6.13	Peak	
2	5715.0000	10.05	41.25	51.30	68.30	-17.00	AVG	
3	5725.0000	25.46	41.27	66.73	78.30	-11.57	Peak	
4	5725.0000	14.48	41.27	55.75	68.30	-12.55	AVG	
5	5760.2000	49.17	41.31	90.48	68.30	22.18	AVG	No Limit
6	5762.6000	61.40	41.32	102.72	78.30	24.42	Peak	No Limit
7	5850.0000	18.64	41.44	60.08	78.30	-18.22	Peak	
8	5850.0000	7.66	41.44	49.10	68.30	-19.20	AVG	
9	5860.0000	15.67	41.45	57.12	78.30	-21.18	Peak	
10	5860.0000	6.84	41.45	48.29	78.30	-30.01	Peak	

Orthogonal Axis:	X
Test Mode:	UNII-3/TX AC80 Mode 5775MHz

Vertical

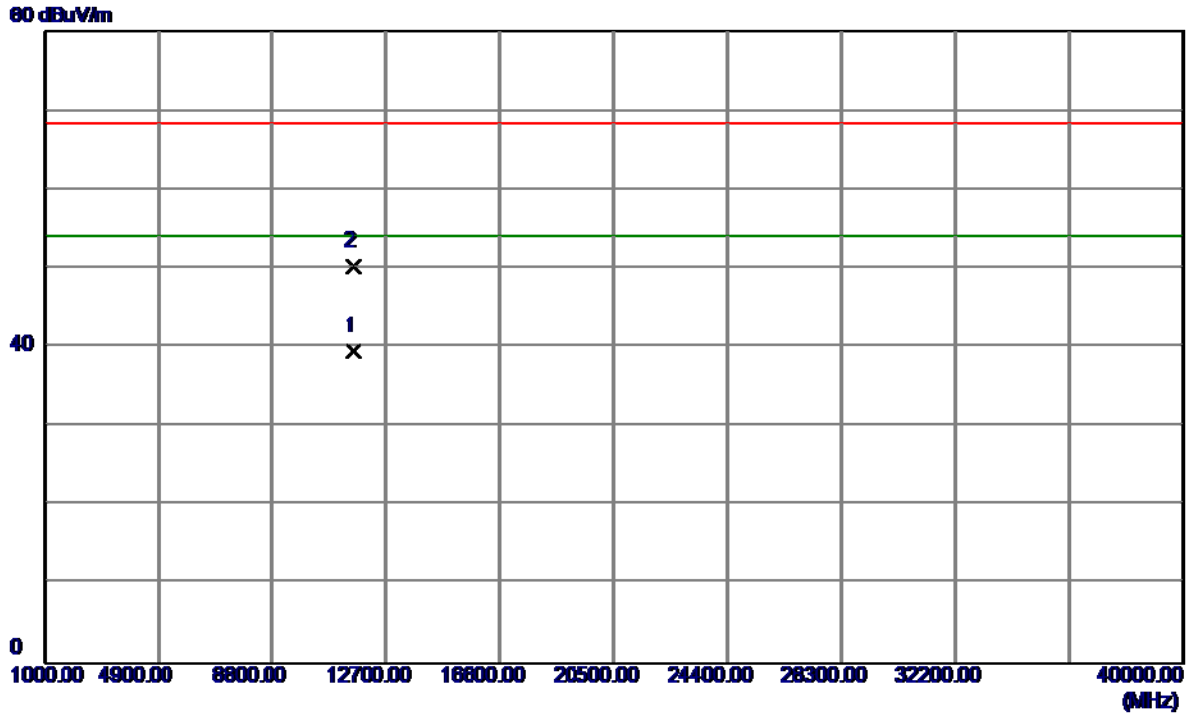

No.	Freq. MHz	Reading Level dBuV/m	Correct Factor dB	Measure ment dBuV/m	Limit dBuV/m	Margin dB	Detector	Comment
1	11552.1560	22.52	17.02	39.54	54.00	-14.46	AVG	
2	11552.3690	33.21	17.02	50.23	68.30	-18.07	Peak	

Orthogonal Axis:	X
Test Mode:	UNII-3/TX AC80 Mode 5775MHz

Horizontal

110 dBuV/m

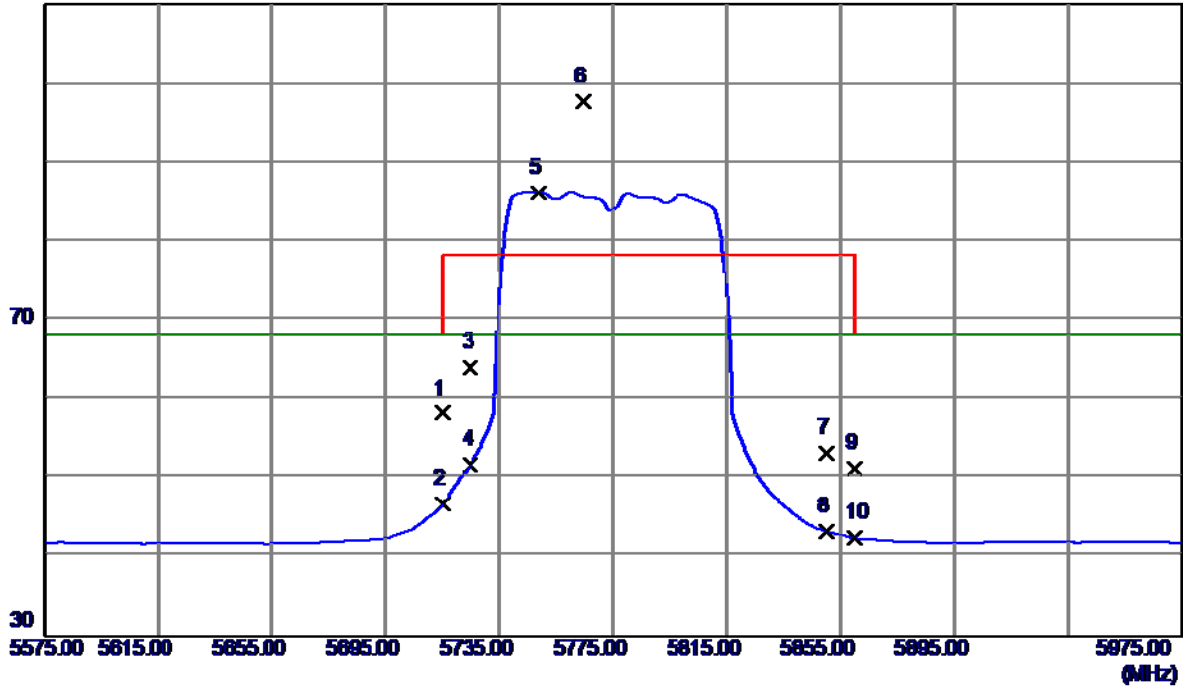

No.	Freq. MHz	Reading Level dBuV/m	Correct Factor dB	Measure ment dBuV/m	Limit dBuV/m	Margin dB	Detector	Comment
1	5715.0000	16.99	41.25	58.24	68.30	-10.06	Peak	
2	5715.0000	5.49	41.25	46.74	68.30	-21.56	AVG	
3	5725.0000	22.78	41.27	64.05	78.30	-14.25	Peak	
4	5725.0000	10.55	41.27	51.82	68.30	-16.48	AVG	
5	5748.6000	44.94	41.30	86.24	68.30	17.94	AVG	No Limit
6	5764.6000	56.39	41.32	97.71	78.30	19.41	Peak	No Limit
7	5850.0000	11.81	41.44	53.25	78.30	-25.05	Peak	
8	5850.0000	1.81	41.44	43.25	68.30	-25.05	AVG	
9	5860.0000	9.87	41.45	51.32	78.30	-26.98	Peak	
10	5860.0000	0.97	41.45	42.42	68.30	-25.88	AVG	

Orthogonal Axis:	X
Test Mode:	UNII-3/TX AC80 Mode 5775MHz

Horizontal

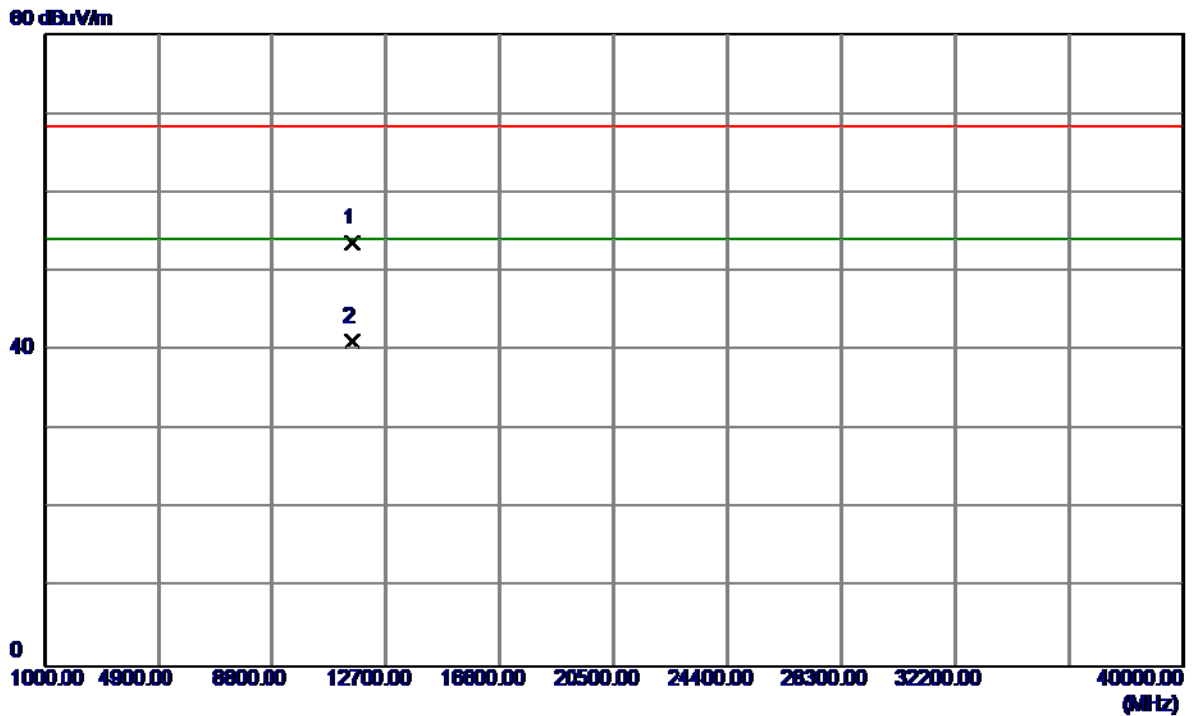

No.	Freq. MHz	Reading Level dBuV/m	Correct Factor dB	Measure ment dBuV/m	Limit dBuV/m	Margin dB	Detector	Comment
1	11550.0000	36.57	17.01	53.58	68.30	-14.72	Peak	
2	11550.1200	24.17	17.01	41.18	54.00	-12.82	AVG	

TX A Mode_DUTY CYCLE

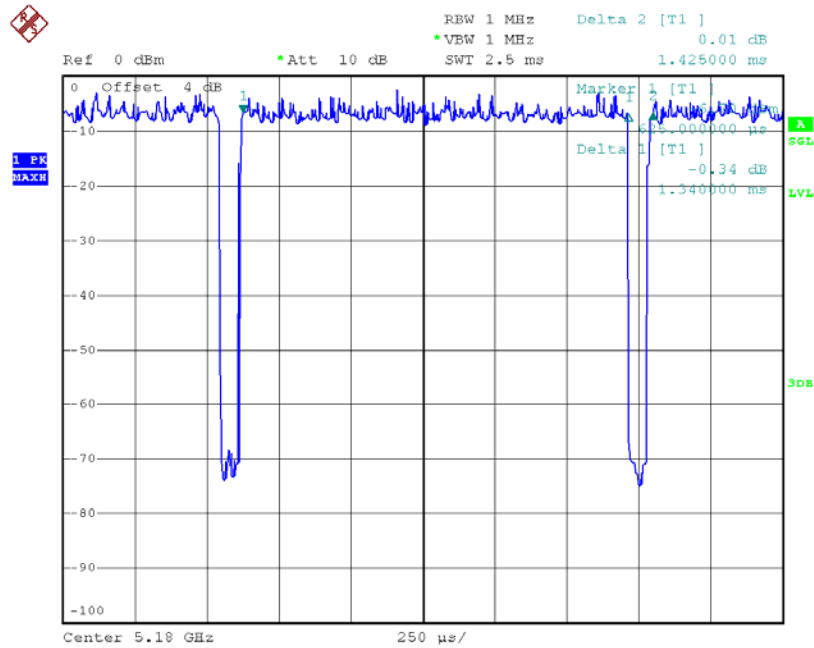

Date: 17.MAR.2016 10:42:00

Duty cycle: TX DUTYMHZ

$$\text{Duty cycle} = T_{\text{ON}} / T_{\text{Total}}$$

T_{ON} : 1.34 msec

T_{Total} : 1.42 msec

Duty cycle: 94.37%

$$\text{Duty Factor} = 10 \log(1/\text{Duty cycle})$$

Duty Factor = 0.25

Note: The EUT was programmed to be in countinously transmitting mode and the transmit duty cycle is not less than 98 %, so, the output power and power density should be cacluated

as Output Power = Measured power + Ducus factor

Power Spectral Density = Measured density + Duty factor

TX N20 Mode_DUTY CYCLE

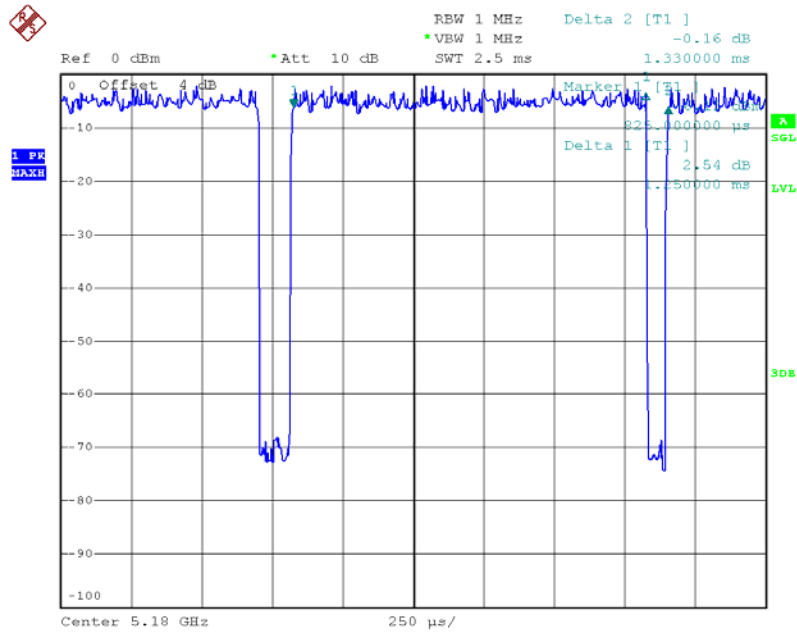

Date: 20.MAR.2016 13:19:19

Duty cycle: TX DUTYMHZ

$$\text{Duty cycle} = T_{\text{ON}} / T_{\text{Total}}$$

T_{ON} : 1.25 msec

T_{Total} : 1.33 msec

Duty cycle: 93.98%

$$\text{Duty Factor} = 10 \log(1/\text{Duty cycle})$$

Duty Factor = 0.27

Note: The EUT was programmed to be in continuously transmitting mode and the transmit duty cycle is not less than 98 %, so, the output power and power density should be calculated as Output Power = Measured power + Duty factor
 Power Spectral Density = Measured density + Duty factor

TX N40 Mode_DUTY CYCLE

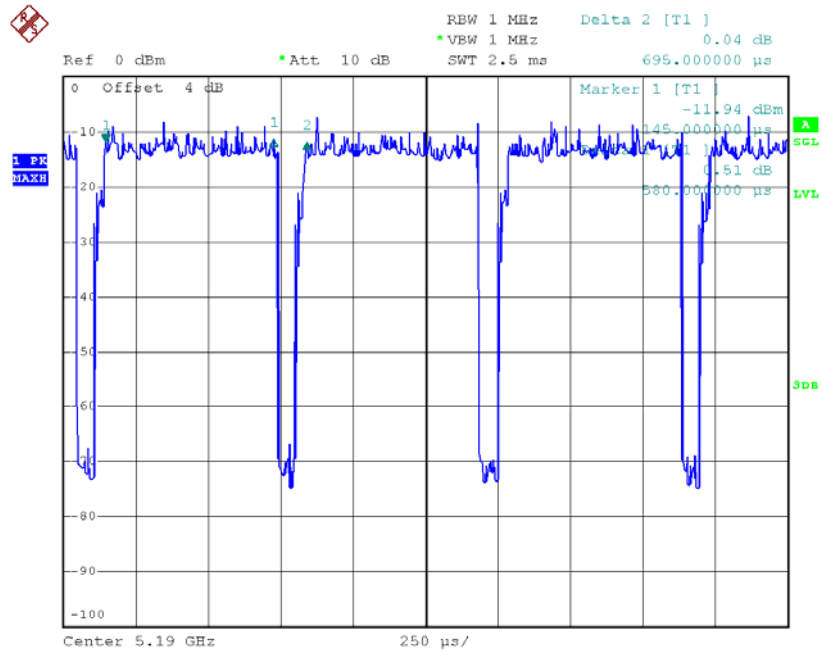

Date: 20.MAR.2016 13:34:46

Duty cycle: TX DUTYMHz

$$\text{Duty cycle} = T_{\text{ON}} / T_{\text{Total}}$$

T_{ON} : 0.58 msec

T_{Total} : 0.70 msec

Duty cycle: 82.86%

$$\text{Duty Factor} = 10 \log(1/\text{Duty cycle})$$

Duty Factor = 0.82

Note: The EUT was programmed to be in continuously transmitting mode and the transmit duty cycle is not less than 98 %, so, the output power and power density should be calculated as Output Power = Measured power + Duty factor
 Power Spectral Density = Measured density + Duty factor

TX AC20 Mode_DUTY CYCLE

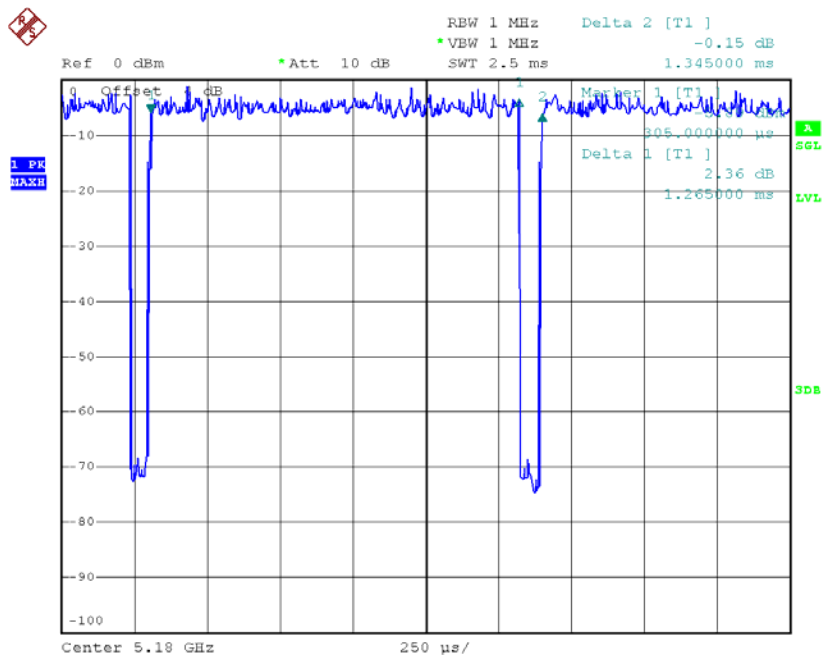

Date: 20.MAR.2016 13:27:38

Duty cycle: TX DUTYMHZ

$$\text{Duty cycle} = T_{\text{ON}} / T_{\text{Total}}$$

T_{ON} : 1.27 msec

T_{Total} : 1.34 msec

Duty cycle: 94.78%

$$\text{Duty Factor} = 10 \log(1/\text{Duty cycle})$$

Duty Factor = 0.23

Note: The EUT was programmed to be in countinously transmitting mode and the transmit duty cycle is not less than 98 %, so, the output power and power density should be cacluated as Output Power = Measured power + Ducus factor
 Power Spectral Density = Measured density + Duty factor

TX AC40 Mode_DUTY CYCLE

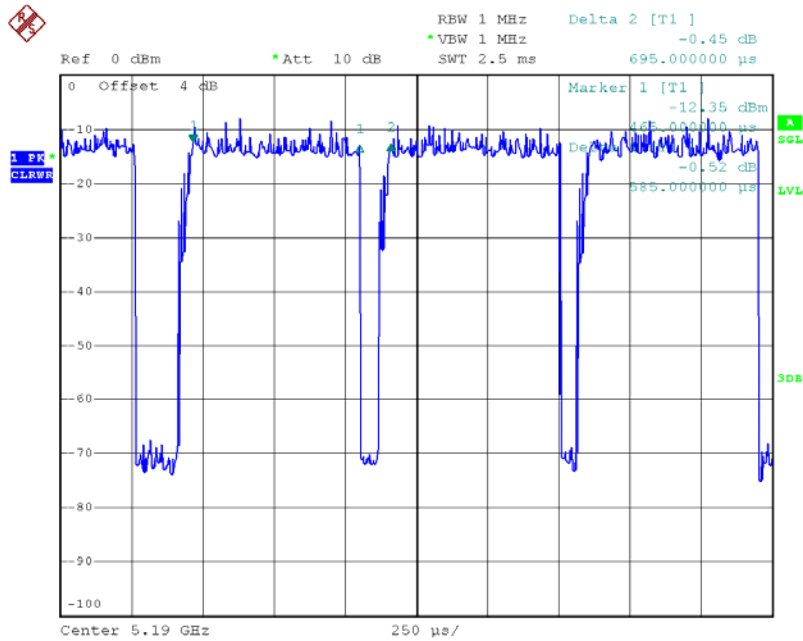

Date: 20.MAR.2016 13:47:37

Duty cycle: TX DUTYMHZ

$$\text{Duty cycle} = T_{\text{ON}} / T_{\text{Total}}$$

T_{ON} : 0.58 msec

T_{Total} : 0.70 msec

Duty cycle: 82.86%

$$\text{Duty Factor} = 10 \log(1/\text{Duty cycle})$$

Duty Factor = 0.82

Note: The EUT was programmed to be in continuously transmitting mode and the transmit duty cycle is not less than 98 %, so, the output power and power density should be calculated as Output Power = Measured power + Duty factor
 Power Spectral Density = Measured density + Duty factor

TX AC80 Mode_DUTY CYCLE

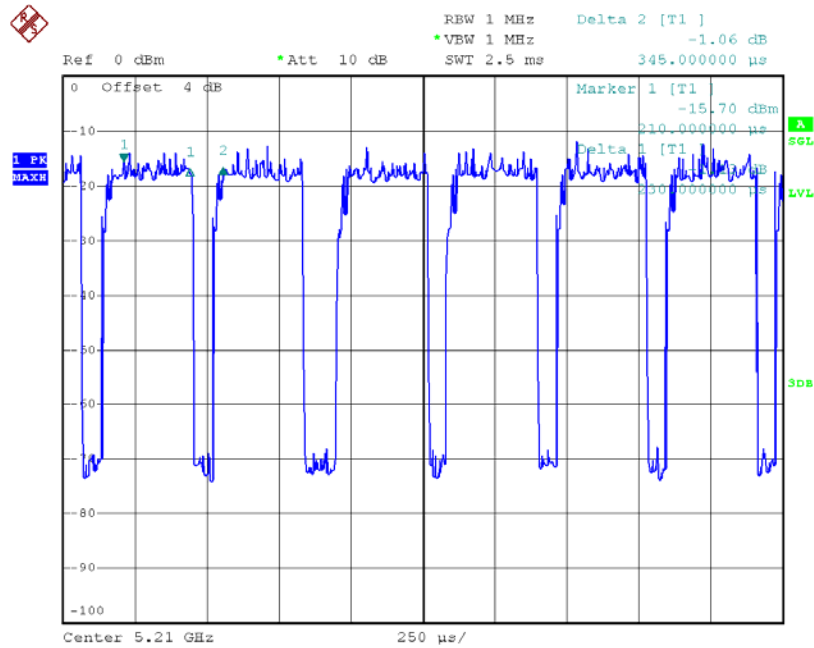

Date: 20.MAR.2016 13:52:07

Duty cycle: TX DUTYMHZ

$$\text{Duty cycle} = T_{\text{ON}} / T_{\text{Total}}$$

T_{ON} : 0.23 msec

T_{Total} : 0.34 msec

Duty cycle: 67.65%

$$\text{Duty Factor} = 10 \log(1/\text{Duty cycle})$$

Duty Factor = 1.70

Note: The EUT was programmed to be in continuously transmitting mode and the transmit duty cycle is not less than 98 %, so, the output power and power density should be calculated as Output Power = Measured power + Duty factor
 Power Spectral Density = Measured density + Duty factor