

FCC Radio Test Report

FCC ID: QISAP8130DN

This report concerns (check one): Original Grant Class I Change Class II Change

Project No. : 1407C034V
Equipment : Outdoor Wireless LAN Access Point
Model Name : AP8130DN
Applicant : Huawei Technologies Co.,Ltd.
Address : Administration Building, Huawei Base, Bantian,
Longgang District ,Shenzhen 518129, P.R.China

Date of Receipt : Mar. 09, 2015
Mar. 07, 2016
Date of Test : Mar. 09, 2015 ~ Jun. 08, 2015
Mar. 07, 2016 ~ Apr. 08, 2016
Issued Date : Apr. 11, 2016
Tested by : BTL Inc.

Testing Engineer : Shawn Xiao
(Shawn Xiao)

Technical Manager : David Mao
(David Mao)

Authorized Signatory : Steven Lu
(Steven Lu)

B T L I N C .

No.3, Jinshagang 1st Road, Shixia, Dalang Town, Dongguan,
Guangdong, China.

TEL: +86-769-8318-3000 FAX: +86-769-8319-6000

Declaration

BTL represents to the client that testing is done in accordance with standard procedures as applicable and that test instruments used has been calibrated with standards traceable to international standard(s) and/or national standard(s).

BTL's reports apply only to the specific samples tested under conditions. It is manufacture's responsibility to ensure that additional production units of this model are manufactured with the identical electrical and mechanical components. **BTL** shall have no liability for any declarations, inferences or generalizations drawn by the client or others from **BTL** issued reports.

BTL's report must not be used by the client to claim product certification, approval, or endorsement by NVLAP, NIST, or any agency of the Federal Government.

This report is the confidential property of the client. As a mutual protection to the clients, the public and **BTL-self**, extracts from the test report shall not be reproduced except in full with **BTL's** authorized written approval.

BTL's laboratory quality assurance procedures are in compliance with the **ISO Guide 17025** requirements, and accredited by the conformity assessment authorities listed in this test report.

Limitation

For the use of the authority's logo is limited unless the Test Standard(s)/Scope(s)/Item(s) mentioned in this test report is (are) included in the conformity assessment authorities acceptance respective.

Table of Contents	Page
1 . CERTIFICATION	6
2 . SUMMARY OF TEST RESULTS	7
2.1 TEST FACILITY	8
2.2 MEASUREMENT UNCERTAINTY	8
3 . GENERAL INFORMATION	9
3.1 GENERAL DESCRIPTION OF EUT	9
3.2 DESCRIPTION OF TEST MODES	11
3.3 TABLE OF PARAMETERS OF TEXT SOFTWARE SETTING	12
3.4 BLOCK DIAGRAM SHOWING THE CONFIGURATION OF SYSTEM TESTED	13
3.5 DESCRIPTION OF SUPPORT UNITS	13
4 . EMC EMISSION TEST	14
4.1 CONDUCTED EMISSION MEASUREMENT	14
4.1.1 POWER LINE CONDUCTED EMISSION LIMITS	14
4.1.2 TEST PROCEDURE	14
4.1.3 DEVIATION FROM TEST STANDARD	14
4.1.4 TEST SETUP	15
4.1.5 EUT OPERATING CONDITIONS	15
4.1.6 EUT TEST CONDITIONS	15
4.1.7 TEST RESULTS	15
4.2 RADIATED EMISSION MEASUREMENT	16
4.2.1 RADIATED EMISSION LIMITS	16
4.2.2 TEST PROCEDURE	17
4.2.3 DEVIATION FROM TEST STANDARD	17
4.2.4 TEST SETUP	18
4.2.5 EUT OPERATING CONDITIONS	19
4.2.6 EUT TEST CONDITIONS	19
4.2.7 TEST RESULTS (9KHZ TO 30MHZ)	20
4.2.8 TEST RESULTS (BETWEEN 30MHZ TO 1000 MHZ)	20
4.2.9 TEST RESULTS (ABOVE 1000 MHZ)	20
5 . BANDWIDTH TEST	21
5.1 APPLIED PROCEDURES	21
5.1.1 TEST PROCEDURE	21
5.1.2 DEVIATION FROM STANDARD	21
5.1.3 TEST SETUP	21
5.1.4 EUT OPERATION CONDITIONS	21
5.1.5 EUT TEST CONDITIONS	21
5.1.6 TEST RESULTS	21
6 . MAXIMUM PEAK CONDUCTED OUTPUT POWER TEST	22

Table of Contents	Page
6.1 APPLIED PROCEDURES / LIMIT	22
6.1.1 TEST PROCEDURE	22
6.1.2 DEVIATION FROM STANDARD	22
6.1.3 TEST SETUP	22
6.1.4 EUT OPERATION CONDITIONS	22
6.1.5 EUT TEST CONDITIONS	22
6.1.6 TEST RESULTS	22
7 . ANTENNA CONDUCTED SPURIOUS EMISSION	23
7.1 APPLIED PROCEDURES / LIMIT	23
7.1.1 TEST PROCEDURE	23
7.1.2 DEVIATION FROM STANDARD	23
7.1.3 TEST SETUP	23
7.1.4 EUT OPERATION CONDITIONS	23
7.1.5 EUT TEST CONDITIONS	23
7.1.6 TEST RESULTS	23
8 . POWER SPECTRAL DENSITY TEST	24
8.1 APPLIED PROCEDURES / LIMIT	24
8.1.1 TEST PROCEDURE	24
8.1.2 DEVIATION FROM STANDARD	24
8.1.3 TEST SETUP	24
8.1.4 EUT OPERATION CONDITIONS	24
8.1.5 EUT TEST CONDITIONS	24
8.1.6 TEST RESULTS	24
9 . MEASUREMENT INSTRUMENTS LIST	25
10 . EUT TEST PHOTO	27
ATTACHMENT A - CONDUCTED EMISSION	31
ATTACHMENT B - RADIATED EMISSION (9KHZ TO 30MHZ)	34
ATTACHMENT C - RADIATED EMISSION (30MHZ TO 1000MHZ)	36
ATTACHMENT D - RADIATED EMISSION (ABOVE 1000MHZ)	43
ATTACHMENT E - BANDWIDTH	92
ATTACHMENT F – MAXIMUM PEAK CONDUCTED OUTPUT POWER	101
ATTACHMENT G - ANTENNA CONDUCTED SPURIOUS EMISSION	109
ATTACHMENT H - POWER SPECTRAL DENSITY	158

REPORT ISSUED HISTORY

Issued No.	Description	Issued Date
BTL-FCCP-1-1407C034B	Original Report.	Jun. 10, 2015
BTL-FCCP-1-1407C034V	Compared with previous report (BTL-FCCP-1-1407C034B), the antennas are added, Conducted Emission and Radiated Emissions have been re-evaluated and recorded in the test report, the rest are kept the same.	Apr. 11, 2016

1. CERTIFICATION

Equipment : Outdoor Wireless LAN Access Point
Brand Name : HUAWEI
Model Name : AP8130DN
Applicant : Huawei Technologies Co.,Ltd.
Manufacturer : Huawei Technologies Co.,Ltd.
Address : Administration Building, Huawei Base, Bantian, Longgang District ,Shenzhen
518129, P.R.China
Factory : Huawei Technologies Co.,Ltd.
Address : Huawei Base, Bantian, Longgang District, Shenzhen 518129, P.R.China
Date of Test : Mar. 09, 2015 ~ Jun. 08, 2015
Mar. 07, 2016 ~ Apr. 08, 2016
Test Sample : Engineering Sample
Standard(s) : FCC Part15, Subpart C:(15.247) / ANSI C63.10-2013

The above equipment has been tested and found compliance with the requirement of the relative standards by BTL Inc.

The test data, data evaluation, and equipment configuration contained in our test report (Ref No. BTL-FCCP-1-1407C034V) were obtained utilizing the test procedures, test instruments, test sites that has been accredited by the Authority of TAF according to the ISO-17025 quality assessment standard and technical standard(s).

Test result included in this report is only for the 2.4GHz part of the product.

2. SUMMARY OF TEST RESULTS

Test procedures according to the technical standard(s):

Applied Standard(s): FCC Part15 (15.247) , Subpart C			
Standard(s) Section	Test Item	Judgment	Remark
15.207	Conducted Emission	PASS	
15.247(d)	Antenna conducted Spurious Emission	PASS	
15.247(a)(2)	6dB Bandwidth	PASS	
15.247(b)(3)	Peak Output Power	PASS	
15.247(e)	Power Spectral Density	PASS	
15.203	Antenna Requirement	PASS	
15.209/15.205	Transmitter Radiated Emissions	PASS	

NOTE:

(1) "N/A" denotes test is not applicable in this test report.

2.1 TEST FACILITY

The test facilities used to collect the test data in this report is at the location of No.3,Jinshagang 1st Road, Shixia, Dalang Town, Dongguan, Guangdong, China.
BTL's test firm number for FCC: 319330

2.2 MEASUREMENT UNCERTAINTY

Where relevant, the following measurement uncertainty levels have been estimated for tests performed on the EUT as specified in CISPR 16-4-2. The BTL measurement uncertainty is less than the CISPR 16-4-2 U_{CISPR} requirement.

The reported uncertainty of measurement $y \pm U$, where expanded uncertainty U is based on a standard uncertainty multiplied by a coverage factor of $k=2$, providing a level of confidence of approximately 95 %.

A. Conducted Measurement:

Test Site	Method	Measurement Frequency Range	U, (dB)
DG-C02	CISPR	150 KHz ~ 30MHz	2.32

B. Radiated Measurement:

Test Site	Method	Measurement Frequency Range	Ant. H / V	U, (dB)
DG-CB03	CISPR	9KHz~30MHz	V	3.79
		9KHz~30MHz	H	3.57
		30MHz ~ 200MHz	V	3.82
		30MHz ~ 200MHz	H	3.78
		200MHz ~ 1,000MHz	V	4.10
		200MHz ~ 1,000MHz	H	4.06
		1GHz~18GHz	V	3.12
		1GHz~18GHz	H	3.68
		18GHz~40GHz	V	4.15
		18GHz~40GHz	H	4.14

Note: Unless specifically mentioned, the uncertainty of measurement has not been taken into account to declare the compliance or non-compliance to the specification.

3. GENERAL INFORMATION

3.1 GENERAL DESCRIPTION OF EUT

Equipment	Outdoor Wireless LAN Access Point	
Brand Name	HUAWEI	
Model Name	AP8130DN	
Model Difference	NA	
Product Description	Operation Frequency	2412~2462 MHz
	Modulation Technology	802.11b:DSSS 802.11g:OFDM 802.11n:OFDM
	Bit Rate of Transmitter	802.11b: 11/5.5/2/1 Mbps 802.11g: 54/48/36/24/18/12/9/6 Mbps 802.11n up to 450 Mbps
	Output Power (Max.) for 1T1R	802.11b: 26.91 dBm 802.11g: 24.16 dBm 802.11n(20MHz): 25.76 dBm 802.11n(40MHz): 22.27 dBm
	Output Power (Max.) for 2T2R	802.11b: 29.24 dBm 802.11g: 29.83 dBm 802.11n(20MHz): 27.35 dBm 802.11n(40MHz): 23.09 dBm
	Output Power (Max.) for 2T2R with Beamforming	802.11n(20MHz): 24.03 dBm 802.11n(40MHz): 18.66 dBm
Power Source	DC voltage supplied from PoE. Model: PoE 35-54A	
Power Rating	I/P: AC 100-240V 50/60Hz 1.0A MAX O/P: DC 54V 0.65A	

Note:

1. For a more detailed features description, please refer to the manufacturer's specifications or the user's manual.

2. Channel List:

CH01 – CH11 for 802.11b, 802.11g, 802.11n(20MHz) CH03 – CH11 for 802.11n(40MHz)							
Channel	Frequency (MHz)	Channel	Frequency (MHz)	Channel	Frequency (MHz)	Channel	Frequency (MHz)
01	2412	04	2427	07	2442	10	2457
02	2417	05	2432	08	2447	11	2462
03	2422	06	2437	09	2452		

3. Table for Filed Antenna

Ant.	Brand	Model Name	Antenna Type	Connector	Gain (dBi)	Note
A	pctel	FP2327-18DP-HW	External Antenna	N-type	5.6	2.4GHz
B	pctel	FP2327-18DP-HW	External Antenna	N-type	5.6	2.4GHz

Note:

1. The EUT incorporates a MIMO function. Physically, the EUT provides two completed transmitters and receivers (2T2R).
2. ANT B for 1TX was found to be the worst case and recorded.
3. A 13dB attenuator is epoxied to the antenna to be one part of antenna.

For 2TX with beamforming

The EUT with beamforming function, then, Direction gain = $G_{ANT} + 10\log(N_{ANT}/N_{SS})$, where N_{SS} = the number of independent spatial streams of data.

Directional gain = $5.6 + 10\log(2/2) = 5.6 + 0 = 5.6$ dBi.

4.

Operating Mode TX Mode	1TX	2TX
802.11b	V (ANT B)	V (ANT A+ANT B)
802.11g	V (ANT B)	V (ANT A+ANT B)
802.11n(20MHz)	V (ANT B)	V (ANT A+ANT B)
802.11n(40MHz)	V (ANT B)	V (ANT A+ANT B)

3.2 DESCRIPTION OF TEST MODES

To investigate the maximum EMI emission characteristics generated from EUT, the test system was pre-scanning tested based on the consideration of following EUT operation mode or test configuration mode which possibly have effect on EMI emission level. Each of these EUT operation mode(s) or test configuration mode(s) mentioned above was evaluated respectively.

Pretest Mode	Description
Mode 1	TX B MODE CHANNEL 01/06/11
Mode 2	TX G MODE CHANNEL 01/06/11
Mode 3	TX N-20MHZ MODE CHANNEL 01/06/11
Mode 4	TX N-40MHZ MODE CHANNEL 03/06/09
Mode 5	Normal Link

The EUT system operated these modes were found to be the worst case during the pre-scanning test as following:

For Conducted Test	
Final Test Mode	Description
Mode 5	Normal Link

For Radiated Test	
Final Test Mode	Description
Mode 1	TX B MODE CHANNEL 01/06/11
Mode 2	TX G MODE CHANNEL 01/06/11
Mode 3	TX N-20MHZ MODE CHANNEL 01/06/11
Mode 4	TX N-40MHZ MODE CHANNEL 03/06/09

Note:

- (1) The measurements are performed at the high, middle, low available channels.
- (2) 802.11b mode: DBPSK (1Mbps)
 802.11g mode: OFDM (6Mbps)
 802.11n HT20 mode : BPSK (6.5Mbps)
 802.11n HT40 mode : BPSK (13.5Mbps)
 For radiated emission tests, the highest output powers were set for final test.
- (3) For radiated below 1G test, the 802.11b is found to be the worst case and recorded.
- (4) The EUT was programmed to be in continuously transmitting mode and the transmit duty cycle is not less than 98%.

3.3 TABLE OF PARAMETERS OF TEXT SOFTWARE SETTING

During testing, channel & power controlling software provided by the customer was used to control the operating channel as well as the output power level. The RF output power selection is for the setting of RF output power expected by the customer and is going to be fixed on the firmware of the final end product power parameters of WLAN

For 1TX

Test software version	TEST-CART		
Frequency (MHz)	2412	2437	2462
802.11b	23	23	23
802.11g	13	18	13
802.11n (20MHz)	13	19	13
Frequency	2422	2437	2452
802.11n (40MHz)	11	15	11

For 2TX

Test software version	CART		
Frequency (MHz)	2412	2437	2462
802.11b	20	23	20
802.11g	10	18	10
802.11n (20MHz)	10	16	10
Frequency	2422	2437	2452
802.11n (40MHz)	8	12	8

For 2TX with beamforming

Test software version	CART		
Frequency (MHz)	2412	2437	2462
802.11n (20MHz)	7	13	7
Frequency	2422	2437	2452
802.11n (40MHz)	5	9	5

3.4 BLOCK DIAGRAM SHOWING THE CONFIGURATION OF SYSTEM TESTED

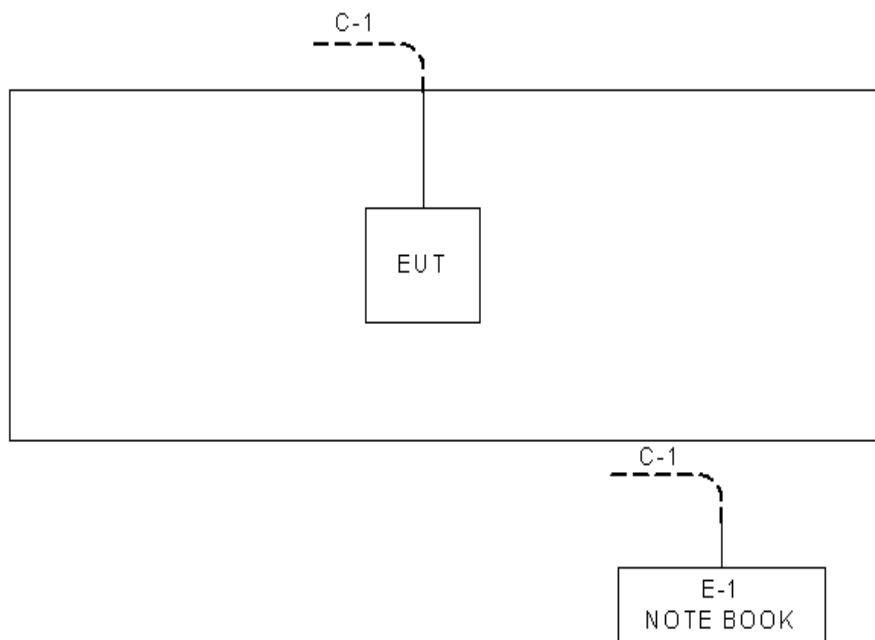

3.5 DESCRIPTION OF SUPPORT UNITS

The EUT has been tested as an independent unit together with other necessary accessories or support units. The following support units or accessories were used to form a representative test configuration during the tests.

Item	Equipment	Mfr/Brand	Model/Type No.	FCC ID	Series No.
E-1	NOTEBOOK	DELL	H2510	DOC	SS07999198

Item	Shielded Type	Ferrite Core	Length	Note
C-1	NA	NA	10m	RJ45 cable

4. EMC EMISSION TEST

4.1 CONDUCTED EMISSION MEASUREMENT

4.1.1 POWER LINE CONDUCTED EMISSION LIMITS (Frequency Range 150KHz-30MHz)

Frequency of Emission (MHz)	Conducted Limit (dB μ V)	
	Quasi-peak	Average
0.15 -0.50	66 to 56*	56 to 46*
0.50 -5.0	56	46
5.0 -30.0	60	50

Note:

- (1) The limit of " * " decreases with the logarithm of the frequency
- (2) The test result calculated as following:
 Measurement Value = Reading Level + Correct Factor
 Correct Factor = Insertion Loss + Cable Loss + Attenuator Factor(if use)
 Margin Level = Measurement Value - Limit Value

The following table is the setting of the receiver

Receiver Parameters	Setting
Attenuation	10 dB
Start Frequency	0.15 MHz
Stop Frequency	30 MHz
IF Bandwidth	9 KHz

4.1.2 TEST PROCEDURE

- a. The EUT was placed 0.8 meters from the horizontal ground plane with EUT being connected to the power mains through a line impedance stabilization network (LISN). All other support equipments powered from additional LISN(s). The LISN provide 50 Ohm/ 50uH of coupling impedance for the measuring instrument.
- b. Interconnecting cables that hang closer than 40 cm to the ground plane shall be folded back and forth in the center forming a bundle 30 to 40 cm long.
- c. I/O cables that are not connected to a peripheral shall be bundled in the center. The end of the cable may be terminated, if required, using the correct terminating impedance. The overall length shall not exceed 1 m.
- d. LISN at least 80 cm from nearest part of EUT chassis.
- e. For the actual test configuration, please refer to the related Item –EUT Test Photos.

4.1.3 DEVIATION FROM TEST STANDARD

No deviation

4.1.4 TEST SETUP

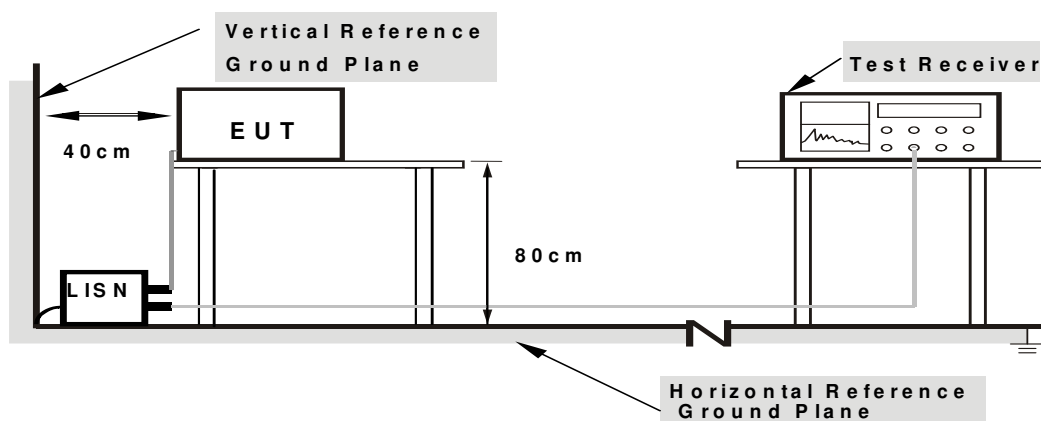

- Note:**
1. Support units were connected to second LISN.
 2. Both of LISNs (AMN) are 80 cm from EUT and at least 80 cm from other units and other metal planes

4.1.5 EUT OPERATING CONDITIONS

The EUT was placed on the test table and programmed in normal function.

4.1.6 EUT TEST CONDITIONS

Temperature: 25°C Relative Humidity: 55% Test Voltage: AC 120V/60Hz

4.1.7 TEST RESULTS

Please refer to the Attachment A.

4.2 RADIATED EMISSION MEASUREMENT

4.2.1 RADIATED EMISSION LIMITS

In case the emission fall within the restricted band specified on 15.205(a), then the 15.209(a) limit in the table below has to be followed.

LIMITS OF RADIATED EMISSION MEASUREMENT (9KHz-1000MHz)

Frequency (MHz)	Field Strength (microvolts/meter)	Measurement Distance (meters)
0.009~0.490	2400/F(KHz)	300
0.490~1.705	24000/F(KHz)	30
1.705~30.0	30	30
30~88	100	3
88~216	150	3
216~960	200	3
960~1000	500	3

LIMITS OF RADIATED EMISSION MEASUREMENT (Above 1000MHz)

Frequency (MHz)	(dBuV/m) (at 3 meters)	
	PEAK	AVERAGE
Above 1000	74	54

Notes:

- (1) The limit for radiated test was performed according to FCC PART 15C.
- (2) The tighter limit applies at the band edges.
- (3) Emission level (dBuV/m)=20log Emission level (uV/m).
- (4) The test result calculated as following:
 Measurement Value = Reading Level + Correct Factor
 Correct Factor = Antenna Factor + Cable Loss - Amplifier Gain(if use)
 Margin Level = Measurement Value - Limit Value

Spectrum Parameter	Setting
Attenuation	Auto
Start Frequency	1000 MHz
Stop Frequency	10th carrier harmonic
RBW / VBW (Emission in restricted band)	1MHz / 3MHz for Peak, 1MHz / 1/T for Average

Receiver Parameter	Setting
Attenuation	Auto
Start ~ Stop Frequency	9KHz~90KHz for PK/AVG detector
Start ~ Stop Frequency	90KHz~110KHz for QP detector
Start ~ Stop Frequency	110KHz~490KHz for PK/AVG detector
Start ~ Stop Frequency	490KHz~30MHz for QP detector
Start ~ Stop Frequency	30MHz~1000MHz for QP detector

4.2.2 TEST PROCEDURE

- a. The measuring distance of 3 m shall be used for measurements. The EUT was placed on the top of a rotating table 0.8 meter above the ground at a 3 meter semi-anechoic chamber. The table was rotated 360 degrees to determine the position of the highest radiation.(below 1GHz)
- b. The measuring distance of 3 m shall be used for measurements. The EUT was placed on the top of a rotating table 1.5 meter above the ground at a 3 meter semi-anechoic chamber. The table was rotated 360 degrees to determine the position of the highest radiation.(above 1GHz)
- c. The height of the equipment or of the substitution antenna shall be 0.8 m or 1.5m, the height of the test antenna shall vary between 1 m to 4 m. Both horizontal and vertical polarizations of the antenna are set to make the measurement.
- d. The initial step in collecting radiated emission data is a receiver peak detector mode pre-scanning the measurement frequency range. Significant peaks are then marked and then Quasi Peak detector mode re-measured.
- e. All readings are Peak unless otherwise stated QP in column of Note. Peak denotes that the Peak reading compliance with the QP Limits and then QP Mode measurement didn't perform. (below 1GHz)
- f. All readings are Peak Mode value unless otherwise stated AVG in column of Note. If the Peak Mode Measured value compliance with the Peak Limits and lower than AVG Limits, the EUT shall be deemed to meet both Peak & AVG Limits and then only Peak Mode was measured, but AVG Mode didn't perform. (above 1GHz)
- g. For the actual test configuration, please refer to the related Item –EUT Test Photos.

4.2.3 DEVIATION FROM TEST STANDARD

No deviation

4.2.4 TEST SETUP

(A) Radiated Emission Test Set-Up Frequency Below 1 GHz

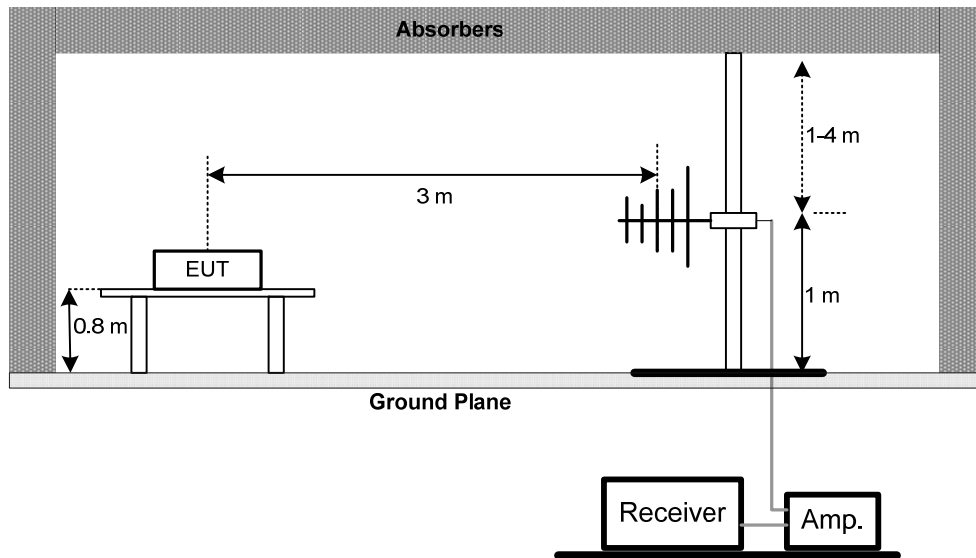

(B) Radiated Emission Test Set-Up Frequency Above 1 GHz

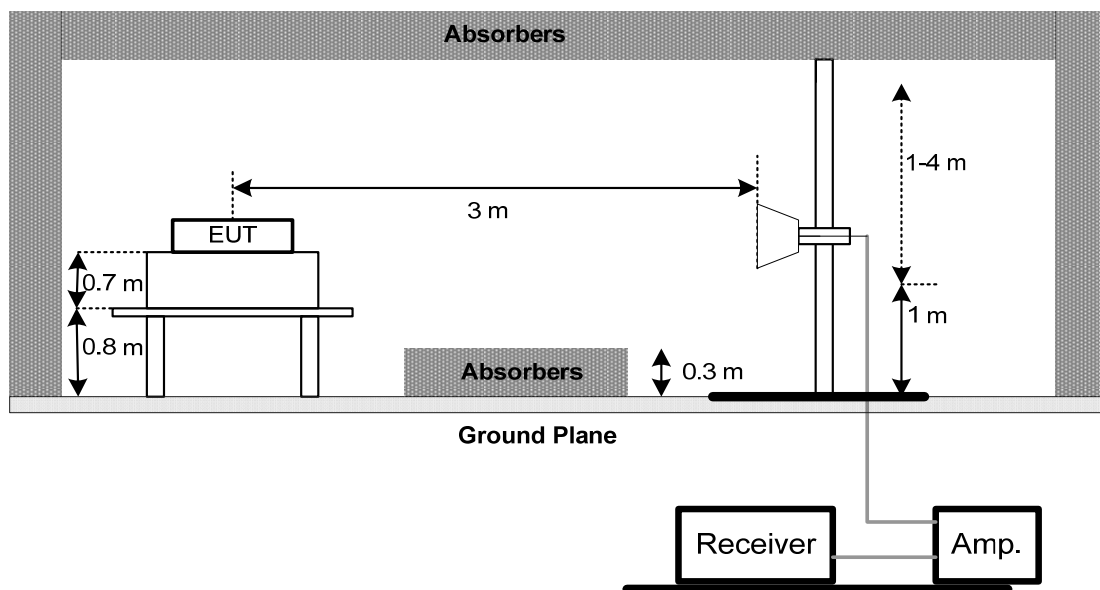

(C) For Radiated Emissions Below 30MHz

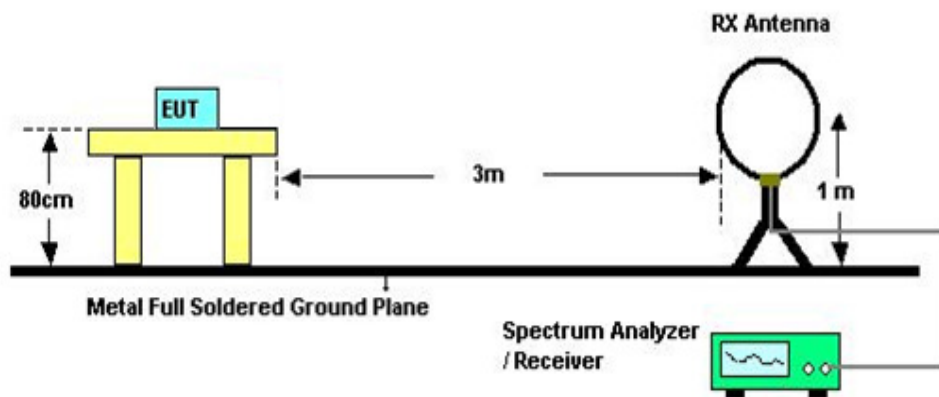

4.2.5 EUT OPERATING CONDITIONS

The EUT was programmed to be in continuously transmitting mode.

4.2.6 EUT TEST CONDITIONS

Temperature: 25°C Relative Humidity: 55% Test Voltage: AC 120V/60Hz

4.2.7 TEST RESULTS (9KHZ TO 30MHZ)

Please refer to the Attachment B

Remark:

- (1) The amplitude of spurious emissions which are attenuated by more than 20 dB below the permissible value has no need to be reported.
- (2) Distance extrapolation factor = $40 \log(\text{specific distance} / \text{test distance})$ (dB).
- (3) Limit line = specific limits (dBuV) + distance extrapolation factor.

4.2.8 TEST RESULTS (30MHZ TO 1000 MHZ)

Please refer to the Attachment C.

4.2.9 TEST RESULTS (ABOVE 1000 MHZ)

Please refer to the Attachment D.

Remark:

- (1) No limit: This is fundamental signal, the judgment is not applicable.
For fundamental signal judgment was referred to Peak output test.

5. BANDWIDTH TEST

5.1 APPLIED PROCEDURES

FCC Part15 (15.247) , Subpart C			
Section	Test Item	Frequency Range (MHz)	Result
15.247(a)(2)	Bandwidth	2400-2483.5	PASS

5.1.1 TEST PROCEDURE

- a. The EUT was directly connected to the spectrum analyzer and antenna output port as show in the block diagram below,
- b. Spectrum Setting: RBW= 100KHz, VBW=300KHz, Sweep time = 2.5 ms.

5.1.2 DEVIATION FROM STANDARD

No deviation.

5.1.3 TEST SETUP

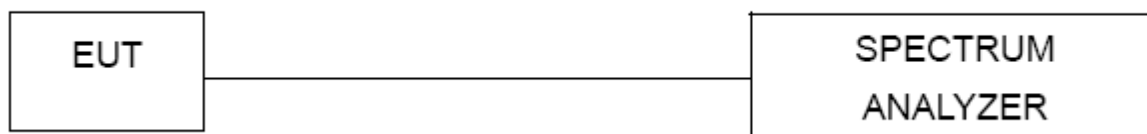

5.1.4 EUT OPERATION CONDITIONS

The EUT was programmed to be in continuously transmitting mode.

5.1.5 EUT TEST CONDITIONS

Temperature: 25°C Relative Humidity: 55% Test Voltage: AC 120V/60Hz

5.1.6 TEST RESULTS

Please refer to the Attachment E.

6. MAXIMUM PEAK CONDUCTED OUTPUT POWER TEST

6.1 APPLIED PROCEDURES / LIMIT

FCC Part15 (15.247) , Subpart C				
Section	Test Item	Limit	Frequency Range (MHz)	Result
15.247(b)(3)	Maximum Output Power	1 Watt or 30dBm	2400-2483.5	PASS

6.1.1 TEST PROCEDURE

- a. The EUT was directly connected to the power meter and antenna output port as show in the block diagram below,
- b. The maximum peak conducted output power was performed in accordance with method 9.1.2 of FCC KDB 558074 D01 DTS Meas Guidance v03r04.

6.1.2 DEVIATION FROM STANDARD

No deviation.

6.1.3 TEST SETUP

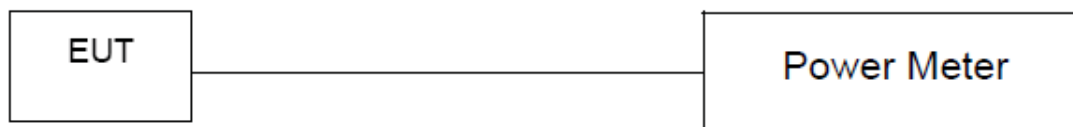

6.1.4 EUT OPERATION CONDITIONS

The EUT was programmed to be in continuously transmitting mode.

6.1.5 EUT TEST CONDITIONS

Temperature: 25°C Relative Humidity: 55% Test Voltage: AC 120V/60Hz

6.1.6 TEST RESULTS

Please refer to the Attachment F.

7. ANTENNA CONDUCTED SPURIOUS EMISSION

7.1 APPLIED PROCEDURES / LIMIT

In any 100 kHz bandwidth outside the frequency band in which the spread spectrum or digitally modulated device is operating, the RF power that is produced shall be at least 20 dB below that in the 100 kHz bandwidth within the band that contains the highest level of the desired power, based on either an RF conducted or a radiated measurement, provided that the transmitter demonstrates compliance with the peak conducted power limits.

7.1.1 TEST PROCEDURE

- a. The EUT was directly connected to the spectrum analyzer and antenna output port as show in the block diagram below,
- b. Spectrum Setting: RBW= 100KHz, VBW=300KHz, Sweep time = Auto.
- c. Offset=antenna gain+cable loss

7.1.2 DEVIATION FROM STANDARD

No deviation.

7.1.3 TEST SETUP



7.1.4 EUT OPERATION CONDITIONS

The EUT was programmed to be in continuously transmitting mode.

7.1.5 EUT TEST CONDITIONS

Temperature: 25°C Relative Humidity: 55% Test Voltage: AC 120V/60Hz

7.1.6 TEST RESULTS

Please refer to the Attachment G.

8. POWER SPECTRAL DENSITY TEST

8.1 APPLIED PROCEDURES / LIMIT

FCC Part15 (15.247) , Subpart C				
Section	Test Item	Limit	Frequency Range (MHz)	Result
15.247(e)	Power Spectral Density	8 dBm (in any 3kHz)	2400-2483.5	PASS

8.1.1 TEST PROCEDURE

- a. The EUT was directly connected to the spectrum analyzer and antenna output port as show in the block diagram below,
- b. Spectrum Setting: RBW=3KHz, VBW=10KHz, Sweep time = Auto.

8.1.2 DEVIATION FROM STANDARD

No deviation.

8.1.3 TEST SETUP

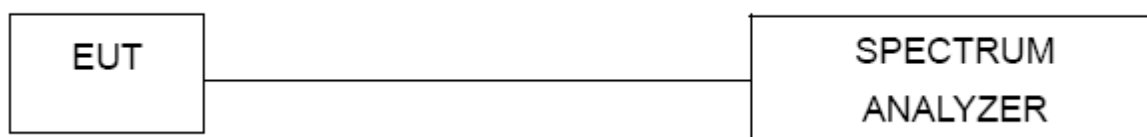

8.1.4 EUT OPERATION CONDITIONS

The EUT was programmed to be in continuously transmitting mode.

8.1.5 EUT TEST CONDITIONS

Temperature: 25°C Relative Humidity: 55% Test Voltage: AC 120V/60Hz

8.1.6 TEST RESULTS

Please refer to the Attachment H.

9. MEASUREMENT INSTRUMENTS LIST

Conducted Emission Measurement					
Item	Kind of Equipment	Manufacturer	Type No.	Serial No.	Calibrated until
1	LISN	EMCO	3816/2	0052765	Mar. 27, 2017
2	LISN	R&S	ENV216	101447	Mar. 27, 2017
3	Test Cable	emci	RG223(9KHz-30 MHz)	C_17	Mar. 10, 2017
4	EMI Test Receiver	R&S	ESCI	100382	Mar. 27, 2017
5	50Ω Terminator	SHX	TF2-3G-A	08122901	Mar. 27, 2017
6	Measurement Software	Farad	EZ-EMC Ver.NB-03A1-01	N/A	N/A

Radiated Emission Measurement					
Item	Kind of Equipment	Manufacturer	Type No.	Serial No.	Calibrated until
1	Antenna	Schwarbeck	VULB9160	9160-3232	Mar. 27, 2017
2	Amplifier	HP	8447D	2944A09673	Nov. 09, 2016
3	Receiver	AGILENT	N9038A	MY52130039	Oct. 11, 2016
4	Test Cable	emci	LMR-400(30MHz-1GHz)	C-01	Jun. 28, 2016
5	Controller	CT	SC100	N/A	N/A
6	Antenna	ETS	3115	00075789	Mar. 27, 2017
7	Amplifier	Agilent	8449B	3008A02274	Nov. 01, 2016
8	Receiver	AGILENT	N9038A	MY52130039	Oct. 11, 2016
9	Test Cable	emci	EMC104-SM-SM-10000(1GHz – 26.5GHz)	C-68	Jun. 28, 2016
10	Controller	CT	SC100	N/A	N/A
11	Broad-Band Horn Antenna	Schwarzbeck	BBHA 9170	9170319	Mar. 27, 2017
12	Microwave Pre-amplifier With Adaptor	EMC INSTRUMENT	EMC2654045	980039 & HA01	Mar. 27, 2017
13	Active Loop Antenna	R&S	HFH2-Z2	830749/020	Sep. 07, 2016
14	Measurement Software	Farad	EZ-EMC Ver.NB-03A1-01	N/A	N/A

6dB Bandwidth Measurement					
Item	Kind of Equipment	Manufacturer	Type No.	Serial No.	Calibrated until
1	Spectrum Analyzer	R&S	FSP 40	100185	Nov. 02, 2015
2	Test Cable	emci	EMC104-SM-SM-9000(0.01GHz – 26.5GHz)	C-100	N/A

Peak Output Power Measurement					
Item	Kind of Equipment	Manufacturer	Type No.	Serial No.	Calibrated until
1	P-series Power meter	Agilent	N1911A	MY45100473	Mar. 29, 2015
2	Wireband Power sensor	Agilent	N1921A	MY51100041	Mar. 29, 2015

Antenna Conducted Spurious Emission Measurement					
Item	Kind of Equipment	Manufacturer	Type No.	Serial No.	Calibrated until
1	Spectrum Analyzer	R&S	FSP 40	100185	Nov. 02, 2015
2	Test Cable	emci	EMC104-SM-SM-9000(0.01GHz – 26.5GHz)	C-100	N/A

Power Spectral Density Measurement					
Item	Kind of Equipment	Manufacturer	Type No.	Serial No.	Calibrated until
1	Spectrum Analyzer	R&S	FSP 40	100185	Nov. 02, 2015
2	Test Cable	emci	EMC104-SM-SM-9000(0.01GHz – 26.5GHz)	C-100	N/A

Remark: "N/A" denotes no model name, serial no. or calibration specified.
 All calibration period of equipment list is one year.

10. EUT TEST PHOTO

Conducted Measurement Photos



Radiated Measurement Photos**9KHz to 30MHz**

Radiated Measurement Photos

30MHz to 1000MHz

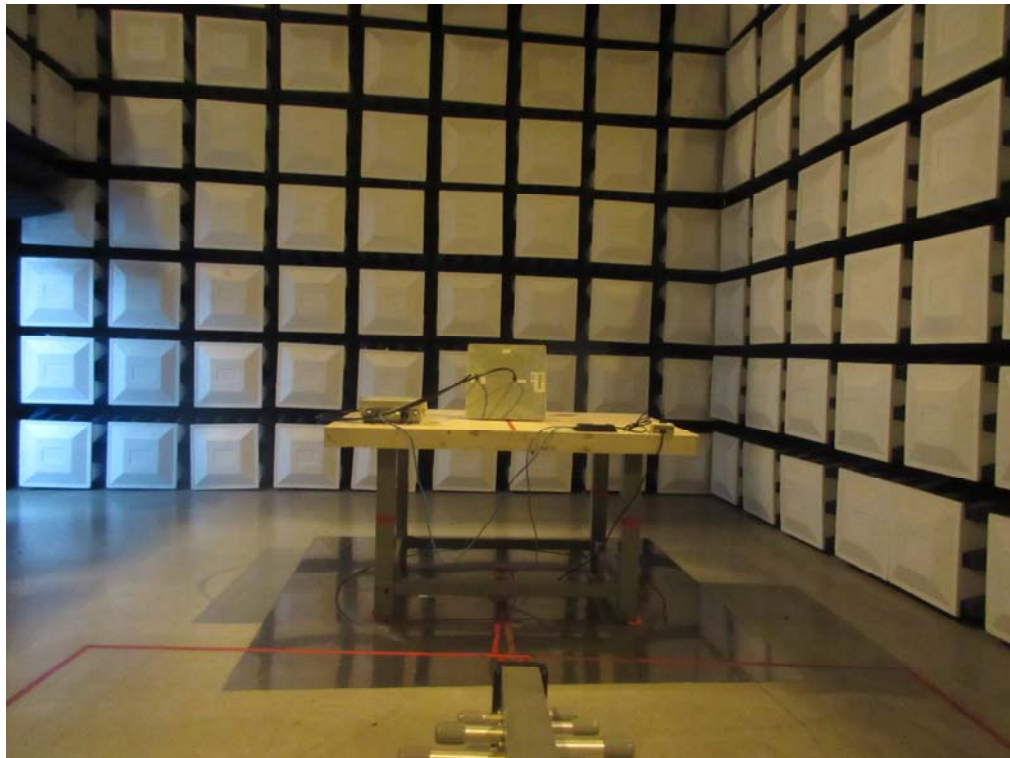
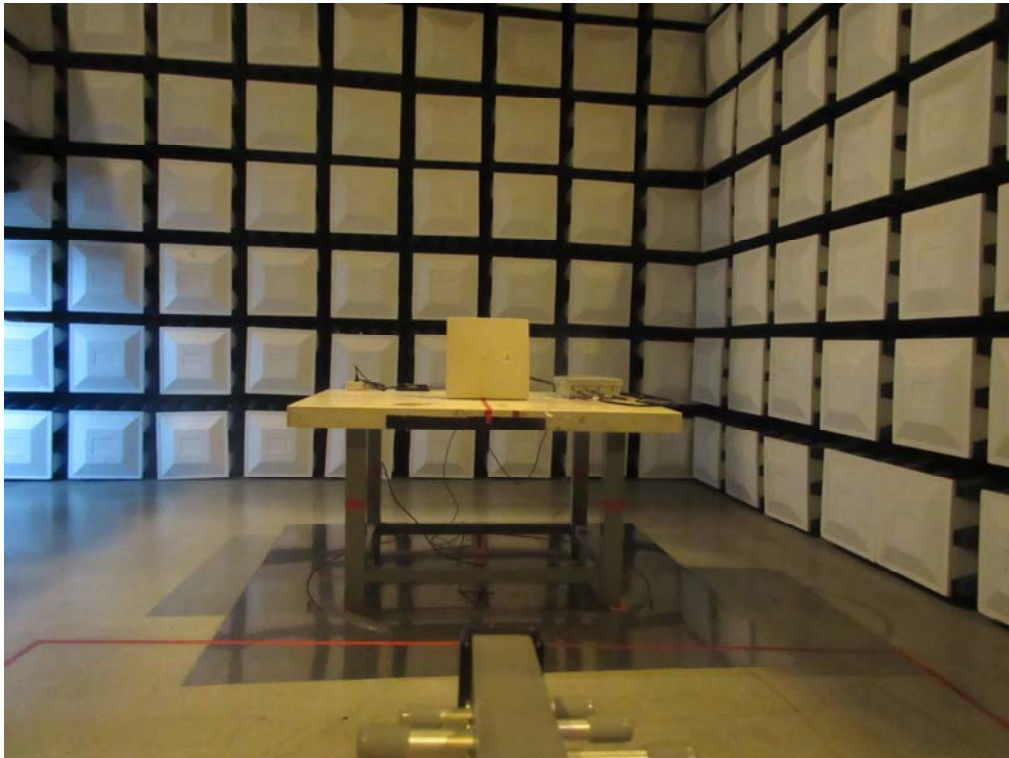

Radiated Measurement Photos

Above 1000MHz

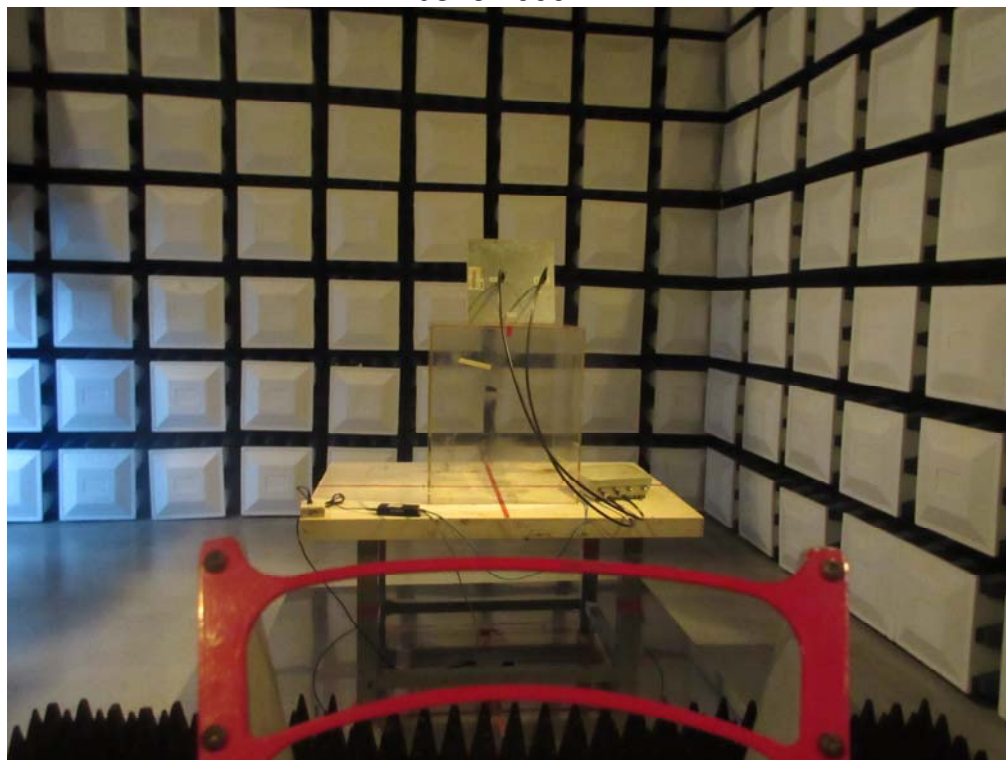

ATTACHMENT A - CONDUCTED EMISSION

Test Mode : Normal Link

Line

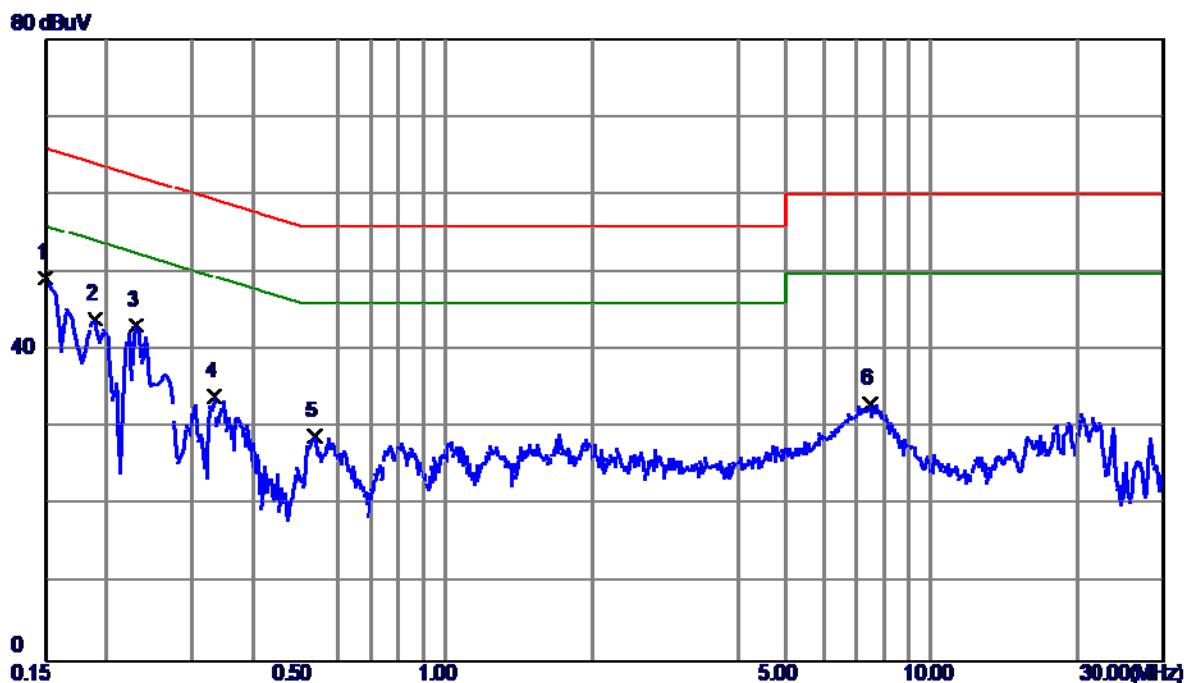

No.	Freq. MHz	Reading Level dBuV	Correct Factor dB	Measure ment dBuV	Limit dBuV	Margin dB	Detector	Comment
1	0.1500	39.74	9.52	49.26	66.00	-16.74	Peak	
2	0.1900	34.50	9.55	44.05	64.04	-19.99	Peak	
3	0.2300	33.62	9.58	43.20	62.45	-19.25	Peak	
4	0.3339	24.44	9.63	34.07	59.35	-25.28	Peak	
5	0.5380	19.22	9.69	28.91	56.00	-27.09	Peak	
6	7.4780	23.19	9.90	33.09	60.00	-26.91	Peak	

Test Mode : Normal Link

Neutral

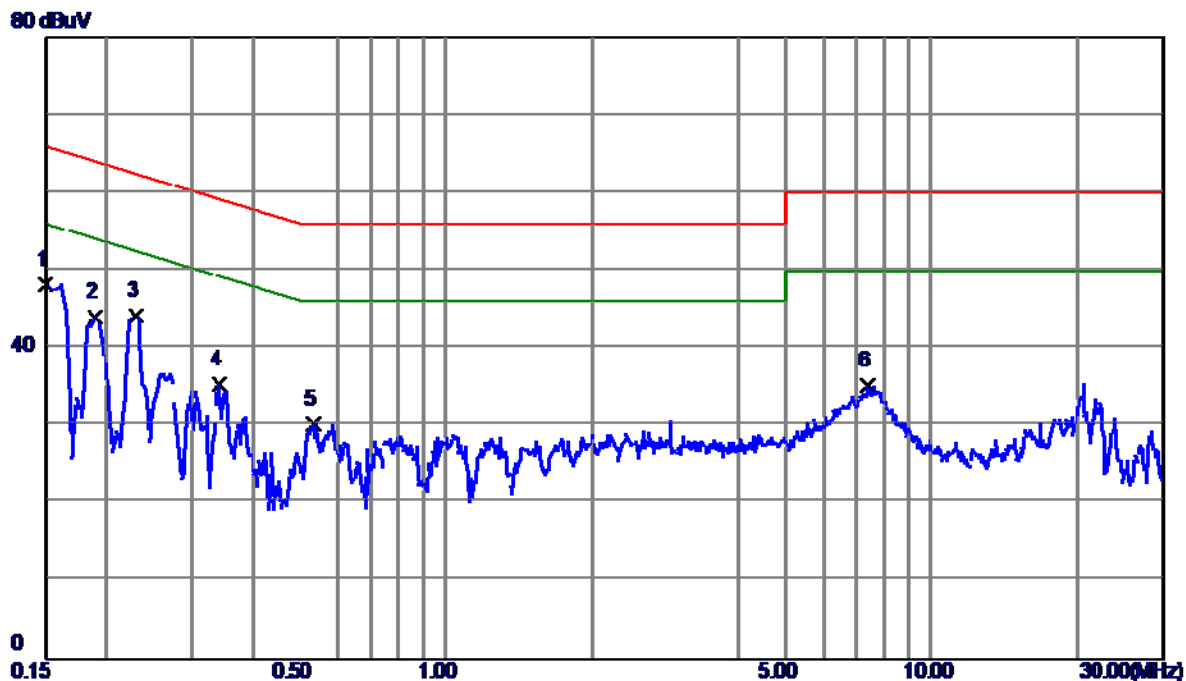

No.	Freq. MHz	Reading Level dBuV	Correct Factor dB	Measure ment dBuV	Limit dBuV	Margin dB	Detector	Comment
1	0.1500	38.69	9.47	48.16	66.00	-17.84	Peak	
2	0.1900	34.53	9.48	44.01	64.04	-20.03	Peak	
3	0.2300	34.63	9.50	44.13	62.45	-18.32	Peak	
4	0.3420	25.86	9.52	35.38	59.15	-23.77	Peak	
5	0.5340	20.69	9.55	30.24	56.00	-25.76	Peak	
6	7.4100	25.35	9.84	35.19	60.00	-24.81	Peak	

ATTACHMENT B - RADIATED EMISSION (9KHZ TO 30MHZ)

Test Mode:	TX B MODE CHANNEL 01
------------	----------------------

Frequency (MHz)	Ant 0°/90°	Read level dBuV/m	Factor (dB)	Measured(FS) (dBuV/m)	Limit (dBuV/m)	Margin (dB)	Note
0.0123	0°	13.42	24.7877	38.2077	125.8061	-87.5985	AVG
0.0123	0°	14.61	24.7877	39.3977	145.8061	-106.4085	PEAK
0.0237	0°	6.72	24.0657	30.7857	120.1093	-89.3236	AVG
0.0237	0°	8.46	24.0657	32.5257	140.1093	-107.5836	PEAK
0.0384	0°	3.77	23.1347	26.9047	115.9176	-89.0129	AVG
0.0384	0°	5.01	23.1347	28.1447	135.9176	-107.7729	PEAK
0.0542	0°	1.43	22.3160	23.7460	112.9242	-89.1782	AVG
0.0542	0°	2.72	22.3160	25.0360	132.9242	-107.8882	PEAK
0.5001	0°	19.22	19.8003	39.0203	73.6231	-34.6028	QP
1.9529	0°	23.46	19.5047	42.9647	69.5400	-26.5753	QP

Frequency (MHz)	Ant 0°/90°	Read level dBuV/m	Factor (dB)	Measured(FS) (dBuV/m)	Limit (dBuV/m)	Margin (dB)	Note
0.0112	90°	13.31	24.3000	37.6100	126.6199	-89.0099	AVG
0.0112	90°	14.43	24.3000	38.7300	146.6199	-107.8899	PEAK
0.0258	90°	7.24	23.9327	31.1727	119.3718	-88.1992	AVG
0.0258	90°	8.6	23.9327	32.5327	139.3718	-106.8392	PEAK
0.0457	90°	5.33	22.6723	28.0023	114.4059	-86.4036	AVG
0.0457	90°	6.61	22.6723	29.2823	134.4059	-105.1236	PEAK
0.0561	90°	1.55	22.2780	23.8280	112.6250	-88.7970	AVG
0.0561	90°	2.31	22.2780	24.5880	132.6250	-108.0370	PEAK
0.6283	90°	22.62	20.2106	42.8306	71.6409	-28.8103	QP
2.0562	90°	24.61	19.4663	44.0763	69.5400	-25.4637	QP

ATTACHMENT C - RADIATED EMISSION (30MHZ TO 1000MHZ)

Test Mode: TX B MODE CHANNEL 01

Vertical

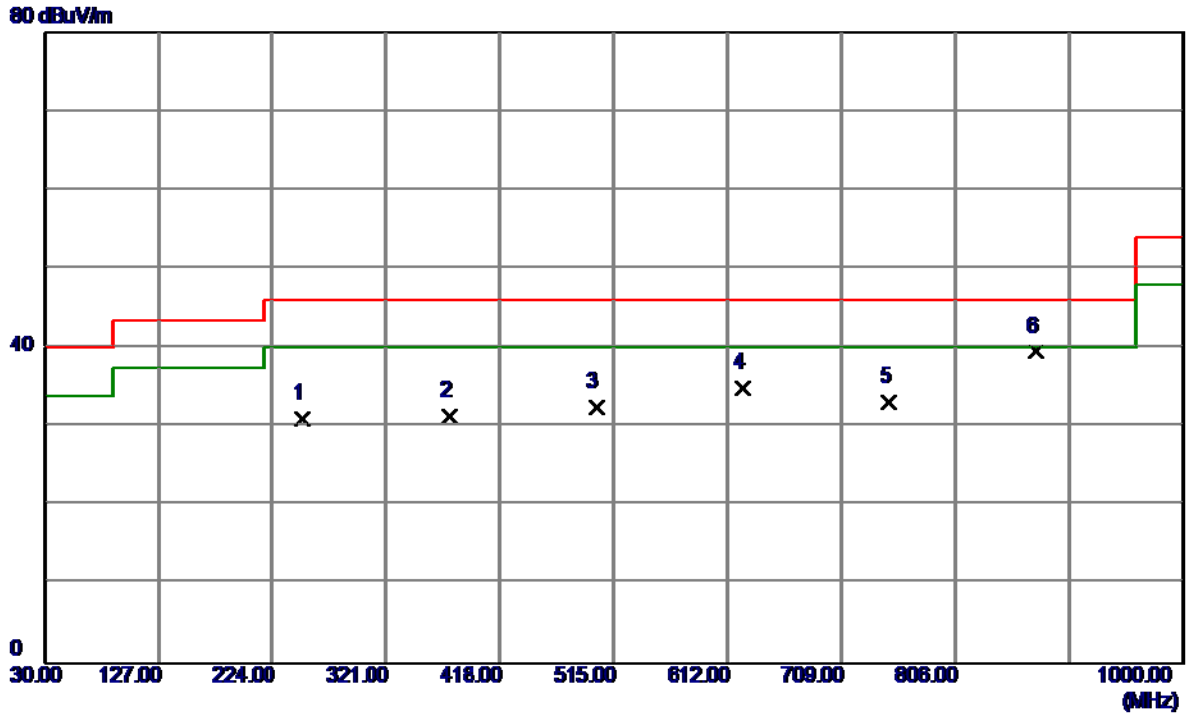

No.	Freq. MHz	Reading Level dBuV/m	Correct Factor dB	Measure ment dBuV/m	Limit dBuV/m	Margin dB	Detector	Comment
1	250.1900	44.37	-13.37	31.00	46.00	-15.00	Peak	
2	375.3200	41.16	-9.78	31.38	46.00	-14.62	Peak	
3	500.4500	39.67	-7.15	32.52	46.00	-13.48	Peak	
4	624.6100	39.71	-4.77	34.94	46.00	-11.06	Peak	
5	749.7400	35.13	-2.00	33.13	46.00	-12.87	Peak	
6	874.8700	39.75	-0.20	39.55	46.00	-6.45	Peak	

Test Mode: TX B MODE CHANNEL 01

Horizontal

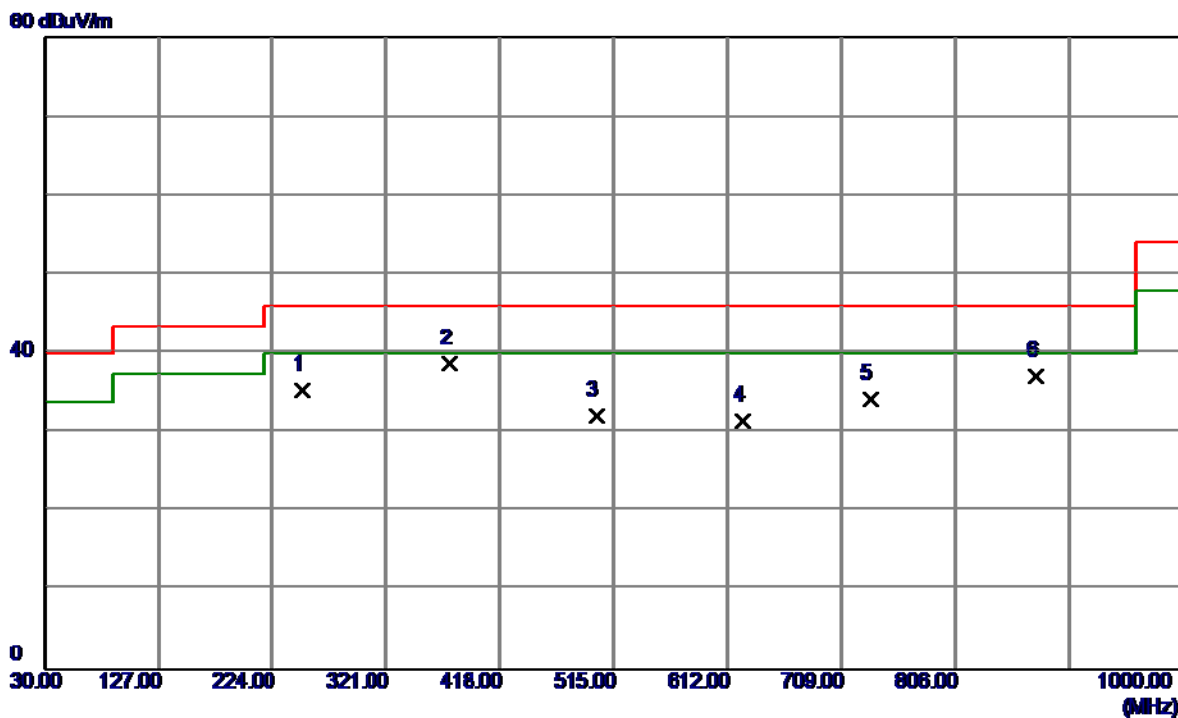

No.	Freq. MHz	Reading Level dBuV/m	Correct Factor dB	Measure ment dBuV/m	Limit dBuV/m	Margin dB	Detector	Comment
1	250.1900	48.73	-13.37	35.36	46.00	-10.64	Peak	
2	375.3200	48.46	-9.78	38.68	46.00	-7.32	Peak	
3	500.4500	39.34	-7.15	32.19	46.00	-13.81	Peak	
4	624.6100	36.35	-4.77	31.58	46.00	-14.42	Peak	
5	733.2500	36.85	-2.59	34.26	46.00	-11.74	Peak	
6	874.8700	37.28	-0.20	37.08	46.00	-8.92	Peak	

Test Mode: TX B MODE CHANNEL 06

Vertical

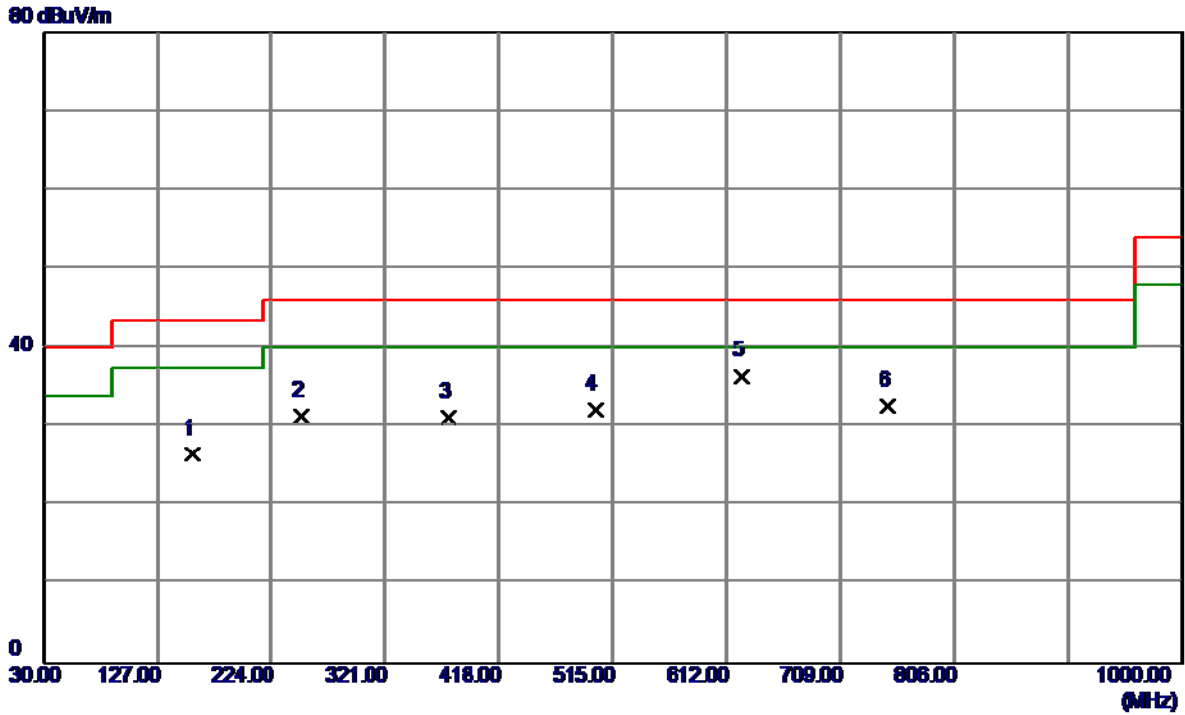

No.	Freq. MHz	Reading Level dBuV/m	Correct Factor dB	Measure ment dBuV/m	Limit dBuV/m	Margin dB	Detector	Comment
1	157.0700	39.37	-12.74	26.63	43.50	-16.87	Peak	
2	250.1900	44.67	-13.37	31.30	46.00	-14.70	Peak	
3	375.3200	40.98	-9.78	31.20	46.00	-14.80	Peak	
4	500.4500	39.36	-7.15	32.21	46.00	-13.79	Peak	
5	624.6100	41.17	-4.77	36.40	46.00	-9.60	Peak	
6	749.7400	34.58	-2.00	32.58	46.00	-13.42	Peak	

Test Mode: TX B MODE CHANNEL 06

Horizontal

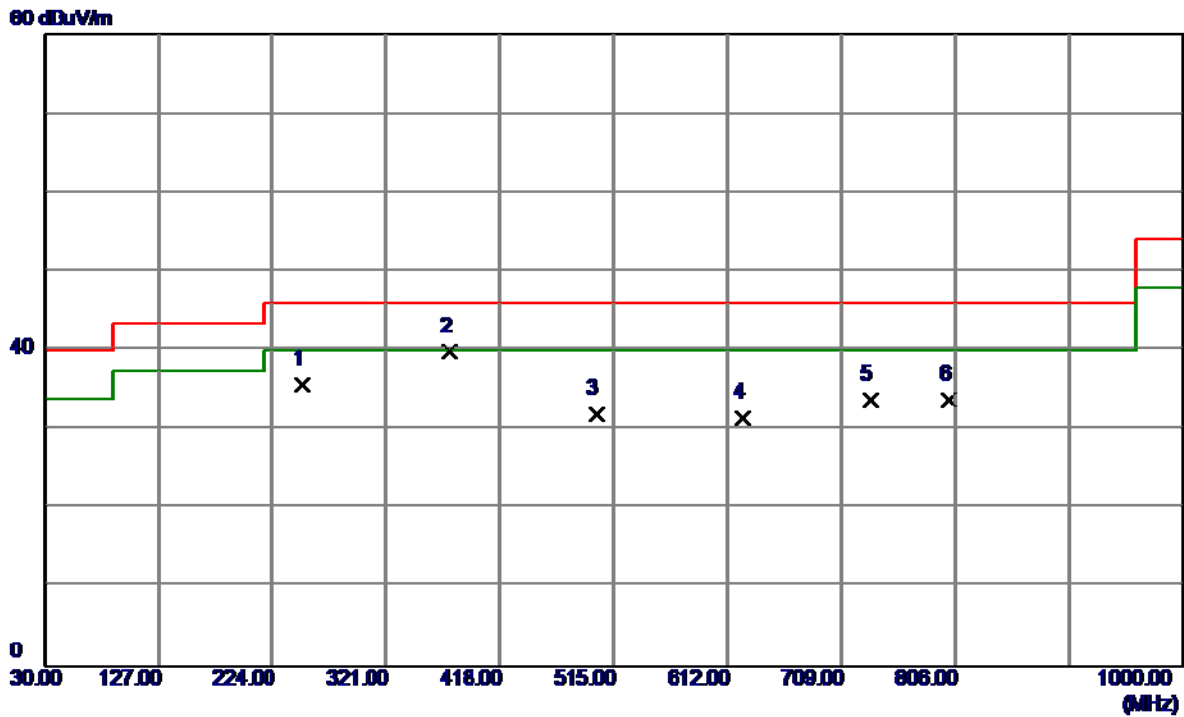

No.	Freq. MHz	Reading Level dBuV/m	Correct Factor dB	Measure ment dBuV/m	Limit dBuV/m	Margin dB	Detector	Comment
1	250.1900	49.03	-13.37	35.66	46.00	-10.34	Peak	
2	375.3200	49.56	-9.78	39.78	46.00	-6.22	Peak	
3	500.4500	39.17	-7.15	32.02	46.00	-13.98	Peak	
4	624.6100	36.23	-4.77	31.46	46.00	-14.54	Peak	
5	733.2500	36.39	-2.59	33.80	46.00	-12.20	Peak	
6	800.1800	35.45	-1.68	33.77	46.00	-12.23	Peak	

Test Mode: TX B MODE CHANNEL 11

Vertical

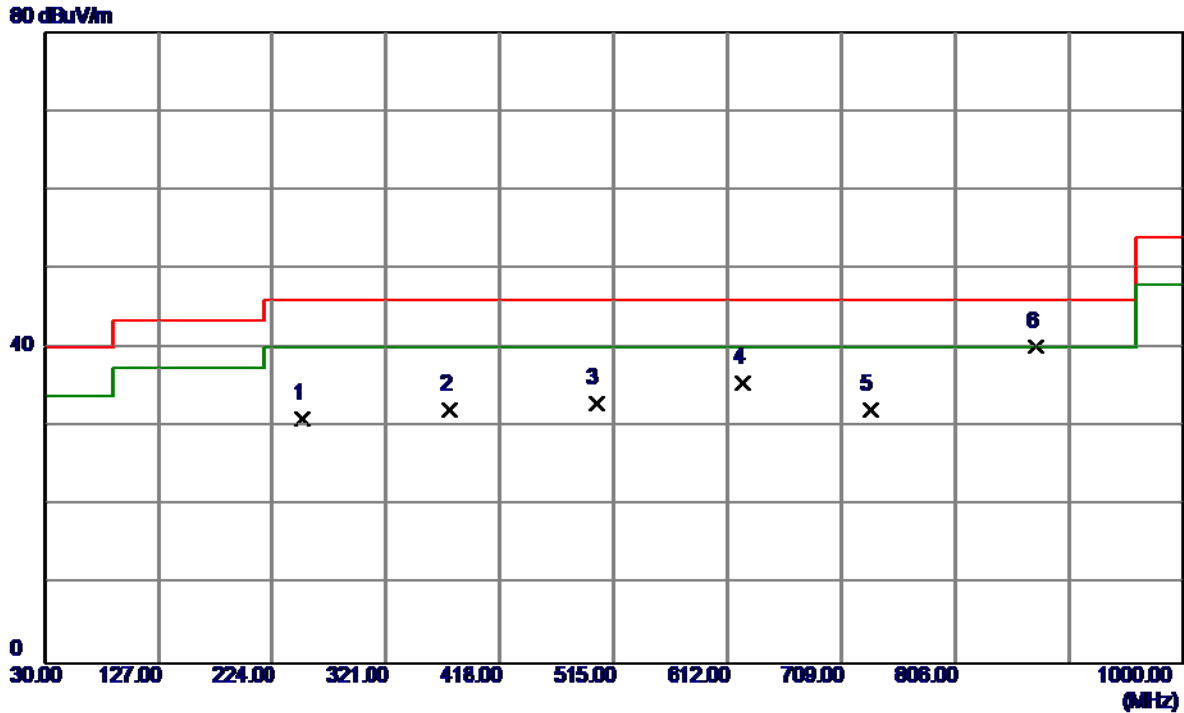

No.	Freq. MHz	Reading Level dBuV/m	Correct Factor dB	Measure ment dBuV/m	Limit dBuV/m	Margin dB	Detector	Comment
1	250.1900	44.43	-13.37	31.06	46.00	-14.94	Peak	
2	375.3200	41.88	-9.78	32.10	46.00	-13.90	Peak	
3	500.4500	40.05	-7.15	32.90	46.00	-13.10	Peak	
4	624.6100	40.27	-4.77	35.50	46.00	-10.50	Peak	
5	733.2500	34.73	-2.59	32.14	46.00	-13.86	Peak	
6	874.8700	40.35	-0.20	40.15	46.00	-5.85	Peak	

Test Mode: TX B MODE CHANNEL 11

Horizontal

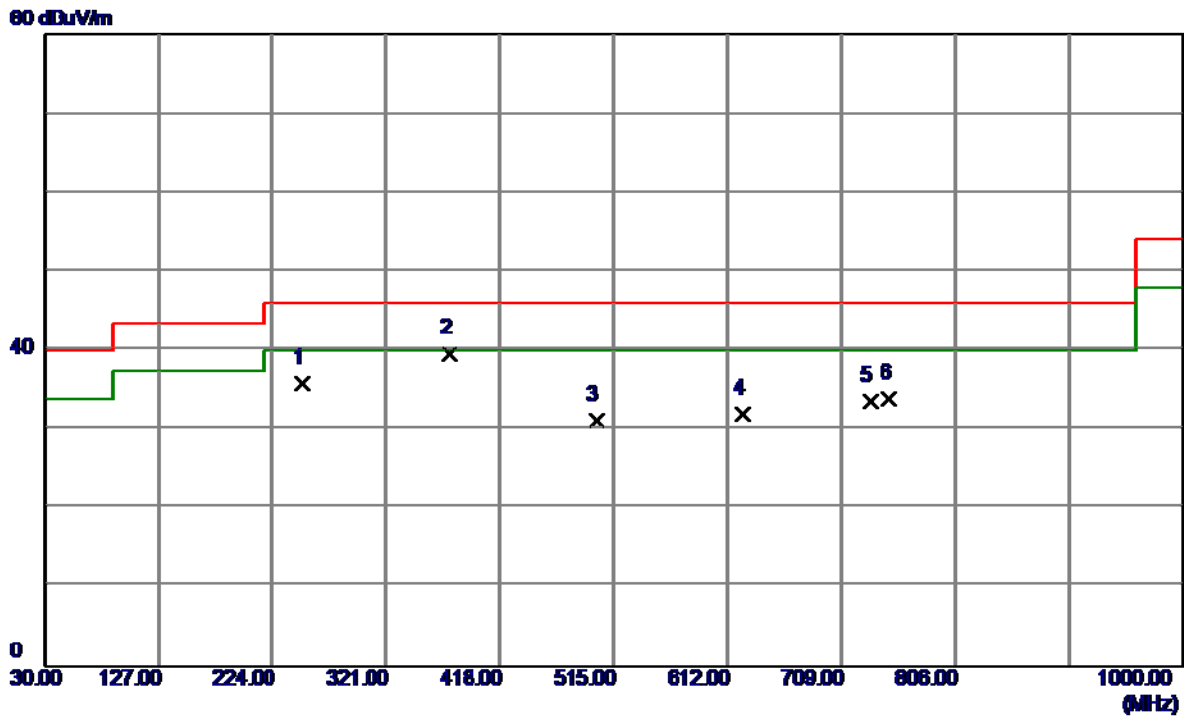

No.	Freq. MHz	Reading Level dBuV/m	Correct Factor dB	Measure ment dBuV/m	Limit dBuV/m	Margin dB	Detector	Comment
1	250.1900	49.25	-13.37	35.88	46.00	-10.12	Peak	
2	375.3200	49.38	-9.78	39.60	46.00	-6.40	Peak	
3	500.4500	38.33	-7.15	31.18	46.00	-14.82	Peak	
4	624.6100	36.82	-4.77	32.05	46.00	-13.95	Peak	
5	733.2500	36.22	-2.59	33.63	46.00	-12.37	Peak	
6	749.7400	35.98	-2.00	33.98	46.00	-12.02	Peak	

ATTACHMENT D - RADIATED EMISSION (ABOVE 1000MHZ)

Orthogonal Axis :	X
Test Mode :	TX B MODE 2412MHz

Vertical

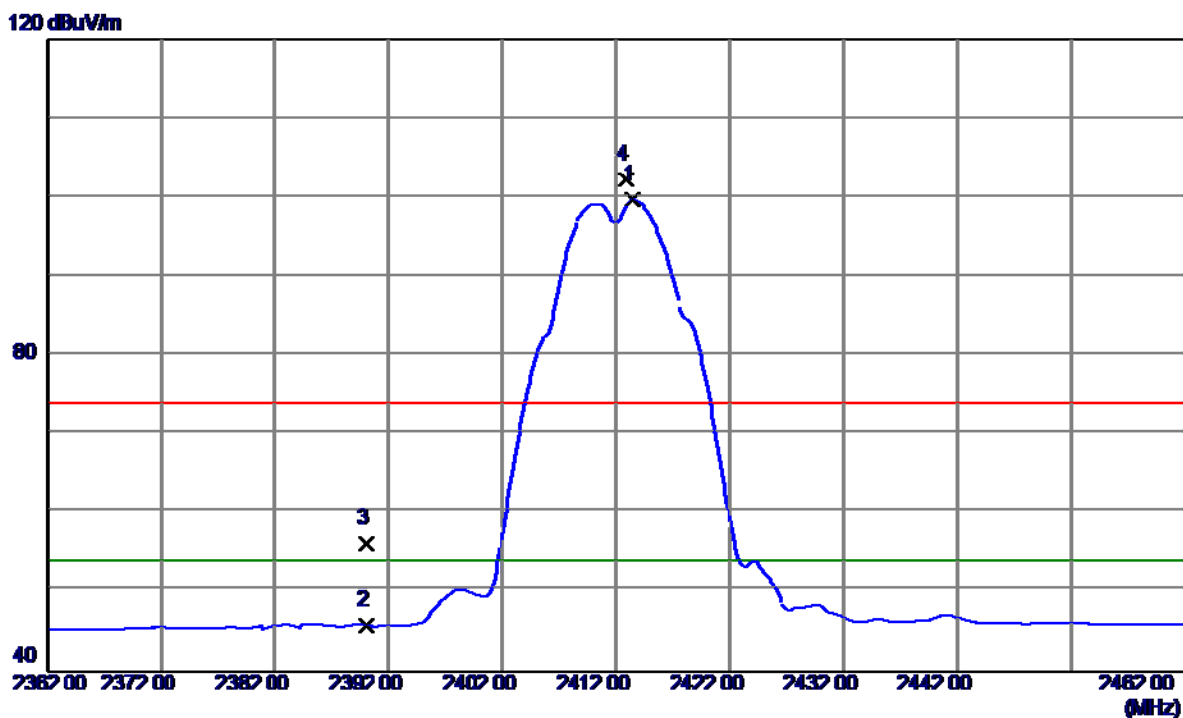

No.	Freq. MHz	Reading Level dBuV/m	Correct Factor dB	Measure ment dBuV/m	Limit dBuV/m	Margin dB	Detector	Comment
1	2413.4000	66.92	32.71	99.63	54.00	45.63	AVG	No Limit
2	2390.0000	13.11	32.68	45.79	54.00	-8.21	AVG	
3	2390.0000	23.43	32.68	56.11	74.00	-17.89	Peak	
4	2412.9000	69.55	32.71	102.26	74.00	28.26	Peak	No Limit

Orthogonal Axis :	X
Test Mode :	TX B MODE 2412MHz

Vertical

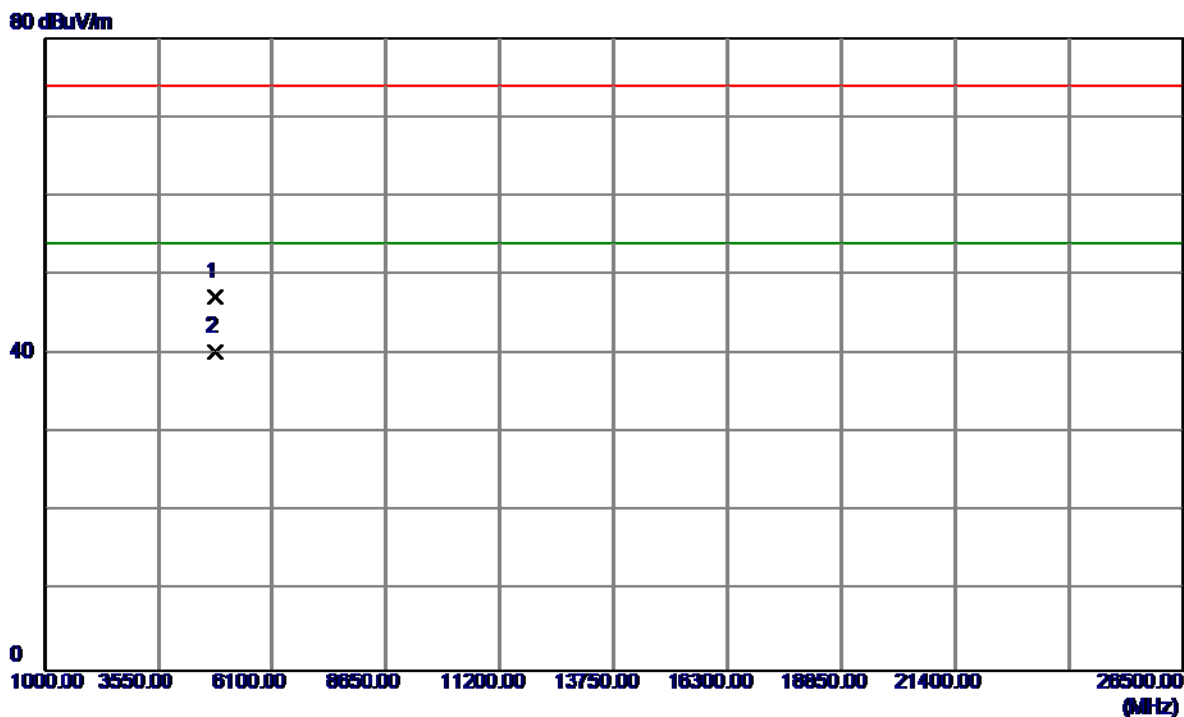

No.	Freq. MHz	Reading Level dBuV/m	Correct Factor dB	Measure ment dBuV/m	Limit dBuV/m	Margin dB	Detector	Comment
1	4823.2300	44.26	3.00	47.26	74.00	-26.74	Peak	
2	4823.8730	37.26	3.00	40.26	54.00	-13.74	AVG	

Orthogonal Axis :	X
Test Mode :	TX B MODE 2412MHz

Horizontal

120 dBuV/m

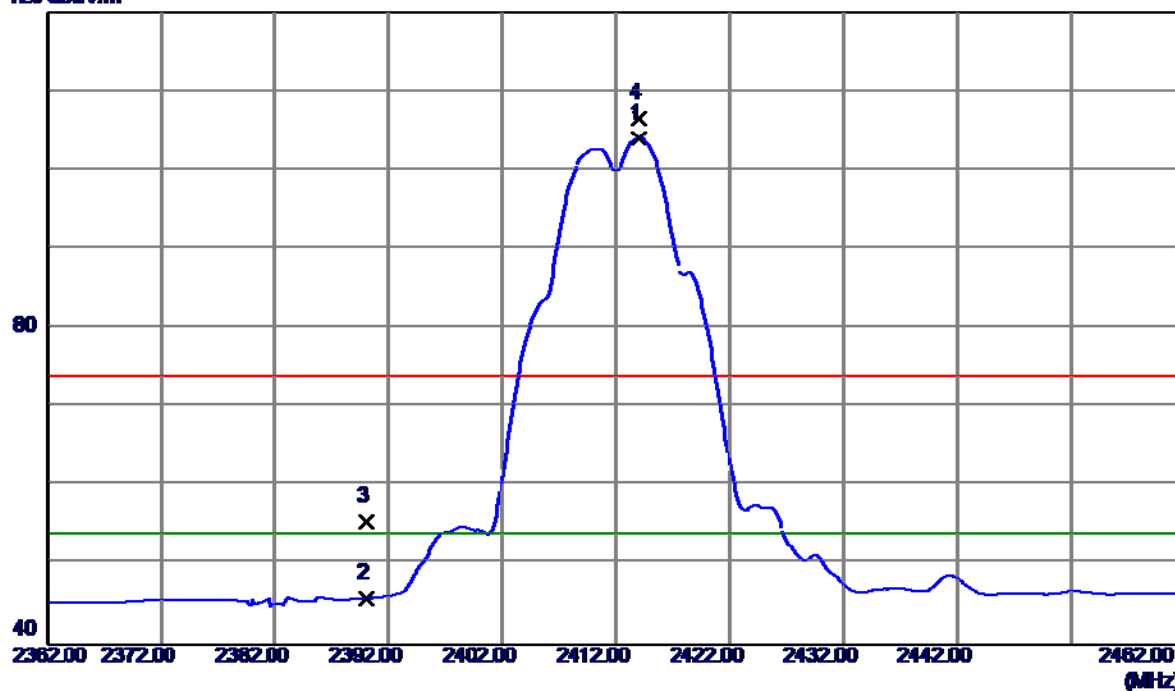

No.	Freq. MHz	Reading Level dBuV/m	Correct Factor dB	Measure ment dBuV/m	Limit dBuV/m	Margin dB	Detector	Comment
1	2414.0000	71.28	32.71	103.99	54.00	49.99	AVG	No Limit
2	2390.0000	13.12	32.68	45.80	54.00	-8.20	AVG	
3	2390.0000	22.84	32.68	55.52	74.00	-18.48	Peak	
4	2414.0000	73.92	32.71	106.63	74.00	32.63	Peak	No Limit

Orthogonal Axis :	X
Test Mode :	TX B MODE 2412MHz

Horizontal

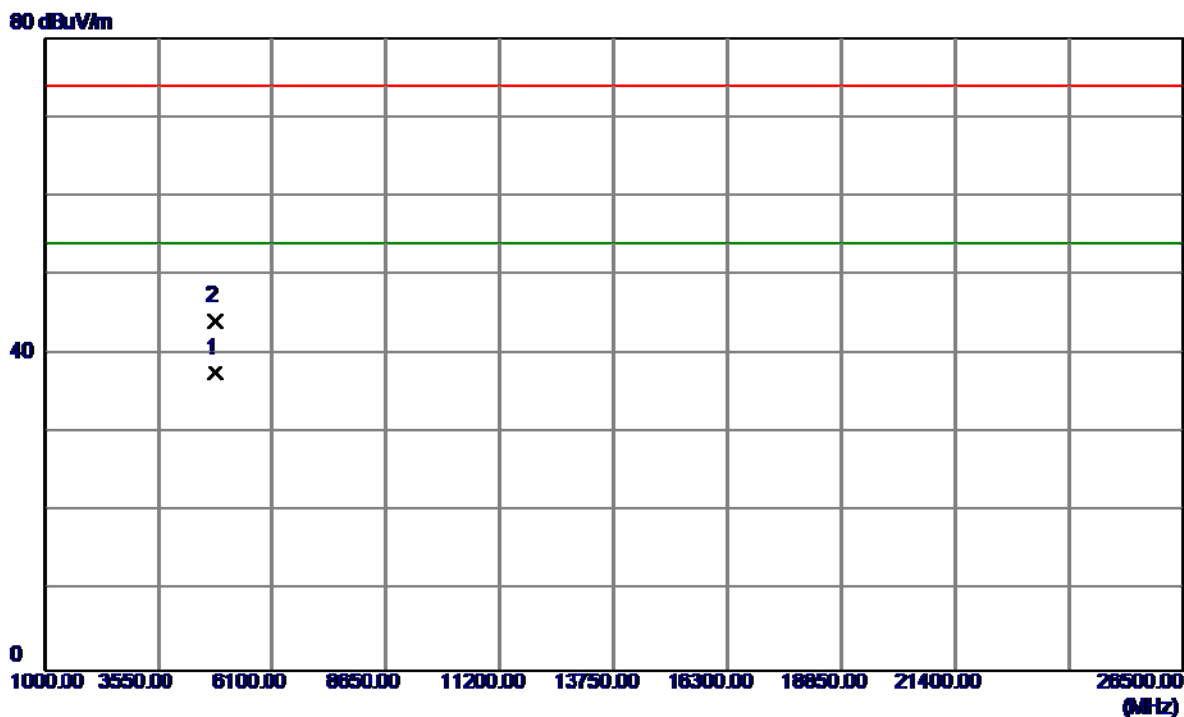

No.	Freq. MHz	Reading Level dBuV/m	Correct Factor dB	Measure ment dBuV/m	Limit dBuV/m	Margin dB	Detector	Comment
1	4823.9600	34.59	3.00	37.59	54.00	-16.41	AVG	
2	4824.0000	41.20	3.00	44.20	74.00	-29.80	Peak	

Orthogonal Axis :	X
Test Mode :	TX B MODE 2437MHz

Vertical

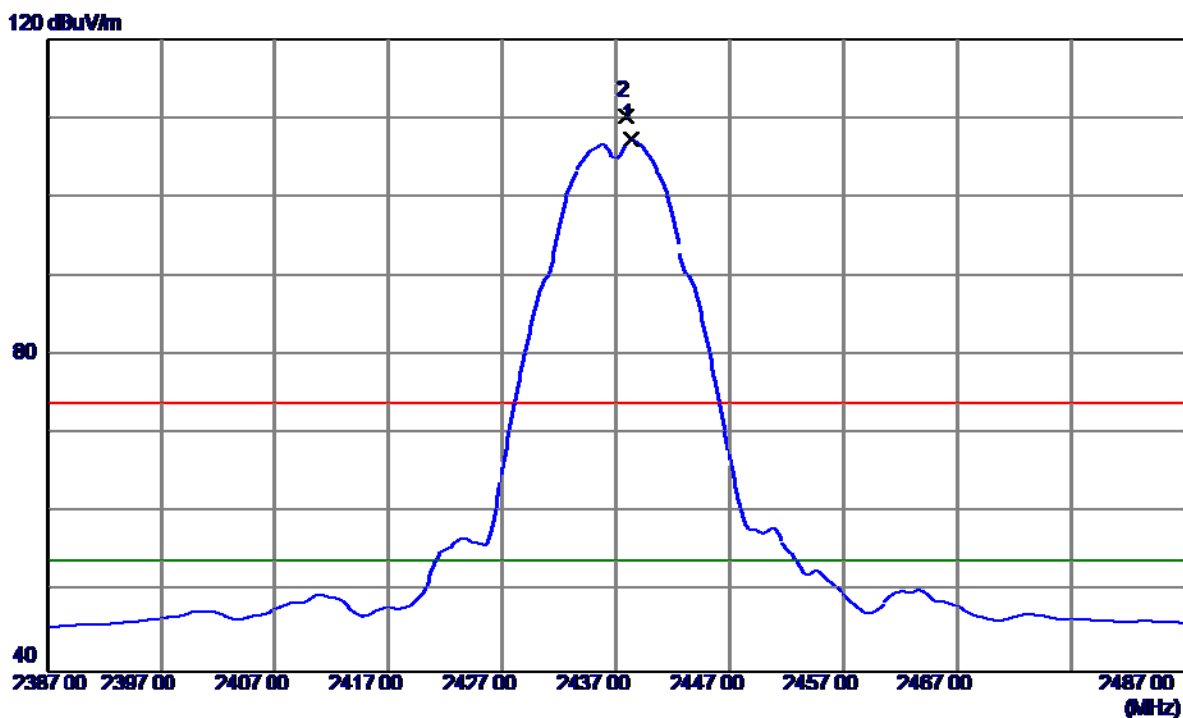

No.	Freq. MHz	Reading Level dBuV/m	Correct Factor dB	Measure ment dBuV/m	Limit dBuV/m	Margin dB	Detector	Comment
1	2438.3000	74.56	32.74	107.30	54.00	53.30	AVG	No Limit
2	2437.9000	77.48	32.74	110.22	74.00	36.22	Peak	No Limit

Orthogonal Axis :	X
Test Mode :	TX B MODE 2437MHz

Vertical

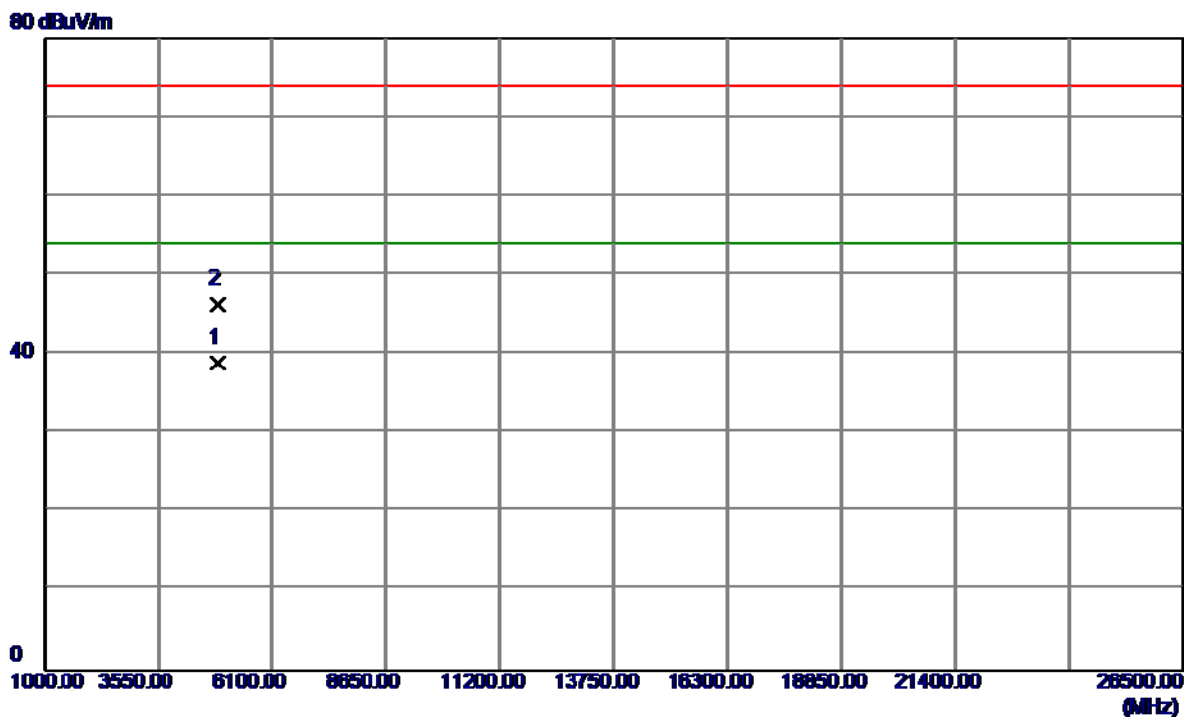

No.	Freq. MHz	Reading Level dBuV/m	Correct Factor dB	Measure ment dBuV/m	Limit dBuV/m	Margin dB	Detector	Comment
1	4873.9200	35.78	3.03	38.81	54.00	-15.19	AVG	
2	4873.9600	43.16	3.03	46.19	74.00	-27.81	Peak	

Orthogonal Axis :	X
Test Mode :	TX B MODE 2437MHz

Horizontal

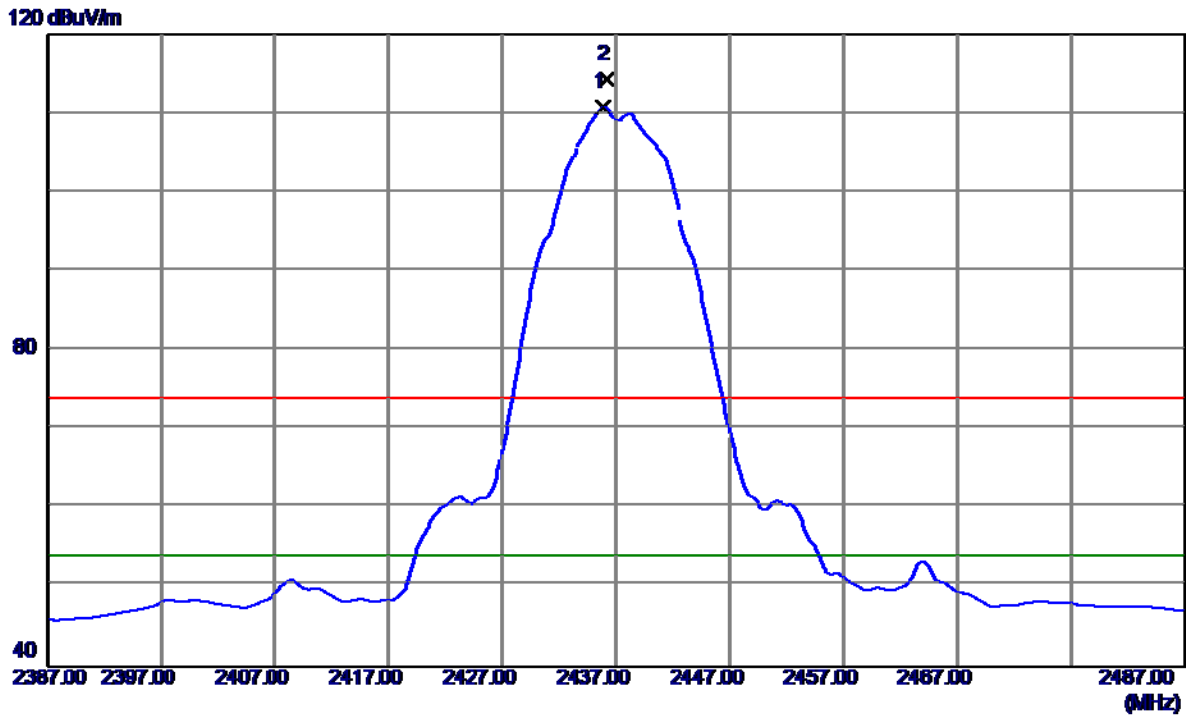

No.	Freq. MHz	Reading Level dBuV/m	Correct Factor dB	Measure ment dBuV/m	Limit dBuV/m	Margin dB	Detector	Comment
1	2435.9000	78.05	32.74	110.79	54.00	56.79	AVG	No Limit
2	2436.2000	81.45	32.74	114.19	74.00	40.19	Peak	No Limit

Orthogonal Axis :	X
Test Mode :	TX B MODE 2437MHz

Horizontal

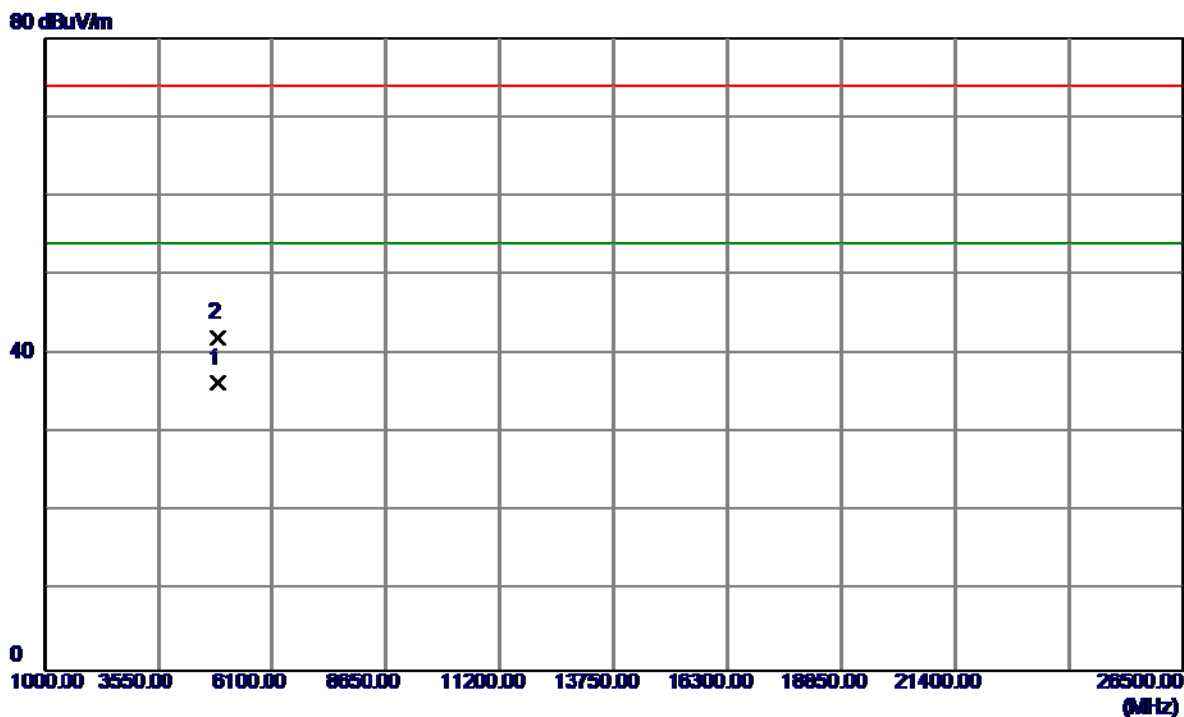

No.	Freq. MHz	Reading Level dBuV/m	Correct Factor dB	Measure ment dBuV/m	Limit dBuV/m	Margin dB	Detector	Comment
1	4873.5900	33.32	3.03	36.35	54.00	-17.65	AVG	
2	4874.5250	39.02	3.03	42.06	74.00	-31.94	Peak	

Orthogonal Axis :	X
Test Mode :	TX B MODE 2462MHz

Vertical

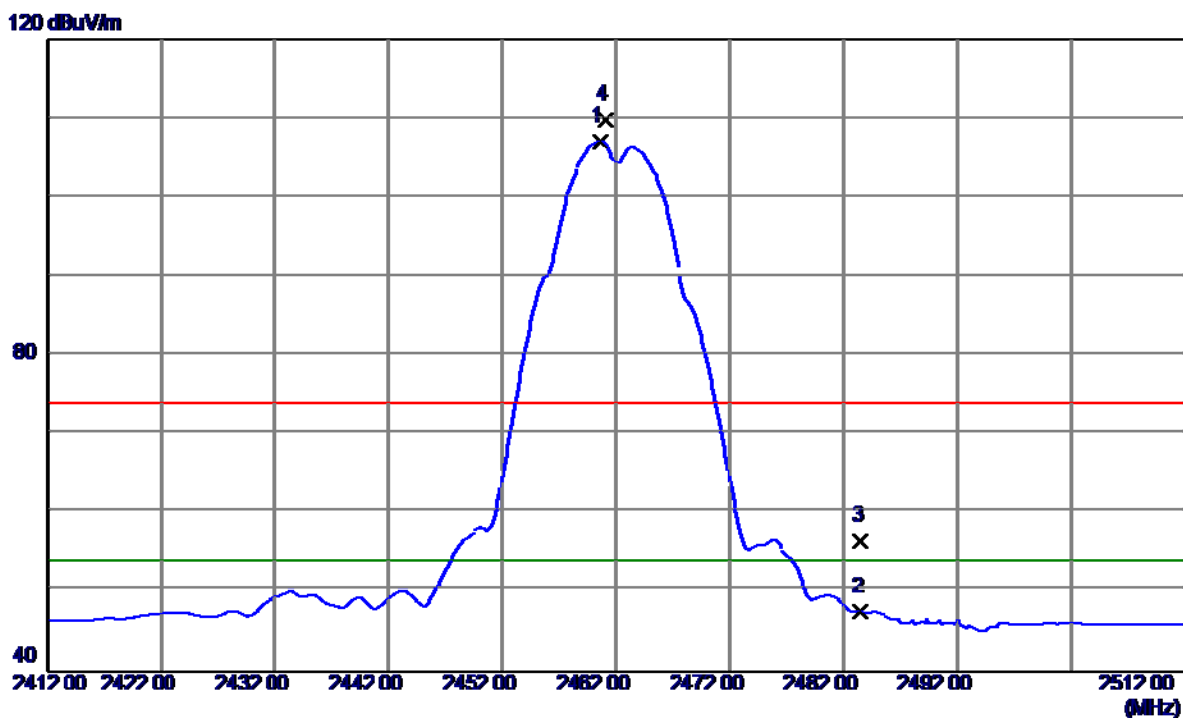

No.	Freq. MHz	Reading Level dBuV/m	Correct Factor dB	Measure ment dBuV/m	Limit dBuV/m	Margin dB	Detector	Comment
1	2460.7000	74.32	32.78	107.10	54.00	53.10	AVG	No Limit
2	2483.5000	14.67	32.81	47.48	54.00	-6.52	AVG	
3	2483.5000	23.70	32.81	56.51	74.00	-17.49	Peak	
4	2461.1000	77.03	32.78	109.81	74.00	35.81	Peak	No Limit

Orthogonal Axis :	X
Test Mode :	TX B MODE 2462MHz

Vertical

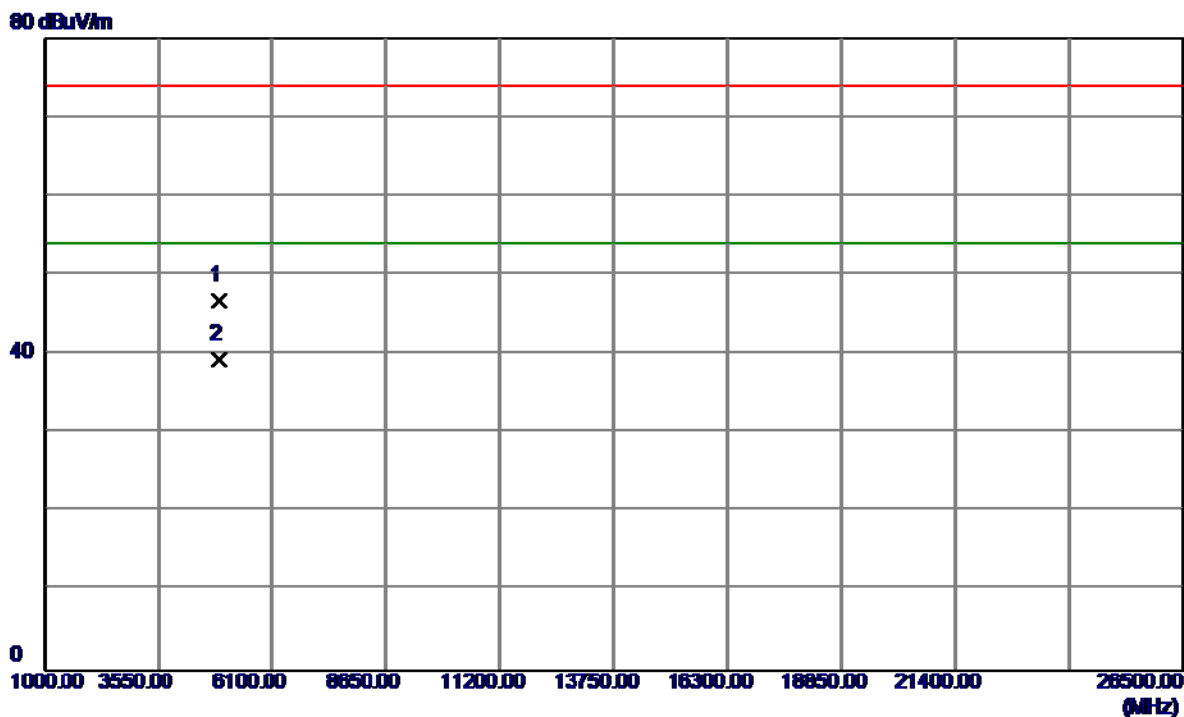

No.	Freq. MHz	Reading Level dBuV/m	Correct Factor dB	Measure ment dBuV/m	Limit dBuV/m	Margin dB	Detector	Comment
1	4923.4980	43.63	3.05	46.68	74.00	-27.32	Peak	
2	4923.9540	36.27	3.05	39.32	54.00	-14.68	AVG	

Orthogonal Axis :	X
Test Mode :	TX B MODE 2462MHz

Horizontal

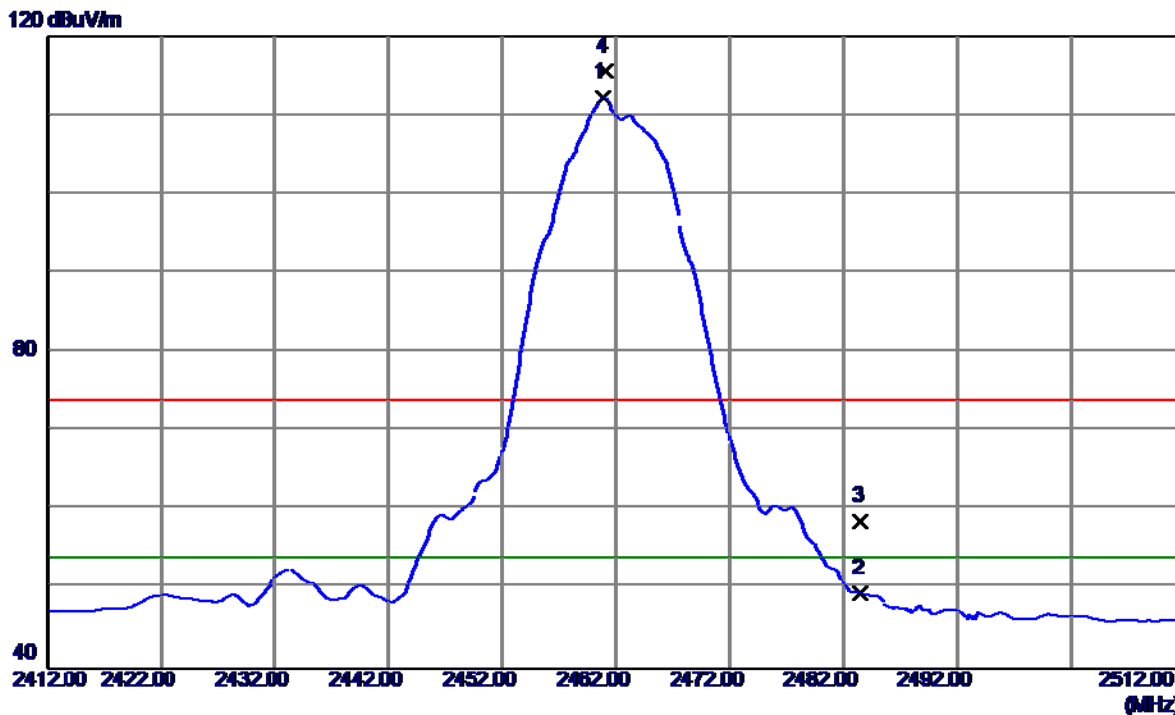

No.	Freq. MHz	Reading Level dBuV/m	Correct Factor dB	Measure ment dBuV/m	Limit dBuV/m	Margin dB	Detector	Comment
1	2460.9000	79.39	32.78	112.17	54.00	58.17	AVG	No Limit
2	2483.5000	16.59	32.81	49.40	54.00	-4.60	AVG	
3	2483.5000	25.81	32.81	58.62	74.00	-15.38	Peak	
4	2461.1000	82.69	32.78	115.47	74.00	41.47	Peak	No Limit

Orthogonal Axis :	X
Test Mode :	TX B MODE 2462MHz

Horizontal

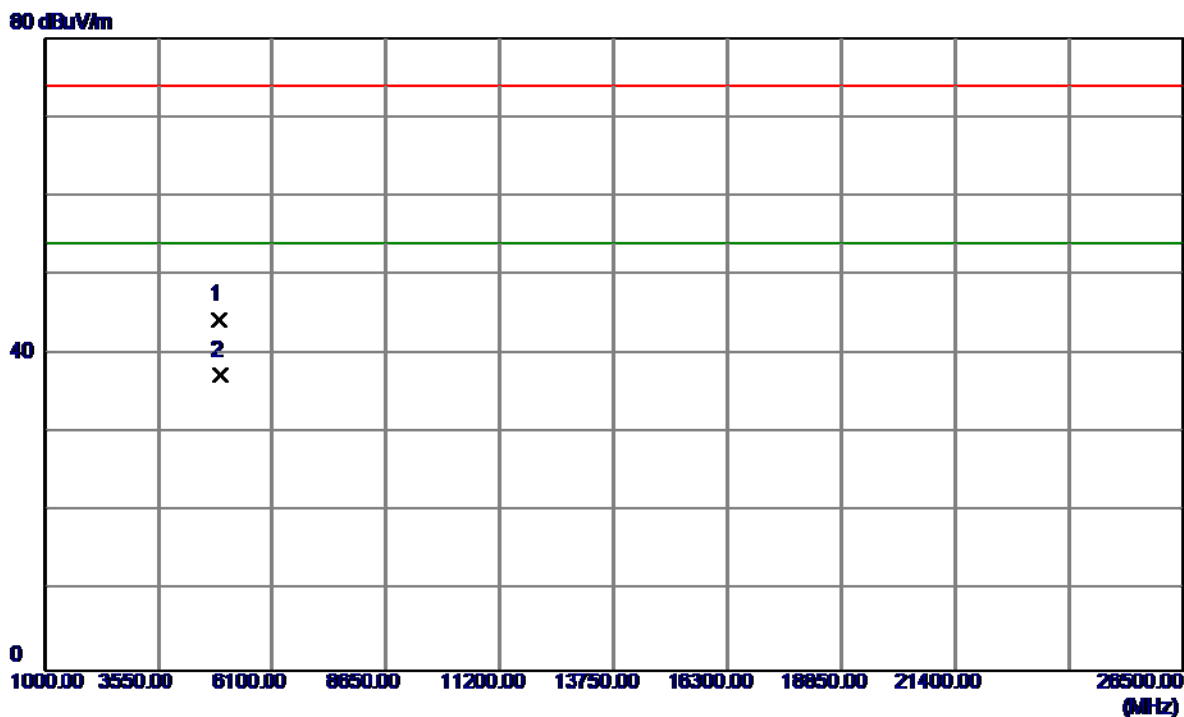

No.	Freq. MHz	Reading Level dBuV/m	Correct Factor dB	Measure ment dBuV/m	Limit dBuV/m	Margin dB	Detector	Comment
1	4923.5000	41.27	3.05	44.32	74.00	-29.68	Peak	
2	4924.5000	34.18	3.05	37.23	54.00	-16.77	AVG	

Orthogonal Axis :	X
Test Mode :	TX G MODE 2412MHz

Vertical

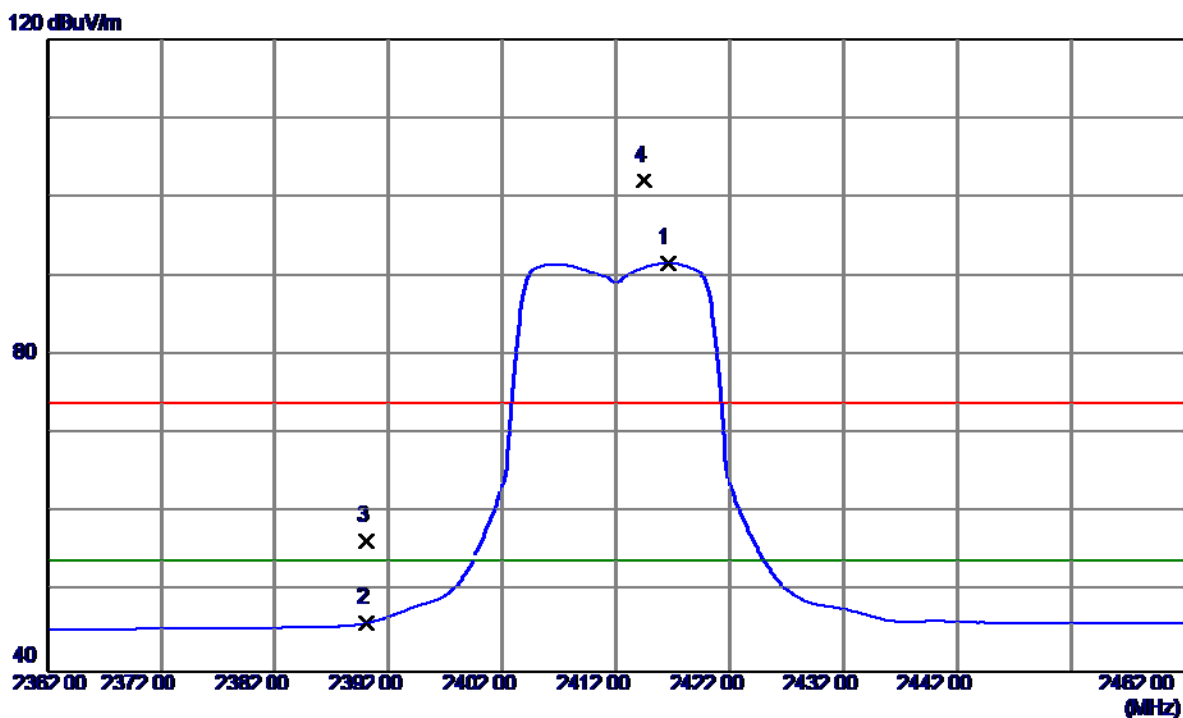

No.	Freq. MHz	Reading Level dBuV/m	Correct Factor dB	Measure ment dBuV/m	Limit dBuV/m	Margin dB	Detector	Comment
1	2416.5000	59.00	32.71	91.71	54.00	37.71	AVG	No Limit
2	2390.0000	13.40	32.68	46.08	54.00	-7.92	AVG	
3	2390.0000	23.78	32.68	56.46	74.00	-17.54	Peak	
4	2414.4000	69.43	32.71	102.14	74.00	28.14	Peak	No Limit

Orthogonal Axis :	X
Test Mode :	TX G MODE 2412MHz

Vertical

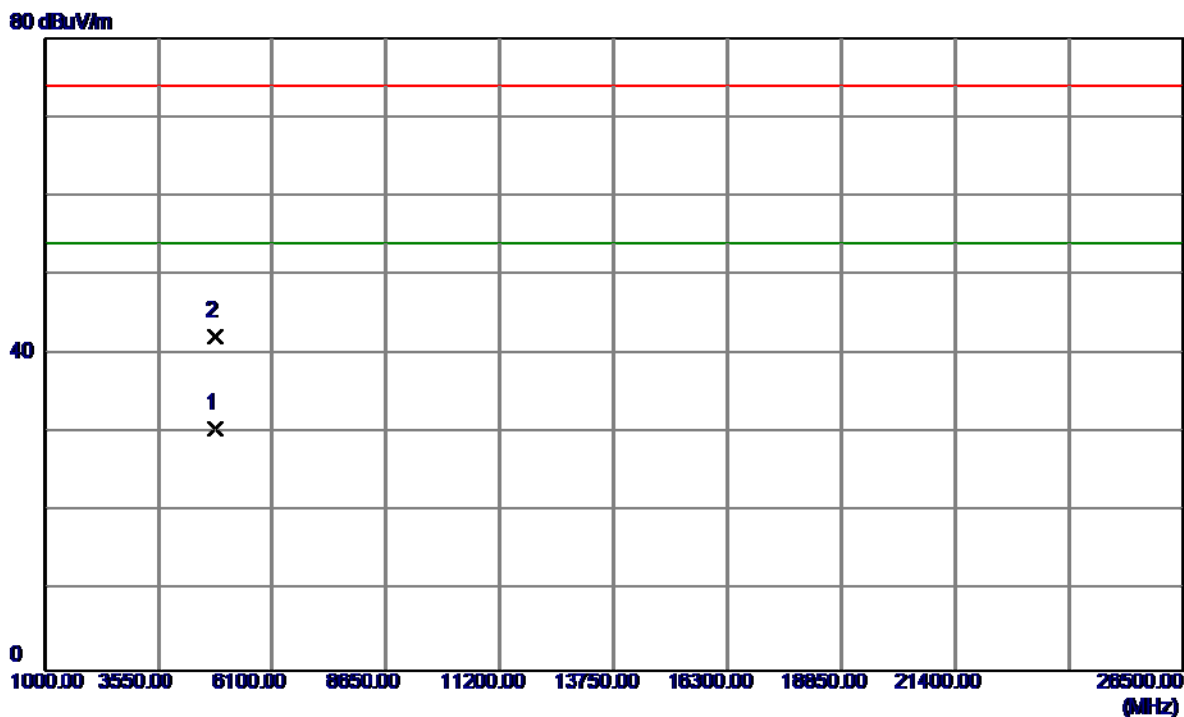

No.	Freq. MHz	Reading Level dBuV/m	Correct Factor dB	Measure ment dBuV/m	Limit dBuV/m	Margin dB	Detector	Comment
1	4823.9600	27.50	3.00	30.50	54.00	-23.50	AVG	
2	4823.9200	39.24	3.00	42.24	74.00	-31.76	Peak	

Orthogonal Axis :	X
Test Mode :	TX G MODE 2412MHz

Horizontal

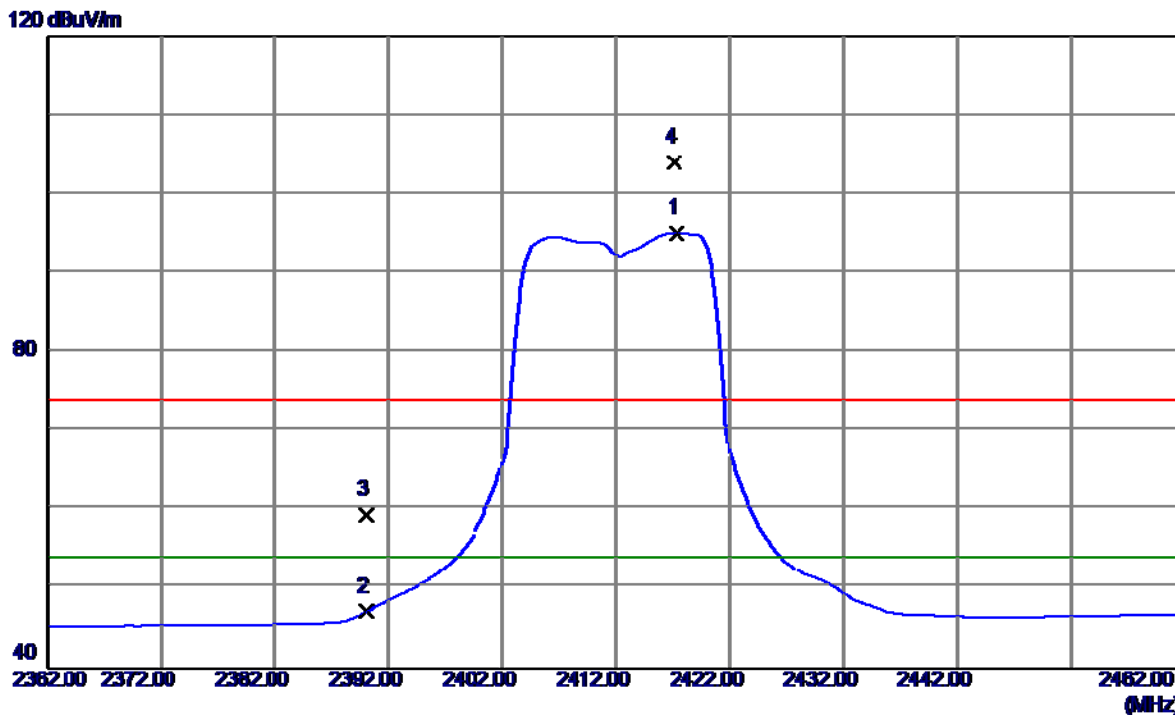

No.	Freq. MHz	Reading Level dBuV/m	Correct Factor dB	Measure ment dBuV/m	Limit dBuV/m	Margin dB	Detector	Comment
1	2417.3000	62.37	32.72	95.09	54.00	41.09	AVG	No Limit
2	2390.0000	14.44	32.68	47.12	54.00	-6.88	AVG	
3	2390.0000	26.64	32.68	59.32	74.00	-14.68	Peak	
4	2417.1000	71.23	32.72	103.95	74.00	29.95	Peak	No Limit

Orthogonal Axis :	X
Test Mode :	TX G MODE 2412MHz

Horizontal

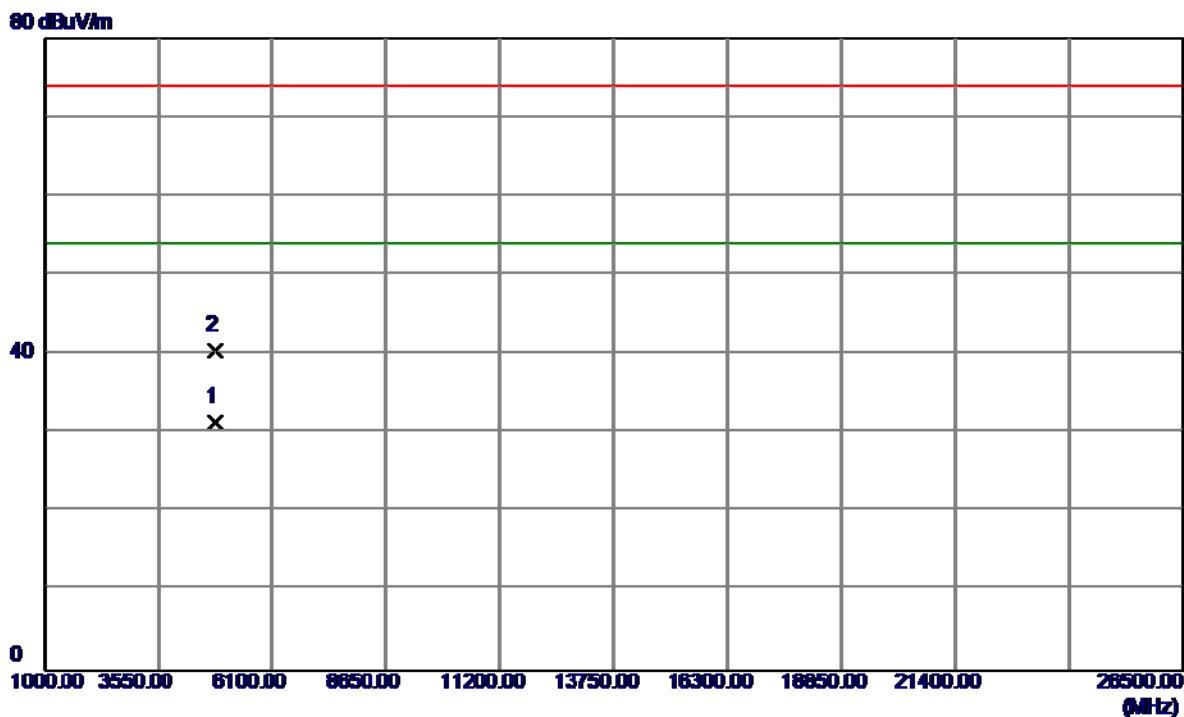

No.	Freq. MHz	Reading Level dBuV/m	Correct Factor dB	Measure ment dBuV/m	Limit dBuV/m	Margin dB	Detector	Comment
1	4823.9600	28.37	3.00	31.37	54.00	-22.63	AVG	
2	4824.0000	37.51	3.00	40.51	74.00	-33.49	Peak	

Orthogonal Axis :	X
Test Mode :	TX G MODE 2437MHz

Vertical

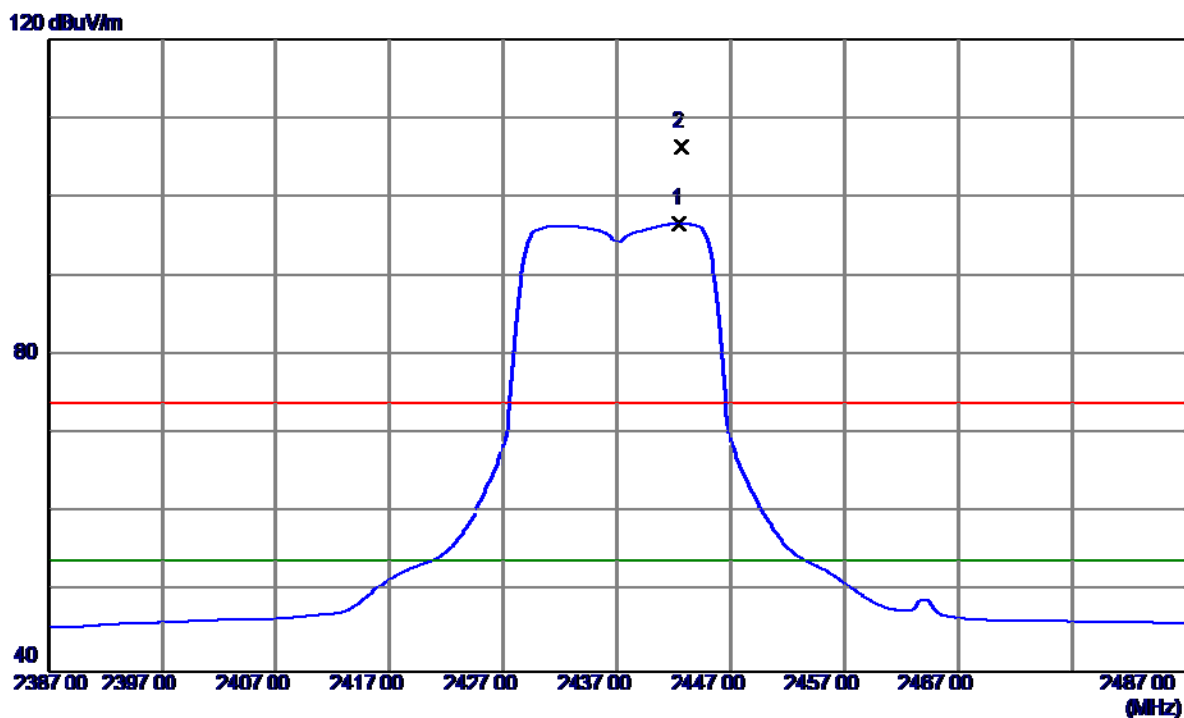

No.	Freq. MHz	Reading Level dBuV/m	Correct Factor dB	Measure ment dBuV/m	Limit dBuV/m	Margin dB	Detector	Comment
1	2442.5000	63.93	32.75	96.68	54.00	42.68	AVG	No Limit
2	2442.7000	73.69	32.75	106.44	74.00	32.44	Peak	No Limit

Orthogonal Axis :	X
Test Mode :	TX G MODE 2437MHz

Vertical

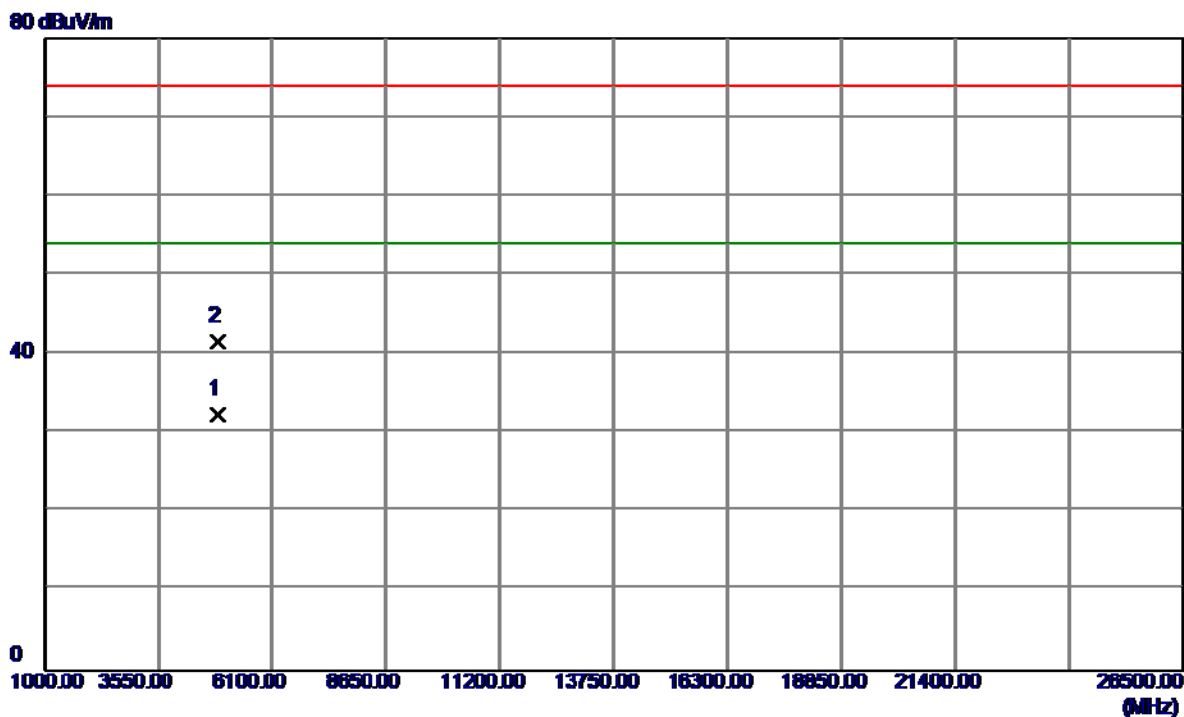

No.	Freq. MHz	Reading Level dBuV/m	Correct Factor dB	Measure ment dBuV/m	Limit dBuV/m	Margin dB	Detector	Comment
1	4874.1400	29.34	3.03	32.37	54.00	-21.63	AVG	
2	4873.1509	38.60	3.03	41.63	74.00	-32.37	Peak	

Orthogonal Axis :	X
Test Mode :	TX G MODE 2437MHz

Horizontal

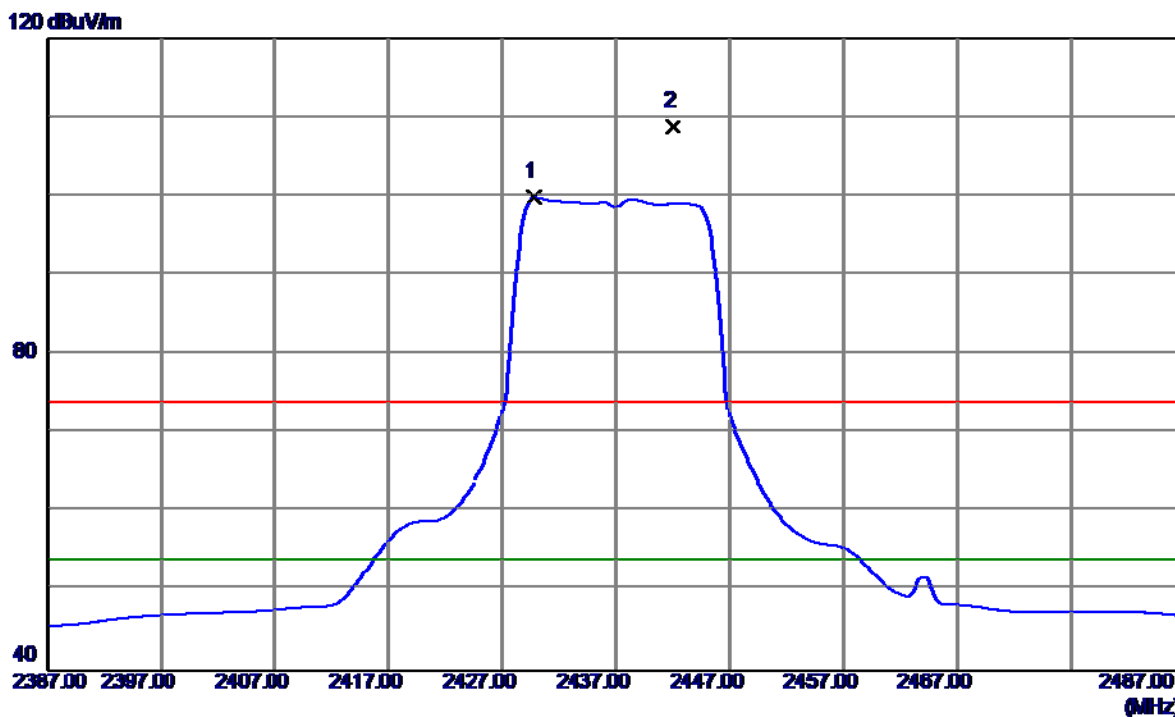

No.	Freq. MHz	Reading Level dBuV/m	Correct Factor dB	Measure ment dBuV/m	Limit dBuV/m	Margin dB	Detector	Comment
1	2429.8000	67.04	32.73	99.77	54.00	45.77	AVG	No Limit
2	2442.0000	76.07	32.75	108.82	74.00	34.82	Peak	No Limit

Orthogonal Axis :	X
Test Mode :	TX G MODE 2437MHz

Horizontal

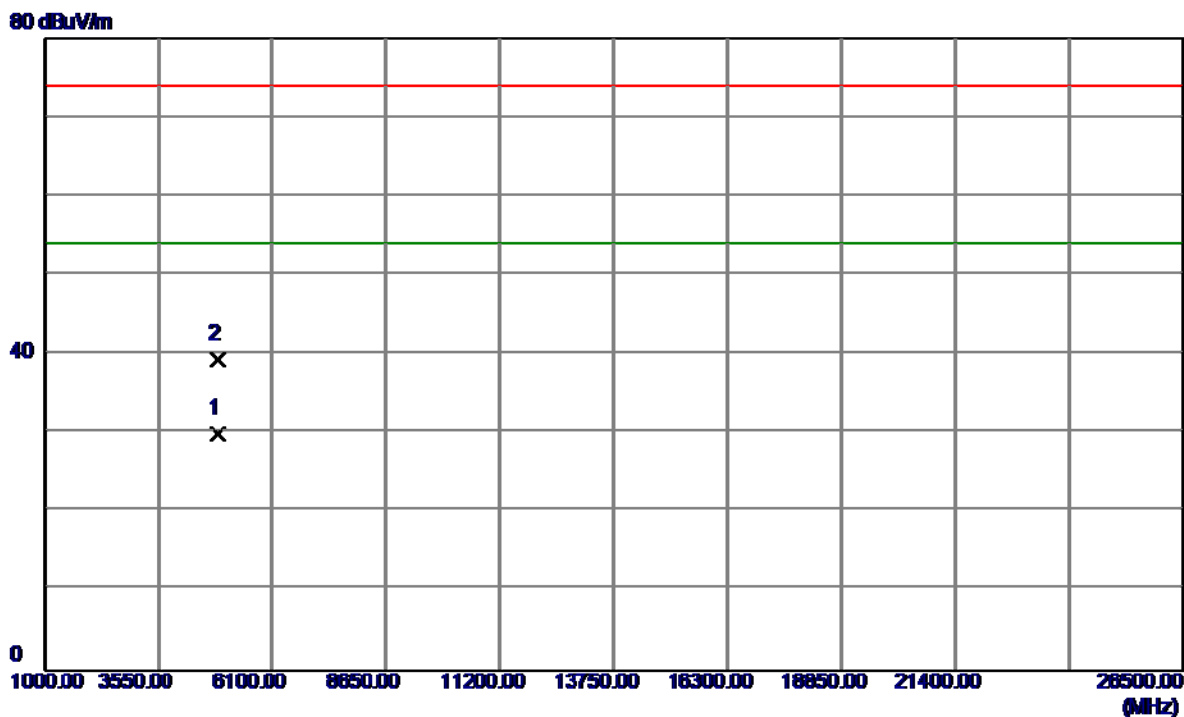

No.	Freq. MHz	Reading Level dBuV/m	Correct Factor dB	Measure ment dBuV/m	Limit dBuV/m	Margin dB	Detector	Comment
1	4873.2660	26.93	3.03	29.96	54.00	-24.04	AVG	
2	4874.4370	36.39	3.03	39.42	74.00	-34.58	Peak	

Orthogonal Axis :	X
Test Mode :	TX G MODE 2462MHz

Vertical

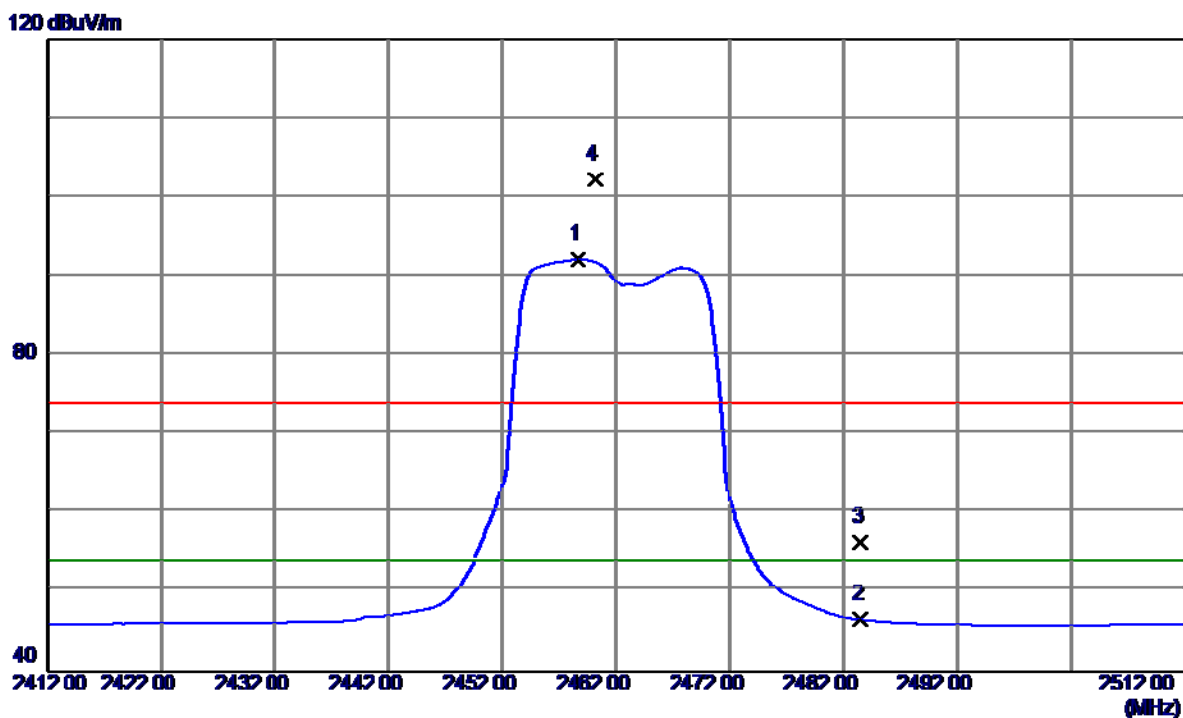

No.	Freq. MHz	Reading Level dBuV/m	Correct Factor dB	Measure ment dBuV/m	Limit dBuV/m	Margin dB	Detector	Comment
1	2458.7000	59.40	32.77	92.17	54.00	38.17	AVG	No Limit
2	2483.5000	13.68	32.81	46.49	54.00	-7.51	AVG	
3	2483.5000	23.55	32.81	56.36	74.00	-17.64	Peak	
4	2460.2000	69.41	32.78	102.19	74.00	28.19	Peak	No Limit

Orthogonal Axis :	X
Test Mode :	TX G MODE 2462MHz

Vertical

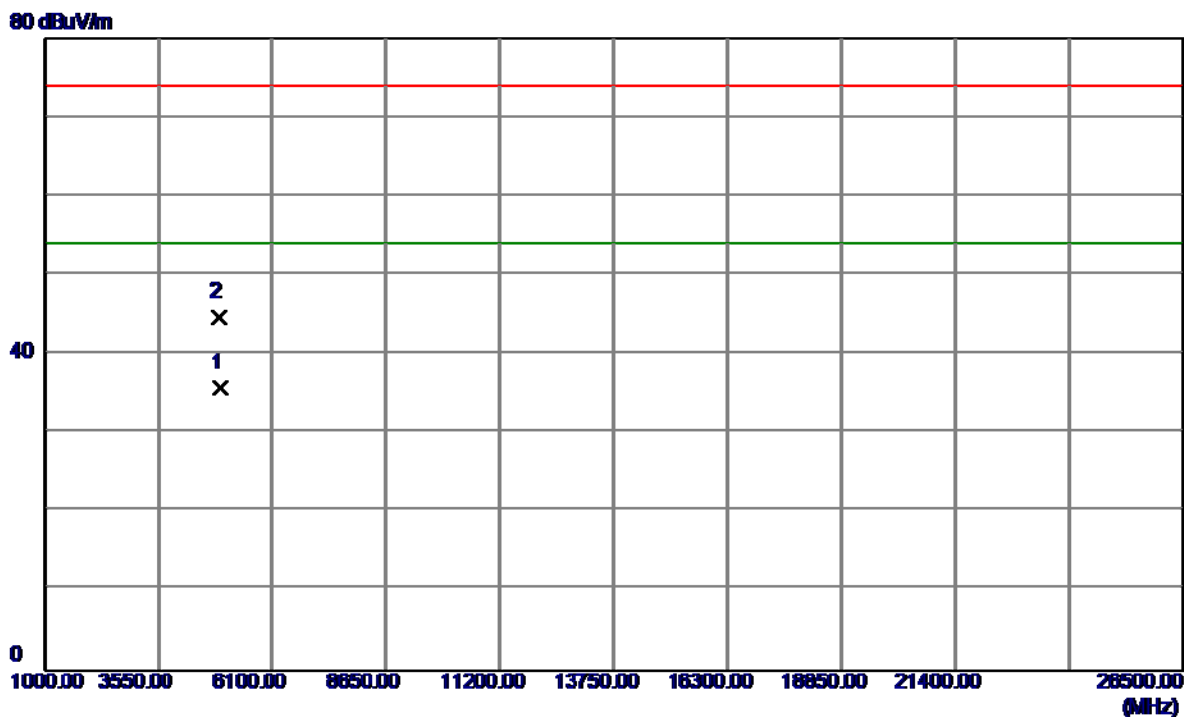

No.	Freq. MHz	Reading Level dBuV/m	Correct Factor dB	Measure ment dBuV/m	Limit dBuV/m	Margin dB	Detector	Comment
1	4924.5500	32.58	3.05	35.63	54.00	-18.37	AVG	
2	4923.8250	41.60	3.05	44.65	74.00	-29.35	Peak	

Orthogonal Axis :	X
Test Mode :	TX G MODE 2462MHz

Horizontal

120 dBuV/m

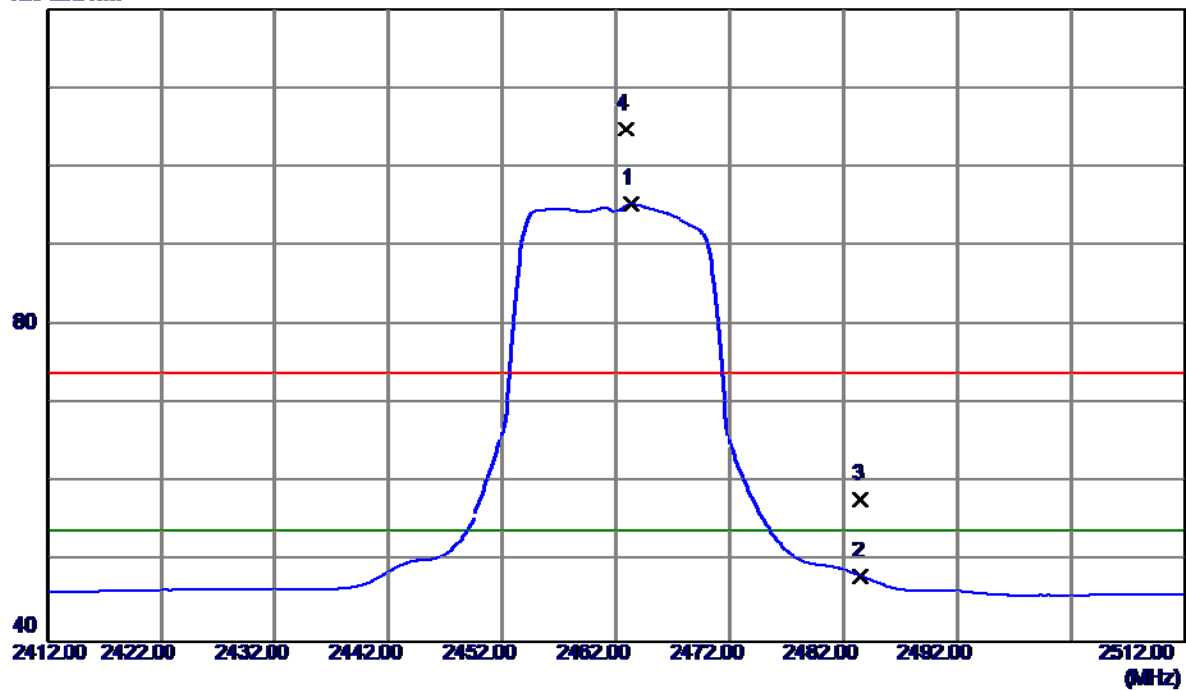

No.	Freq. MHz	Reading Level dBuV/m	Correct Factor dB	Measure ment dBuV/m	Limit dBuV/m	Margin dB	Detector	Comment
1	2463.3000	62.57	32.78	95.35	54.00	41.35	AVG	No Limit
2	2483.5000	15.39	32.81	48.20	54.00	-5.80	AVG	
3	2483.5000	25.06	32.81	57.87	74.00	-16.13	Peak	
4	2462.9000	72.02	32.78	104.80	74.00	30.80	Peak	No Limit

Orthogonal Axis :	X
Test Mode :	TX G MODE 2462MHz

Horizontal

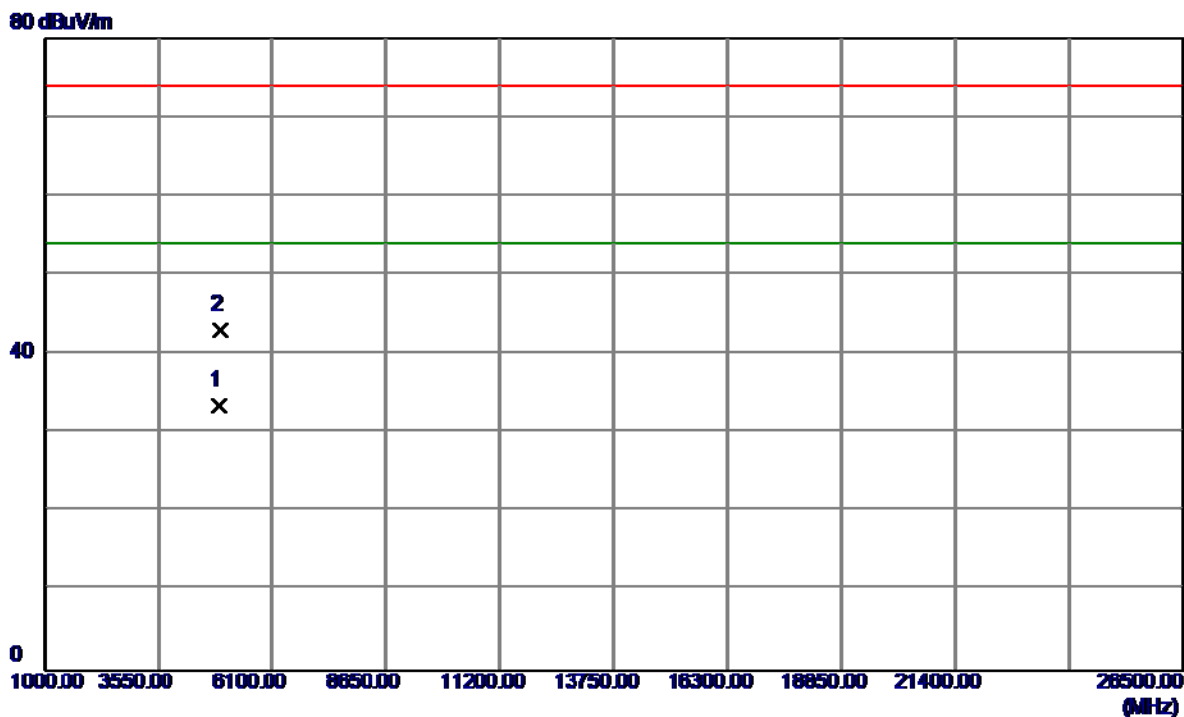

No.	Freq. MHz	Reading Level dBuV/m	Correct Factor dB	Measure ment dBuV/m	Limit dBuV/m	Margin dB	Detector	Comment
1	4923.5000	30.39	3.05	33.44	54.00	-20.56	AVG	
2	4924.5000	39.97	3.05	43.02	74.00	-30.98	Peak	

Orthogonal Axis :	X
Test Mode :	TX N-20M MODE 2412MHz

Vertical

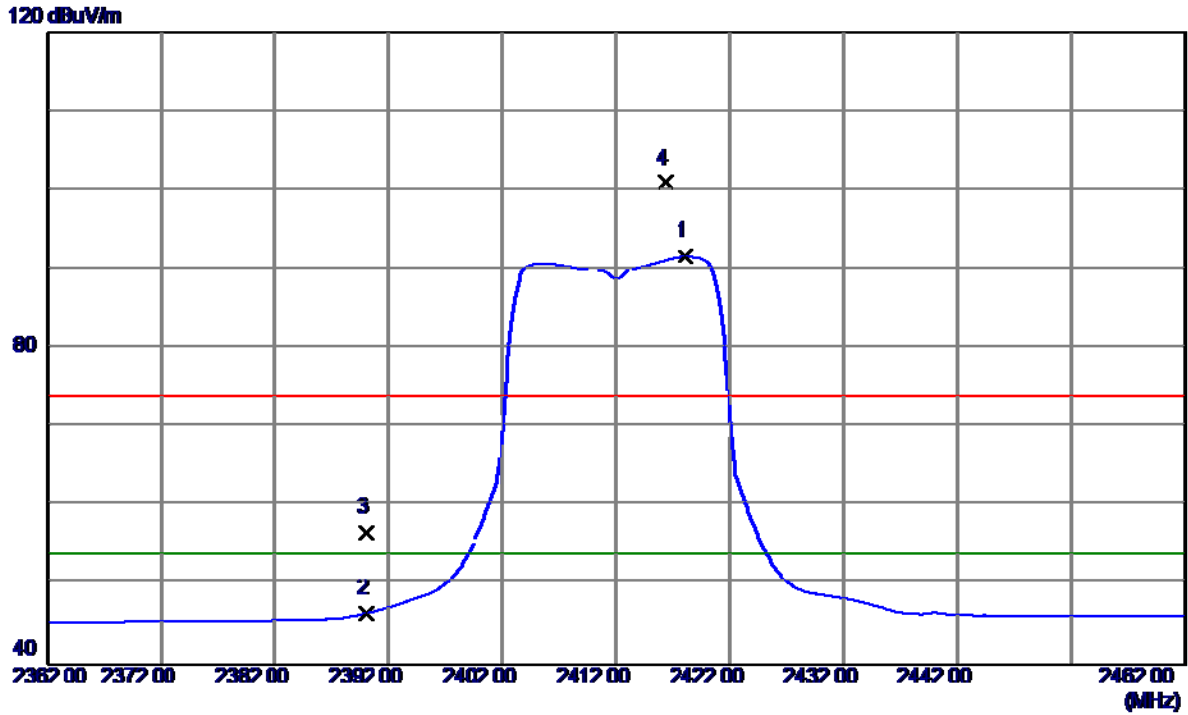

No.	Freq. MHz	Reading Level dBuV/m	Correct Factor dB	Measure ment dBuV/m	Limit dBuV/m	Margin dB	Detector	Comment
1	2418.1000	58.94	32.72	91.66	54.00	37.66	AVG	No Limit
2	2390.0000	13.74	32.68	46.42	54.00	-7.58	AVG	
3	2390.0000	23.93	32.68	56.61	74.00	-17.39	Peak	
4	2416.3000	68.17	32.71	100.88	74.00	26.88	Peak	No Limit

Orthogonal Axis :	X
Test Mode :	TX N-20M MODE 2412MHz

Vertical

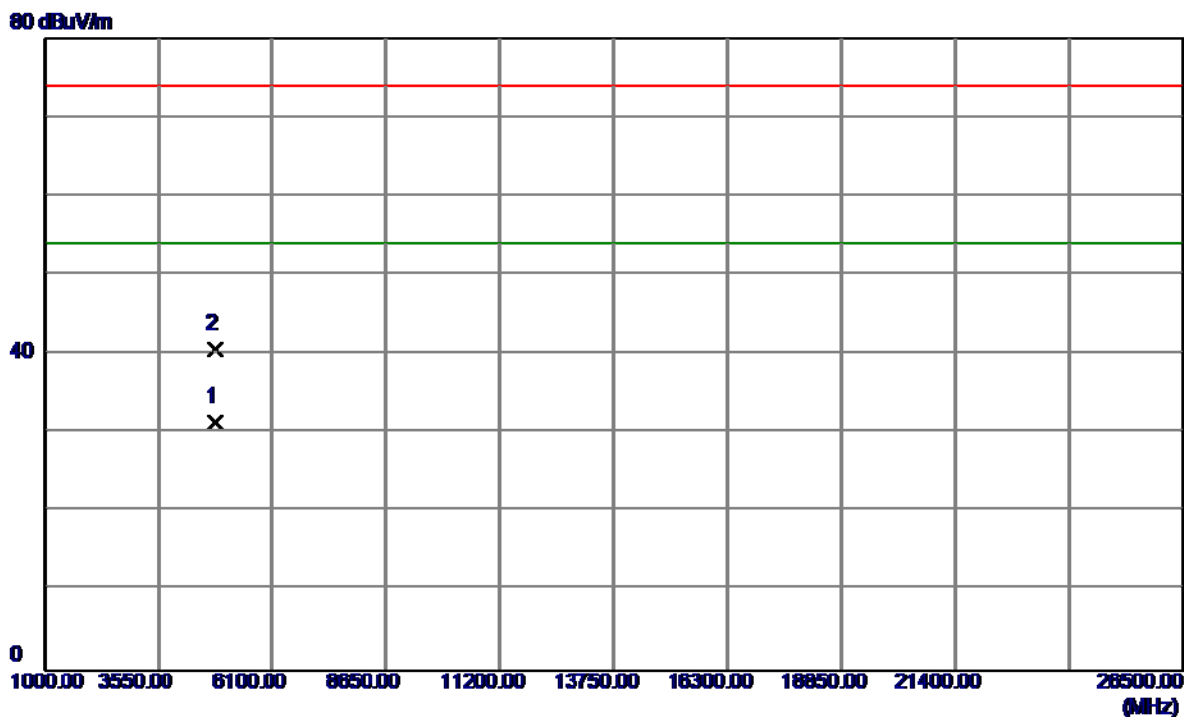

No.	Freq. MHz	Reading Level dBuV/m	Correct Factor dB	Measure ment dBuV/m	Limit dBuV/m	Margin dB	Detector	Comment
1	4823.8600	28.40	3.00	31.40	54.00	-22.60	AVG	
2	4824.1000	37.67	3.00	40.67	74.00	-33.33	Peak	

Orthogonal Axis :	X
Test Mode :	TX N-20M MODE 2412MHz

Horizontal

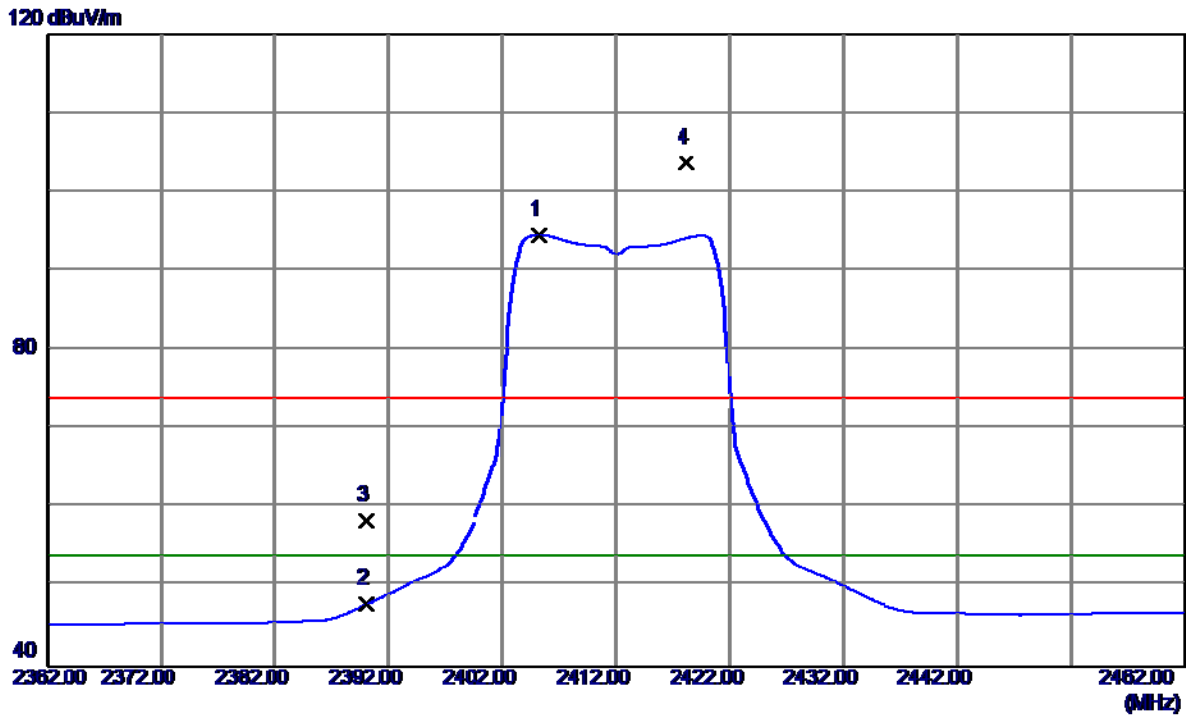

No.	Freq. MHz	Reading Level dBuV/m	Correct Factor dB	Measure ment dBuV/m	Limit dBuV/m	Margin dB	Detector	Comment
1	2405.2000	61.91	32.70	94.61	54.00	40.61	AVG	No Limit
2	2390.0000	15.13	32.68	47.81	54.00	-6.19	AVG	
3	2390.0000	25.74	32.68	58.42	74.00	-15.58	Peak	
4	2418.2000	70.93	32.72	103.65	74.00	29.65	Peak	No Limit

Orthogonal Axis :	X
Test Mode :	TX N-20M MODE 2412MHz

Horizontal

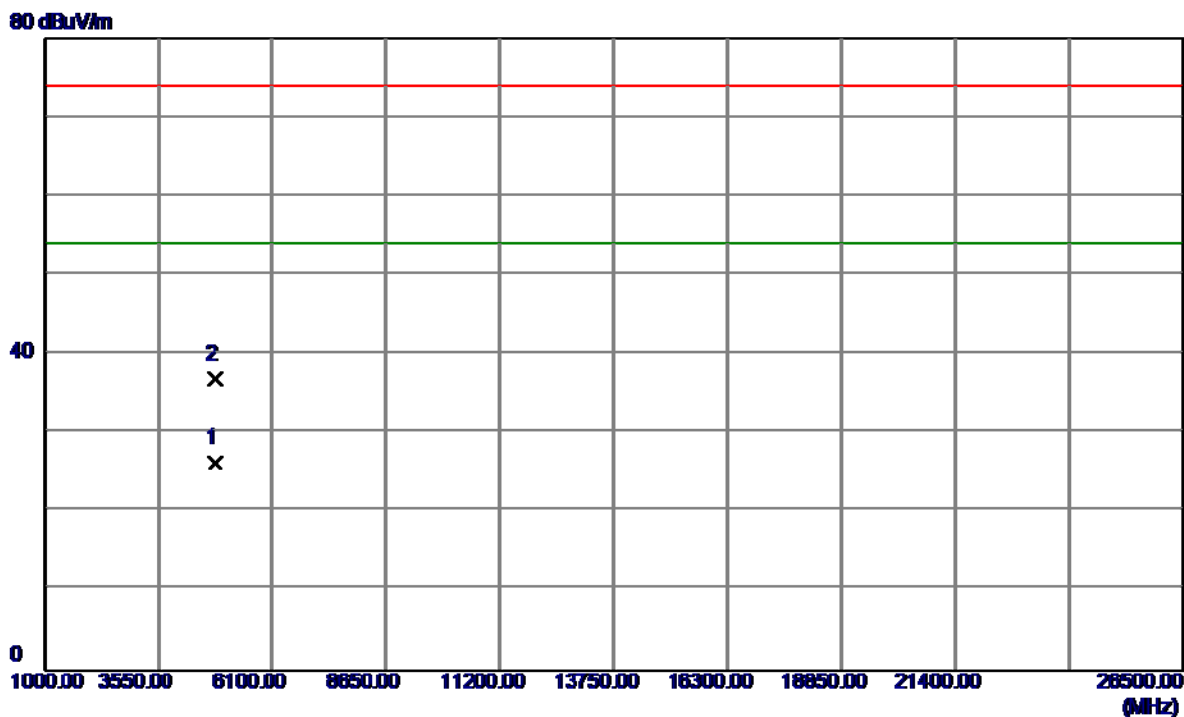

No.	Freq. MHz	Reading Level dBuV/m	Correct Factor dB	Measure ment dBuV/m	Limit dBuV/m	Margin dB	Detector	Comment
1	4823.5690	23.30	3.00	26.30	54.00	-27.70	AVG	
2	4823.9360	33.77	3.00	36.77	74.00	-37.23	Peak	

Orthogonal Axis :	X
Test Mode :	TX N-20M MODE 2437MHz

Vertical

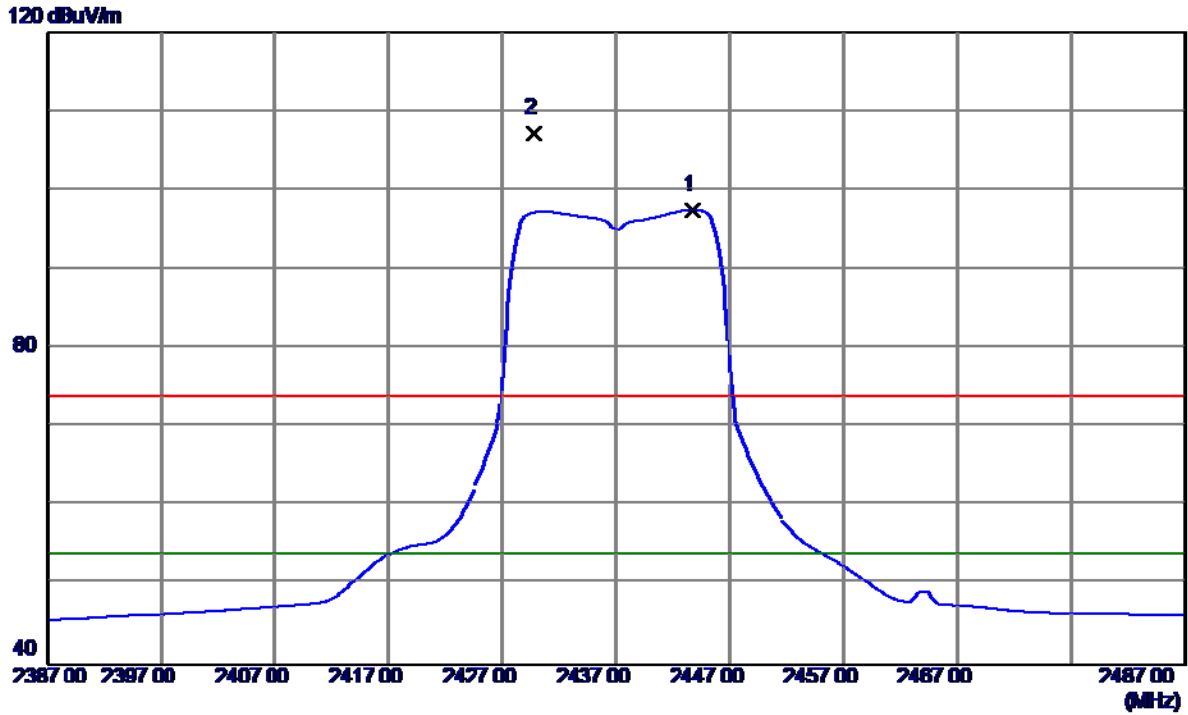

No.	Freq. MHz	Reading Level dBuV/m	Correct Factor dB	Measure ment dBuV/m	Limit dBuV/m	Margin dB	Detector	Comment
1	2443.8000	64.73	32.75	97.48	54.00	43.48	AVG	No Limit
2	2429.8000	74.43	32.73	107.16	74.00	33.16	Peak	No Limit

Orthogonal Axis :	X
Test Mode :	TX N-20M MODE 2437MHz

Vertical

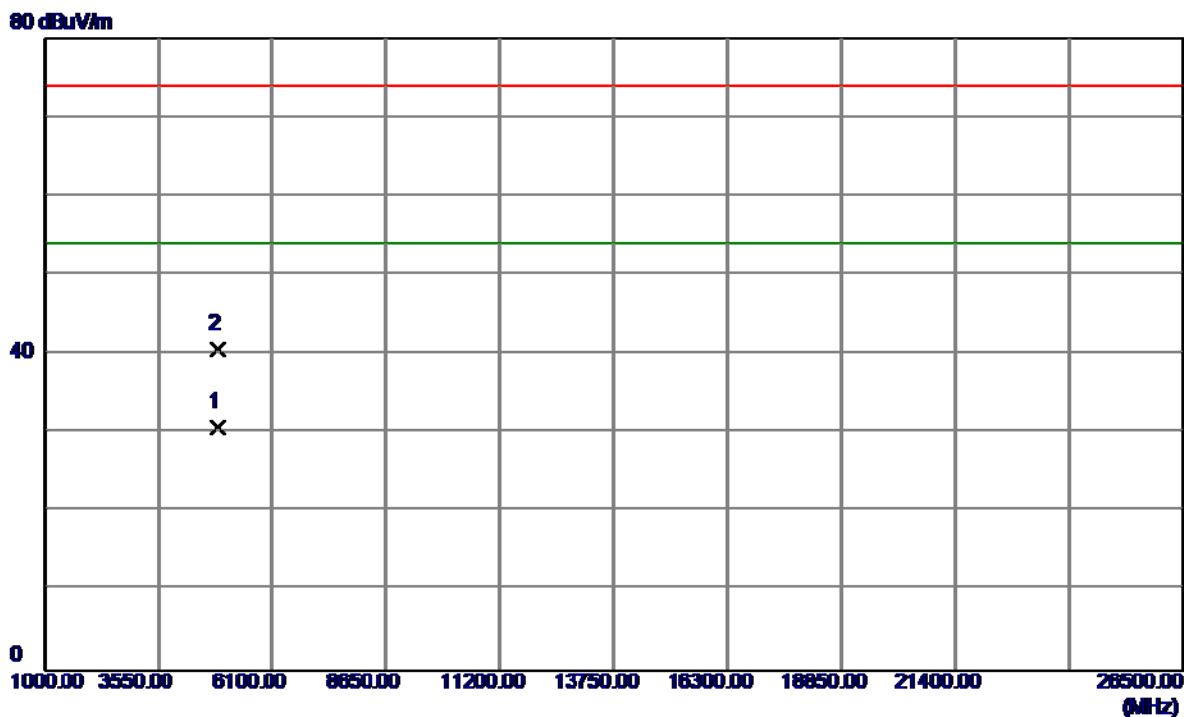

No.	Freq. MHz	Reading Level dBuV/m	Correct Factor dB	Measure ment dBuV/m	Limit dBuV/m	Margin dB	Detector	Comment
1	4873.5930	27.67	3.03	30.70	54.00	-23.30	AVG	
2	4874.0930	37.60	3.03	40.63	74.00	-33.37	Peak	

Orthogonal Axis :	X
Test Mode :	TX N-20M MODE 2437MHz

Horizontal

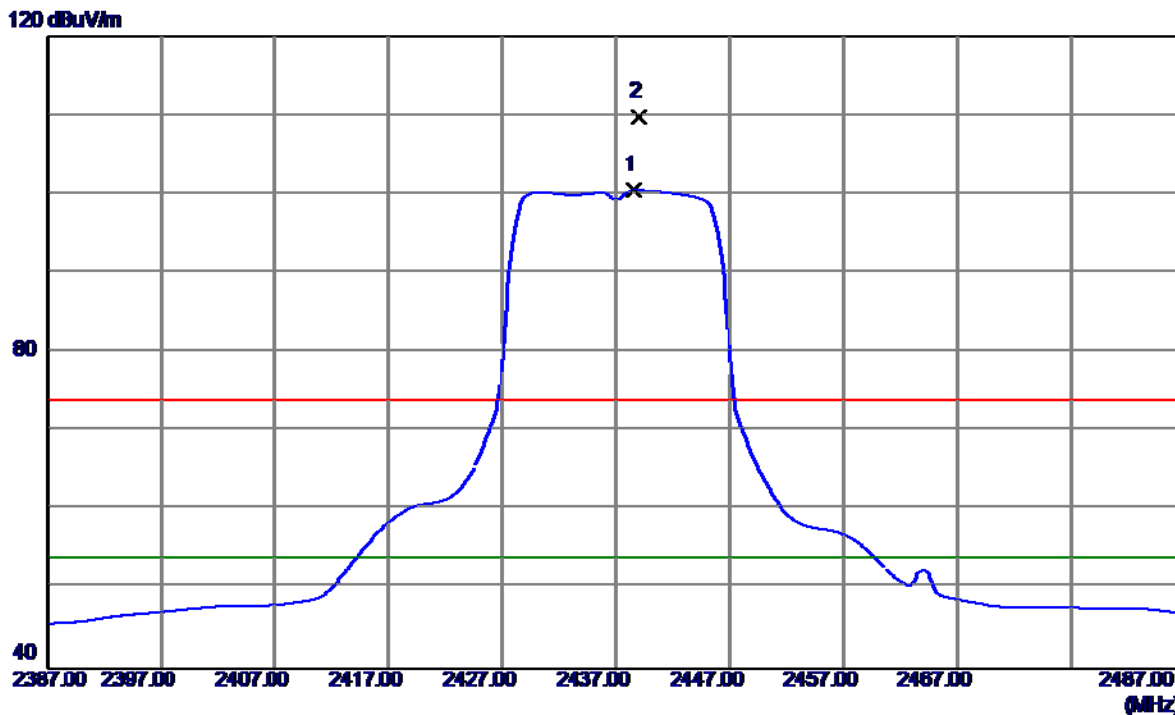

No.	Freq. MHz	Reading Level dBuV/m	Correct Factor dB	Measure ment dBuV/m	Limit dBuV/m	Margin dB	Detector	Comment
1	2438.6000	67.67	32.75	100.42	54.00	46.42	AVG	No Limit
2	2439.0000	77.08	32.75	109.83	74.00	35.83	Peak	No Limit

Orthogonal Axis :	X
Test Mode :	TX N-20M MODE 2437MHz

Horizontal

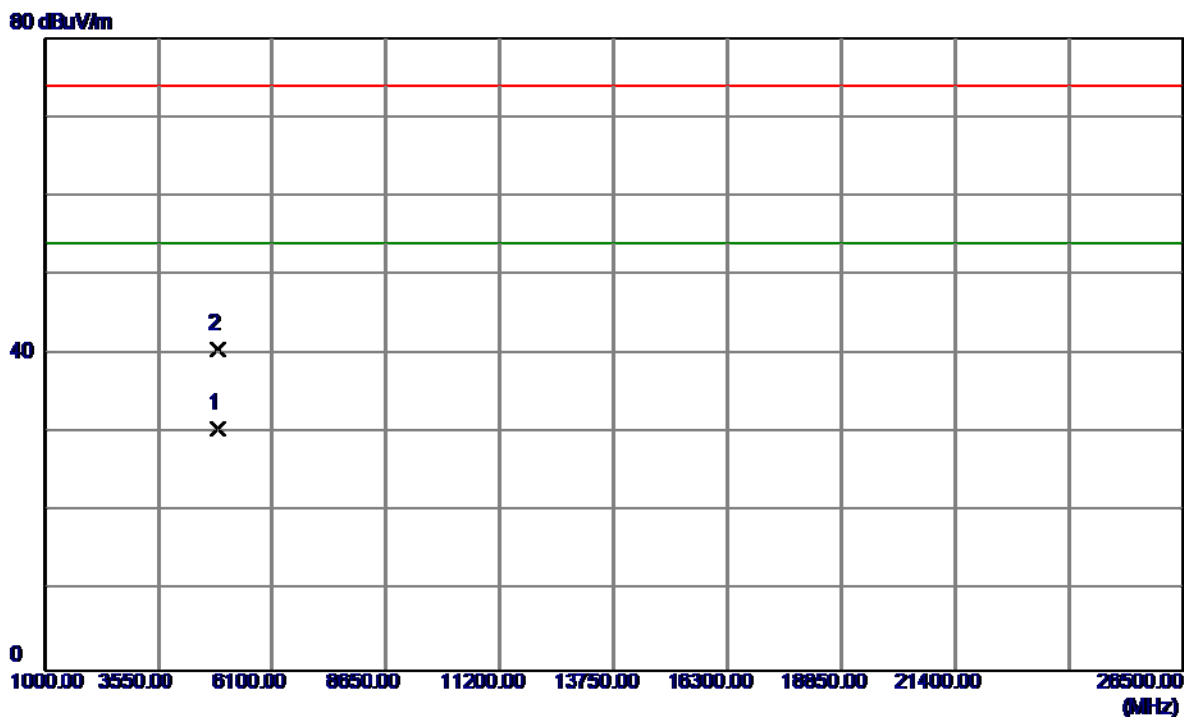

No.	Freq. MHz	Reading Level dBuV/m	Correct Factor dB	Measure ment dBuV/m	Limit dBuV/m	Margin dB	Detector	Comment
1	4873.3780	27.53	3.03	30.56	54.00	-23.44	AVG	
2	4874.3200	37.68	3.03	40.71	74.00	-33.29	Peak	

Orthogonal Axis :	X
Test Mode :	TX N-20M MODE 2462MHz

Vertical

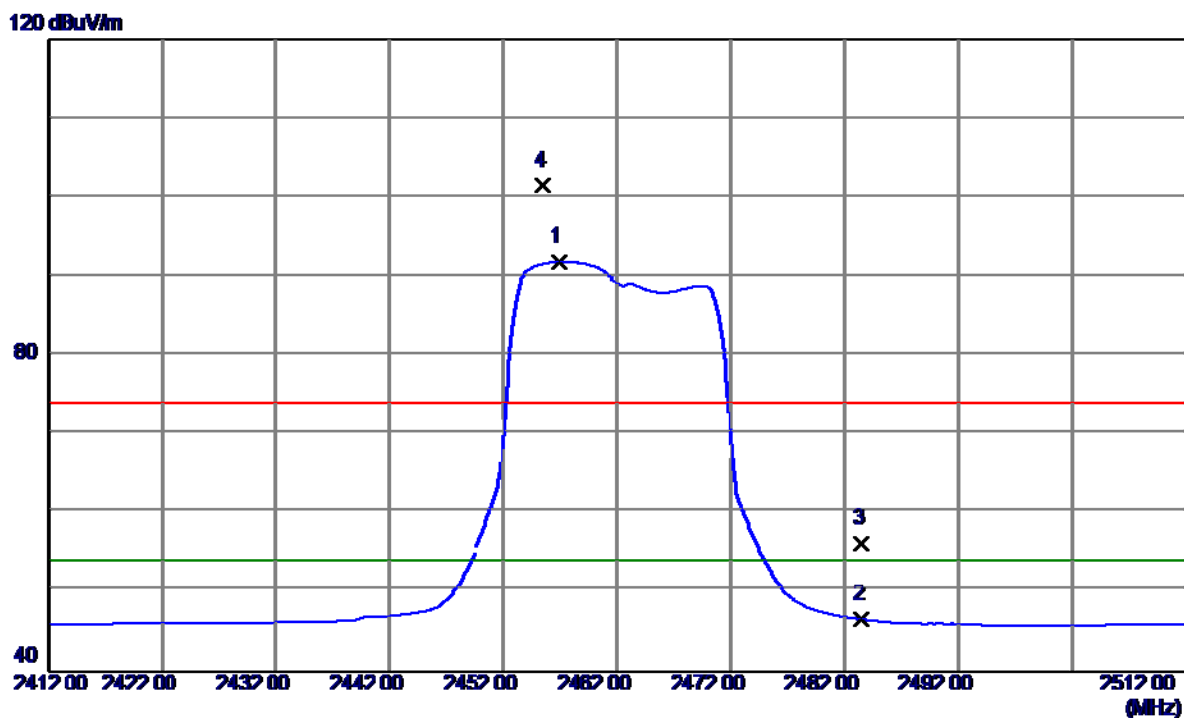

No.	Freq. MHz	Reading Level dBuV/m	Correct Factor dB	Measure ment dBuV/m	Limit dBuV/m	Margin dB	Detector	Comment
1	2456.9000	59.10	32.77	91.87	54.00	37.87	AVG	No Limit
2	2483.5000	13.73	32.81	46.54	54.00	-7.46	AVG	
3	2483.5000	23.32	32.81	56.13	74.00	-17.87	Peak	
4	2455.5000	68.63	32.77	101.40	74.00	27.40	Peak	No Limit

Orthogonal Axis :	X
Test Mode :	TX N-20M MODE 2462MHz

Vertical

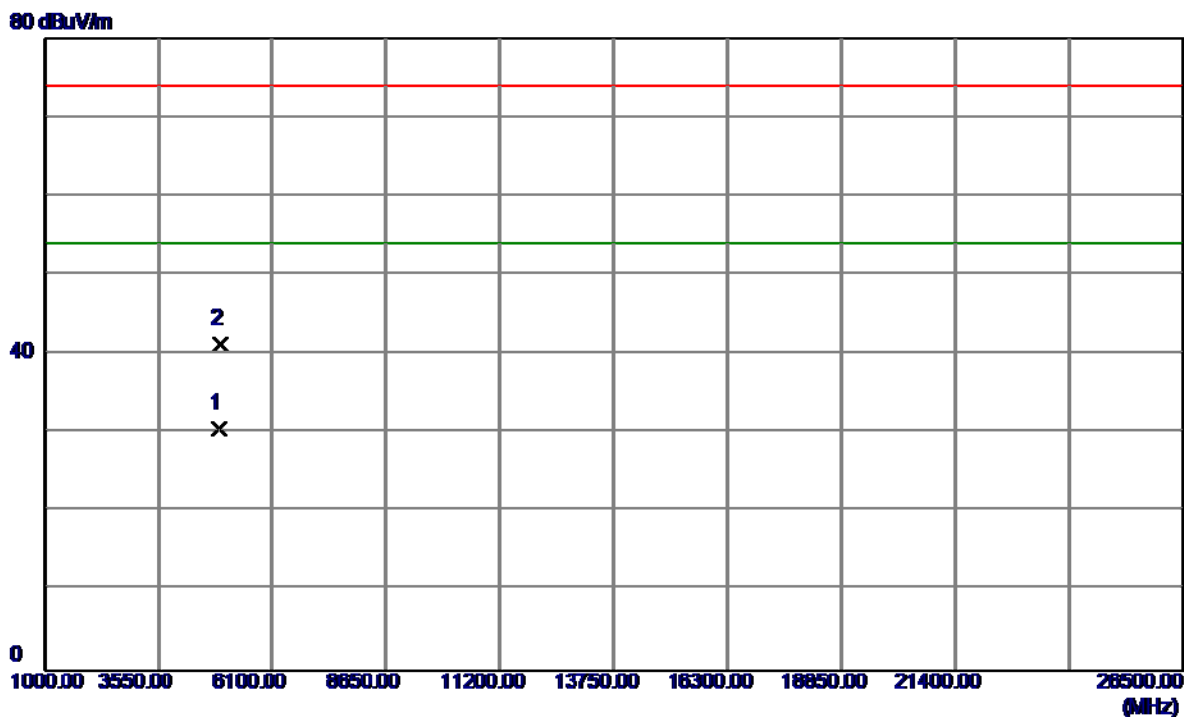

No.	Freq. MHz	Reading Level dBuV/m	Correct Factor dB	Measure ment dBuV/m	Limit dBuV/m	Margin dB	Detector	Comment
1	4923.5000	27.49	3.05	30.54	54.00	-23.46	AVG	
2	4924.3600	38.23	3.05	41.28	74.00	-32.72	Peak	

Orthogonal Axis :	X
Test Mode :	TX N-20M MODE 2462MHz

Horizontal

120 dBuV/m

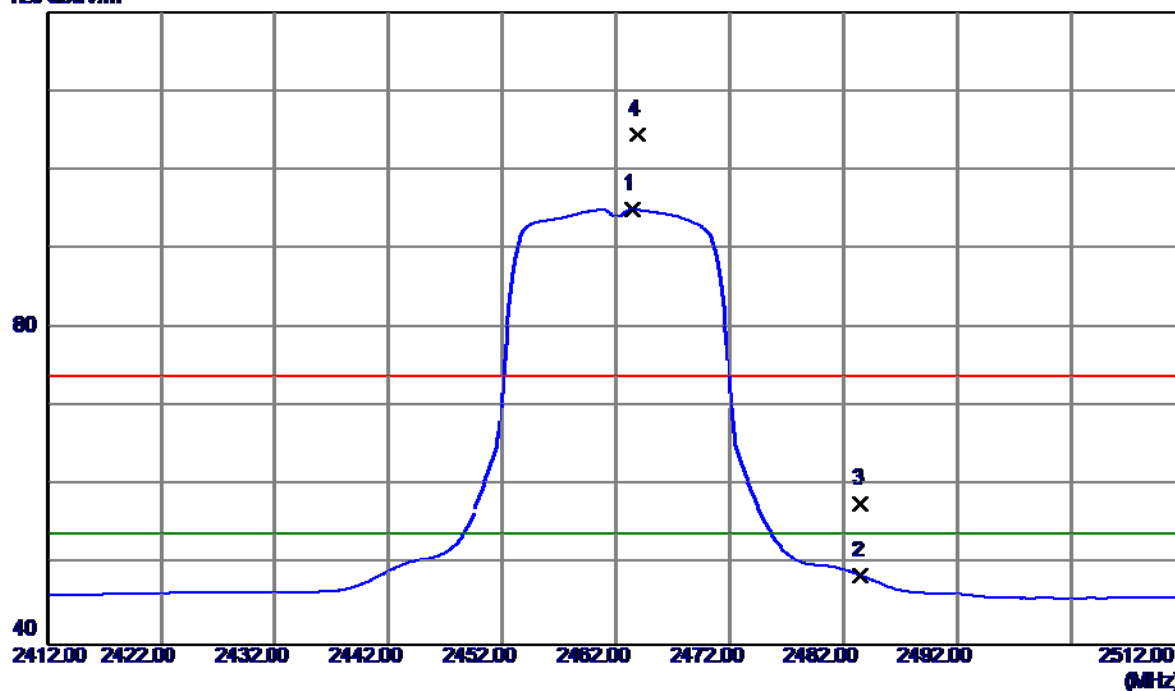

No.	Freq. MHz	Reading Level dBuV/m	Correct Factor dB	Measure ment dBuV/m	Limit dBuV/m	Margin dB	Detector	Comment
1	2463.4000	62.26	32.78	95.04	54.00	41.04	AVG	No Limit
2	2483.5000	15.83	32.81	48.64	54.00	-5.36	AVG	
3	2483.5000	25.00	32.81	57.81	74.00	-16.19	Peak	
4	2463.9000	71.72	32.78	104.50	74.00	30.50	Peak	No Limit

Orthogonal Axis :	X
Test Mode :	TX N-20M MODE 2462MHz

Horizontal

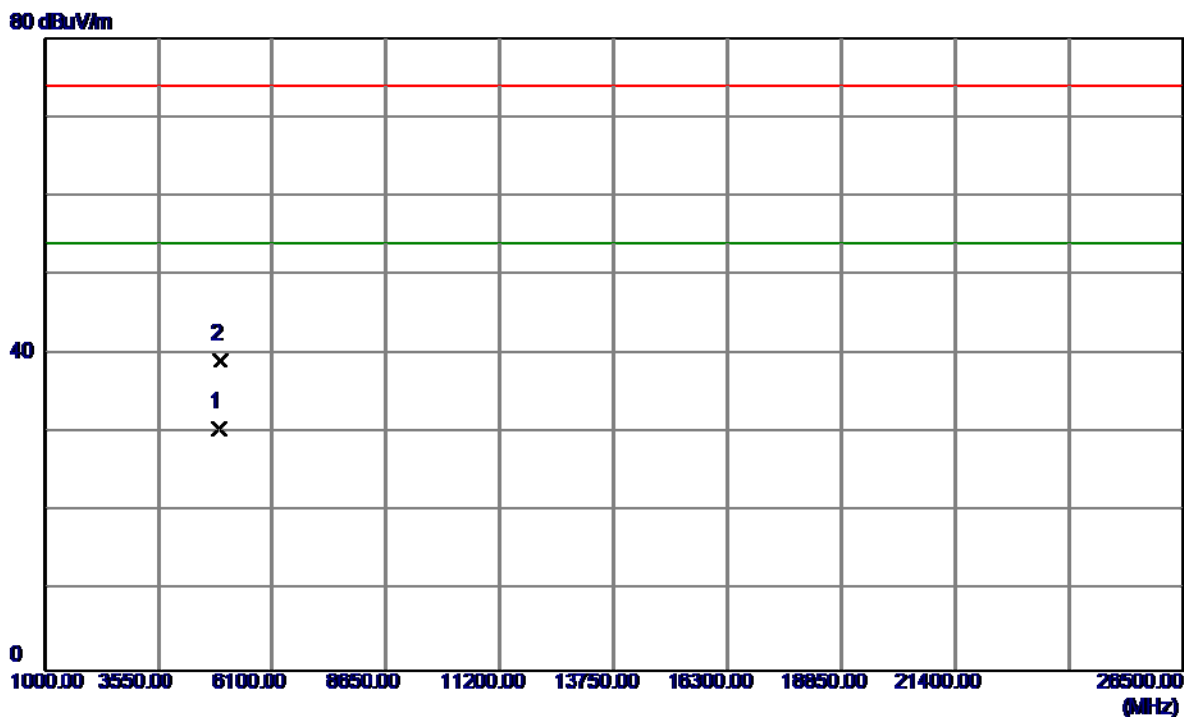

No.	Freq. MHz	Reading Level dBuV/m	Correct Factor dB	Measure ment dBuV/m	Limit dBuV/m	Margin dB	Detector	Comment
1	4923.3809	27.59	3.05	30.64	54.00	-23.36	AVG	
2	4924.5490	36.23	3.05	39.28	74.00	-34.72	Peak	

Orthogonal Axis :	X
Test Mode :	TX N-40M MODE 2422MHz

Vertical

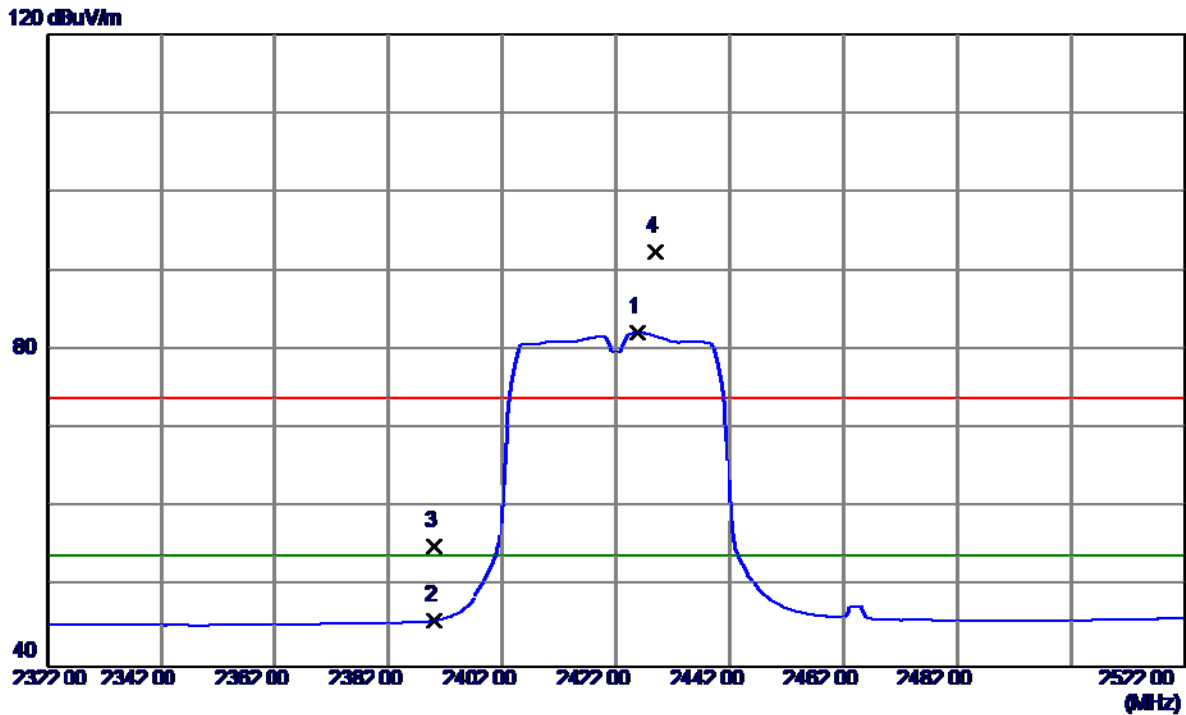

No.	Freq. MHz	Reading Level dBuV/m	Correct Factor dB	Measure ment dBuV/m	Limit dBuV/m	Margin dB	Detector	Comment
1	2425.8000	49.51	32.73	82.24	54.00	28.24	AVG	No Limit
2	2390.0000	13.08	32.68	45.76	54.00	-8.24	AVG	
3	2390.0000	22.59	32.68	55.27	74.00	-18.73	Peak	
4	2428.8000	59.74	32.73	92.47	74.00	18.47	Peak	No Limit

Orthogonal Axis :	X
Test Mode :	TX N-40M MODE 2422MHz

Vertical

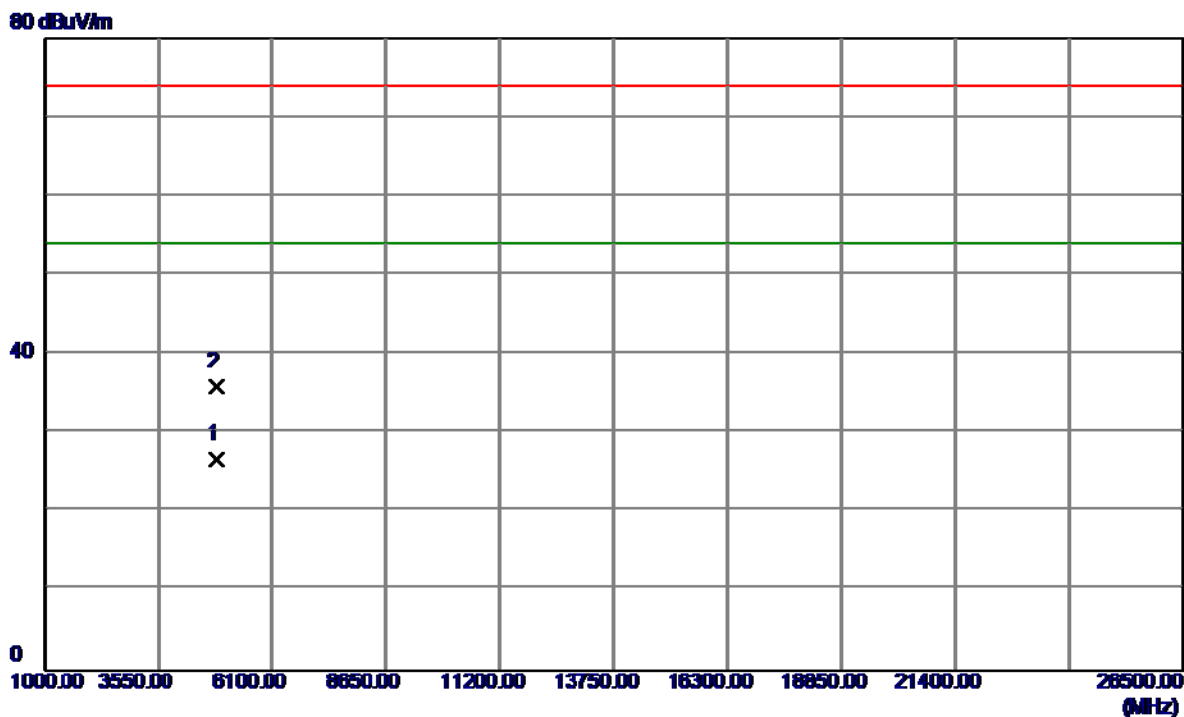

No.	Freq. MHz	Reading Level dBuV/m	Correct Factor dB	Measure ment dBuV/m	Limit dBuV/m	Margin dB	Detector	Comment
1	4843.5400	23.69	3.01	26.70	54.00	-27.30	AVG	
2	4843.9200	32.85	3.01	35.86	74.00	-38.14	Peak	

Orthogonal Axis :	X
Test Mode :	TX N-40M MODE 2422MHz

Horizontal

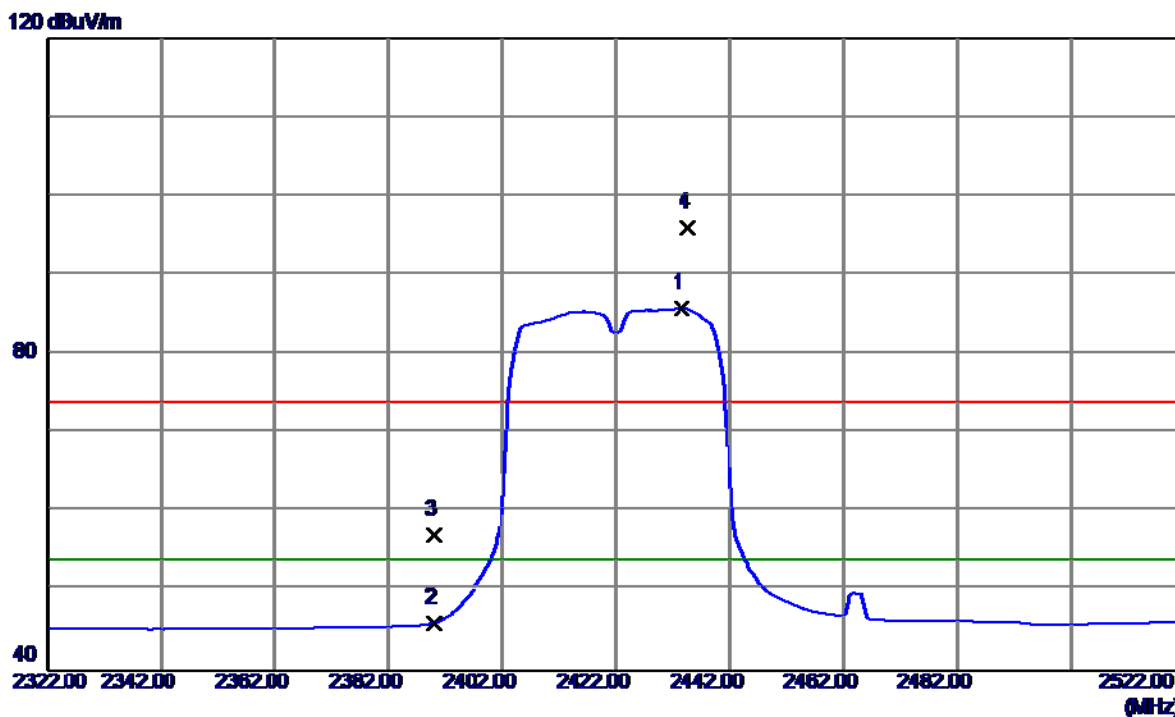

No.	Freq. MHz	Reading Level dBuV/m	Correct Factor dB	Measure ment dBuV/m	Limit dBuV/m	Margin dB	Detector	Comment
1	2433.6000	53.00	32.74	85.74	54.00	31.74	AVG	No Limit
2	2390.0000	13.31	32.68	45.99	54.00	-8.01	AVG	
3	2390.0000	24.39	32.68	57.07	74.00	-16.93	Peak	
4	2434.6000	63.32	32.74	96.06	74.00	22.06	Peak	No Limit

Orthogonal Axis :	X
Test Mode :	TX N-40M MODE 2422MHz

Horizontal

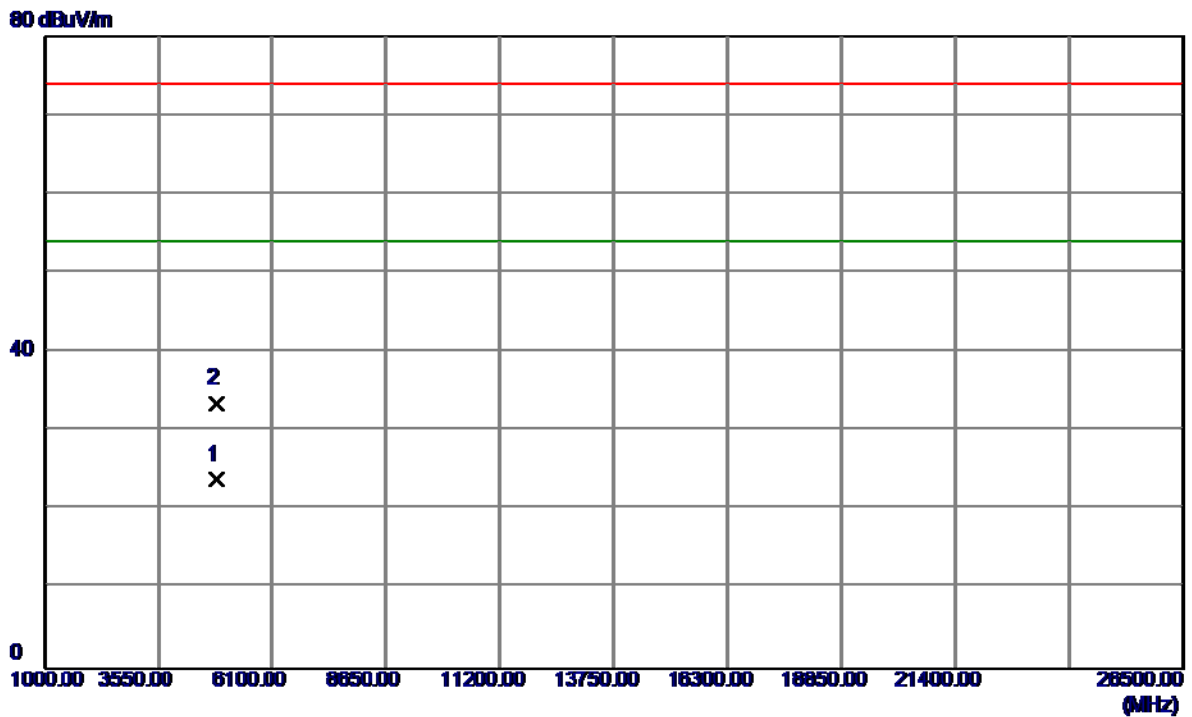

No.	Freq. MHz	Reading Level dBuV/m	Correct Factor dB	Measure ment dBuV/m	Limit dBuV/m	Margin dB	Detector	Comment
1	4843.5480	20.89	3.01	23.90	54.00	-30.10	AVG	
2	4844.0360	30.37	3.01	33.38	74.00	-40.62	Peak	

Orthogonal Axis :	X
Test Mode :	TX N-40M MODE 2437MHz

Vertical

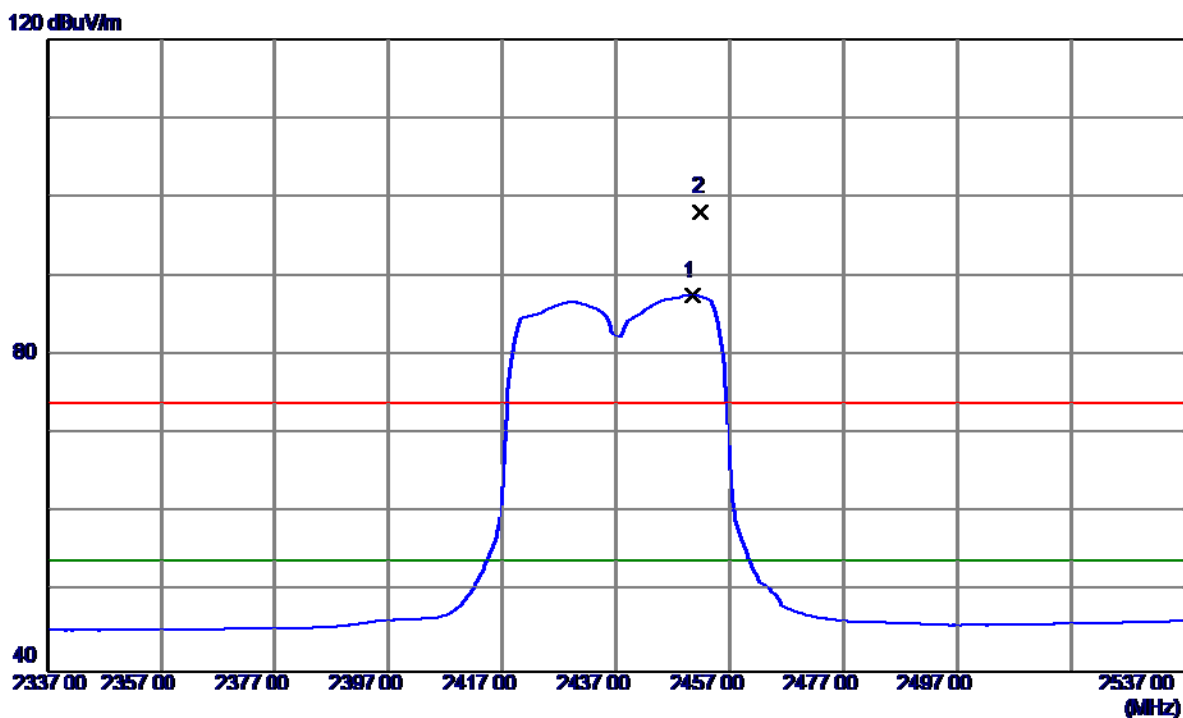

No.	Freq. MHz	Reading Level dBuV/m	Correct Factor dB	Measure ment dBuV/m	Limit dBuV/m	Margin dB	Detector	Comment
1	2450.6000	54.76	32.76	87.52	54.00	33.52	AVG	No Limit
2	2452.0000	65.25	32.76	98.01	74.00	24.01	Peak	No Limit

Orthogonal Axis :	X
Test Mode :	TX N-40M MODE 2437MHz

Vertical

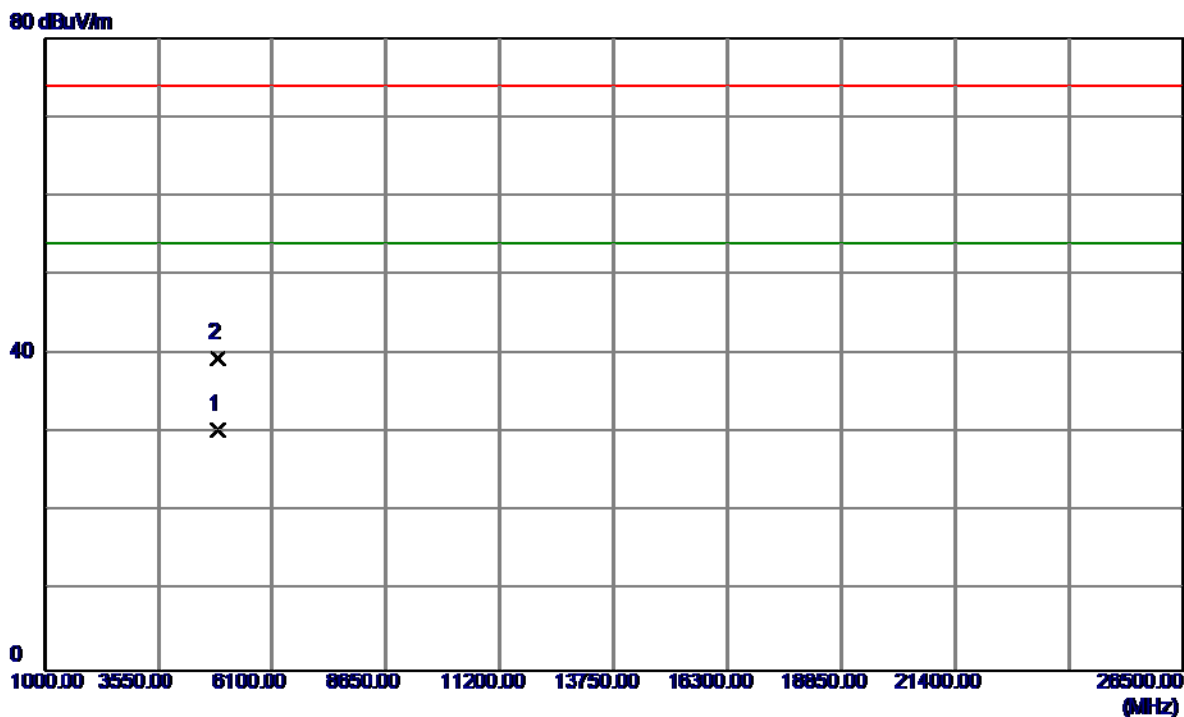

No.	Freq. MHz	Reading Level dBuV/m	Correct Factor dB	Measure ment dBuV/m	Limit dBuV/m	Margin dB	Detector	Comment
1	4873.7590	27.37	3.03	30.40	54.00	-23.60	AVG	
2	4873.3280	36.47	3.03	39.50	74.00	-34.50	Peak	

Orthogonal Axis :	X
Test Mode :	TX N-40M MODE 2437MHz

Horizontal

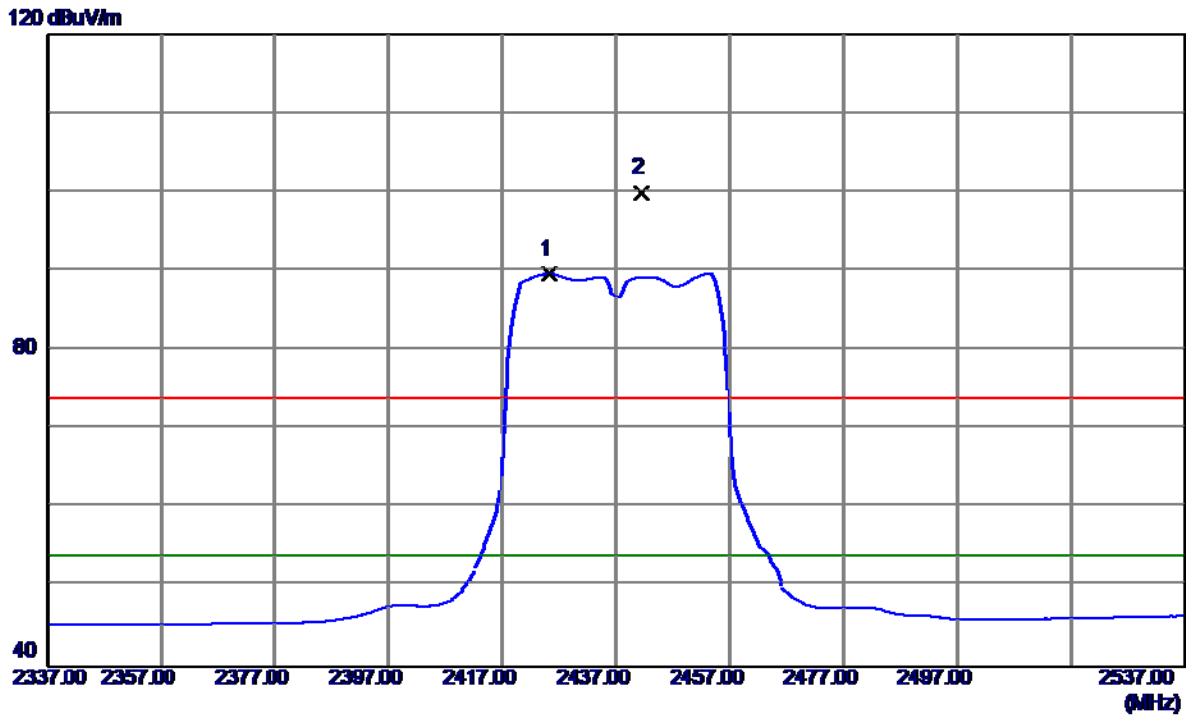

No.	Freq. MHz	Reading Level dBuV/m	Correct Factor dB	Measure ment dBuV/m	Limit dBuV/m	Margin dB	Detector	Comment
1	2425.2000	56.89	32.73	89.62	54.00	35.62	AVG	No Limit
2	2441.4000	67.15	32.75	99.90	74.00	25.90	Peak	No Limit

Orthogonal Axis :	X
Test Mode :	TX N-40M MODE 2437MHz

Horizontal

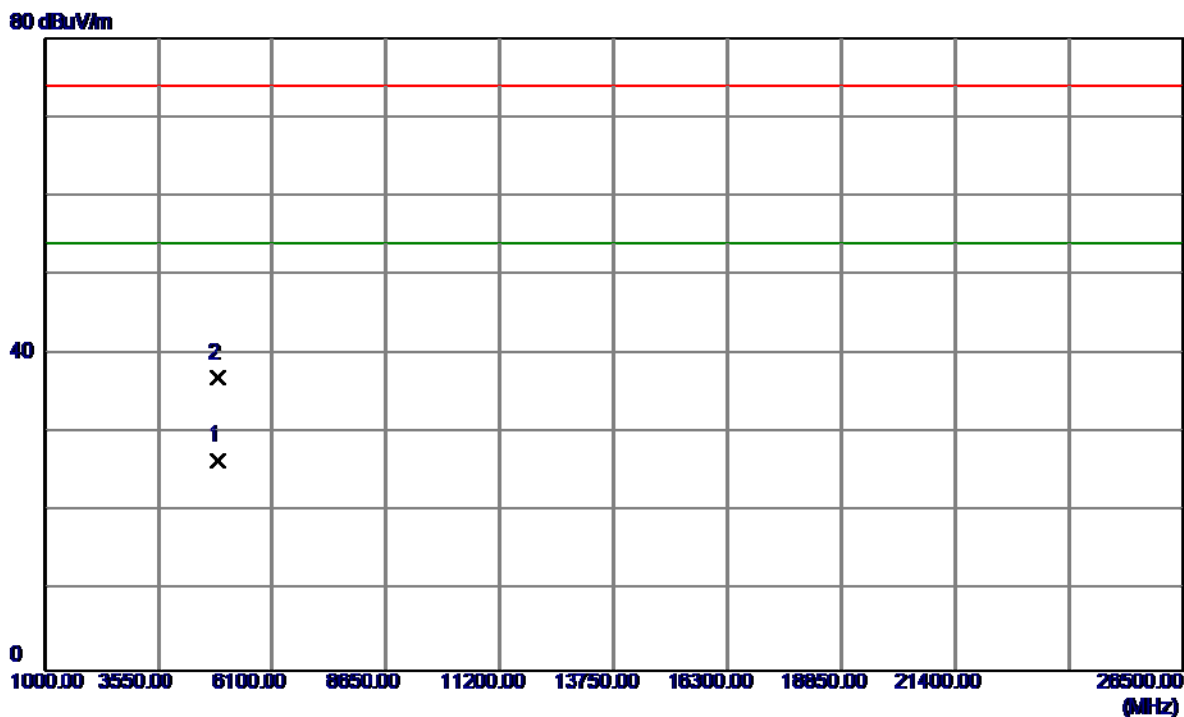

No.	Freq. MHz	Reading Level dBuV/m	Correct Factor dB	Measure ment dBuV/m	Limit dBuV/m	Margin dB	Detector	Comment
1	4873.9347	23.48	3.03	26.51	54.00	-27.49	AVG	
2	4873.8470	33.97	3.03	37.00	74.00	-37.00	Peak	

Orthogonal Axis :	X
Test Mode :	TX N-40M MODE 2452MHz

Vertical

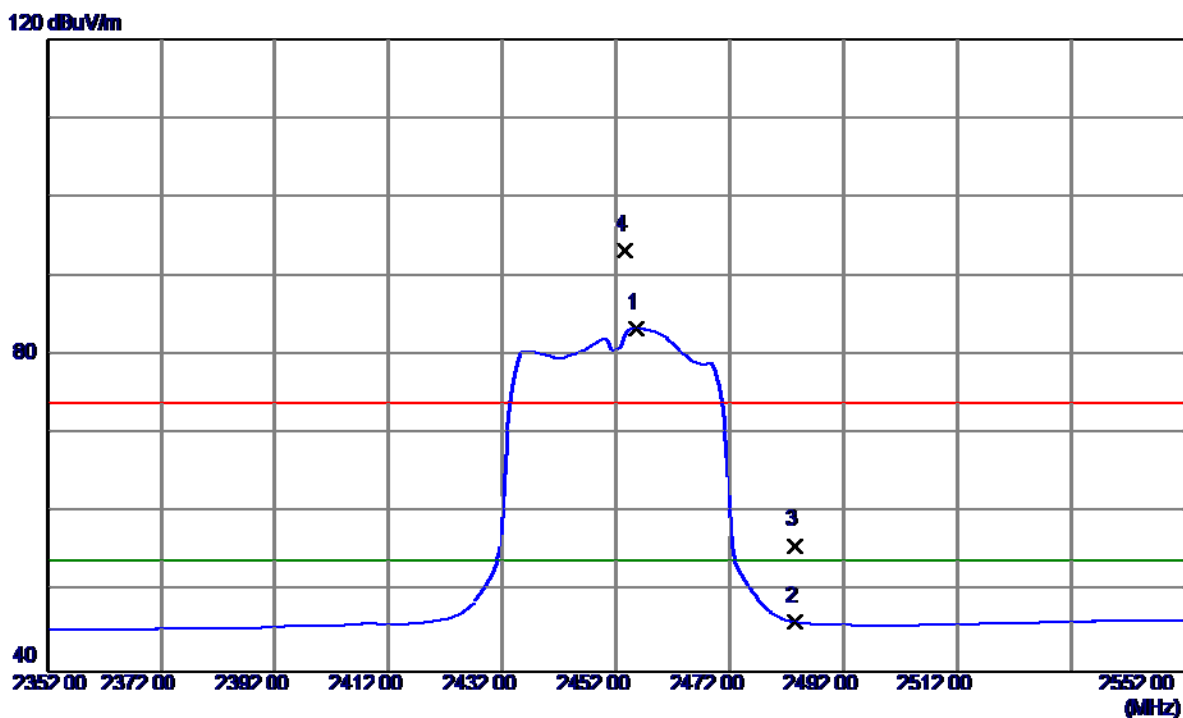

No.	Freq. MHz	Reading Level dBuV/m	Correct Factor dB	Measure ment dBuV/m	Limit dBuV/m	Margin dB	Detector	Comment
1	2455.6000	50.61	32.77	83.38	54.00	29.38	AVG	No Limit
2	2483.5000	13.39	32.81	46.20	54.00	-7.80	AVG	
3	2483.5000	23.11	32.81	55.92	74.00	-18.08	Peak	
4	2453.6000	60.46	32.77	93.23	74.00	19.23	Peak	No Limit

Orthogonal Axis :	X
Test Mode :	TX N-40M MODE 2452MHz

Vertical

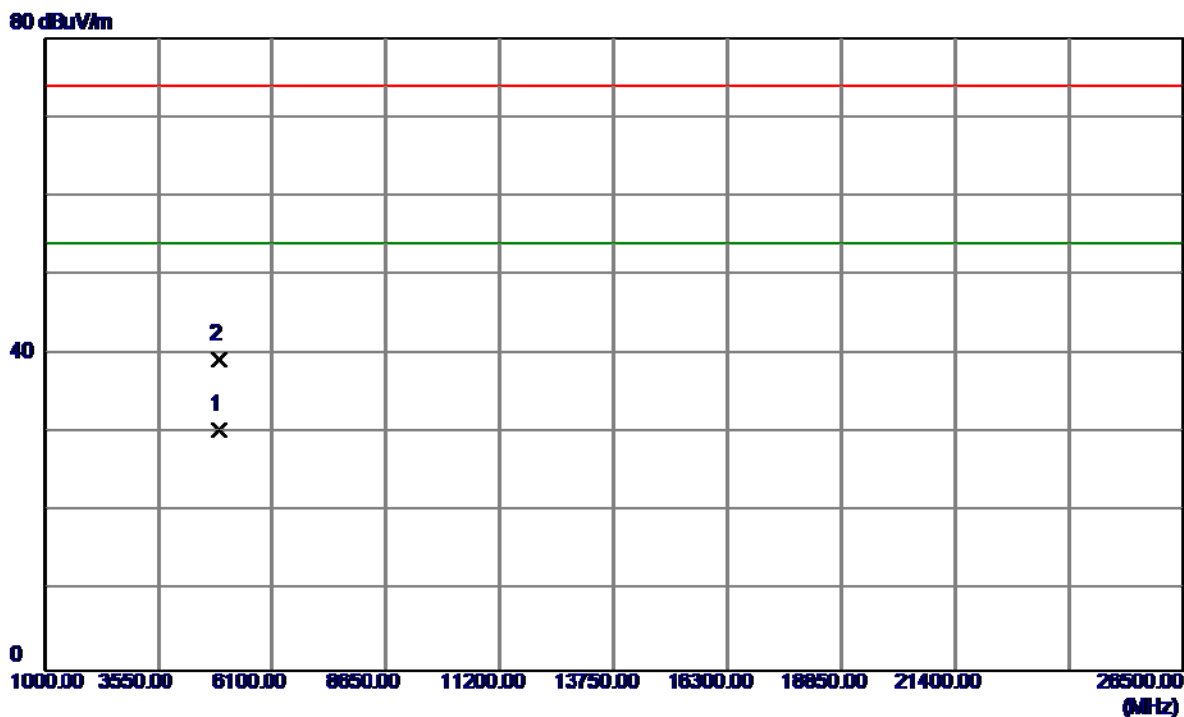

No.	Freq. MHz	Reading Level dBuV/m	Correct Factor dB	Measure ment dBuV/m	Limit dBuV/m	Margin dB	Detector	Comment
1	4903.5480	27.40	3.04	30.44	54.00	-23.56	AVG	
2	4904.2330	36.32	3.04	39.36	74.00	-34.64	Peak	

Orthogonal Axis :	X
Test Mode :	TX N-40M MODE 2452MHz

Horizontal

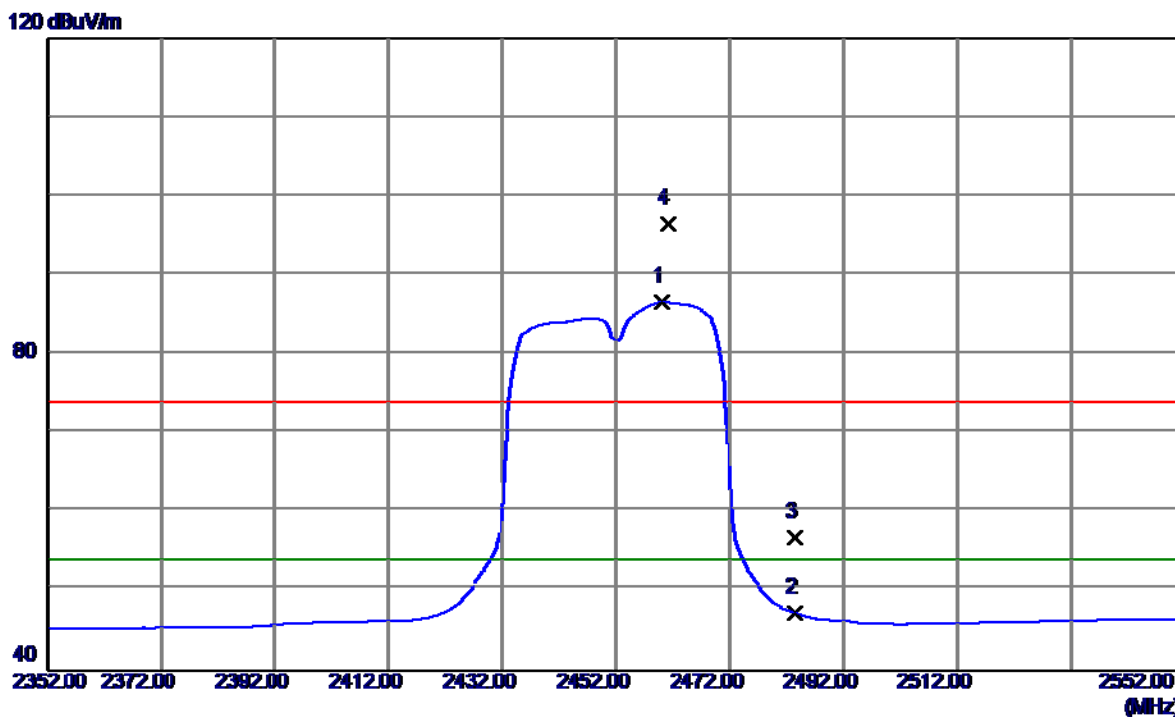

No.	Freq. MHz	Reading Level dBuV/m	Correct Factor dB	Measure ment dBuV/m	Limit dBuV/m	Margin dB	Detector	Comment
1	2460.0000	53.79	32.77	86.56	54.00	32.56	AVG	No Limit
2	2483.5000	14.36	32.81	47.17	54.00	-6.83	AVG	
3	2483.5000	24.04	32.81	56.85	74.00	-17.15	Peak	
4	2461.0000	63.72	32.78	96.50	74.00	22.50	Peak	No Limit

Orthogonal Axis :	X
Test Mode :	TX N-40M MODE 2452MHz

Horizontal

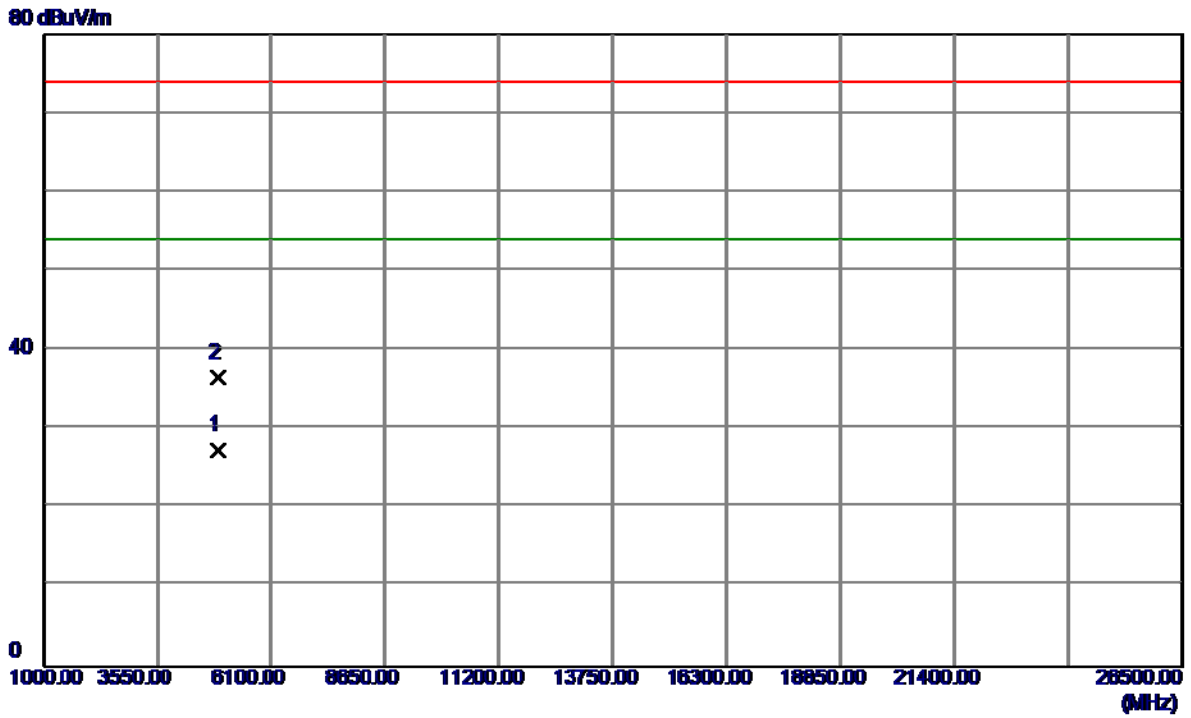

No.	Freq. MHz	Reading Level dBuV/m	Correct Factor dB	Measure ment dBuV/m	Limit dBuV/m	Margin dB	Detector	Comment
1	4903.4800	24.34	3.04	27.38	54.00	-26.62	AVG	
2	4903.9320	33.40	3.04	36.44	74.00	-37.56	Peak	

ATTACHMENT E - BANDWIDTH

Test Mode : TX B Mode_CH01/06/11

Frequency (MHz)	6dB Bandwidth (MHz)	99% Occupied BW (MHz)	Min. Limit (kHz)	Test Result
2412	7.07	11.64	500	Complies
2437	7.50	11.84	500	Complies
2462	6.64	10.84	500	Complies

TX CH01

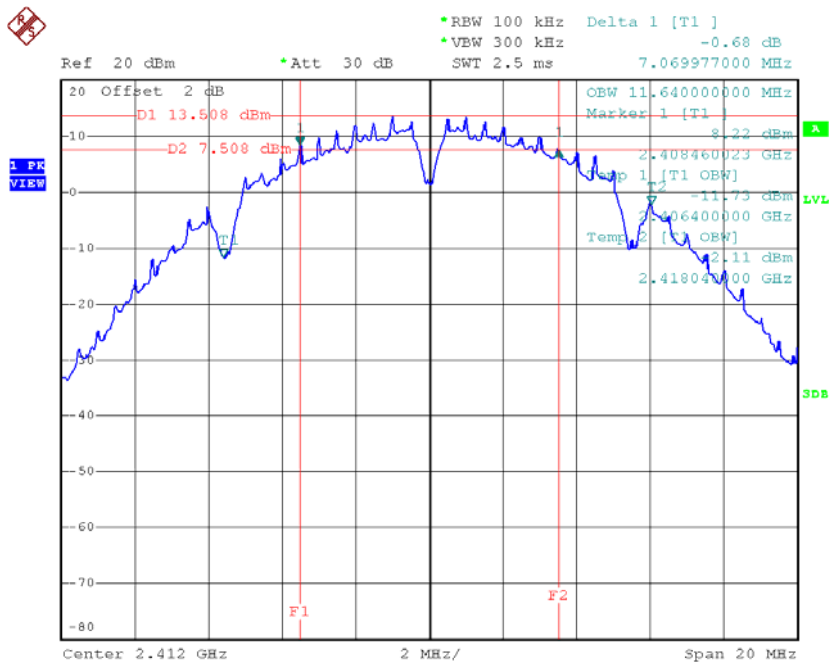

Date: 18.MAR.2015 13:23:08

TX CH06

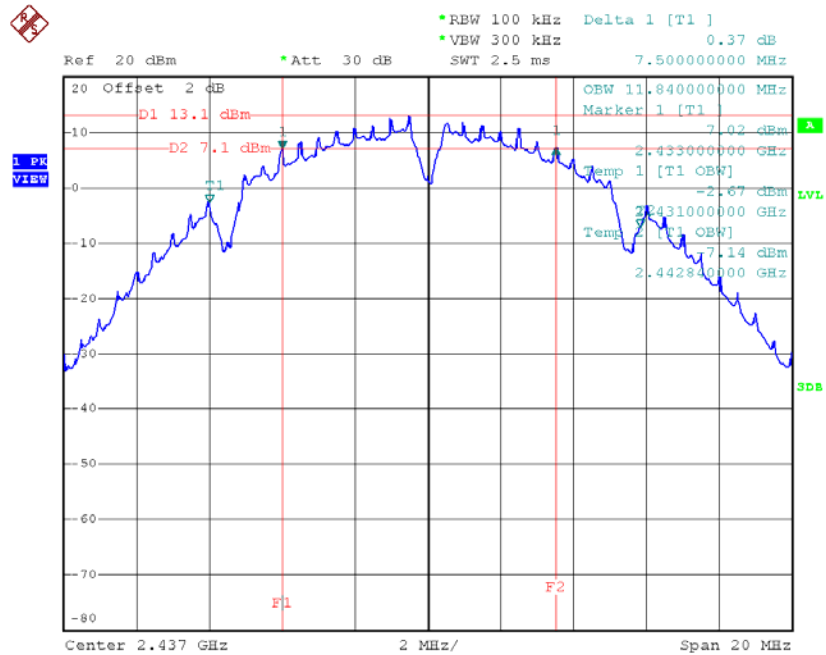

Date: 18.MAR.2015 13:24:40

TX CH11

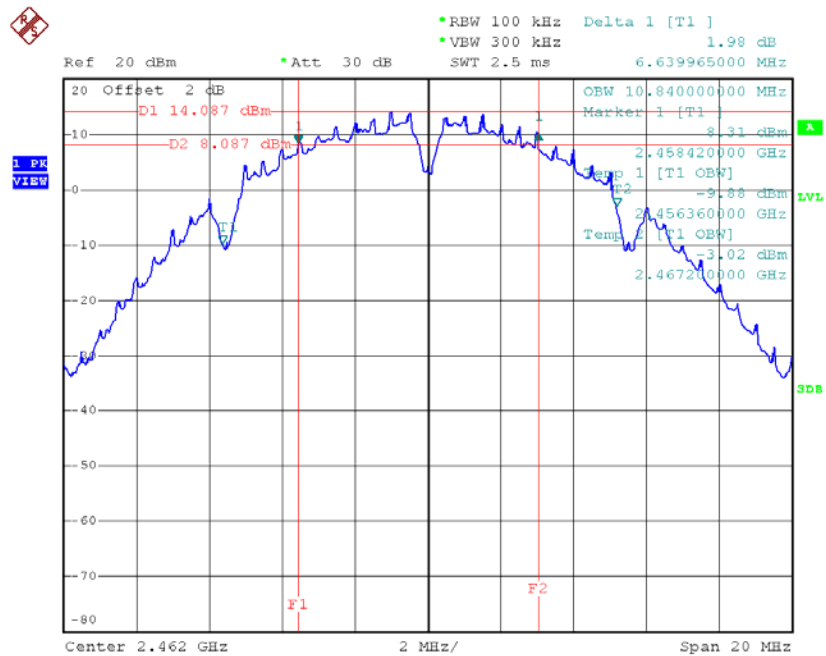

Date: 18.MAR.2015 13:25:42

Test Mode: TX G Mode_CH01/06/11

Frequency (MHz)	6dB Bandwidth (MHz)	99% Occupied BW (MHz)	Min. Limit (kHz)	Test Result
2412	16.08	16.44	500	Complies
2437	16.40	16.48	500	Complies
2462	16.28	16.36	500	Complies

TX CH01

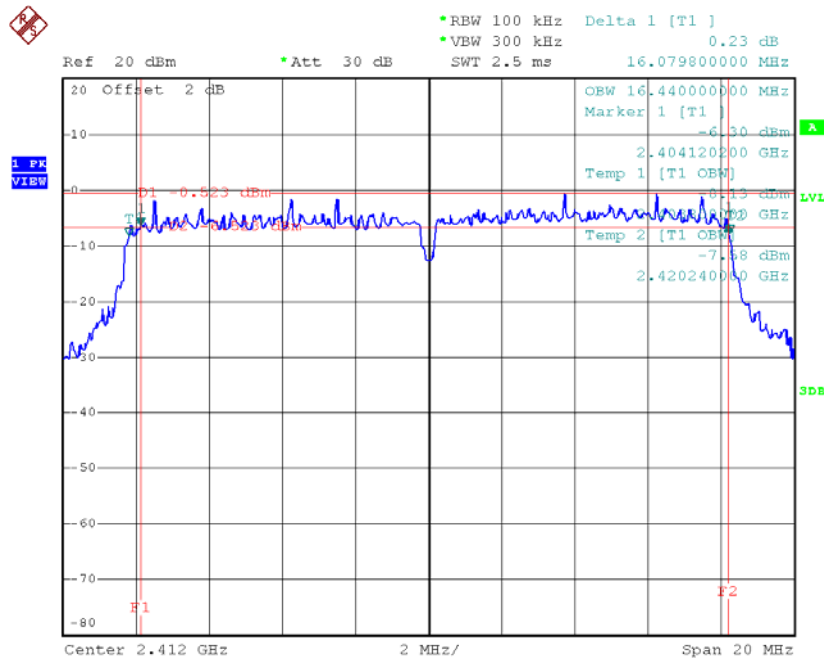

Date: 18.MAR.2015 13:27:14

TX CH06

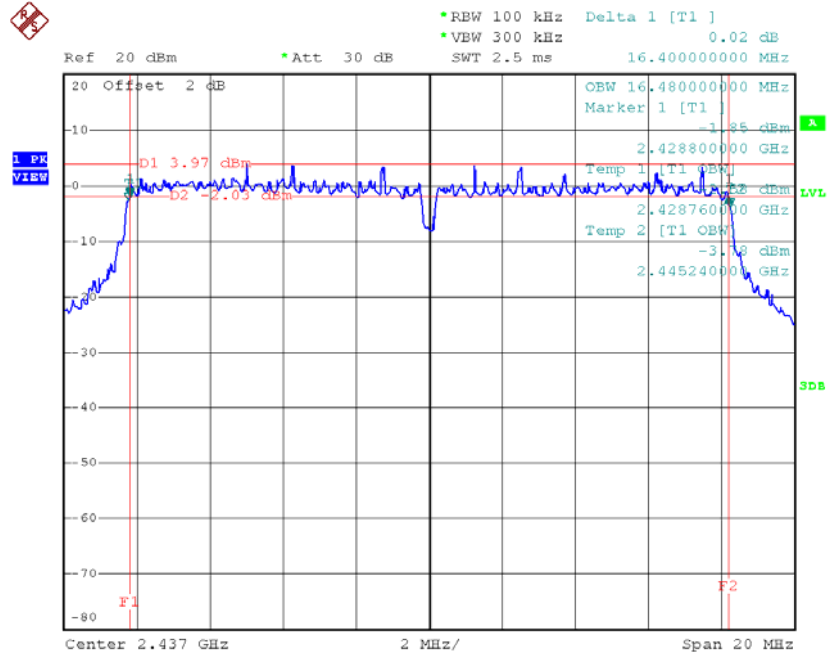

Date: 18.MAR.2015 13:31:14

TX CH11

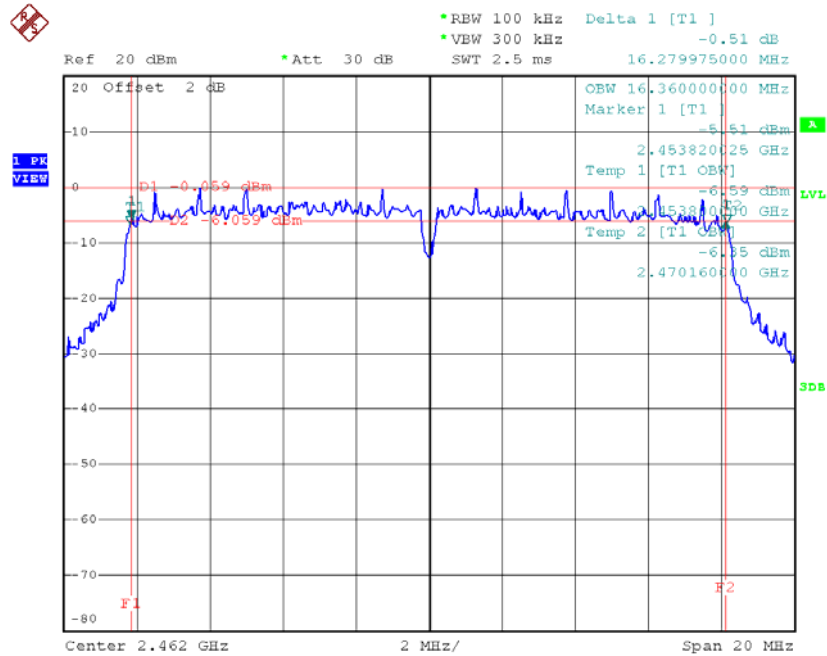

Date: 18.MAR.2015 13:35:28

Test Mode : TX N-20MHz Mode_CH01/06/11

Frequency (MHz)	6dB Bandwidth (MHz)	99% Occupied BW (MHz)	Min. Limit (kHz)	Test Result
2412	16.98	17.64	500	Complies
2437	17.20	17.64	500	Complies
2462	16.68	17.56	500	Complies

TX CH01

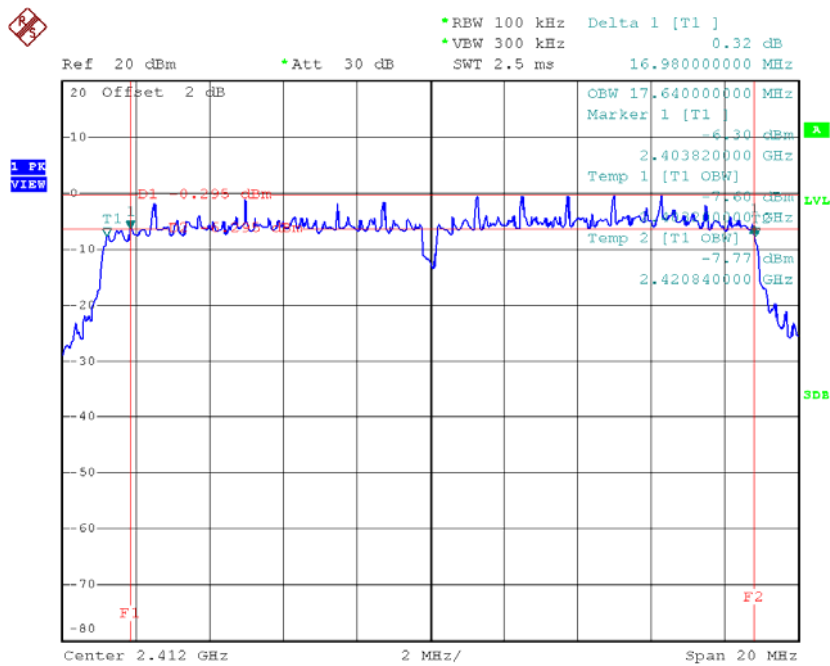

Date: 18.MAR.2015 13:37:19

TX CH06

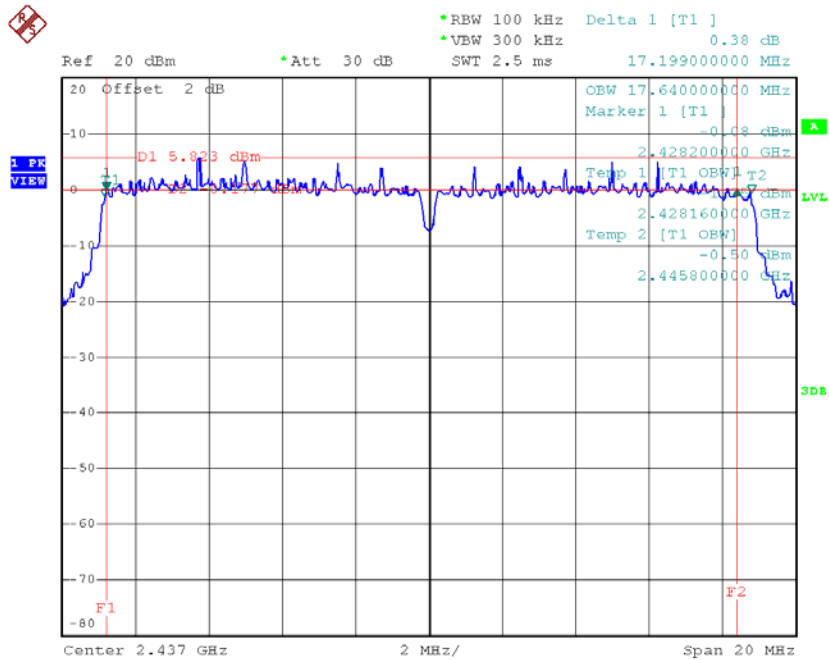

Date: 18.MAR.2015 13:38:25

TX CH11

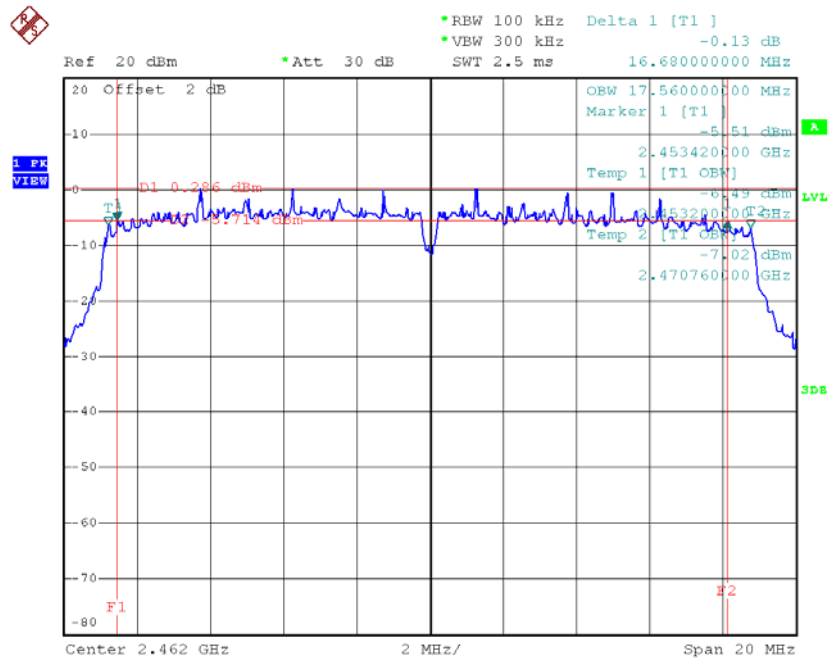

Date: 18.MAR.2015 13:39:23

Test Mode : TX N-40MHz Mode_CH03/06/09

Frequency (MHz)	6dB Bandwidth (MHz)	99% Occupied BW (MHz)	Min. Limit (kHz)	Test Result
2422	35.24	36.00	500	Complies
2437	36.00	36.24	500	Complies
2452	33.96	35.92	500	Complies

TX CH03

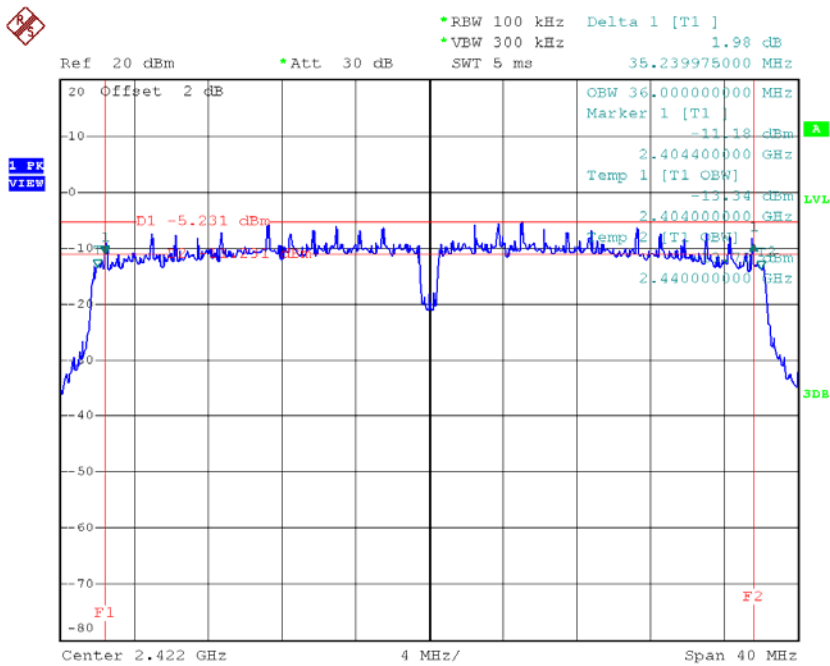

Date: 18.MAR.2015 13:40:40

TX CH06

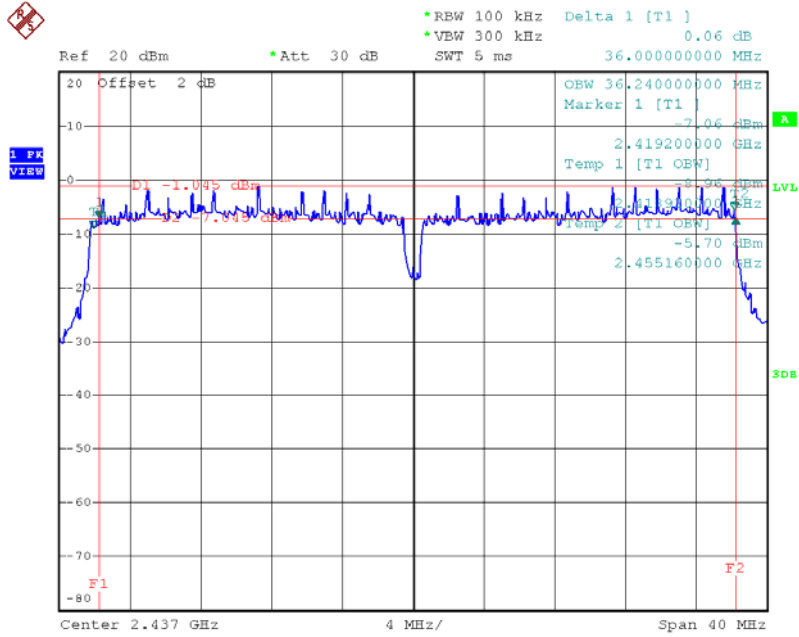

Date: 18.MAR.2015 13:41:52

TX CH09

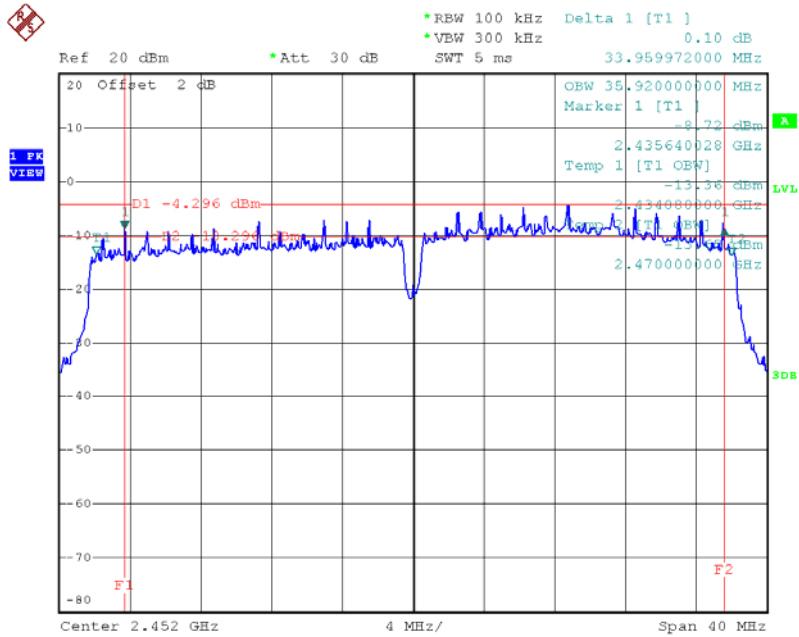

Date: 18.MAR.2015 13:42:59

ATTACHMENT F – MAXIMUM PEAK CONDUCTED OUTPUT POWER

For 1TX

Test Mode :TX B Mode_CH01/06/11

Frequency (MHz)	Conducted Power (dBm)	Conducted Power (W)	Max. Limit (dBm)	Max. Limit (W)	Result
2412	26.63	0.46	30.00	1.00	Complies
2437	26.87	0.49	30.00	1.00	Complies
2462	26.91	0.49	30.00	1.00	Complies

Test Mode :TX G Mode_CH01/06/11

Frequency (MHz)	Conducted Power (dBm)	Conducted Power (W)	Max. Limit (dBm)	Max. Limit (W)	Result
2412	19.87	0.10	30.00	1.00	Complies
2437	24.16	0.26	30.00	1.00	Complies
2462	20.09	0.10	30.00	1.00	Complies

Test Mode :TX N20 Mode_CH01/06/11

Frequency (MHz)	Conducted Power (dBm)	Conducted Power (W)	Max. Limit (dBm)	Max. Limit (W)	Result
2412	19.28	0.08	30.00	1.00	Complies
2437	25.76	0.38	30.00	1.00	Complies
2462	19.13	0.08	30.00	1.00	Complies

Test Mode :TX N40 Mode_CH03/06/09

Frequency (MHz)	Conducted Power (dBm)	Conducted Power (W)	Max. Limit (dBm)	Max. Limit (W)	Result
2422	18.69	0.07	30.00	1.00	Complies
2437	22.27	0.17	30.00	1.00	Complies
2452	18.37	0.07	30.00	1.00	Complies

For 2TX

Test Mode :TX B Mode_CH01/06/11_ANT 1

Frequency (MHz)	Conducted Power (dBm)	Conducted Power (W)	Max. Limit (dBm)	Max. Limit (W)	Result
2412	23.87	0.24	30.00	1.00	Complies
2437	26.19	0.42	30.00	1.00	Complies
2462	23.68	0.23	30.00	1.00	Complies

Test Mode :TX B Mode_CH01/06/11_ANT 2

Frequency (MHz)	Conducted Power (dBm)	Conducted Power (W)	Max. Limit (dBm)	Max. Limit (W)	Result
2412	23.19	0.21	30.00	1.00	Complies
2437	26.27	0.42	30.00	1.00	Complies
2462	23.16	0.21	30.00	1.00	Complies

Test Mode :TX B Mode_CH01/06/11_Total

Frequency (MHz)	Conducted Power (dBm)	Conducted Power (W)	Max. Limit (dBm)	Max. Limit (W)	Result
2412	26.55	0.45	30.00	1.00	Complies
2437	29.24	0.84	30.00	1.00	Complies
2462	26.44	0.44	30.00	1.00	Complies

Test Mode :TX G Mode_CH01/06/11_ANT 1

Frequency (MHz)	Conducted Power (dBm)	Conducted Power (W)	Max. Limit (dBm)	Max. Limit (W)	Result
2412	18.52	0.07	30.00	1.00	Complies
2437	26.67	0.46	30.00	1.00	Complies
2462	18.16	0.07	30.00	1.00	Complies

Test Mode :TX G Mode_CH01/06/11_ANT 2

Frequency (MHz)	Conducted Power (dBm)	Conducted Power (W)	Max. Limit (dBm)	Max. Limit (W)	Result
2412	18.25	0.07	30.00	1.00	Complies
2437	26.97	0.50	30.00	1.00	Complies
2462	18.34	0.07	30.00	1.00	Complies

Test Mode :TX G Mode_CH01/06/11_Total

Frequency (MHz)	Conducted Power (dBm)	Conducted Power (W)	Max. Limit (dBm)	Max. Limit (W)	Result
2412	21.40	0.14	30.00	1.00	Complies
2437	29.83	0.96	30.00	1.00	Complies
2462	21.26	0.13	30.00	1.00	Complies

Test Mode :TX N20 Mode_CH01/06/11_ANT 1

Frequency (MHz)	Conducted Power (dBm)	Conducted Power (W)	Max. Limit (dBm)	Max. Limit (W)	Result
2412	18.25	0.07	30.00	1.00	Complies
2437	24.08	0.26	30.00	1.00	Complies
2462	18.37	0.07	30.00	1.00	Complies

Test Mode :TX N20 Mode_CH01/06/11_ANT 2

Frequency (MHz)	Conducted Power (dBm)	Conducted Power (W)	Max. Limit (dBm)	Max. Limit (W)	Result
2412	18.61	0.07	30.00	1.00	Complies
2437	24.58	0.29	30.00	1.00	Complies
2462	18.72	0.07	30.00	1.00	Complies

Test Mode :TX N20 Mode_CH01/06/11_Total

Frequency (MHz)	Conducted Power (dBm)	Conducted Power (W)	Max. Limit (dBm)	Max. Limit (W)	Result
2412	21.44	0.14	30.00	1.00	Complies
2437	27.35	0.54	30.00	1.00	Complies
2462	21.56	0.14	30.00	1.00	Complies

Test Mode :TX N40 Mode_CH03/06/09_ANT 1

Frequency (MHz)	Conducted Power (dBm)	Conducted Power (W)	Max. Limit (dBm)	Max. Limit (W)	Result
2422	16.57	0.05	30.00	1.00	Complies
2437	20.03	0.10	30.00	1.00	Complies
2452	16.45	0.04	30.00	1.00	Complies

Test Mode :TX N40 Mode_CH03/06/09_ANT 2

Frequency (MHz)	Conducted Power (dBm)	Conducted Power (W)	Max. Limit (dBm)	Max. Limit (W)	Result
2422	16.51	0.04	30.00	1.00	Complies
2437	20.12	0.10	30.00	1.00	Complies
2452	16.55	0.05	30.00	1.00	Complies

Test Mode :TX N40 Mode_CH03/06/09_Total

Frequency (MHz)	Conducted Power (dBm)	Conducted Power (W)	Max. Limit (dBm)	Max. Limit (W)	Result
2422	19.55	0.09	30.00	1.00	Complies
2437	23.09	0.20	30.00	1.00	Complies
2452	19.51	0.09	30.00	1.00	Complies

For 2TX with beamforming

Test Mode :TX N20 Mode_CH01/06/11_ANT 1

Frequency (MHz)	Conducted Power (dBm)	Conducted Power (W)	Max. Limit (dBm)	Max. Limit (W)	Result
2412	15.36	0.03	28.74	0.75	Complies
2437	21.08	0.13	28.74	0.75	Complies
2462	15.21	0.03	28.74	0.75	Complies

Test Mode :TX N20 Mode_CH01/06/11_ANT 2

Frequency (MHz)	Conducted Power (dBm)	Conducted Power (W)	Max. Limit (dBm)	Max. Limit (W)	Result
2412	15.33	0.03	28.74	0.75	Complies
2437	20.96	0.12	28.74	0.75	Complies
2462	15.82	0.04	28.74	0.75	Complies

Test Mode :TX N20 Mode_CH01/06/11_Total

Frequency (MHz)	Conducted Power (dBm)	Conducted Power (W)	Max. Limit (dBm)	Max. Limit (W)	Result
2412	18.36	0.07	28.74	0.75	Complies
2437	24.03	0.25	28.74	0.75	Complies
2462	18.54	0.07	28.74	0.75	Complies

Test Mode :TX N40 Mode_CH03/06/09_ANT 1

Frequency (MHz)	Conducted Power (dBm)	Conducted Power (W)	Max. Limit (dBm)	Max. Limit (W)	Result
2422	13.52	0.02	28.74	0.75	Complies
2437	17.17	0.05	28.74	0.75	Complies
2452	13.39	0.02	28.74	0.75	Complies

Test Mode :TX N40 Mode_CH03/06/09_ANT 2

Frequency (MHz)	Conducted Power (dBm)	Conducted Power (W)	Max. Limit (dBm)	Max. Limit (W)	Result
2422	13.51	0.02	28.74	0.75	Complies
2437	13.28	0.02	28.74	0.75	Complies
2452	13.36	0.02	28.74	0.75	Complies

Test Mode :TX N40 Mode_CH03/06/09_Total

Frequency (MHz)	Conducted Power (dBm)	Conducted Power (W)	Max. Limit (dBm)	Max. Limit (W)	Result
2422	16.53	0.04	28.74	0.75	Complies
2437	18.66	0.07	28.74	0.75	Complies
2452	16.39	0.04	28.74	0.75	Complies

**ATTACHMENT G - ANTENNA CONDUCTED SPURIOUS
EMISSION**

For 1TX

Test Mode : TX B Mode

TX B mode CH01

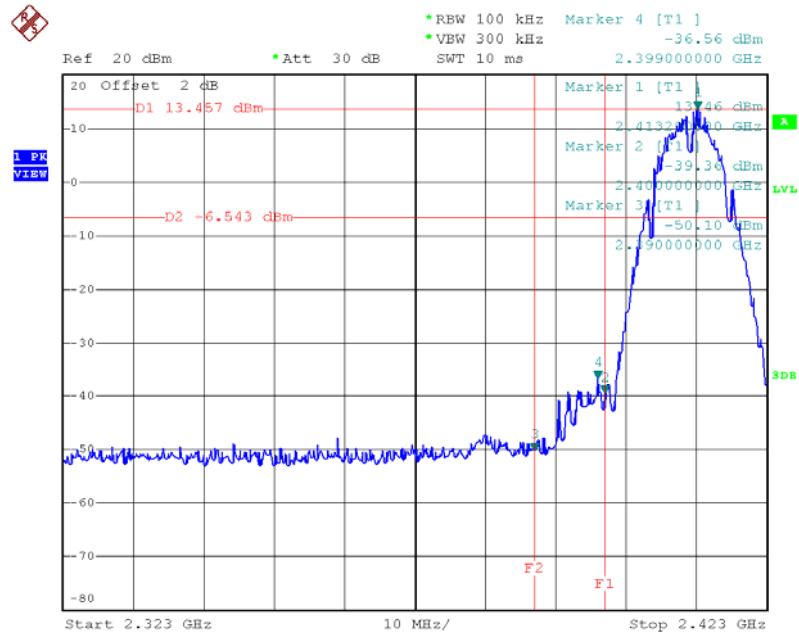

Date: 18.MAR.2015 13:23:30

TX B mode CH11

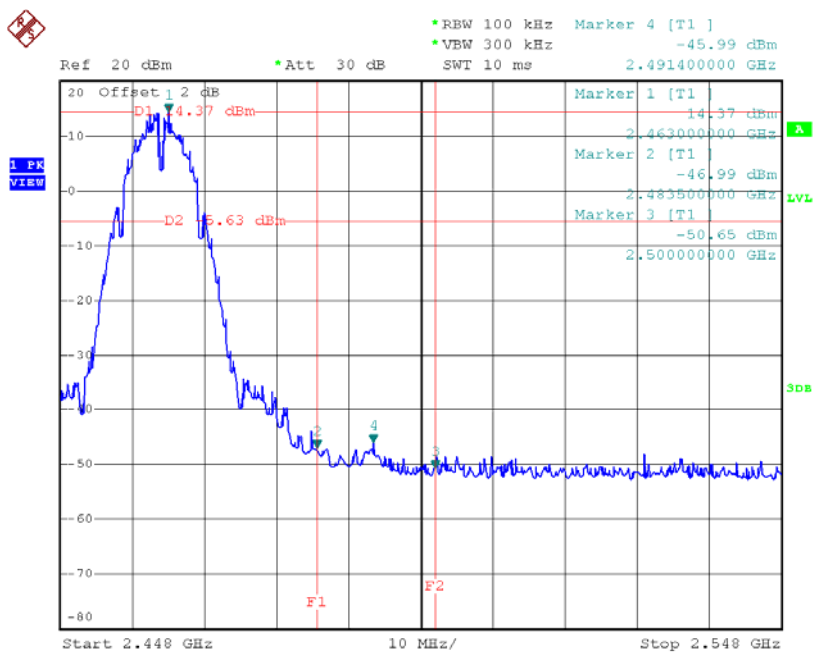

Date: 18.MAR.2015 13:26:03

TX B mode CH01 (10 Harmonic of the frequency)

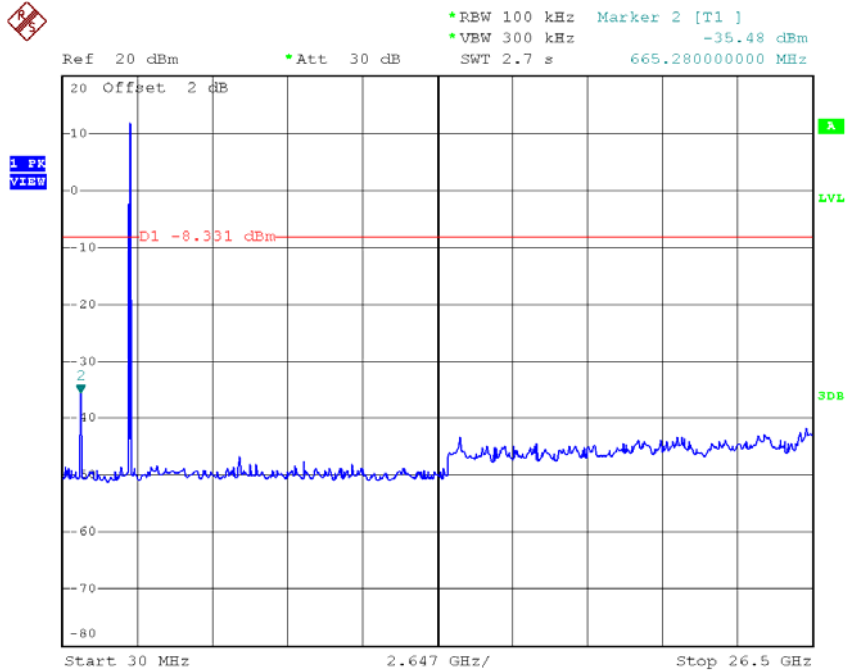

Date: 18.MAR.2015 13:23:22

TX B mode CH06 (10 Harmonic of the frequency)

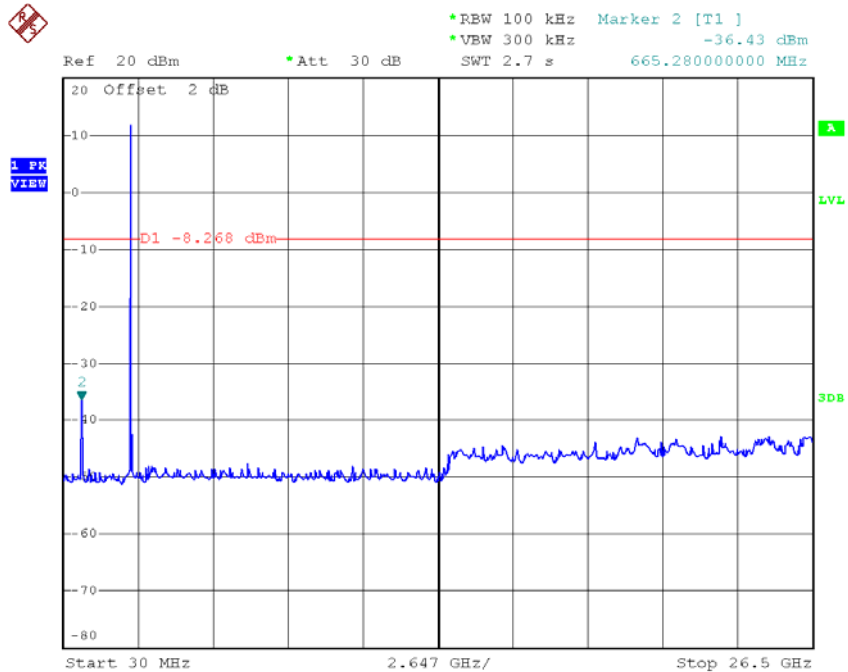

Date: 18.MAR.2015 13:24:53

TX B mode CH11 (10 Harmonic of the frequency)



*REW 100 kHz Marker 2 [T1]
*VBW 300 kHz -33.26 dBm
SWT 2.7 s 718.22000000 MHz

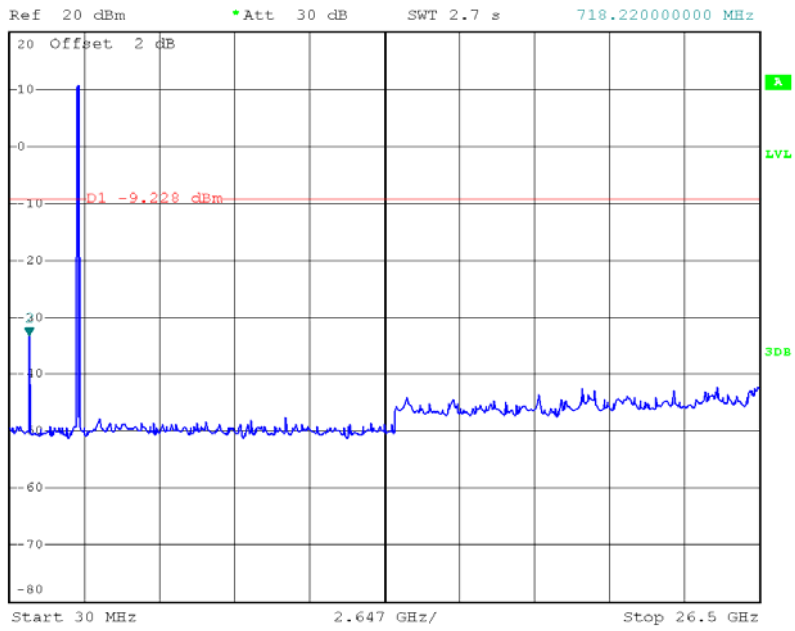

Date: 18.MAR.2015 13:25:56

Test Mode : TX G Mode

TX G mode CH01

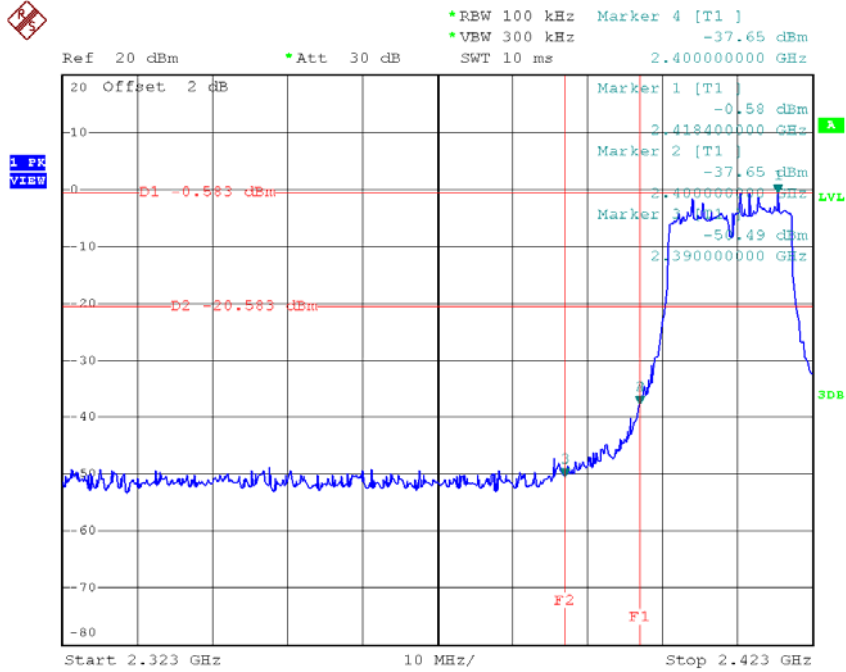

Date: 18.MAR.2015 13:27:35

TX G mode CH11

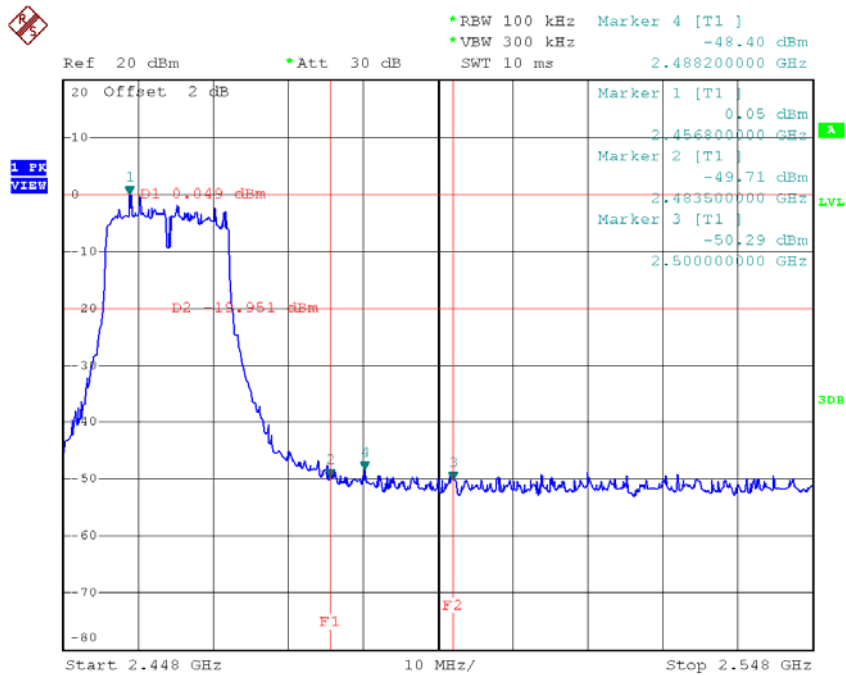

Date: 18.MAR.2015 13:35:49

TX G mode CH01 (10 Harmonic of the frequency)

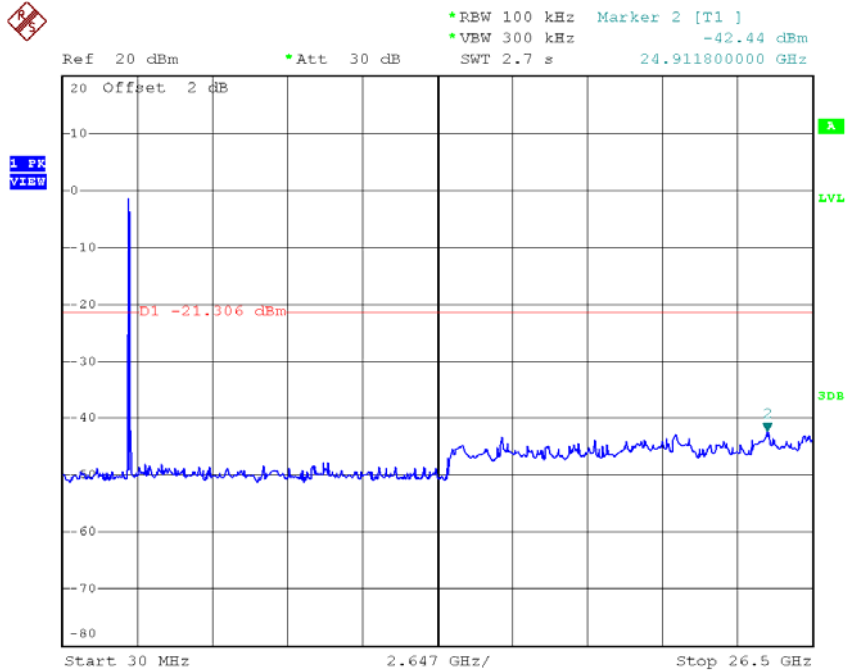

Date: 18.MAR.2015 13:27:28

TX G mode CH06 (10 Harmonic of the frequency)

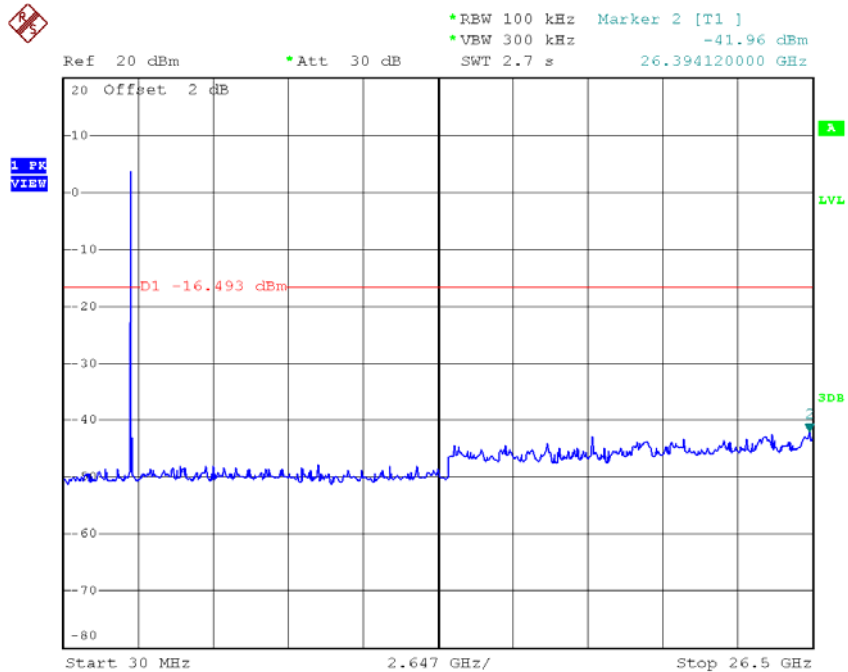

Date: 18.MAR.2015 13:31:28

TX G mode CH11 (10 Harmonic of the frequency)



Ref 20 dBm *Att 30 dB *REW 100 kHz Marker 2 [T1]
*VBW 300 kHz -42.16 dBm
SWT 2.7 s 21.682460000 GHz

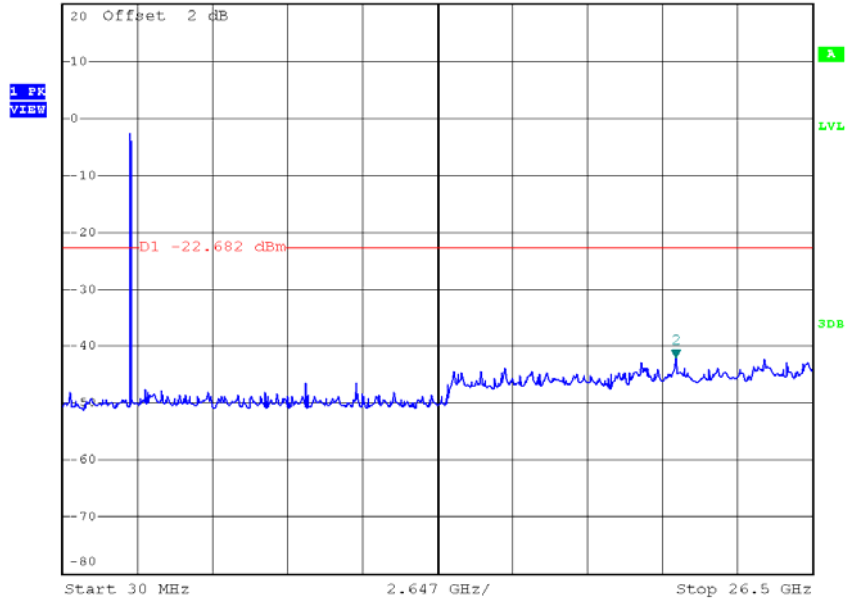

Date: 18.MAR.2015 13:35:42

Test Mode : TX N-20M Mode

TX HT20 mode CH01

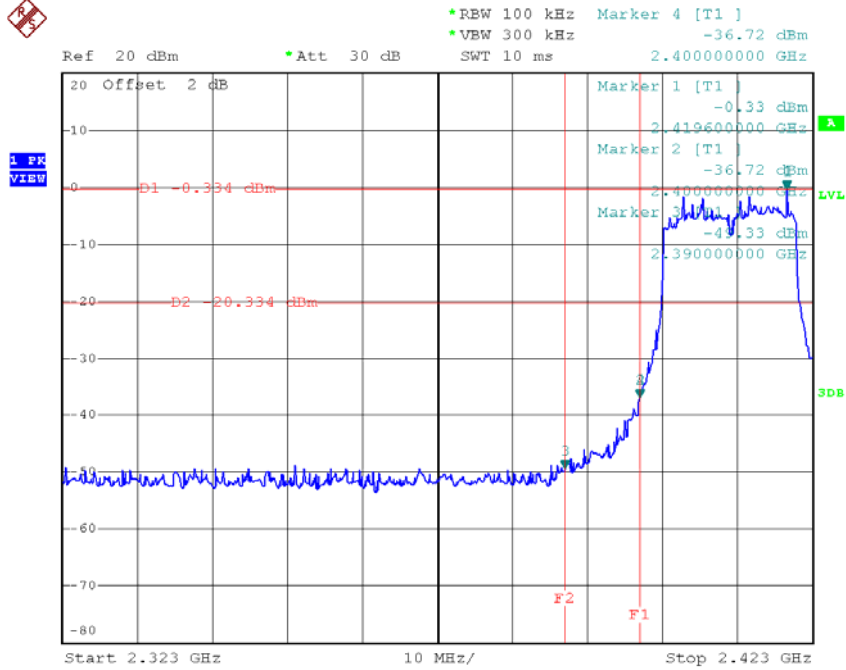

Date: 18.MAR.2015 13:37:40

TX HT20 mode CH11

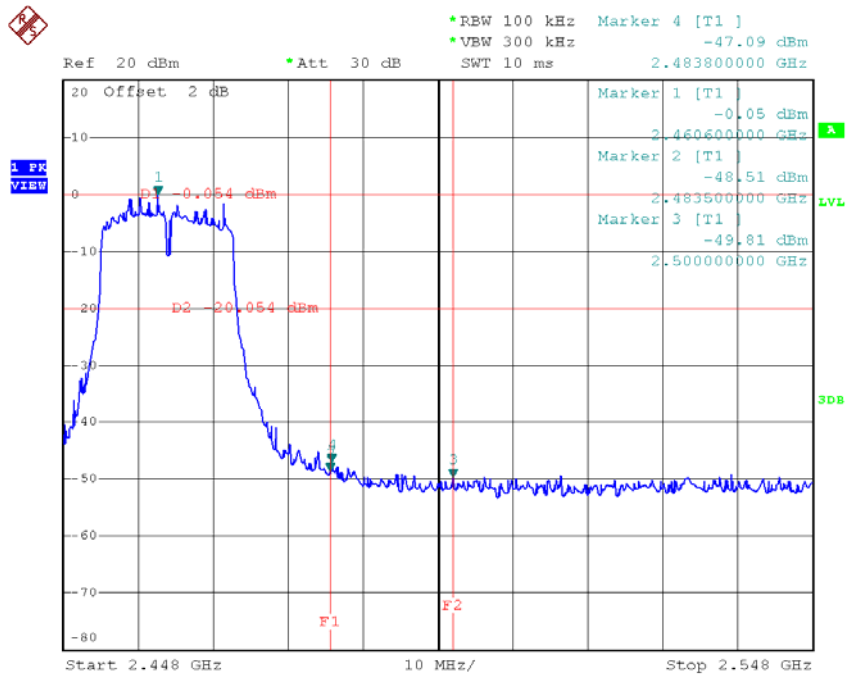

Date: 18.MAR.2015 13:39:44

TX HT20 mode CH01 (10 Harmonic of the frequency)

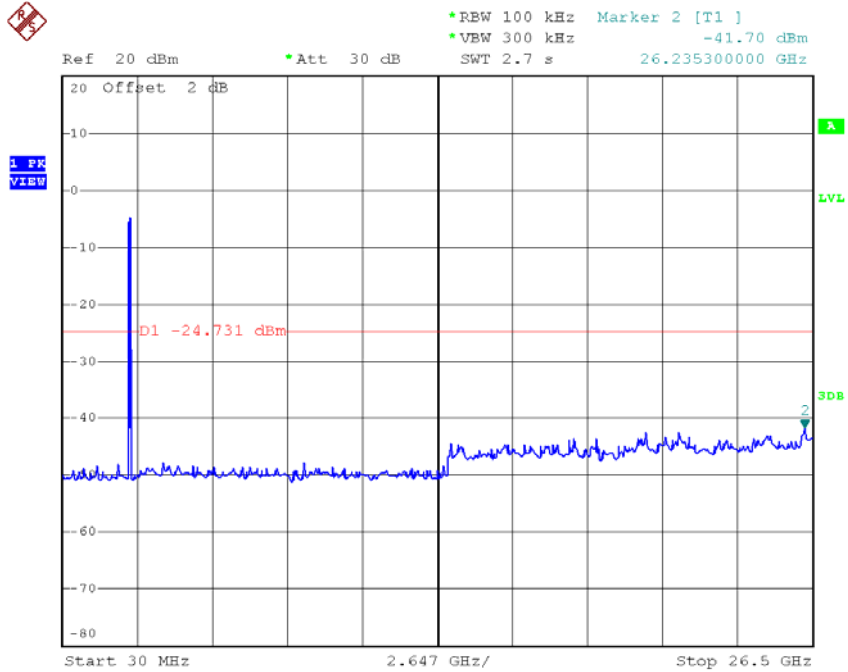

Date: 18.MAR.2015 13:37:33

TX HT20 mode CH06 (10 Harmonic of the frequency)

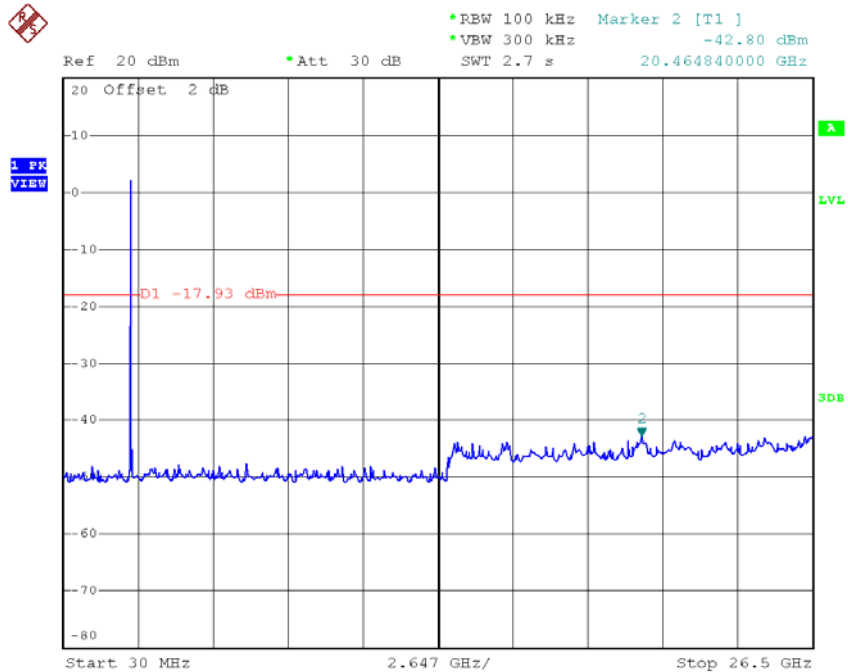

Date: 18.MAR.2015 13:38:39

TX HT20 mode CH11 (10 Harmonic of the frequency)



Ref 20 dBm *Att 30 dB *REW 100 kHz Marker 2 [T1]
*VBW 300 kHz -42.33 dBm
SWT 2.7 s 26.394120000 GHz

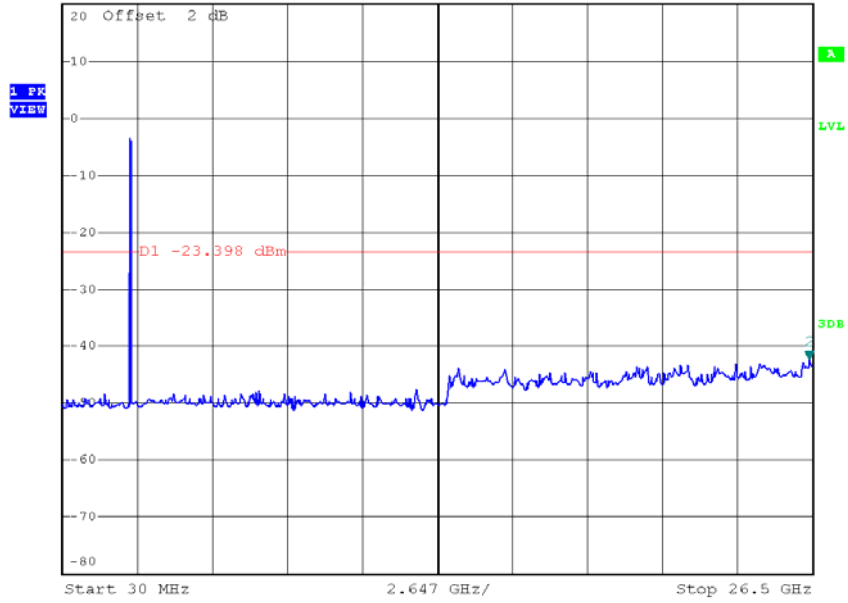

Date: 18.MAR.2015 13:39:36

Test Mode : TX N-40M Mode

TX HT40 mode CH03

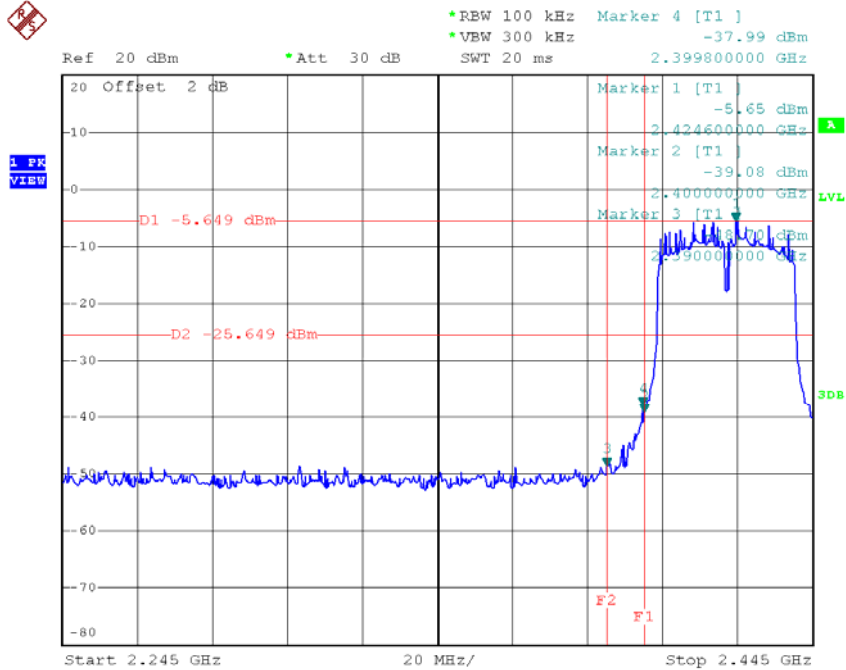

Date: 18.MAR.2015 13:41:01

TX HT40 mode CH09

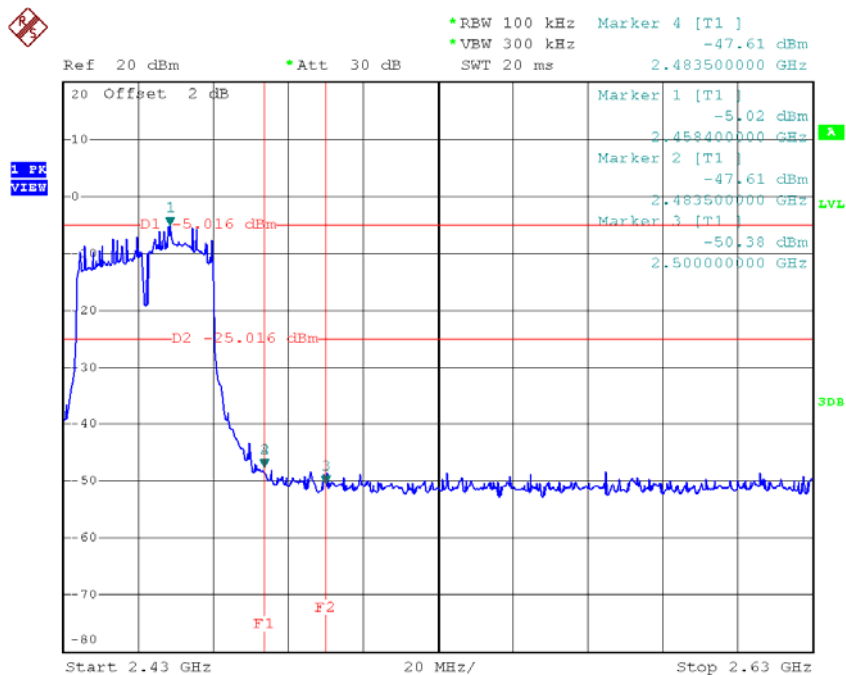

Date: 18.MAR.2015 13:43:20

TX HT40 mode CH03 (10 Harmonic of the frequency)

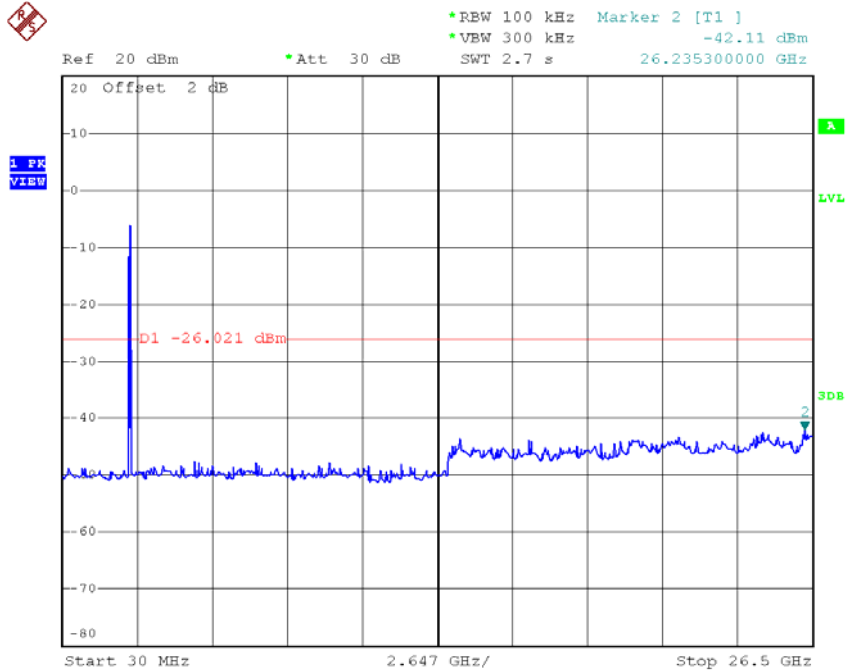

Date: 18.MAR.2015 13:40:53

TX HT40 mode CH06 (10 Harmonic of the frequency)

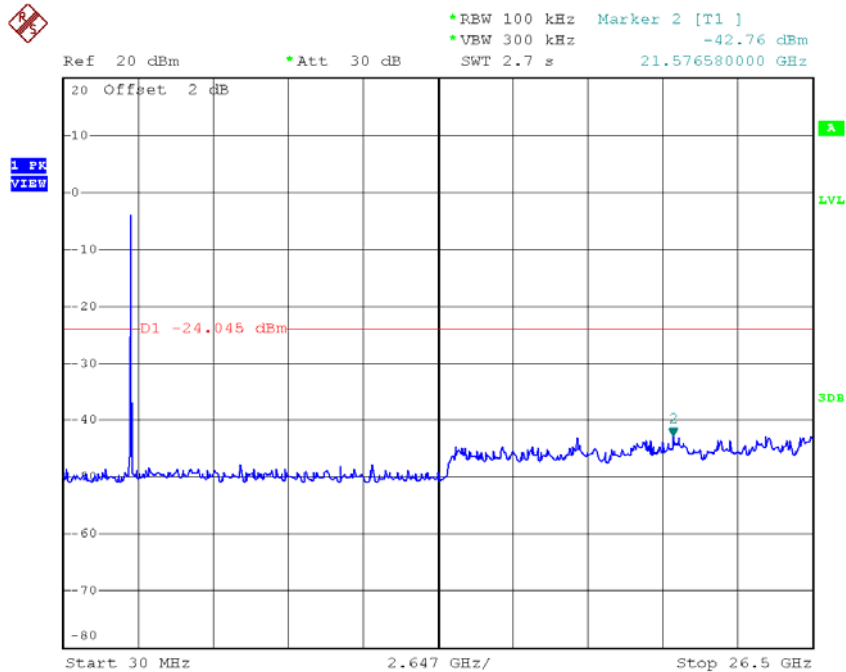

Date: 18.MAR.2015 13:42:05

TX HT40 mode CH09 (10 Harmonic of the frequency)



*REW 100 kHz Marker 2 [T1]
*VBW 300 kHz -42.29 dBm
SWT 2.7 s 24.964740000 GHz

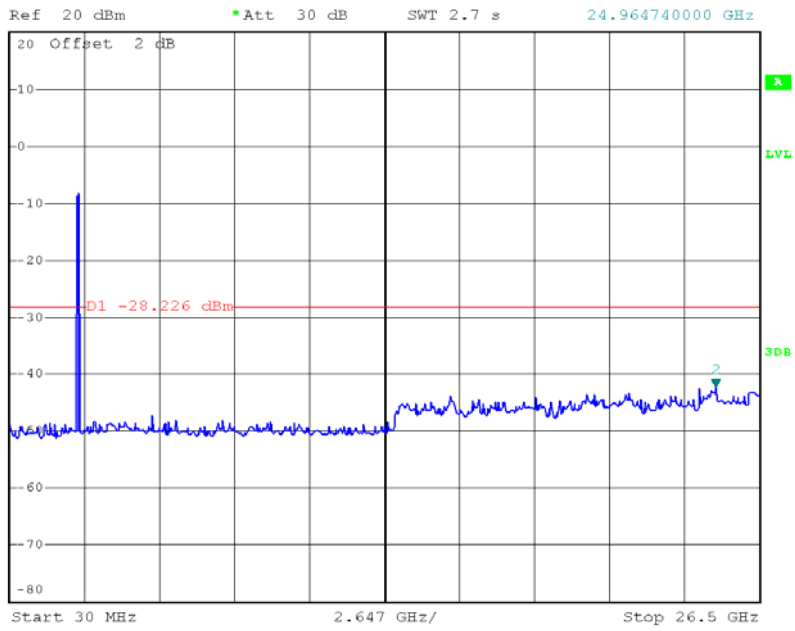

Date: 18.MAR.2015 13:43:13

For 2TX

Test Mode : TX B Mode_ANT 1

TX B mode CH01

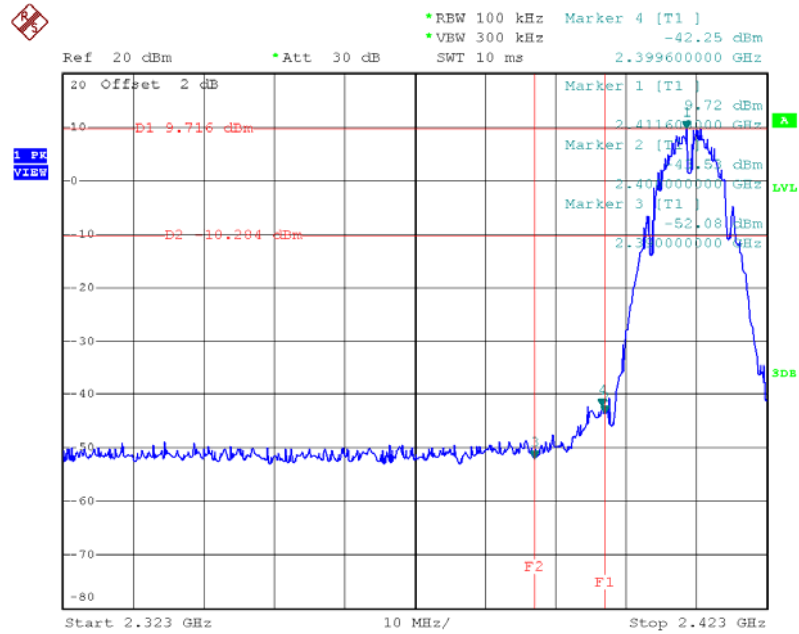

Date: 18.MAR.2015 13:48:51

TX B mode CH11

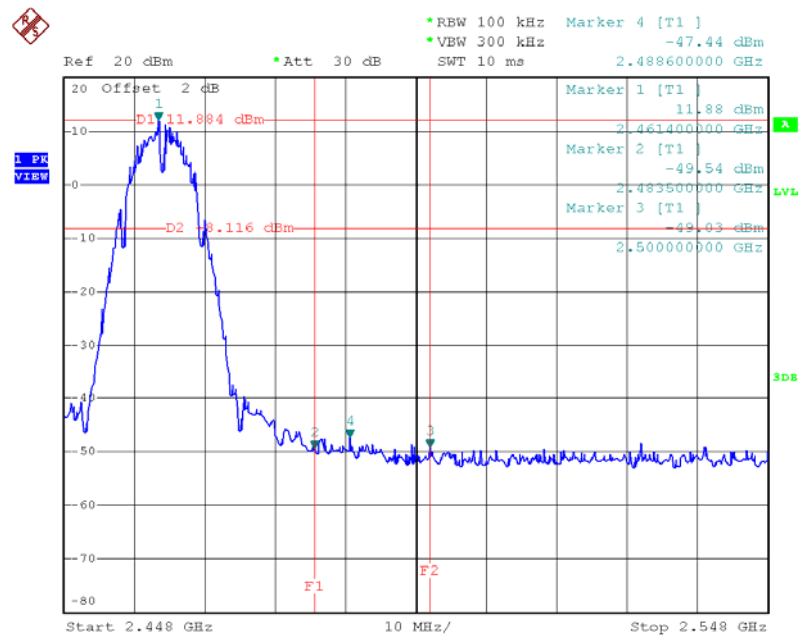

Date: 18.MAR.2015 13:52:27

TX B mode CH01 (10 Harmonic of the frequency)

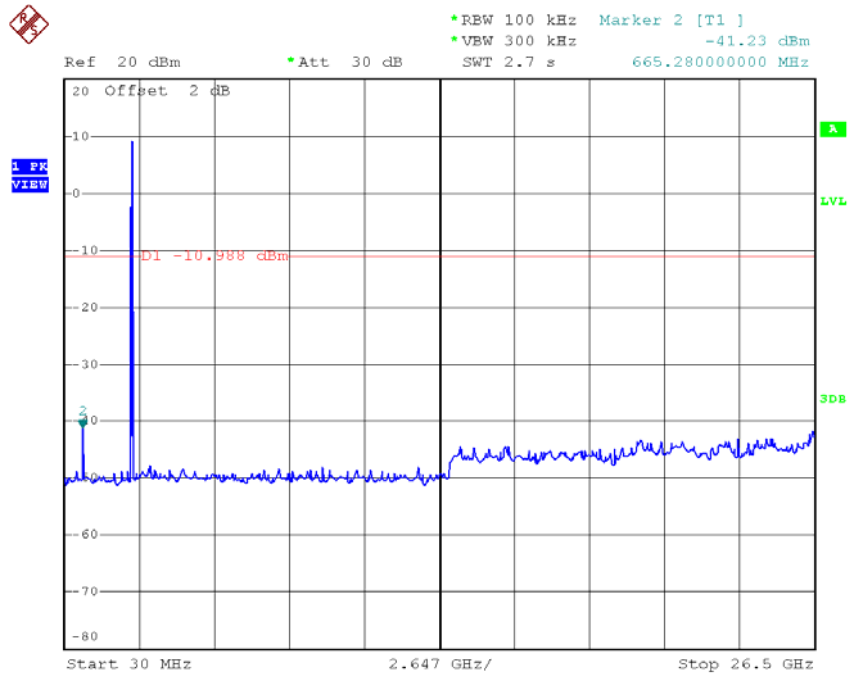

Date: 18.MAR.2015 13:48:43

TX B mode CH06 (10 Harmonic of the frequency)

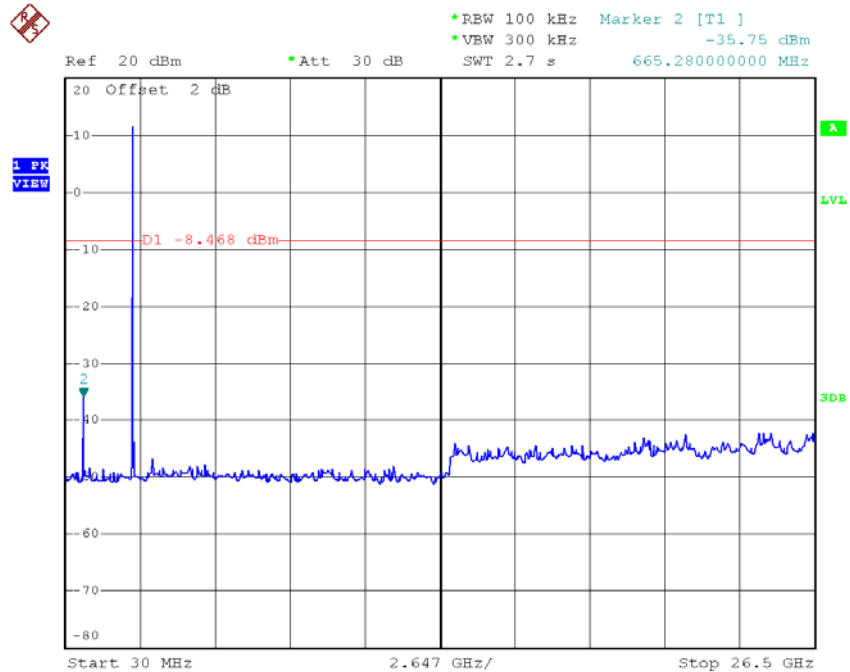

Date: 18.MAR.2015 13:51:19

TX B mode CH11 (10 Harmonic of the frequency)

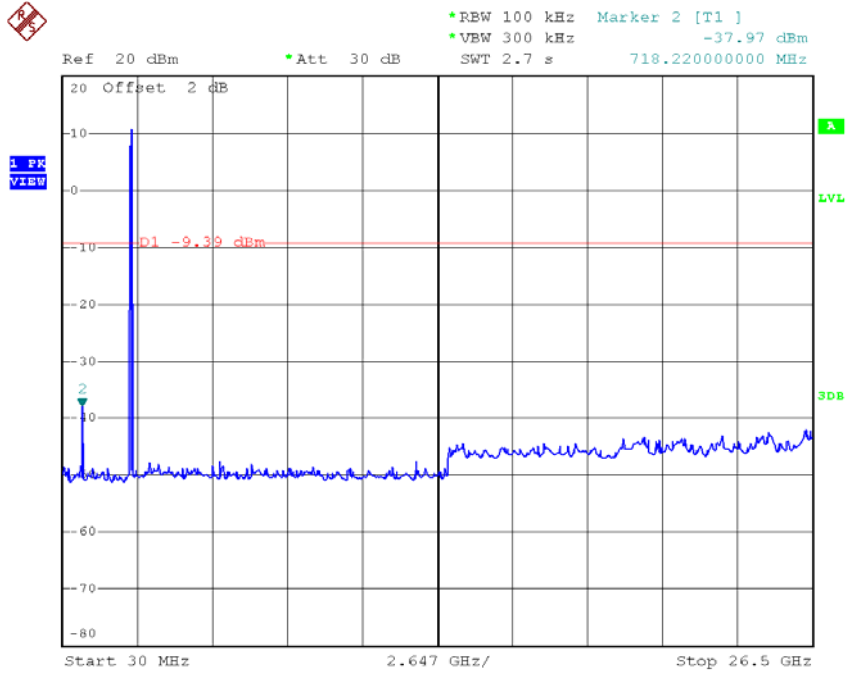

Date: 18.MAR.2015 13:52:19

Test Mode : TX B Mode_ANT 2

TX B mode CH01

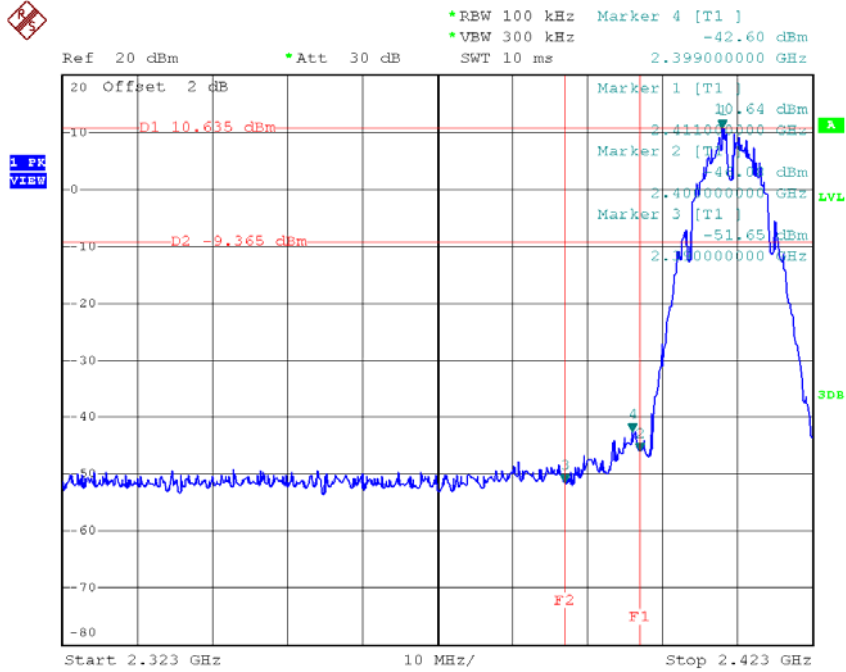

Date: 18.MAR.2015 14:10:44

TX B mode CH11

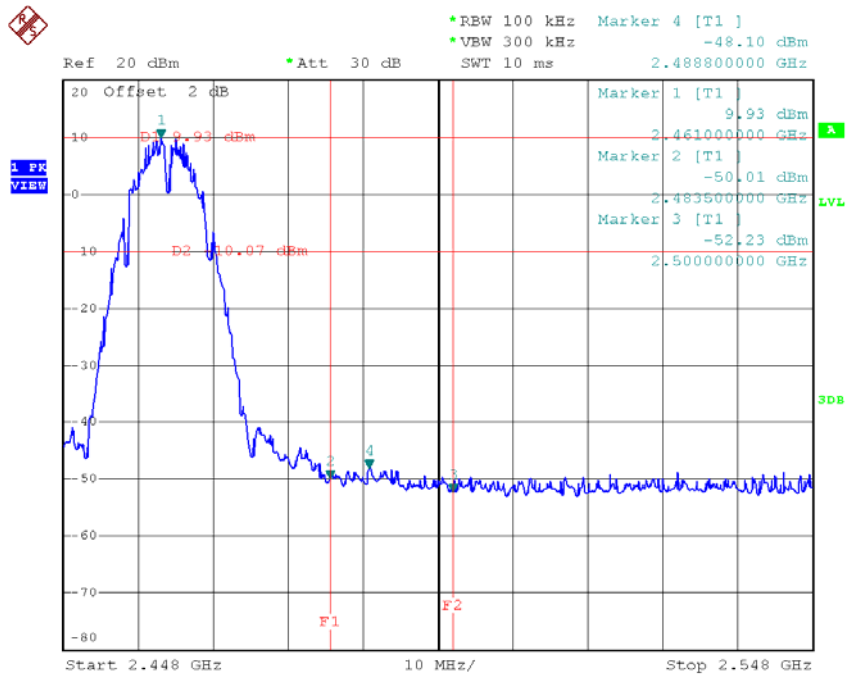

Date: 18.MAR.2015 14:12:43

TX B mode CH01 (10 Harmonic of the frequency)

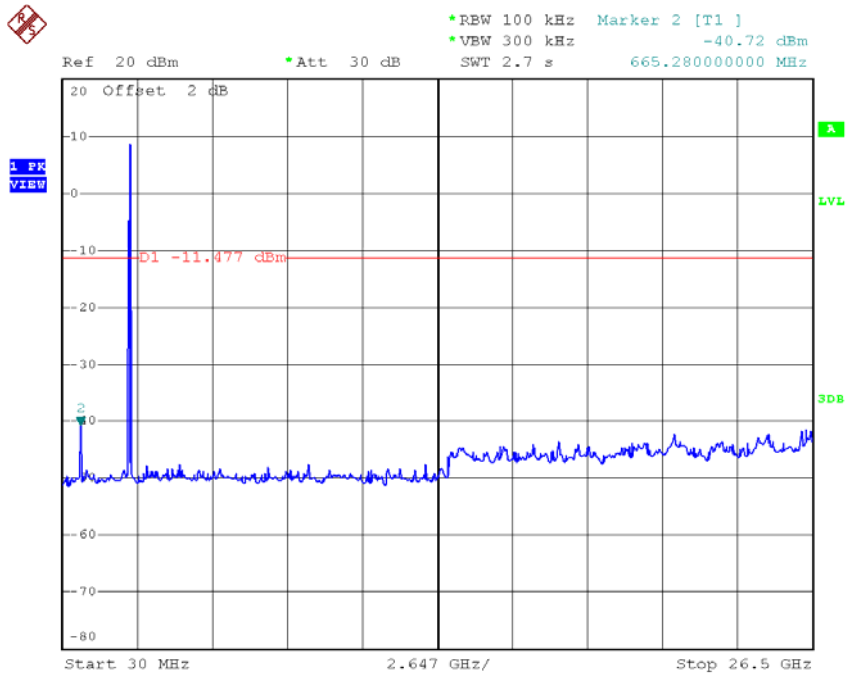

Date: 18.MAR.2015 14:10:36

TX B mode CH06 (10 Harmonic of the frequency)

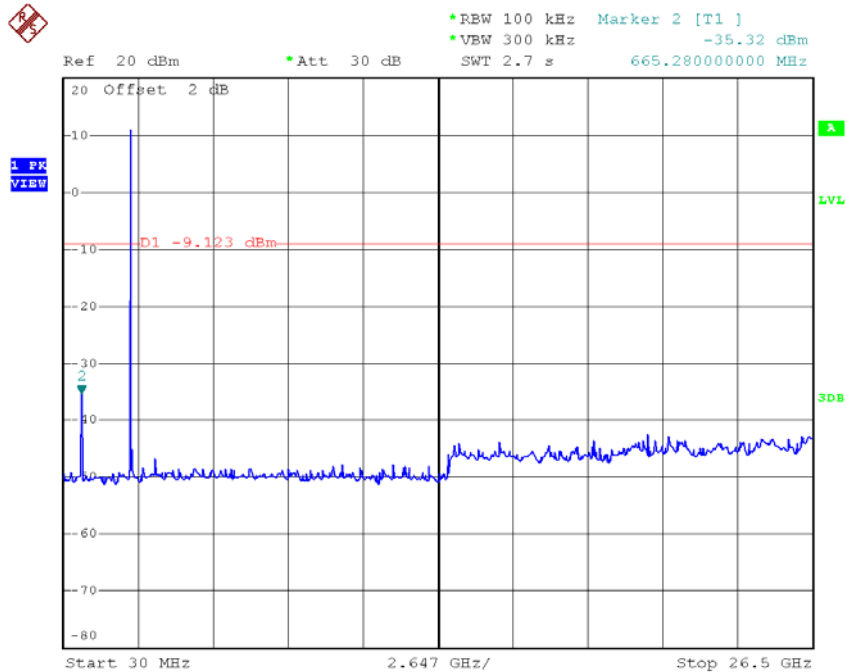

Date: 18.MAR.2015 14:11:48

TX B mode CH11 (10 Harmonic of the frequency)



*REW 100 kHz Marker 2 [T1]
*VBW 300 kHz -40.53 dBm
SWT 2.7 s 718.22000000 MHz

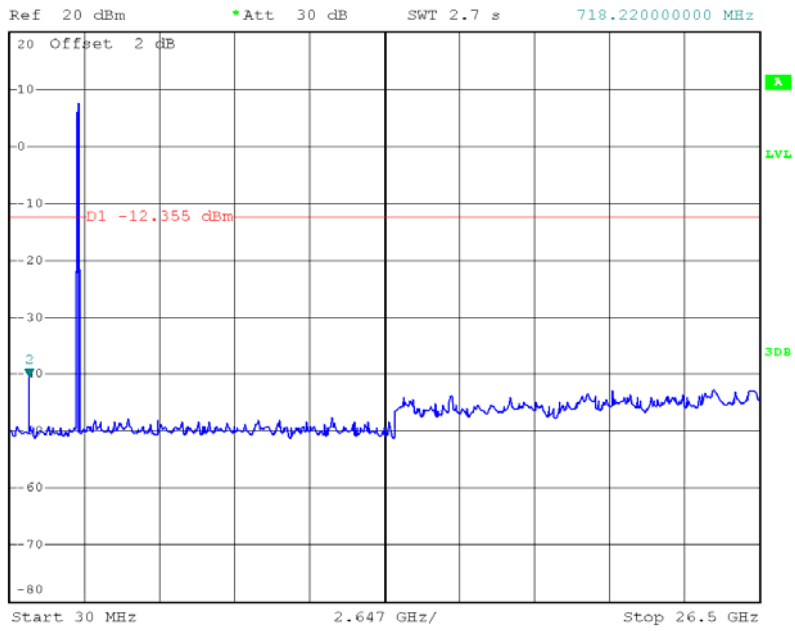

Date: 18.MAR.2015 14:12:36

Test Mode : TX G Mode_ANT 1

TX G mode CH01

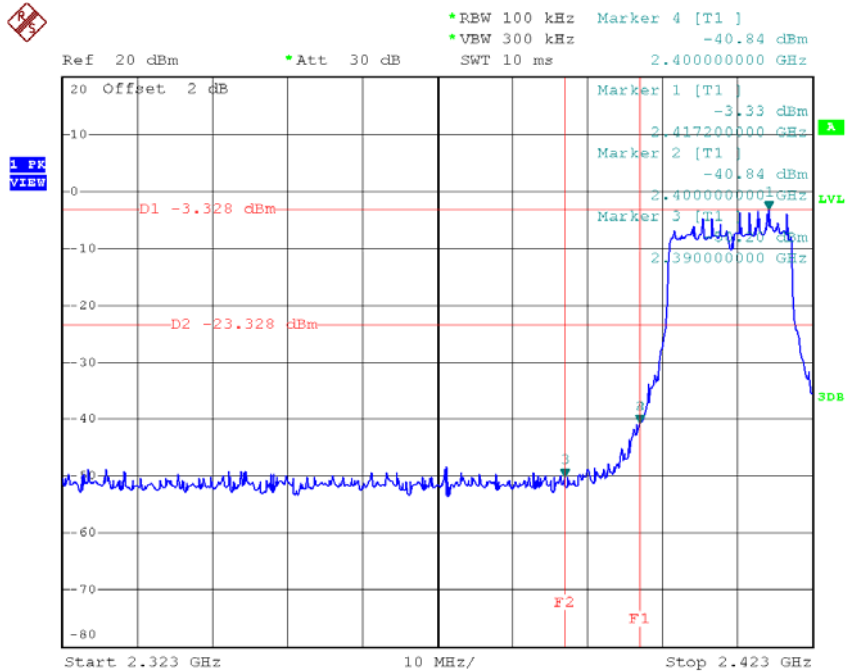

Date: 18.MAR.2015 13:54:02

TX G mode CH11

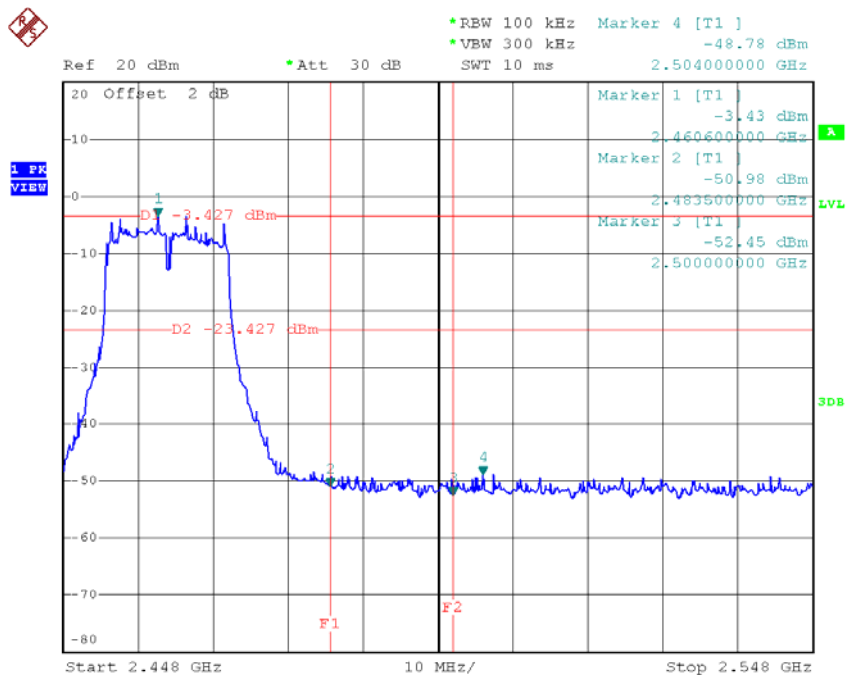

Date: 18.MAR.2015 13:56:16

TX G mode CH11 (10 Harmonic of the frequency)



*REW 100 kHz Marker 2 [T1]
*VBW 300 kHz -42.21 dBm
SWT 2.7 s 26.447060000 GHz

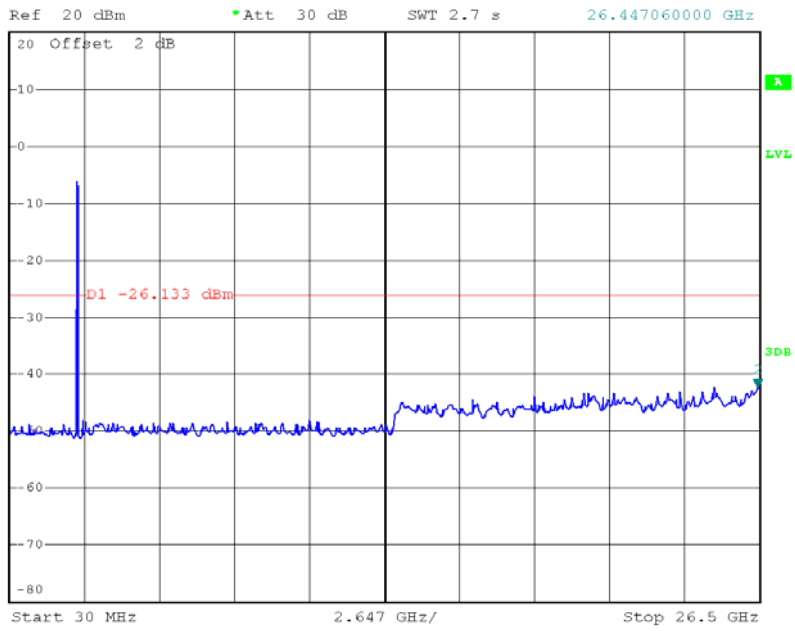

Date: 18.MAR.2015 13:56:09

Test Mode : TX G Mode_ANT 2

TX G mode CH01

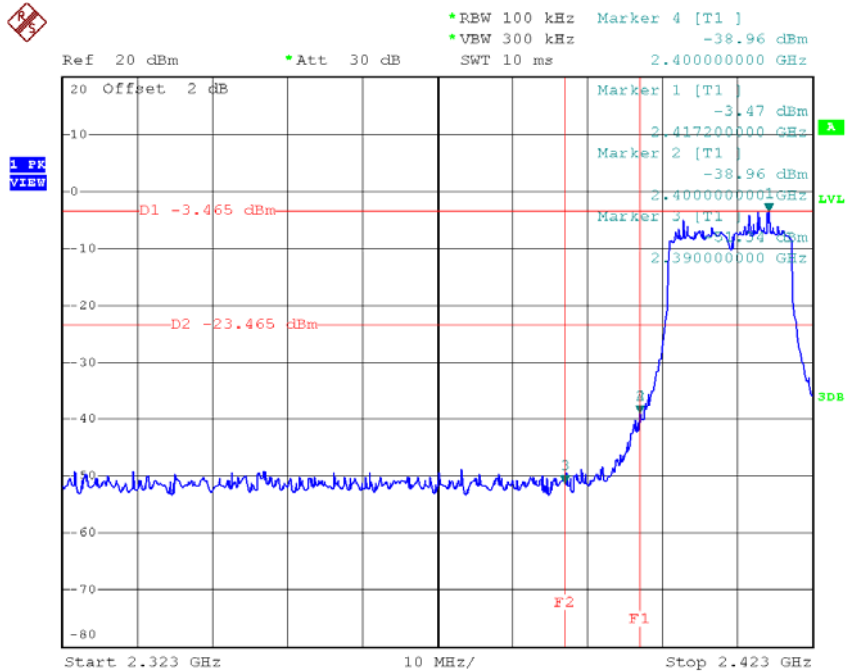

Date: 18.MAR.2015 14:13:55

TX G mode CH11

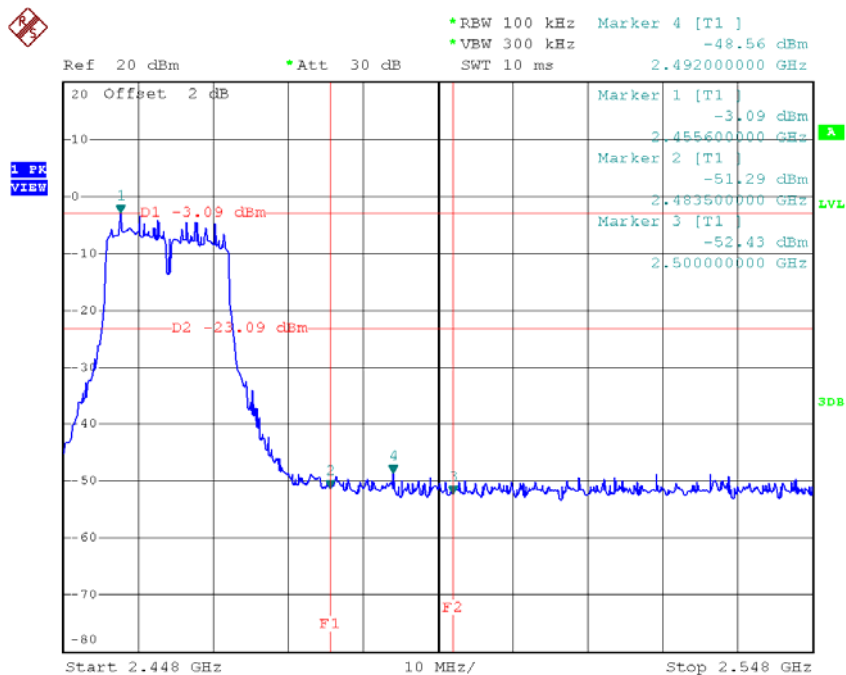

Date: 18.MAR.2015 14:15:41

TX G mode CH11 (10 Harmonic of the frequency)



*REW 100 kHz Marker 2 [T1]
*VBW 300 kHz -42.49 dBm
SWT 2.7 s 26.235300000 GHz

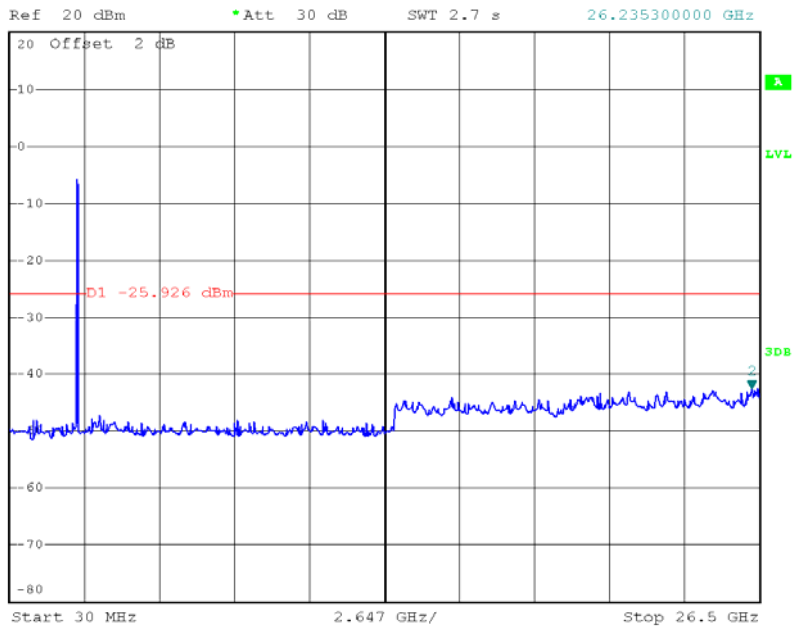

Date: 18.MAR.2015 14:15:34

Test Mode : TX N-20M Mode_ANT 1

TX HT20 mode CH01

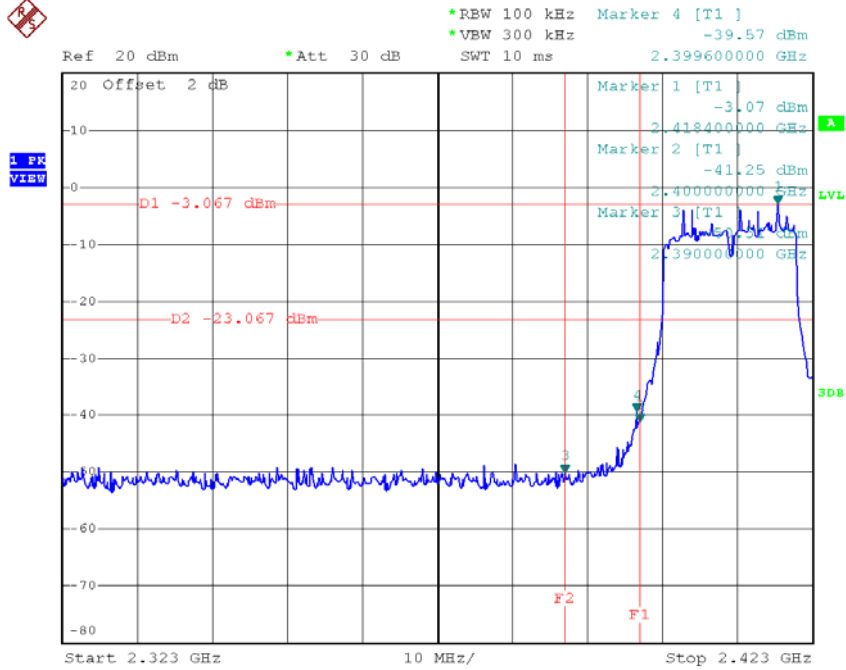

Date: 18.MAR.2015 13:57:44

TX HT20 mode CH11

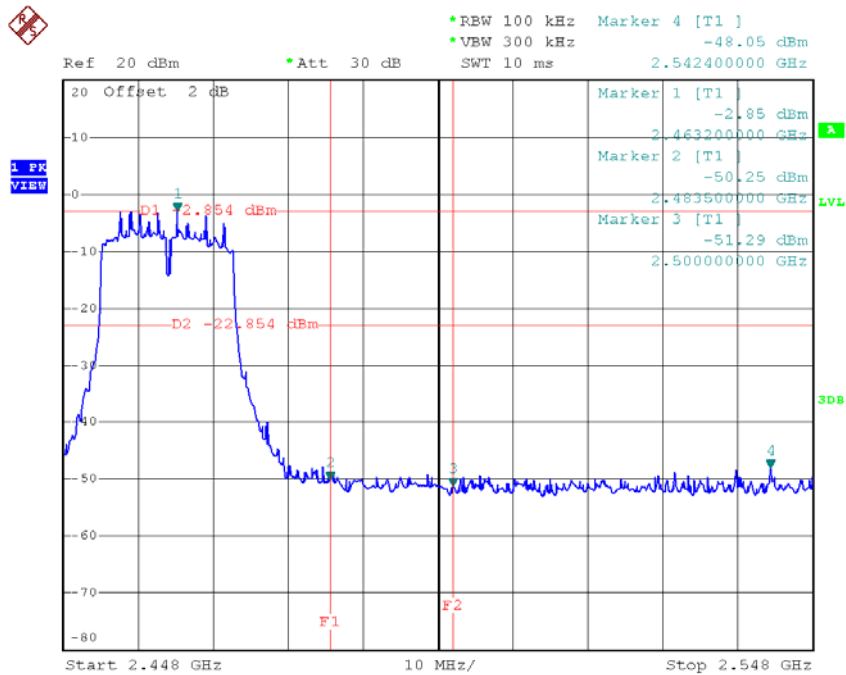

Date: 18.MAR.2015 13:59:58

TX HT20 mode CH01 (10 Harmonic of the frequency)

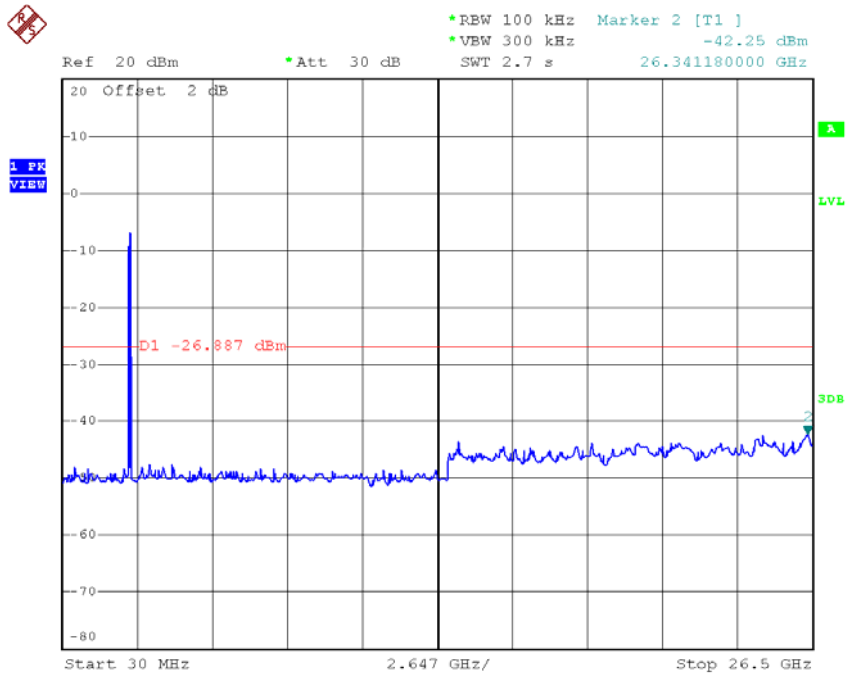

Date: 18.MAR.2015 13:57:36

TX HT20 mode CH06 (10 Harmonic of the frequency)

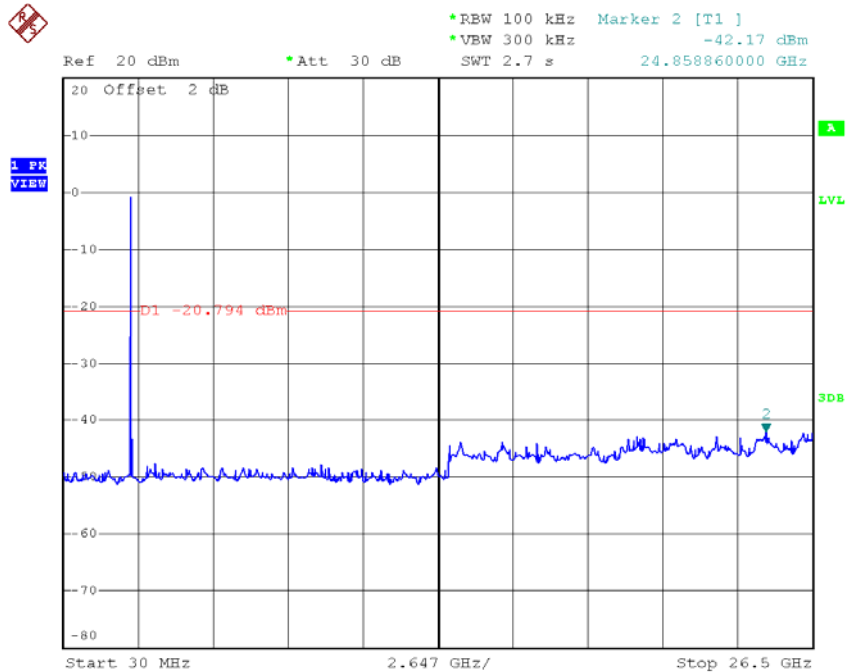

Date: 18.MAR.2015 13:58:57

TX HT20 mode CH11 (10 Harmonic of the frequency)



*REW 100 kHz Marker 2 [T1]
 *VBW 300 kHz -41.38 dBm
 Ref 20 dBm *Att 30 dB SWT 2.7 s 24.805920000 GHz

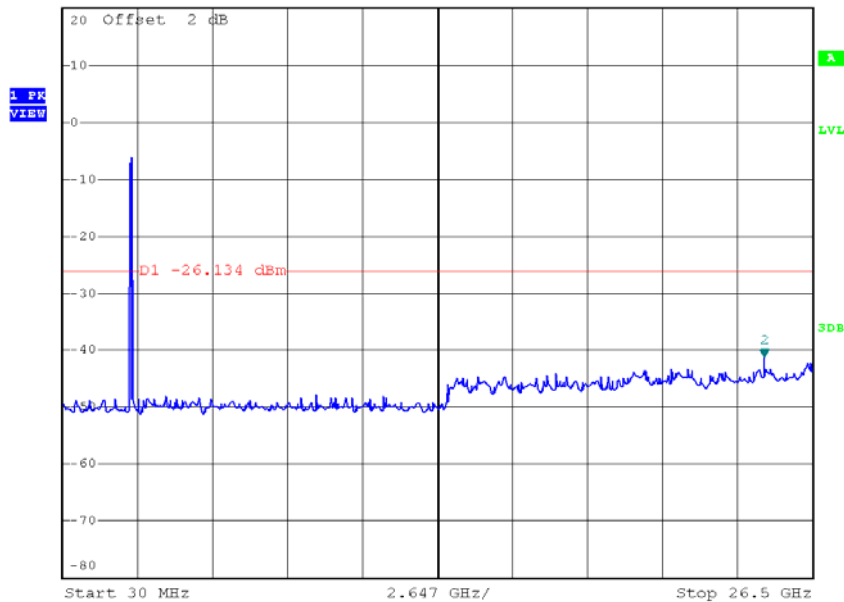

Date: 18.MAR.2015 13:59:50

Test Mode : TX N-20M Mode_ANT 2

TX HT20 mode CH01

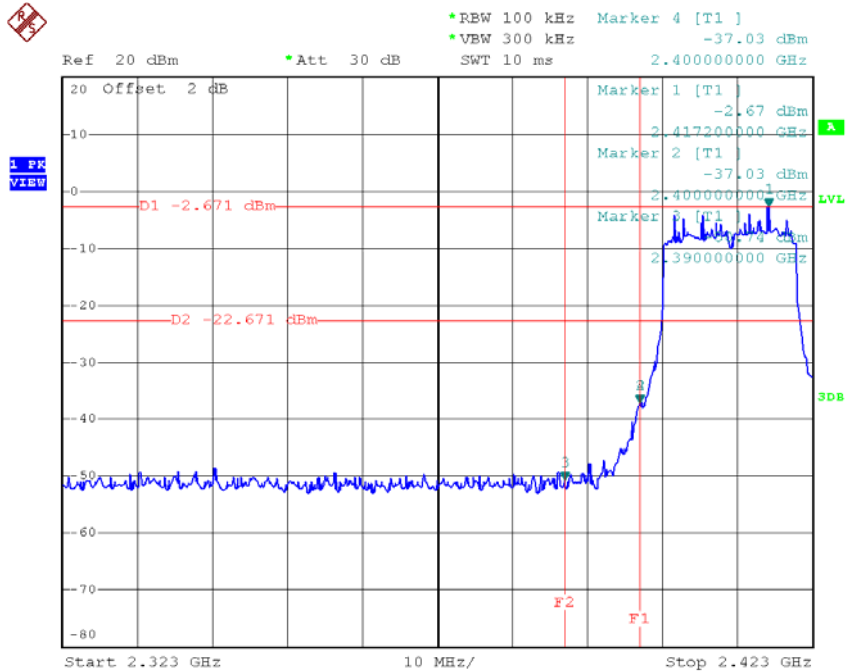

Date: 18.MAR.2015 14:16:45

TX HT20 mode CH11

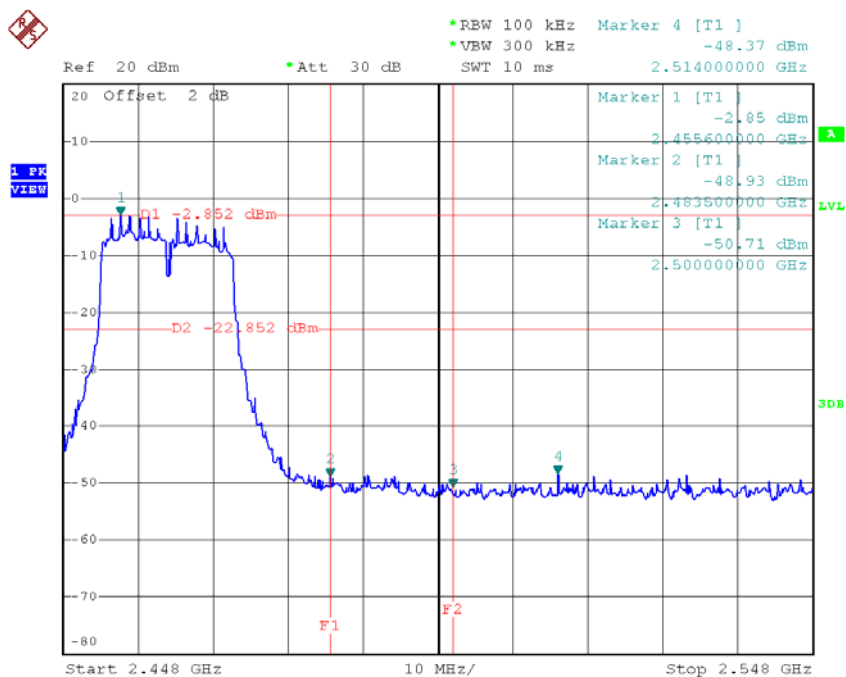

Date: 18.MAR.2015 14:18:49

TX HT20 mode CH01 (10 Harmonic of the frequency)

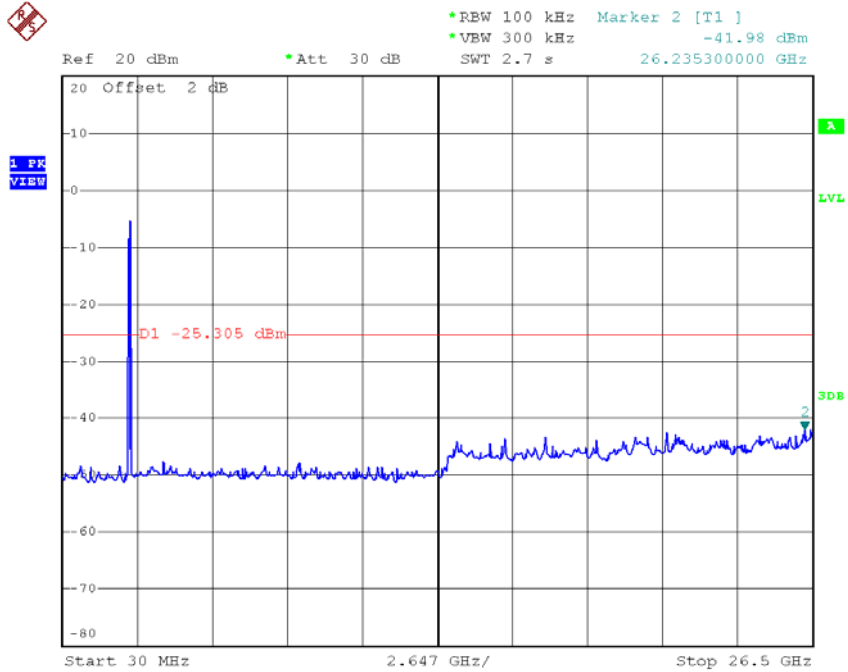

Date: 18.MAR.2015 14:16:38

TX HT20 mode CH06 (10 Harmonic of the frequency)

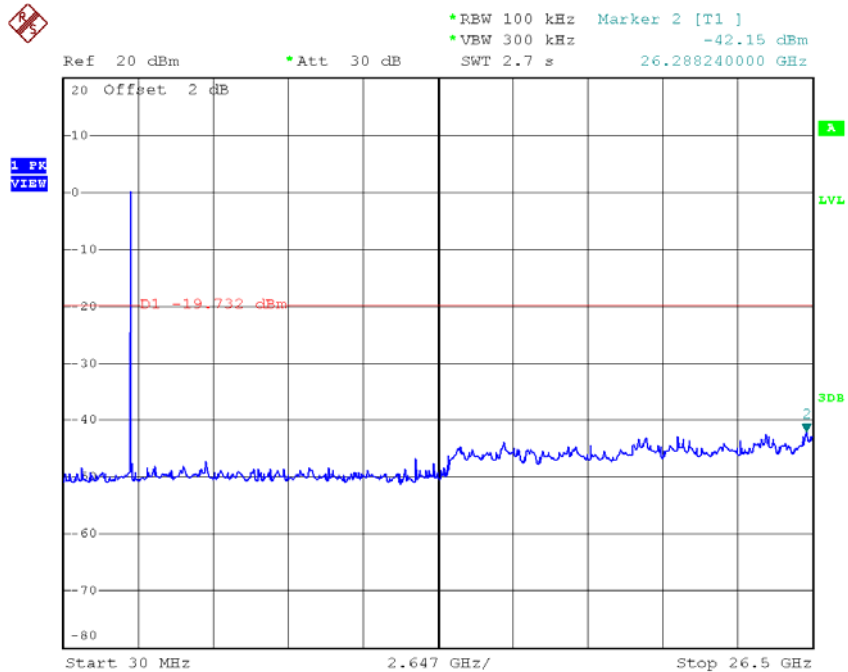

Date: 18.MAR.2015 14:17:33

TX HT20 mode CH11 (10 Harmonic of the frequency)



Ref 20 dBm *Att 30 dB *REW 100 kHz Marker 2 [T1]
*VBW 300 kHz -42.01 dBm
SWT 2.7 s 26.341180000 GHz

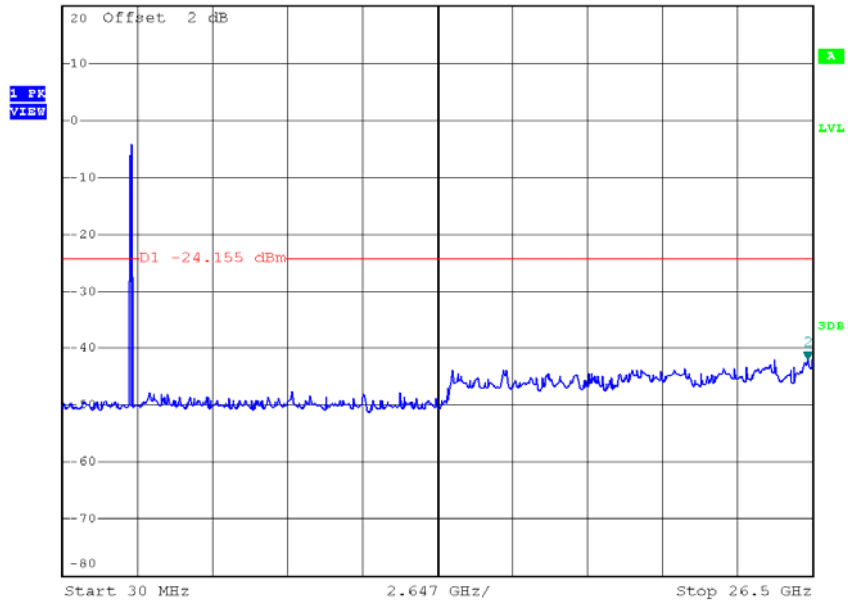

Date: 18.MAR.2015 14:18:42

Test Mode : TX N-40M Mode_ANT 1

TX HT40 mode CH03

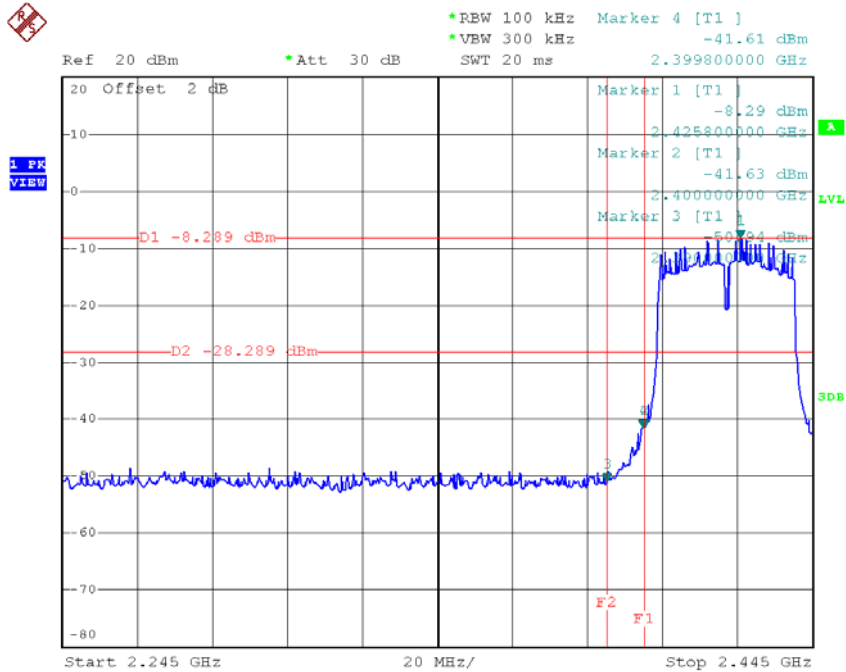

Date: 18.MAR.2015 14:01:08

TX HT40 mode CH09

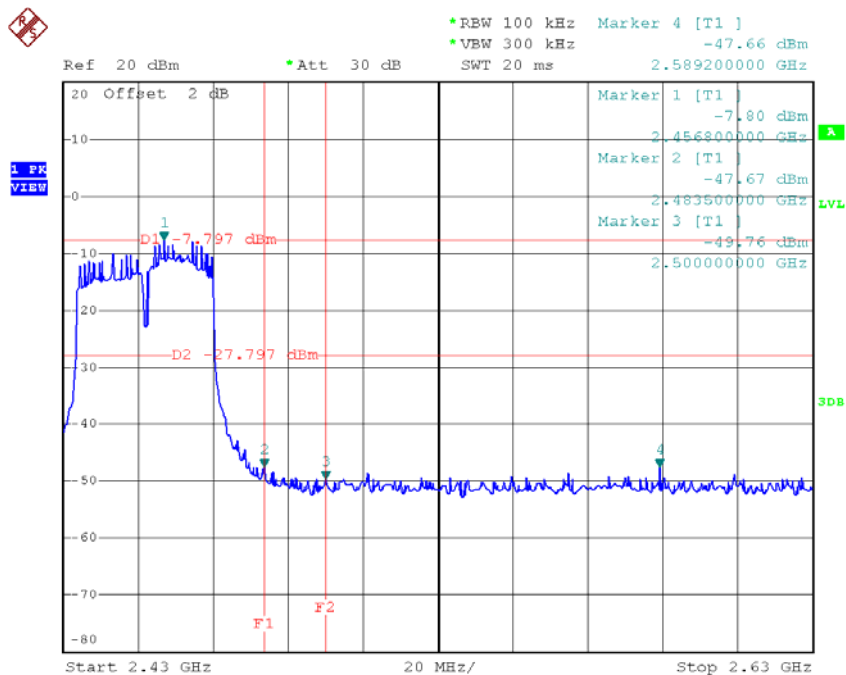

Date: 18.MAR.2015 14:07:27

TX HT40 mode CH03 (10 Harmonic of the frequency)

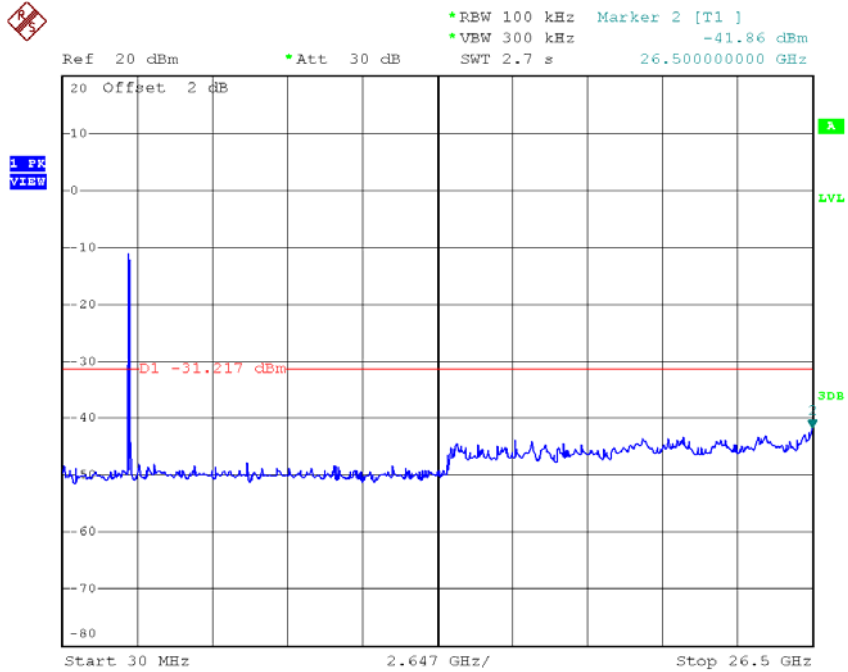

Date: 18.MAR.2015 14:01:01

TX HT40 mode CH06 (10 Harmonic of the frequency)

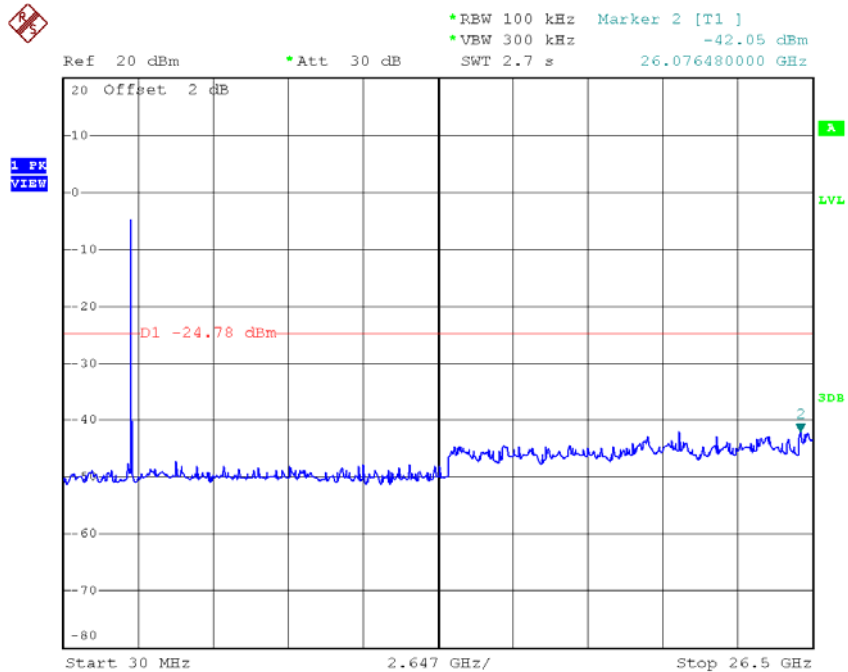

Date: 18.MAR.2015 14:02:09

TX HT40 mode CH09 (10 Harmonic of the frequency)



Ref 20 dBm *Att 30 dB *REW 100 kHz Marker 2 [T1]
*VBW 300 kHz -41.41 dBm
SWT 2.7 s 26.182360000 GHz

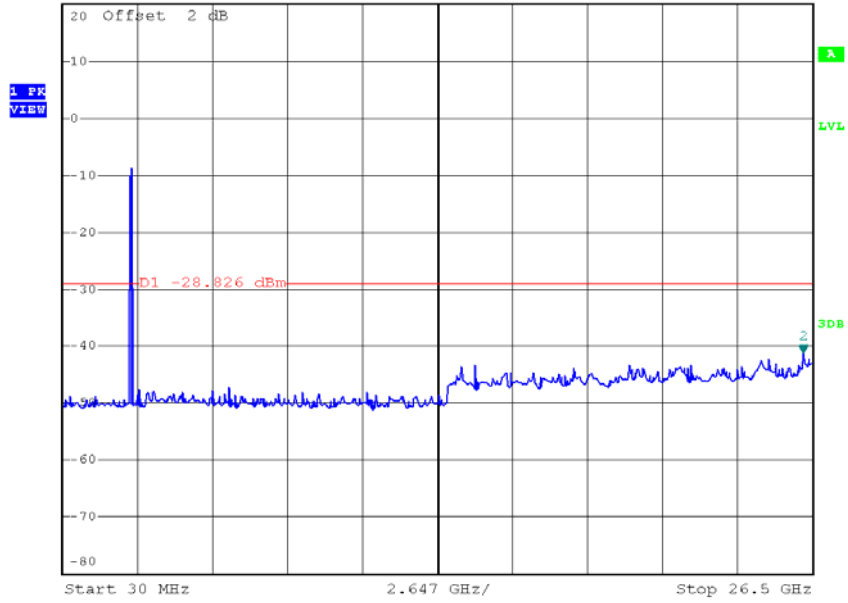

Date: 18.MAR.2015 14:07:19

Test Mode : TX N-40M Mode_ANT 2

TX HT40 mode CH03

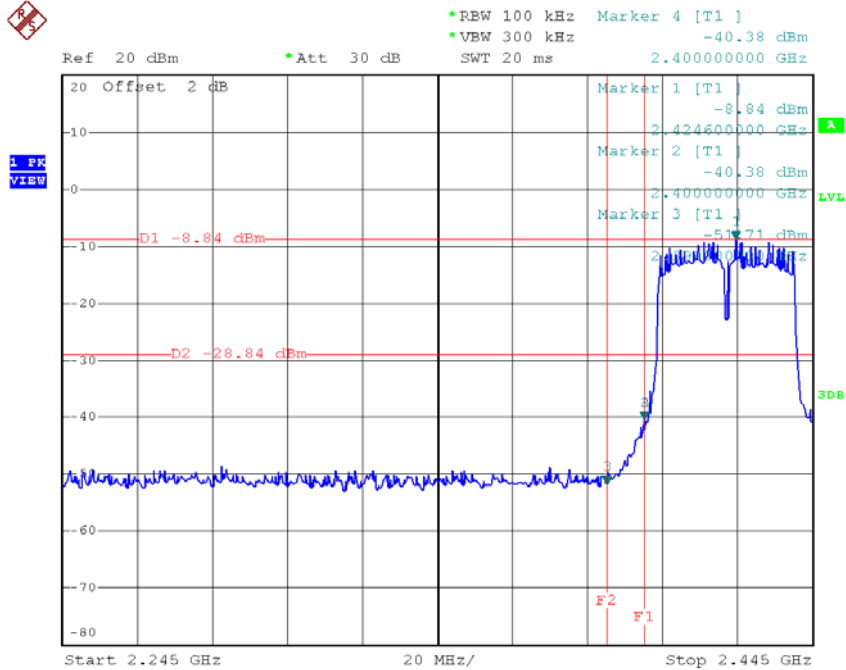

Date: 18.MAR.2015 14:22:03

TX HT40 mode CH09

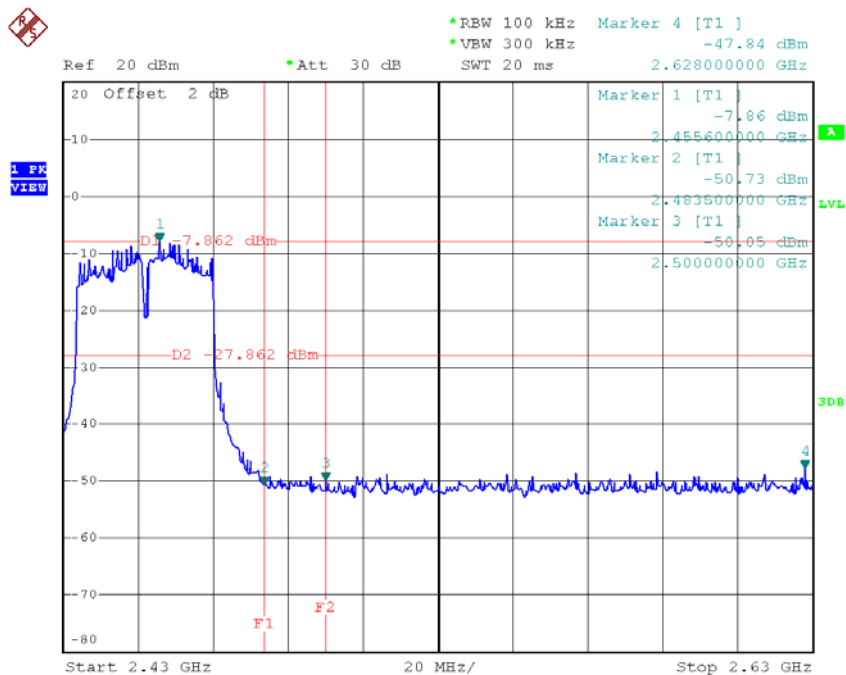

Date: 18.MAR.2015 14:24:22

TX HT40 mode CH09 (10 Harmonic of the frequency)



*REW 100 kHz Marker 2 [T1]
*VBW 300 kHz -42.24 dBm
SWT 2.7 s 25.070620000 GHz

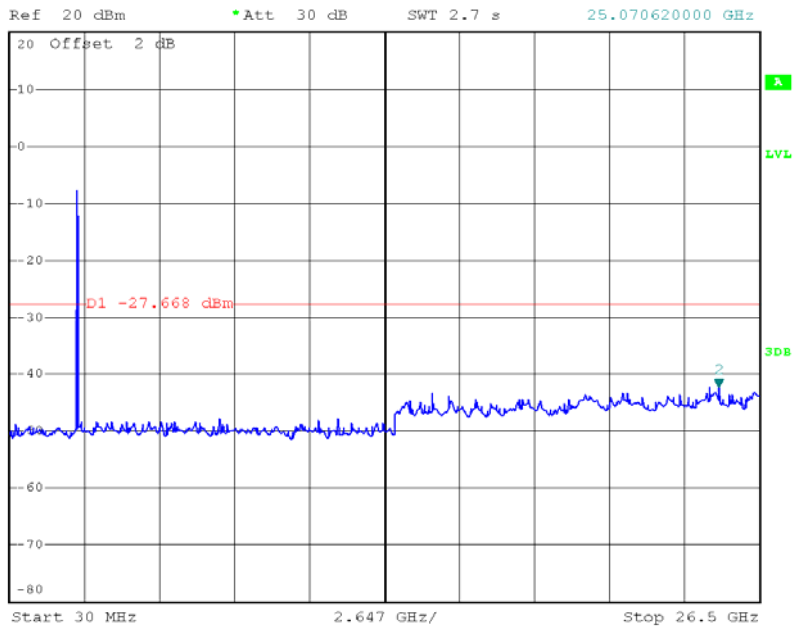

Date: 18.MAR.2015 14:24:14

For 2TX with beamforming

Test Mode : TX N-20M Mode_ANT 1

TX HT20 mode CH01

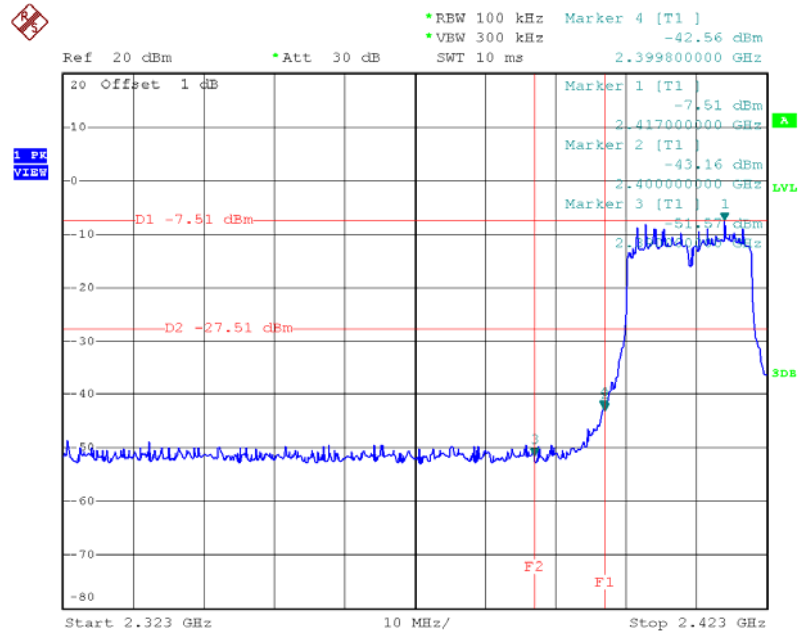

Date: 7.APR.2015 15:25:47

TX HT20 mode CH11

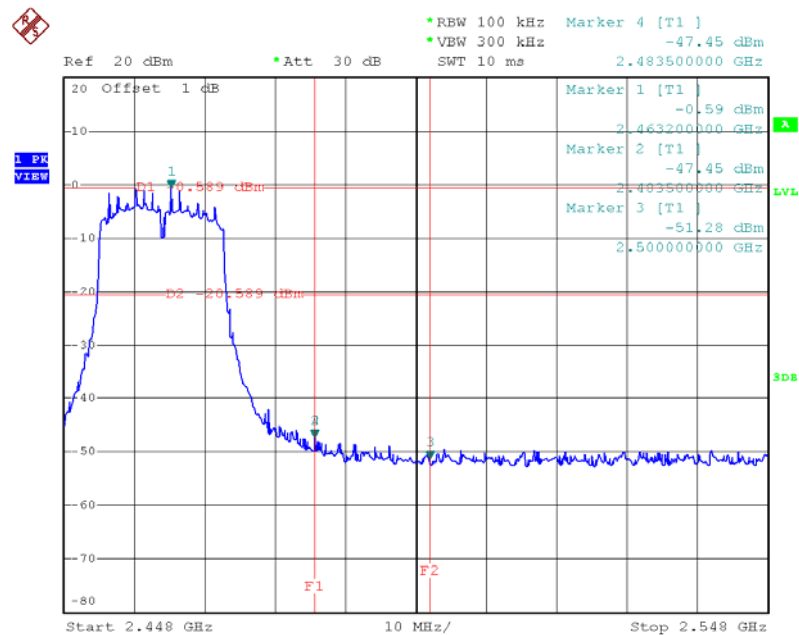

Date: 7.APR.2015 15:28:55

TX HT20 mode CH01 (10 Harmonic of the frequency)

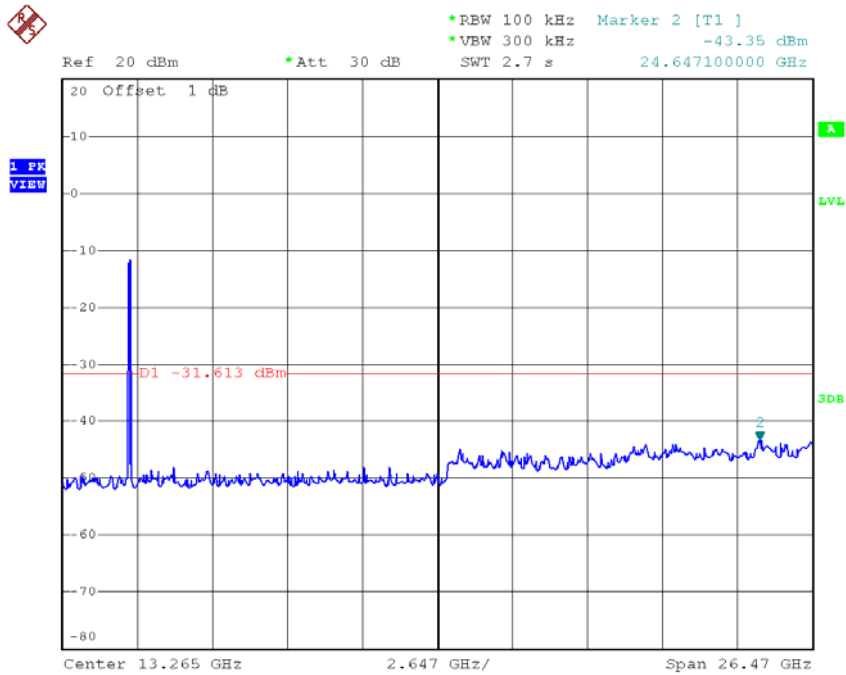

Date: 7.APR.2015 15:25:07

TX HT20 mode CH06 (10 Harmonic of the frequency)

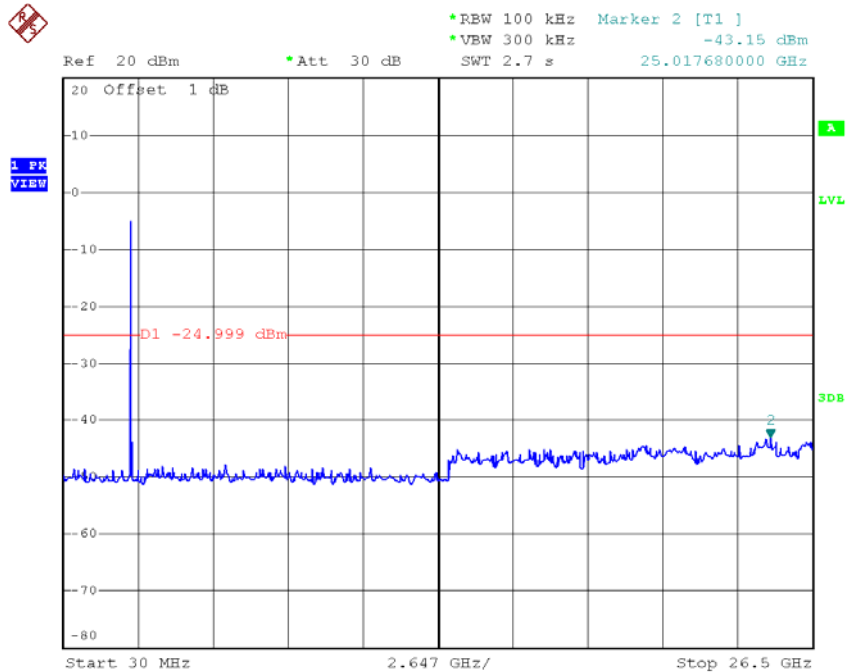

Date: 7.APR.2015 15:26:38

TX HT20 mode CH11 (10 Harmonic of the frequency)



*REW 100 kHz Marker 2 [T1]
*VBW 300 kHz -42.79 dBm
Ref 20 dBm *Att 30 dB SWT 2.7 s 26.394120000 GHz

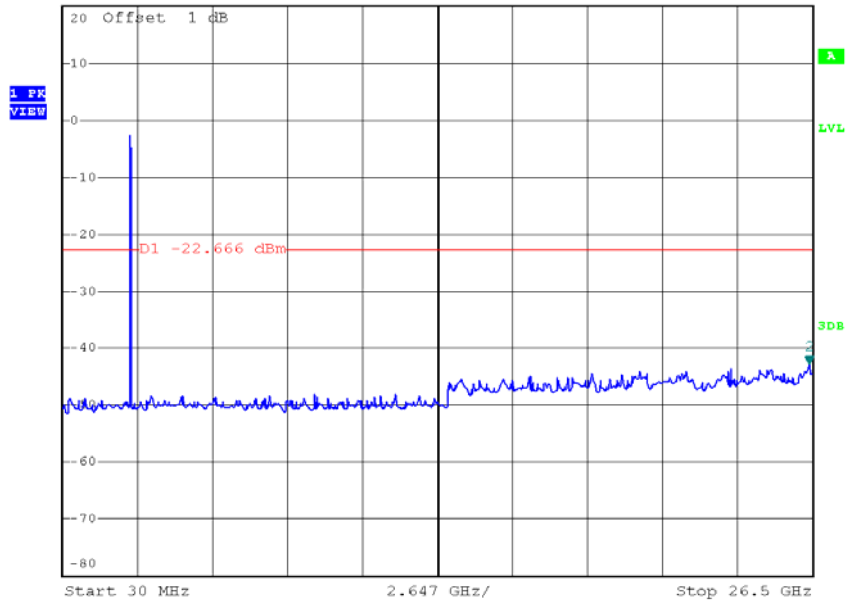

Date: 7.APR.2015 15:28:48

Test Mode : TX N-20M Mode_ANT 2

TX HT20 mode CH01

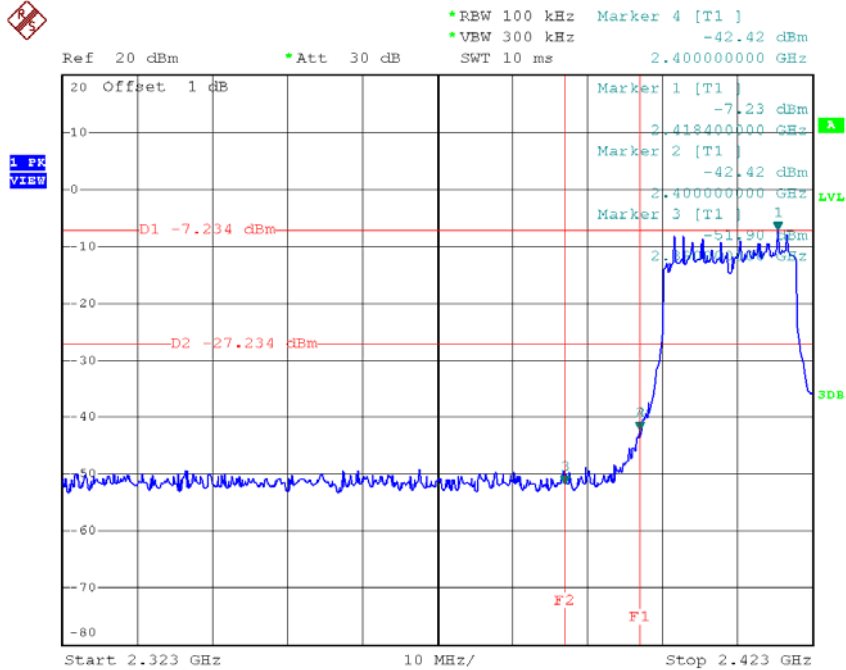

Date: 7.APR.2015 15:33:55

TX HT20 mode CH11

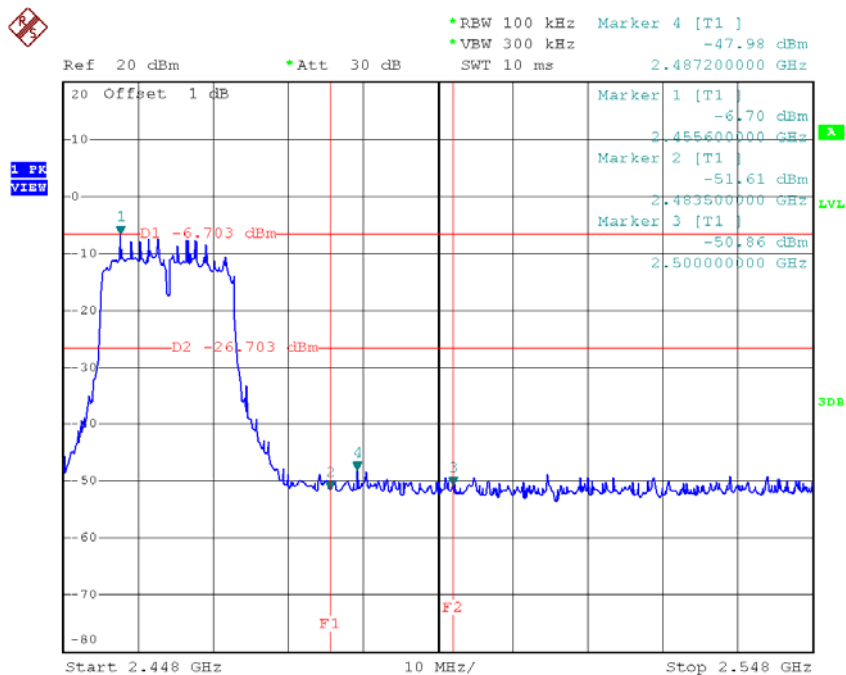

Date: 7.APR.2015 15:35:28

TX HT20 mode CH01 (10 Harmonic of the frequency)

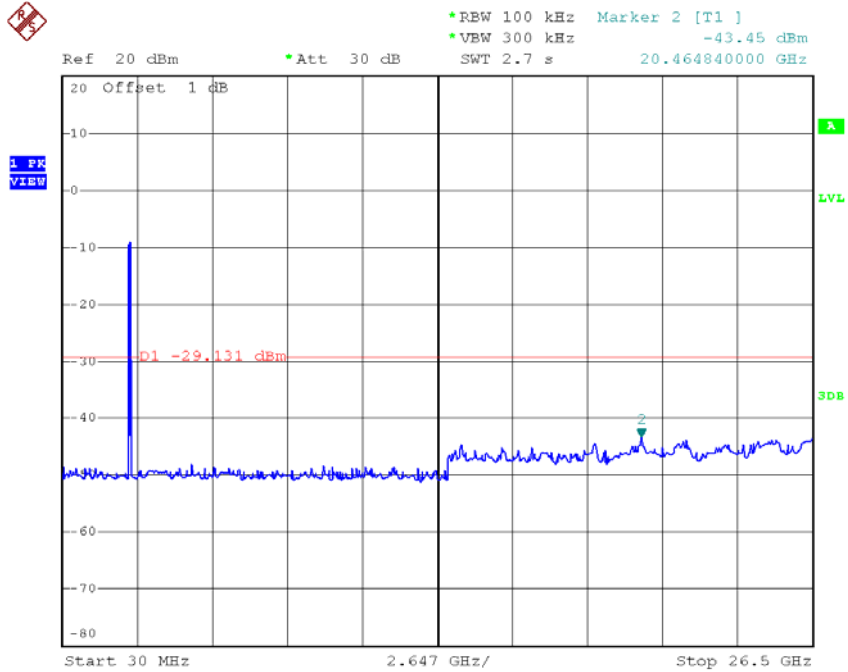

Date: 7.APR.2015 15:33:48

TX HT20 mode CH06 (10 Harmonic of the frequency)

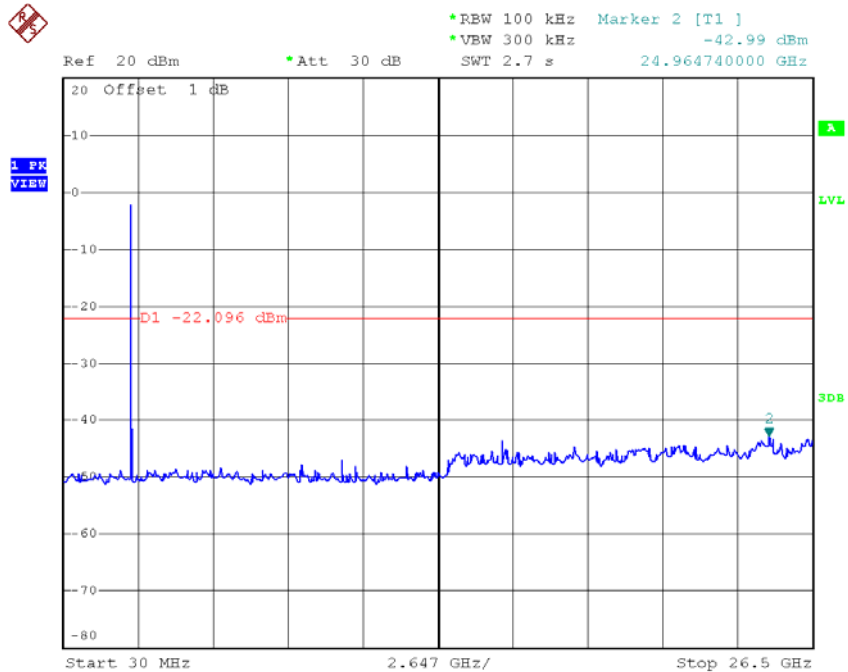

Date: 7.APR.2015 15:34:42

TX HT20 mode CH11 (10 Harmonic of the frequency)

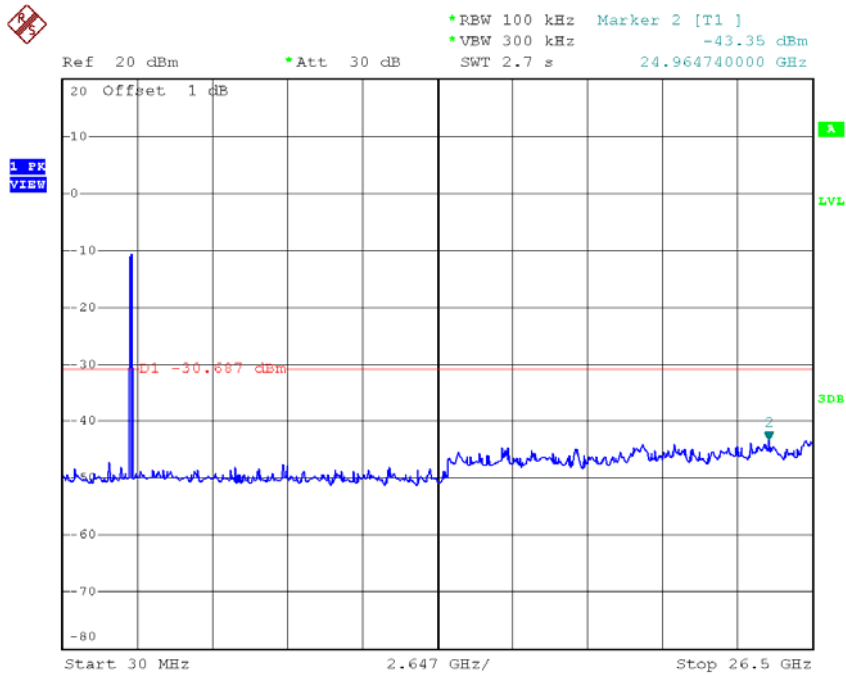

Date: 7.APR.2015 15:35:21

Test Mode : TX N-40M Mode_ANT 1

TX HT40 mode CH03

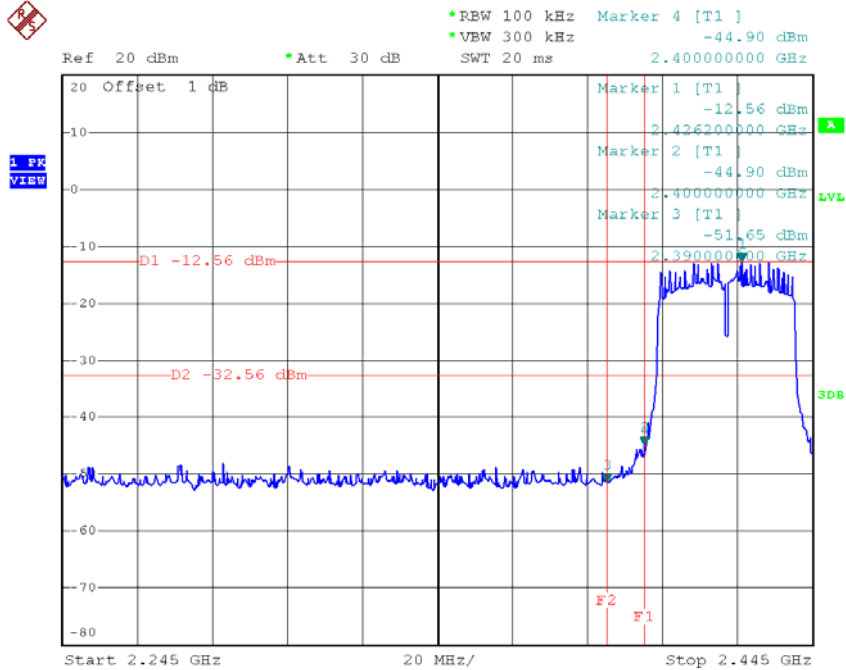

Date: 7.APR.2015 15:30:13

TX HT40 mode CH09

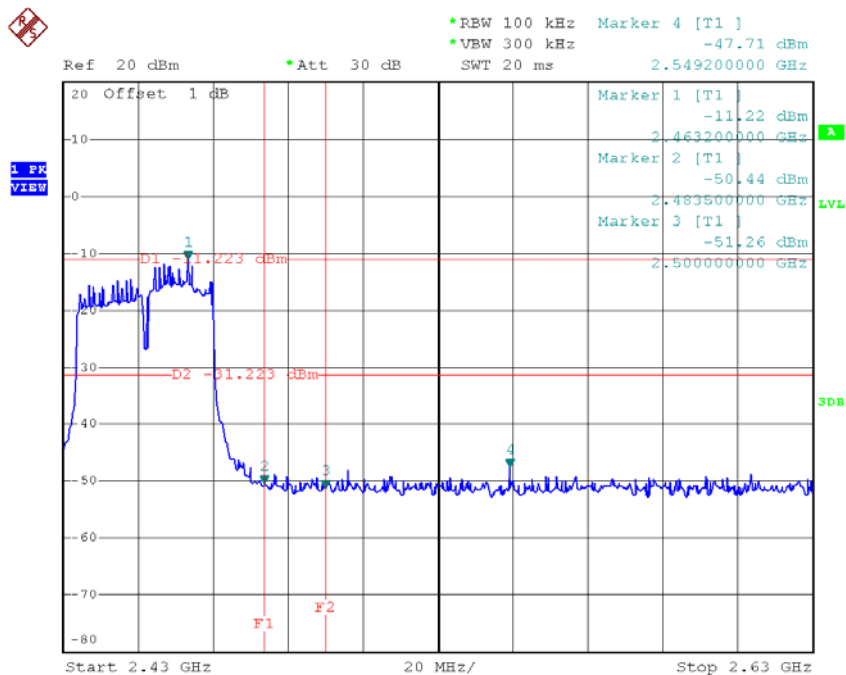

Date: 7.APR.2015 15:32:49

TX HT40 mode CH03 (10 Harmonic of the frequency)

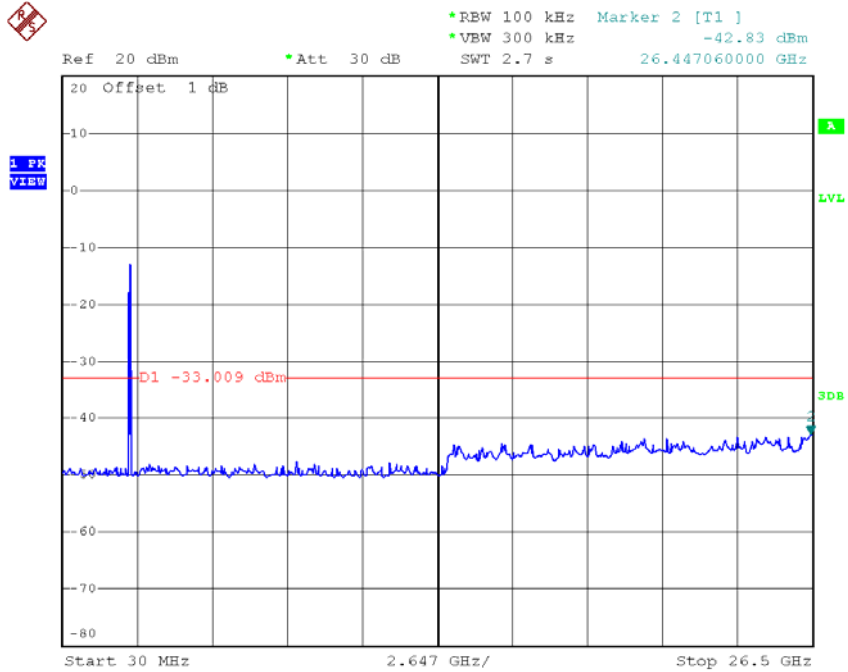

Date: 7.APR.2015 15:30:06

TX HT40 mode CH06 (10 Harmonic of the frequency)

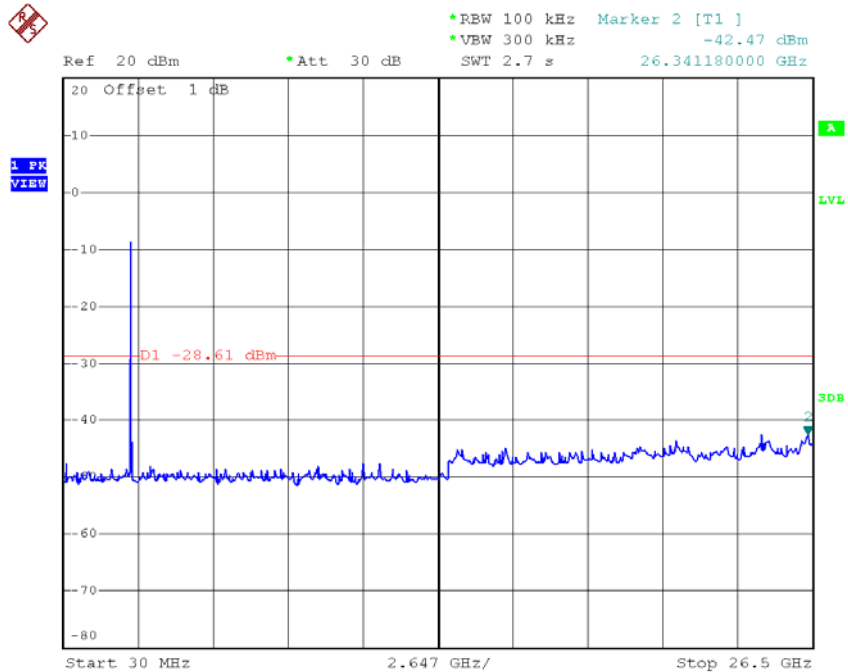

Date: 7.APR.2015 15:31:41

TX HT40 mode CH09 (10 Harmonic of the frequency)



Ref 20 dBm *Att 30 dB *REW 100 kHz Marker 2 [T1]
*VBW 300 kHz -42.89 dBm
SWT 2.7 s 23.429480000 GHz

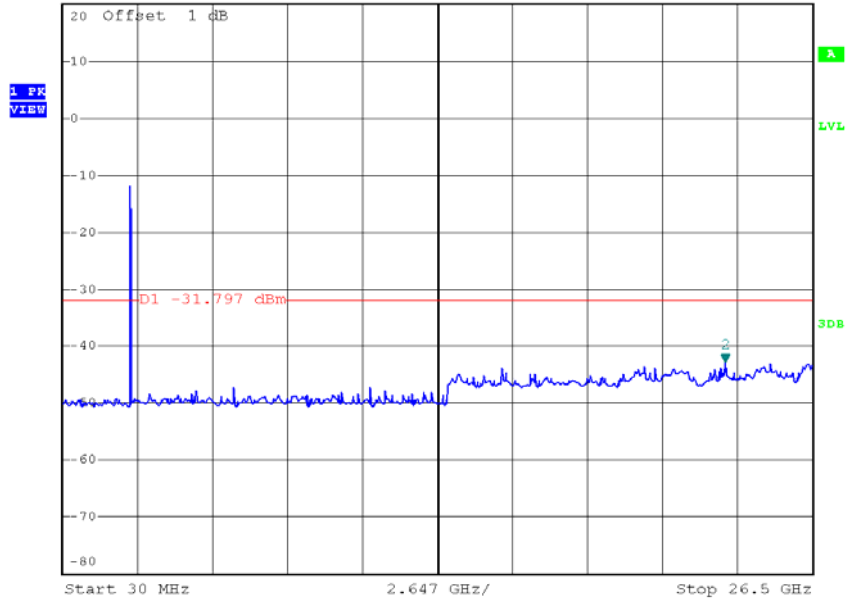

Date: 7.APR.2015 15:32:42

Test Mode : TX N-40M Mode_ANT 2

TX HT40 mode CH03

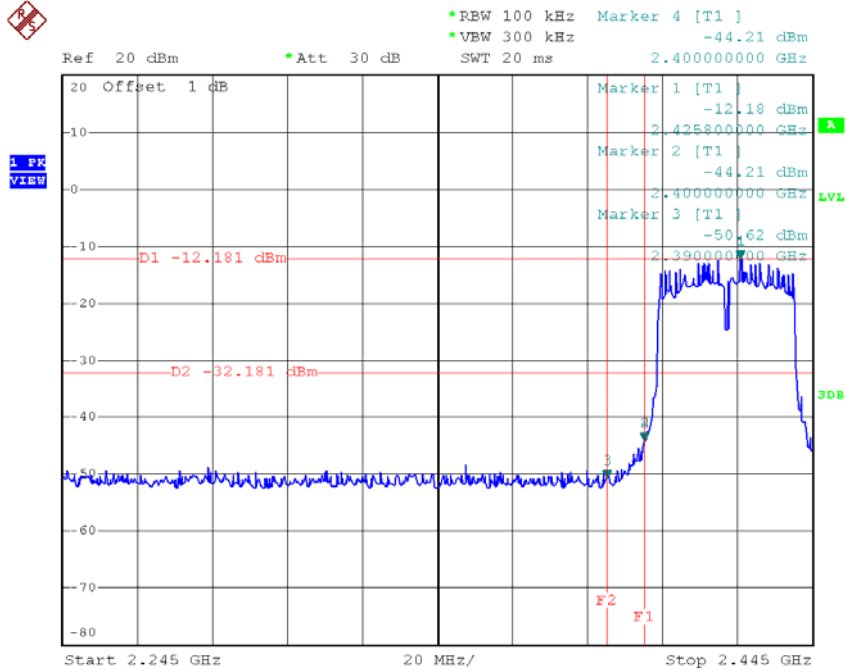

Date: 7.APR.2015 15:36:23

TX HT40 mode CH09

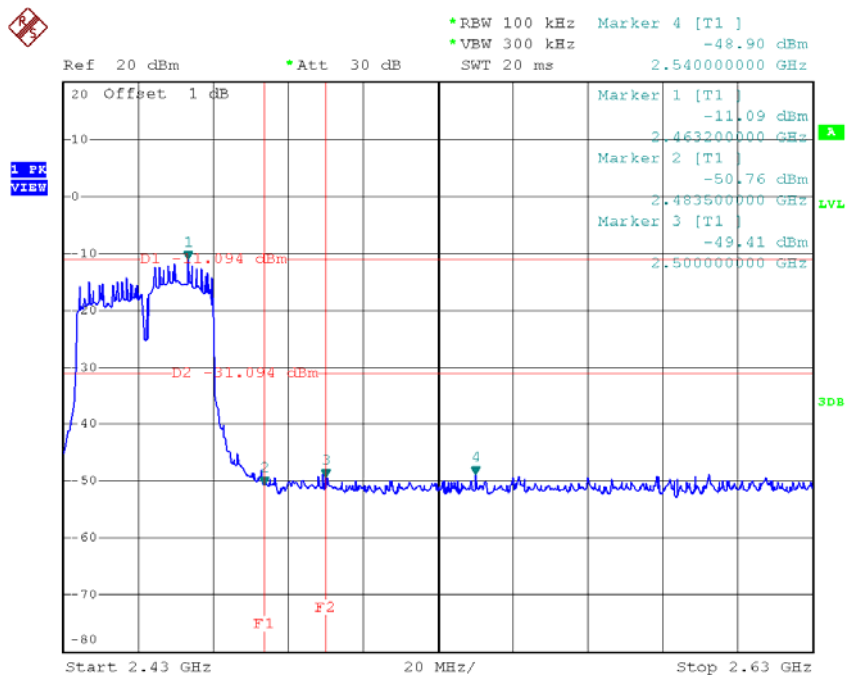

Date: 7.APR.2015 15:38:04

TX HT40 mode CH03 (10 Harmonic of the frequency)

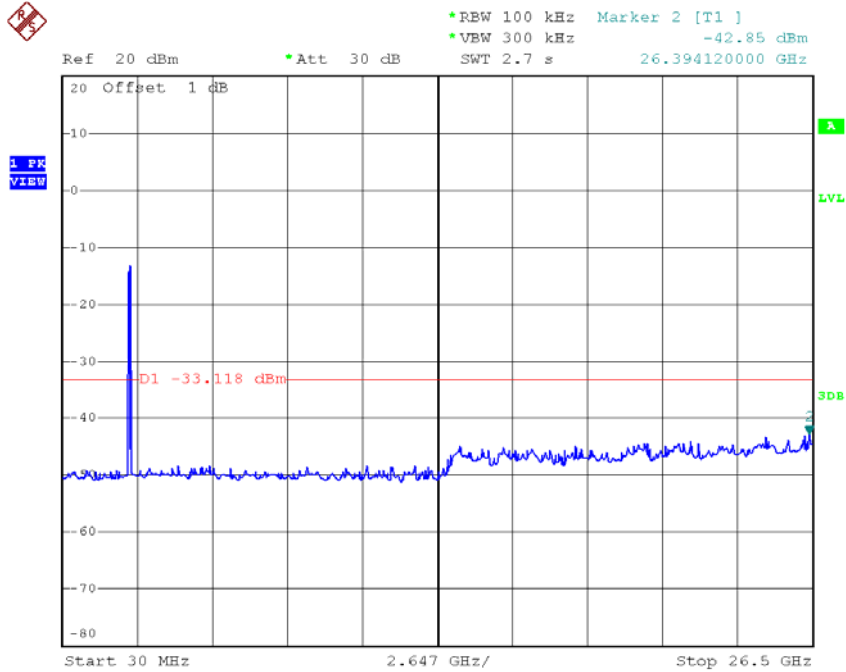

Date: 7.APR.2015 15:36:16

TX HT40 mode CH06 (10 Harmonic of the frequency)

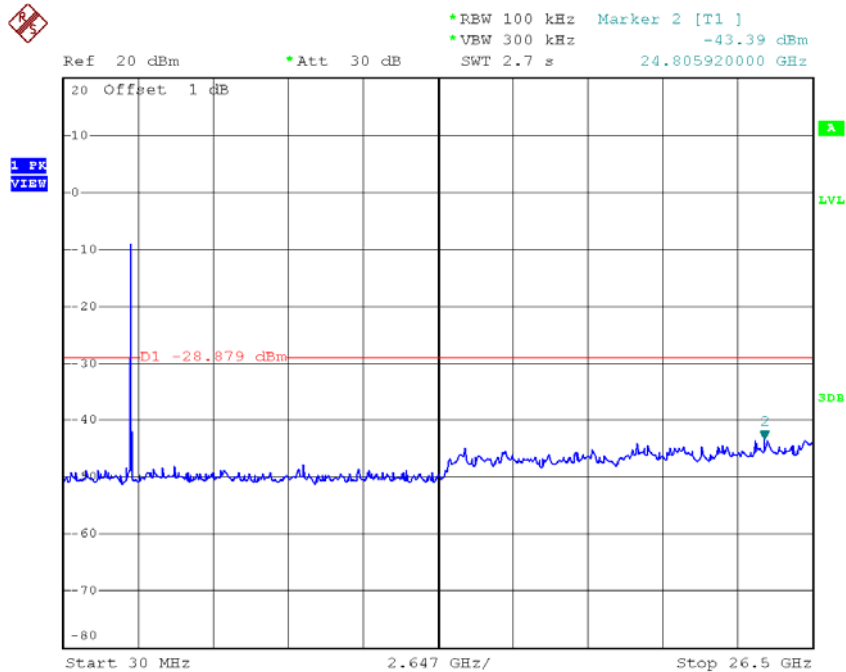

Date: 7.APR.2015 15:37:11

TX HT40 mode CH09 (10 Harmonic of the frequency)



*REW 100 kHz Marker 2 [T1]
*VBW 300 kHz -42.29 dBm
SWT 2.7 s 26.341180000 GHz

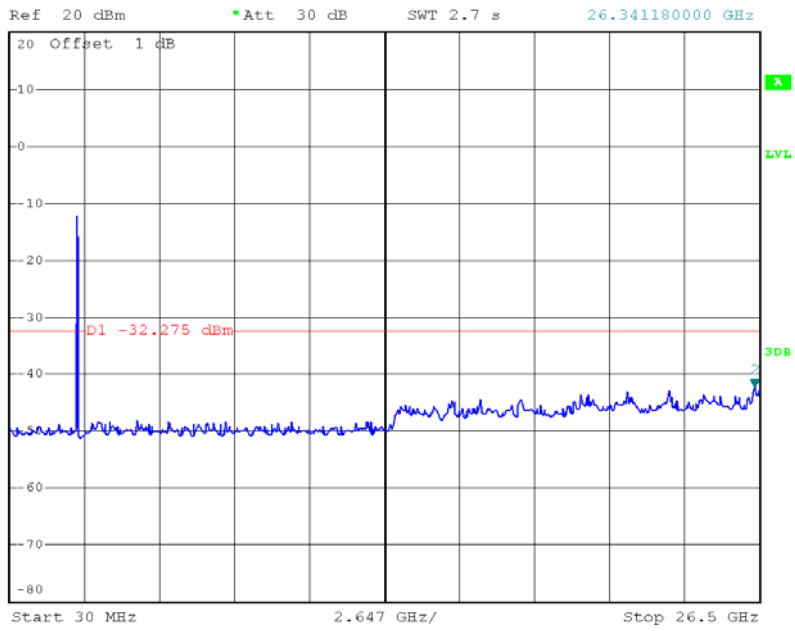

Date: 7.APR.2015 15:37:56

ATTACHMENT H - POWER SPECTRAL DENSITY

For 1TX

Test Mode :TX B Mode_CH01/06/11

Frequency (MHz)	Power Density (dBm/3kHz)	Power Density (mW/3kHz)	Max. Limit (dBm/3kHz)	Result
2412	-0.28	0.94	8.00	Complies
2437	-1.96	0.64	8.00	Complies
2462	0.09	1.02	8.00	Complies

TX CH01

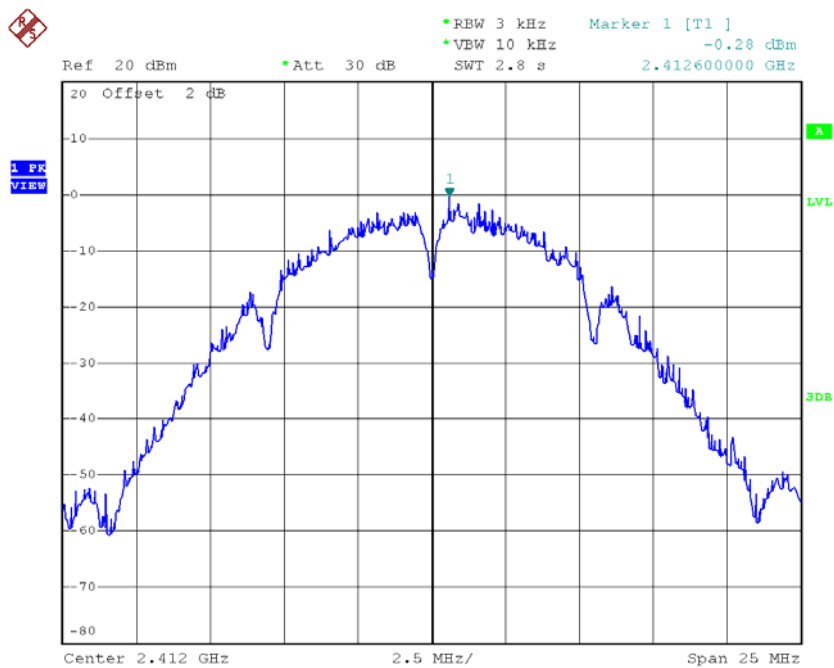

Date: 18.MAR.2015 13:23:39

TX CH06

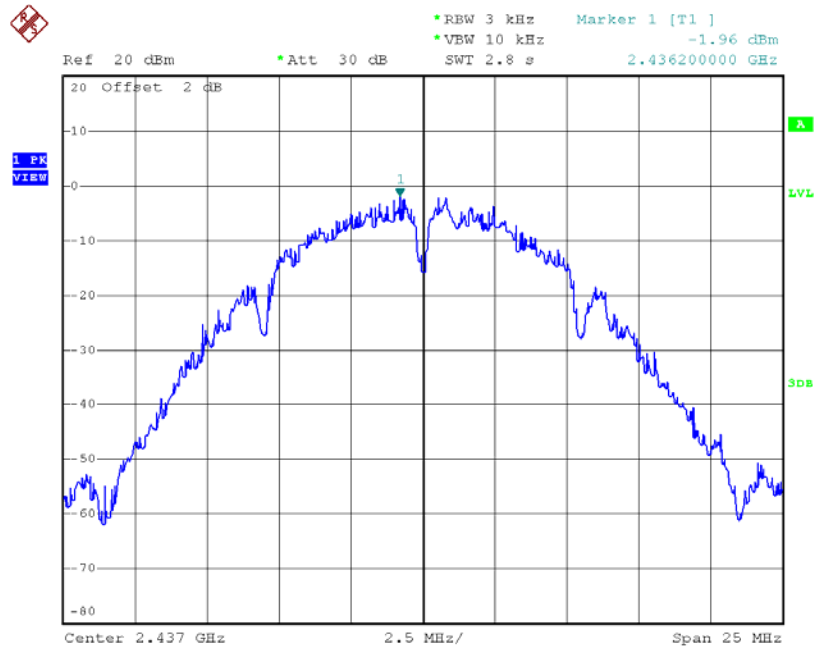

Date: 18.MAR.2015 13:25:02

TX CH11

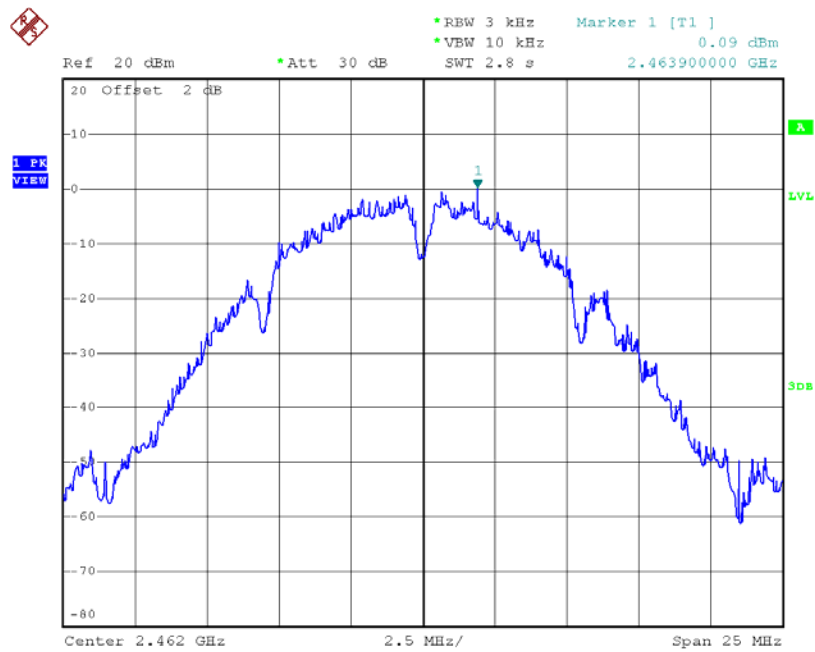

Date: 18.MAR.2015 13:26:12

TX CH06

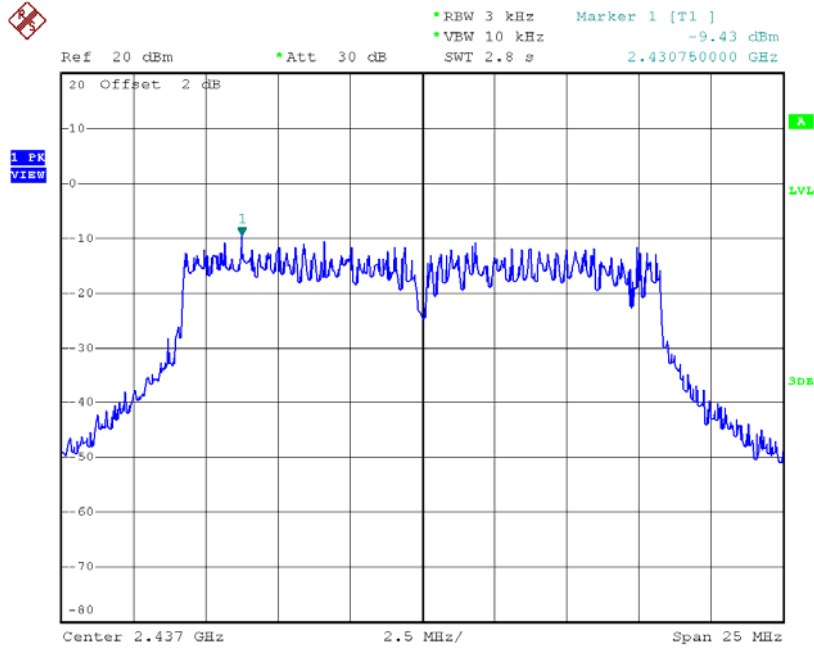

Date: 18.MAR.2015 13:31:36

TX CH11

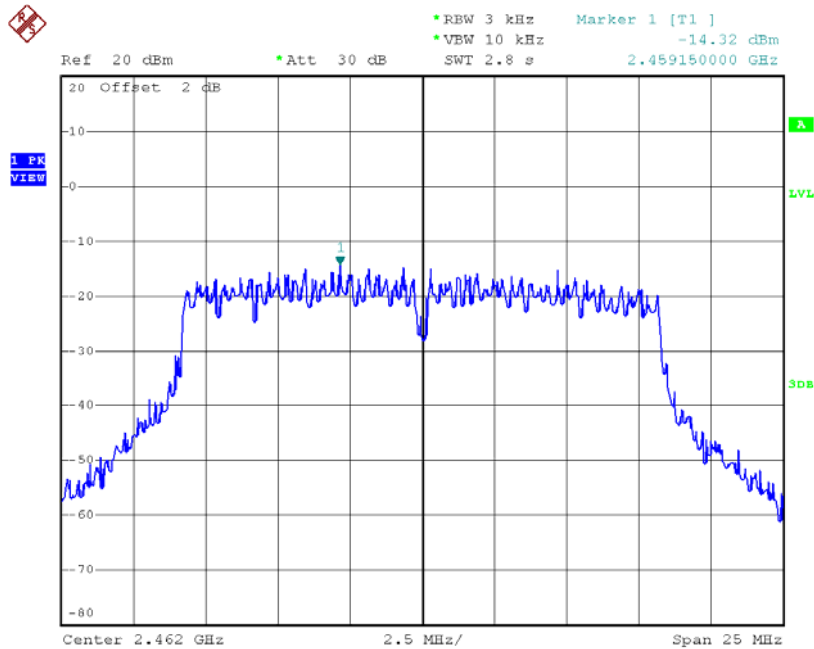

Date: 18.MAR.2015 13:35:58

TX CH06

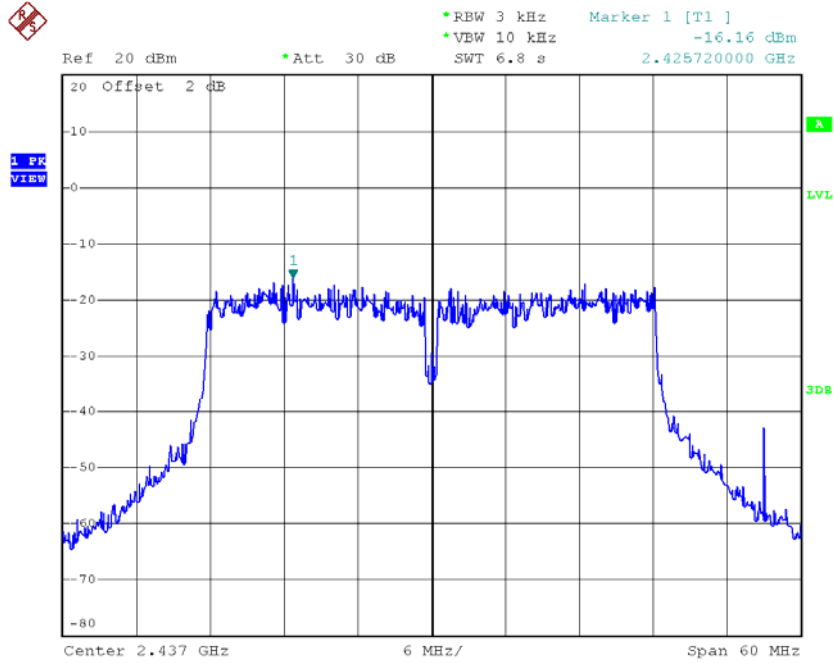

Date: 18.MAR.2015 13:42:17

TX CH09

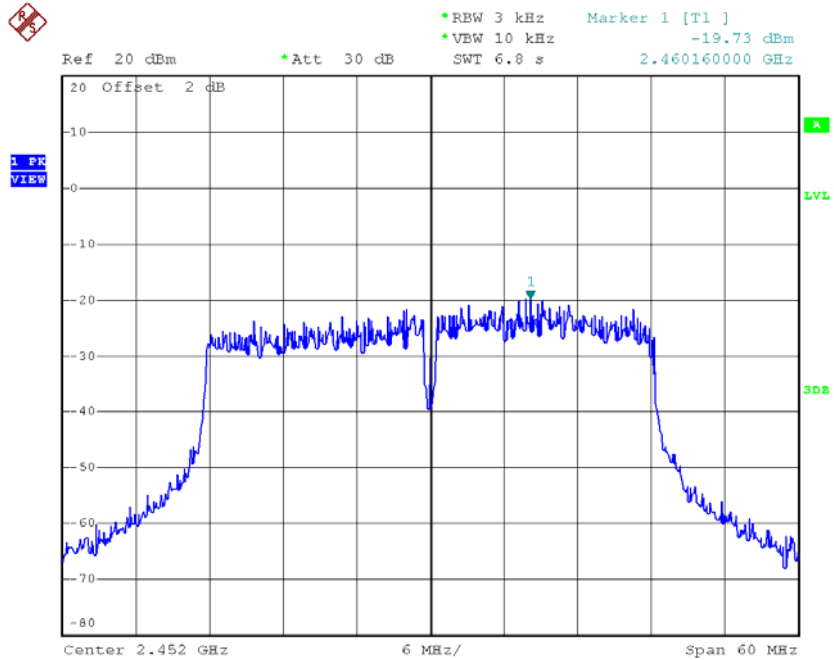

Date: 18.MAR.2015 13:43:32

For 2TX

Test Mode :TX B Mode_CH01/06/11_ANT 1

Frequency (MHz)	Power Density (dBm/3kHz)	Power Density (mW/3kHz)	Max. Limit (dBm/3kHz)	Result
2412	-4.02	0.40	8.00	Complies
2437	-1.71	0.67	8.00	Complies
2462	-3.24	0.47	8.00	Complies

TX CH01

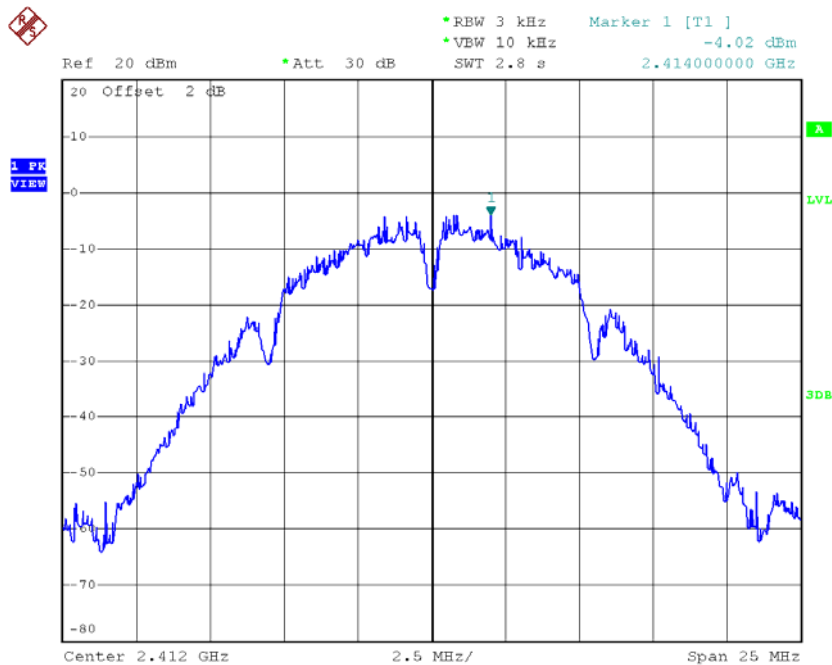

Date: 18.MAR.2015 13:49:00

TX CH06

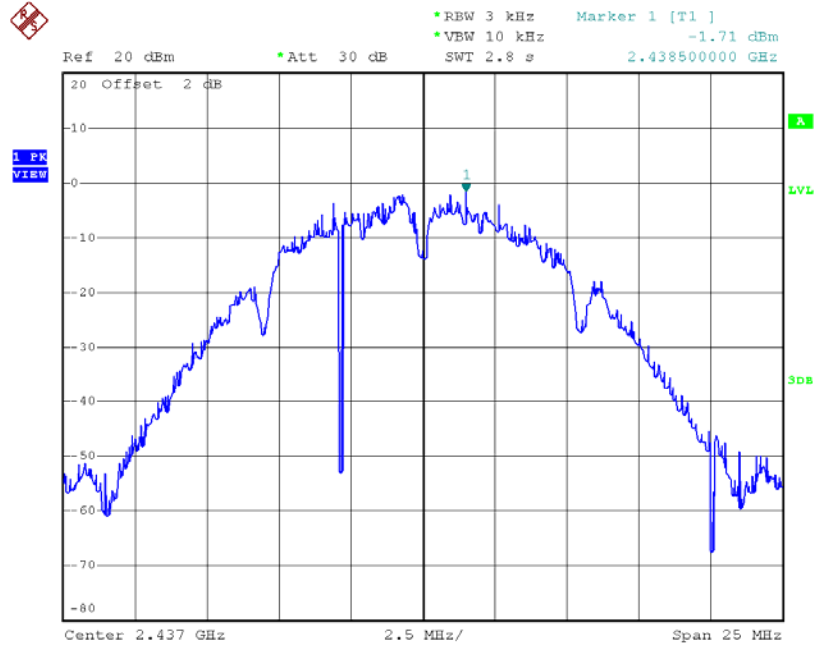

Date: 18.MAR.2015 13:51:27

TX CH11

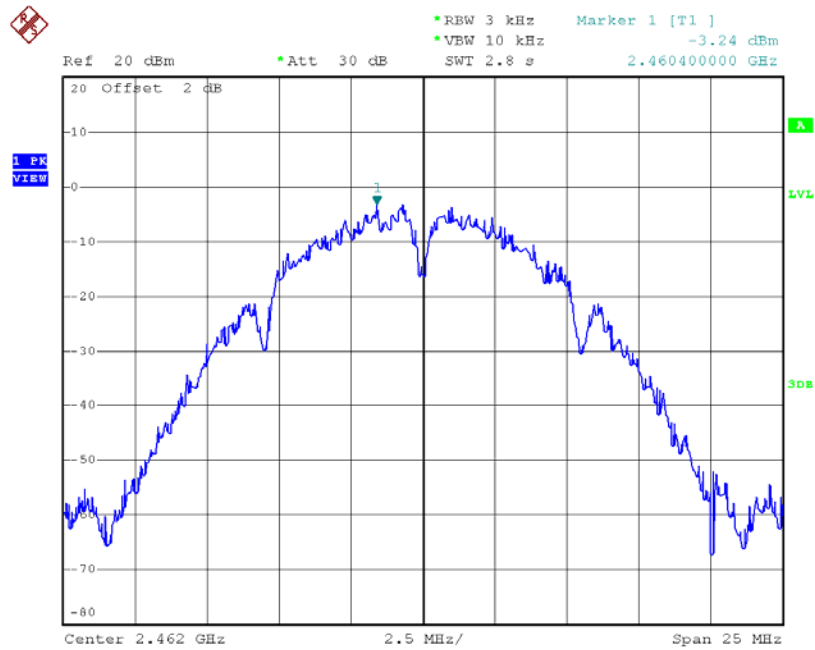

Date: 18.MAR.2015 13:52:36

Test Mode :TX B Mode_CH01/06/11_ANT 2

Frequency (MHz)	Power Density (dBm/3kHz)	Power Density (mW/3kHz)	Max. Limit (dBm/3kHz)	Result
2412	-3.74	0.42	8.00	Complies
2437	-1.35	0.73	8.00	Complies
2462	-3.63	0.43	8.00	Complies

TX CH01

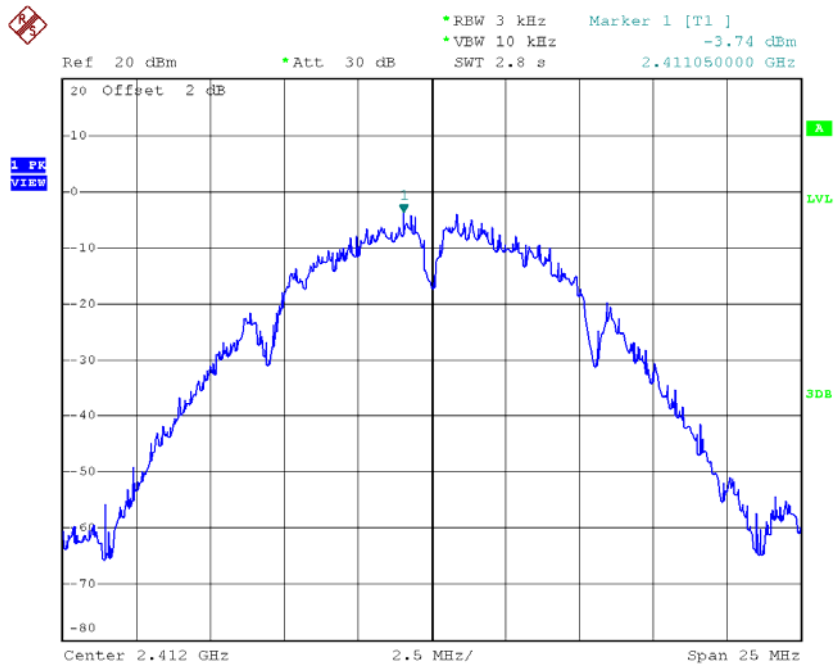

Date: 18.MAR.2015 14:10:52

TX CH06

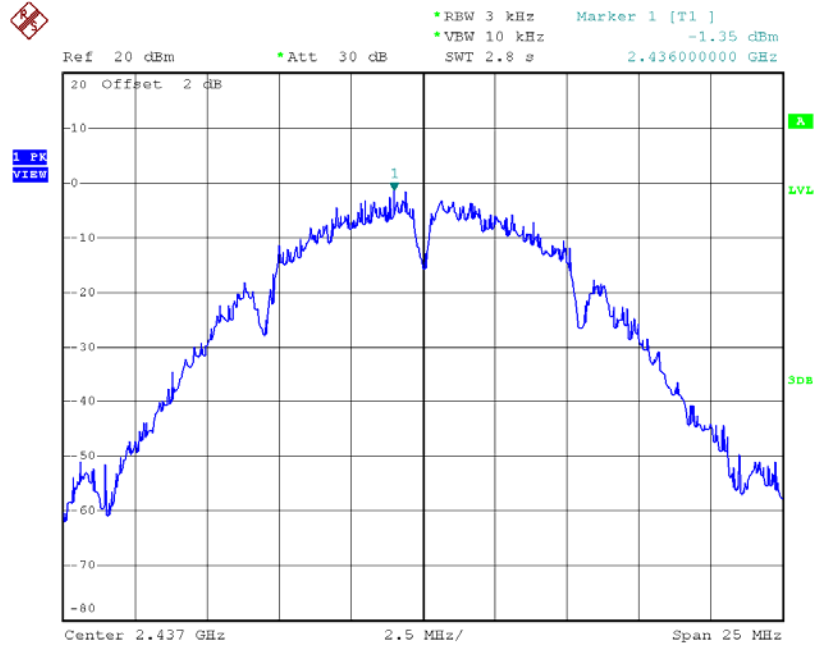

Date: 18.MAR.2015 14:11:57

TX CH11

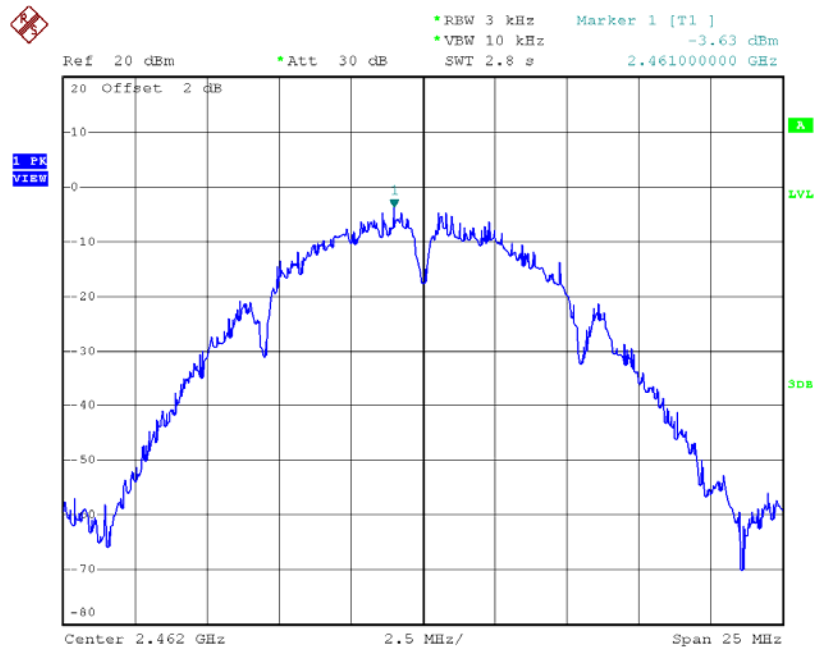

Date: 18.MAR.2015 14:12:52

Test Mode :TX B Mode_CH01/06/11_Total

Frequency (MHz)	Power Density (dBm/3kHz)	Power Density (mW/3kHz)	Max. Limit (dBm/3kHz)	Result
2412	-0.87	0.82	8.00	Complies
2437	1.48	1.41	8.00	Complies
2462	-0.42	0.91	8.00	Complies

TX CH06

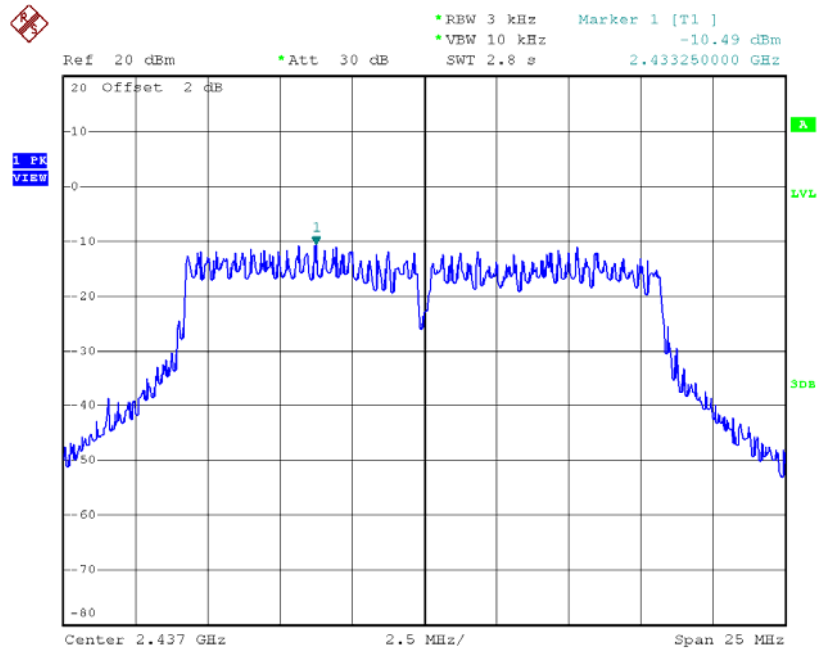

Date: 18.MAR.2015 13:55:23

TX CH11

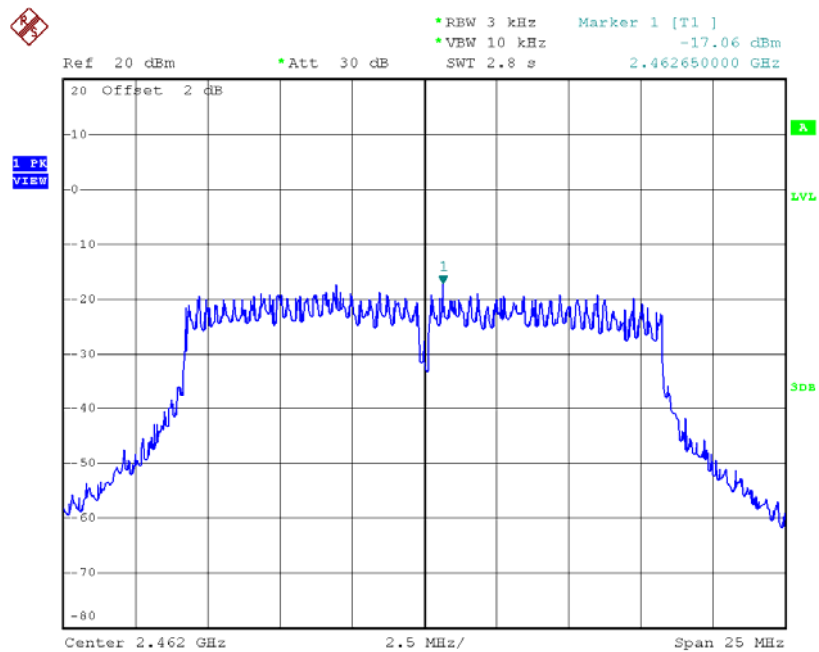

Date: 18.MAR.2015 13:56:25

Test Mode :TX G Mode_CH01/06/11_ANT 2

Frequency (MHz)	Power Density (dBm/3kHz)	Power Density (mW/3kHz)	Max. Limit (dBm/3kHz)	Result
2412	-16.76	0.02	8.00	Complies
2437	-10.32	0.09	8.00	Complies
2462	-17.86	0.02	8.00	Complies

TX CH01

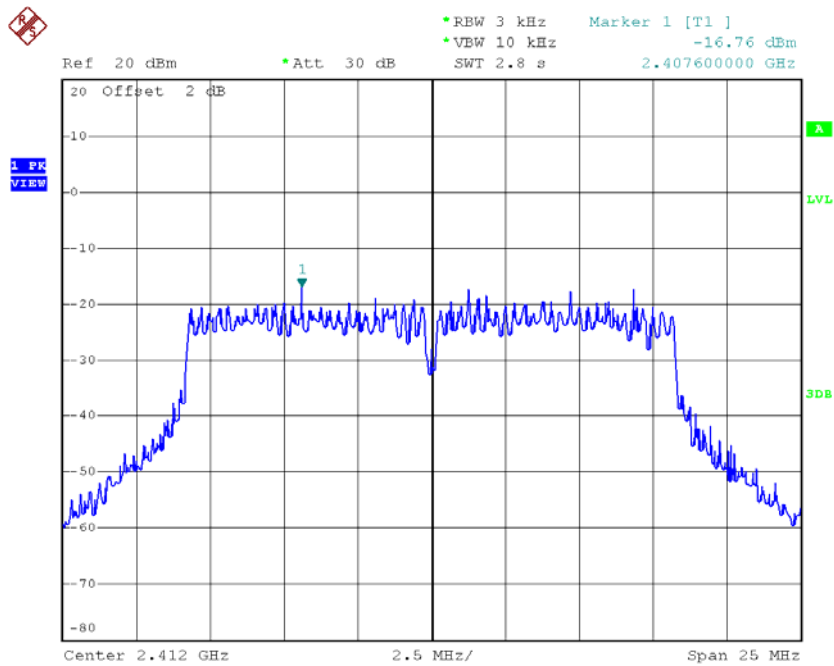

Date: 18.MAR.2015 14:14:04

TX CH06

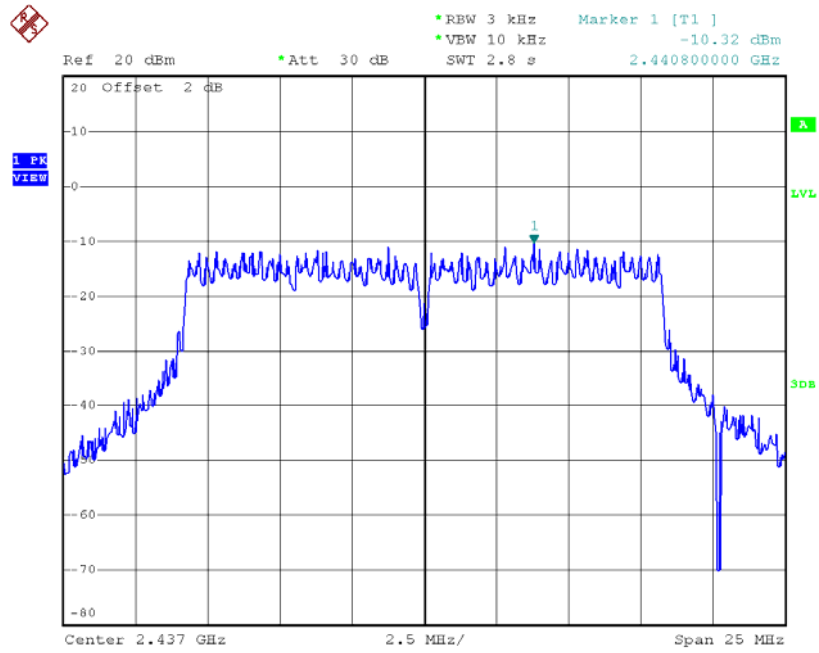

Date: 18.MAR.2015 14:14:59

TX CH11

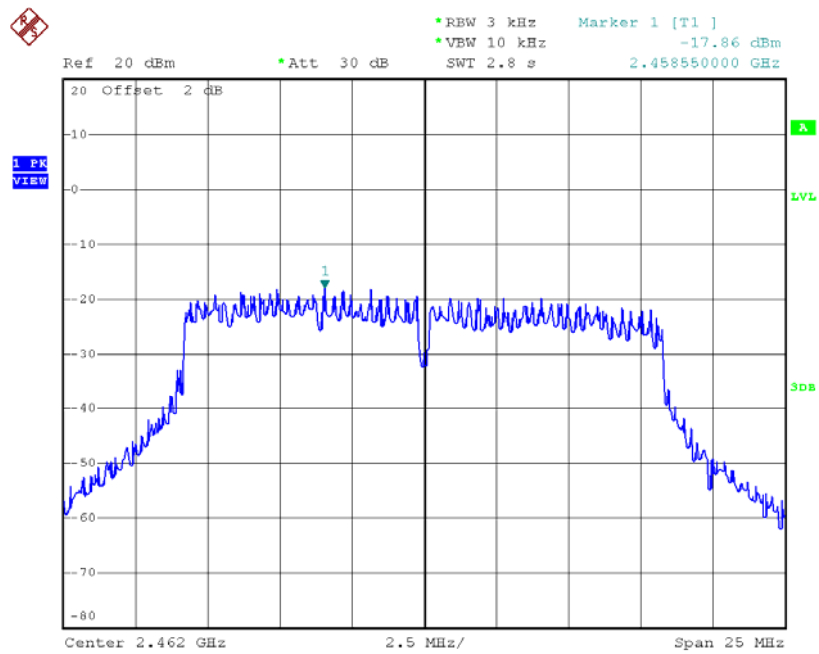

Date: 18.MAR.2015 14:15:50

Test Mode :TX G Mode_CH01/06/11_Total

Frequency (MHz)	Power Density (dBm/3kHz)	Power Density (mW/3kHz)	Max. Limit (dBm/3kHz)	Result
2412	-14.36	0.04	8.00	Complies
2437	-7.39	0.18	8.00	Complies
2462	-14.43	0.04	8.00	Complies

Test Mode : TX N-20M Mode_CH01/06/11_ANT 1

Frequency (MHz)	Power Density (dBm/3kHz)	Power Density (mW/3kHz)	Max. Limit (dBm/3kHz)	Result
2412	-17.96	0.02	8.00	Complies
2437	-12.04	0.06	8.00	Complies
2462	-17.98	0.02	8.00	Complies

TX CH01

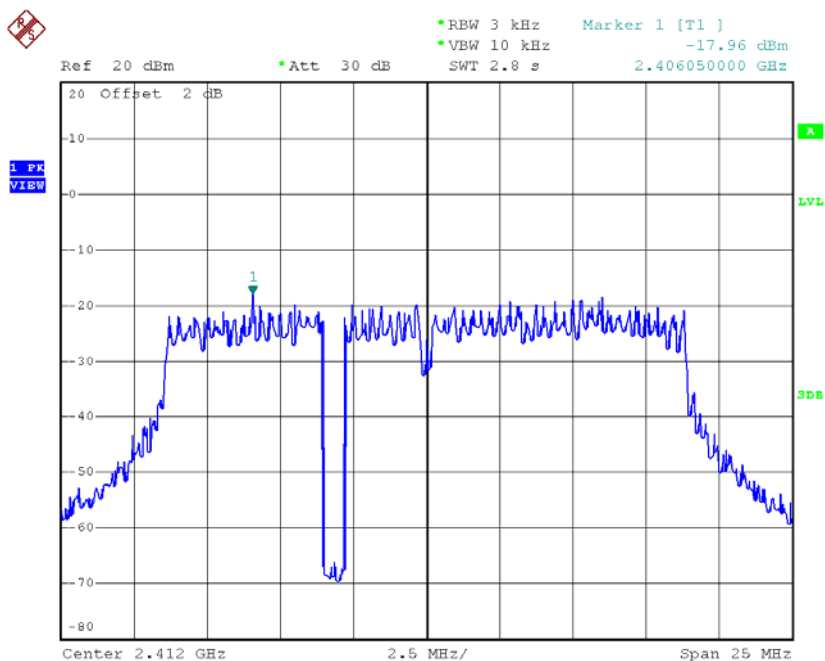

Date: 18.MAR.2015 13:57:52

TX CH06

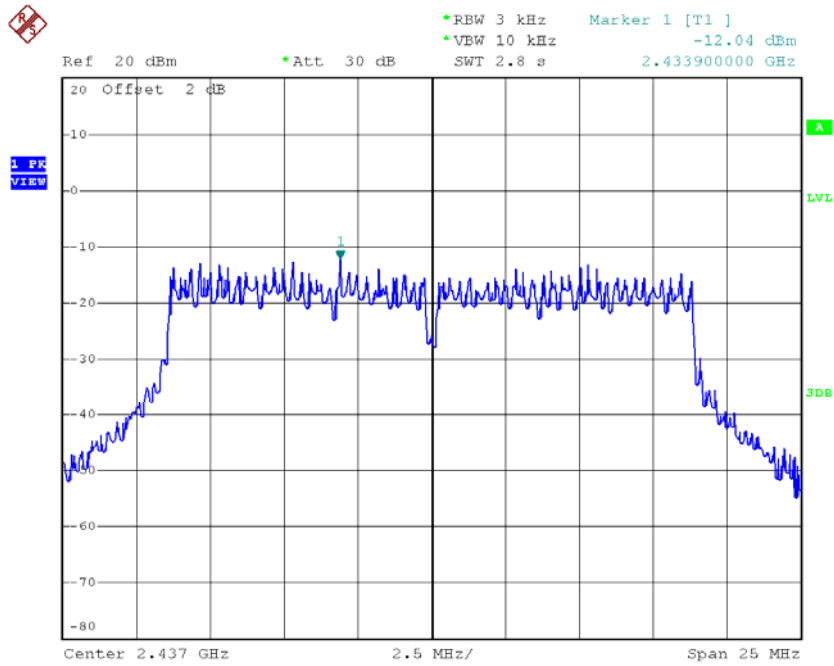

Date: 18.MAR.2015 13:59:06

TX CH11

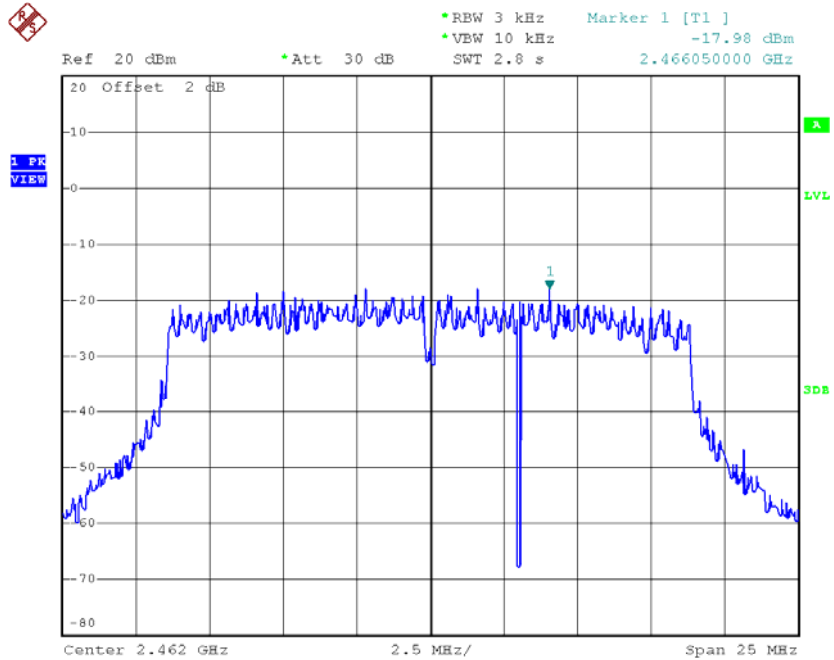

Date: 18.MAR.2015 14:00:06

TX CH06

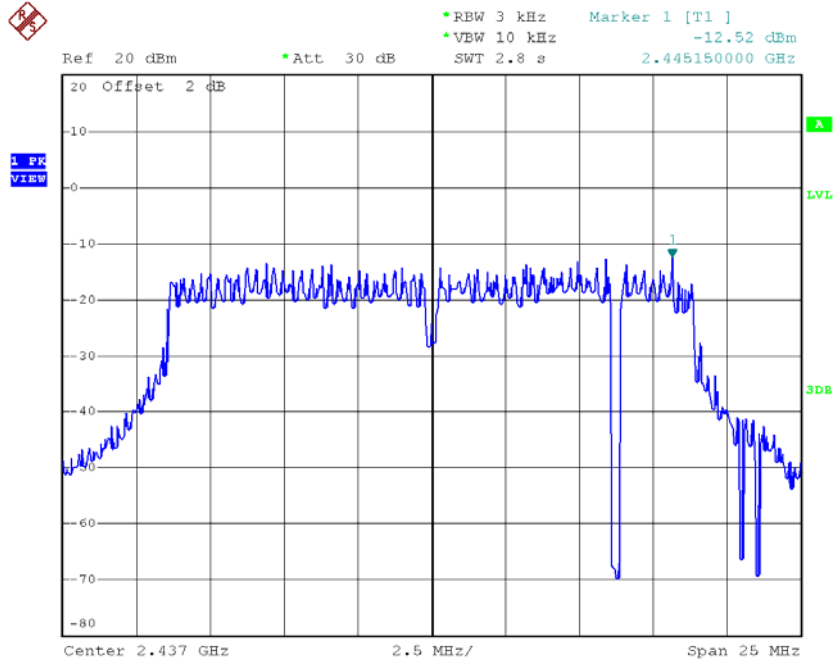

Date: 18.MAR.2015 14:17:42

TX CH11

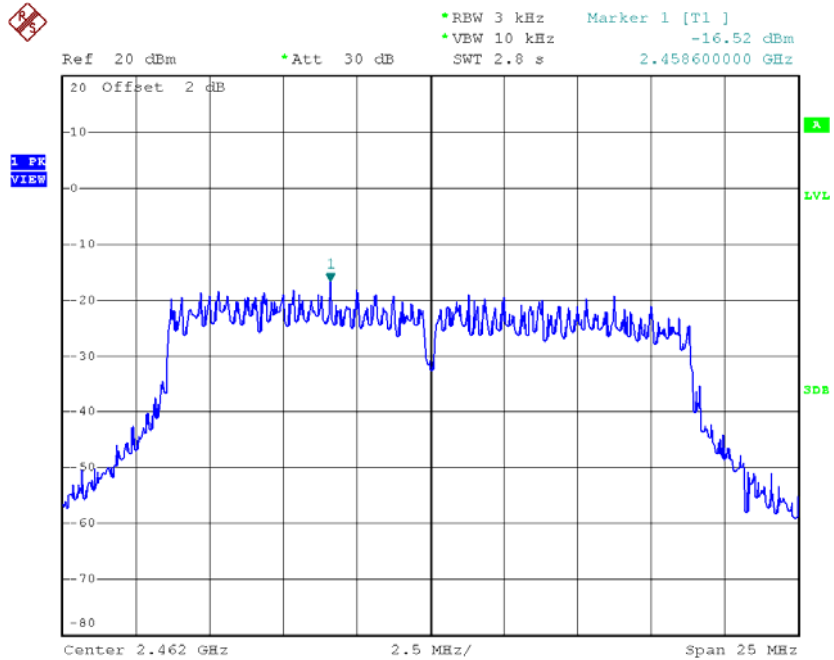

Date: 18.MAR.2015 14:18:58

Test Mode : TX N-20M Mode_CH01/06/11_Total

Frequency (MHz)	Power Density (dBm/3kHz)	Power Density (mW/3kHz)	Max. Limit (dBm/3kHz)	Result
2412	-15.40	0.03	8.00	Complies
2437	-9.26	0.12	8.00	Complies
2462	-14.18	0.04	8.00	Complies

Test Mode : TX N-40M Mode_CH03/06/09_ANT 1

Frequency (MHz)	Power Density (dBm/3kHz)	Power Density (mW/3kHz)	Max. Limit (dBm/3kHz)	Result
2422	-23.71	0.00	8.00	Complies
2437	-18.02	0.02	8.00	Complies
2452	-23.30	0.00	8.00	Complies

TX CH03

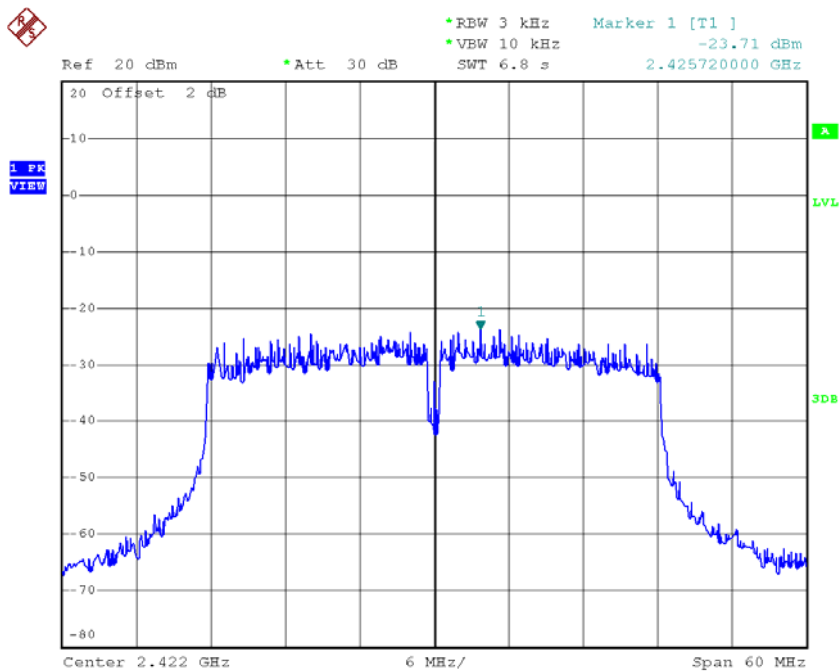

Date: 18.MAR.2015 14:01:20

TX CH06

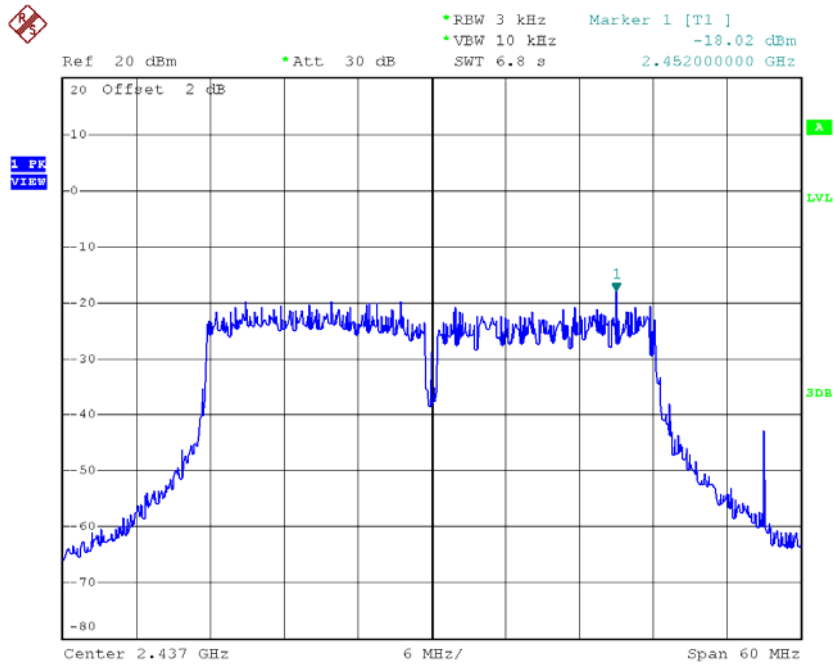

Date: 18.MAR.2015 14:06:30

TX CH09

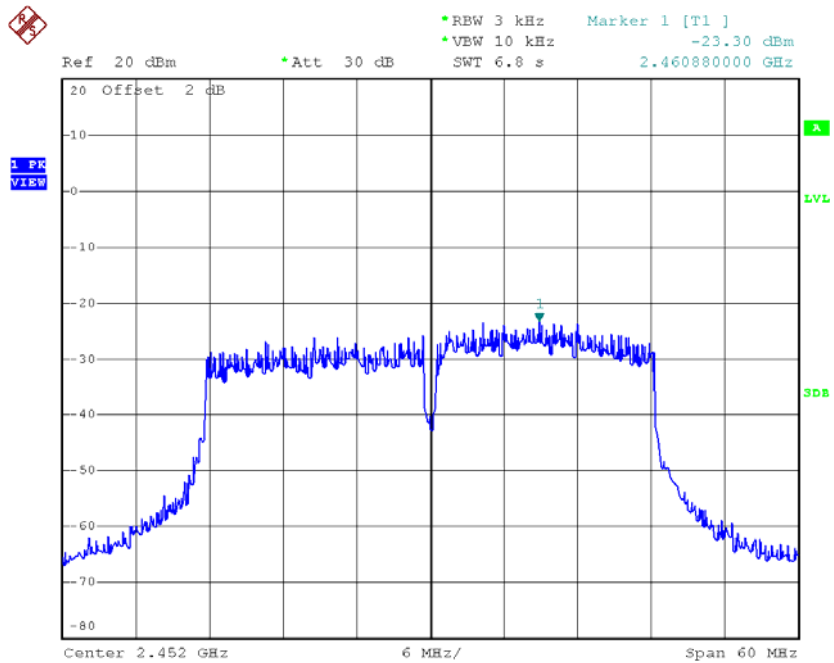

Date: 18.MAR.2015 14:07:39

Test Mode : TX N-40M Mode_CH03/06/09_ANT 2

Frequency (MHz)	Power Density (dBm/3kHz)	Power Density (mW/3kHz)	Max. Limit (dBm/3kHz)	Result
2422	-22.50	0.01	8.00	Complies
2437	-19.27	0.01	8.00	Complies
2452	-22.49	0.01	8.00	Complies

TX CH03

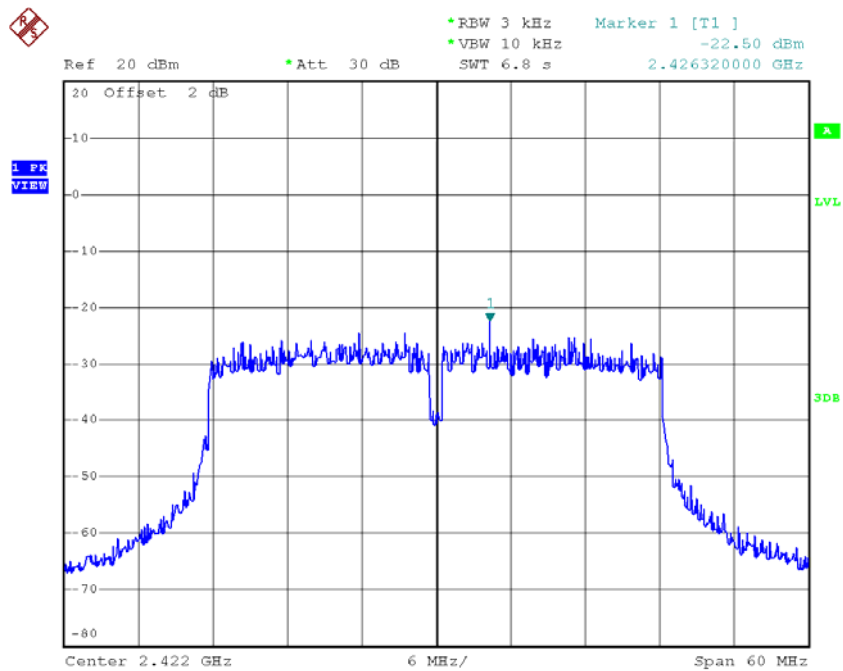

Date: 18.MAR.2015 14:22:15

TX CH06

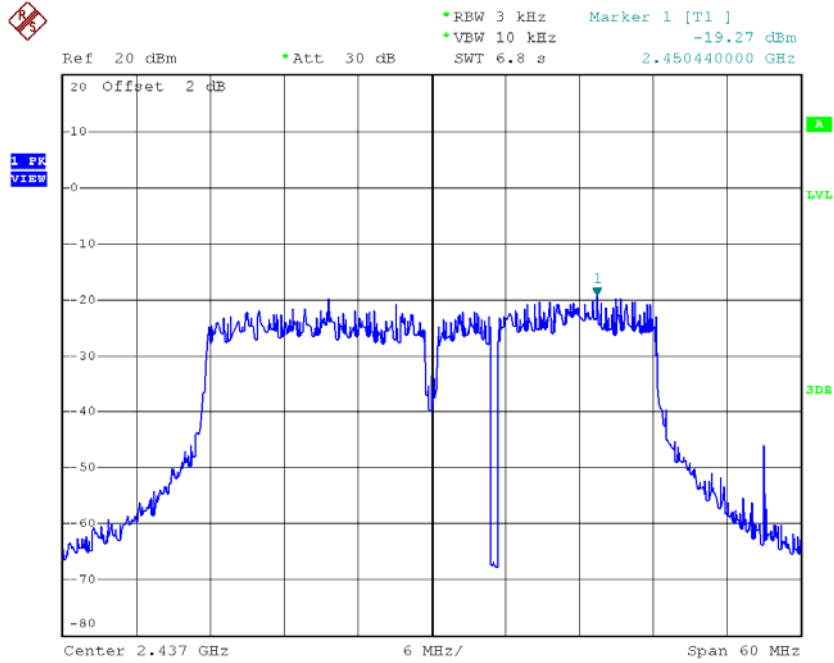

Date: 18.MAR.2015 14:23:36

TX CH09

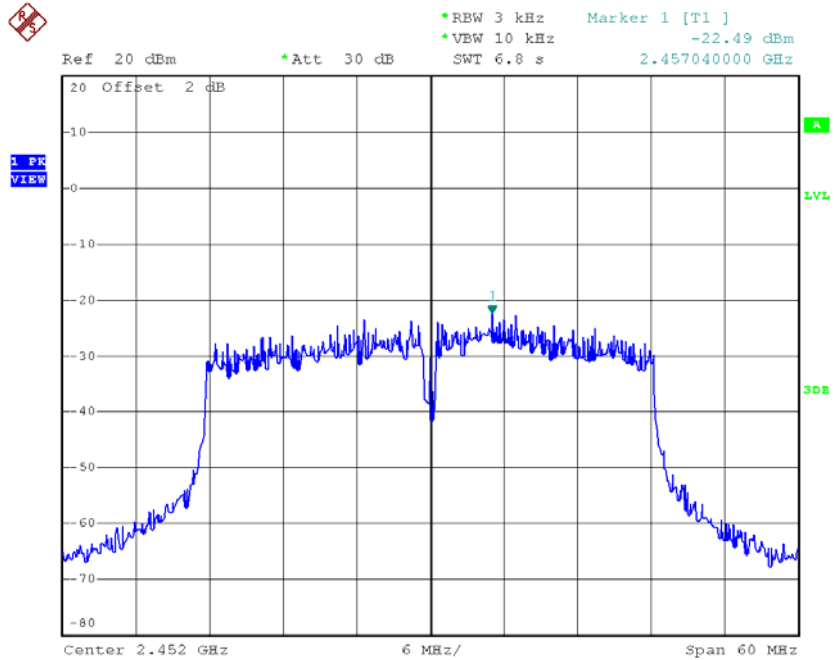

Date: 18.MAR.2015 14:24:34

Test Mode : TX N-40M Mode_CH03/06/09_Total

Frequency (MHz)	Power Density (dBm/3kHz)	Power Density (mW/3kHz)	Max. Limit (dBm/3kHz)	Result
2422	-20.05	0.01	8.00	Complies
2437	-15.59	0.03	8.00	Complies
2452	-19.87	0.01	8.00	Complies

For 2TX with beamforming

Test Mode : TX N-20M Mode_CH01/06/11_ANT 1

Frequency (MHz)	Power Density (dBm/3kHz)	Power Density (mW/3kHz)	Max. Limit (dBm/3kHz)	Result
2412	-22.84	0.01	6.74	Complies
2437	-16.59	0.02	6.74	Complies
2462	-16.26	0.02	6.74	Complies

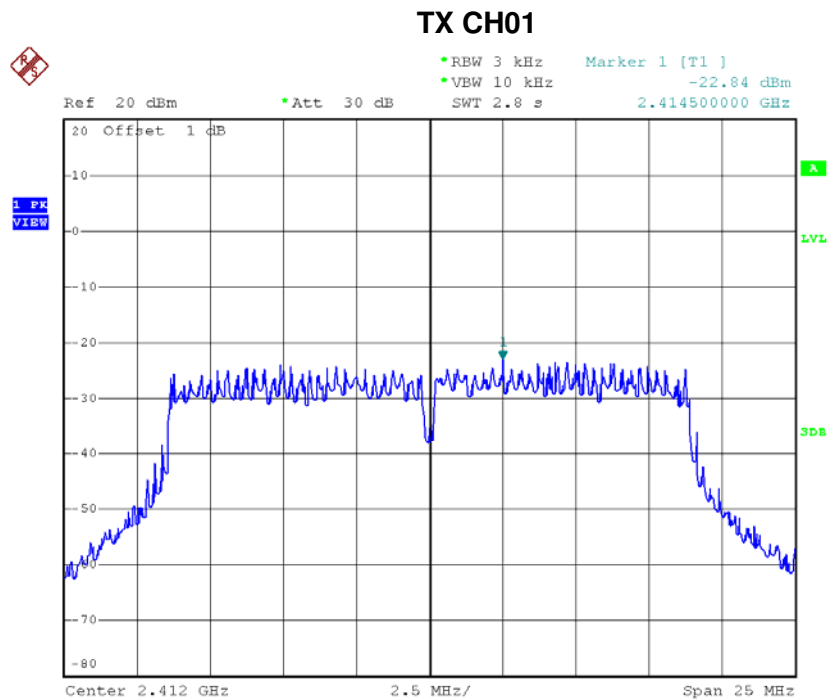

Date: 7.APR.2015 15:25:56

TX CH06

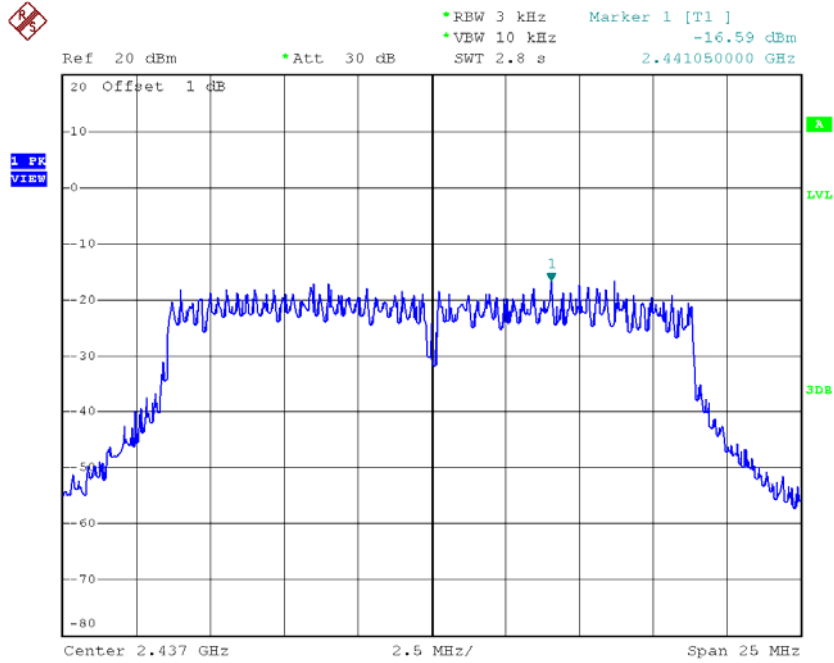

Date: 7.APR.2015 15:28:12

TX CH11

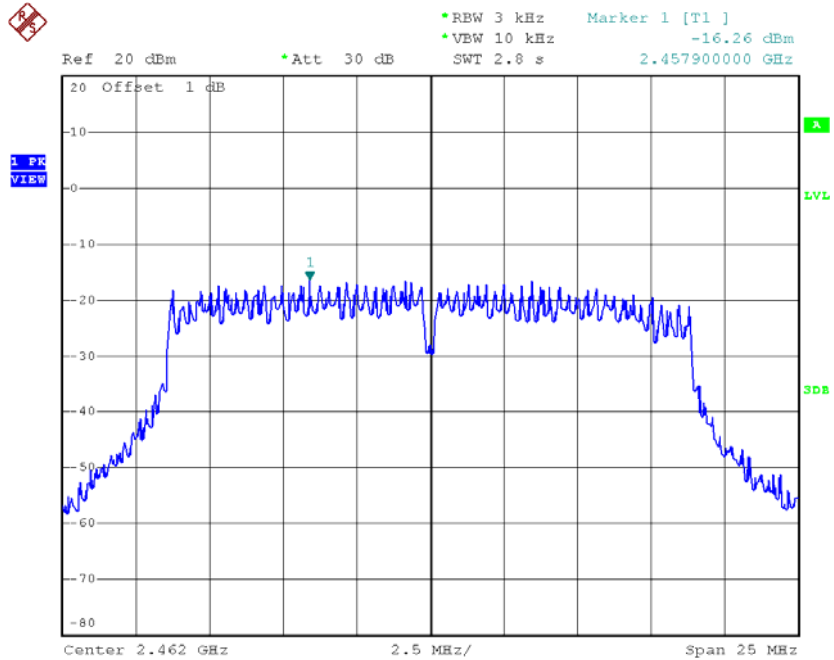

Date: 7.APR.2015 15:29:04

Test Mode : TX N-20M Mode_CH01/06/11_ANT 2

Frequency (MHz)	Power Density (dBm/3kHz)	Power Density (mW/3kHz)	Max. Limit (dBm/3kHz)	Result
2412	-21.38	0.01	6.74	Complies
2437	-16.72	0.02	6.74	Complies
2462	-22.33	0.01	6.74	Complies

TX CH01

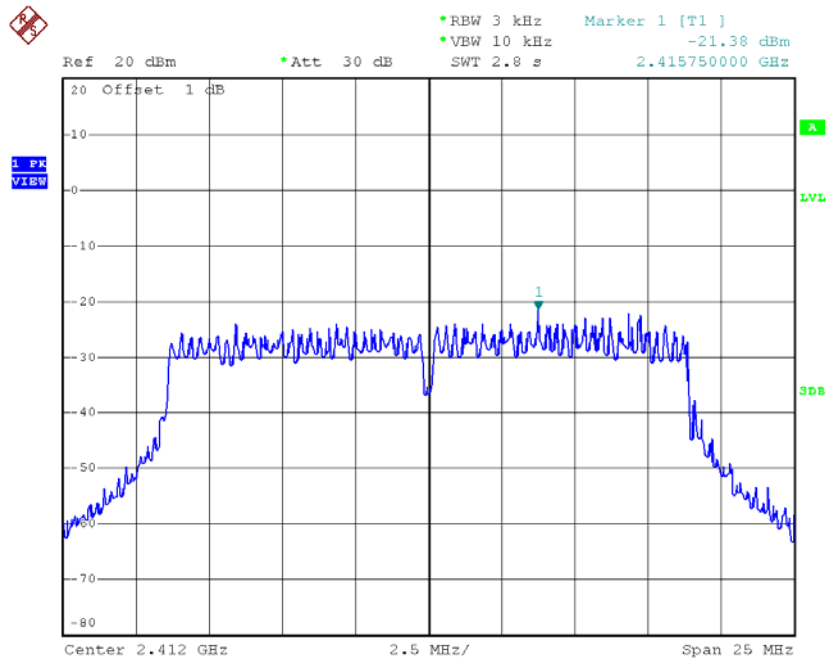

Date: 7.APR.2015 15:34:04

TX CH06

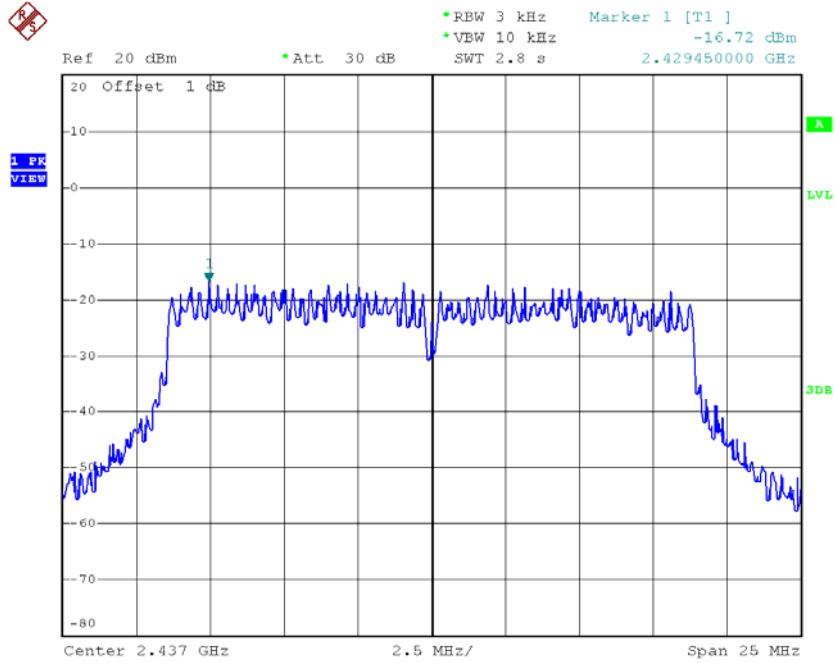

Date: 7.APR.2015 15:34:50

TX CH11

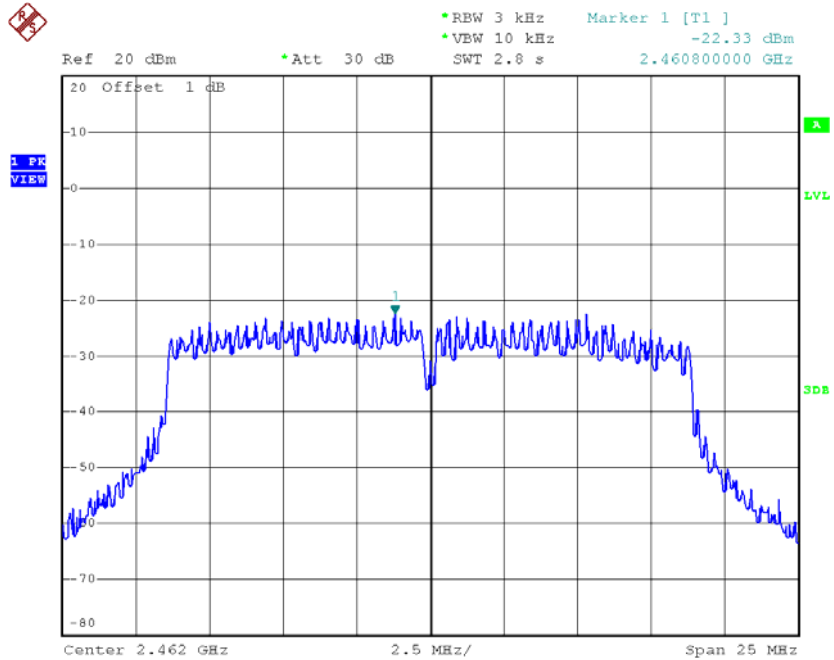

Date: 7.APR.2015 15:35:37

Test Mode : TX N-20M Mode_CH01/06/11_Total

Frequency (MHz)	Power Density (dBm/3kHz)	Power Density (mW/3kHz)	Max. Limit (dBm/3kHz)	Result
2412	-19.04	0.01	6.74	Complies
2437	-13.64	0.04	6.74	Complies
2462	-15.30	0.03	6.74	Complies

Test Mode : TX N-40M Mode_CH03/06/09_ANT 1

Frequency (MHz)	Power Density (dBm/3kHz)	Power Density (mW/3kHz)	Max. Limit (dBm/3kHz)	Result
2422	-27.34	0.00	6.74	Complies
2437	-23.64	0.00	6.74	Complies
2452	-26.93	0.00	6.74	Complies

TX CH03

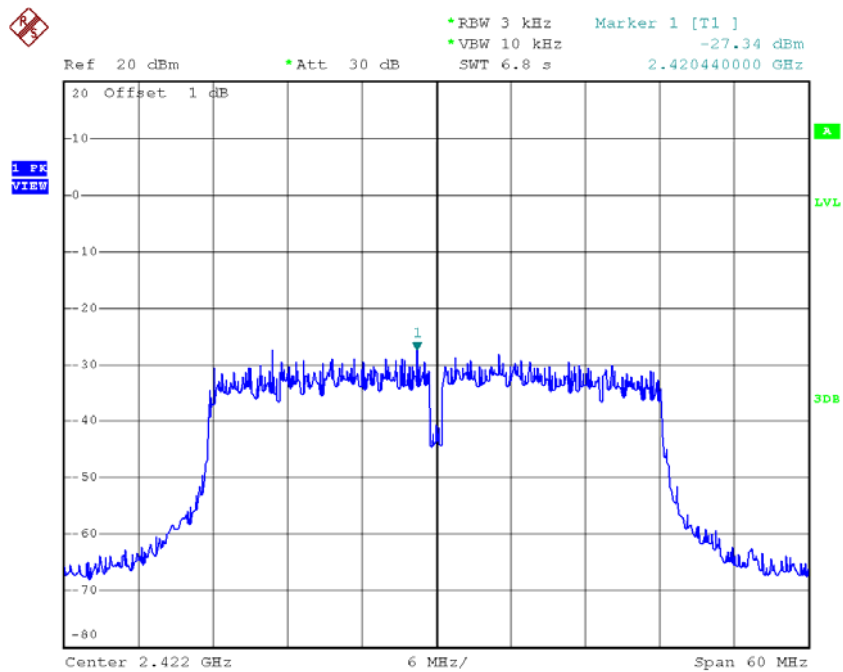

Date: 7.APR.2015 15:30:25

Test Mode : TX N-40M Mode_CH03/06/09_ANT 2

Frequency (MHz)	Power Density (dBm/3kHz)	Power Density (mW/3kHz)	Max. Limit (dBm/3kHz)	Result
2422	-27.47	0.00	6.74	Complies
2437	-22.50	0.01	6.74	Complies
2452	-25.87	0.00	6.74	Complies

TX CH03

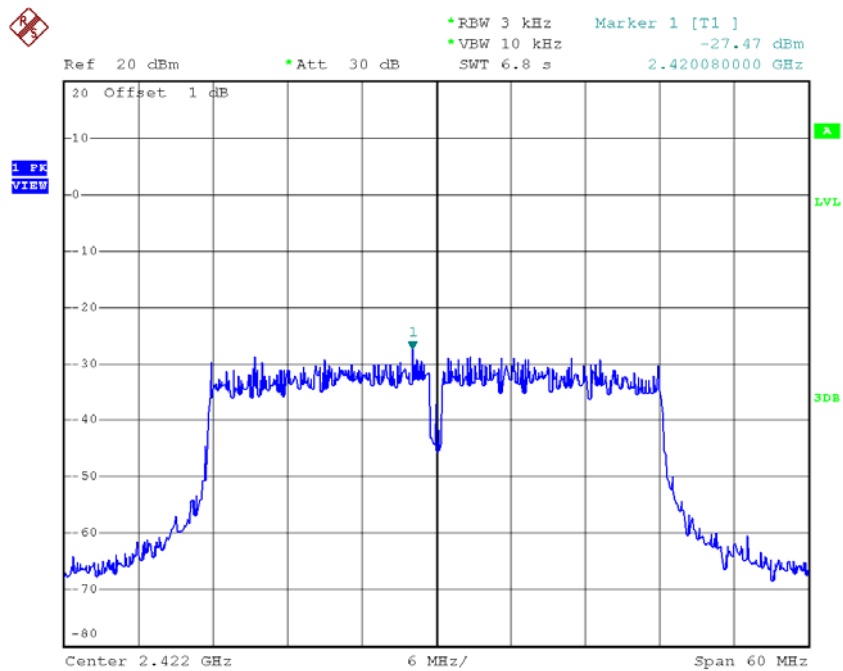

Date: 7.APR.2015 15:36:35

TX CH06

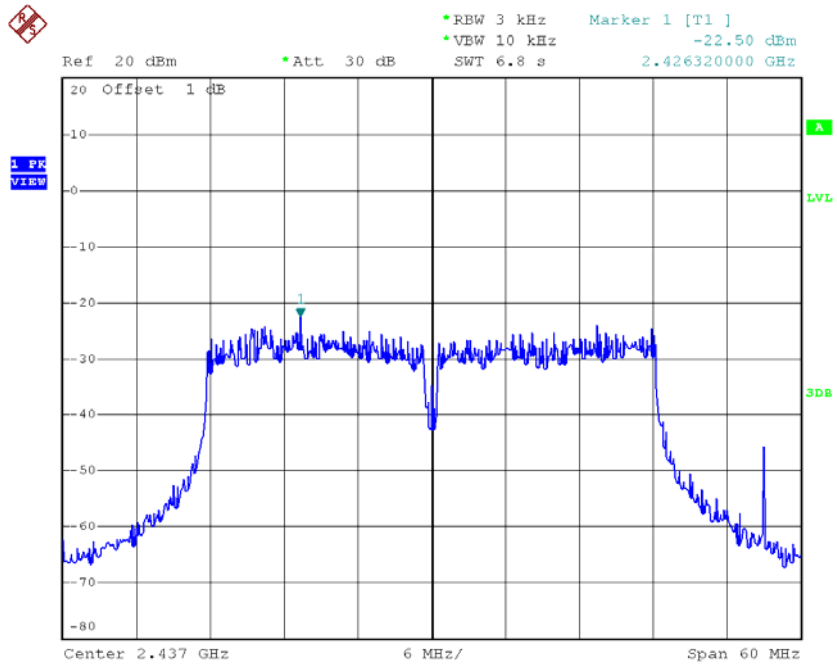

Date: 7.APR.2015 15:37:22

TX CH09

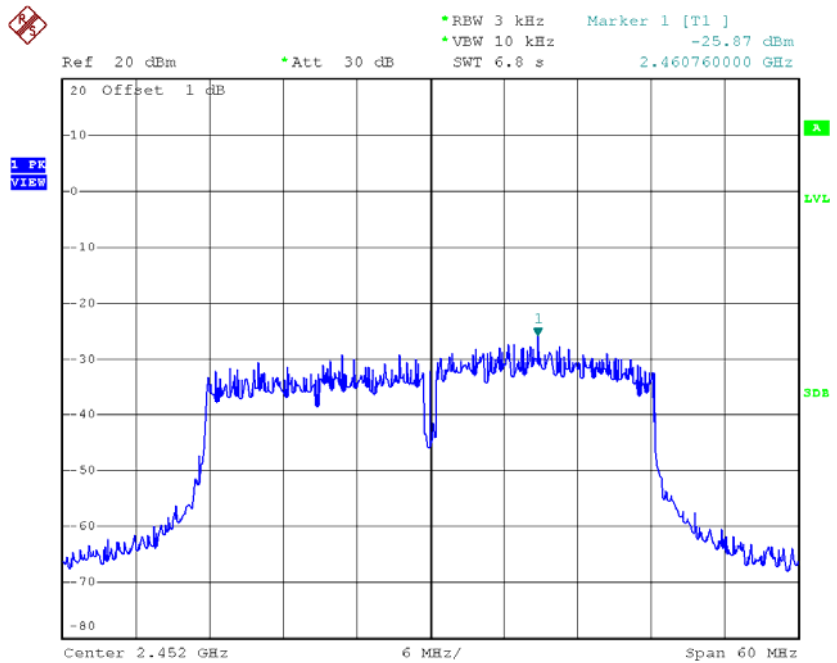

Date: 7.APR.2015 15:38:16

Test Mode : TX N-40M Mode_CH03/06/09_Total

Frequency (MHz)	Power Density (dBm/3kHz)	Power Density (mW/3kHz)	Max. Limit (dBm/3kHz)	Result
2422	-24.39	0.00	6.74	Complies
2437	-20.02	0.01	6.74	Complies
2452	-23.36	0.00	6.74	Complies