

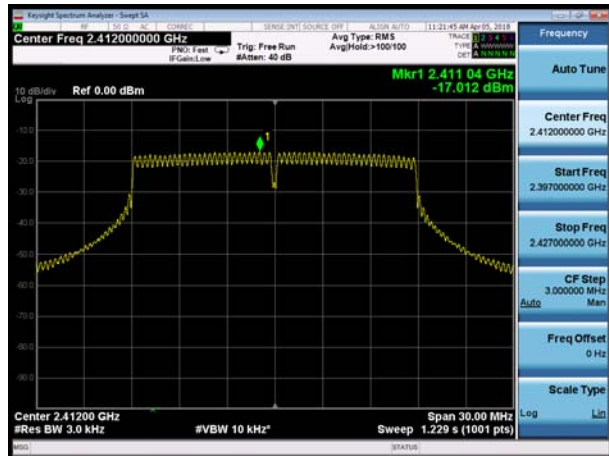

MIMO Antenna 3

802.11n(HT20), Channel No. 1



802.11n(HT40), Channel No. 3

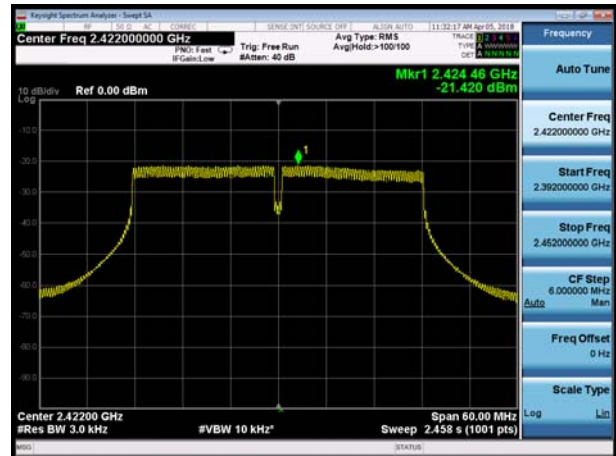

802.11n(HT20), Channel No. 6

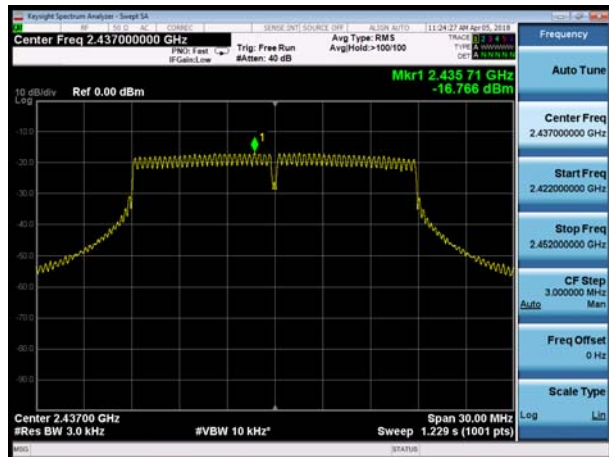

802.11n(HT40), Channel No. 6

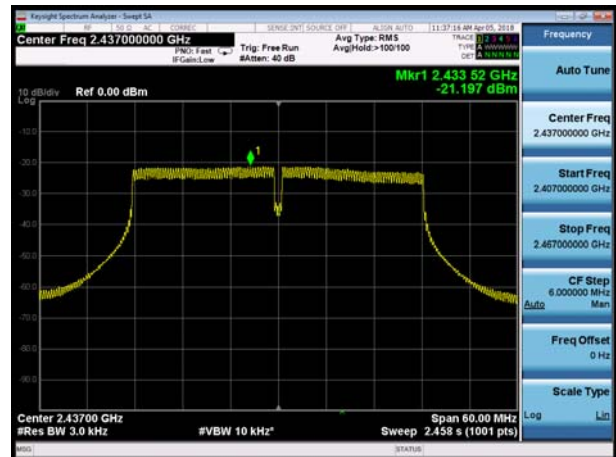

802.11n(HT20), Channel No. 11

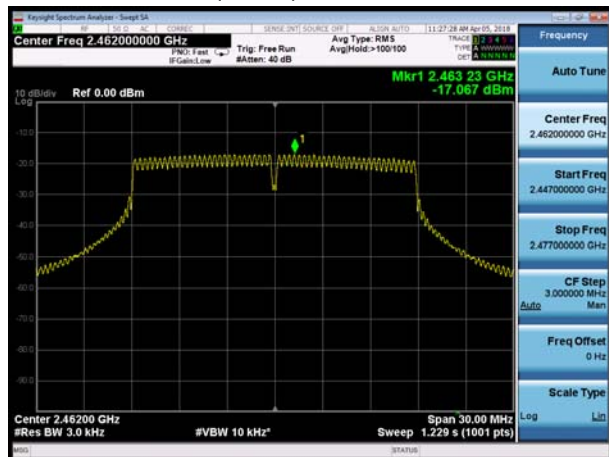

802.11n(HT40), Channel No. 9

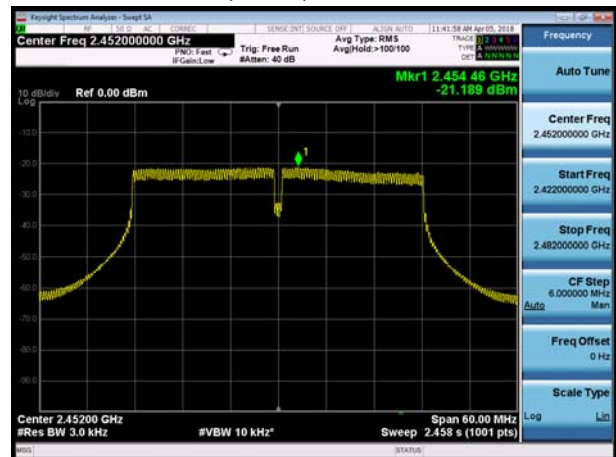



MIMO Antenna 4X4 without beamforming

MIMO Antenna 1

802.11b, Channel No.: 1



802.11g, Channel No.: 1

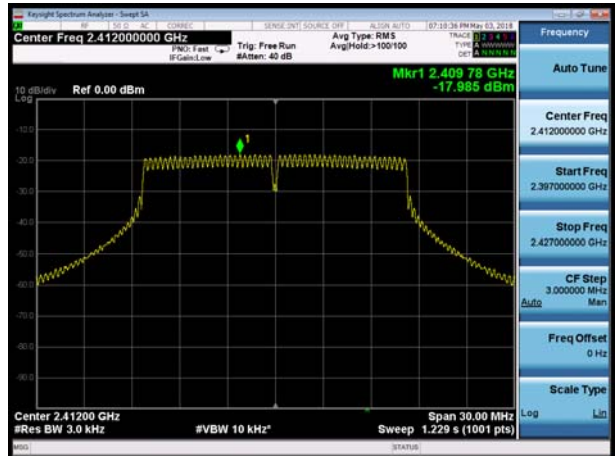

802.11b, Channel No.: 6



802.11g, Channel No.: 6

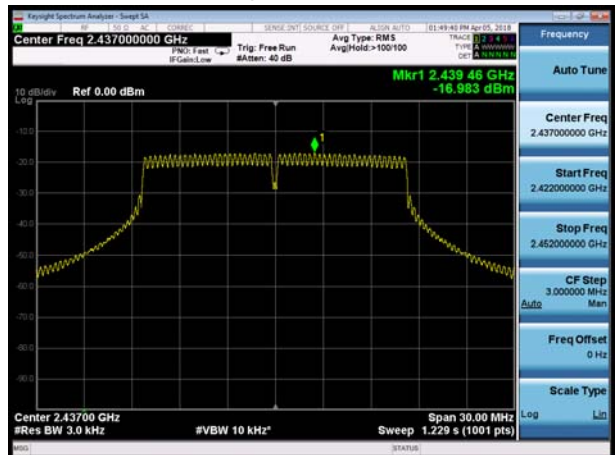

802.11b, Channel No.: 11



802.11g, Channel No.: 11

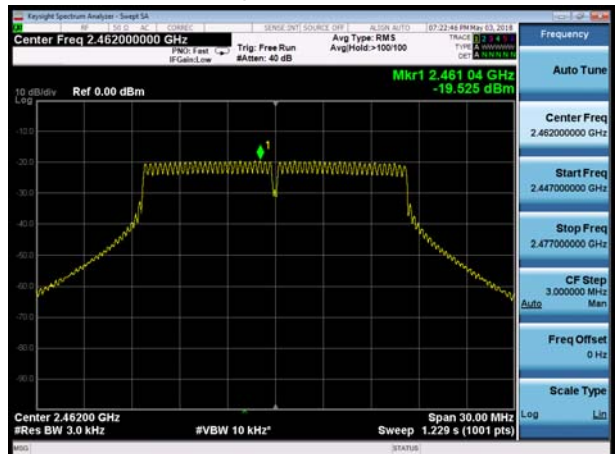



802.11n(HT20), Channel No. 1

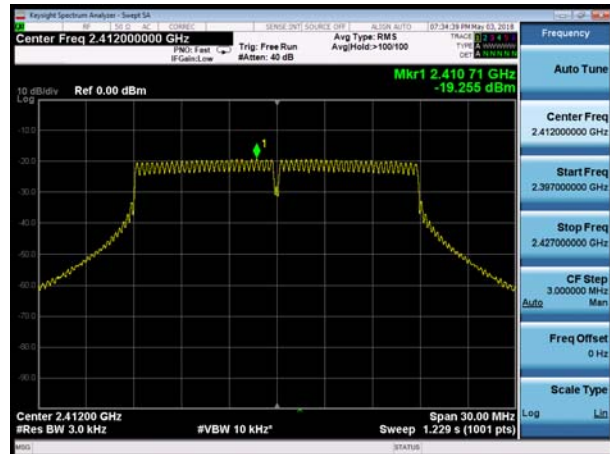

802.11n(HT40), Channel No. 3

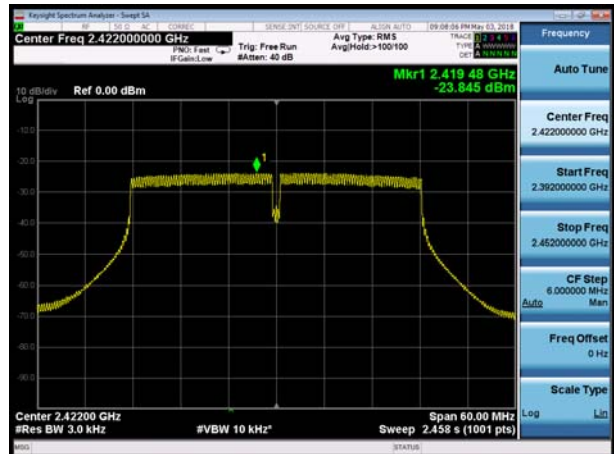

802.11n(HT20), Channel No. 6

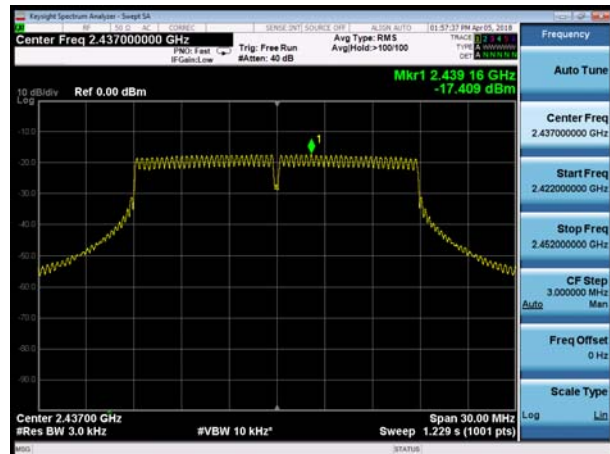

802.11n(HT40), Channel No. 6

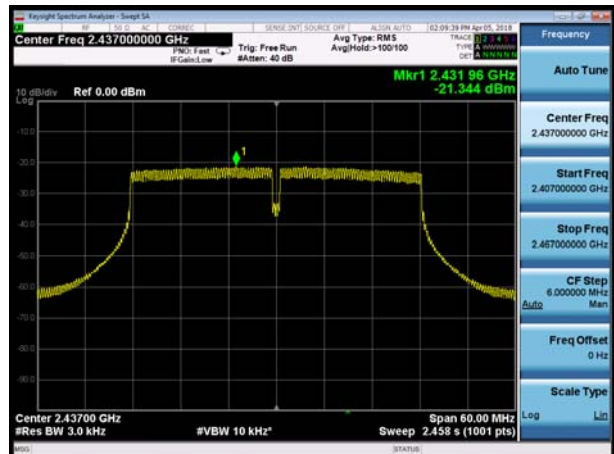

802.11n(HT20), Channel No. 11

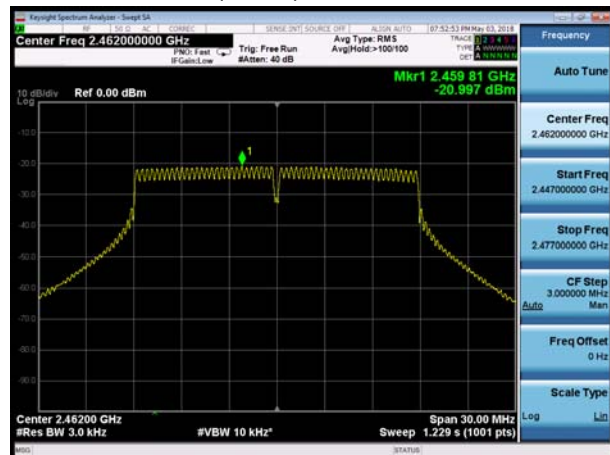

802.11n(HT40), Channel No. 9

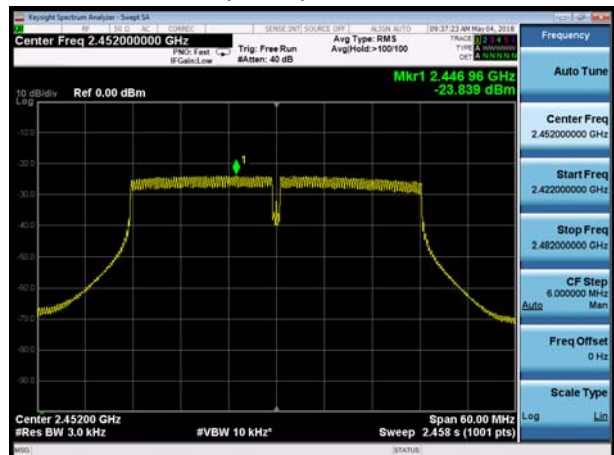



MIMO Antenna 2

802.11b, Channel No.: 1



802.11g, Channel No.: 1

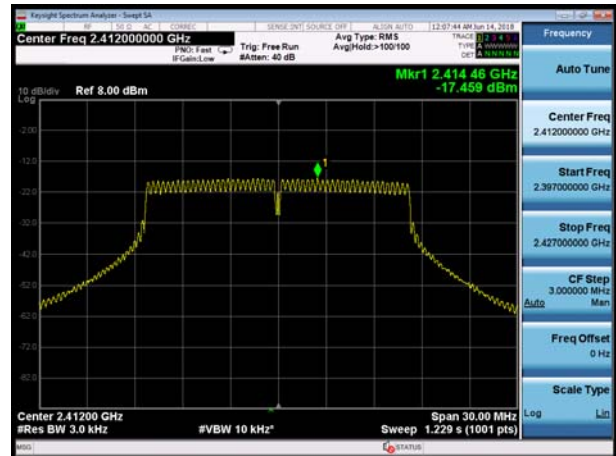

802.11b, Channel No.: 6



802.11g, Channel No.: 6

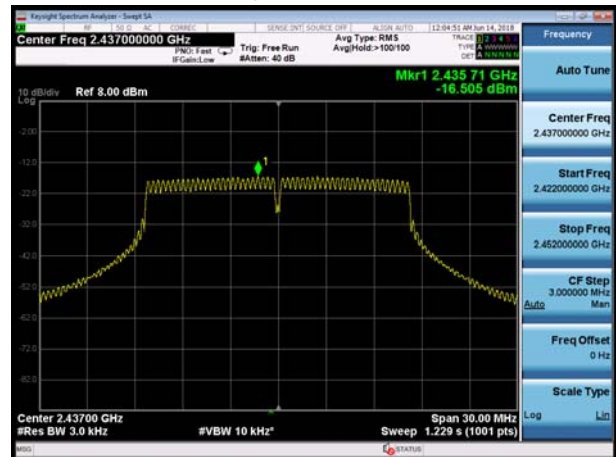

802.11b, Channel No.: 11



802.11g, Channel No.: 11





802.11n(HT20), Channel No. 1

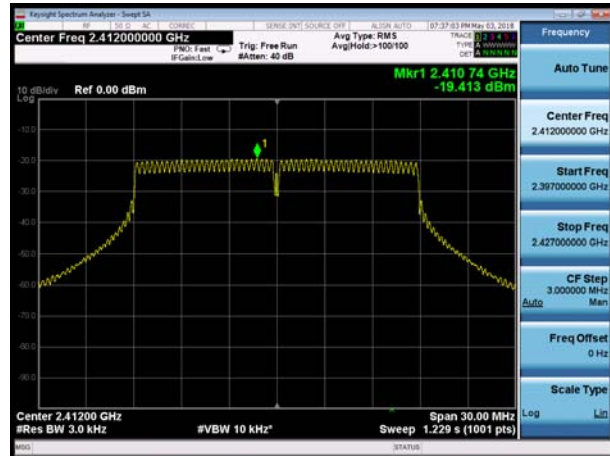

802.11n(HT40), Channel No. 3

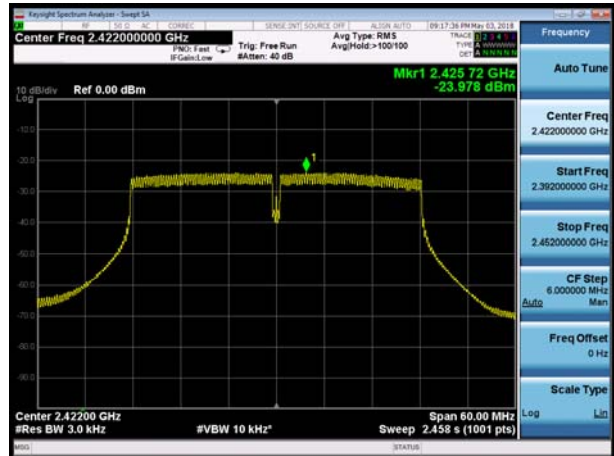

802.11n(HT20), Channel No. 6

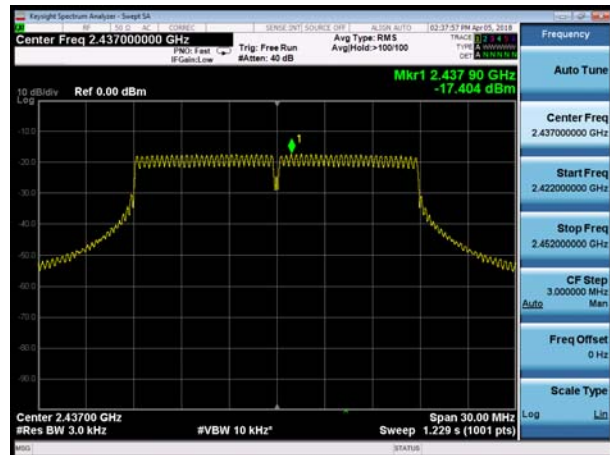

802.11n(HT40), Channel No. 6

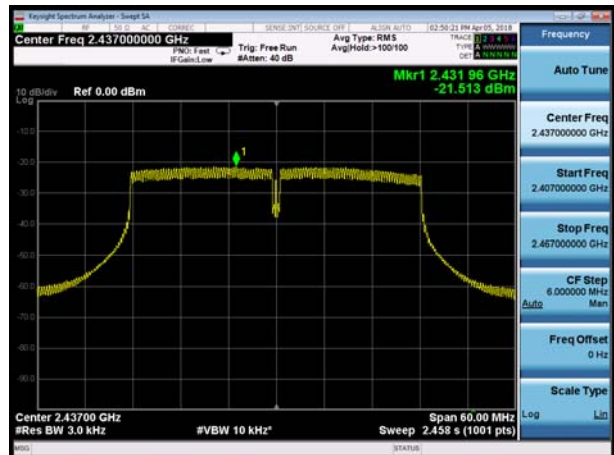

802.11n(HT20), Channel No. 11

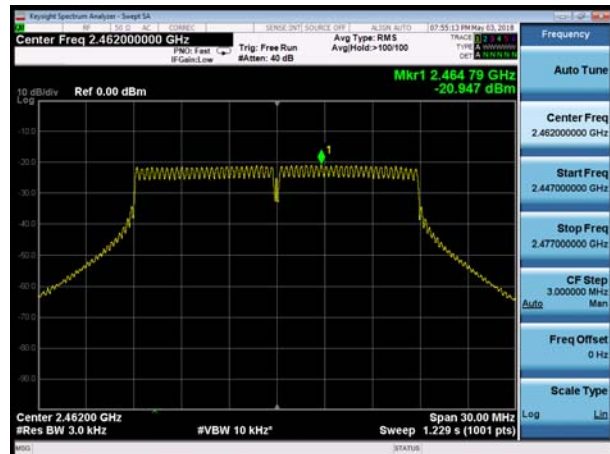

802.11n(HT40), Channel No. 9

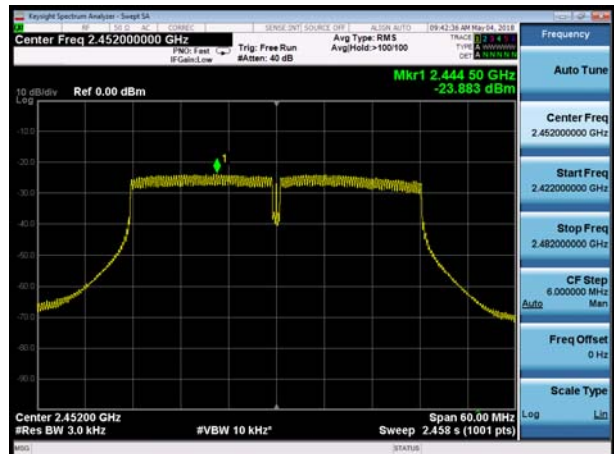



MIMO Antenna 3

802.11b, Channel No.: 1



802.11g, Channel No.: 1



802.11b, Channel No.: 6



802.11g, Channel No.: 6



802.11b, Channel No.: 11



802.11g, Channel No.: 11





802.11n(HT20), Channel No. 1

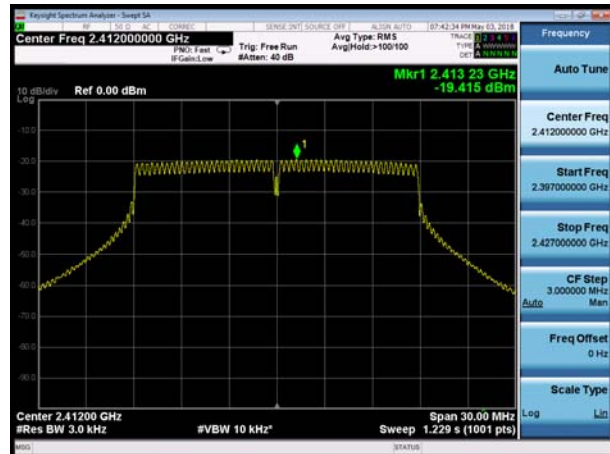

802.11n(HT40), Channel No. 3

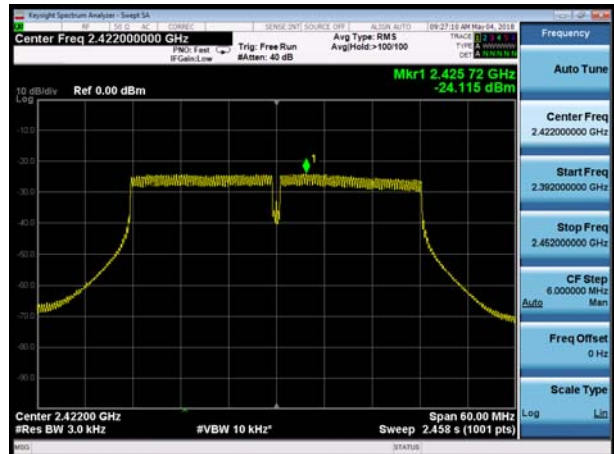

802.11n(HT20), Channel No. 6

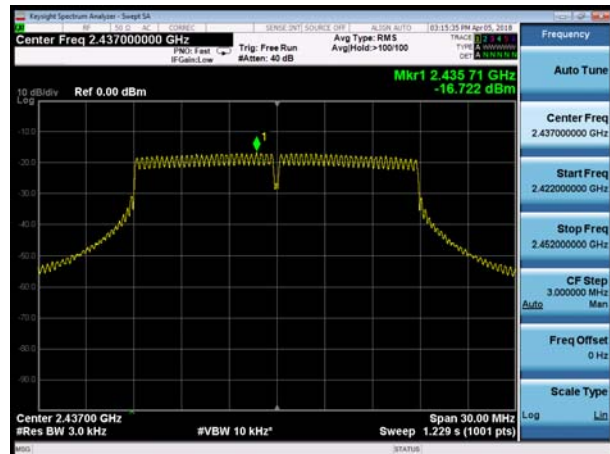

802.11n(HT40), Channel No. 6

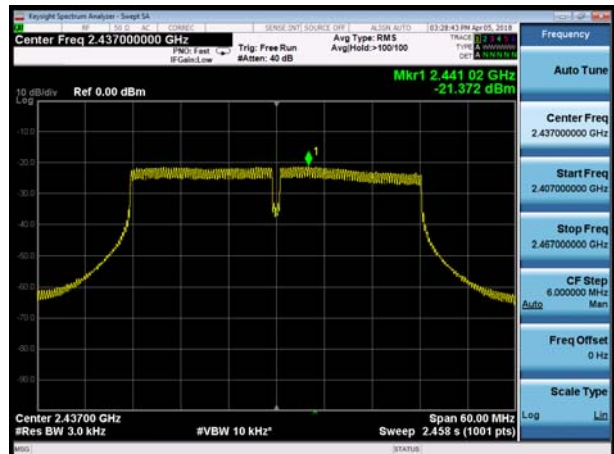

802.11n(HT20), Channel No. 11

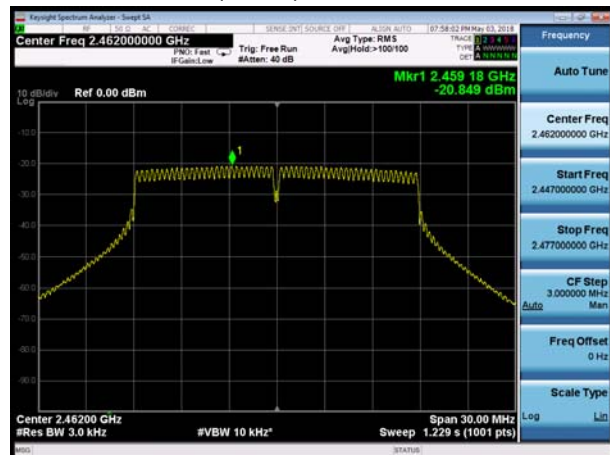

802.11n(HT40), Channel No. 9

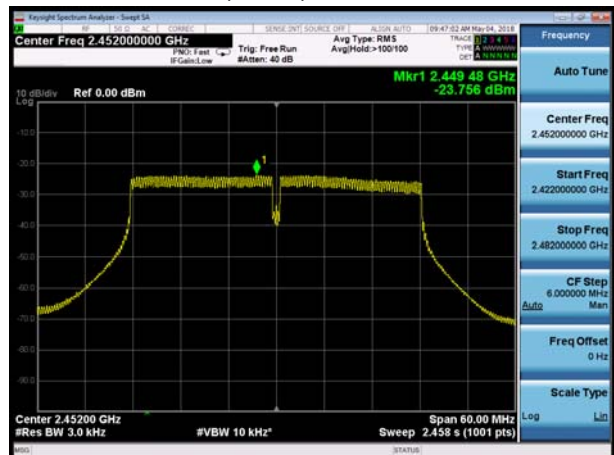



MIMO Antenna 4

802.11b, Channel No.: 1



802.11g, Channel No.: 1



802.11b, Channel No.: 6



802.11g, Channel No.: 6



802.11b, Channel No.: 11



802.11g, Channel No.: 11





802.11n(HT20), Channel No. 1

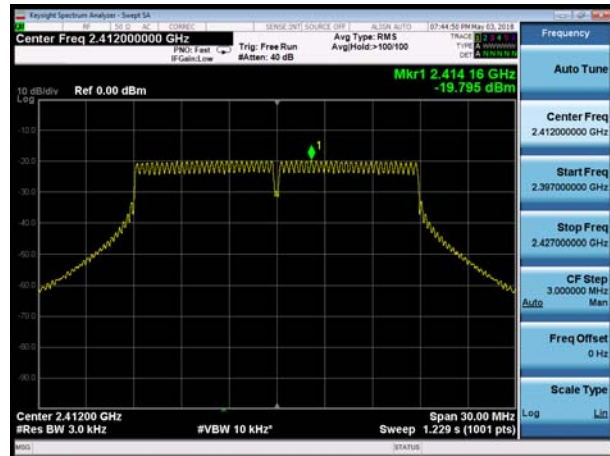

802.11n(HT40), Channel No. 3

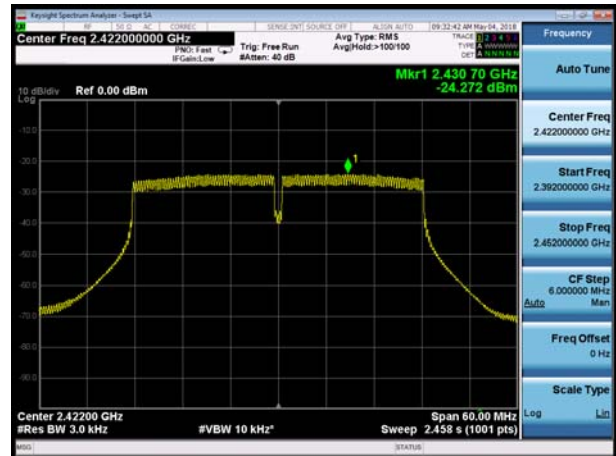

802.11n(HT20), Channel No. 6

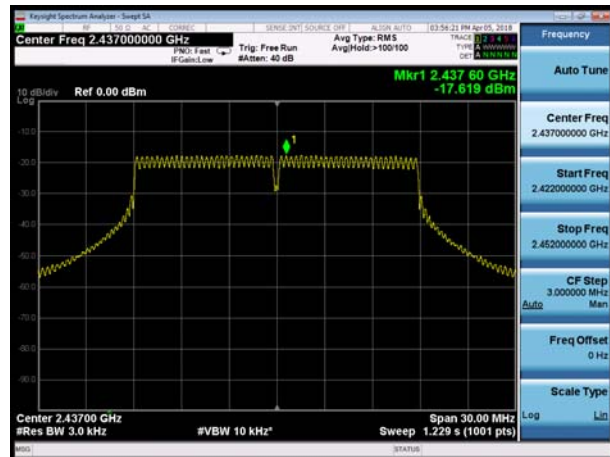

802.11n(HT40), Channel No. 6

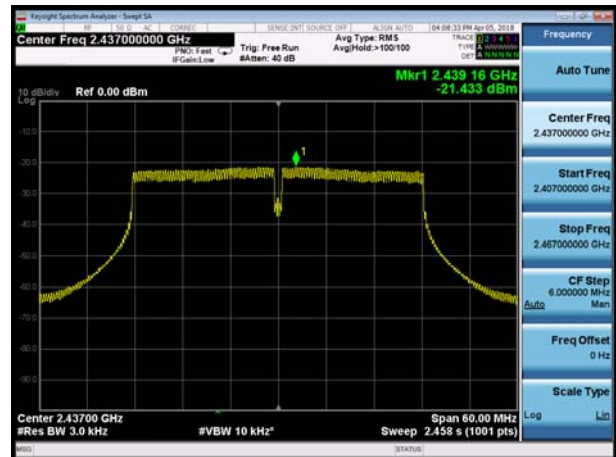

802.11n(HT20), Channel No. 11

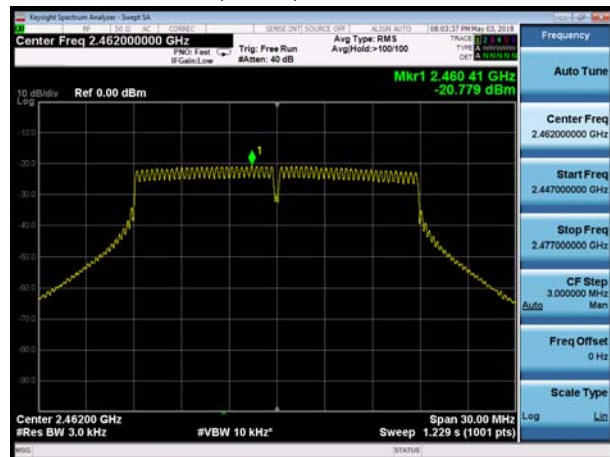

802.11n(HT40), Channel No. 9





MIMO Antenna 4X4 with beamforming MIMO Antenna 1

802.11n(HT20), Channel No. 1

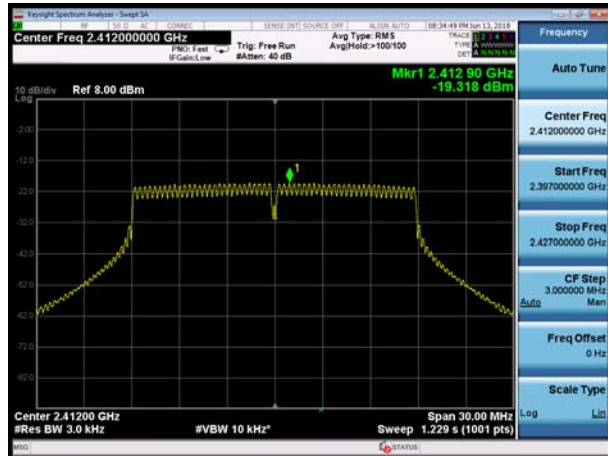

802.11n(HT40), Channel No. 3



802.11n(HT20), Channel No. 6

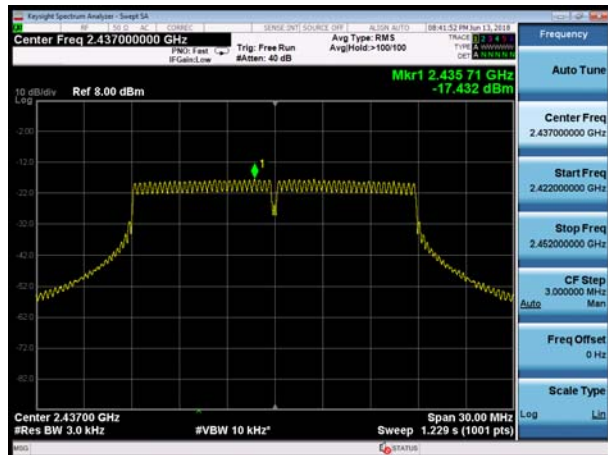

802.11n(HT40), Channel No. 6



802.11n(HT20), Channel No. 11

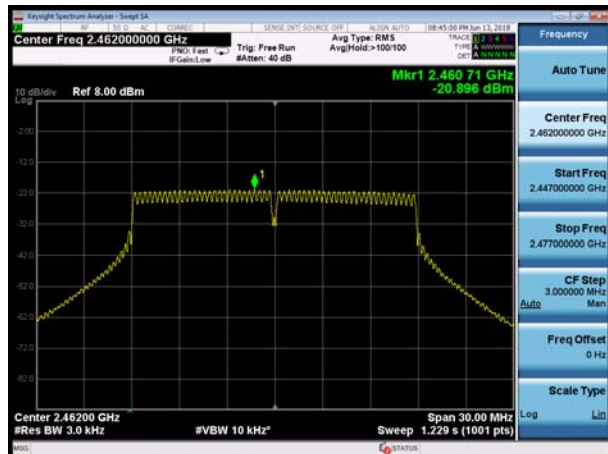

802.11n(HT40), Channel No. 9





MIMO Antenna 2

802.11n(HT20), Channel No. 1

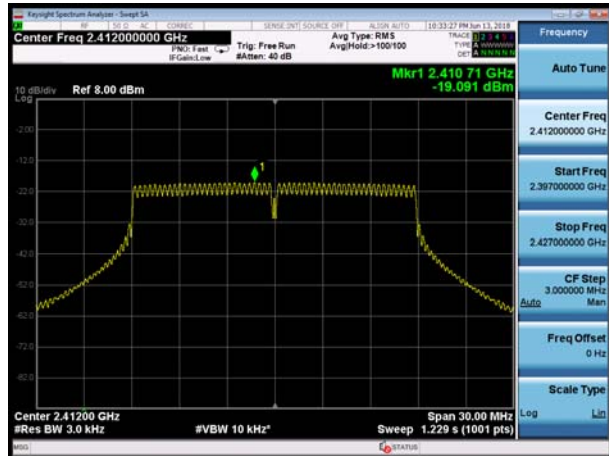

802.11n(HT40), Channel No. 3



802.11n(HT20), Channel No. 6

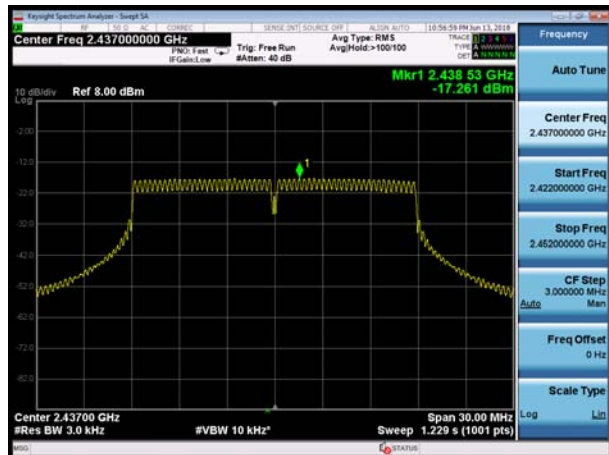

802.11n(HT40), Channel No. 6

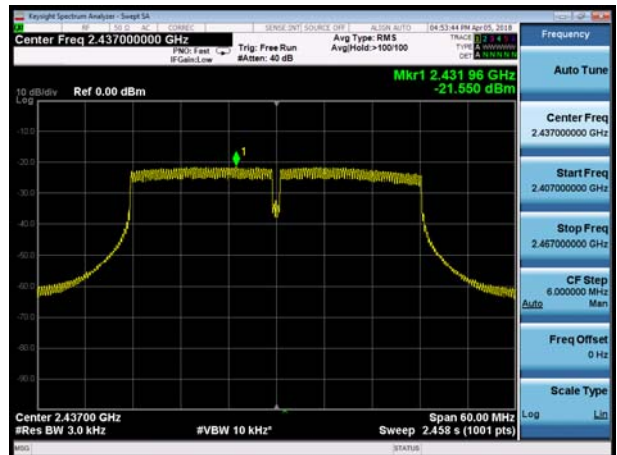

802.11n(HT20), Channel No. 11

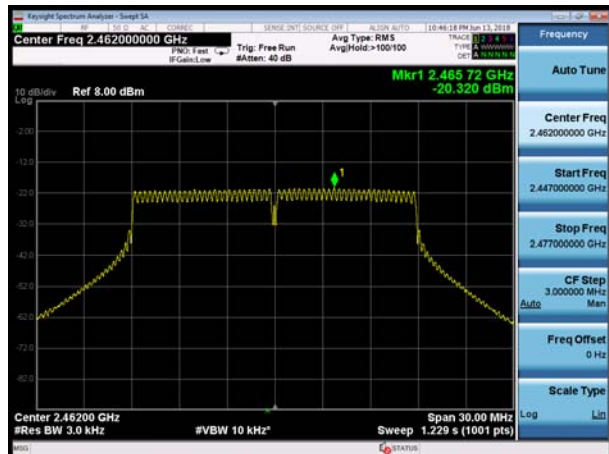

802.11n(HT40), Channel No. 9





MIMO Antenna 3

802.11n(HT20), Channel No. 1

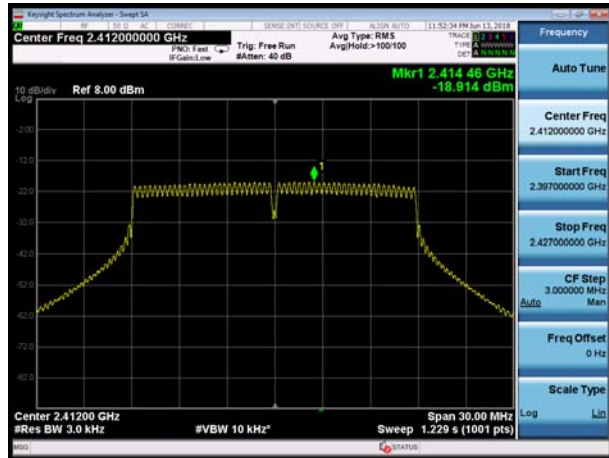

802.11n(HT40), Channel No. 3



802.11n(HT20), Channel No. 6

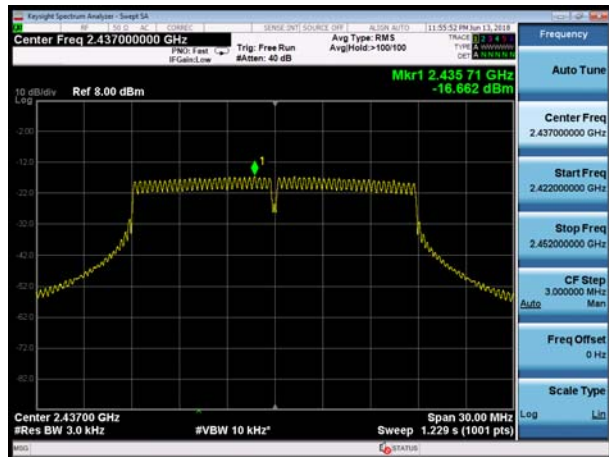

802.11n(HT40), Channel No. 6

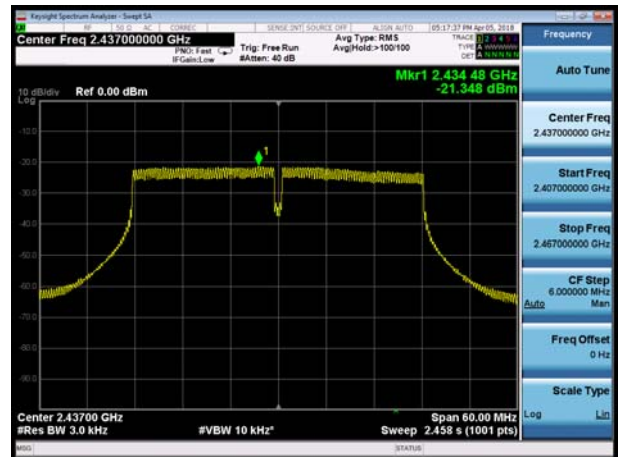

802.11n(HT20), Channel No. 11

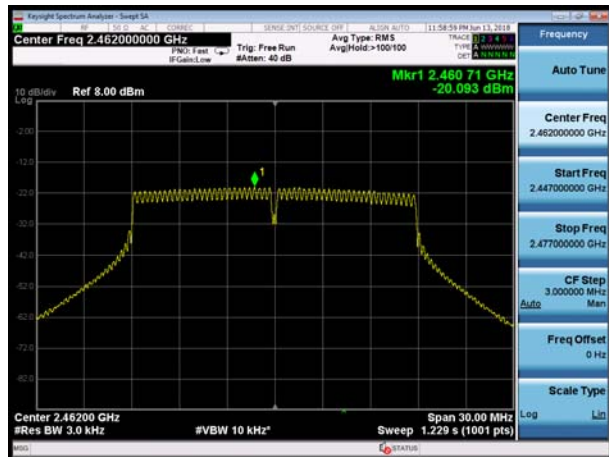

802.11n(HT40), Channel No. 9





MIMO ANT4

802.11n(HT20), Channel No. 1

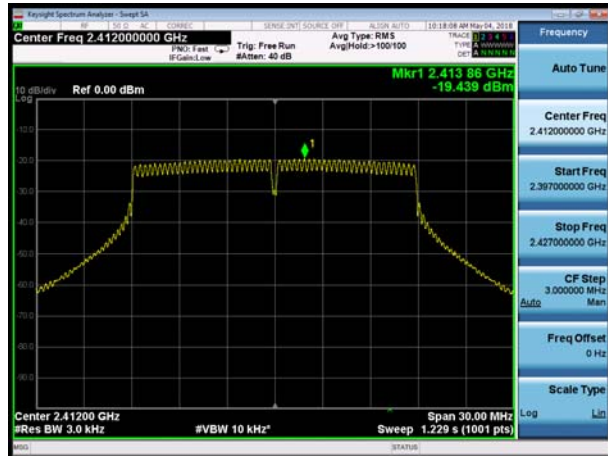

802.11n(HT40), Channel No. 3

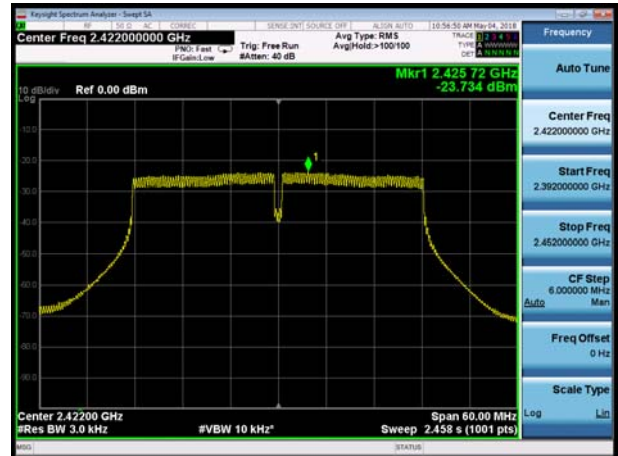

802.11n(HT20), Channel No. 6

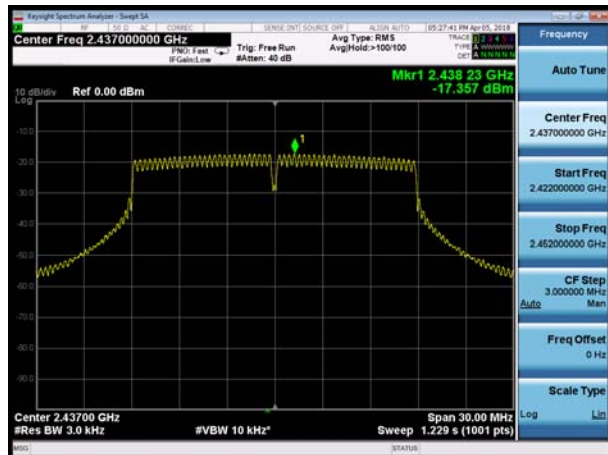

802.11n(HT40), Channel No. 6

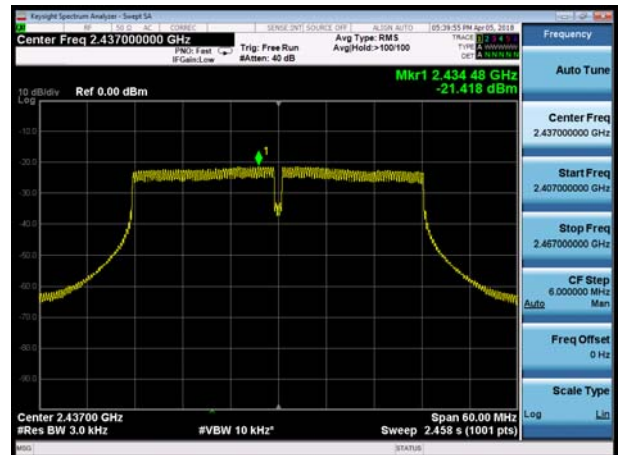

802.11n(HT20), Channel No. 11

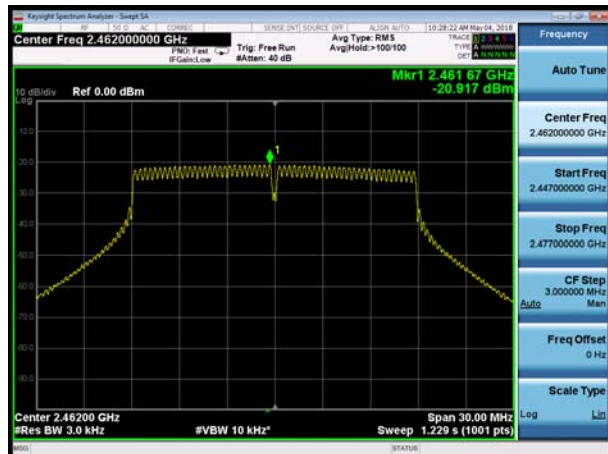

802.11n(HT40), Channel No. 9



5.5. Spurious RF Conducted Emissions

Ambient condition

Temperature	Relative humidity	Pressure
23°C ~25°C	45%~50%	101.5kPa

Method of Measurement

The EUT was connected to the spectrum analyzer with a known loss. The spectrum analyzer scans from 30MHz to the 10th harmonic of the carrier. The peak detector is used. Set RBW to100kHz and VBW to 300 kHz, Sweep is set to ATUO.

The test is in transmitting mode.

Test setup



Limits

Rule Part 15.247(d) pacifies that “In any 100 kHz bandwidth outside the frequency band in which the spread spectrum intentional radiator is operating, the radio frequency power that is produced by the intentional radiator shall be at least 30 dB below that in the 100 kHz bandwidth within the band that contains the highest level of the desired power.” If the transmitter complies with the conducted power limits based on the use of RMS averaging over a time interval, as permitted under paragraph (b)(3) of this section, the attenuation required under this paragraph shall be 30 dB instead of 20 dB.”

Network Standards	Carrier frequency (MHz)	Reference value (dBm)	Limit
802.11b	2412	11.07	-18.93
	2437	10.37	-19.63
	2462	10.86	-19.14
802.11g	2412	6.99	-23.01
	2437	5.92	-24.08
	2462	6.61	-23.39
802.11n HT20	2412	5.73	-24.27
	2437	5.84	-24.16
	2462	5.66	-24.34
802.11n HT40	2422	2.77	-27.23
	2437	2.85	-27.15
	2452	2.70	-27.30

**Measurement Uncertainty**

The assessed measurement uncertainty to ensure 95% confidence level for the normal distribution is with the coverage factor $k = 1.96$.

Frequency	Uncertainty
100kHz-2GHz	0.684 dB
2GHz-26GHz	1.407 dB



Test Results:

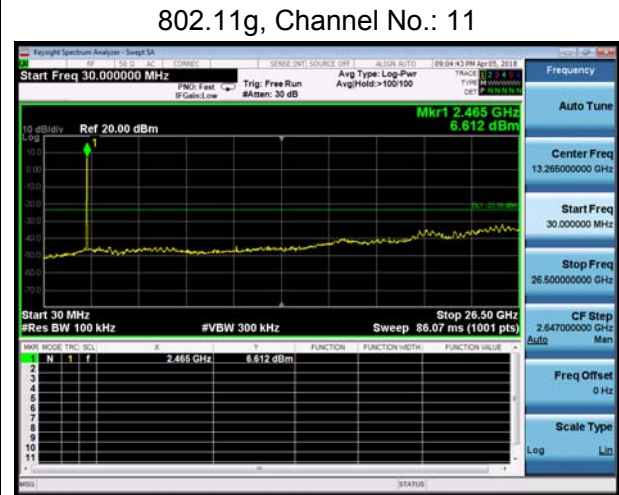
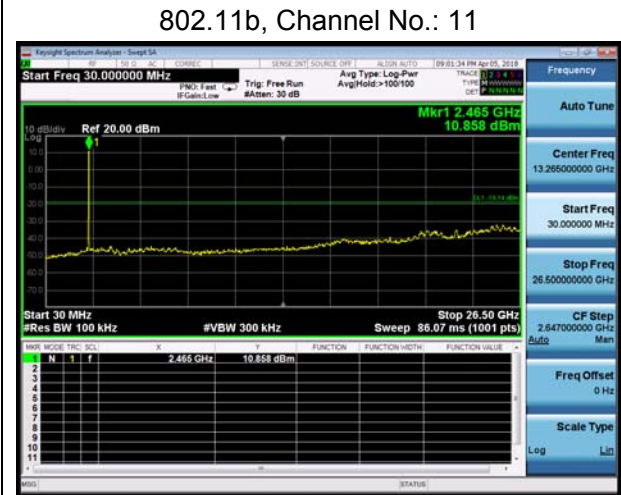
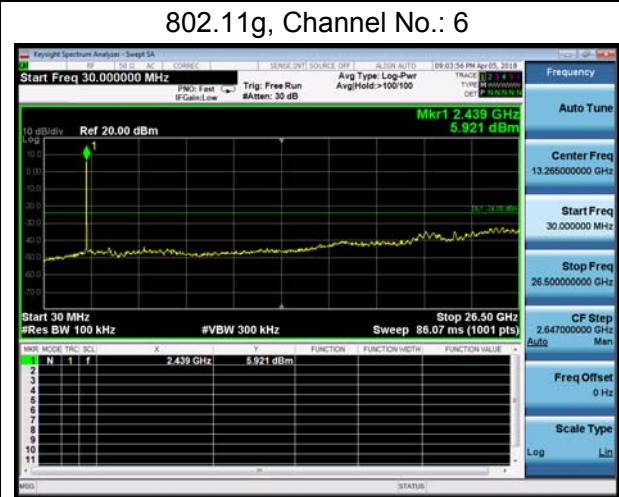
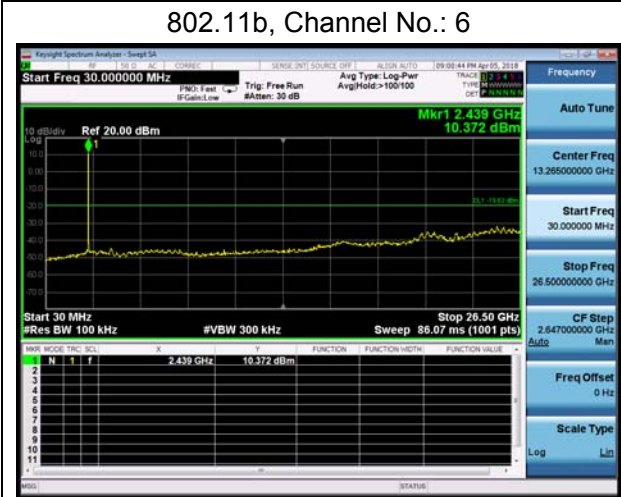
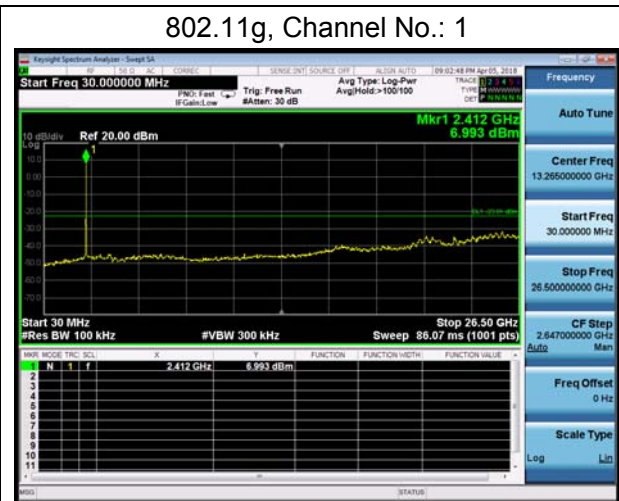
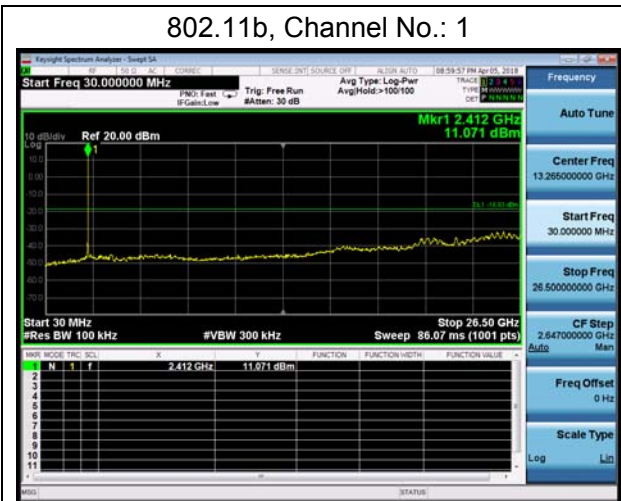



802.11n(HT20), Channel No. 1

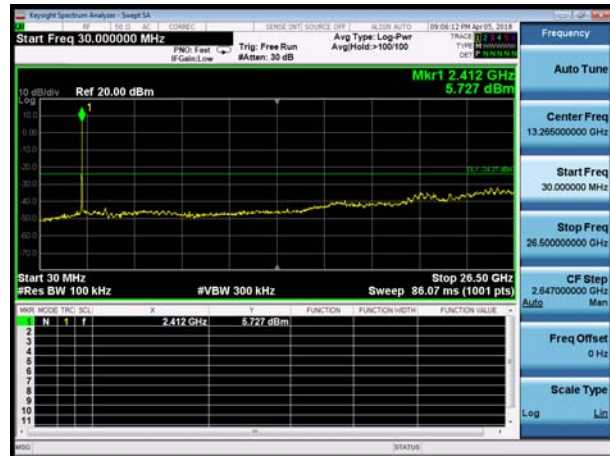

802.11n(HT40), Channel No. 3

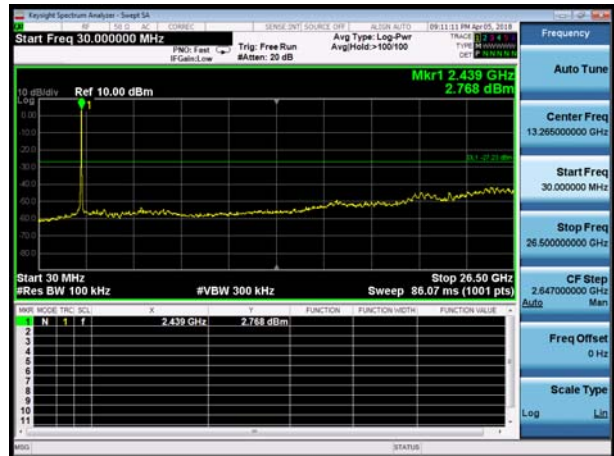

802.11n(HT20), Channel No. 6

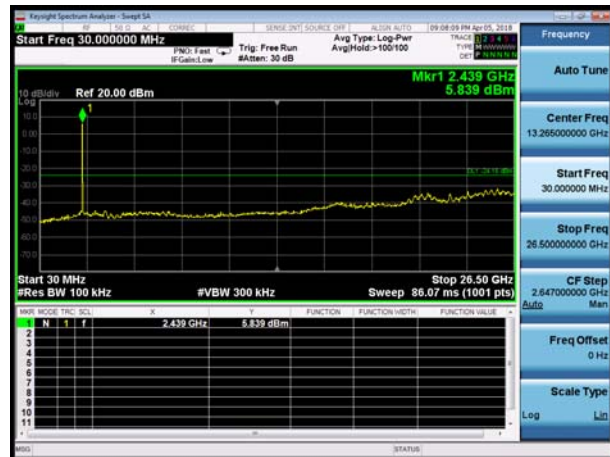

802.11n(HT40), Channel No. 6

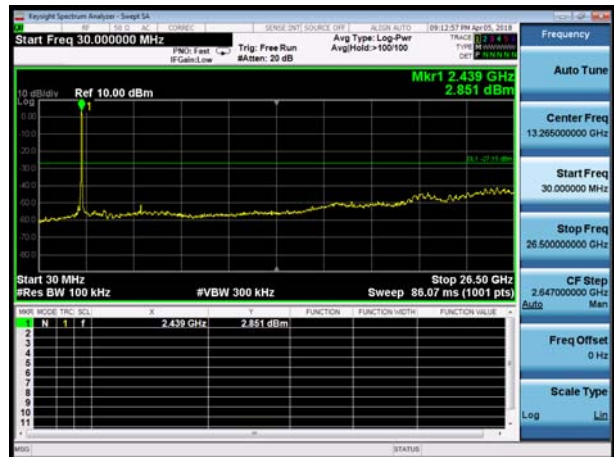

802.11n(HT20), Channel No. 11

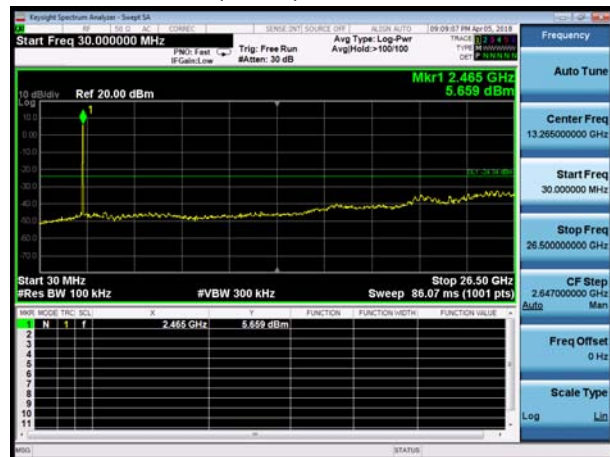

802.11n(HT40), Channel No. 9



5.6. Radiated Emissions in the Restricted Band

Ambient condition

Temperature	Relative humidity	Pressure
23°C ~25°C	45%~50%	101.5kPa

Method of Measurement

The Equipment Under Test (EUT) was set up on a non-conductive table in the semi-anechoic chamber. The test was performed at the distance of 3 m between the EUT and the receiving antenna. The turntable shall be rotated from 0 to 360 degrees for detecting the maximum of radiated spurious signal level. The measurements shall be repeated with orthogonal polarization of the test antenna. The data of cable loss and antenna factor has been calibrated in full testing frequency range before the testing. Sweep the Restricted Band and the emissions less than 20 dB below the permissible value are reported.

This method refer to KDB 558074.

The procedure for peak unwanted emissions measurements above 1000 MHz is as follows:

I) Peak emission levels are measured by setting the instrument as follows:

- 1) RBW = 1 MHz.
- 2) VBW \geq [3 \times RBW]
- 3) Detector = peak.
- 4) Sweep time = auto.
- 5) Trace mode = max hold.
- 6) Allow sweeps to continue until the trace stabilizes. Note that if the transmission is not continuous, then the time required for the trace to stabilize will increase by a factor of approximately 1 / D, where D is the duty cycle.

II) Average emission levels are measured by setting the instrument as follows:

- a) RBW = 1 MHz.
- b) VBW \geq [3 \times RBW].
- c) Detector = RMS (power averaging), if [span / (# of points in sweep)] \leq RBW / 2. Satisfying this condition can require increasing the number of points in the sweep or reducing the span. If the condition is not satisfied, then the detector mode shall be set to peak.
- d) Averaging type = power (i.e., rms) (As an alternative, the detector and averaging type may be set for linear voltage averaging. Some instruments require linear display mode to use linear voltage averaging. Log or dB averaging shall not be used.)
- e) Sweep time = auto.
- f) Perform a trace average of at least 100 traces if the transmission is continuous. If the transmission is not continuous, then the number of traces shall be increased by a factor of 1 / D, where D is the duty cycle. For example, with 50% duty cycle, at least 200 traces shall be averaged. (If a specific emission is demonstrated to be continuous—i.e., 100% duty cycle—then rather than turning ON and OFF with the transmit cycle, at least 100 traces shall be averaged.)

g) If tests are performed with the EUT transmitting at a duty cycle less than 98%, then a correction factor shall be added to the measurement results prior to comparing with the emission limit, to compute the emission level that would have been measured had the test been performed at 100% duty cycle. The correction factor is computed as follows:

1) If power averaging (rms) mode was used in the preceding step e), then the correction factor is $[10 \log (1 / D)]$, where D is the duty cycle. For example, if the transmit duty cycle was 50%, then 3 dB shall be added to the measured emission levels.

2) If linear voltage averaging mode was used in the preceding step e), then the correction factor is $[20 \log (1 / D)]$, where D is the duty cycle. For example, if the transmit duty cycle was 50%, then 6 dB shall be added to the measured emission levels.

3) If a specific emission is demonstrated to be continuous (100% duty cycle) rather than turning ON and OFF with the transmit cycle, then no duty cycle correction is required for that emission.

The field strength of spurious emission was measured in the following position: EUT stand-up position (Z axis), lie-down position (X, Y axis). The worst emission was found in stand-up position (Z axis) and the antenna is vertical.

The test is in transmitting mode.

Test setup

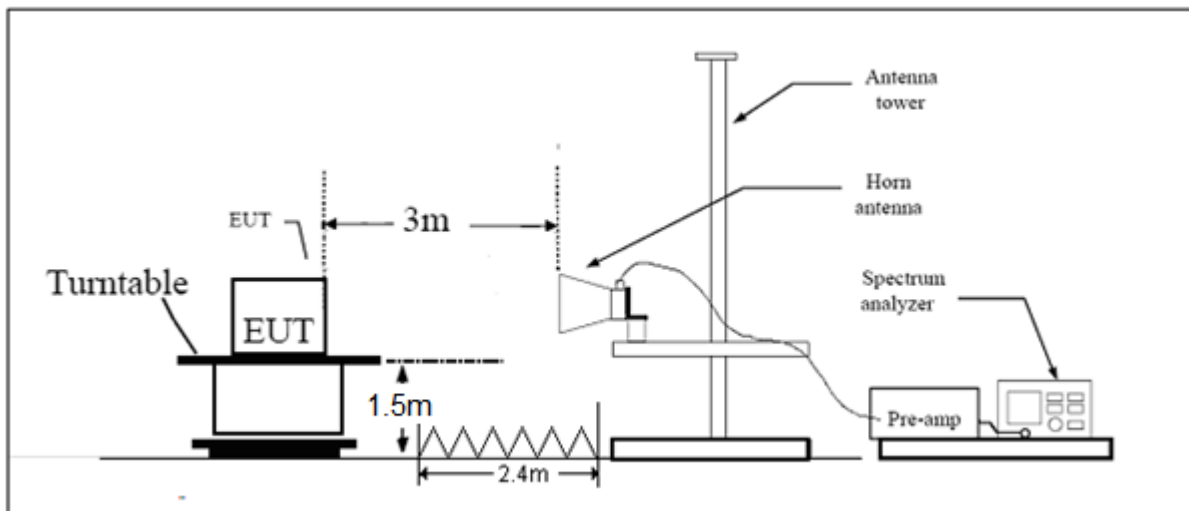

Note: Area side: 2.4mX3.6m

Limits

Spurious Radiated Emissions are permitted in any of the frequency bands listed below:



MHz	MHz	MHz	GHz
0.090 - 0.110	16.42 - 16.423	399.9 - 410	4.5 - 5.15
0.495 - 0.505	16.69475 - 16.69525	608 - 614	5.35 - 5.46
2.1735 - 2.1905	16.80425 - 16.80475	960 - 1240	7.25 - 7.75
4.125 - 4.128	25.5 - 25.67	1300 - 1427	8.025 - 8.5
4.17725 - 4.17775	37.5 - 38.25	1435 - 1626.5	9.0 - 9.2
4.20725 - 4.20775	73 - 74.6	1645.5 - 1646.5	9.3 - 9.5
6.215 - 6.218	74.8 - 75.2	1660 - 1710	10.6 - 12.7
6.26775 - 6.26825	108 - 121.94	1718.8 - 1722.2	13.25 - 13.4
6.31175 - 6.31225	123 - 138	2200 - 2300	14.47 - 14.5
8.291 - 8.294	149.9 - 150.05	2310 - 2390	15.35 - 16.2
8.362 - 8.366	156.52475 - 156.52525	2483.5 - 2500	17.7 - 21.4
8.37625 - 8.38675	156.7 - 156.9	2690 - 2900	22.01 - 23.12
8.41425 - 8.41475	162.0125 - 167.17	3260 - 3267	23.6 - 24.0
12.29 - 12.293	167.72 - 173.2	3332 - 3339	31.2 - 31.8
12.51975 - 12.52025	240 - 285	3345.8 - 3358	36.43 - 36.5
12.57675 - 12.57725	322 - 335.4	3600 - 4400	(²)
13.36 - 13.41			

Limit in restricted band

Frequency of emission (MHz)	Field strength(uV/m)	Field strength(dBuV/m)
30-88	100	40
88-216	150	43.5
216-960	200	46
Above960	500	54

§15.35(b)

There is also a limit on the radio frequency emissions, as measured using instrumentation with a peak detector function, corresponding to 20 dB above the maximum permitted average limit.

Peak Limit=74 dBuV/m

Average Limit=54 dBuV/m

Measurement Uncertainty

The assessed measurement uncertainty to ensure 95% confidence level for the normal distribution is with the coverage factor $k = 1.96$, $U = 3.55$ dB.

**Test Results:**

Band	T _{on} (ms)	T _(on+off) (ms)	Duty cycle	Duty cycle correction Factor(dB)
802.11b	12.22	12.29	0.99	0.00
802.11g	2.03	2.10	0.97	0.15
802.11n HT20	4.96	5.02	0.99	0.00
802.11n HT40	2.41	2.48	0.97	0.12

Note: when Duty cycle>0.98, Duty cycle correction Factor not required.

There is more than one Antenna Type, each one should be applied throughout the compliance test respectively, and however, only the worst case (Antenna Type 1) will be recorded in this report.

802.11b-Channel 1

Frequency (MHz)	Peak (dBuV/m)	Average (dBuV/m)	Height (cm)	Polarization	Azimuth (deg)	Duty cycle correction Factor(dB)	conclusion value (dBuV/m)	Margin (dB)	Limit (dBuV/m)
2390	59.894	--	200.0	V	135	0.00	59.894	14.106	74
2390	--	46.396	200.0	V	135	0.00	46.396	7.604	54

802.11b-Channel 11

Frequency (MHz)	Peak (dBuV/m)	Average (dBuV/m)	Height (cm)	Polarization	Azimuth (deg)	Duty cycle correction Factor(dB)	conclusion value (dBuV/m)	Margin (dB)	Limit (dBuV/m)
2483.5	67.060	--	200.0	V	135	0.00	67.060	6.940	74
2483.5	--	48.414	200.0	V	135	0.00	48.414	5.586	54

802.11g-Channel 1

Frequency (MHz)	Peak (dBuV/m)	Average (dBuV/m)	Height (cm)	Polarization	Azimuth (deg)	Duty cycle correction Factor(dB)	conclusion value (dBuV/m)	Margin (dB)	Limit (dBuV/m)
2390	69.683	--	150	V	65	0.15	69.833	4.167	74
2390	--	51.152	150	V	65	0.15	51.302	2.698	54

802.11g-Channel 11

Frequency (MHz)	Peak (dBuV/m)	Average (dBuV/m)	Height (cm)	Polarization	Azimuth (deg)	Duty cycle correction Factor(dB)	conclusion value (dBuV/m)	Margin (dB)	Limit (dBuV/m)
2483.5	72.689	--	150	V	78	0.15	72.839	1.161	74
2483.5	--	52.697	150	V	78	0.15	52.847	1.153	54

**802.11n HT20 -Channel 1**

Frequency (MHz)	Peak (dBuV/m)	Average (dBuV/m)	Height (cm)	Polarization	Azimuth (deg)	Duty cycle correction Factor(dB)	conclusion value (dBuV/m)	Margin (dB)	Limit (dBuV/m)
2390	70.750	--	200	V	90	0.00	70.750	3.250	74
2390	--	48.400	200	V	90	0.00	48.400	5.600	54

802.11n HT20-Channel 11

Frequency (MHz)	Peak (dBuV/m)	Average (dBuV/m)	Height (cm)	Polarization	Azimuth (deg)	Duty cycle correction Factor(dB)	conclusion value (dBuV/m)	Margin (dB)	Limit (dBuV/m)
2483.5	72.776	--	200	V	90	0.00	72.776	1.224	74
2483.5	--	52.054	200	V	90	0.00	52.054	1.946	54

802.11n HT40 -Channel 3

Frequency (MHz)	Peak (dBuV/m)	Average (dBuV/m)	Height (cm)	Polarization	Azimuth (deg)	Duty cycle correction Factor(dB)	conclusion value (dBuV/m)	Margin (dB)	Limit (dBuV/m)
2390	72.575	--	150	V	46	0.12	72.695	1.305	74
2390	--	51.396	150	V	46	0.12	51.516	2.484	54

802.11n HT40-Channel 9

Frequency (MHz)	Peak (dBuV/m)	Average (dBuV/m)	Height (cm)	Polarization	Azimuth (deg)	Duty cycle correction Factor(dB)	conclusion value (dBuV/m)	Margin (dB)	Limit (dBuV/m)
2483.5	71.756	--	150	V	46	0.12	71.876	2.124	74
2483.5	--	52.422	150	V	46	0.12	52.542	1.458	54

5.7. Radiates Emission

Ambient condition

Temperature	Relative humidity	Pressure
23°C ~25°C	45%~50%	102.5kPa

Method of Measurement

The test set-up was made in accordance to the general provisions of ANSI C63.10-2013. The Equipment Under Test (EUT) was set up on a non-conductive table in the semi-anechoic chamber. The test was performed at the distance of 3 m between the EUT and the receiving antenna. The radiated emissions measurements were made in a typical installation configuration.

Sweep the whole frequency band through the range from 9 kHz to the 10th harmonic of the carrier, and the emissions less than 20 dB below the permissible value are reported.

During the test, below 30MHz, the center of the loop shall be 1 meters; above 30MHz, the height of receive antenna shall be moved from 1 to 4 meters, and the antenna shall be performed under horizontal and vertical polarization. The turntable shall be rotated from 0 to 360 degrees for detecting the maximum of radiated spurious signal level. The measurements shall be repeated with orthogonal polarization of the test antenna. The data of cable loss and antenna factor has been calibrated in full testing frequency range before the testing.

Set the spectrum analyzer in the following:

Below 1GHz (detector: Peak and Quasi-Peak)

RBW=100 kHz / VBW=300 kHz / Sweep=AUTO

Above 1GHz (detector: Peak):

(a) PEAK: RBW=1MHz / VBW=3MHz/ Sweep=AUTO

(b) AVERAGE: RBW=1MHz / VBW=10Hz, when duty cycle is not less than 98%

VBW \geq 1/T when duty cycle is less than 98%, where T is transmit on time

Sweep=AUTO

The radiated emission was measured in the following position: EUT stand-up position (Z axis), lie-down position (X, Y axis). The worst emission was found in lie-down position (X axis) and the worst case was recorded.

The test is in transmitting mode.

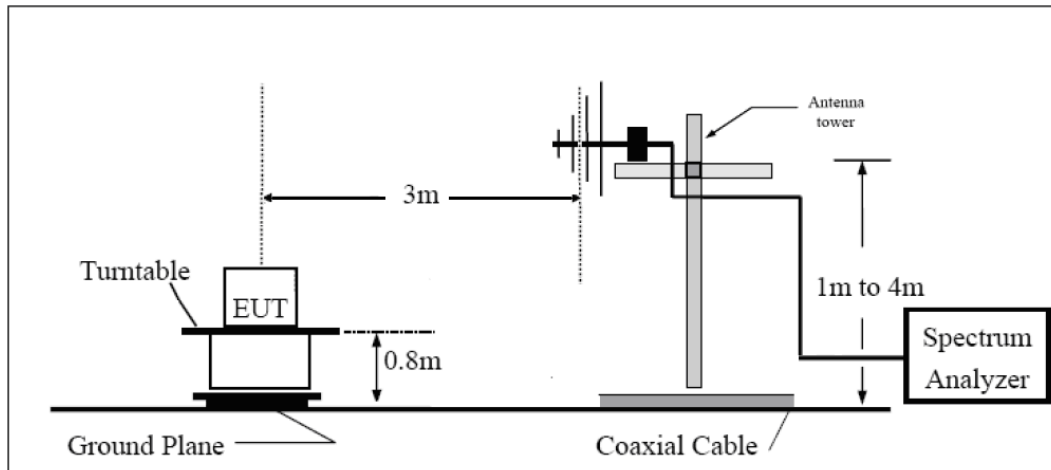
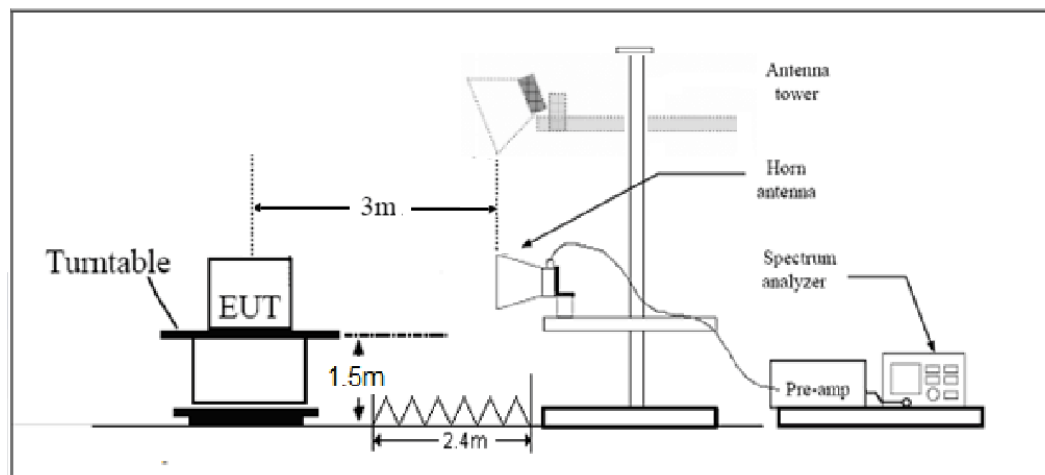
Test setup**30MHz ~ 1GHz****Above 1GHz**

Note: Area side:2.4mX3.6m

Limits

Rule Part 15.247(d) specifies that “In addition, radiated emissions which fall in the restricted bands, as defined in § 15.205(a), must also comply with the radiated emission limits specified in § 15.209(a) (see § 15.205(c)).”

Limit in restricted band

Frequency of emission (MHz)	Field strength(uV/m)	Field strength(dBuV/m)
0.009–0.490	2400/F(kHz)	/
0.490–1.705	24000/F(kHz)	/
1.705–30.0	30	/
30-88	100	40
88-216	150	43.5
216-960	200	46
Above960	500	54

§15.35(b)

There is also a limit on the radio frequency emissions, as measured using instrumentation with a peak detector function, corresponding to 20 dB above the maximum permitted average limit.

Measurement Uncertainty

The assessed measurement uncertainty to ensure 95% confidence level for the normal distribution is with the coverage factor $k = 1.96$.

Frequency	Uncertainty
9KHz-30MHz	3.55 dB
30MHz-200MHz	4.19 dB
200MHz-1GHz	3.63 dB
Above 1GHz	3.68 dB

Test result

Sweep the whole frequency band through the range from 9kHz to the 10th harmonic of the carrier, the emissions more than 20 dB below the permissible value are not reported.

The following graphs display the maximum values of horizontal and vertical by software.

For above 1GHz, Blue trace uses the peak detection, Green trace uses the average detection.

After the pre test, Antenna Type 1 was selected as the worst antenna.

During the test, the Radiates Emission from 30MHz to 1GHz was performed in all modes with all channels, 802.11n (HT40), Channel 6 are selected as the worst condition. The test data of the worst-case condition was recorded in this report.

Continuous TX mode:

RE 30M-1GHz QP

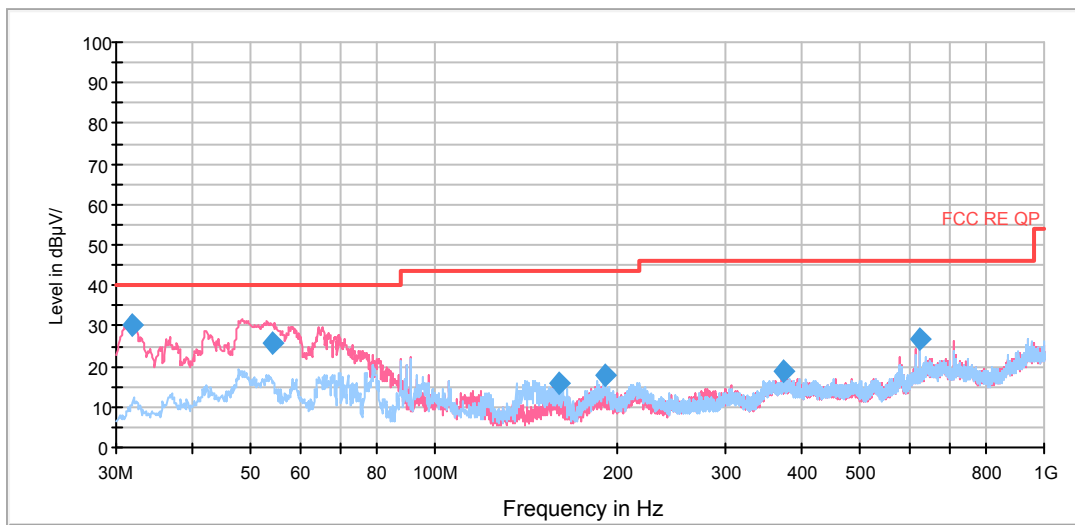

Radiates Emission from 30MHz to 1GHz

Frequency (MHz)	Quasi-Peak (dBuV/m)	Reading value (dBuV/m)	Height (cm)	Polarization	Azimuth (deg)	Correct Factor (dB)	Margin (dB)	Limit (dBuV/m)
31.898297	30.2	49.2	100.0	V	145.0	-19.0	9.8	40.0
54.356269	25.8	45.8	121.0	V	0.0	-20.0	14.2	40.0
160.421944	15.8	43.7	125.0	H	268.0	-27.9	27.7	43.5
190.740556	17.8	43.2	100.0	H	108.0	-25.4	25.7	43.5
375.018750	18.8	38.2	119.0	H	227.0	-19.4	27.2	46.0
625.012500	26.9	43.1	100.0	H	226.0	-16.2	19.1	46.0

Remark: 1. Quasi-Peak = Reading value + Correction factor

2. Correction Factor = Antenna factor+ Insertion loss(cable loss+amplifier gain)

3. Margin = Limit – Quasi-Peak

802.11b CH1

RE 1G-3GHz PK+AV

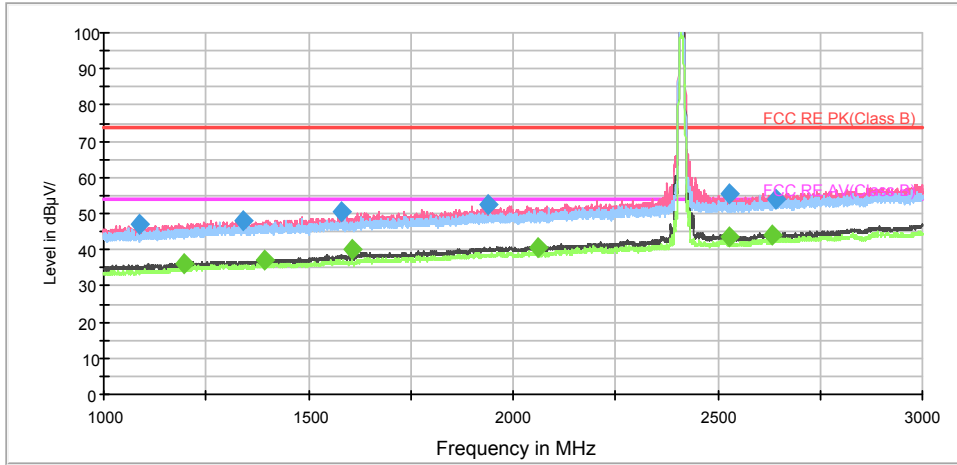

Note: The signal beyond the limit is carrier.
Radiates Emission from 1GHz to 3GHz

RE 3-18GHz PK+AV

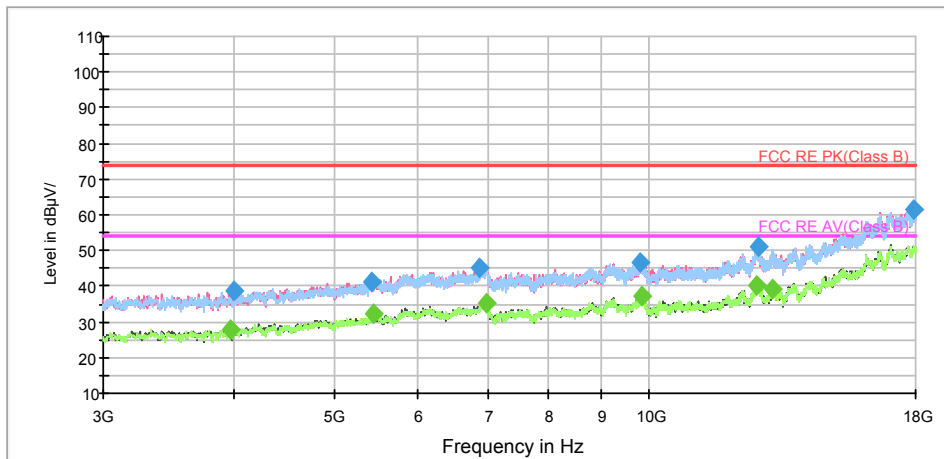

Radiates Emission from 3GHz to 18GHz

Frequency (MHz)	Peak (dBuV/m)	Height (cm)	Polarization	Azimuth (deg)	Reading value (dBuV/m)	Correct Factor (dB)	Margin (dB)	Limit (dBuV/m)
1089.500000	47.0	200.0	V	313.0	47.9	-0.9	27.0	74.0
1339.000000	48.3	200.0	V	269.0	47.7	0.6	25.7	74.0
1579.500000	50.6	200.0	V	269.0	48.9	1.7	23.4	74.0
1938.250000	52.6	200.0	V	330.0	48.3	4.3	21.4	74.0
2528.250000	55.3	200.0	V	200.0	47.6	7.7	18.7	74.0
2641.750000	54.1	200.0	V	226.0	45.9	8.2	19.9	74.0

Remark: 1. Correction Factor = Antenna factor+ Insertion loss (cable loss + amplifier gain)



Frequency (MHz)	Average (dBuV/m)	Height (cm)	Polarization	Azimuth (deg)	Reading value (dBuV/m)	Correct Factor (dB)	Margin (dB)	Limit (dBuV/m)
1195.750000	36.2	200.0	V	0.0	36.4	-0.2	17.8	54.0
1393.750000	37.4	200.0	V	217.0	36.4	1.0	16.6	54.0
1608.000000	40.1	200.0	V	130.0	38.1	2.0	13.9	54.0
2062.250000	40.8	200.0	V	0.0	35.9	4.9	13.2	54.0
2528.000000	43.5	200.0	V	242.0	35.8	7.7	10.5	54.0
2635.000000	44.1	200.0	V	313.0	36.1	8.0	9.9	54.0

Remark: 1. Correction Factor = Antenna factor+ Insertion loss (cable loss + amplifier gain)

802.11b CH6

RE 1G-3GHz PK+AV

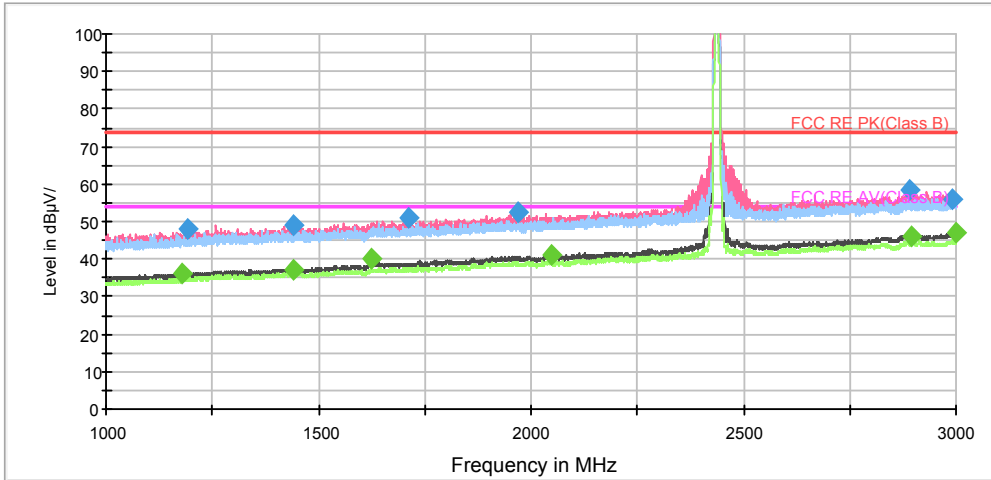

Note: The signal beyond the limit is carrier.
Radiates Emission from 1GHz to 3GHz

RE 3-18GHz PK+AV

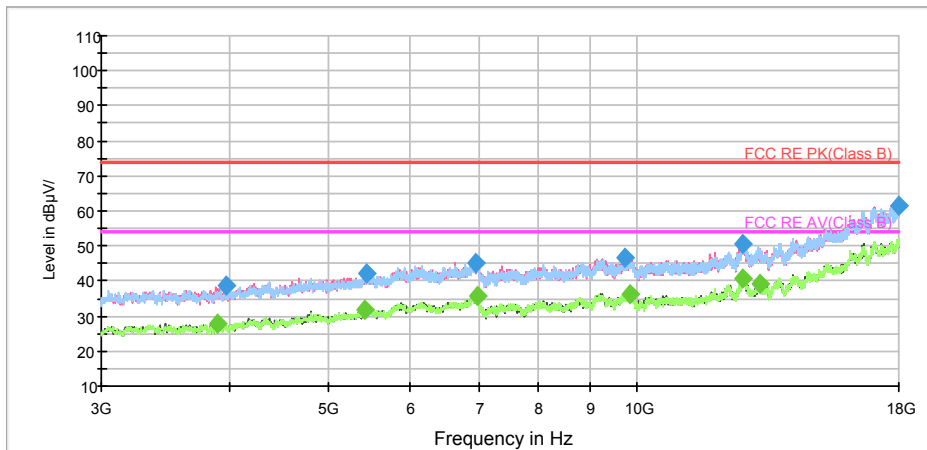

Radiates Emission from 3GHz to 18GHz

Frequency (MHz)	Peak (dBuV/m)	Height (cm)	Polarization	Azimuth (deg)	Reading value (dBuV/m)	Correct Factor (dB)	Margin (dB)	Limit (dBuV/m)
1191.750000	48.0	200.0	V	0.0	48.2	-0.2	26.0	74.0
1441.500000	49.2	200.0	V	284.0	48.1	1.1	24.8	74.0
1711.500000	51.1	200.0	V	267.0	47.9	3.2	22.9	74.0
1968.750000	52.2	200.0	V	319.0	47.7	4.5	21.8	74.0
2891.750000	58.6	200.0	V	0.0	48.5	10.1	15.4	74.0
2989.500000	56.2	200.0	V	153.0	46.0	10.2	17.8	74.0

Remark: 1. Correction Factor = Antenna factor+ Insertion loss (cable loss + amplifier gain)



Frequency (MHz)	Average (dBuV/m)	Height (cm)	Polarization	Azimuth (deg)	Reading value (dBuV/m)	Correct Factor (dB)	Margin (dB)	Limit (dBuV/m)
1177.750000	36.2	200.0	V	87.0	36.2	0.0	17.8	54.0
1439.000000	37.4	200.0	V	327.0	36.3	1.1	16.6	54.0
1625.000000	40.0	200.0	V	345.0	36.8	3.2	14.0	54.0
2046.000000	41.1	200.0	V	267.0	36.3	4.8	12.9	54.0
2894.250000	46.0	200.0	V	276.0	35.9	10.1	8.0	54.0
2999.250000	46.9	200.0	V	0.0	36.6	10.3	7.1	54.0

Remark: 1. Correction Factor = Antenna factor+ Insertion loss (cable loss + amplifier gain)

802.11b CH11

RE 1G-3GHz PK+AV

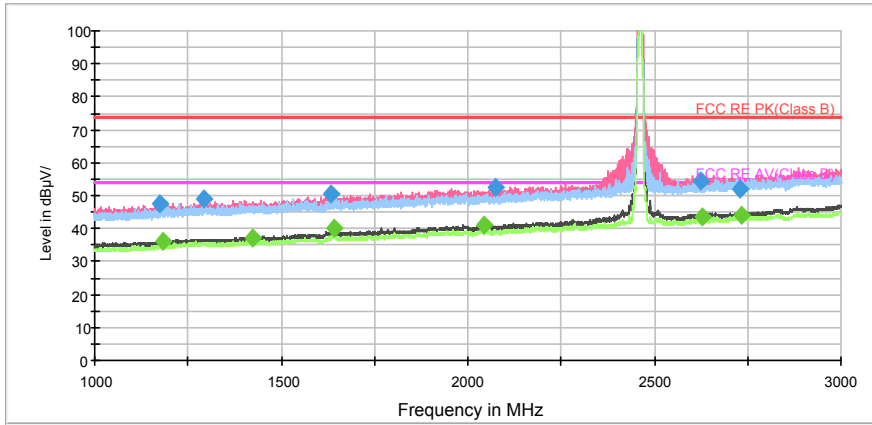

Note: The signal beyond the limit is carrier.
Radiates Emission from 1GHz to 3GHz

RE 3-18GHz PK+AV

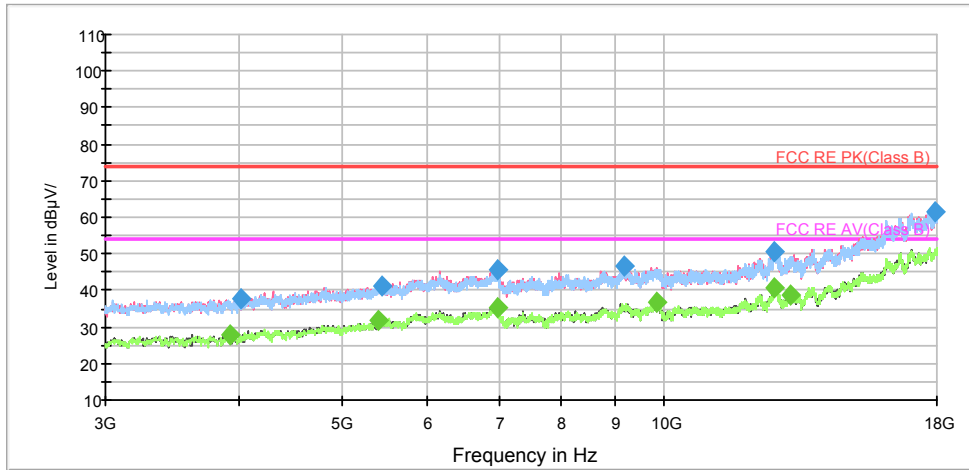

Radiates Emission from 3GHz to 18GHz

Frequency (MHz)	Peak (dBuV/m)	Height (cm)	Polarization	Azimuth (deg)	Reading value (dBuV/m)	Correct Factor (dB)	Margin (dB)	Limit (dBuV/m)
1174.750000	47.5	200.0	V	240.0	47.5	0.0	26.5	74.0
1291.250000	48.8	200.0	V	0.0	48.5	0.3	25.2	74.0
1634.250000	50.7	200.0	V	276.0	47.4	3.3	23.3	74.0
2073.000000	52.3	200.0	V	121.0	47.4	4.9	21.7	74.0
2625.750000	54.3	200.0	V	276.0	46.5	7.8	19.7	74.0
2728.000000	52.2	200.0	H	0.0	43.8	8.4	21.8	74.0

Remark: 1. Correction Factor = Antenna factor+ Insertion loss (cable loss + amplifier gain)



Frequency (MHz)	Average (dBuV/m)	Height (cm)	Polarization	Azimuth (deg)	Reading value (dBuV/m)	Correct Factor (dB)	Margin (dB)	Limit (dBuV/m)
1183.000000	36.0	200.0	V	276.0	36.0	0.0	18.0	54.0
1425.250000	37.2	200.0	V	354.0	36.1	1.1	16.8	54.0
1641.250000	40.0	200.0	V	99.0	36.7	3.3	14.0	54.0
2041.750000	41.1	200.0	V	232.0	36.3	4.8	12.9	54.0
2628.000000	43.6	200.0	V	0.0	35.7	7.9	10.4	54.0
2733.250000	44.0	200.0	V	169.0	35.4	8.6	10.0	54.0

Remark: 1. Correction Factor = Antenna factor+ Insertion loss (cable loss + amplifier gain)



802.11g CH1

RE 1G-3GHz PK+AV

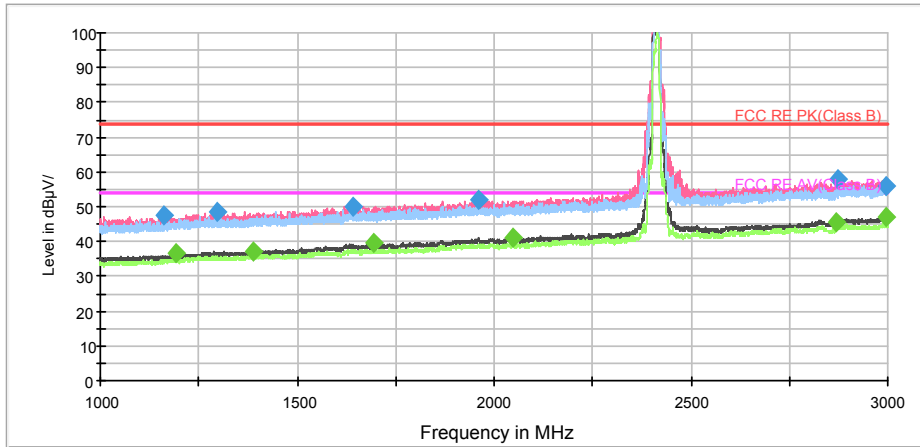

Note: The signal beyond the limit is carrier.
Radiates Emission from 1GHz to 3GHz

RE 3-18GHz PK+AV

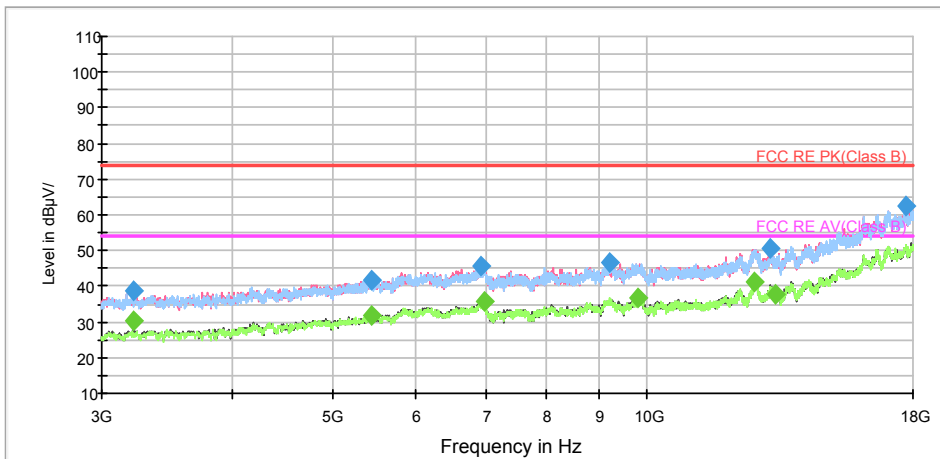

Radiates Emission from 3GHz to 18GHz

Frequency (MHz)	Peak (dBuV/m)	Height (cm)	Polarization	Azimuth (deg)	Reading value (dBuV/m)	Correct Factor (dB)	Margin (dB)	Limit (dBuV/m)
1163.500000	47.6	200.0	V	249.0	47.9	-0.3	26.4	74.0
1298.000000	48.4	200.0	V	178.0	48.2	0.2	25.6	74.0
1642.000000	50.0	200.0	V	0.0	46.8	3.2	24.0	74.0
1960.250000	51.9	200.0	V	284.0	47.1	4.8	22.1	74.0
2874.750000	57.7	200.0	V	327.0	47.4	10.3	16.3	74.0
2996.500000	55.7	200.0	V	0.0	45.4	10.3	18.3	74.0

Remark: 1. Correction Factor = Antenna factor+ Insertion loss (cable loss + amplifier gain)



Frequency (MHz)	Average (dBuV/m)	Height (cm)	Polarization	Azimuth (deg)	Reading value (dBuV/m)	Correct Factor (dB)	Margin (dB)	Limit (dBuV/m)
1192.000000	36.4	200.0	V	266.0	36.6	-0.2	17.6	54.0
1389.250000	37.4	200.0	V	310.0	36.4	1.0	16.6	54.0
1694.750000	39.6	200.0	V	0.0	36.6	3.0	14.4	54.0
2048.250000	40.9	200.0	V	140.0	36.1	4.8	13.1	54.0
2870.500000	45.5	200.0	V	319.0	35.4	10.1	8.5	54.0
2996.500000	47.0	200.0	V	0.0	36.7	10.3	7.0	54.0

Remark: 1. Correction Factor = Antenna factor+ Insertion loss (cable loss + amplifier gain)



802.11g CH6

RE 1G-3GHz PK+AV

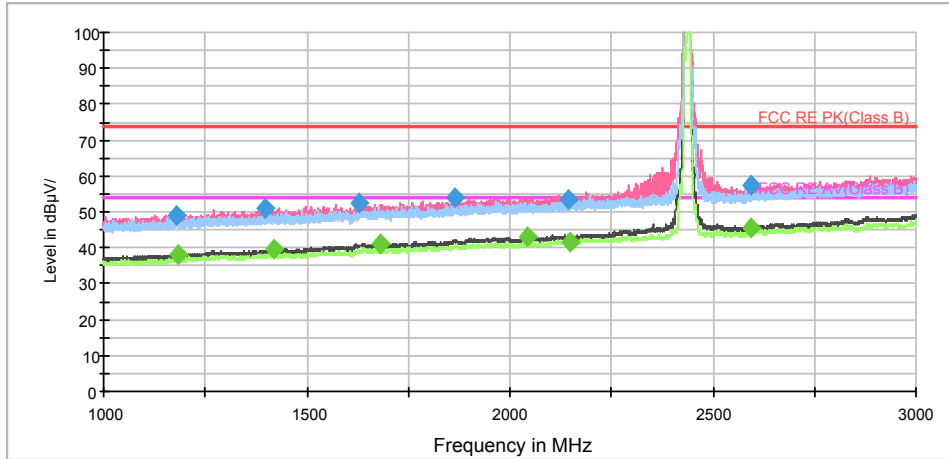

Note: The signal beyond the limit is carrier.
Radiates Emission from 1GHz to 3GHz

RE 3-18GHz PK+AV

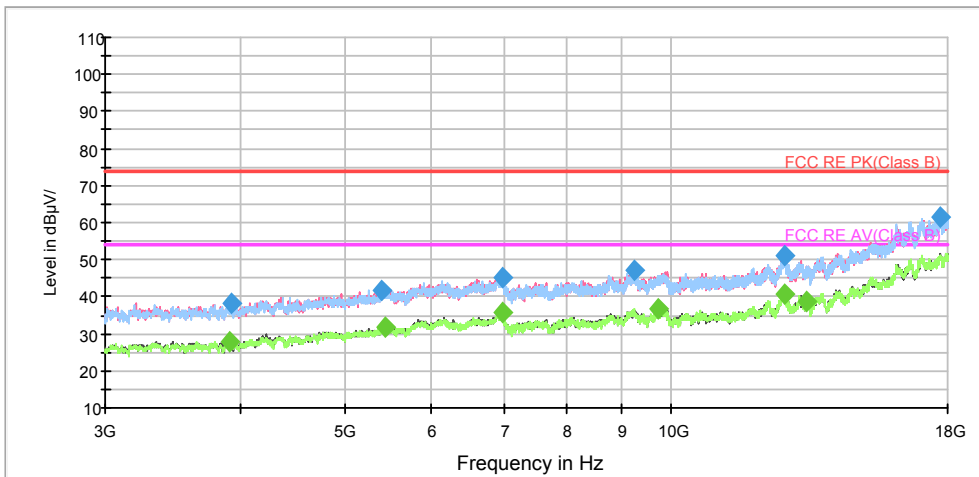

Radiates Emission from 3GHz to 18GHz

Frequency (MHz)	Peak (dBuV/m)	Height (cm)	Polarization	Azimuth (deg)	Reading value (dBuV/m)	Correct Factor (dB)	Margin (dB)	Limit (dBuV/m)
1178.000000	49.2	200.0	V	279.0	47.2	2.0	24.8	74.0
1397.750000	51.0	200.0	V	0.0	48.1	2.9	23.0	74.0
1630.000000	52.5	200.0	V	295.0	47.2	5.3	21.5	74.0
1863.250000	54.0	200.0	V	304.0	47.7	6.3	20.0	74.0
2145.000000	53.6	200.0	V	355.0	46.1	7.5	20.4	74.0
2592.000000	57.7	200.0	V	295.0	47.6	10.1	16.3	74.0

Remark: 1. Correction Factor = Antenna factor+ Insertion loss (cable loss + amplifier gain)



Frequency (MHz)	Average (dBuV/m)	Height (cm)	Polarization	Azimuth (deg)	Reading value (dBuV/m)	Correct Factor (dB)	Margin (dB)	Limit (dBuV/m)
1184.250000	38.2	200.0	V	173.0	36.3	1.9	15.8	54.0
1421.000000	39.5	200.0	V	0.0	36.4	3.1	14.5	54.0
1680.750000	41.3	200.0	V	0.0	36.4	4.9	12.7	54.0
2045.500000	42.9	200.0	V	0.0	36.1	6.8	11.1	54.0
2147.250000	41.5	200.0	H	0.0	34.0	7.5	12.5	54.0
2594.500000	45.6	200.0	V	0.0	35.4	10.2	8.4	54.0

Remark: 1. Correction Factor = Antenna factor+ Insertion loss (cable loss + amplifier gain)



802.11g CH11

RE 1G-3GHz PK+AV

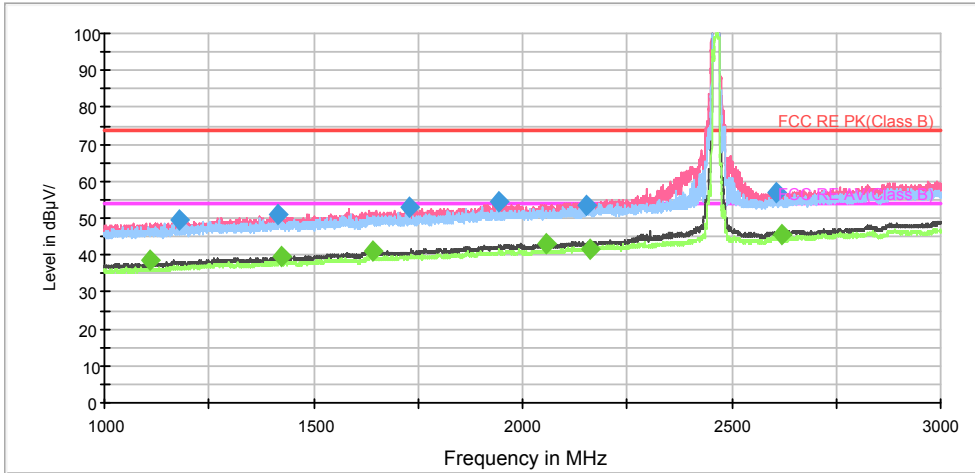

Note: The signal beyond the limit is carrier.
Radiates Emission from 1GHz to 3GHz

RE 3-18GHz PK+AV

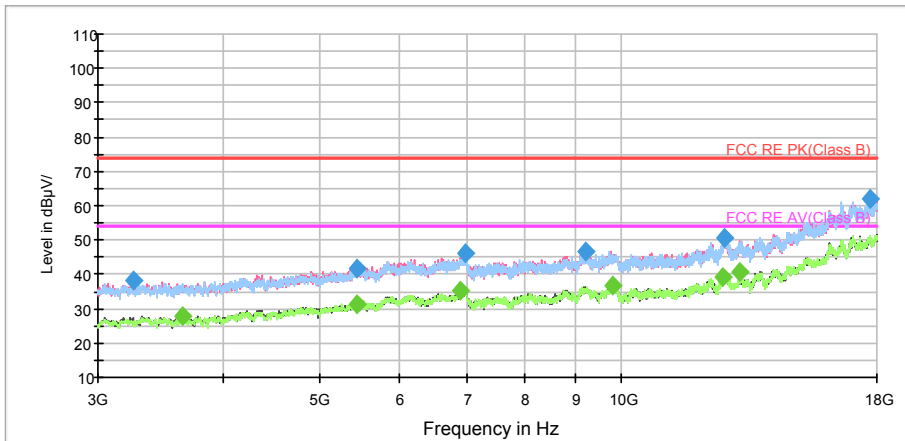

Radiates Emission from 3GHz to 18GHz

Frequency (MHz)	Peak (dBuV/m)	Height (cm)	Polarization	Azimuth (deg)	Reading value (dBuV/m)	Correct Factor (dB)	Margin (dB)	Limit (dBuV/m)
1178.500000	49.4	200.0	V	238.0	47.4	2.0	24.6	74.0
1415.250000	50.9	200.0	V	238.0	47.9	3.0	23.1	74.0
1728.750000	53.1	200.0	V	0.0	48.1	5.0	20.9	74.0
1945.000000	54.2	200.0	V	289.0	47.5	6.7	19.8	74.0
2150.750000	53.7	200.0	V	0.0	46.1	7.6	20.3	74.0
2609.000000	56.9	200.0	V	264.0	46.7	10.2	17.1	74.0

Remark: 1. Correction Factor = Antenna factor+ Insertion loss (cable loss + amplifier gain)



Frequency (MHz)	Average (dBuV/m)	Height (cm)	Polarization	Azimuth (deg)	Reading value (dBuV/m)	Correct Factor (dB)	Margin (dB)	Limit (dBuV/m)
1109.250000	38.4	200.0	V	273.0	37.1	1.3	15.6	54.0
1423.000000	39.5	200.0	V	331.0	36.4	3.1	14.5	54.0
1641.000000	41.3	200.0	V	131.0	36.0	5.3	12.7	54.0
2055.750000	42.9	200.0	V	314.0	36.1	6.8	11.1	54.0
2163.250000	41.6	200.0	H	26.0	33.8	7.8	12.4	54.0
2618.250000	45.6	200.0	V	0.0	35.6	10.0	8.4	54.0

Remark: 1. Correction Factor = Antenna factor+ Insertion loss (cable loss + amplifier gain)



802.11n (HT20) CH1

RE 1G-3GHz PK+AV

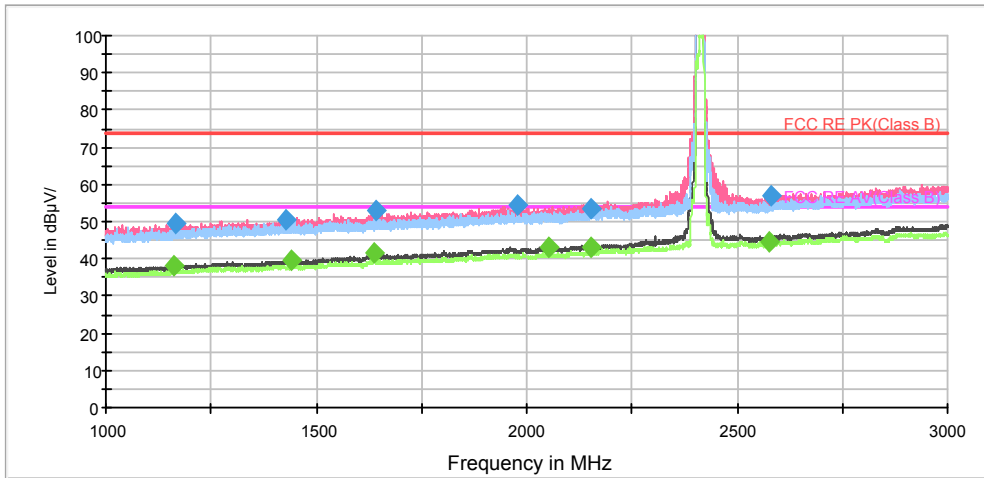

Note: The signal beyond the limit is carrier.
Radiates Emission from 1GHz to 3GHz

RE 3-18GHz PK+AV

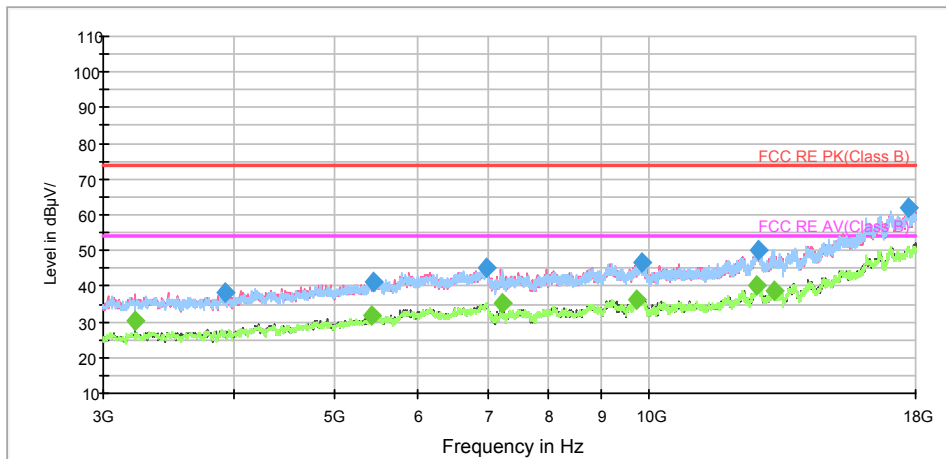

Radiates Emission from 3GHz to 18GHz

Frequency (MHz)	Peak (dBuV/m)	Height (cm)	Polarization	Azimuth (deg)	Reading value (dBuV/m)	Correct Factor (dB)	Margin (dB)	Limit (dBuV/m)
1165.000000	49.6	200.0	V	182.0	47.8	1.8	24.4	74.0
1430.000000	50.6	200.0	V	0.0	47.5	3.1	23.4	74.0
1641.000000	52.9	200.0	V	0.0	47.6	5.3	21.1	74.0
1979.500000	54.2	200.0	V	130.0	47.9	6.3	19.8	74.0
2154.250000	53.5	200.0	V	298.0	45.8	7.7	20.5	74.0
2580.250000	56.8	200.0	V	307.0	47.2	9.6	17.2	74.0

Remark: 1. Correction Factor = Antenna factor+ Insertion loss (cable loss + amplifier gain)



Frequency (MHz)	Average (dBuV/m)	Height (cm)	Polarization	Azimuth (deg)	Reading value (dBuV/m)	Correct Factor (dB)	Margin (dB)	Limit (dBuV/m)
1163.750000	38.4	200.0	V	307.0	36.7	1.7	15.6	54.0
1441.500000	39.4	200.0	V	0.0	36.3	3.1	14.6	54.0
1637.250000	41.4	200.0	V	0.0	36.1	5.3	12.6	54.0
2051.750000	42.9	200.0	V	298.0	36.1	6.8	11.1	54.0
2153.750000	42.9	200.0	V	130.0	35.2	7.7	11.1	54.0
2577.750000	44.7	200.0	V	324.0	35.2	9.5	9.3	54.0

Remark: 1. Correction Factor = Antenna factor+ Insertion loss (cable loss + amplifier gain)



802.11n (HT20) CH6

RE 1G-3GHz PK+AV

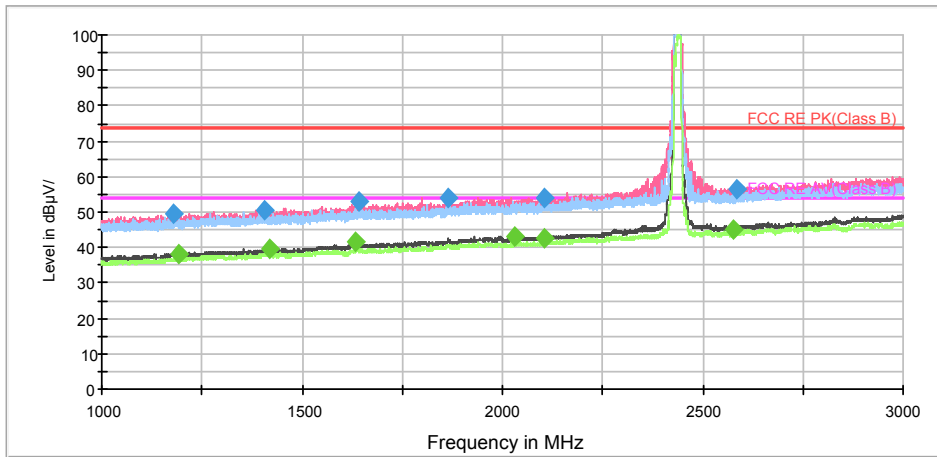

Note: The signal beyond the limit is carrier.
Radiates Emission from 1GHz to 3GHz

RE 3-18GHz PK+AV

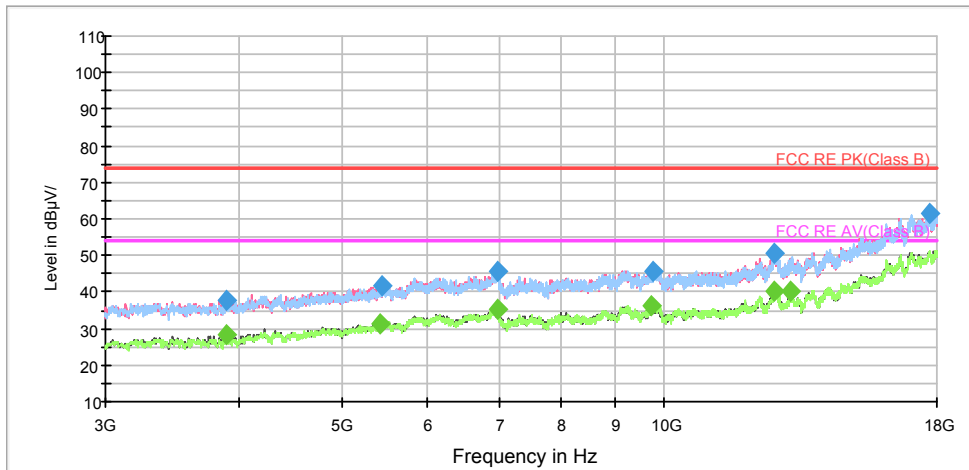

Radiates Emission from 3GHz to 18GHz

Frequency (MHz)	Peak (dBuV/m)	Height (cm)	Polarization	Azimuth (deg)	Reading value (dBuV/m)	Correct Factor (dB)	Margin (dB)	Limit (dBuV/m)
1179.750000	49.6	200.0	V	296.0	47.6	2.0	24.4	74.0
1407.750000	50.4	200.0	V	342.0	47.5	2.9	23.6	74.0
1643.500000	52.8	200.0	V	279.0	47.6	5.2	21.2	74.0
1863.250000	54.1	200.0	V	0.0	47.8	6.3	19.9	74.0
2104.250000	53.8	200.0	V	0.0	46.3	7.5	20.2	74.0
2583.750000	56.3	200.0	V	0.0	46.6	9.7	17.7	74.0

Remark: 1. Correction Factor = Antenna factor+ Insertion loss (cable loss + amplifier gain)



Frequency (MHz)	Average (dBuV/m)	Height (cm)	Polarization	Azimuth (deg)	Reading value (dBuV/m)	Correct Factor (dB)	Margin (dB)	Limit (dBuV/m)
1190.750000	38.2	200.0	V	0.0	36.4	1.8	15.8	54.0
1419.000000	39.6	200.0	V	296.0	36.5	3.1	14.4	54.0
1635.250000	41.4	200.0	V	0.0	36.1	5.3	12.6	54.0
2029.250000	43.1	200.0	V	237.0	36.5	6.6	10.9	54.0
2106.250000	42.8	200.0	V	0.0	35.3	7.5	11.2	54.0
2577.750000	45.1	200.0	V	0.0	35.6	9.5	8.9	54.0

Remark: 1. Correction Factor = Antenna factor+ Insertion loss (cable loss + amplifier gain)



802.11n (HT20) CH11

RE 1G-3GHz PK+AV

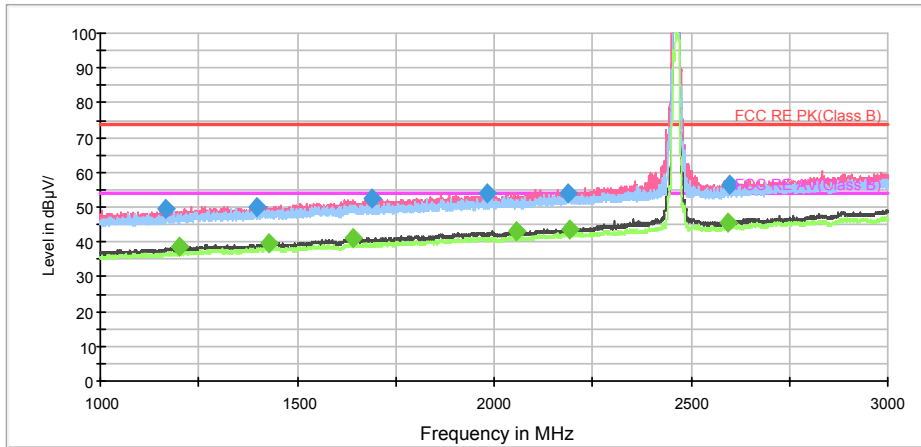

Note: The signal beyond the limit is carrier.
Radiates Emission from 1GHz to 3GHz

RE 3-18GHz PK+AV

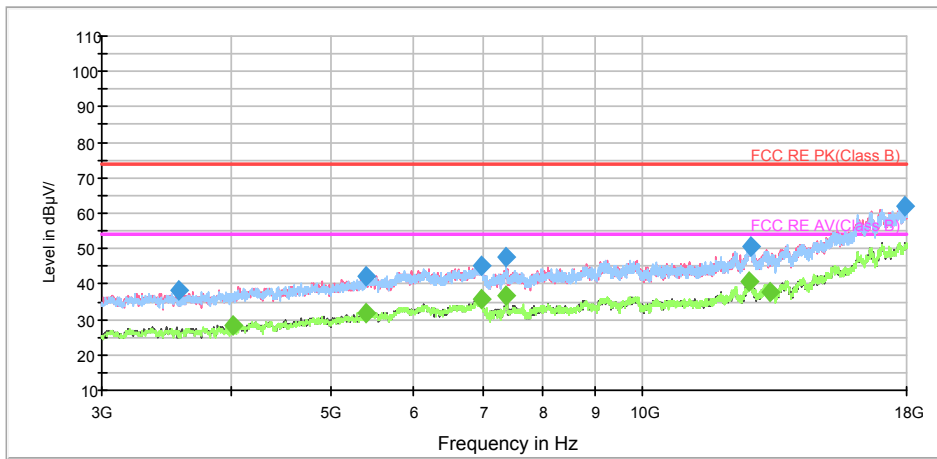

Radiates Emission from 3GHz to 18GHz

Frequency (MHz)	Peak (dBuV/m)	Height (cm)	Polarization	Azimuth (deg)	Reading value (dBuV/m)	Correct Factor (dB)	Margin (dB)	Limit (dBuV/m)
1166.750000	49.6	200.0	V	0.0	47.8	1.8	24.4	74.0
1396.000000	50.1	200.0	V	0.0	47.2	2.9	23.9	74.0
1690.250000	52.6	200.0	V	151.0	47.6	5.0	21.4	74.0
1982.250000	54.1	200.0	V	196.0	47.9	6.2	19.9	74.0
2186.250000	54.0	200.0	V	0.0	46.2	7.8	20.0	74.0
2599.500000	56.6	200.0	V	327.0	46.2	10.4	17.4	74.0

Remark: 1. Correction Factor = Antenna factor+ Insertion loss (cable loss + amplifier gain)



Frequency (MHz)	Average (dBuV/m)	Height (cm)	Polarization	Azimuth (deg)	Reading value (dBuV/m)	Correct Factor (dB)	Margin (dB)	Limit (dBuV/m)
1199.000000	38.5	200.0	V	0.0	36.7	1.8	15.5	54.0
1427.500000	39.6	200.0	V	354.0	36.5	3.1	14.4	54.0
1642.000000	41.2	200.0	V	232.0	36.0	5.2	12.8	54.0
2056.000000	43.1	200.0	V	250.0	36.3	6.8	10.9	54.0
2192.500000	43.5	200.0	V	293.0	35.6	7.9	10.5	54.0
2594.250000	45.5	200.0	V	241.0	35.3	10.2	8.5	54.0

Remark: 1. Correction Factor = Antenna factor+ Insertion loss (cable loss + amplifier gain)



802.11n (HT40) CH3

RE 1G-3GHz PK+AV

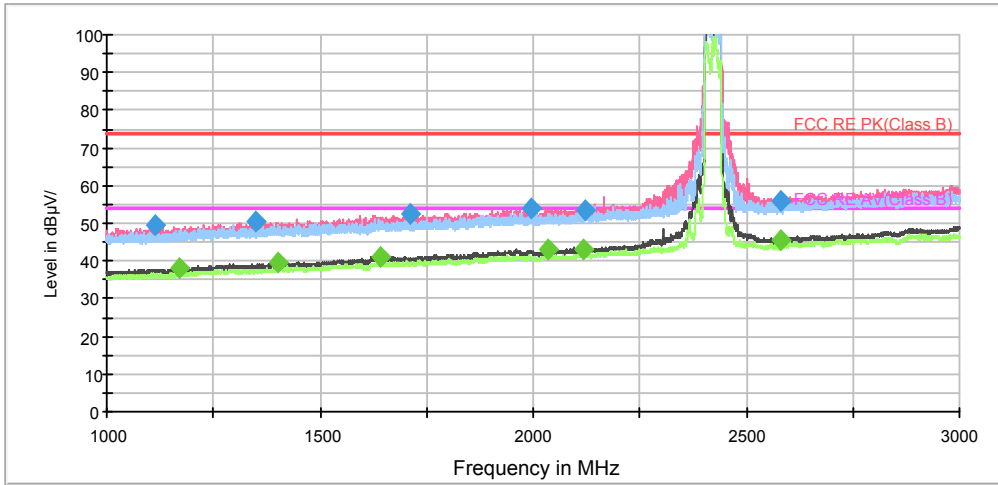

Note: The signal beyond the limit is carrier.
Radiates Emission from 1GHz to 3GHz

RE 3-18GHz PK+AV

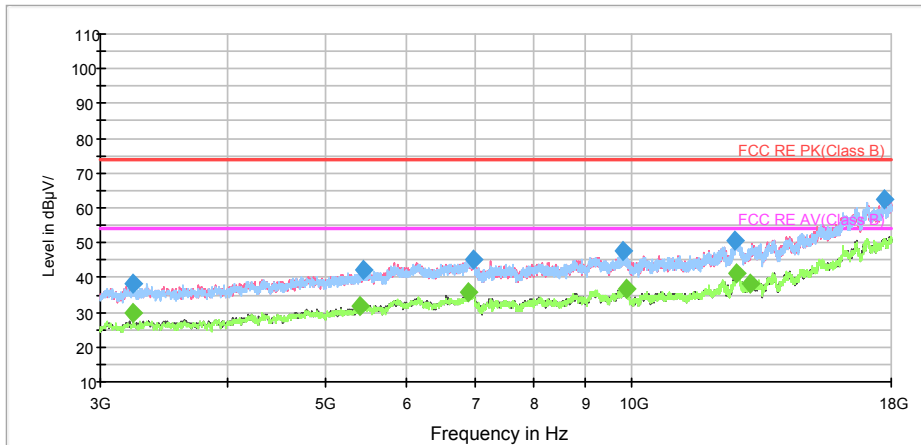

Radiates Emission from 3GHz to 18GHz

Frequency (MHz)	Peak (dBuV/m)	Height (cm)	Polarization	Azimuth (deg)	Reading value (dBuV/m)	Correct Factor (dB)	Margin (dB)	Limit (dBuV/m)
1113.750000	49.3	200.0	V	299.0	47.9	1.4	24.7	74.0
1350.250000	50.3	200.0	V	263.0	47.9	2.4	23.7	74.0
1711.000000	52.5	200.0	V	334.0	47.3	5.2	21.5	74.0
1996.750000	54.2	200.0	V	334.0	47.5	6.7	19.8	74.0
2121.000000	53.5	200.0	V	359.0	45.7	7.8	20.5	74.0
2580.500000	56.1	200.0	V	299.0	46.5	9.6	17.9	74.0

Remark: 1. Correction Factor = Antenna factor+ Insertion loss (cable loss + amplifier gain)



Frequency (MHz)	Average (dBuV/m)	Height (cm)	Polarization	Azimuth (deg)	Reading value (dBuV/m)	Correct Factor (dB)	Margin (dB)	Limit (dBuV/m)
1168.250000	38.2	200.0	V	199.0	36.3	1.9	15.8	54.0
1402.750000	39.5	200.0	V	290.0	36.6	2.9	14.5	54.0
1640.000000	41.2	200.0	V	359.0	35.9	5.3	12.8	54.0
2035.500000	43.0	200.0	V	263.0	36.3	6.7	11.0	54.0
2118.750000	42.9	200.0	V	199.0	35.1	7.8	11.1	54.0
2579.000000	45.6	200.0	V	350.0	36.1	9.5	8.4	54.0

Remark: 1. Correction Factor = Antenna factor+ Insertion loss (cable loss + amplifier gain)



802.11n (HT40) CH6

RE 1G-3GHz PK+AV

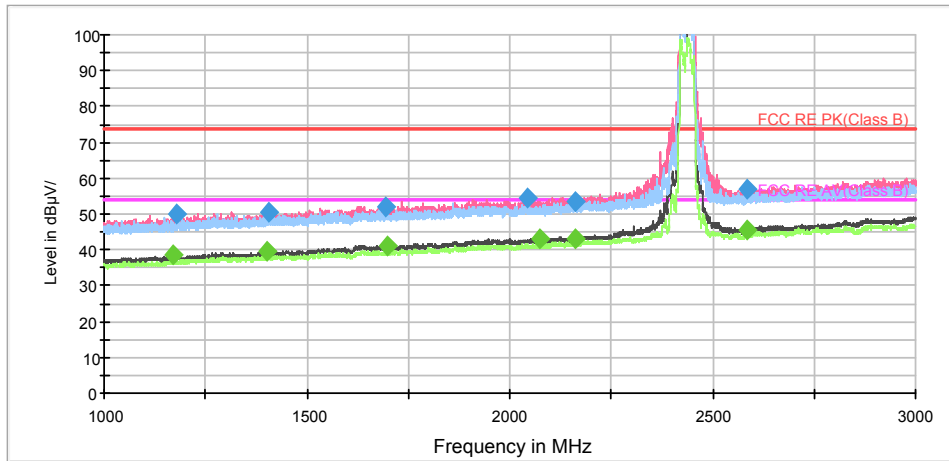

Note: The signal beyond the limit is carrier.
Radiates Emission from 1GHz to 3GHz

RE 3-18GHz PK+AV

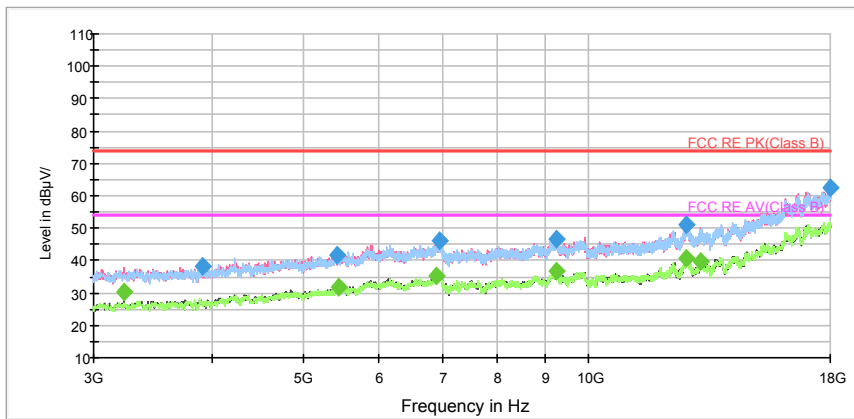

Radiates Emission from 3GHz to 18GHz

Frequency (MHz)	Peak (dBuV/m)	Height (cm)	Polarization	Azimuth (deg)	Reading value (dBuV/m)	Correct Factor (dB)	Margin (dB)	Limit (dBuV/m)
1177.500000	49.8	200.0	V	190.0	47.8	2.0	24.2	74.0
1406.500000	50.7	200.0	V	287.0	47.8	2.9	23.3	74.0
1694.000000	52.2	200.0	V	141.0	47.2	5.0	21.8	74.0
2043.500000	54.3	200.0	V	287.0	47.5	6.8	19.7	74.0
2160.000000	53.4	200.0	V	0.0	45.6	7.8	20.6	74.0
2586.000000	56.8	200.0	V	338.0	47.0	9.8	17.2	74.0

Remark: 1. Correction Factor = Antenna factor+ Insertion loss (cable loss + amplifier gain)



Frequency (MHz)	Average (dBuV/m)	Height (cm)	Polarization	Azimuth (deg)	Reading value (dBuV/m)	Correct Factor (dB)	Margin (dB)	Limit (dBuV/m)
1169.750000	38.4	200.0	V	0.0	36.5	1.9	15.6	54.0
1399.750000	39.7	200.0	V	347.0	36.8	2.9	14.3	54.0
1699.500000	41.1	200.0	V	120.0	36.1	5.0	12.9	54.0
2076.000000	43.1	200.0	V	181.0	36.1	7.0	10.9	54.0
2161.500000	43.3	200.0	V	338.0	35.5	7.8	10.7	54.0
2585.000000	45.5	200.0	V	225.0	35.7	9.8	8.5	54.0

Remark: 1. Correction Factor = Antenna factor+ Insertion loss (cable loss + amplifier gain)

802.11n (HT40) CH9

RE 1G-3GHz PK+AV

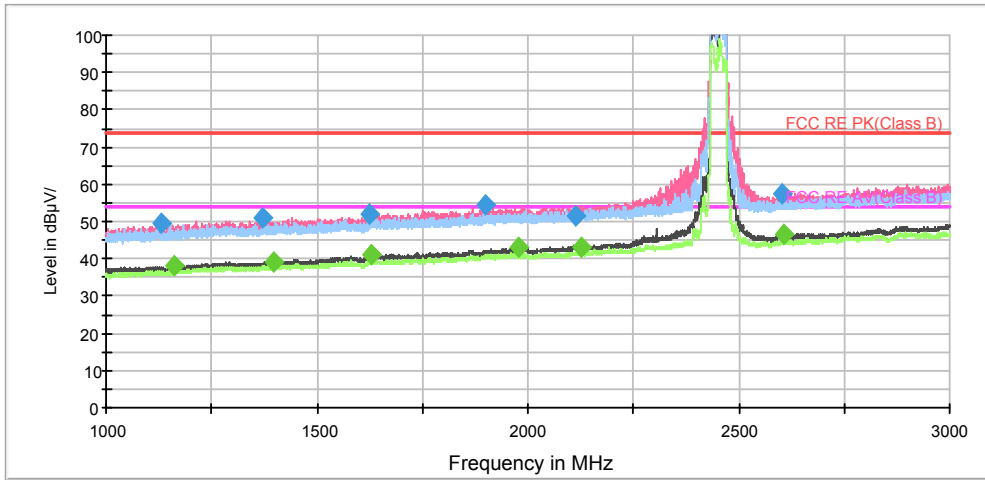

Note: The signal beyond the limit is carrier.
Radiates Emission from 1GHz to 3GHz

RE 3-18GHz PK+AV

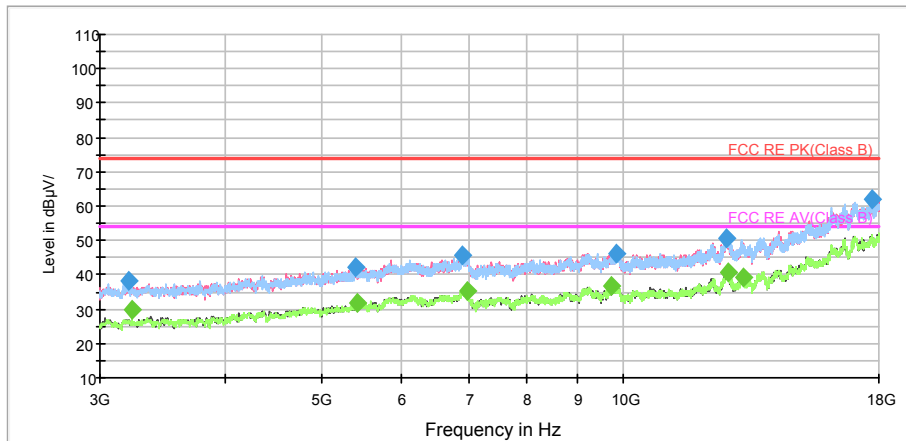

Radiates Emission from 3GHz to 18GHz

Frequency (MHz)	Peak (dBuV/m)	Height (cm)	Polarization	Azimuth (deg)	Reading value (dBuV/m)	Correct Factor (dB)	Margin (dB)	Limit (dBuV/m)
1132.500000	49.5	200.0	V	311.0	47.9	1.6	24.5	74.0
1371.000000	50.8	200.0	V	0.0	48.0	2.8	23.2	74.0
1624.250000	52.2	200.0	V	0.0	47.0	5.2	21.8	74.0
1897.500000	54.4	200.0	V	329.0	48.3	6.1	19.6	74.0
2113.750000	51.6	200.0	V	311.0	43.9	7.7	22.4	74.0
2604.250000	57.6	200.0	V	108.0	47.3	10.3	16.4	74.0

Remark: 1. Correction Factor = Antenna factor+ Insertion loss (cable loss + amplifier gain)



Frequency (MHz)	Average (dBuV/m)	Height (cm)	Polarization	Azimuth (deg)	Reading value (dBuV/m)	Correct Factor (dB)	Margin (dB)	Limit (dBuV/m)
1163.500000	38.3	200.0	V	285.0	36.6	1.7	15.7	54.0
1399.250000	39.2	200.0	V	354.0	36.3	2.9	14.8	54.0
1628.500000	41.1	200.0	V	303.0	35.8	5.3	12.9	54.0
1978.250000	42.8	200.0	V	285.0	36.5	6.3	11.2	54.0
2125.500000	43.1	200.0	V	285.0	35.4	7.7	10.9	54.0
2606.250000	46.3	200.0	V	244.0	36.0	10.3	7.7	54.0

Remark: 1. Correction Factor = Antenna factor+ Insertion loss (cable loss + amplifier gain)

Co- transmission between 2.4GHz and 5GHz

During the test, the Co- transmission between 2.4GHz and 5GHz was performed in all modes, WIFI 2.4G 802.11b CH1+ WIFI 5G 802.11n(HT40)_CH38 are selected as the worst condition. The test data of the worst-case condition was recorded in this report.

The carrier frequency is limited by notchfilter.

RE 1G-3GHz PK+AV

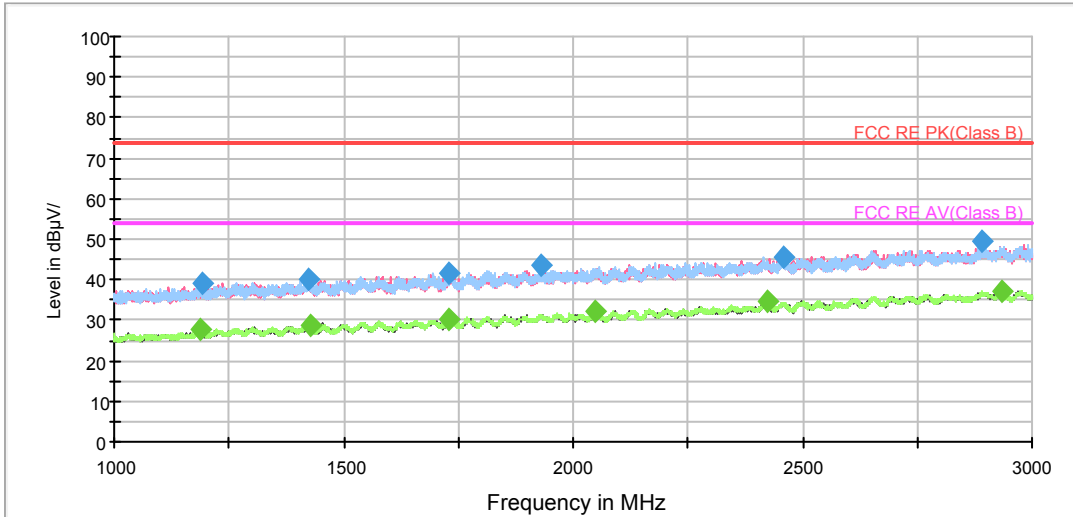

Radiates Emission from 1GHz to 3GHz

RE 3-18GHz PK+AV

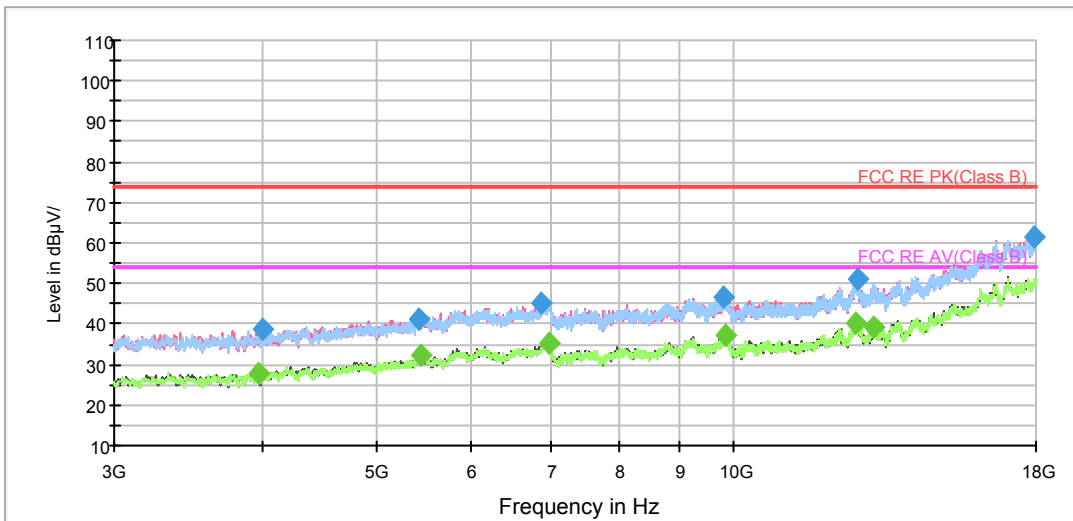

Radiates Emission from 3GHz to 18GHz



Frequency (MHz)	Peak (dBuV/m)	Height (cm)	Polarization	Azimuth (deg)	Reading value (dBuV/m)	Correct Factor (dB)	Margin (dB)	Limit (dBuV/m)
1194.000000	38.9	200.0	V	231.0	47.1	-8.2	35.1	74.0
1423.500000	40.0	200.0	V	356.0	46.9	-6.9	34.0	74.0
1728.750000	41.5	200.0	H	86.0	46.5	-5.0	32.5	74.0
1930.750000	43.7	200.0	V	245.0	47.4	-3.7	30.3	74.0
2457.250000	45.7	200.0	V	343.0	46.2	-0.5	28.3	74.0
2891.500000	49.6	200.0	V	294.0	47.5	2.1	24.4	74.0

Remark: 1. Correction Factor = Antenna factor+ Insertion loss (cable loss + amplifier gain)

Frequency (MHz)	Average (dBuV/m)	Height (cm)	Polarization	Azimuth (deg)	Reading value (dBuV/m)	Correct Factor (dB)	Margin (dB)	Limit (dBuV/m)
1189.750000	27.6	200.0	H	72.0	35.8	-8.2	26.4	54.0
1426.000000	28.9	200.0	H	86.0	35.8	-6.9	25.1	54.0
1731.000000	30.3	200.0	H	274.0	35.2	-4.9	23.7	54.0
2048.500000	32.0	200.0	H	193.0	35.2	-3.2	22.0	54.0
2421.500000	34.5	200.0	H	72.0	35.0	-0.5	19.5	54.0
2935.750000	37.2	200.0	H	92.0	35.4	1.8	16.8	54.0

Remark: 1. Correction Factor = Antenna factor+ Insertion loss (cable loss + amplifier gain)

5.8. Conducted Emission

Ambient condition

Temperature	Relative humidity	Pressure
23°C ~25°C	45%~50%	101.5kPa

Methods of Measurement

The EUT is placed on a non-metallic table of 80cm height above the horizontal metal reference ground plane. During the test, the EUT was operating in its typical mode. The test method is according to ANSI C63.10-2013. Connect the AC power line of the EUT to the L.I.S.N. Use EMI receiver to detect the average and Quasi-peak value. RBW is set to 9 kHz, VBW is set to 30kHz. The measurement result should include both L line and N line.

The test is in transmitting mode.

Test Setup

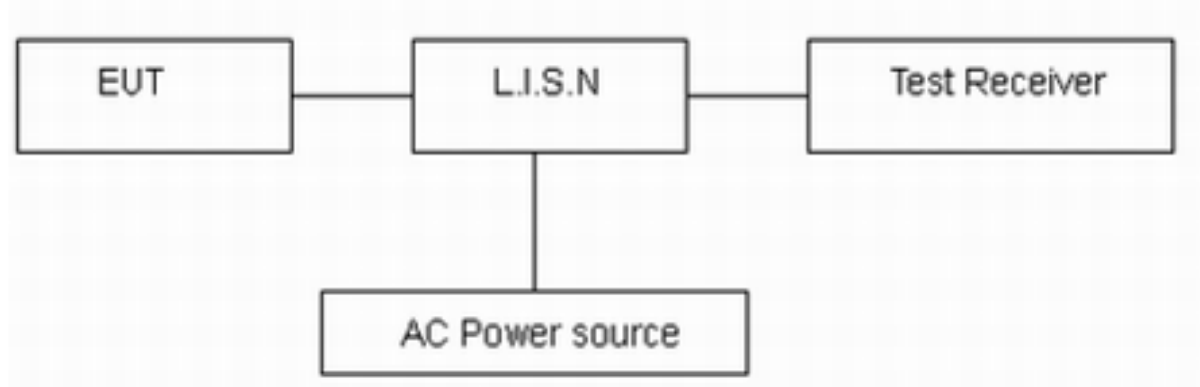

Note: AC Power source is used to change the voltage 110V/60Hz.

Limits

Frequency (MHz)	Conducted Limits(dBμV)	
	Quasi-peak	Average
0.15 - 0.5	66 to 56 *	56 to 46*
0.5 - 5	56	46
5 - 30	60	50

*: Decreases with the logarithm of the frequency.

Measurement Uncertainty

The assessed measurement uncertainty to ensure 95% confidence level for the normal distribution is with the coverage factor $k = 1.96$, $U = 2.69$ dB.

Test Results:

Following plots, Blue trace uses the peak detection and Green trace uses the average detection. During the test, the Conducted Emission was performed in all modes with WIFI 2.4G all channels, 802.11n (HT40), Channel 6 are selected as the worst condition. The test data of the worst-case condition was recorded in this report.

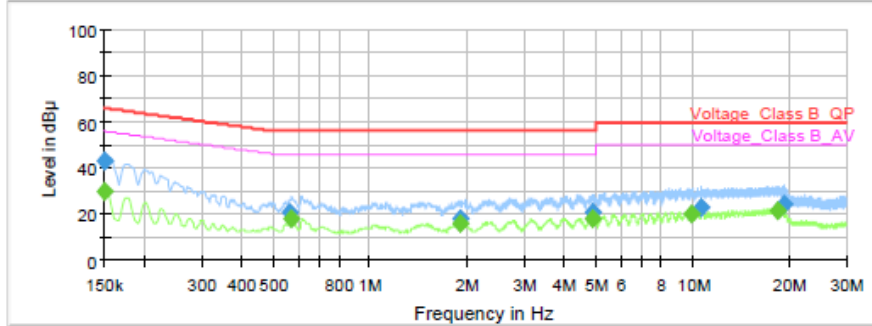

Frequency (MHz)	QuasiPeak (dB µ V)	Average (dB µ V)	Limit (dB µ V)	Margin (dB)	Meas. Time (ms)	Bandwidth (kHz)	Line	Filter
0.150000	---	30.13	56.00	25.87	1000.0	9.000	L1	ON
0.150000	43.31	---	66.00	22.69	1000.0	9.000	L1	ON
0.561750	20.59	---	56.00	35.41	1000.0	9.000	L1	ON
0.570750	---	18.27	46.00	27.73	1000.0	9.000	L1	ON
1.909500	---	15.79	46.00	30.21	1000.0	9.000	L1	ON
1.911750	18.14	---	56.00	37.86	1000.0	9.000	L1	ON
4.913250	21.03	---	56.00	34.97	1000.0	9.000	L1	ON
4.926750	---	18.02	46.00	27.98	1000.0	9.000	L1	ON
9.951000	---	20.43	50.00	29.57	1000.0	9.000	L1	ON
10.675500	23.17	---	60.00	36.83	1000.0	9.000	L1	ON
18.370500	---	21.49	50.00	28.51	1000.0	9.000	L1	ON
19.198500	24.02	---	60.00	35.98	1000.0	9.000	L1	ON

CE_2.4G_L_0.15-30M

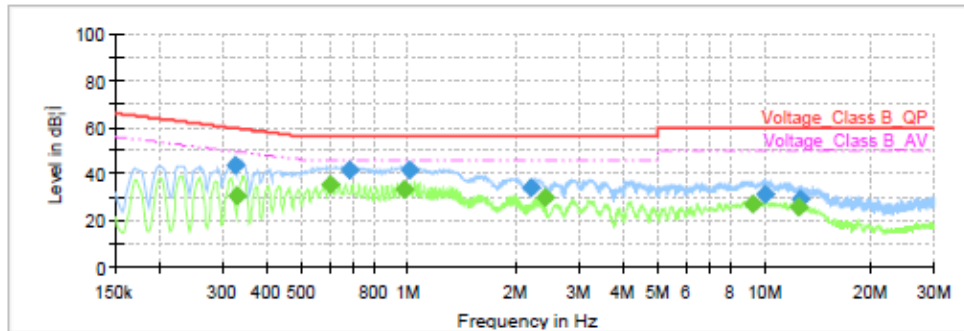

Frequency (MHz)	QuasiPeak (dB; i V)	Average (dB; i V)	Limit (dB; i V)	Margin (dB)	Meas. Time (ms)	Bandwidth (kHz)	Line	Filter
0.325500	43.69	---	59.57	15.88	1000.0	9.000	N	ON
0.327750	---	30.34	49.51	19.17	1000.0	9.000	N	ON
0.604500	---	35.64	46.00	10.36	1000.0	9.000	N	ON
0.681000	41.42	---	56.00	14.58	1000.0	9.000	N	ON
0.969000	---	33.40	46.00	12.60	1000.0	9.000	N	ON
1.009500	41.67	---	56.00	14.33	1000.0	9.000	N	ON
2.211000	34.20	---	56.00	21.80	1000.0	9.000	N	ON
2.411250	---	29.77	46.00	16.23	1000.0	9.000	N	ON
9.244500	---	26.81	50.00	23.19	1000.0	9.000	N	ON
10.099500	31.36	---	60.00	28.64	1000.0	9.000	N	ON
12.439500	---	25.83	50.00	24.17	1000.0	9.000	N	ON
12.682500	28.98	---	60.00	31.02	1000.0	9.000	N	ON

CE_2.4G_N_0.15-30M



6. Main Test Instruments

Name	Manufacturer	Type	Serial Number	Calibration Date	Expiration Date
Spectrum Analyzer	R&S	FSV30	100815	2017-12-17	2018-12-16
EMI Test Receiver	R&S	ESCI	100948	2017-05-20	2018-05-19
TRILOG Broadband Antenna	Schwarzbeck	VULB 9163	9163-201	2017-11-18	2020-11-17
Double Ridged Waveguide Horn Antenna	R&S	HF907	100126	2014-12-06	2019-12-05
Loop Antenna	SCHWARZBECK	FMZB1519	1519-047	2017-11-18	2020-11-17
Standard Gain Horn	ETS-Lindgren	3160-09	00102644	2015-01-30	2020-01-29
EMI Test Receiver	R&S	ESR	101667	2017-09-06	2018-09-05
LISN	R&S	ENV216	101171	2016-12-16	2019-12-15
Spectrum Analyzer	Agilent	N9010A	MY47191109	2017-05-20	2018-05-19
Power Meter	R&S	NRP2	1144.1374K02 -104306-EX	2017-12-21	2018-12-20
Power Sensor	R&S	NRP-Z21	104799	2017-05-24	2018-05-23
RF Cable	Agilent	SMA 15cm	0001	/	/
Software (CE)	ROHDE&SCHW ARZ	EMC32	9.26.0	/	/
Software (RE/RSE)	ROHDE&SCHW ARZ	EMC32	8.52.0	/	/

*****END OF REPORT *****

ANNEX A: EUT Appearance and Test Setup

A.1 EUT Appearance



a: EUT

Picture 1 EUT



Antenna Type 1



Antenna Type 2

Picture 2 Antenna

A.2 Test Setup



30M Hz-1GHz

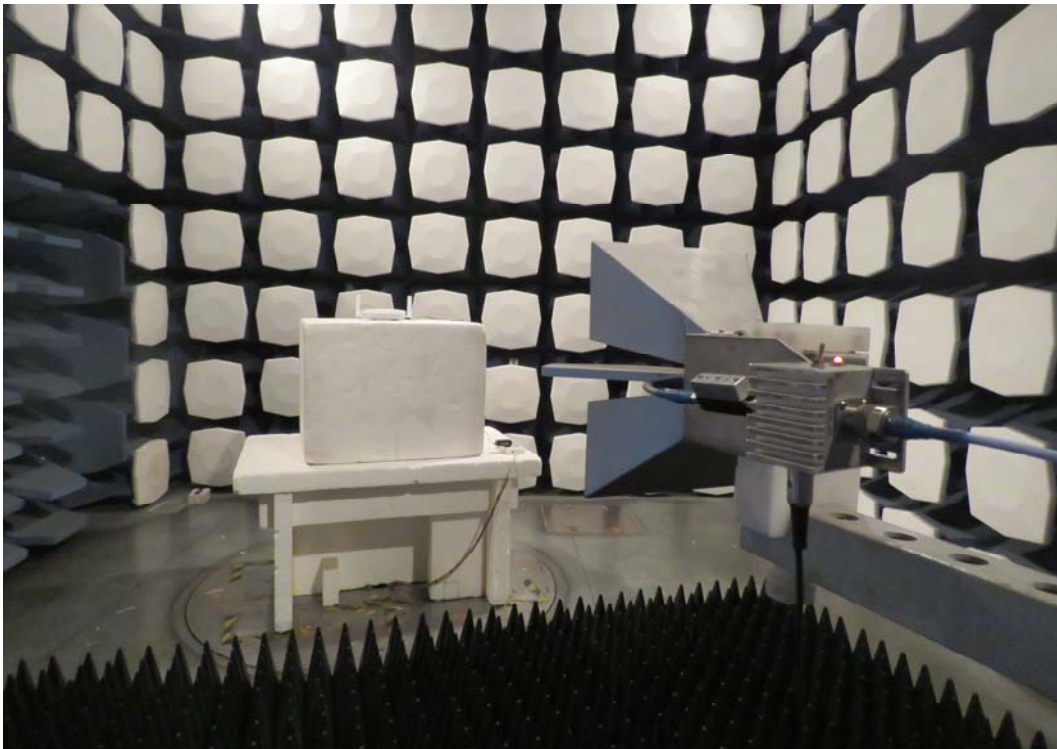

Above 1GHz
Antenna Type 1

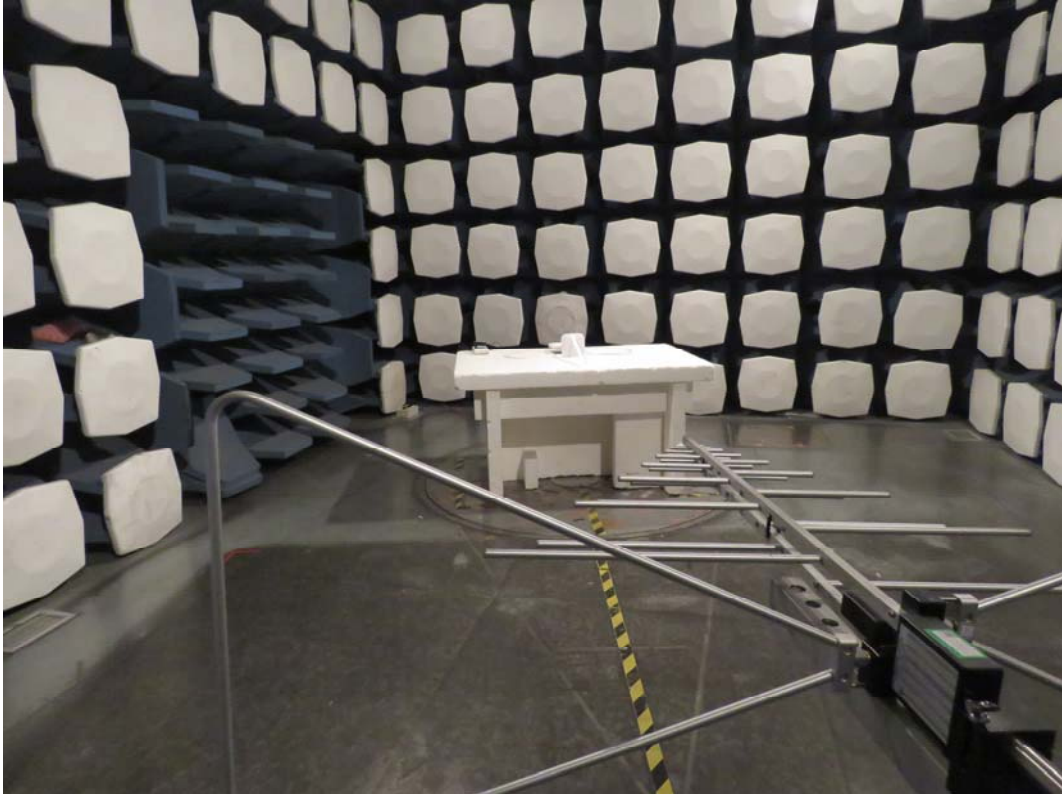

30M Hz-1GHz



Above 1GHz
Antenna Type 2

Picture 3 Radiated Emission Test Setup

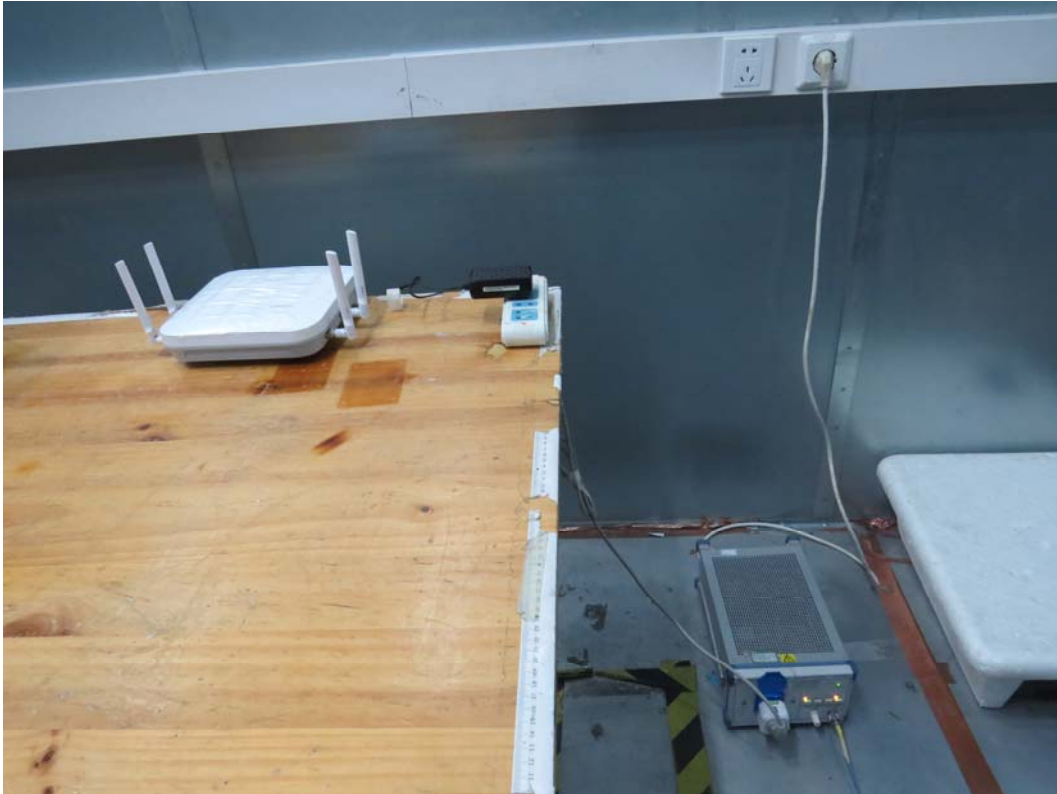

Picture 4 Conducted Emission Test Setup



Picture 5 Conducted Test Setup