



802.11ac VHT80+80, Channel No.: 42



802.11ac VHT80+80, Channel No.: 138



802.11ac VHT80+80, Channel No.: 42



802.11ac VHT80+80, Channel No.: 155



802.11ac VHT80+80, Channel No.: 58

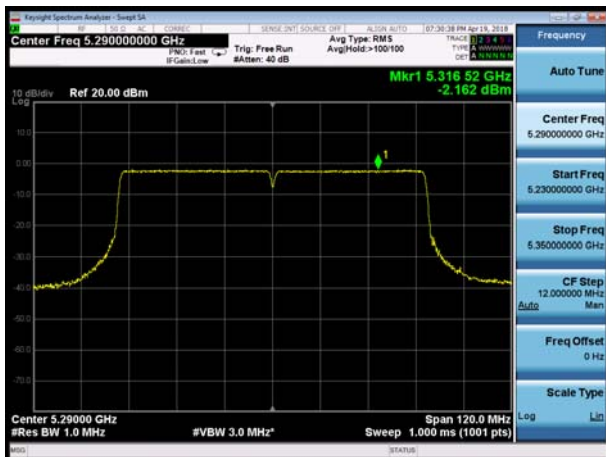

802.11ac VHT80+80, Channel No.: 106

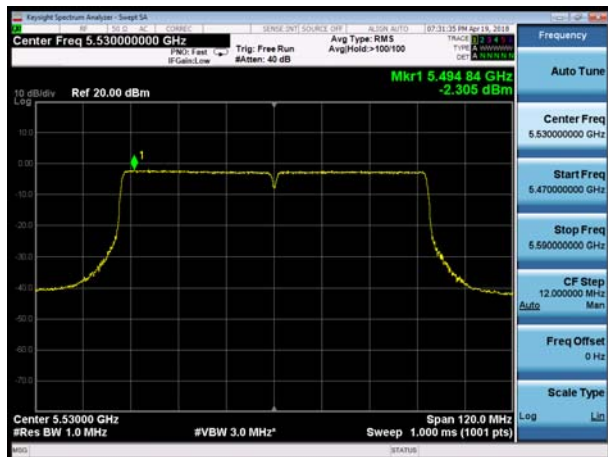

802.11ac VHT80+80, Channel No.: 58



802.11ac VHT80+80, Channel No.: 122

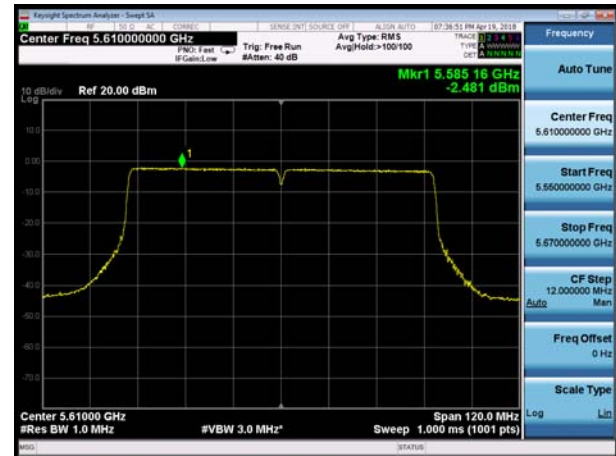

802.11ac VHT80+80, Channel No.: 58

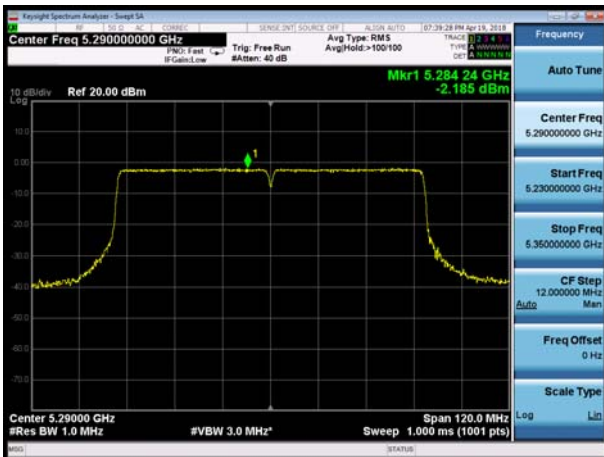

802.11ac VHT80+80, Channel No.: 138

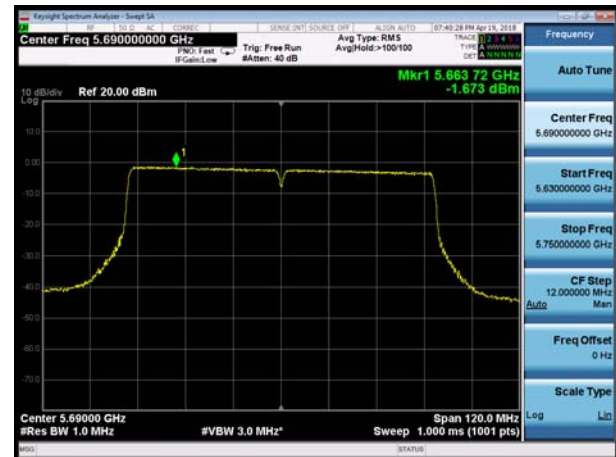

802.11ac VHT80+80, Channel No.: 58



802.11ac VHT80+80, Channel No.: 155

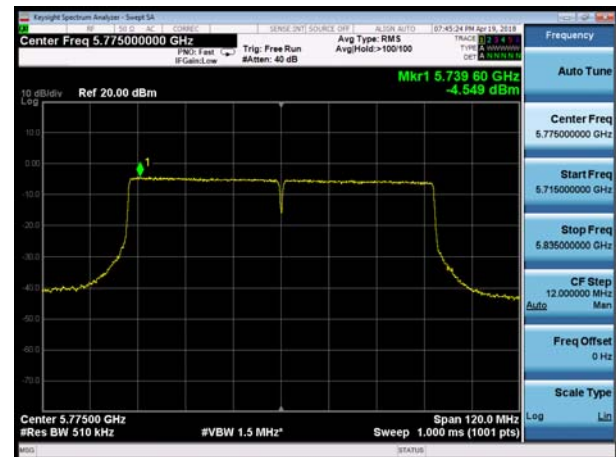



802.11ac VHT80+80, Channel No.: 106



802.11ac VHT80+80, Channel No.: 122



802.11ac VHT80+80, Channel No.: 106



802.11ac VHT80+80, Channel No.: 138



802.11ac VHT80+80, Channel No.: 106



802.11ac VHT80+80, Channel No.: 155





802.11ac VHT80+80, Channel No.: 122



802.11ac VHT80+80, Channel No.: 138



802.11ac VHT80+80, Channel No.: 122



802.11ac VHT80+80, Channel No.: 155



802.11ac VHT80+80, Channel No.: 138

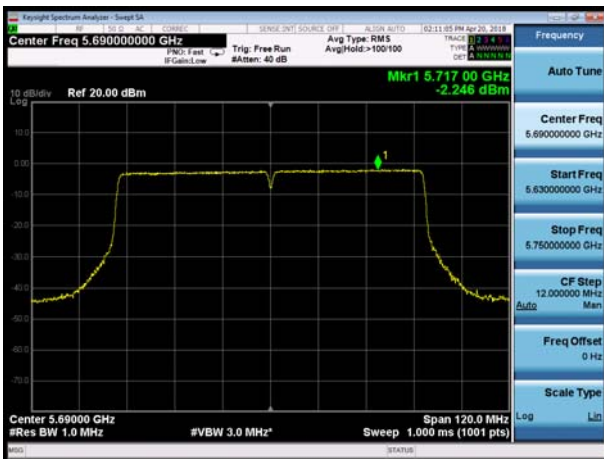

802.11ac VHT80+80, Channel No.: 155



5.5. Unwanted Emission

Ambient condition

Temperature	Relative humidity	Pressure
23°C ~25°C	45%~50%	101.5kPa

Method of Measurement

The test set-up was made in accordance to the general provisions of ANSI C63.10-2013. The Equipment Under Test (EUT) was set up on a non-conductive table in the semi-anechoic chamber. The test was performed at the distance of 3 m between the EUT and the receiving antenna. The radiated emissions measurements were made in a typical installation configuration. Sweep the whole frequency band range from 9kHz to the 10th harmonic of the carrier, and the emissions less than 20 dB below the permissible value are reported.

During the test, the height of receive antenna shall be moved from 1 to 4 meters, and the antenna shall be performed under horizontal and vertical polarization. The turntable shall be rotated from 0 to 360 degrees for detecting the maximum of radiated spurious signal level. The measurements shall be repeated with orthogonal polarization of the test antenna. The data of cable loss and antenna factor has been calibrated in full testing frequency range before the testing.

Set the spectrum analyzer in the following:

Below 1GHz (detector: Peak and Quasi-Peak)

RBW=100kHz / VBW=300kHz / Sweep=AUTO

Above 1GHz (detector: Peak):

I) Peak emission levels are measured by setting the instrument as follows:

1) RBW = 1 MHz.

2) VBW \geq [3 \times RBW]

3) Detector = peak.

4) Sweep time = auto.

5) Trace mode = max hold.

6) Allow sweeps to continue until the trace stabilizes. Note that if the transmission is not continuous, then the time required for the trace to stabilize will increase by a factor of approximately 1 / D, where D is the duty cycle.

II) Average emission levels are measured by setting the instrument as follows:

a) RBW = 1 MHz.

b) VBW \geq [3 \times RBW].

c) Detector = RMS (power averaging), if [span / (# of points in sweep)] \leq RBW / 2. Satisfying this condition can require increasing the number of points in the sweep or reducing the span. If the condition is not satisfied, then the detector mode shall be set to peak.

d) Averaging type = power (i.e., rms) (As an alternative, the detector and averaging type may be set for linear voltage averaging. Some instruments require linear display mode to use linear voltage averaging. Log or dB averaging shall not be used.)



e) Sweep time = auto.

f) Perform a trace average of at least 100 traces if the transmission is continuous. If the transmission is not continuous, then the number of traces shall be increased by a factor of $1 / D$, where D is the duty cycle. For example, with 50% duty cycle, at least 200 traces shall be averaged. (If a specific emission is demonstrated to be continuous—i.e., 100% duty cycle—then rather than turning ON and OFF with the transmit cycle, at least 100 traces shall be averaged.)

g) If tests are performed with the EUT transmitting at a duty cycle less than 98%, then a correction factor shall be added to the measurement results prior to comparing with the emission limit, to compute the emission level that would have been measured had the test been performed at 100% duty cycle. The correction factor is computed as follows:

1) If power averaging (rms) mode was used in the preceding step e), then the correction factor is $[10 \log (1 / D)]$, where D is the duty cycle. For example, if the transmit duty cycle was 50%, then 3 dB shall be added to the measured emission levels.

2) If linear voltage averaging mode was used in the preceding step e), then the correction factor is $[20 \log (1 / D)]$, where D is the duty cycle. For example, if the transmit duty cycle was 50%, then 6 dB shall be added to the measured emission levels.

3) If a specific emission is demonstrated to be continuous (100% duty cycle) rather than turning ON and OFF with the transmit cycle, then no duty cycle correction is required for that emission.

The field strength of spurious emission was measured in the following position: EUT stand-up position (Z axis), lie-down position (X, Y axis). The worst emission was found in stand-up position (Z axis) and the antenna is vertical.

The test is in transmitting mode.

9KHz~~~30MHz

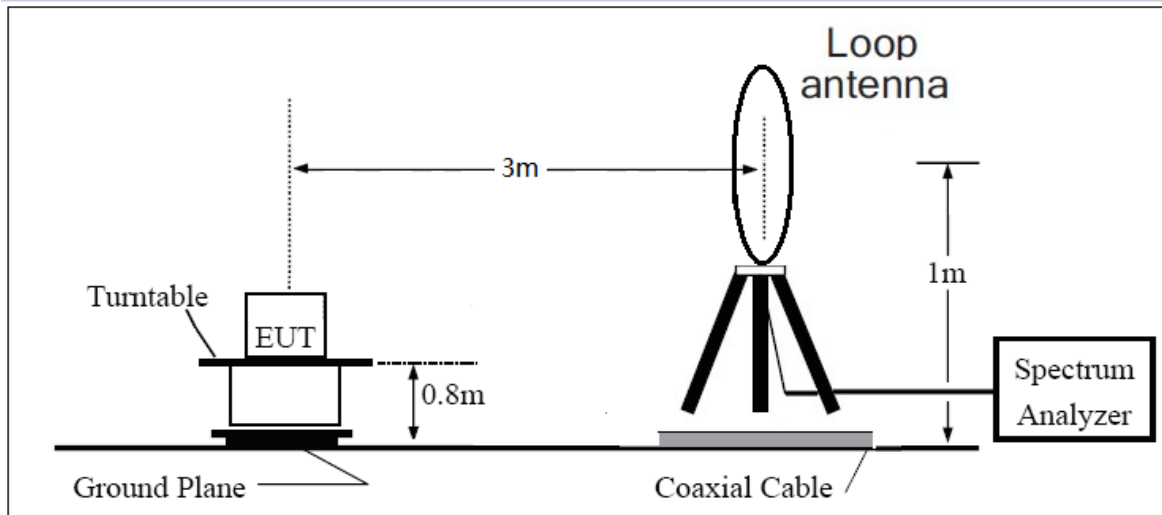

30MHz~~~ 1GHz

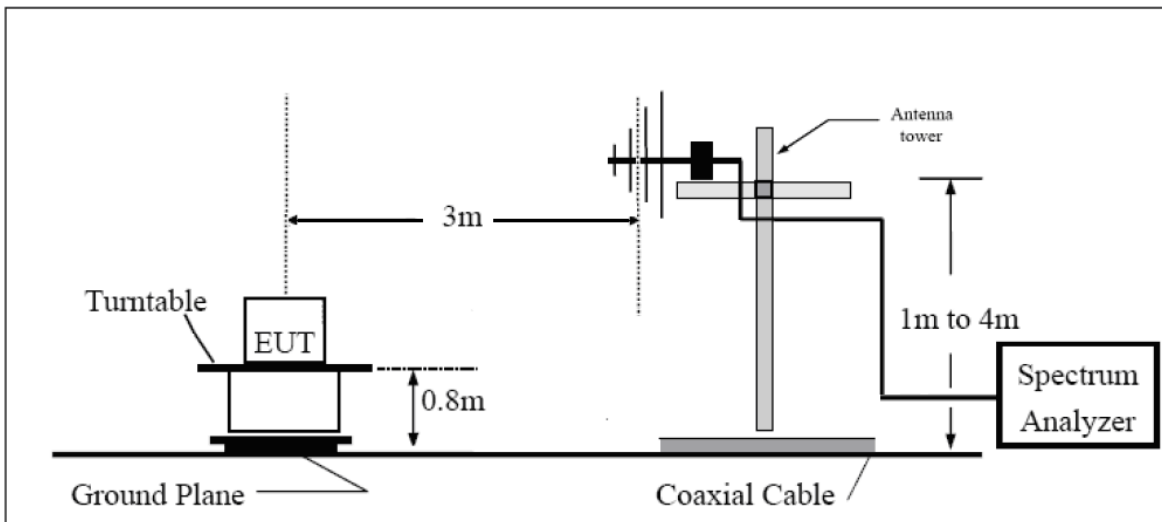

Above 1GHz

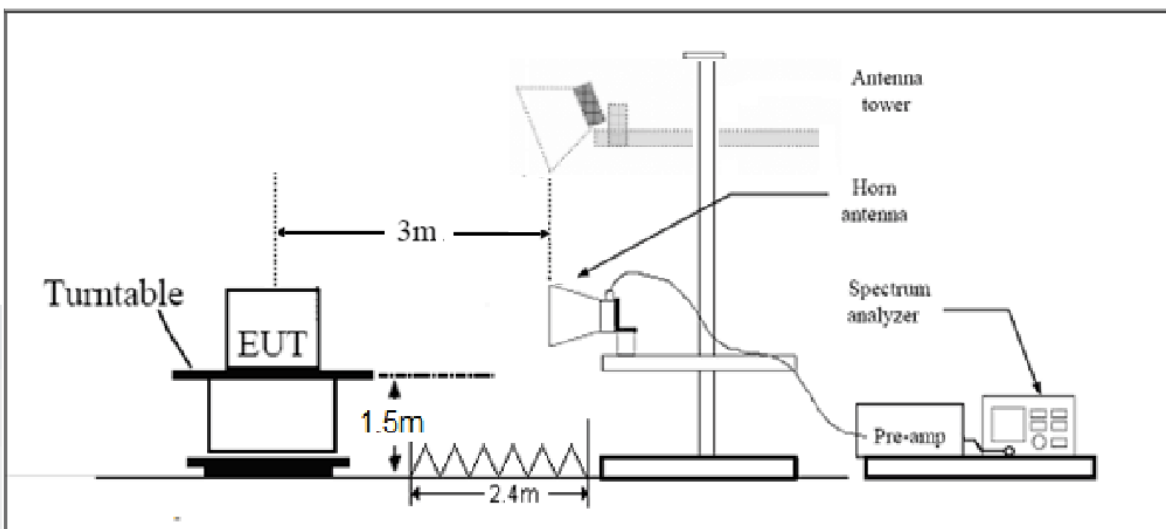

Note: Area side:2.4mX3.6m

Limits

- (1) For transmitters operating in the 5725-5850 MHz band: All emissions shall be limited to a level of -27 dBm/MHz at 75 MHz or more above or below the band edge increasing linearly to 10 dBm/MHz at 25 MHz above or below the band edge, and from 25 MHz above or below the band edge increasing linearly to a level of 15.6 dBm/MHz at 5 MHz above or below the band edge, and from 5 MHz above or below the band edge increasing linearly to a level of 27 dBm/MHz at the band edge.
- (2) For transmitters operating in the 5.15-5.25 GHz band: All emissions outside of the 5.15-5.35 GHz band shall not exceed an e.i.r.p. of -27 dBm/MHz(68.2dBμV/m).
- (3) For transmitters operating in the 5.25-5.35 GHz band: All emissions outside of the 5.15-5.35 GHz band shall not exceed an e.i.r.p. of -27 dBm/MHz(68.2dBμV/m).
- (4) For transmitters operating in the 5.47-5.725 GHz band: All emissions outside of the 5.47-5.725 GHz band shall not exceed an e.i.r.p. of -27 dBm/MHz(68.2dBμV/m).

Note: the following formula is used to convert the EIRP to field strength

§1、 $E[\text{dB}\mu\text{V}/\text{m}] = \text{EIRP}[\text{dBm}] - 20 \log(d[\text{meters}]) + 104.77$, where E = field strength and

d = distance at which field strength limit is specified in the rules;

§2、 $E[\text{dB}\mu\text{V}/\text{m}] = \text{EIRP}[\text{dBm}] + 95.2$, for d = 3 meters

- (5) Unwanted spurious emissions fallen in restricted bands per FCC Part15.205 shall comply with the general field strength limits set forth in § 15.209 as below table.

Frequency of emission (MHz)	Field strength(uV/m)	Field strength(dBuV/m)
0.009–0.490	2400/F(kHz)	/
0.490–1.705	24000/F(kHz)	/
1.705–30.0	30	/
30-88	100	40
88-216	150	43.5
216-960	200	46
Above960	500	54



MHz	MHz	MHz	GHz
0.090 - 0.110	16.42 - 16.423	399.9 - 410	4.5 - 5.15
0.495 - 0.505	16.69475 - 16.69525	608 - 614	5.35 - 5.46
2.1735 - 2.1905	16.80425 - 16.80475	960 - 1240	7.25 - 7.75
4.125 - 4.128	25.5 - 25.67	1300 - 1427	8.025 - 8.5
4.17725 - 4.17775	37.5 - 38.25	1435 - 1626.5	9.0 - 9.2
4.20725 - 4.20775	73 - 74.6	1645.5 - 1646.5	9.3 - 9.5
6.215 - 6.218	74.8 - 75.2	1660 - 1710	10.6 - 12.7
6.26775 - 6.26825	108 - 121.94	1718.8 - 1722.2	13.25 - 13.4
6.31175 - 6.31225	123 - 138	2200 - 2300	14.47 - 14.5
8.291 - 8.294	149.9 - 150.05	2310 - 2390	15.35 - 16.2
8.362 - 8.366	156.52475 - 156.52525	2483.5 - 2500	17.7 - 21.4
8.37625 - 8.38675	156.7 - 156.9	2690 - 2900	22.01 - 23.12
8.41425 - 8.41475	162.0125 - 167.17	3260 - 3267	23.6 - 24.0
12.29 - 12.293	167.72 - 173.2	3332 - 3339	31.2 - 31.8
12.51975 - 12.52025	240 - 285	3345.8 - 3358	36.43 - 36.5
12.57675 - 12.57725	322 - 335.4	3600 - 4400	(²)
13.36 - 13.41			

Measurement Uncertainty

The assessed measurement uncertainty to ensure 95% confidence level for the normal distribution is with the coverage factor $k = 1.96$.

Frequency	Uncertainty
9KHz-30MHz	3.55 dB
30MHz-200MHz	4.19 dB
200MHz-1GHz	3.63 dB
1GHz-26.5G	3.68 dB
26.5G-40GHz	4.76dB

Test Results:

The signal beyond the limit is carrier.

There is more than one Antenna Type, each one should be applied throughout the compliance test respectively, and however, only the worst case (Antenna Type 1) will be recorded in this report.

U-NII-1

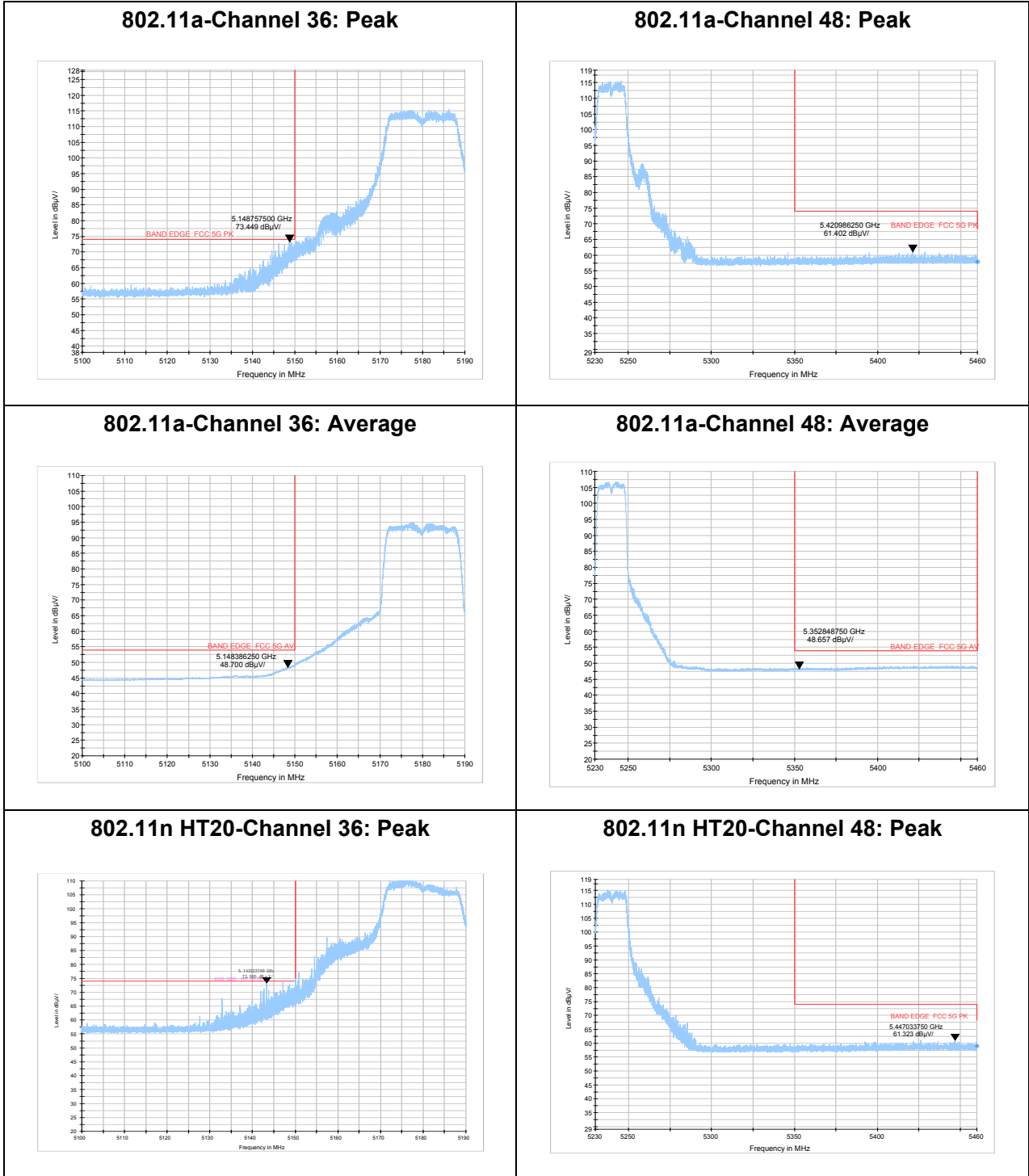



802.11n HT20-Channel 36: Average

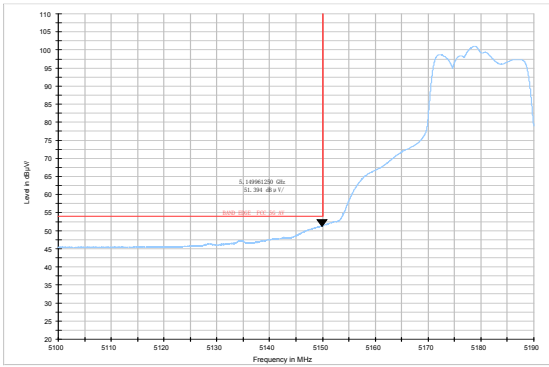

802.11n HT20-Channel 48: Average

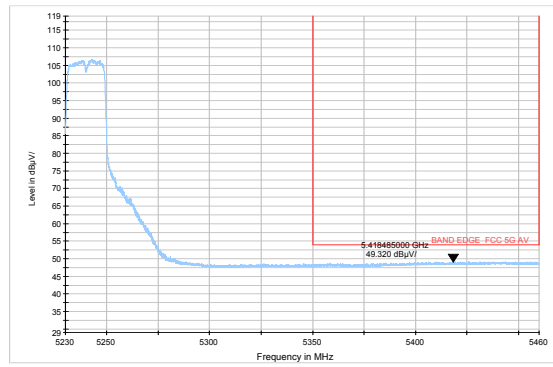

802.11n HT40-Channel 38: Peak

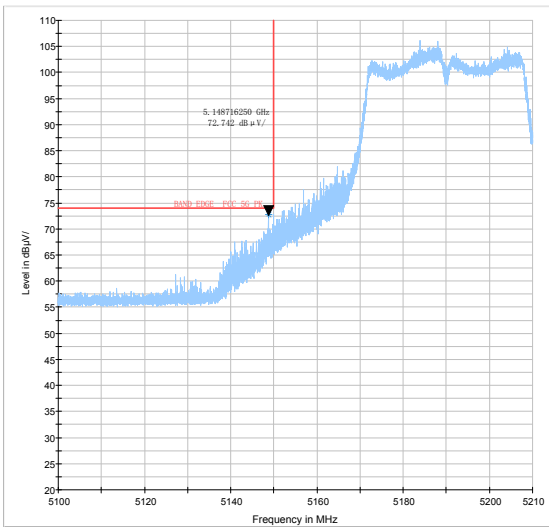

802.11n HT40-Channel 38: Average

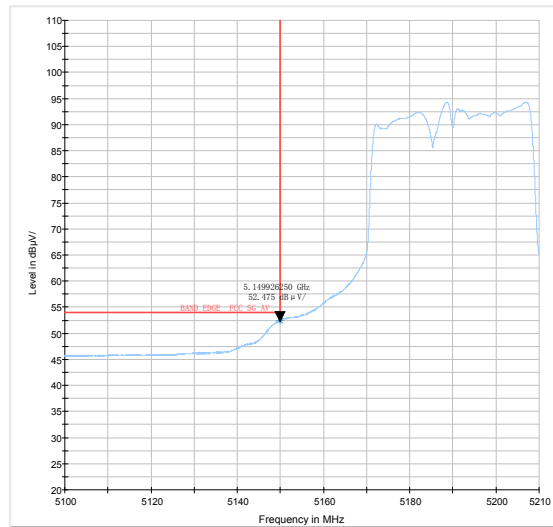

802.11ac VHT80 -Channel 42: Peak

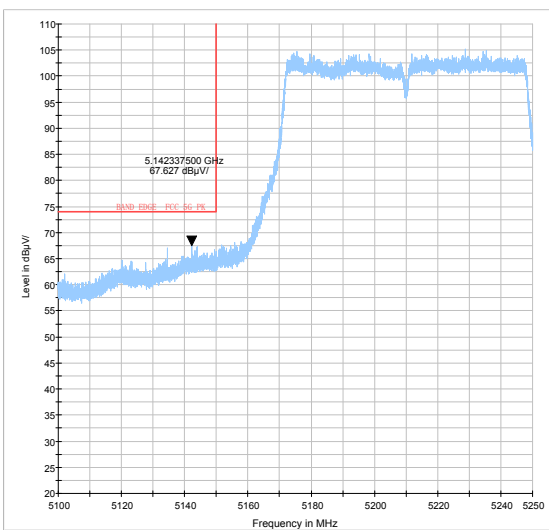

802.11ac VHT80- Channel 42: Average

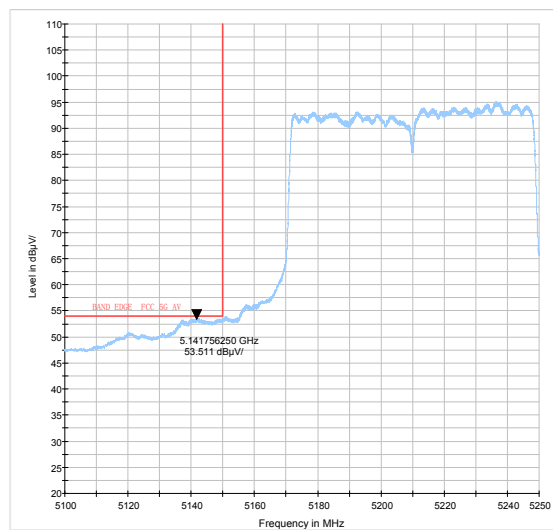



U-NII-2A

802.11a-Channel 52: Peak

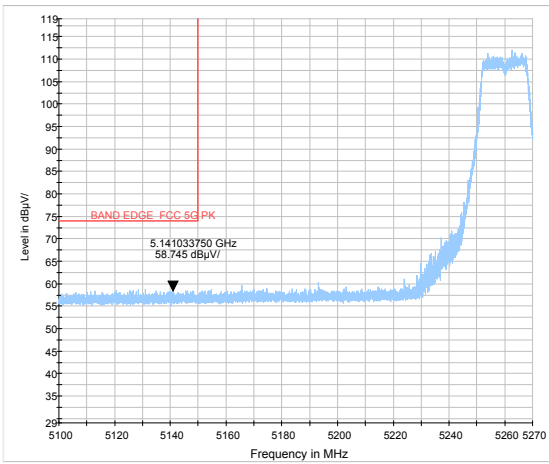

802.11a-Channel 64: Peak

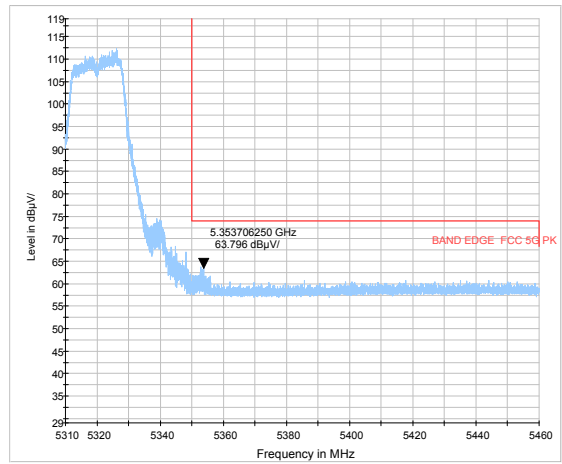

802.11a-Channel 52: Average

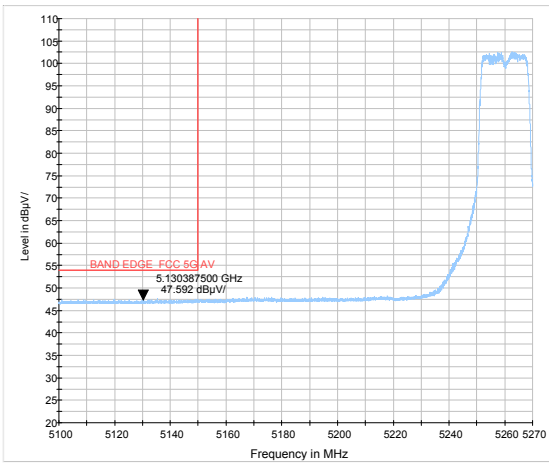

802.11a-Channel 64: Average

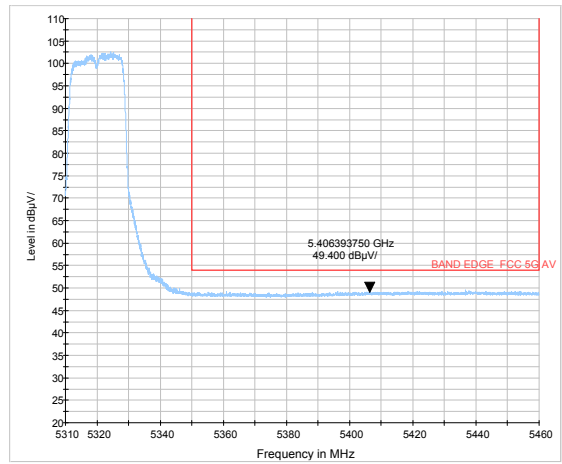

802.11n HT20-Channel 52: Peak

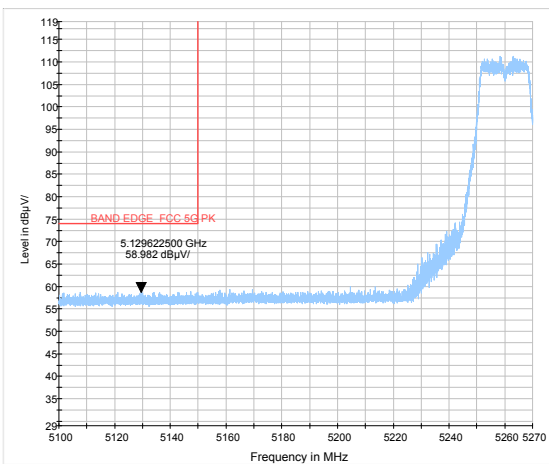

802.11n HT20-Channel 64: Peak

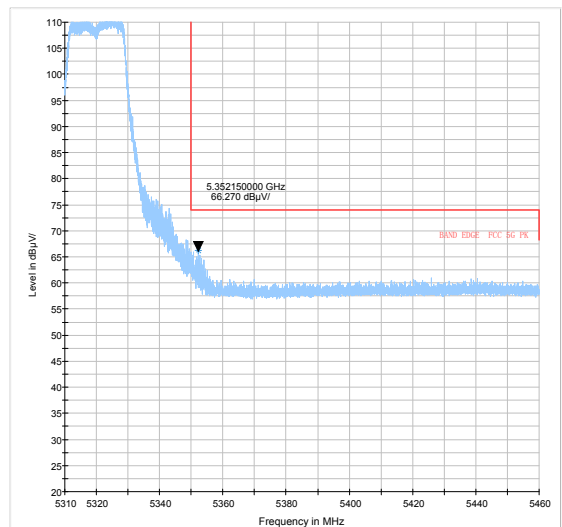



802.11n HT20-Channel 52: Average

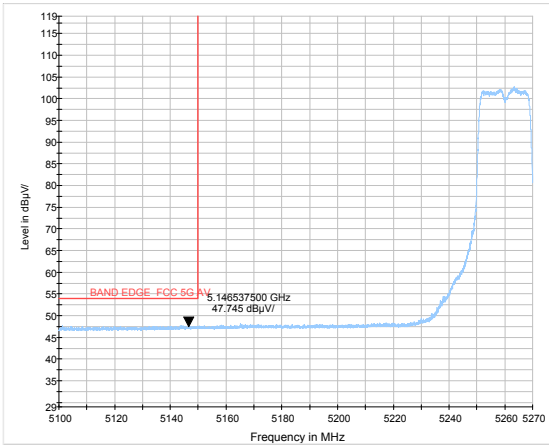

802.11n HT20-Channel 64: Average

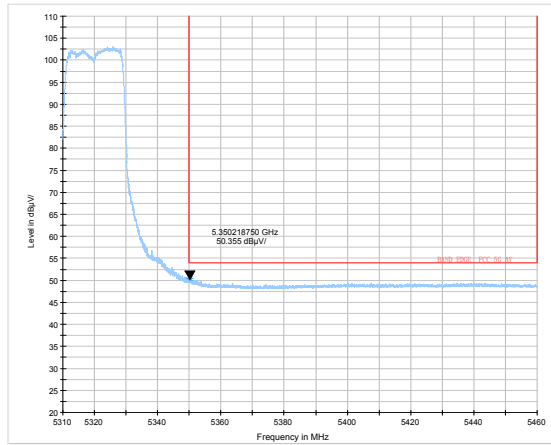

802.11n HT40-Channel 62: Peak

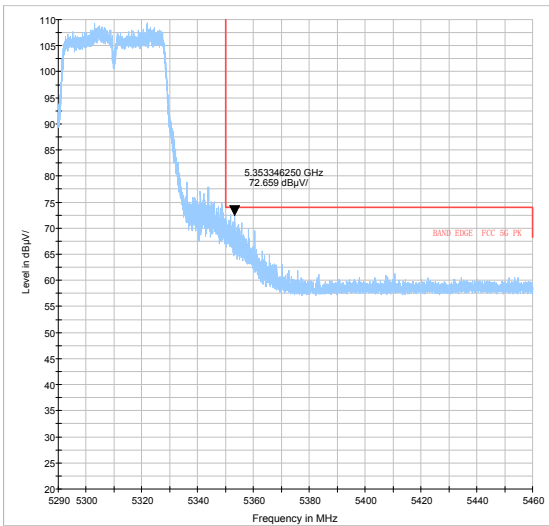

802.11n HT40-Channel 62: Average

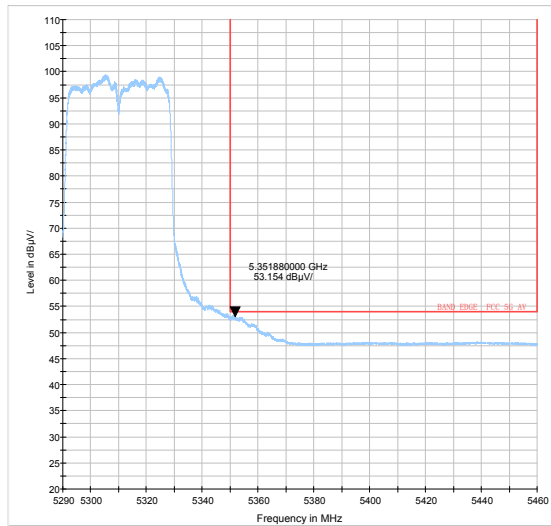

802.11ac VHT80 -Channel 58: Peak

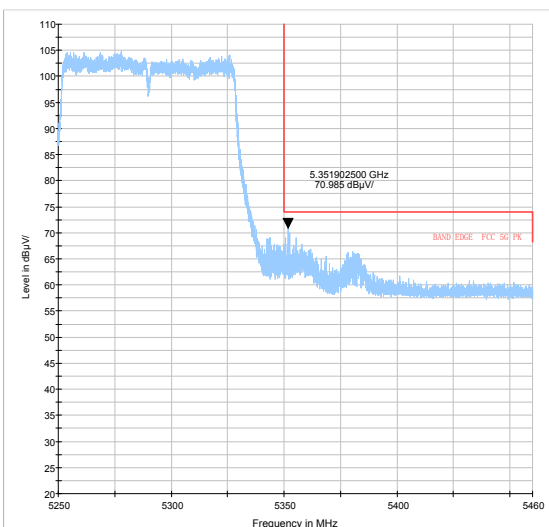

802.11ac VHT80- Channel 58: Average

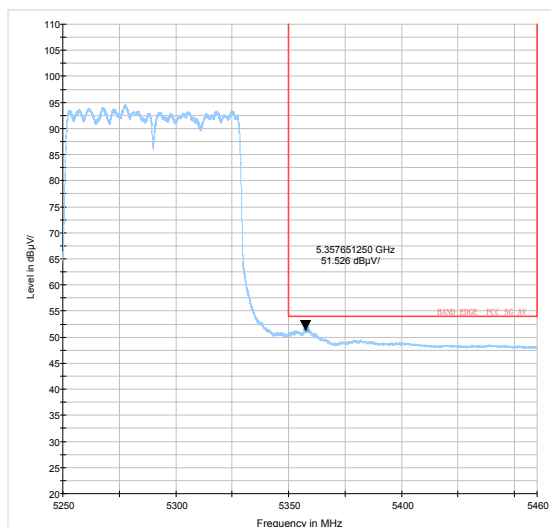



802.11ac VHT80+80 –Channel 42+58: Peak

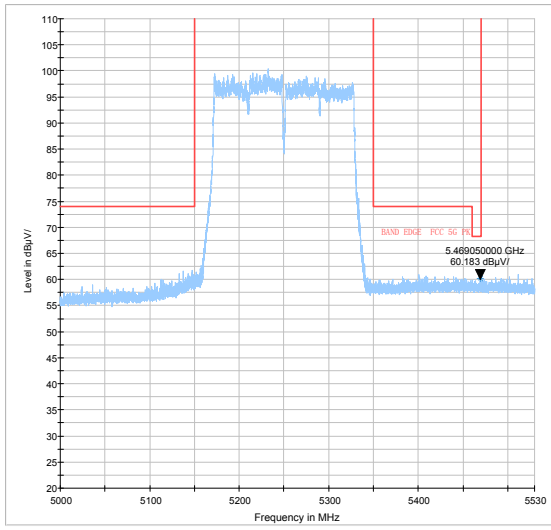

802.11ac VHT80+80 –Channel 42+58: Average

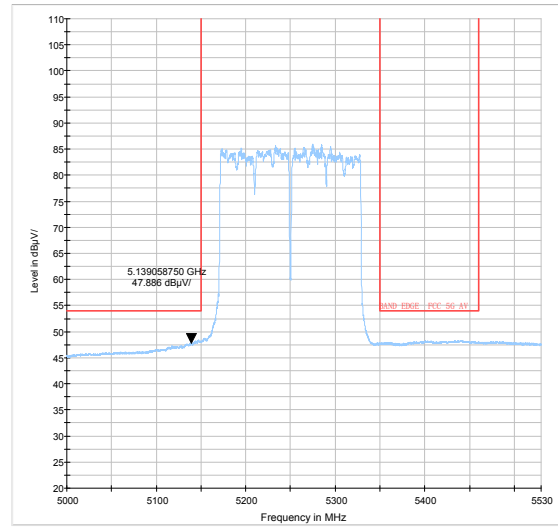



U-NII-2C

802.11a-Channel 100: Peak

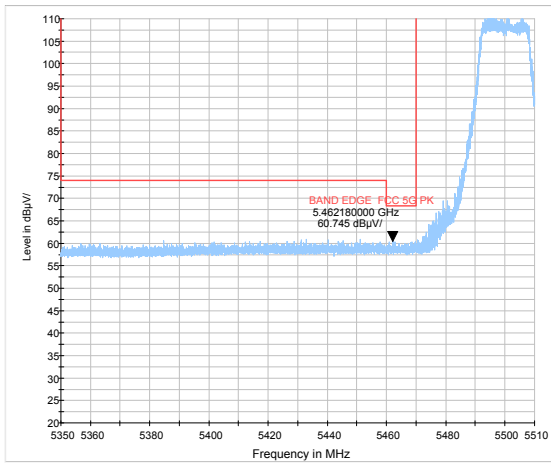

802.11n HT20-Channel 100: Peak

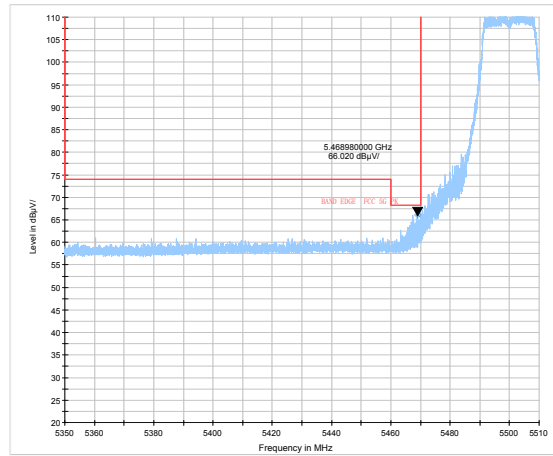

802.11a-Channel 100: Average

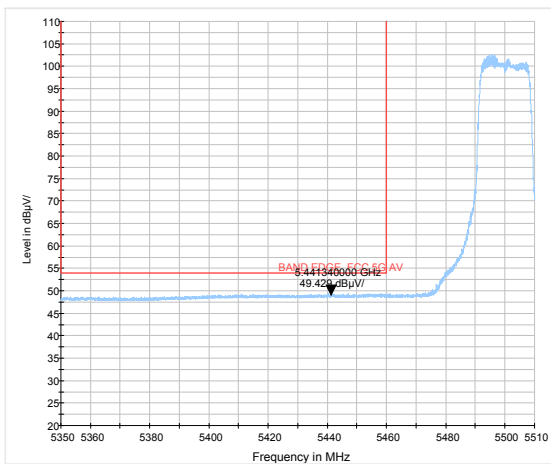

802.11n HT20-Channel 100: Average

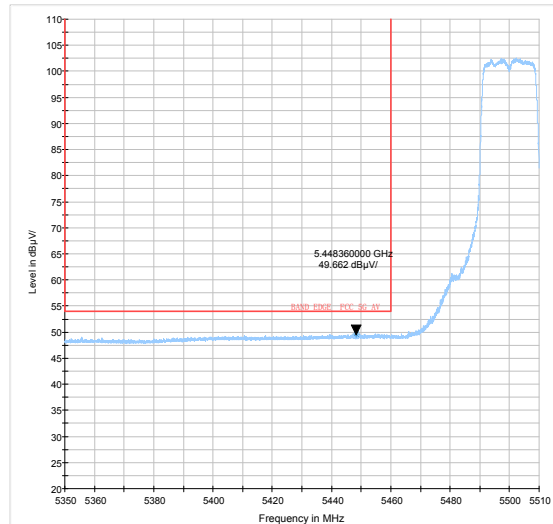

802.11a-Channel 140: Peak

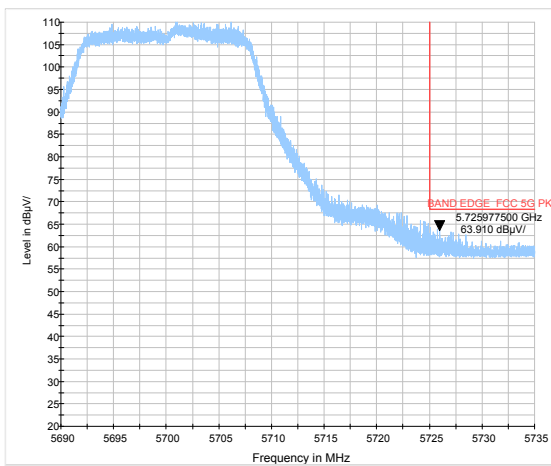

802.11n HT20-Channel 140: Peak

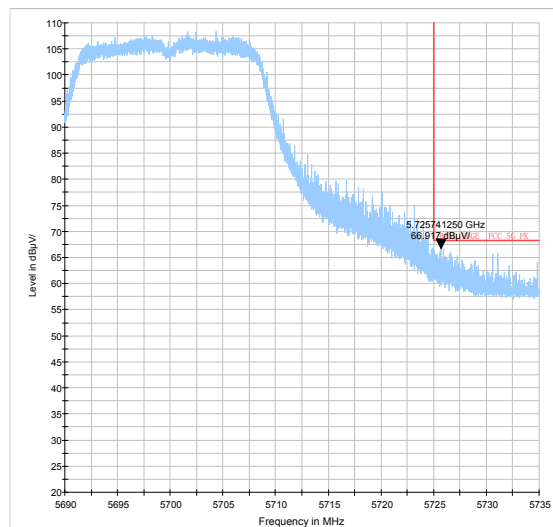



802.11n HT40-Channel 102: Peak

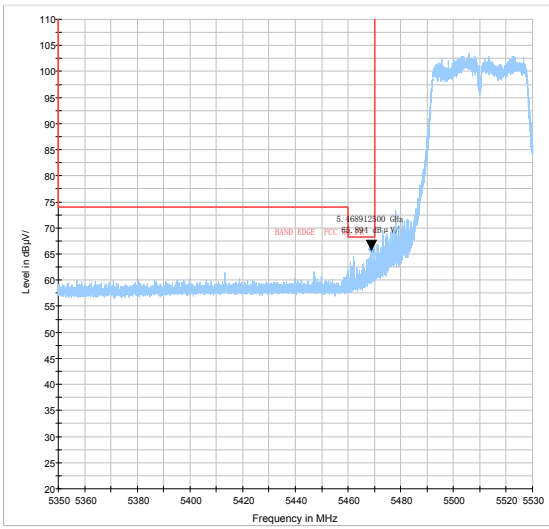

802.11n HT40-Channel 134: Peak

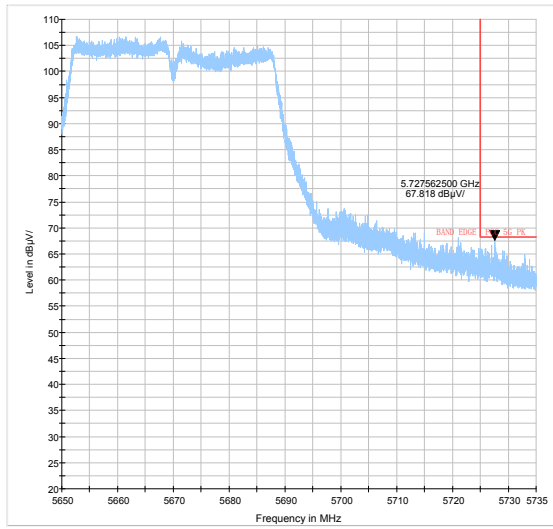

802.11n HT40-Channel 102: Average

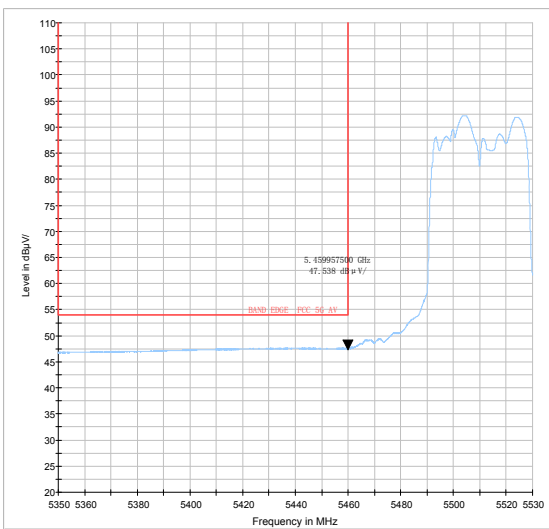

802.11ac VHT80- Channel 106: Peak

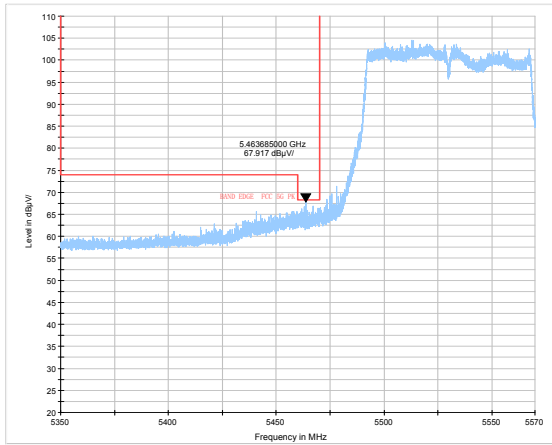

802.11ac VHT80- Channel 106: Average

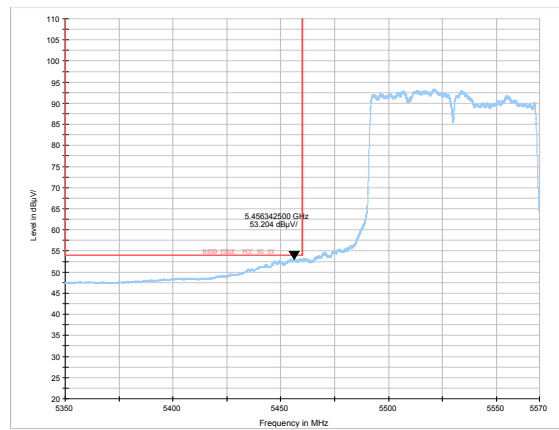

802.11ac VHT80+80- Channel 106+122: Peak

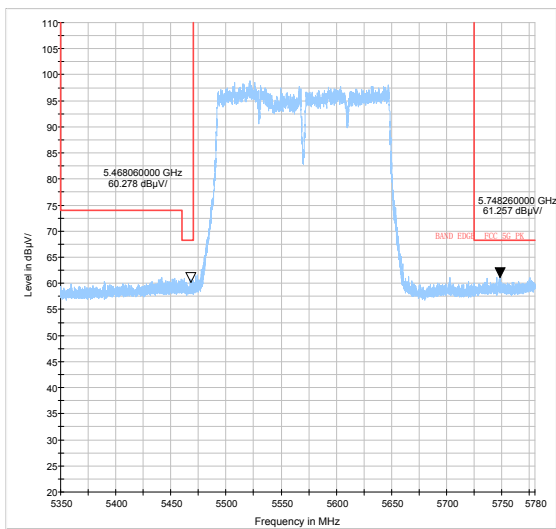

802.11ac VHT80+80- Channel 106+122: Average

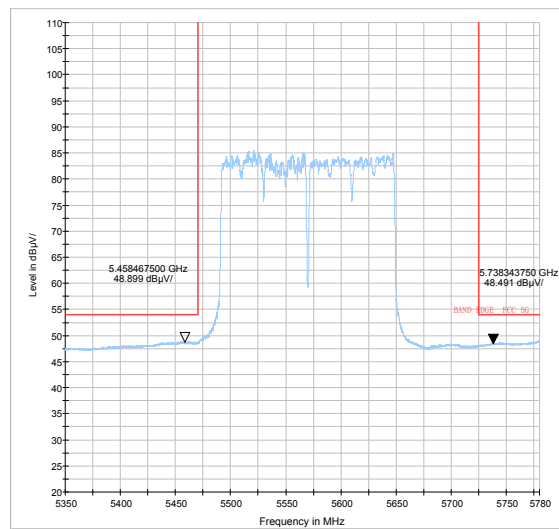



U-NII-3

802.11a-Channel 149: Peak

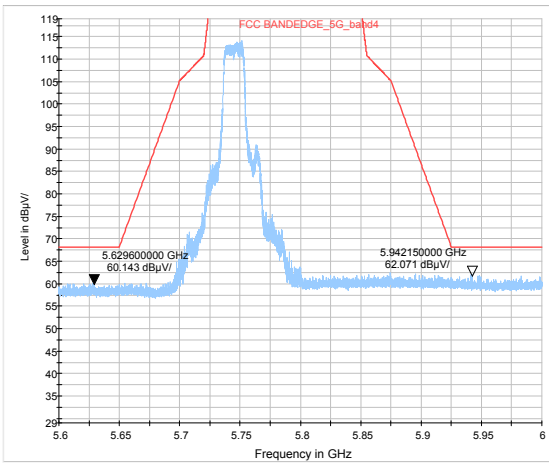

802.11a-Channel 165: Peak

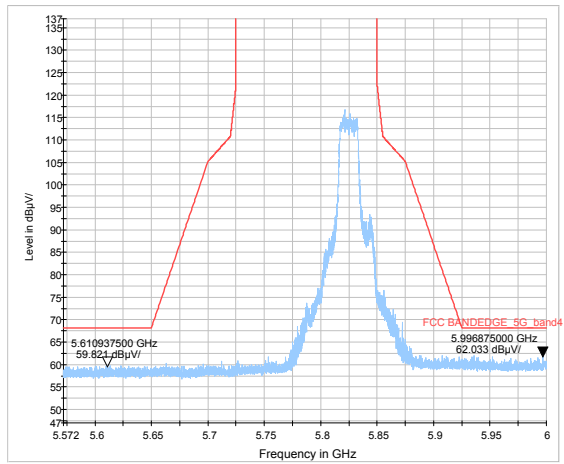

802.11n HT20-Channel 149: Peak

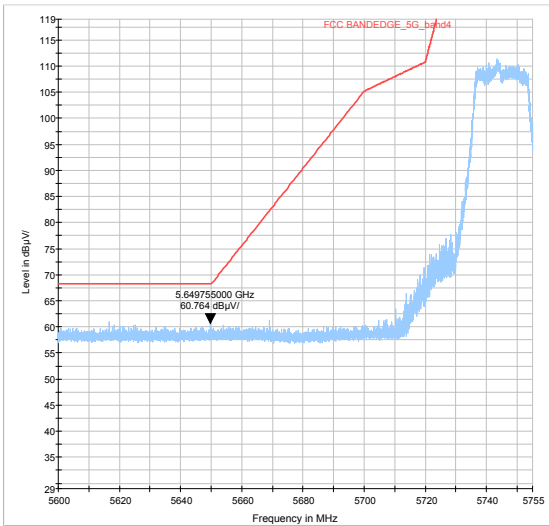

802.11n HT20-Channel 165: Peak

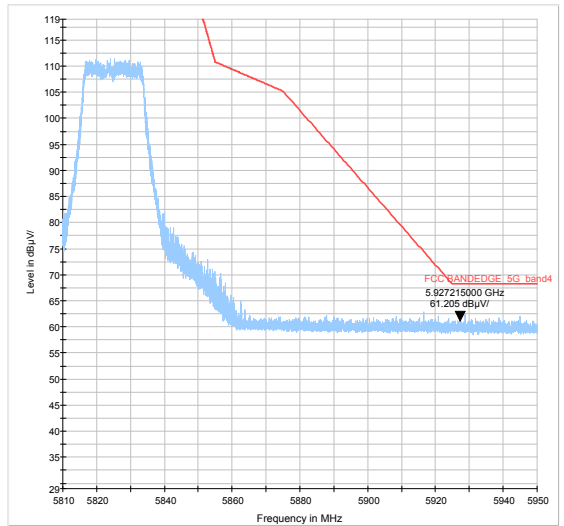

802.11n HT40-Channel 151: Peak

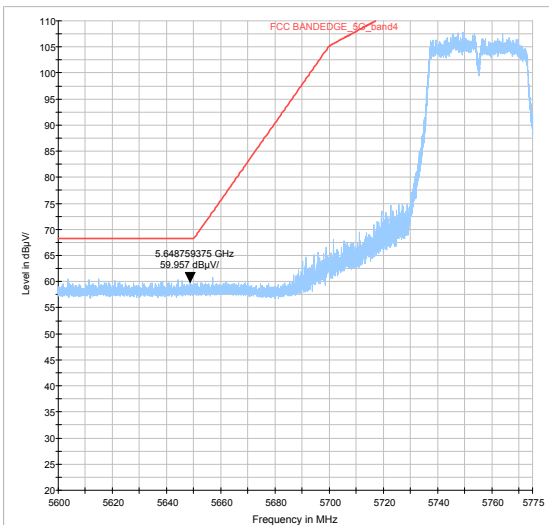

802.11n HT40-Channel 159: Peak

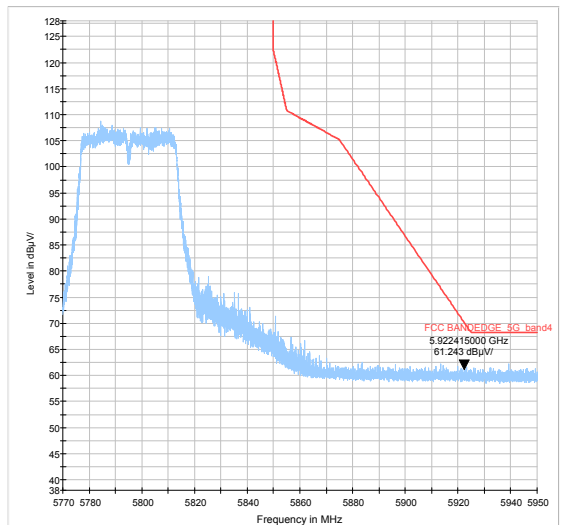



802.11ac VHT80-Channel 155: Peak

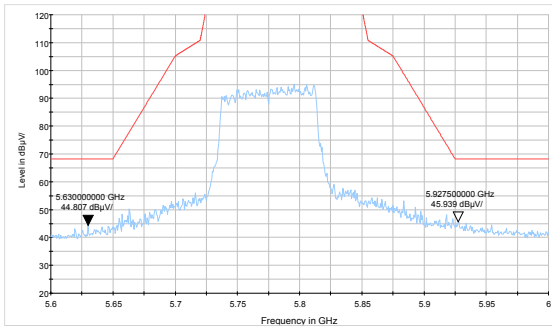

Result of RE

Test result

Sweep the whole frequency band through the range from 9kHz to the 10th harmonic of the carrier, the emissions more than 20 dB below the permissible value are not reported.

After the pre test, Antenna Type 1 was selected as the worst antenna.

During the test, the Radiates Emission from 30MHz to 1GHz was performed in all modes with all channels, 802.11n (HT40), Channel 54 are selected as the worst condition. The test data of the worst-case condition was recorded in this report.

Continuous TX mode:

RE 30M-1GHz QP

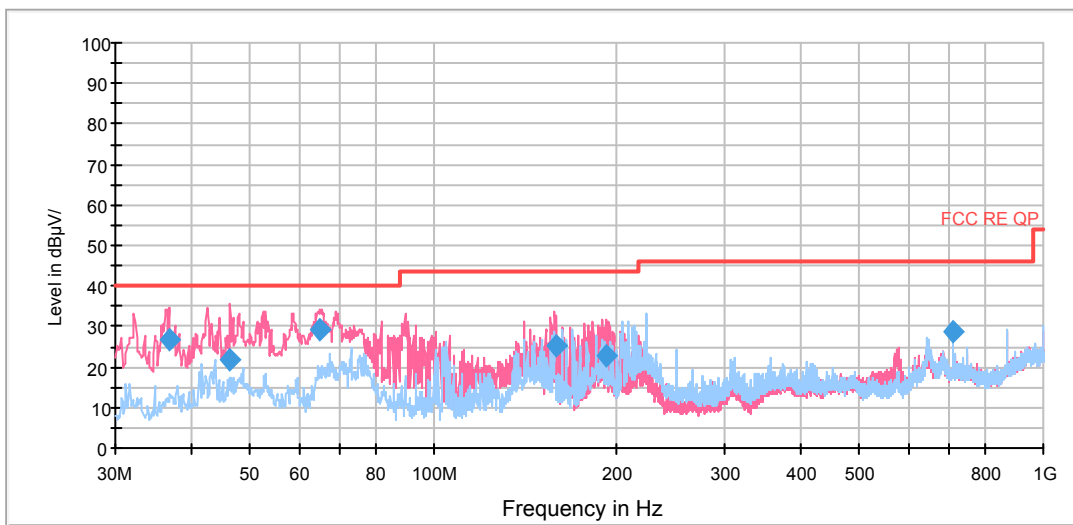

Radiates Emission from 30MHz to 1GHz

Frequency (MHz)	Quasi-Peak (dBuV/m)	Reading value (dBuV/m)	Height (cm)	Polarization	Azimuth (deg)	Correct Factor (dB)	Margin (dB)	Limit (dBuV/m)
36.858025	26.7	45.3	100.0	V	196.0	-18.6	13.3	40.0
46.332828	21.6	39.2	100.0	V	6.0	-17.6	18.4	40.0
64.797700	29.3	53.9	100.0	V	348.0	-24.6	10.7	40.0
158.163953	25.4	53.6	100.0	V	0.0	-28.2	18.1	43.5
192.269078	22.8	48.0	100.0	V	331.0	-25.2	20.7	43.5
711.245250	28.9	43.8	100.0	V	82.0	-14.9	17.1	46.0

- Remark:**
1. Quasi-Peak = Reading value + Correction factor
 2. Correction Factor = Antenna factor+ Insertion loss(cable loss+amplifier gain)
 3. Margin = Limit – Quasi-Peak

802.11a CH36

RE 1G-3GHz PK+AV

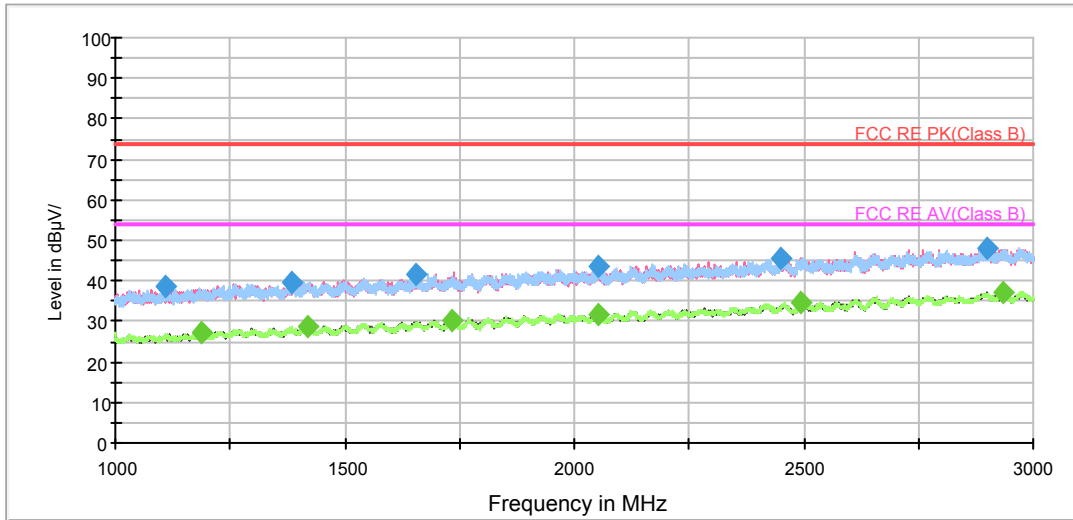

Radiates Emission from 1GHz to 3GHz

RE 3-18GHz PK+AV

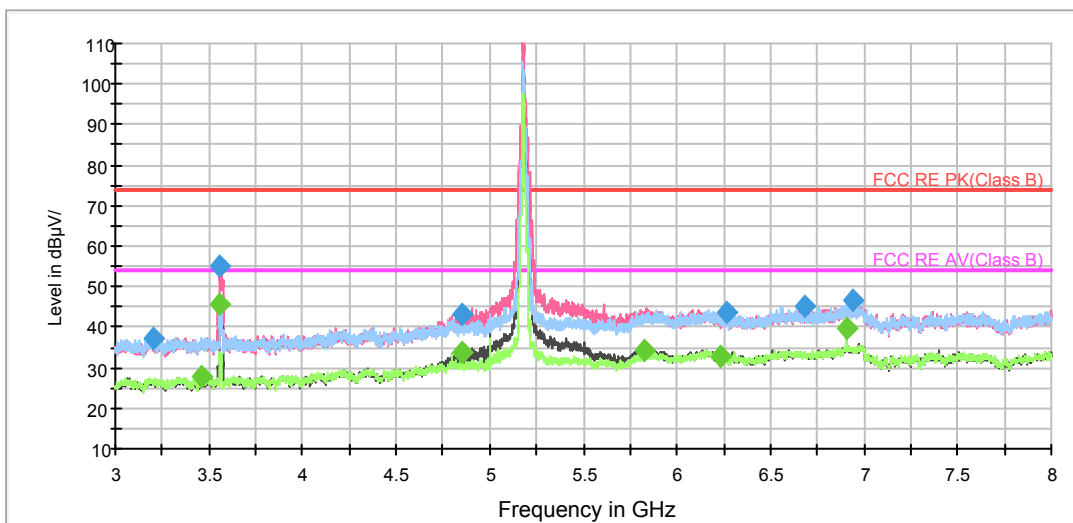

Note: The signal beyond the limit is carrier.

Radiates Emission from 3GHz to 8GHz



RE 3-18GHz PK+AV

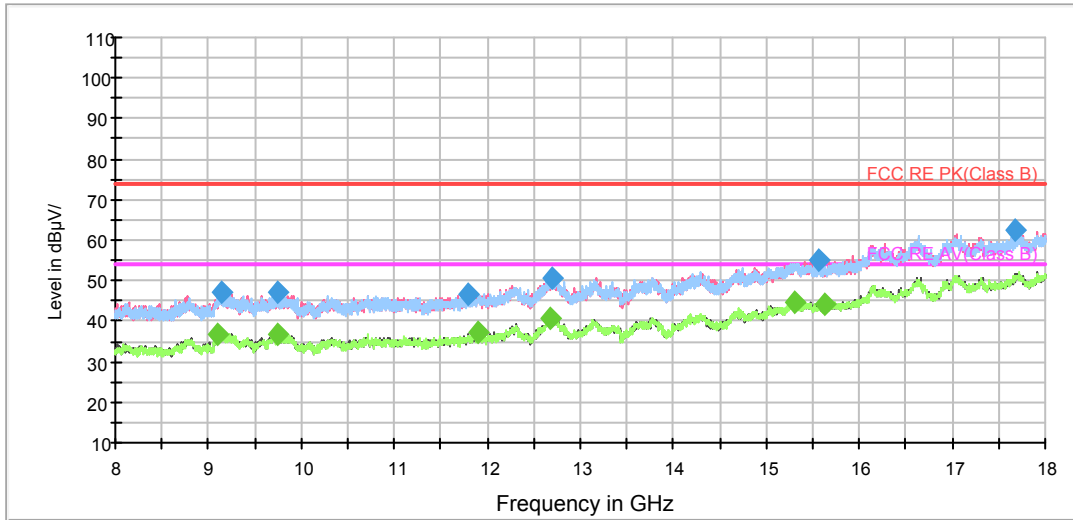

Radiates Emission from 8GHz to 18GHz

Frequency (MHz)	Peak (dBuV/m)	Height (cm)	Polarization	Azimuth (deg)	Reading value (dBuV/m)	Correct Factor (dB)	Margin (dB)	Limit (dBuV/m)
3201.250000	37.5	200.0	H	163.0	40.3	-2.8	36.5	74.0
3559.375000	54.9	200.0	V	292.0	57.0	-2.1	19.1	74.0
4848.125000	43.1	200.0	V	56.0	41.5	1.6	30.9	74.0
6265.000000	43.4	200.0	V	292.0	37.9	5.5	30.6	74.0
6688.125000	45.2	200.0	H	94.0	39.8	5.4	28.8	74.0
6936.250000	46.8	200.0	V	189.0	40.7	6.1	27.2	74.0

Remark: 1. Correction Factor = Antenna factor+ Insertion loss (cable loss + amplifier gain)

Frequency (MHz)	Average (dBuV/m)	Height (cm)	Polarization	Azimuth (deg)	Reading value (dBuV/m)	Correct Factor (dB)	Margin (dB)	Limit (dBuV/m)
3456.875000	27.8	200.0	H	45.0	30.0	-2.2	26.2	54.0
3560.625000	45.4	200.0	V	292.0	47.5	-2.1	8.6	54.0
4848.125000	33.6	200.0	V	56.0	32.0	1.6	20.4	54.0
5830.625000	34.4	200.0	V	335.0	29.9	4.5	19.6	54.0
6233.125000	33.0	200.0	V	199.0	27.7	5.3	21.0	54.0
6906.875000	39.7	200.0	V	268.0	33.4	6.3	14.3	54.0

Remark: 1. Correction Factor = Antenna factor+ Insertion loss (cable loss + amplifier gain)

802.11a CH40

RE 1G-3GHz PK+AV

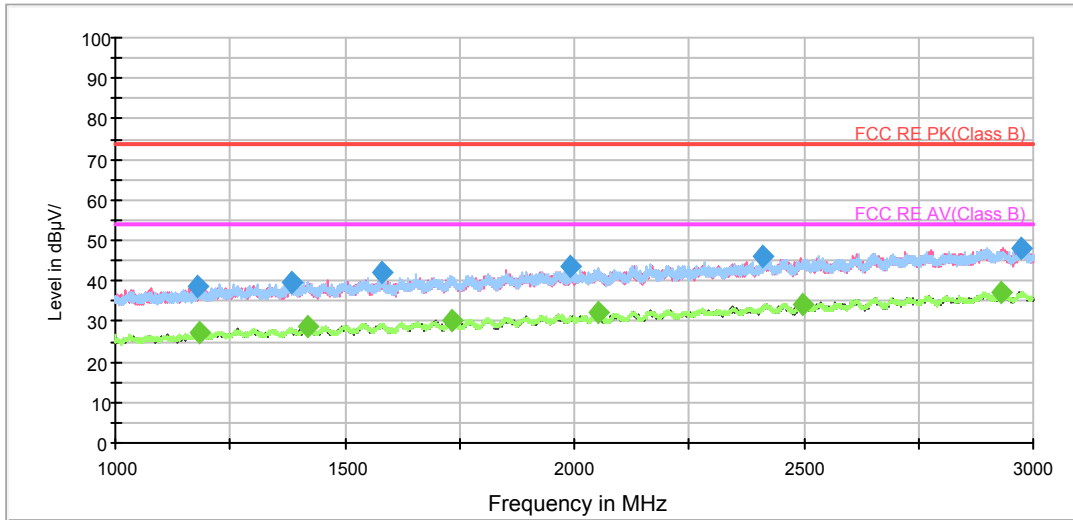

Radiates Emission from 1GHz to 3GHz

RE 3-18GHz PK+AV

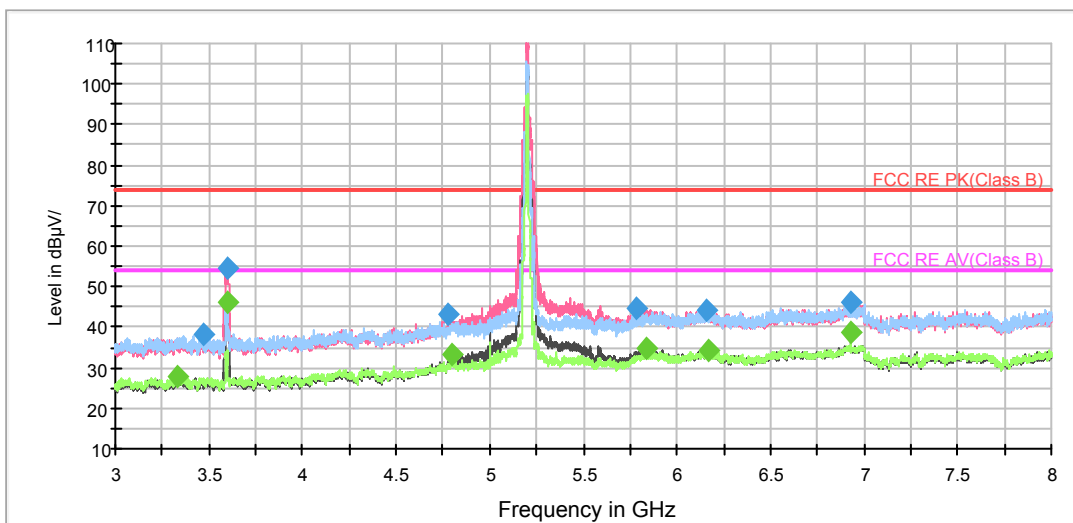

Note: The signal beyond the limit is carrier.

Radiates Emission from 3GHz to 8GHz

RE 3-18GHz PK+AV

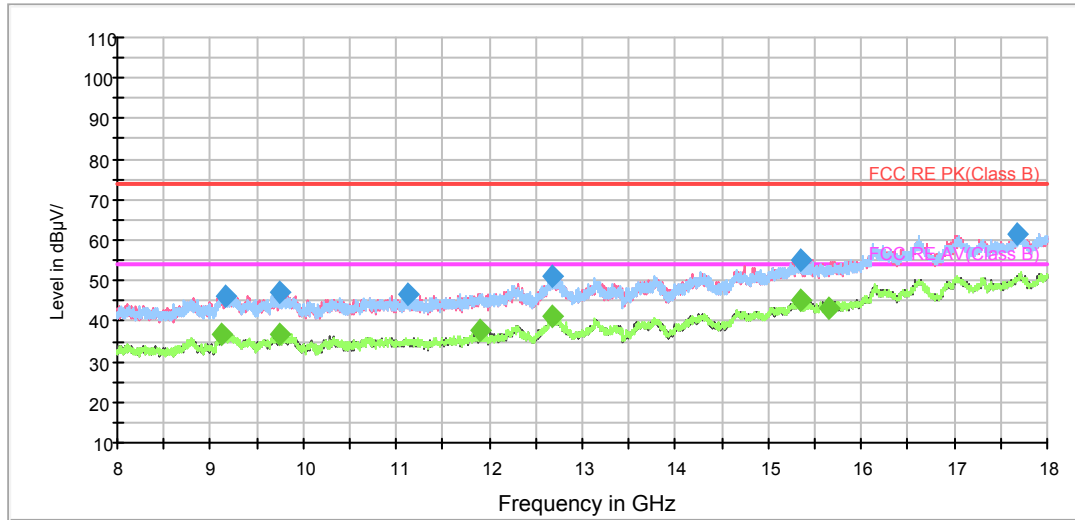

Radiates Emission from 8GHz to 18GHz

Frequency (MHz)	Peak (dBuV/m)	Height (cm)	Polarization	Azimuth (deg)	Reading value (dBuV/m)	Correct Factor (dB)	Margin (dB)	Limit (dBuV/m)
3468.750000	38.2	200.0	H	7.0	40.3	-2.1	35.8	74.0
3600.000000	54.6	200.0	V	106.0	56.8	-2.2	19.4	74.0
4776.250000	43.0	200.0	V	255.0	41.9	1.1	31.0	74.0
5781.250000	44.6	200.0	V	0.0	40.6	4.0	29.4	74.0
6158.125000	44.4	200.0	V	175.0	38.8	5.6	29.6	74.0
6933.125000	46.1	200.0	V	264.0	39.9	6.2	27.9	74.0

Remark: 1. Correction Factor = Antenna factor+ Insertion loss (cable loss + amplifier gain)

Frequency (MHz)	Average (dBuV/m)	Height (cm)	Polarization	Azimuth (deg)	Reading value (dBuV/m)	Correct Factor (dB)	Margin (dB)	Limit (dBuV/m)
3326.875000	27.6	200.0	V	136.0	29.8	-2.2	26.4	54.0
3596.875000	46.2	200.0	V	106.0	48.4	-2.2	7.8	54.0
4800.000000	33.3	200.0	V	86.0	32.0	1.3	20.7	54.0
5833.750000	35.0	200.0	V	10.0	30.5	4.5	19.0	54.0
6168.750000	34.2	200.0	V	255.0	28.7	5.5	19.8	54.0
6933.750000	38.6	200.0	V	264.0	32.4	6.2	15.4	54.0

Remark: 1. Correction Factor = Antenna factor+ Insertion loss (cable loss + amplifier gain)

802.11a CH48

RE 1G-3GHz PK+AV

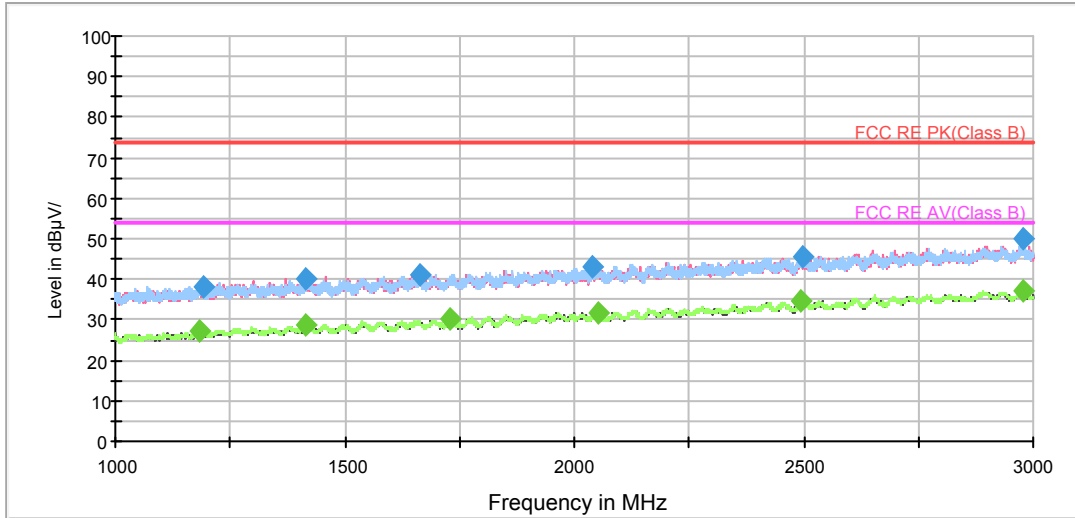

Radiates Emission from 1GHz to 3GHz

RE 3-18GHz PK+AV

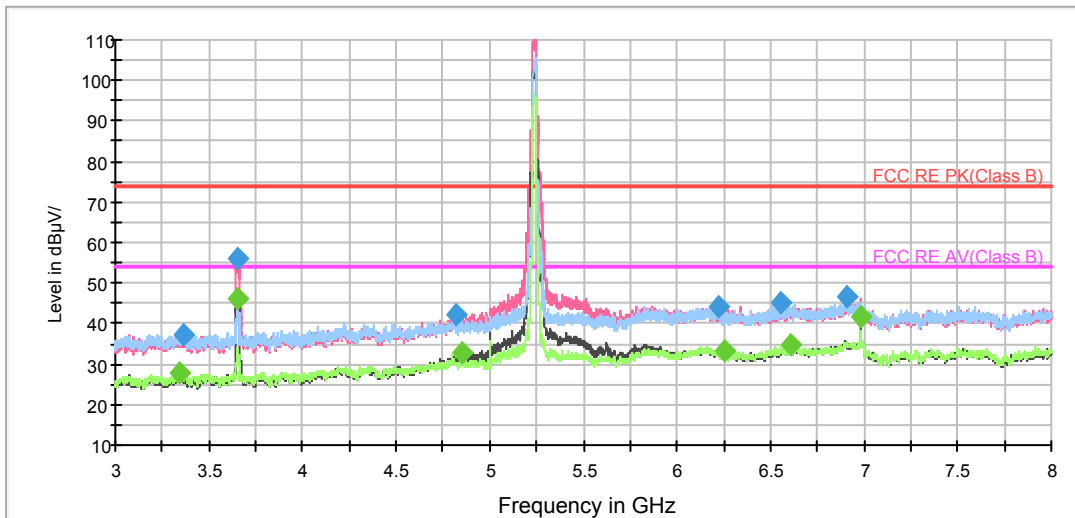

Note: The signal beyond the limit is carrier.

Radiates Emission from 3GHz to 8GHz

RE 3-18GHz PK+AV

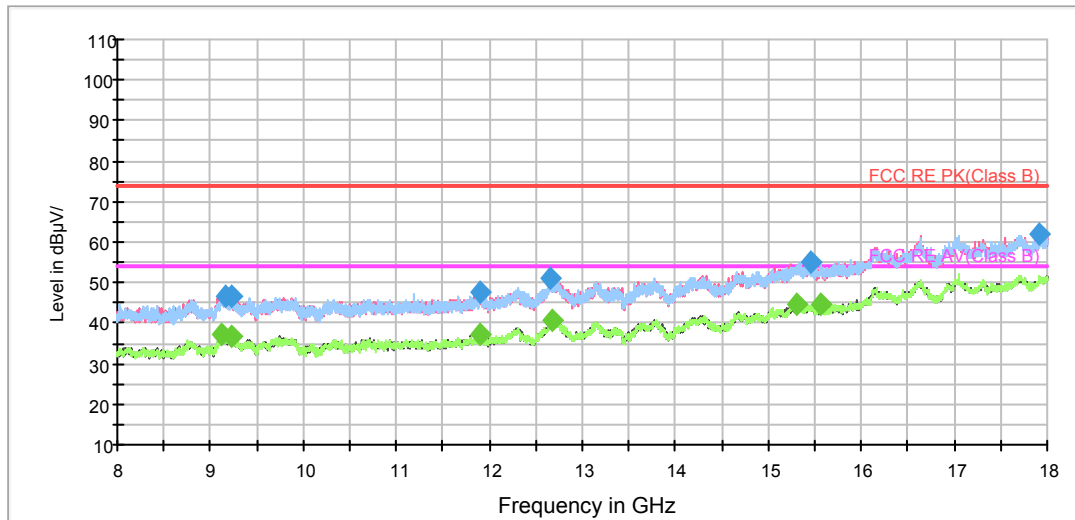

Radiates Emission from 8GHz to 18GHz

Frequency (MHz)	Peak (dBuV/m)	Height (cm)	Polarization	Azimuth (deg)	Reading value (dBuV/m)	Correct Factor (dB)	Margin (dB)	Limit (dBuV/m)
3360.000000	37.4	200.0	H	86.0	39.7	-2.3	36.6	74.0
3657.500000	55.9	200.0	V	107.0	57.8	-1.9	18.1	74.0
4816.250000	42.3	200.0	V	265.0	41.0	1.3	31.7	74.0
6224.375000	44.2	200.0	H	164.0	38.8	5.4	29.8	74.0
6553.750000	44.9	200.0	V	186.0	39.3	5.6	29.1	74.0
6905.625000	46.5	200.0	H	56.0	40.2	6.3	27.5	74.0

Remark: 1. Correction Factor = Antenna factor+ Insertion loss (cable loss + amplifier gain)

Frequency (MHz)	Average (dBuV/m)	Height (cm)	Polarization	Azimuth (deg)	Reading value (dBuV/m)	Correct Factor (dB)	Margin (dB)	Limit (dBuV/m)
3344.375000	27.7	200.0	H	125.0	30.1	-2.4	26.3	54.0
3657.500000	46.3	200.0	V	107.0	48.2	-1.9	7.7	54.0
4848.125000	32.8	200.0	V	166.0	31.2	1.6	21.2	54.0
6255.625000	33.2	200.0	V	265.0	27.7	5.5	20.8	54.0
6603.125000	35.0	200.0	H	184.0	29.3	5.7	19.0	54.0
6986.875000	41.7	200.0	V	275.0	35.3	6.4	12.3	54.0

Remark: 1. Correction Factor = Antenna factor+ Insertion loss (cable loss + amplifier gain)

802.11a CH52

RE 1G-3GHz PK+AV

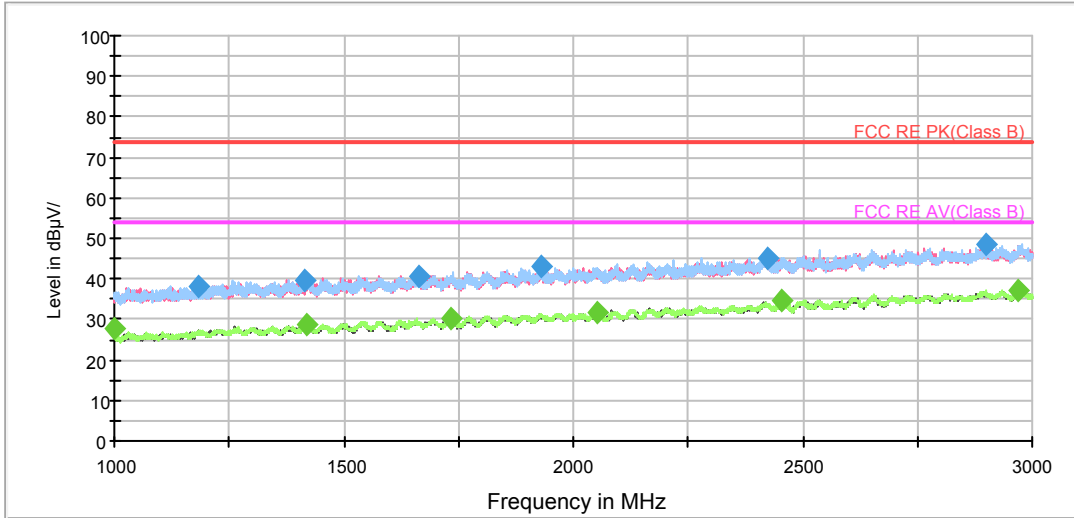

Radiates Emission from 1GHz to 3GHz

RE 3-18GHz PK+AV

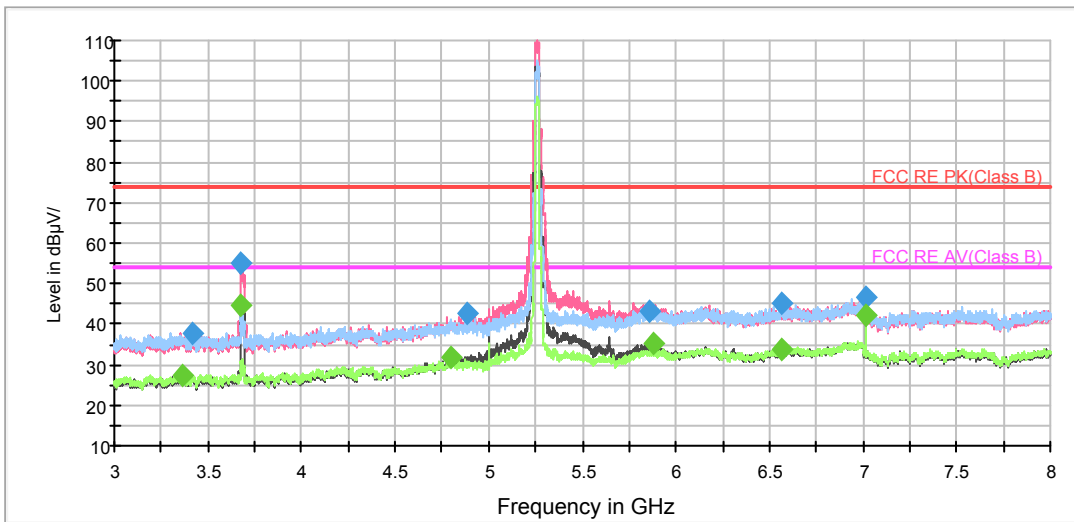

Note: The signal beyond the limit is carrier.

Radiates Emission from 3GHz to 8GHz

RE 3-18GHz PK+AV

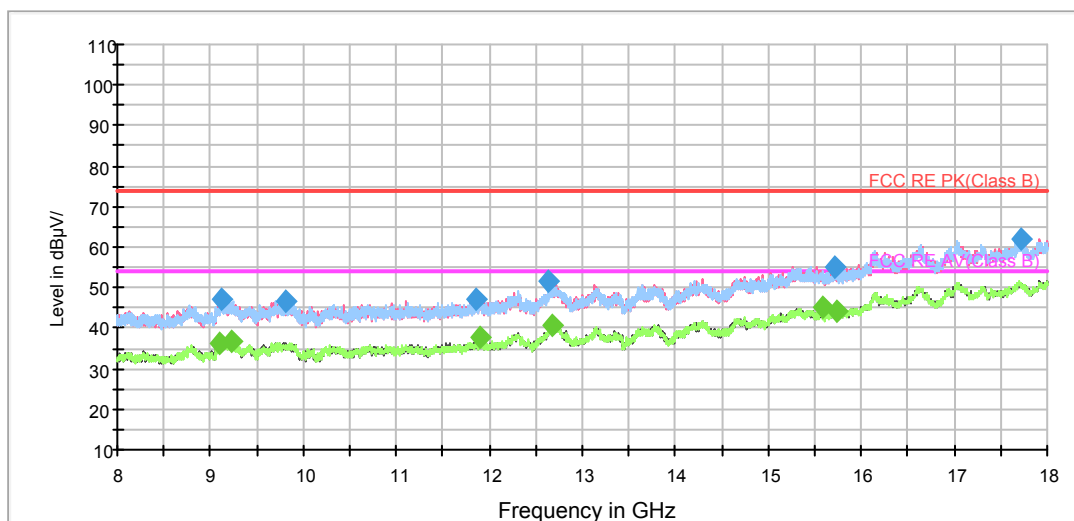

Radiates Emission from 8GHz to 18GHz

Frequency (MHz)	Peak (dBuV/m)	Height (cm)	Polarization	Azimuth (deg)	Reading value (dBuV/m)	Correct Factor (dB)	Margin (dB)	Limit (dBuV/m)
3419.375000	38.0	200.0	V	156.0	40.6	-2.6	36.0	74.0
3675.000000	55.0	200.0	V	127.0	56.8	-1.8	19.0	74.0
4888.125000	42.7	200.0	V	265.0	40.8	1.9	31.3	74.0
5863.750000	43.0	200.0	V	0.0	38.2	4.8	31.0	74.0
6570.000000	45.0	200.0	V	344.0	39.3	5.7	29.0	74.0
7013.750000	46.5	200.0	V	275.0	40.0	6.5	27.5	74.0

Remark: 1. Correction Factor = Antenna factor+ Insertion loss (cable loss + amplifier gain)

Frequency (MHz)	Average (dBuV/m)	Height (cm)	Polarization	Azimuth (deg)	Reading value (dBuV/m)	Correct Factor (dB)	Margin (dB)	Limit (dBuV/m)
3368.125000	27.4	200.0	V	324.0	29.8	-2.4	26.6	54.0
3678.750000	44.7	200.0	V	304.0	46.5	-1.8	9.3	54.0
4802.500000	32.0	200.0	V	176.0	30.7	1.3	22.0	54.0
5875.000000	35.0	200.0	V	0.0	30.1	4.9	19.0	54.0
6566.250000	33.6	200.0	V	285.0	27.9	5.7	20.4	54.0
7013.750000	42.1	200.0	V	275.0	35.6	6.5	11.9	54.0

Remark: 1. Correction Factor = Antenna factor+ Insertion loss (cable loss + amplifier gain)

802.11a CH60

RE 1G-3GHz PK+AV

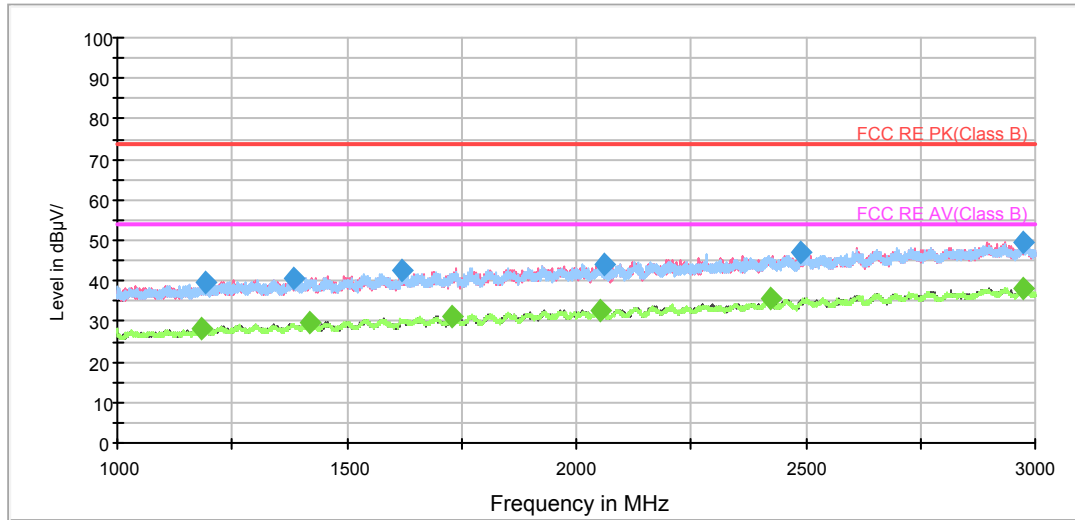

Radiates Emission from 1GHz to 3GHz

RE 3-18GHz PK+AV

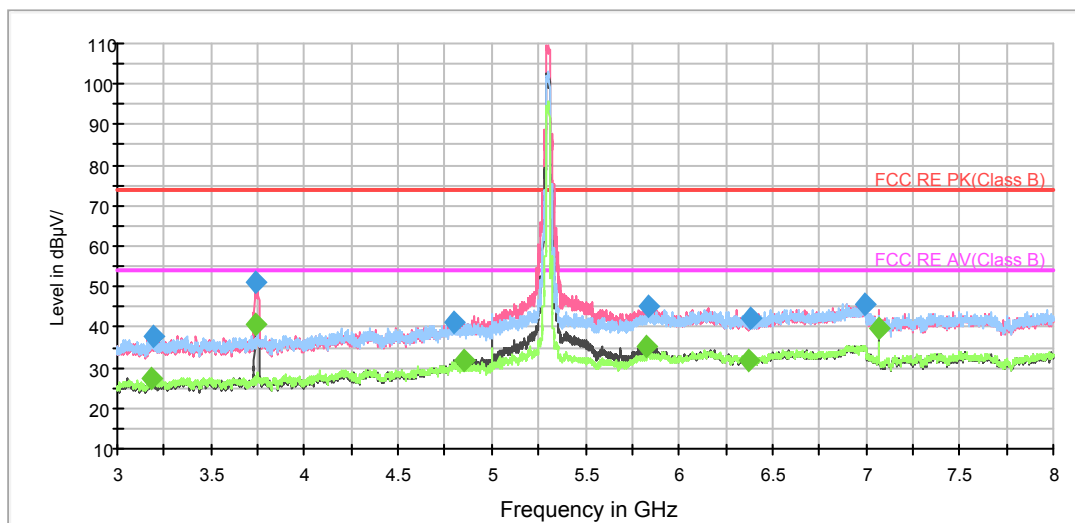

Note: The signal beyond the limit is carrier.

Radiates Emission from 3GHz to 8GHz

RE 3-18GHz PK+AV

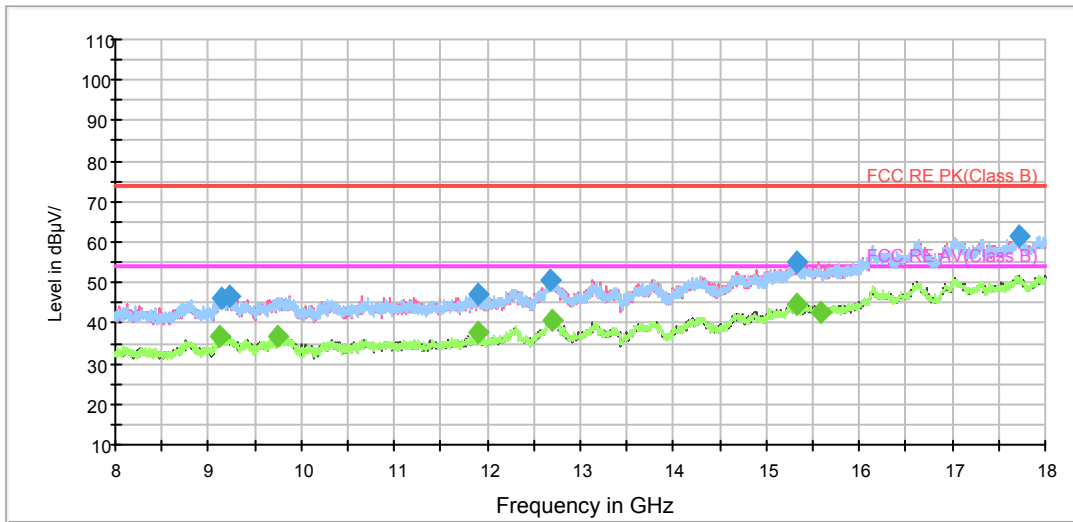

Radiates Emission from 8GHz to 18GHz

Frequency (MHz)	Peak (dBuV/m)	Height (cm)	Polarization	Azimuth (deg)	Reading value (dBuV/m)	Correct Factor (dB)	Margin (dB)	Limit (dBuV/m)
3187.500000	37.8	200.0	H	62.0	40.7	-2.9	36.2	74.0
3735.000000	50.9	200.0	V	128.0	52.6	-1.7	23.1	74.0
4794.375000	41.2	200.0	V	78.0	40.0	1.2	32.8	74.0
5834.375000	45.1	200.0	V	338.0	40.6	4.5	28.9	74.0
6385.625000	41.9	200.0	V	169.0	36.9	5.0	32.1	74.0
6991.250000	45.8	200.0	V	0.0	39.3	6.5	28.2	74.0

Remark: 1. Correction Factor = Antenna factor+ Insertion loss (cable loss + amplifier gain)

Frequency (MHz)	Average (dBuV/m)	Height (cm)	Polarization	Azimuth (deg)	Reading value (dBuV/m)	Correct Factor (dB)	Margin (dB)	Limit (dBuV/m)
3185.625000	27.6	200.0	H	32.0	30.5	-2.9	26.4	54.0
3741.250000	40.6	200.0	V	298.0	42.3	-1.7	13.4	54.0
4848.125000	32.0	200.0	V	57.0	30.4	1.6	22.0	54.0
5829.375000	35.3	200.0	V	358.0	30.8	4.5	18.7	54.0
6376.875000	31.9	200.0	H	32.0	26.9	5.0	22.1	54.0
7066.875000	39.7	200.0	V	270.0	33.5	6.2	14.3	54.0

Remark: 1. Correction Factor = Antenna factor+ Insertion loss (cable loss + amplifier gain)

802.11a CH64

RE 1G-3GHz PK+AV

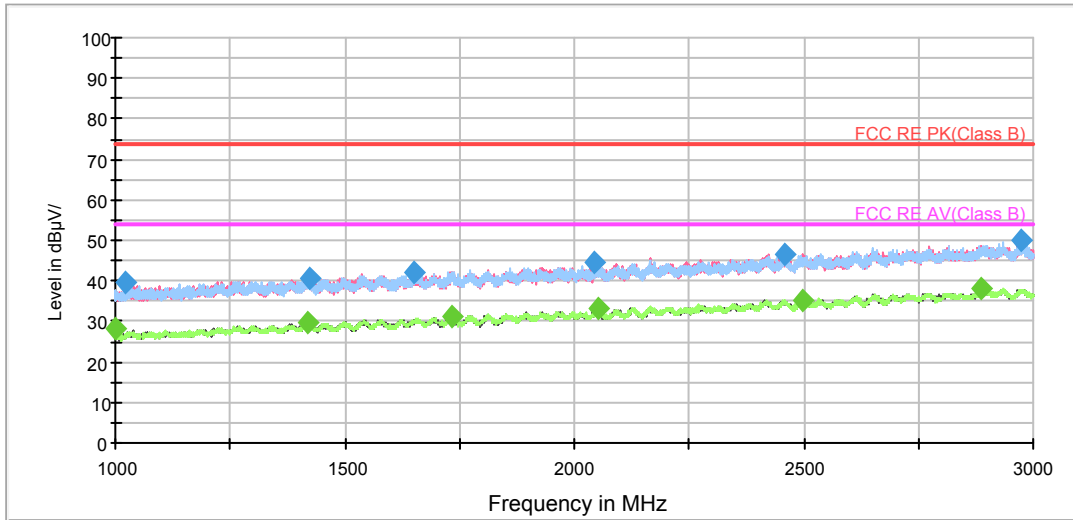

Radiates Emission from 1GHz to 3GHz

RE 3-18GHz PK+AV

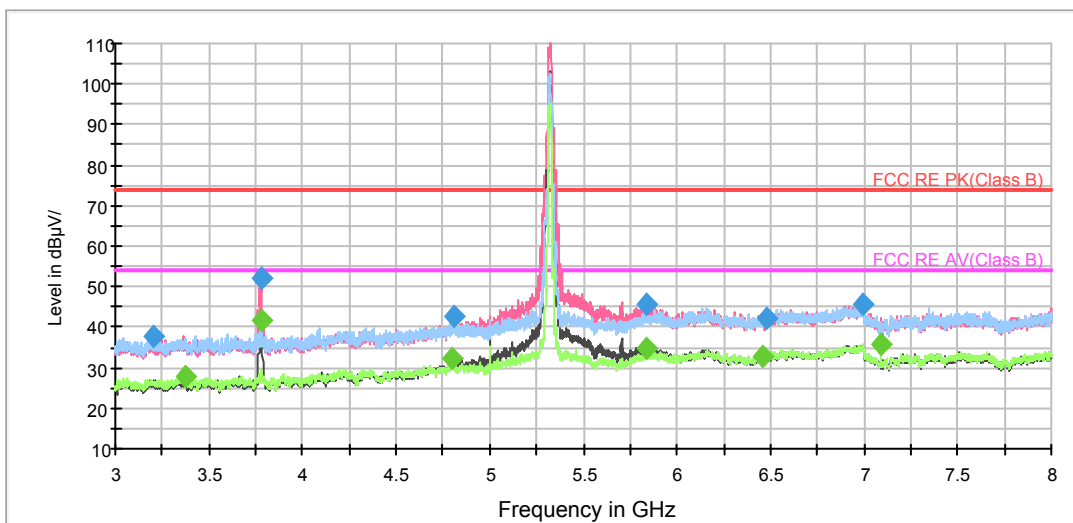

Note: The signal beyond the limit is carrier.

Radiates Emission from 3GHz to 8GHz

RE 3-18GHz PK+AV

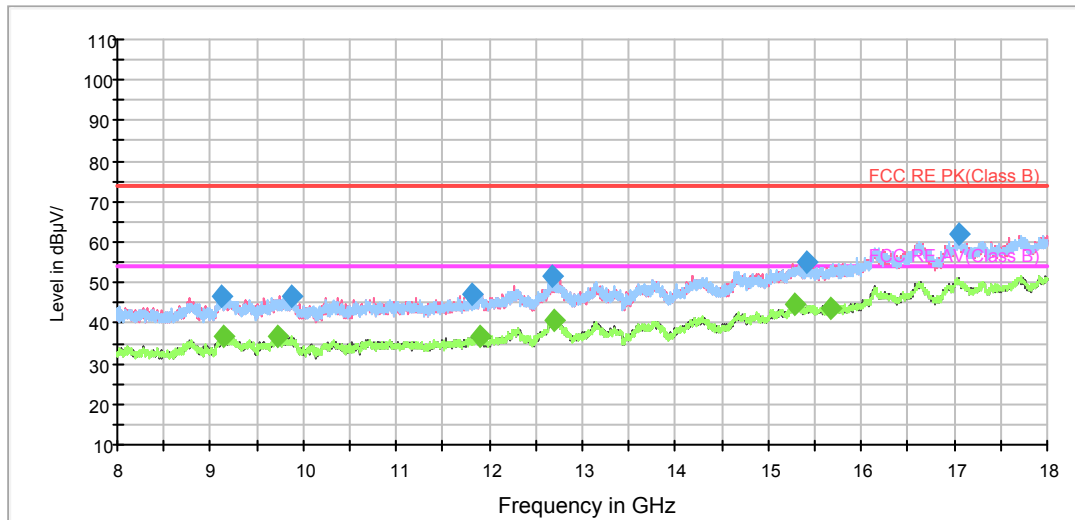

Radiates Emission from 8GHz to 18GHz

Frequency (MHz)	Peak (dBuV/m)	Height (cm)	Polarization	Azimuth (deg)	Reading value (dBuV/m)	Correct Factor (dB)	Margin (dB)	Limit (dBuV/m)
3201.875000	37.9	200.0	H	66.0	40.7	-2.8	36.1	74.0
3783.125000	52.1	200.0	V	122.0	53.9	-1.8	21.9	74.0
4807.500000	42.5	200.0	V	78.0	41.2	1.3	31.5	74.0
5836.875000	45.7	200.0	V	279.0	41.2	4.5	28.3	74.0
6476.875000	41.9	200.0	H	315.0	36.8	5.1	32.1	74.0
6992.500000	45.6	200.0	H	0.0	39.1	6.5	28.4	74.0

Remark: 1. Correction Factor = Antenna factor+ Insertion loss (cable loss + amplifier gain)

Frequency (MHz)	Average (dBuV/m)	Height (cm)	Polarization	Azimuth (deg)	Reading value (dBuV/m)	Correct Factor (dB)	Margin (dB)	Limit (dBuV/m)
3370.000000	27.7	200.0	H	134.0	30.2	-2.5	26.3	54.0
3779.375000	41.5	200.0	V	68.0	43.3	-1.8	12.5	54.0
4800.000000	32.2	200.0	V	0.0	30.9	1.3	21.8	54.0
5839.375000	35.0	200.0	V	268.0	30.5	4.5	19.0	54.0
6461.250000	32.6	200.0	V	78.0	27.5	5.1	21.4	54.0
7093.750000	35.8	200.0	V	268.0	29.7	6.1	18.2	54.0

Remark: 1. Correction Factor = Antenna factor+ Insertion loss (cable loss + amplifier gain)

802.11a CH100

RE 1G-3GHz PK+AV

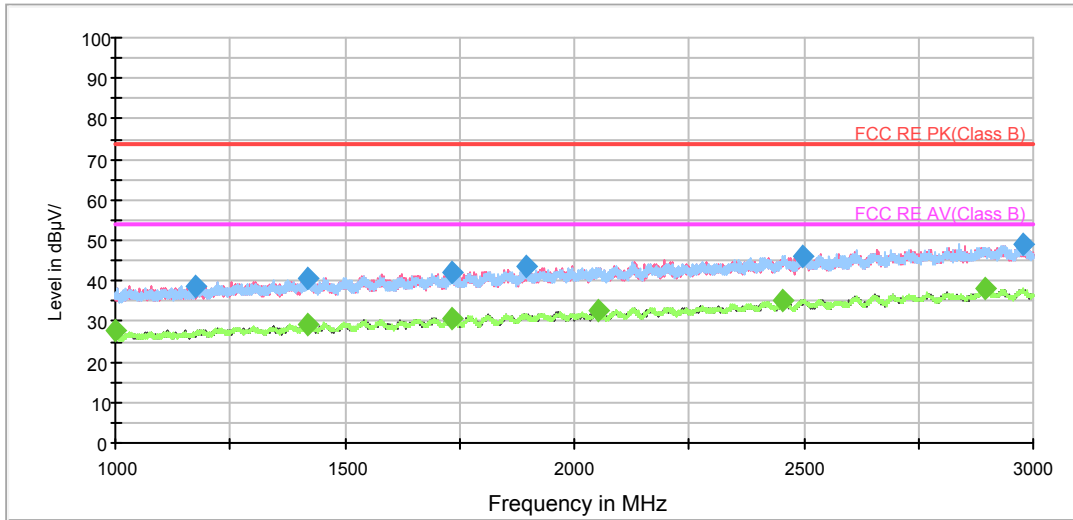

Radiates Emission from 1GHz to 3GHz

RE 3-18GHz PK+AV

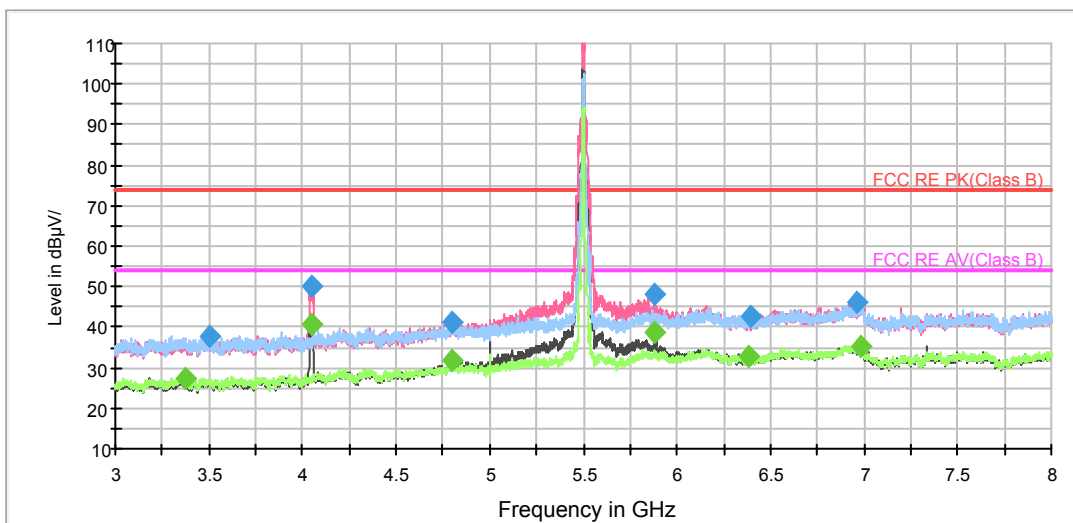

Note: The signal beyond the limit is carrier.

Radiates Emission from 3GHz to 8GHz

RE 3-18GHz PK+AV

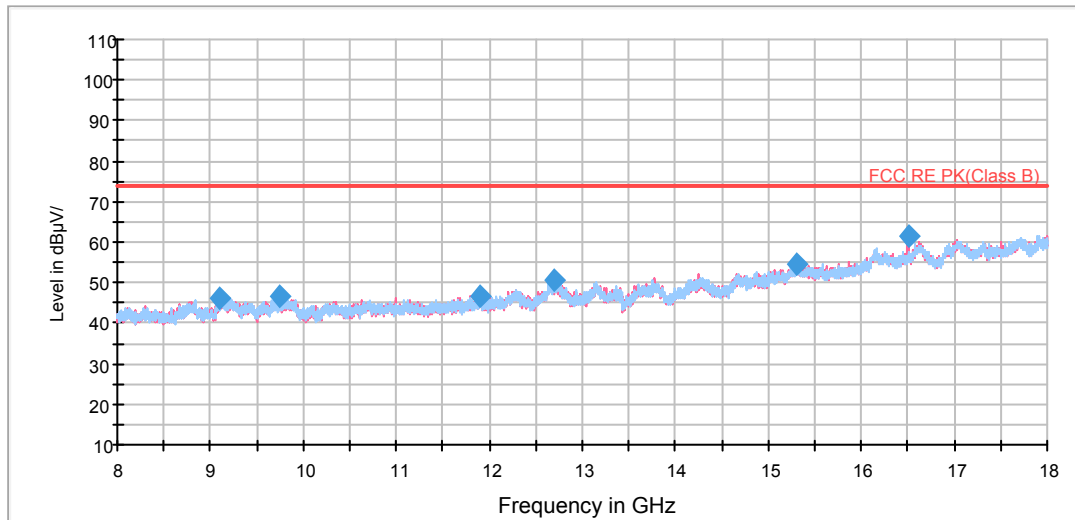

RE 3-18GHz AV

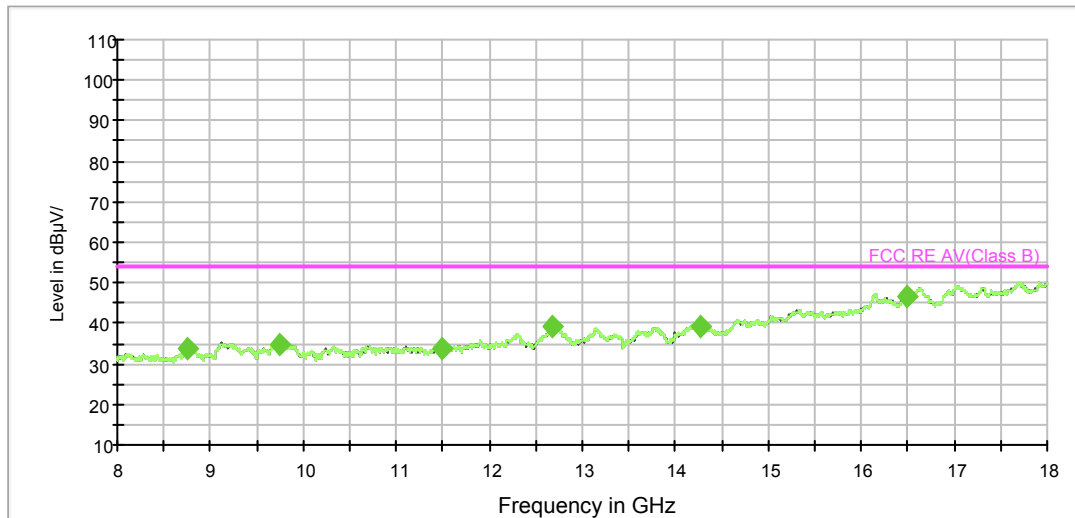

Radiates Emission from 8GHz to 18GHz

Frequency (MHz)	Peak (dBuV/m)	Height (cm)	Polarization	Azimuth (deg)	Reading value (dBuV/m)	Correct Factor (dB)	Margin (dB)	Limit (dBuV/m)
3499.375000	37.8	200.0	V	117.0	39.9	-2.1	36.2	74.0
4045.000000	50.0	200.0	V	107.0	51.0	-1.0	24.0	74.0
4799.375000	41.4	200.0	H	18.0	40.1	1.3	32.6	74.0
5883.750000	47.9	200.0	V	278.0	43.0	4.9	26.1	74.0
6396.875000	42.7	200.0	H	174.0	37.8	4.9	31.3	74.0
6956.250000	46.0	200.0	V	219.0	39.8	6.2	28.0	74.0

Remark: 1. Correction Factor = Antenna factor+ Insertion loss (cable loss + amplifier gain)



Frequency (MHz)	Average (dBuV/m)	Height (cm)	Polarization	Azimuth (deg)	Reading value (dBuV/m)	Correct Factor (dB)	Margin (dB)	Limit (dBuV/m)
3374.375000	27.6	200.0	V	0.0	30.2	-2.6	26.4	54.0
4046.250000	40.7	200.0	V	336.0	41.7	-1.0	13.3	54.0
4800.000000	31.6	200.0	V	259.0	30.3	1.3	22.4	54.0
5884.375000	38.7	200.0	V	278.0	33.8	4.9	15.3	54.0
6382.500000	32.9	200.0	H	0.0	27.9	5.0	21.1	54.0
6982.500000	35.4	200.0	V	356.0	29.0	6.4	18.6	54.0

Remark: 1. Correction Factor = Antenna factor+ Insertion loss (cable loss + amplifier gain)

802.11a CH116

RE 1G-3GHz PK+AV

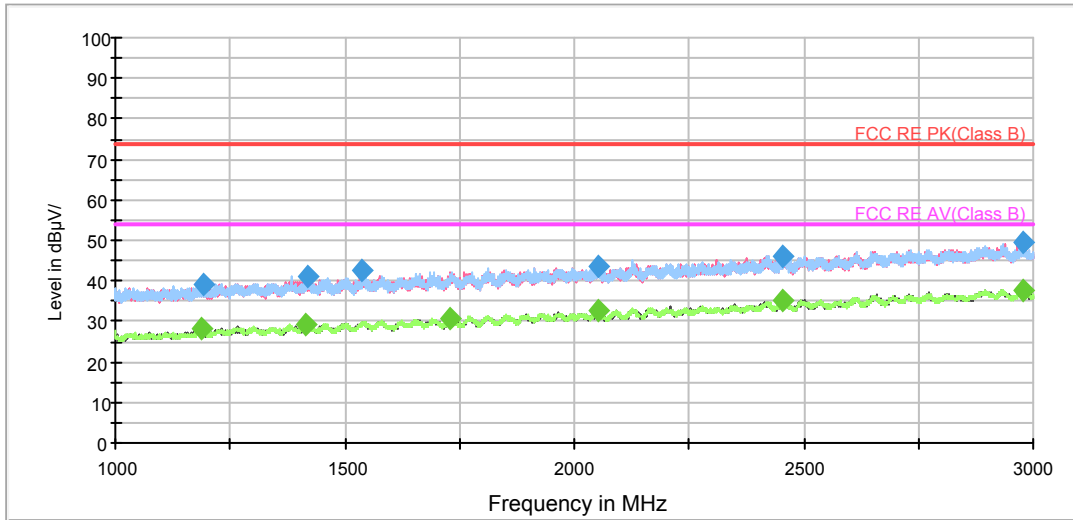

Radiates Emission from 1GHz to 3GHz

RE 3-18GHz PK+AV

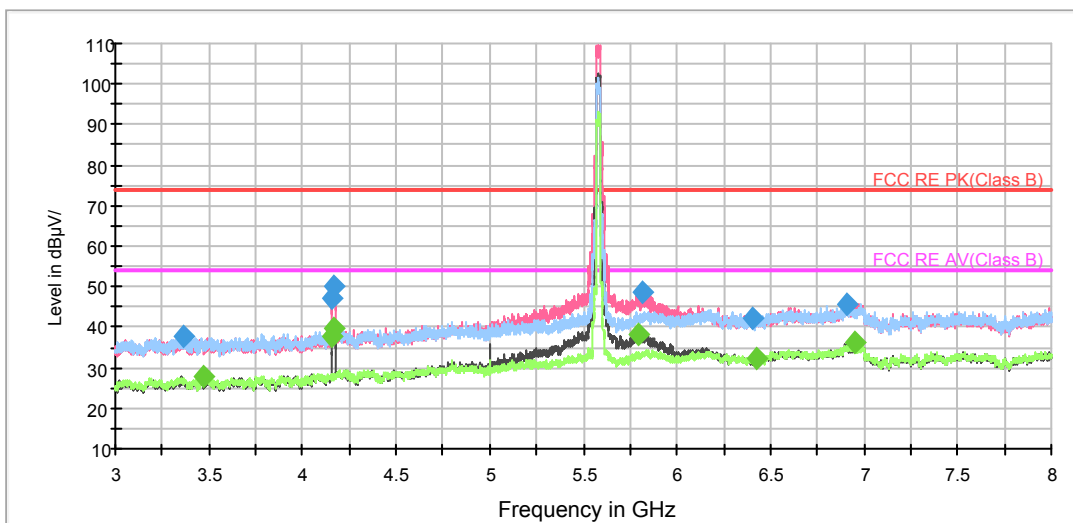

Note: The signal beyond the limit is carrier.

Radiates Emission from 3GHz to 8GHz

RE 3-18GHz PK+AV

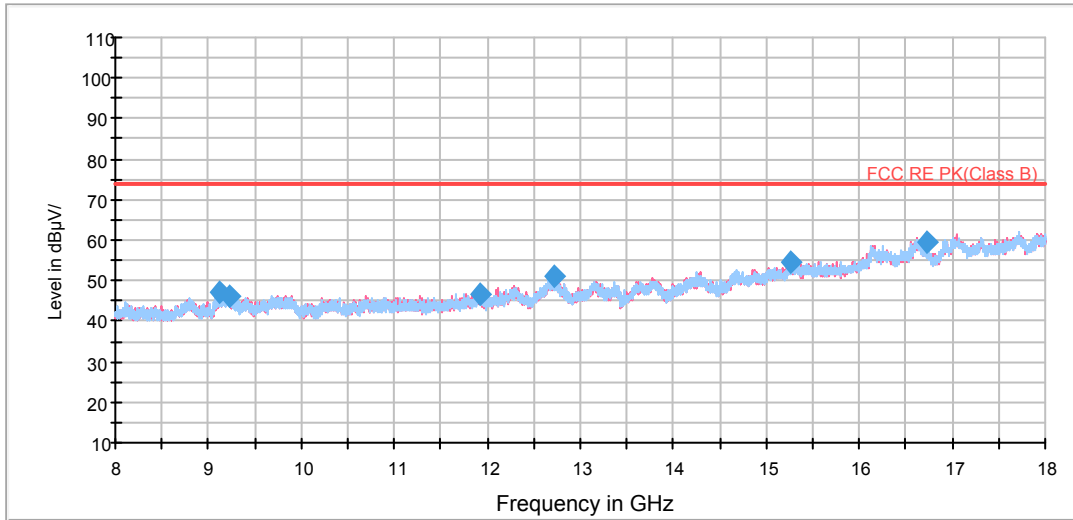

RE 3-18GHz AV

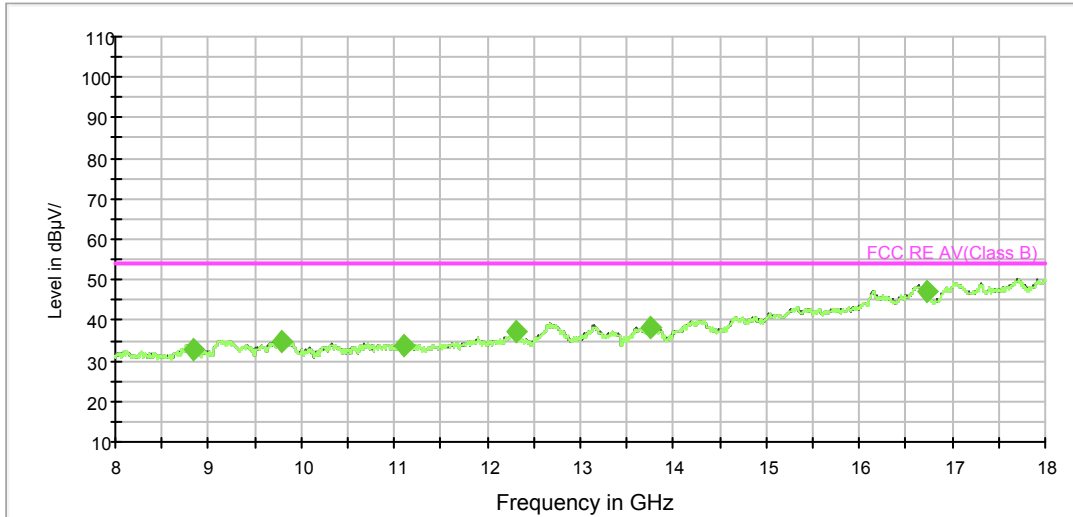

Radiates Emission from 8GHz to 18GHz

Frequency (MHz)	Peak (dBuV/m)	Height (cm)	Polarization	Azimuth (deg)	Reading value (dBuV/m)	Correct Factor (dB)	Margin (dB)	Limit (dBuV/m)
3366.250000	37.6	200.0	H	149.0	40.0	-2.4	36.4	74.0
4158.750000	47.0	200.0	V	157.0	47.0	0.0	27.0	74.0
4168.125000	50.0	200.0	V	333.0	50.0	0.0	24.0	74.0
5818.125000	48.8	200.0	V	206.0	44.3	4.5	25.2	74.0
6408.125000	42.4	200.0	V	0.0	37.5	4.9	31.6	74.0
6908.750000	45.8	200.0	H	80.0	39.6	6.2	28.2	74.0

Remark: 1. Correction Factor = Antenna factor+ Insertion loss (cable loss + amplifier gain)



Frequency (MHz)	Average (dBuV/m)	Height (cm)	Polarization	Azimuth (deg)	Reading value (dBuV/m)	Correct Factor (dB)	Margin (dB)	Limit (dBuV/m)
3466.250000	27.7	200.0	H	0.0	29.8	-2.1	26.3	54.0
4157.500000	37.8	200.0	V	157.0	37.9	-0.1	16.2	54.0
4165.000000	39.7	200.0	V	45.0	39.7	0.0	14.3	54.0
5795.000000	38.2	200.0	V	343.0	34.1	4.1	15.8	54.0
6426.250000	32.4	200.0	V	34.0	27.5	4.9	21.6	54.0
6955.625000	36.3	200.0	V	206.0	38.4	-2.1	17.7	54.0

Remark: 1. Correction Factor = Antenna factor+ Insertion loss (cable loss + amplifier gain)

802.11a CH140

RE 1G-3GHz PK+AV

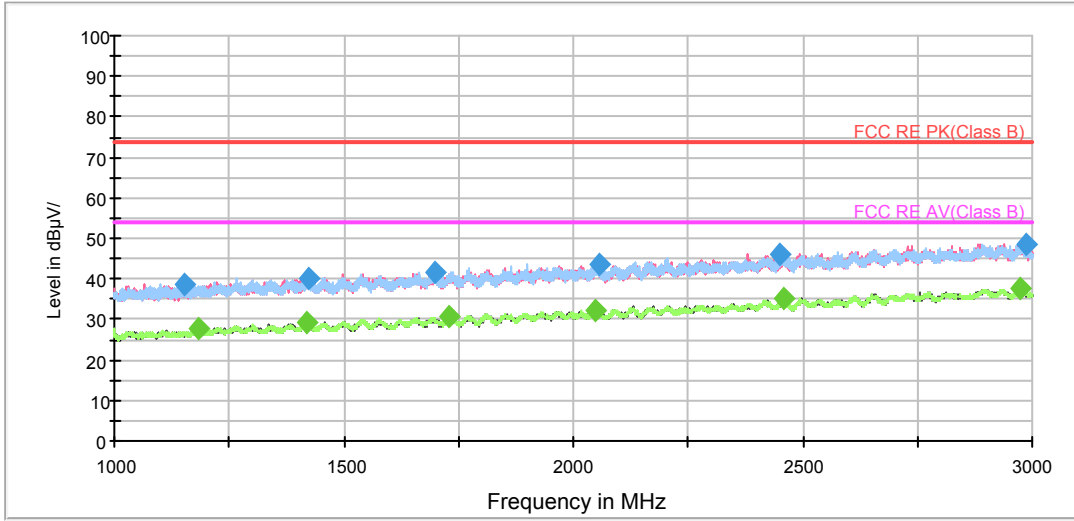

Radiates Emission from 1GHz to 3GHz

RE 3-18GHz PK+AV

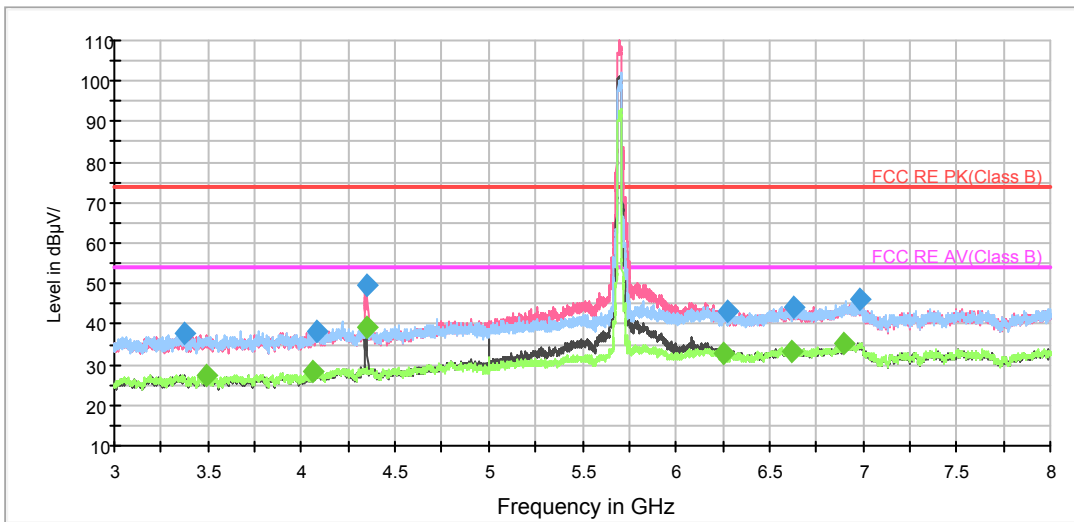

Note: The signal beyond the limit is carrier.

Radiates Emission from 3GHz to 8GHz

RE 3-18GHz PK+AV

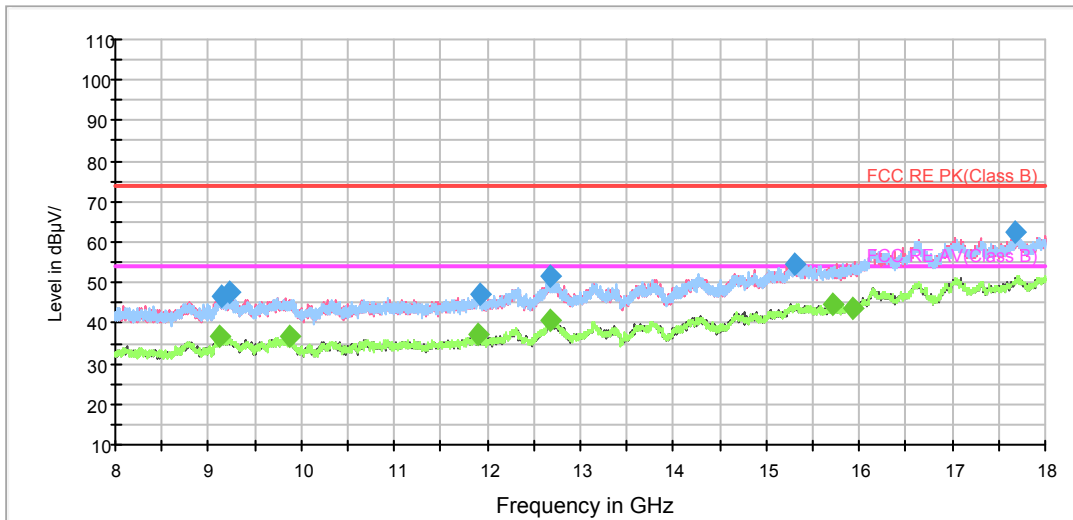

Radiates Emission from 8GHz to 18GHz

Frequency (MHz)	Peak (dBuV/m)	Height (cm)	Polarization	Azimuth (deg)	Reading value (dBuV/m)	Correct Factor (dB)	Margin (dB)	Limit (dBuV/m)
3375.000000	37.6	200.0	H	165.0	40.2	-2.6	36.4	74.0
4081.250000	38.4	200.0	V	140.0	39.3	-0.9	35.6	74.0
4346.250000	49.4	200.0	V	199.0	48.9	0.5	24.6	74.0
6271.875000	43.1	200.0	H	165.0	37.7	5.4	30.9	74.0
6633.125000	44.2	200.0	H	97.0	38.7	5.5	29.8	74.0
6981.875000	46.0	200.0	H	146.0	39.6	6.4	28.0	74.0

Remark: 1. Correction Factor = Antenna factor+ Insertion loss (cable loss + amplifier gain)

Frequency (MHz)	Average (dBuV/m)	Height (cm)	Polarization	Azimuth (deg)	Reading value (dBuV/m)	Correct Factor (dB)	Margin (dB)	Limit (dBuV/m)
3493.750000	27.4	200.0	H	146.0	29.5	-2.1	26.6	54.0
4060.000000	28.2	200.0	H	10.0	29.3	-1.1	25.8	54.0
4345.625000	39.4	200.0	V	337.0	38.9	0.5	14.6	54.0
6255.000000	33.0	200.0	V	278.0	27.6	5.4	21.0	54.0
6622.500000	33.5	200.0	V	199.0	28.0	5.5	20.5	54.0
6897.500000	35.2	200.0	H	1.0	29.0	6.2	18.8	54.0

Remark: 1. Correction Factor = Antenna factor+ Insertion loss (cable loss + amplifier gain)

802.11a CH149

RE 1G-3GHz PK+AV

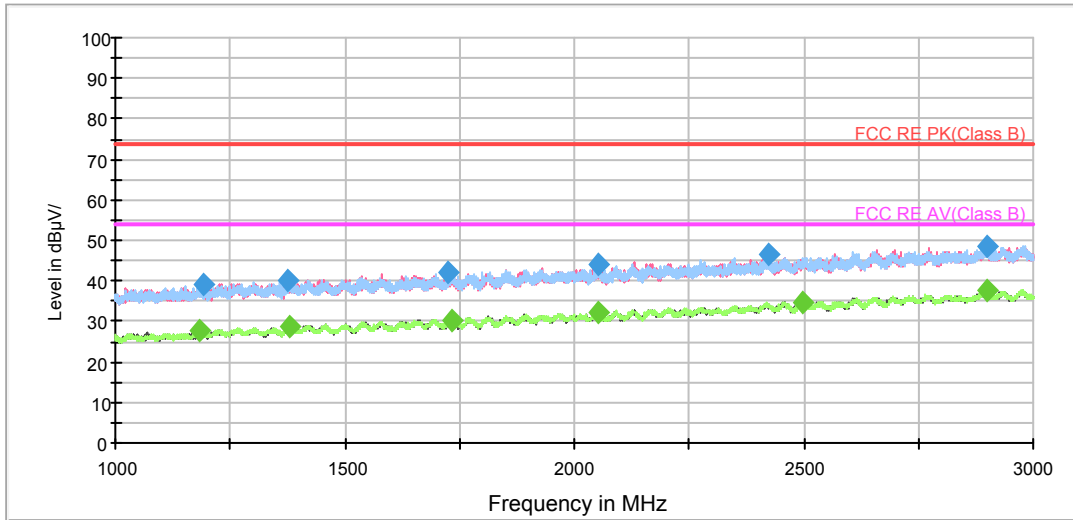

Radiates Emission from 1GHz to 3GHz

RE 3-18GHz PK+AV

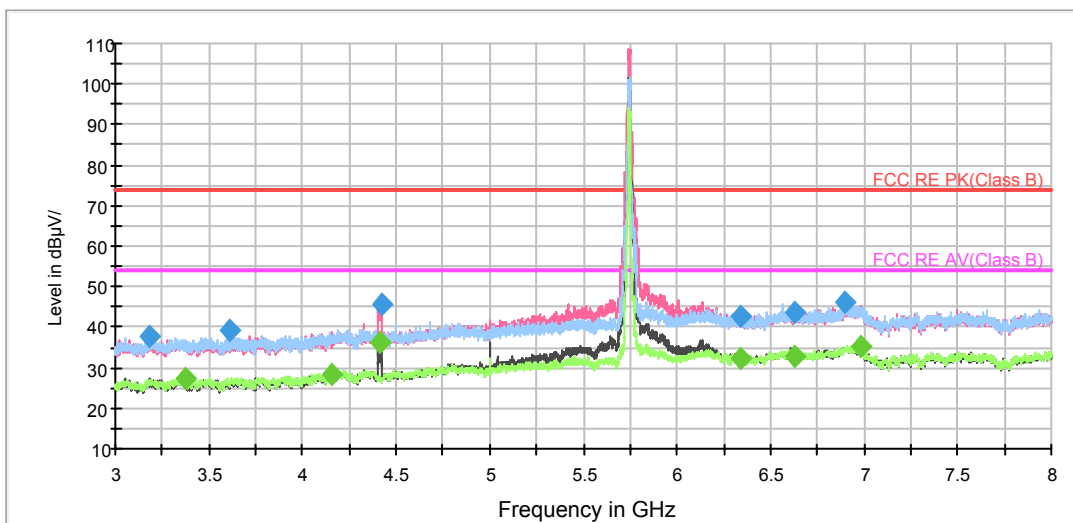

Note: The signal beyond the limit is carrier.

Radiates Emission from 3GHz to 8GHz



RE 3-18GHz PK+AV

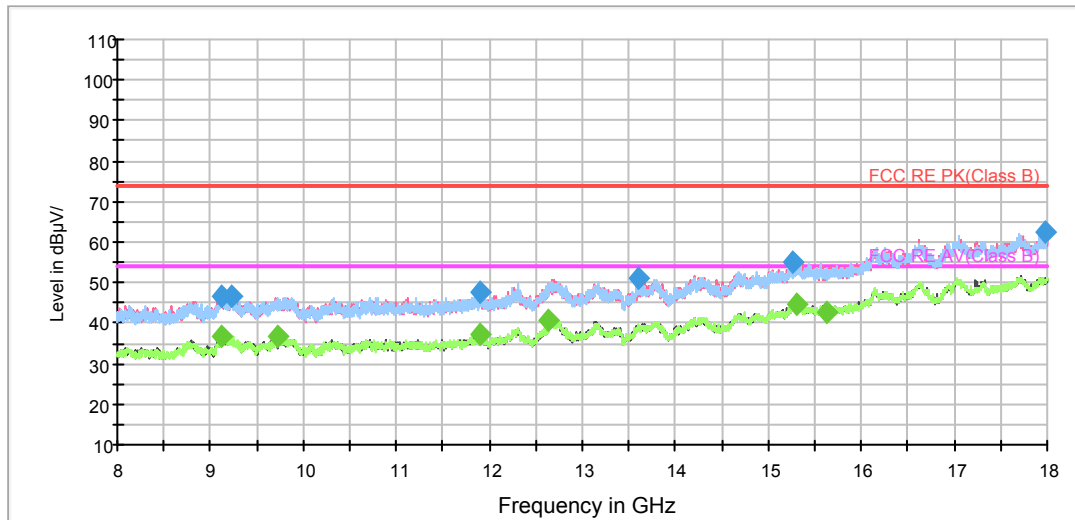

Radiates Emission from 8GHz to 18GHz

Frequency (MHz)	Peak (dBuV/m)	Height (cm)	Polarization	Azimuth (deg)	Reading value (dBuV/m)	Correct Factor (dB)	Margin (dB)	Limit (dBuV/m)
3181.875000	37.7	200.0	V	130.0	40.6	-2.9	36.3	74.0
3613.125000	39.0	200.0	H	305.0	41.1	-2.1	35.0	74.0
4421.250000	45.8	200.0	V	359.0	45.6	0.2	28.2	74.0
6342.500000	42.5	200.0	V	310.0	37.1	5.4	31.5	74.0
6625.625000	43.5	200.0	H	86.0	38.0	5.5	30.5	74.0
6901.250000	46.1	200.0	V	130.0	39.8	6.3	27.9	74.0

Remark: 1. Correction Factor = Antenna factor+ Insertion loss (cable loss + amplifier gain)

Frequency (MHz)	Average (dBuV/m)	Height (cm)	Polarization	Azimuth (deg)	Reading value (dBuV/m)	Correct Factor (dB)	Margin (dB)	Limit (dBuV/m)
3370.625000	27.4	200.0	H	8.0	29.9	-2.5	26.6	54.0
4153.125000	28.5	200.0	H	195.0	28.6	-0.1	25.5	54.0
4411.875000	36.2	200.0	V	340.0	36.0	0.2	17.8	54.0
6342.500000	32.3	200.0	V	310.0	26.9	5.4	21.7	54.0
6628.750000	32.9	200.0	V	261.0	27.4	5.5	21.1	54.0
6979.375000	35.3	200.0	H	67.0	29.0	6.3	18.7	54.0

Remark: 1. Correction Factor = Antenna factor+ Insertion loss (cable loss + amplifier gain)

802.11a CH157

RE 1G-3GHz PK+AV

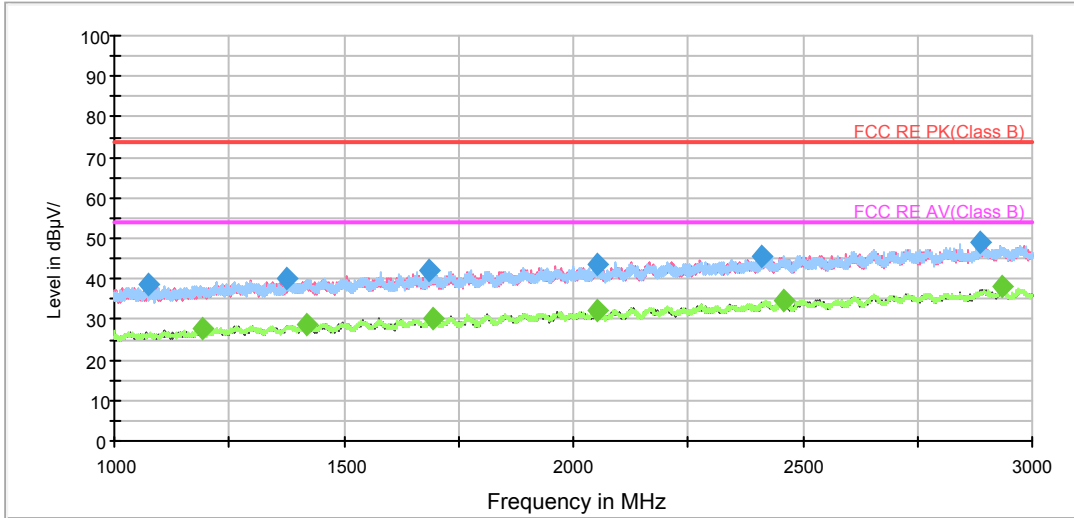

Radiates Emission from 1GHz to 3GHz

RE 3-18GHz PK+AV

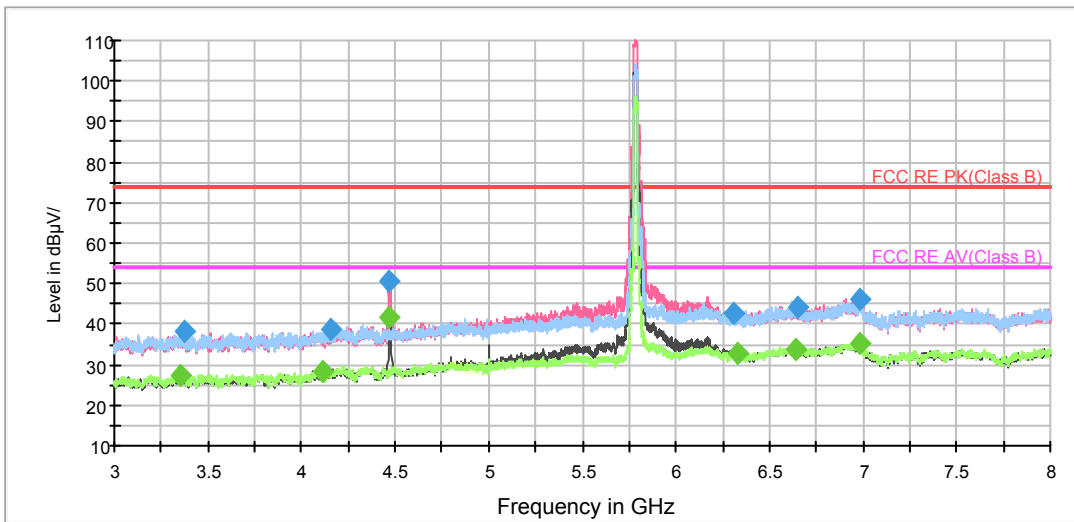

Note: The signal beyond the limit is carrier.

Radiates Emission from 3GHz to 8GHz



RE 3-18GHz PK+AV

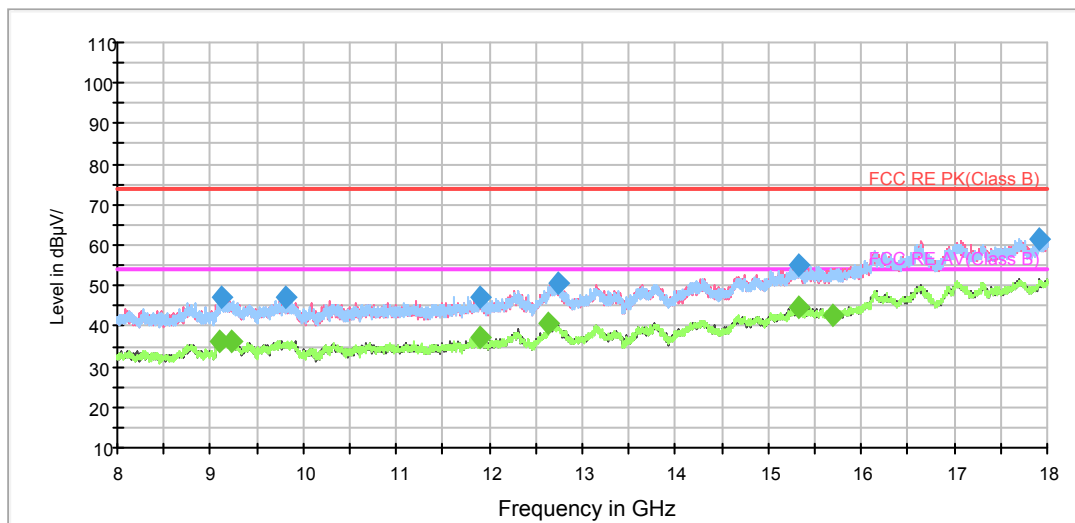

Radiates Emission from 8GHz to 18GHz

Frequency (MHz)	Peak (dBuV/m)	Height (cm)	Polarization	Azimuth (deg)	Reading value (dBuV/m)	Correct Factor (dB)	Margin (dB)	Limit (dBuV/m)
3373.750000	38.3	200.0	H	43.0	40.8	-2.5	35.7	74.0
4153.125000	38.6	200.0	H	0.0	38.7	-0.1	35.4	74.0
4471.875000	50.4	200.0	V	339.0	50.0	0.4	23.6	74.0
6309.375000	42.9	200.0	V	259.0	37.5	5.4	31.1	74.0
6651.250000	44.0	200.0	V	329.0	38.5	5.5	30.0	74.0
6983.125000	46.2	200.0	H	62.0	39.8	6.4	27.8	74.0

Remark: 1. Correction Factor = Antenna factor+ Insertion loss (cable loss + amplifier gain)

Frequency (MHz)	Average (dBuV/m)	Height (cm)	Polarization	Azimuth (deg)	Reading value (dBuV/m)	Correct Factor (dB)	Margin (dB)	Limit (dBuV/m)
3350.625000	27.5	200.0	H	0.0	29.8	-2.3	26.5	54.0
4111.250000	28.3	200.0	H	350.0	29.0	-0.7	25.7	54.0
4471.875000	41.6	200.0	V	339.0	41.2	0.4	12.4	54.0
6325.625000	33.0	200.0	V	209.0	27.7	5.3	21.0	54.0
6637.500000	33.6	200.0	V	319.0	28.1	5.5	20.4	54.0
6985.625000	35.3	200.0	V	279.0	28.9	6.4	18.7	54.0

Remark: 1. Correction Factor = Antenna factor+ Insertion loss (cable loss + amplifier gain)

802.11a CH165

RE 1G-3GHz PK+AV

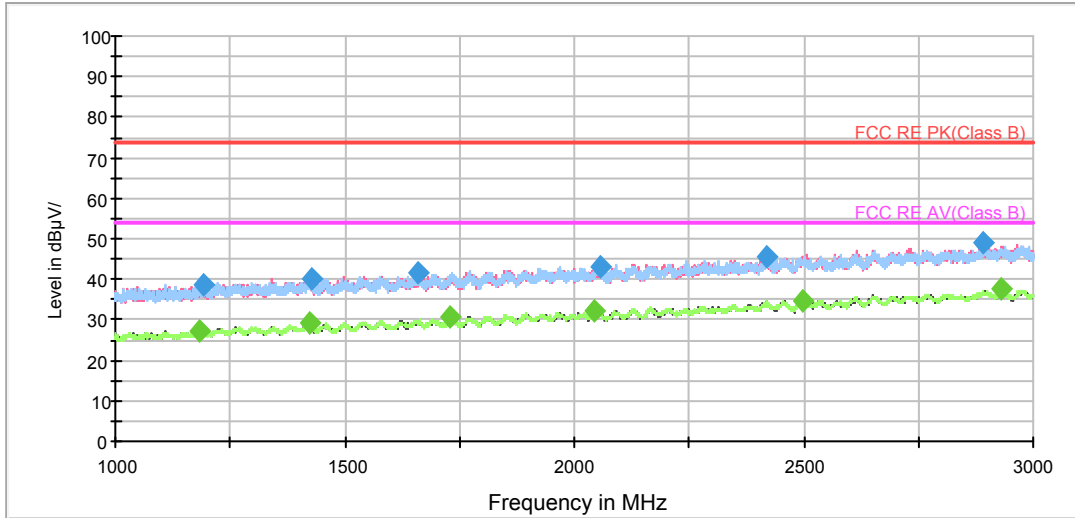

Radiates Emission from 1GHz to 3GHz

RE 3-18GHz PK+AV

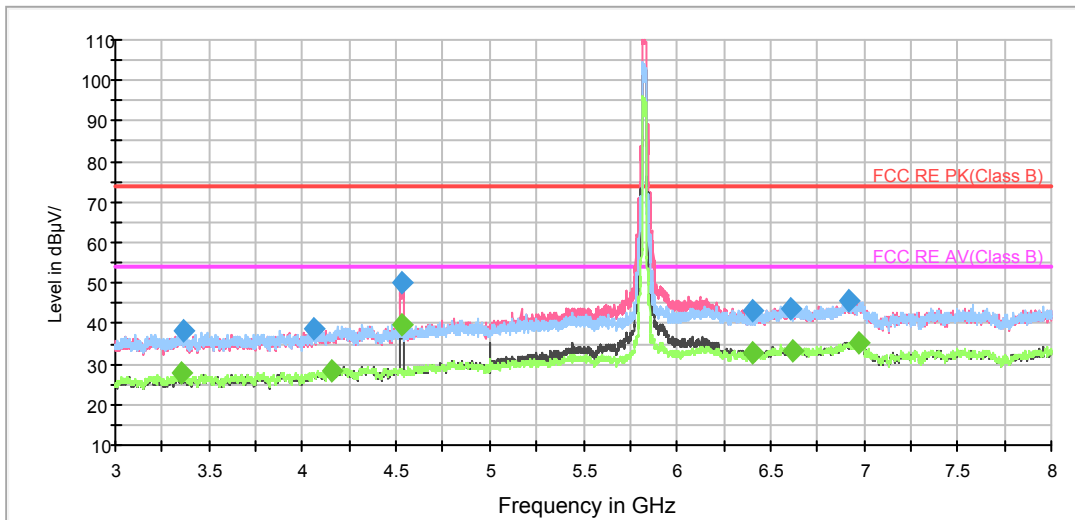

Note: The signal beyond the limit is carrier.

Radiates Emission from 3GHz to 8GHz

RE 3-18GHz PK+AV

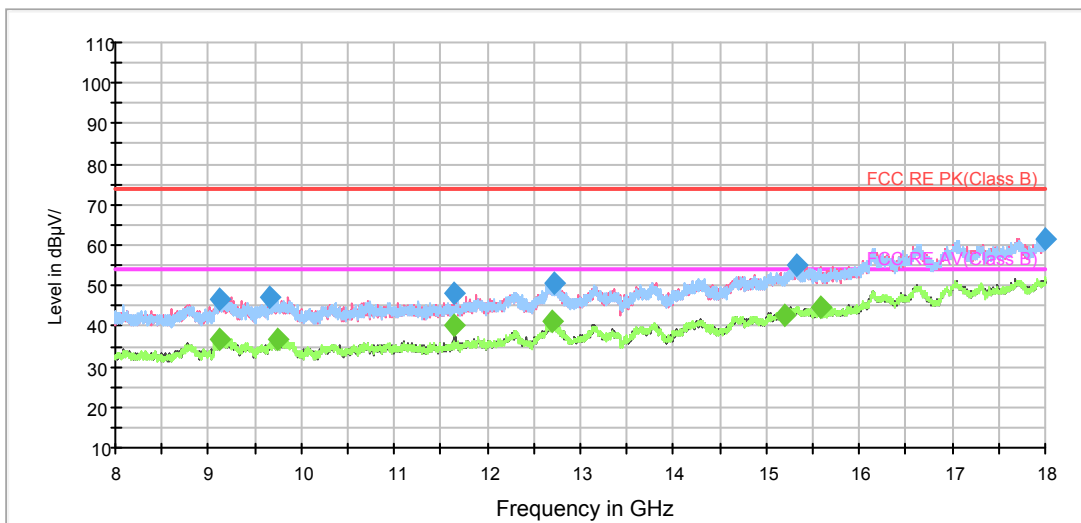

Radiates Emission from 8GHz to 18GHz

Frequency (MHz)	Peak (dBuV/m)	Height (cm)	Polarization	Azimuth (deg)	Reading value (dBuV/m)	Correct Factor (dB)	Margin (dB)	Limit (dBuV/m)
3364.375000	38.1	200.0	H	59.0	40.5	-2.4	35.9	74.0
4060.000000	38.6	200.0	V	355.0	39.7	-1.1	35.4	74.0
4533.750000	50.1	200.0	V	355.0	49.5	0.6	23.9	74.0
6404.375000	43.0	200.0	V	305.0	38.1	4.9	31.0	74.0
6608.750000	43.7	200.0	V	257.0	38.1	5.6	30.3	74.0
6921.875000	45.4	200.0	H	49.0	39.2	6.2	28.6	74.0

Remark: 1. Correction Factor = Antenna factor+ Insertion loss (cable loss + amplifier gain)

Frequency (MHz)	Average (dBuV/m)	Height (cm)	Polarization	Azimuth (deg)	Reading value (dBuV/m)	Correct Factor (dB)	Margin (dB)	Limit (dBuV/m)
3357.500000	27.6	200.0	H	59.0	29.9	-2.3	26.4	54.0
4153.125000	28.4	200.0	H	0.0	28.5	-0.1	25.6	54.0
4531.875000	39.8	200.0	V	355.0	39.2	0.6	14.2	54.0
6403.750000	32.9	200.0	V	287.0	28.0	4.9	21.1	54.0
6623.125000	33.0	200.0	V	130.0	27.5	5.5	21.0	54.0
6977.500000	35.5	200.0	V	100.0	29.2	6.3	18.5	54.0

Remark: 1. Correction Factor = Antenna factor+ Insertion loss (cable loss + amplifier gain)

802.11n (HT20) CH36

RE 1G-3GHz PK+AV

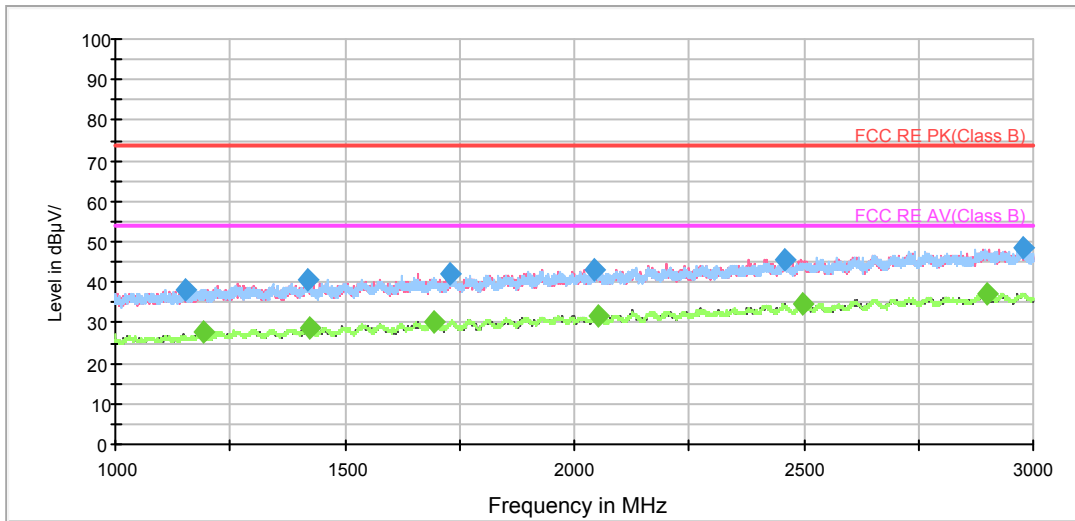

Radiates Emission from 1GHz to 3GHz

RE 3-18GHz PK+AV

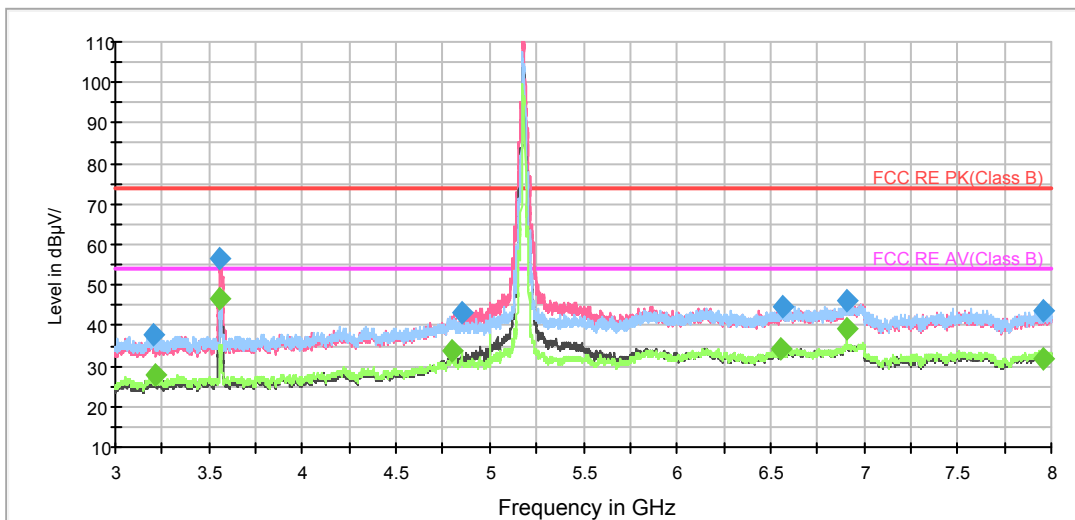

Note: The signal beyond the limit is carrier.

Radiates Emission from 3GHz to 8GHz

RE 3-18GHz PK+AV

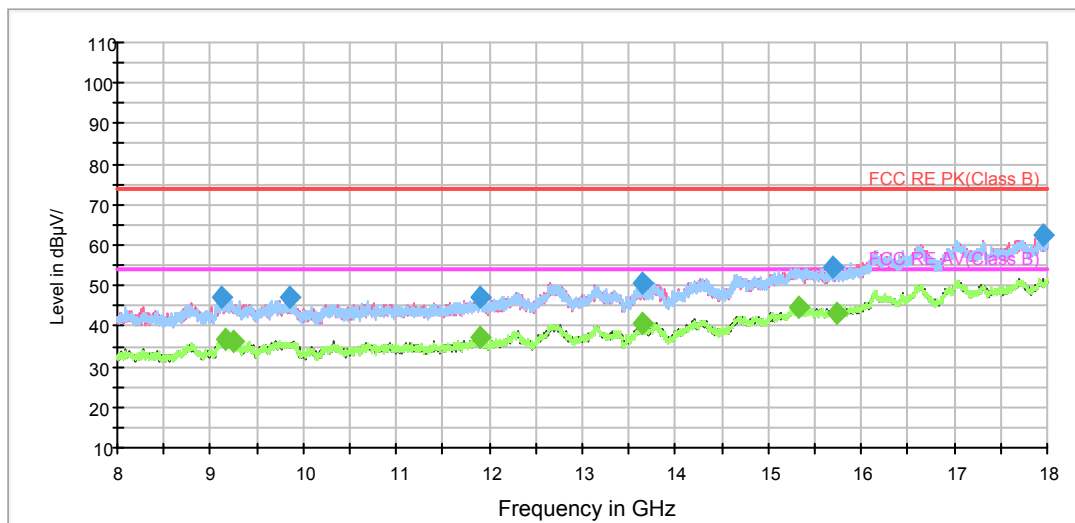

Radiates Emission from 8GHz to 18GHz

Frequency (MHz)	Peak (dBuV/m)	Height (cm)	Polarization	Azimuth (deg)	Reading value (dBuV/m)	Correct Factor (dB)	Margin (dB)	Limit (dBuV/m)
3200.000000	37.7	200.0	H	65.0	40.5	-2.8	36.3	74.0
3558.750000	56.5	200.0	V	0.0	58.6	-2.1	17.5	74.0
4854.375000	43.0	200.0	V	235.0	41.4	1.6	31.0	74.0
6563.125000	44.8	200.0	H	26.0	39.1	5.7	29.2	74.0
6906.875000	46.2	200.0	V	275.0	39.9	6.3	27.8	74.0
7961.250000	43.6	200.0	H	284.0	36.5	7.1	30.4	74.0

Remark: 1. Correction Factor = Antenna factor+ Insertion loss (cable loss + amplifier gain)

Frequency (MHz)	Average (dBuV/m)	Height (cm)	Polarization	Azimuth (deg)	Reading value (dBuV/m)	Correct Factor (dB)	Margin (dB)	Limit (dBuV/m)
3210.000000	27.6	200.0	H	96.0	30.4	-2.8	26.4	54.0
3557.500000	46.6	200.0	V	0.0	48.7	-2.1	7.4	54.0
4800.000000	34.0	200.0	H	0.0	32.7	1.3	20.0	54.0
6556.250000	34.4	200.0	V	316.0	28.7	5.7	19.6	54.0
6906.875000	39.1	200.0	V	275.0	32.8	6.3	14.9	54.0
7956.875000	31.9	200.0	V	182.0	24.8	7.1	22.1	54.0

Remark: 1. Correction Factor = Antenna factor+ Insertion loss (cable loss + amplifier gain)

802.11n (HT20) CH40

RE 1G-3GHz PK+AV

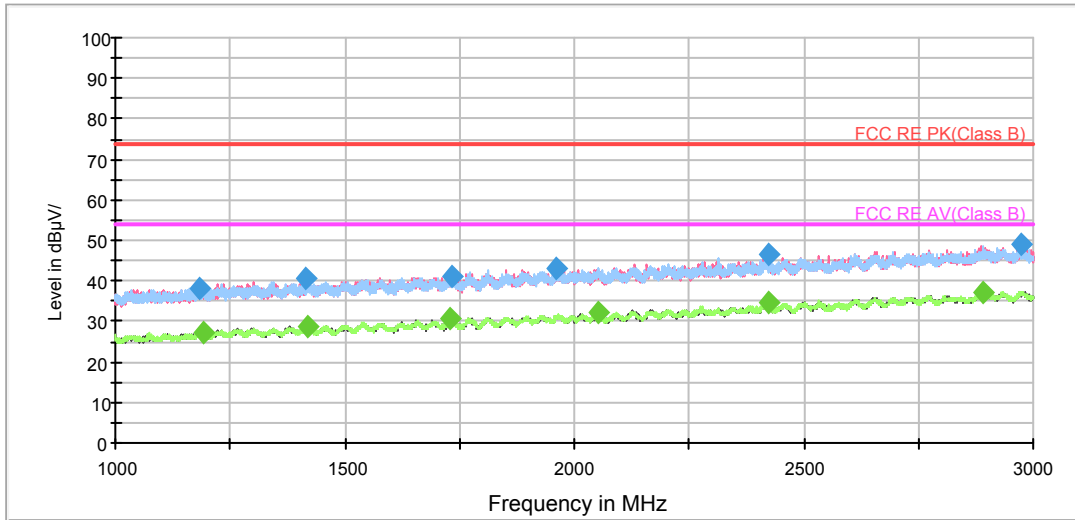

Radiates Emission from 1GHz to 3GHz

RE 3-18GHz PK+AV

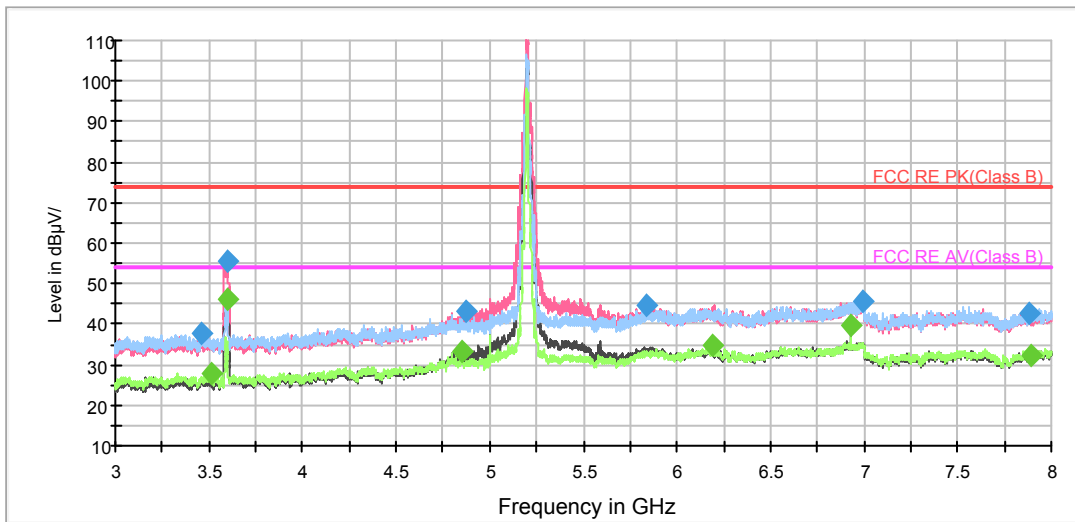

Note: The signal beyond the limit is carrier.

Radiates Emission from 3GHz to 8GHz

RE 3-18GHz PK+AV

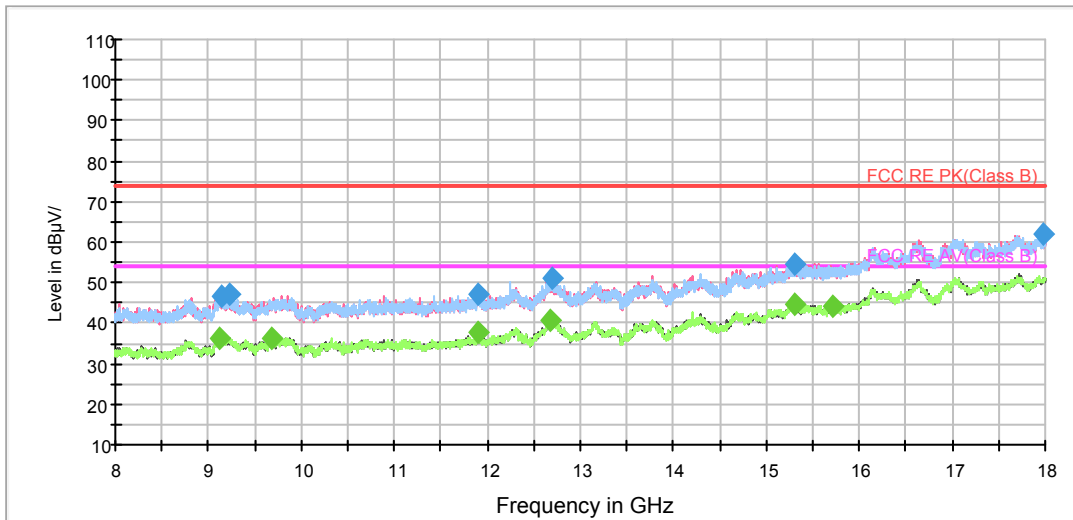

Radiates Emission from 8GHz to 18GHz

Frequency (MHz)	Peak (dBuV/m)	Height (cm)	Polarization	Azimuth (deg)	Reading value (dBuV/m)	Correct Factor (dB)	Margin (dB)	Limit (dBuV/m)
3463.750000	37.6	200.0	H	74.0	39.7	-2.1	36.4	74.0
3594.375000	55.5	200.0	V	248.0	57.8	-2.3	18.5	74.0
4876.250000	43.2	200.0	V	248.0	41.4	1.8	30.8	74.0
5839.375000	44.8	200.0	V	0.0	40.3	4.5	29.2	74.0
6990.000000	45.7	200.0	H	143.0	39.2	6.5	28.3	74.0
7887.500000	42.6	200.0	H	0.0	35.6	7.0	31.4	74.0

Remark: 1. Correction Factor = Antenna factor+ Insertion loss (cable loss + amplifier gain)

Frequency (MHz)	Average (dBuV/m)	Height (cm)	Polarization	Azimuth (deg)	Reading value (dBuV/m)	Correct Factor (dB)	Margin (dB)	Limit (dBuV/m)
3510.000000	27.9	200.0	H	25.0	29.9	-2.0	26.1	54.0
3594.375000	46.3	200.0	V	248.0	48.6	-2.3	7.7	54.0
4848.125000	33.4	200.0	V	288.0	31.8	1.6	20.6	54.0
6186.250000	34.6	200.0	V	0.0	29.2	5.4	19.4	54.0
6933.750000	39.5	200.0	V	278.0	33.3	6.2	14.5	54.0
7892.500000	32.4	200.0	H	15.0	25.4	7.0	21.6	54.0

Remark: 1. Correction Factor = Antenna factor+ Insertion loss (cable loss + amplifier gain)

802.11n (HT20) CH48

RE 1G-3GHz PK+AV

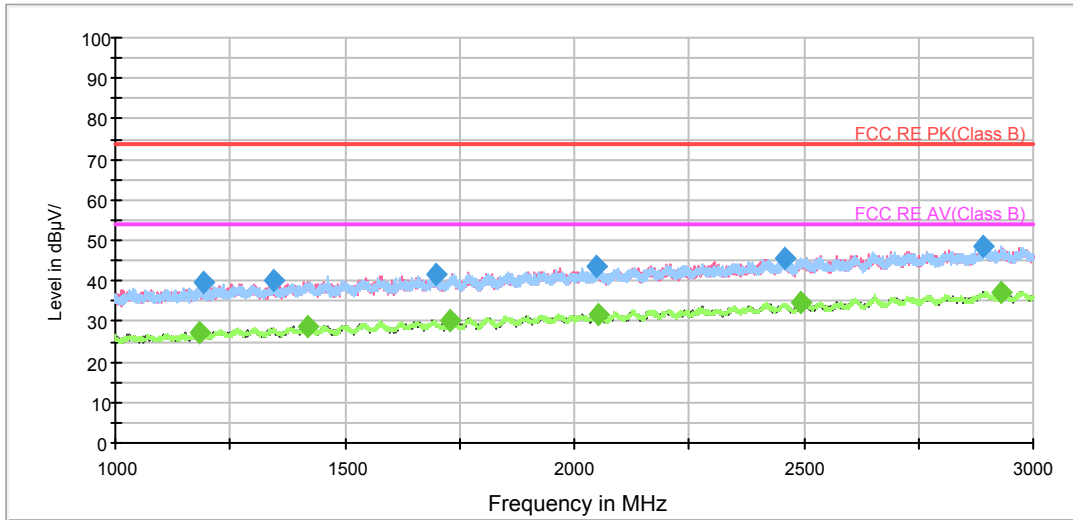

Radiates Emission from 1GHz to 3GHz

RE 3-18GHz PK+AV

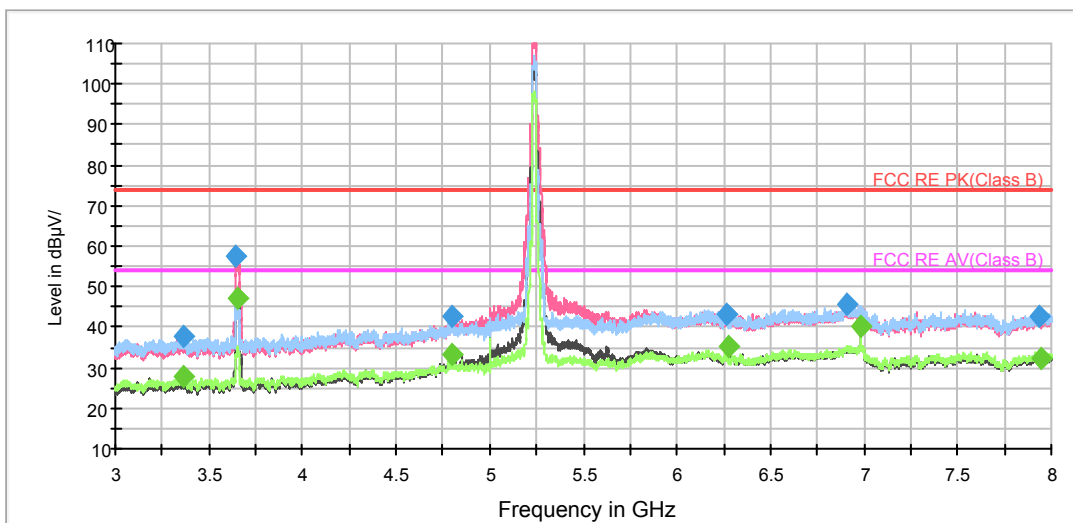

Note: The signal beyond the limit is carrier.

Radiates Emission from 3GHz to 8GHz

RE 3-18GHz PK+AV

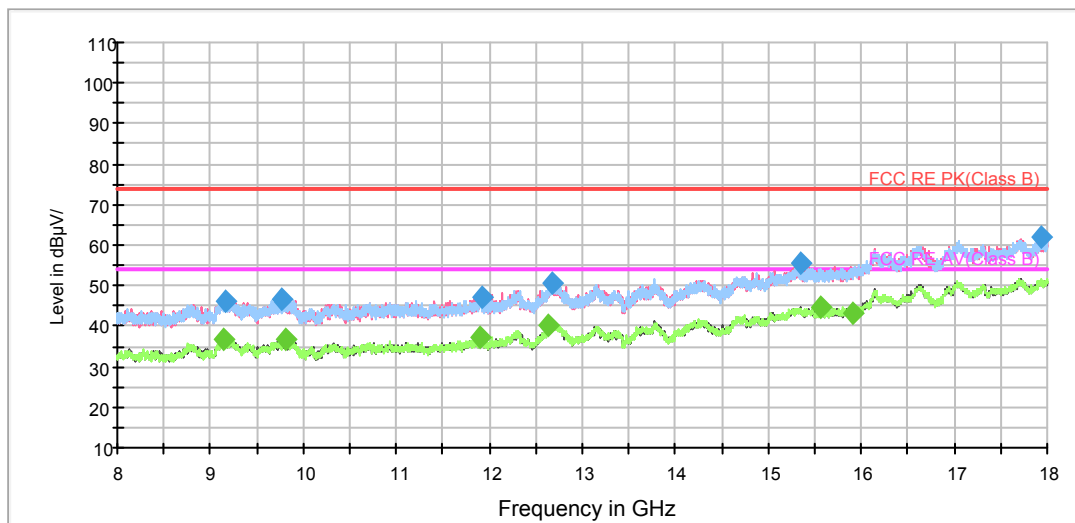

Radiates Emission from 8GHz to 18GHz

Frequency (MHz)	Peak (dBuV/m)	Height (cm)	Polarization	Azimuth (deg)	Reading value (dBuV/m)	Correct Factor (dB)	Margin (dB)	Limit (dBuV/m)
3358.750000	37.7	200.0	H	273.0	40.0	-2.3	36.3	74.0
3646.250000	57.3	200.0	V	0.0	59.2	-1.9	16.7	74.0
4800.000000	42.5	200.0	H	0.0	41.2	1.3	31.5	74.0
6265.625000	43.1	200.0	V	0.0	37.6	5.5	30.9	74.0
6911.875000	45.8	200.0	V	264.0	39.6	6.2	28.2	74.0
7939.375000	42.7	200.0	H	61.0	35.3	7.4	31.3	74.0

Remark: 1. Correction Factor = Antenna factor+ Insertion loss (cable loss + amplifier gain)

Frequency (MHz)	Average (dBuV/m)	Height (cm)	Polarization	Azimuth (deg)	Reading value (dBuV/m)	Correct Factor (dB)	Margin (dB)	Limit (dBuV/m)
3362.500000	27.9	200.0	H	71.0	30.2	-2.3	26.1	54.0
3655.000000	46.9	200.0	V	342.0	48.8	-1.9	7.1	54.0
4800.000000	33.3	200.0	H	0.0	32.0	1.3	20.7	54.0
6272.500000	35.1	200.0	V	332.0	29.7	5.4	18.9	54.0
6986.875000	40.1	200.0	V	274.0	33.7	6.4	13.9	54.0
7945.625000	32.1	200.0	V	303.0	24.8	7.3	21.9	54.0

Remark: 1. Correction Factor = Antenna factor+ Insertion loss (cable loss + amplifier gain)

802.11n (HT20) CH52

RE 1G-3GHz PK+AV

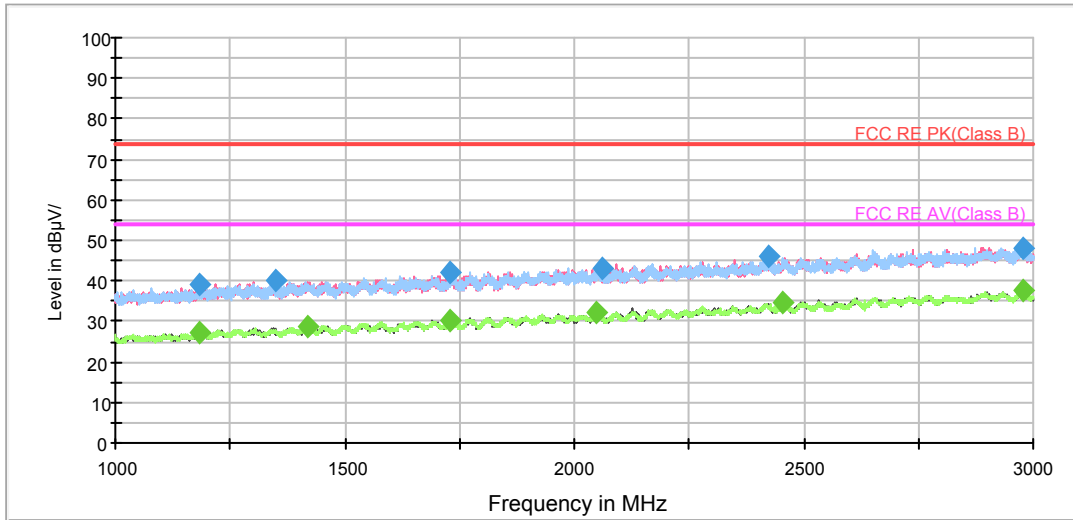

Radiates Emission from 1GHz to 3GHz

RE 3-18GHz PK+AV

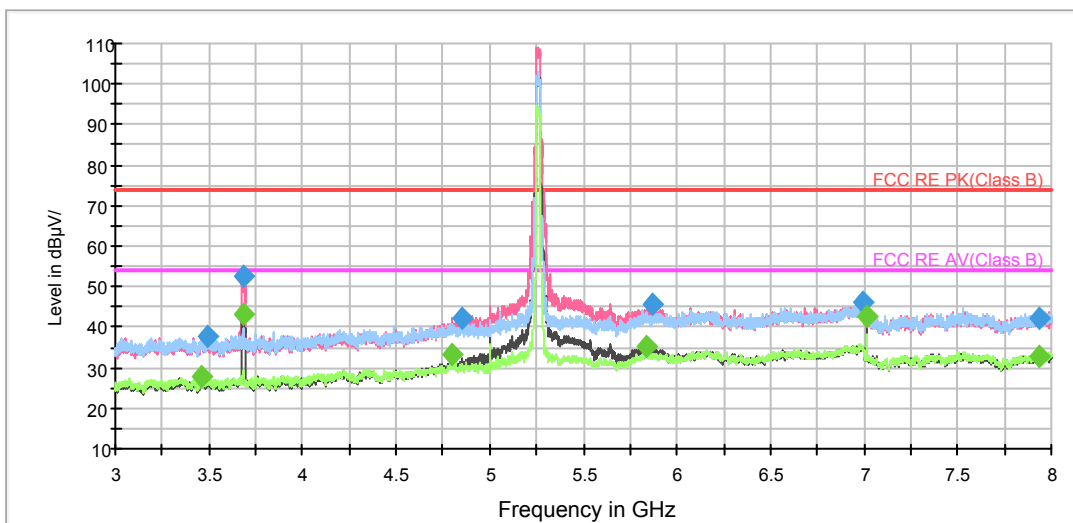

Note: The signal beyond the limit is carrier.

Radiates Emission from 3GHz to 8GHz

RE 3-18GHz PK+AV

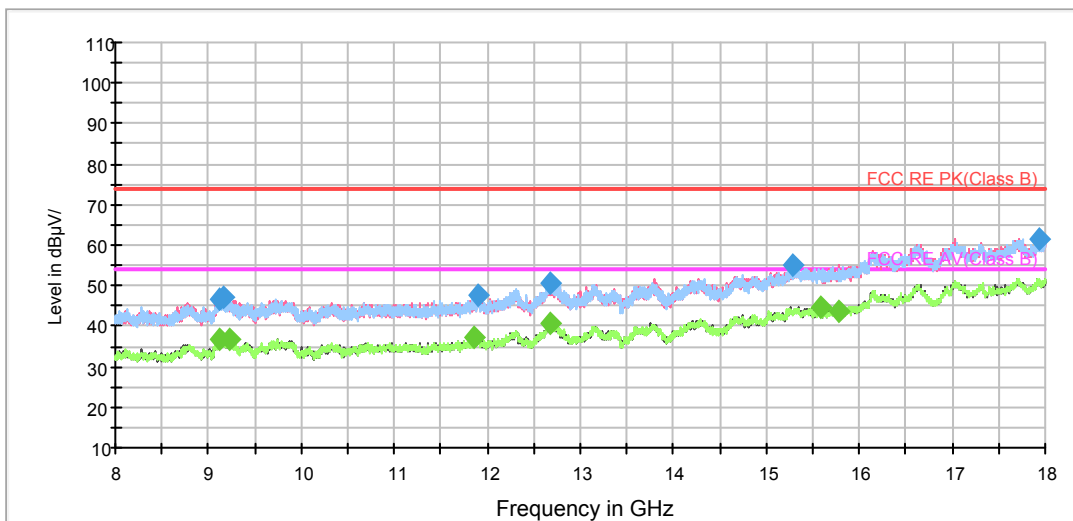

Radiates Emission from 8GHz to 18GHz

Frequency (MHz)	Peak (dBuV/m)	Height (cm)	Polarization	Azimuth (deg)	Reading value (dBuV/m)	Correct Factor (dB)	Margin (dB)	Limit (dBuV/m)
3487.500000	37.5	200.0	H	9.0	39.5	-2.0	36.5	74.0
3681.875000	52.6	200.0	V	246.0	54.4	-1.8	21.4	74.0
4850.000000	42.1	200.0	V	127.0	40.5	1.6	31.9	74.0
5872.500000	45.5	200.0	V	176.0	40.6	4.9	28.5	74.0
6989.375000	46.2	200.0	V	276.0	39.8	6.4	27.8	74.0
7940.000000	42.2	200.0	V	176.0	34.8	7.4	31.8	74.0

Remark: 1. Correction Factor = Antenna factor+ Insertion loss (cable loss + amplifier gain)

Frequency (MHz)	Average (dBuV/m)	Height (cm)	Polarization	Azimuth (deg)	Reading value (dBuV/m)	Correct Factor (dB)	Margin (dB)	Limit (dBuV/m)
3465.000000	27.8	200.0	H	316.0	29.9	-2.1	26.2	54.0
3680.000000	43.4	200.0	V	0.0	45.2	-1.8	10.6	54.0
4800.000000	33.3	200.0	V	136.0	32.0	1.3	20.7	54.0
5841.875000	35.1	200.0	V	0.0	30.6	4.5	18.9	54.0
7013.750000	42.9	200.0	V	276.0	36.4	6.5	11.1	54.0
7940.625000	33.0	200.0	V	266.0	25.6	7.4	21.0	54.0

Remark: 1. Correction Factor = Antenna factor+ Insertion loss (cable loss + amplifier gain)

802.11n (HT20) CH60

RE 1G-3GHz PK+AV

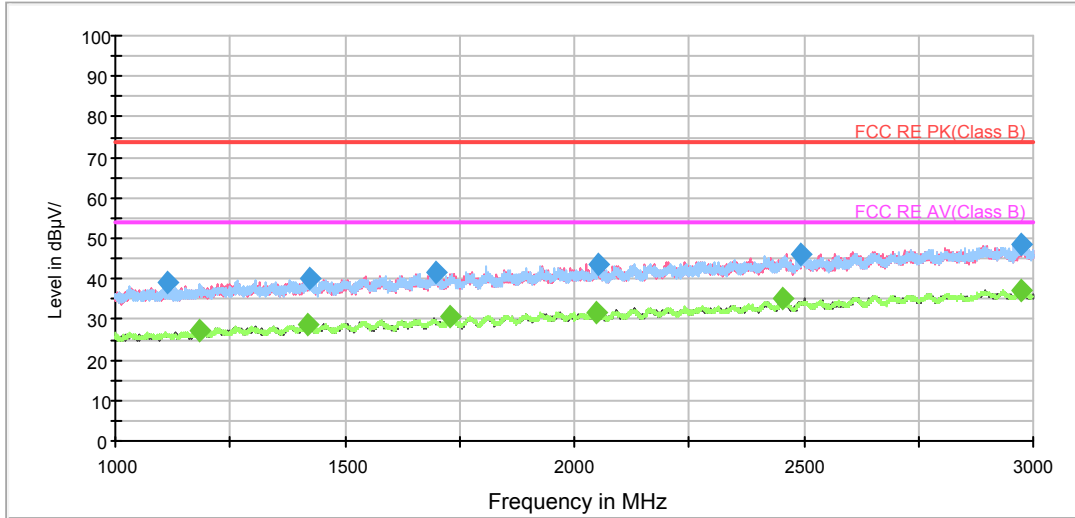

Radiates Emission from 1GHz to 3GHz

RE 3-18GHz PK+AV

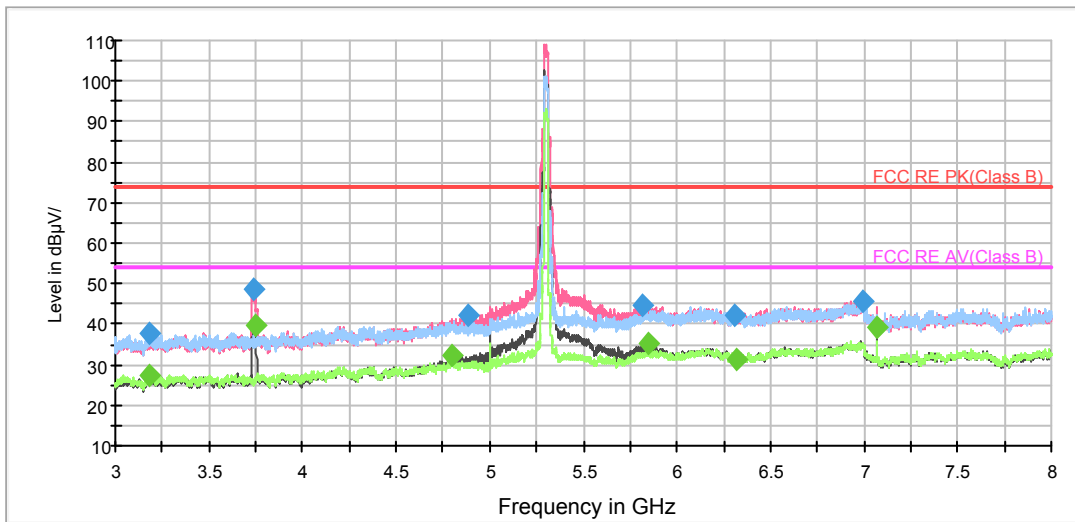

Note: The signal beyond the limit is carrier.

Radiates Emission from 3GHz to 8GHz

RE 3-18GHz PK+AV

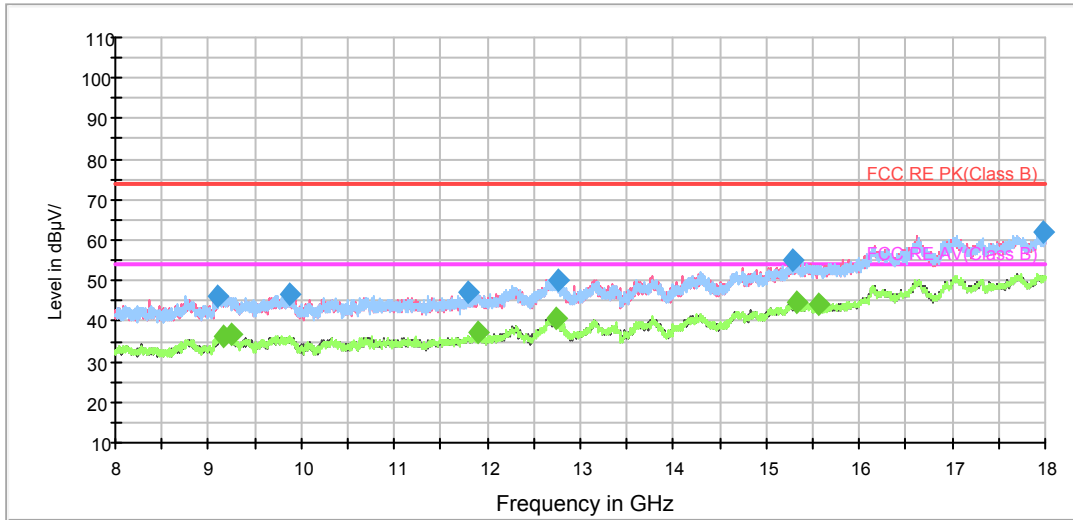

Radiates Emission from 8GHz to 18GHz

Frequency (MHz)	Peak (dBuV/m)	Height (cm)	Polarization	Azimuth (deg)	Reading value (dBuV/m)	Correct Factor (dB)	Margin (dB)	Limit (dBuV/m)
3177.500000	38.0	200.0	V	275.0	40.9	-2.9	36.0	74.0
3734.375000	48.7	200.0	V	128.0	50.4	-1.7	25.3	74.0
4881.875000	42.2	200.0	V	235.0	40.4	1.8	31.8	74.0
5817.500000	44.5	200.0	V	206.0	40.0	4.5	29.5	74.0
6313.125000	42.2	200.0	V	296.0	36.8	5.4	31.8	74.0
6989.375000	45.7	200.0	V	147.0	39.3	6.4	28.3	74.0

Remark: 1. Correction Factor = Antenna factor+ Insertion loss (cable loss + amplifier gain)

Frequency (MHz)	Average (dBuV/m)	Height (cm)	Polarization	Azimuth (deg)	Reading value (dBuV/m)	Correct Factor (dB)	Margin (dB)	Limit (dBuV/m)
3181.250000	27.2	200.0	V	352.0	30.1	-2.9	26.8	54.0
3746.250000	39.5	200.0	V	107.0	41.2	-1.7	14.5	54.0
4800.000000	32.4	200.0	V	285.0	31.1	1.3	21.6	54.0
5845.000000	35.1	200.0	V	206.0	30.5	4.6	18.9	54.0
6315.625000	31.1	200.0	V	343.0	25.8	5.3	22.9	54.0
7066.875000	39.0	200.0	V	275.0	32.8	6.2	15.0	54.0

Remark: 1. Correction Factor = Antenna factor+ Insertion loss (cable loss + amplifier gain)

802.11n (HT20) CH64

RE 1G-3GHz PK+AV

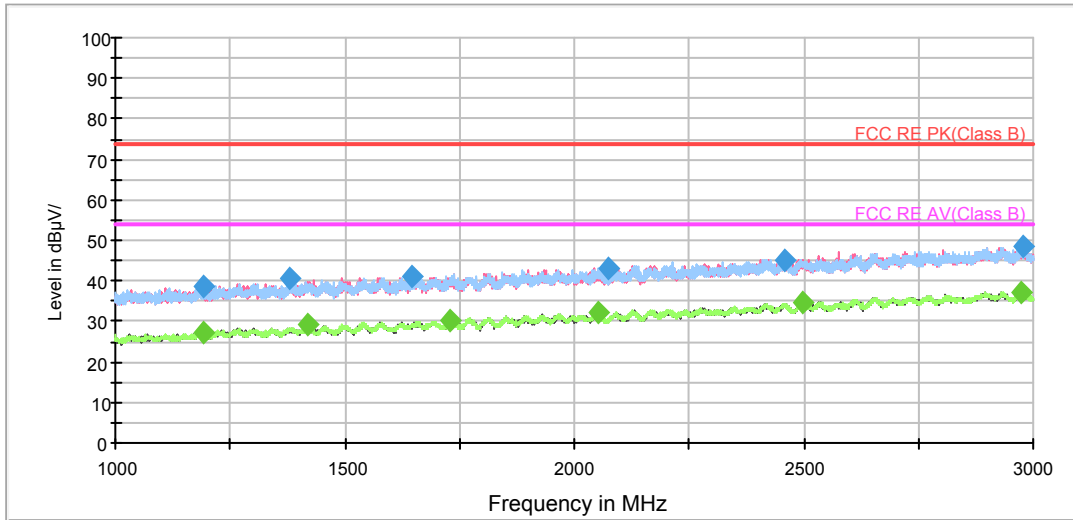

Radiates Emission from 1GHz to 3GHz

RE 3-18GHz PK+AV

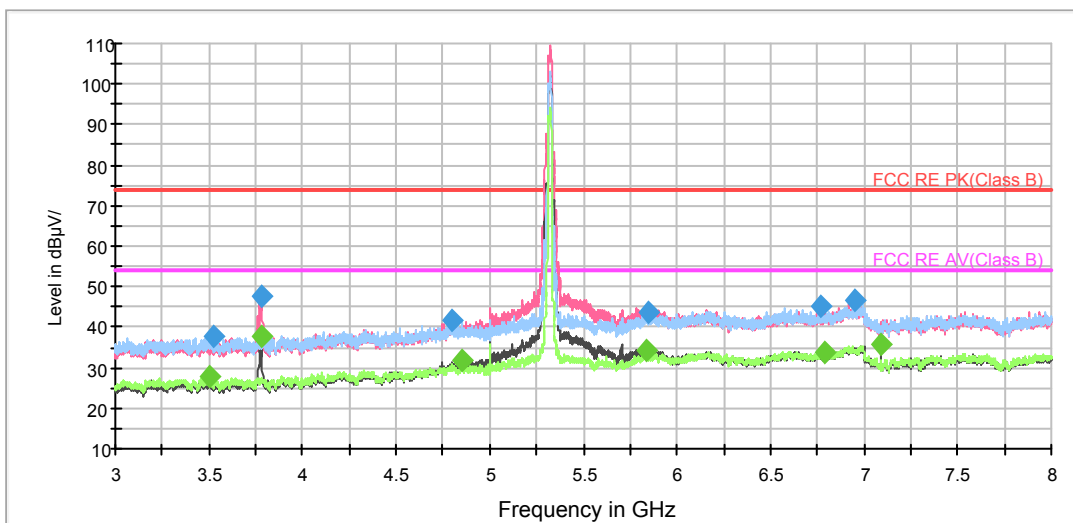

Note: The signal beyond the limit is carrier.

Radiates Emission from 3GHz to 8GHz

RE 3-18GHz PK+AV

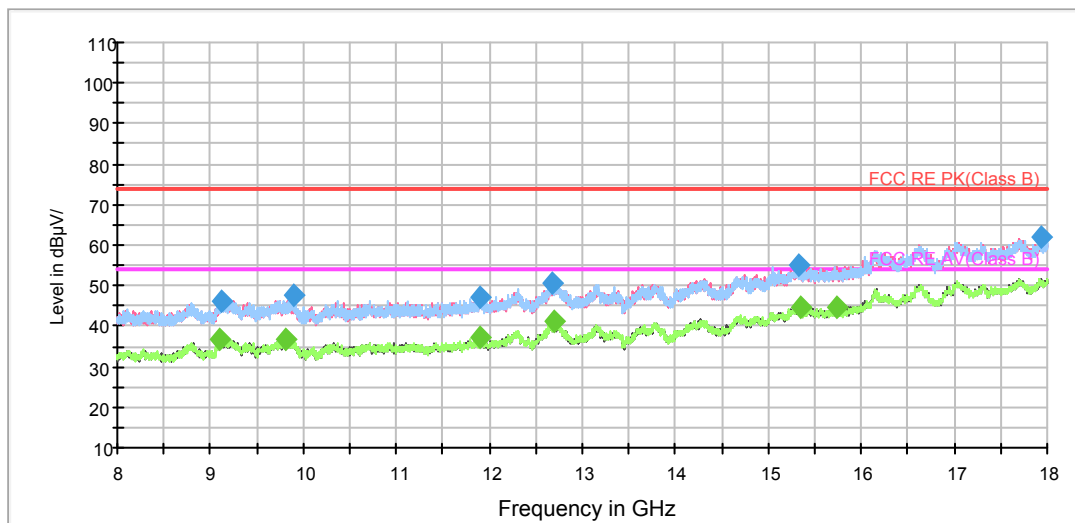

Radiates Emission from 8GHz to 18GHz

Frequency (MHz)	Peak (dBuV/m)	Height (cm)	Polarization	Azimuth (deg)	Reading value (dBuV/m)	Correct Factor (dB)	Margin (dB)	Limit (dBuV/m)
3528.750000	37.5	200.0	H	17.0	39.6	-2.1	36.5	74.0
3777.500000	47.7	200.0	V	250.0	49.5	-1.8	26.3	74.0
4800.625000	41.6	200.0	H	0.0	40.3	1.3	32.4	74.0
5846.250000	43.6	200.0	V	0.0	39.0	4.6	30.4	74.0
6773.125000	45.0	200.0	V	0.0	39.4	5.6	29.0	74.0
6955.625000	46.6	200.0	V	330.0	40.4	6.2	27.4	74.0

Remark: 1. Correction Factor = Antenna factor+ Insertion loss (cable loss + amplifier gain)

Frequency (MHz)	Average (dBuV/m)	Height (cm)	Polarization	Azimuth (deg)	Reading value (dBuV/m)	Correct Factor (dB)	Margin (dB)	Limit (dBuV/m)
3505.625000	27.6	200.0	H	185.0	29.7	-2.1	26.4	54.0
3778.125000	37.7	200.0	V	250.0	39.5	-1.8	16.3	54.0
4848.125000	31.6	200.0	V	77.0	30.0	1.6	22.4	54.0
5836.875000	34.5	200.0	V	0.0	30.0	4.5	19.5	54.0
6794.375000	33.9	200.0	H	135.0	28.2	5.7	20.1	54.0
7093.750000	35.7	200.0	V	270.0	29.6	6.1	18.3	54.0

Remark: 1. Correction Factor = Antenna factor+ Insertion loss (cable loss + amplifier gain)

802.11n (HT20) CH100

RE 1G-3GHz PK+AV

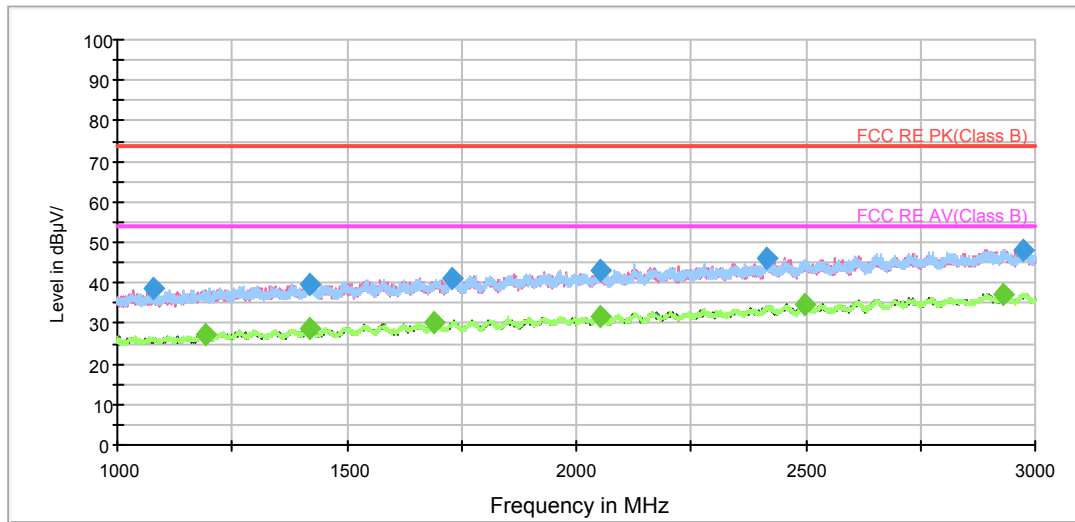

Radiates Emission from 1GHz to 3GHz

RE 3-18GHz PK+AV

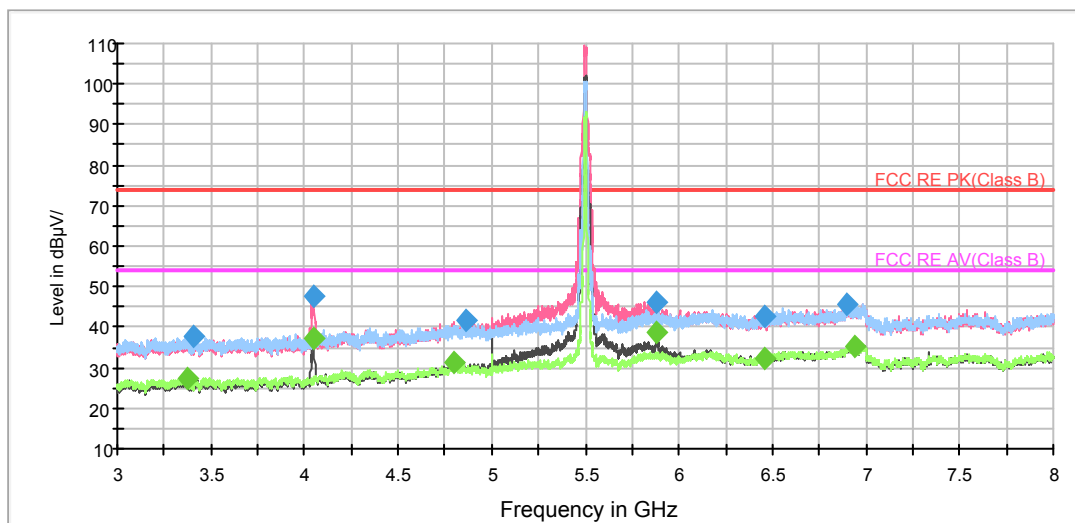

Note: The signal beyond the limit is carrier.

Radiates Emission from 3GHz to 8GHz

RE 3-18GHz PK+AV

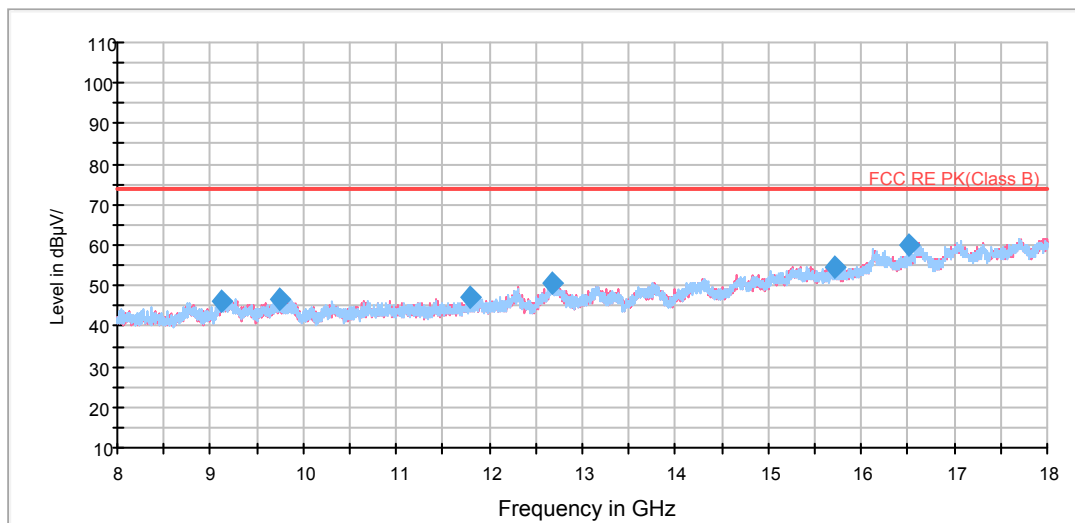

RE 3-18GHz AV

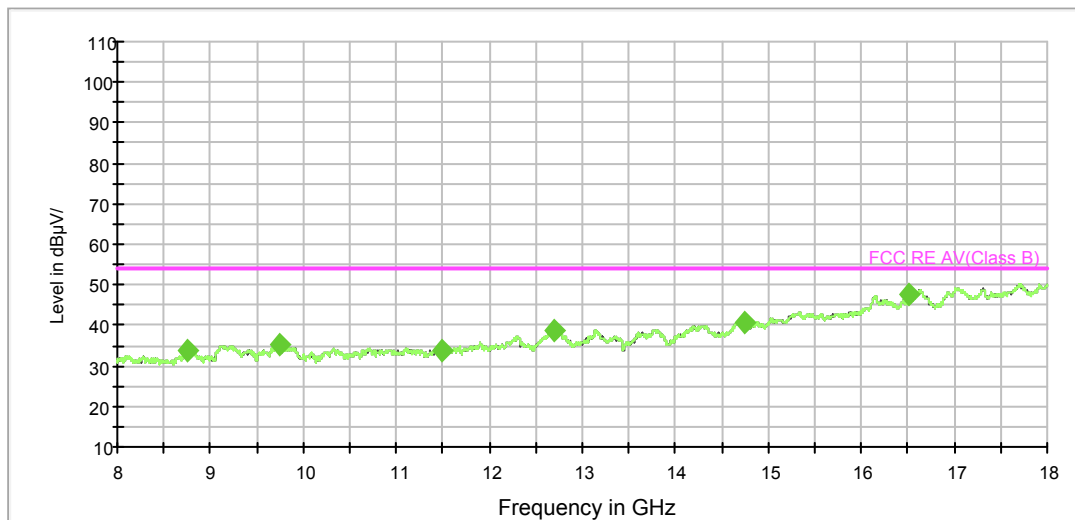

Radiates Emission from 8GHz to 18GHz

Frequency (MHz)	Peak (dBuV/m)	Height (cm)	Polarization	Azimuth (deg)	Reading value (dBuV/m)	Correct Factor (dB)	Margin (dB)	Limit (dBuV/m)
3410.625000	37.9	200.0	H	244.0	40.4	-2.5	36.1	74.0
4044.375000	47.6	200.0	V	344.0	48.6	-1.0	26.4	74.0
4861.875000	41.6	200.0	V	195.0	39.9	1.7	32.4	74.0
5884.375000	46.1	200.0	V	273.0	41.2	4.9	27.9	74.0
6457.500000	42.9	200.0	H	127.0	37.8	5.1	31.1	74.0
6895.000000	45.7	200.0	V	243.0	39.5	6.2	28.3	74.0

Remark: 1. Correction Factor = Antenna factor+ Insertion loss (cable loss + amplifier gain)



Frequency (MHz)	Average (dBuV/m)	Height (cm)	Polarization	Azimuth (deg)	Reading value (dBuV/m)	Correct Factor (dB)	Margin (dB)	Limit (dBuV/m)
3377.500000	27.3	200.0	H	69.0	29.9	-2.6	26.7	54.0
4047.500000	37.4	200.0	V	344.0	38.4	-1.0	16.6	54.0
4800.000000	31.5	200.0	V	263.0	30.2	1.3	22.5	54.0
5884.375000	38.5	200.0	V	273.0	33.6	4.9	15.5	54.0
6456.250000	32.4	200.0	V	273.0	27.3	5.1	21.6	54.0
6935.625000	35.4	200.0	H	0.0	29.3	6.1	18.6	54.0

Remark: 1. Correction Factor = Antenna factor+ Insertion loss (cable loss + amplifier gain)

802.11n (HT20) CH116

RE 1G-3GHz PK+AV

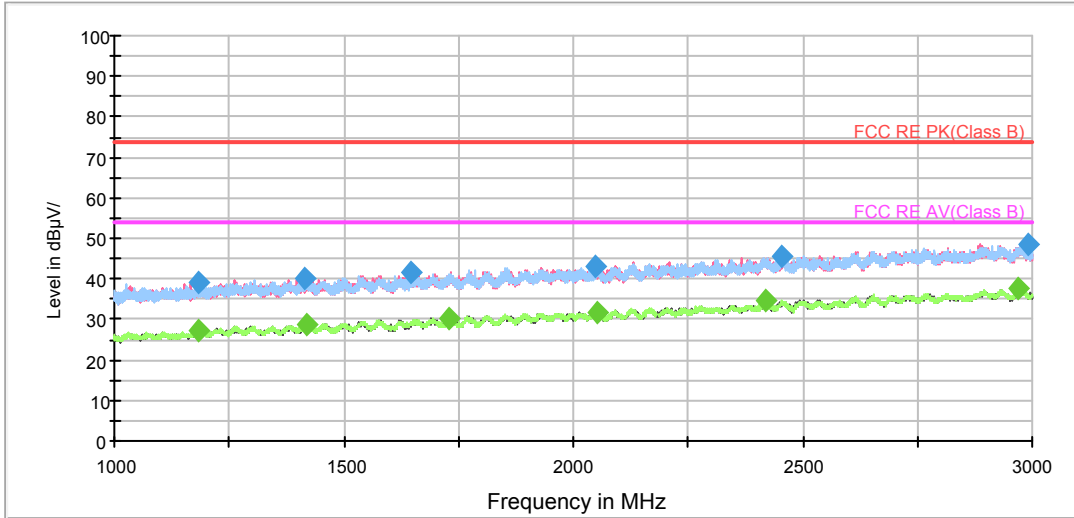

Radiates Emission from 1GHz to 3GHz

RE 3-18GHz PK+AV

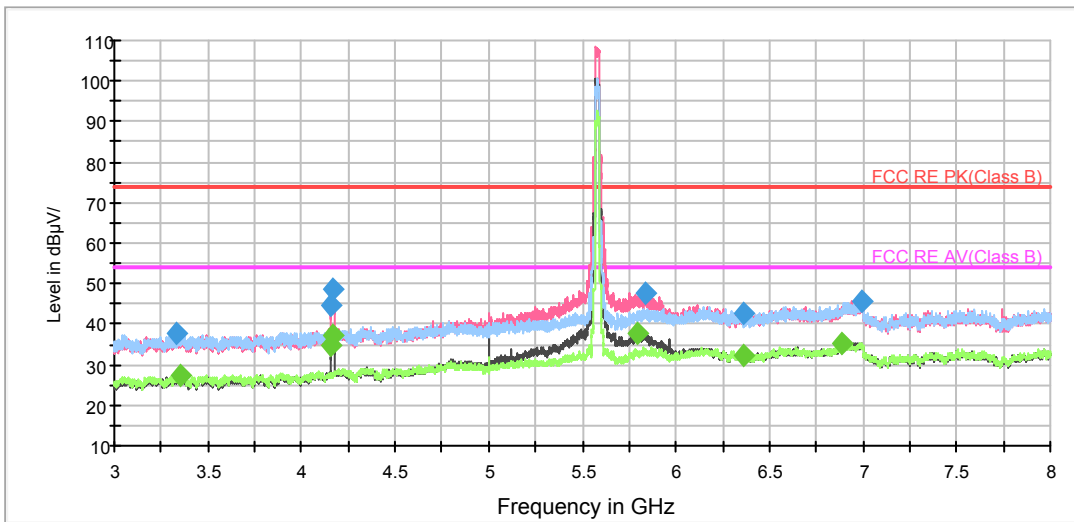

Note: The signal beyond the limit is carrier.

Radiates Emission from 3GHz to 8GHz

RE 3-18GHz PK+AV

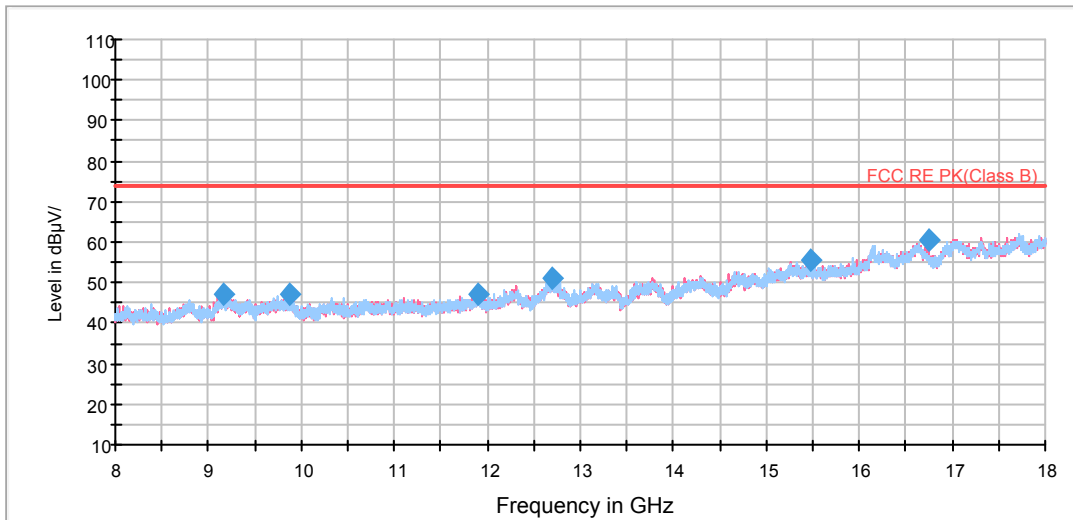

RE 3-18GHz AV

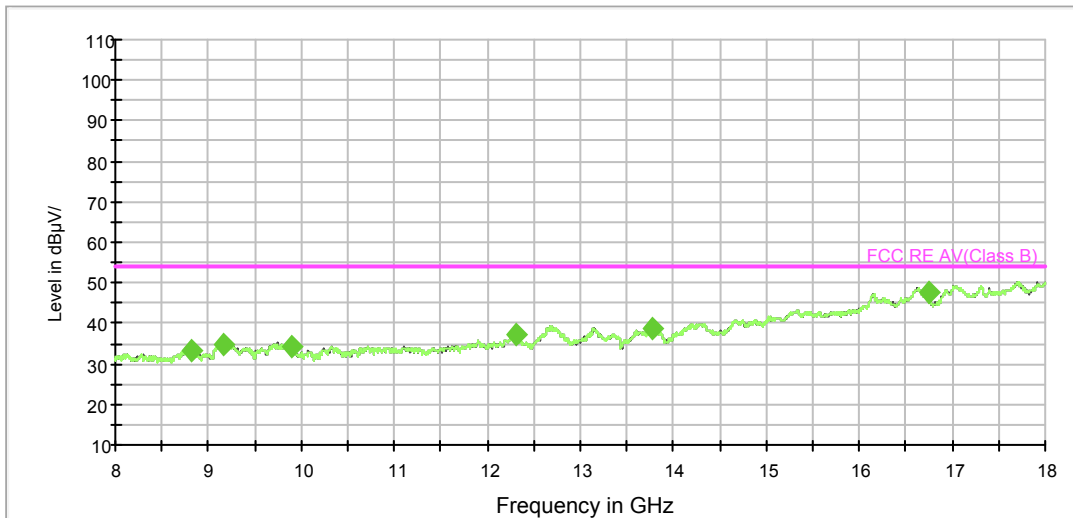

Radiates Emission from 8GHz to 18GHz

Frequency (MHz)	Peak (dBuV/m)	Height (cm)	Polarization	Azimuth (deg)	Reading value (dBuV/m)	Correct Factor (dB)	Margin (dB)	Limit (dBuV/m)
3330.625000	37.9	200.0	V	353.0	40.1	-2.2	36.1	74.0
4158.750000	44.5	200.0	V	0.0	44.5	0.0	29.5	74.0
4165.625000	48.4	200.0	V	218.0	48.4	0.0	25.6	74.0
5834.375000	47.5	200.0	V	9.0	43.0	4.5	26.5	74.0
6359.375000	42.5	200.0	V	353.0	37.5	5.0	31.5	74.0
6990.625000	45.7	200.0	V	227.0	39.2	6.5	28.3	74.0

Remark: 1. Correction Factor = Antenna factor+ Insertion loss (cable loss + amplifier gain)



Frequency (MHz)	Average (dBuV/m)	Height (cm)	Polarization	Azimuth (deg)	Reading value (dBuV/m)	Correct Factor (dB)	Margin (dB)	Limit (dBuV/m)
3348.750000	27.3	200.0	H	38.0	29.6	-2.3	26.7	54.0
4159.375000	34.8	200.0	V	0.0	34.8	0.0	19.2	54.0
4167.500000	37.2	200.0	V	218.0	37.2	0.0	16.8	54.0
5790.625000	37.9	200.0	V	9.0	33.8	4.1	16.1	54.0
6361.250000	32.1	200.0	H	116.0	27.1	5.0	21.9	54.0
6891.250000	35.4	200.0	H	146.0	29.3	6.1	18.6	54.0

Remark: 1. Correction Factor = Antenna factor+ Insertion loss (cable loss + amplifier gain)

802.11n (HT20) CH140

RE 1G-3GHz PK+AV

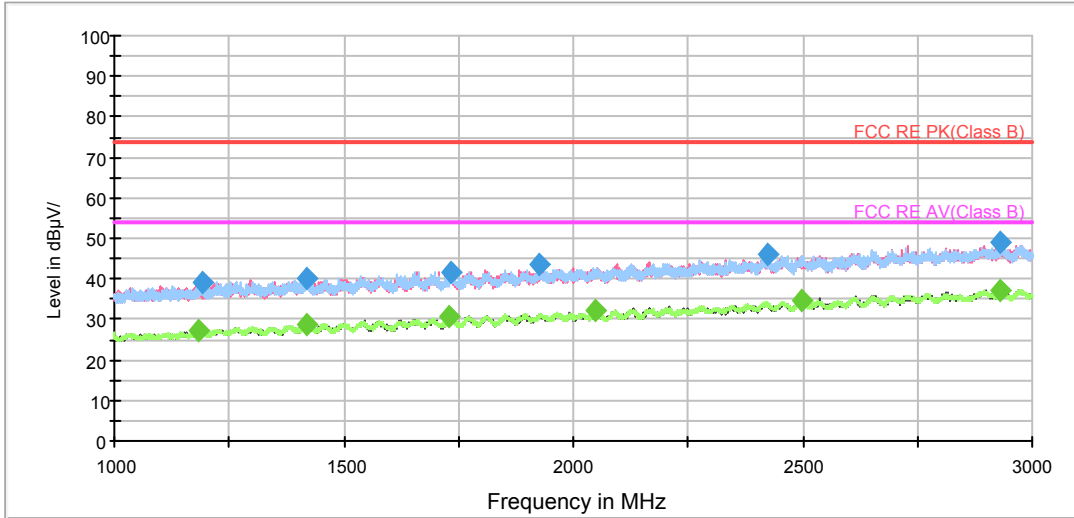

Radiates Emission from 1GHz to 3GHz

RE 3-18GHz PK+AV

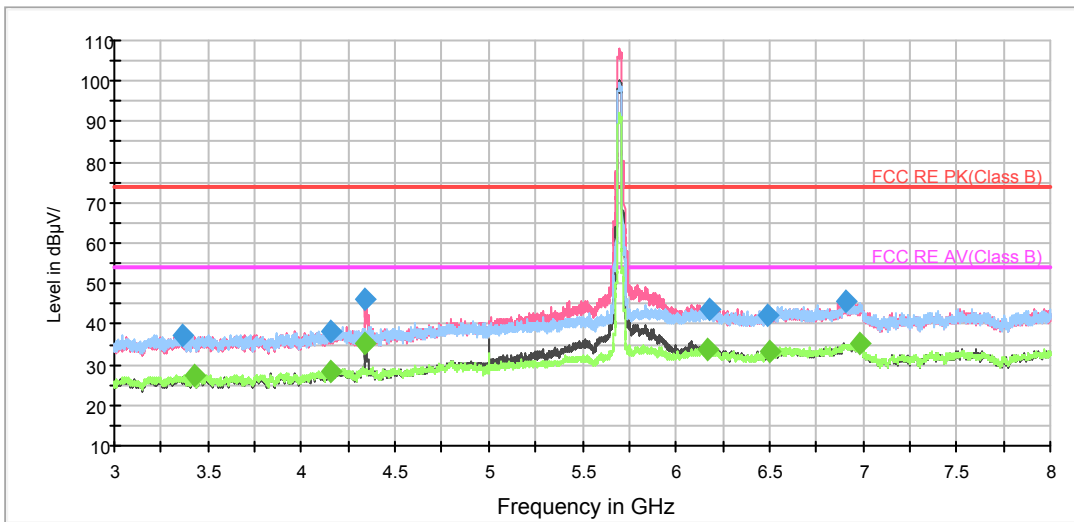

Note: The signal beyond the limit is carrier.

Radiates Emission from 3GHz to 8GHz

RE 3-18GHz PK+AV

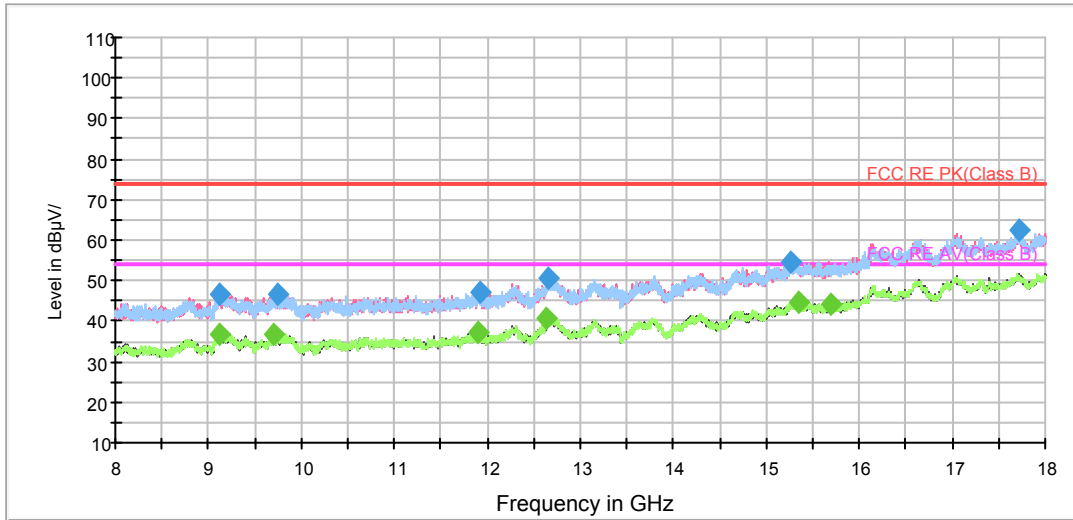

Radiates Emission from 8GHz to 18GHz

Frequency (MHz)	Peak (dBuV/m)	Height (cm)	Polarization	Azimuth (deg)	Reading value (dBuV/m)	Correct Factor (dB)	Margin (dB)	Limit (dBuV/m)
3361.875000	37.3	200.0	H	62.0	39.6	-2.3	36.7	74.0
4159.375000	38.4	200.0	H	62.0	38.4	0.0	35.6	74.0
4341.875000	46.0	200.0	V	343.0	45.5	0.5	28.0	74.0
6182.500000	43.5	200.0	V	284.0	38.1	5.4	30.5	74.0
6486.875000	42.4	200.0	H	0.0	37.3	5.1	31.6	74.0
6907.500000	45.8	200.0	H	103.0	39.6	6.2	28.2	74.0

Remark: 1. Correction Factor = Antenna factor+ Insertion loss (cable loss + amplifier gain)

Frequency (MHz)	Average (dBuV/m)	Height (cm)	Polarization	Azimuth (deg)	Reading value (dBuV/m)	Correct Factor (dB)	Margin (dB)	Limit (dBuV/m)
3428.750000	27.6	200.0	H	14.0	30.0	-2.4	26.4	54.0
4155.000000	28.5	200.0	H	0.0	28.6	-0.1	25.5	54.0
4341.875000	35.5	200.0	V	343.0	35.0	0.5	18.5	54.0
6166.875000	33.9	200.0	V	323.0	28.3	5.6	20.1	54.0
6496.875000	33.3	200.0	V	343.0	28.1	5.2	20.7	54.0
6980.000000	35.3	200.0	V	294.0	28.9	6.4	18.7	54.0

Remark: 1. Correction Factor = Antenna factor+ Insertion loss (cable loss + amplifier gain)

802.11n (HT20) CH149

RE 1G-3GHz PK+AV

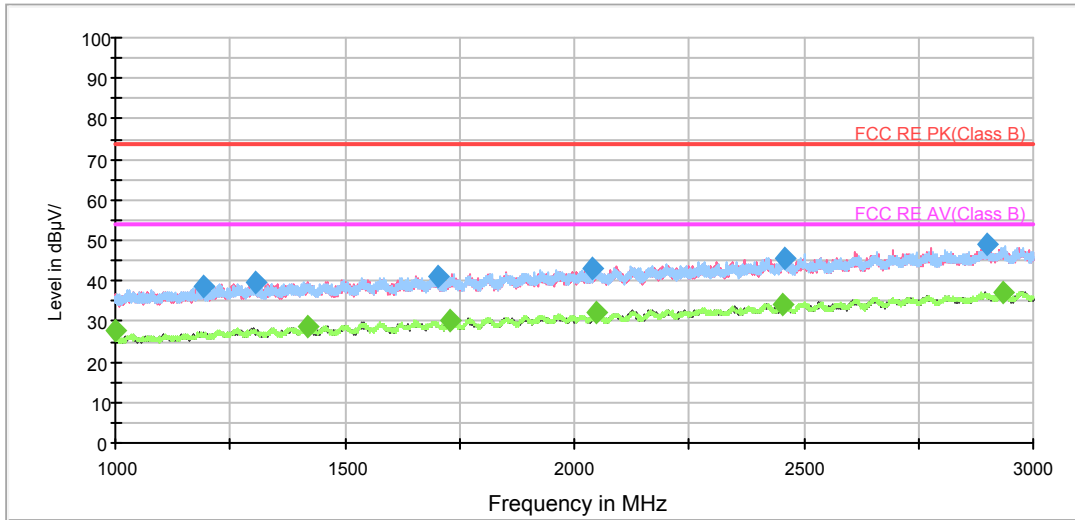

Radiates Emission from 1GHz to 3GHz

RE 3-18GHz PK+AV

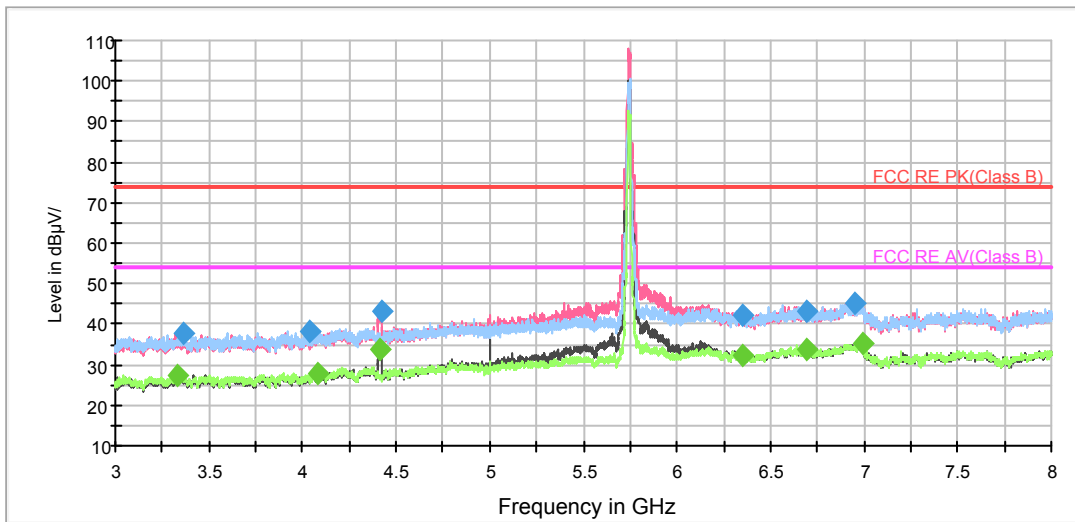

Note: The signal beyond the limit is carrier.

Radiates Emission from 3GHz to 8GHz

RE 3-18GHz PK+AV

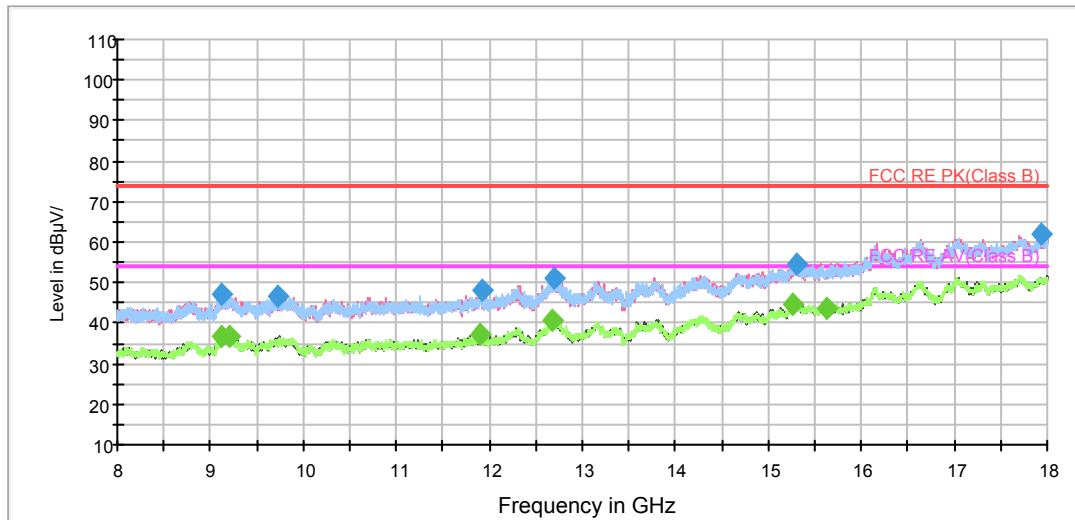

Radiates Emission from 8GHz to 18GHz

Frequency (MHz)	Peak (dBuV/m)	Height (cm)	Polarization	Azimuth (deg)	Reading value (dBuV/m)	Correct Factor (dB)	Margin (dB)	Limit (dBuV/m)
3362.500000	37.9	200.0	H	174.0	40.2	-2.3	36.1	74.0
4041.875000	38.3	200.0	H	155.0	39.3	-1.0	35.7	74.0
4419.375000	43.1	200.0	V	204.0	42.9	0.2	30.9	74.0
6353.750000	42.4	200.0	H	56.0	37.3	5.1	31.6	74.0
6691.875000	42.9	200.0	H	264.0	37.6	5.3	31.1	74.0
6949.375000	45.3	200.0	H	0.0	39.1	6.2	28.7	74.0

Remark: 1. Correction Factor = Antenna factor+ Insertion loss (cable loss + amplifier gain)

Frequency (MHz)	Average (dBuV/m)	Height (cm)	Polarization	Azimuth (deg)	Reading value (dBuV/m)	Correct Factor (dB)	Margin (dB)	Limit (dBuV/m)
3333.750000	27.5	200.0	H	283.0	29.8	-2.3	26.5	54.0
4086.250000	28.0	200.0	H	174.0	28.9	-0.9	26.0	54.0
4415.000000	33.5	200.0	V	341.0	33.3	0.2	20.5	54.0
6354.375000	32.4	200.0	V	272.0	27.3	5.1	21.6	54.0
6693.125000	33.6	200.0	H	0.0	28.3	5.3	20.4	54.0
6995.625000	35.2	200.0	V	224.0	28.7	6.5	18.8	54.0

Remark: 1. Correction Factor = Antenna factor+ Insertion loss (cable loss + amplifier gain)

802.11n (HT20) CH157

RE 1G-3GHz PK+AV

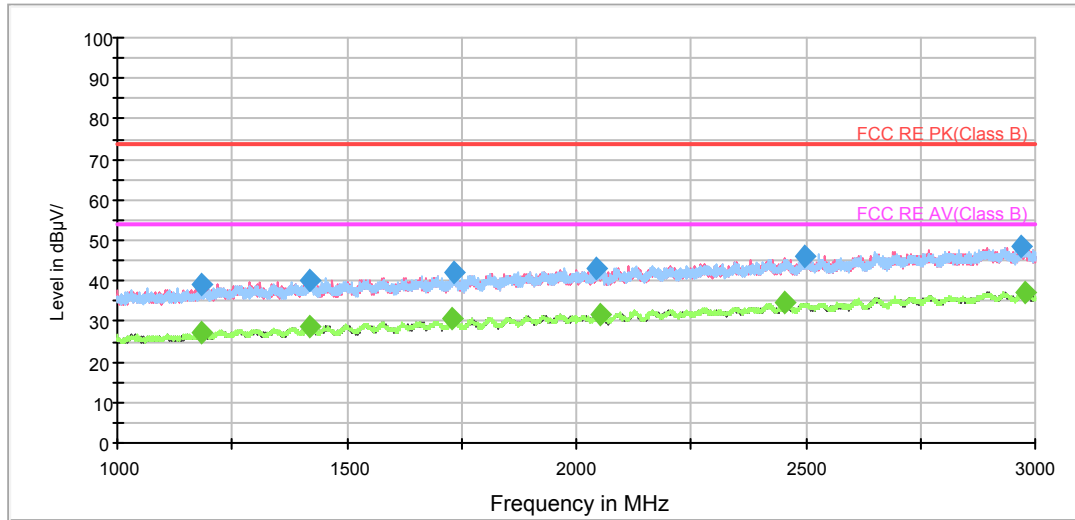

Radiates Emission from 1GHz to 3GHz

RE 3-18GHz PK+AV

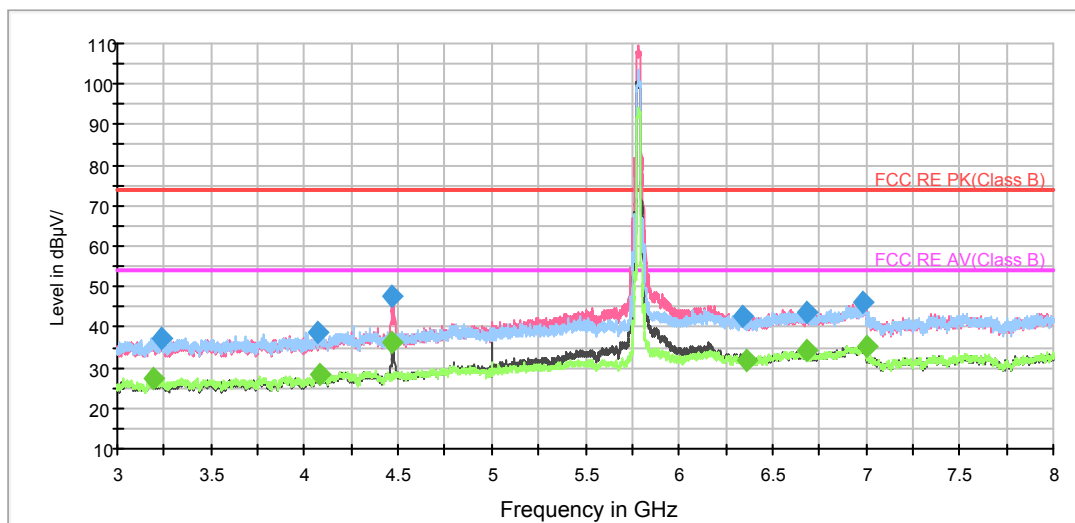

Note: The signal beyond the limit is carrier.

Radiates Emission from 3GHz to 8GHz

RE 3-18GHz PK+AV

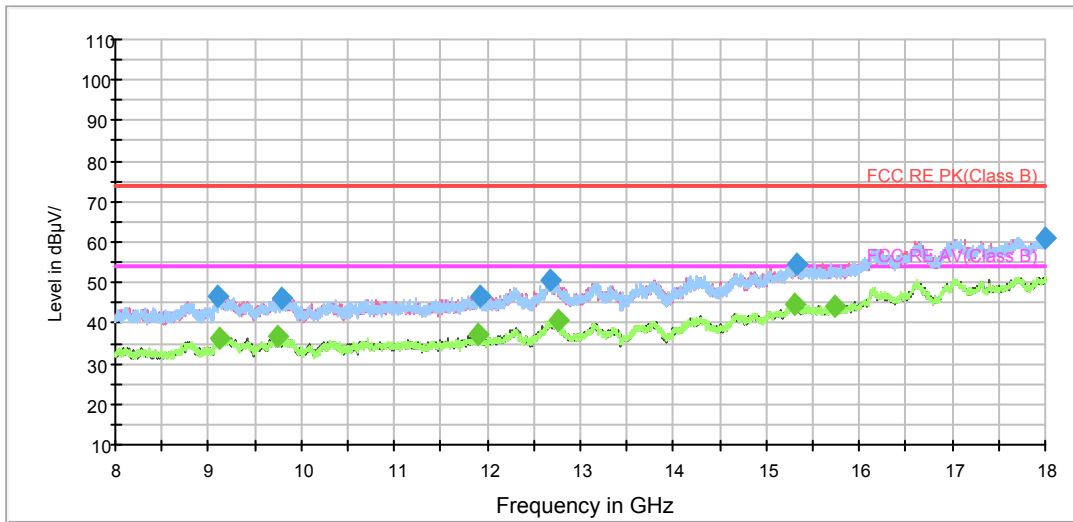

Radiates Emission from 8GHz to 18GHz

Frequency (MHz)	Peak (dBuV/m)	Height (cm)	Polarization	Azimuth (deg)	Reading value (dBuV/m)	Correct Factor (dB)	Margin (dB)	Limit (dBuV/m)
3240.625000	37.2	200.0	H	57.0	39.8	-2.6	36.8	74.0
4075.000000	38.6	200.0	H	16.0	39.5	-0.9	35.4	74.0
4470.000000	47.5	200.0	V	353.0	47.1	0.4	26.5	74.0
6344.375000	42.7	200.0	H	195.0	37.4	5.3	31.3	74.0
6681.250000	43.7	200.0	H	6.0	38.2	5.5	30.3	74.0
6984.375000	46.2	200.0	V	136.0	39.8	6.4	27.8	74.0

Remark: 1. Correction Factor = Antenna factor+ Insertion loss (cable loss + amplifier gain)

Frequency (MHz)	Average (dBuV/m)	Height (cm)	Polarization	Azimuth (deg)	Reading value (dBuV/m)	Correct Factor (dB)	Margin (dB)	Limit (dBuV/m)
3188.125000	27.3	200.0	H	304.0	30.2	-2.9	26.7	54.0
4076.875000	28.1	200.0	H	146.0	29.0	-0.9	25.9	54.0
4470.000000	36.4	200.0	V	353.0	36.0	0.4	17.6	54.0
6361.875000	32.0	200.0	H	0.0	27.0	5.0	22.0	54.0
6680.000000	34.0	200.0	V	294.0	28.5	5.5	20.0	54.0
6999.375000	35.3	200.0	H	0.0	28.8	6.5	18.7	54.0

Remark: 1. Correction Factor = Antenna factor+ Insertion loss (cable loss + amplifier gain)

802.11n (HT20) CH165

RE 1G-3GHz PK+AV

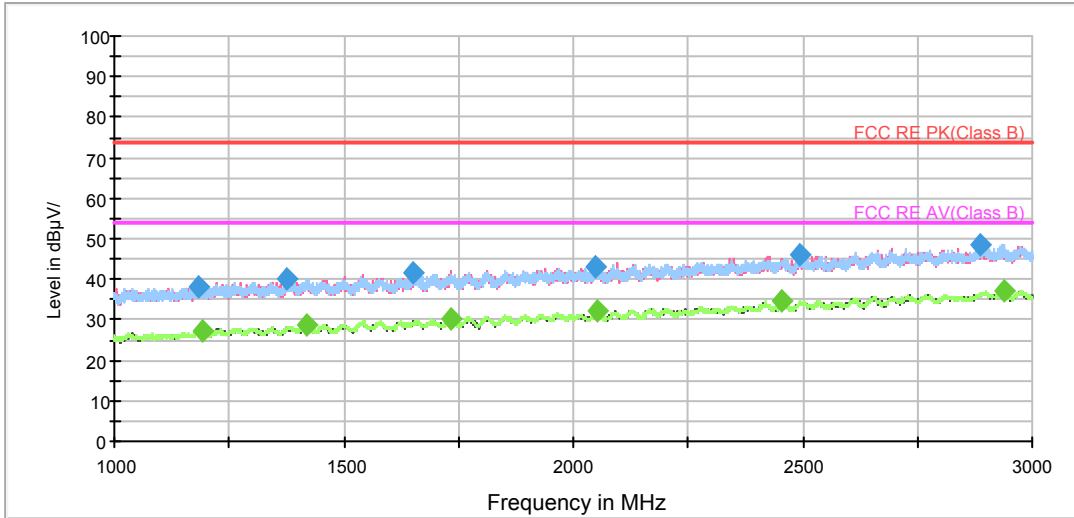

Radiates Emission from 1GHz to 3GHz

RE 3-18GHz PK+AV

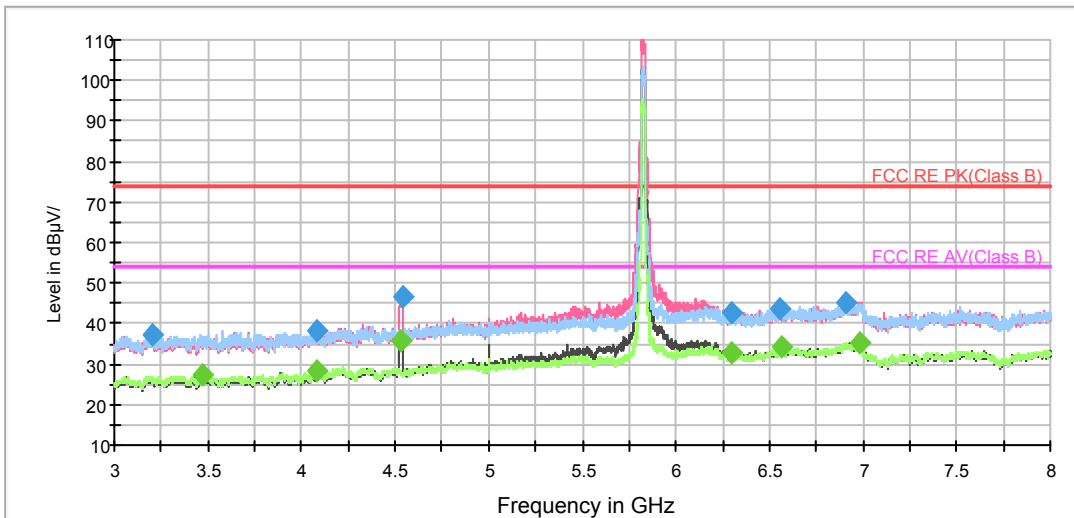

Note: The signal beyond the limit is carrier.

Radiates Emission from 3GHz to 8GHz

RE 3-18GHz PK+AV

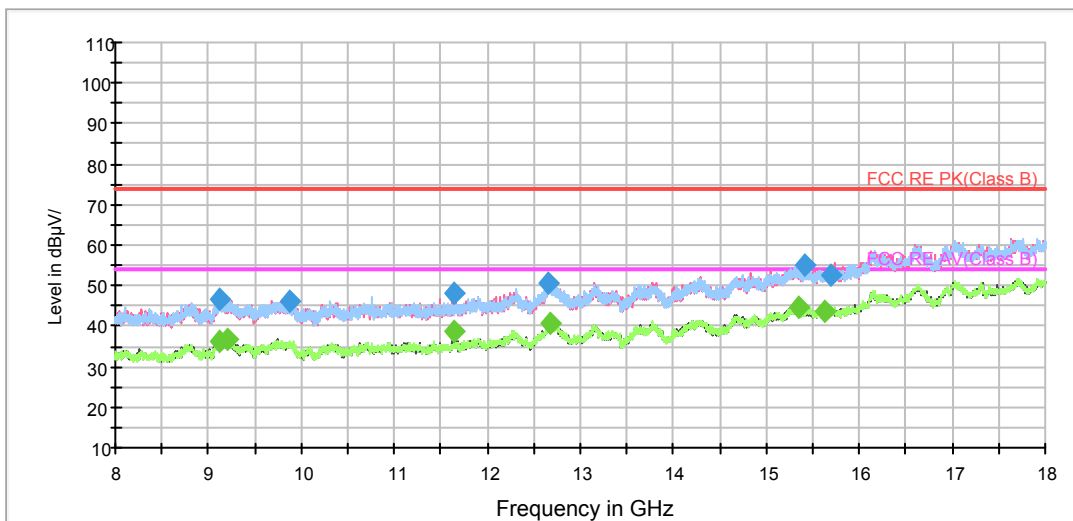

Radiates Emission from 8GHz to 18GHz

Frequency (MHz)	Peak (dBuV/m)	Height (cm)	Polarization	Azimuth (deg)	Reading value (dBuV/m)	Correct Factor (dB)	Margin (dB)	Limit (dBuV/m)
3208.750000	37.5	200.0	H	43.0	40.3	-2.8	36.5	74.0
4083.125000	38.3	200.0	H	0.0	39.2	-0.9	35.7	74.0
4541.250000	46.5	200.0	V	197.0	45.8	0.7	27.5	74.0
6296.250000	42.5	200.0	V	258.0	37.1	5.4	31.5	74.0
6553.750000	43.8	200.0	V	248.0	38.2	5.6	30.2	74.0
6906.875000	45.3	200.0	V	0.0	39.0	6.3	28.7	74.0

Remark: 1. Correction Factor = Antenna factor+ Insertion loss (cable loss + amplifier gain)

Frequency (MHz)	Average (dBuV/m)	Height (cm)	Polarization	Azimuth (deg)	Reading value (dBuV/m)	Correct Factor (dB)	Margin (dB)	Limit (dBuV/m)
3467.500000	27.2	200.0	V	208.0	29.3	-2.1	26.8	54.0
4078.125000	28.1	200.0	H	73.0	29.0	-0.9	25.9	54.0
4536.250000	35.9	200.0	V	197.0	35.2	0.7	18.1	54.0
6301.250000	33.0	200.0	V	258.0	27.6	5.4	21.0	54.0
6561.875000	34.0	200.0	V	340.0	28.2	5.8	20.0	54.0
6986.250000	35.5	200.0	H	83.0	29.1	6.4	18.5	54.0

Remark: 1. Correction Factor = Antenna factor+ Insertion loss (cable loss + amplifier gain)

802.11n (HT40) CH38

RE 1G-3GHz PK+AV

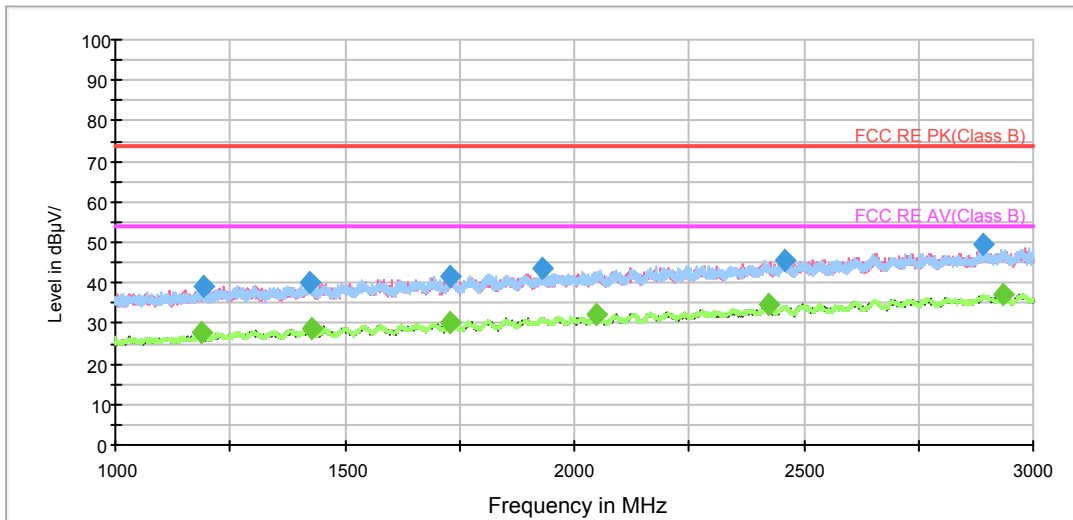

Radiates Emission from 1GHz to 3GHz

RE 3-18GHz PK+AV

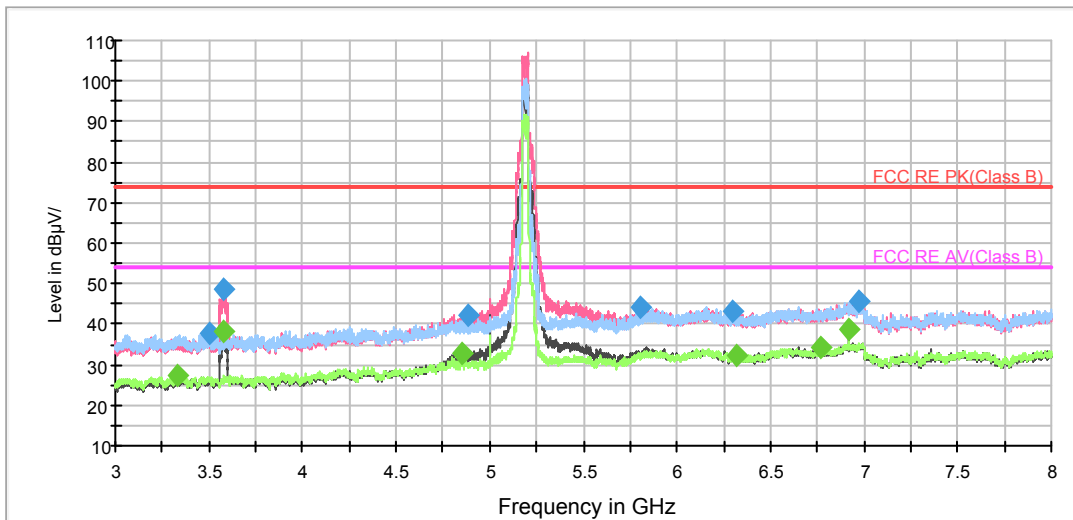

Note: The signal beyond the limit is carrier.

Radiates Emission from 3GHz to 8GHz

RE 3-18GHz PK+AV

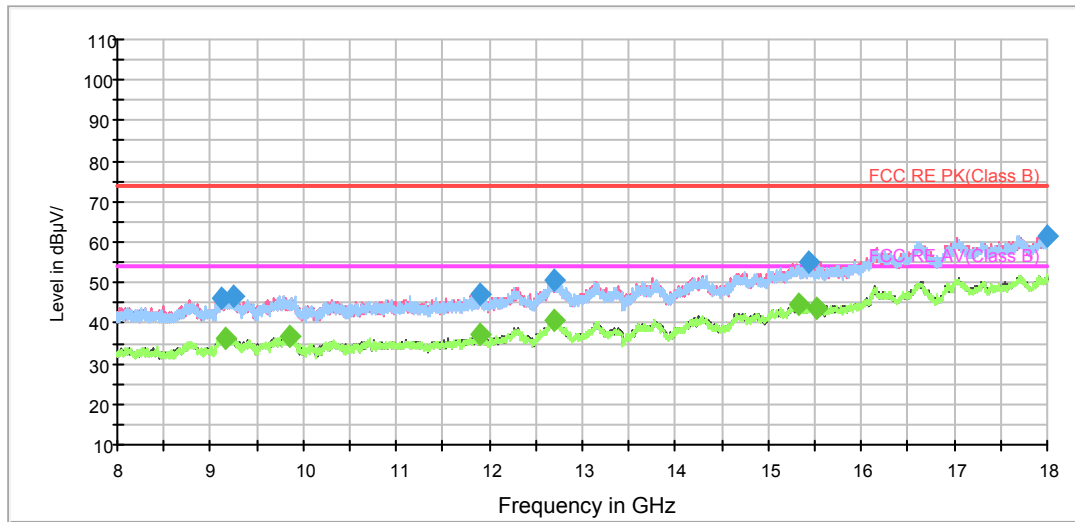

Radiates Emission from 8GHz to 18GHz

Frequency (MHz)	Peak (dBuV/m)	Height (cm)	Polarization	Azimuth (deg)	Reading value (dBuV/m)	Correct Factor (dB)	Margin (dB)	Limit (dBuV/m)
3501.875000	37.6	200.0	H	155.0	39.7	-2.1	36.4	74.0
3576.875000	48.6	200.0	V	106.0	50.8	-2.2	25.4	74.0
4886.875000	42.1	200.0	V	254.0	40.2	1.9	31.9	74.0
5810.000000	44.2	200.0	V	354.0	39.8	4.4	29.8	74.0
6300.625000	43.2	200.0	V	45.0	37.8	5.4	30.8	74.0
6975.625000	45.4	200.0	V	333.0	39.1	6.3	28.6	74.0

Remark: 1. Correction Factor = Antenna factor+ Insertion loss (cable loss + amplifier gain)

Frequency (MHz)	Average (dBuV/m)	Height (cm)	Polarization	Azimuth (deg)	Reading value (dBuV/m)	Correct Factor (dB)	Margin (dB)	Limit (dBuV/m)
3334.375000	27.2	200.0	H	0.0	29.5	-2.3	26.8	54.0
3582.500000	38.4	200.0	V	117.0	40.7	-2.3	15.6	54.0
4847.500000	32.8	200.0	V	275.0	31.2	1.6	21.2	54.0
6315.625000	32.0	200.0	H	77.0	26.7	5.3	22.0	54.0
6763.750000	34.2	200.0	V	195.0	28.7	5.5	19.8	54.0
6920.000000	38.8	200.0	V	275.0	32.6	6.2	15.2	54.0

Remark: 1. Correction Factor = Antenna factor+ Insertion loss (cable loss + amplifier gain)

802.11n (HT40) CH46

RE 1G-3GHz PK+AV

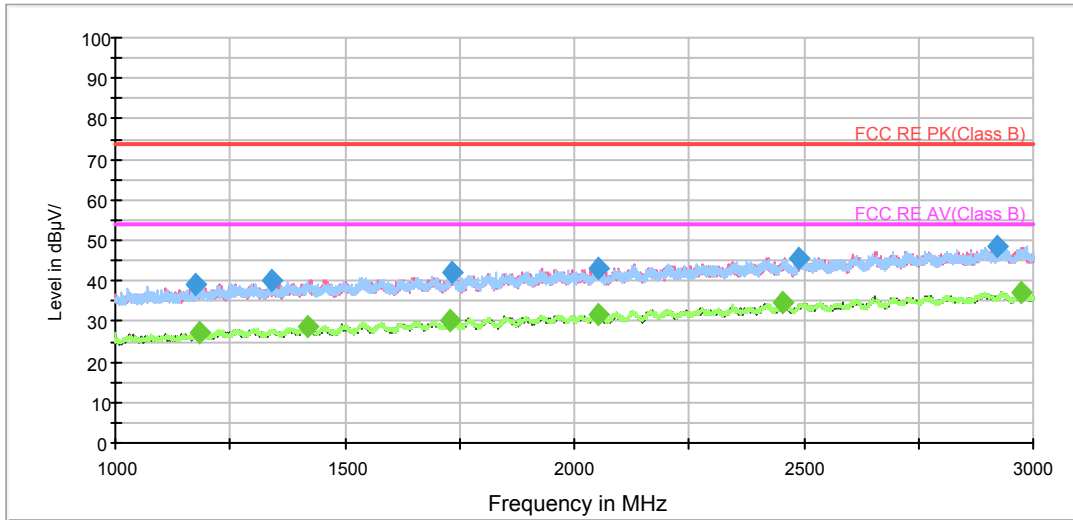

Radiates Emission from 1GHz to 3GHz

RE 3-18GHz PK+AV

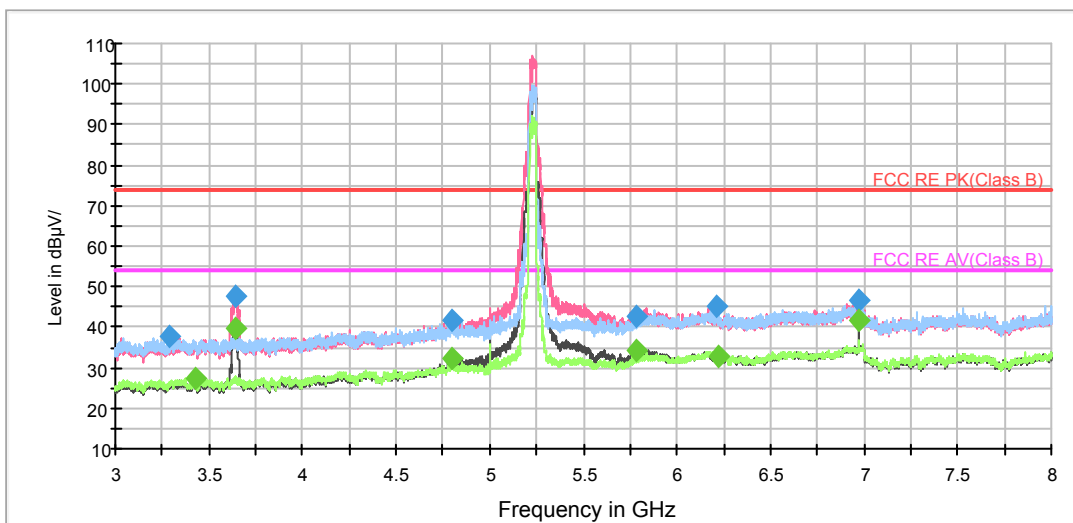

Note: The signal beyond the limit is carrier.

Radiates Emission from 3GHz to 8GHz

RE 3-18GHz PK+AV

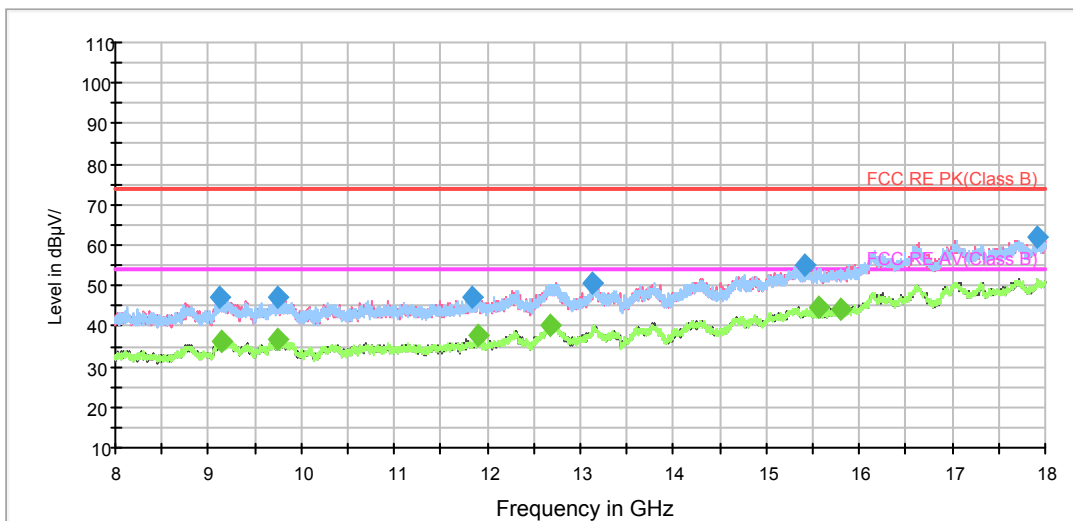

Radiates Emission from 8GHz to 18GHz

Frequency (MHz)	Peak (dBuV/m)	Height (cm)	Polarization	Azimuth (deg)	Reading value (dBuV/m)	Correct Factor (dB)	Margin (dB)	Limit (dBuV/m)
3293.750000	37.5	200.0	H	117.0	39.7	-2.2	36.5	74.0
3640.000000	47.8	200.0	V	119.0	49.6	-1.8	26.2	74.0
4796.875000	41.5	200.0	V	286.0	40.2	1.3	32.5	74.0
5781.250000	42.9	200.0	V	159.0	38.9	4.0	31.1	74.0
6216.875000	45.1	200.0	H	117.0	39.7	5.4	28.9	74.0
6973.125000	46.7	200.0	V	276.0	40.4	6.3	27.3	74.0

Remark: 1. Correction Factor = Antenna factor+ Insertion loss (cable loss + amplifier gain)

Frequency (MHz)	Average (dBuV/m)	Height (cm)	Polarization	Azimuth (deg)	Reading value (dBuV/m)	Correct Factor (dB)	Margin (dB)	Limit (dBuV/m)
3425.625000	27.2	200.0	H	98.0	29.7	-2.5	26.8	54.0
3640.625000	39.8	200.0	V	108.0	41.6	-1.8	14.2	54.0
4800.000000	32.1	200.0	V	0.0	30.8	1.3	21.9	54.0
5781.875000	34.1	200.0	V	266.0	30.1	4.0	19.9	54.0
6219.375000	32.9	200.0	H	127.0	27.5	5.4	21.1	54.0
6973.750000	41.9	200.0	V	266.0	35.6	6.3	12.1	54.0

Remark: 1. Correction Factor = Antenna factor+ Insertion loss (cable loss + amplifier gain)

802.11n (HT40) CH54

RE 1G-3GHz PK+AV

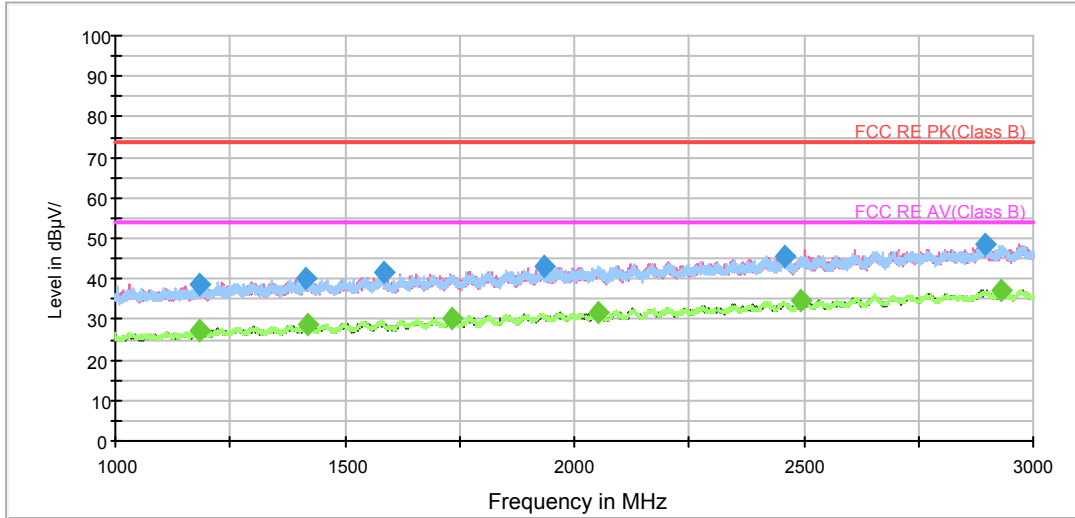

Radiates Emission from 1GHz to 3GHz

RE 3-18GHz PK+AV

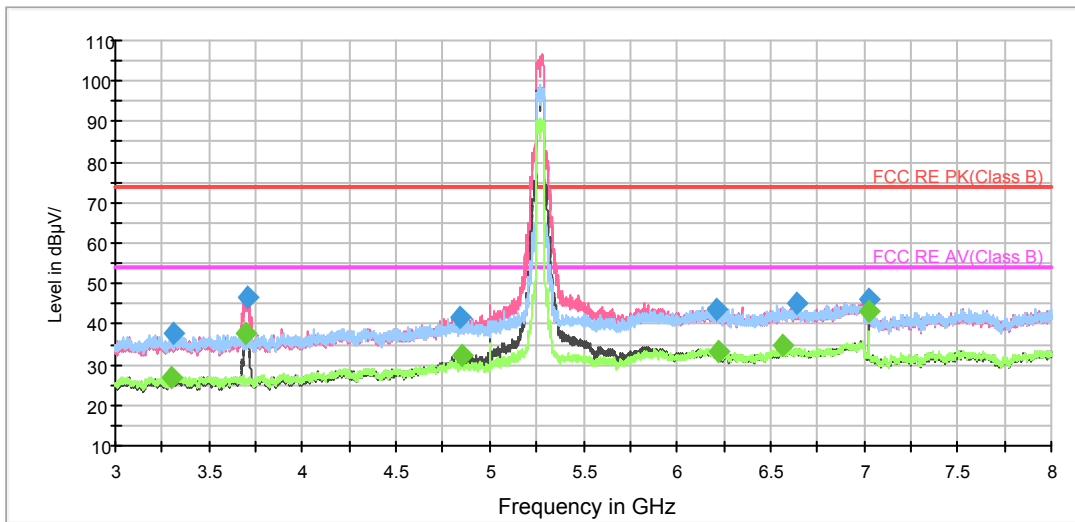

Note: The signal beyond the limit is carrier.

Radiates Emission from 3GHz to 8GHz

RE 3-18GHz PK+AV

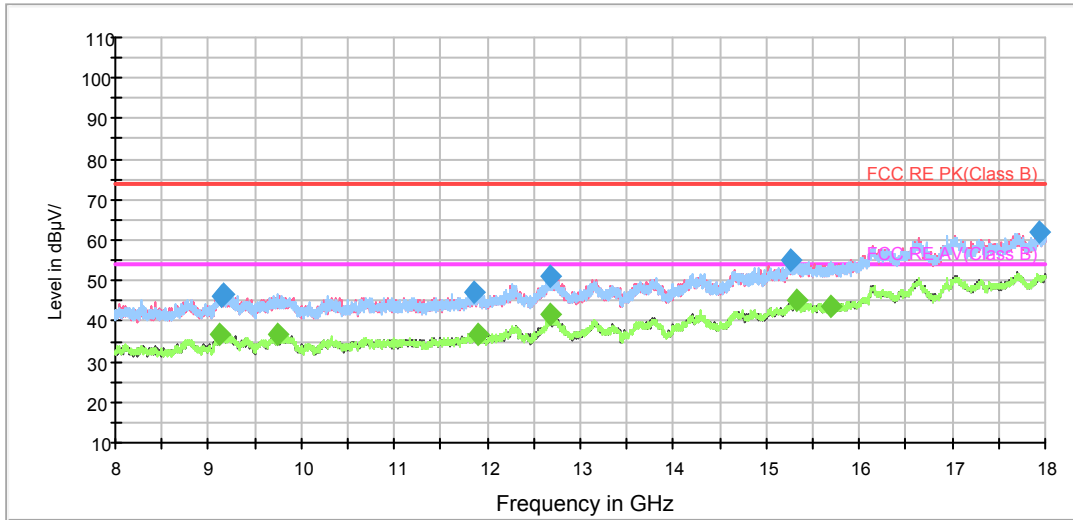

Radiates Emission from 8GHz to 18GHz

Frequency (MHz)	Peak (dBuV/m)	Height (cm)	Polarization	Azimuth (deg)	Reading value (dBuV/m)	Correct Factor (dB)	Margin (dB)	Limit (dBuV/m)
3312.500000	37.6	200.0	H	184.0	39.7	-2.1	36.4	74.0
3702.500000	46.4	200.0	V	108.0	48.0	-1.6	27.6	74.0
4844.375000	41.5	200.0	V	305.0	39.9	1.6	32.5	74.0
6211.250000	43.5	200.0	V	356.0	38.1	5.4	30.5	74.0
6641.875000	45.2	200.0	H	125.0	39.7	5.5	28.8	74.0
7026.875000	46.1	200.0	V	266.0	39.7	6.4	27.9	74.0

Remark: 1. Correction Factor = Antenna factor+ Insertion loss (cable loss + amplifier gain)

Frequency (MHz)	Average (dBuV/m)	Height (cm)	Polarization	Azimuth (deg)	Reading value (dBuV/m)	Correct Factor (dB)	Margin (dB)	Limit (dBuV/m)
3301.875000	27.0	200.0	H	164.0	29.2	-2.2	27.0	54.0
3700.625000	37.7	200.0	V	108.0	39.3	-1.6	16.3	54.0
4848.125000	32.3	200.0	V	347.0	30.7	1.6	21.7	54.0
6218.750000	33.5	200.0	H	193.0	28.1	5.4	20.5	54.0
6568.750000	34.7	200.0	V	334.0	29.0	5.7	19.3	54.0
7026.875000	43.4	200.0	V	266.0	37.0	6.4	10.6	54.0

Remark: 1. Correction Factor = Antenna factor+ Insertion loss (cable loss + amplifier gain)

802.11n (HT40) CH62

RE 1G-3GHz PK+AV

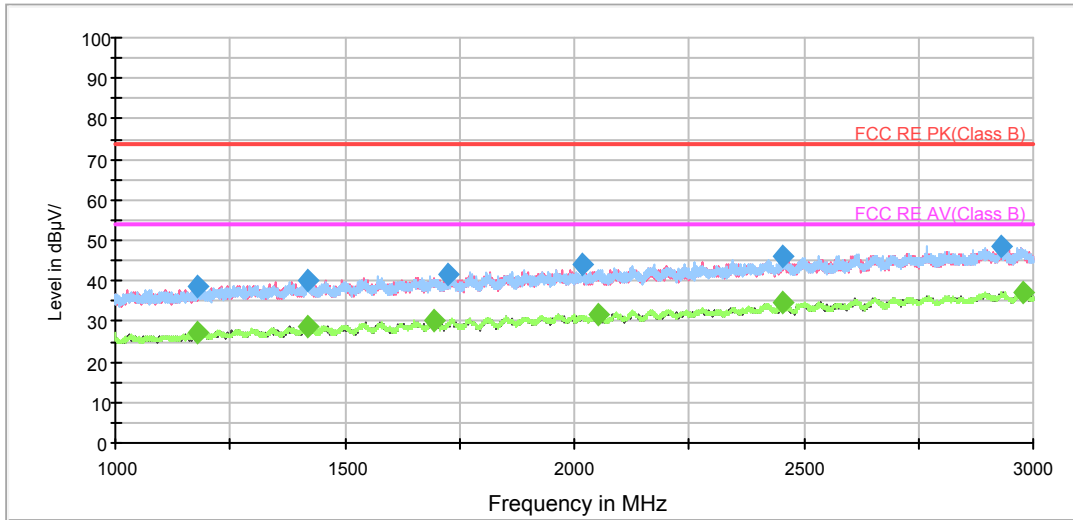

Radiates Emission from 1GHz to 3GHz

RE 3-18GHz PK+AV

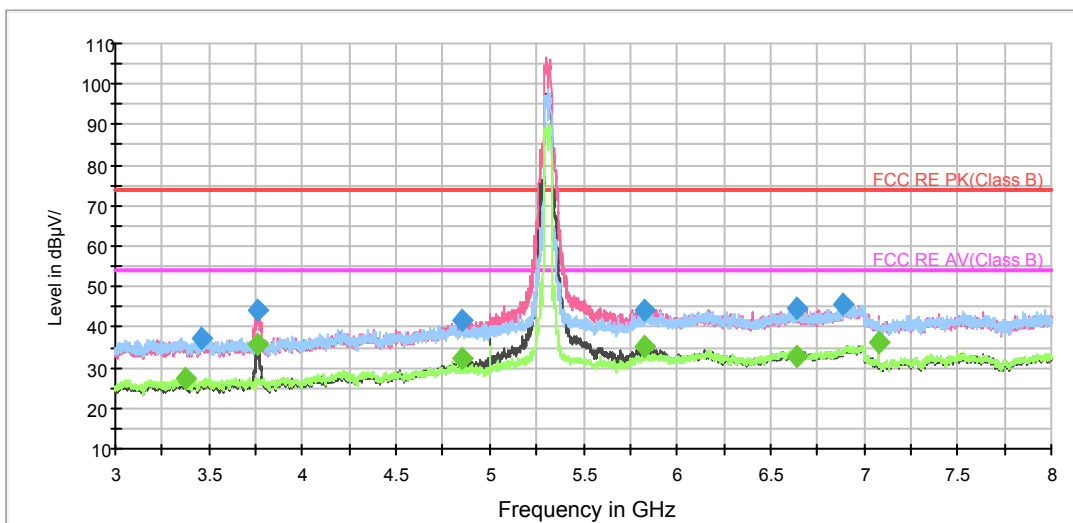

Note: The signal beyond the limit is carrier.

Radiates Emission from 3GHz to 8GHz

RE 3-18GHz PK+AV

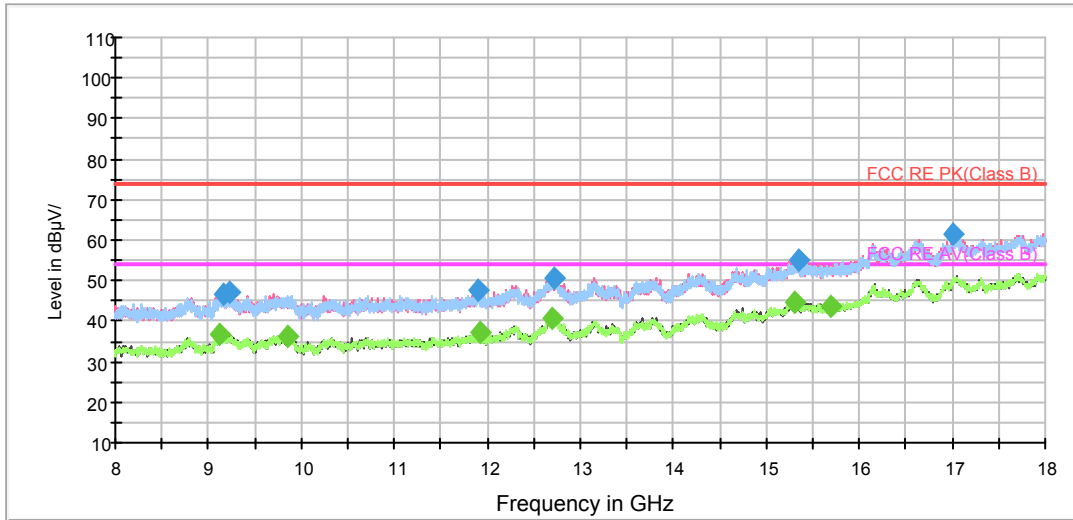

Radiates Emission from 8GHz to 18GHz

Frequency (MHz)	Peak (dBuV/m)	Height (cm)	Polarization	Azimuth (deg)	Reading value (dBuV/m)	Correct Factor (dB)	Margin (dB)	Limit (dBuV/m)
3461.250000	37.1	200.0	V	276.0	39.3	-2.2	36.9	74.0
3758.125000	44.2	200.0	V	129.0	45.8	-1.6	29.8	74.0
4850.000000	41.5	200.0	V	347.0	39.9	1.6	32.5	74.0
5821.875000	44.1	200.0	V	276.0	39.6	4.5	29.9	74.0
6643.125000	44.8	200.0	V	168.0	39.3	5.5	29.2	74.0
6891.250000	45.7	200.0	H	95.0	39.6	6.1	28.3	74.0

Remark: 1. Correction Factor = Antenna factor+ Insertion loss (cable loss + amplifier gain)

Frequency (MHz)	Average (dBuV/m)	Height (cm)	Polarization	Azimuth (deg)	Reading value (dBuV/m)	Correct Factor (dB)	Margin (dB)	Limit (dBuV/m)
3370.000000	27.3	200.0	H	33.0	29.8	-2.5	26.7	54.0
3756.250000	35.7	200.0	V	129.0	37.3	-1.6	18.3	54.0
4848.125000	32.1	200.0	V	10.0	30.5	1.6	21.9	54.0
5828.750000	35.3	200.0	V	357.0	30.8	4.5	18.7	54.0
6636.250000	32.8	200.0	V	108.0	27.3	5.5	21.2	54.0
7080.000000	36.1	200.0	V	266.0	29.9	6.2	17.9	54.0

Remark: 1. Correction Factor = Antenna factor+ Insertion loss (cable loss + amplifier gain)

802.11n (HT40) CH102

RE 1G-3GHz PK+AV

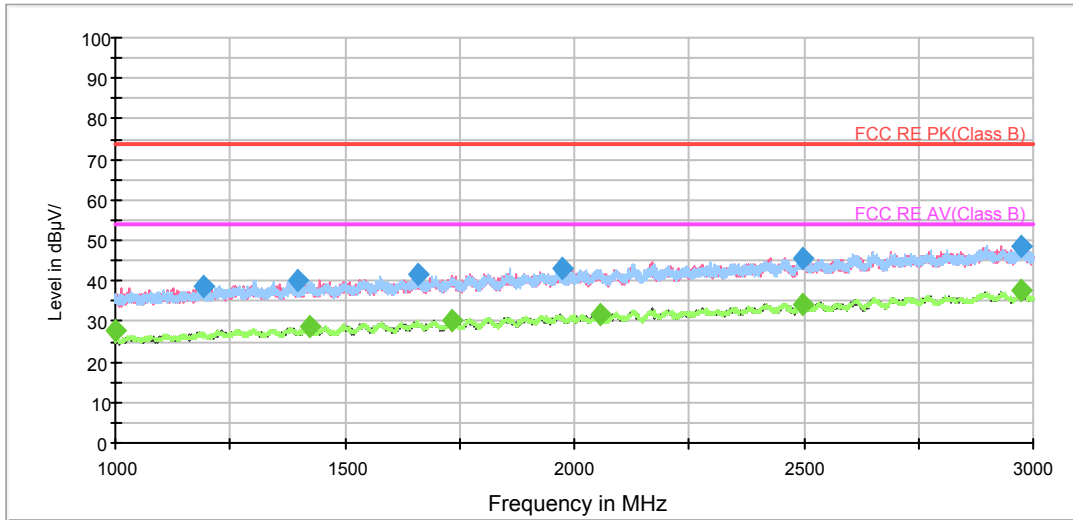

Radiates Emission from 1GHz to 3GHz

RE 3-18GHz PK+AV

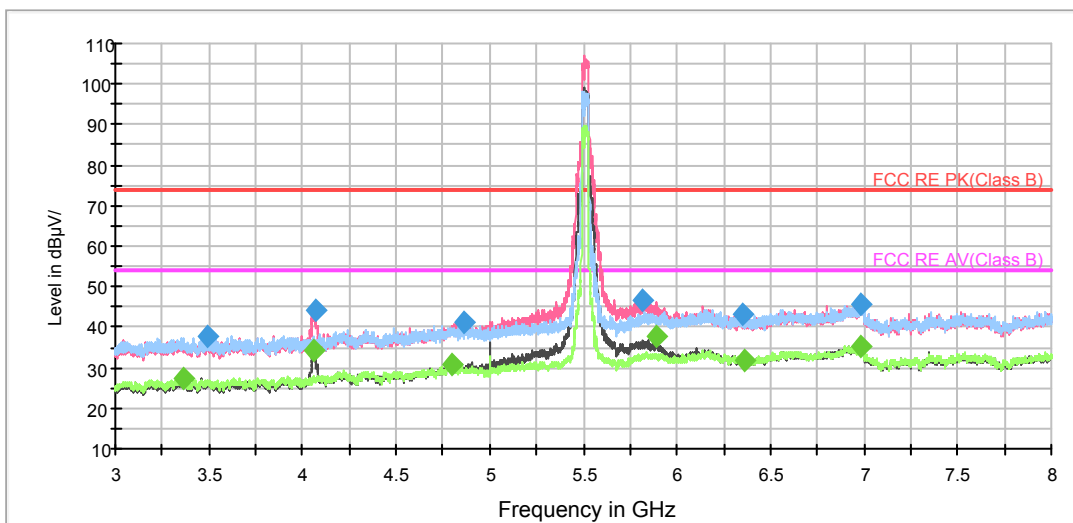

Note: The signal beyond the limit is carrier.

Radiates Emission from 3GHz to 8GHz



RE 3-18GHz PK+AV

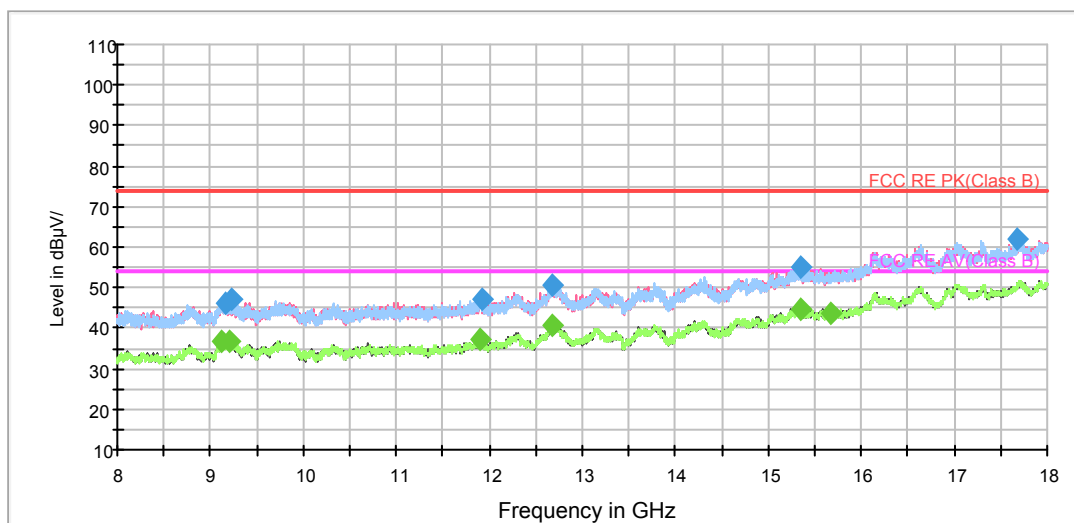

Radiates Emission from 8GHz to 18GHz

Frequency (MHz)	Peak (dBuV/m)	Height (cm)	Polarization	Azimuth (deg)	Reading value (dBuV/m)	Correct Factor (dB)	Margin (dB)	Limit (dBuV/m)
3492.500000	37.6	200.0	H	136.0	39.7	-2.1	36.4	74.0
4066.250000	44.0	200.0	V	107.0	45.0	-1.0	30.0	74.0
4860.000000	41.0	200.0	H	0.0	39.3	1.7	33.0	74.0
5820.000000	46.8	200.0	V	344.0	42.3	4.5	27.2	74.0
6348.125000	43.1	200.0	V	78.0	37.9	5.2	30.9	74.0
6987.500000	45.8	200.0	V	226.0	39.4	6.4	28.2	74.0

Remark: 1. Correction Factor = Antenna factor+ Insertion loss (cable loss + amplifier gain)

Frequency (MHz)	Average (dBuV/m)	Height (cm)	Polarization	Azimuth (deg)	Reading value (dBuV/m)	Correct Factor (dB)	Margin (dB)	Limit (dBuV/m)
3358.750000	27.3	200.0	H	38.0	29.6	-2.3	26.7	54.0
4064.375000	34.2	200.0	V	107.0	35.3	-1.1	19.8	54.0
4800.000000	30.8	200.0	V	275.0	29.5	1.3	23.2	54.0
5894.375000	37.8	200.0	V	275.0	32.9	4.9	16.2	54.0
6358.750000	31.9	200.0	V	265.0	26.9	5.0	22.1	54.0
6982.500000	35.3	200.0	V	334.0	28.9	6.4	18.7	54.0

Remark: 1. Correction Factor = Antenna factor+ Insertion loss (cable loss + amplifier gain)

802.11n (HT40) CH118

RE 1G-3GHz PK+AV

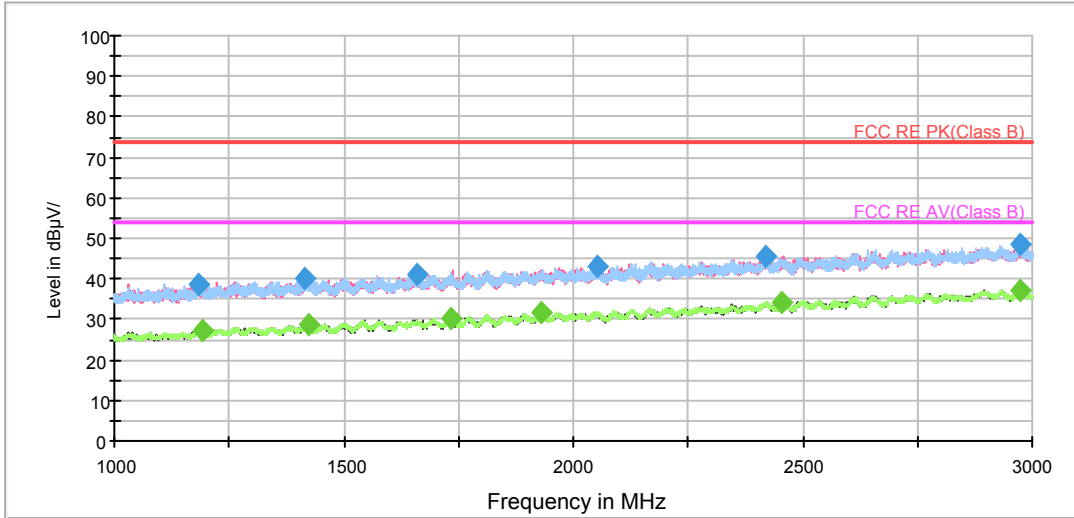

Radiates Emission from 1GHz to 3GHz

RE 3-18GHz PK+AV

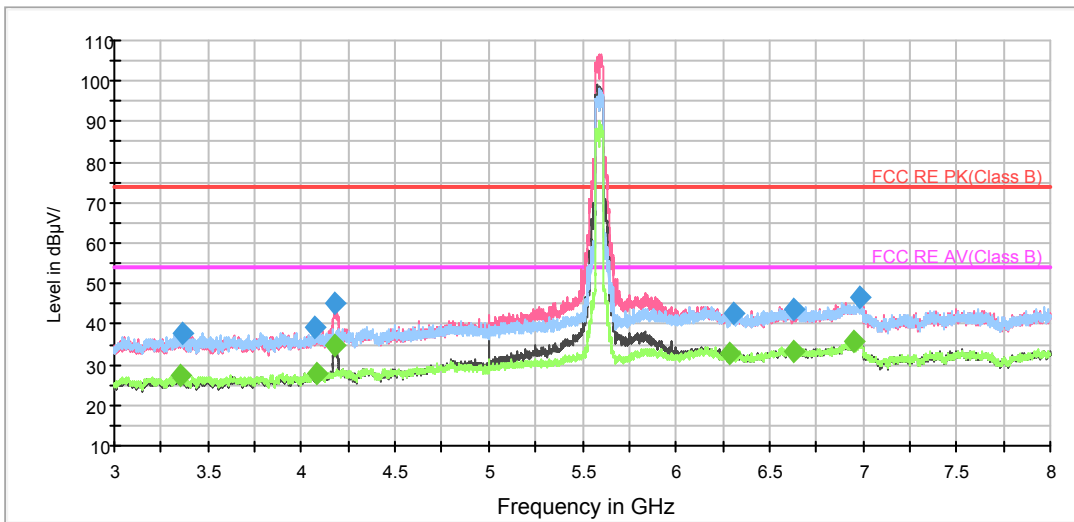

Note: The signal beyond the limit is carrier.

Radiates Emission from 3GHz to 8GHz



RE 3-18GHz PK+AV

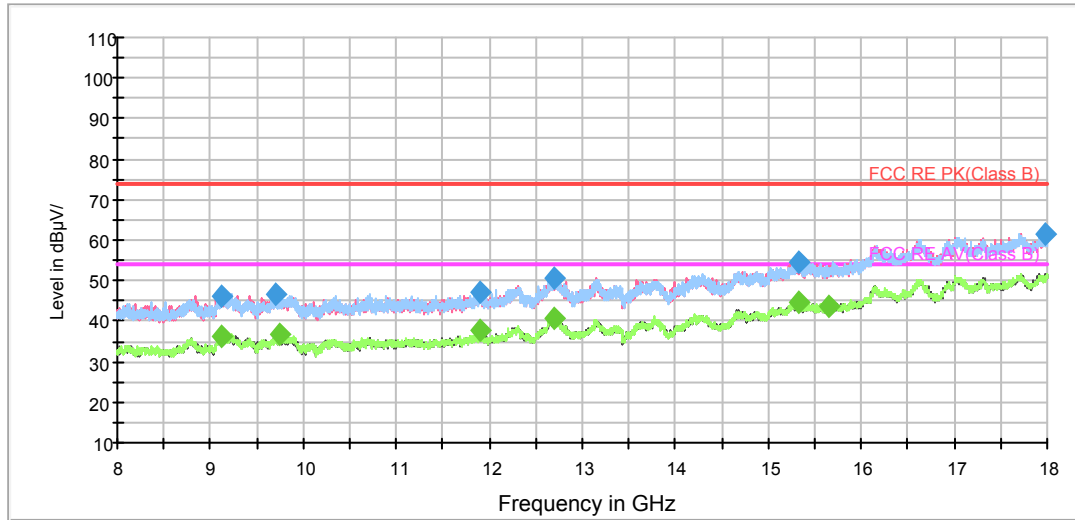

Radiates Emission from 8GHz to 18GHz

Frequency (MHz)	Peak (dBuV/m)	Height (cm)	Polarization	Azimuth (deg)	Reading value (dBuV/m)	Correct Factor (dB)	Margin (dB)	Limit (dBuV/m)
3366.250000	37.6	200.0	H	312.0	40.0	-2.4	36.4	74.0
4075.625000	39.0	200.0	V	248.0	39.9	-0.9	35.0	74.0
4178.750000	44.9	200.0	V	218.0	44.8	0.1	29.1	74.0
6306.250000	42.8	200.0	V	208.0	37.4	5.4	31.2	74.0
6625.625000	43.5	200.0	H	103.0	38.0	5.5	30.5	74.0
6982.500000	46.6	200.0	V	248.0	40.2	6.4	27.4	74.0

Remark: 1. Correction Factor = Antenna factor+ Insertion loss (cable loss + amplifier gain)

Frequency (MHz)	Average (dBuV/m)	Height (cm)	Polarization	Azimuth (deg)	Reading value (dBuV/m)	Correct Factor (dB)	Margin (dB)	Limit (dBuV/m)
3357.500000	27.2	200.0	H	0.0	29.5	-2.3	26.8	54.0
4081.250000	28.0	200.0	H	36.0	28.9	-0.9	26.0	54.0
4178.125000	34.6	200.0	V	59.0	34.5	0.1	19.4	54.0
6290.625000	32.9	200.0	V	276.0	27.5	5.4	21.1	54.0
6626.250000	33.5	200.0	H	55.0	28.0	5.5	20.5	54.0
6952.500000	35.6	200.0	V	0.0	29.4	6.2	18.4	54.0

Remark: 1. Correction Factor = Antenna factor+ Insertion loss (cable loss + amplifier gain)

802.11n (HT40) CH134

RE 1G-3GHz PK+AV

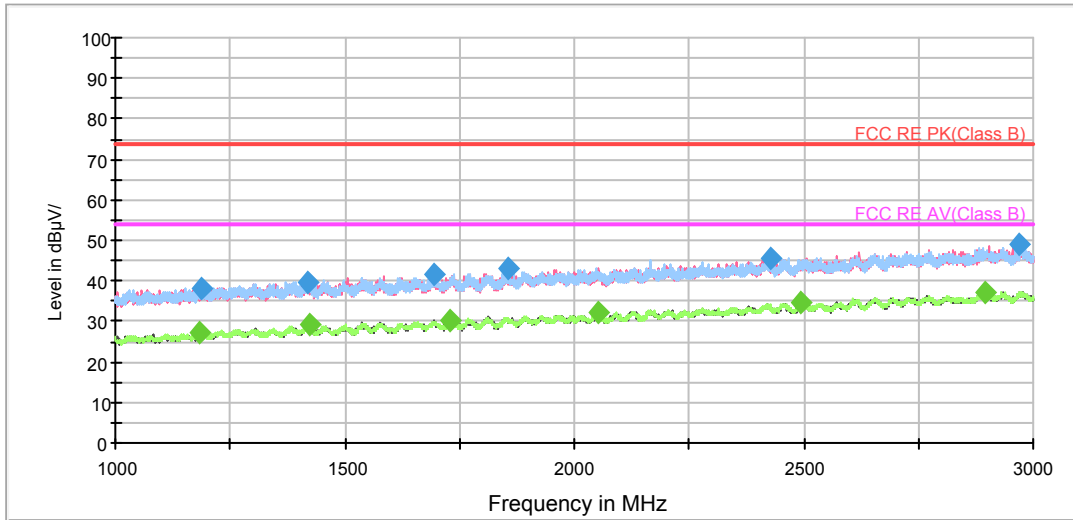

Radiates Emission from 1GHz to 3GHz

RE 3-18GHz PK+AV

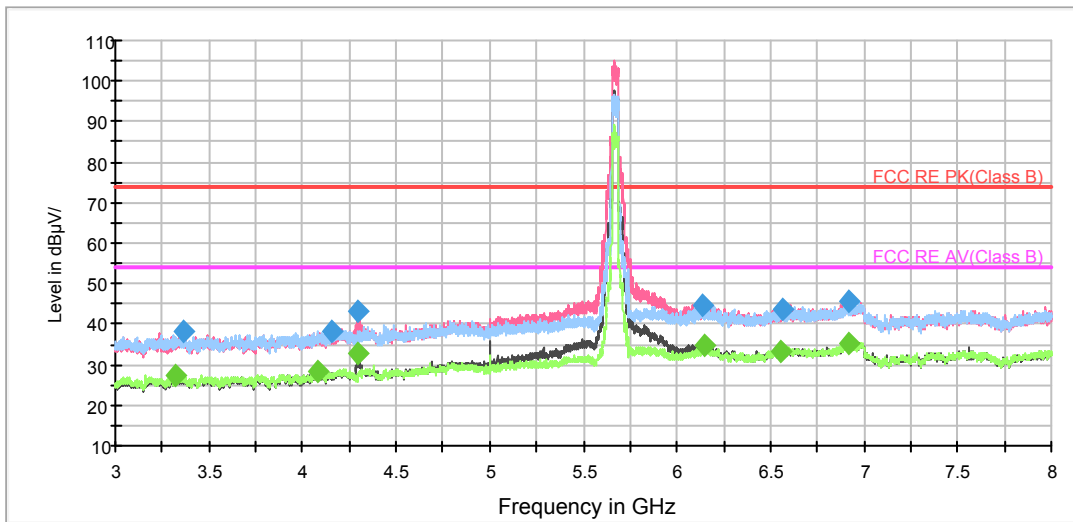

Note: The signal beyond the limit is carrier.

Radiates Emission from 3GHz to 8GHz

RE 3-18GHz PK+AV

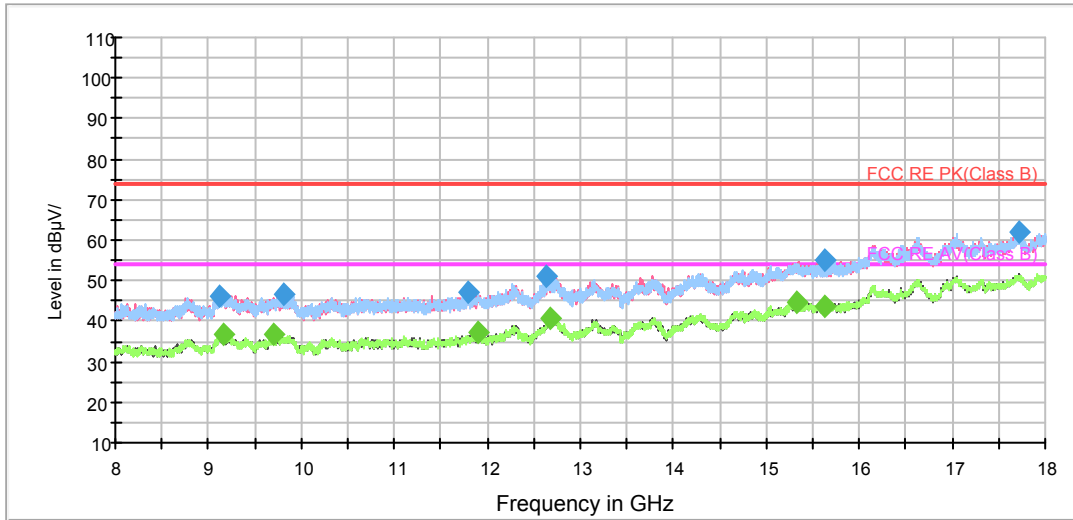

Radiates Emission from 8GHz to 18GHz

Frequency (MHz)	Peak (dBuV/m)	Height (cm)	Polarization	Azimuth (deg)	Reading value (dBuV/m)	Correct Factor (dB)	Margin (dB)	Limit (dBuV/m)
3361.250000	38.2	200.0	H	64.0	40.5	-2.3	35.8	74.0
4154.375000	38.4	200.0	V	207.0	38.5	-0.1	35.6	74.0
4296.250000	43.1	200.0	V	0.0	42.3	0.8	30.9	74.0
6138.125000	44.5	200.0	V	306.0	39.1	5.4	29.5	74.0
6565.000000	43.6	200.0	V	316.0	37.9	5.7	30.4	74.0
6916.250000	45.6	200.0	H	153.0	39.4	6.2	28.4	74.0

Remark: 1. Correction Factor = Antenna factor+ Insertion loss (cable loss + amplifier gain)

Frequency (MHz)	Average (dBuV/m)	Height (cm)	Polarization	Azimuth (deg)	Reading value (dBuV/m)	Correct Factor (dB)	Margin (dB)	Limit (dBuV/m)
3317.500000	27.3	200.0	V	336.0	29.4	-2.1	26.7	54.0
4083.750000	28.3	200.0	H	264.0	29.2	-0.9	25.7	54.0
4300.000000	32.7	200.0	V	158.0	31.8	0.9	21.3	54.0
6145.625000	34.7	200.0	V	267.0	29.3	5.4	19.3	54.0
6558.750000	33.0	200.0	V	118.0	27.2	5.8	21.0	54.0
6914.375000	35.2	200.0	H	104.0	29.0	6.2	18.8	54.0

Remark: 1. Correction Factor = Antenna factor+ Insertion loss (cable loss + amplifier gain)

802.11n (HT40) CH151

RE 1G-3GHz PK+AV

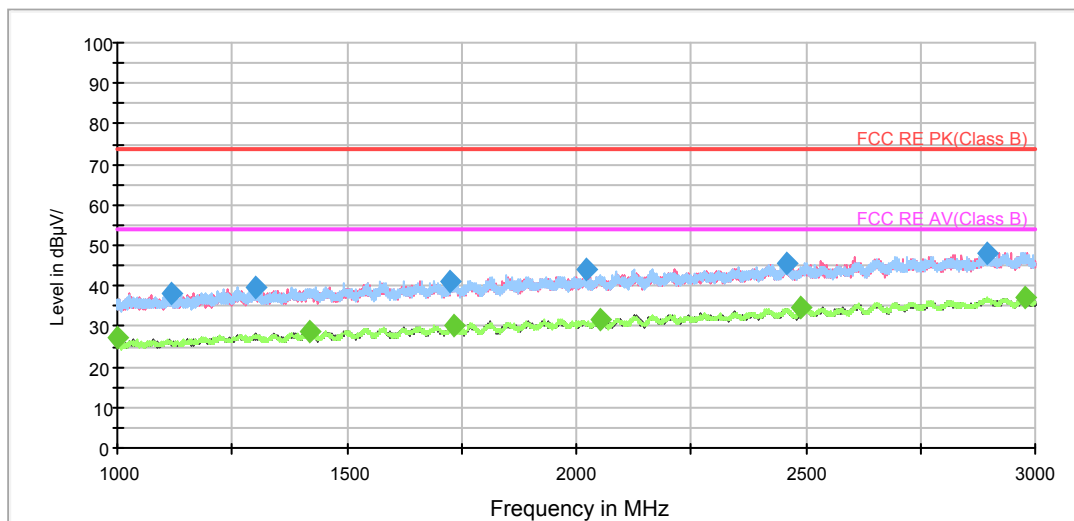

Radiates Emission from 1GHz to 3GHz

RE 3-18GHz PK+AV

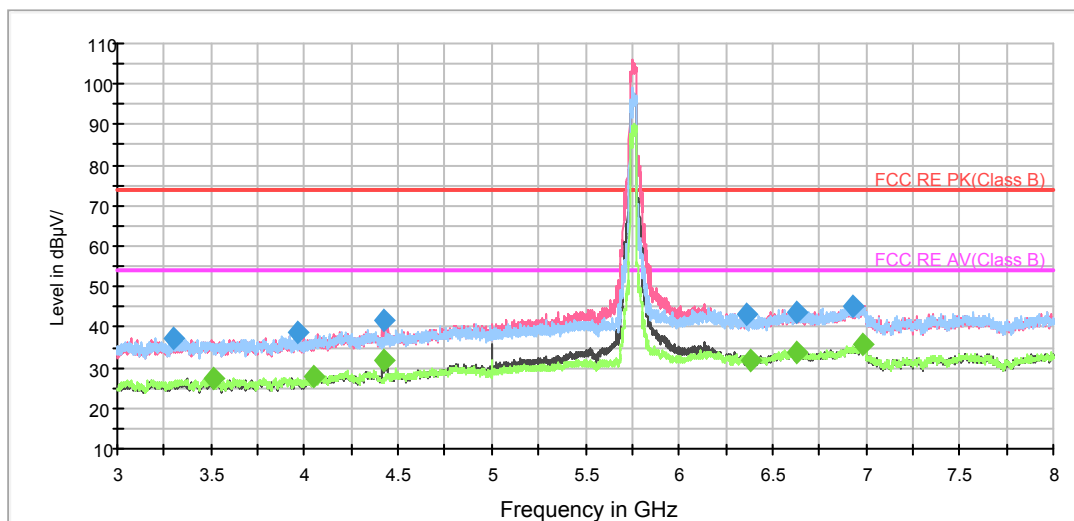

Note: The signal beyond the limit is carrier.

Radiates Emission from 3GHz to 8GHz

RE 3-18GHz PK+AV

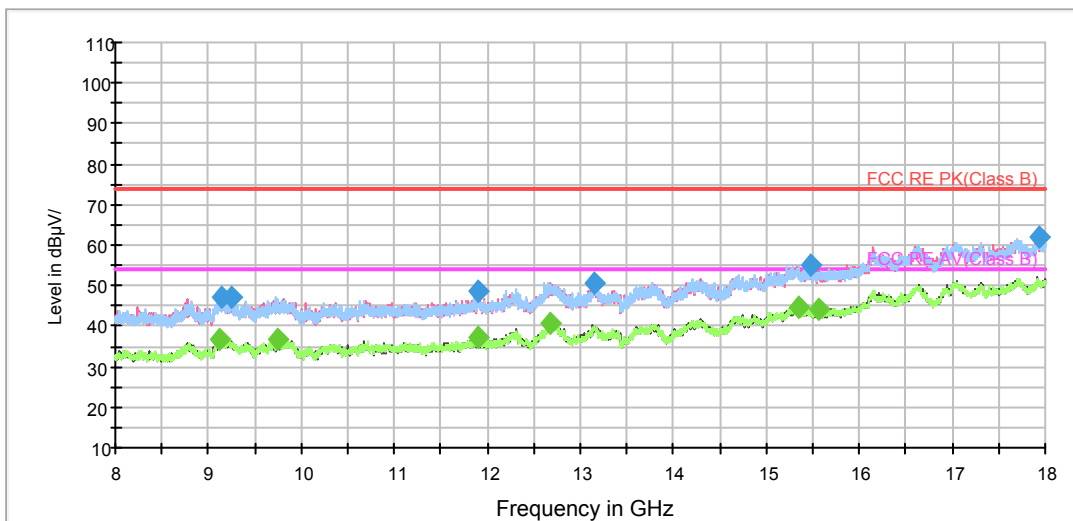

Radiates Emission from 8GHz to 18GHz

Frequency (MHz)	Peak (dBuV/m)	Height (cm)	Polarization	Azimuth (deg)	Reading value (dBuV/m)	Correct Factor (dB)	Margin (dB)	Limit (dBuV/m)
3300.625000	37.3	200.0	V	118.0	39.5	-2.2	36.7	74.0
3965.000000	38.5	200.0	V	314.0	39.5	-1.0	35.5	74.0
4425.625000	41.9	200.0	V	22.0	41.7	0.2	32.1	74.0
6361.250000	43.3	200.0	V	66.0	38.3	5.0	30.7	74.0
6624.375000	43.7	200.0	H	75.0	38.2	5.5	30.3	74.0
6925.000000	45.1	200.0	V	0.0	38.9	6.2	28.9	74.0

Remark: 1. Correction Factor = Antenna factor+ Insertion loss (cable loss + amplifier gain)

Frequency (MHz)	Average (dBuV/m)	Height (cm)	Polarization	Azimuth (deg)	Reading value (dBuV/m)	Correct Factor (dB)	Margin (dB)	Limit (dBuV/m)
3510.625000	27.6	200.0	H	18.0	29.6	-2.0	26.4	54.0
4051.875000	28.0	200.0	H	225.0	29.1	-1.1	26.0	54.0
4428.125000	31.9	200.0	V	9.0	31.7	0.2	22.1	54.0
6378.125000	31.9	200.0	V	354.0	26.9	5.0	22.1	54.0
6629.375000	33.7	200.0	V	226.0	28.2	5.5	20.3	54.0
6982.500000	35.7	200.0	H	164.0	29.3	6.4	18.3	54.0

Remark: 1. Correction Factor = Antenna factor+ Insertion loss (cable loss + amplifier gain)

802.11n (HT40) CH159

RE 1G-3GHz PK+AV

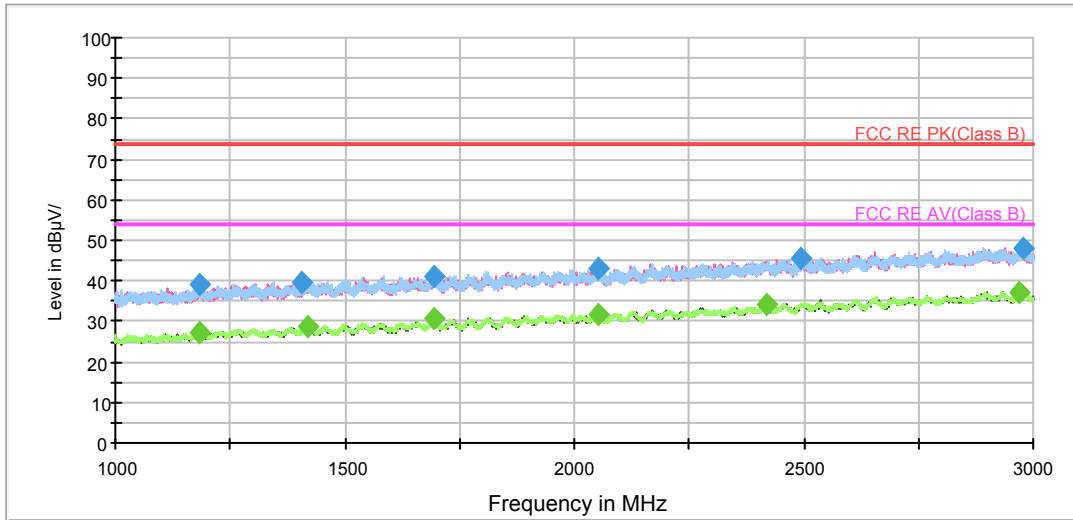

Radiates Emission from 1GHz to 3GHz

RE 3-18GHz PK+AV

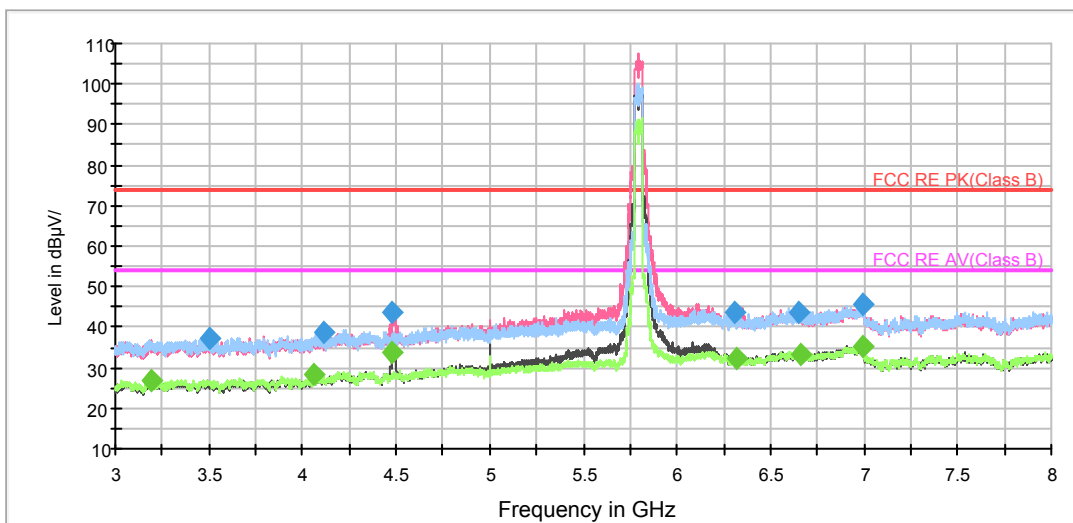

Note: The signal beyond the limit is carrier.

Radiates Emission from 3GHz to 8GHz

RE 3-18GHz PK+AV

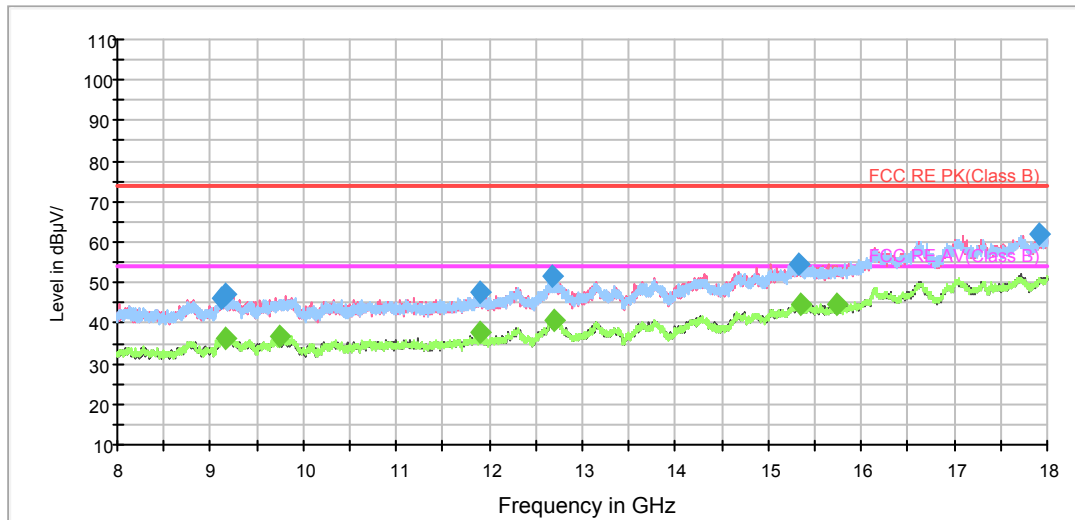

Radiates Emission from 8GHz to 18GHz

Frequency (MHz)	Peak (dBuV/m)	Height (cm)	Polarization	Azimuth (deg)	Reading value (dBuV/m)	Correct Factor (dB)	Margin (dB)	Limit (dBuV/m)
3498.750000	37.1	200.0	H	114.0	39.2	-2.1	36.9	74.0
4113.125000	38.6	200.0	V	186.0	39.3	-0.7	35.4	74.0
4482.500000	43.9	200.0	V	34.0	43.4	0.5	30.1	74.0
6306.250000	43.6	200.0	V	245.0	38.2	5.4	30.4	74.0
6650.625000	43.6	200.0	H	304.0	38.1	5.5	30.4	74.0
6998.125000	45.6	200.0	H	114.0	39.1	6.5	28.4	74.0

Remark: 1. Correction Factor = Antenna factor+ Insertion loss (cable loss + amplifier gain)

Frequency (MHz)	Average (dBuV/m)	Height (cm)	Polarization	Azimuth (deg)	Reading value (dBuV/m)	Correct Factor (dB)	Margin (dB)	Limit (dBuV/m)
3188.125000	27.0	200.0	H	75.0	29.9	-2.9	27.0	54.0
4056.875000	28.1	200.0	H	17.0	29.2	-1.1	25.9	54.0
4481.875000	33.8	200.0	V	9.0	33.3	0.5	20.2	54.0
6320.625000	32.4	200.0	V	137.0	27.1	5.3	21.6	54.0
6660.000000	33.4	200.0	V	0.0	27.9	5.5	20.6	54.0
6996.875000	35.3	200.0	V	77.0	28.8	6.5	18.7	54.0

Remark: 1. Correction Factor = Antenna factor+ Insertion loss (cable loss + amplifier gain)

802.11ac (HT80) CH42

RE 1G-3GHz PK+AV

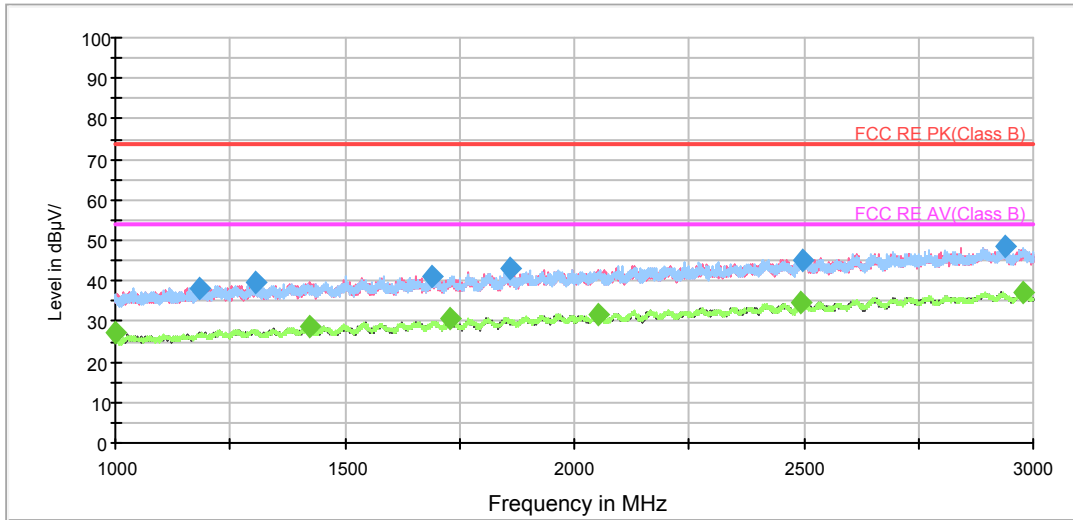

Radiates Emission from 1GHz to 3GHz

RE 3-18GHz PK+AV

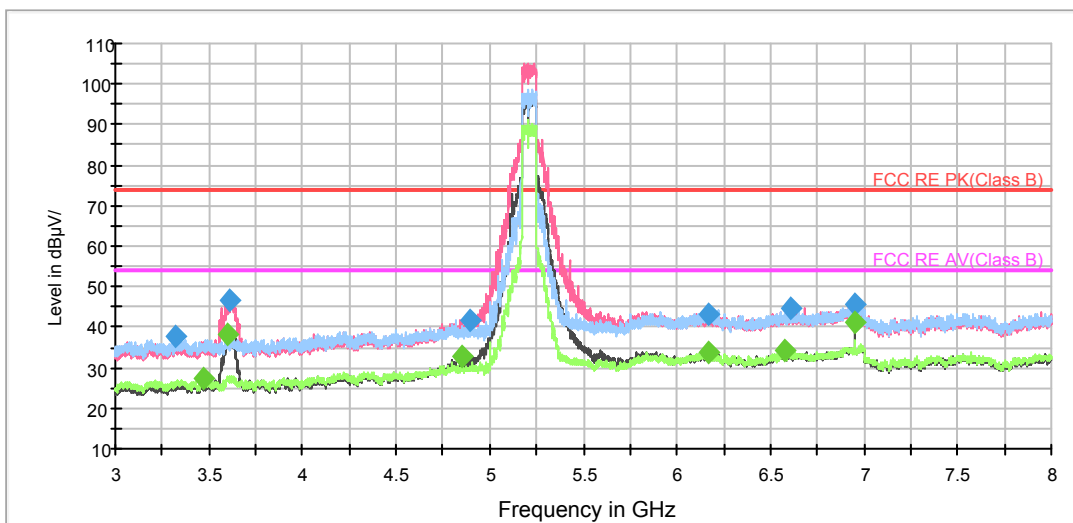

Note: The signal beyond the limit is carrier.

Radiates Emission from 3GHz to 8GHz

RE 3-18GHz PK+AV

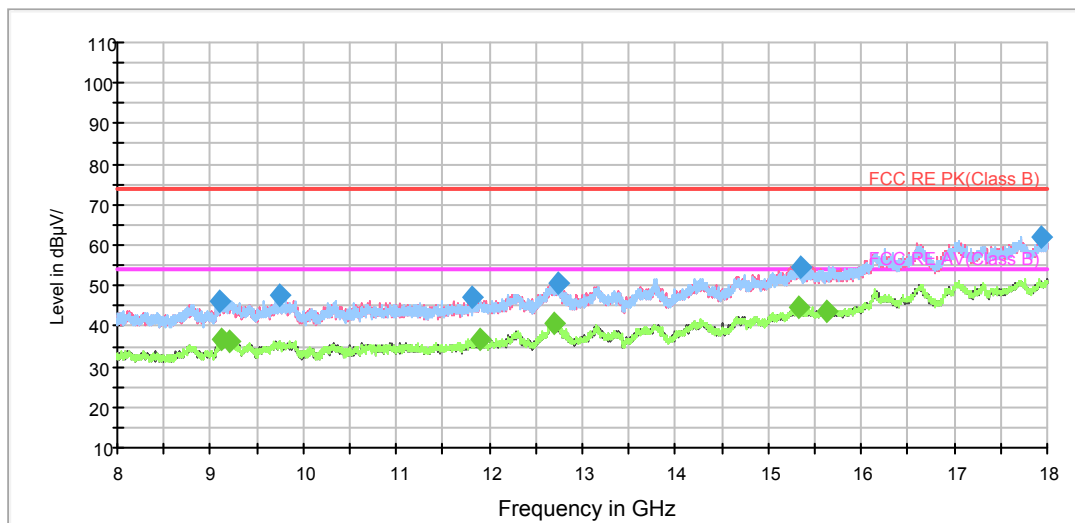

Radiates Emission from 8GHz to 18GHz

Frequency (MHz)	Peak (dBuV/m)	Height (cm)	Polarization	Azimuth (deg)	Reading value (dBuV/m)	Correct Factor (dB)	Margin (dB)	Limit (dBuV/m)
3325.000000	37.8	200.0	H	210.0	39.9	-2.1	36.2	74.0
3612.500000	46.8	200.0	V	309.0	48.9	-2.1	27.2	74.0
4891.250000	41.8	200.0	H	4.0	39.9	1.9	32.2	74.0
6172.500000	43.2	200.0	V	280.0	37.7	5.5	30.8	74.0
6606.875000	44.8	200.0	V	231.0	39.2	5.6	29.2	74.0
6946.875000	45.7	200.0	V	270.0	39.5	6.2	28.3	74.0

Remark: 1. Correction Factor = Antenna factor+ Insertion loss (cable loss + amplifier gain)

Frequency (MHz)	Average (dBuV/m)	Height (cm)	Polarization	Azimuth (deg)	Reading value (dBuV/m)	Correct Factor (dB)	Margin (dB)	Limit (dBuV/m)
3468.750000	27.2	200.0	H	53.0	29.3	-2.1	26.8	54.0
3601.250000	38.1	200.0	V	107.0	40.3	-2.2	15.9	54.0
4848.125000	32.8	200.0	V	77.0	31.2	1.6	21.2	54.0
6164.375000	33.6	200.0	H	160.0	28.0	5.6	20.4	54.0
6571.875000	34.1	200.0	H	34.0	28.5	5.6	19.9	54.0
6946.875000	41.2	200.0	V	270.0	35.0	6.2	12.8	54.0

Remark: 1. Correction Factor = Antenna factor+ Insertion loss (cable loss + amplifier gain)

802.11ac (HT80) CH58

RE 1G-3GHz PK+AV

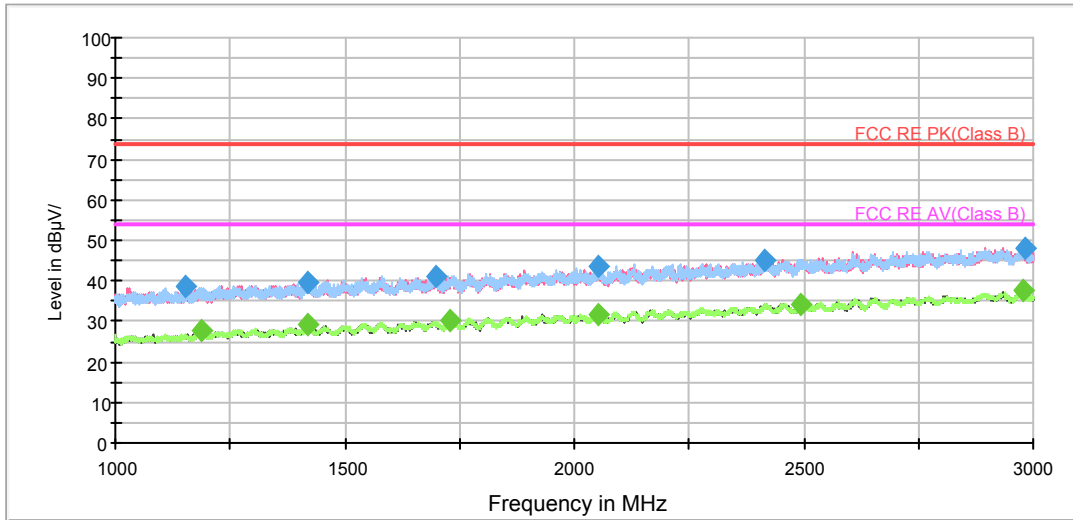

Radiates Emission from 1GHz to 3GHz

RE 3-18GHz PK+AV

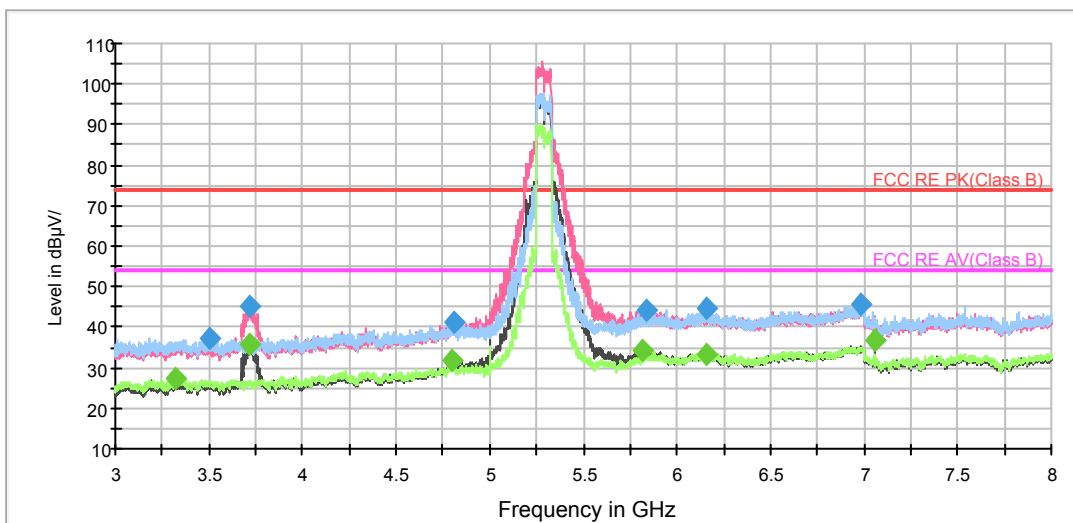

Note: The signal beyond the limit is carrier.

Radiates Emission from 3GHz to 8GHz



RE 3-18GHz PK+AV

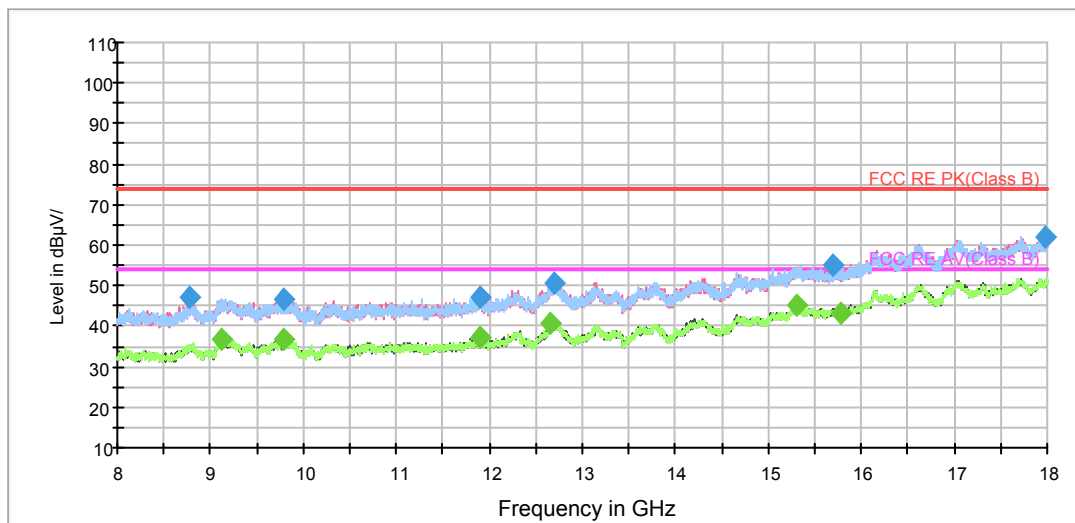

Radiates Emission from 8GHz to 18GHz

Frequency (MHz)	Peak (dBuV/m)	Height (cm)	Polarization	Azimuth (deg)	Reading value (dBuV/m)	Correct Factor (dB)	Margin (dB)	Limit (dBuV/m)
3501.875000	37.4	200.0	V	295.0	39.5	-2.1	36.6	74.0
3721.250000	45.1	200.0	V	314.0	46.7	-1.6	28.9	74.0
4809.375000	41.3	200.0	V	265.0	40.0	1.3	32.7	74.0
5835.625000	44.0	200.0	V	207.0	39.5	4.5	30.0	74.0
6156.250000	44.6	200.0	V	334.0	39.0	5.6	29.4	74.0
6983.125000	45.5	200.0	V	334.0	39.1	6.4	28.5	74.0

Remark: 1. Correction Factor = Antenna factor+ Insertion loss (cable loss + amplifier gain)

Frequency (MHz)	Average (dBuV/m)	Height (cm)	Polarization	Azimuth (deg)	Reading value (dBuV/m)	Correct Factor (dB)	Margin (dB)	Limit (dBuV/m)
3316.250000	27.3	200.0	H	0.0	29.4	-2.1	26.7	54.0
3721.250000	35.5	200.0	V	314.0	37.1	-1.6	18.5	54.0
4800.000000	31.6	200.0	V	275.0	30.3	1.3	22.4	54.0
5820.625000	34.1	200.0	V	265.0	29.6	4.5	19.9	54.0
6161.875000	33.3	200.0	V	217.0	27.7	5.6	20.7	54.0
7053.750000	36.8	200.0	V	275.0	30.6	6.2	17.2	54.0

Remark: 1. Correction Factor = Antenna factor+ Insertion loss (cable loss + amplifier gain)

802.11ac (HT80) CH106

RE 1G-3GHz PK+AV

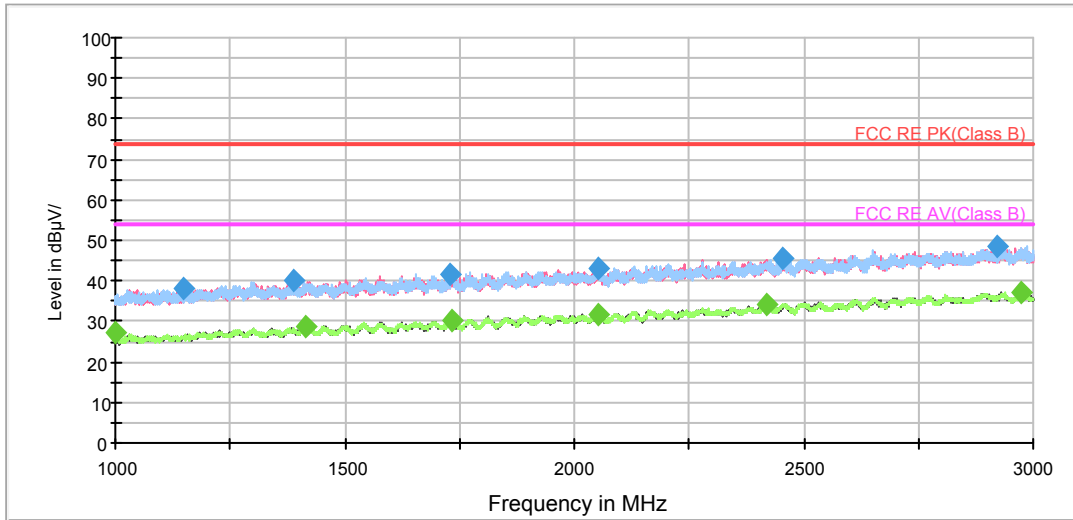

Radiates Emission from 1GHz to 3GHz

RE 3-18GHz PK+AV

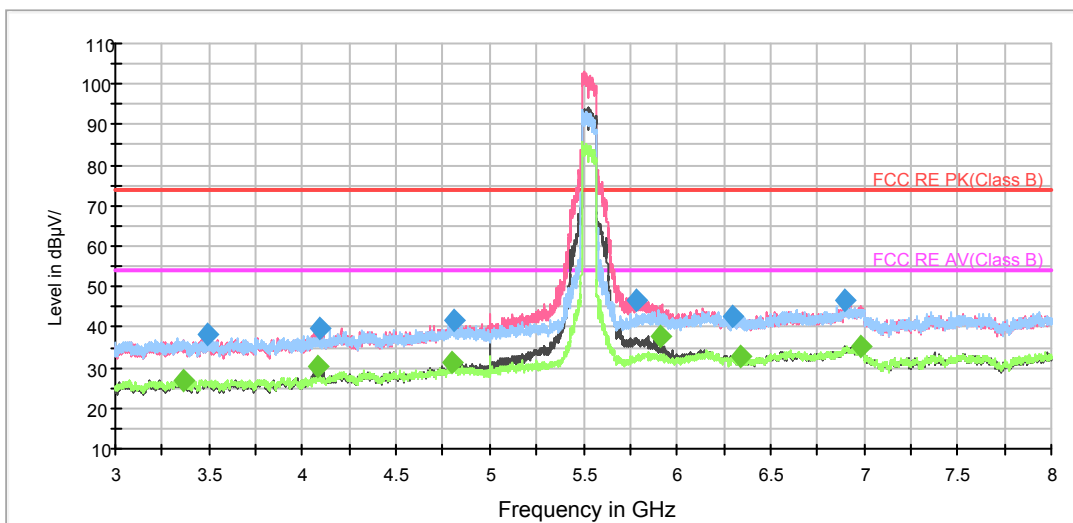

Note: The signal beyond the limit is carrier.

Radiates Emission from 3GHz to 8GHz

RE 3-18GHz PK+AV

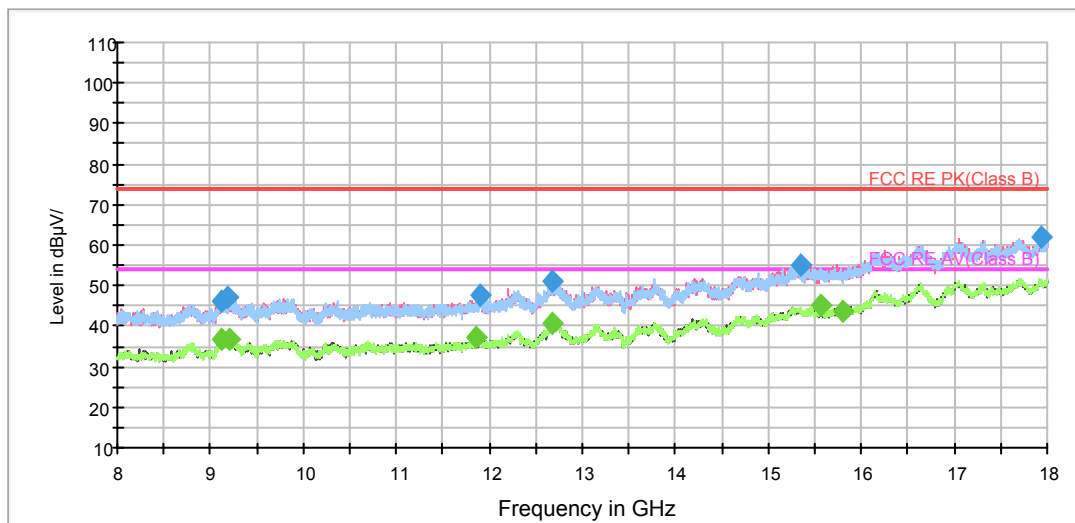

Radiates Emission from 8GHz to 18GHz

Frequency (MHz)	Peak (dBuV/m)	Height (cm)	Polarization	Azimuth (deg)	Reading value (dBuV/m)	Correct Factor (dB)	Margin (dB)	Limit (dBuV/m)
3487.500000	38.0	200.0	H	60.0	40.0	-2.0	36.0	74.0
4088.125000	39.7	200.0	V	147.0	40.6	-0.9	34.3	74.0
4808.125000	41.7	200.0	V	314.0	40.4	1.3	32.3	74.0
5784.375000	46.5	200.0	V	0.0	42.5	4.0	27.5	74.0
6301.875000	42.5	200.0	V	269.0	37.1	5.4	31.5	74.0
6900.000000	46.4	200.0	V	305.0	40.1	6.3	27.6	74.0

Remark: 1. Correction Factor = Antenna factor+ Insertion loss (cable loss + amplifier gain)

Frequency (MHz)	Average (dBuV/m)	Height (cm)	Polarization	Azimuth (deg)	Reading value (dBuV/m)	Correct Factor (dB)	Margin (dB)	Limit (dBuV/m)
3366.875000	27.1	200.0	H	40.0	29.5	-2.4	26.9	54.0
4080.625000	30.2	200.0	V	107.0	31.1	-0.9	23.8	54.0
4803.125000	31.1	200.0	V	287.0	29.8	1.3	22.9	54.0
5913.750000	37.6	200.0	V	333.0	32.7	4.9	16.4	54.0
6337.500000	32.8	200.0	V	137.0	27.4	5.4	21.2	54.0
6982.500000	35.2	200.0	V	186.0	28.8	6.4	18.8	54.0

Remark: 1. Correction Factor = Antenna factor+ Insertion loss (cable loss + amplifier gain)

802.11ac (HT80) CH122

RE 1G-3GHz PK+AV

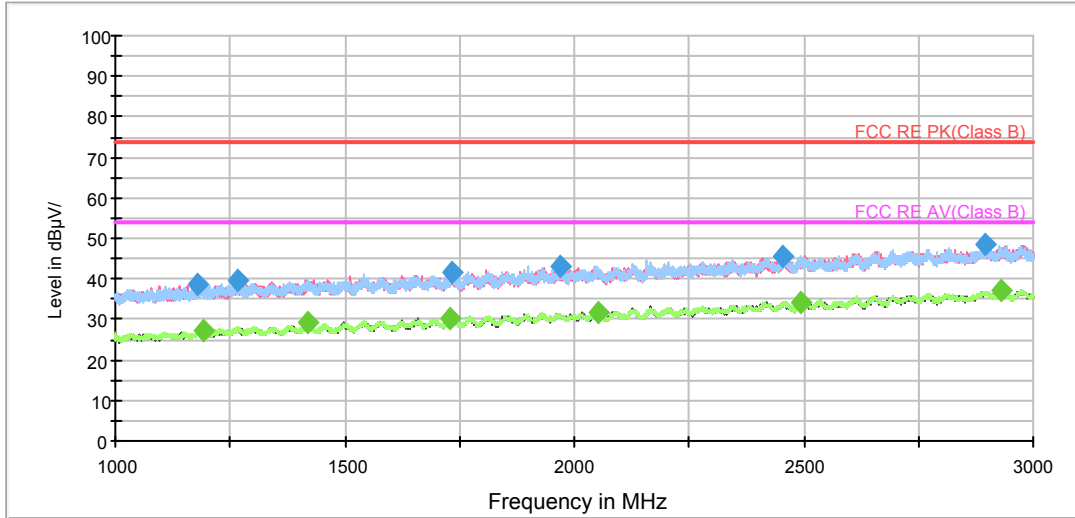

Radiates Emission from 1GHz to 3GHz

RE 3-18GHz PK+AV

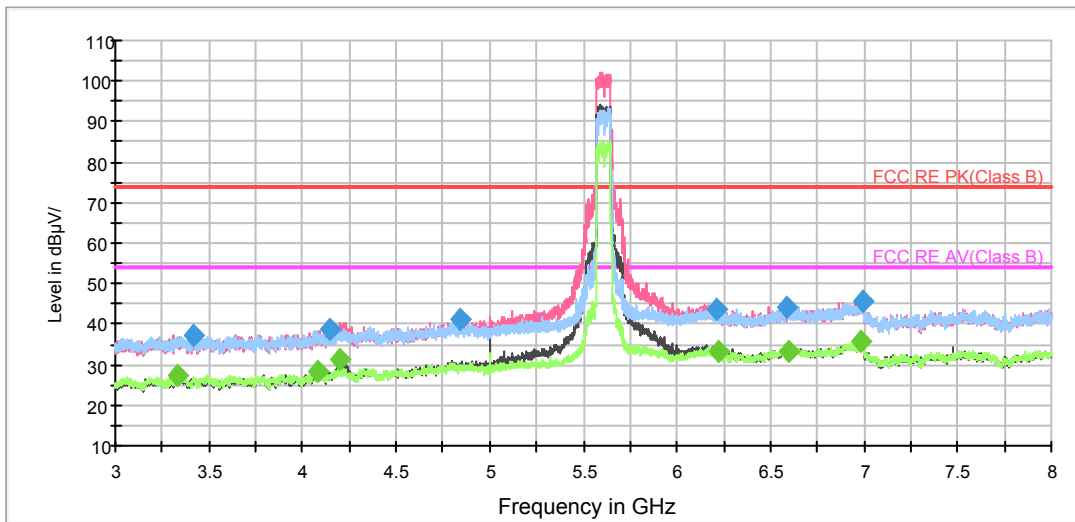

Note: The signal beyond the limit is carrier.

Radiates Emission from 3GHz to 8GHz



RE 3-18GHz PK+AV

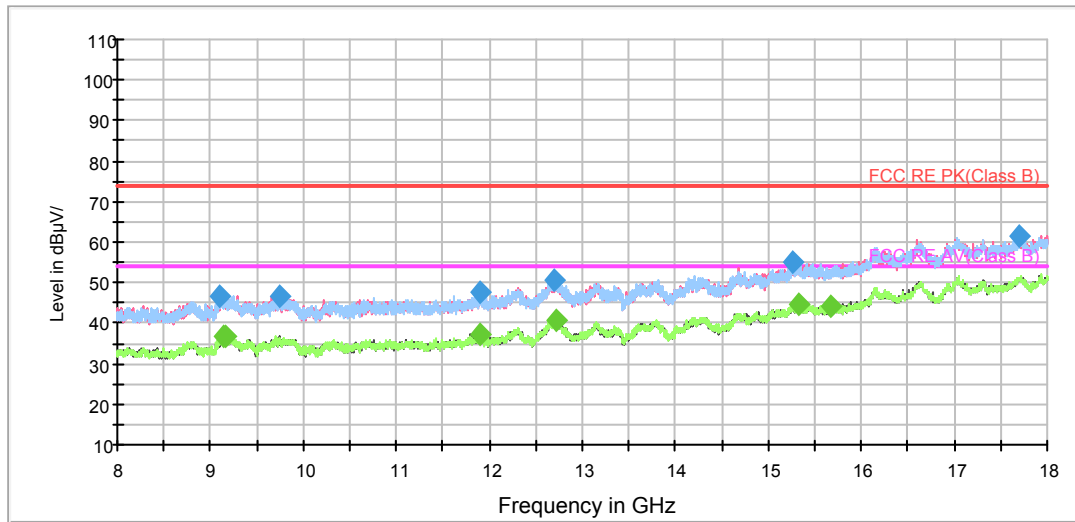

Radiates Emission from 8GHz to 18GHz

Frequency (MHz)	Peak (dBuV/m)	Height (cm)	Polarization	Azimuth (deg)	Reading value (dBuV/m)	Correct Factor (dB)	Margin (dB)	Limit (dBuV/m)
3416.875000	37.1	200.0	H	0.0	39.7	-2.6	36.9	74.0
4141.250000	38.8	200.0	V	0.0	39.1	-0.3	35.2	74.0
4836.875000	41.3	200.0	V	277.0	39.8	1.5	32.7	74.0
6211.250000	43.6	200.0	V	257.0	38.2	5.4	30.4	74.0
6590.625000	44.4	200.0	V	257.0	38.8	5.6	29.6	74.0
6990.000000	45.8	200.0	H	183.0	39.3	6.5	28.2	74.0

Remark: 1. Correction Factor = Antenna factor+ Insertion loss (cable loss + amplifier gain)

Frequency (MHz)	Average (dBuV/m)	Height (cm)	Polarization	Azimuth (deg)	Reading value (dBuV/m)	Correct Factor (dB)	Margin (dB)	Limit (dBuV/m)
3336.250000	27.2	200.0	H	36.0	29.5	-2.3	26.8	54.0
4083.125000	28.4	200.0	H	57.0	29.3	-0.9	25.6	54.0
4204.375000	31.1	200.0	V	45.0	30.7	0.4	22.9	54.0
6221.875000	33.2	200.0	V	345.0	27.8	5.4	20.8	54.0
6600.000000	33.0	200.0	V	296.0	27.3	5.7	21.0	54.0
6987.500000	35.6	200.0	V	325.0	29.2	6.4	18.4	54.0

Remark: 1. Correction Factor = Antenna factor+ Insertion loss (cable loss + amplifier gain)

802.11ac (HT80) CH138

RE 1G-3GHz PK+AV

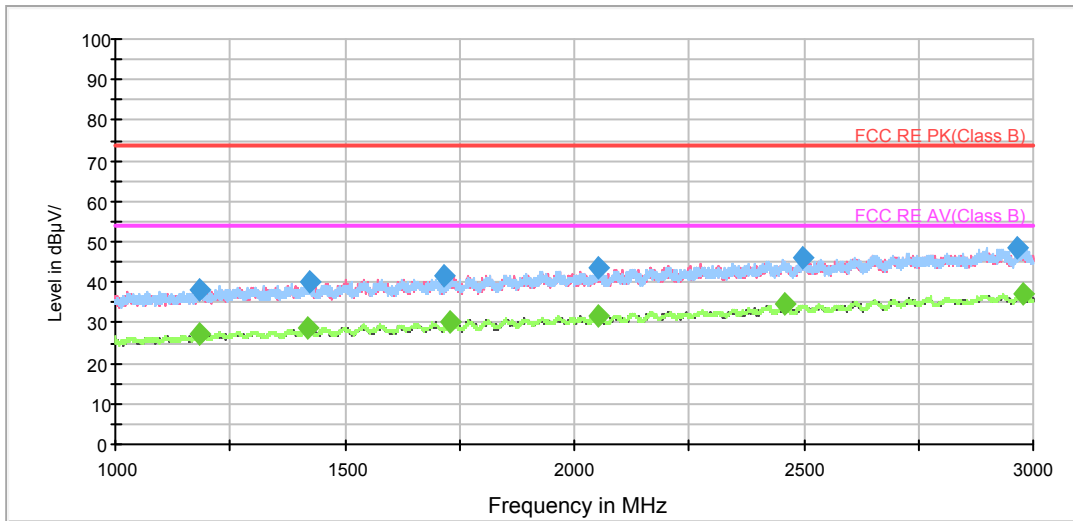

Radiates Emission from 1GHz to 3GHz

RE 3-18GHz PK+AV

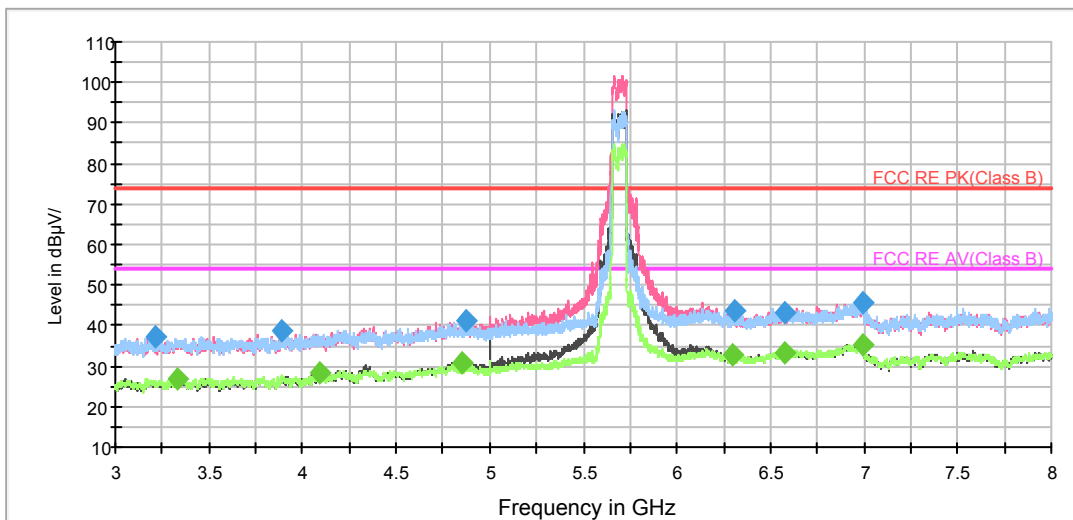

Note: The signal beyond the limit is carrier.

Radiates Emission from 3GHz to 8GHz

RE 3-18GHz PK+AV

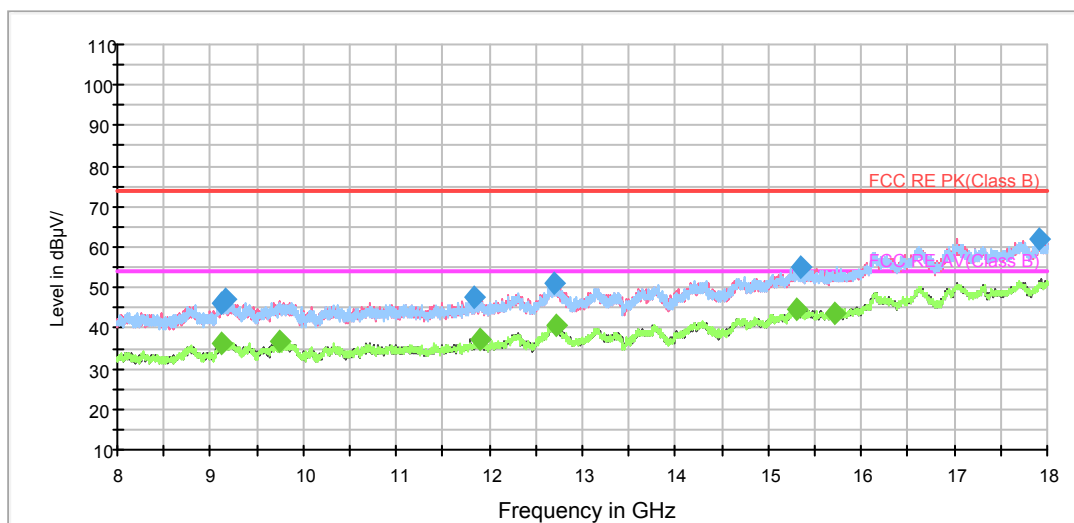

Radiates Emission from 8GHz to 18GHz

Frequency (MHz)	Peak (dBuV/m)	Height (cm)	Polarization	Azimuth (deg)	Reading value (dBuV/m)	Correct Factor (dB)	Margin (dB)	Limit (dBuV/m)
3213.750000	37.3	200.0	H	244.0	40.1	-2.8	36.7	74.0
3892.500000	38.5	200.0	H	164.0	39.8	-1.3	35.5	74.0
4878.125000	41.0	200.0	V	315.0	39.2	1.8	33.0	74.0
6304.375000	43.4	200.0	V	296.0	38.0	5.4	30.6	74.0
6579.375000	43.2	200.0	H	104.0	37.7	5.5	30.8	74.0
6989.375000	45.5	200.0	H	57.0	39.1	6.4	28.5	74.0

Remark: 1. Correction Factor = Antenna factor+ Insertion loss (cable loss + amplifier gain)

Frequency (MHz)	Average (dBuV/m)	Height (cm)	Polarization	Azimuth (deg)	Reading value (dBuV/m)	Correct Factor (dB)	Margin (dB)	Limit (dBuV/m)
3336.875000	27.0	200.0	H	95.0	29.3	-2.3	27.0	54.0
4087.500000	28.2	200.0	H	27.0	29.1	-0.9	25.8	54.0
4848.125000	30.8	200.0	V	247.0	29.2	1.6	23.2	54.0
6296.250000	32.7	200.0	V	199.0	27.3	5.4	21.3	54.0
6572.500000	33.5	200.0	V	86.0	27.9	5.6	20.5	54.0
6998.125000	35.2	200.0	V	315.0	28.7	6.5	18.8	54.0

Remark: 1. Correction Factor = Antenna factor+ Insertion loss (cable loss + amplifier gain)

802.11ac (HT80) CH155

RE 1G-3GHz PK+AV

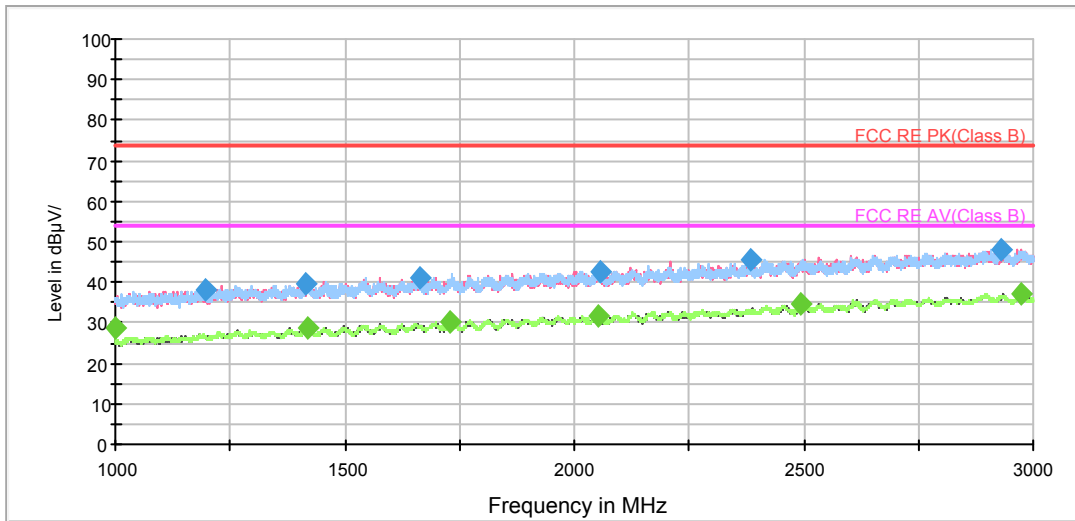

Radiates Emission from 1GHz to 3GHz

RE 3-18GHz PK+AV

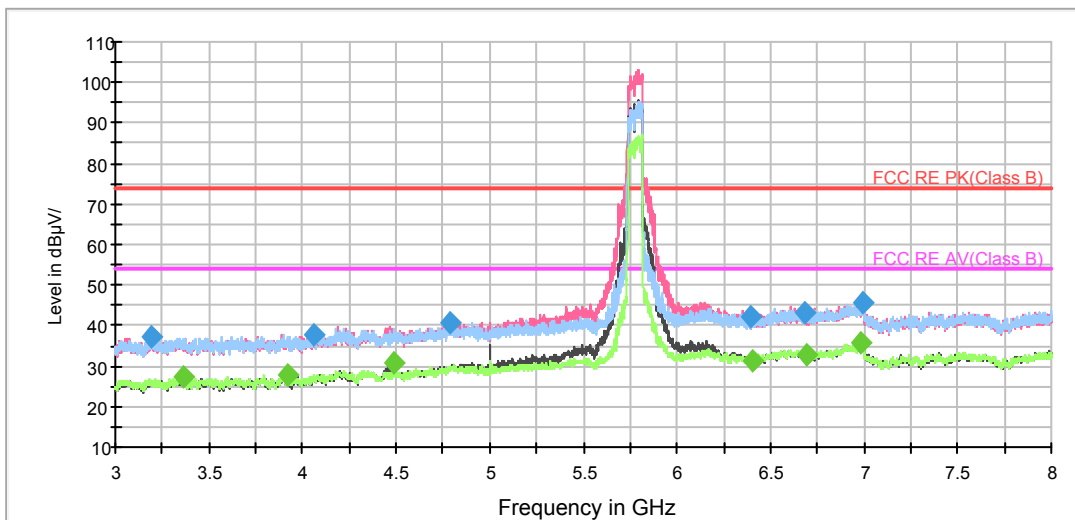

Note: The signal beyond the limit is carrier.

Radiates Emission from 3GHz to 8GHz

RE 3-18GHz PK+AV

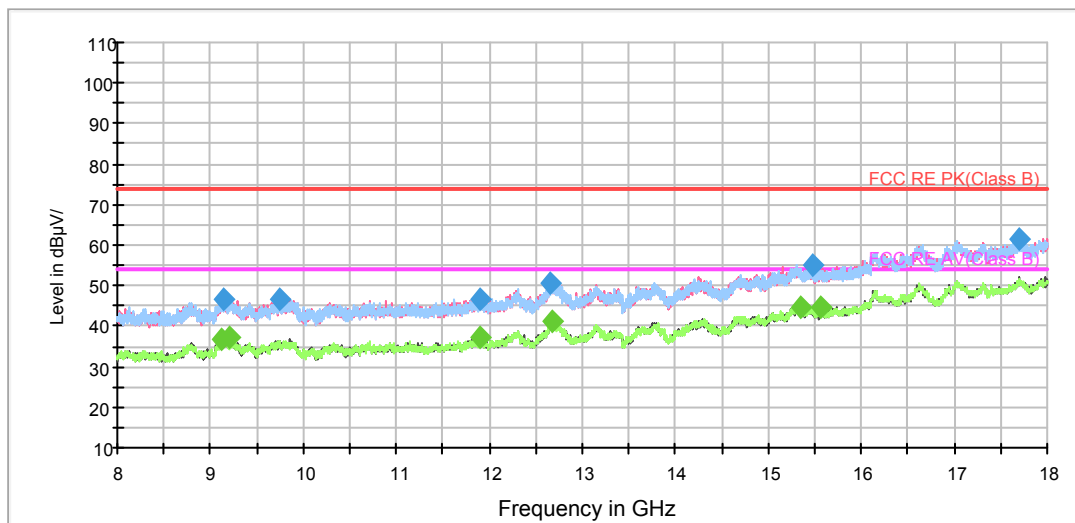

Radiates Emission from 8GHz to 18GHz

Frequency (MHz)	Peak (dBuV/m)	Height (cm)	Polarization	Azimuth (deg)	Reading value (dBuV/m)	Correct Factor (dB)	Margin (dB)	Limit (dBuV/m)
3191.875000	37.1	200.0	H	103.0	40.0	-2.9	36.9	74.0
4057.500000	37.9	200.0	H	64.0	39.0	-1.1	36.1	74.0
4786.250000	40.8	200.0	H	25.0	39.7	1.1	33.2	74.0
6390.000000	42.1	200.0	V	270.0	37.1	5.0	31.9	74.0
6682.500000	43.2	200.0	V	98.0	37.7	5.5	30.8	74.0
6990.625000	45.7	200.0	V	318.0	39.2	6.5	28.3	74.0

Remark: 1. Correction Factor = Antenna factor+ Insertion loss (cable loss + amplifier gain)

Frequency (MHz)	Average (dBuV/m)	Height (cm)	Polarization	Azimuth (deg)	Reading value (dBuV/m)	Correct Factor (dB)	Margin (dB)	Limit (dBuV/m)
3369.375000	27.2	200.0	H	142.0	29.7	-2.5	26.8	54.0
3922.500000	27.9	200.0	H	93.0	29.1	-1.2	26.1	54.0
4484.375000	30.6	200.0	V	22.0	30.1	0.5	23.4	54.0
6406.875000	31.4	200.0	V	250.0	26.5	4.9	22.6	54.0
6688.750000	32.9	200.0	V	358.0	27.6	5.3	21.1	54.0
6985.625000	35.5	200.0	V	338.0	29.1	6.4	18.5	54.0

Remark: 1. Correction Factor = Antenna factor+ Insertion loss (cable loss + amplifier gain)

802.11ac (HT80+80) CH50

RE 1G-3GHz PK+AV

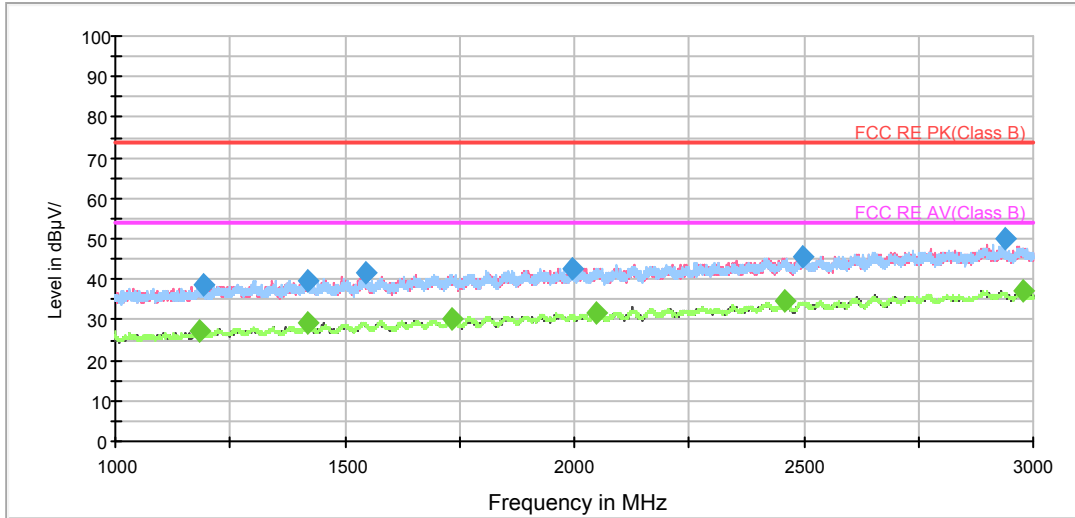

Radiates Emission from 1GHz to 3GHz

RE 3-18GHz PK+AV

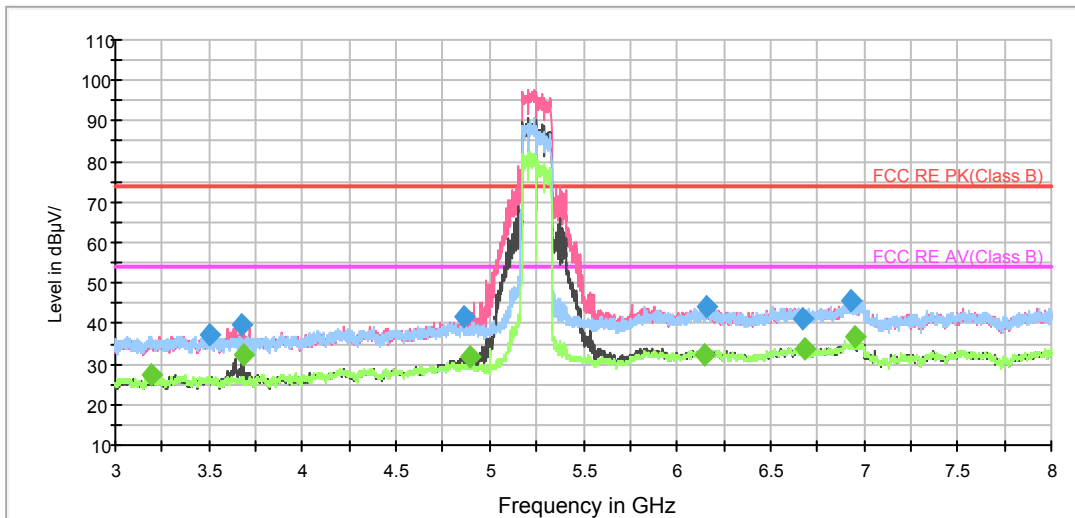

Note: The signal beyond the limit is carrier.

Radiates Emission from 3GHz to 8GHz



RE 3-18GHz PK+AV

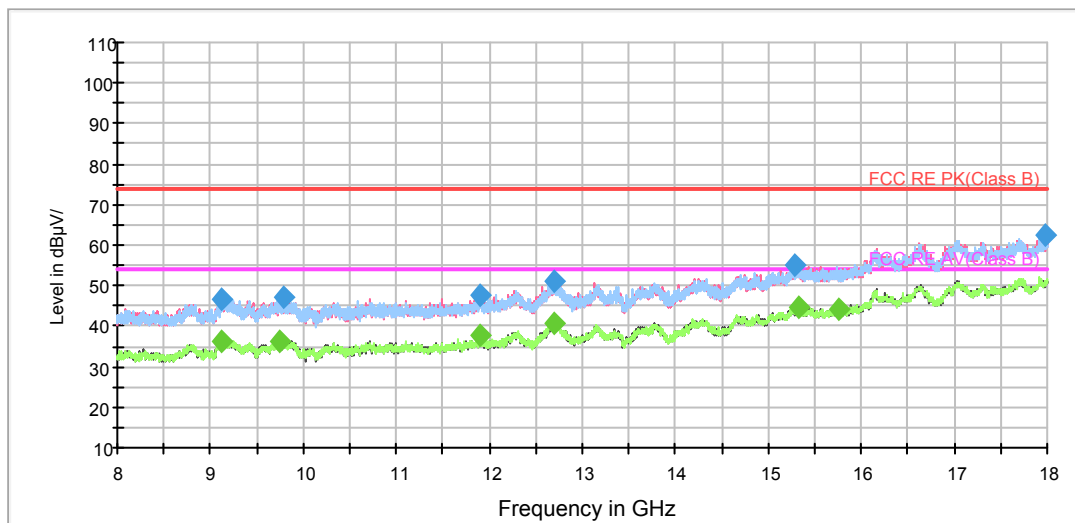

Radiates Emission from 8GHz to 18GHz

Frequency (MHz)	Peak (dBuV/m)	Height (cm)	Polarization	Azimuth (deg)	Reading value (dBuV/m)	Correct Factor (dB)	Margin (dB)	Limit (dBuV/m)
3498.125000	37.0	200.0	V	168.0	39.1	-2.1	37.0	74.0
3678.750000	39.8	200.0	V	237.0	41.6	-1.8	34.2	74.0
4865.000000	41.6	200.0	V	318.0	39.9	1.7	32.4	74.0
6153.750000	44.4	200.0	H	285.0	38.8	5.6	29.6	74.0
6676.250000	41.4	200.0	V	318.0	35.9	5.5	32.6	74.0
6930.000000	45.8	200.0	H	0.0	39.6	6.2	28.2	74.0

Remark: 1. Correction Factor = Antenna factor+ Insertion loss (cable loss + amplifier gain)

Frequency (MHz)	Average (dBuV/m)	Height (cm)	Polarization	Azimuth (deg)	Reading value (dBuV/m)	Correct Factor (dB)	Margin (dB)	Limit (dBuV/m)
3189.375000	27.5	200.0	H	35.0	30.4	-2.9	26.5	54.0
3682.500000	32.3	200.0	V	129.0	34.1	-1.8	21.7	54.0
4895.000000	31.7	200.0	V	107.0	29.8	1.9	22.3	54.0
6149.375000	32.4	200.0	V	227.0	26.9	5.5	21.6	54.0
6688.125000	33.9	200.0	V	129.0	28.5	5.4	20.1	54.0
6946.875000	36.6	200.0	V	87.0	30.4	6.2	17.4	54.0

Remark: 1. Correction Factor = Antenna factor+ Insertion loss (cable loss + amplifier gain)

802.11ac (HT80+80) CH114

RE 1G-3GHz PK+AV

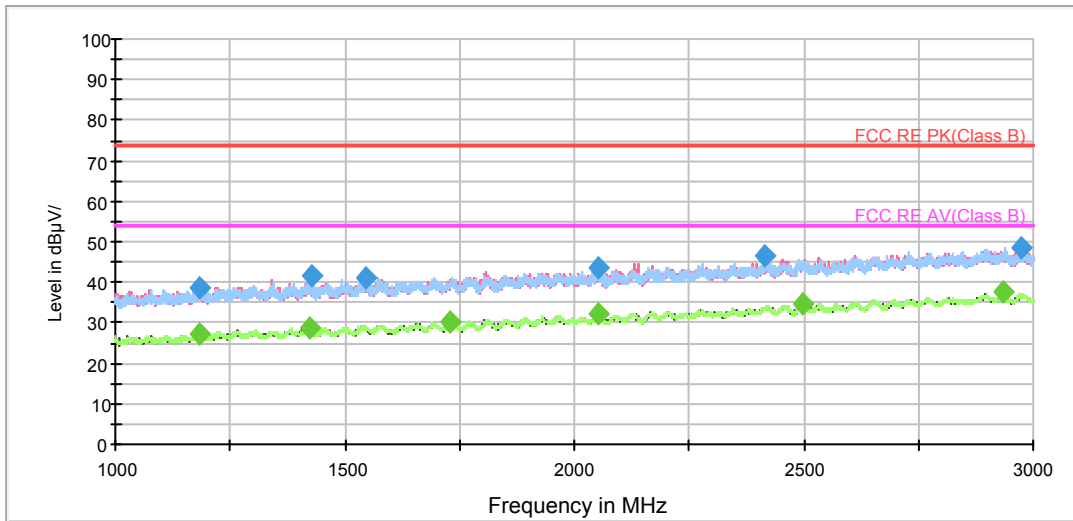

Radiates Emission from 1GHz to 3GHz

RE 3-18GHz PK+AV

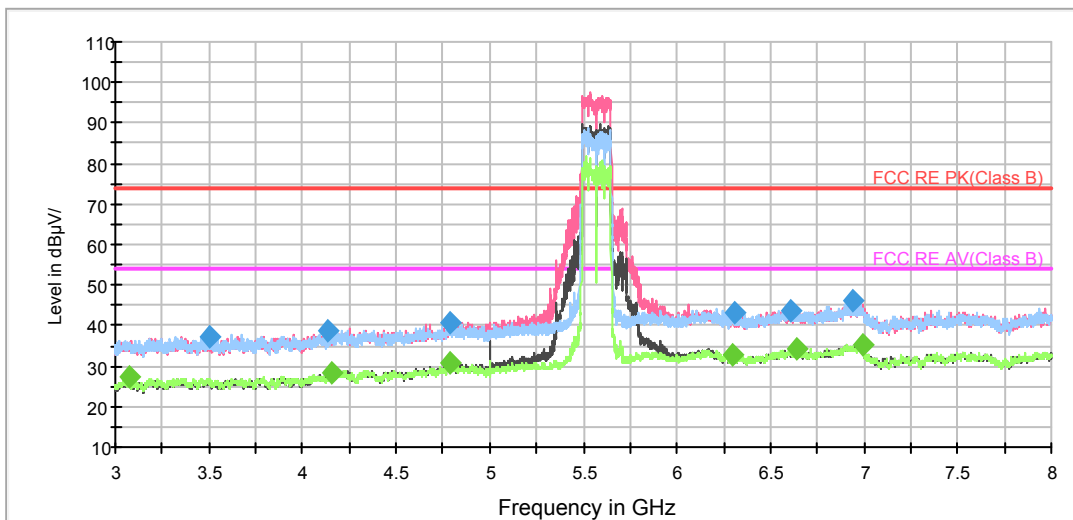

Note: The signal beyond the limit is carrier.

Radiates Emission from 3GHz to 8GHz

RE 3-18GHz PK+AV

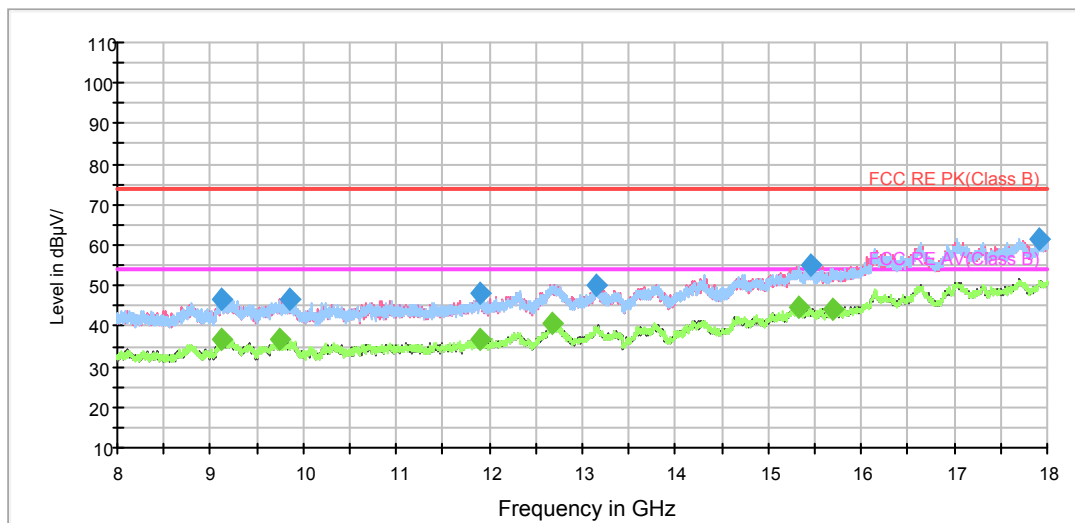

Radiates Emission from 8GHz to 18GHz

Frequency (MHz)	Peak (dBuV/m)	Height (cm)	Polarization	Azimuth (deg)	Reading value (dBuV/m)	Correct Factor (dB)	Margin (dB)	Limit (dBuV/m)
3499.375000	37.5	200.0	V	12.0	39.6	-2.1	36.5	74.0
4134.375000	38.7	200.0	V	348.0	39.0	-0.3	35.3	74.0
4788.750000	40.6	200.0	H	184.0	39.5	1.1	33.4	74.0
6303.125000	43.1	200.0	H	29.0	37.7	5.4	30.9	74.0
6605.625000	43.6	200.0	V	259.0	38.0	5.6	30.4	74.0
6936.250000	45.9	200.0	V	239.0	39.8	6.1	28.1	74.0

Remark: 1. Correction Factor = Antenna factor+ Insertion loss (cable loss + amplifier gain)

Frequency (MHz)	Average (dBuV/m)	Height (cm)	Polarization	Azimuth (deg)	Reading value (dBuV/m)	Correct Factor (dB)	Margin (dB)	Limit (dBuV/m)
3076.250000	27.2	200.0	H	0.0	30.2	-3.0	26.8	54.0
4152.500000	28.5	200.0	V	259.0	28.6	-0.1	25.5	54.0
4791.875000	30.7	200.0	H	184.0	29.5	1.2	23.3	54.0
6301.250000	32.9	200.0	V	279.0	27.5	5.4	21.1	54.0
6644.375000	34.1	200.0	V	309.0	28.6	5.5	19.9	54.0
6990.000000	35.3	200.0	H	78.0	28.8	6.5	18.7	54.0

Remark: 1. Correction Factor = Antenna factor+ Insertion loss (cable loss + amplifier gain)

Co- transmission between 2.4GHz and 5GHz

During the test, the Co- transmission between 2.4GHz and 5GHz was performed in all modes, WIFI 2.4G 802.11b CH1+ WIFI 5G 802.11n(HT40)_CH38 are selected as the worst condition. The test data of the worst-case condition was recorded in this report.

The carrier frequency is limited by notchfilter.

RE 1G-3GHz PK+AV

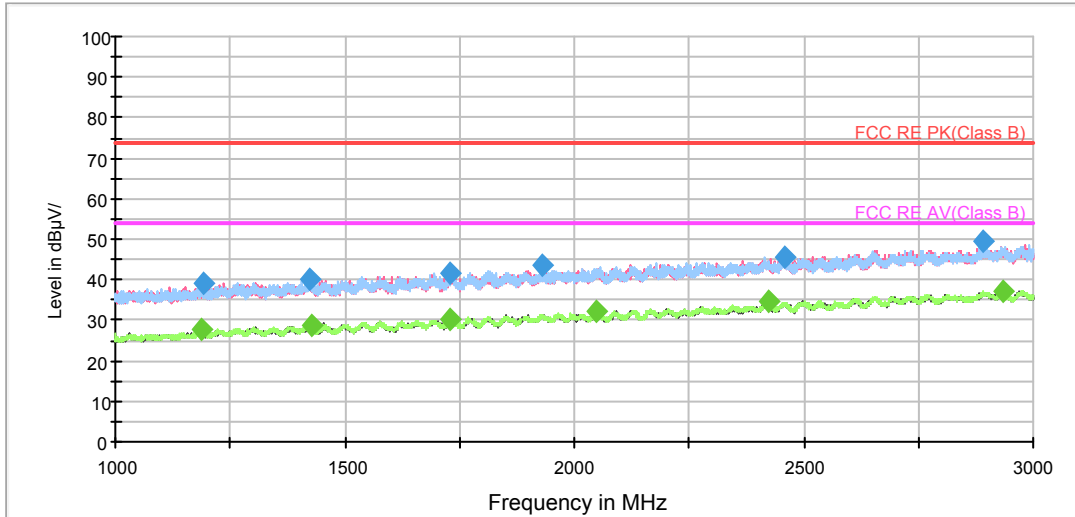

Radiates Emission from 1GHz to 3GHz

RE 3-18GHz PK+AV

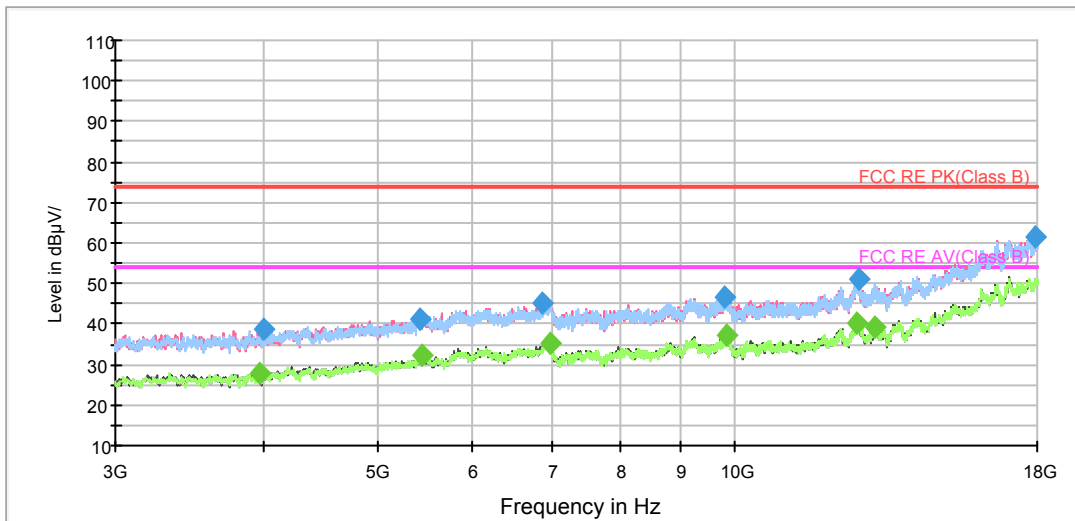

Radiates Emission from 3GHz to 18GHz



Frequency (MHz)	Peak (dBuV/m)	Height (cm)	Polarization	Azimuth (deg)	Reading value (dBuV/m)	Correct Factor (dB)	Margin (dB)	Limit (dBuV/m)
1194.000000	38.9	200.0	V	231.0	47.1	-8.2	35.1	74.0
1423.500000	40.0	200.0	V	356.0	46.9	-6.9	34.0	74.0
1728.750000	41.5	200.0	H	86.0	46.5	-5.0	32.5	74.0
1930.750000	43.7	200.0	V	245.0	47.4	-3.7	30.3	74.0
2457.250000	45.7	200.0	V	343.0	46.2	-0.5	28.3	74.0
2891.500000	49.6	200.0	V	294.0	47.5	2.1	24.4	74.0

Remark: 1. Correction Factor = Antenna factor+ Insertion loss (cable loss + amplifier gain)

Frequency (MHz)	Average (dBuV/m)	Height (cm)	Polarization	Azimuth (deg)	Reading value (dBuV/m)	Correct Factor (dB)	Margin (dB)	Limit (dBuV/m)
1189.750000	27.6	200.0	H	72.0	35.8	-8.2	26.4	54.0
1426.000000	28.9	200.0	H	86.0	35.8	-6.9	25.1	54.0
1731.000000	30.3	200.0	H	274.0	35.2	-4.9	23.7	54.0
2048.500000	32.0	200.0	H	193.0	35.2	-3.2	22.0	54.0
2421.500000	34.5	200.0	H	72.0	35.0	-0.5	19.5	54.0
2935.750000	37.2	200.0	H	92.0	35.4	1.8	16.8	54.0

Remark: 1. Correction Factor = Antenna factor+ Insertion loss (cable loss + amplifier gain)

5.6. Conducted Emission

Ambient condition

Temperature	Relative humidity	Pressure
23°C ~25°C	45%~50%	101.5kPa

Methods of Measurement

The EUT IS placed on a non-metallic table of 80cm height above the horizontal metal reference ground plane. During the test, the EUT was operating in its typical mode. The test method is according to ANSI C63.10-2013. Connect the AC power line of the EUT to the LISN Use EMI receiver to detect the average and Quasi-peak value. RBW is set to 9kHz, VBW is set to 30kHz The measurement result should include both L line and N line.

The test is in transmitting mode.

Test Setup

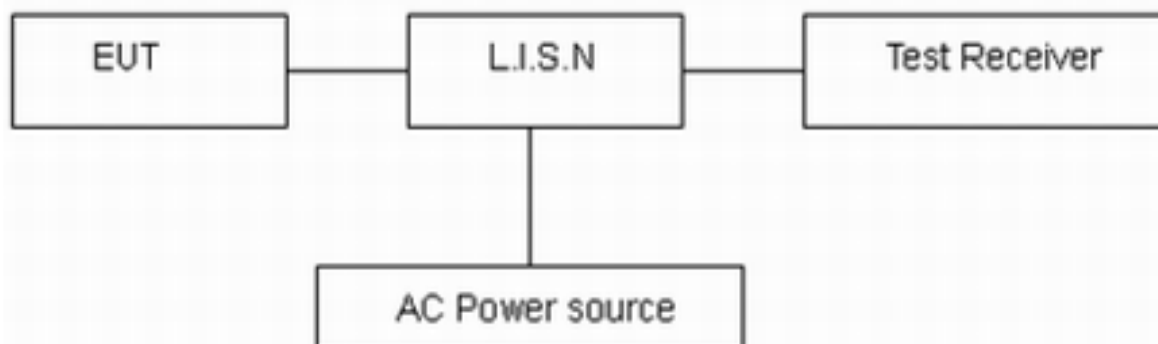

Note: AC Power source is used to change the voltage 110V/60Hz.

Limits

Frequency (MHz)	Conducted Limits(dBμV)	
	Quasi-peak	Average
0.15 - 0.5	66 to 56 *	56 to 46 *
0.5 - 5	56	46
5 - 30	60	50

*: Decreases with the logarithm of the frequency.

Measurement Uncertainty

The assessed measurement uncertainty to ensure 95% confidence level for the normal distribution is with the coverage factor $k = 1.96$, $U = 2.69$ dB.



Test Results:

Following plots, Blue trace uses the peak detection and Green trace uses the average detection. During the test, the Conducted Emission was performed in all modes with all channels, 802.11n (HT40), Channel 54 are selected as the worst condition. The test data of the worst-case condition was recorded in this report.

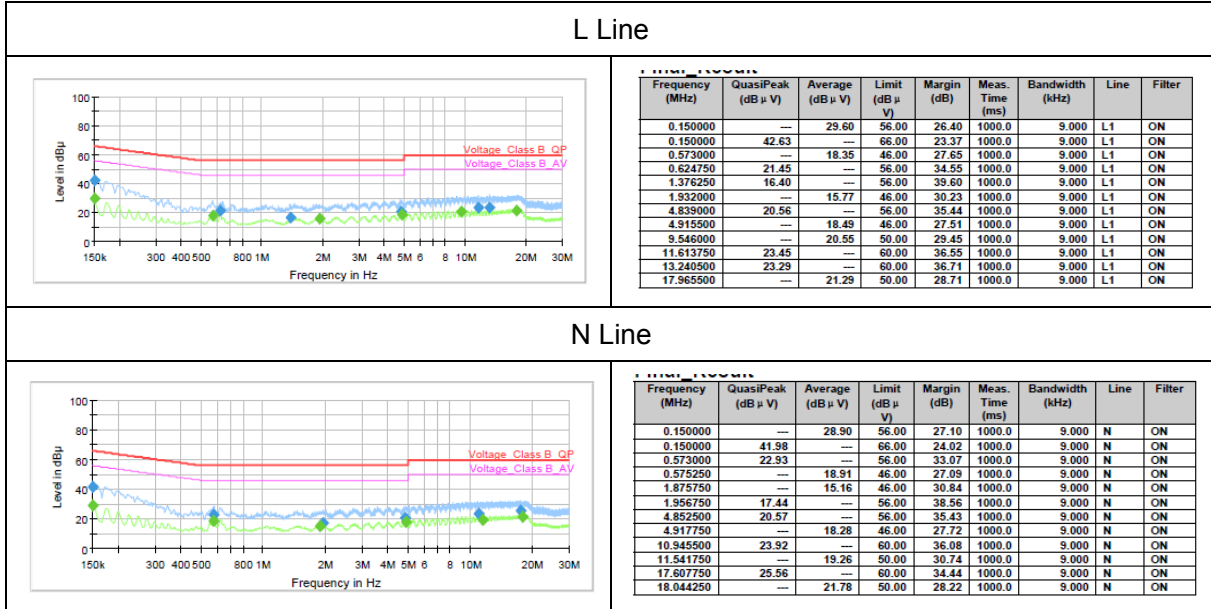



6. Main Test Instruments

Name	Manufacturer	Type	Serial Number	Calibration Date	Expiration Date
Spectrum Analyzer	R&S	FSV40	15195-01-00	2017-05-14	2018-05-13
EMI Test Receiver	R&S	ESCI	100948	2017-05-20	2018-05-19
Loop Antenna	SCHWARZBECK	FMZB1519	1519-047	2017-02-18	2020-02-17
TRILOG Broadband Antenna	Schwarzbeck	VULB 9163	9163-201	2017-11-18	2020-11-17
Double Ridged Waveguide Horn Antenna	R&S	HF907	100126	2014-12-06	2019-12-05
Standard Gain Horn	ETS-Lindgren	3160-09	00102644	2015-01-30	2020-01-29
Standard Gain Horn	STEATITE	QSH-SL-26-40 -K-15	16779	2016-03-21	2019-03-20
Broadband Horn Antenna	Schwarzbeck	BBHA9170	MRTSUE06024	2016-11-24	2019-11-23
EMI Test Receiver	R&S	ESR	101667	2017-09-06	2018-09-05
LISN	R&S	ENV216	101171	2016-12-16	2019-12-15
Spectrum Analyzer	Agilent	N9010A	MY47191109	2017-05-20	2018-05-19
RF Cable	Agilent	SMA 15cm	0001	2017-08-04	2018-02-03
TEMPERATURE CHAMBER	ESPEC	SU-242	93000506	2017-12-27	2018-12-26
AV Power Meter	R&S	NRP	102437	2017-12-17	2018-12-16
Power Probe	R&S	NRP-Z21	104799	2017-05-20	2018-05-19

*****END OF REPORT *****

ANNEX A: EUT Appearance and Test Setup

A.1 EUT Appearance

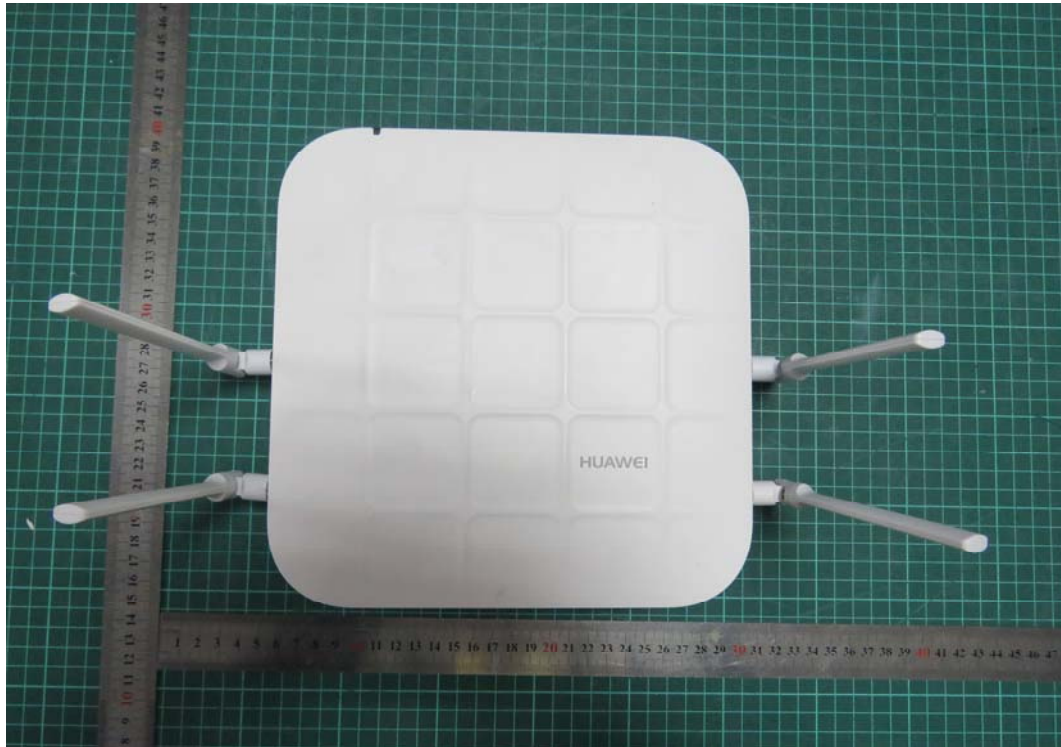

a: EUT

Picture 1 EUT



Antenna Type 1



Antenna Type 2

Picture 2 Antenna

A.2 Test Setup



30MHz-1GHz

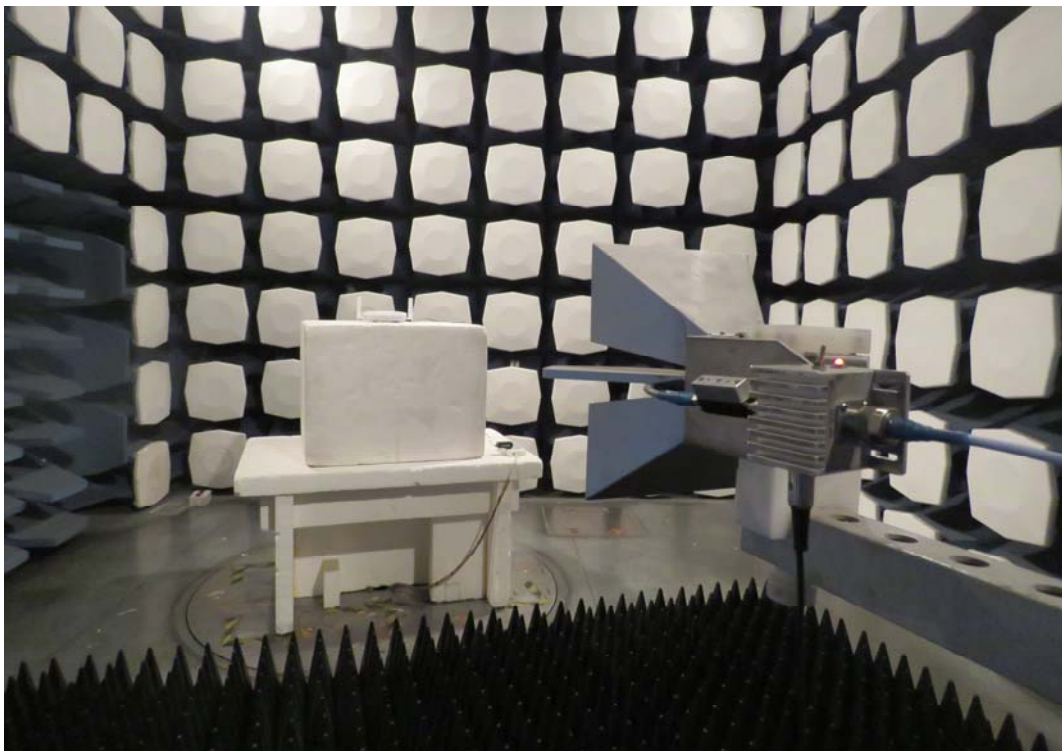

Above 1GHz
Antenna Type 1

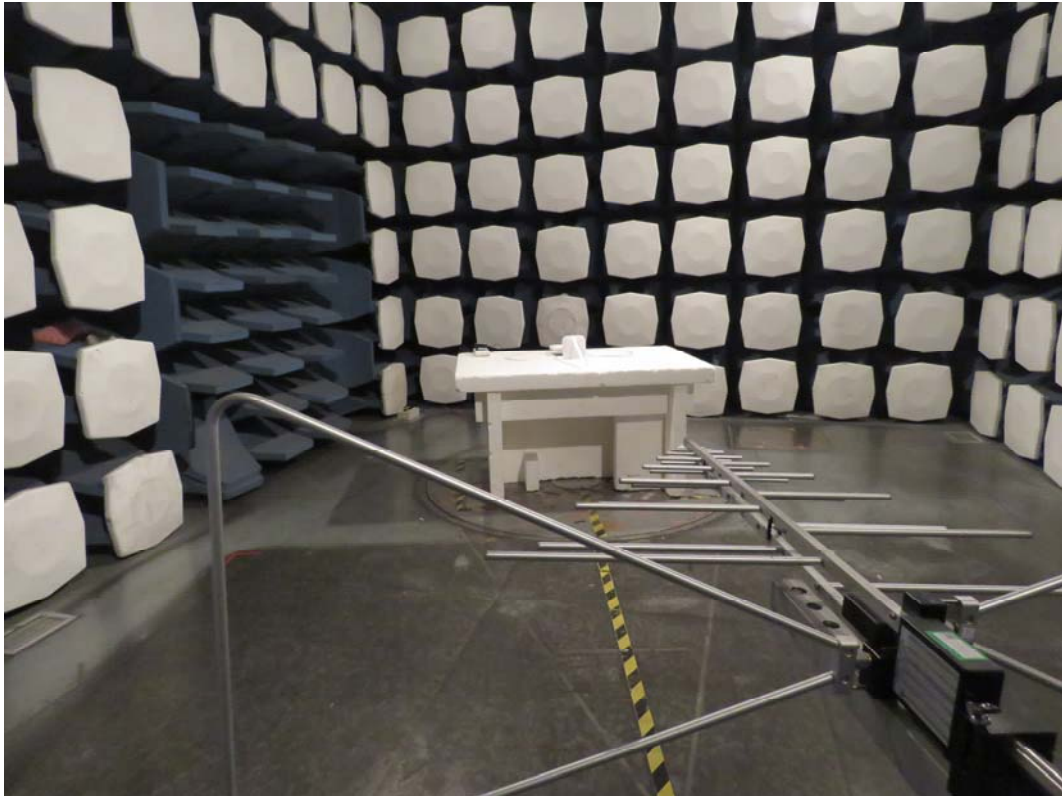

30M Hz-1GHz



Above 1GHz
Antenna Type 2

Picture 3 Radiated Emission Test Setup

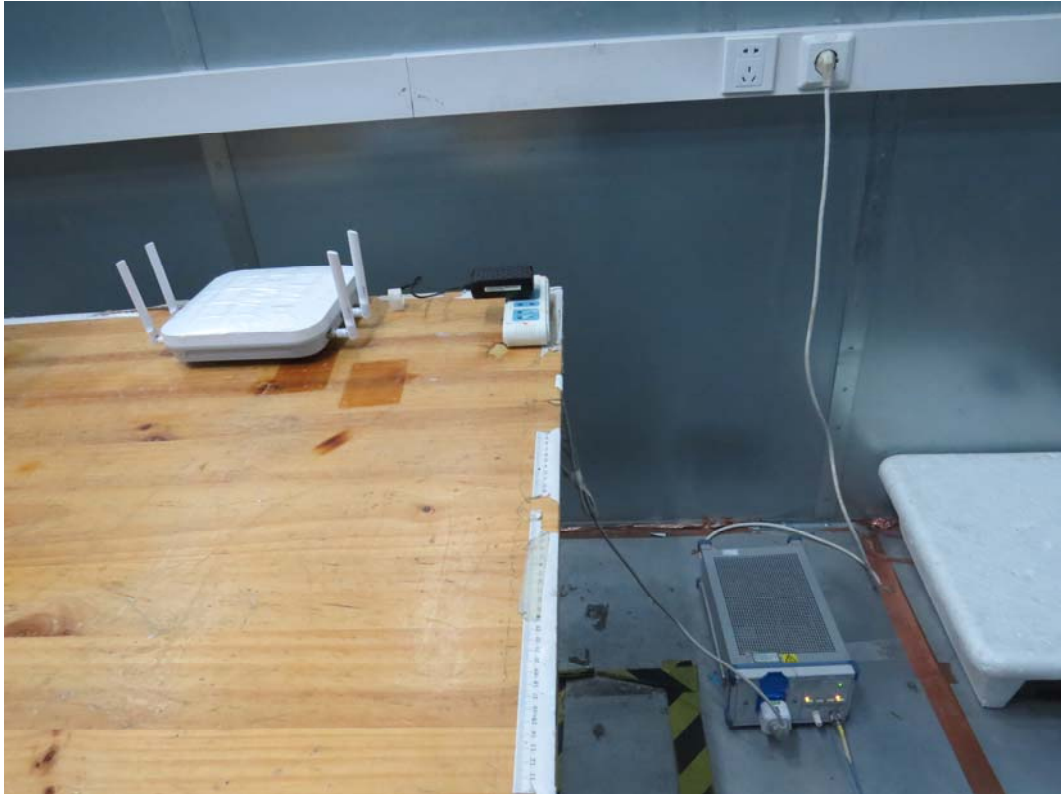

Picture 4 Conducted Emission Test Setup



Picture 5 Conducted Test Setup