

FCCRadio Test Report

FCC ID:QISAP6050DN6150DN

This report concerns (check one): Original Grant Class I Change Class II Change

Project No. : 1604C201C
Equipment : Wireless LAN Access Point
Model Name : AP6050DN
Applicant : Huawei Technologies Co.,Ltd.
Address : Administration Building, Headquarters of Huawei Technologies Co., Ltd.,Bantian, Longgang District, Shenzhen 518129 China

Date of Receipt : Dec. 16, 2016
Date of Test : Dec. 16, 2016 ~ Dec. 28, 2016
Issued Date : Dec. 29, 2016
Tested by : BTL Inc.

Testing Engineer : Shawn Xiao
(Shawn Xiao)

Technical Manager : David Mao
(David Mao)

Authorized Signatory : Steven Lu
(Steven Lu)

B T L I N C .

No.3, Jinshagang 1st Road, Shixia, Dalang Town, Dongguan,
Guangdong, China.

TEL: +86-769-8318-3000 FAX: +86-769-8319-6000

Declaration

BTL represents to the client that testing is done in accordance with standard procedures as applicable and that test instruments used has been calibrated with standards traceable to international standard(s) and/or national standard(s).

BTL's reports apply only to the specific samples tested under conditions. It is manufacture's responsibility to ensure that additional production units of this model are manufactured with the identical electrical and mechanical components. **BTL** shall have no liability for any declarations, inferences or generalizations drawn by the client or others from **BTL** issued reports.

BTL's report must not be used by the client to claim product certification, approval, or endorsement by NVLAP, NIST, or any agency of the Federal Government.

This report is the confidential property of the client. As a mutual protection to the clients, the public and **BTL-self**, extracts from the test report shall not be reproduced except in full with **BTL's** authorized written approval.

BTL's laboratory quality assurance procedures are in compliance with the **ISO Guide17025** requirements, and accredited by the conformity assessment authorities listed in this test report.

Limitation

For the use of the authority's logo is limited unless the Test Standard(s)/Scope(s)/Item(s) mentioned in this test report is (are) included in the conformity assessment authorities acceptance respective.

Table of Contents

Page

1 . CERTIFICATION	6
2 . SUMMARY OF TEST RESULTS	7
2.1 TEST FACILITY	8
2.2 MEASUREMENT UNCERTAINTY	8
3 . GENERAL INFORMATION	9
3.1 GENERAL DESCRIPTION OF EUT	9
3.2 DESCRIPTION OF TEST MODES	15
3.3 TABLE OF PARAMETERS OF TEST SOFTWARE SETTING	17
3.4 BLOCKDIAGRAMSHOWINGTHECONFIGURATIONOFSYSTEMTESTED	25
3.5 DESCRIPTION OF SUPPORT UNITS	25
4 . EMC EMISSION TEST	26
4.1 CONDUCTED EMISSION MEASUREMENT	26
4.1.1 POWER LINE CONDUCTED EMISSION	26
4.1.2 TEST PROCEDURE	26
4.1.3 DEVIATIONFROMTESTSTANDARD	26
4.1.4 TESTSETUP	27
4.1.5 EUT OPERATING CONDITIONS	27
4.1.6 EUT TEST CONDITIONS	27
4.1.7 TEST RESULTS	27
4.2 RADIATED EMISSION MEASUREMENT	28
4.2.1 RADIATED EMISSION LIMITS	28
4.2.2 TEST PROCEDURE	29
4.2.3 DEVIATIONFROMTESTSTANDARD	29
4.2.4 TESTSETUP	29
4.2.5 EUT OPERATING CONDITIONS	30
4.2.6 EUT TEST CONDITIONS	30
4.2.7 TEST RESULTS (9K TO 30MHz)	31
4.2.8 TEST RESULTS(BETWEEN30 TO 1000 MHz)	31
4.2.9 TEST RESULTS (ABOVE1000 MHz)	31
5 . 26dB SPECTRUM BANDWIDTH	32
5.1 APPLIED PROCEDURES / LIMIT	32
5.1.1 TEST PROCEDURE	32
5.1.2 DEVIATION FROM STANDARD	32
5.1.3 TEST SETUP	32
5.1.4 EUT OPERATION CONDITIONS	32
5.1.5 EUT TEST CONDITIONS	32
5.1.6 TEST RESULTS	32
6 . MAXIMUM CONDUCTED OUTPUT POWER	33

Table of Contents	Page
6.1 APPLIED PROCEDURES / LIMIT	33
6.1.1 TEST PROCEDURE	33
6.1.2 DEVIATION FROM STANDARD	34
6.1.3 TEST SETUP	34
6.1.4 EUT OPERATION CONDITIONS	34
6.1.5 EUT TEST CONDITIONS	34
6.1.6 TEST RESULTS	34
7 . POWER SPECTRAL DENSITY TEST	35
7.1 APPLIED PROCEDURES / LIMIT	35
8.1.1 TEST PROCEDURE	35
7.1.1 DEVIATION FROM STANDARD	36
7.1.2 TEST SETUP	36
7.1.3 EUT OPERATION CONDITIONS	36
7.1.4 EUT TEST CONDITIONS	36
7.1.5 TEST RESULTS	36
8 . FREQUENCY STABILITY MEASUREMENT	37
8.1 APPLIED PROCEDURES / LIMIT	37
8.1.1 TEST PROCEDURE	37
8.1.2 DEVIATION FROM STANDARD	37
8.1.3 TEST SETUP	38
8.1.4 EUT OPERATION CONDITIONS	38
8.1.5 EUT TEST CONDITIONS	38
8.1.6 TEST RESULTS	38
9 . MEASUREMENT INSTRUMENTS LIST	39
10 . EUT TEST PHOTOS	41
ATTACHMENT A -CONDUCTED EMISSION	45
ATTACHMENT B -RADIATED EMISSION (9KHZ TO 30MHZ)	48
ATTACHMENT C -RADIATED EMISSION (30MHZ TO 1000MHZ)	53
ATTACHMENT D -RADIATED EMISSION (ABOVE 1000MHZ)	70
ATTACHMENT E -BANDWIDTH	208
ATTACHMENT F - MAXIMUM OUTPUT POWER	255
ATTACHMENT G - POWER SPECTRAL DENSITY	364
ATTACHMENT H-FREQUENCY STABILITY	844

REPORT ISSUED HISTORY

Issued No.	Description	Issued Date
BTL-FCCP-1-1604C201C	Original Issue.	Dec. 29, 2016

1. CERTIFICATION

Equipment : Wireless LAN Access Point
Brand Name : HUAWEI
Model Name : AP6050DN
Applicant : Huawei Technologies Co.,Ltd.
Manufacturer : Huawei Technologies Co.,Ltd.
Address : Administration Building, Huawei Base, Bantian, Longgang District ,Shenzhen
518129, P.R.China
Factory : CIG Shanghai Co.,Ltd., Shanghai Branch.
Address : F/2,3 Building 1, No. 505 Jiangyue Road, Minhang District, Shanghai, P.R.
China
Date of Test : Dec. 16, 2016 ~ Dec. 28, 2016
Test Sample : Engineering Sample
Standard(s) : FCC Part15, Subpart E(15.407) / ANSI C63.10-2013

The above equipment has been tested and found compliance with the requirement of the relative standards by BTL Inc.

The test data, data evaluation, and equipment configuration contained in our test report (Ref No. BTL-FCCP-1-1604C201C) were obtained utilizing the test procedures, test instruments, test sites that has been accredited by the Authority of TAF according to the ISO-17025 quality assessment standard and technical standard(s).

2. SUMMARY OF TEST RESULTS

Test procedures according to the technical standard(s):

FCC Part15, Subpart E			
Standard(s) Section	Test Item	Judgment	Remark
15.207	AC Power Line Conducted Emissions	PASS	
15.407(a)	26dB Spectrum Bandwidth	PASS	
15.407(a)	Maximum Conducted Output Power	PASS	
15.407(a)	Power Spectral Density	PASS	
15.407(a)	Radiated Emissions	PASS	
15.407(b)	Band Edge Emissions	PASS	
15.407(g)	Frequency Stability	PASS	
15.203	Antenna Requirements	PASS	

NOTE:

(1) "N/A" denotes test is not applicable in this test report.

2.1 TEST FACILITY

The test facilities used to collect the test data in this report is at the location of No.3,Jinshagang 1st Road, Shixia, Dalang Town, Dongguan, Guangdong, China.
 BTL's test firm number for FCC: 319330

2.2 MEASUREMENT UNCERTAINTY

Where relevant, the following measurement uncertainty levels have been estimated for tests performed on the EUT as specified in CISPR 16-4-2. The BTL measurement uncertainty is less than the CISPR 16-4-2 U_{cispr} requirement.

The reported uncertainty of measurement $y \pm U$, where expanded uncertainty U is based on a standard uncertainty multiplied by a coverage factor of $k=2$, providing a level of confidence of approximately 95%.

A. Conducted Measurement:

Test Site	Method	Measurement Frequency Range	U, (dB)
DG-C02	CISPR	150 KHz~30MHz	2.32

B. Radiated Measurement:

Test Site	Method	Measurement Frequency Range	Ant. H / V	U, (dB)
DG-CB03	CISPR	9kHz~30MHz	V	3.79
		9kHz~30MHz	H	3.57
		30MHz~200MHz	V	3.82
		30MHz~200MHz	H	3.60
		200MHz~ 1,000MHz	V	3.86
		200MHz~ 1,000MHz	H	3.94
		1GHz~18GHz	V	3.12
		1GHz~18GHz	H	3.68
		18GHz~40GHz	V	4.15
		18GHz~40GHz	H	4.14

Note: Unless specifically mentioned, the uncertainty of measurement has not been taken into account to declare the compliance or non-compliance to the specification.

3. GENERAL INFORMATION

3.1 GENERAL DESCRIPTION OF EUT

Equipment	Wireless LAN Access Point	
Brand Name	HUAWEI	
Model Name	AP6050DN	
Mode Different	N/A	
Product Description	Operation Frequency	UNII-2A: 5250-5350MHz UNII-2C: 5470-5725MHz
	Modulation Type	OFDM
	Bit Rate of Transmitter	1733Mbps
Power Source	#1 DC voltage supplied from AC Adapter. #2 Supplied from PoE. Model: PoE35-54A	
Power Rating	#1 DC 12V 2A #2 PoE -48V	
Output Power	Output Power (Max.)for UNII-2A (1TX) Non-Beamforming	802.11a:18.59dBm 802.11n (20M): 18.57dBm 802.11n (40M): 17.77dBm 802.11ac Wave2(20 MHz): 18.40dBm 802.11ac Wave2(40 MHz): 17.78dBm 802.11ac Wave2(80 MHz): 14.70dBm 802.11ac Wave2(160MHz):13.61dBm
	Output Power (Max.)for UNII-2C (1TX) Non-Beamforming	802.11a:18.65dBm 802.11n (20M): 18.51dBm 802.11n (40M): 17.78dBm 802.11ac Wave2(20 MHz): 18.58dBm 802.11ac Wave2(40 MHz): 17.55dBm 802.11ac Wave2(80 MHz): 14.72dBm 802.11ac Wave2(160MHz):13.63dBm
	Output Power (Max.)for UNII-2A (2TX) Non-Beamforming	802.11a:21.55dBm 802.11n (20M): 21.54dBm 802.11n (40M): 20.70dBm 802.11ac Wave2(20 MHz): 21.63dBm 802.11ac Wave2(40 MHz): 20.73dBm 802.11ac Wave2(80 MHz): 16.70dBm 802.11ac Wave2(160MHz):16.59dBm
	Output Power (Max.)for UNII-2C (2TX) Non-Beamforming	802.11a:21.61dBm 802.11n (20M): 21.57dBm 802.11n (40M): 20.58dBm 802.11ac Wave2(20 MHz): 21.52dBm 802.11ac Wave2(40 MHz): 20.68dBm 802.11ac Wave2(80 MHz): 16.70dBm 802.11ac Wave2(160MHz):16.57dBm

Output Power	Output Power (Max.)for UNII-2A (3TX) Non-Beamforming	802.11a:22.32dBm 802.11n (20M): 22.24dBm 802.11n (40M): 22.34dBm 802.11ac Wave2(20 MHz): 22.18dBm 802.11ac Wave2(40 MHz): 22.25dBm 802.11ac Wave2(80 MHz): 17.38dBm
	Output Power (Max.)for UNII-2C (3TX) Non-Beamforming	802.11a:22.27dBm 802.11n (20M): 22.21dBm 802.11n (40M): 22.28dBm 802.11ac Wave2(20 MHz): 22.15dBm 802.11ac Wave2(40 MHz): 22.30dBm 802.11ac Wave2(80 MHz): 17.43dBm
	Output Power (Max.)for UNII-2A (4TX) Non-Beamforming	802.11a:22.68dBm 802.11n (20M): 22.37dBm 802.11n (40M): 22.49dBm 802.11ac Wave2(20 MHz): 22.44dBm 802.11ac Wave2(40 MHz): 21.29dBm 802.11ac Wave2(80 MHz): 17.53dBm
	Output Power (Max.)for UNII-2C (4TX) Non-Beamforming	802.11a:22.75dBm 802.11n (20M): 22.40dBm 802.11n (40M): 22.52dBm 802.11ac Wave2(20 MHz): 12.37dBm 802.11ac Wave2(40 MHz): 21.30dBm 802.11ac Wave2(80 MHz): 17.66dBm
	Output Power (Max.)for UNII-2A (2TX) Beamforming	802.11n (20M): 18.50dBm 802.11n (40M): 18.56dBm 802.11ac Wave2(20 MHz): 18.47dBm 802.11ac Wave2(40 MHz): 18.51dBm 802.11ac Wave2(80 MHz): 13.62dBm 802.11ac Wave2(160MHz):14.61dBm
	Output Power (Max.)for UNII-2C (2TX) Beamforming	802.11n (20M): 18.50dBm 802.11n (40M): 18.59dBm 802.11ac Wave2(20 MHz): 18.52dBm 802.11ac Wave2(40 MHz): 18.61dBm 802.11ac Wave2(80 MHz): 13.58dBm 802.11ac Wave2(160MHz):14.57dBm
	Output Power (Max.)for UNII-2A (3TX) Beamforming	802.11n (20M): 17.23dBm 802.11n (40M): 17.28dBm 802.11ac Wave2(20 MHz): 17.97dBm 802.11ac Wave2(40 MHz): 17.22dBm 802.11ac Wave2(80 MHz): 12.35dBm
	Output Power (Max.)for UNII-2C (3TX) Beamforming	802.11n (20M): 17.17dBm 802.11n (40M): 18.09dBm 802.11ac Wave2(20 MHz): 17.22dBm 802.11ac Wave2(40 MHz): 17.33dBm 802.11ac Wave2(80 MHz): 12.35dBm

Output Power	Output Power (Max.)for UNII-2A (4TX) Beamforming	802.11n (20M): 16.45dBm 802.11n (40M): 16.54dBm 802.11ac Wave2(20 MHz): 16.41dBm 802.11ac Wave2(40 MHz): 15.24dBm 802.11ac Wave2(80 MHz): 11.55dBm
	Output Power (Max.)for UNII-2C (4TX) Beamforming	802.11n (20M): 16.48dBm 802.11n (40M): 16.54dBm 802.11ac Wave2(20 MHz): 16.42dBm 802.11ac Wave2(40 MHz): 15.25dBm 802.11ac Wave2(80 MHz): 11.61dBm

Note:

1. For a more detailed features description, please refer to the manufacturer's specifications or the user's manual.
2. Channel List:

802.11a 802.11n 20MHz 802.11ac Wave2(20 MHz)		802.11n 40MHz 802.11ac Wave2(40 MHz)		802.11ac Wave2(80 MHz)	
UNII-2A		UNII-2A		UNII-2A	
Channel	Frequency (MHz)	Channel	Frequency (MHz)	Channel	Frequency (MHz)
52	5260	54	5270	58	5290
56	5280	62	5310		
60	5300				
64	5320				

802.11a 802.11n 20MHz 802.11ac Wave2(20 MHz)		802.11n 40MHz 802.11ac Wave2(40 MHz)		802.11ac Wave2(80 MHz)	
UNII-2C		UNII-2C		UNII-2C	
Channel	Frequency (MHz)	Channel	Frequency (MHz)	Channel	Frequency (MHz)
100	5500	102	5510	106	5530
104	5520	110	5550	122	5610
108	5540	118	5590		
112	5560	126	5630		
116	5580	134	5670		
120	5600				
124	5620				
128	5640				
132	5660				
136	5680				
140	5700				

802.11ac Wave2(160MHz)							
In 5G band, 160MHz channel is combined by two 80MHz channels and the working form is 80+80MHz. Each 80MHz channel selects discontinuity requirements.							
In this FCC test, only tested two typical combination (5290+5610MHz) for 160MHz test.							
802.11ac wave2 (160MHz)							
Channel	Frequency (MHz)	Channel	Frequency (MHz)	Channel	Frequency (MHz)	Channel	Frequency (MHz)
42+106	5210+5530	106+42	5530+5210	42+122	5210+5610	122+42	5610+5210
42+155	5210+5775	155+42	5775+5210	58+122	5290+5610	122+58	5610+5290
58+106	5290+5530	106+58	5530+5290	58+155	5290+5775	155+58	5775+5290
106+155	5530+5775	155+106	5775+5530	122+155	5610+5775	155+122	5775+5610

3. Antenna Specification:

Ant.	Manufacturer	Model Name	Antenna Type	Connector	Gain (dBi)
1	上海旌泓通信技术有限公司	N/A	Internal	U.FL	6.58
2	上海旌泓通信技术有限公司	N/A	Internal	U.FL	6.58
3	上海旌泓通信技术有限公司	N/A	Internal	U.FL	6.58
4	上海旌泓通信技术有限公司	N/A	Internal	U.FL	6.58

Note:

The EUT incorporates a MIMO function. Physically, the EUT provides three completed transmitters and receivers (4T4R), all transmit signals are completely correlated, then, Direction gain = G_{ANT} , that is Directional gain=6.58. So for fixed device, the UNII-2A, UNII-2C output power limit is $24-6.58+6=23.42$.

The UNII-2A power density limit is $11-6.58+6=10.42$, the UNII-2C power density limit is $11-6.58+6=10.42$.

Remark:When antenna gain is larger than 6dBi , for every 1 dBi increase in gain, the power limit is reduced by 1 dBm.

(1) For 2TX without beamforming:

The EUT with beamforming function, then, Direction gain = $G_{ANT}+10\log(N_{ANT}/N_{SS})$.

For 2TX without beamforming: Directional gain= $6.58+10\log(2/2)=6.58+0=6.58$ dBi.

So for fixed device, the UNII-2A, UNII-2C output power limit is $24-6.58+6=23.42$. The UNII-2A power density limit is $11-6.58+6=10.42$, the UNII-2C power density limit is $11-6.58+6=10.42$.

(2) For 3TX without beamforming:

The EUT with beamforming function, then, Direction gain = $G_{ANT}+10\log(N_{ANT}/N_{SS})$.

For 3TX without beamforming: Directional gain= $6.58+10\log(3/3)=6.58+0=6.58$ dBi.

So for fixed device, the UNII-2A, UNII-2C output power limit is $24-6.58+6=23.42$. The UNII-2A power density limit is $11-6.58+6=10.42$, the UNII-2C power density limit is $11-6.58+6=10.42$.

(3) For 4TX without beamforming:

The EUT with beamforming function, then, Direction gain = $G_{ANT}+10\log(N_{ANT}/N_{SS})$.

For 4TX without beamforming: Directional gain= $6.58+10\log(4/4)=6.58+0=6.58$ dBi.

So for fixed device, the UNII-2A, UNII-2C output power limit is $24-6.58+6=23.42$. The UNII-2A power density limit is $11-6.58+6=10.42$, the UNII-2C power density limit is $11-6.58+6=10.42$.

(1) For 2TX with beamforming:

The EUT with beamforming function, then, Direction gain = $G_{ANT}+10\log(N_{ANT})$.

For 2TX with beamforming: Directional gain= $6.58+10\log(2)=6.58+3=9.58$ dBi.

So for fixed device, the UNII-2A, UNII-2C output power limit is $24-(9.58-6)=20.42$. The UNII-2A power density limit is $11-(9.58-6)=7.42$, the UNII-2C power density limit is $11-(9.58-6)=7.42$.

(2) For 3TX with beamforming:

The EUT with beamforming function, then, Direction gain = $G_{ANT}+10\log(N_{ANT})$.

For 3TX with beamforming: Directional gain= $6.58+10\log(3)=6.58+4.77=11.35$ dBi.

So for fixed device, the UNII-2A, UNII-2C output power limit is $24-(11.35-6)=18.65$.

The UNII-2A power density limit is $11-(11.35-6)=5.65$, the UNII-2C power density limit is $11-(11.35-6)=5.65$.

(3) For 4TX with beamforming:

The EUT with beamforming function, then, Direction gain = $G_{ANT}+10\log(N_{ANT})$. For 4TX with beamforming: Directional gain= $6.58+10\log(4)=6.58 + 6=12.58$ dBi.

So for fixed device, the UNII-2A, UNII-2C output power limit is $24-(12.58-6)=17.42$. The UNII-2A power density limit is $11-(12.58-6)=4.42$, the UNII-2C power density limit is $11-(12.58-6)=4.42$.

4.

Operating Mode / TX Mode	1TX	2TX
802.11a	V (Ant 1)	V (Ant 1+Ant 2)
802.11n(20MHz)	V (Ant 1)	V (Ant 1+Ant 2)
802.11n(40MHz)	V (Ant 1)	V (Ant 1+Ant 2)
802.11ac Wave2(20MHz)	V (Ant 1)	V (Ant 1+Ant 2)
802.11ac Wave2(40MHz)	V (Ant 1)	V (Ant 1+Ant 2)
802.11ac Wave2(80MHz)	V (Ant 1)	V (Ant 1+Ant 2)
802.11ac Wave2(160MHz)	V (Ant 1+Ant 2)	V (Ant 1+Ant 2+ Ant 3+Ant 4)

Operating Mode / TX Mode	3TX	4TX
802.11a	V (Ant 1+Ant 2+Ant 3)	V (Ant 1+Ant 2+ Ant 3+Ant 4)
802.11n(20MHz)	V (Ant 1+Ant 2+Ant 3)	V (Ant 1+Ant 2+ Ant 3+Ant 4)
802.11n(40MHz)	V (Ant 1+Ant 2+Ant 3)	V (Ant 1+Ant 2+ Ant 3+Ant 4)
802.11ac Wave2(20MHz)	V (Ant 1+Ant 2+Ant 3)	V (Ant 1+Ant 2+ Ant 3+Ant 4)
802.11ac Wave2(40MHz)	V (Ant 1+Ant 2+Ant 3)	V (Ant 1+Ant 2+ Ant 3+Ant 4)
802.11ac Wave2(80MHz)	V (Ant 1+Ant 2+Ant 3)	V (Ant 1+Ant 2+ Ant 3+Ant 4)

Note: 1TX means Nss=1, 2TX means Nss=2, 3TX means Nss=3, 4TX means Nss=4.

3.2 DESCRIPTION OF TEST MODES

To investigate the maximum EMI emission characteristics generates from EUT, the test system was pre-scanning tested base on the consideration of following EUT operation mode or test configuration mode which possible have effect on EMI emission level. Each of these EUT operation mode(s) or test configuration mode(s) mentioned above was evaluated respectively.

Pretest Mode	Description
Mode 1	TX A Mode/ CH52, CH60, CH64 (UNII-2A)
Mode 2	TX N20 Mode/ CH52, CH60, CH64 (UNII-2A)
Mode 3	TX N40 Mode/ CH54, CH62 (UNII-2A)
Mode 4	TX AC Wave2(20 MHz) Mode/ CH52, CH60, CH64 (UNII-2A)
Mode 5	TX AC Wave2(40 MHz)/ CH54, CH62 (UNII-2A)
Mode 6	TX AC Wave2(80 MHz) / CH58 (UNII-2A)
Mode 7	TX A Mode/ CH100, CH116, CH140 (UNII-2C)
Mode 8	TX N20 Mode/ CH100, CH116, CH140 (UNII-2C)
Mode 9	TX N40 Mode/CH102, CH110, CH134(UNII-2C)
Mode 10	TX AC Wave2(20 MHz) Mode/ CH100, CH116, CH140 (UNII-2C)
Mode 11	TX AC Wave2(40 MHz)/CH102, CH110, CH134(UNII-2C)
Mode 12	TX AC Wave2(80 MHz) / CH106, CH122 (UNII-2C)
Mode 13	TX AC Wave2(160 MHz) Mode / CH58(UNII-2A)+CH122 (UNII-2C)
Mode 14	TX Mode

The EUT system operated these modes were found to be the worst case during the pre-scanning test as following:

For Conducted Test	
Final Test Mode	Description
Mode 14	TX Mode

For Radiated Test	
Final Test Mode	Description
Mode 1	TX A Mode/ CH52, CH60, CH64 (UNII-2A)
Mode 2	TX N20 Mode/ CH52, CH60, CH64 (UNII-2A)
Mode 3	TX N40 Mode/ CH54, CH62 (UNII-2A)
Mode 4	TX AC Wave2(20 MHz) Mode/ CH52, CH60, CH64 (UNII-2A)
Mode 5	TX AC Wave2(40 MHz)/ CH54, CH62 (UNII-2A)
Mode 6	TX AC Wave2(80 MHz) / CH58 (UNII-2A)
Mode 7	TX A Mode/ CH100, CH116, CH140 (UNII-2C)
Mode 8	TX N20 Mode/ CH100, CH116, CH140 (UNII-2C)
Mode 9	TX N40 Mode/CH102, CH110, CH134(UNII-2C)
Mode 10	TX AC Wave2(20 MHz) Mode/ CH100, CH116, CH140 (UNII-2C)
Mode 11	TX AC Wave2(40 MHz)/CH102, CH110, CH134(UNII-2C)
Mode 12	TX AC Wave2(80 MHz) / CH106, CH122 (UNII-2C)
Mode 13	TX AC Wave2(160 MHz) Mode / CH58(UNII-2A)+CH122 (UNII-2C)

Note:

(1) For radiated below 1GHz test, the 802.11a mode is found to be the worst case and recorded.

3.3 TABLE OF PARAMETERS OF TEST SOFTWARE SETTING

During testing channel & power controlling software provided by the customer was used to control the operating channel as well as the output power level. The RF output power selection is for the setting of RF output power expected by the customer and is going to be fixed on the firmware of the final end product

UNII-2A - 1TX Non-Beamforming			
Test Software Version	QRCT		
Frequency (MHz)	5260	5300	5320
A Mode	19	19	18
Frequency (MHz)	5260	5300	5320
N20 Mode	19	19	15
Frequency (MHz)	5270	5310	
N40 Mode	18	15	

UNII-2C - 1TX Non-Beamforming			
Test Software Version	QRCT		
Frequency (MHz)	5500	5580	5700
A Mode	17	19	17
Frequency (MHz)	5500	5580	5700
N20 Mode	15	19	17
Frequency (MHz)	5510	5550	5670
N40 Mode	15	18	16

UNII-2A - 1TX Non-Beamforming			
Test Software Version	QRCT		
Frequency (MHz)	5260	5300	5320
AC Wave2(20 MHz) Mode	19	19	17
Frequency (MHz)	5270	5310	
AC Wave2(40 MHz) Mode	18	15	
Frequency (MHz)	5290		
AC Wave2(80 MHz) Mode	15		

UNII-2C - 1TX Non-Beamforming			
Test Software Version	QRCT		
Frequency (MHz)	5500	5580	5700
AC Wave2(20 MHz) Mode	17	19	17
Frequency (MHz)	5510	5550	5670
AC Wave2(40 MHz) Mode	15	18	16
Frequency (MHz)	5530	5610	
AC Wave2(80 MHz) Mode	15	15	

UNII-2A + UNII-2C - 1TX Non-Beamforming			
Test Software Version	QRCT		
Frequency (MHz)	5290	5610	
AC Wave2(160 MHz) Mode	14	14	

UNII-2A - 2TX Non-Beamforming			
Test Software Version	QRCT		
Frequency (MHz)	5260	5300	5320
A Mode	19	19	18
Frequency (MHz)	5260	5300	5320
N20 Mode	19	19	16
Frequency (MHz)	5270	5310	
N40 Mode	18	14	

UNII-2C - 2TX Non-Beamforming			
Test Software Version	QRCT		
Frequency (MHz)	5500	5580	5700
A Mode	17	19	17
Frequency (MHz)	5500	5580	5700
N20 Mode	16	19	17
Frequency (MHz)	5510	5550	5670
N40 Mode	14	18	15

UNII-2A - 2TX Non-Beamforming			
Test Software Version	QRCT		
Frequency (MHz)	5260	5300	5320
AC Wave2(20 MHz) Mode	19	19	16
Frequency (MHz)	5270	5310	
AC Wave2(40 MHz) Mode	18	14	
Frequency (MHz)	5290		
AC Wave2(80 MHz) Mode	14		

UNII-2C - 2TX Non-Beamforming			
Test Software Version	QRCT		
Frequency (MHz)	5500	5580	5700
AC Wave2(20 MHz) Mode	16	19	17
Frequency (MHz)	5510	5550	5670
AC Wave2(40 MHz) Mode	14	18	15
Frequency□(MHz)	5530	5610	
AC Wave2(80 MHz) Mode	14	14	

UNII-2A + UNII-2C - 2TX Non-Beamforming			
Test Software Version	QRCT		
Frequency (MHz)	5290	5610	
AC Wave2(160 MHz) Mode	14	14	

UNII-2A - 3TX Non-Beamforming			
Test Software Version	QRCT		
Frequency (MHz)	5260	5300	5320
A Mode	18	18	17
Frequency (MHz)	5260	5300	5320
N20 Mode	18	18	15
Frequency (MHz)	5270	5310	
N40 Mode	18	13	

UNII-2C - 3TX Non-Beamforming			
Test Software Version	QRCT		
Frequency (MHz)	5500	5580	5700
A Mode	16	18	16
Frequency (MHz)	5500	5580	5700
N20 Mode	15	18	16
Frequency (MHz)	5510	5550	5670
N40 Mode	13	18	14

UNII-2A - 3TX Non-Beamforming			
Test Software Version	QRCT		
Frequency (MHz)	5260	5300	5320
AC Wave2(20 MHz) Mode	18	18	15
Frequency (MHz)	5270	5310	
AC Wave2(40 MHz) Mode	18	13	
Frequency (MHz)	5290		
AC Wave2(80 MHz) Mode	13		

UNII-2C - 3TX Non-Beamforming			
Test Software Version	QRCT		
Frequency (MHz)	5500	5580	5700
AC Wave2(20 MHz) Mode	15	18	16
Frequency (MHz)	5510	5550	5670
AC Wave2(40 MHz) Mode	13	18	14
Frequency (MHz)	5530	5610	
AC Wave2(80 MHz) Mode	13	13	

UNII-2A - 4TX Non-Beamforming			
Test Software Version	QRCT		
Frequency (MHz)	5260	5300	5320
A Mode	17	17	16
Frequency (MHz)	5260	5300	5320
N20 Mode	17	17	14
Frequency (MHz)	5270	5310	
N40 Mode	17	12	

UNII-2C - 4TX Non-Beamforming			
Test Software Version	QRCT		
Frequency (MHz)	5500	5580	5700
A Mode	15	17	15
Frequency (MHz)	5500	5580	5700
N20 Mode	14	17	15
Frequency (MHz)	5510	5550	5670
N40 Mode	12	17	13

UNII-2A - 4TX Non-Beamforming			
Test Software Version	QRCT		
Frequency (MHz)	5260	5300	5320
AC Wave2(20 MHz) Mode	17	17	14
Frequency (MHz)	5270	5310	
AC Wave2(40 MHz) Mode	17	12	
Frequency (MHz)	5290		
AC Wave2(80 MHz) Mode	12		

UNII-2C - 4TX Non-Beamforming			
Test Software Version	QRCT		
Frequency (MHz)	5500	5580	5700
AC Wave2(20 MHz) Mode	14	17	15
Frequency (MHz)	5510	5550	5670
AC Wave2(40 MHz) Mode	12	17	13
Frequency (MHz)	5530	5610	
AC Wave2(80 MHz) Mode	12	12	

UNII-2A - 2TXBeamforming			
Test Software Version	QRCT		
Frequency (MHz)	5260	5300	5320
N20 Mode	16	16	13
Frequency (MHz)	5270	5310	
N40 Mode	16	11	

UNII-2C - 2TXBeamforming			
Test Software Version	QRCT		
Frequency (MHz)	5500	5580	5700
N20 Mode	13	16	14
Frequency (MHz)	5510	5550	5670
N40 Mode	11	16	12

UNII-2A - 2TXBeamforming			
Test Software Version	QRCT		
Frequency (MHz)	5260	5300	5320
AC Wave2(20 MHz) Mode	16	16	13
Frequency (MHz)	5270	5310	
AC Wave2(40 MHz) Mode	16	11	
Frequency (MHz)	5290		
AC Wave2(80 MHz) Mode	11		

UNII-2C - 2TXBeamforming			
Test Software Version	QRCT		
Frequency (MHz)	5500	5580	5700
AC Wave2(20 MHz) Mode	13	16	15
Frequency (MHz)	5510	5550	5670
AC Wave2(40 MHz) Mode	11	16	12
Frequency (MHz)	5530	5610	
AC Wave2(80 MHz) Mode	11	11	

UNII-2A + UNII-2C - 2TX Beamforming			
Test Software Version	QRCT		
Frequency (MHz)	5290	5610	
AC Wave2(160 MHz) Mode	12	12	

UNII-2A - 3TXBeamforming			
Test Software Version	QRCT		
Frequency (MHz)	5260	5300	5320
N20 Mode	13	13	10
Frequency (MHz)	5270	5310	
N40 Mode	13	8	

UNII-2C - 3TXBeamforming			
Test Software Version	QRCT		
Frequency (MHz)	5500	5580	5700
N20 Mode	10	13	11
Frequency (MHz)	5510	5550	5670
N40 Mode	8	13	9

UNII-2A - 3TXBeamforming			
Test Software Version	QRCT		
Frequency (MHz)	5260	5300	5320
AC Wave2(20 MHz) Mode	13	13	10
Frequency (MHz)	5270	5310	
AC Wave2(40 MHz) Mode	13	8	
Frequency (MHz)	5290		
AC Wave2(80 MHz) Mode	8		

UNII-2C - 3TXBeamforming			
Test Software Version	QRCT		
Frequency (MHz)	5500	5580	5700
AC Wave2(20 MHz) Mode	10	13	11
Frequency (MHz)	5510	5550	5670
AC Wave2(40 MHz) Mode	8	13	9
Frequency (MHz)	5530	5610	
AC Wave2(80 MHz) Mode	8	8	

UNII-2A - 4TXBeamforming			
Test Software Version	QRCT		
Frequency (MHz)	5260	5300	5320
N20 Mode	11	11	8
Frequency (MHz)	5270	5310	
N40 Mode	11	6	

UNII-2C - 4TXBeamforming			
Test Software Version	QRCT		
Frequency (MHz)	5500	5580	5700
N20 Mode	8	11	9
Frequency (MHz)	5510	5550	5670
N40 Mode	6	11	7

UNII-2A - 4TXBeamforming			
Test Software Version	QRCT		
Frequency (MHz)	5260	5300	5320
AC Wave2(20 MHz) Mode	11	11	8
Frequency (MHz)	5270	5310	
AC Wave2(40 MHz) Mode	11	6	
Frequency (MHz)	5290		
AC Wave2(80 MHz) Mode	6		

UNII-2C - 4TXBeamforming			
Test Software Version	QRCT		
Frequency (MHz)	5500	5580	5700
AC Wave2(20 MHz) Mode	8	11	9
Frequency (MHz)	5510	5550	5670
AC Wave2(40 MHz) Mode	6	11	7
Frequency (MHz)	5530	5610	
AC Wave2(80 MHz) Mode	6	6	

3.4 BLOCKDIAGRAMSHOWINGTHECONFIGURATIONOFSYSTEMTESTED

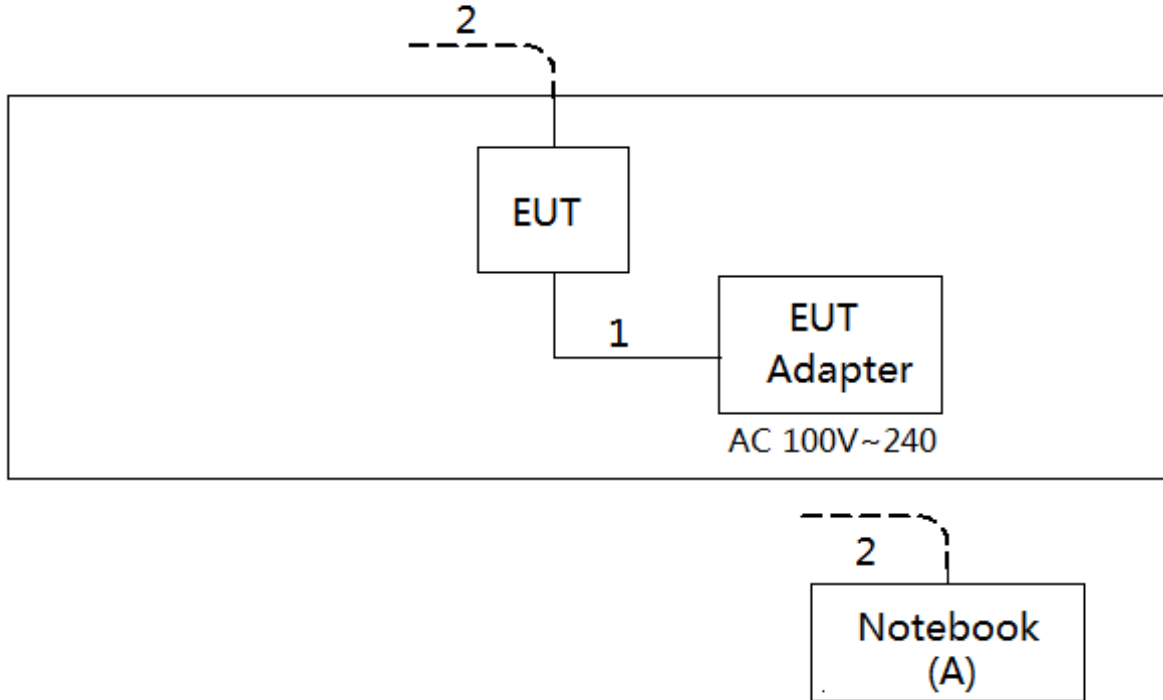

3.5 DESCRIPTION OF SUPPORT UNITS

The EUT has been tested as an independent unit together with other necessary accessories or support units. The following support units or accessories were used to form a representative test configuration during the tests.

Item	Equipment	Mfr/Brand	Model/Type No.	FCC ID	Series No.
A	Notebook	Lenovo	INSPIRON 1420-	DOC	JX193A01SDC2

Item	Shielded Type	Ferrite Core	Length	Note
1	NO	NO	10m	RJ45 Cable
2	NO	NO	1.5m	Power Cable

4. EMC EMISSION TEST

4.1 CONDUCTED EMISSION MEASUREMENT

4.1.1 POWER LINE CONDUCTED EMISSION (Frequency Range 150kHz-30MHz)

FREQUENCY (MHz)	Class A (dBuV)		Class B (dBuV)	
	Quasi-peak	Average	Quasi-peak	Average
0.15 -0.5	79.00	66.00	66 - 56 *	56 - 46 *
0.50 -5.0	73.00	60.00	56.00	46.00
5.0 -30.0	73.00	60.00	60.00	50.00

Note:

- (1) The tighter limit applies at the band edges.
- (2) The limit of " * " marked band means the limitation decreases linearly with the logarithm of the frequency in the range.

4.1.2 TEST PROCEDURE

- a. The EUT was placed 0.8 meters from the horizontal ground plane with EUT being connected to the power mains through a line impedance stabilization network (LISN). All other support equipments powered from additional LISN(s). The LISN provide 50 Ohm/ 50uH of coupling impedance for the measuring instrument.
- b. Interconnecting cables that hang closer than 40 cm to the groundplane shall be folded back and forth in the center forming a bundle 30 to 40 cm long.
- c. I/O cables that are not connected to a peripheral shall be bundled in the center. The end of the cable may be terminated, if required, using the correct terminating impedance. The overall length shall not exceed 1 m.
- d. LISN at least 80 cm from nearest part of EUT chassis.
- e. For the actual test configuration, please refer to the related Item –EUT Test Photos.

4.1.3 DEVIATION FROM TEST STANDARD

No deviation

4.1.4 TESTSETUP

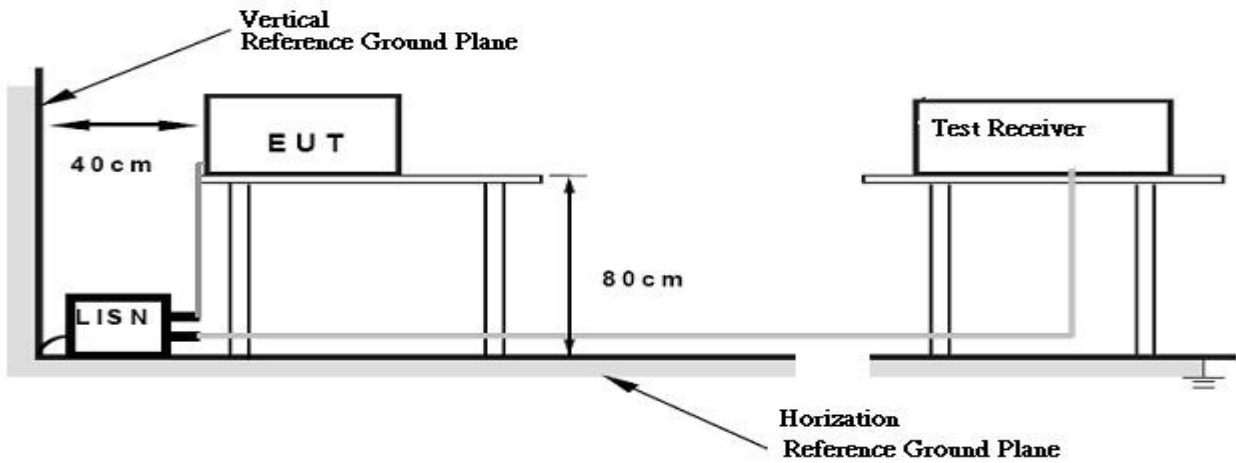

4.1.5 EUT OPERATING CONDITIONS

The EUT was configured for testing in a typical fashion (as a customer would normally use it). The EUT has been programmed to continuously transmit during test. This operating condition was tested and used to collect the included data.

The EUT was programmed to be in continuously transmitting/TX Mode mode.

4.1.6 EUT TEST CONDITIONS

Temperature: 25°C Relative Humidity: 53% Test Voltage: AC 120V/60Hz

4.1.7 TEST RESULTS

Please refer to the Attachment A.

Remark:

- (1) All readings are QP Mode value unless otherwise stated AVG in column of『Note』. If the QP Mode Measured value compliance with the QP Limits and lower than AVG Limits, the EUT shall be deemed to meet both QP & AVG Limits and then only QP Mode was measured, but AVG Mode didn't perform. In this case, a “ * ” marked in AVG Mode column of Interference Voltage Measured.
- (2) Measuring frequency range from 150kHz to 30MHz.

4.2 RADIATED EMISSION MEASUREMENT

4.2.1 RADIATED EMISSION LIMITS

20dBc in any 100 kHz bandwidth outside the operating frequency band. In case the emission fall within the restricted band specified on 15.205(a), then the 15.209(a) limit in the table below has to be followed.

Frequencies (MHz)	Field Strength (microrvolts/meter)	Measurement Distance (meters)
0.009~0.490	2400/F(kHz)	300
0.490~1.705	24000/F(kHz)	30
1.705~30.0	30	30
30~88	100	3
88~216	150	3
216~960	200	3
Above 960	500	3

Frequencies (MHz)	EIRP Limit (dBm)	Equivalent Field Strength at 3m (dBμV/m)
5150-5250	-27	68.3
5250-5350	-27	68.3
5470-5725	-27	68.3
5725-5850	-27(Note 2)	68.3
	10(Note 2)	105.3
	15.6(Note 2)	110.9
	27(Note 2)	122.3

Note:

1. The following formula is used to convert the equipment isotropic radiated power (eirp) to

field strength: $E = \frac{1000000\sqrt{30P}}{3} \mu\text{V/m}$, where P is the eirp (Watts)

2. According to FCC 16-24, All emissions shall be limited to a level of -27 dBm/MHz at 75 MHz or more above or below the band edge increasing linearly to 10 dBm/MHz at 25 MHz above or below the band edge, and from 25MHz above or below the band edge increasing linearly to a level of 15.6 dBm/MHz at 5 MHz above or below the band edge, and from 5 MHz above or below the band edge increasing linearly to a level of 27dBm/MHz at the band edge.

4.2.2 TEST PROCEDURE

- a. The measuring distance of 3 m shall be used for measurements. The EUT was placed on the top of a rotating table 0.8 meter above the ground at a 3 meter semi-anechoic chamber. The table was rotated 360 degrees to determine the position of the highest radiation.(below 1GHz)
- b. The measuring distance of 3 m shall be used for measurements. The EUT was placed on the top of a rotating table 1.5 meter above the ground at a 3 meter semi-anechoic chamber. The table was rotated 360 degrees to determine the position of the highest radiation.(above 1GHz)
- c. The height of the equipment or of the substitution antenna shall be 0.8m or 1.5m; the height of the test antenna shall vary between 1 m to 4 m. Both horizontal and vertical polarizations of the antenna are set to make the measurement.
- d. For each suspected emission, the EUT was arranged to its worst case and then the antenna was tuned to heights find the maximum reading (used Bore sight function).
- e. The receiver system was set to peak and average detect function and specified bandwidth with maximum hold mode when the test frequency is above 1GHz.
- f. The initial step in collecting radiated emission data is a receiver peak detector mode pre-scanning the measurement frequency range. Significant peaks are then marked and then Quasi Peak detector mode re-measured.
- g. All readings are Peak unless otherwise stated QP in column of Note. Peak denotes that the Peak reading compliance with the QP Limits and then QP Mode measurement didn't perform. (below 1GHz)
- h. All readings are Peak Mode value unless otherwise stated AVG in column of Note. If the Peak Mode Measured value compliance with the Peak Limits and lower than AVG Limits, the EUT shall be deemed to meet both Peak & AVG Limits and then only Peak Mode was measured, but AVG Mode didn't perform. (above 1GHz)
- i. For the actual test configuration, please refer to the related Item –EUT Test Photos.

4.2.3 DEVIATIONFROMTESTSTANDARD

No deviation

4.2.4 TESTSETUP

(A)Radiated Emission Test Set-Up Frequency Below 1GHz

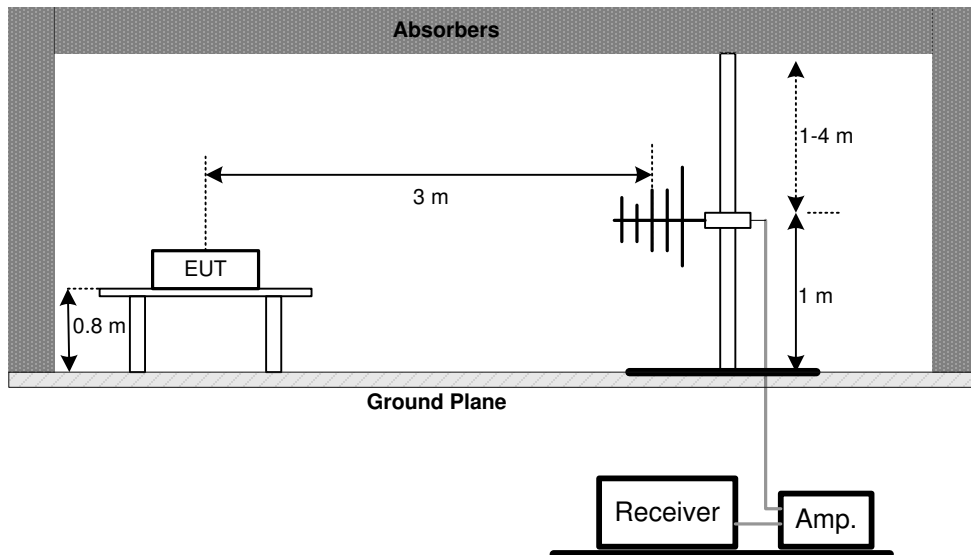

(B) Radiated Emission Test Set-Up Frequency Above 1 GHz

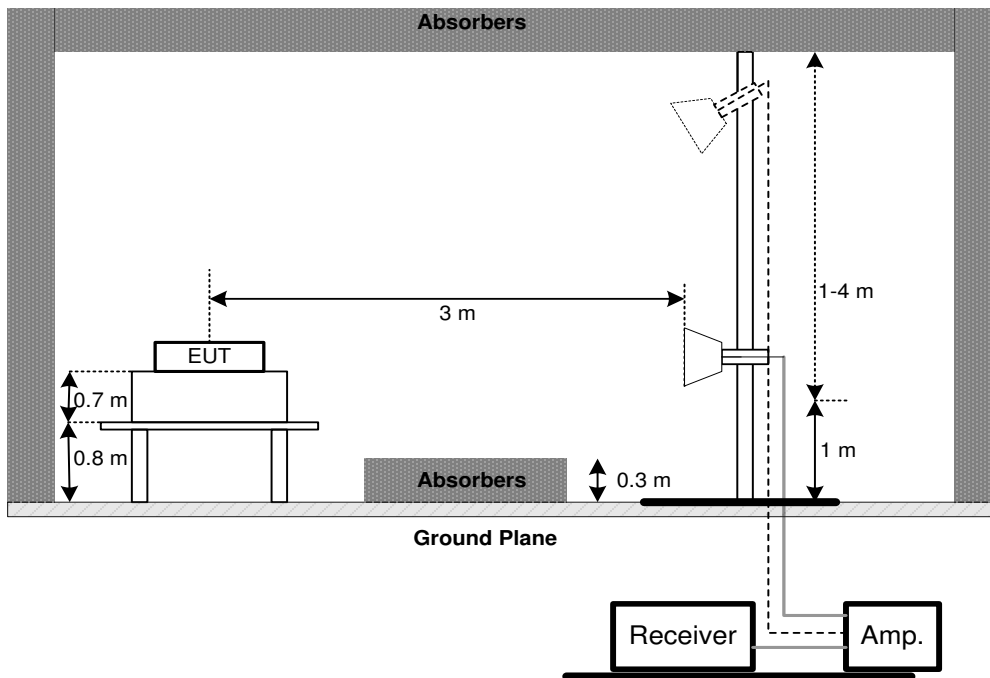

(C) Radiated emissions below 30MHz

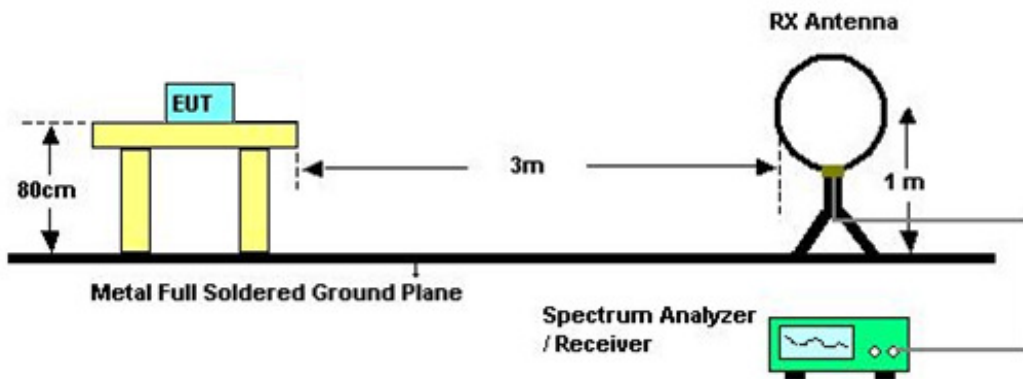

4.2.5 EUT OPERATING CONDITIONS

The EUT tested system was configured as the statements of 4.1.5 unless otherwise a special operating condition is specified in the follows during the testing.

4.2.6 EUT TEST CONDITIONS

Temperature: 25°C Relative Humidity: 60% Test Voltage: AC 120V/60Hz

4.2.7 TEST RESULTS (9K TO 30MHz)

Please refer to the Attachment B

Remark:

- (1) The amplitude of spurious emissions which are attenuated by more than 20 dB below the permissible value has no need to be reported.
- (2) Distance extrapolation factor = $40 \log (\text{specific distance} / \text{test distance})$ (dB);
- (3) Limit line = specific limits (dBuV) + distance extrapolation factor.

4.2.8 TEST RESULTS(BETWEEN30 TO 1000 MHz)

Please refer to the Attachment C.

4.2.9 TEST RESULTS (ABOVE1000 MHz)

Please refer to the Attachment D.

Remark:

- (1) No limit:This is fundamental signal, the judgment is not applicable.
For fundamental signal judgment was referred to Peak output test.

5. 26dB SPECTRUM BANDWIDTH

5.1 APPLIED PROCEDURES / LIMIT

FCC Part15, Subpart E			
Test Item	Limit	Frequency Range (MHz)	Result
Bandwidth	26 dB Bandwidth	5250-5350	PASS
	26 dB Bandwidth	5470-5725	PASS

5.1.1 TEST PROCEDURE

a. The EUT was directly connected to the spectrum analyzer and antenna output port as show in the block diagram below,

b.

Spectrum Parameters	Setting
Attenuation	Auto
Span Frequency	> 26dB Bandwidth
RBW	300 kHz(Bandwidth 20MHz) 1MHz(Bandwidth 40MHz and 80MHz)
VBW	1MHz(Bandwidth 20MHz) 3MHz(Bandwidth 40MHz and 80MHz)
Detector	Peak
Trace	Max Hold
Sweep Time	Auto

c. Measured the spectrum width with power higher than 26dB below carrier

5.1.2 DEVIATION FROM STANDARD

No deviation.

5.1.3 TEST SETUP



5.1.4 EUT OPERATION CONDITIONS

The EUT tested system was configured as the statements of 4.1.5 unless otherwise a special operating condition is specified in the follows during the testing.

5.1.5 EUT TEST CONDITIONS

Temperature: 25°C Relative Humidity: 60% Test Voltage: AC 120V/60Hz

5.1.6 TEST RESULTS

Please refer to the Attachment E.

6. MAXIMUM CONDUCTED OUTPUT POWER

6.1 APPLIED PROCEDURES / LIMIT

FCC Part15, Subpart E			
Test Item	Limit	Frequency Range (MHz)	Result
Conducted Output Power	250mW (24dBm)	5250-5350	PASS
	250mW (24dBm)	5470-5725	PASS
Note: The maximum e.i.r.p at anyelevation angle above 30 degrees as measured from the horizon must not exceed 125mW(21dBm)			

6.1.1 TEST PROCEDURE

a. The EUT was directly connected to the power meter and antenna output port as show in the block diagram below,

b.

Spectrum Parameter	Setting
Attenuation	Auto
Span Frequency	Encompass the entire emissions bandwidth (EBW) ofthe signal
RBW	= 1MHz.
VBW	\geq 3MHz.
Detector	RMS
Trace	Max Hold
Sweep Time	auto

c. Test was performed in accordance with method of KDB 789033 D02.

6.1.2 DEVIATION FROM STANDARD

No deviation.

6.1.3 TEST SETUP

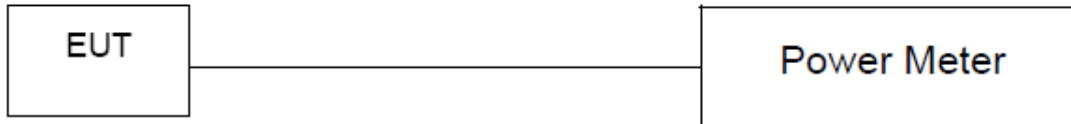

6.1.4 EUT OPERATION CONDITIONS

The EUT tested system was configured as the statements of 4.1.5 unless otherwise a special operating condition is specified in the follows during the testing.

6.1.5 EUT TEST CONDITIONS

Temperature: 25°C Relative Humidity: 60% Test Voltage: AC 120V/60Hz

6.1.6 TEST RESULTS

Please refer to the Attachment F.

7. POWER SPECTRAL DENSITY TEST

7.1 APPLIED PROCEDURES / LIMIT

FCC Part15, Subpart E			
Test Item	Limit	Frequency Range (MHz)	Result
Power Spectral Density	11dBm/MHz	5250-5350	PASS
	11dBm/MHz	5470-5725	PASS

8.1.1 TEST PROCEDURE

a. The EUT was directly connected to the spectrum analyzer and antenna output port as show in the block diagram below,

b.

Spectrum Parameter	Setting
Attenuation	Auto
Span Frequency	Encompass the entire emissions bandwidth (EBW) ofthe signal
RBW	= 1MHz.
VBW	≥ 3MHz.
Detector	RMS
Trace average	100 trace
Sweep Time	Auto

Note:

- 1.For UNII-3, according to KDB publication 789033 D02 General UNII Test Procedures New Rules v01r02, section II.F.5., it is acceptable to set RBW at 1MHz and VBW at 3MHz if the spectrum analyzer does not have 500kHz RBW.
- 2.The value measured with RBW=1MHz is to be added with $10\log(500\text{kHz}/1\text{MHz})$ which is -3dB. For example, if the measured value is +10dBm using RBW=1MHz (that is

7.1.1 DEVIATION FROM STANDARD

No deviation.

7.1.2 TEST SETUP



7.1.3 EUT OPERATION CONDITIONS

The EUT tested system was configured as the statements of 4.1.5 unless otherwise a special operating condition is specified in the follows during the testing.

7.1.4 EUT TEST CONDITIONS

Temperature: 25°C Relative Humidity: 60% Test Voltage: AC 120V/60Hz

7.1.5 TEST RESULTS

Please refer to the Attachment H.

8. FREQUENCY STABILITY MEASUREMENT

8.1 APPLIED PROCEDURES / LIMIT

FCC Part15, Subpart E			
Test Item	Limit	Frequency Range (MHz)	Result
Frequency Stability	Specified in the user's manual	5250-5350	PASS
		5470-5725	PASS

8.1.1 TEST PROCEDURE

a. The EUT was directly connected to the spectrum analyzer and antenna output port as show in the block diagram below,

b.

Spectrum Parameter	Setting
Attenuation	Auto
Span Frequency	Entire absence of modulation emissionsbandwidth
RBW	10 kHz
VBW	10kHz
Sweep Time	Auto

c. The test extreme voltage is to change the primary supply voltage from 85 to 115 percent of the nominal value.

d. User manual temperature is0°C~40°C.

8.1.2 DEVIATION FROM STANDARD

No deviation.

8.1.3 TEST SETUP

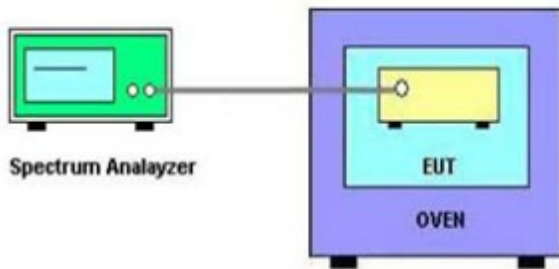

8.1.4 EUT OPERATION CONDITIONS

The EUT tested system was configured as the statements of 4.1.5 unless otherwise a special operating condition is specified in the follows during the testing.

8.1.5 EUT TEST CONDITIONS

Temperature: 25°C Relative Humidity: 55% Test Voltage: AC 120V/60Hz

8.1.6 TEST RESULTS

Please refer to the Attachment I.

9. MEASUREMENT INSTRUMENTS LIST

Conducted Emission Measurement					
Item	Kind of Equipment	Manufacturer	Type No.	Serial No.	Calibrated until
1	LISN	EMCO	3816/2	0052765	Mar. 27, 2017
2	LISN	R&S	ENV216	101447	Mar. 27, 2017
3	Test Cable	emci	RG223(9KHz-30 MHz)	C_17	Mar. 10, 2017
4	EMI Test Receiver	R&S	ESCI	100382	Mar. 27, 2017
5	50Ω Terminator	SHX	TF2-3G-A	08122901	Mar. 27, 2017
6	Measurement Software	Farad	EZ-EMC Ver.NB-03A1-01	N/A	N/A

Radiated Emission Measurement					
Item	Kind of Equipment	Manufacturer	Type No.	Serial No.	Calibrated until
1	Antenna	Schwarzbeck	VULB9160	9160-3232	Mar. 27, 2017
2	Amplifier	HP	8447D	2944A09673	Nov. 08, 2017
3	Receiver	AGILENT	N9038A	MY52130039	Oct. 10, 2017
4	Test Cable	emci	LMR-400(30MHz-1GHz)	C-01	Jun. 26, 2017
5	Control	CT	SC100	N/A	N/A
6	Position Control	MF	MF-7802	MF780208416	N/A
7	Antenna	ETS	3115	00075789	Mar. 27, 2017
8	Amplifier	Agilent	8449B	3008A02274	Nov. 01, 2017
9	Receiver	AGILENT	N9038A	MY52130039	Oct. 10, 2017
10	Test Cable	emci	EMC104-SM-S M-10000(1GHz-26.5GHz)	C-68	Jun. 26, 2017
11	Controller	CT	SC100	N/A	N/A
12	Broad-Band Horn Antenna	Schwarzbeck	BBHA 9170	9170319	Apr. 23, 2017
13	Microwave Pre-amplifier With Adaptor	EMC INSTRUMENT	EMC2654045	980039 & HA01	Mar. 27, 2017
14	Active Loop Antenna	R&S	HFH2-Z2	830749/020	Sep. 06, 2017
15	Measurement Software	Farad	EZ-EMC Ver.NB-03A1-01	N/A	N/A

Spectrum Bandwidth Measurement					
Item	Kind of Equipment	Manufacturer	Type No.	Serial No.	Calibrated until
1	Spectrum Analyzer	R&S	FSP 40	100185	Sep. 04, 2017

Maximum Conducted Output Power Measurement					
Item	Kind of Equipment	Manufacturer	Type No.	Serial No.	Calibrated until
1	P-series Power meter	Agilent	N1911A	MY45100473	Sep. 04, 2017
2	Wireband Power sensor	Agilent	N1921A	MY51100041	Sep. 04, 2017

Power Spectral Density Measurement					
Item	Kind of Equipment	Manufacturer	Type No.	Serial No.	Calibrated until
1	Spectrum Analyzer	R&S	FSP 40	100185	Sep. 04, 2017

Frequency Stability Measurement					
Item	Kind of Equipment	Manufacturer	Type No.	Serial No.	Calibrated until
1	Spectrum Analyzer	R&S	FSP 40	100185	Sep. 04, 2017
2	Precision Oven Tester	HOLINK	H-T-1F-D	BA03101701	May 22, 2017

Remark: "N/A" denotes no model name, serial no. or calibration specified.
 All calibration period of equipment list is one year.

ATTACHMENT A -CONDUCTED EMISSION

Test Mode: TX MODE

Line

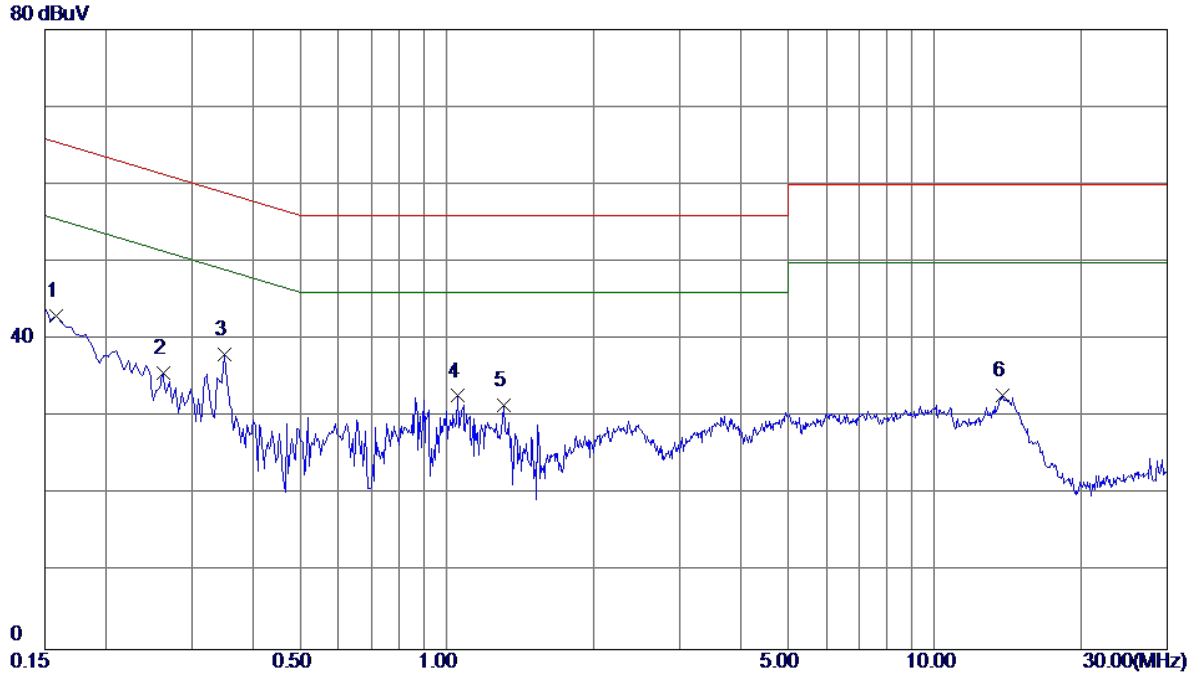

No.	Freq. MHz	Reading Level dBuV	Correct Factor dB	Measure ment dBuV	Limit dBuV	Margin dB	Detector	Comment
1	0.1580	33.57	9.52	43.09	65.57	-22.48	Peak	
2	0.2620	26.09	9.53	35.62	61.37	-25.75	Peak	
3 *	0.3500	28.61	9.53	38.14	58.96	-20.82	Peak	
4	1.0500	22.96	9.76	32.72	56.00	-23.28	Peak	
5	1.3060	21.67	9.80	31.47	56.00	-24.53	Peak	
6	13.8300	22.55	10.32	32.87	60.00	-27.13	Peak	

Note : The test result has included the cable loss.

Test Mode: TX MODE

Neutral

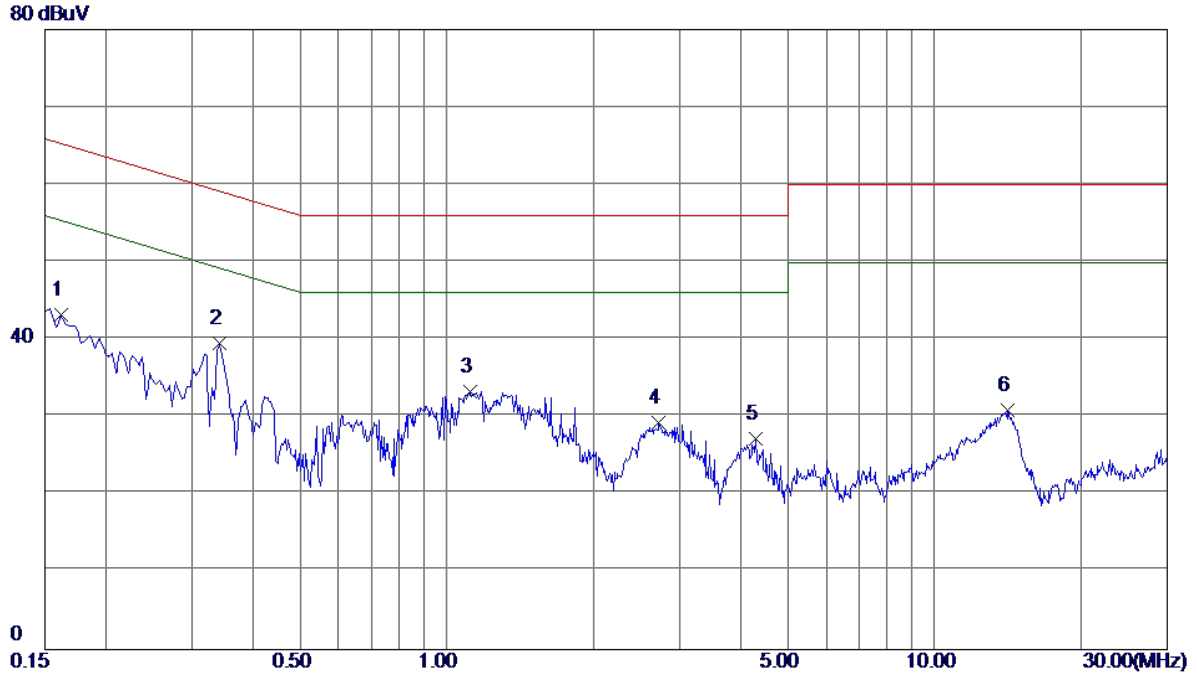

No.	Freq. MHz	Reading Level dBuV	Correct Factor dB	Measure ment dBuV	Limit dBuV	Margin dB	Detector	Comment
1	0.1620	33.75	9.46	43.21	65.36	-22.15	Peak	
2 *	0.3420	29.92	9.53	39.45	59.15	-19.70	Peak	
3	1.1180	23.58	9.66	33.24	56.00	-22.76	Peak	
4	2.7220	19.53	9.79	29.32	56.00	-26.68	Peak	
5	4.3020	17.21	9.92	27.13	56.00	-28.87	Peak	
6	14.1540	20.48	10.35	30.83	60.00	-29.17	Peak	

Note : The test result has included the cable loss.

ATTACHMENT B -RADIATED EMISSION (9KHZ TO 30MHZ)

Test Mode: TX MODE

Ant 0°

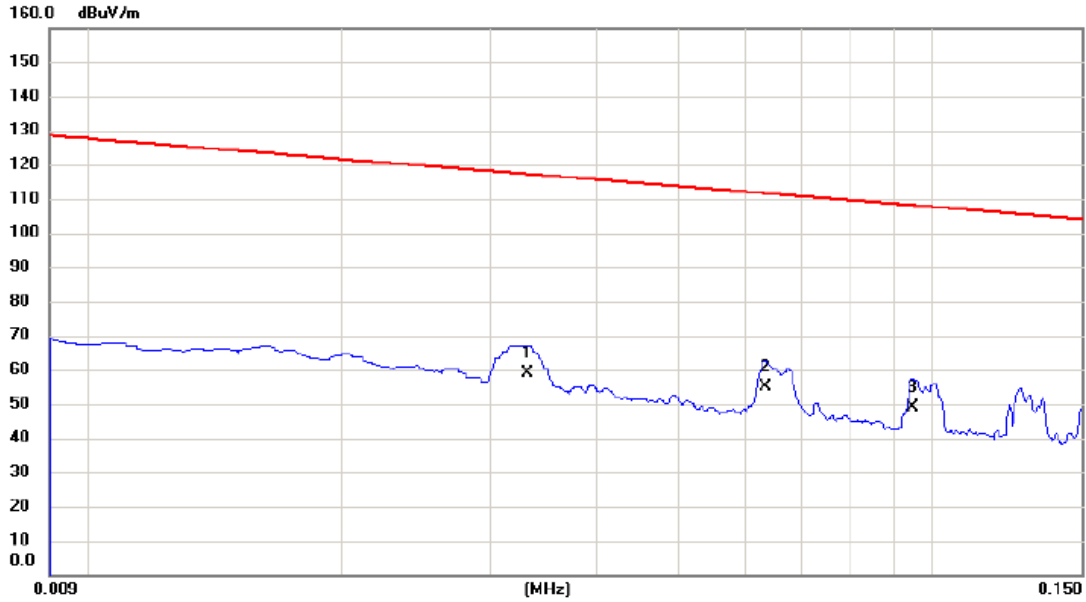

No.	Mk.	Freq.	Reading Level	Correct Factor	Measurement	Limit	Margin	Detector	Comment
		MHz	dBuV	dB	dBuV/m	dBuV/m	dB		
1		0.033	37.11	21.90	59.01	117.21	-58.20	AVG	
2	*	0.063	35.24	19.67	54.91	111.56	-56.65	AVG	
3		0.095	30.45	18.66	49.11	108.08	-58.97	AVG	

Test Mode: TX MODE

Ant 0°

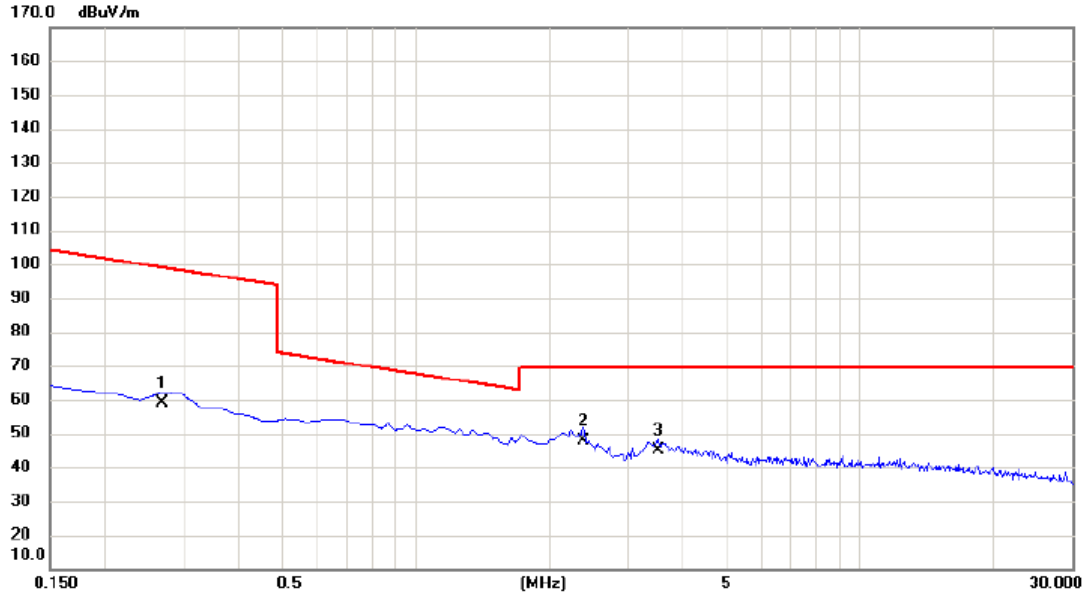

No.	Mk.	Freq. MHz	Reading Level dBuV	Correct Factor dB	Measure- ment dBuV/m	Limit dBuV/m	Margin dB	Detector	Comment
1		0.269	40.22	18.63	58.85	99.00	-40.15	AVG	
2	*	2.389	30.37	17.40	47.77	69.54	-21.77	QP	
3		3.523	27.32	17.74	45.06	69.54	-24.48	QP	

Test Mode: TX MODE

Ant 90°

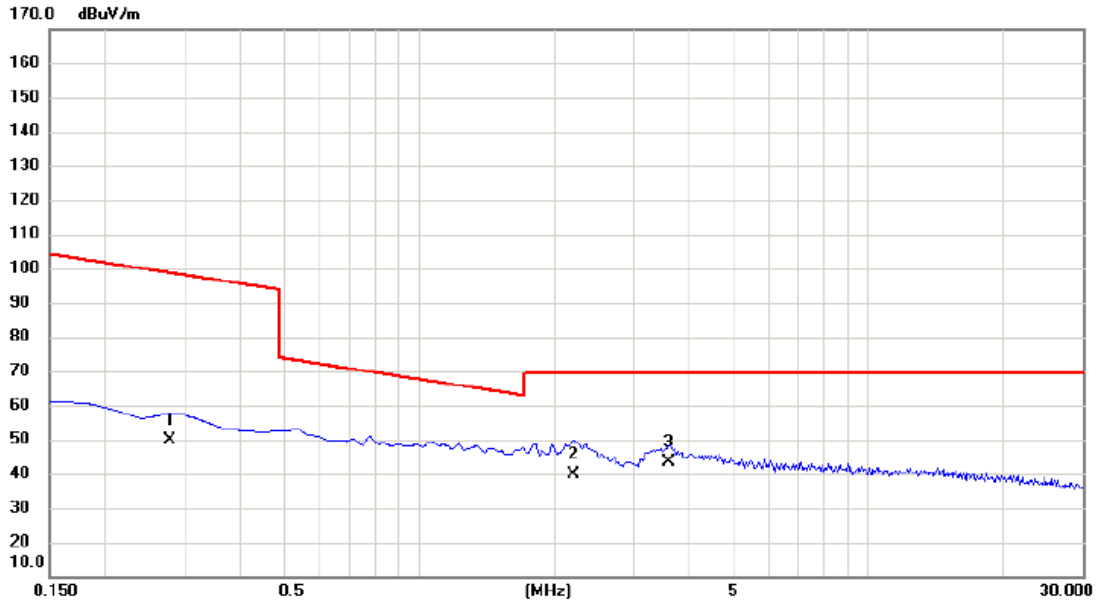

No.	Mk.	Freq. MHz	Reading Level dBuV	Correct Factor dB	Measure- ment dBuV/m	Limit dBuV/m	Margin dB	Detector	Comment
1		0.279	31.24	18.62	49.86	98.70	-48.84	AVG	
2		2.210	22.34	17.64	39.98	69.54	-29.56	QP	
3	*	3.583	25.49	17.86	43.35	69.54	-26.19	QP	

Test Mode: TX MODE

Ant 90°

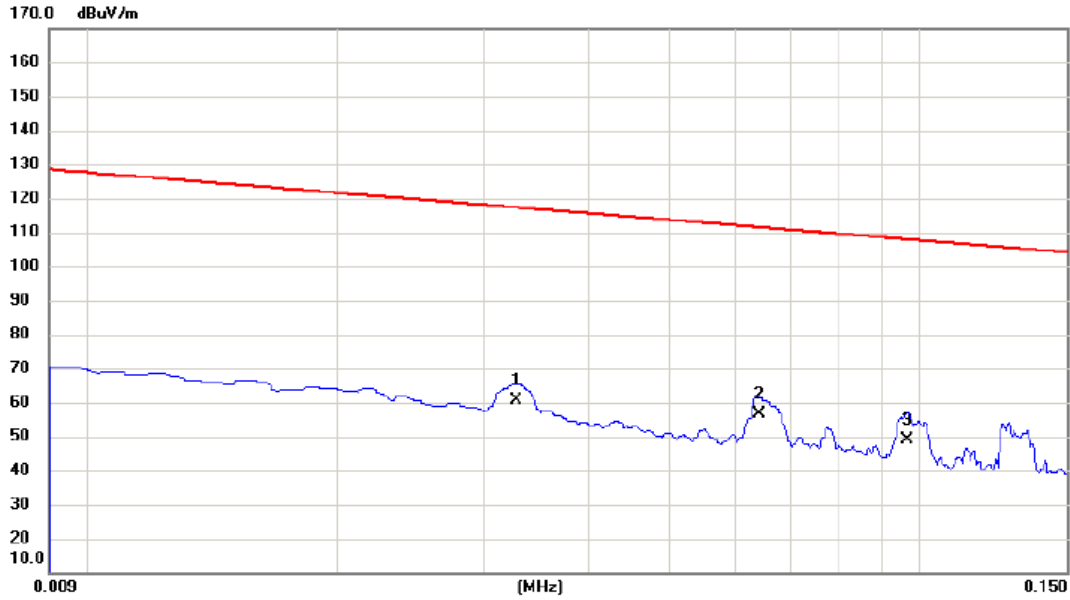

No.	Mk.	Freq. MHz	Reading Level dBuV	Correct Factor dB	Measure- ment dBuV/m	Limit dBuV/m	Margin dB	Detector	Comment
1		0.033	38.78	21.94	60.72	117.29	-56.57	AVG	
2	*	0.064	37.11	19.66	56.77	111.47	-54.70	AVG	
3		0.097	30.58	18.58	49.16	107.90	-58.74	AVG	

ATTACHMENT C -RADIATED EMISSION (30MHZ TO 1000MHZ)

Test Mode: UNII-2A/TX A Mode 5260MHz

Vertical

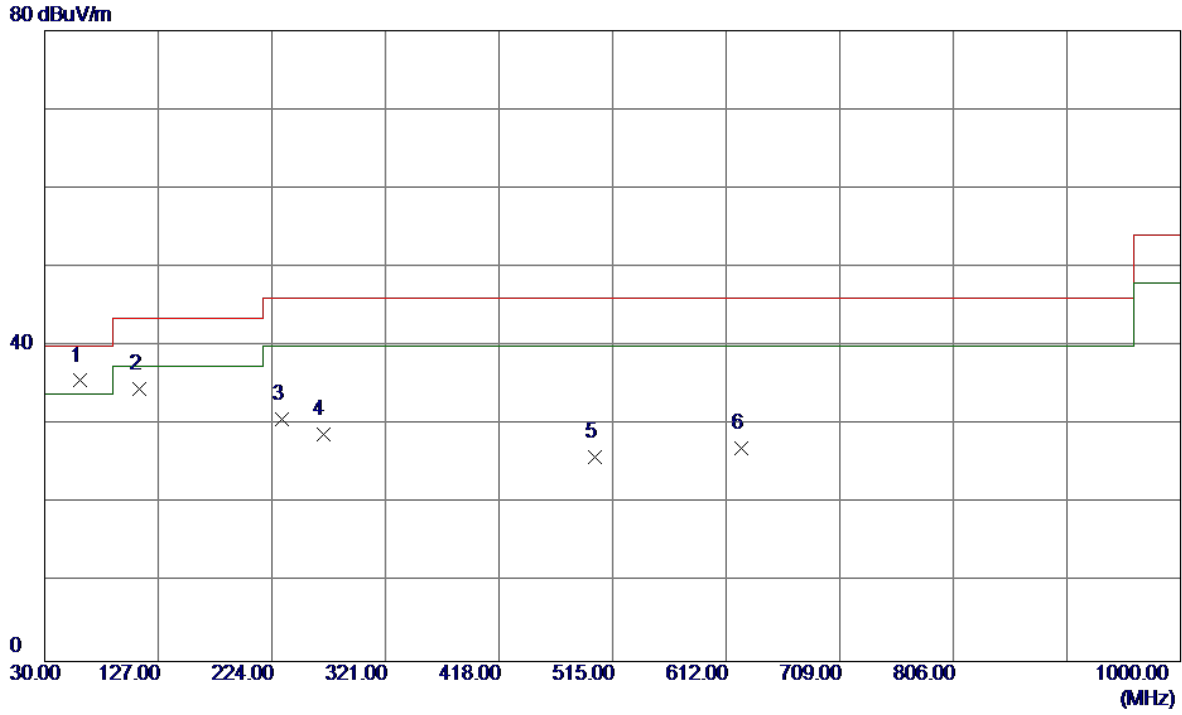

No.	Freq. MHz	Reading Level dBuV/m	Correct Factor dB	Measure ment dBuV/m	Limit dBuV/m	Margin dB	Detector	Comment
1 *	60.0700	49.34	-13.74	35.60	40.00	-4.40	Peak	
2	110.5100	49.17	-14.60	34.57	43.50	-8.93	Peak	
3	232.2450	44.11	-13.46	30.65	46.00	-15.35	Peak	
4	267.6500	42.39	-13.61	28.78	46.00	-17.22	Peak	
5	499.9650	35.70	-9.72	25.98	46.00	-20.02	Peak	
6	625.0949	32.59	-5.61	26.98	46.00	-19.02	Peak	

Test Mode: UNII-2A/TX A Mode 5260MHz

Horizontal

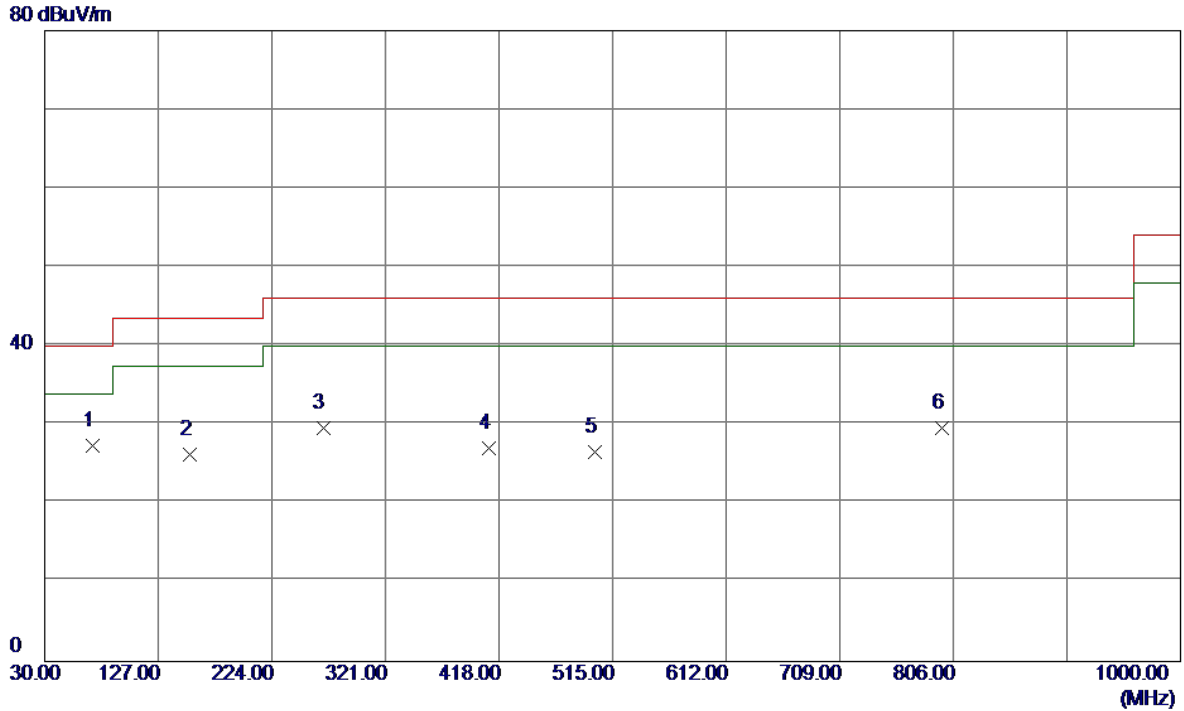

No.	Freq. MHz	Reading Level dBuV/m	Correct Factor dB	Measure ment dBuV/m	Limit dBuV/m	Margin dB	Detector	Comment
1 *	70.7400	43.87	-16.53	27.34	40.00	-12.66	Peak	
2	153.6750	38.89	-12.65	26.24	43.50	-17.26	Peak	
3	267.6500	43.14	-13.61	29.53	46.00	-16.47	Peak	
4	409.7550	34.80	-7.82	26.98	46.00	-19.02	Peak	
5	499.9650	36.21	-9.72	26.49	46.00	-19.51	Peak	
6	796.7849	29.51	0.12	29.63	46.00	-16.37	Peak	

Test Mode: UNII-2A/TX A Mode 5300MHz

Vertical

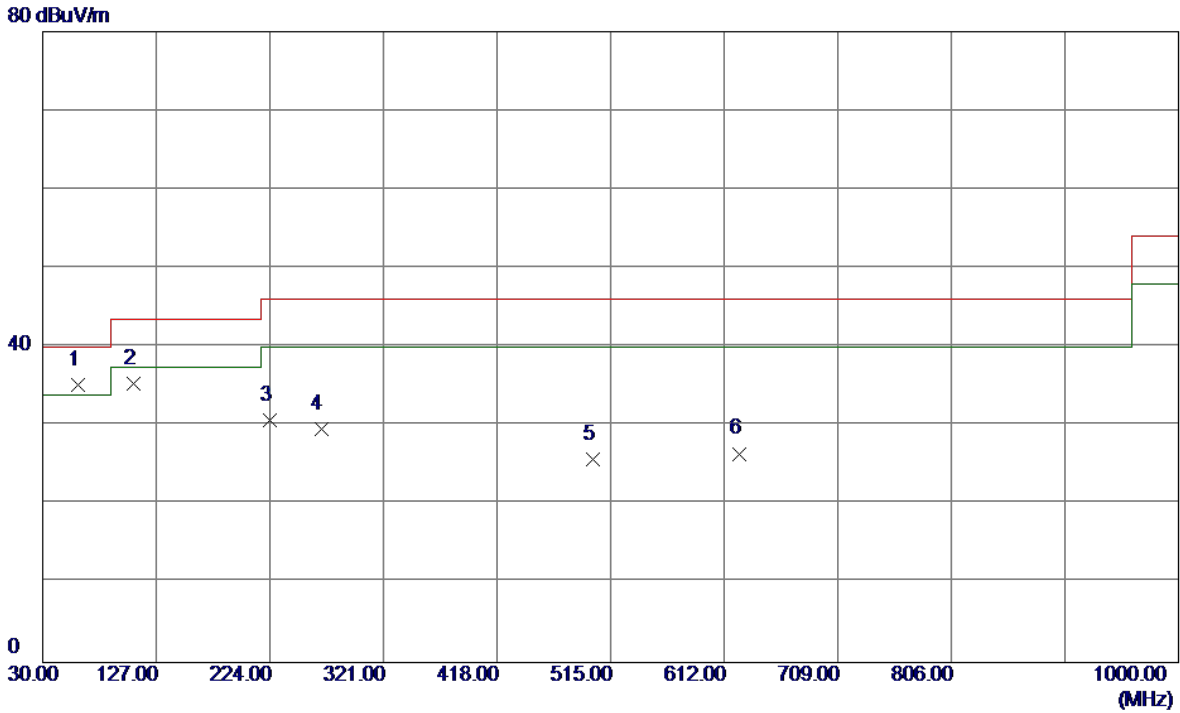

No.	Freq. MHz	Reading Level dBuV/m	Correct Factor dB	Measure ment dBuV/m	Limit dBuV/m	Margin dB	Detector	Comment
1 *	60.0700	48.97	-13.74	35.23	40.00	-4.77	Peak	
2	107.6000	50.23	-14.85	35.38	43.50	-8.12	Peak	
3	223.5150	44.69	-13.94	30.75	46.00	-15.25	Peak	
4	267.6500	43.18	-13.61	29.57	46.00	-16.43	Peak	
5	499.9650	35.54	-9.72	25.82	46.00	-20.18	Peak	
6	625.0949	32.09	-5.61	26.48	46.00	-19.52	Peak	

Test Mode: UNII-2A/TX A Mode 5300MHz

Horizontal

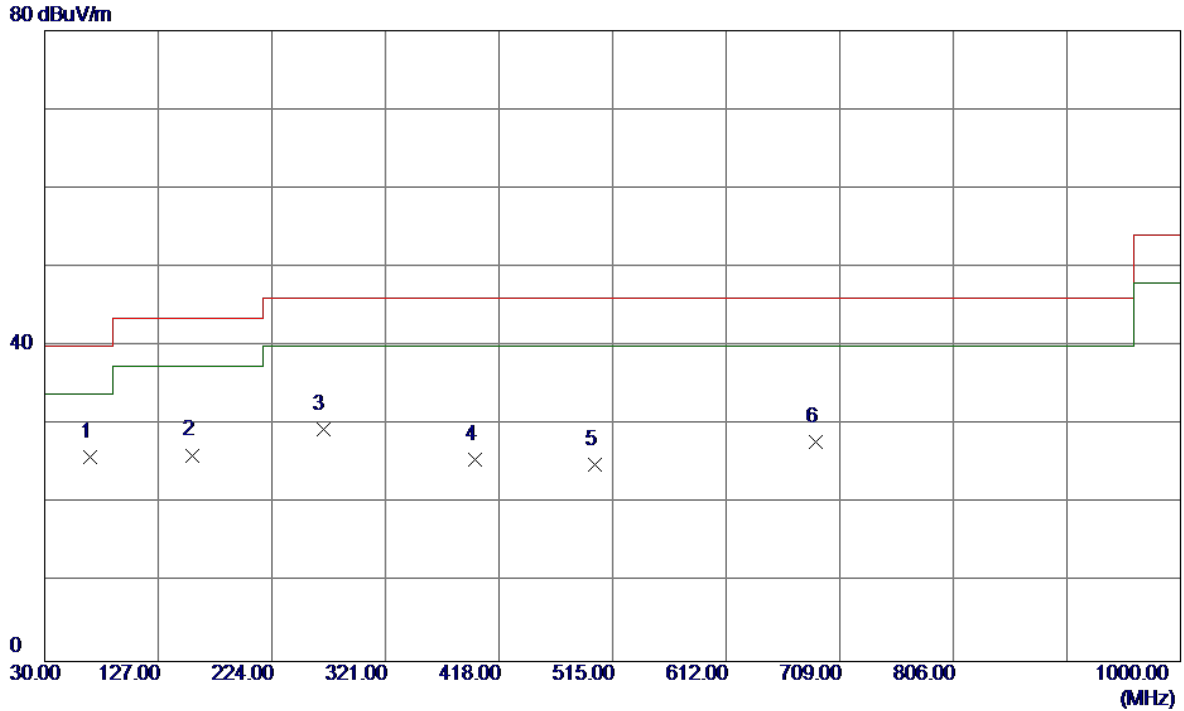

No.	Freq. MHz	Reading Level dBuV/m	Correct Factor dB	Measure ment dBuV/m	Limit dBuV/m	Margin dB	Detector	Comment
1 *	69.2850	42.32	-16.33	25.99	40.00	-14.01	Peak	
2	155.6150	38.66	-12.50	26.16	43.50	-17.34	Peak	
3	267.6500	43.09	-13.61	29.48	46.00	-16.52	Peak	
4	397.6300	33.47	-7.94	25.53	46.00	-20.47	Peak	
5	499.9650	34.68	-9.72	24.96	46.00	-21.04	Peak	
6	688.1450	30.39	-2.59	27.80	46.00	-18.20	Peak	

Test Mode: UNII-2A/TX A Mode 5320MHz

Vertical

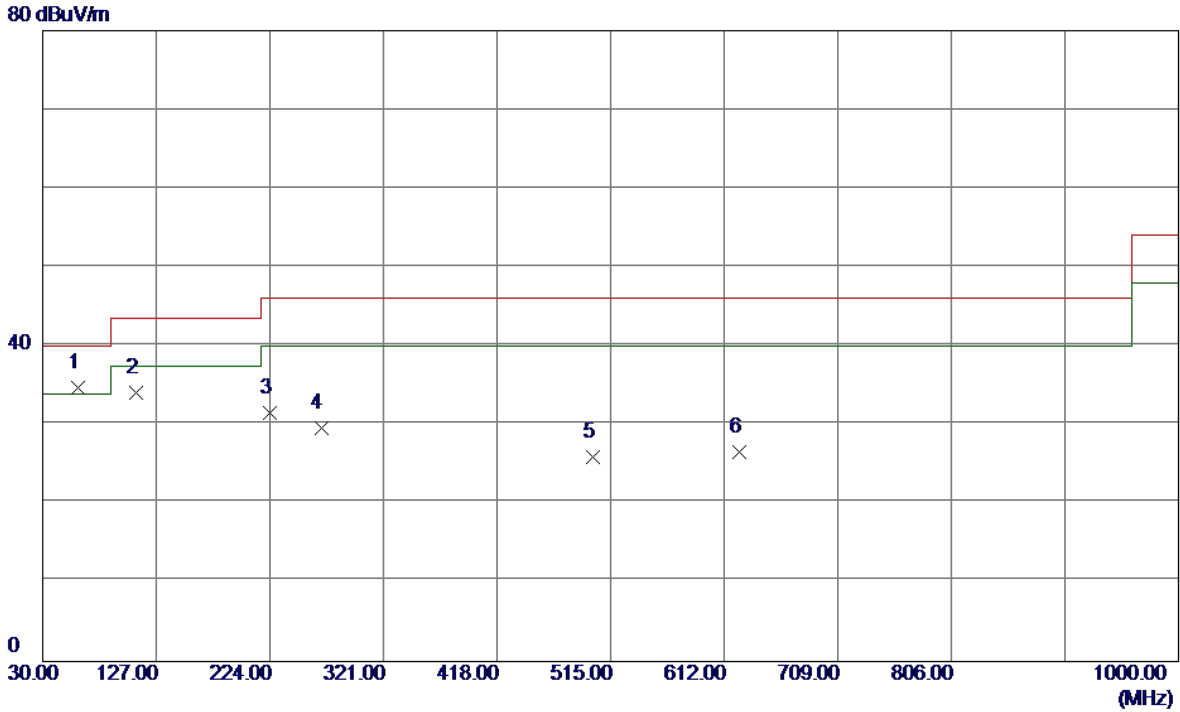

No.	Freq. MHz	Reading Level dBuV/m	Correct Factor dB	Measure ment dBuV/m	Limit dBuV/m	Margin dB	Detector	Comment
1 *	60.0700	48.50	-13.74	34.76	40.00	-5.24	Peak	
2	110.0250	48.72	-14.66	34.06	43.50	-9.44	Peak	
3	223.5150	45.48	-13.94	31.54	46.00	-14.46	Peak	
4	267.6500	43.24	-13.61	29.63	46.00	-16.37	Peak	
5	499.9650	35.67	-9.72	25.95	46.00	-20.05	Peak	
6	625.0949	32.11	-5.61	26.50	46.00	-19.50	Peak	

Test Mode: UNII-2A/TX A Mode 5320MHz

Horizontal

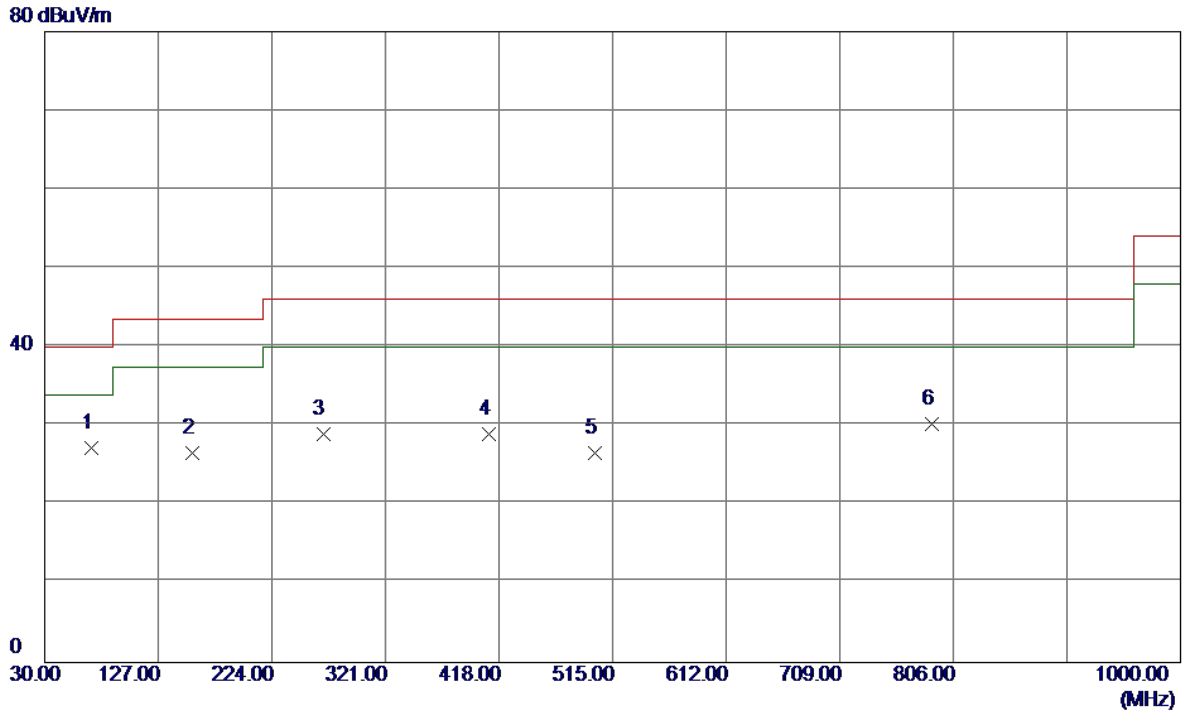

No.	Freq. MHz	Reading Level dBuV/m	Correct Factor dB	Measure ment dBuV/m	Limit dBuV/m	Margin dB	Detector	Comment
1 *	69.7699	43.69	-16.46	27.23	40.00	-12.77	Peak	
2	156.5850	38.97	-12.42	26.55	43.50	-16.95	Peak	
3	267.6500	42.50	-13.61	28.89	46.00	-17.11	Peak	
4	409.7550	36.76	-7.82	28.94	46.00	-17.06	Peak	
5	499.9650	36.35	-9.72	26.63	46.00	-19.37	Peak	
6	788.0550	30.50	-0.27	30.23	46.00	-15.77	Peak	

Test Mode: UNII-2C/TX A Mode 5500MHz

Vertical

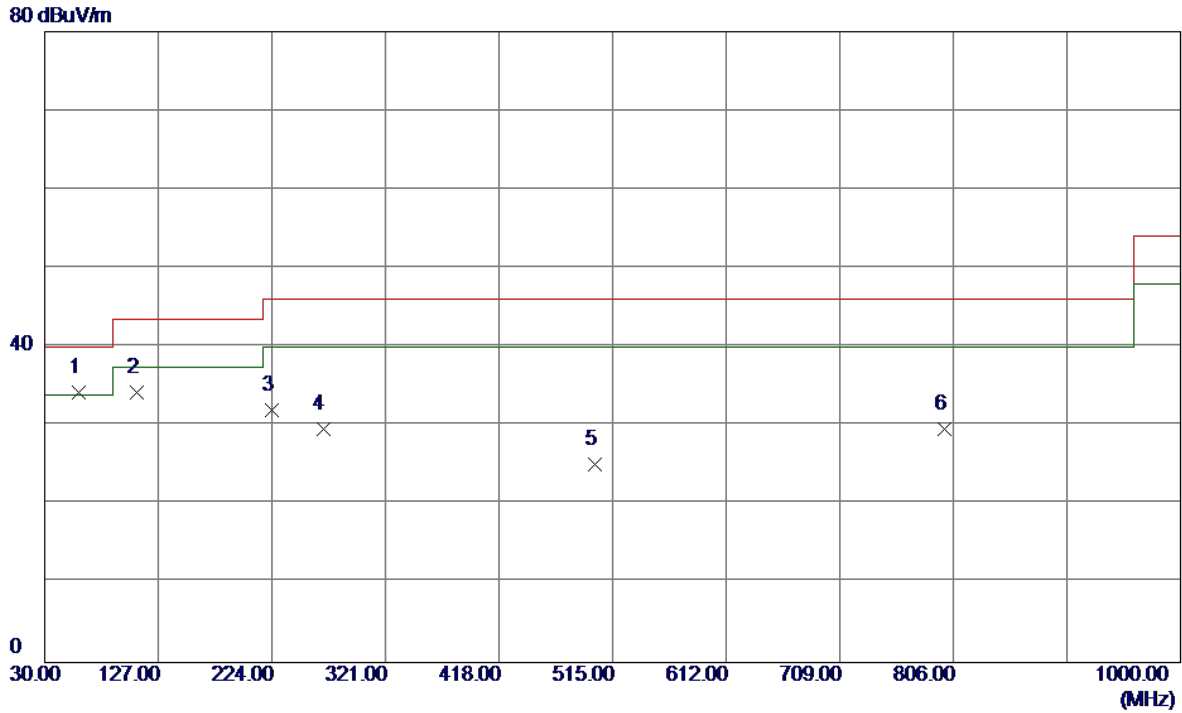

No.	Freq. MHz	Reading Level dBuV/m	Correct Factor dB	Measure ment dBuV/m	Limit dBuV/m	Margin dB	Detector	Comment
1 *	59.1000	48.02	-13.77	34.25	40.00	-5.75	Peak	
2	108.5700	48.96	-14.77	34.19	43.50	-9.31	Peak	
3	223.5150	46.00	-13.94	32.06	46.00	-13.94	Peak	
4	267.6500	43.16	-13.61	29.55	46.00	-16.45	Peak	
5	499.9650	34.89	-9.72	25.17	46.00	-20.83	Peak	
6	798.2400	29.44	0.18	29.62	46.00	-16.38	Peak	

Test Mode: UNII-2C/TX A Mode 5500MHz

Horizontal

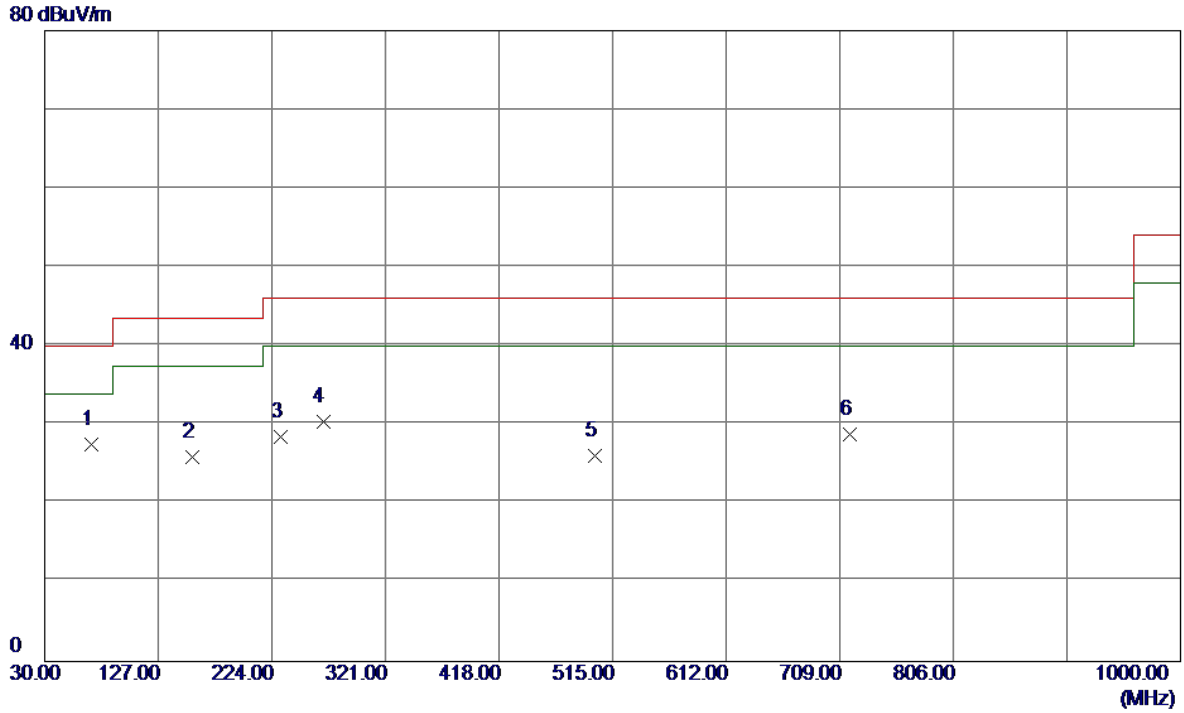

No.	Freq. MHz	Reading Level dBuV/m	Correct Factor dB	Measure ment dBuV/m	Limit dBuV/m	Margin dB	Detector	Comment
1 *	69.7699	43.97	-16.46	27.51	40.00	-12.49	Peak	
2	156.5850	38.39	-12.42	25.97	43.50	-17.53	Peak	
3	231.7600	41.88	-13.44	28.44	46.00	-17.56	Peak	
4	267.6500	43.94	-13.61	30.33	46.00	-15.67	Peak	
5	499.9650	35.76	-9.72	26.04	46.00	-19.96	Peak	
6	717.2450	30.81	-2.06	28.75	46.00	-17.25	Peak	

Test Mode: UNII-2C/TX A Mode 5580MHz

Vertical

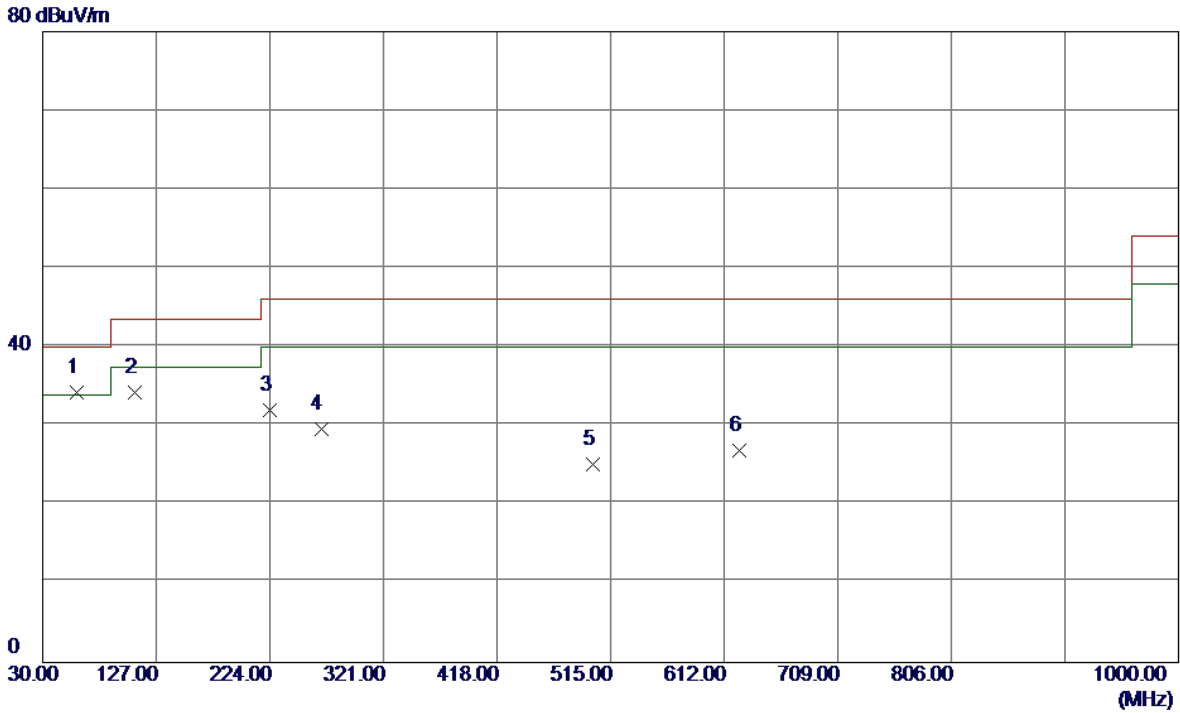

No.	Freq. MHz	Reading Level dBuV/m	Correct Factor dB	Measure ment dBuV/m	Limit dBuV/m	Margin dB	Detector	Comment
1 *	59.1000	48.02	-13.77	34.25	40.00	-5.75	Peak	
2	108.5700	48.96	-14.77	34.19	43.50	-9.31	Peak	
3	223.5150	46.00	-13.94	32.06	46.00	-13.94	Peak	
4	267.6500	43.16	-13.61	29.55	46.00	-16.45	Peak	
5	499.9650	34.89	-9.72	25.17	46.00	-20.83	Peak	
6	625.0949	32.44	-5.61	26.83	46.00	-19.17	Peak	

Test Mode: UNII-2C/TX A Mode 5580MHz

Horizontal

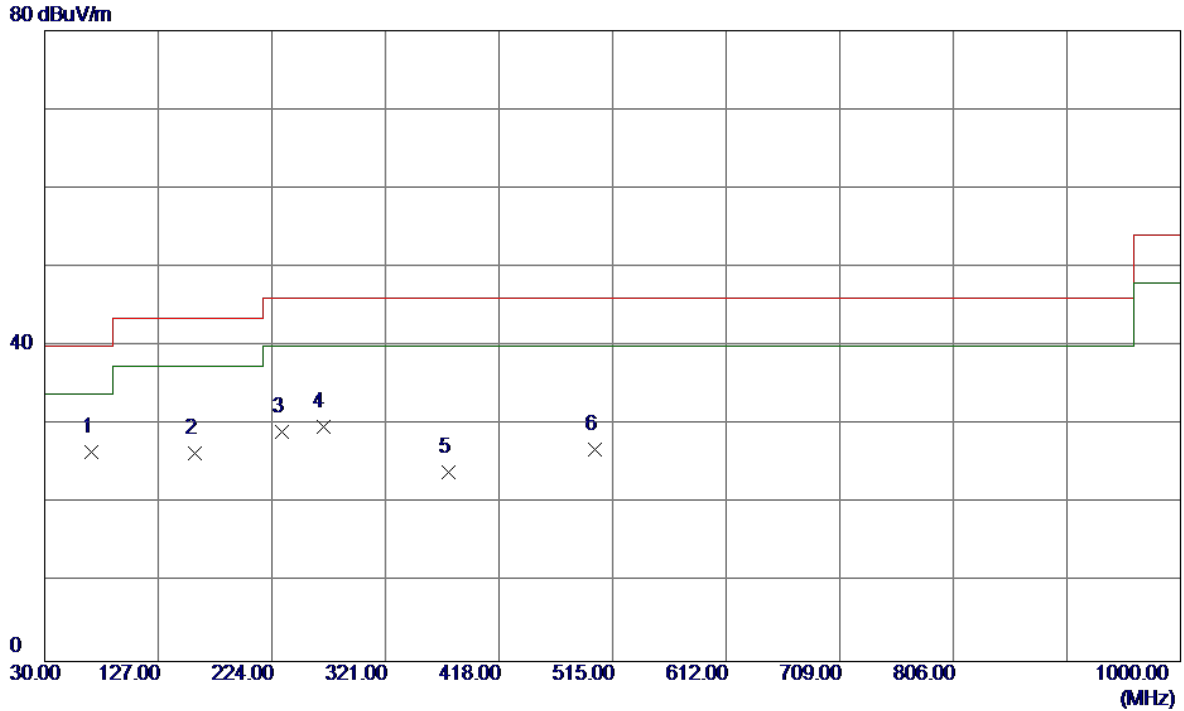

No.	Freq. MHz	Reading Level dBuV/m	Correct Factor dB	Measure ment dBuV/m	Limit dBuV/m	Margin dB	Detector	Comment
1 *	69.7699	43.07	-16.46	26.61	40.00	-13.39	Peak	
2	158.0399	38.66	-12.30	26.36	43.50	-17.14	Peak	
3	232.2450	42.62	-13.46	29.16	46.00	-16.84	Peak	
4	267.6500	43.35	-13.61	29.74	46.00	-16.26	Peak	
5	374.8350	33.55	-9.51	24.04	46.00	-21.96	Peak	
6	499.9650	36.66	-9.72	26.94	46.00	-19.06	Peak	

Test Mode: UNII-2C/TX A Mode 5700MHz

Vertical

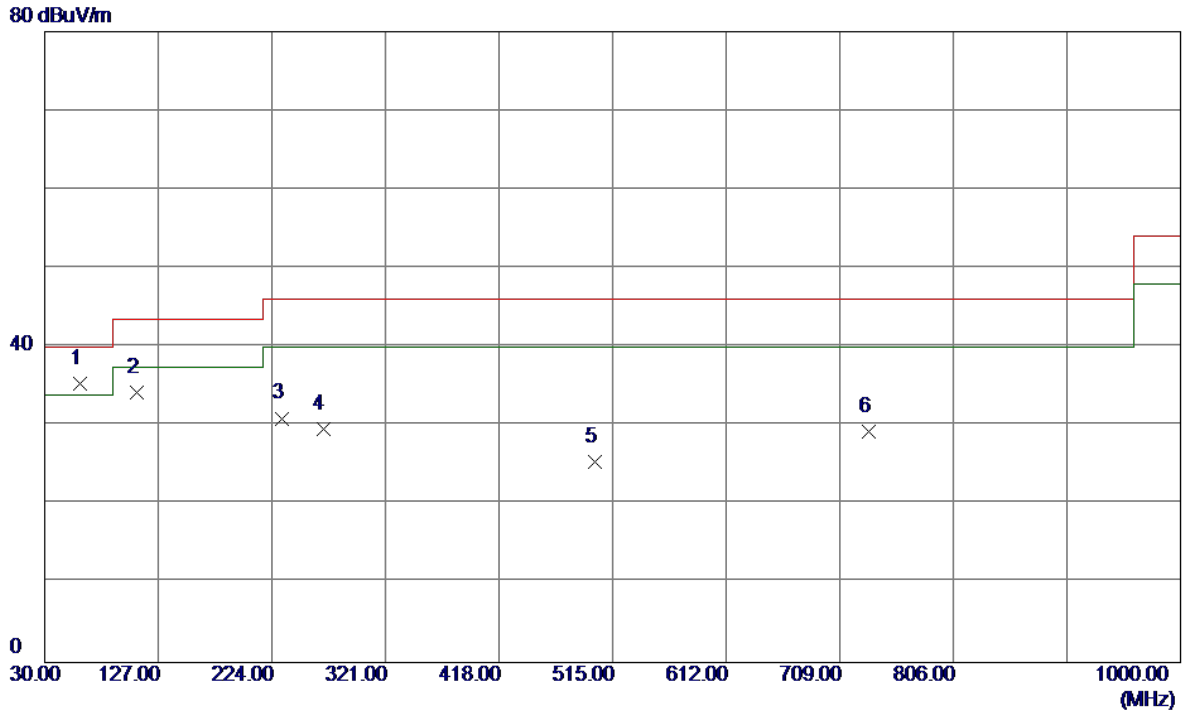

No.	Freq. MHz	Reading Level dBuV/m	Correct Factor dB	Measure ment dBuV/m	Limit dBuV/m	Margin dB	Detector	Comment
1 *	60.0700	49.15	-13.74	35.41	40.00	-4.59	Peak	
2	108.5700	48.94	-14.77	34.17	43.50	-9.33	Peak	
3	232.2450	44.42	-13.46	30.96	46.00	-15.04	Peak	
4	267.6500	43.20	-13.61	29.59	46.00	-16.41	Peak	
5	499.9650	35.17	-9.72	25.45	46.00	-20.55	Peak	
6	733.7350	31.27	-2.01	29.26	46.00	-16.74	Peak	

Test Mode: UNII-2C/TX A Mode 5700MHz

Horizontal

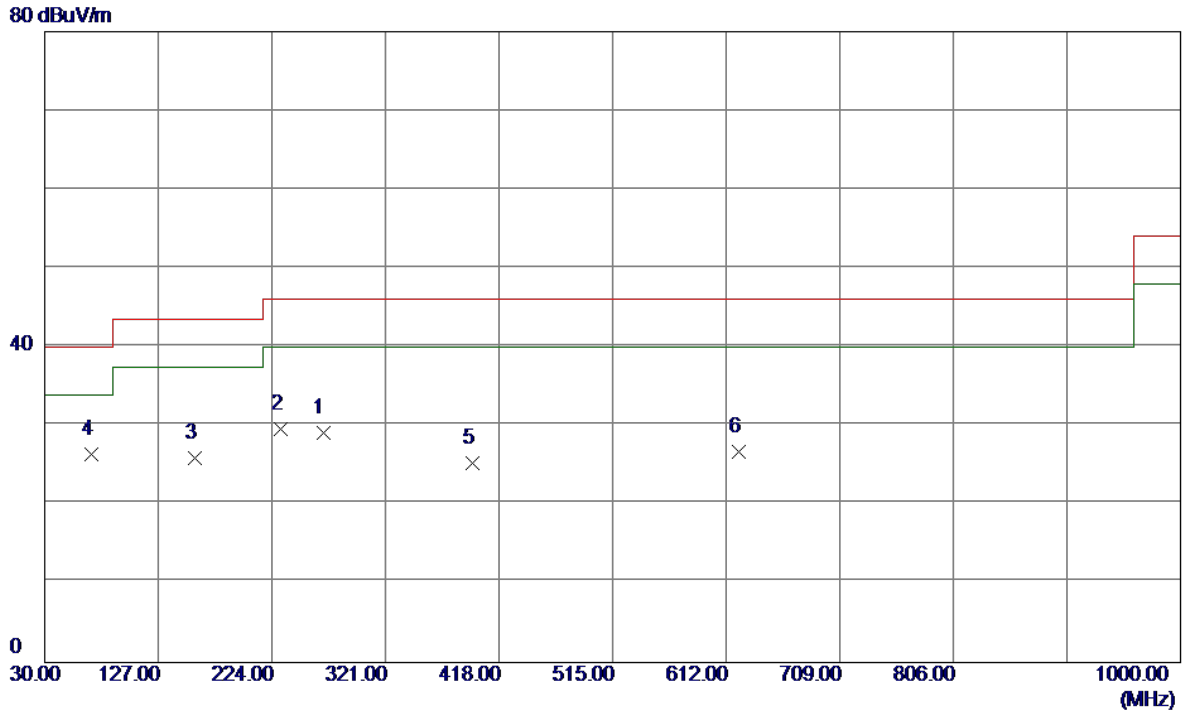

No.	Freq. MHz	Reading Level dBuV/m	Correct Factor dB	Measure ment dBuV/m	Limit dBuV/m	Margin dB	Detector	Comment
1	267.6500	42.80	-13.61	29.19	46.00	-16.81	Peak	
2	231.7600	42.98	-13.44	29.54	46.00	-16.46	Peak	
3	158.0399	38.21	-12.30	25.91	43.50	-17.59	Peak	
4 *	70.2550	42.86	-16.53	26.33	40.00	-13.67	Peak	
5	395.6900	33.43	-8.08	25.35	46.00	-20.65	Peak	
6	622.6700	32.47	-5.75	26.72	46.00	-19.28	Peak	

Test Mode: TX AC Wave2(160 MHz) Mode 5290MHz

Vertical

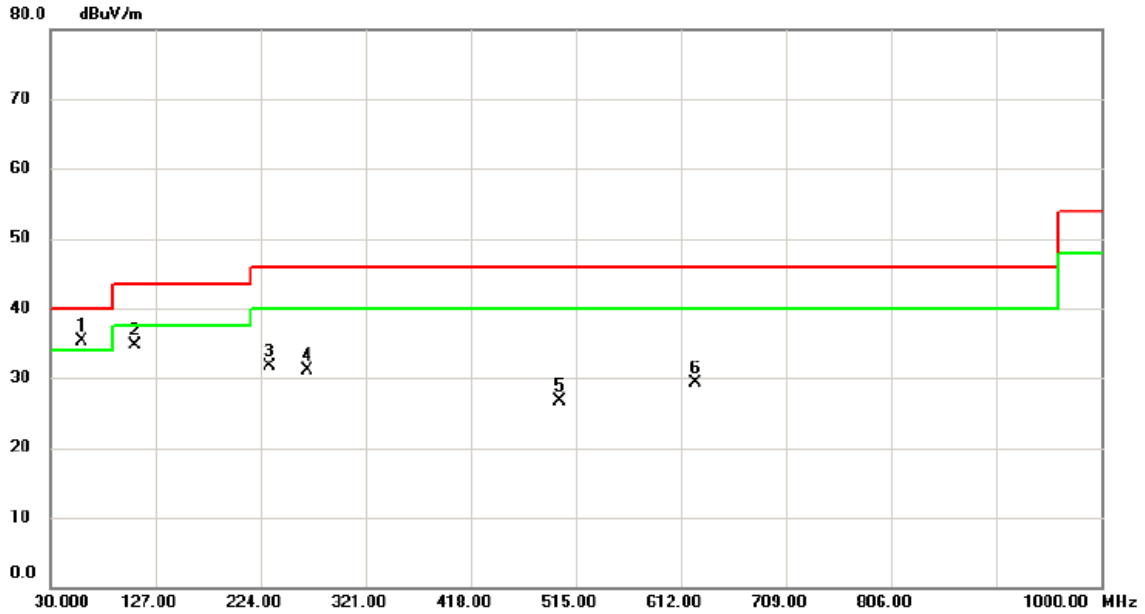

No.	Mk.	Freq. MHz	Reading Level dBuV	Correct Factor dB	Measure- ment dBuV/m	Limit dBuV/m	Margin dB	Detector	Comment
1	*	59.100	49.02	-13.78	35.24	40.00	-4.76	peak	
2		108.570	49.46	-14.78	34.68	43.50	-8.82	peak	
3		232.245	45.15	-13.46	31.69	46.00	-14.31	peak	
4		267.650	44.67	-13.60	31.07	46.00	-14.93	peak	
5		499.965	36.34	-9.72	26.62	46.00	-19.38	peak	
6		625.095	35.01	-5.61	29.40	46.00	-16.60	peak	

Test Mode: TX AC Wave2(160 MHz) Mode 5290MHz

Horizontal

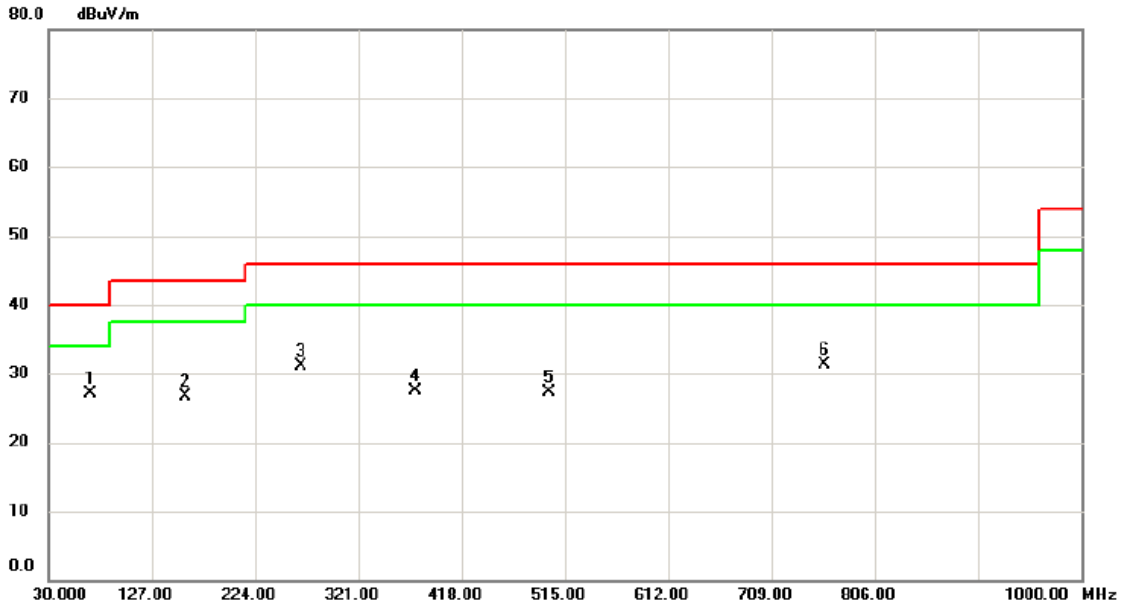

No.	Mk.	Freq. MHz	Reading Level dBuV	Correct Factor dB	Measure- ment dBuV/m	Limit dBuV/m	Margin dB	Detector	Comment
1	*	68.800	43.35	-16.20	27.15	40.00	-12.85	peak	
2		158.040	39.04	-12.31	26.73	43.50	-16.77	peak	
3		267.650	44.62	-13.60	31.02	46.00	-14.98	peak	
4		374.835	36.95	-9.51	27.44	46.00	-18.56	peak	
5		499.965	37.02	-9.72	27.30	46.00	-18.70	peak	
6		758.955	32.89	-1.57	31.32	46.00	-14.68	peak	

Test Mode: TX AC Wave2(160 MHz) Mode 5610MHz

Vertical

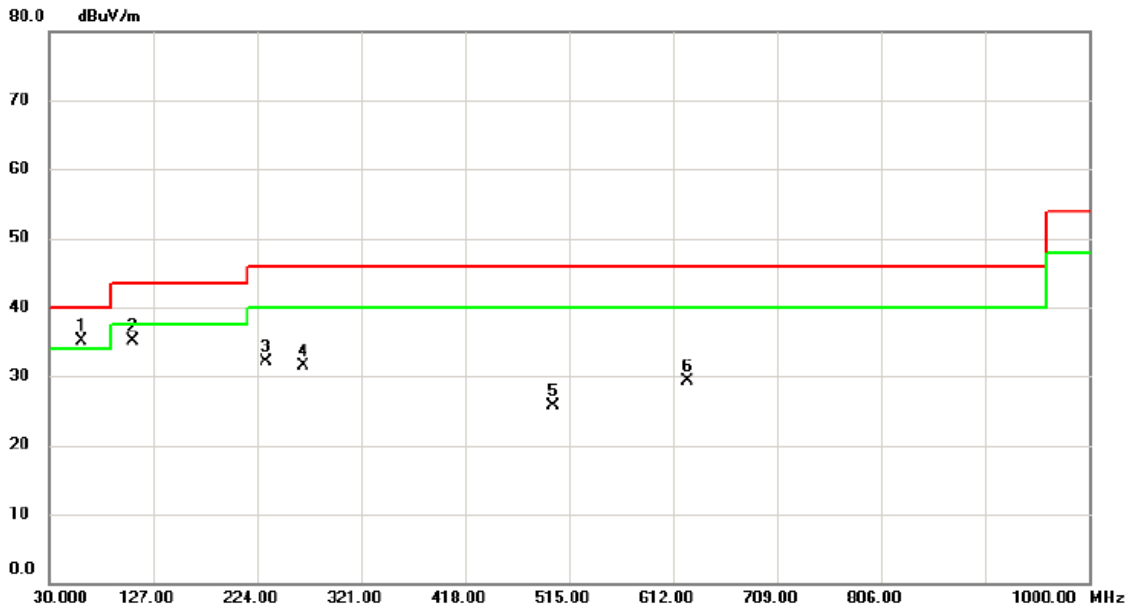

No.	Mk.	Freq. MHz	Reading Level dBuV	Correct Factor dB	Measure- ment dBuV/m	Limit dBuV/m	Margin dB	Detector	Comment
1	*	60.070	48.78	-13.74	35.04	40.00	-4.96	peak	
2		108.570	49.96	-14.78	35.18	43.50	-8.32	peak	
3		232.245	45.65	-13.46	32.19	46.00	-13.81	peak	
4		267.650	45.17	-13.60	31.57	46.00	-14.43	peak	
5		499.965	35.34	-9.72	25.62	46.00	-20.38	peak	
6		625.095	35.01	-5.61	29.40	46.00	-16.60	peak	

Test Mode: TX AC Wave2(160 MHz) Mode 5610MHz

Horizontal

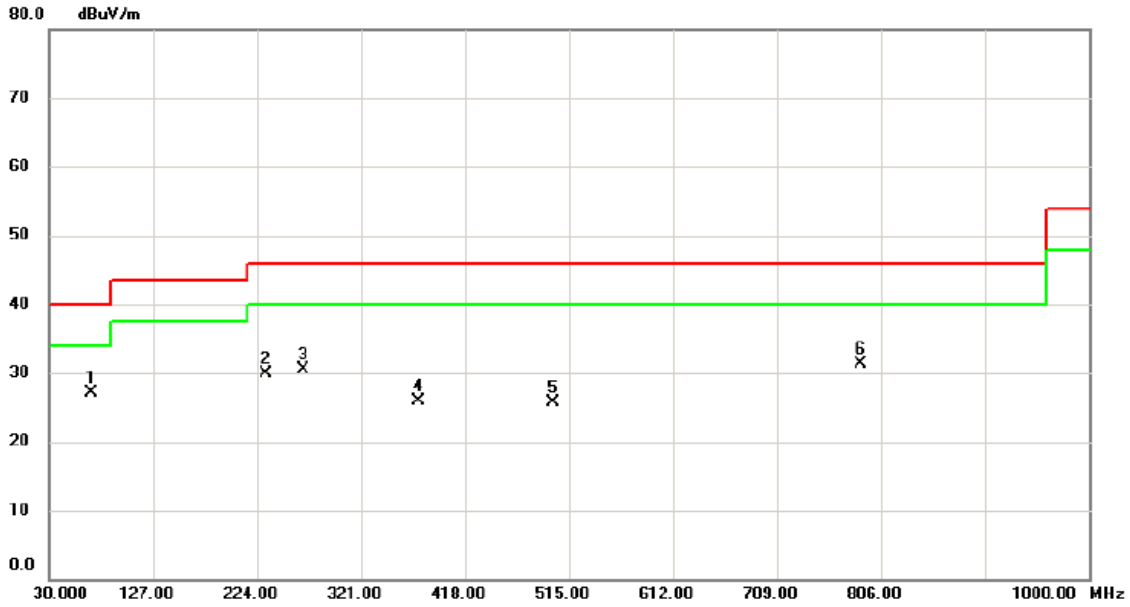

No.	Mk.	Freq. MHz	Reading Level dBuV	Correct Factor dB	Measure- ment dBuV/m	Limit dBuV/m	Margin dB	Detector	Comment
1	*	68.800	43.35	-16.20	27.15	40.00	-12.85	peak	
2		232.245	43.33	-13.46	29.87	46.00	-16.13	peak	
3		267.650	44.12	-13.60	30.52	46.00	-15.48	peak	
4		374.835	35.45	-9.51	25.94	46.00	-20.06	peak	
5		499.965	35.52	-9.72	25.80	46.00	-20.20	peak	
6		787.570	31.57	-0.29	31.28	46.00	-14.72	peak	

ATTACHMENT D -RADIATED EMISSION (ABOVE 1000MHZ)

Orthogonal Axis :	X
Test Mode :	UNII-2A/ TX A Mode 5260MHz

Vertical

115 dBuV/m

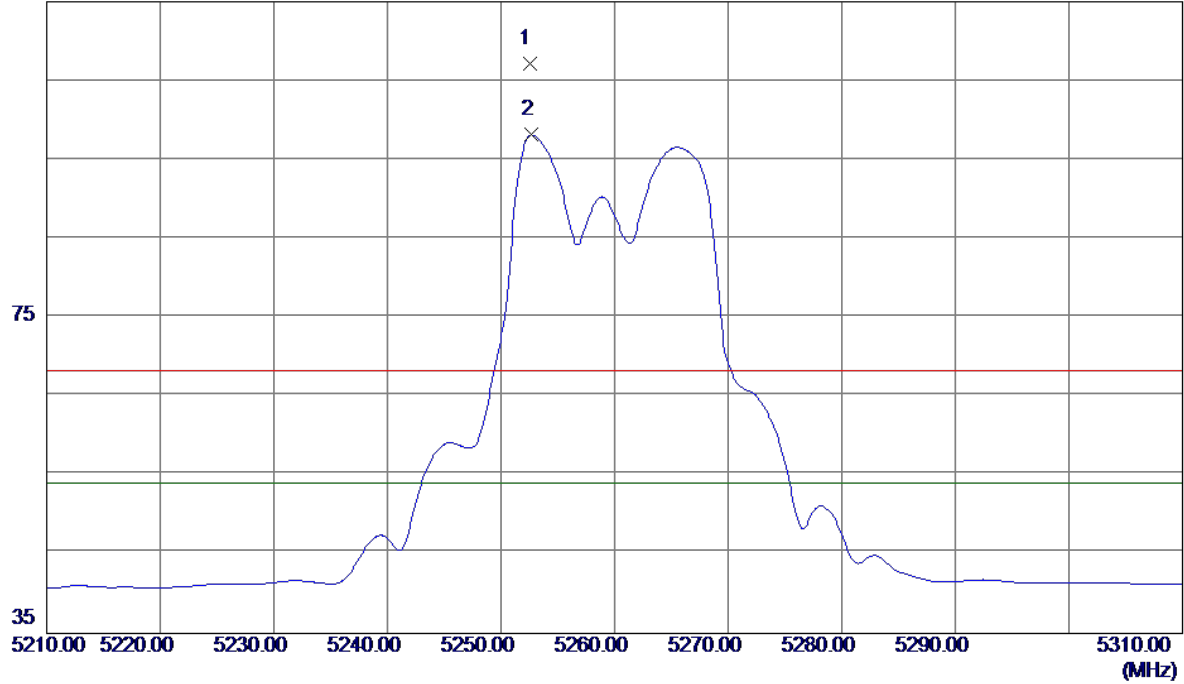

No.	Freq. MHz	Reading Level dBuV/m	Correct Factor dB	Measure ment dBuV/m	Limit dBuV/m	Margin dB	Detector	Comment
1	5252.5000	66.15	40.96	107.11	68.20	38.91	Peak	No Limit
2 *	5252.7000	57.18	40.96	98.14	54.00	44.14	AVG	No Limit

Orthogonal Axis :	X
Test Mode :	UNII-2A/ TX A Mode 5260MHz

Vertical

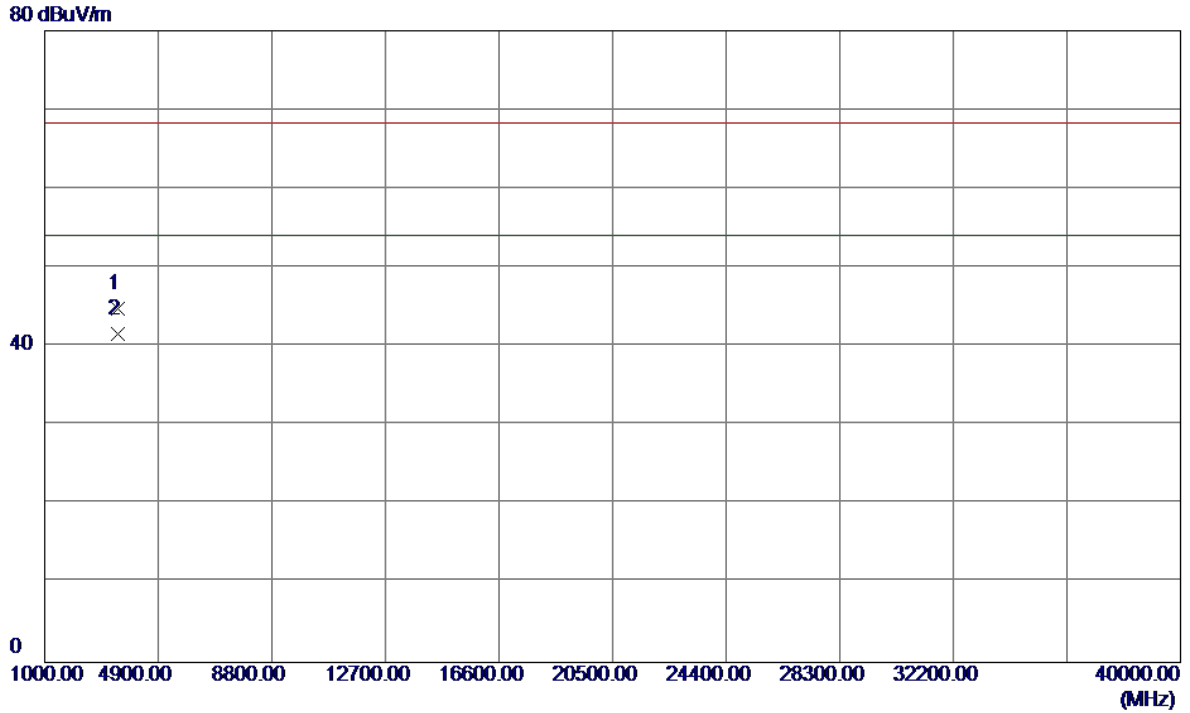

No.	Freq. MHz	Reading Level dBuV/m	Correct Factor dB	Measure ment dBuV/m	Limit dBuV/m	Margin dB	Detector	Comment
1	3506.6100	43.42	1.34	44.76	68.30	-23.54	Peak	
2 *	3506.6400	40.25	1.34	41.59	54.00	-12.41	AVG	

Orthogonal Axis :	X
Test Mode :	UNII-2A/ TX A Mode 5260MHz

Horizontal

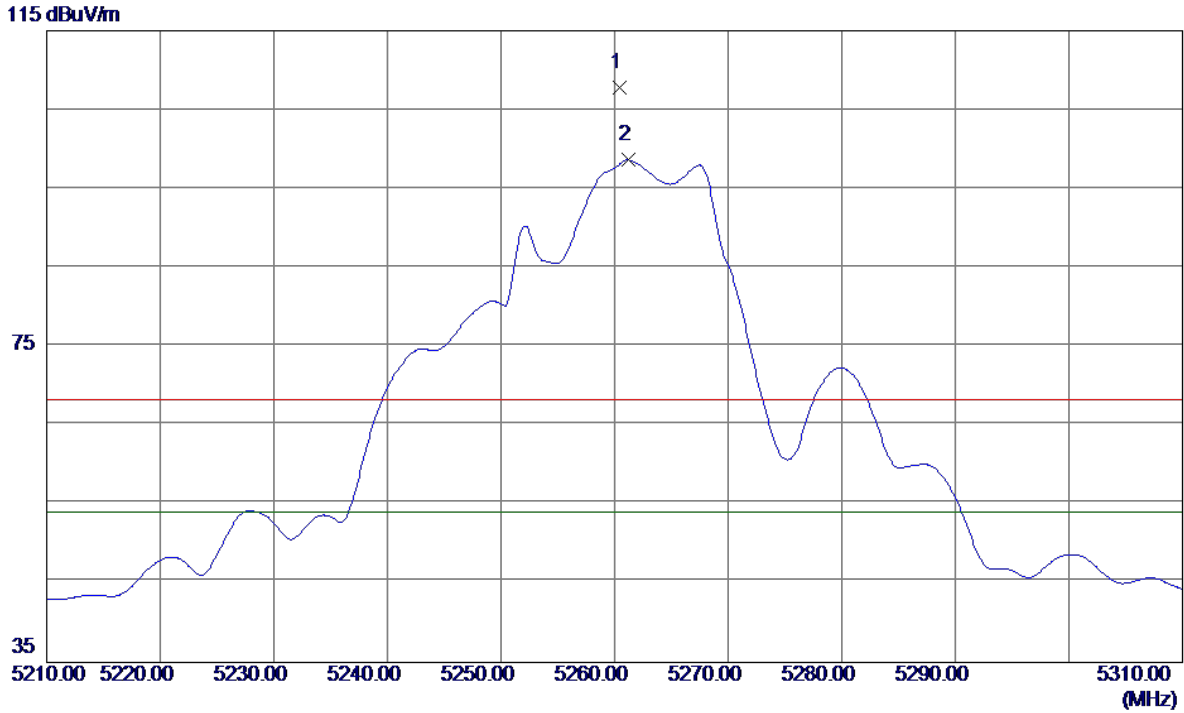

No.	Freq. MHz	Reading Level dBuV/m	Correct Factor dB	Measure ment dBuV/m	Limit dBuV/m	Margin dB	Detector	Comment
1	5260.4000	66.76	40.99	107.75	68.30	39.45	Peak	No Limit
2 *	5261.2000	57.63	40.99	98.62	54.00	44.62	AVG	No Limit

Orthogonal Axis :	X
Test Mode :	UNII-2A/ TX A Mode 5260MHz

Horizontal

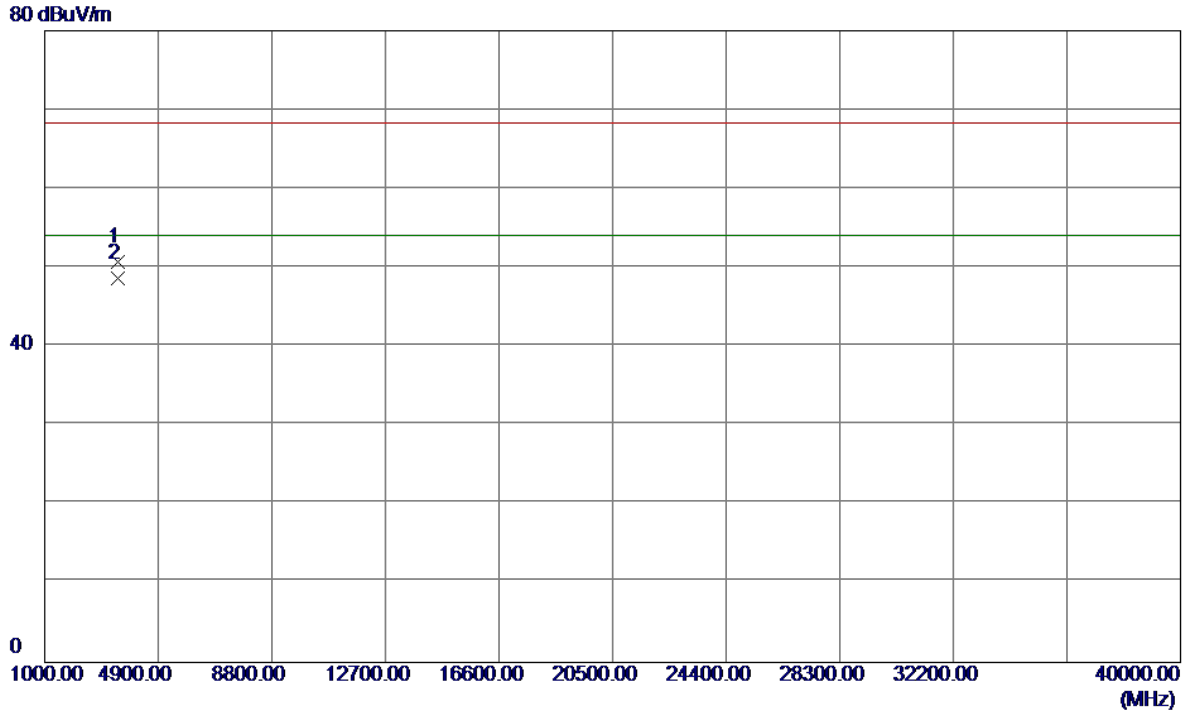

No.	Freq. MHz	Reading Level dBuV/m	Correct Factor dB	Measure ment dBuV/m	Limit dBuV/m	Margin dB	Detector	Comment
1	3506.6300	49.42	1.34	50.76	68.30	-17.54	Peak	
2 *	3506.6500	47.25	1.34	48.59	54.00	-5.41	AVG	

Orthogonal Axis :	X
Test Mode :	UNII-2A/ TX A Mode 5300MHz

Vertical

115 dBuV/m

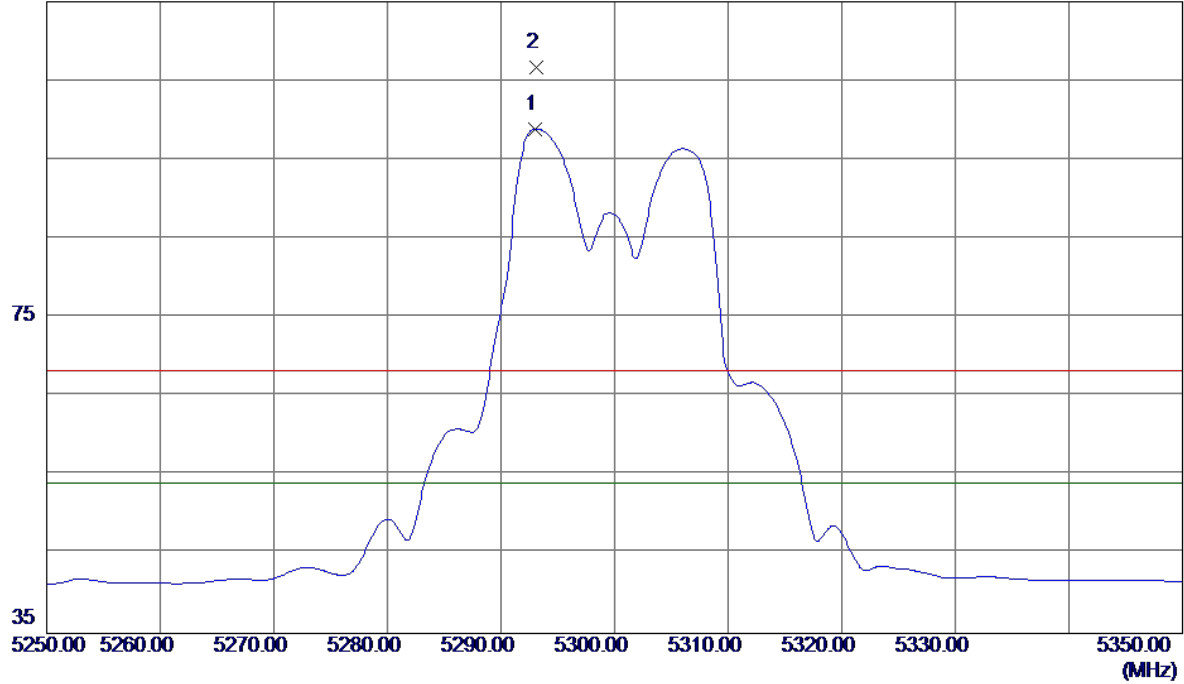

No.	Freq. MHz	Reading Level dBuV/m	Correct Factor dB	Measure ment dBuV/m	Limit dBuV/m	Margin dB	Detector	Comment
1 *	5293.0000	57.81	41.10	98.91	54.00	44.91	AVG	No Limit
2	5293.1500	65.52	41.10	106.62	68.20	38.42	Peak	No Limit

Orthogonal Axis :	X
Test Mode :	UNII-2A/ TX A Mode 5300MHz

Vertical

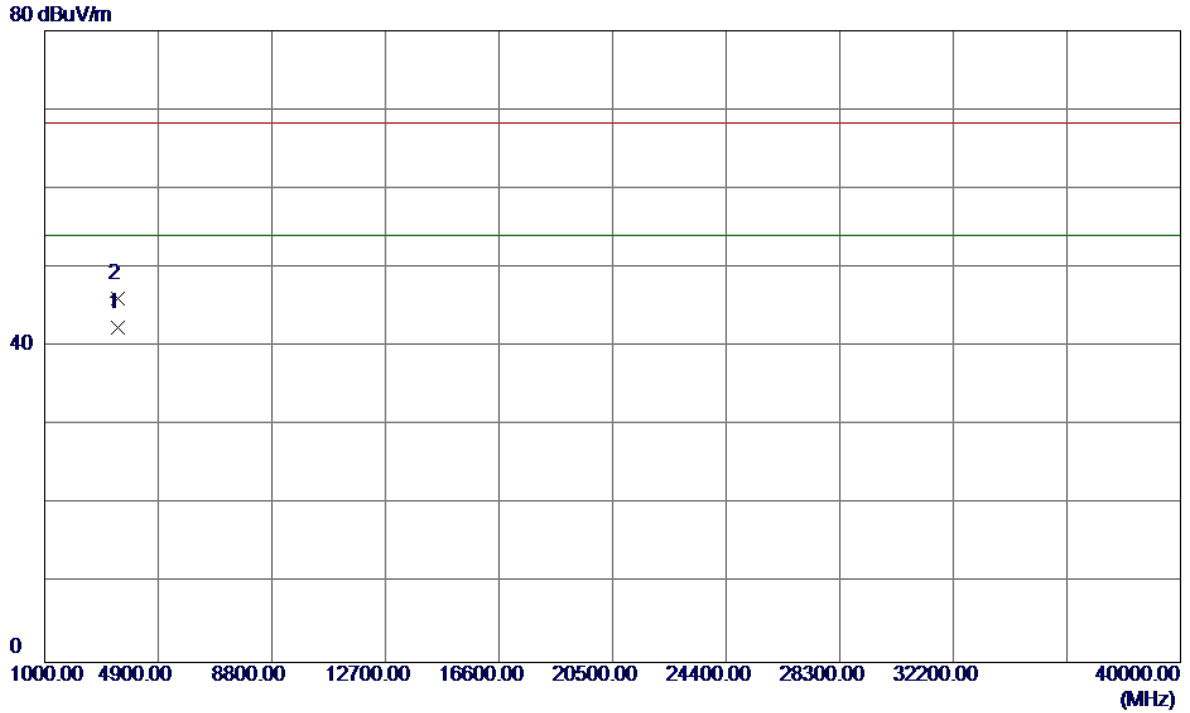

No.	Freq. MHz	Reading Level dBuV/m	Correct Factor dB	Measure ment dBuV/m	Limit dBuV/m	Margin dB	Detector	Comment
1 *	3533.3050	41.02	1.42	42.44	54.00	-11.56	AVG	
2	3533.3800	44.72	1.42	46.14	68.30	-22.16	Peak	

Orthogonal Axis :	X
Test Mode :	UNII-2A/ TX A Mode 5300MHz

Horizontal

115 dBuV/m

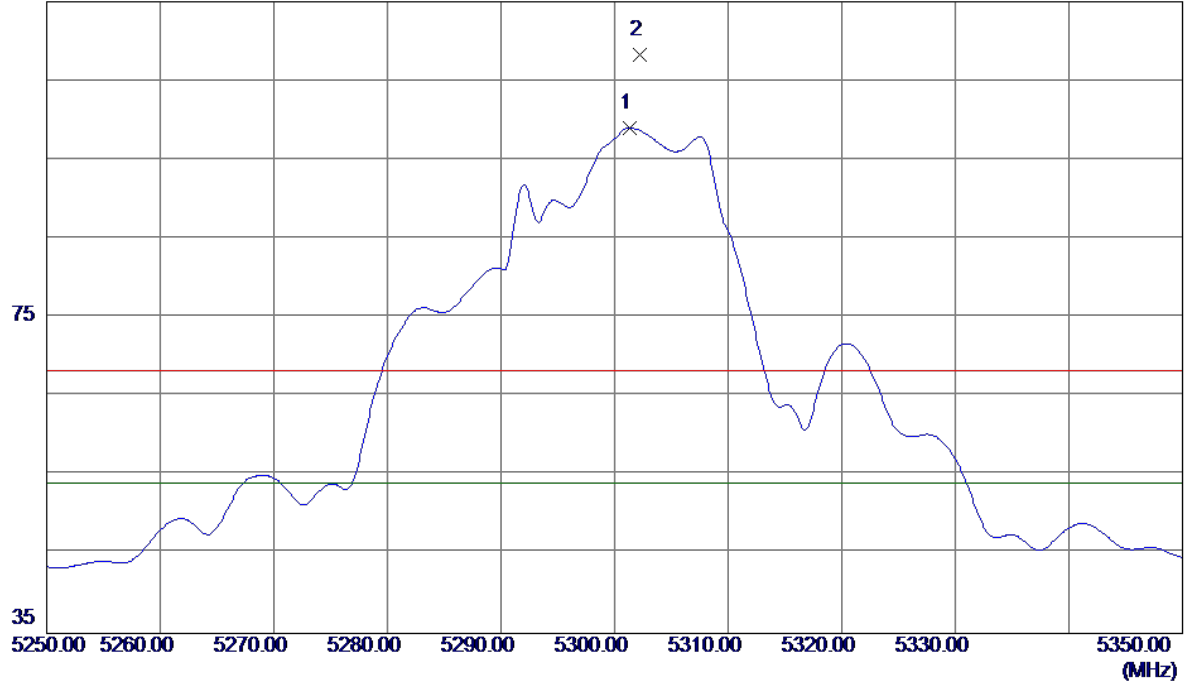

No.	Freq. MHz	Reading Level dBuV/m	Correct Factor dB	Measure ment dBuV/m	Limit dBuV/m	Margin dB	Detector	Comment
1 *	5301.3000	57.91	41.12	99.03	54.00	45.03	AVG	No Limit
2	5302.2000	67.09	41.13	108.22	68.30	39.92	Peak	No Limit

Orthogonal Axis :	X
Test Mode :	UNII-2A/ TX A Mode 5300MHz

Horizontal

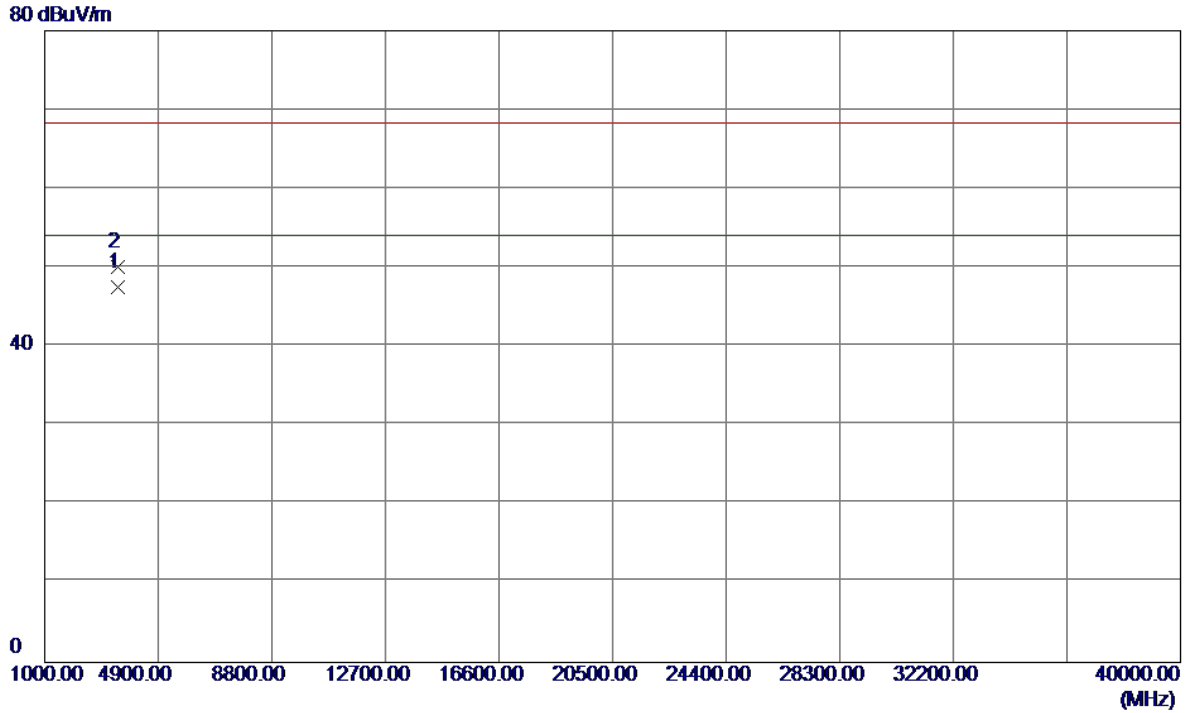

No.	Freq. MHz	Reading Level dBuV/m	Correct Factor dB	Measure ment dBuV/m	Limit dBuV/m	Margin dB	Detector	Comment
1 *	3533.3400	46.06	1.42	47.48	54.00	-6.52	AVG	
2	3533.3750	48.72	1.42	50.14	68.30	-18.16	Peak	

Orthogonal Axis :	X
Test Mode :	UNII-2A/ TX A Mode 5320MHz

Vertical

115 dBuV/m

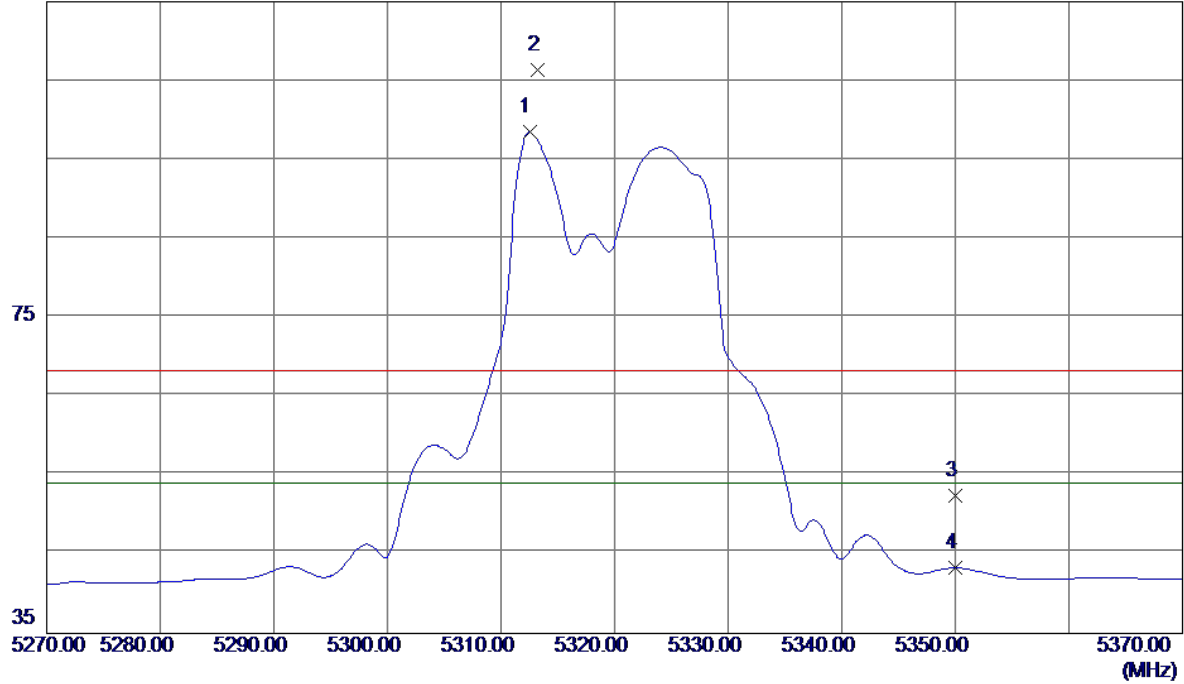

No.	Freq. MHz	Reading Level dBuV/m	Correct Factor dB	Measure ment dBuV/m	Limit dBuV/m	Margin dB	Detector	Comment
1 *	5312.5000	57.32	41.16	98.48	54.00	44.48	AVG	No Limit
2	5313.2000	65.23	41.16	106.39	68.20	38.19	Peak	No Limit
3	5350.0000	11.23	41.28	52.51	68.20	-15.69	Peak	
4	5350.0000	2.03	41.28	43.31	54.00	-10.69	AVG	

Orthogonal Axis :	X
Test Mode :	UNII-2A/ TX A Mode 5320MHz

Vertical

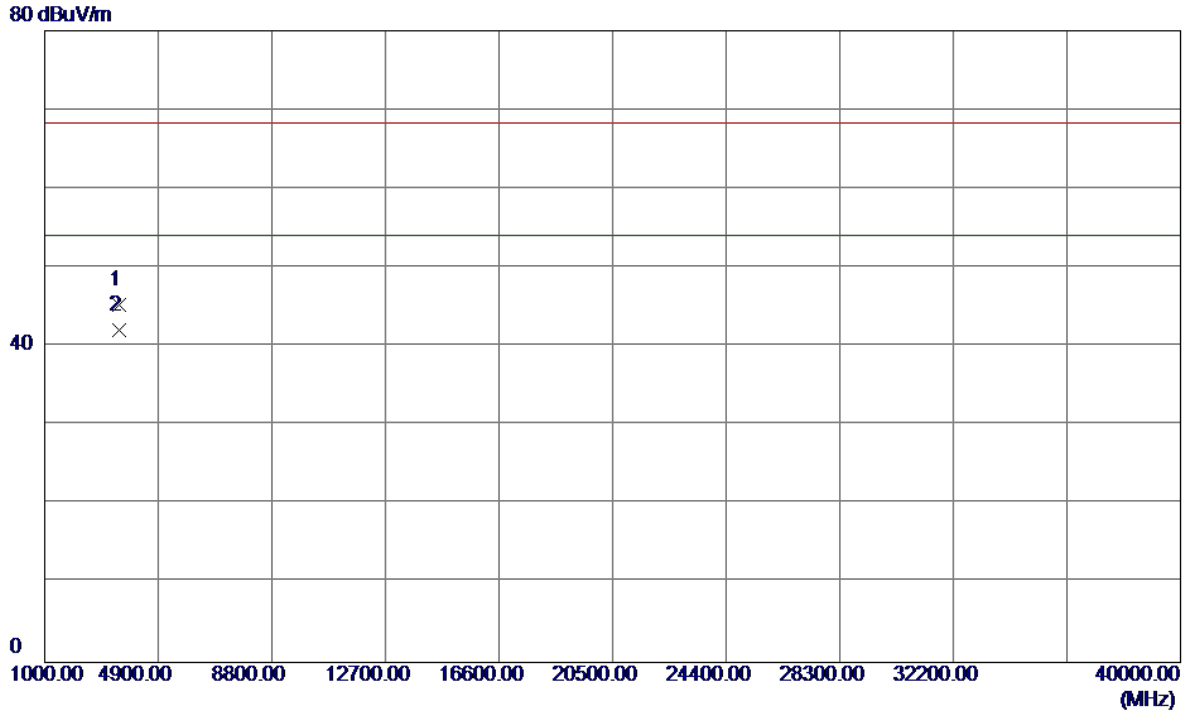

No.	Freq. MHz	Reading Level dBuV/m	Correct Factor dB	Measure ment dBuV/m	Limit dBuV/m	Margin dB	Detector	Comment
1	3546.5800	43.76	1.47	45.23	68.30	-23.07	Peak	
2 *	3546.6450	40.58	1.47	42.05	54.00	-11.95	AVG	

Orthogonal Axis :	X
Test Mode :	UNII-2A/ TX A Mode 5320MHz

Horizontal

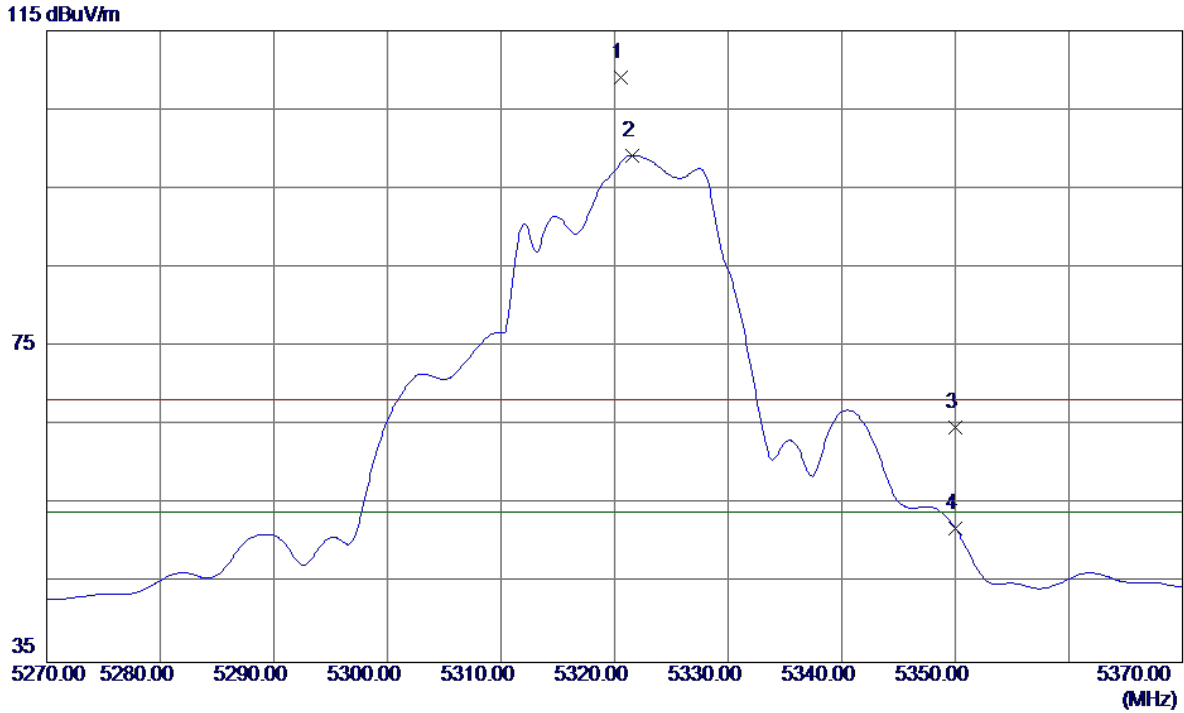

No.	Freq. MHz	Reading Level dBuV/m	Correct Factor dB	Measure ment dBuV/m	Limit dBuV/m	Margin dB	Detector	Comment
1	5320.6000	67.96	41.19	109.15	68.30	40.85	Peak	No Limit
2 *	5321.6000	58.04	41.19	99.23	54.00	45.23	AVG	No Limit
3	5350.0000	23.44	41.28	64.72	68.30	-3.58	Peak	
4	5350.0000	10.72	41.28	52.00	54.00	-2.00	AVG	

Orthogonal Axis :	X
Test Mode :	UNII-2A/ TX A Mode 5320MHz

Horizontal

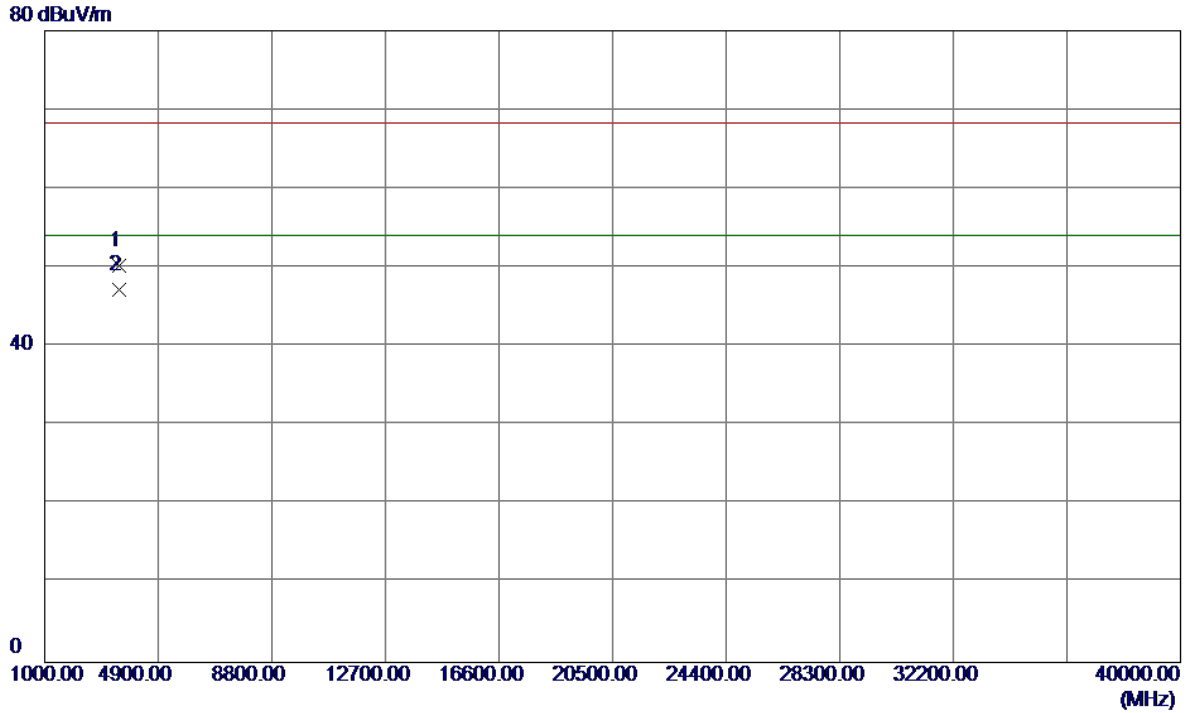

No.	Freq. MHz	Reading Level dBuV/m	Correct Factor dB	Measure ment dBuV/m	Limit dBuV/m	Margin dB	Detector	Comment
1	3546.5750	48.78	1.47	50.25	68.30	-18.05	Peak	
2 *	3546.6350	45.77	1.47	47.24	54.00	-6.76	AVG	

Orthogonal Axis :	X
Test Mode :	UNII-2A/ TX N20 Mode 5260MHz

Vertical

115 dBuV/m

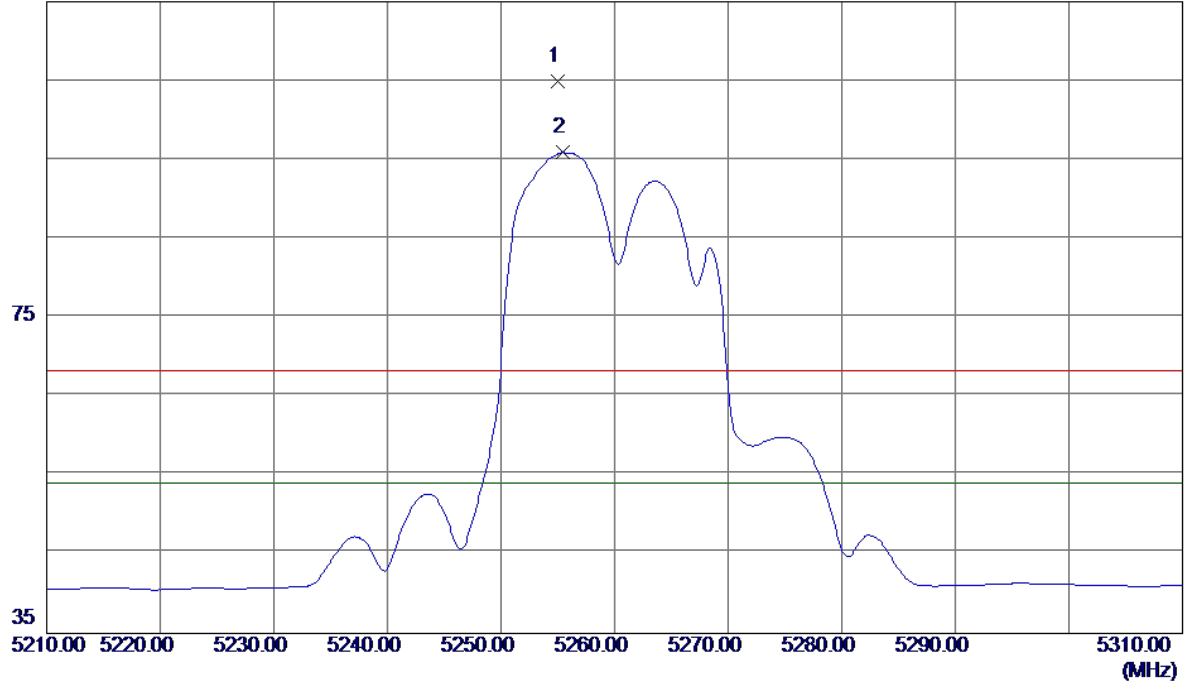

No.	Freq. MHz	Reading Level dBuV/m	Correct Factor dB	Measure ment dBuV/m	Limit dBuV/m	Margin dB	Detector	Comment
1	5254.9500	63.94	40.97	104.91	68.20	36.71	Peak	No Limit
2 *	5255.4000	54.94	40.97	95.91	54.00	41.91	AVG	No Limit

Orthogonal Axis :	X
Test Mode :	UNII-2A/ TX N20 Mode 5260MHz

Vertical

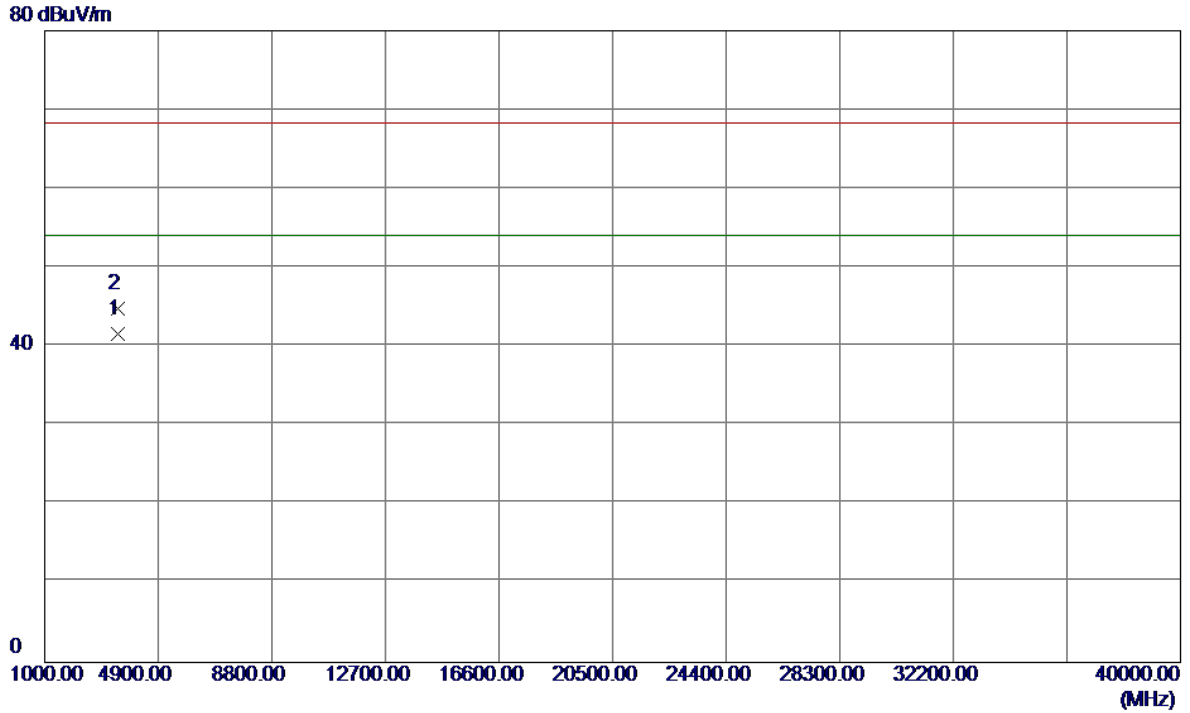

No.	Freq. MHz	Reading Level dBuV/m	Correct Factor dB	Measure ment dBuV/m	Limit dBuV/m	Margin dB	Detector	Comment
1 *	3506.6250	40.24	1.34	41.58	54.00	-12.42	AVG	
2	3506.8200	43.52	1.34	44.86	68.30	-23.44	Peak	

Orthogonal Axis :	X
Test Mode :	UNII-2A/ TX N20 Mode 5260MHz

Horizontal

115 dBuV/m

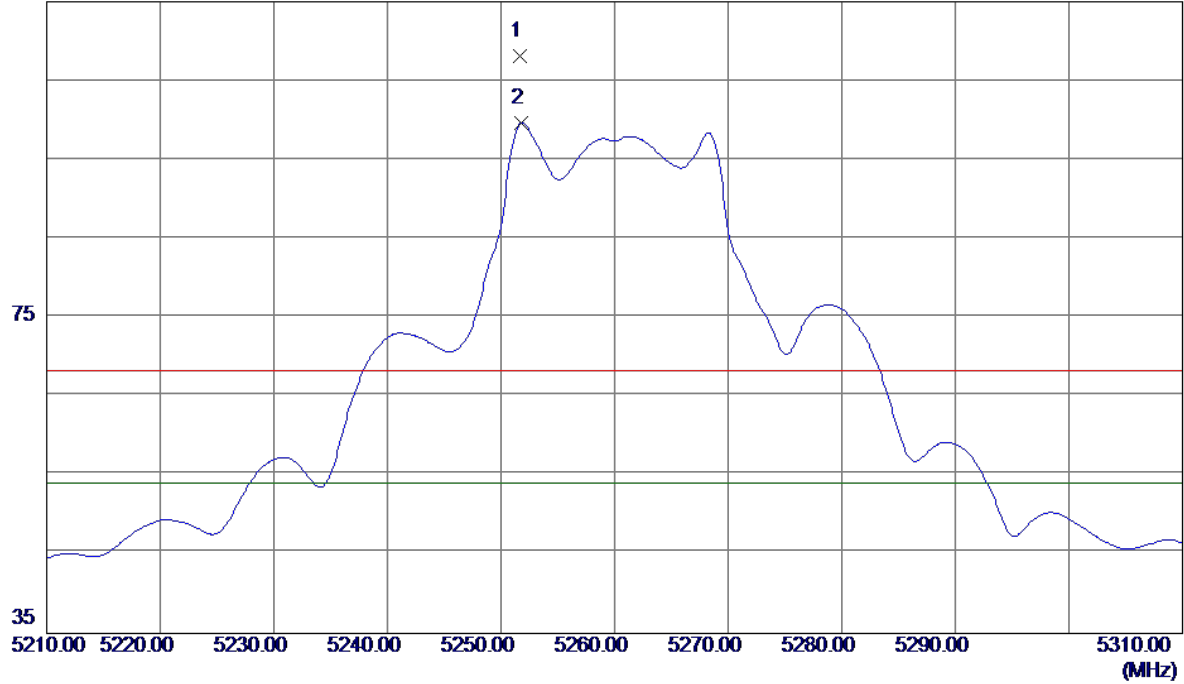

No.	Freq. MHz	Reading Level dBuV/m	Correct Factor dB	Measure ment dBuV/m	Limit dBuV/m	Margin dB	Detector	Comment
1	5251.7000	67.09	40.96	108.05	68.30	39.75	Peak	No Limit
2 *	5251.8000	58.75	40.96	99.71	54.00	45.71	AVG	No Limit

Orthogonal Axis :	X
Test Mode :	UNII-2A/ TX N20 Mode 5260MHz

Horizontal

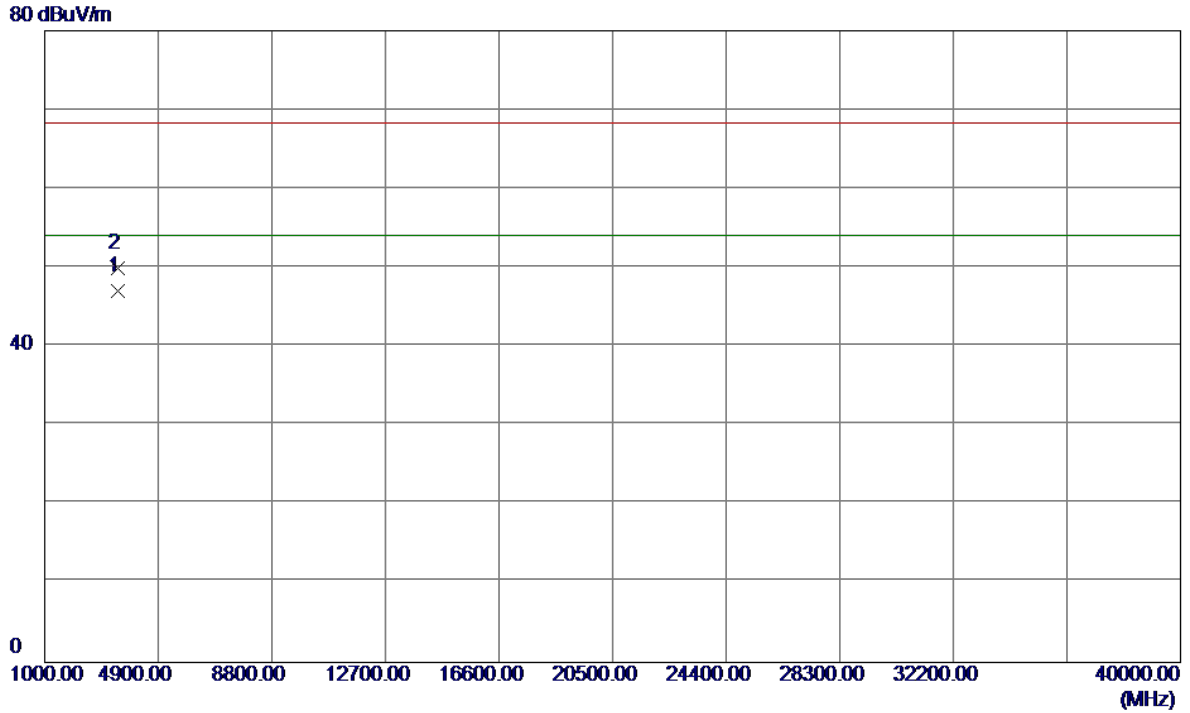

No.	Freq. MHz	Reading Level dBuV/m	Correct Factor dB	Measure ment dBuV/m	Limit dBuV/m	Margin dB	Detector	Comment
1 *	3506.6400	45.64	1.34	46.98	54.00	-7.02	AVG	
2	3506.7050	48.56	1.34	49.90	68.30	-18.40	Peak	

Orthogonal Axis :	X
Test Mode :	UNII-2A/ TX N20 Mode 5300MHz

Vertical

115 dBuV/m

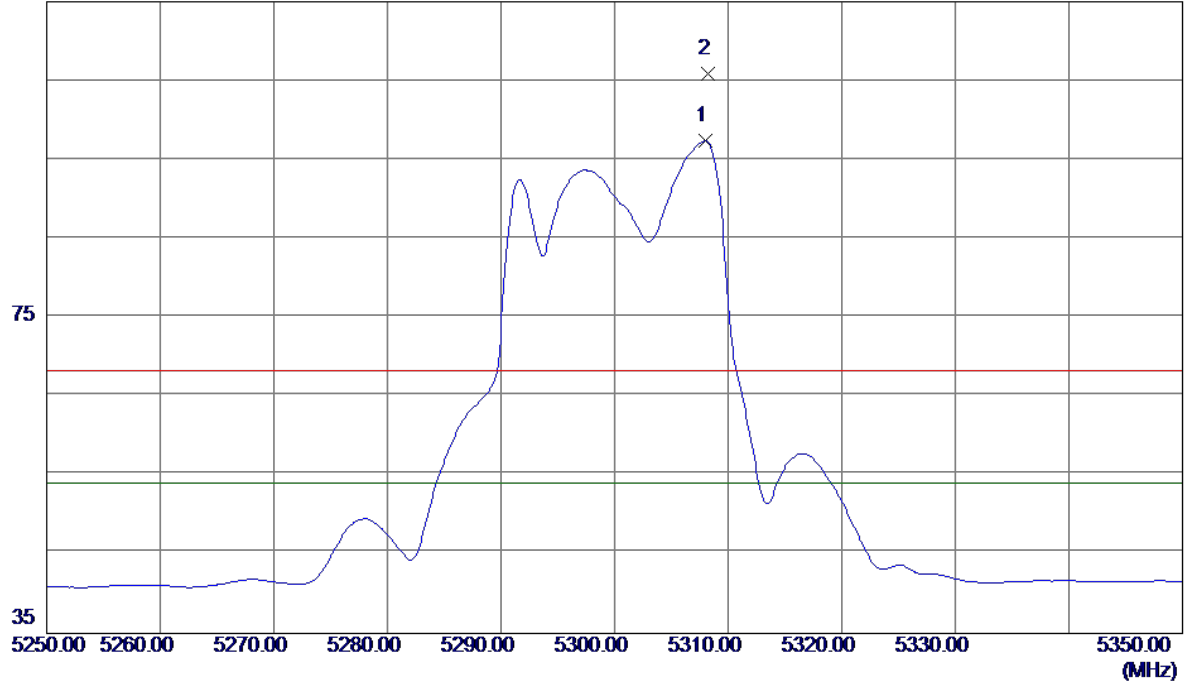

No.	Freq. MHz	Reading Level dBuV/m	Correct Factor dB	Measure ment dBuV/m	Limit dBuV/m	Margin dB	Detector	Comment
1 *	5308.0000	56.23	41.15	97.38	54.00	43.38	AVG	No Limit
2	5308.2000	64.81	41.15	105.96	68.20	37.76	Peak	No Limit

Orthogonal Axis :	X
Test Mode :	UNII-2A/ TX N20 Mode 5300MHz

Vertical

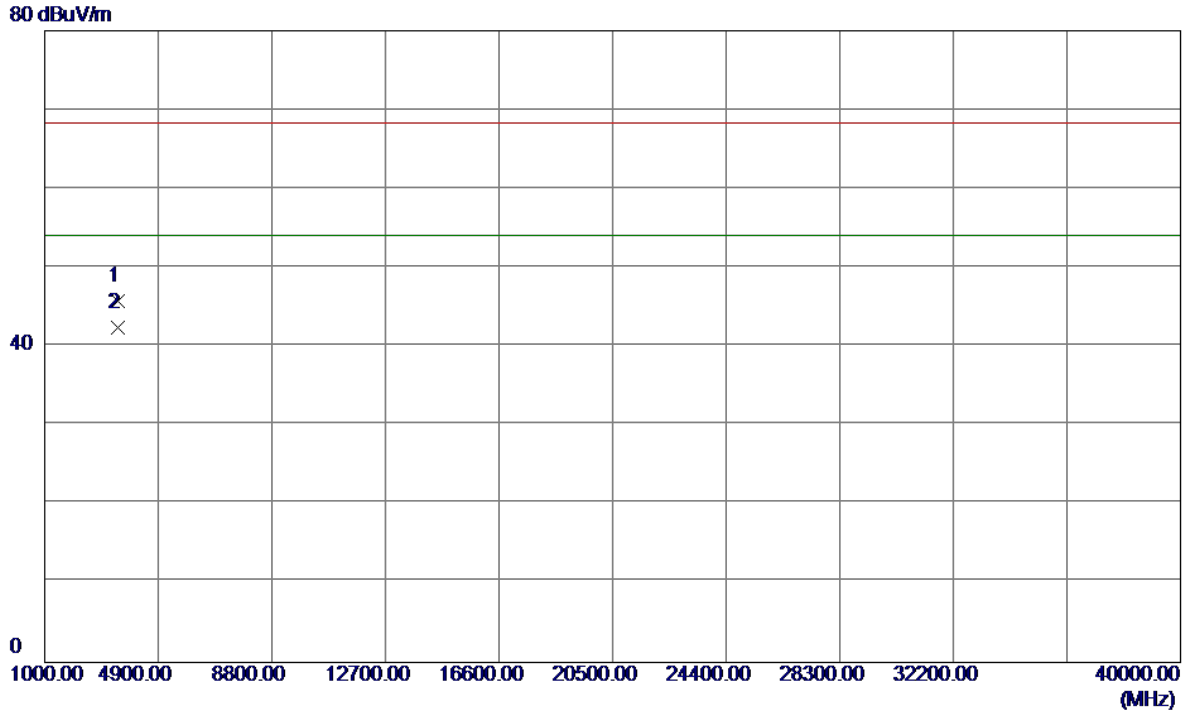

No.	Freq. MHz	Reading Level dBuV/m	Correct Factor dB	Measure ment dBuV/m	Limit dBuV/m	Margin dB	Detector	Comment
1	3533.2150	44.35	1.42	45.77	68.30	-22.53	Peak	
2 *	3533.3050	41.01	1.42	42.43	54.00	-11.57	AVG	

Orthogonal Axis :	X
Test Mode :	UNII-2A/ TX N20 Mode 5300MHz

Horizontal

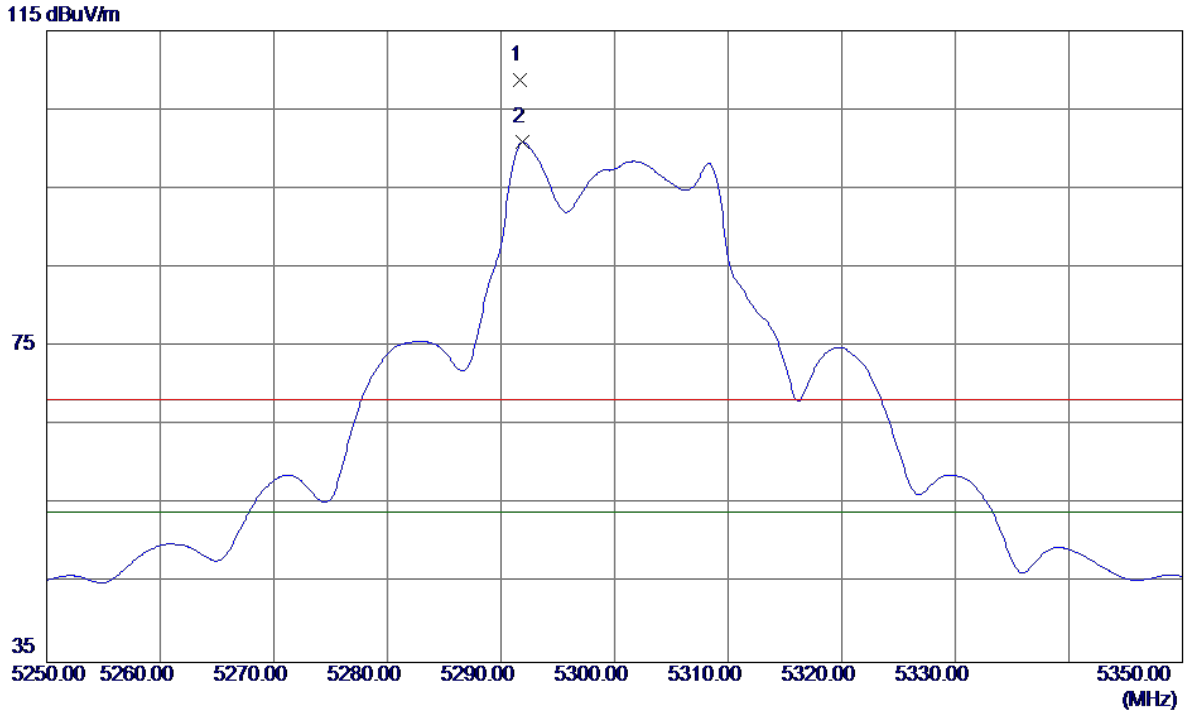

No.	Freq. MHz	Reading Level dBuV/m	Correct Factor dB	Measure ment dBuV/m	Limit dBuV/m	Margin dB	Detector	Comment
1	5291.7000	67.65	41.09	108.74	68.30	40.44	Peak	No Limit
2 *	5291.9000	59.77	41.09	100.86	54.00	46.86	AVG	No Limit

Orthogonal Axis :	X
Test Mode :	UNII-2A/ TX N20 Mode 5300MHz

Horizontal

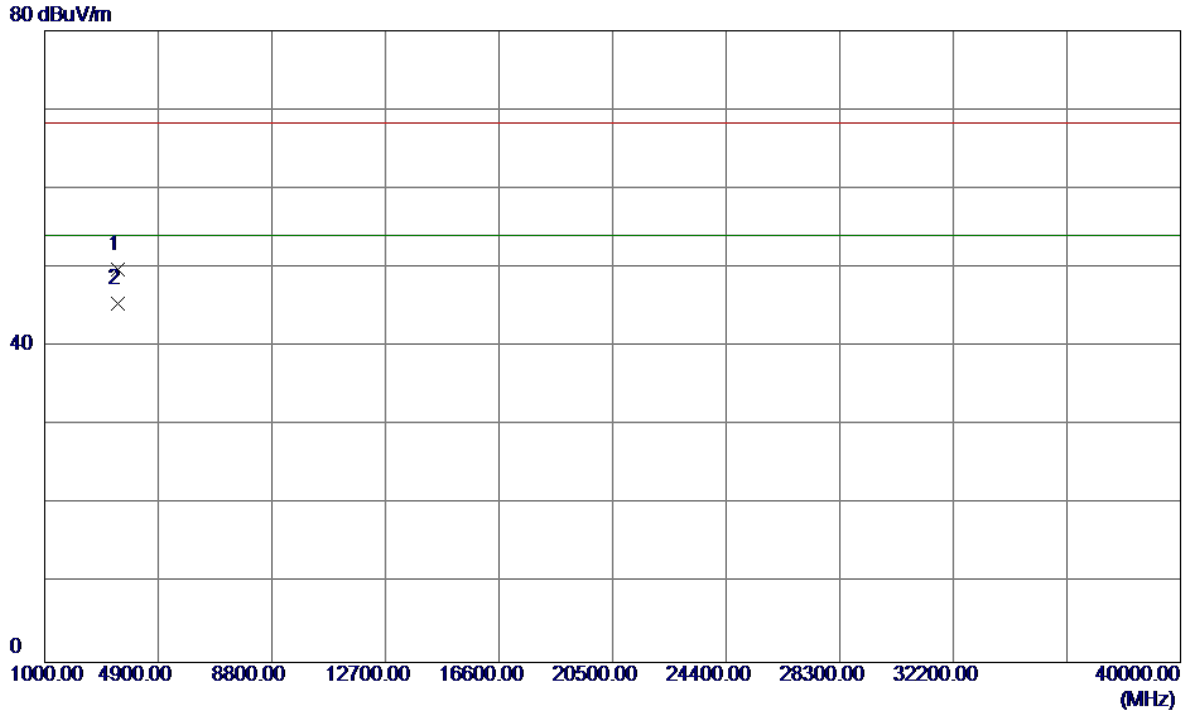

No.	Freq. MHz	Reading Level dBuV/m	Correct Factor dB	Measure ment dBuV/m	Limit dBuV/m	Margin dB	Detector	Comment
1	3533.2200	48.35	1.42	49.77	68.30	-18.53	Peak	
2 *	3533.3700	44.01	1.42	45.43	54.00	-8.57	AVG	

Orthogonal Axis :	X
Test Mode :	UNII-2A/ TX N20 Mode 5320MHz

Vertical

115 dBuV/m

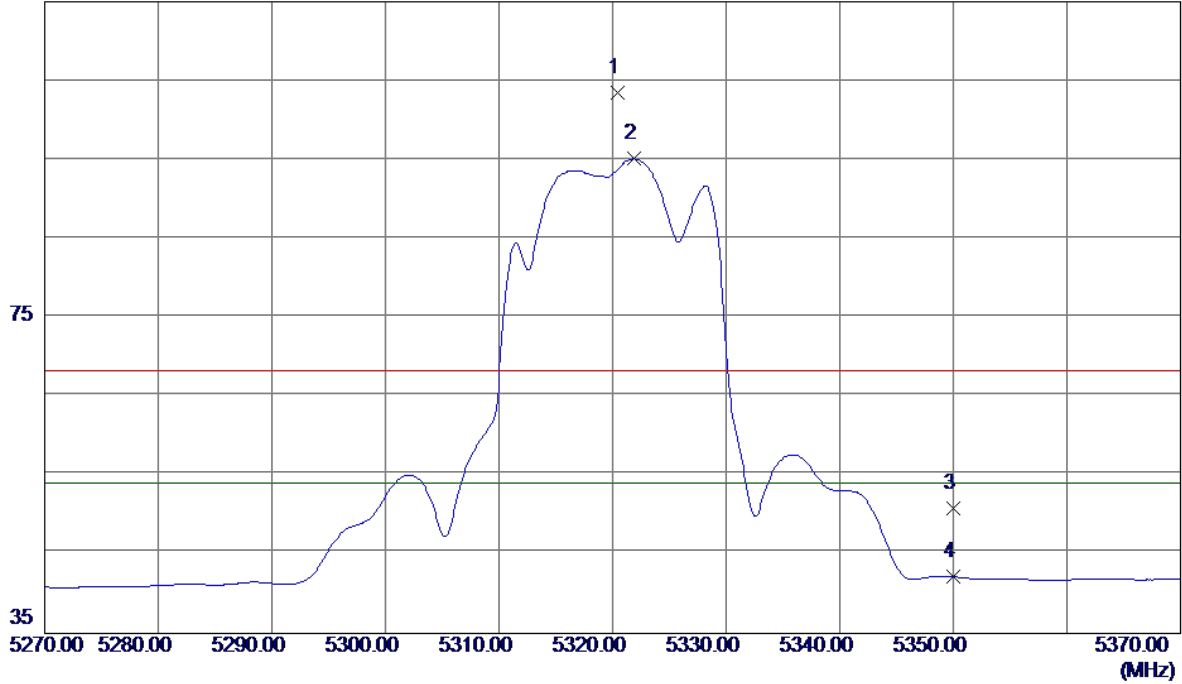

No.	Freq. MHz	Reading Level dBuV/m	Correct Factor dB	Measure ment dBuV/m	Limit dBuV/m	Margin dB	Detector	Comment
1	5320.4500	62.26	41.19	103.45	68.20	35.25	Peak	No Limit
2 *	5321.8500	53.90	41.19	95.09	54.00	41.09	AVG	No Limit
3	5350.0000	9.49	41.28	50.77	68.20	-17.43	Peak	
4	5350.0000	0.88	41.28	42.16	54.00	-11.84	AVG	

Orthogonal Axis :	X
Test Mode :	UNII-2A/ TX N20 Mode 5320MHz

Vertical

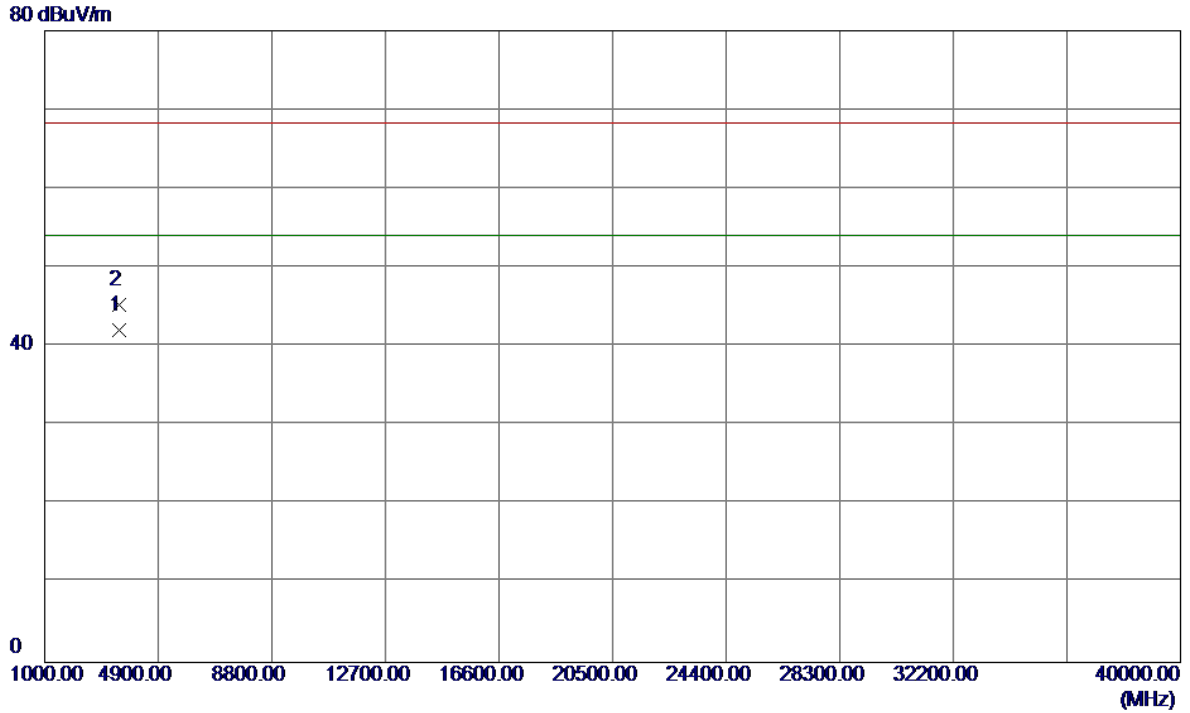

No.	Freq. MHz	Reading Level dBuV/m	Correct Factor dB	Measure ment dBuV/m	Limit dBuV/m	Margin dB	Detector	Comment
1 *	3546.6400	40.58	1.47	42.05	54.00	-11.95	AVG	
2	3546.7000	43.88	1.47	45.35	68.30	-22.95	Peak	

Orthogonal Axis :	X
Test Mode :	UNII-2A/ TX N20 Mode 5320MHz

Horizontal

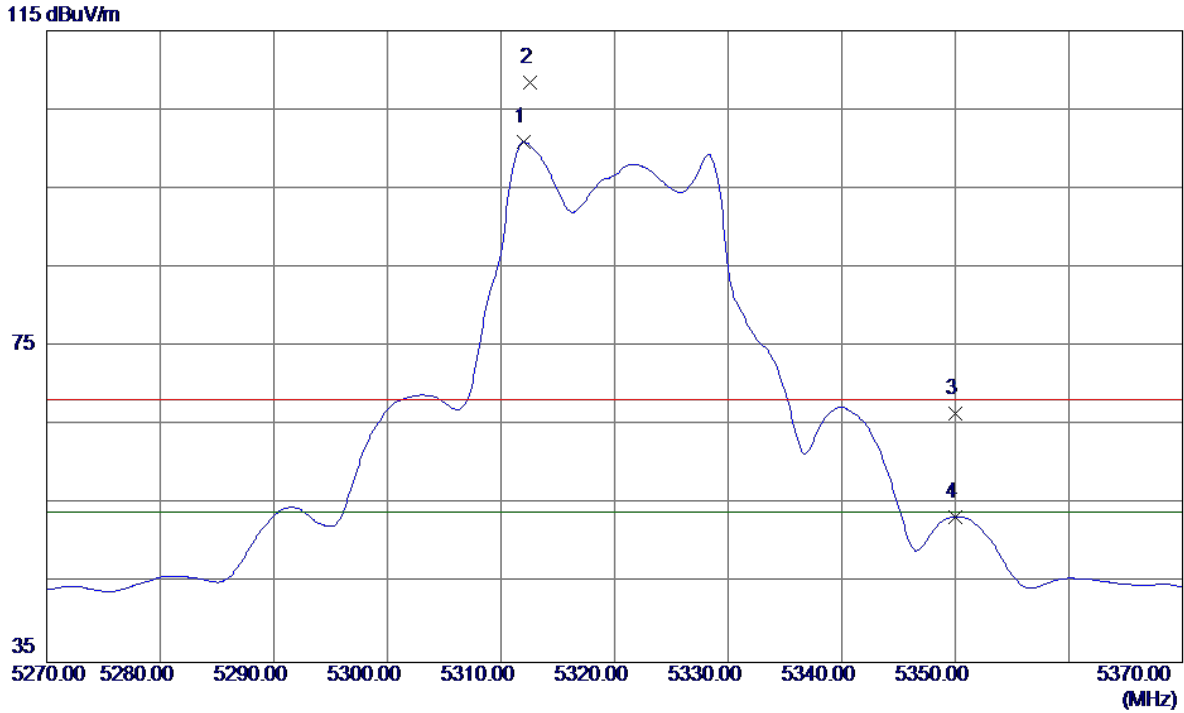

No.	Freq. MHz	Reading Level dBuV/m	Correct Factor dB	Measure ment dBuV/m	Limit dBuV/m	Margin dB	Detector	Comment
1 *	5312.0000	59.71	41.16	100.87	54.00	46.87	AVG	No Limit
2	5312.6000	67.31	41.16	108.47	68.30	40.17	Peak	No Limit
3	5350.0000	25.26	41.28	66.54	68.30	-1.76	Peak	
4	5350.0000	12.17	41.28	53.45	54.00	-0.55	AVG	

Orthogonal Axis :	X
Test Mode :	UNII-2A/ TX N20 Mode 5320MHz

Horizontal

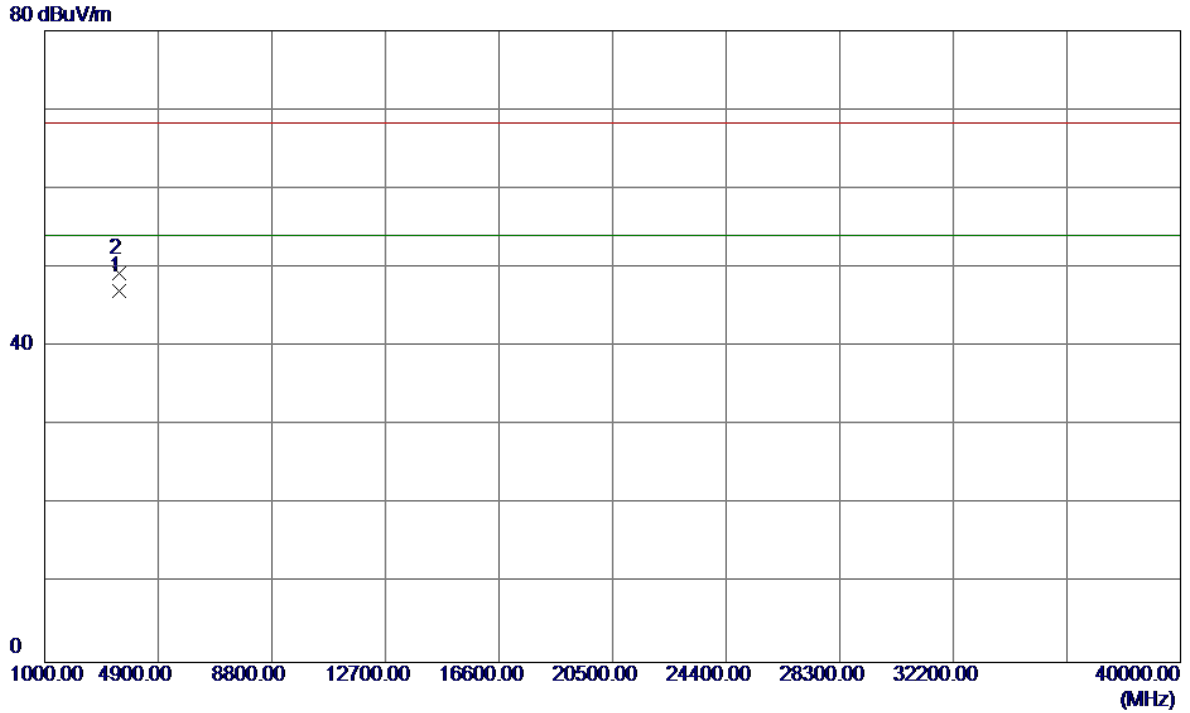

No.	Freq. MHz	Reading Level dBuV/m	Correct Factor dB	Measure ment dBuV/m	Limit dBuV/m	Margin dB	Detector	Comment
1 *	3546.6250	45.58	1.47	47.05	54.00	-6.95	AVG	
2	3546.7950	47.88	1.47	49.35	68.30	-18.95	Peak	

Orthogonal Axis :	X
Test Mode :	UNII-2A/ TX N40 Mode 5270MHz

Vertical

115 dBuV/m

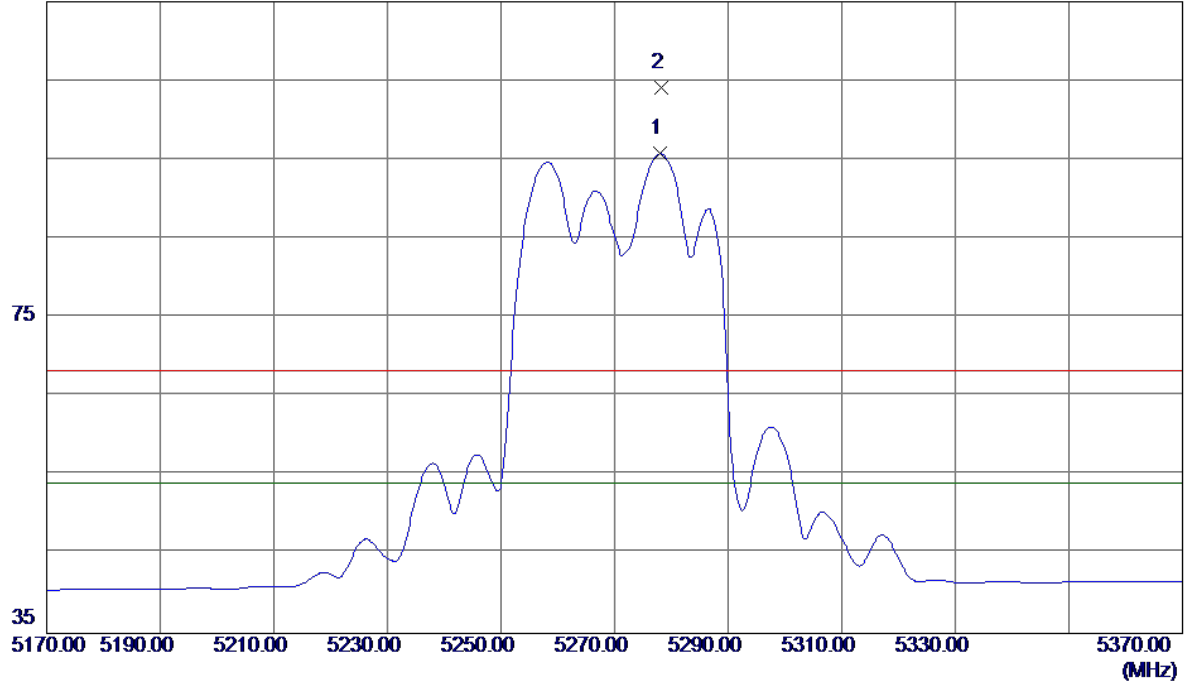

No.	Freq. MHz	Reading Level dBuV/m	Correct Factor dB	Measure ment dBuV/m	Limit dBuV/m	Margin dB	Detector	Comment
1 *	5278.1000	54.70	41.05	95.75	54.00	41.75	AVG	No Limit
2	5278.2000	63.06	41.05	104.11	68.20	35.91	Peak	No Limit

Orthogonal Axis :	X
Test Mode :	UNII-2A/ TX N40 Mode 5270MHz

Vertical

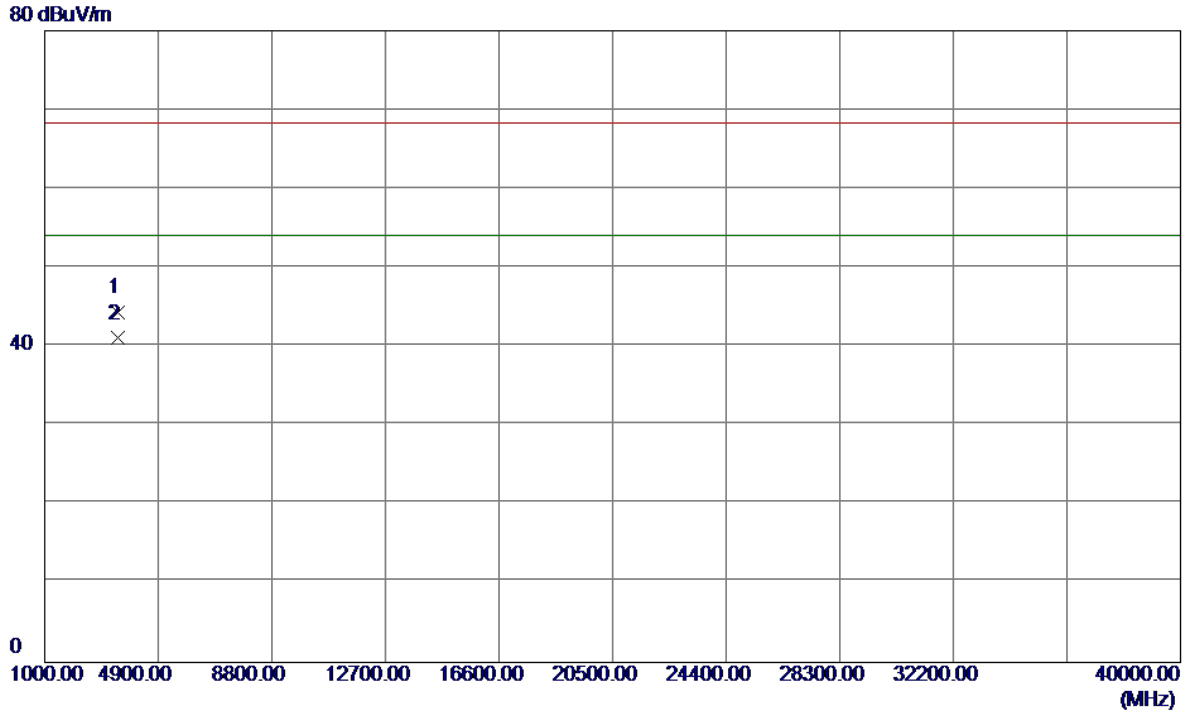

No.	Freq. MHz	Reading Level dBuV/m	Correct Factor dB	Measure ment dBuV/m	Limit dBuV/m	Margin dB	Detector	Comment
1	3513.2150	42.94	1.36	44.30	68.30	-24.00	Peak	
2 *	3513.3050	39.68	1.36	41.04	54.00	-12.96	AVG	

Orthogonal Axis :	X
Test Mode :	UNII-2A/ TX N40 Mode 5270MHz

Horizontal

115 dBuV/m

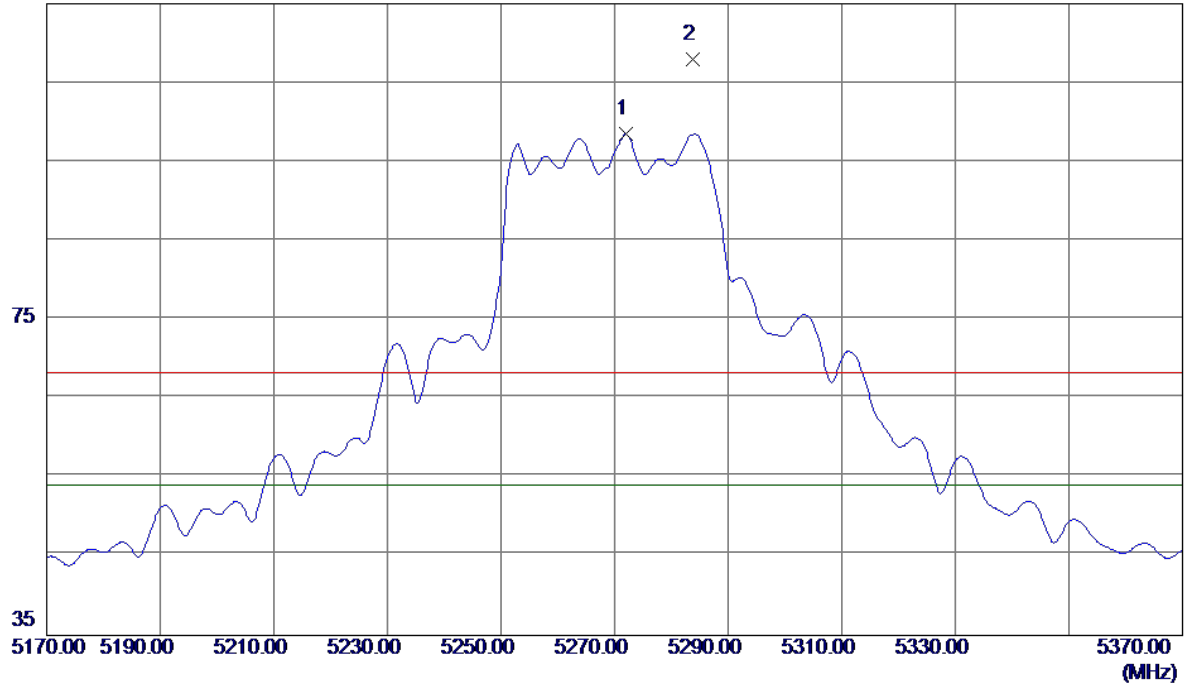

No.	Freq. MHz	Reading Level dBuV/m	Correct Factor dB	Measure ment dBuV/m	Limit dBuV/m	Margin dB	Detector	Comment
1 *	5272.0000	57.47	41.03	98.50	54.00	44.50	AVG	No Limit
2	5283.8000	66.90	41.07	107.97	68.30	39.67	Peak	No Limit

Orthogonal Axis :	X
Test Mode :	UNII-2A/ TX N40 Mode 5270MHz

Horizontal

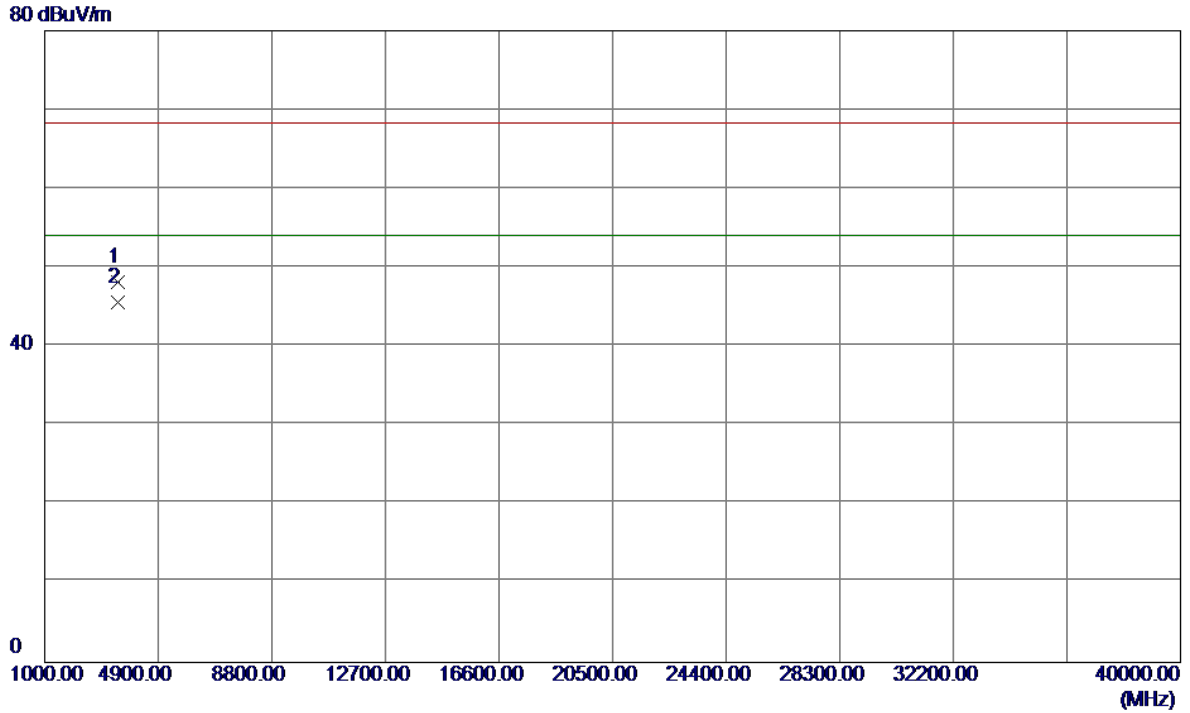

No.	Freq. MHz	Reading Level dBuV/m	Correct Factor dB	Measure ment dBuV/m	Limit dBuV/m	Margin dB	Detector	Comment
1	3513.1700	46.86	1.36	48.22	68.30	-20.08	Peak	
2 *	3513.2850	44.25	1.36	45.61	54.00	-8.39	AVG	

Orthogonal Axis :	X
Test Mode :	UNII-2A/ TX N40 Mode 5310MHz

Vertical

115 dBuV/m

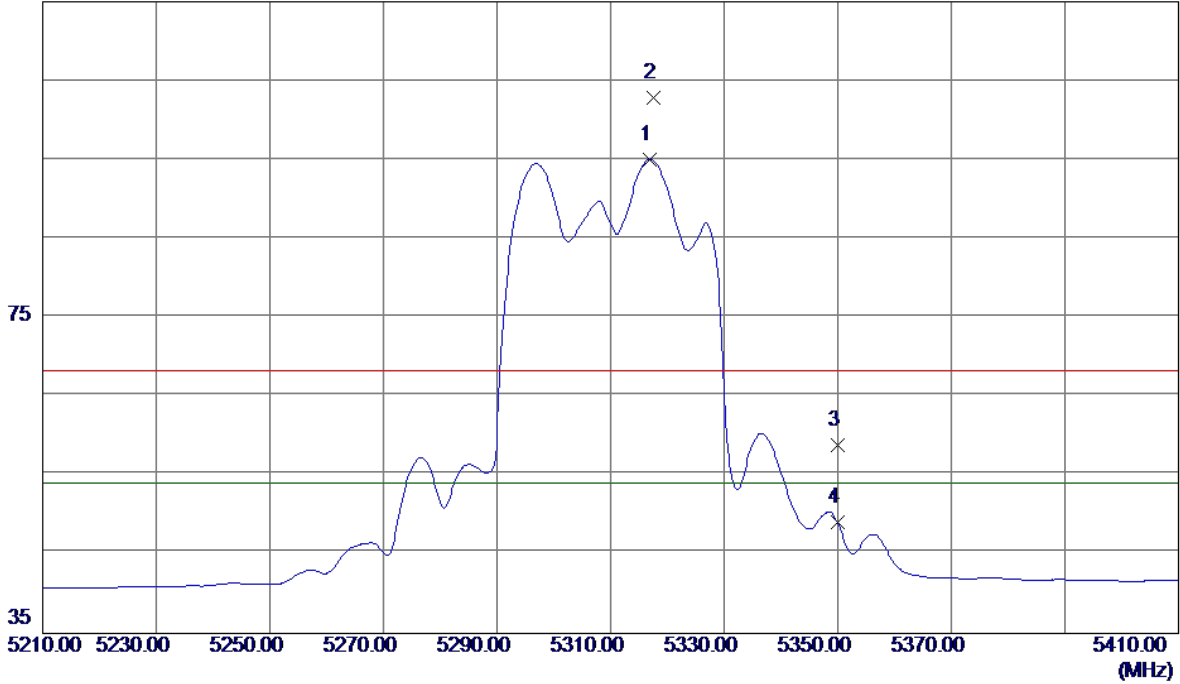

No.	Freq. MHz	Reading Level dBuV/m	Correct Factor dB	Measure ment dBuV/m	Limit dBuV/m	Margin dB	Detector	Comment
1 *	5316.9000	53.84	41.18	95.02	54.00	41.02	AVG	No Limit
2	5317.6000	61.58	41.18	102.76	68.20	34.56	Peak	No Limit
3	5350.0000	17.60	41.28	58.88	68.20	-9.32	Peak	
4	5350.0000	7.73	41.28	49.01	54.00	-4.99	AVG	

Orthogonal Axis :	X
Test Mode :	UNII-2A/ TX N40 Mode 5310MHz

Vertical

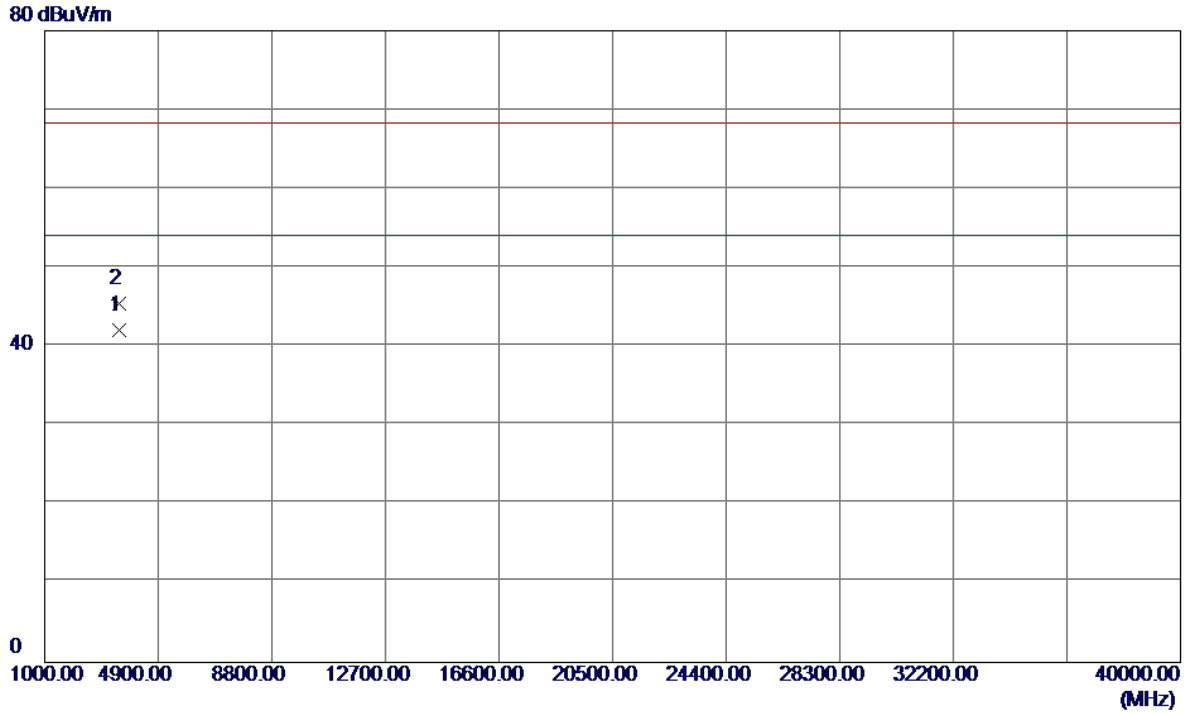

No.	Freq. MHz	Reading Level dBuV/m	Correct Factor dB	Measure ment dBuV/m	Limit dBuV/m	Margin dB	Detector	Comment
1 *	3539.9750	40.61	1.45	42.06	54.00	-11.94	AVG	
2	3539.9900	43.96	1.45	45.41	68.30	-22.89	Peak	

Orthogonal Axis :	X
Test Mode :	UNII-2A/ TX N40 Mode 5310MHz

Horizontal

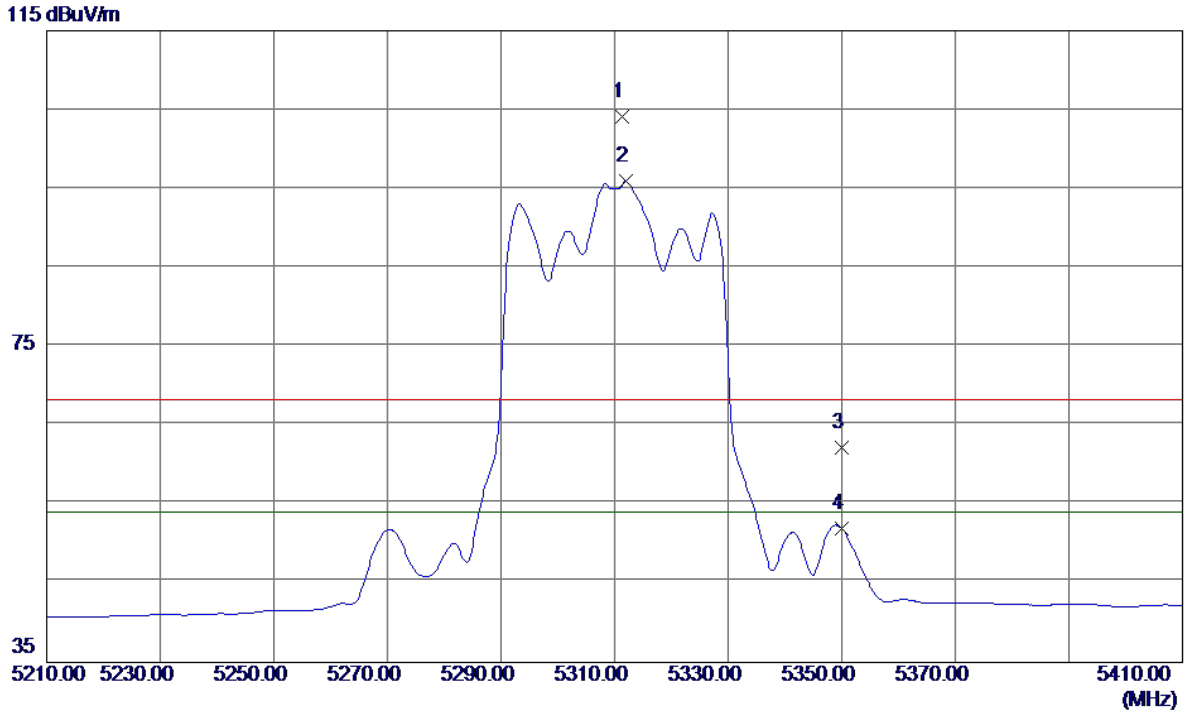

No.	Freq. MHz	Reading Level dBuV/m	Correct Factor dB	Measure ment dBuV/m	Limit dBuV/m	Margin dB	Detector	Comment
1	5311.4000	62.99	41.16	104.15	68.30	35.85	Peak	No Limit
2 *	5312.0000	54.76	41.16	95.92	54.00	41.92	AVG	No Limit
3	5350.0000	20.97	41.28	62.25	68.30	-6.05	Peak	
4	5350.0000	10.66	41.28	51.94	54.00	-2.06	AVG	

Orthogonal Axis :	X
Test Mode :	UNII-2A/ TX N40 Mode 5310MHz

Horizontal

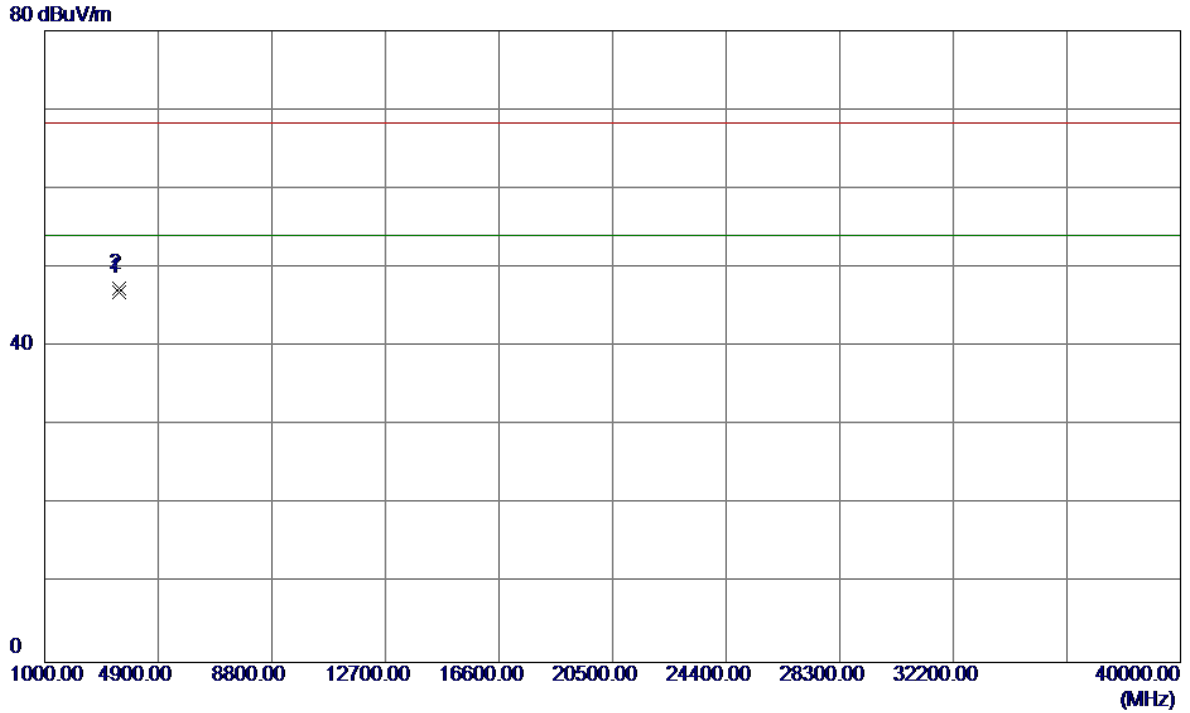

No.	Freq. MHz	Reading Level dBuV/m	Correct Factor dB	Measure ment dBuV/m	Limit dBuV/m	Margin dB	Detector	Comment
1 *	3539.8450	45.43	1.45	46.88	54.00	-7.12	AVG	
2	3539.9200	45.92	1.45	47.37	68.30	-20.93	Peak	

Orthogonal Axis :	X
Test Mode :	UNII-2C/ TX A Mode 5500MHz

Vertical

115 dBuV/m

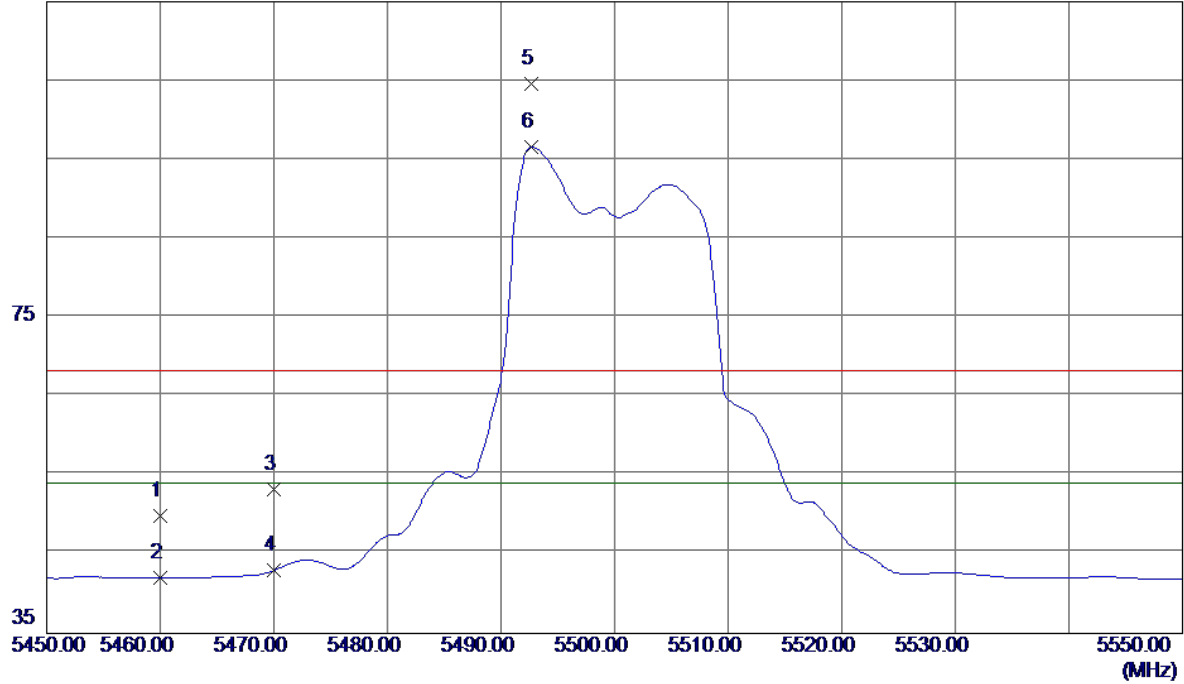

No.	Freq. MHz	Reading Level dBuV/m	Correct Factor dB	Measure ment dBuV/m	Limit dBuV/m	Margin dB	Detector	Comment
1	5460.0000	8.25	41.65	49.90	68.20	-18.30	Peak	
2	5460.0000	0.39	41.65	42.04	54.00	-11.96	AVG	
3	5470.0000	11.51	41.68	53.19	68.20	-15.01	Peak	
4	5470.0000	1.34	41.68	43.02	54.00	-10.98	AVG	
5	5492.6500	62.90	41.76	104.66	68.20	36.46	Peak	No Limit
6 *	5492.7000	54.84	41.76	96.60	54.00	42.60	AVG	No Limit

Orthogonal Axis :	X
Test Mode :	UNII-2C/ TX A Mode 5500MHz

Vertical

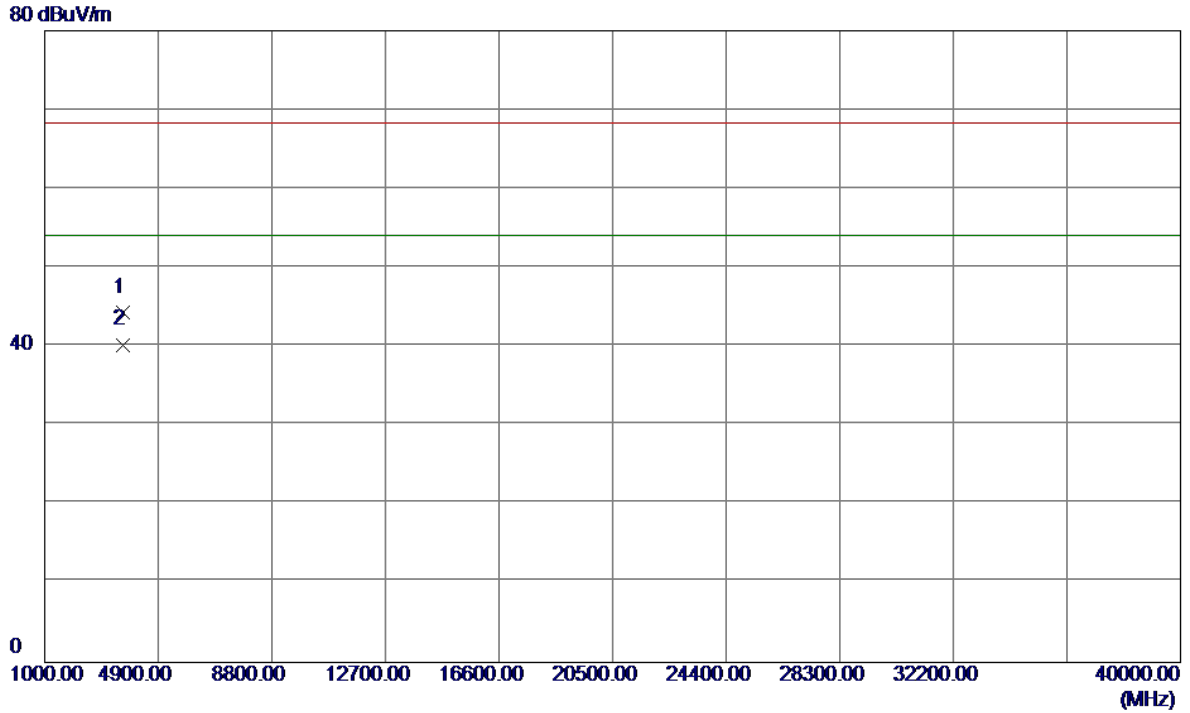

No.	Freq. MHz	Reading Level dBuV/m	Correct Factor dB	Measure ment dBuV/m	Limit dBuV/m	Margin dB	Detector	Comment
1	3666.5700	42.41	1.86	44.27	68.30	-24.03	Peak	
2 *	3666.6350	38.38	1.86	40.24	54.00	-13.76	AVG	

Orthogonal Axis :	X
Test Mode :	UNII-2C/ TX A Mode 5500MHz

Horizontal

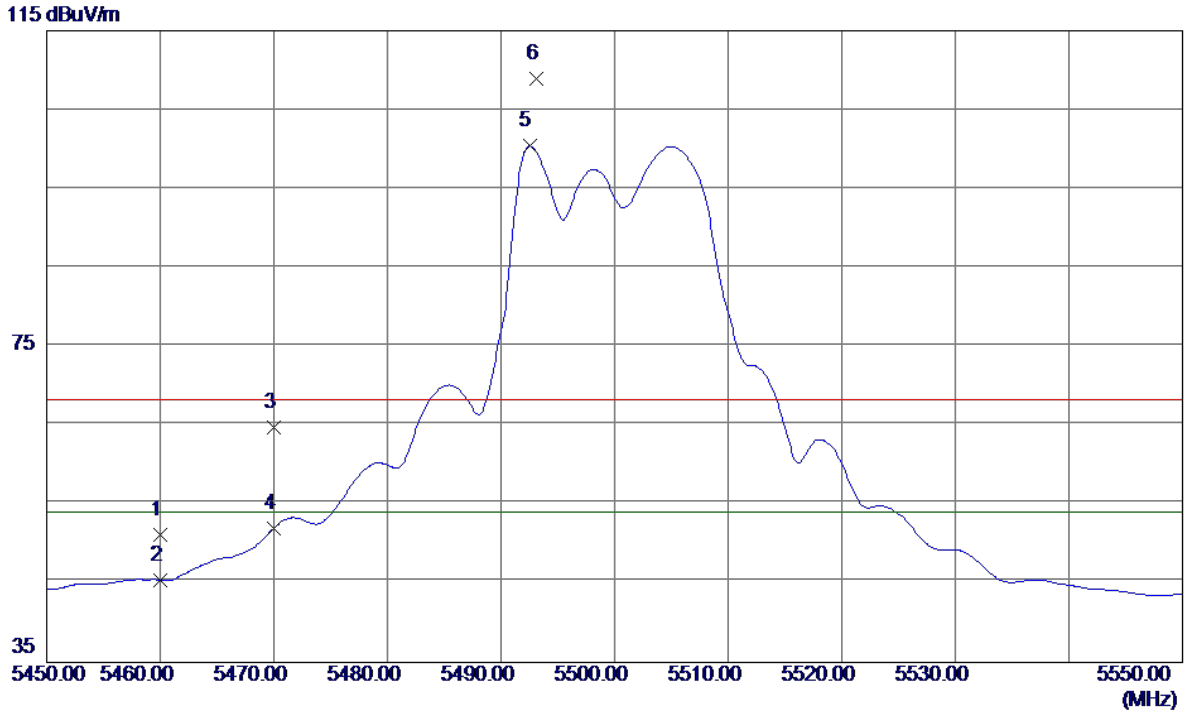

No.	Freq. MHz	Reading Level dBuV/m	Correct Factor dB	Measure ment dBuV/m	Limit dBuV/m	Margin dB	Detector	Comment
1	5460.0000	9.47	41.65	51.12	68.30	-17.18	Peak	
2	5460.0000	3.77	41.65	45.42	54.00	-8.58	AVG	
3	5470.0000	23.00	41.68	64.68	68.30	-3.62	Peak	
4	5470.0000	10.30	41.68	51.98	54.00	-2.02	AVG	
5 *	5492.5000	58.64	41.76	100.40	54.00	46.40	AVG	No Limit
6	5493.1000	67.16	41.76	108.92	68.30	40.62	Peak	No Limit

Orthogonal Axis :	X
Test Mode :	UNII-2C/ TX A Mode 5500MHz

Horizontal

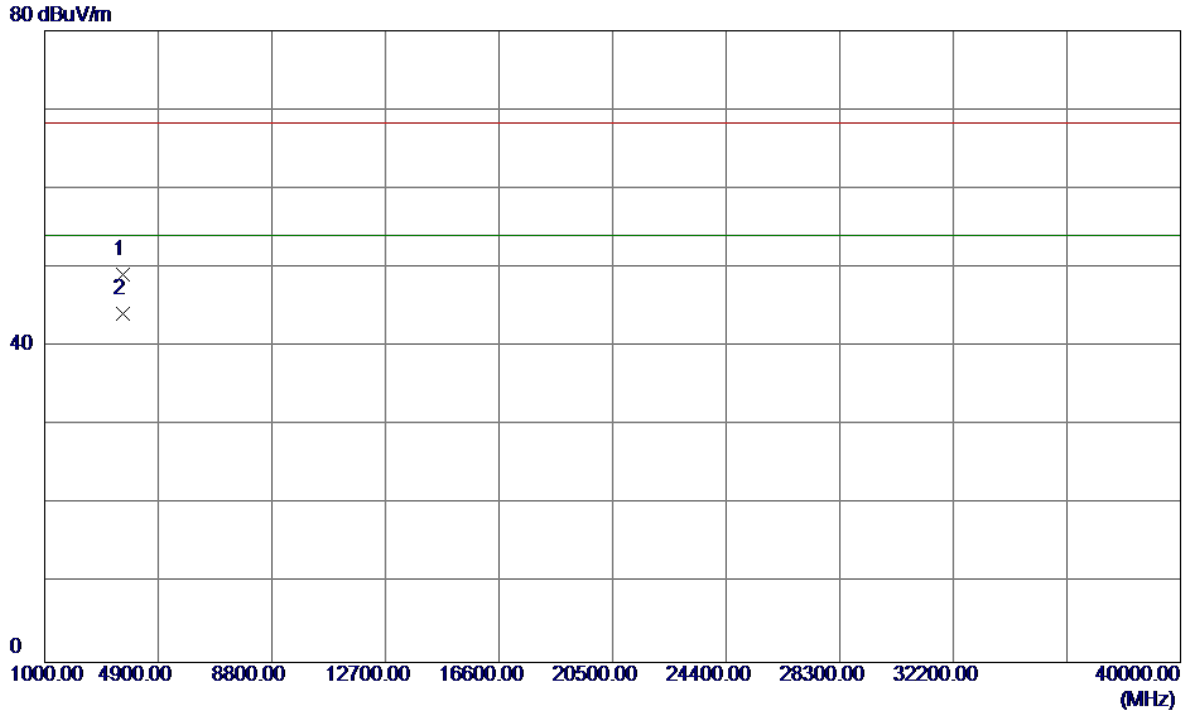

No.	Freq. MHz	Reading Level dBuV/m	Correct Factor dB	Measure ment dBuV/m	Limit dBuV/m	Margin dB	Detector	Comment
1	3666.5500	47.26	1.86	49.12	68.30	-19.18	Peak	
2 *	3666.6250	42.32	1.86	44.18	54.00	-9.82	AVG	

Orthogonal Axis :	X
Test Mode :	UNII-2C/ TX A Mode 5580MHz

Vertical

115 dBuV/m

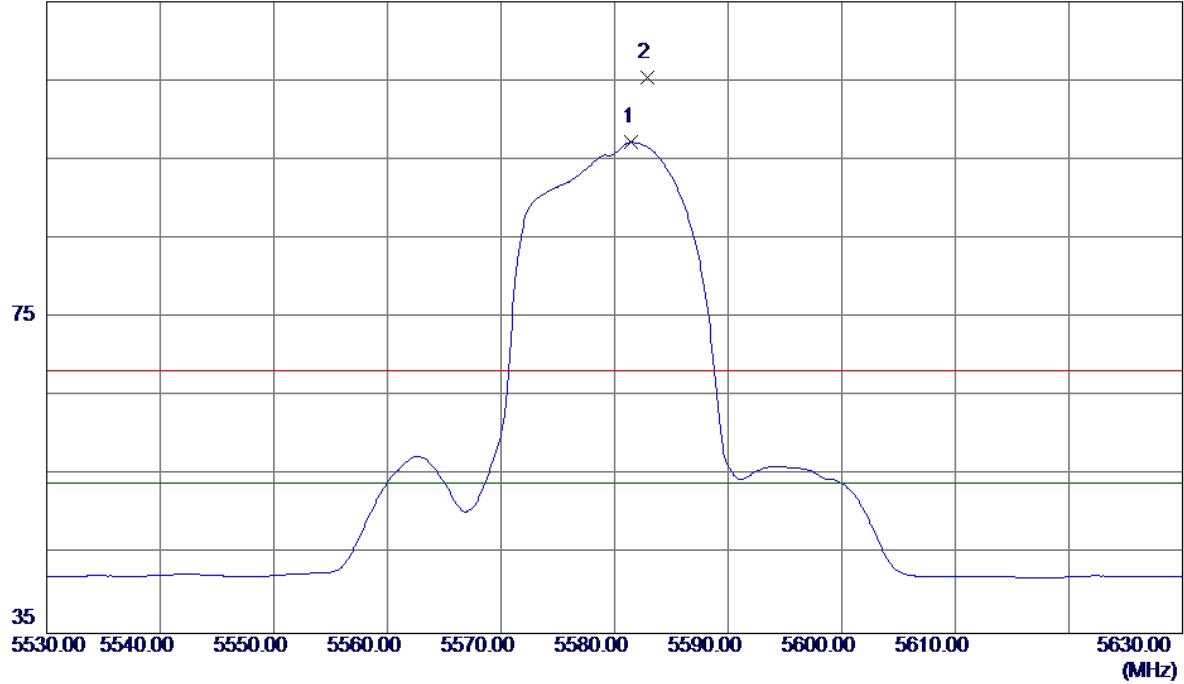

No.	Freq. MHz	Reading Level dBuV/m	Correct Factor dB	Measure ment dBuV/m	Limit dBuV/m	Margin dB	Detector	Comment
1 *	5581.5000	55.11	42.07	97.18	54.00	43.18	AVG	No Limit
2	5582.8500	63.32	42.07	105.39	68.20	37.19	Peak	No Limit

Orthogonal Axis :	X
Test Mode :	UNII-2C/ TX A Mode 5580MHz

Vertical

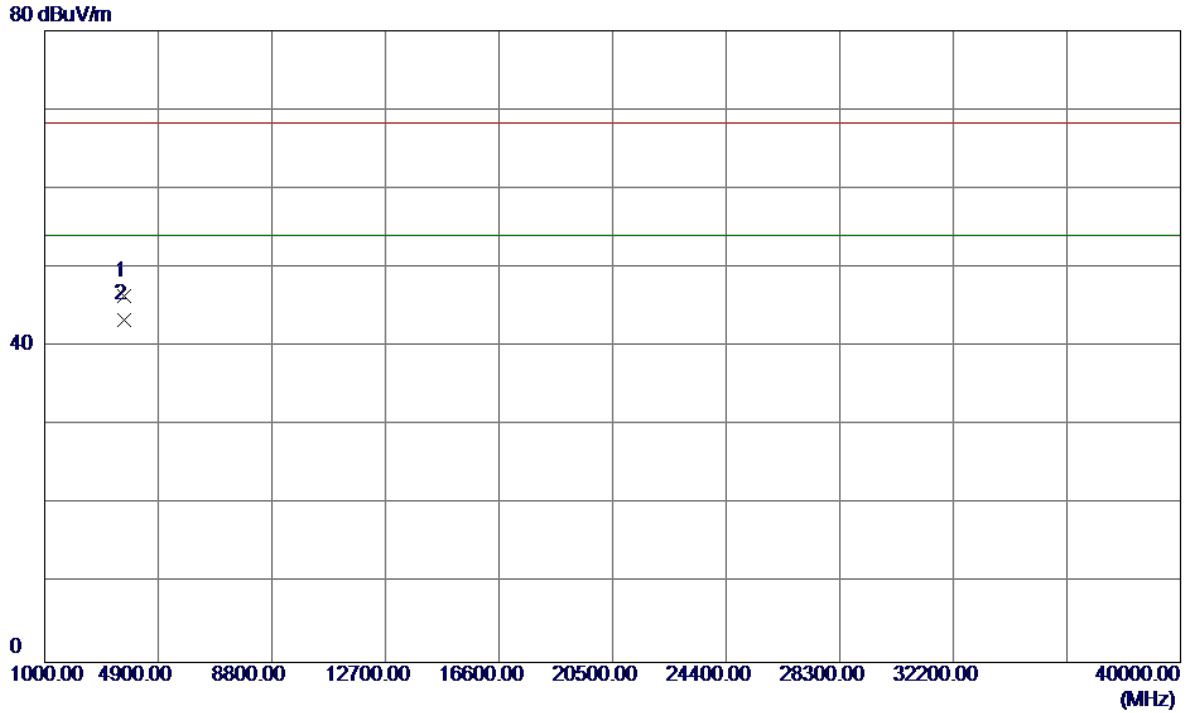

No.	Freq. MHz	Reading Level dBuV/m	Correct Factor dB	Measure ment dBuV/m	Limit dBuV/m	Margin dB	Detector	Comment
1	3719.9600	44.38	2.03	46.41	68.30	-21.89	Peak	
2 *	3719.9800	41.41	2.03	43.44	54.00	-10.56	AVG	

Orthogonal Axis :	X
Test Mode :	UNII-2C/ TX A Mode 5580MHz

Horizontal

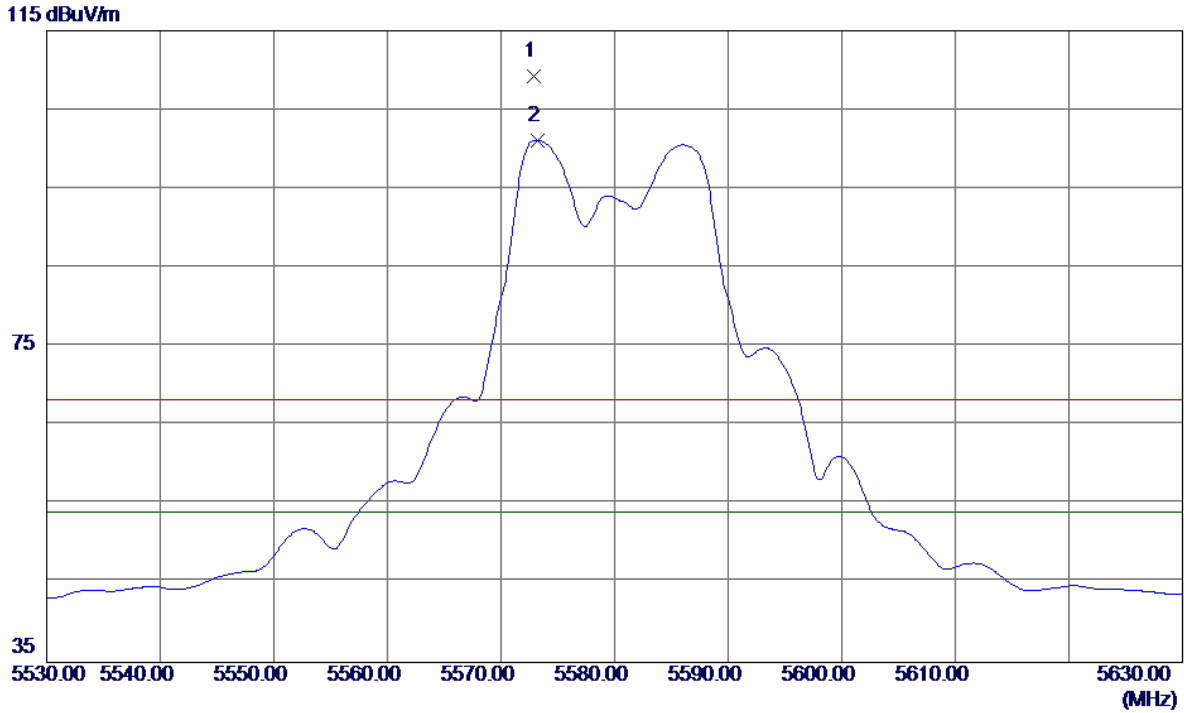

No.	Freq. MHz	Reading Level dBuV/m	Correct Factor dB	Measure ment dBuV/m	Limit dBuV/m	Margin dB	Detector	Comment
1	5572.9000	67.27	42.04	109.31	68.30	41.01	Peak	No Limit
2 *	5573.2000	59.11	42.04	101.15	54.00	47.15	AVG	No Limit

Orthogonal Axis :	X
Test Mode :	UNII-2C/ TX A Mode 5580MHz

Horizontal

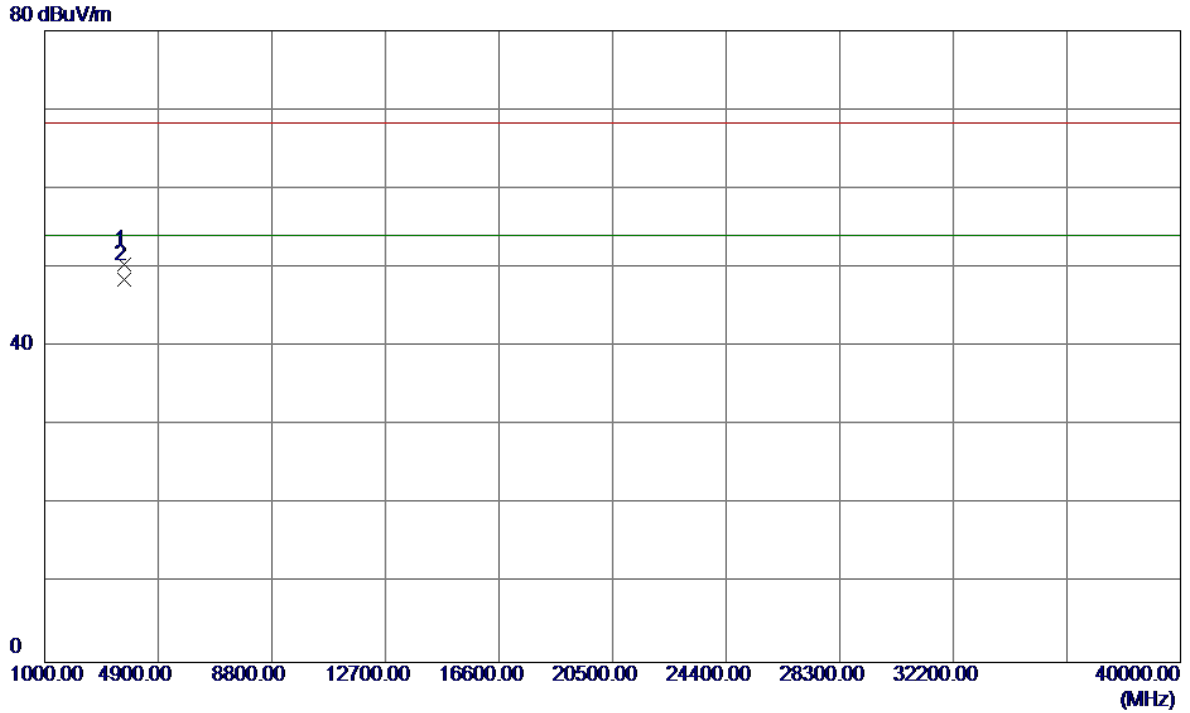

No.	Freq. MHz	Reading Level dBuV/m	Correct Factor dB	Measure ment dBuV/m	Limit dBuV/m	Margin dB	Detector	Comment
1	3719.9600	48.38	2.03	50.41	68.30	-17.89	Peak	
2 *	3719.9750	46.41	2.03	48.44	54.00	-5.56	AVG	

Orthogonal Axis :	X
Test Mode :	UNII-2C/ TX A Mode 5700MHz

Vertical

115 dBuV/m

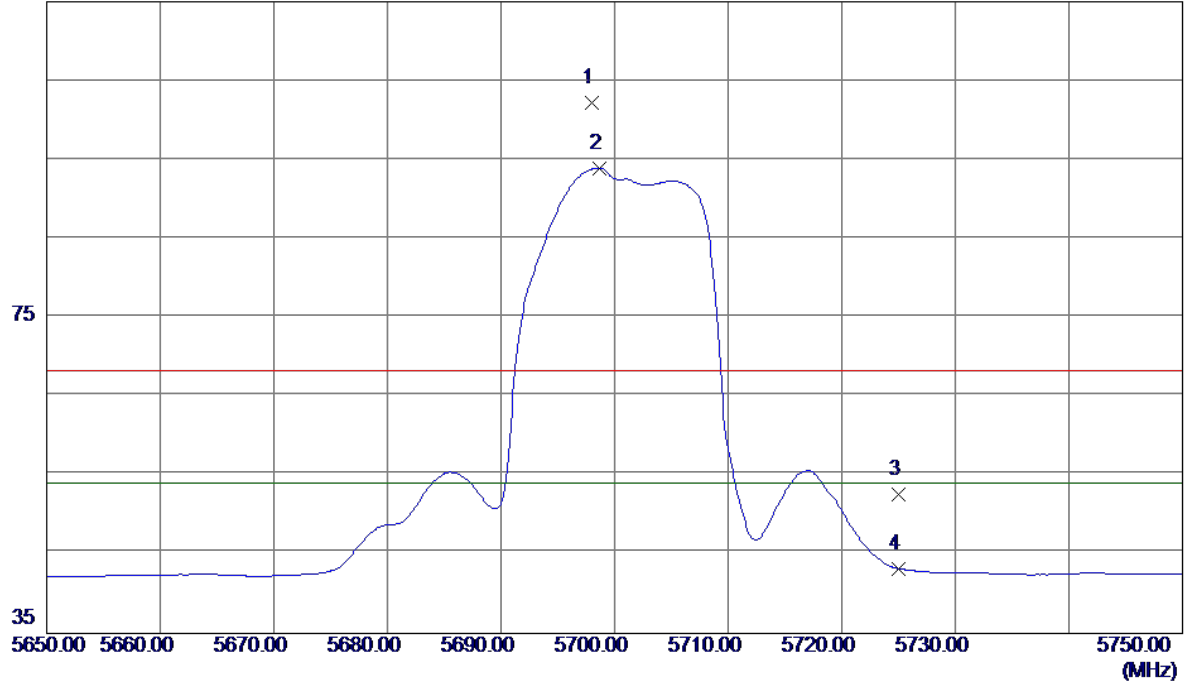

No.	Freq. MHz	Reading Level dBuV/m	Correct Factor dB	Measure ment dBuV/m	Limit dBuV/m	Margin dB	Detector	Comment
1	5698.0000	59.70	42.48	102.18	68.20	33.98	Peak	No Limit
2 *	5698.6500	51.46	42.49	93.95	54.00	39.95	AVG	No Limit
3	5725.0000	9.99	42.58	52.57	68.20	-15.63	Peak	
4	5725.0000	0.61	42.58	43.19	54.00	-10.81	AVG	

Orthogonal Axis :	X
Test Mode :	UNII-2C/ TX A Mode 5700MHz

Vertical

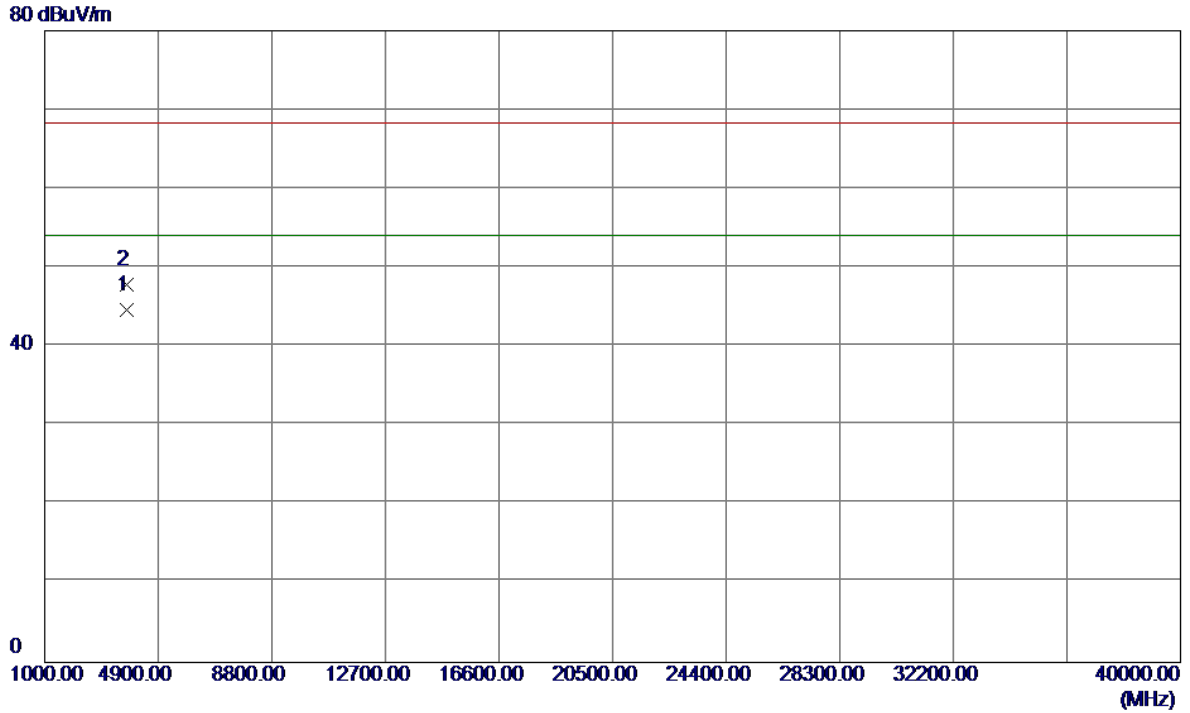

No.	Freq. MHz	Reading Level dBuV/m	Correct Factor dB	Measure ment dBuV/m	Limit dBuV/m	Margin dB	Detector	Comment
1 *	3799.9650	42.36	2.30	44.66	54.00	-9.34	AVG	
2	3800.0500	45.48	2.30	47.78	68.30	-20.52	Peak	

Orthogonal Axis :	X
Test Mode :	UNII-2C/ TX A Mode 5700MHz

Horizontal

115 dBuV/m

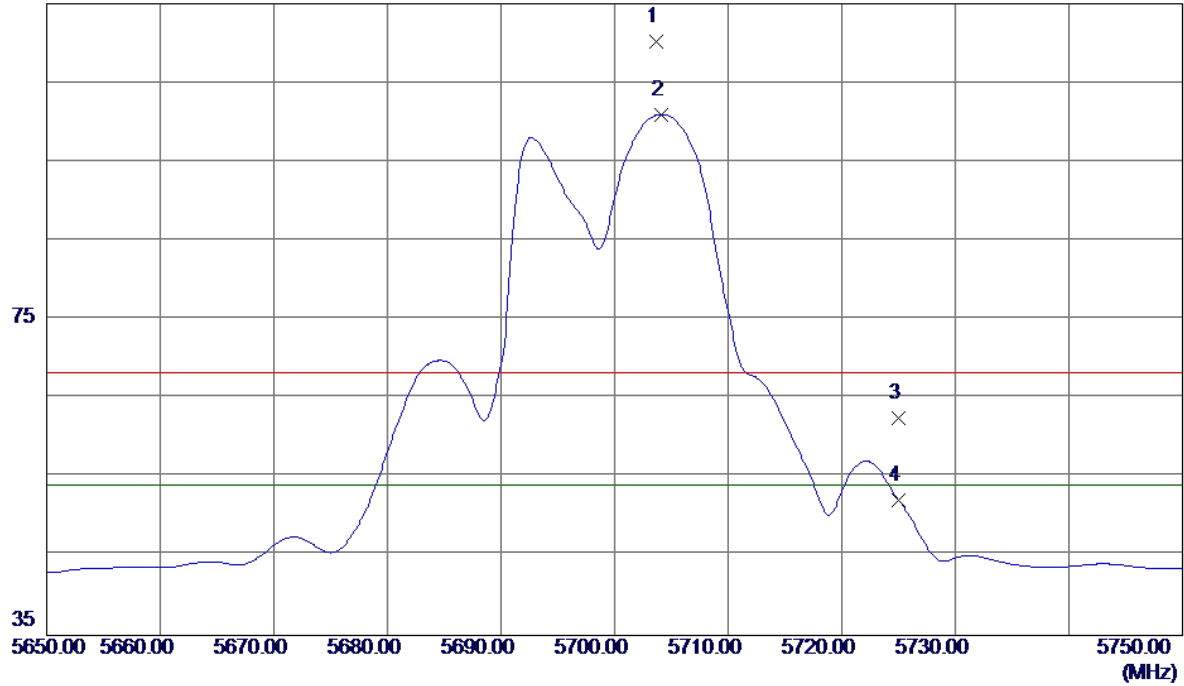

No.	Freq. MHz	Reading Level dBuV/m	Correct Factor dB	Measure ment dBuV/m	Limit dBuV/m	Margin dB	Detector	Comment
1	5703.7000	67.67	42.51	110.18	68.30	41.88	Peak	No Limit
2 *	5704.1000	58.47	42.51	100.98	54.00	46.98	AVG	No Limit
3	5725.0000	19.98	42.58	62.56	68.30	-5.74	Peak	
4	5725.0000	9.58	42.58	52.16	54.00	-1.84	AVG	

Orthogonal Axis :	X
Test Mode :	UNII-2C/ TX A Mode 5700MHz

Horizontal

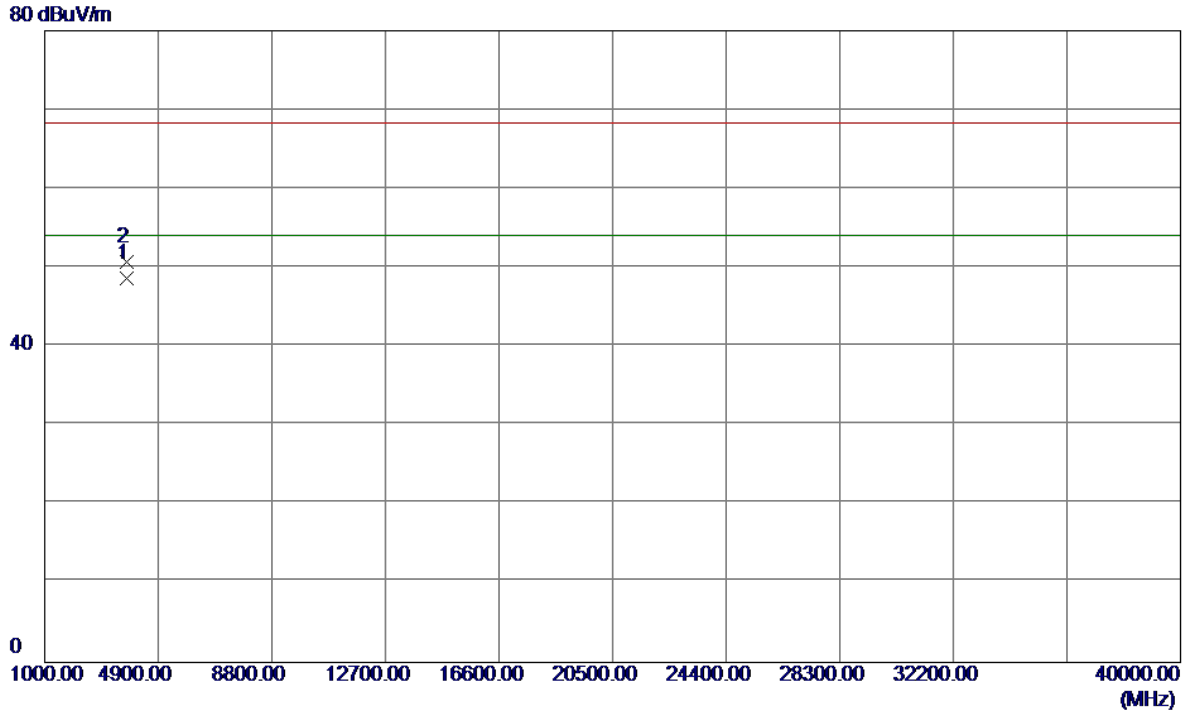

No.	Freq. MHz	Reading Level dBuV/m	Correct Factor dB	Measure ment dBuV/m	Limit dBuV/m	Margin dB	Detector	Comment
1 *	3799.9450	46.36	2.30	48.66	54.00	-5.34	AVG	
2	3800.1500	48.48	2.30	50.78	68.30	-17.52	Peak	

Orthogonal Axis :	X
Test Mode :	UNII-2C/ TX N20 Mode 5500MHz

Vertical

115 dBuV/m

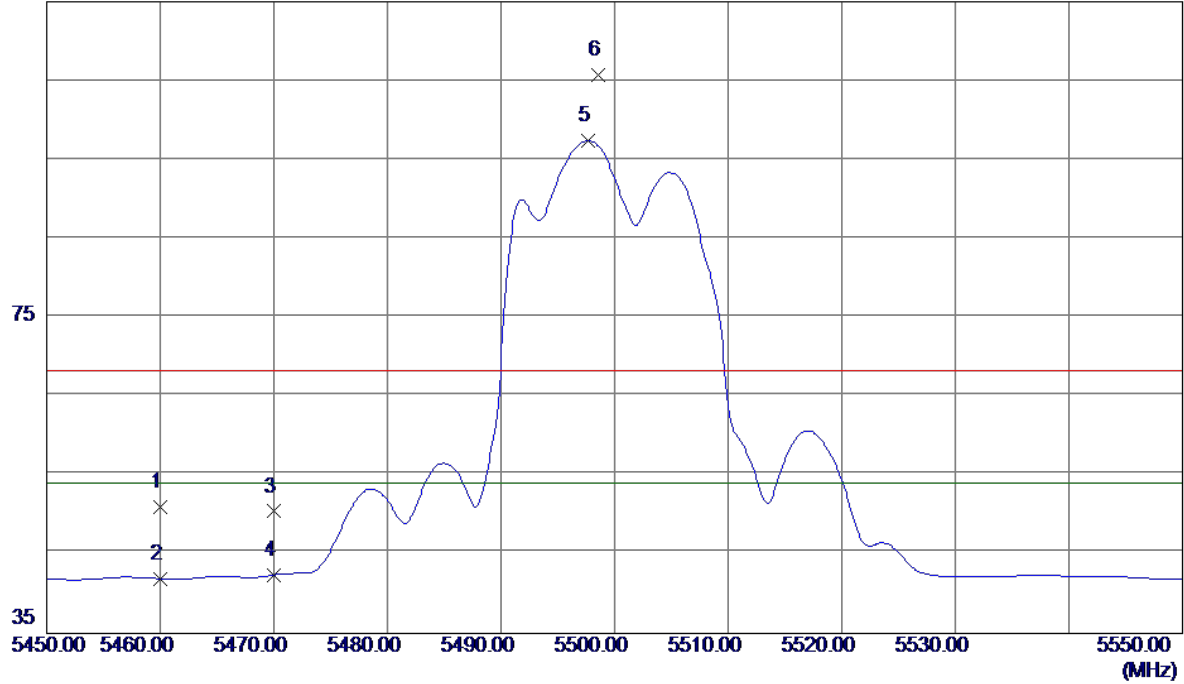

No.	Freq. MHz	Reading Level dBuV/m	Correct Factor dB	Measure ment dBuV/m	Limit dBuV/m	Margin dB	Detector	Comment
1	5460.0000	9.32	41.65	50.97	68.20	-17.23	Peak	
2	5460.0000	0.26	41.65	41.91	54.00	-12.09	AVG	
3	5470.0000	8.76	41.68	50.44	68.20	-17.76	Peak	
4	5470.0000	0.72	41.68	42.40	54.00	-11.60	AVG	
5 *	5497.6500	55.59	41.77	97.36	54.00	43.36	AVG	No Limit
6	5498.6000	63.91	41.78	105.69	68.20	37.49	Peak	No Limit

Orthogonal Axis :	X
Test Mode :	UNII-2C/ TX N20 Mode 5500MHz

Vertical

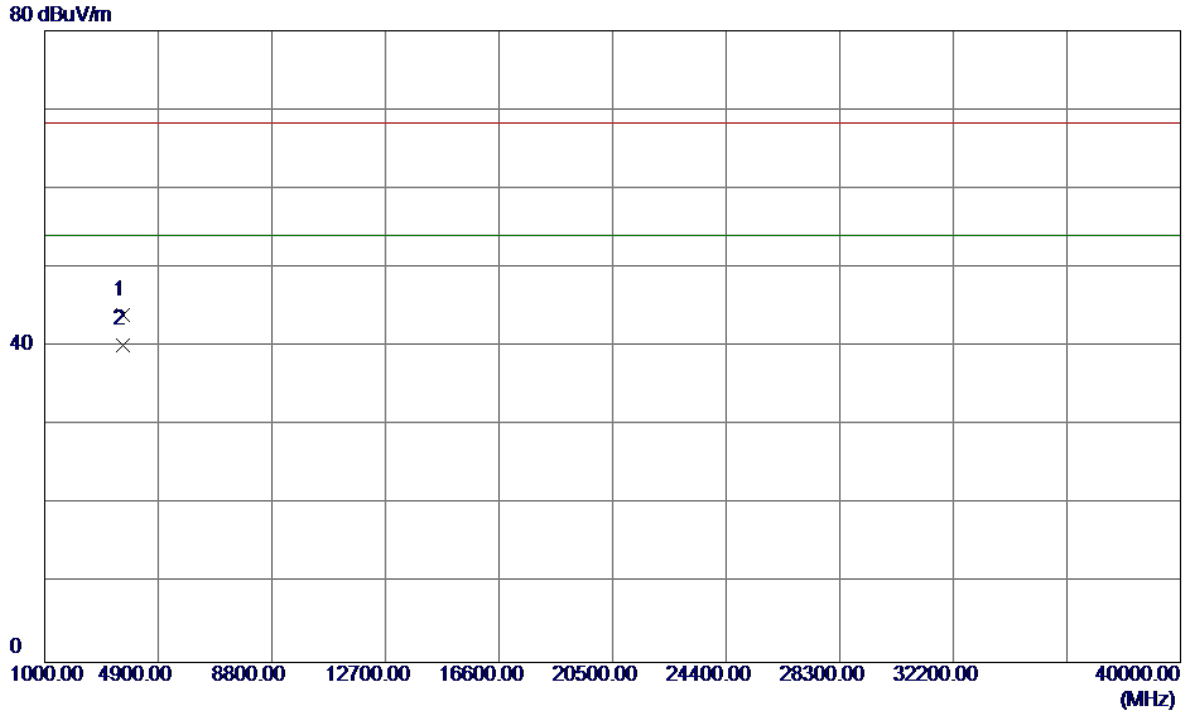

No.	Freq. MHz	Reading Level dBuV/m	Correct Factor dB	Measure ment dBuV/m	Limit dBuV/m	Margin dB	Detector	Comment
1	3666.5950	42.11	1.86	43.97	68.30	-24.33	Peak	
2 *	3666.6450	38.38	1.86	40.24	54.00	-13.76	AVG	

Orthogonal Axis :	X
Test Mode :	UNII-2C/ TX N20 Mode 5500MHz

Horizontal

115 dBuV/m

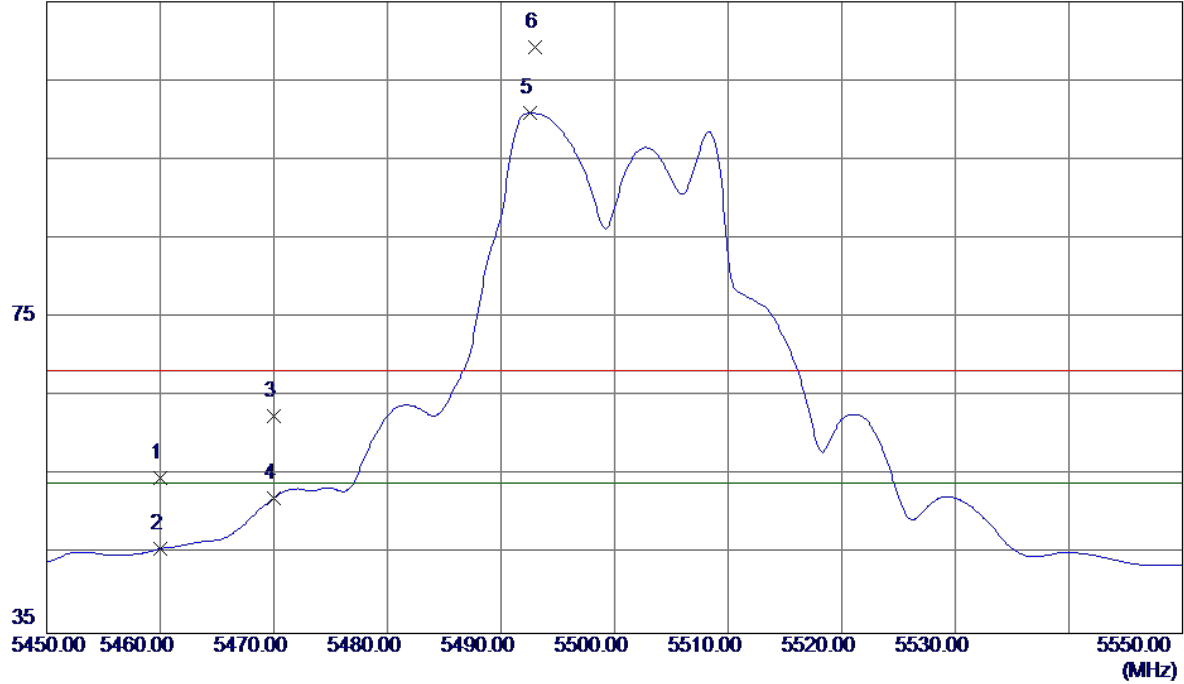

No.	Freq. MHz	Reading Level dBuV/m	Correct Factor dB	Measure ment dBuV/m	Limit dBuV/m	Margin dB	Detector	Comment
1	5460.0000	13.01	41.65	54.66	68.30	-13.64	Peak	
2	5460.0000	4.08	41.65	45.73	54.00	-8.27	AVG	
3	5470.0000	20.88	41.68	62.56	68.30	-5.74	Peak	
4	5470.0000	10.46	41.68	52.14	54.00	-1.86	AVG	
5 *	5492.6000	59.14	41.76	100.90	54.00	46.90	AVG	No Limit
6	5493.0000	67.55	41.76	109.31	68.30	41.01	Peak	No Limit

Orthogonal Axis :	X
Test Mode :	UNII-2C/ TX N20 Mode 5500MHz

Horizontal

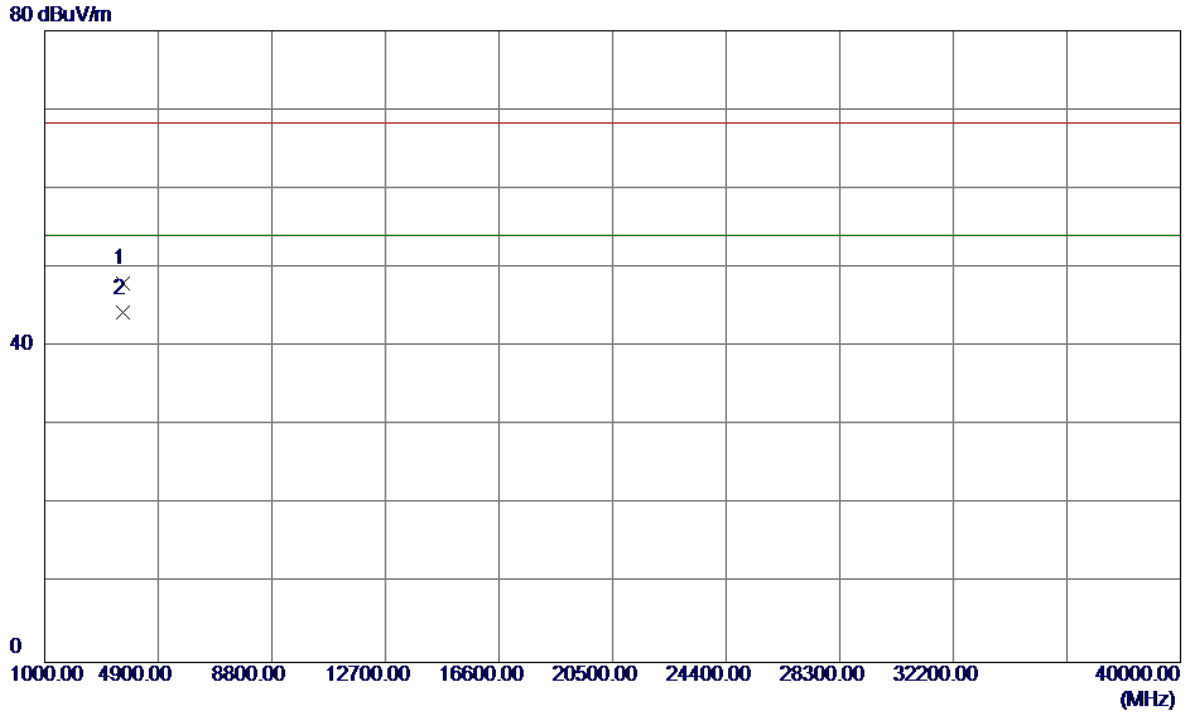

No.	Freq. MHz	Reading Level dBuV/m	Correct Factor dB	Measure ment dBuV/m	Limit dBuV/m	Margin dB	Detector	Comment
1	3666.5200	46.11	1.86	47.97	68.30	-20.33	Peak	
2 *	3666.6750	42.38	1.86	44.24	54.00	-9.76	AVG	

Orthogonal Axis :	X
Test Mode :	UNII-2C/ TX N20 Mode 5580MHz

Vertical

115 dBuV/m

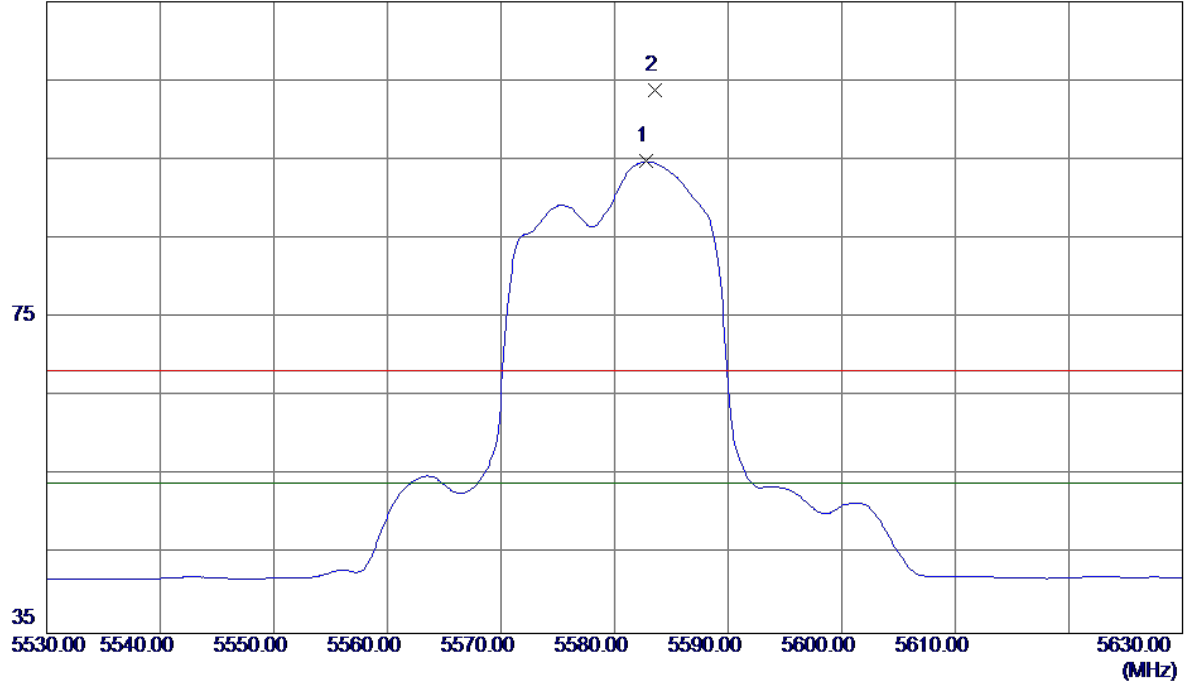

No.	Freq. MHz	Reading Level dBuV/m	Correct Factor dB	Measure ment dBuV/m	Limit dBuV/m	Margin dB	Detector	Comment
1 *	5582.8000	52.69	42.07	94.76	54.00	40.76	AVG	No Limit
2	5583.5500	61.66	42.08	103.74	68.20	35.54	Peak	No Limit

Orthogonal Axis :	X
Test Mode :	UNII-2C/ TX N20 Mode 5580MHz

Vertical

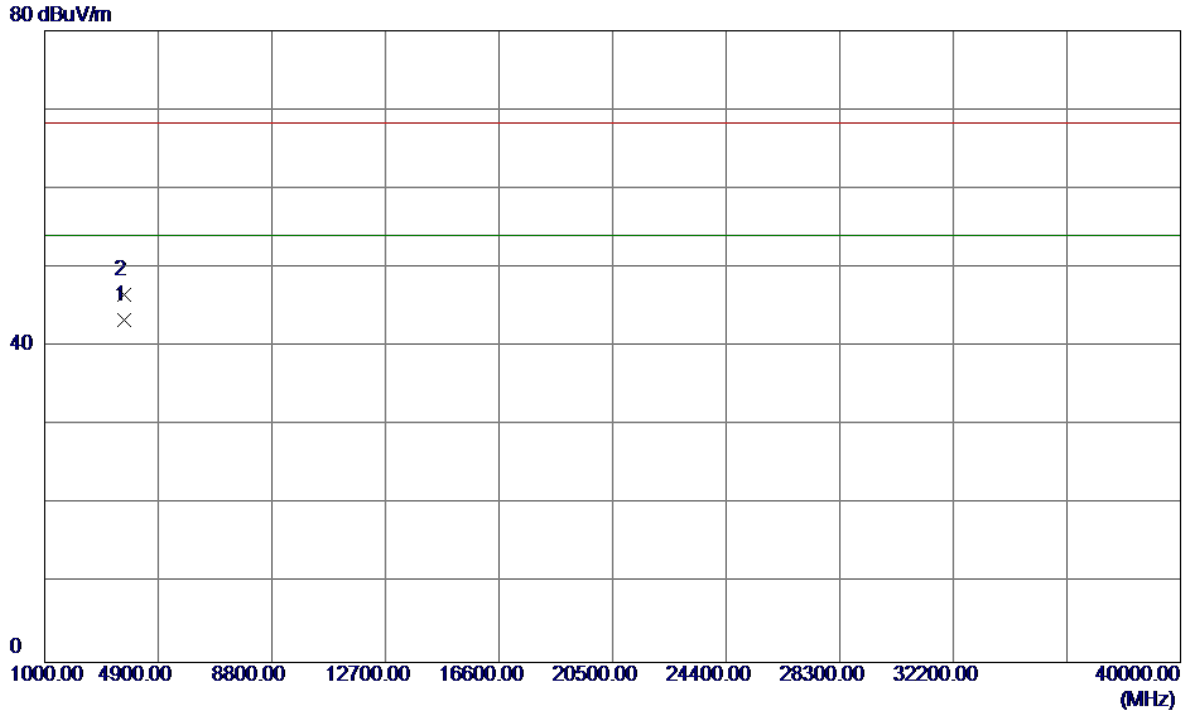

No.	Freq. MHz	Reading Level dBuV/m	Correct Factor dB	Measure ment dBuV/m	Limit dBuV/m	Margin dB	Detector	Comment
1 *	3719.9750	41.39	2.03	43.42	54.00	-10.58	AVG	
2	3719.9900	44.54	2.03	46.57	68.30	-21.73	Peak	

Orthogonal Axis :	X
Test Mode :	UNII-2C/ TX N20 Mode 5580MHz

Horizontal

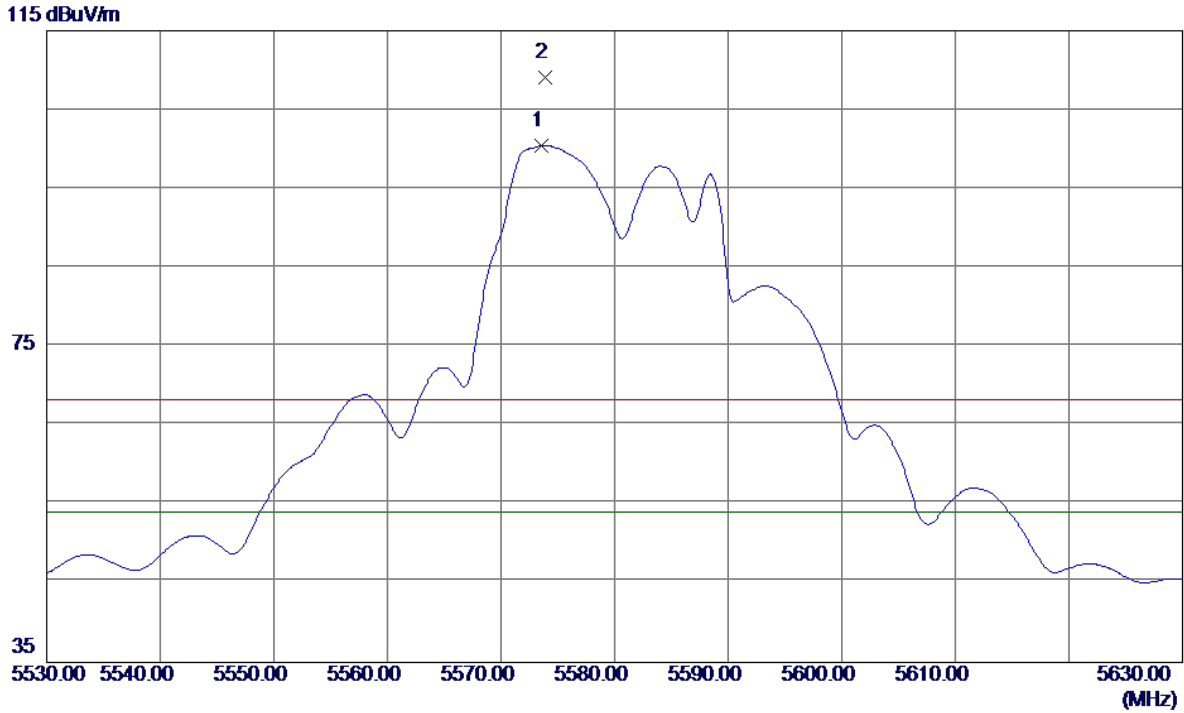

No.	Freq. MHz	Reading Level dBuV/m	Correct Factor dB	Measure ment dBuV/m	Limit dBuV/m	Margin dB	Detector	Comment
1 *	5573.6000	58.40	42.04	100.44	54.00	46.44	AVG	No Limit
2	5573.9000	66.98	42.04	109.02	68.30	40.72	Peak	No Limit

Orthogonal Axis :	X
Test Mode :	UNII-2C/ TX N20 Mode 5580MHz

Horizontal

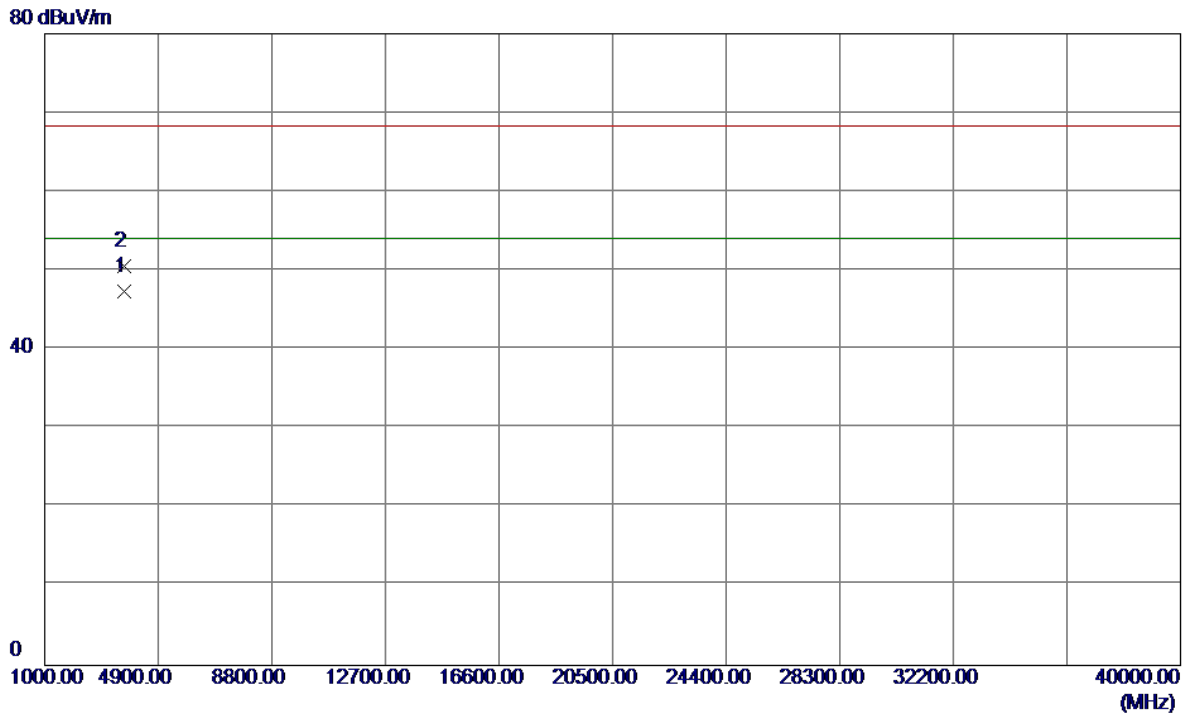

No.	Freq. MHz	Reading Level dBuV/m	Correct Factor dB	Measure ment dBuV/m	Limit dBuV/m	Margin dB	Detector	Comment
1 *	3719.9350	45.39	2.03	47.42	54.00	-6.58	AVG	
2	3719.9600	48.54	2.03	50.57	68.30	-17.73	Peak	

Orthogonal Axis :	X
Test Mode :	UNII-2C/ TX N20 Mode 5700MHz

Vertical

115 dBuV/m

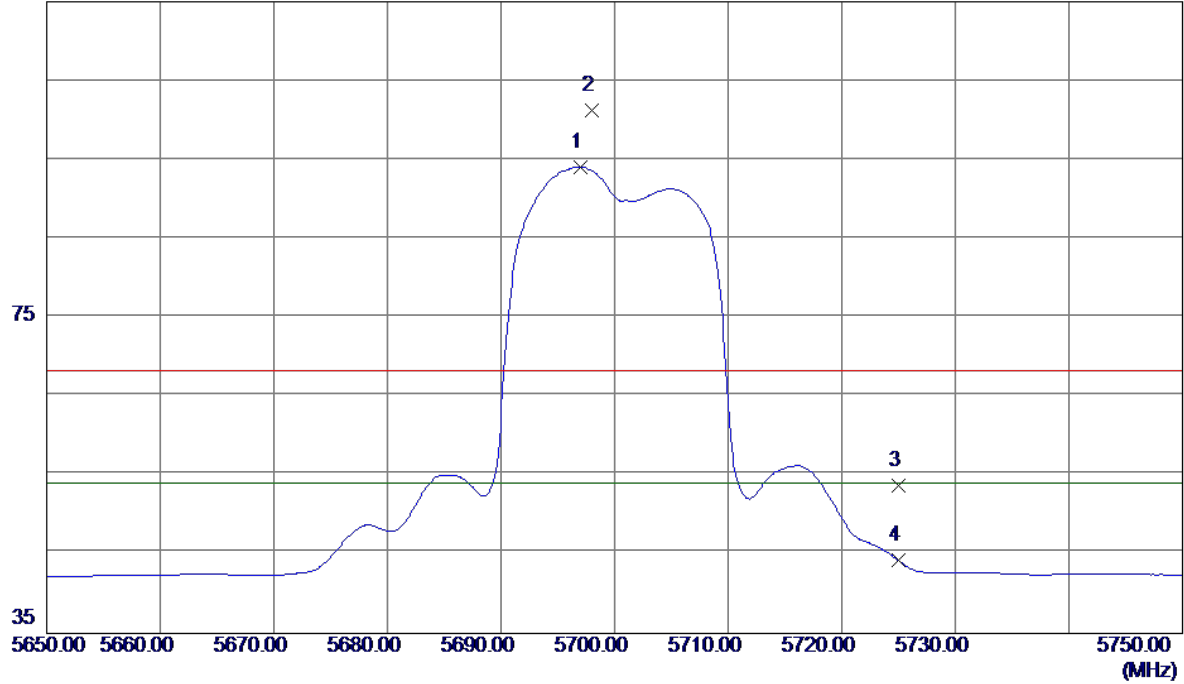

No.	Freq. MHz	Reading Level dBuV/m	Correct Factor dB	Measure ment dBuV/m	Limit dBuV/m	Margin dB	Detector	Comment
1 *	5697.0500	51.58	42.48	94.06	54.00	40.06	AVG	No Limit
2	5698.0000	58.69	42.48	101.17	68.20	32.97	Peak	No Limit
3	5725.0000	11.17	42.58	53.75	68.20	-14.45	Peak	
4	5725.0000	1.66	42.58	44.24	54.00	-9.76	AVG	

Orthogonal Axis :	X
Test Mode :	UNII-2C/ TX N20 Mode 5700MHz

Vertical

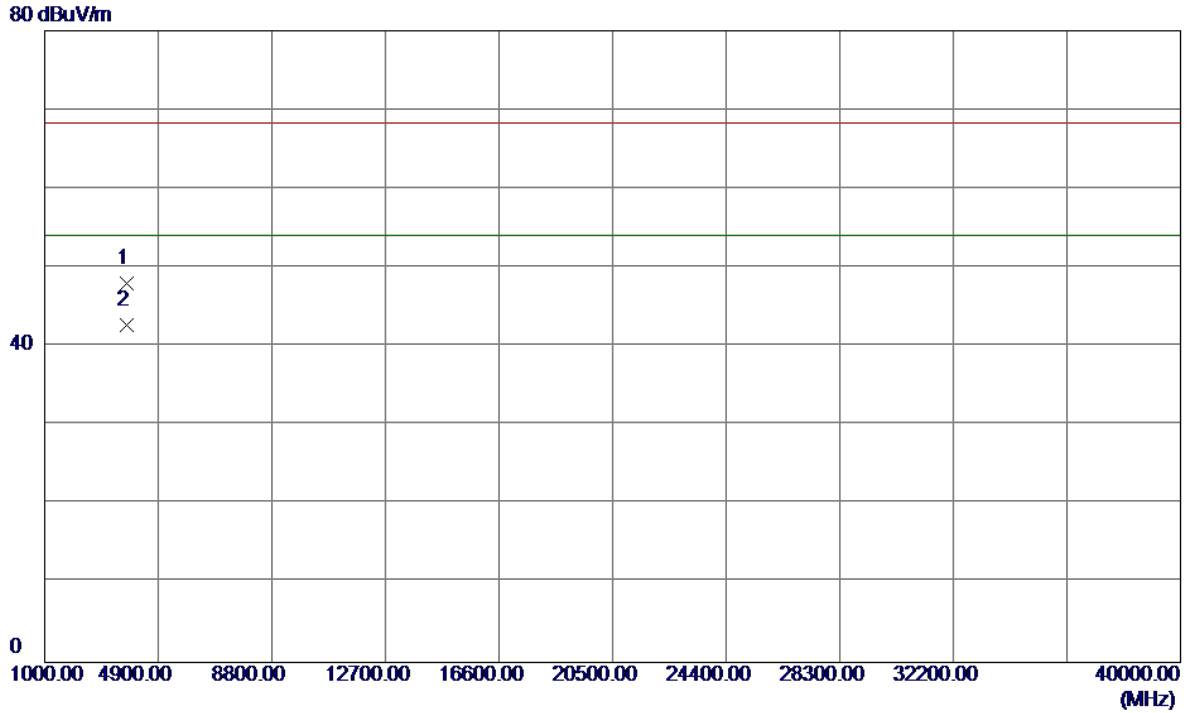

No.	Freq. MHz	Reading Level dBuV/m	Correct Factor dB	Measure ment dBuV/m	Limit dBuV/m	Margin dB	Detector	Comment
1	3799.9100	45.69	2.30	47.99	68.30	-20.31	Peak	
2 *	3799.9650	40.40	2.30	42.70	54.00	-11.30	AVG	

Orthogonal Axis :	X
Test Mode :	UNII-2C/ TX N20 Mode 5700MHz

Horizontal

115 dBuV/m

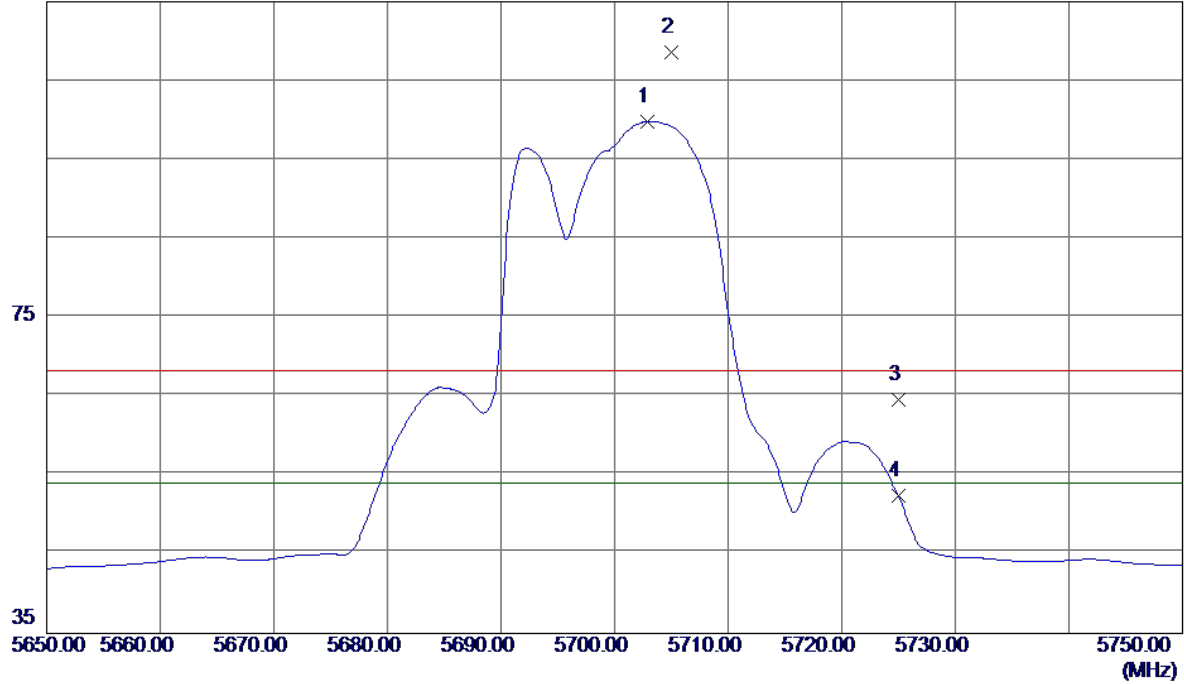

No.	Freq. MHz	Reading Level dBuV/m	Correct Factor dB	Measure ment dBuV/m	Limit dBuV/m	Margin dB	Detector	Comment
1 *	5702.9000	57.35	42.50	99.85	54.00	45.85	AVG	No Limit
2	5705.0000	66.14	42.51	108.65	68.30	40.35	Peak	No Limit
3	5725.0000	22.08	42.58	64.66	68.30	-3.64	Peak	
4	5725.0000	9.81	42.58	52.39	54.00	-1.61	AVG	

Orthogonal Axis :	X
Test Mode :	UNII-2C/ TX N20 Mode 5700MHz

Horizontal

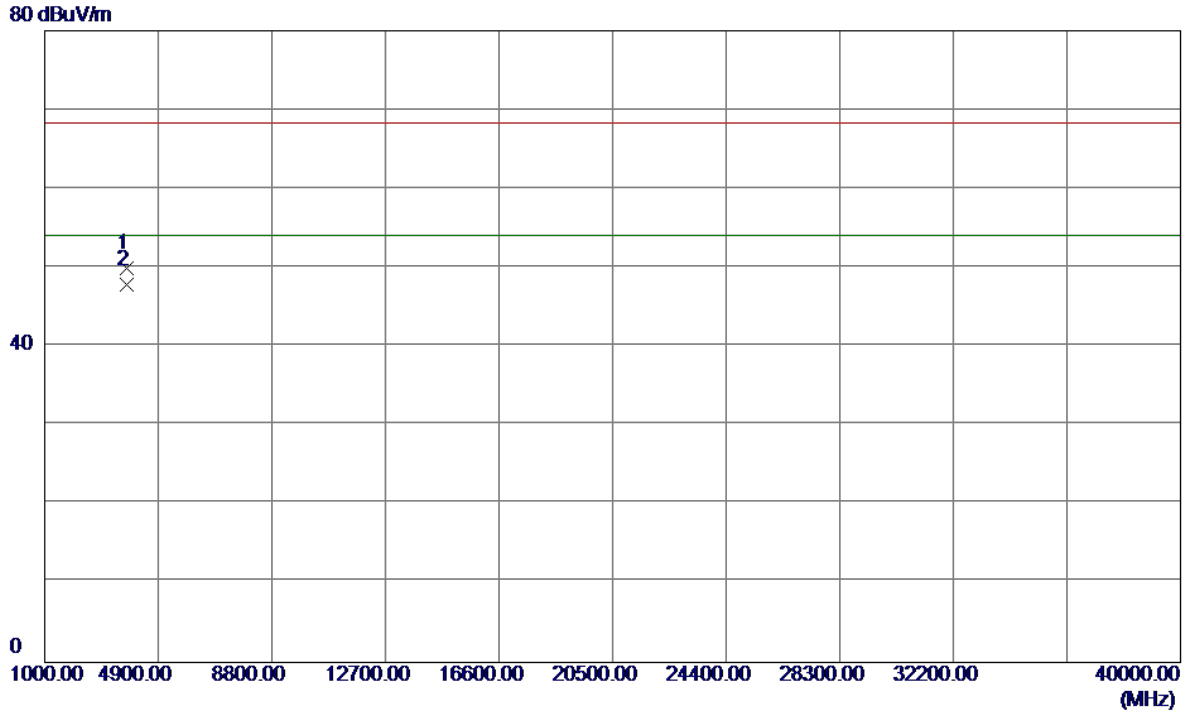

No.	Freq. MHz	Reading Level dBuV/m	Correct Factor dB	Measure ment dBuV/m	Limit dBuV/m	Margin dB	Detector	Comment
1	3799.9250	47.69	2.30	49.99	68.30	-18.31	Peak	
2 *	3799.9850	45.48	2.30	47.78	54.00	-6.22	AVG	

Orthogonal Axis :	X
Test Mode :	UNII-2C/ TX N40 Mode 5510MHz

Vertical

115 dBuV/m

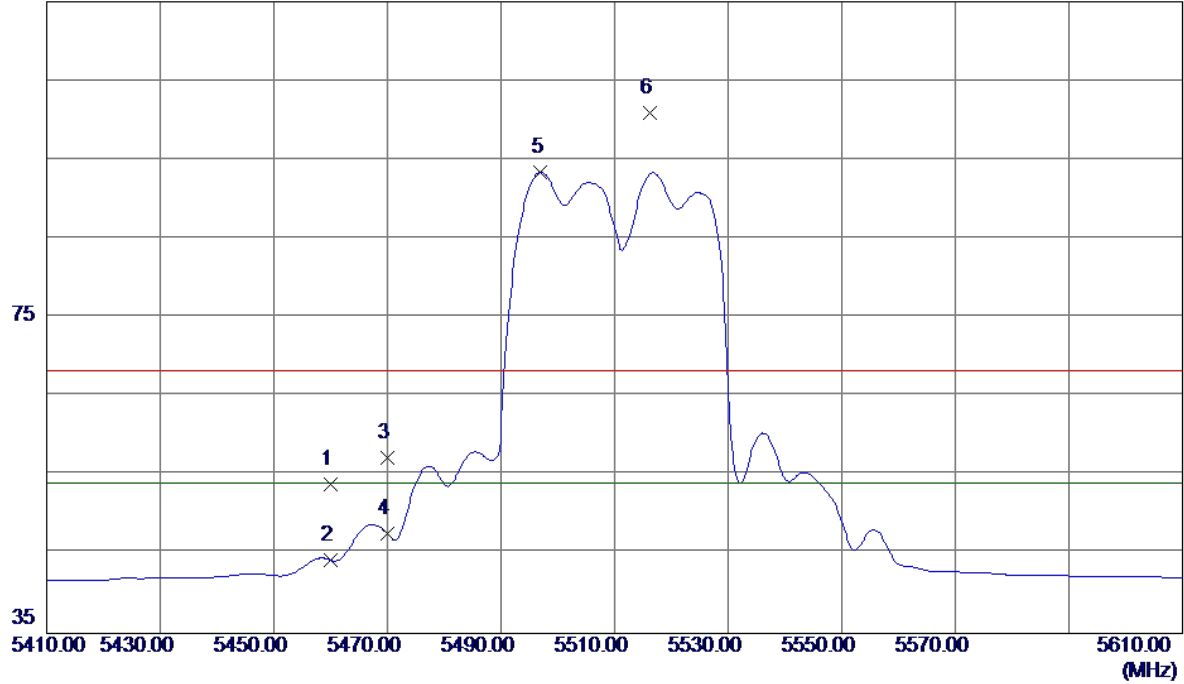

No.	Freq. MHz	Reading Level dBuV/m	Correct Factor dB	Measure ment dBuV/m	Limit dBuV/m	Margin dB	Detector	Comment
1	5460.0000	12.29	41.65	53.94	68.20	-14.26	Peak	
2	5460.0000	2.63	41.65	44.28	54.00	-9.72	AVG	
3	5470.0000	15.50	41.68	57.18	68.20	-11.02	Peak	
4	5470.0000	5.92	41.68	47.60	54.00	-6.40	AVG	
5 *	5497.0000	51.66	41.77	93.43	54.00	39.43	AVG	No Limit
6	5516.2000	59.07	41.84	100.91	68.20	32.71	Peak	No Limit

Orthogonal Axis :	X
Test Mode :	UNII-2C/ TX N40 Mode 5510MHz

Vertical

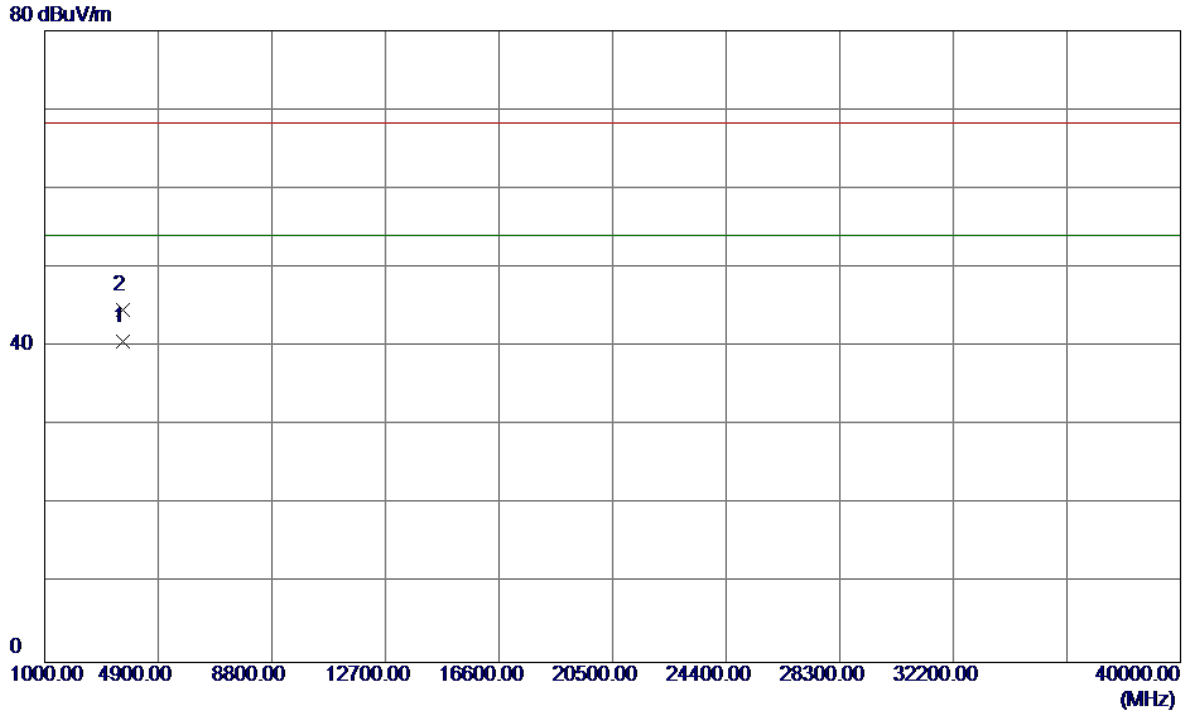

No.	Freq. MHz	Reading Level dBuV/m	Correct Factor dB	Measure ment dBuV/m	Limit dBuV/m	Margin dB	Detector	Comment
1 *	3673.3050	38.70	1.88	40.58	54.00	-13.42	AVG	
2	3673.4600	42.74	1.88	44.62	68.30	-23.68	Peak	

Orthogonal Axis :	X
Test Mode :	UNII-2C/ TX N40 Mode 5510MHz

Horizontal

115 dBuV/m

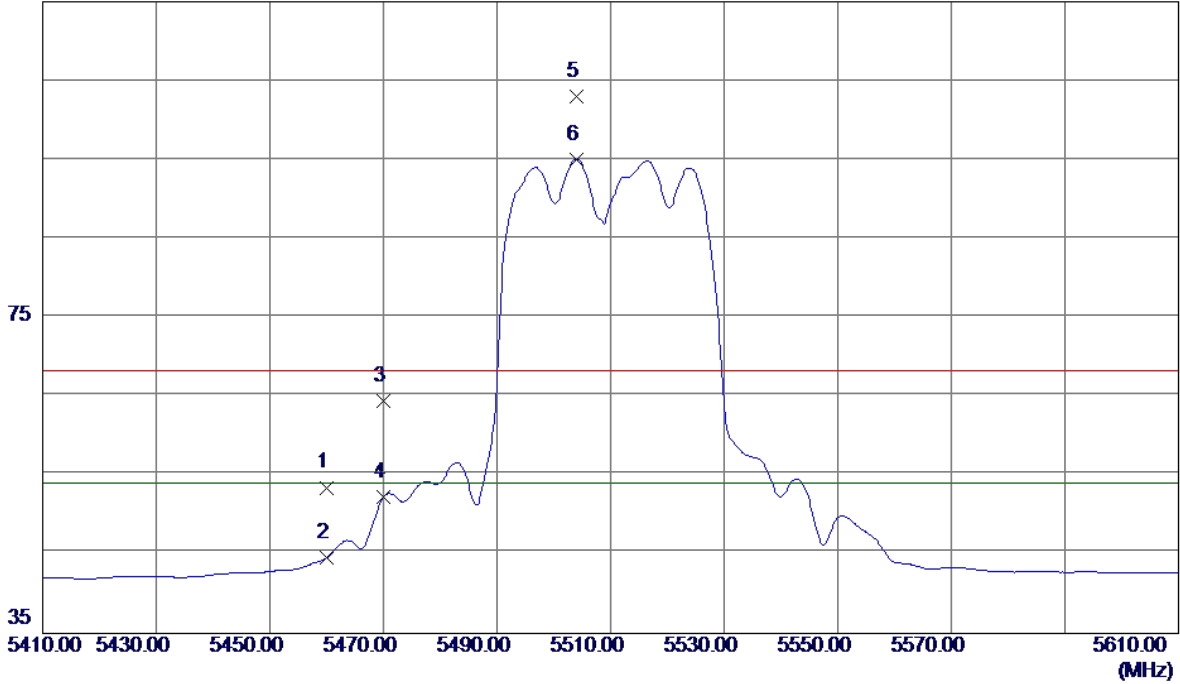

No.	Freq. MHz	Reading Level dBuV/m	Correct Factor dB	Measure ment dBuV/m	Limit dBuV/m	Margin dB	Detector	Comment
1	5460.0000	11.83	41.65	53.48	68.30	-14.82	Peak	
2	5460.0000	2.89	41.65	44.54	54.00	-9.46	AVG	
3	5470.0000	22.71	41.68	64.39	68.30	-3.91	Peak	
4	5470.0000	10.60	41.68	52.28	54.00	-1.72	AVG	
5	5504.0000	61.27	41.79	103.06	68.30	34.76	Peak	No Limit
6 *	5504.0000	53.21	41.79	95.00	54.00	41.00	AVG	No Limit

Orthogonal Axis :	X
Test Mode :	UNII-2C/ TX N40 Mode 5510MHz

Horizontal

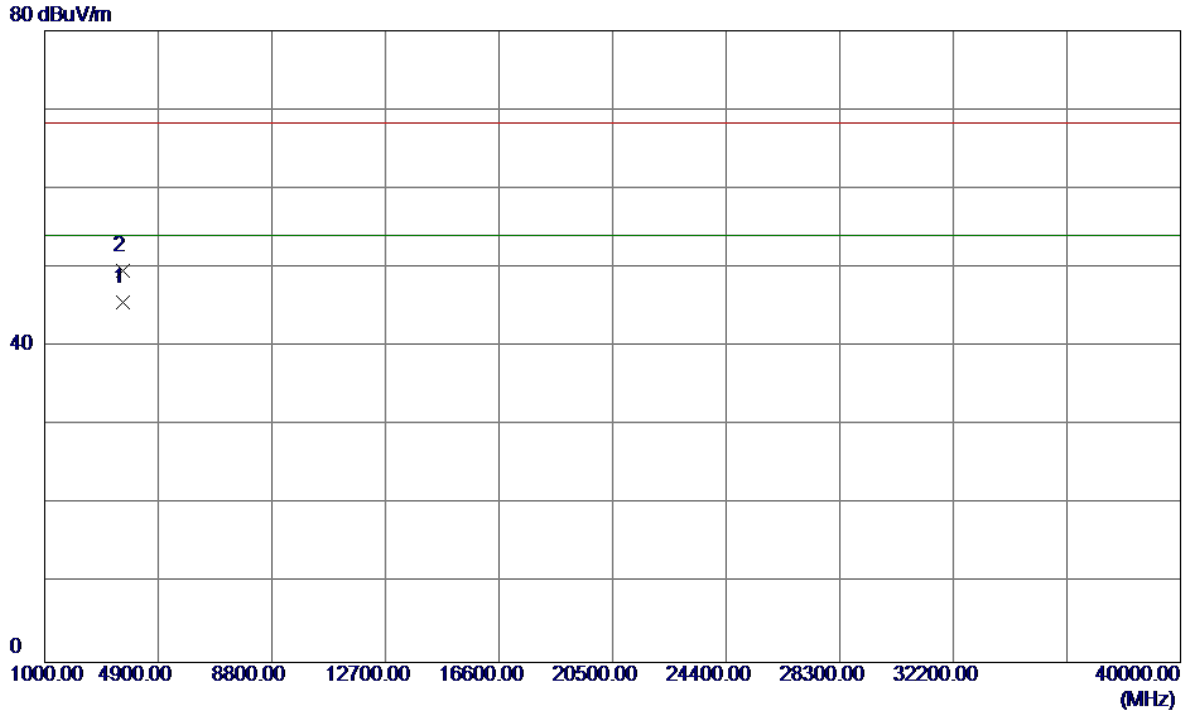

No.	Freq. MHz	Reading Level dBuV/m	Correct Factor dB	Measure ment dBuV/m	Limit dBuV/m	Margin dB	Detector	Comment
1 *	3673.4600	43.70	1.88	45.58	54.00	-8.42	AVG	
2	3673.4250	47.74	1.88	49.62	68.30	-18.68	Peak	

Orthogonal Axis :	X
Test Mode :	UNII-2C/ TX N40 Mode 5550MHz

Vertical

115 dBuV/m

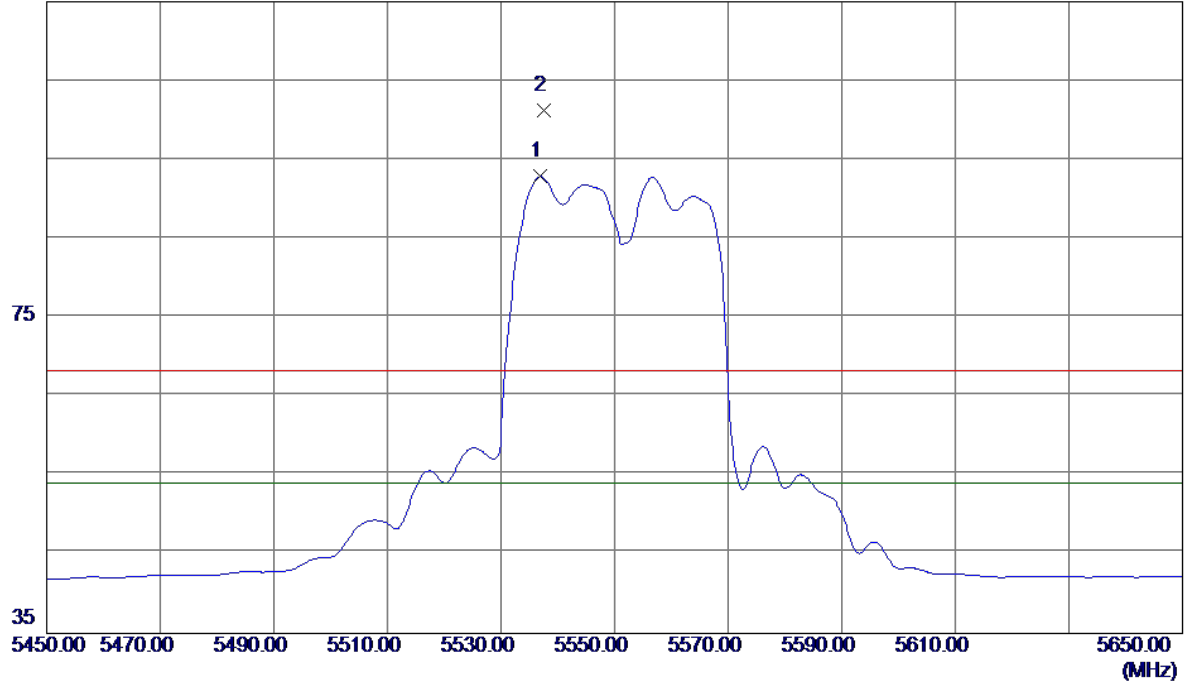

No.	Freq. MHz	Reading Level dBuV/m	Correct Factor dB	Measure ment dBuV/m	Limit dBuV/m	Margin dB	Detector	Comment
1 *	5536.9000	50.94	41.91	92.85	54.00	38.85	AVG	No Limit
2	5537.6000	59.36	41.91	101.27	68.20	33.07	Peak	No Limit

Orthogonal Axis :	X
Test Mode :	UNII-2C/ TX N40 Mode 5550MHz

Vertical

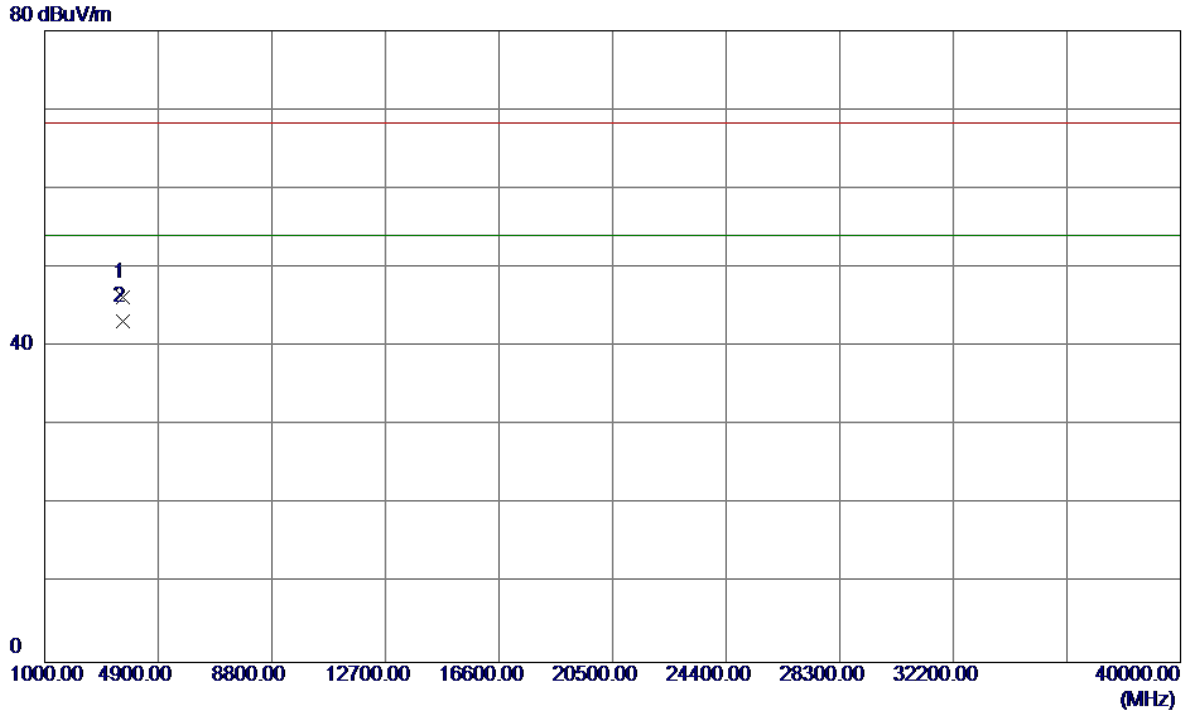

No.	Freq. MHz	Reading Level dBuV/m	Correct Factor dB	Measure ment dBuV/m	Limit dBuV/m	Margin dB	Detector	Comment
1	3699.9250	44.21	1.97	46.18	68.30	-22.12	Peak	
2 *	3699.9700	41.17	1.97	43.14	54.00	-10.86	AVG	

Orthogonal Axis :	X
Test Mode :	UNII-2C/ TX N40 Mode 5550MHz

Horizontal

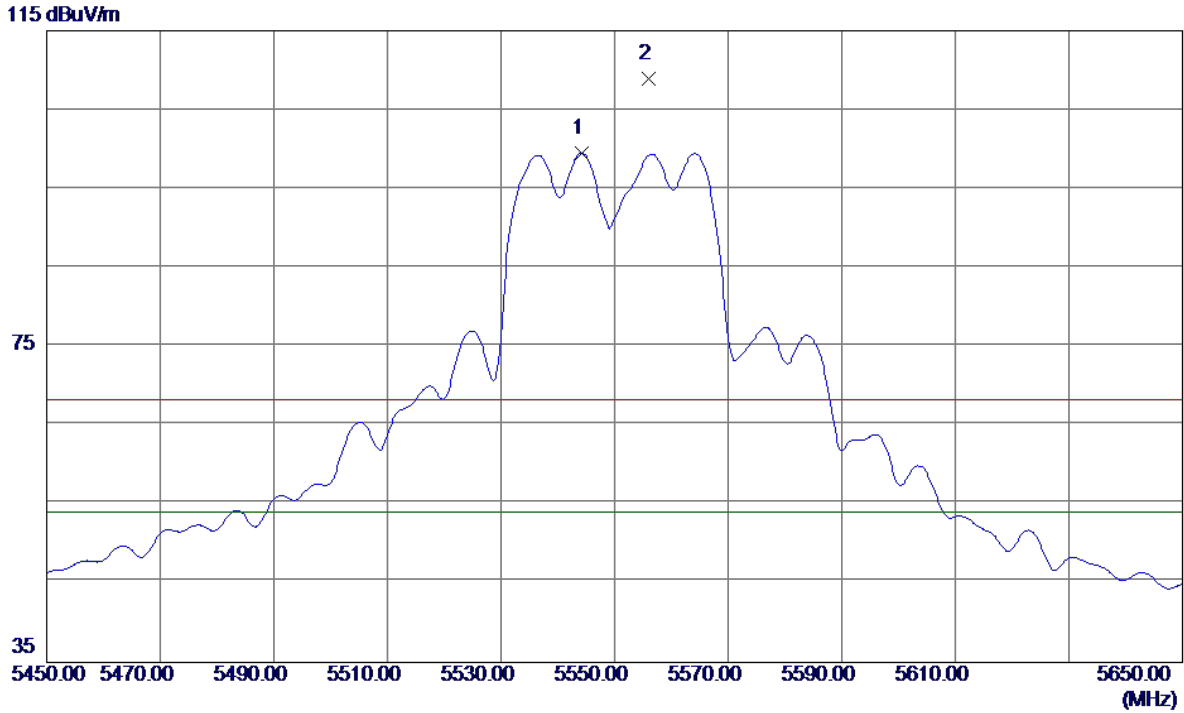

No.	Freq. MHz	Reading Level dBuV/m	Correct Factor dB	Measure ment dBuV/m	Limit dBuV/m	Margin dB	Detector	Comment
1 *	5544.2000	57.54	41.94	99.48	54.00	45.48	AVG	No Limit
2	5556.0000	66.87	41.98	108.85	68.30	40.55	Peak	No Limit

Orthogonal Axis :	X
Test Mode :	UNII-2C/ TX N40 Mode 5550MHz

Horizontal

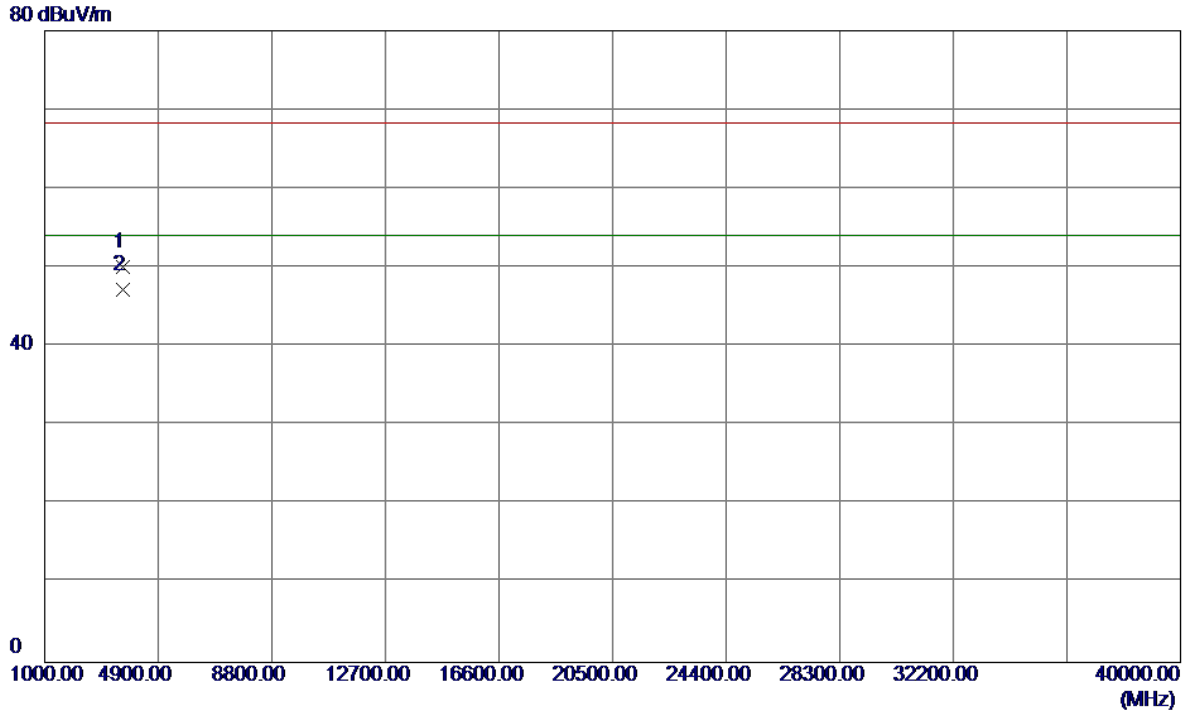

No.	Freq. MHz	Reading Level dBuV/m	Correct Factor dB	Measure ment dBuV/m	Limit dBuV/m	Margin dB	Detector	Comment
1	3699.9100	48.16	1.97	50.13	68.30	-18.17	Peak	
2 *	3699.9450	45.23	1.97	47.20	54.00	-6.80	AVG	

Orthogonal Axis :	X
Test Mode :	UNII-2C/ TX N40 Mode 5670MHz

Vertical

115 dBuV/m

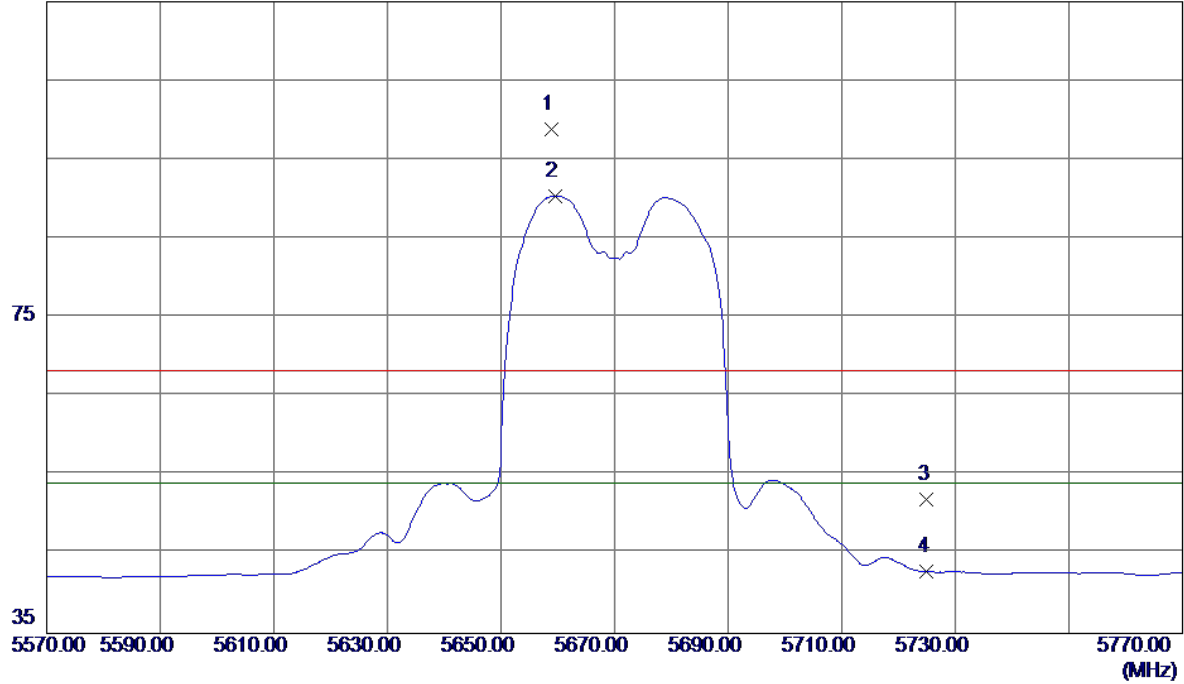

No.	Freq. MHz	Reading Level dBuV/m	Correct Factor dB	Measure ment dBuV/m	Limit dBuV/m	Margin dB	Detector	Comment
1	5658.8000	56.53	42.35	98.88	68.20	30.68	Peak	No Limit
2 *	5659.6000	48.03	42.35	90.38	54.00	36.38	AVG	No Limit
3	5725.0000	9.37	42.58	51.95	68.20	-16.25	Peak	
4	5725.0000	0.21	42.58	42.79	54.00	-11.21	AVG	

Orthogonal Axis :	X
Test Mode :	UNII-2C/ TX N40 Mode 5670MHz

Vertical

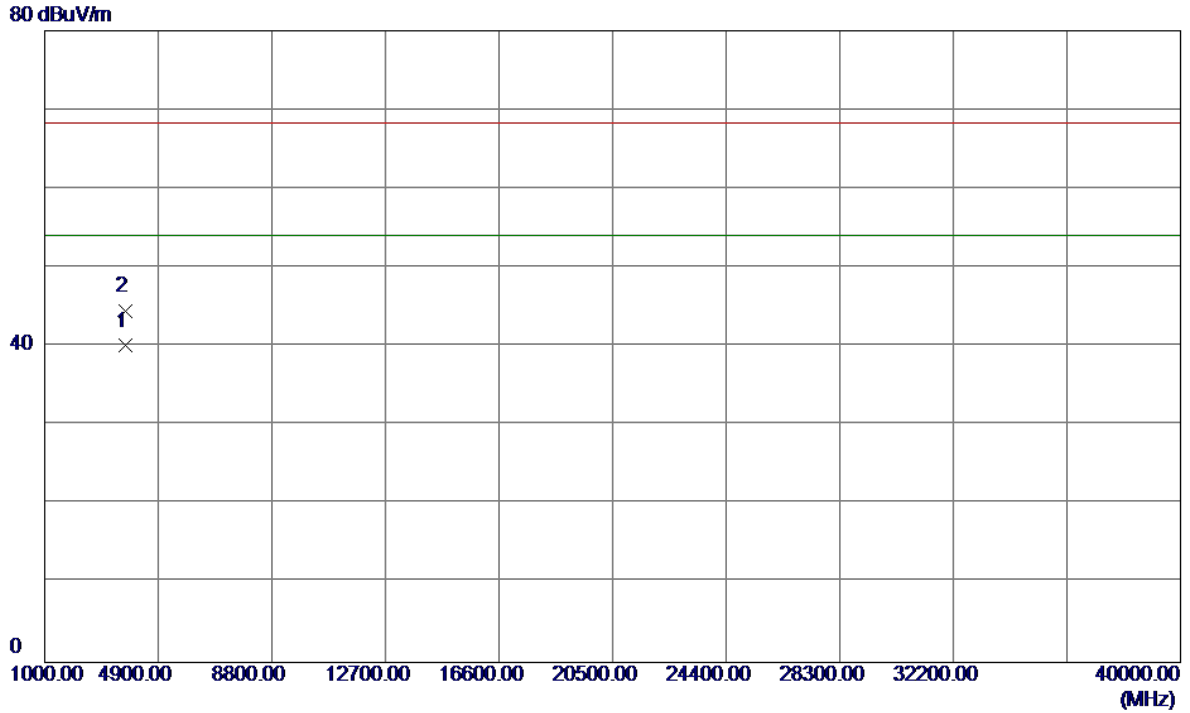

No.	Freq. MHz	Reading Level dBuV/m	Correct Factor dB	Measure ment dBuV/m	Limit dBuV/m	Margin dB	Detector	Comment
1 *	3779.9700	37.85	2.23	40.08	54.00	-13.92	AVG	
2	3779.9800	42.18	2.23	44.41	68.30	-23.89	Peak	

Orthogonal Axis :	X
Test Mode :	UNII-2C/ TX N40 Mode 5670MHz

Horizontal

115 dBuV/m

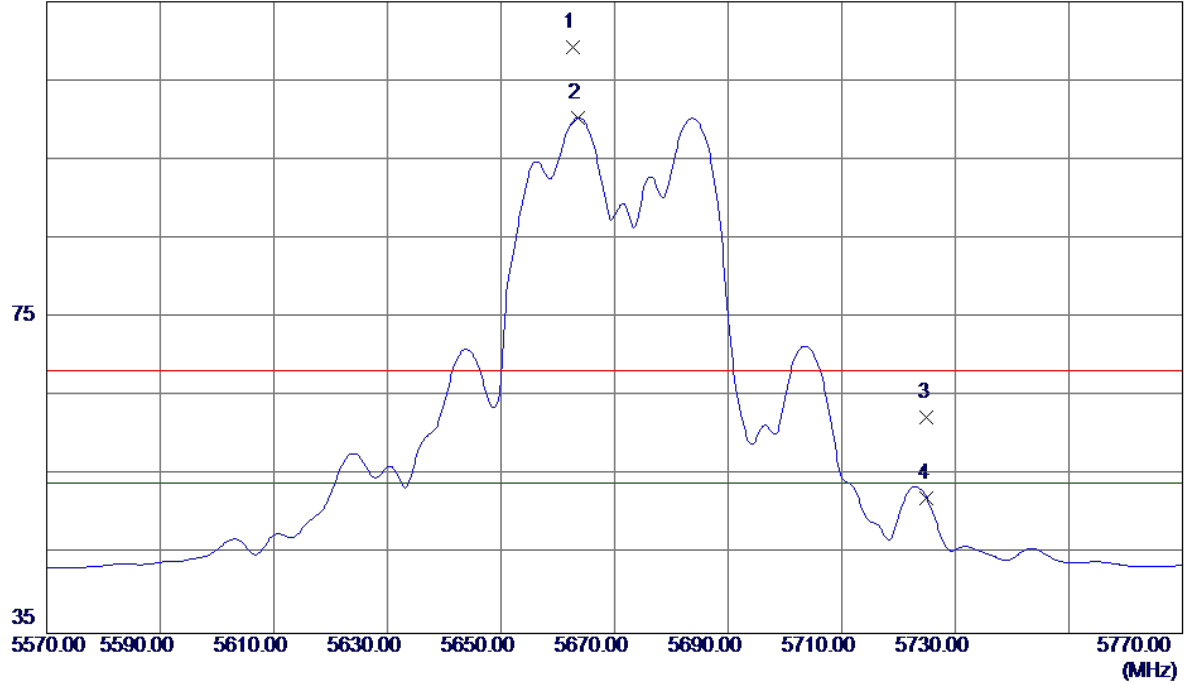

No.	Freq. MHz	Reading Level dBuV/m	Correct Factor dB	Measure ment dBuV/m	Limit dBuV/m	Margin dB	Detector	Comment
1	5662.6000	66.88	42.36	109.24	68.30	40.94	Peak	No Limit
2 *	5663.6000	57.96	42.36	100.32	54.00	46.32	AVG	No Limit
3	5725.0000	19.72	42.58	62.30	68.30	-6.00	Peak	
4	5725.0000	9.54	42.58	52.12	54.00	-1.88	AVG	

Orthogonal Axis :	X
Test Mode :	UNII-2C/ TX N40 Mode 5670MHz

Horizontal

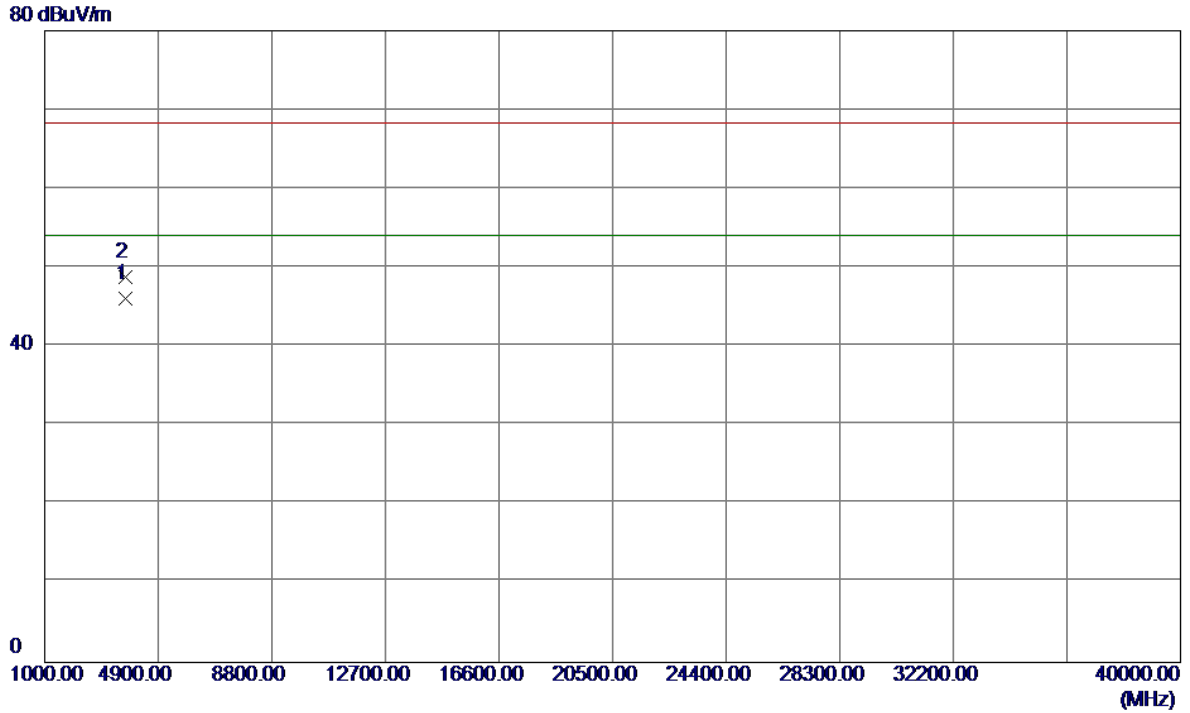

No.	Freq. MHz	Reading Level dBuV/m	Correct Factor dB	Measure ment dBuV/m	Limit dBuV/m	Margin dB	Detector	Comment
1 *	3779.8400	43.85	2.23	46.08	54.00	-7.92	AVG	
2	3779.9200	46.58	2.23	48.81	68.30	-19.49	Peak	

Orthogonal Axis :	X
Test Mode :	UNII-2A/ TX AC Wave2(20 MHz) Mode 5260MHz

Vertical

115 dBuV/m

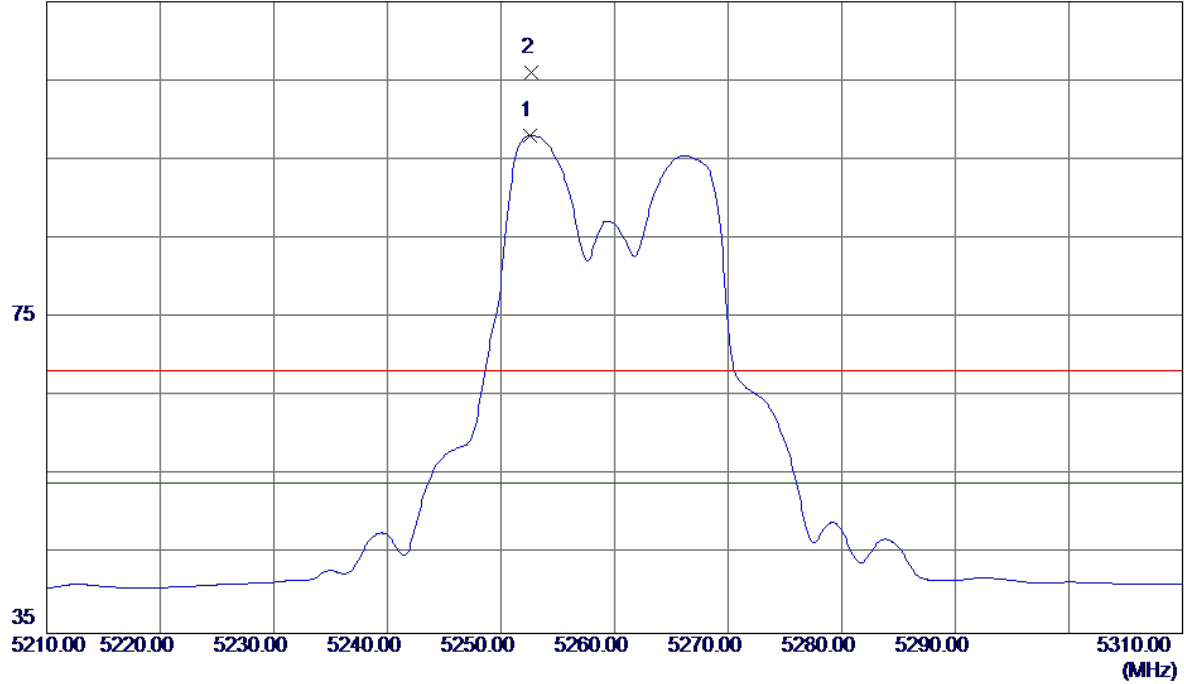

No.	Freq. MHz	Reading Level dBuV/m	Correct Factor dB	Measure ment dBuV/m	Limit dBuV/m	Margin dB	Detector	Comment
1 *	5252.6000	57.10	40.96	98.06	54.00	44.06	AVG	No Limit
2	5252.7000	65.08	40.96	106.04	68.20	37.84	Peak	No Limit

Orthogonal Axis :	X
Test Mode :	UNII-2A/ TX AC Wave2(20 MHz) Mode 5260MHz

Vertical

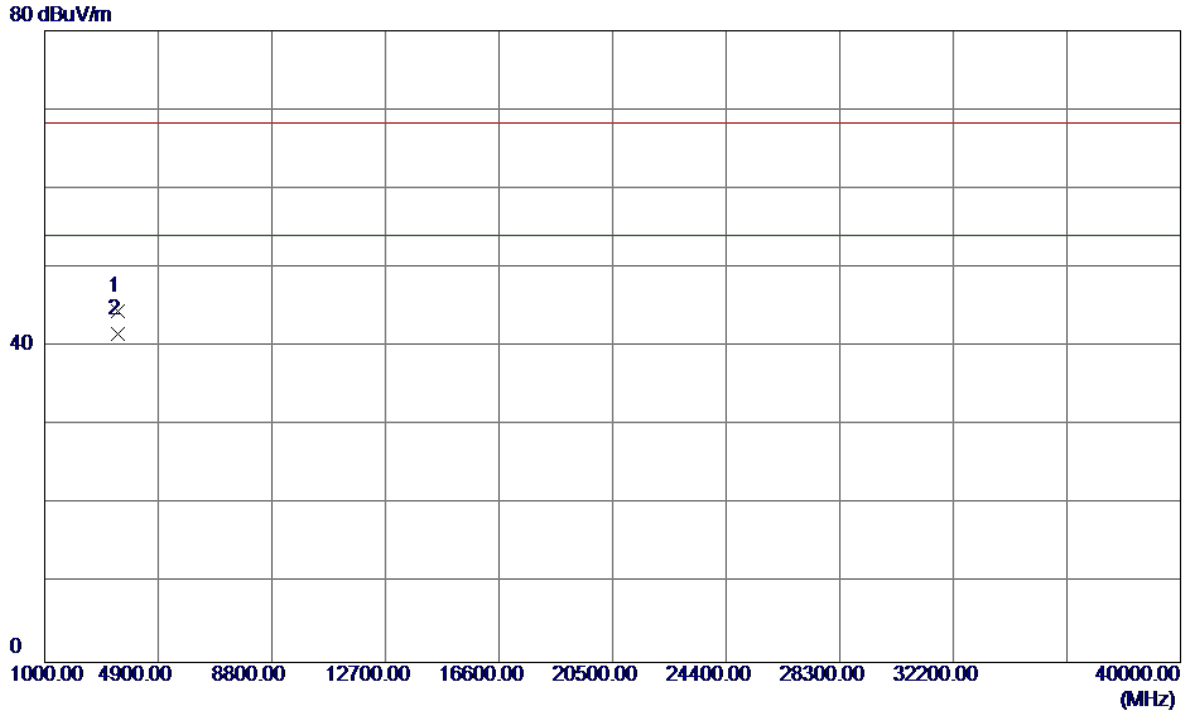

No.	Freq. MHz	Reading Level dBuV/m	Correct Factor dB	Measure ment dBuV/m	Limit dBuV/m	Margin dB	Detector	Comment
1	3506.6150	43.21	1.34	44.55	68.30	-23.75	Peak	
2 *	3506.6450	40.25	1.34	41.59	54.00	-12.41	AVG	

Orthogonal Axis :	X
Test Mode :	UNII-2A/ TX AC Wave2(20 MHz) Mode 5260MHz

Horizontal

115 dBuV/m

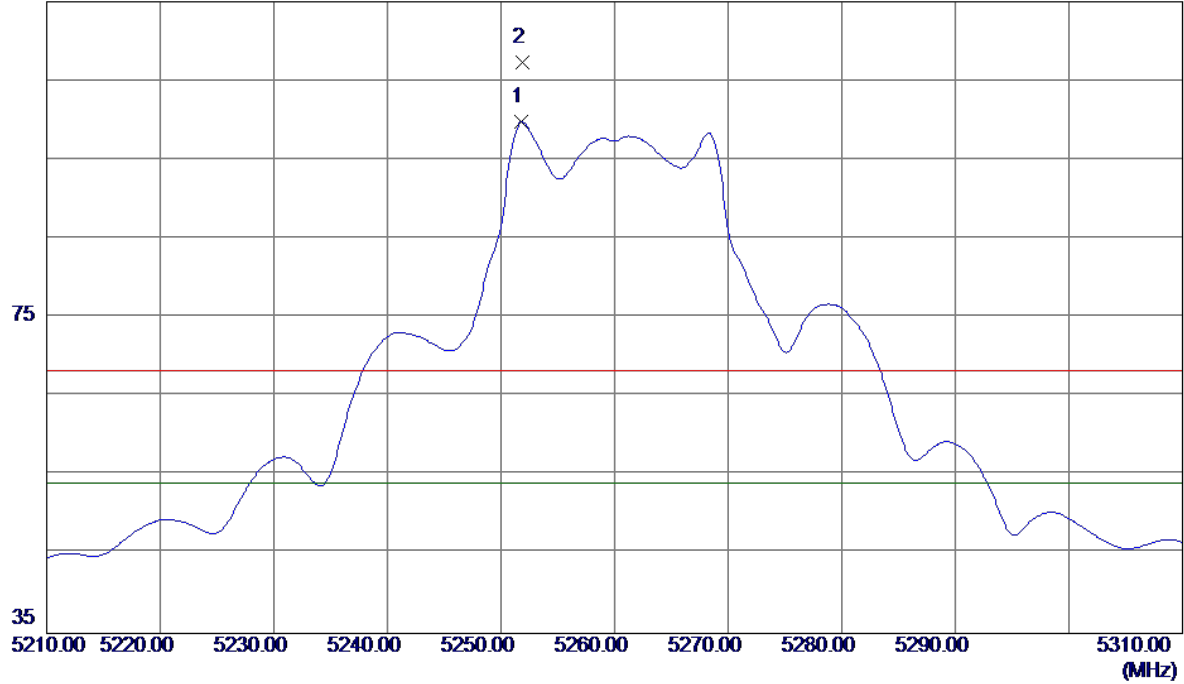

No.	Freq. MHz	Reading Level dBuV/m	Correct Factor dB	Measure ment dBuV/m	Limit dBuV/m	Margin dB	Detector	Comment
1 *	5251.8000	58.80	40.96	99.76	54.00	45.76	AVG	No Limit
2	5251.9000	66.39	40.96	107.35	68.30	39.05	Peak	No Limit

Orthogonal Axis :	X
Test Mode :	UNII-2A/ TX AC Wave2(20 MHz) Mode 5260MHz

Horizontal

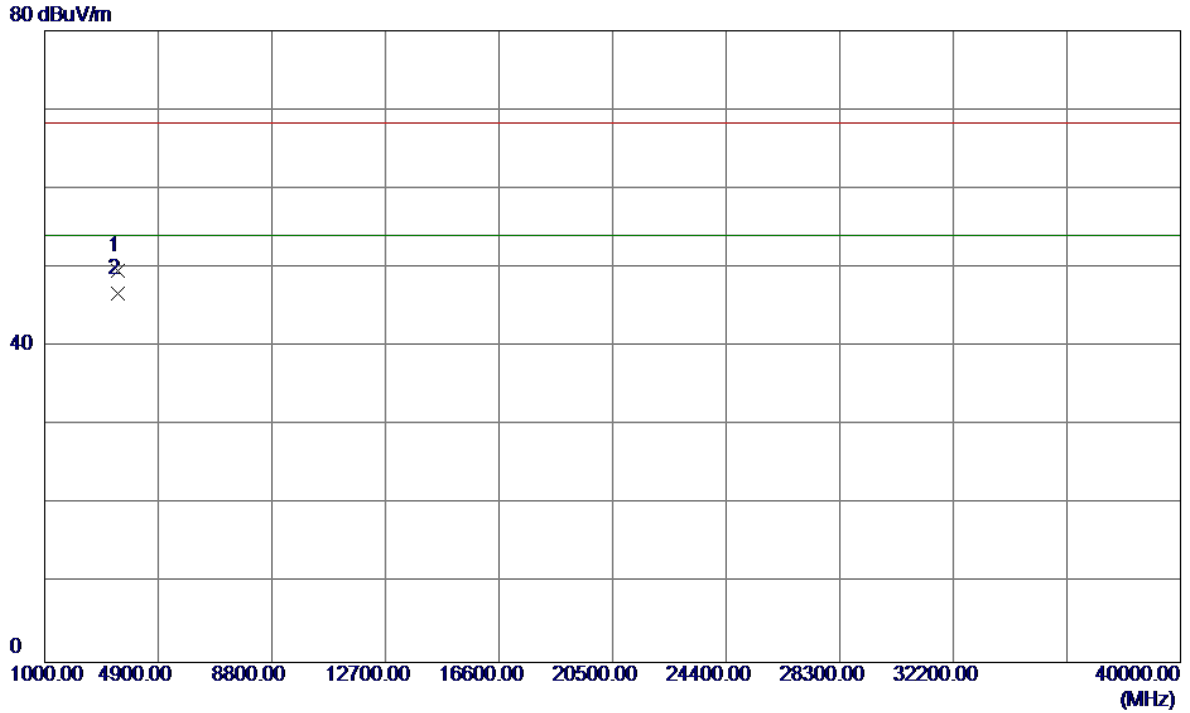

No.	Freq. MHz	Reading Level dBuV/m	Correct Factor dB	Measure ment dBuV/m	Limit dBuV/m	Margin dB	Detector	Comment
1	3506.6450	48.23	1.34	49.57	68.30	-18.73	Peak	
2 *	3506.6700	45.36	1.34	46.70	54.00	-7.30	AVG	

Orthogonal Axis :	X
Test Mode :	UNII-2A/ TX AC Wave2(20 MHz) Mode 5300MHz

Vertical

115 dBuV/m

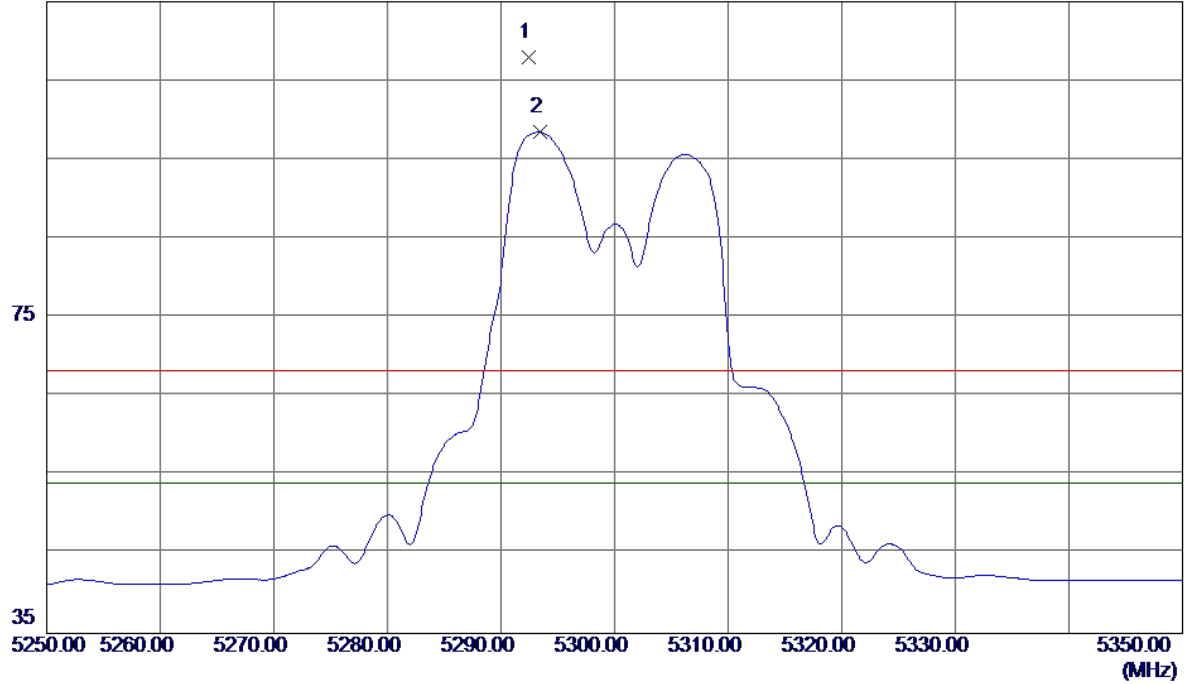

No.	Freq. MHz	Reading Level dBuV/m	Correct Factor dB	Measure ment dBuV/m	Limit dBuV/m	Margin dB	Detector	Comment
1	5292.4500	66.80	41.09	107.89	68.20	39.69	Peak	No Limit
2 *	5293.4000	57.42	41.10	98.52	54.00	44.52	AVG	No Limit

Orthogonal Axis :	X
Test Mode :	UNII-2A/ TX AC Wave2(20 MHz) Mode 5300MHz

Vertical

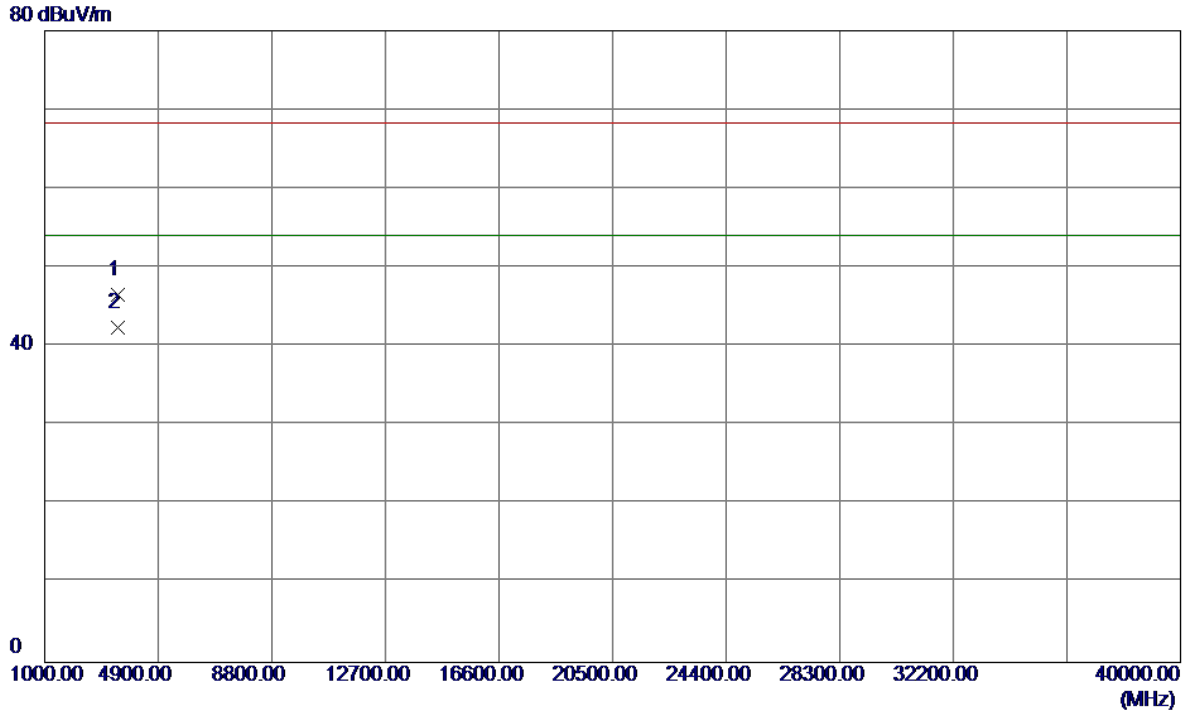

No.	Freq. MHz	Reading Level dBuV/m	Correct Factor dB	Measure ment dBuV/m	Limit dBuV/m	Margin dB	Detector	Comment
1	3533.2250	45.08	1.42	46.50	68.30	-21.80	Peak	
2 *	3533.3100	41.00	1.42	42.42	54.00	-11.58	AVG	

Orthogonal Axis :	X
Test Mode :	UNII-2A/ TX AC Wave2(20 MHz) Mode 5300MHz

Horizontal

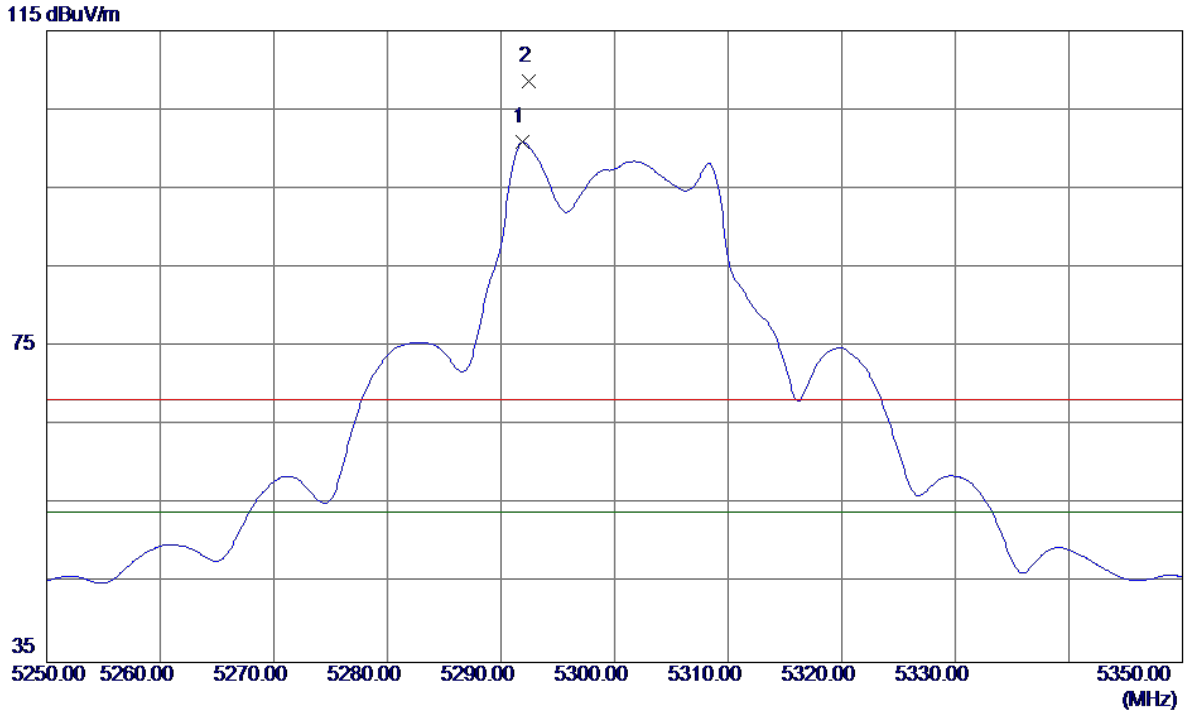

No.	Freq. MHz	Reading Level dBuV/m	Correct Factor dB	Measure ment dBuV/m	Limit dBuV/m	Margin dB	Detector	Comment
1 *	5291.9000	59.76	41.09	100.85	54.00	46.85	AVG	No Limit
2	5292.4000	67.53	41.09	108.62	68.30	40.32	Peak	No Limit

Orthogonal Axis :	X
Test Mode :	UNII-2A/ TX AC Wave2(20 MHz) Mode 5300MHz

Horizontal

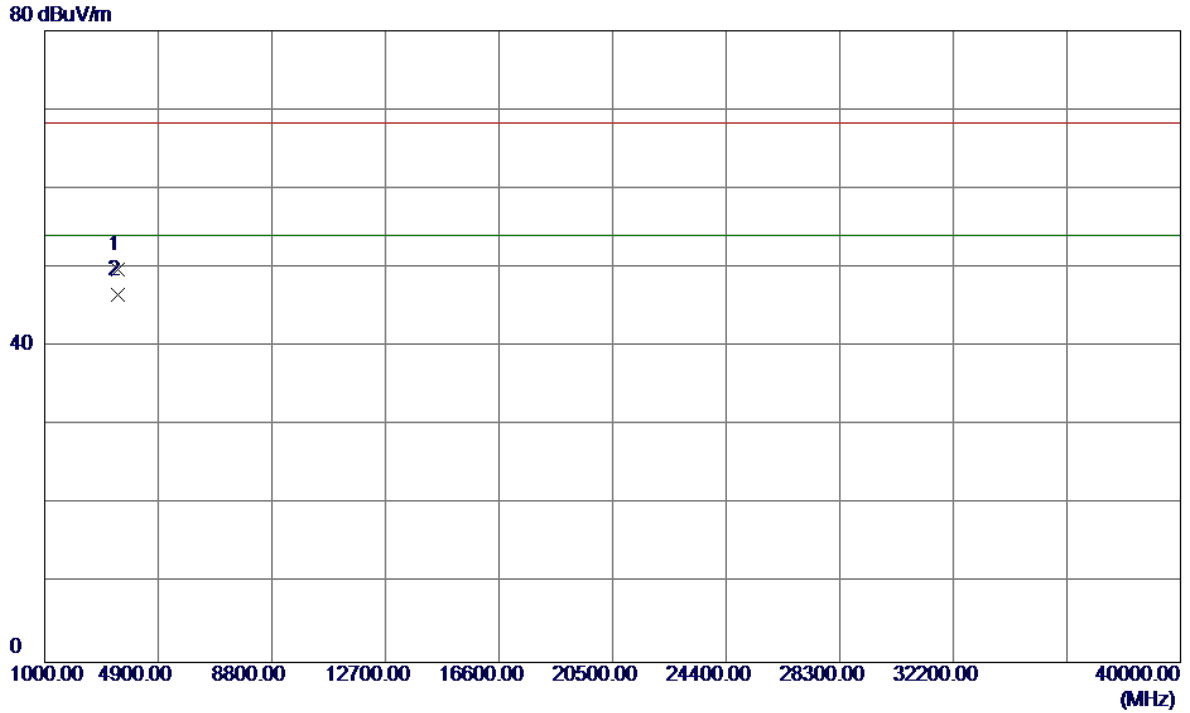

No.	Freq. MHz	Reading Level dBuV/m	Correct Factor dB	Measure ment dBuV/m	Limit dBuV/m	Margin dB	Detector	Comment
1	3533.2150	48.28	1.42	49.70	68.30	-18.60	Peak	
2 *	3533.3260	45.07	1.42	46.49	54.00	-7.51	AVG	

Orthogonal Axis :	X
Test Mode :	UNII-2A/ TX AC Wave2(20 MHz) Mode 5320MHz

Vertical

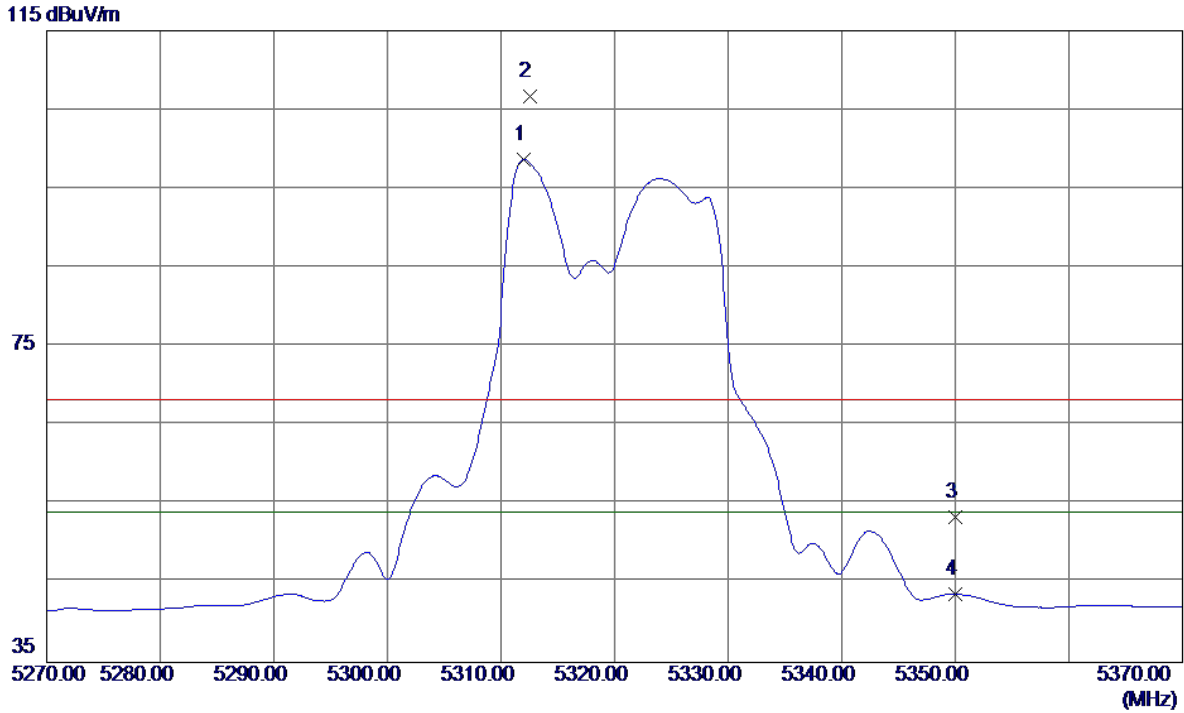

No.	Freq. MHz	Reading Level dBuV/m	Correct Factor dB	Measure ment dBuV/m	Limit dBuV/m	Margin dB	Detector	Comment
1 *	5311.9500	57.53	41.16	98.69	54.00	44.69	AVG	No Limit
2	5312.5000	65.51	41.16	106.67	68.20	38.47	Peak	No Limit
3	5350.0000	12.11	41.28	53.39	68.20	-14.81	Peak	
4	5350.0000	2.34	41.28	43.62	54.00	-10.38	AVG	

Orthogonal Axis :	X
Test Mode :	UNII-2A/ TX AC Wave2(20 MHz) Mode 5320MHz

Vertical

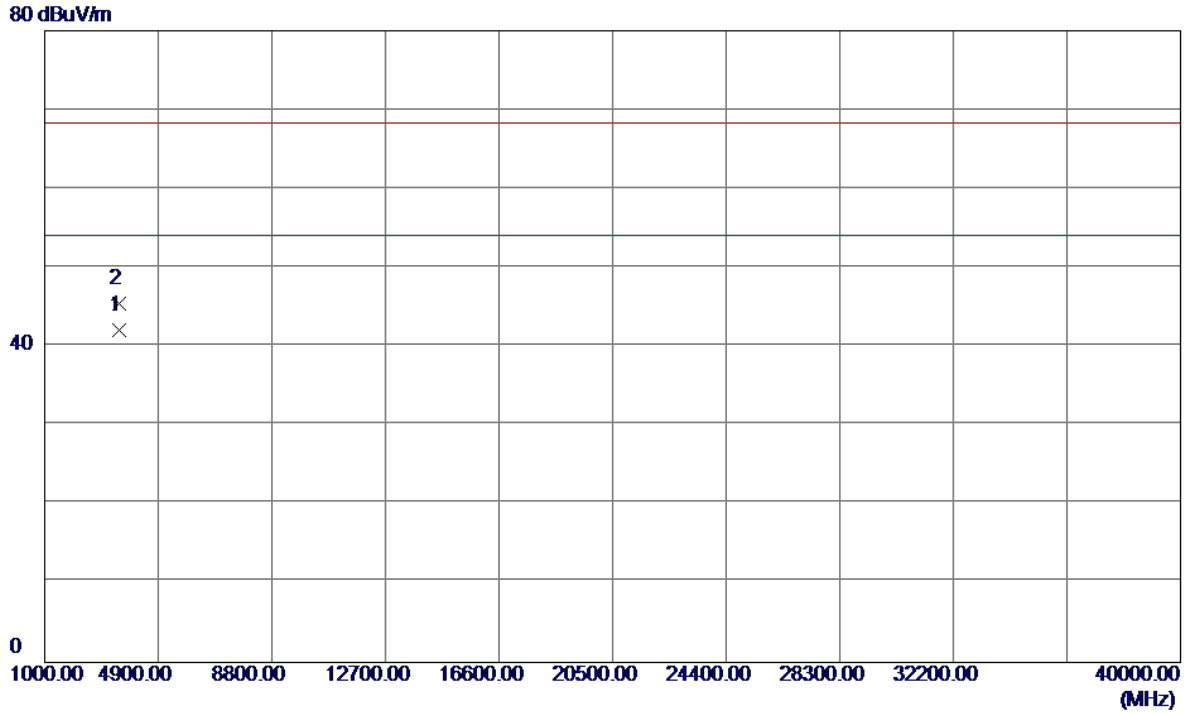

No.	Freq. MHz	Reading Level dBuV/m	Correct Factor dB	Measure ment dBuV/m	Limit dBuV/m	Margin dB	Detector	Comment
1 *	3546.6400	40.60	1.47	42.07	54.00	-11.93	AVG	
2	3546.6450	43.97	1.47	45.44	68.30	-22.86	Peak	

Orthogonal Axis :	X
Test Mode :	UNII-2A/ TX AC Wave2(20 MHz) Mode 5320MHz

Horizontal

115 dBuV/m

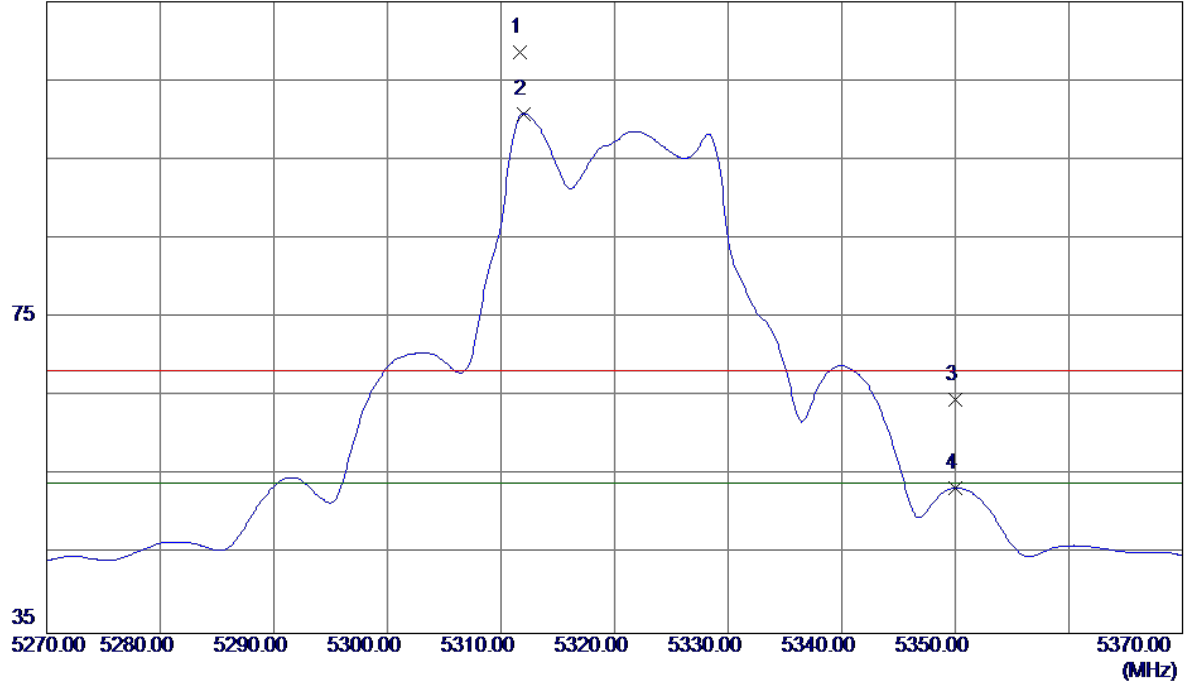

No.	Freq. MHz	Reading Level dBuV/m	Correct Factor dB	Measure ment dBuV/m	Limit dBuV/m	Margin dB	Detector	Comment
1	5311.7000	67.45	41.16	108.61	68.30	40.31	Peak	No Limit
2 *	5312.0000	59.68	41.16	100.84	54.00	46.84	AVG	No Limit
3	5350.0000	23.26	41.28	64.54	68.30	-3.76	Peak	
4	5350.0000	12.06	41.28	53.34	54.00	-0.66	AVG	

Orthogonal Axis :	X
Test Mode :	UNII-2A/ TX AC Wave2(20 MHz) Mode 5320MHz

Horizontal

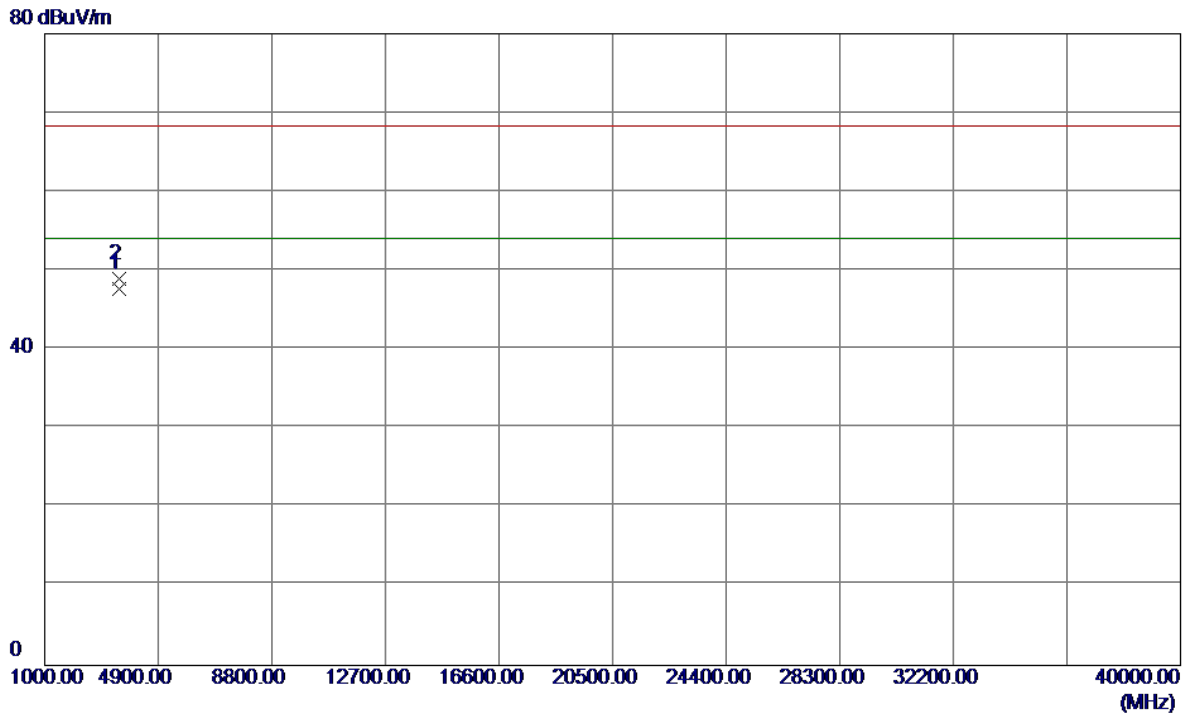

No.	Freq. MHz	Reading Level dBuV/m	Correct Factor dB	Measure ment dBuV/m	Limit dBuV/m	Margin dB	Detector	Comment
1 *	3546.6430	46.26	1.47	47.73	54.00	-6.27	AVG	
2	3546.6250	47.48	1.47	48.95	68.30	-19.35	Peak	

Orthogonal Axis :	X
Test Mode :	UNII-2A/ TX AC Wave2(40 MHz) 5270MHz

Vertical

115 dBuV/m

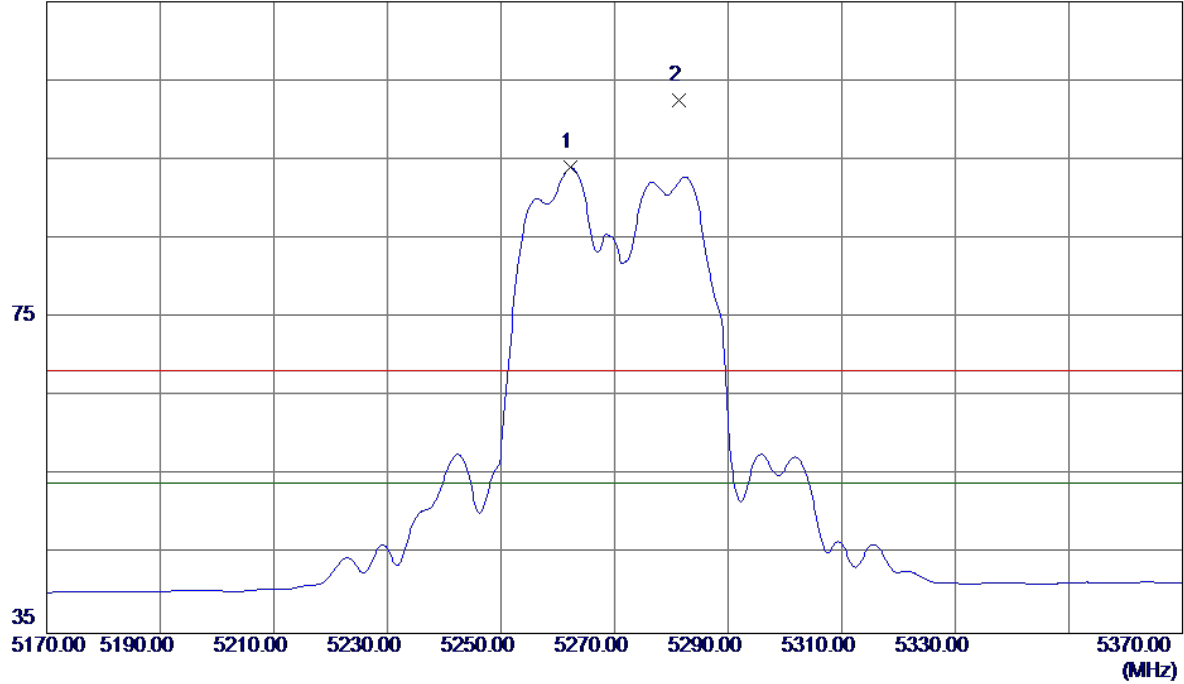

No.	Freq. MHz	Reading Level dBuV/m	Correct Factor dB	Measure ment dBuV/m	Limit dBuV/m	Margin dB	Detector	Comment
1 *	5262.3000	52.97	41.00	93.97	54.00	39.97	AVG	No Limit
2	5281.4000	61.49	41.06	102.55	68.20	34.35	Peak	No Limit

Orthogonal Axis :	X
Test Mode :	UNII-2A/ TX AC Wave2(40 MHz) 5270MHz

Vertical

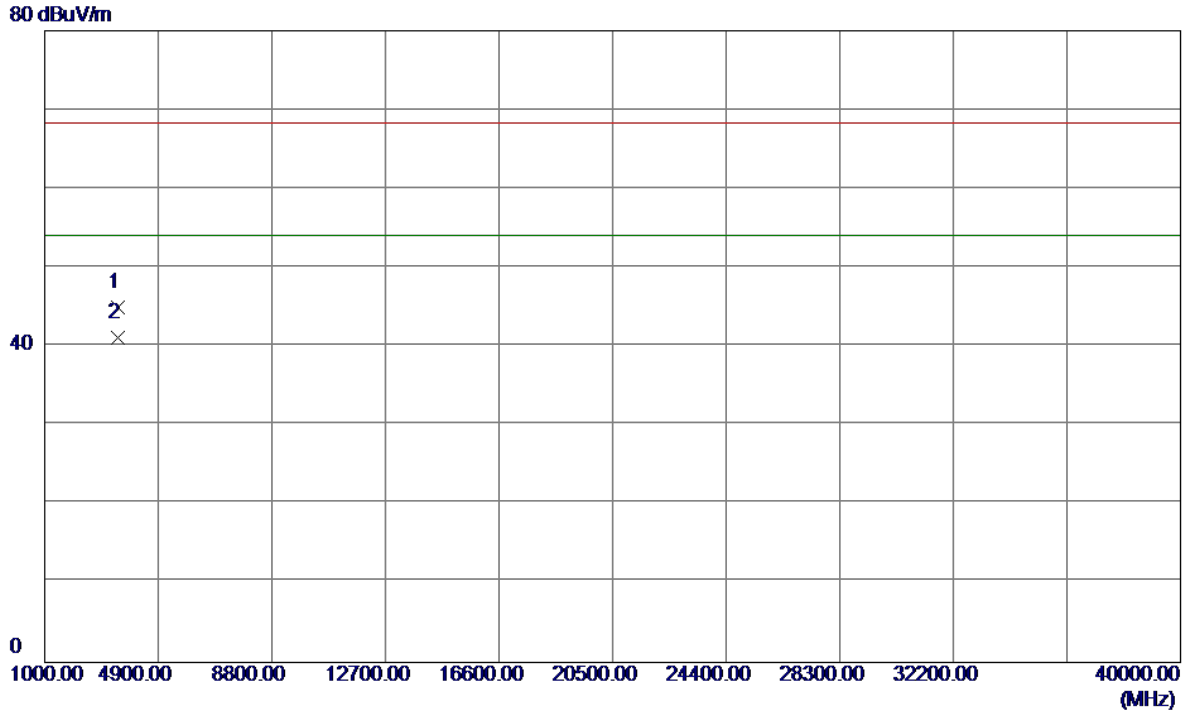

No.	Freq. MHz	Reading Level dBuV/m	Correct Factor dB	Measure ment dBuV/m	Limit dBuV/m	Margin dB	Detector	Comment
1	3513.3100	43.54	1.36	44.90	68.30	-23.40	Peak	
2 *	3513.3100	39.69	1.36	41.05	54.00	-12.95	AVG	

Orthogonal Axis :	X
Test Mode :	UNII-2A/ TX AC Wave2(40 MHz) 5270MHz

Horizontal

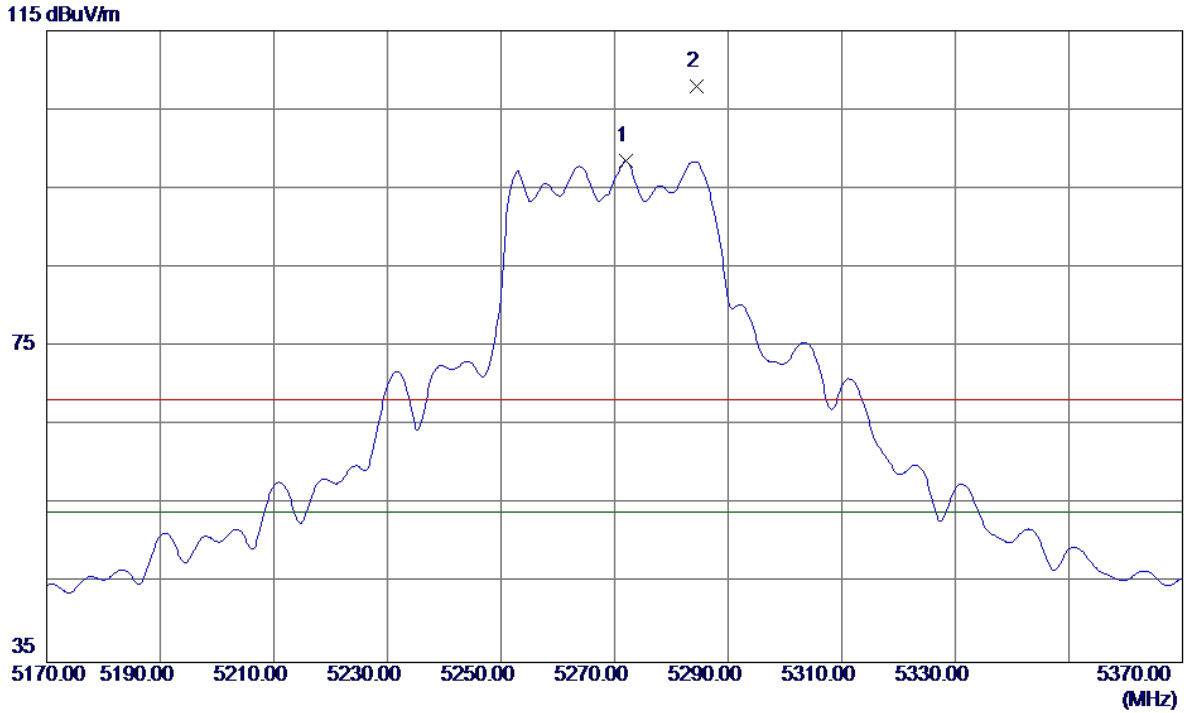

No.	Freq. MHz	Reading Level dBuV/m	Correct Factor dB	Measure ment dBuV/m	Limit dBuV/m	Margin dB	Detector	Comment
1 *	5272.0000	57.46	41.03	98.49	54.00	44.49	AVG	No Limit
2	5284.4000	66.93	41.07	108.00	68.30	39.70	Peak	No Limit

Orthogonal Axis :	X
Test Mode :	UNII-2A/ TX AC Wave2(40 MHz) 5270MHz

Horizontal

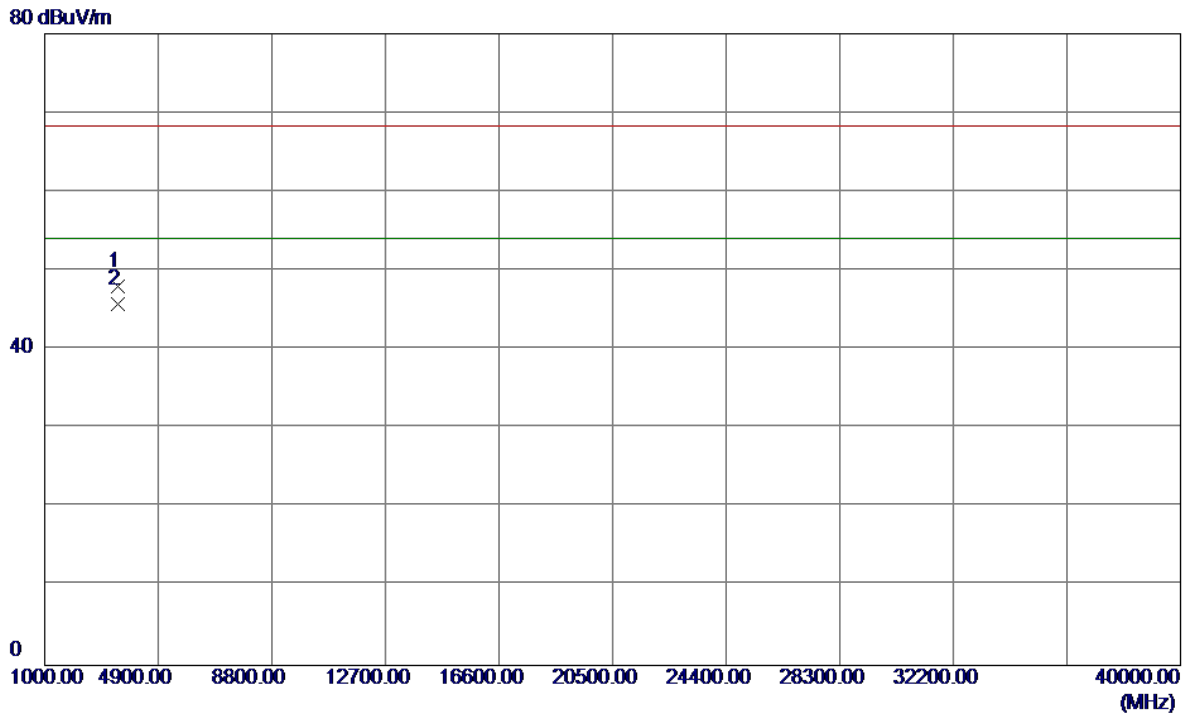

No.	Freq. MHz	Reading Level dBuV/m	Correct Factor dB	Measure ment dBuV/m	Limit dBuV/m	Margin dB	Detector	Comment
1	3513.3400	46.62	1.36	47.98	68.30	-20.32	Peak	
2 *	3513.5700	44.42	1.36	45.78	54.00	-8.22	AVG	

Orthogonal Axis :	X
Test Mode :	UNII-2A/ TX AC Wave2(40 MHz) 5310MHz

Vertical

115 dBuV/m

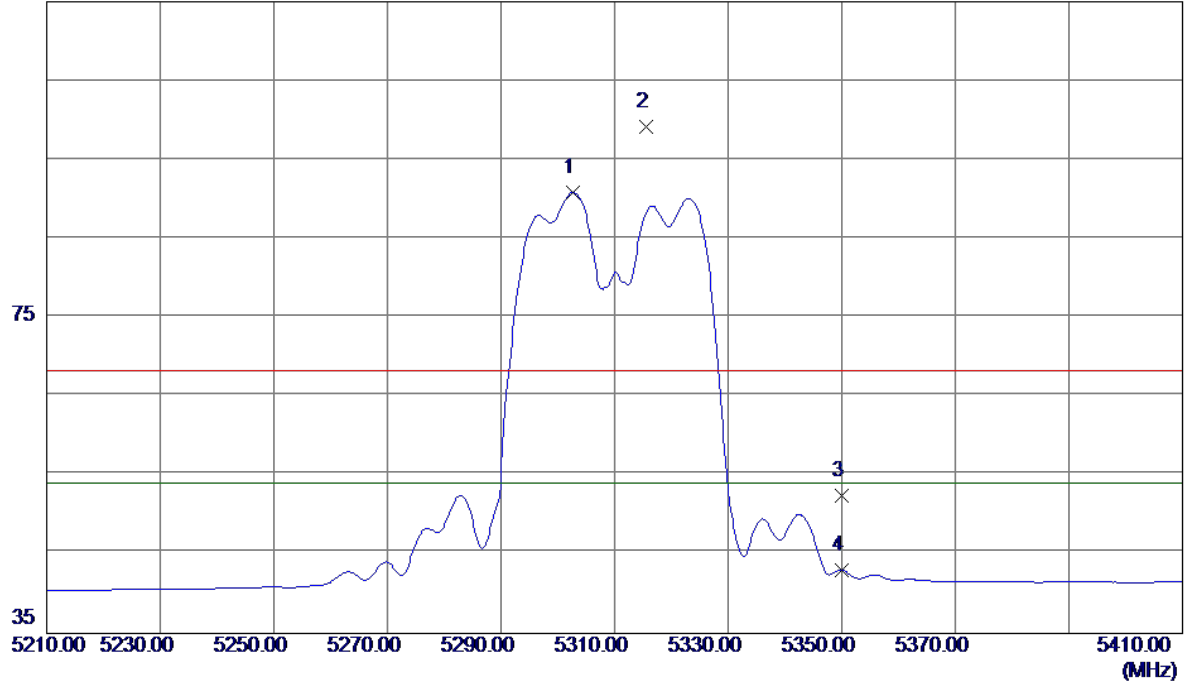

No.	Freq. MHz	Reading Level dBuV/m	Correct Factor dB	Measure ment dBuV/m	Limit dBuV/m	Margin dB	Detector	Comment
1 *	5302.7000	49.75	41.13	90.88	54.00	36.88	AVG	No Limit
2	5315.5000	58.05	41.17	99.22	68.20	31.02	Peak	No Limit
3	5350.0000	11.11	41.28	52.39	68.20	-15.81	Peak	
4	5350.0000	1.75	41.28	43.03	54.00	-10.97	AVG	

Orthogonal Axis :	X
Test Mode :	UNII-2A/ TX AC Wave2(40 MHz) 5310MHz

Vertical

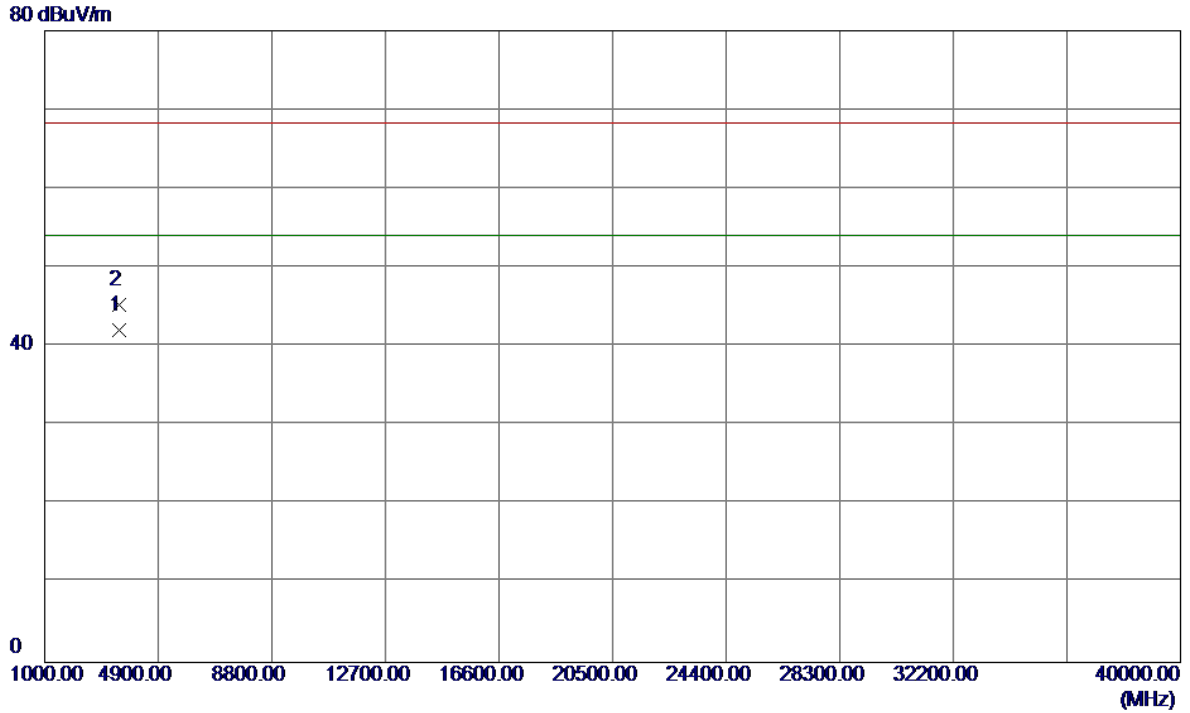

No.	Freq. MHz	Reading Level dBuV/m	Correct Factor dB	Measure ment dBuV/m	Limit dBuV/m	Margin dB	Detector	Comment
1 *	3539.9750	40.60	1.45	42.05	54.00	-11.95	AVG	
2	3540.0600	43.85	1.45	45.30	68.30	-23.00	Peak	

Orthogonal Axis :	X
Test Mode :	UNII-2A/ TX AC Wave2(40 MHz) 5310MHz

Horizontal

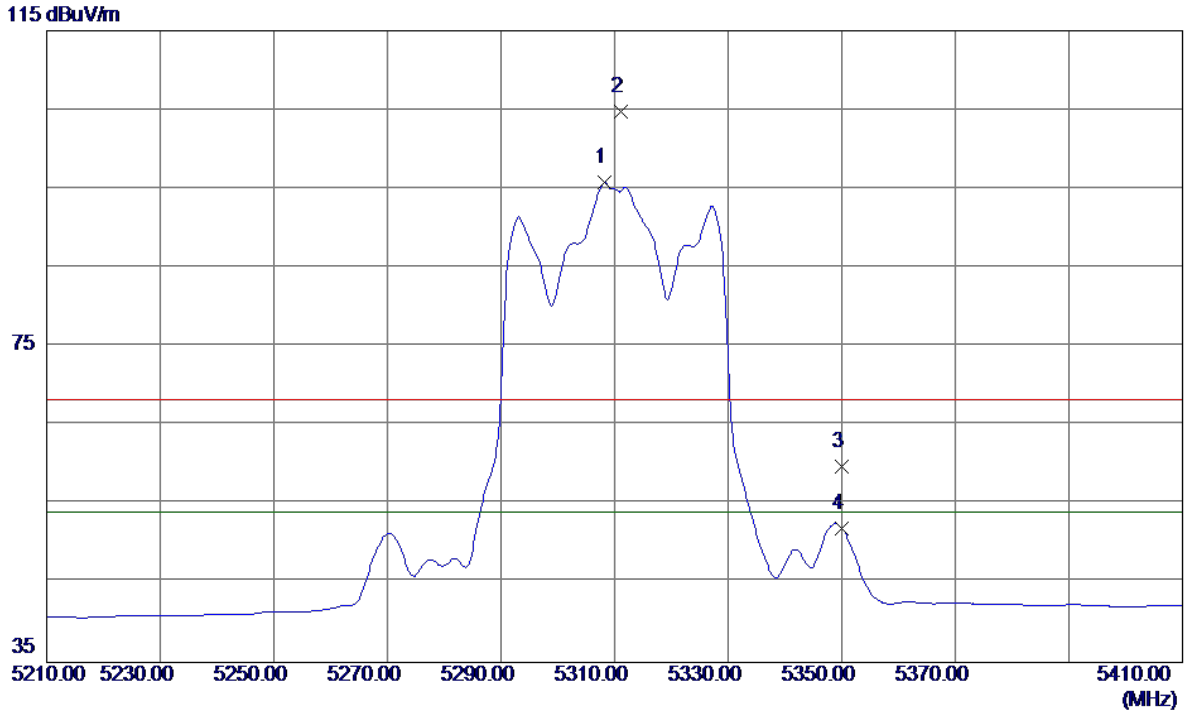

No.	Freq. MHz	Reading Level dBuV/m	Correct Factor dB	Measure ment dBuV/m	Limit dBuV/m	Margin dB	Detector	Comment
1 *	5308.2000	54.65	41.15	95.80	54.00	41.80	AVG	No Limit
2	5311.2000	63.54	41.16	104.70	68.30	36.40	Peak	No Limit
3	5350.0000	18.53	41.28	59.81	68.30	-8.49	Peak	
4	5350.0000	10.74	41.28	52.02	54.00	-1.98	AVG	

Orthogonal Axis :	X
Test Mode :	UNII-2A/ TX AC Wave2(40 MHz) 5310MHz

Horizontal

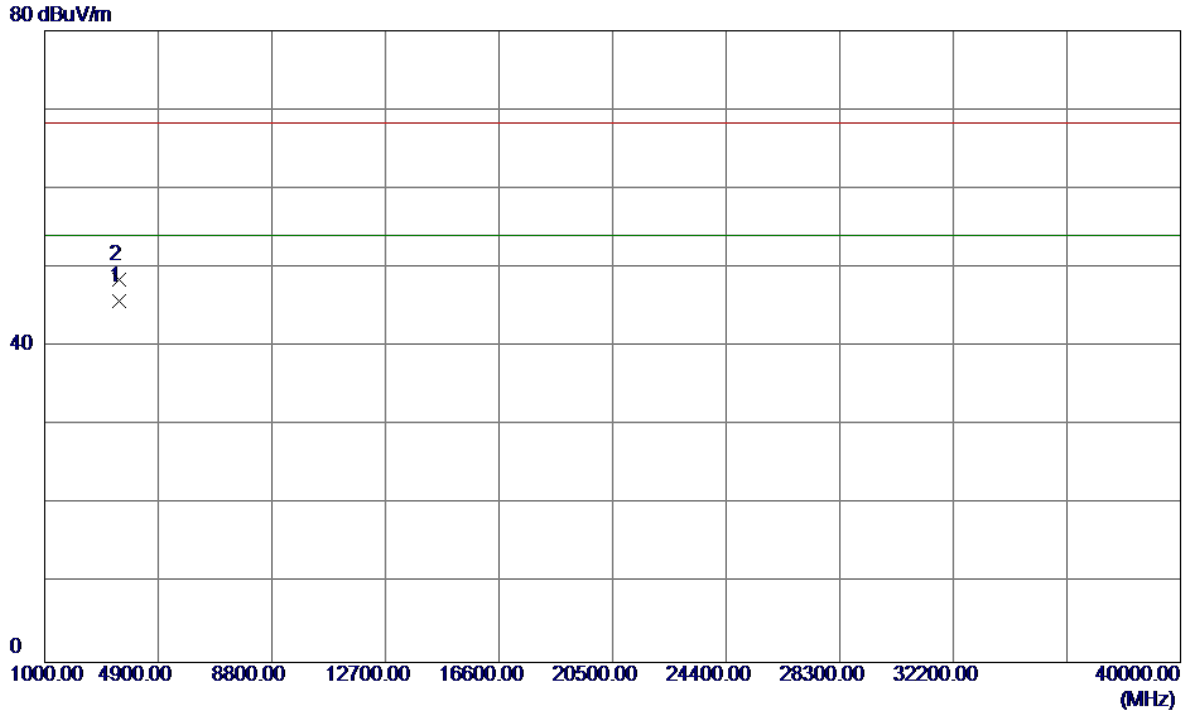

No.	Freq. MHz	Reading Level dBuV/m	Correct Factor dB	Measure ment dBuV/m	Limit dBuV/m	Margin dB	Detector	Comment
1 *	3539.3500	44.26	1.44	45.70	54.00	-8.30	AVG	
2	3540.1300	46.97	1.45	48.42	68.30	-19.88	Peak	

Orthogonal Axis :	X
Test Mode :	UNII-2A/ TX AC Wave2(80 MHz) 5290MHz

Vertical

115 dBuV/m

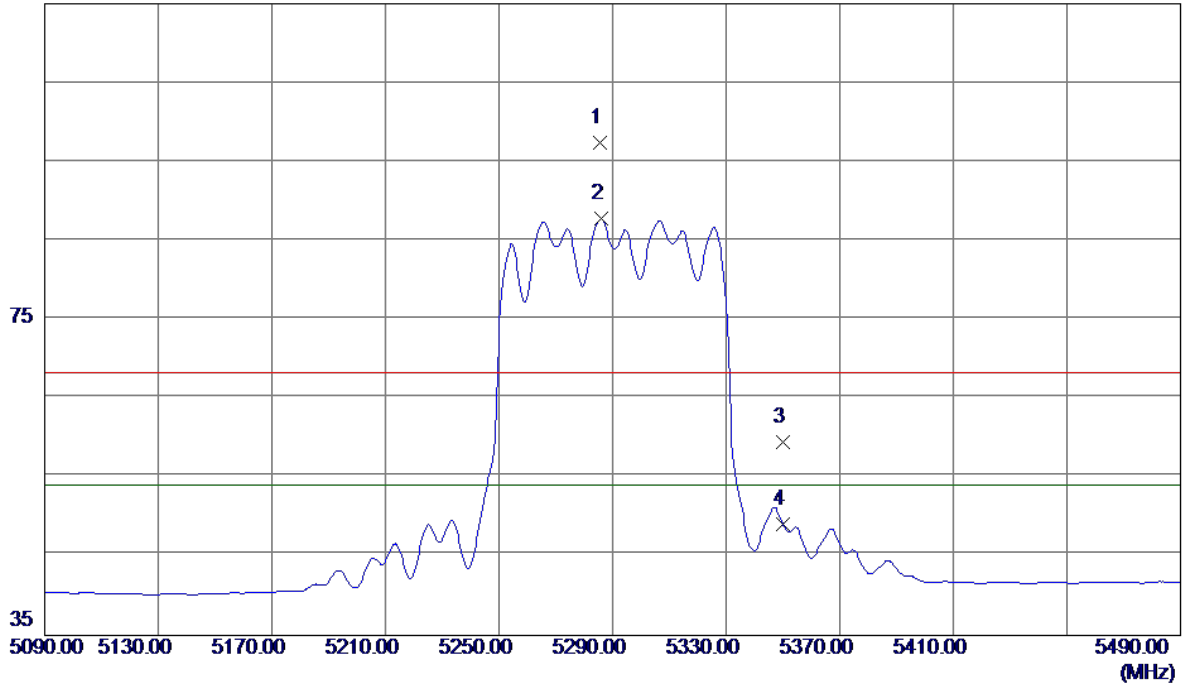

No.	Freq. MHz	Reading Level dBuV/m	Correct Factor dB	Measure ment dBuV/m	Limit dBuV/m	Margin dB	Detector	Comment
1	5285.6000	56.27	41.07	97.34	68.20	29.14	Peak	No Limit
2 *	5285.8000	46.68	41.07	87.75	54.00	33.75	AVG	No Limit
3	5350.0000	18.17	41.28	59.45	68.20	-8.75	Peak	
4	5350.0000	7.84	41.28	49.12	54.00	-4.88	AVG	

Orthogonal Axis :	X
Test Mode :	UNII-2A/ TX AC Wave2(80 MHz) 5290MHz

Vertical

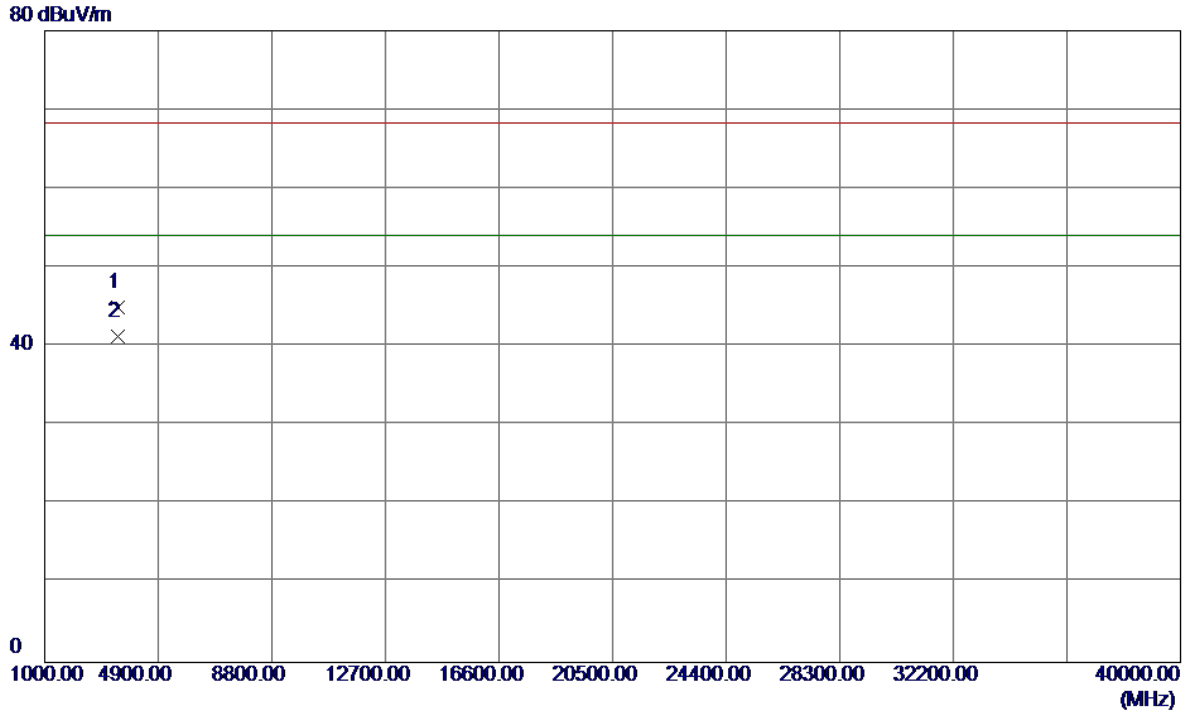

No.	Freq. MHz	Reading Level dBuV/m	Correct Factor dB	Measure ment dBuV/m	Limit dBuV/m	Margin dB	Detector	Comment
1	3526.6450	43.60	1.40	45.00	68.30	-23.30	Peak	
2 *	3526.6500	39.90	1.40	41.30	54.00	-12.70	AVG	

Orthogonal Axis :	X
Test Mode :	UNII-2A/ TX AC Wave2(80 MHz) 5290MHz

Horizontal

115 dBuV/m

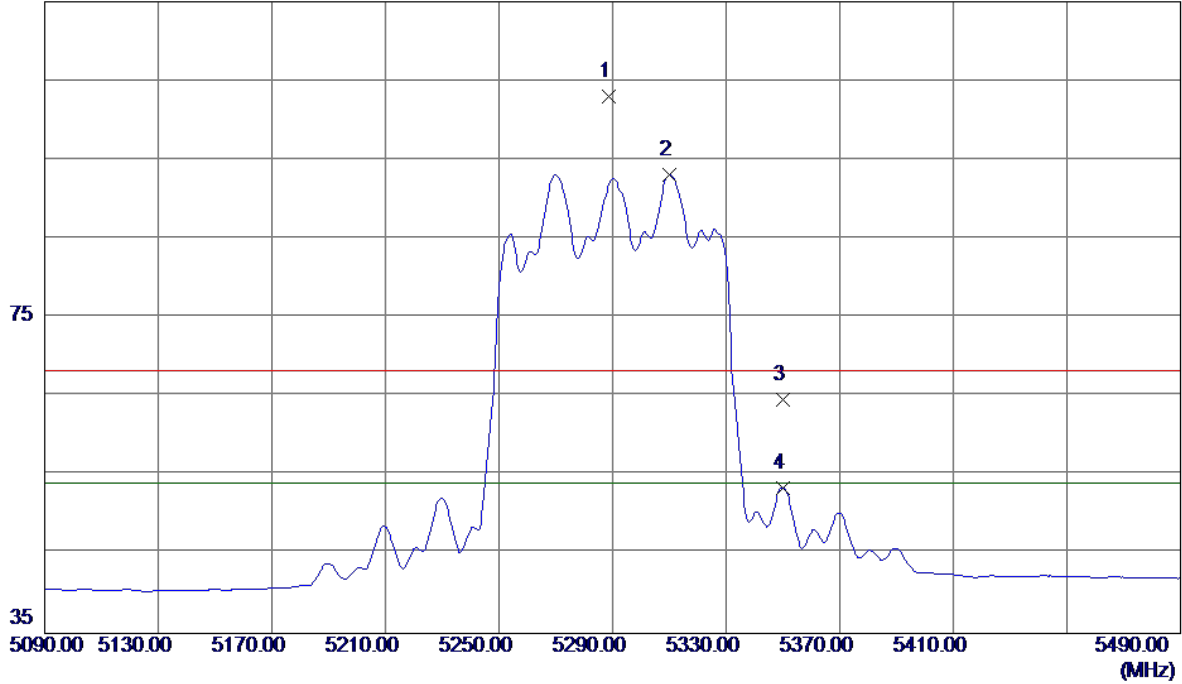

No.	Freq. MHz	Reading Level dBuV/m	Correct Factor dB	Measure ment dBuV/m	Limit dBuV/m	Margin dB	Detector	Comment
1	5288.8000	61.99	41.08	103.07	68.30	34.77	Peak	No Limit
2 *	5310.0000	51.91	41.15	93.06	54.00	39.06	AVG	No Limit
3	5350.0000	23.37	41.28	64.65	68.30	-3.65	Peak	
4	5350.0000	12.18	41.28	53.46	54.00	-0.54	AVG	

Orthogonal Axis :	X
Test Mode :	UNII-2A/ TX AC Wave2(80 MHz) 5290MHz

Horizontal

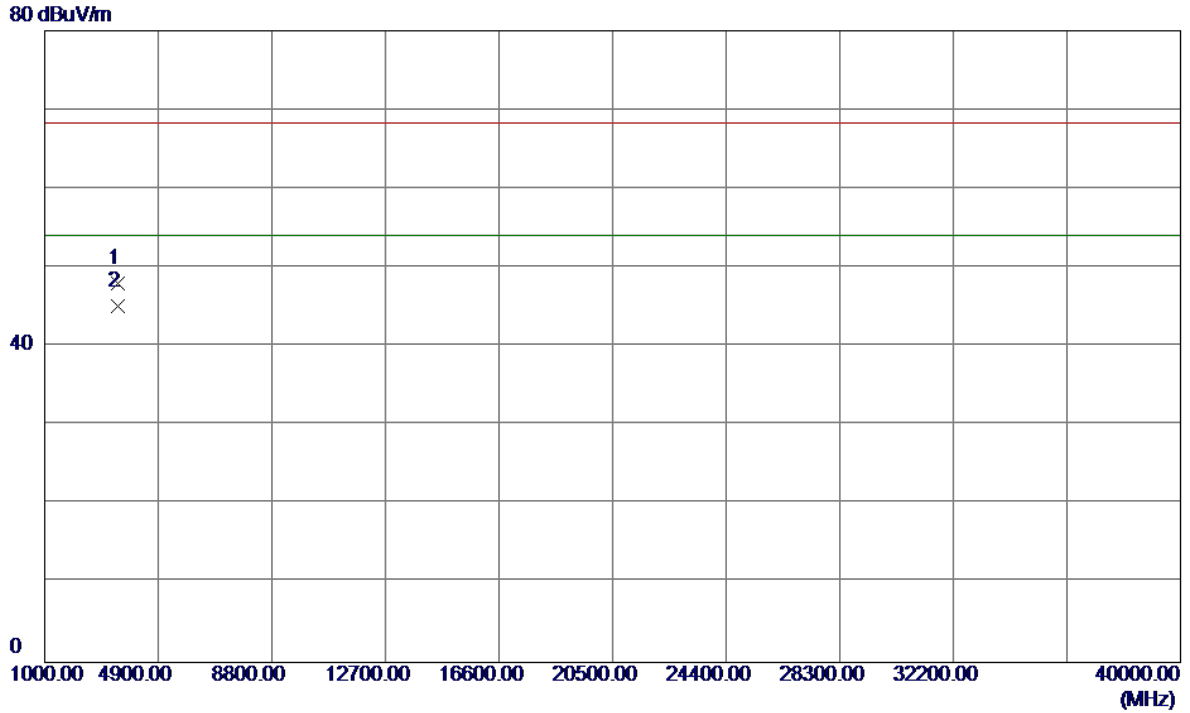

No.	Freq. MHz	Reading Level dBuV/m	Correct Factor dB	Measure ment dBuV/m	Limit dBuV/m	Margin dB	Detector	Comment
1	3526.1450	46.60	1.40	48.00	68.30	-20.30	Peak	
2 *	3526.5200	43.76	1.40	45.16	54.00	-8.84	AVG	

Orthogonal Axis :	X
Test Mode :	UNII-2C/ TX AC Wave2(20 MHz) Mode 5500MHz

Vertical

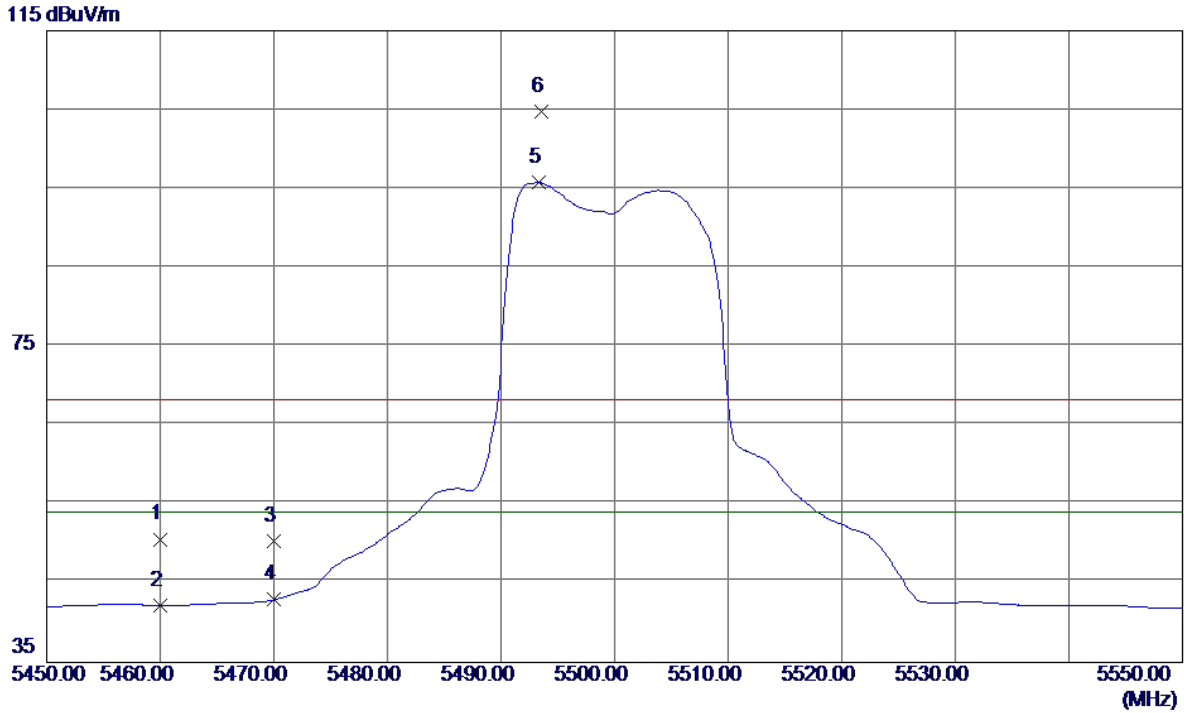

No.	Freq. MHz	Reading Level dBuV/m	Correct Factor dB	Measure ment dBuV/m	Limit dBuV/m	Margin dB	Detector	Comment
1	5460.0000	8.95	41.65	50.60	68.20	-17.60	Peak	
2	5460.0000	0.60	41.65	42.25	54.00	-11.75	AVG	
3	5470.0000	8.64	41.68	50.32	68.20	-17.88	Peak	
4	5470.0000	1.26	41.68	42.94	54.00	-11.06	AVG	
5 *	5493.3000	54.01	41.76	95.77	54.00	41.77	AVG	No Limit
6	5493.6000	63.08	41.76	104.84	68.20	36.64	Peak	No Limit

Orthogonal Axis :	X
Test Mode :	UNII-2C/ TX AC Wave2(20 MHz) Mode 5500MHz

Vertical

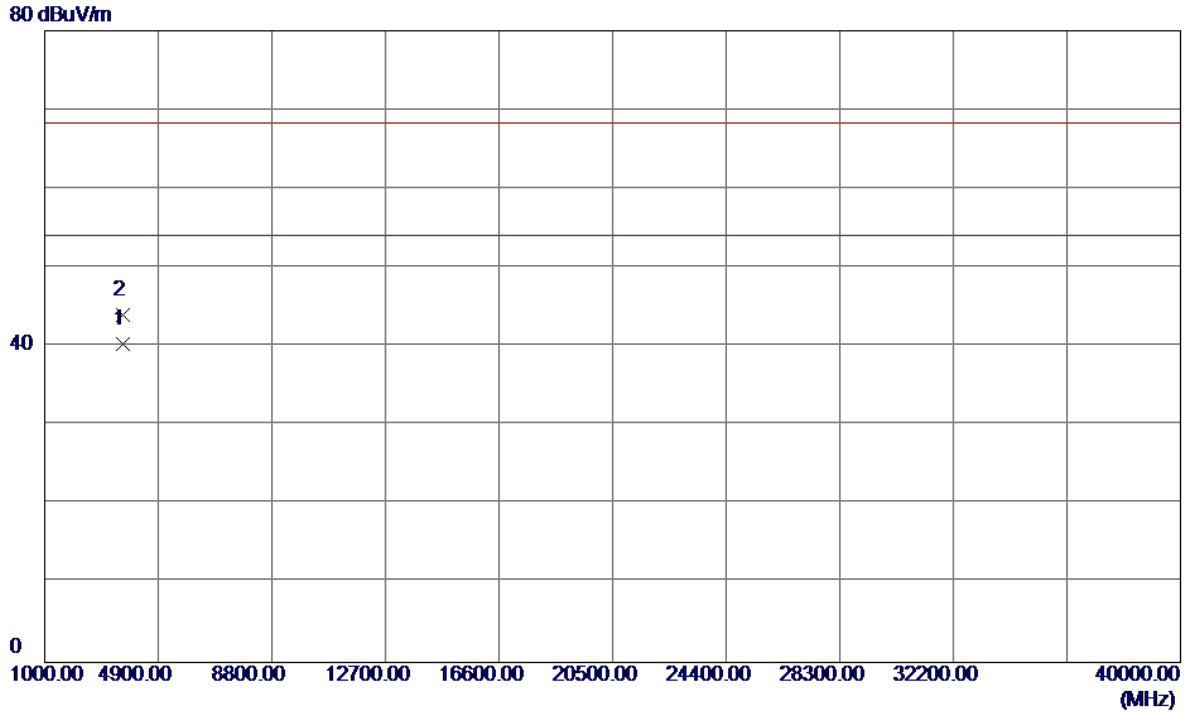

No.	Freq. MHz	Reading Level dBuV/m	Correct Factor dB	Measure ment dBuV/m	Limit dBuV/m	Margin dB	Detector	Comment
1 *	3666.6400	38.41	1.86	40.27	54.00	-13.73	AVG	
2	3666.6650	42.18	1.86	44.04	68.30	-24.26	Peak	

Orthogonal Axis :	X
Test Mode :	UNII-2C/ TX AC Wave2(20 MHz) Mode 5500MHz

Horizontal

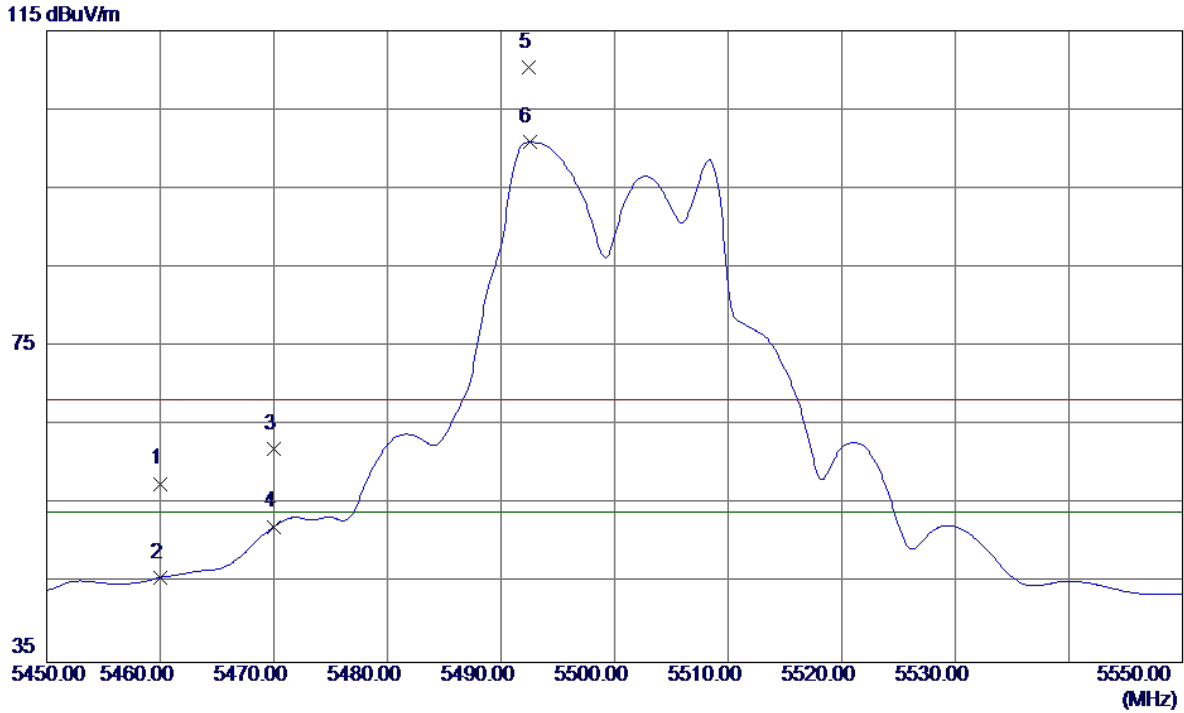

No.	Freq. MHz	Reading Level dBuV/m	Correct Factor dB	Measure ment dBuV/m	Limit dBuV/m	Margin dB	Detector	Comment
1	5460.0000	15.99	41.65	57.64	68.30	-10.66	Peak	
2	5460.0000	4.10	41.65	45.75	54.00	-8.25	AVG	
3	5470.0000	20.40	41.68	62.08	68.30	-6.22	Peak	
4	5470.0000	10.52	41.68	52.20	54.00	-1.80	AVG	
5	5492.4000	68.64	41.75	110.39	68.30	42.09	Peak	No Limit
6 *	5492.5000	59.13	41.76	100.89	54.00	46.89	AVG	No Limit

Orthogonal Axis :	X
Test Mode :	UNII-2C/ TX AC Wave2(20 MHz) Mode 5500MHz

Horizontal

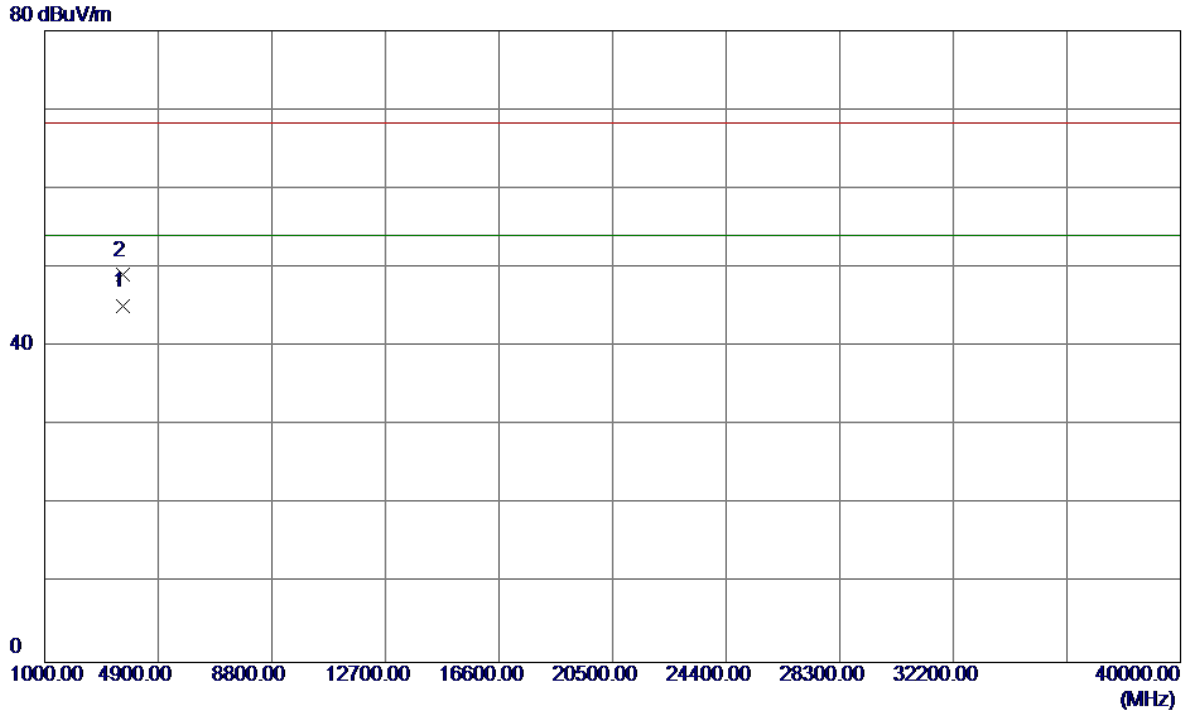

No.	Freq. MHz	Reading Level dBuV/m	Correct Factor dB	Measure ment dBuV/m	Limit dBuV/m	Margin dB	Detector	Comment
1 *	3666.6750	43.27	1.86	45.13	54.00	-8.87	AVG	
2	3666.6200	47.18	1.86	49.04	68.30	-19.26	Peak	

Orthogonal Axis :	X
Test Mode :	UNII-2C/ TX AC Wave2(20 MHz) Mode 5580MHz

Vertical

115 dBuV/m

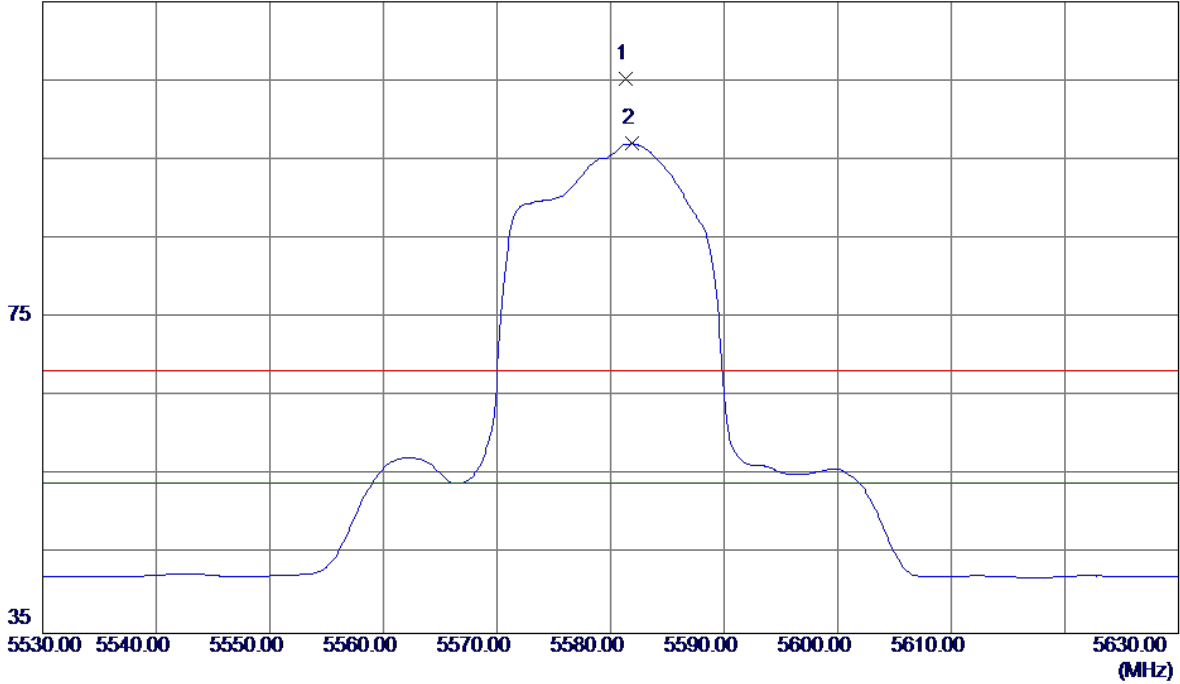

No.	Freq. MHz	Reading Level dBuV/m	Correct Factor dB	Measure ment dBuV/m	Limit dBuV/m	Margin dB	Detector	Comment
1	5581.3000	63.21	42.07	105.28	68.20	37.08	Peak	No Limit
2 *	5581.9000	54.95	42.07	97.02	54.00	43.02	AVG	No Limit

Orthogonal Axis :	X
Test Mode :	UNII-2C/ TX AC Wave2(20 MHz) Mode 5580MHz

Vertical

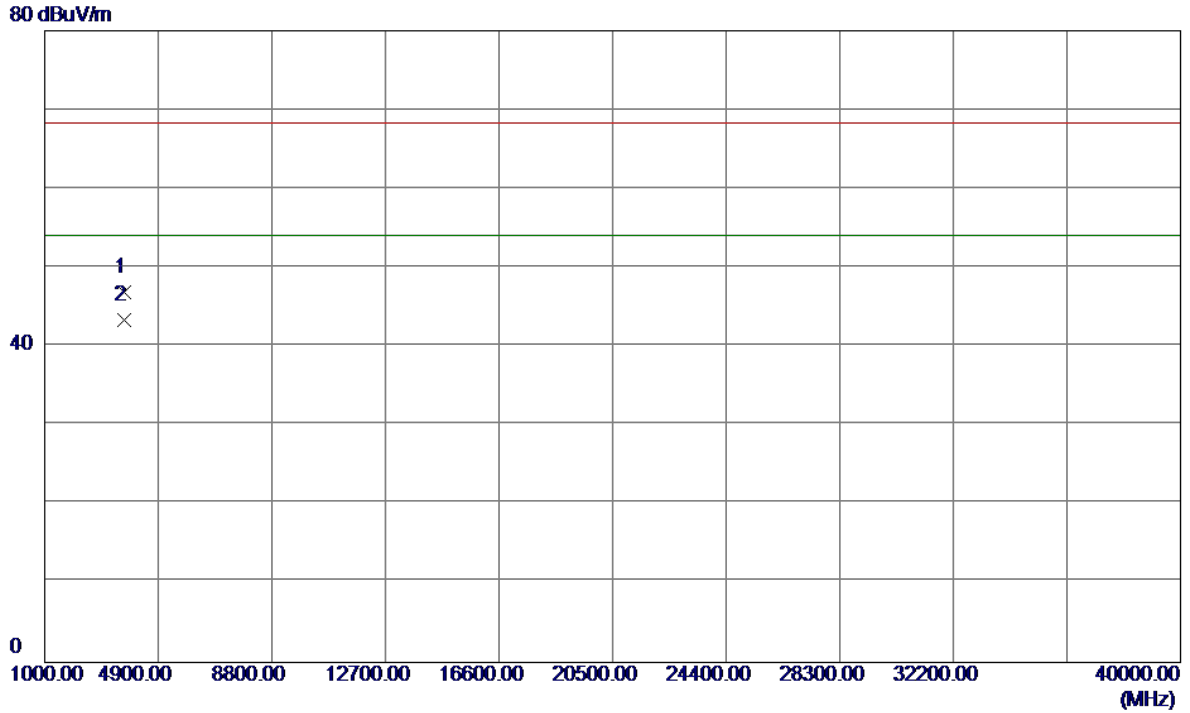

No.	Freq. MHz	Reading Level dBuV/m	Correct Factor dB	Measure ment dBuV/m	Limit dBuV/m	Margin dB	Detector	Comment
1	3719.8600	44.80	2.03	46.83	68.30	-21.47	Peak	
2 *	3719.9700	41.39	2.03	43.42	54.00	-10.58	AVG	

Orthogonal Axis :	X
Test Mode :	UNII-2C/ TX AC Wave2(20 MHz) Mode 5580MHz

Horizontal

115 dBuV/m

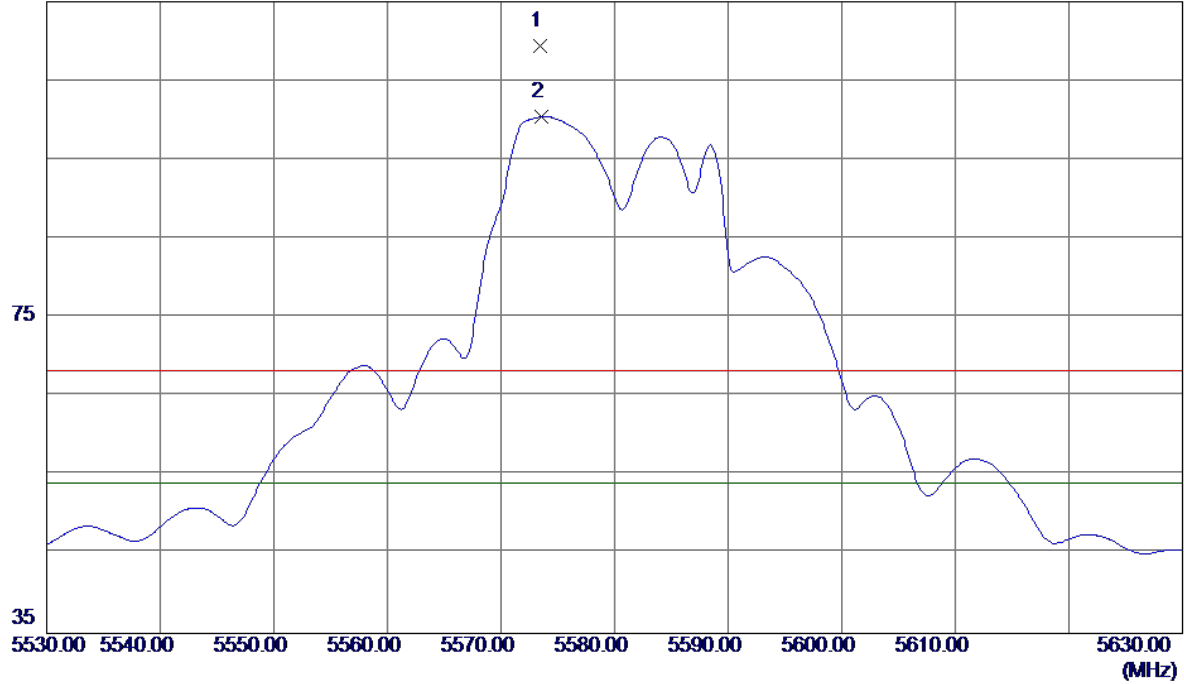

No.	Freq. MHz	Reading Level dBuV/m	Correct Factor dB	Measure ment dBuV/m	Limit dBuV/m	Margin dB	Detector	Comment
1	5573.4000	67.36	42.04	109.40	68.30	41.10	Peak	No Limit
2 *	5573.6000	58.41	42.04	100.45	54.00	46.45	AVG	No Limit

Orthogonal Axis :	X
Test Mode :	UNII-2C/ TX AC Wave2(20 MHz) Mode 5580MHz

Horizontal

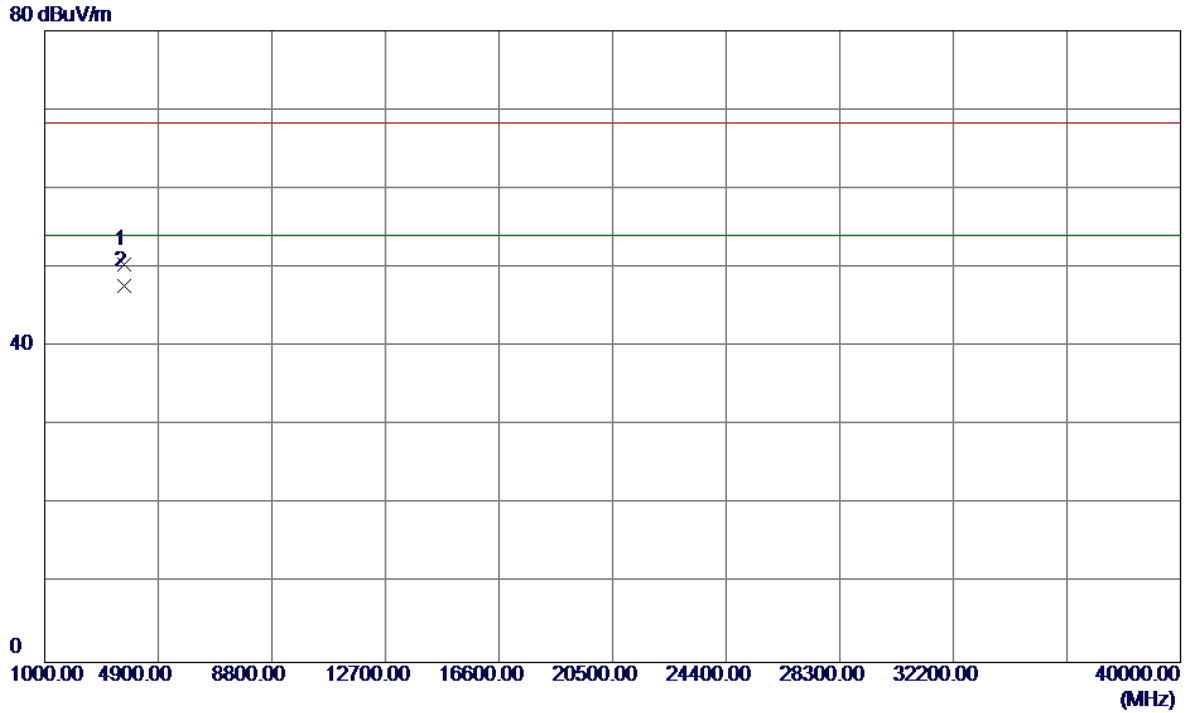

No.	Freq. MHz	Reading Level dBuV/m	Correct Factor dB	Measure ment dBuV/m	Limit dBuV/m	Margin dB	Detector	Comment
1	3719.8250	48.37	2.03	50.40	68.30	-17.90	Peak	
2 *	3719.9600	45.60	2.03	47.63	54.00	-6.37	AVG	

Orthogonal Axis :	X
Test Mode :	UNII-2C/ TX AC Wave2(20 MHz) Mode 5700MHz

Vertical

115 dBuV/m

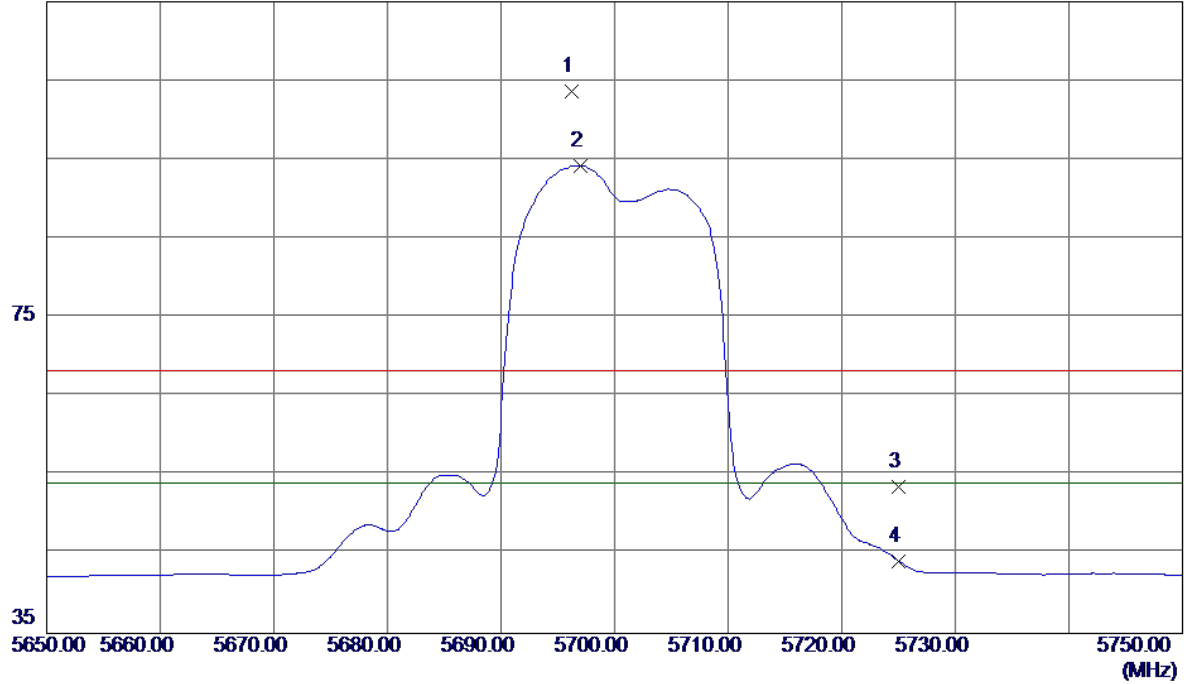

No.	Freq. MHz	Reading Level dBuV/m	Correct Factor dB	Measure ment dBuV/m	Limit dBuV/m	Margin dB	Detector	Comment
1	5696.2500	61.22	42.48	103.70	68.20	35.50	Peak	No Limit
2 *	5697.0000	51.76	42.48	94.24	54.00	40.24	AVG	No Limit
3	5725.0000	10.93	42.58	53.51	68.20	-14.69	Peak	
4	5725.0000	1.61	42.58	44.19	54.00	-9.81	AVG	

Orthogonal Axis :	X
Test Mode :	UNII-2C/ TX AC Wave2(20 MHz) Mode 5700MHz

Vertical

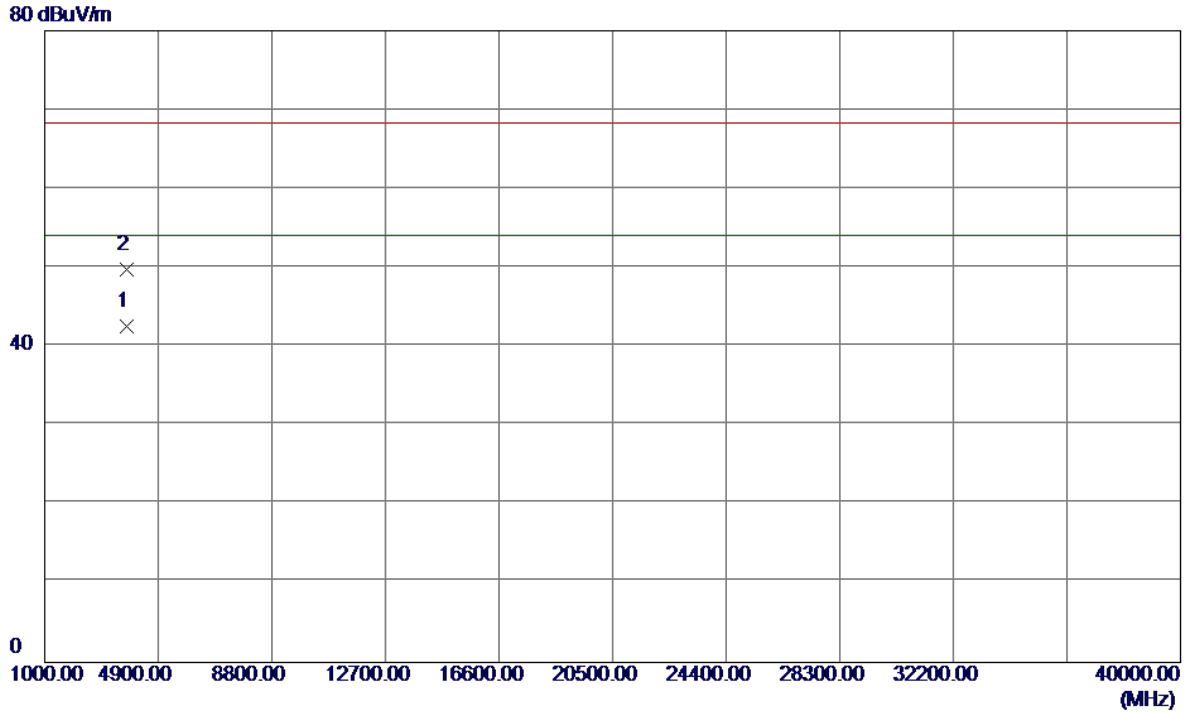

No.	Freq. MHz	Reading Level dBuV/m	Correct Factor dB	Measure ment dBuV/m	Limit dBuV/m	Margin dB	Detector	Comment
1 *	3799.9650	40.25	2.30	42.55	54.00	-11.45	AVG	
2	3799.9700	47.42	2.30	49.72	68.30	-18.58	Peak	

Orthogonal Axis :	X
Test Mode :	UNII-2C/ TX AC Wave2(20 MHz) Mode 5700MHz

Horizontal

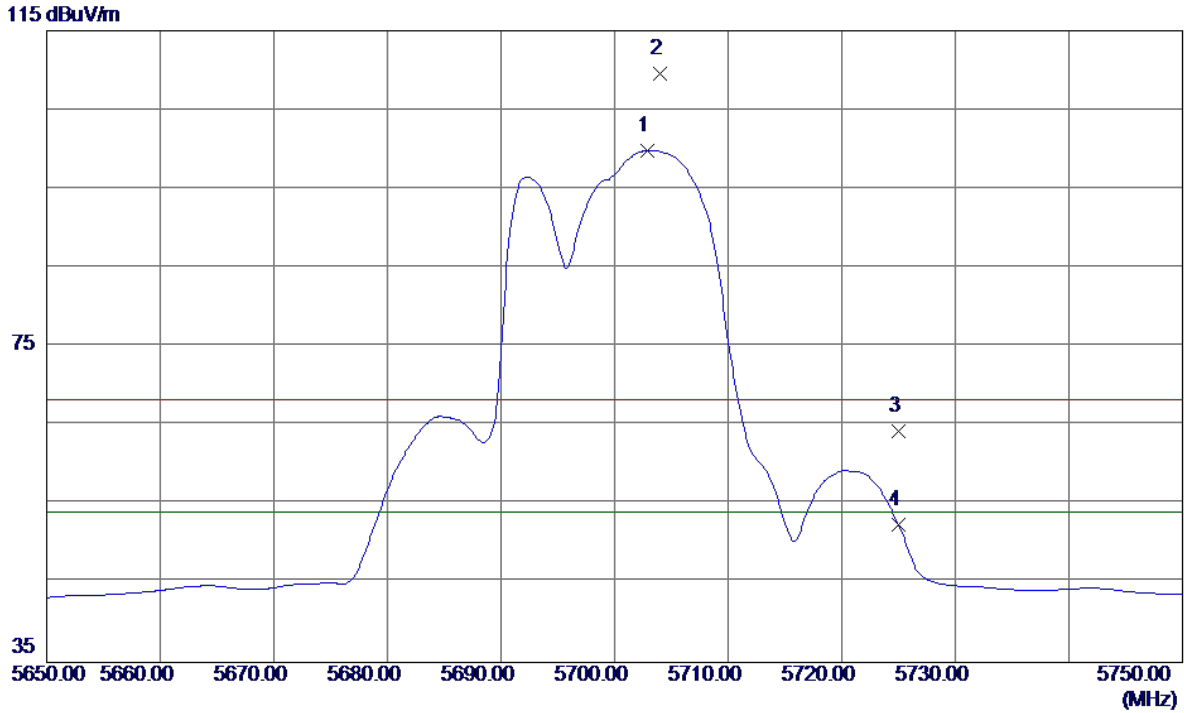

No.	Freq. MHz	Reading Level dBuV/m	Correct Factor dB	Measure ment dBuV/m	Limit dBuV/m	Margin dB	Detector	Comment
1 *	5702.9000	57.37	42.50	99.87	54.00	45.87	AVG	No Limit
2	5704.0000	67.11	42.51	109.62	68.30	41.32	Peak	No Limit
3	5725.0000	21.65	42.58	64.23	68.30	-4.07	Peak	
4	5725.0000	9.87	42.58	52.45	54.00	-1.55	AVG	

Orthogonal Axis :	X
Test Mode :	UNII-2C/ TX AC Wave2(20 MHz) Mode 5700MHz

Horizontal

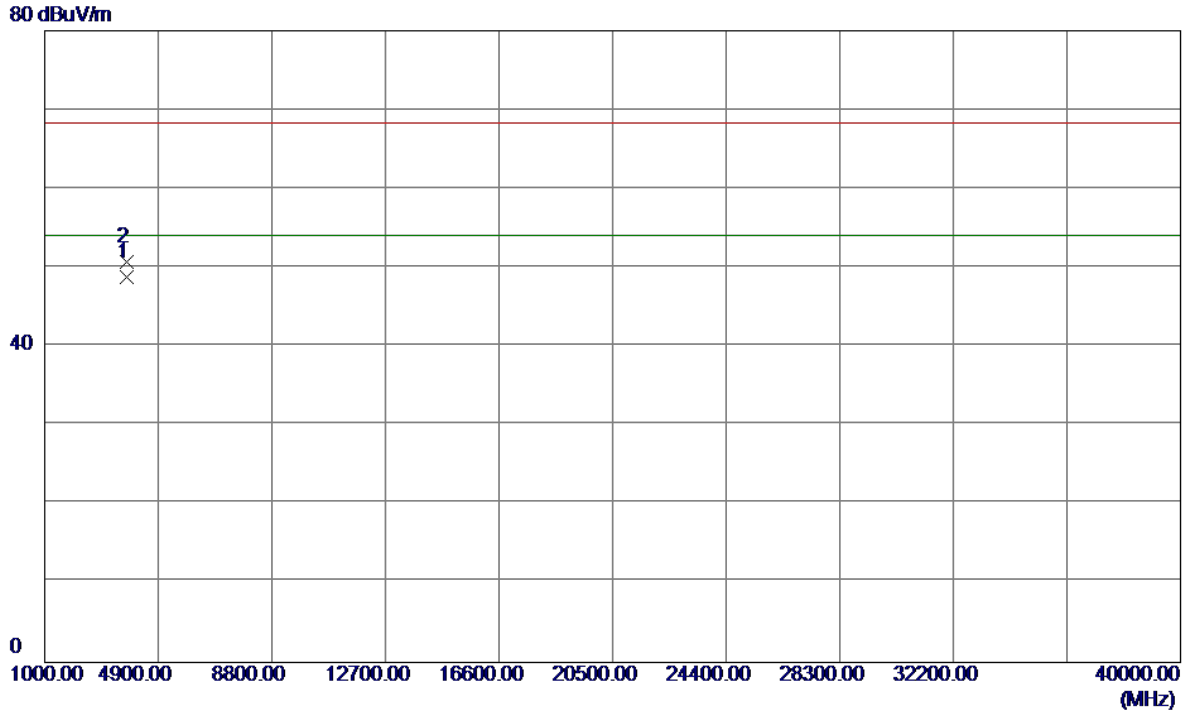

No.	Freq. MHz	Reading Level dBuV/m	Correct Factor dB	Measure ment dBuV/m	Limit dBuV/m	Margin dB	Detector	Comment
1 *	3799.9300	46.43	2.30	48.73	54.00	-5.27	AVG	
2	3799.9250	48.42	2.30	50.72	68.30	-17.58	Peak	

Orthogonal Axis :	X
Test Mode :	UNII-2C/ TX AC Wave2(40 MHz) 5510MHz

Vertical

115 dBuV/m

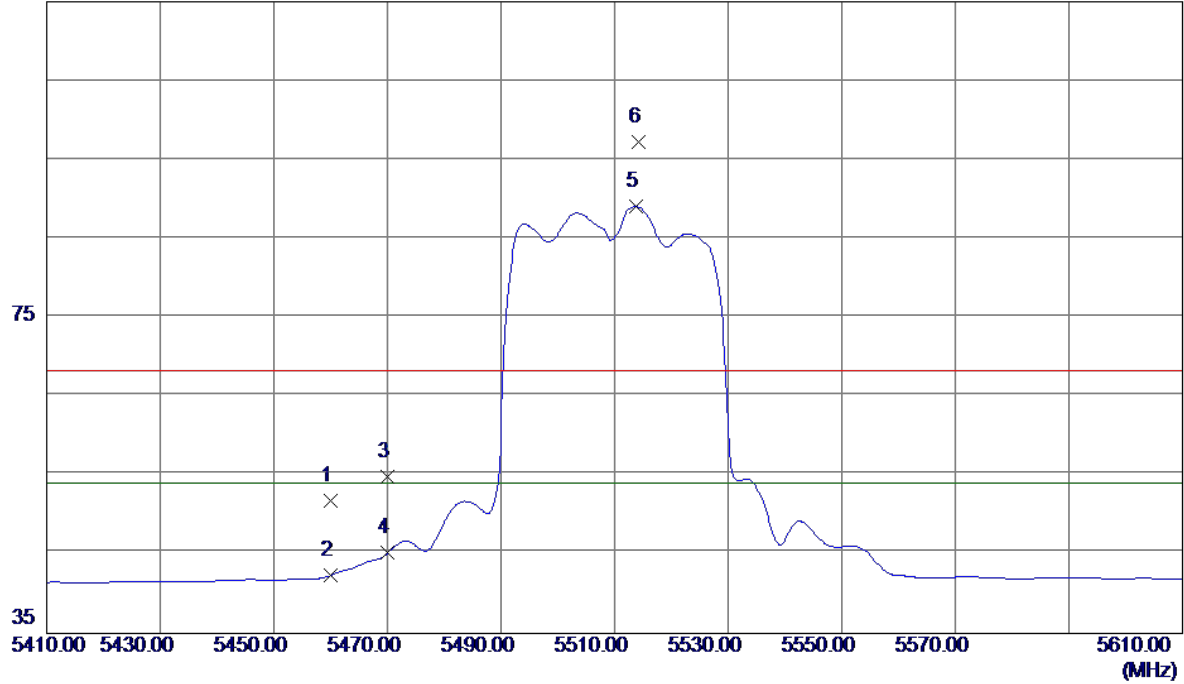

No.	Freq. MHz	Reading Level dBuV/m	Correct Factor dB	Measure ment dBuV/m	Limit dBuV/m	Margin dB	Detector	Comment
1	5460.0000	10.12	41.65	51.77	68.20	-16.43	Peak	
2	5460.0000	0.73	41.65	42.38	54.00	-11.62	AVG	
3	5470.0000	13.23	41.68	54.91	68.20	-13.29	Peak	
4	5470.0000	3.56	41.68	45.24	54.00	-8.76	AVG	
5 *	5513.7000	47.22	41.83	89.05	54.00	35.05	AVG	No Limit
6	5514.2000	55.39	41.83	97.22	68.20	29.02	Peak	No Limit

Orthogonal Axis :	X
Test Mode :	UNII-2C/ TX AC Wave2(40 MHz) 5510MHz

Vertical

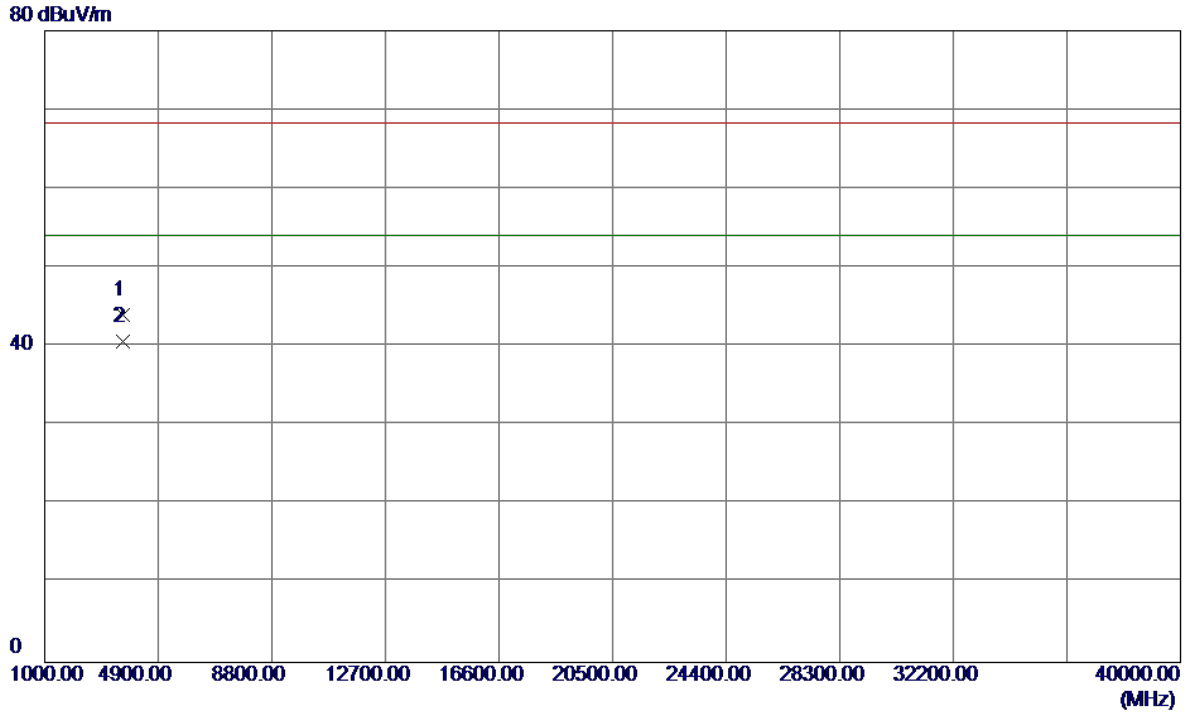

No.	Freq. MHz	Reading Level dBuV/m	Correct Factor dB	Measure ment dBuV/m	Limit dBuV/m	Margin dB	Detector	Comment
1	3673.2950	42.13	1.88	44.01	68.30	-24.29	Peak	
2 *	3673.3050	38.69	1.88	40.57	54.00	-13.43	AVG	

Orthogonal Axis :	X
Test Mode :	UNII-2C/ TX AC Wave2(40 MHz) 5510MHz

Horizontal

115 dBuV/m

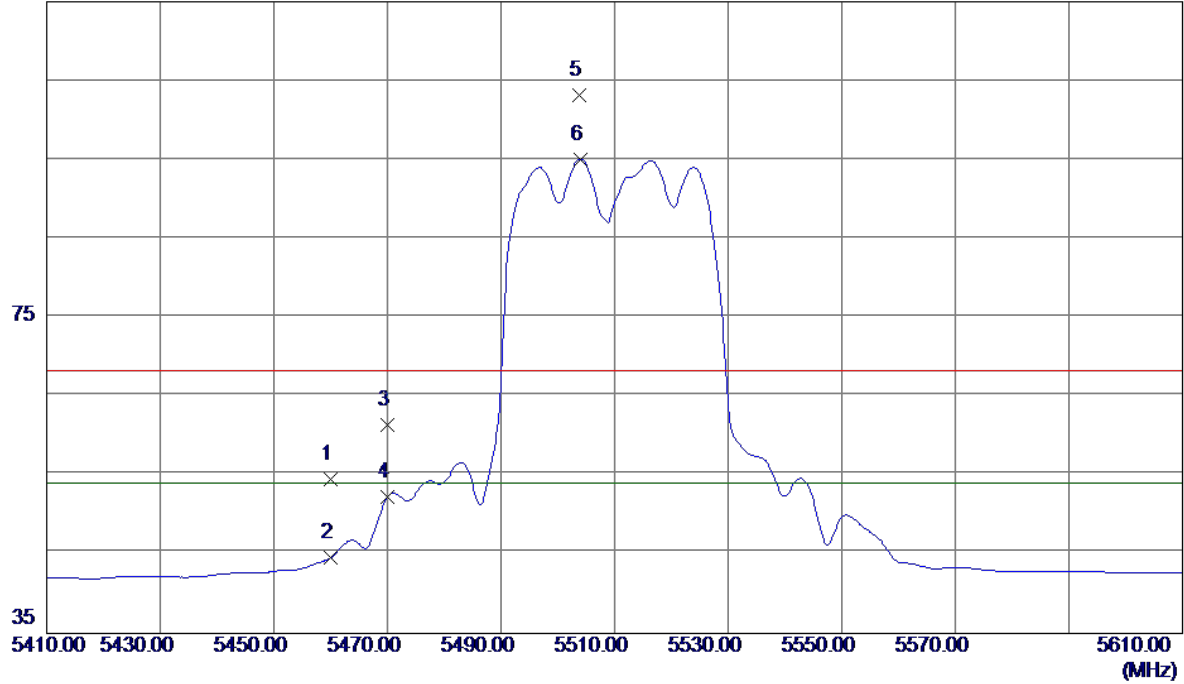

No.	Freq. MHz	Reading Level dBuV/m	Correct Factor dB	Measure ment dBuV/m	Limit dBuV/m	Margin dB	Detector	Comment
1	5460.0000	12.90	41.65	54.55	68.30	-13.75	Peak	
2	5460.0000	2.92	41.65	44.57	54.00	-9.43	AVG	
3	5470.0000	19.75	41.68	61.43	68.30	-6.87	Peak	
4	5470.0000	10.64	41.68	52.32	54.00	-1.68	AVG	
5	5503.8000	61.40	41.79	103.19	68.30	34.89	Peak	No Limit
6 *	5504.0000	53.24	41.79	95.03	54.00	41.03	AVG	No Limit

Orthogonal Axis :	X
Test Mode :	UNII-2C/ TX AC Wave2(40 MHz) 5510MHz

Horizontal

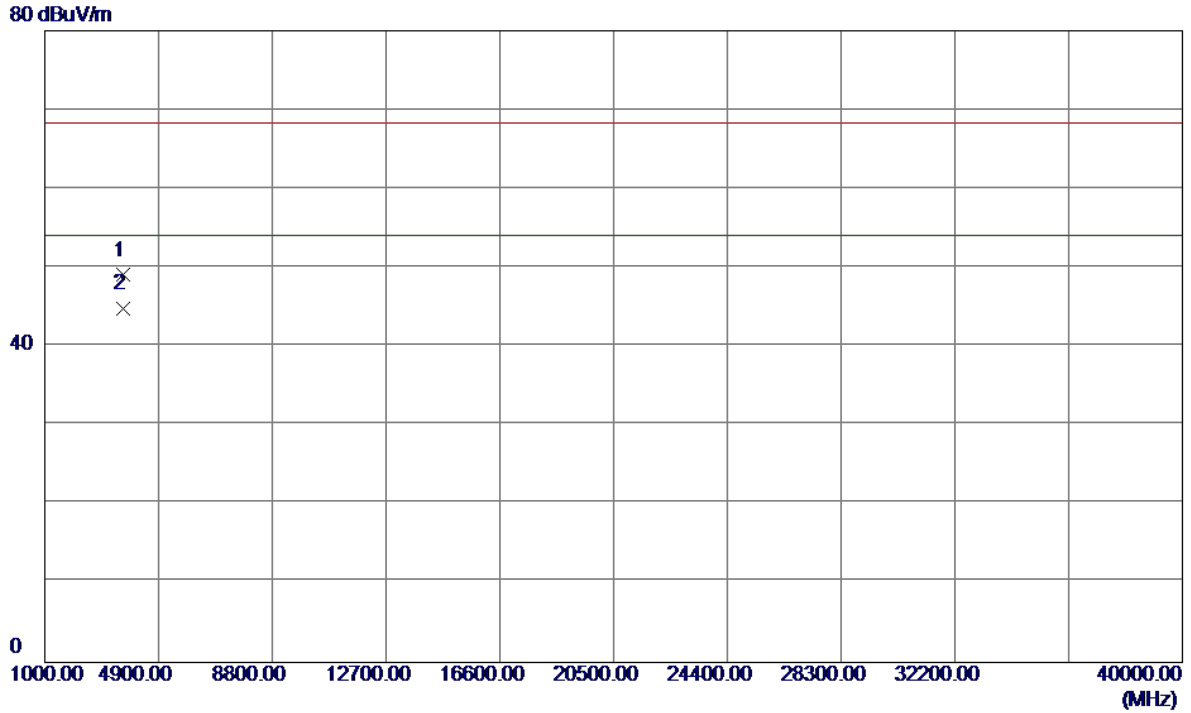

No.	Freq. MHz	Reading Level dBuV/m	Correct Factor dB	Measure ment dBuV/m	Limit dBuV/m	Margin dB	Detector	Comment
1	3673.3700	47.16	1.88	49.04	68.30	-19.26	Peak	
2 *	3673.1250	42.94	1.88	44.82	54.00	-9.18	AVG	

Orthogonal Axis :	X
Test Mode :	UNII-2C/TX AC Wave2(40 MHz) 5550MHz

Vertical

115 dBuV/m

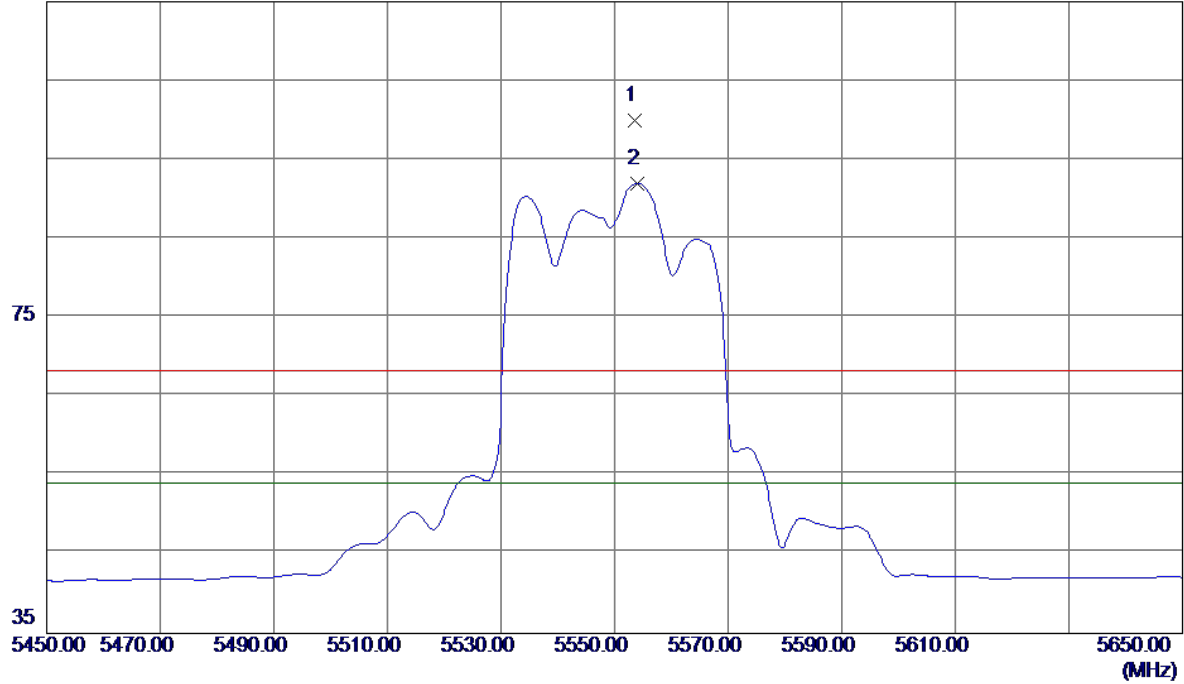

No.	Freq. MHz	Reading Level dBuV/m	Correct Factor dB	Measure ment dBuV/m	Limit dBuV/m	Margin dB	Detector	Comment
1	5553.5000	57.93	41.97	99.90	68.20	31.70	Peak	No Limit
2 *	5554.1000	50.03	41.97	92.00	54.00	38.00	AVG	No Limit

Orthogonal Axis :	X
Test Mode :	UNII-2C/ TX AC Wave2(40 MHz) 5550MHz

Vertical

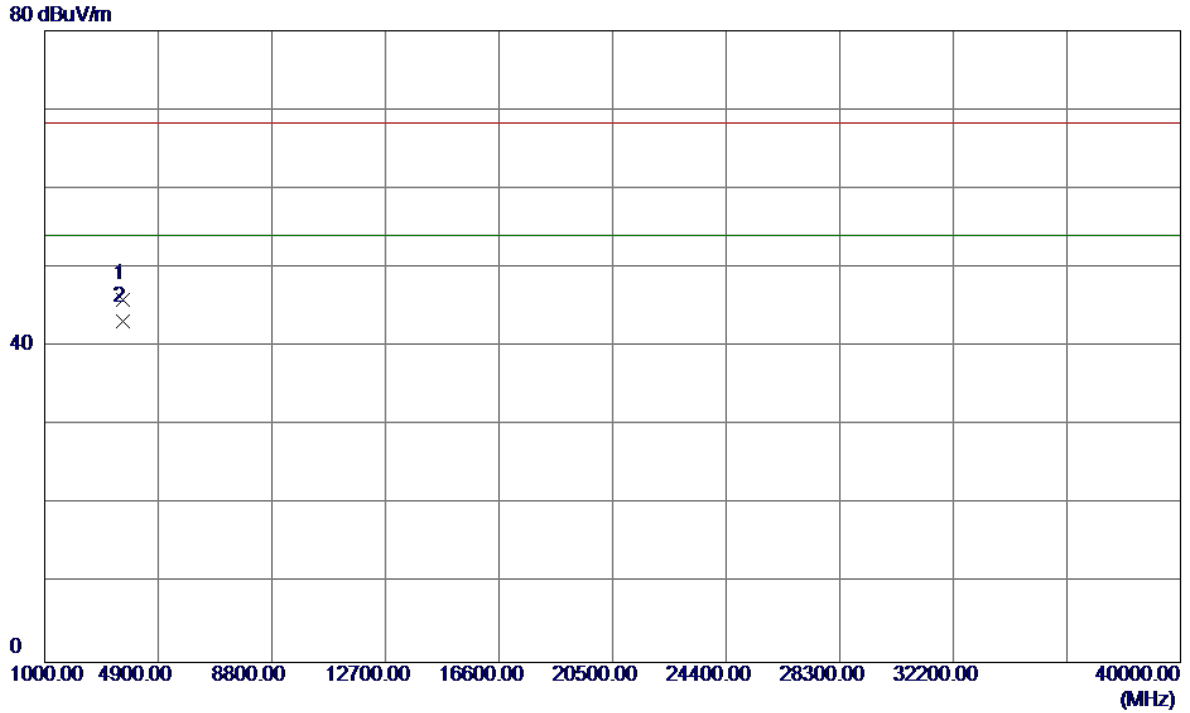

No.	Freq. MHz	Reading Level dBuV/m	Correct Factor dB	Measure ment dBuV/m	Limit dBuV/m	Margin dB	Detector	Comment
1	3699.9450	44.03	1.97	46.00	68.30	-22.30	Peak	
2 *	3699.9750	41.18	1.97	43.15	54.00	-10.85	AVG	

Orthogonal Axis :	X
Test Mode :	UNII-2C/ TX AC Wave2(40 MHz) 5550MHz

Horizontal

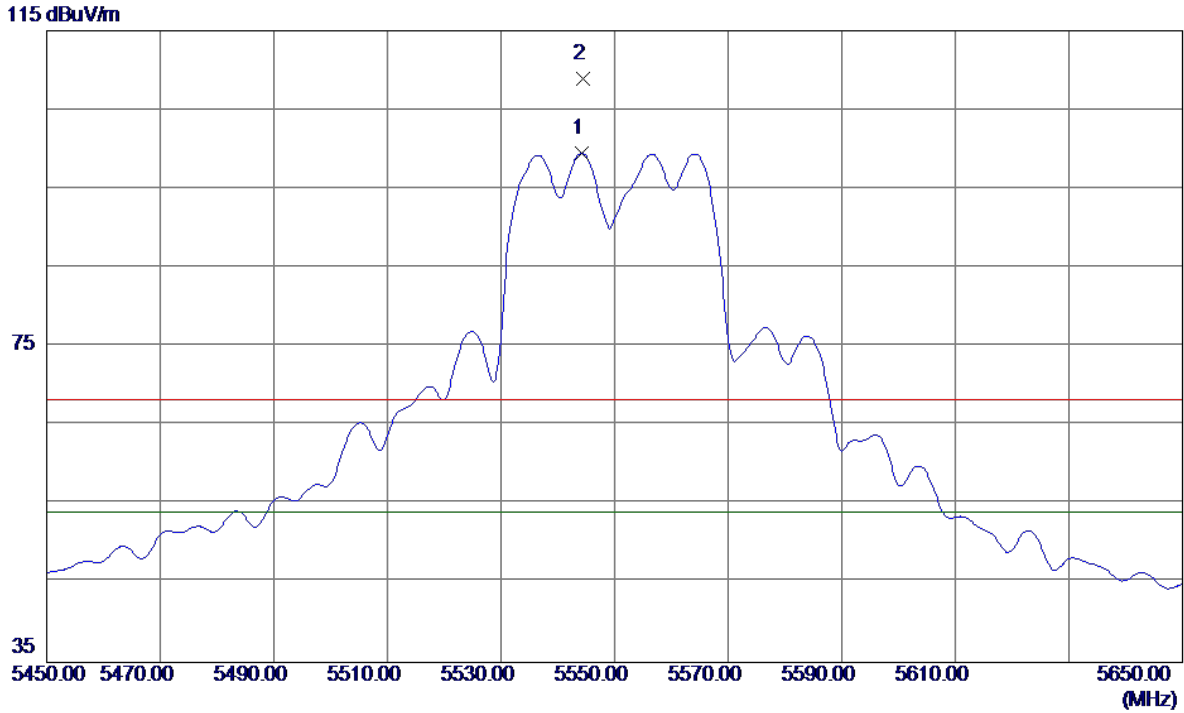

No.	Freq. MHz	Reading Level dBuV/m	Correct Factor dB	Measure ment dBuV/m	Limit dBuV/m	Margin dB	Detector	Comment
1 *	5544.2000	57.53	41.94	99.47	54.00	45.47	AVG	No Limit
2	5544.4000	67.01	41.94	108.95	68.30	40.65	Peak	No Limit

Orthogonal Axis :	X
Test Mode :	UNII-2C/ TX AC Wave2(40 MHz) 5550MHz

Horizontal

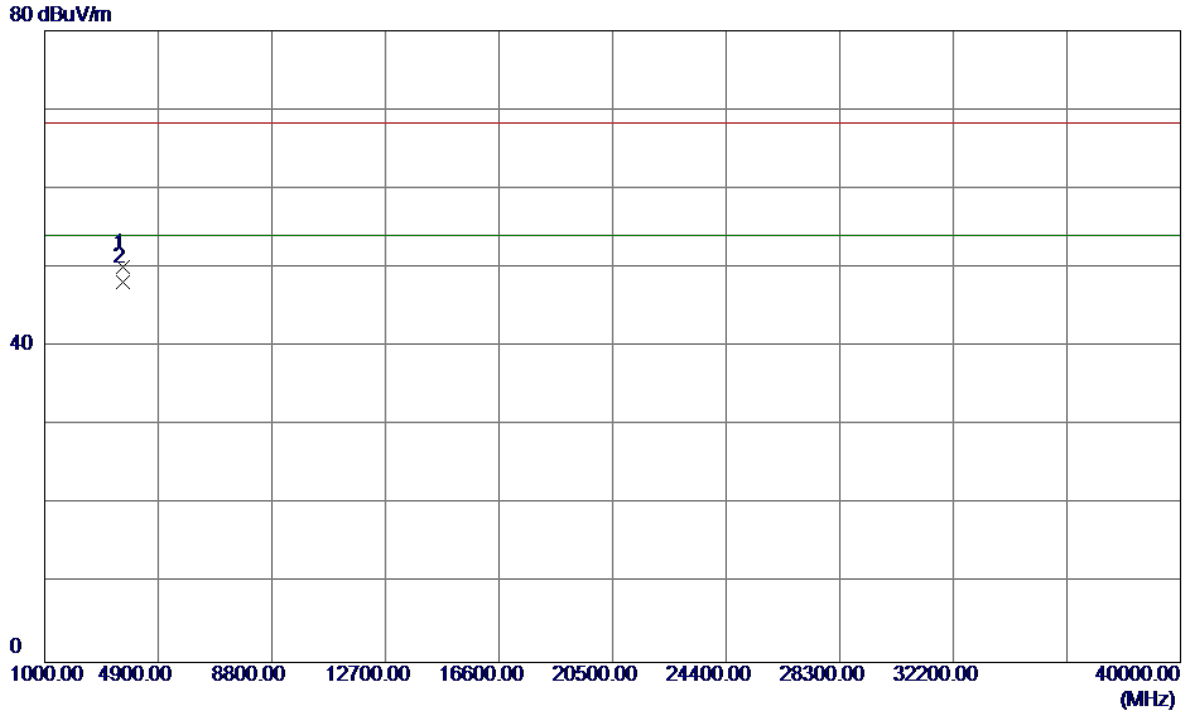

No.	Freq. MHz	Reading Level dBuV/m	Correct Factor dB	Measure ment dBuV/m	Limit dBuV/m	Margin dB	Detector	Comment
1	3699.9850	48.03	1.97	50.00	68.30	-18.30	Peak	
2 *	3699.9100	46.18	1.97	48.15	54.00	-5.85	AVG	

Orthogonal Axis :	X
Test Mode :	UNII-2C/ TX AC Wave2(40 MHz) 5670MHz

Vertical

115 dBuV/m

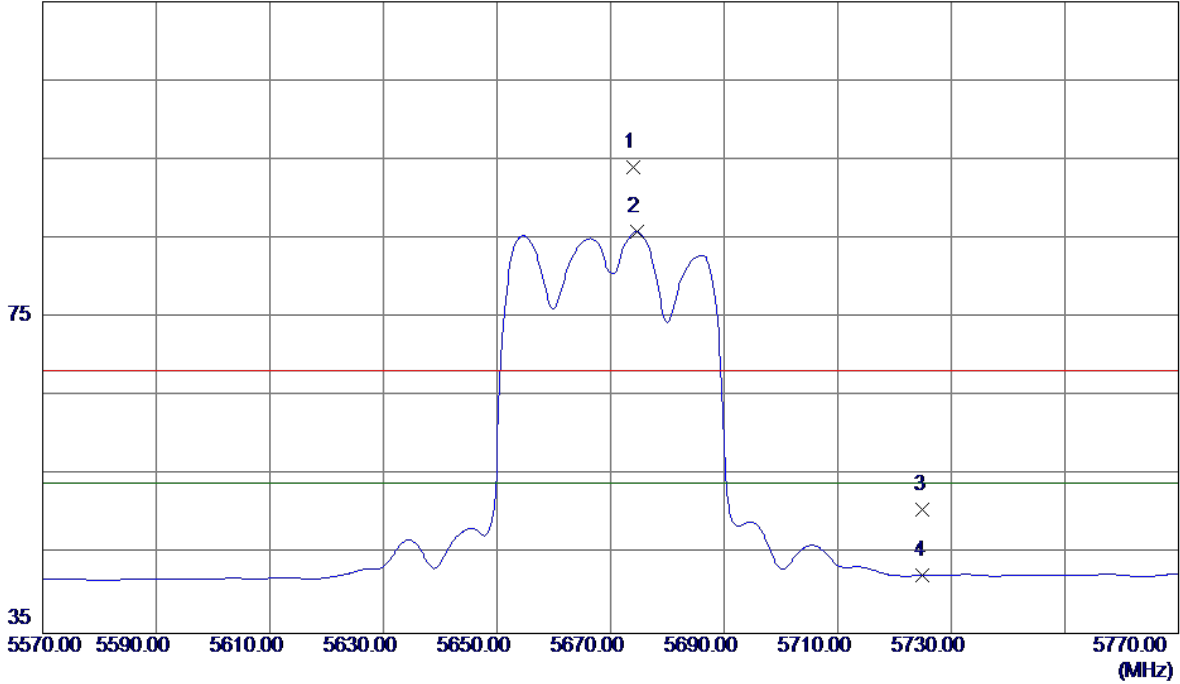

No.	Freq. MHz	Reading Level dBuV/m	Correct Factor dB	Measure ment dBuV/m	Limit dBuV/m	Margin dB	Detector	Comment
1	5673.9000	51.69	42.40	94.09	68.20	25.89	Peak	No Limit
2 *	5674.6000	43.45	42.40	85.85	54.00	31.85	AVG	No Limit
3	5725.0000	8.16	42.58	50.74	68.20	-17.46	Peak	
4	5725.0000	-0.21	42.58	42.37	54.00	-11.63	AVG	

Orthogonal Axis :	X
Test Mode :	UNII-2C/ TX AC Wave2(40 MHz) 5670MHz

Vertical

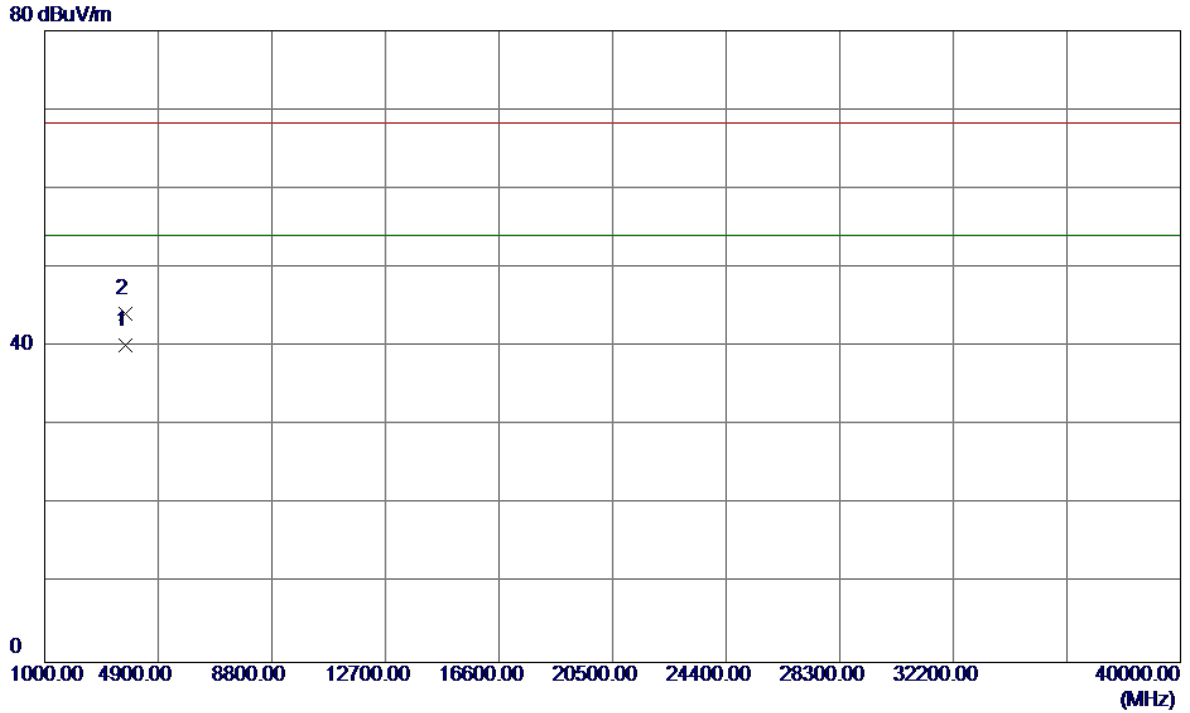

No.	Freq. MHz	Reading Level dBuV/m	Correct Factor dB	Measure ment dBuV/m	Limit dBuV/m	Margin dB	Detector	Comment
1 *	3779.9650	37.87	2.23	40.10	54.00	-13.90	AVG	
2	3780.0250	41.98	2.23	44.21	68.30	-24.09	Peak	

Orthogonal Axis :	X
Test Mode :	UNII-2C/ TX AC Wave2(40 MHz) 5670MHz

Horizontal

115 dBuV/m

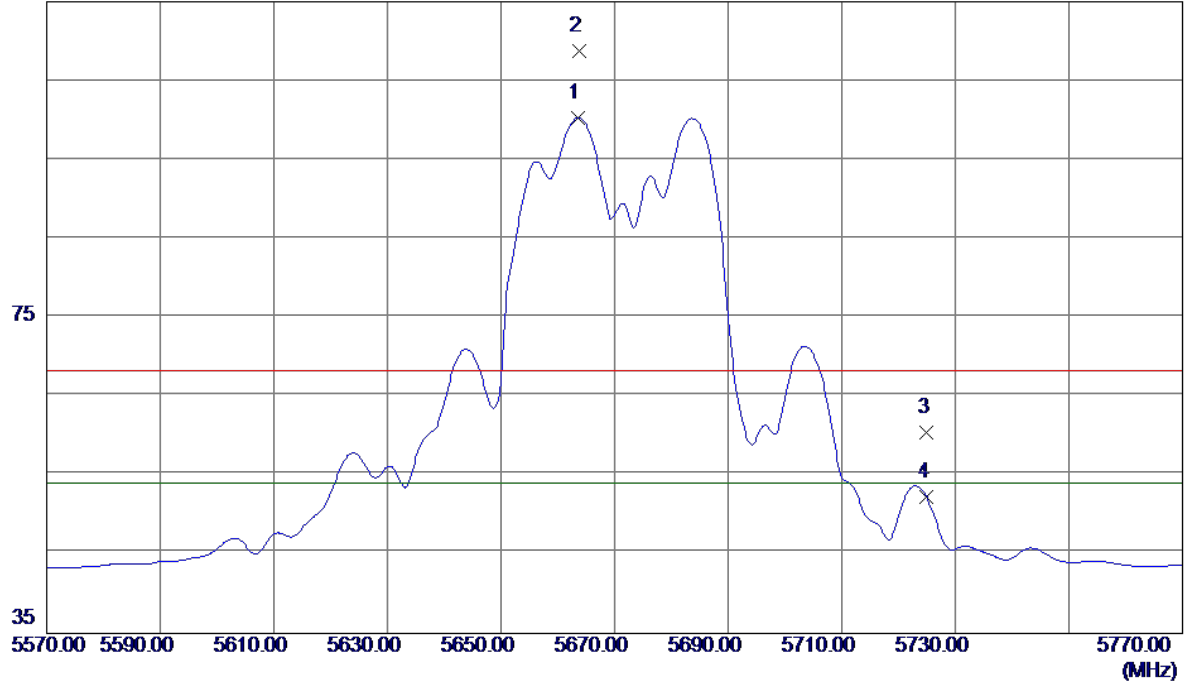

No.	Freq. MHz	Reading Level dBuV/m	Correct Factor dB	Measure ment dBuV/m	Limit dBuV/m	Margin dB	Detector	Comment
1 *	5663.6000	57.94	42.36	100.30	54.00	46.30	AVG	No Limit
2	5663.8000	66.44	42.36	108.80	68.30	40.50	Peak	No Limit
3	5725.0000	17.88	42.58	60.46	68.30	-7.84	Peak	
4	5725.0000	9.63	42.58	52.21	54.00	-1.79	AVG	

Orthogonal Axis :	X
Test Mode :	UNII-2C/ TX AC Wave2(40 MHz) 5670MHz

Horizontal

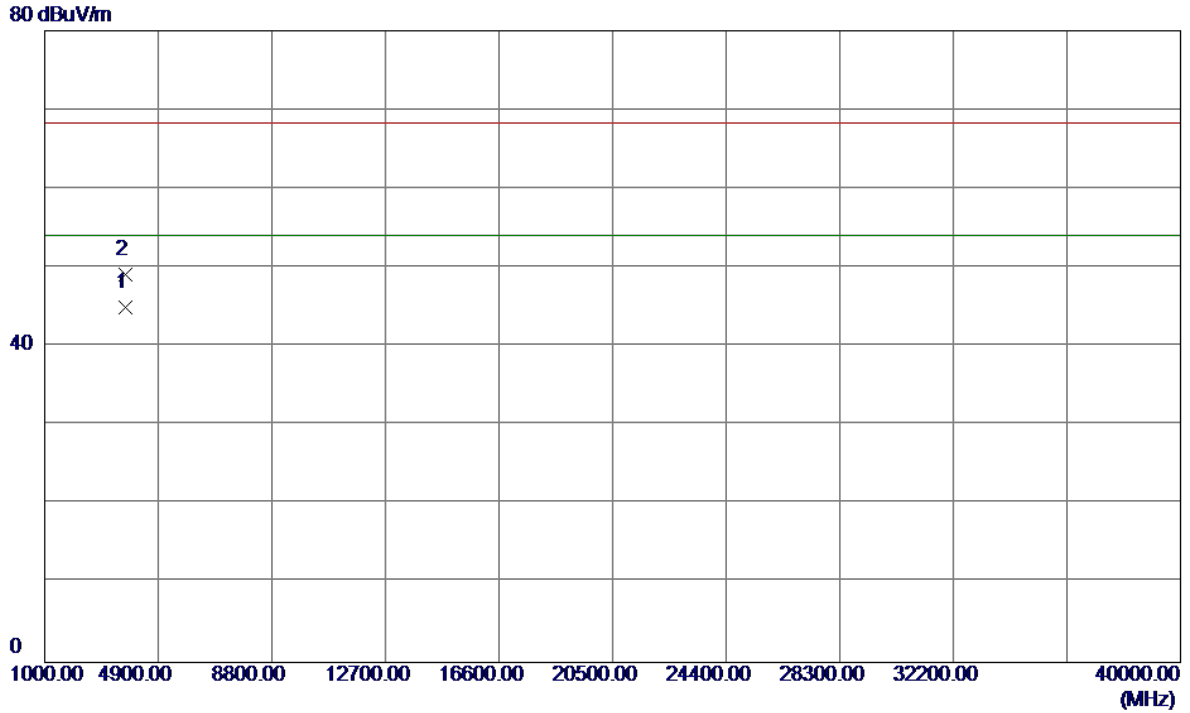

No.	Freq. MHz	Reading Level dBuV/m	Correct Factor dB	Measure ment dBuV/m	Limit dBuV/m	Margin dB	Detector	Comment
1 *	3779.6400	42.72	2.23	44.95	54.00	-9.05	AVG	
2	3780.1500	46.95	2.23	49.18	68.30	-19.12	Peak	

Orthogonal Axis :	X
Test Mode :	UNII-2C/ TX AC Wave2(80 MHz) 5530MHz

Vertical

115 dBuV/m

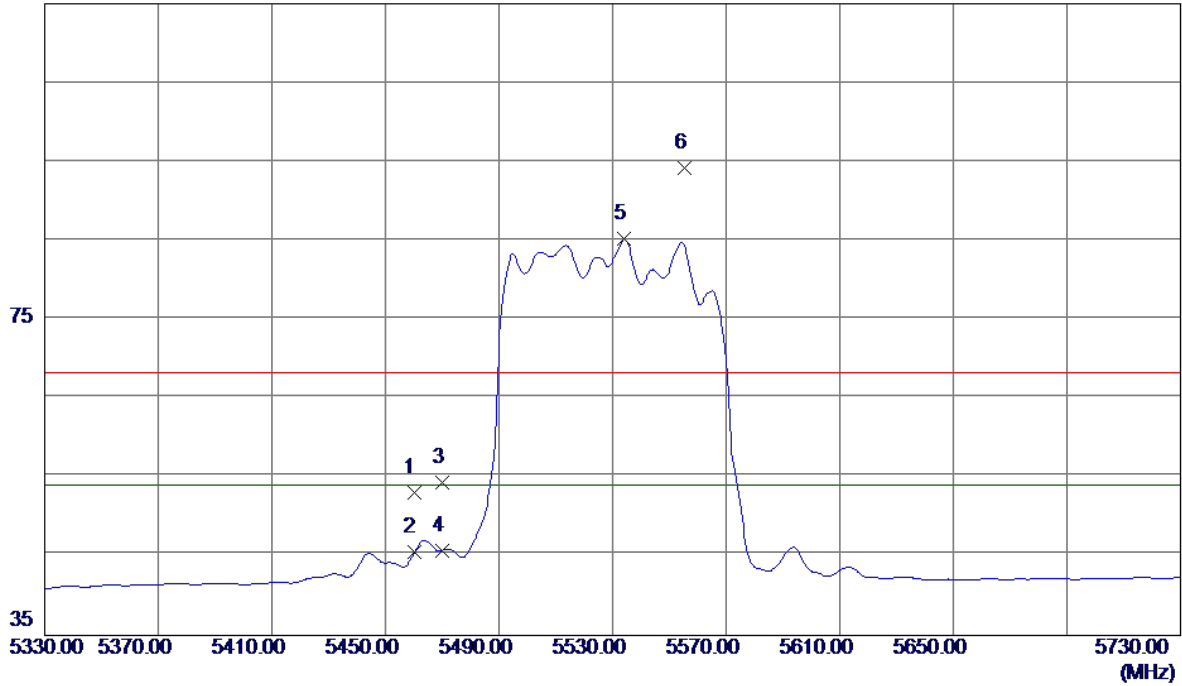

No.	Freq. MHz	Reading Level dBuV/m	Correct Factor dB	Measure ment dBuV/m	Limit dBuV/m	Margin dB	Detector	Comment
1	5460.0000	11.47	41.65	53.12	68.20	-15.08	Peak	
2	5460.0000	3.90	41.65	45.55	54.00	-8.45	AVG	
3	5470.0000	12.74	41.68	54.42	68.20	-13.78	Peak	
4	5470.0000	4.09	41.68	45.77	54.00	-8.23	AVG	
5 *	5533.8000	43.30	41.90	85.20	54.00	31.20	AVG	No Limit
6	5555.2000	52.29	41.98	94.27	68.20	26.07	Peak	No Limit

Orthogonal Axis :	X
Test Mode :	UNII-2C/ TX AC Wave2(80 MHz) 5530MHz

Vertical

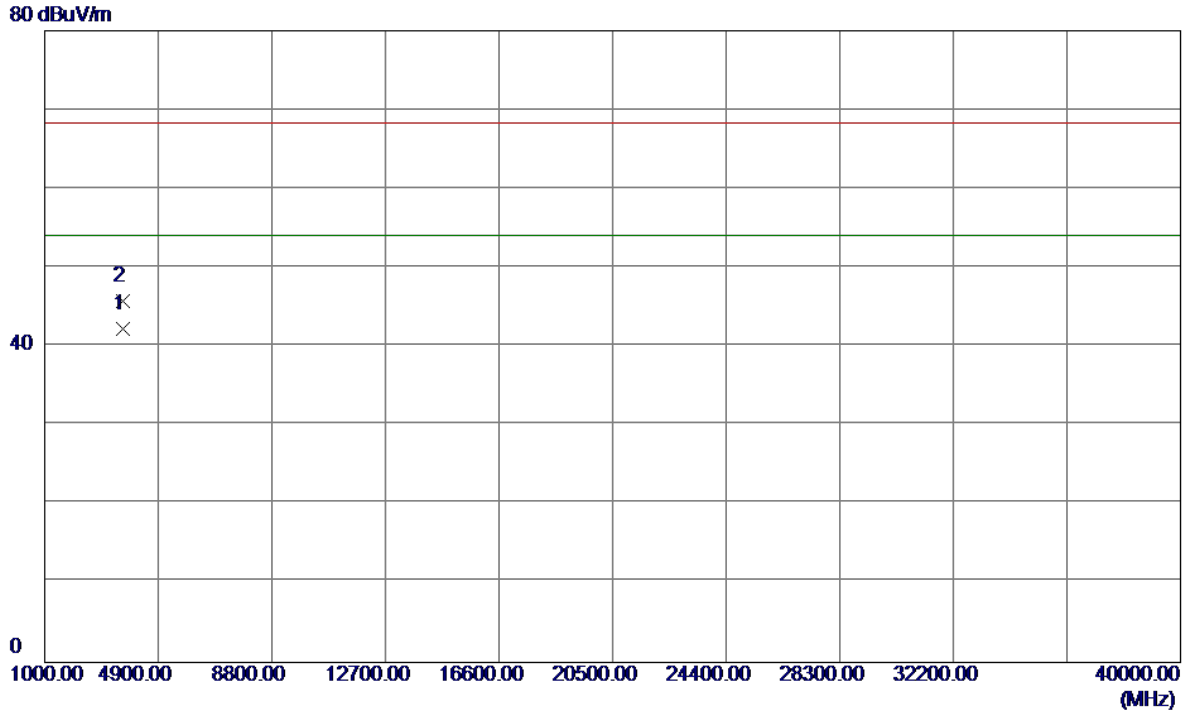

No.	Freq. MHz	Reading Level dBuV/m	Correct Factor dB	Measure ment dBuV/m	Limit dBuV/m	Margin dB	Detector	Comment
1 *	3686.6400	40.29	1.93	42.22	54.00	-11.78	AVG	
2	3686.6600	43.88	1.93	45.81	68.30	-22.49	Peak	

Orthogonal Axis :	X
Test Mode :	UNII-2C/ TX AC Wave2(80 MHz) 5530MHz

Horizontal

115 dBuV/m

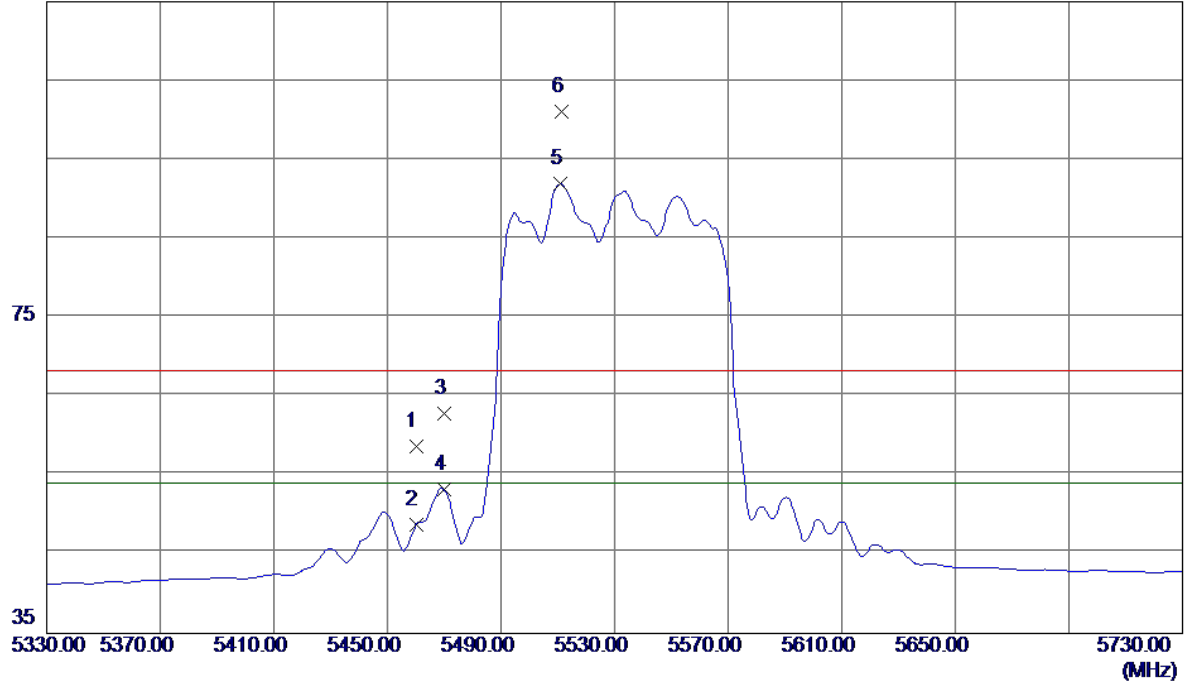

No.	Freq. MHz	Reading Level dBuV/m	Correct Factor dB	Measure ment dBuV/m	Limit dBuV/m	Margin dB	Detector	Comment
1	5460.0000	17.07	41.65	58.72	68.30	-9.58	Peak	
2	5460.0000	7.08	41.65	48.73	54.00	-5.27	AVG	
3	5470.0000	21.22	41.68	62.90	68.30	-5.40	Peak	
4	5470.0000	11.50	41.68	53.18	54.00	-0.82	AVG	
5 *	5510.8000	50.08	41.82	91.90	54.00	37.90	AVG	No Limit
6	5511.2000	59.29	41.82	101.11	68.30	32.81	Peak	No Limit

Orthogonal Axis :	X
Test Mode :	UNII-2C/ TX AC Wave2(80 MHz) 5530MHz

Horizontal

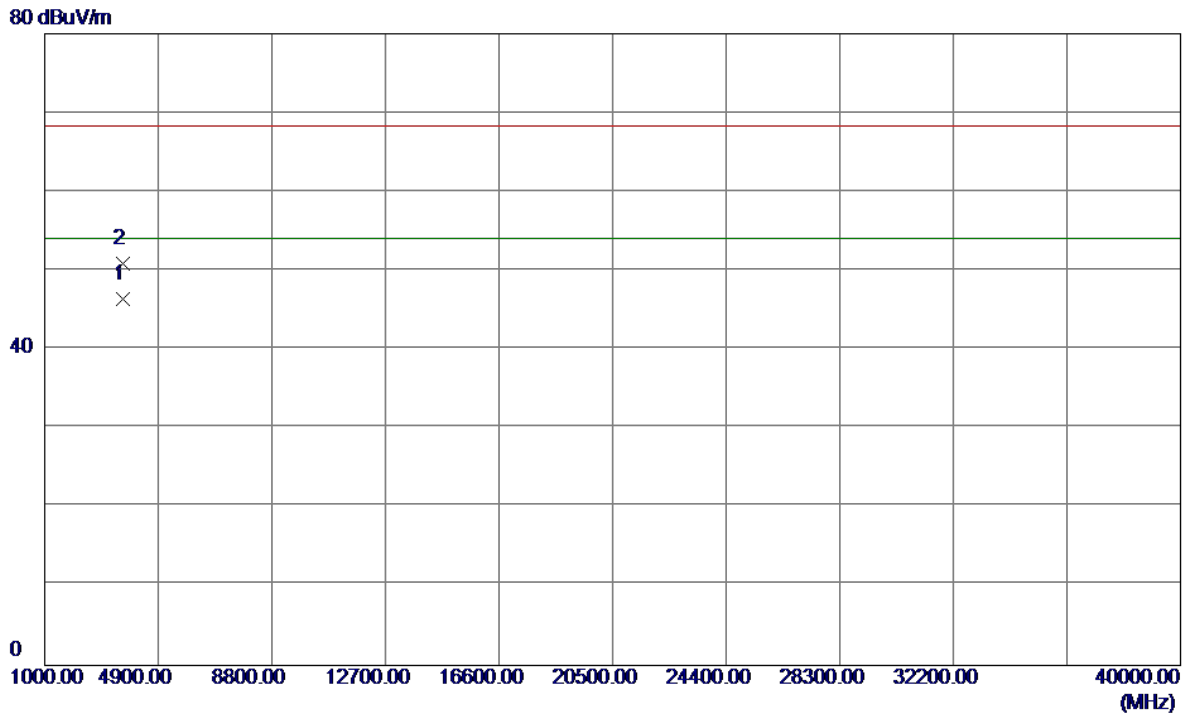

No.	Freq. MHz	Reading Level dBuV/m	Correct Factor dB	Measure ment dBuV/m	Limit dBuV/m	Margin dB	Detector	Comment
1 *	3686.3200	44.53	1.92	46.45	54.00	-7.55	AVG	
2	3686.8400	48.96	1.93	50.89	68.30	-17.41	Peak	

Orthogonal Axis :	X
Test Mode :	UNII-2C/ TX AC Wave2(80 MHz) 5610MHz

Vertical

115 dBuV/m

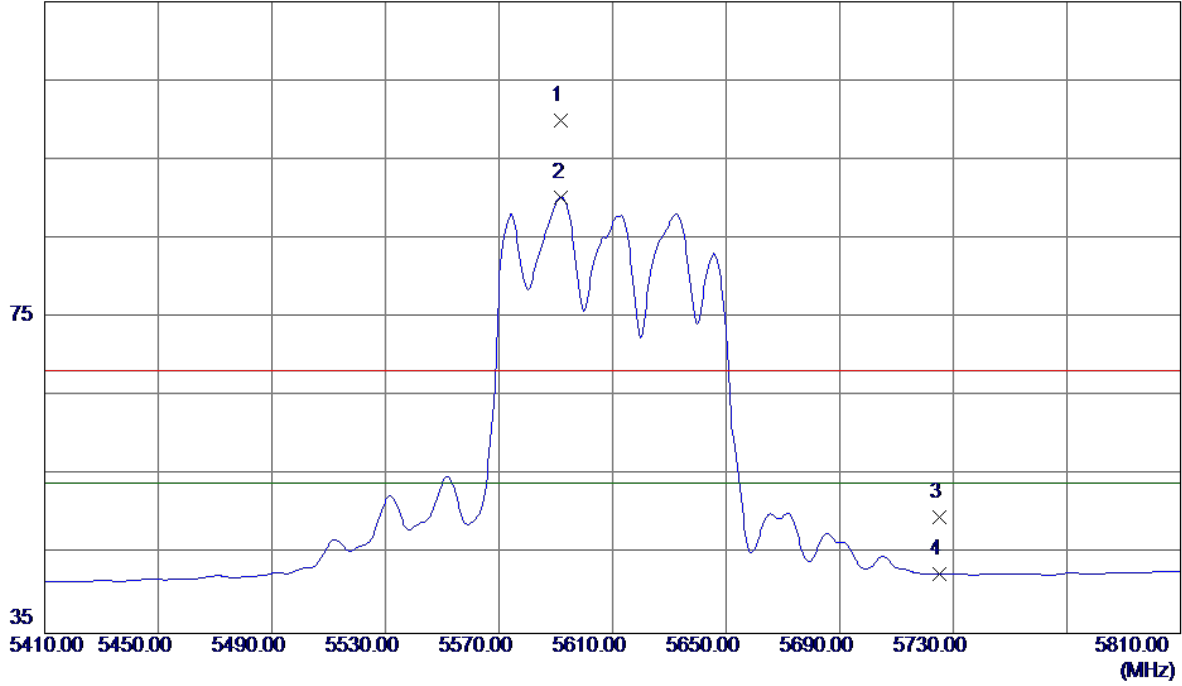

No.	Freq. MHz	Reading Level dBuV/m	Correct Factor dB	Measure ment dBuV/m	Limit dBuV/m	Margin dB	Detector	Comment
1	5591.6000	57.82	42.11	99.93	68.20	31.73	Peak	No Limit
2 *	5592.0000	48.16	42.11	90.27	54.00	36.27	AVG	No Limit
3	5725.0000	7.15	42.58	49.73	68.20	-18.47	Peak	
4	5725.0000	-0.01	42.58	42.57	54.00	-11.43	AVG	

Orthogonal Axis :	X
Test Mode :	UNII-2C/ TX AC Wave2(80 MHz) 5610MHz

Vertical

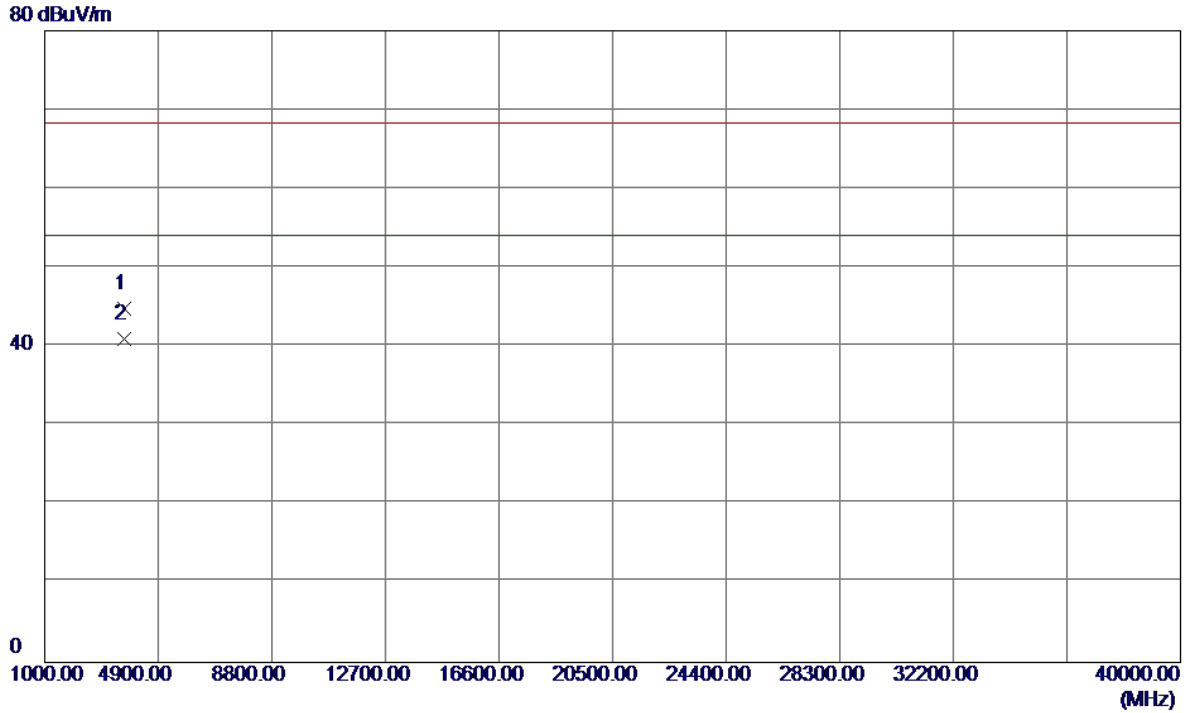

No.	Freq. MHz	Reading Level dBuV/m	Correct Factor dB	Measure ment dBuV/m	Limit dBuV/m	Margin dB	Detector	Comment
1	3739.7650	42.73	2.10	44.83	68.30	-23.47	Peak	
2 *	3739.9800	38.86	2.10	40.96	54.00	-13.04	AVG	

Orthogonal Axis :	X
Test Mode :	UNII-2C/ TX AC Wave2(80 MHz) 5610MHz

Horizontal

115 dBuV/m

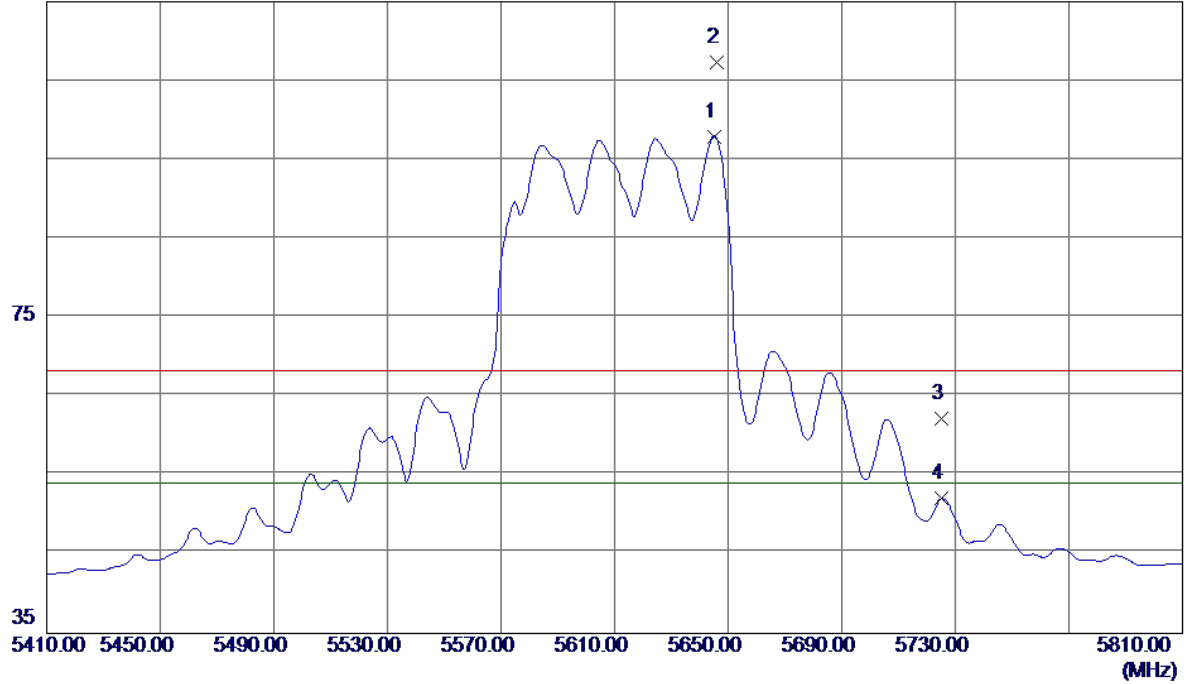

No.	Freq. MHz	Reading Level dBuV/m	Correct Factor dB	Measure ment dBuV/m	Limit dBuV/m	Margin dB	Detector	Comment
1 *	5645.2000	55.66	42.30	97.96	54.00	43.96	AVG	No Limit
2	5646.0000	65.06	42.30	107.36	68.30	39.06	Peak	No Limit
3	5725.0000	19.64	42.58	62.22	68.30	-6.08	Peak	
4	5725.0000	9.47	42.58	52.05	54.00	-1.95	AVG	

Orthogonal Axis :	X
Test Mode :	UNII-2C/ TX AC Wave2(80 MHz) 5610MHz

Horizontal

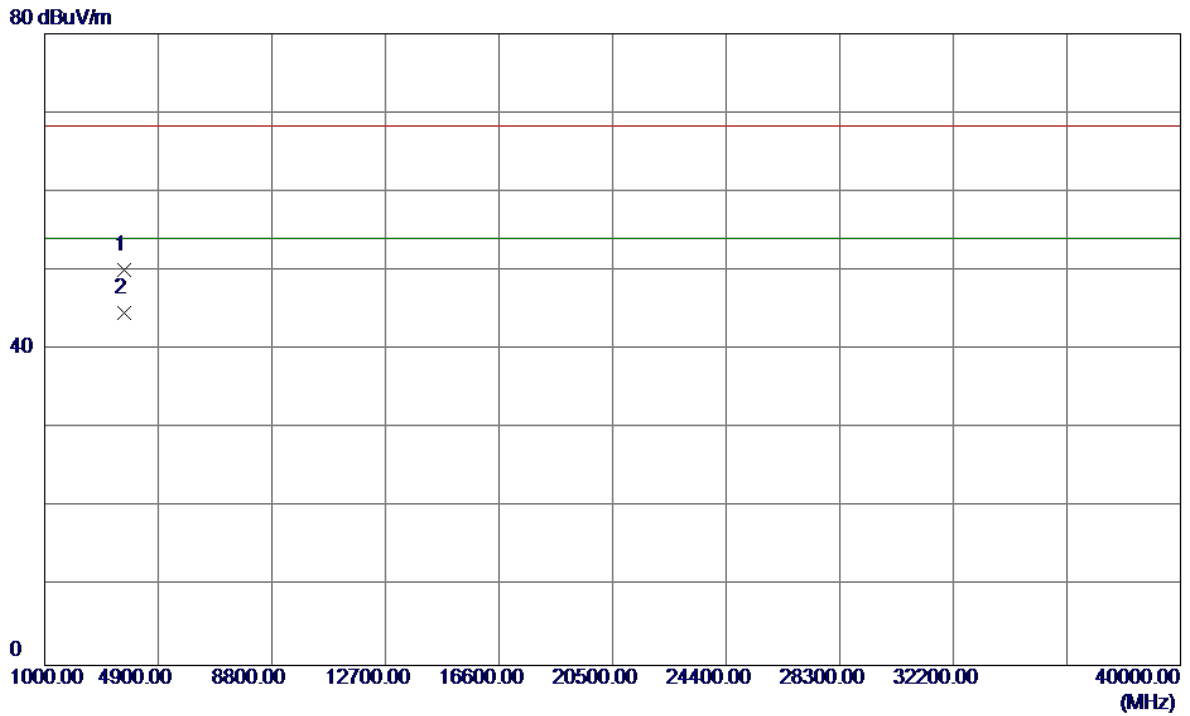

No.	Freq. MHz	Reading Level dBuV/m	Correct Factor dB	Measure ment dBuV/m	Limit dBuV/m	Margin dB	Detector	Comment
1	3739.6550	47.96	2.10	50.06	68.30	-18.24	Peak	
2 *	3739.4200	42.50	2.10	44.60	54.00	-9.40	AVG	

Test Mode: TX AC Wave2(160 MHz) Mode 5290MHz

Vertical

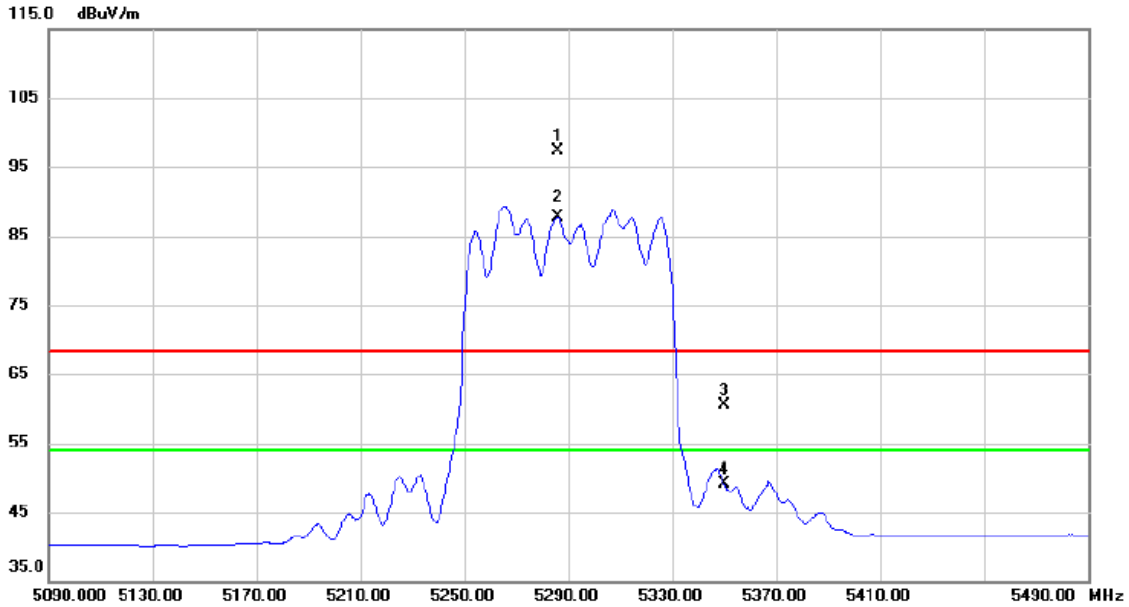

No.	Mk.	Freq. MHz	Reading Level dBuV	Correct Factor dB	Measure- ment dBuV/m	Limit dBuV/m	Margin dB	Detector	Comment
1	X	5285.750	56.26	41.08	97.34	68.20	29.14	peak	No Limit
2	*	5285.800	46.67	41.08	87.75	54.00	33.75	AVG	No Limit
3		5350.000	19.17	41.28	60.45	68.20	-7.75	peak	
4		5350.000	7.84	41.28	49.12	68.20	-19.08	peak	

Test Mode: TX AC Wave2(160 MHz) Mode 5290MHz

Horizontal

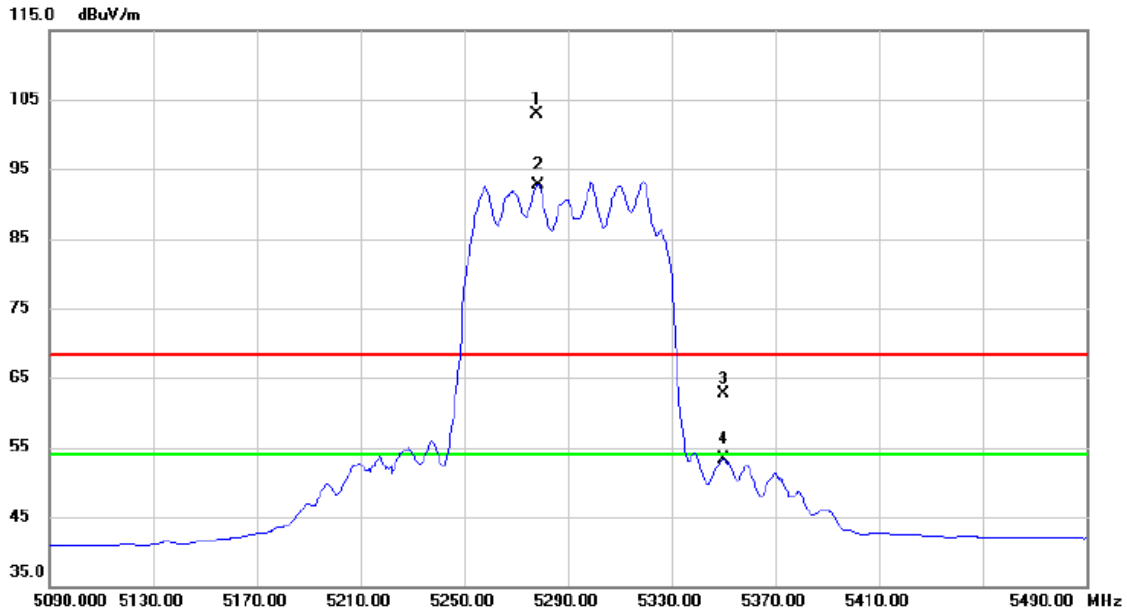

No.	Mk.	Freq. MHz	Reading Level dBuV	Correct Factor dB	Measure- ment dBuV/m	Limit dBuV/m	Margin dB	Detector	Comment
1	X	5278.200	61.81	41.05	102.86	68.20	34.66	peak	No Limit
2	*	5278.380	51.65	41.05	92.70	54.00	38.70	AVG	No Limit
3		5350.000	21.51	41.28	62.79	68.20	-5.41	peak	
4		5350.000	11.97	41.28	53.25	54.00	-0.75	AVG	

Test Mode: TX AC Wave2(160 MHz) Mode 5610MHz

Vertical

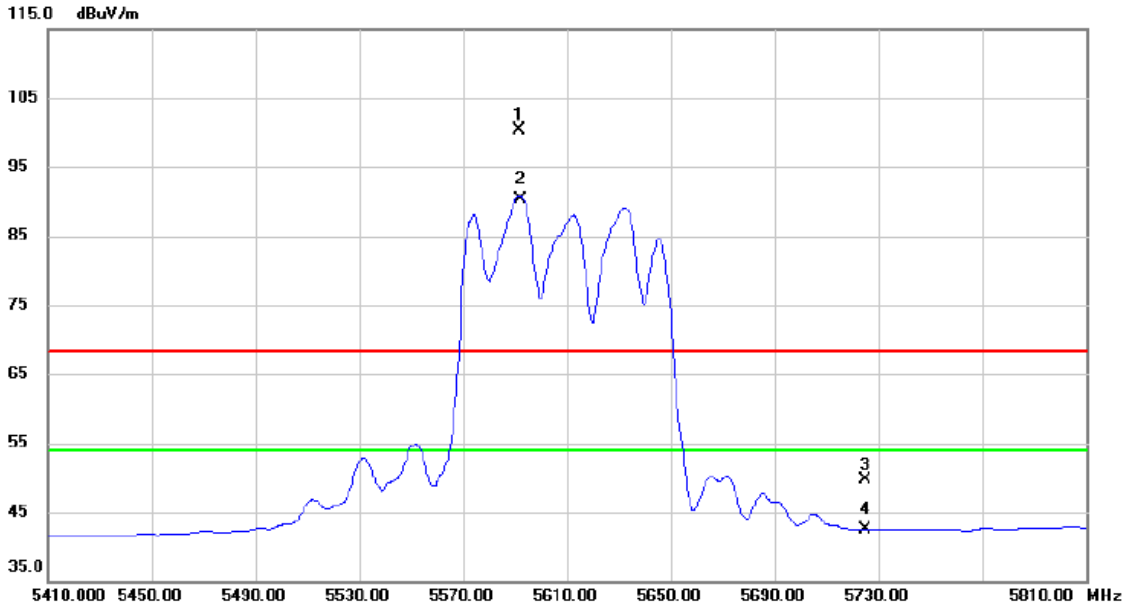

No.	Mk.	Freq. MHz	Reading Level dBuV	Correct Factor dB	Measure- ment dBuV/m	Limit dBuV/m	Margin dB	Detector	Comment
1	X	5591.600	58.19	42.11	100.30	68.20	32.10	peak	No Limit
2	*	5592.210	48.16	42.11	90.27	54.00	36.27	AVG	No Limit
3		5725.000	7.15	42.58	49.73	68.20	-18.47	peak	
4		5725.000	-0.01	42.58	42.57	54.00	-11.43	AVG	

Test Mode: TX AC Wave2(160 MHz) Mode 5610MHz

Horizontal

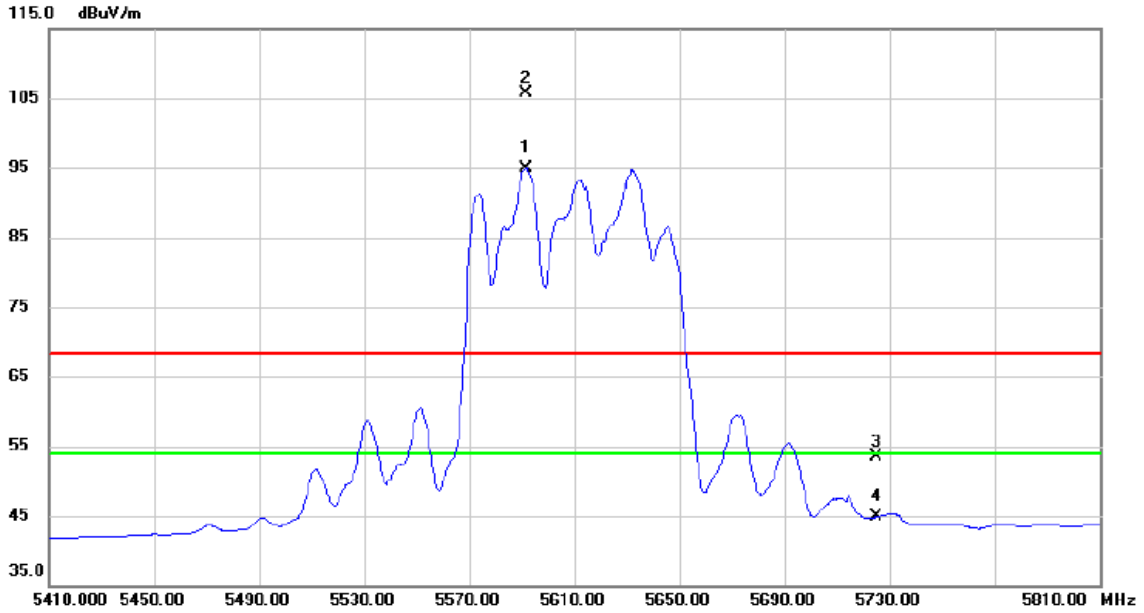

No.	Mk.	Freq. MHz	Reading Level dBuV	Correct Factor dB	Measure- ment dBuV/m	Limit dBuV/m	Margin dB	Detector	Comment
1	*	5591.720	52.80	42.11	94.91	54.00	40.91	AVG	No Limit
2	X	5591.810	63.63	42.11	105.74	68.20	37.54	peak	No Limit
3		5725.000	10.95	42.58	53.53	68.20	-14.67	peak	
4		5725.000	2.27	42.58	44.85	54.00	-9.15	AVG	

Test Mode: TX AC Wave2(160 MHz) Mode 5290MHz+5610MHz

Vertical

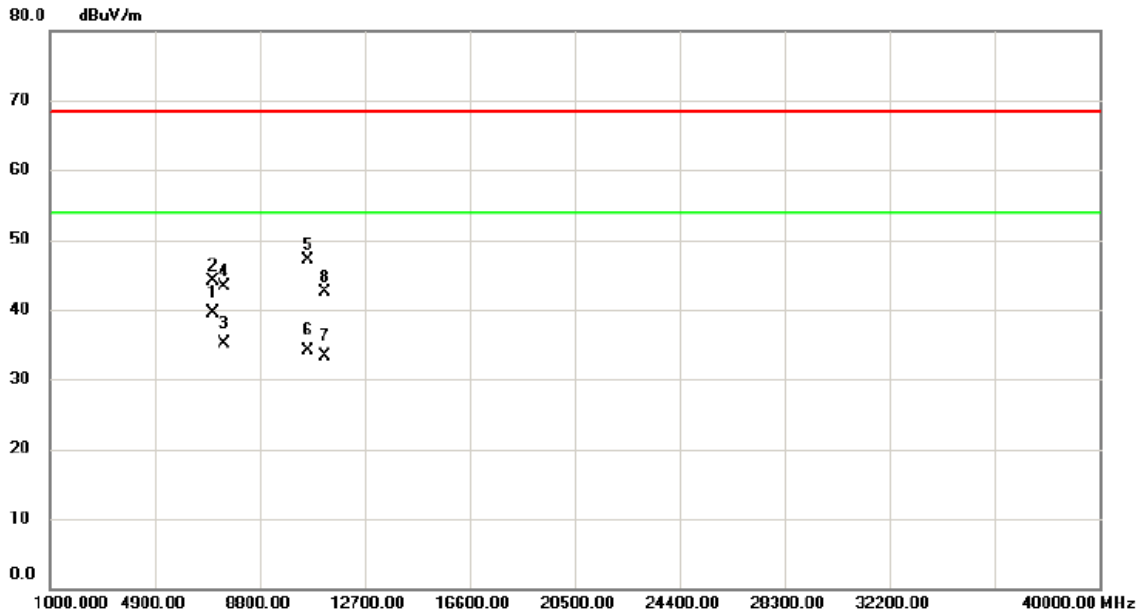

No.	Mk.	Freq. MHz	Reading Level dBuV	Correct Factor dB	Measure- ment dBuV/m	Limit dBuV/m	Margin dB	Detector	Comment
1	*	7053.660	28.66	10.85	39.51	54.00	-14.49	AVG	
2		7053.905	33.35	10.85	44.20	68.30	-24.10	peak	
3		7480.000	23.40	11.72	35.12	54.00	-18.88	AVG	
4		7481.000	31.64	11.72	43.36	68.30	-24.94	peak	
5		10579.500	31.81	15.39	47.20	68.30	-21.10	peak	
6		10580.000	18.62	15.39	34.01	54.00	-19.99	AVG	
7		11220.500	17.59	15.74	33.33	54.00	-20.67	AVG	
8		11220.750	26.74	15.73	42.47	68.30	-25.83	peak	

Test Mode: TX AC Wave2(160 MHz) Mode 5290MHz+5610MHz

Horizontal

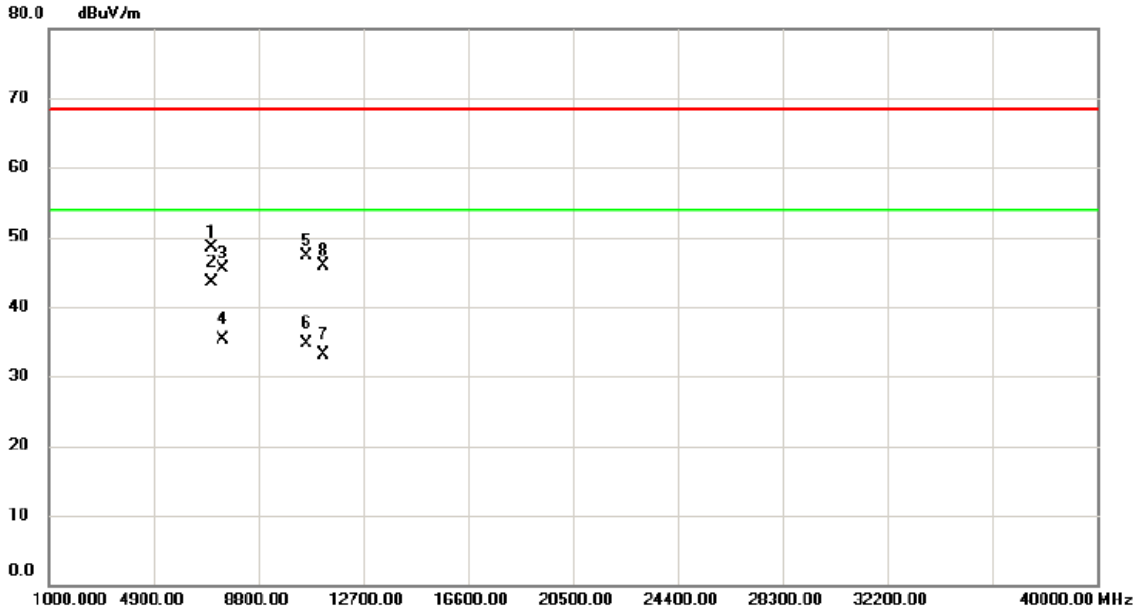

No.	Mk.	Freq. MHz	Reading Level dBuV	Correct Factor dB	Measure- ment dBuV/m	Limit dBuV/m	Margin dB	Detector	Comment
1		7053.512	37.63	10.86	48.49	68.30	-19.81	peak	
2	*	7053.655	32.58	10.85	43.43	54.00	-10.57	AVG	
3		7480.057	33.77	11.72	45.49	68.30	-22.81	peak	
4		7480.970	23.52	11.72	35.24	54.00	-18.76	AVG	
5		10580.540	31.86	15.39	47.25	68.30	-21.05	peak	
6		10580.983	19.36	15.39	34.75	54.00	-19.25	AVG	
7		11220.250	17.37	15.74	33.11	54.00	-20.89	AVG	
8		11220.750	30.13	15.73	45.86	68.30	-22.44	peak	

TX A Mode_DUTY CYCLE

Duty cycle: TX DUTYMHZ

Duty cycle = T_{ON} / T_{Total}

T_{ON} :2.07msec

T_{Total} :2.14msec

Duty cycle: 96.73%

Duty Factor= $10 \log(1/\text{Duty cycle})$

Duty Factor =0.14

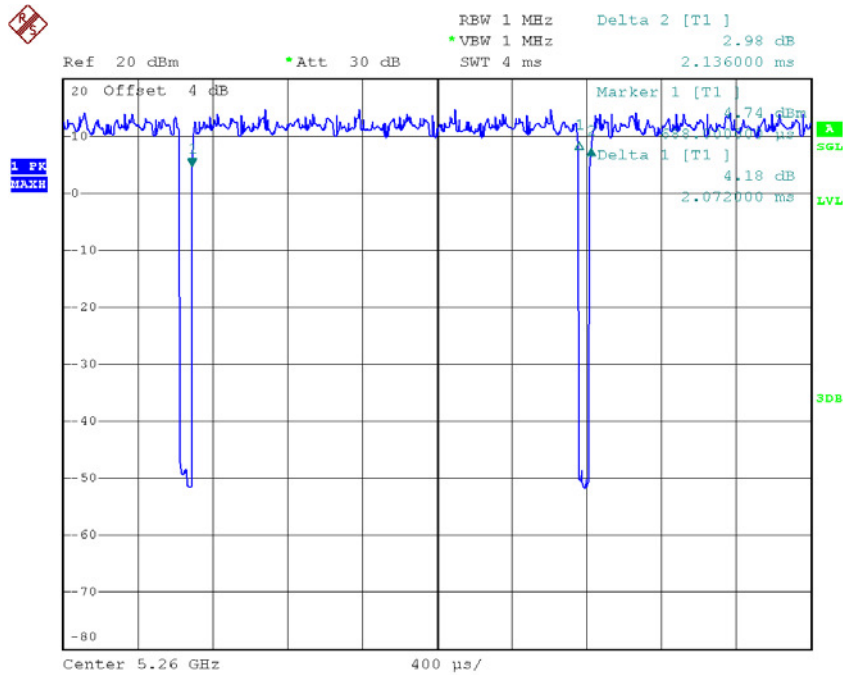

Date: 13.DEC.2016 09:19:27

Note: The EUT was programmed to be in countinously transmitting mode and the transmit duty cycle isless than 98 %, so, the output power and power density should be cacluated

asOutput Power = Measured power + Ducus factor

Power Spectral Density = Measured density + Duty factor

TX N20 Mode_DUTY CYCLE

Duty cycle: TX DUTYMHZ

Duty cycle = T_{ON} / T_{Total}

T_{ON} :5.01msec

T_{Total} :5.08msec

Duty cycle: 98.62%

Duty Factor= $10 \log(1/\text{Duty cycle})$

Duty Factor =0.06

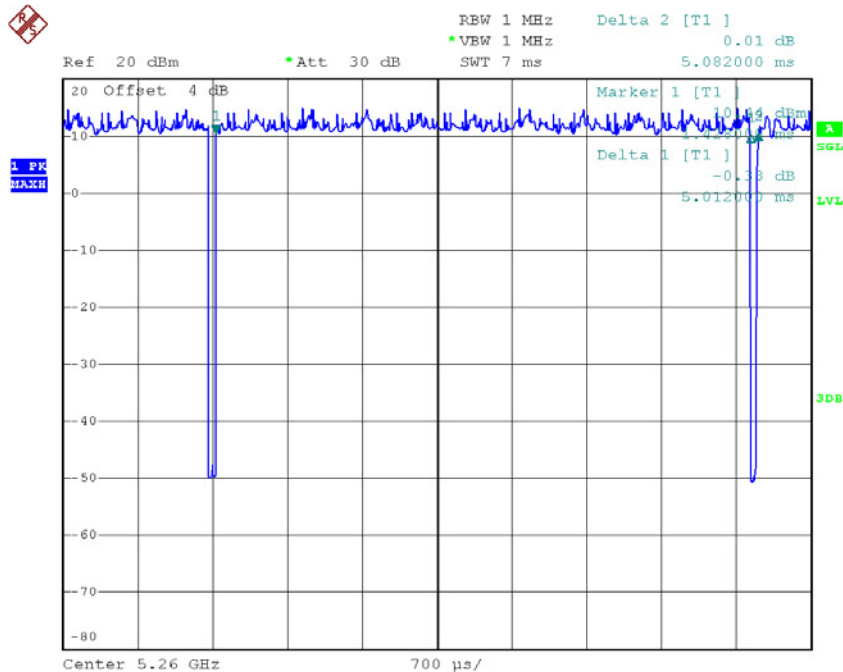

Date: 13.DEC.2016 09:36:52

Note: The EUT was programmed to be in countinously transmitting mode and the transmit duty cycle is not less than 98 %, so, the output power and power density should be cacluated as
 asOutput Power = Measured power + Ducus factor
 Power Spectral Density = Measured density + Duty factor

TX N40 Mode_DUTY CYCLE

Duty cycle: TX DUTYMHZ

Duty cycle = T_{ON} / T_{Total}

T_{ON} :2.42msec

T_{Total} :2.50msec

Duty cycle: 96.80%

Duty Factor= $10 \log(1/\text{Duty cycle})$

Duty Factor =0.14

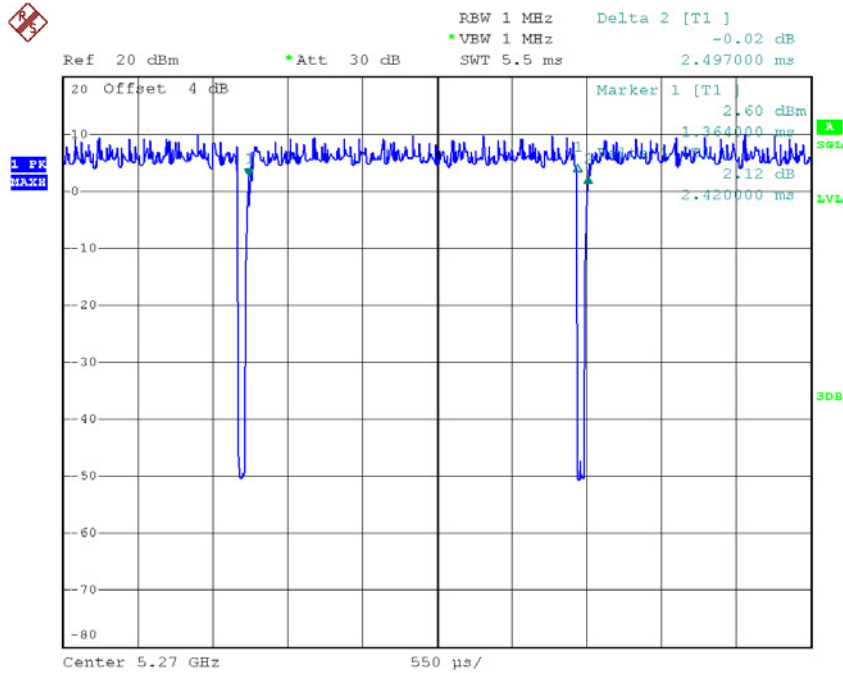

Date: 13.DEC.2016 13:56:24

Note: The EUT was programmed to be in countinously transmitting mode and the transmit duty cycle is less than 98 %, so, the output power and power density should be cacluated as
 asOutput Power = Measured power + Ducus factor
 Power Spectral Density = Measured density + Duty factor

TX AC Wave2(20 MHz) Mode_DUTY CYCLE

Duty cycle: TX DUTYMHZ

Duty cycle = T_{ON} / T_{Total}

T_{ON} :5.03msec

T_{Total} :5.10msec

Duty cycle: 98.63%

Duty Factor= $10 \log(1/\text{Duty cycle})$

Duty Factor =0.06

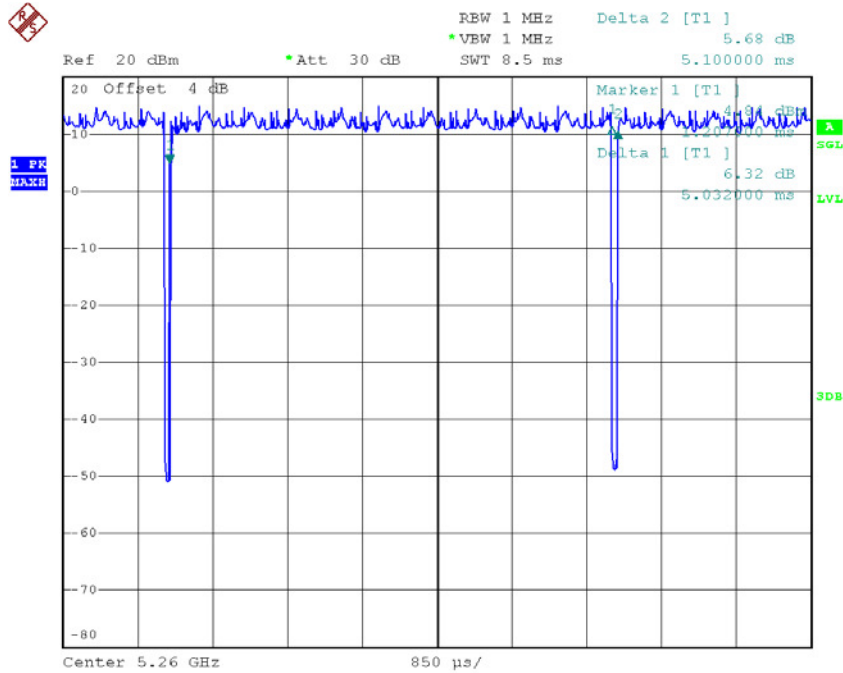

Date: 13.DEC.2016 13:39:19

Note: The EUT was programmed to be in continuously transmitting mode and the transmit duty cycle is not less than 98 %, so, the output power and power density should be calculated as
 Output Power = Measured power + Duty factor
 Power Spectral Density = Measured density + Duty factor

TX AC Wave2(40 MHz)_DUTY CYCLE

Duty cycle: TX DUTYMHZ

Duty cycle = T_{ON} / T_{Total}

T_{ON} :2.42msec

T_{Total} :2.50msec

Duty cycle: 96.80%

Duty Factor= $10 \log(1/\text{Duty cycle})$

Duty Factor =0.14

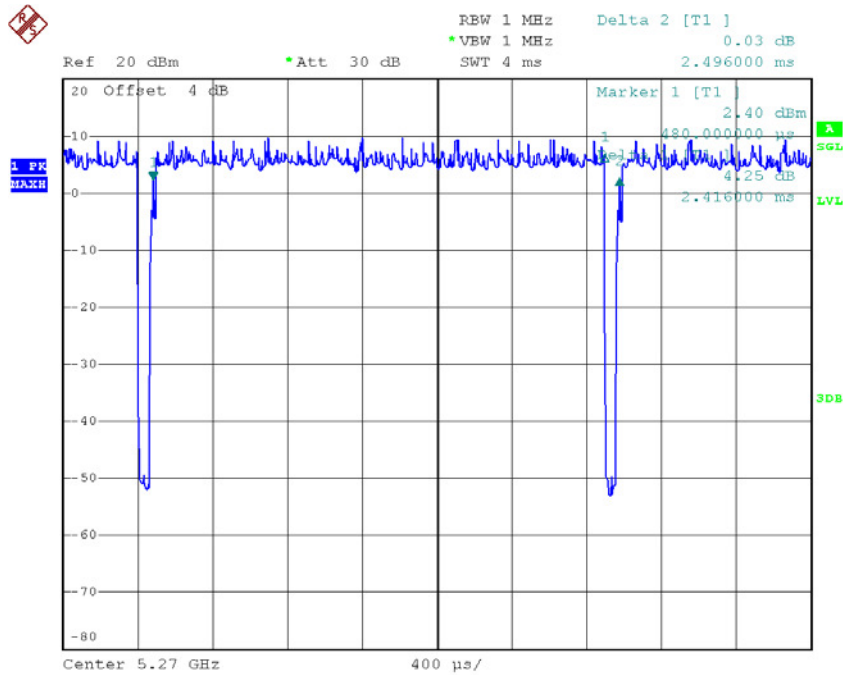

Date: 13.DEC.2016 14:03:57

Note: The EUT was programmed to be in countinously transmitting mode and the transmit duty cycle is less than 98 %, so, the output power and power density should be cacluated

asOutput Power = Measured power + Ducus factor

Power Spectral Density = Measured density + Duty factor

TX AC Wave2(80 MHz)_DUTY CYCLE

Duty cycle: TX DUTYMHZ

Duty cycle = T_{ON} / T_{Total}

T_{ON} :1.16msec

T_{Total} :1.22msec

Duty cycle: 95.08%

Duty Factor= $10 \log(1/Duty \text{ cycle})$

Duty Factor =0.22

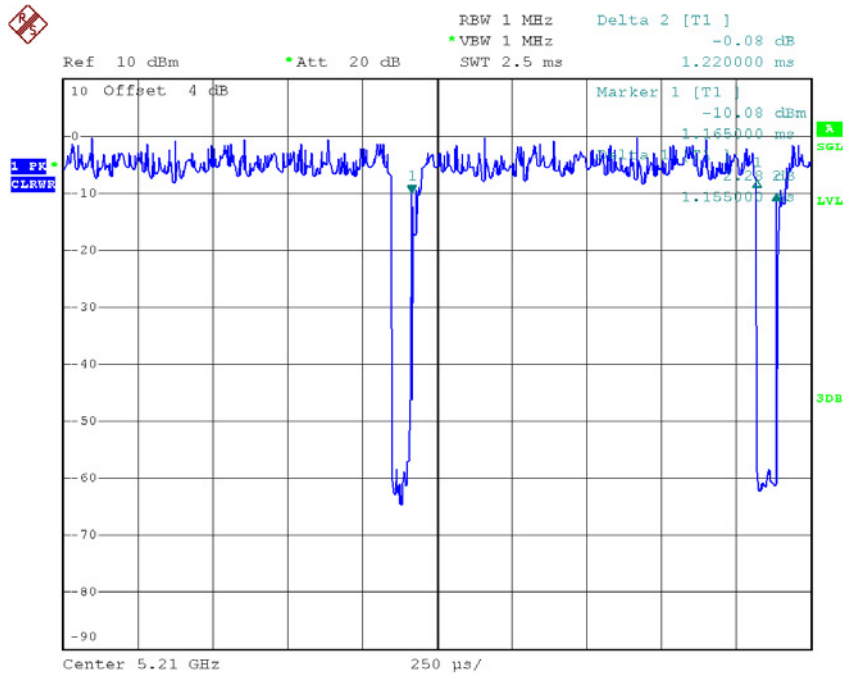

Date: 22.SEP.2016 20:34:03

Note: The EUT was programmed to be in countinously transmitting mode and the transmit duty cycle is less than 98 %, so, the output power and power density should be cacluated as
 asOutput Power = Measured power + Ducus factor
 Power Spectral Density = Measured density + Duty factor

TX AC Wave2(160 MHz) Mode_DUTY CYCLE

Duty cycle: TX DUTYMHZ

Duty cycle = T_{ON} / T_{Total}

T_{ON} :2.20 msec

T_{Total} :2.26msec

Duty cycle: 97.35%

Duty Factor= $10 \log(1/Duty \ cycle)$

Duty Factor =0.12

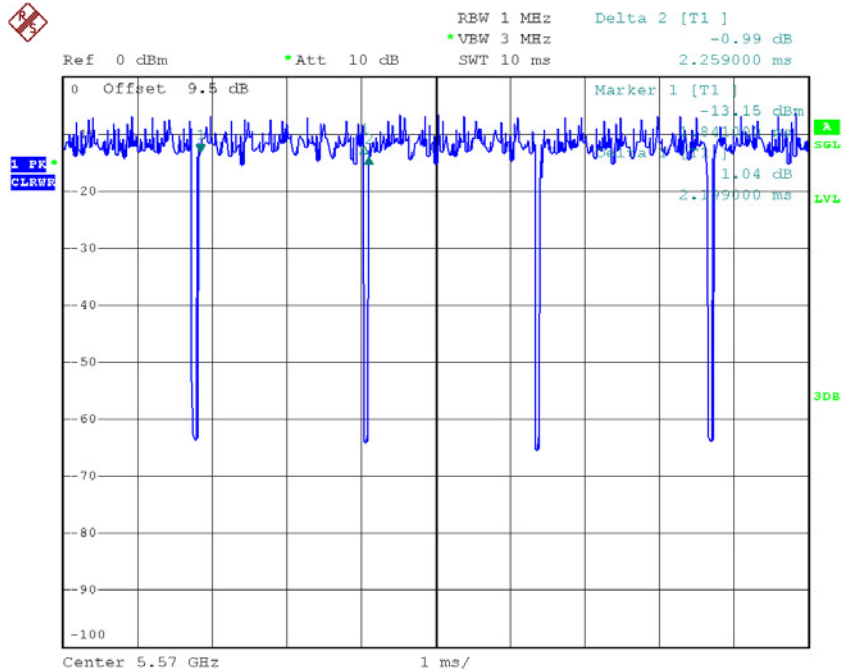

Date: 22.DEC.2016 09:57:03

Note: The EUT was programmed to be in countinously transmitting mode and the transmit duty cycle is less than 98 %, so, the output power and power density should be cacluated as
 Output Power = Measured power + Ducus factor
 Power Spectral Density = Measured density + Duty factor

ATTACHMENT E -BANDWIDTH

Non-Beamforming

Test Mode: UNII-2A/TX A Mode_CH52/CH60/CH64

Channel	Frequency (MHz)	26dB Bandwidth (MHz)	99% Occupied Bandwidth (MHz)
CH52	5260	21.20	17.80
CH60	5300	21.01	17.80
CH64	5320	20.90	17.70

TX CH52

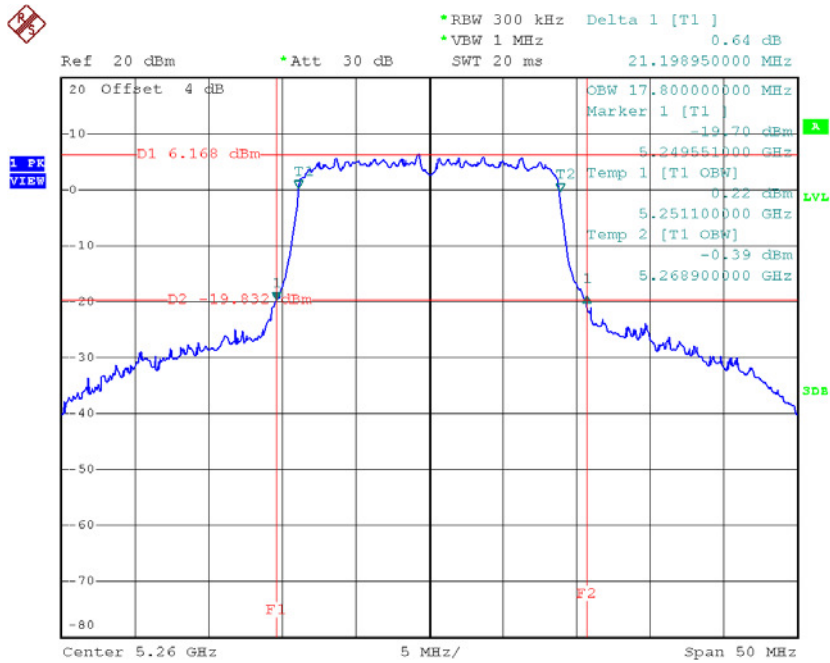

Date: 29.DEC.2016 10:28:02

TX CH60

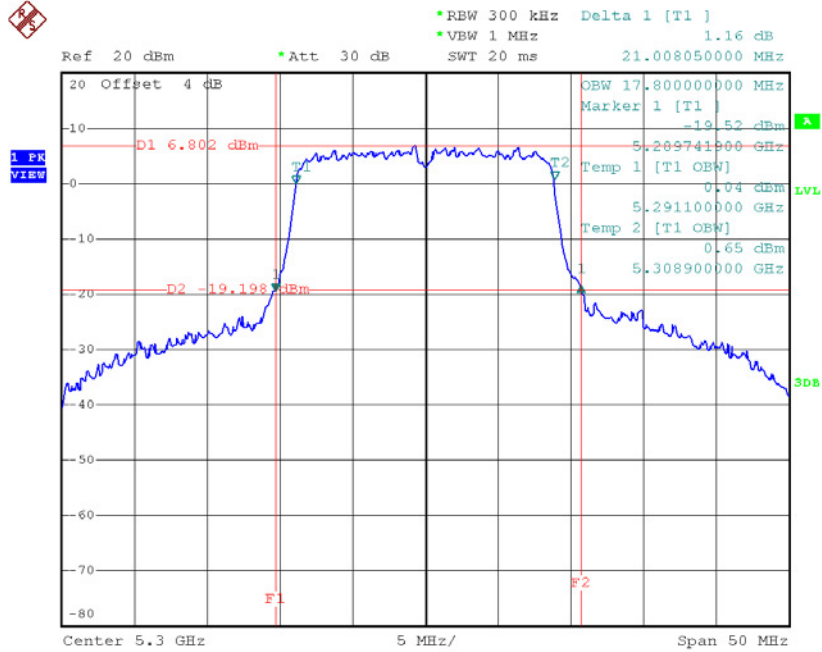

Date: 29.DEC.2016 10:32:11

TX CH64

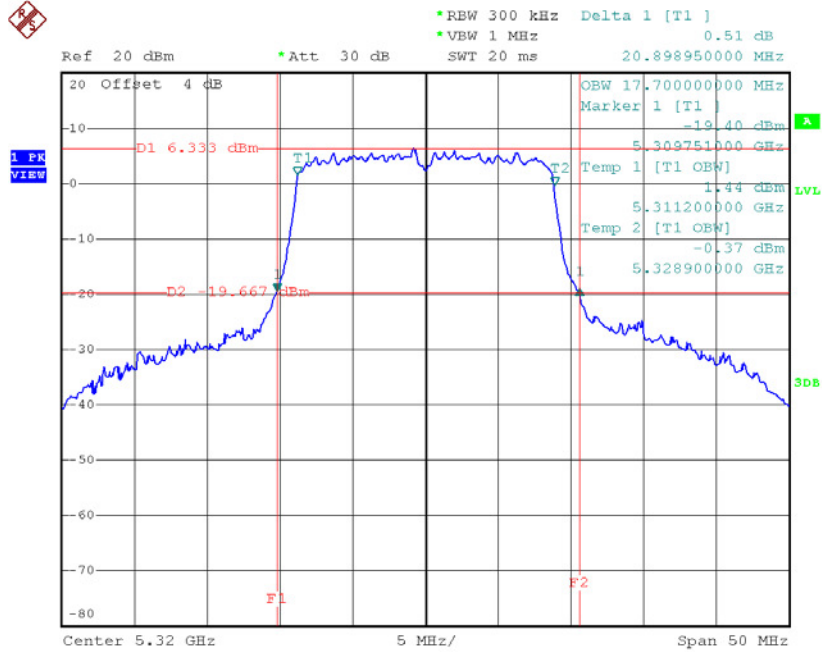

Date: 29.DEC.2016 10:38:56

Test Mode: UNII-2A/TX N20 Mode_CH52/CH60/CH64

Channel	Frequency (MHz)	26dB Bandwidth (MHz)	99% Occupied Bandwidth (MHz)
CH52	5260	20.95	17.80
CH60	5300	20.90	17.80
CH64	5320	20.95	17.80

TX CH52

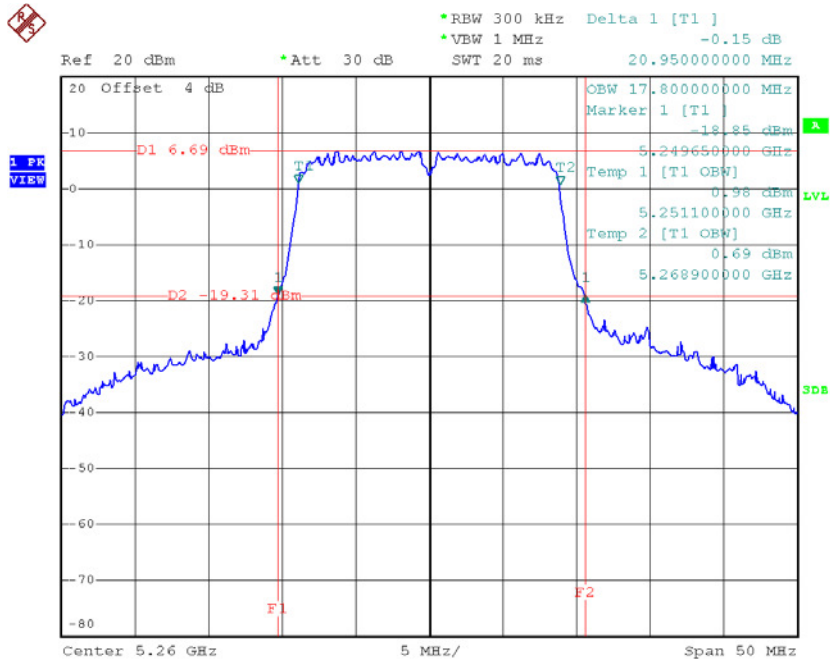

Date: 29.DEC.2016 10:29:59

TX CH60

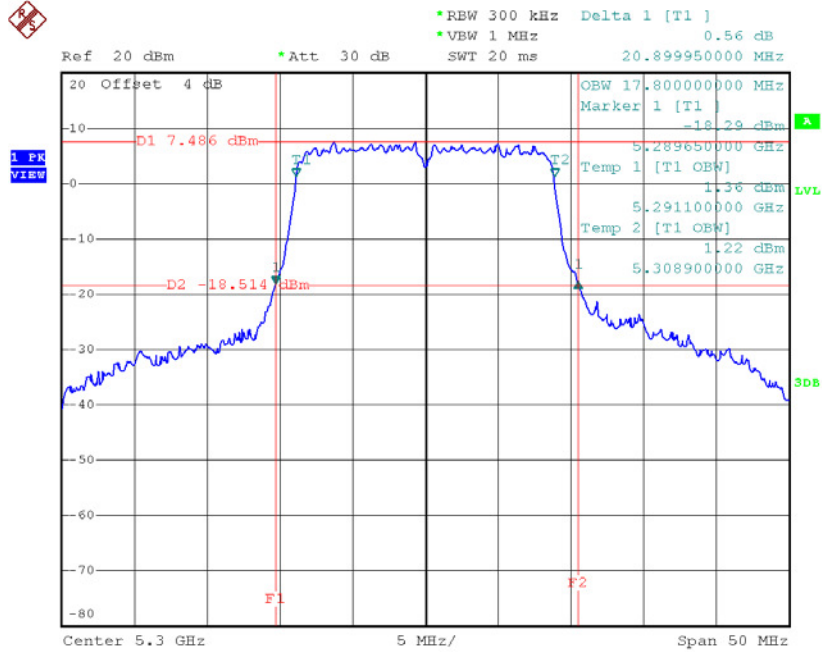

Date: 29.DEC.2016 10:33:18

TX CH64

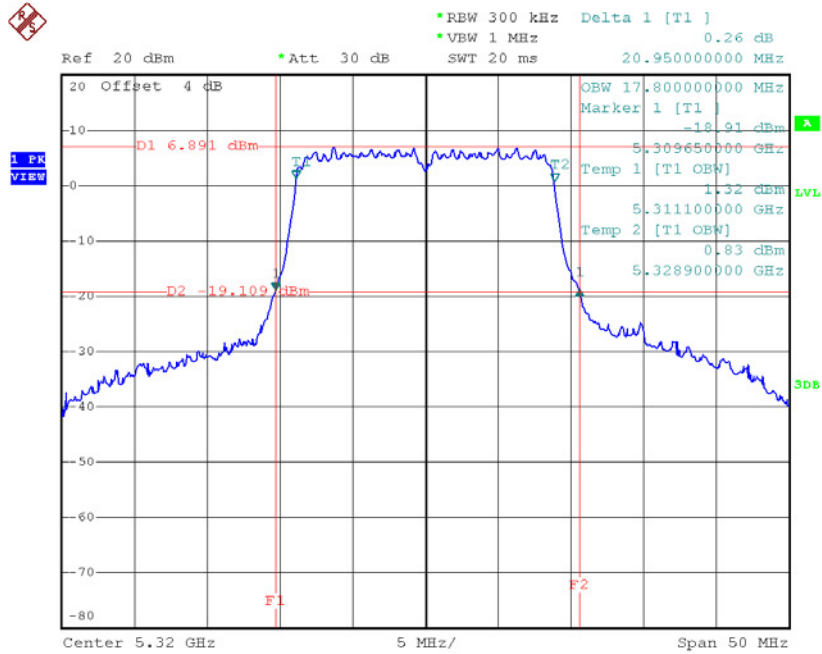

Date: 29.DEC.2016 10:37:20

Test Mode: UNII-2A/TX N40 Mode_CH54/CH62

Channel	Frequency (MHz)	26dB Bandwidth (MHz)	99% Occupied Bandwidth (MHz)
CH54	5270	41.60	36.00
CH62	5310	45.20	36.00

TX CH54

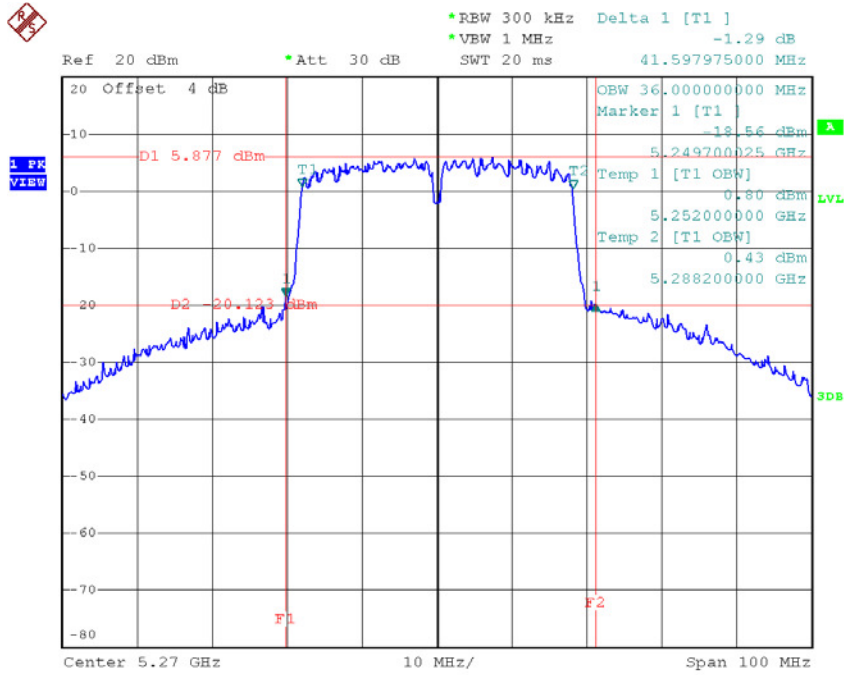

Date: 29.DEC.2016 13:20:46

TX CH62

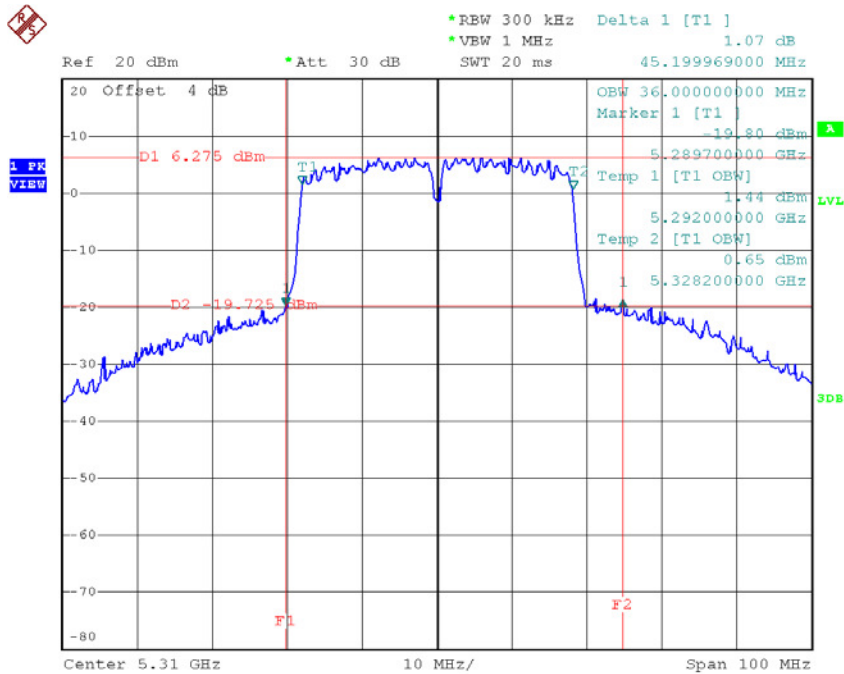

Date: 29.DEC.2016 13:22:22

Test Mode: UNII-2C/TX A Mode_CH100/CH116/CH140

Channel	Frequency (MHz)	26dB Bandwidth (MHz)	99% Occupied Bandwidth (MHz)
CH100	5500	20.99	17.70
CH116	5580	21.29	17.80
CH140	5700	21.30	17.80

TX CH100

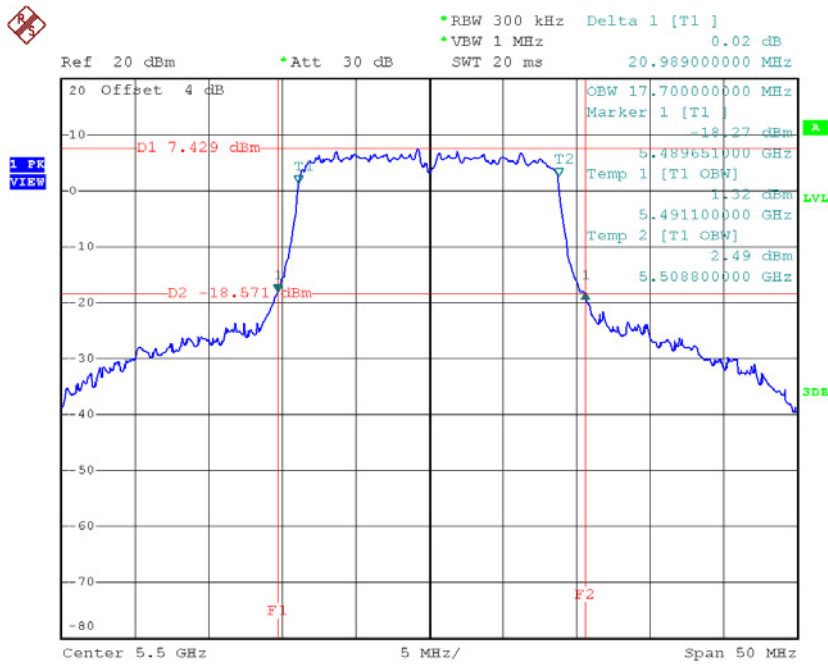

Date: 29.DEC.2016 10:41:35

TX CH116

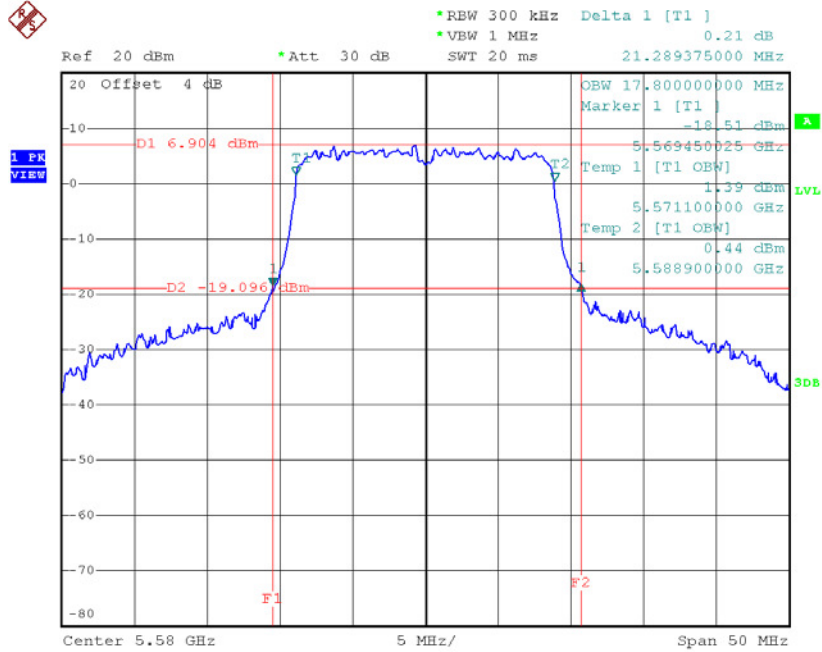

Date: 29.DEC.2016 10:52:56

TX CH140

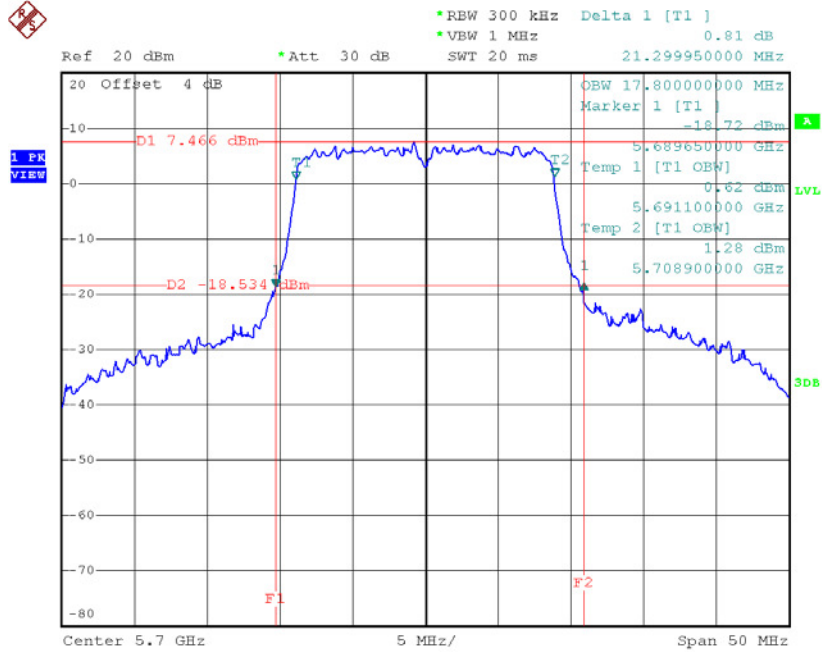

Date: 29.DEC.2016 10:55:36

Test Mode: UNII-2C/TX N20 Mode_CH100/CH116/CH140

Channel	Frequency (MHz)	26dB Bandwidth (MHz)	99% Occupied Bandwidth (MHz)
CH100	5500	21.05	17.80
CH116	5580	20.95	17.80
CH140	5700	20.95	17.80

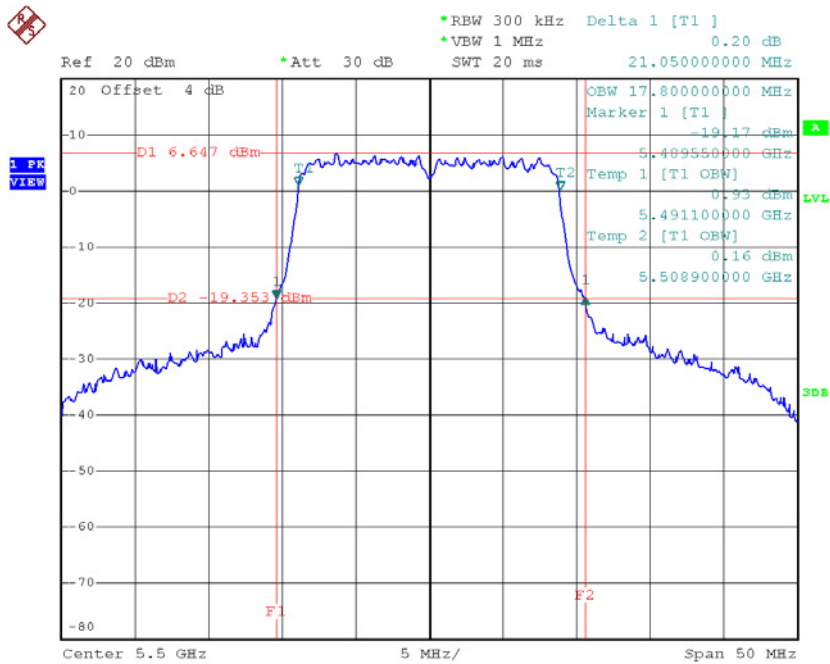
TX CH100

Date: 29.DEC.2016 10:49:14