

FCC Radio Test Report

FCC ID: QISAP6050DN6150DN

This report concerns (check one): Original Grant Class I Change Class II Change

Project No. : 1604C201B
Equipment : Wireless LAN Access Point
Model Name : AP6150DN
Applicant : Huawei Technologies Co.,Ltd.
Address : Administration Building, Headquarters of Huawei Technologies Co., Ltd.,Bantian, Longgang District, Shenzhen 518129 China

Date of Receipt : Sep. 09, 2016
Date of Test : Sep. 09, 2016 ~ Nov. 03, 2016
Issued Date : Nov. 07, 2016
Tested by : BTL Inc.

Testing Engineer :

Shawn Xiao

(Shawn Xiao)

Technical Manager :

David Mao

(David Mao)

Authorized Signatory :

Steven Lu

(Steven Lu)

B T L I N C .

No.3, Jinshagang 1st Road, Shixia, Dalang Town, Dongguan,
Guangdong, China.

TEL: +86-769-8318-3000 FAX: +86-769-8319-6000

Declaration

BTL represents to the client that testing is done in accordance with standard procedures as applicable and that test instruments used has been calibrated with standards traceable to international standard(s) and/or national standard(s).

BTL's reports apply only to the specific samples tested under conditions. It is manufacture's responsibility to ensure that additional production units of this model are manufactured with the identical electrical and mechanical components. **BTL** shall have no liability for any declarations, inferences or generalizations drawn by the client or others from **BTL** issued reports.

BTL's report must not be used by the client to claim product certification, approval, or endorsement by NVLAP, NIST, or any agency of the Federal Government.

This report is the confidential property of the client. As a mutual protection to the clients, the public and **BTL-self**, extracts from the test report shall not be reproduced except in full with **BTL's** authorized written approval.

BTL's laboratory quality assurance procedures are in compliance with the **ISO Guide 17025** requirements, and accredited by the conformity assessment authorities listed in this test report.

Limitation

For the use of the authority's logo is limited unless the Test Standard(s)/Scope(s)/Item(s) mentioned in this test report is (are) included in the conformity assessment authorities acceptance respective.

Table of Contents	Page
1 . CERTIFICATION	6
2 . SUMMARY OF TEST RESULTS	7
2.1 TEST FACILITY	8
2.2 MEASUREMENT UNCERTAINTY	8
3 . GENERAL INFORMATION	9
3.1 GENERAL DESCRIPTION OF EUT	9
3.2 DESCRIPTION OF TEST MODES	12
3.3 TABLE OF PARAMETERS OF TEXT SOFTWARE SETTING	14
3.4 BLOCK DIAGRAM SHOWING THE CONFIGURATION OF SYSTEM TESTED	16
3.5 DESCRIPTION OF SUPPORT UNITS	16
4 . EMC EMISSION TEST	17
4.1 CONDUCTED EMISSION MEASUREMENT	17
4.1.1 POWER LINE CONDUCTED EMISSION LIMITS	17
4.1.2 TEST PROCEDURE	17
4.1.3 DEVIATION FROM TEST STANDARD	17
4.1.4 TEST SETUP	18
4.1.5 EUT OPERATING CONDITIONS	18
4.1.6 EUT TEST CONDITIONS	18
4.1.7 TEST RESULTS	18
4.2 RADIATED EMISSION MEASUREMENT	19
4.2.1 RADIATED EMISSION LIMITS	19
4.2.2 TEST PROCEDURE	20
4.2.3 DEVIATION FROM TEST STANDARD	20
4.2.4 TEST SETUP	21
4.2.5 EUT OPERATING CONDITIONS	22
4.2.6 EUT TEST CONDITIONS	22
4.2.7 TEST RESULTS (9KHZ TO 30MHZ)	22
4.2.8 TEST RESULTS (30MHZ TO 1000 MHZ)	22
4.2.9 TEST RESULTS (ABOVE 1000 MHZ)	22
5 . BANDWIDTH TEST	23
5.1 APPLIED PROCEDURES	23
5.1.1 TEST PROCEDURE	23
5.1.2 DEVIATION FROM STANDARD	23
5.1.3 TEST SETUP	23
5.1.4 EUT OPERATION CONDITIONS	23
5.1.5 EUT TEST CONDITIONS	23
5.1.6 TEST RESULTS	23
6 . MAXIMUM OUTPUT POWER	24

Table of Contents	Page
6.1 APPLIED PROCEDURES / LIMIT	24
6.1.1 TEST PROCEDURE	24
6.1.2 DEVIATION FROM STANDARD	24
6.1.3 TEST SETUP	24
6.1.4 EUT OPERATION CONDITIONS	24
6.1.5 EUT TEST CONDITIONS	24
6.1.6 TEST RESULTS	24
7 . ANTENNA CONDUCTED SPURIOUS EMISSION	25
7.1 APPLIED PROCEDURES / LIMIT	25
7.1.1 TEST PROCEDURE	25
7.1.2 DEVIATION FROM STANDARD	25
7.1.3 TEST SETUP	25
7.1.4 EUT OPERATION CONDITIONS	25
7.1.5 EUT TEST CONDITIONS	25
7.1.6 TEST RESULTS	25
8 . POWER SPECTRAL DENSITY TEST	26
8.1 APPLIED PROCEDURES / LIMIT	26
8.1.1 TEST PROCEDURE	26
8.1.2 DEVIATION FROM STANDARD	26
8.1.3 TEST SETUP	26
8.1.4 EUT OPERATION CONDITIONS	26
8.1.5 EUT TEST CONDITIONS	26
8.1.6 TEST RESULTS	26
9 . MEASUREMENT INSTRUMENTS LIST	27
10 . EUT TEST PHOTO	29
ATTACHMENT A - CONDUCTED EMISSION	33
ATTACHMENT B - RADIATED EMISSION (9KHZ TO 30MHZ)	36
ATTACHMENT C - RADIATED EMISSION (30MHZ TO 1000MHZ)	41
ATTACHMENT D - RADIATED EMISSION (ABOVE 1000MHZ)	48
ATTACHMENT E - BANDWIDTH	97
ATTACHMENT F – MAXIMUM OUTPUT POWER	110
ATTACHMENT G - ANTENNA CONDUCTED SPURIOUS EMISSION	130
ATTACHMENT H - POWER SPECTRAL DENSITY	479

REPORT ISSUED HISTORY

Issued No.	Description	Issued Date
BTL-FCCP-3-1604C201B	Original Issue.	Nov. 07, 2016

1. CERTIFICATION

Equipment : Wireless LAN Access Point
Brand Name : HUAWEI
Model Name : AP6150DN
Applicant : Huawei Technologies Co.,Ltd.
Manufacturer : Huawei Technologies Co.,Ltd.
Address : Administration Building, Huawei Base, Bantian, Longgang District ,Shenzhen
518129, P.R.China
Factory : CIG Shanghai Co.,Ltd., Shanghai Branch.
Address : F/2,3 Building 1, No. 505 Jiangyue Road, Minhang District, Shanghai, P.R.
China
Date of Test : Sep. 09, 2016 ~ Nov. 03, 2016
Test Sample : Engineering Sample
Standard(s) : FCC Part15, Subpart C:(15.247) / ANSI C63.10-2013

The above equipment has been tested and found compliance with the requirement of the relative standards by BTL Inc.

The test data, data evaluation, and equipment configuration contained in our test report (Ref No. BTL-FCCP-3-1604C201B) were obtained utilizing the test procedures, test instruments, test sites that has been accredited by the Authority of TAF according to the ISO-17025 quality assessment standard and technical standard(s).

2. SUMMARY OF TEST RESULTS

Test procedures according to the technical standard(s):

Applied Standard(s): FCC Part15 (15.247) , Subpart C				
Standard(s)	Section	Test Item	Judgment	Remark
	15.207	Conducted Emission	PASS	
	15.247(d)	Antenna conducted Spurious Emission	PASS	
	15.247(a)(2)	6dB Bandwidth	PASS	
	15.247(b)(3)	Peak Output Power	PASS	
	15.247(e)	Power Spectral Density	PASS	
	15.203	Antenna Requirement	PASS	
	15.209/15.205	Transmitter Radiated Emissions	PASS	

NOTE:

(1) "N/A" denotes test is not applicable in this test report.

2.1 TEST FACILITY

The test facilities used to collect the test data in this report is at the location of No.3,Jinshagang 1st Road, Shixia, Dalang Town, Dongguan, Guangdong, China.
 BTL's test firm number for FCC: 319330

2.2 MEASUREMENT UNCERTAINTY

Where relevant, the following measurement uncertainty levels have been estimated for tests performed on the EUT as specified in CISPR 16-4-2. The BTL measurement uncertainty is less than the CISPR 16-4-2 U_{CISPR} requirement.

The reported uncertainty of measurement $y \pm U$, where expanded uncertainty U is based on a standard uncertainty multiplied by a coverage factor of $k=2$, providing a level of confidence of approximately 95 %.

A. Conducted Measurement:

Test Site	Method	Measurement Frequency Range	U, (dB)
DG-C02	CISPR	150 KHz ~ 30MHz	2.32

B. Radiated Measurement:

Test Site	Method	Measurement Frequency Range	Ant. H / V	U, (dB)
DG-CB03	CISPR	9KHz~30MHz	V	3.79
		9KHz~30MHz	H	3.57
		30MHz ~ 200MHz	V	3.82
		30MHz ~ 200MHz	H	3.78
		200MHz ~ 1,000MHz	V	4.10
		200MHz ~ 1,000MHz	H	4.06
		1GHz~18GHz	V	3.12
		1GHz~18GHz	H	3.68
		18GHz~40GHz	V	4.15
		18GHz~40GHz	H	4.14

Note: Unless specifically mentioned, the uncertainty of measurement has not been taken into account to declare the compliance or non-compliance to the specification.

3. GENERAL INFORMATION

3.1 GENERAL DESCRIPTION OF EUT

Equipment	Wireless LAN Access Point	
Brand Name	HUAWEI	
Model Name	AP6150DN	
Model Difference	N/A	
Product Description	Operation Frequency	2412~2462 MHz
	Modulation Technology	802.11b:DSSS 802.11g:OFDM 802.11n:OFDM
	Bit Rate of Transmitter	802.11b: 11/5.5/2/1 Mbps 802.11g: 54/48/36/24/18/12/9/6 Mbps 802.11n up to 600 Mbps
	Output Power (Max.) - (1TX)- Non-Beamforming	802.11b: 19.78dBm 802.11g: 18.01dBm 802.11n(20MHz): 17.63dBm 802.11n(40MHz): 16.95dBm
	Output Power (Max.) - (2TX) - Non-Beamforming	802.11b: 22.53dBm 802.11g: 20.57dBm 802.11n(20MHz): 20.76dBm 802.11n(40MHz): 19.71dBm
	Output Power (Max.) - (3TX) - Non-Beamforming	802.11b: 24.55dBm 802.11g: 22.26dBm 802.11n(20MHz): 22.35dBm 802.11n(40MHz): 21.43dBm
	Output Power (Max.) - (4TX) - Non-Beamforming	802.11b:25.69dBm 802.11g: 23.49dBm 802.11n(20MHz): 23.43dBm 802.11n(40MHz): 22.62dBm
Power Source	#1 DC voltage supplied from AC Adapter. #2 Supplied from PoE. Model: PoE35-54A	
Power Rating	#1 DC 12V 2A #2 PoE -48V	

	Output Power (Max.) - (2TX) -Beamforming	802.11n(20MHz): 20.76dBm 802.11n(40MHz): 19.55dBm
	Output Power (Max.) - (3TX) -Beamforming	802.11n(20MHz): 22.57dBm 802.11n(40MHz): 21.27dBm
	Output Power (Max.) - (4TX) -Beamforming	802.11n(20MHz): 23.67dBm 802.11n(40MHz): 22.62dBm

Note:

1. For a more detailed features description, please refer to the manufacturer's specifications or the user's manual.

2. Channel List:

CH01 – CH11 for 802.11b, 802.11g, 802.11n(20MHz) CH03 – CH09 for 802.11n(40MHz)							
Channel	Frequency (MHz)	Channel	Frequency (MHz)	Channel	Frequency (MHz)	Channel	Frequency (MHz)
01	2412	04	2427	07	2442	10	2457
02	2417	05	2432	08	2447	11	2462
03	2422	06	2437	09	2452		

3. Table for Filed Antenna

Ant.	Brand	Model Name	Antenna Type	Connector	Gain (dBi)
1	中山通宇	TT-245804-6W1	External	SMA	3.87
2	中山通宇	TT-245804-6W1	External	SMA	3.87
3	中山通宇	TT-245804-6W1	External	SMA	3.87
4	中山通宇	TT-245804-6W1	External	SMA	3.87

Note:

- (1) The EUT incorporates a MIMO function. Physically, the EUT provides four completed transmitters and receivers (4T4R).
- (2) **For 2TX with beamforming:**
The EUT with beamforming function, then, Direction gain = $G_{ANT} + 10\log(N_{ANT}/N_{SS})$, where N_{SS} = the number of independent spatial streams of data.
For 2TX with beamforming: Directional gain = $3.87 + 10\log(2/2) = 3.87 + 0 = 3.87$ dBi.
- (3) **For 3TX with beamforming:**
The EUT with beamforming function, then, Direction gain = $G_{ANT} + 10\log(N_{ANT}/N_{SS})$, where N_{SS} = the number of independent spatial streams of data.
For 3TX with beamforming: Directional gain = $3.87 + 10\log(3/3) = 3.87 + 0 = 3.87$ dBi.
- (4) **For 4TX with beamforming:**
The EUT with beamforming function, then, Direction gain = $G_{ANT} + 10\log(N_{ANT}/N_{SS})$, where N_{SS} = the number of independent spatial streams of data.
For 4TX with beamforming: Directional gain = $3.87 + 10\log(4/4) = 3.87 + 0 = 3.87$ dBi.

4.

Operating Mode	TX Mode	
	1TX	2TX
802.11b	V (ANT 1)	V (ANT 1+ANT 2)
802.11g	V (ANT 1)	V (ANT 1+ANT 2)
802.11n(20MHz)	V (ANT 1)	V (ANT 1+ANT 2)
802.11n(40MHz)	V (ANT 1)	V (ANT 1+ANT 2)

Operating Mode	TX Mode	
	3TX	4TX
802.11b	V (ANT 1+ANT 2+ANT 3)	V (ANT 1+ANT 2+ANT 3+ANT 4)
802.11g	V (ANT 1+ANT 2+ANT 3)	V (ANT 1+ANT 2+ANT 3+ANT 4)
802.11n(20MHz)	V (ANT 1+ANT 2+ANT 3)	V (ANT 1+ANT 2+ANT 3+ANT 4)
802.11n(40MHz)	V (ANT 1+ANT 2+ANT 3)	V (ANT 1+ANT 2+ANT 3+ANT 4)

3.2 DESCRIPTION OF TEST MODES

To investigate the maximum EMI emission characteristics generates from EUT, the test system was pre-scanning tested base on the consideration of following EUT operation mode or test configuration mode which possible have effect on EMI emission level. Each of these EUT operation mode(s) or test configuration mode(s) mentioned above was evaluated respectively.

Pretest Mode	Description
Mode 1	TX B MODE CHANNEL 01/06/11
Mode 2	TX G MODE CHANNEL 01/06/11
Mode 3	TX N-20MHZ MODE CHANNEL 01/06/11
Mode 4	TX N-40MHZ MODE CHANNEL 03/06/09
Mode 5	TX MODE

The EUT system operated these modes were found to be the worst case during the pre-scanning test as following:

For Conducted Test	
Final Test Mode	Description
Mode 5	TX MODE

For Radiated Test	
Final Test Mode	Description
Mode 1	TX B MODE CHANNEL 01/06/11
Mode 2	TX G MODE CHANNEL 01/06/11
Mode 3	TX N-20MHZ MODE CHANNEL 01/06/11
Mode 4	TX N-40MHZ MODE CHANNEL 03/06/09

For Band Edge Test	
Final Test Mode	Description
Mode 1	TX B MODE CHANNEL 01/06/11
Mode 2	TX G MODE CHANNEL 01/06/11
Mode 3	TX N-20MHZ MODE CHANNEL 01/06/11
Mode 4	TX N-40MHZ MODE CHANNEL 03/06/09

6dB Spectrum Bandwidth	
Final Test Mode	Description
Mode 1	TX B MODE CHANNEL 01/06/11
Mode 2	TX G MODE CHANNEL 01/06/11
Mode 3	TX N-20MHZ MODE CHANNEL 01/06/11
Mode 4	TX N-40MHZ MODE CHANNEL 03/06/09

Maximum Conducted Output Power	
Final Test Mode	Description
Mode 1	TX B MODE CHANNEL 01/06/11
Mode 2	TX G MODE CHANNEL 01/06/11
Mode 3	TX N-20MHZ MODE CHANNEL 01/06/11
Mode 4	TX N-40MHZ MODE CHANNEL 03/06/09

Power Spectral Density	
Final Test Mode	Description
Mode 1	TX B MODE CHANNEL 01/06/11
Mode 2	TX G MODE CHANNEL 01/06/11
Mode 3	TX N-20MHZ MODE CHANNEL 01/06/11
Mode 4	TX N-40MHZ MODE CHANNEL 03/06/09

Note:

- (1) The measurements are performed at the high, middle, low available channels.
- (2) 802.11b mode: DBPSK (1Mbps)
 802.11g mode: OFDM (6Mbps)
 802.11n HT20 mode : BPSK (13Mbps)
 802.11n HT40 mode : BPSK (27Mbps)
 For radiated emission tests, the highest output powers were set for final test.
- (3) For radiated below 1G test, the 802.11b is found to be the worst case and recorded.
- (4) The EUT was programmed to be in continuously transmitting mode and the transmit duty cycle is not less than 98%.

3.3 TABLE OF PARAMETERS OF TEXT SOFTWARE SETTING

During testing, channel & power controlling software provided by the customer was used to control the operating channel as well as the output power level. The RF output power selection is for the setting of RF output power expected by the customer and is going to be fixed on the firmware of the final end product power parameters of WLAN

For 1TX Non-Beamforming

Test software version	QRCT		
Frequency (MHz)	2412	2437	2462
802.11b	20	20	20
802.11g	17	18	16
802.11n (20MHz)	16	18	16
Frequency	2422	2437	2452
802.11n (40MHz)	16	17	14

For 2TX Non-Beamforming

Test software version	QRCT		
Frequency (MHz)	2412	2437	2462
802.11b	20	20	20
802.11g	16	18	15
802.11n (20MHz)	15	18	15
Frequency	2422	2437	2452
802.11n (40MHz)	15	17	13

For 3TX Non-Beamforming

Test software version	QRCT		
Frequency (MHz)	2412	2437	2462
802.11b	20	20	20
802.11g	15	18	14
802.11n (20MHz)	14	18	14
Frequency	2422	2437	2452
802.11n (40MHz)	14	17	12

For 4TX Non-Beamforming

Test software version	QRCT		
Frequency (MHz)	2412	2437	2462
802.11b	20	20	20
802.11g	15	18	14
802.11n (20MHz)	14	18	14
Frequency	2422	2437	2452
802.11n (40MHz)	14	17	12

For 2TX Beamforming

Test software version	QRCT		
Frequency (MHz)	2412	2437	2462
802.11n (20MHz)	14	18	14
Frequency	2422	2437	2452
802.11n (40MHz)	14	17	12

For 3TX Beamforming

Test software version	QRCT		
Frequency (MHz)	2412	2437	2462
802.11n (20MHz)	14	18	14
Frequency	2422	2437	2452
802.11n (40MHz)	14	17	12

For 4TX Beamforming

Test software version	QRCT		
Frequency (MHz)	2412	2437	2462
802.11n (20MHz)	14	18	14
Frequency	2422	2437	2452
802.11n (40MHz)	14	17	12

3.4 BLOCK DIAGRAM SHOWING THE CONFIGURATION OF SYSTEM TESTED

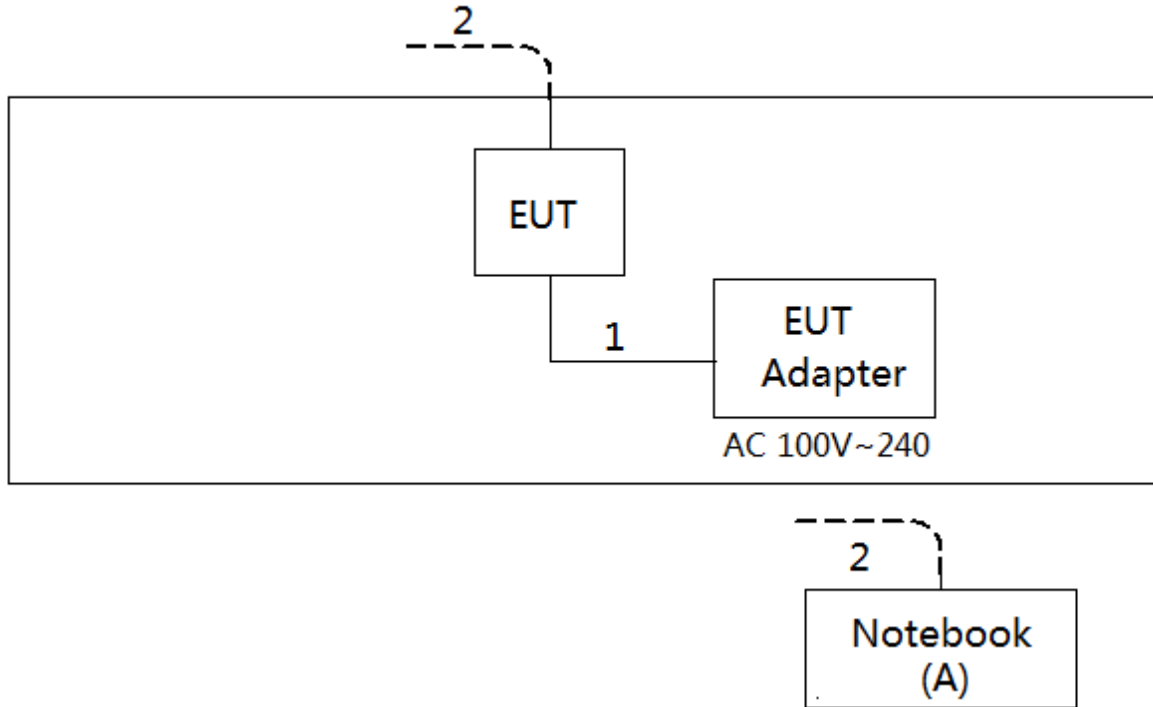

3.5 DESCRIPTION OF SUPPORT UNITS

The EUT has been tested as an independent unit together with other necessary accessories or support units. The following support units or accessories were used to form a representative test configuration during the tests.

Item	Equipment	Mfr/Brand	Model/Type No.	FCC ID	Series No.
A	Notebook	Lenovo	INSPIRON 1420-	DOC	JX193A01SDC2

Item	Shielded Type	Ferrite Core	Length	Note
1	NO	NO	10m	RJ45 Cable
2	NO	NO	1.5m	Power Cable

4. EMC EMISSION TEST

4.1 CONDUCTED EMISSION MEASUREMENT

4.1.1 POWER LINE CONDUCTED EMISSION LIMITS (Frequency Range 150KHz-30MHz)

Frequency of Emission (MHz)	Conducted Limit (dBµV)	
	Quasi-peak	Average
0.15 -0.50	66 to 56*	56 to 46*
0.50 -5.0	56	46
5.0 -30.0	60	50

Note:

- (1) The limit of " * " decreases with the logarithm of the frequency
- (2) The test result calculated as following:
 Measurement Value = Reading Level + Correct Factor
 Correct Factor = Insertion Loss + Cable Loss + Attenuator Factor(if use)
 Margin Level = Measurement Value - Limit Value

The following table is the setting of the receiver

Receiver Parameters	Setting
Attenuation	10 dB
Start Frequency	0.15 MHz
Stop Frequency	30 MHz
IF Bandwidth	9 KHz

4.1.2 TEST PROCEDURE

- a. The EUT was placed 0.8 meters from the horizontal ground plane with EUT being connected to the power mains through a line impedance stabilization network (LISN). All other support equipments powered from additional LISN(s). The LISN provide 50 Ohm/ 50uH of coupling impedance for the measuring instrument.
- b. Interconnecting cables that hang closer than 40 cm to the ground plane shall be folded back and forth in the center forming a bundle 30 to 40 cm long.
- c. I/O cables that are not connected to a peripheral shall be bundled in the center. The end of the cable may be terminated, if required, using the correct terminating impedance. The overall length shall not exceed 1 m.
- d. LISN at least 80 cm from nearest part of EUT chassis.
- e. For the actual test configuration, please refer to the related Item –EUT Test Photos.

4.1.3 DEVIATION FROM TEST STANDARD

No deviation

4.1.4 TEST SETUP

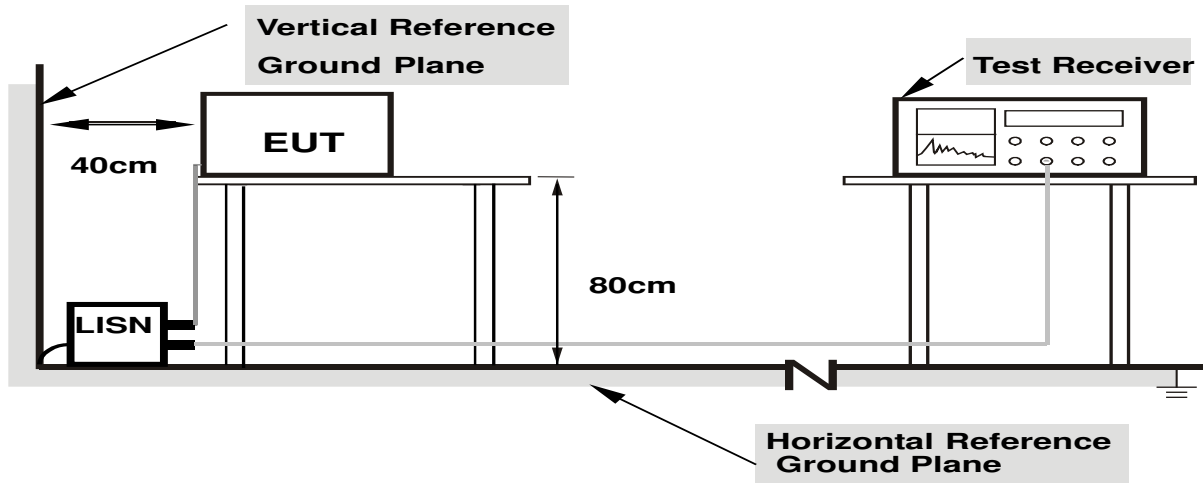

- Note:**
- 1. Support units were connected to second LISN.
 - 2. Both of LISNs (AMN) are 80 cm from EUT and at least 80 from other units and other metal planes

4.1.5 EUT OPERATING CONDITIONS

The EUT was placed on the test table and programmed in normal function.

4.1.6 EUT TEST CONDITIONS

Temperature: 25°C Relative Humidity: 55% Test Voltage: AC 120V/60Hz

4.1.7 TEST RESULTS

Please refer to the Attachment A.

4.2 RADIATED EMISSION MEASUREMENT

4.2.1 RADIATED EMISSION LIMITS

In case the emission fall within the restricted band specified on 15.205(a), then the 15.209(a) limit in the table below has to be followed.

LIMITS OF RADIATED EMISSION MEASUREMENT (9KHz-1000MHz)

Frequency (MHz)	Field Strength (microvolts/meter)	Measurement Distance (meters)
0.009~0.490	2400/F(KHz)	300
0.490~1.705	24000/F(KHz)	30
1.705~30.0	30	30
30~88	100	3
88~216	150	3
216~960	200	3
960~1000	500	3

LIMITS OF RADIATED EMISSION MEASUREMENT (Above 1000MHz)

Frequency (MHz)	(dBuV/m) (at 3 meters)	
	PEAK	AVERAGE
Above 1000	74	54

Notes:

- (1) The limit for radiated test was performed according to FCC PART 15C.
- (2) The tighter limit applies at the band edges.
- (3) Emission level (dBuV/m)=20log Emission level (uV/m).
- (4) The test result calculated as following:
 Measurement Value = Reading Level + Correct Factor
 Correct Factor = Antenna Factor + Cable Loss - Amplifier Gain(if use)
 Margin Level = Measurement Value - Limit Value

Spectrum Parameter	Setting
Attenuation	Auto
Start Frequency	1000 MHz
Stop Frequency	10th carrier harmonic
RBW / VBW (Emission in restricted band)	1MHz / 3MHz for Peak, 1MHz / 1/T for Average

Receiver Parameter	Setting
Attenuation	Auto
Start ~ Stop Frequency	9KHz~90KHz for PK/AVG detector
Start ~ Stop Frequency	90KHz~110KHz for QP detector
Start ~ Stop Frequency	110KHz~490KHz for PK/AVG detector
Start ~ Stop Frequency	490KHz~30MHz for QP detector
Start ~ Stop Frequency	30MHz~1000MHz for QP detector

4.2.2 TEST PROCEDURE

- a. The measuring distance of 3 m shall be used for measurements. The EUT was placed on the top of a rotating table 0.8 meter above the ground at a 3 meter semi-anechoic chamber. The table was rotated 360 degrees to determine the position of the highest radiation.(below 1GHz)
- b. The measuring distance of 3 m shall be used for measurements. The EUT was placed on the top of a rotating table 1.5 meter above the ground at a 3 meter semi-anechoic chamber. The table was rotated 360 degrees to determine the position of the highest radiation.(above 1GHz)
- c. The height of the equipment or of the substitution antenna shall be 0.8m or 1.5m; the height of the test antenna shall vary between 1 m to 4 m. Both horizontal and vertical polarizations of the antenna are set to make the measurement.
- d. For each suspected emission, the EUT was arranged to its worst case and then the antenna was tuned to heights find the maximum reading (used Bore sight function).
- e. The receiver system was set to peak and average detect function and specified bandwidth with maximum hold mode when the test frequency is above 1GHz.
- f. The initial step in collecting radiated emission data is a receiver peak detector mode pre-scanning the measurement frequency range. Significant peaks are then marked and then Quasi Peak detector mode re-measured.
- g. All readings are Peak unless otherwise stated QP in column of Note. Peak denotes that the Peak reading compliance with the QP Limits and then QP Mode measurement didn't perform. (below 1GHz)
- h. All readings are Peak Mode value unless otherwise stated AVG in column of Note. If the Peak Mode Measured value compliance with the Peak Limits and lower than AVG Limits, the EUT shall be deemed to meet both Peak & AVG Limits and then only Peak Mode was measured, but AVG Mode didn't perform. (above 1GHz)
- i. For the actual test configuration, please refer to the related Item –EUT Test Photos.

4.2.3 DEVIATION FROM TEST STANDARD

No deviation

4.2.4 TEST SETUP

(A) Radiated Emission Test Set-Up Frequency Below 1 GHz

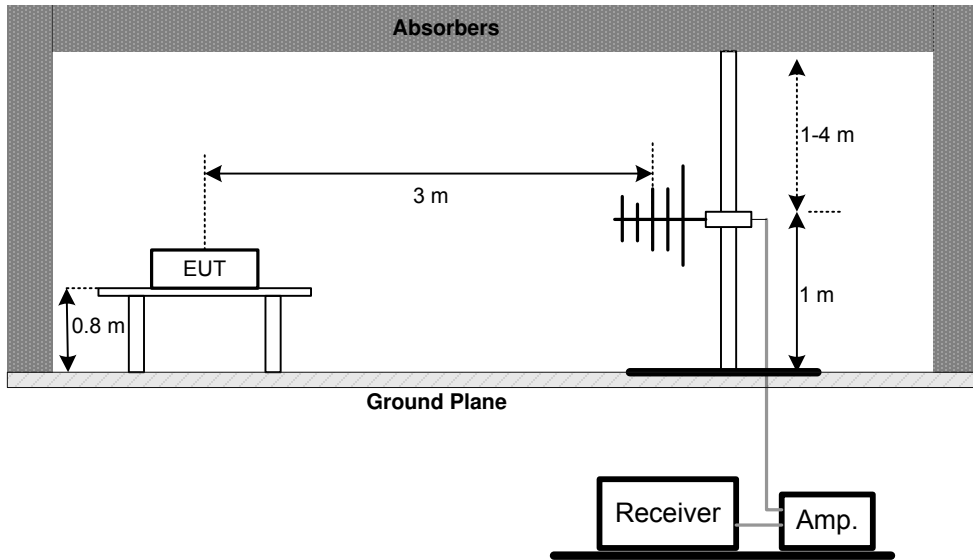

(B) Radiated Emission Test Set-Up Frequency Above 1 GHz

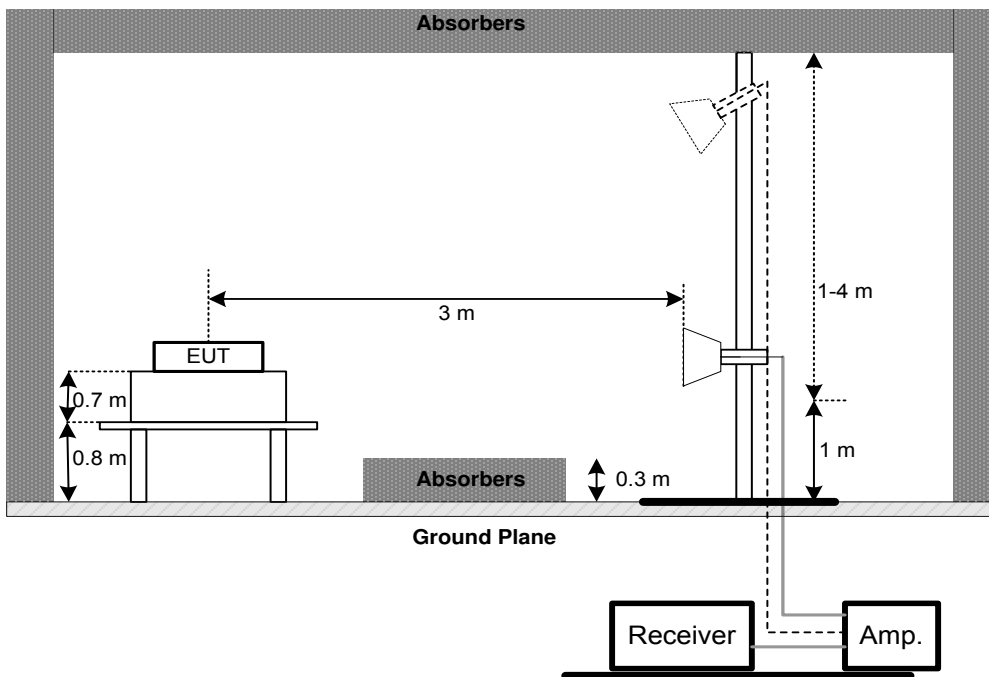

(C) For Radiated Emissions Below 30MHz

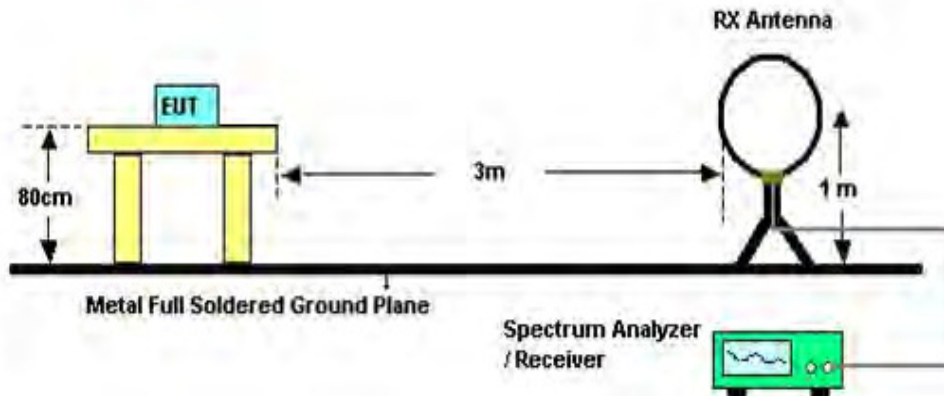

4.2.5 EUT OPERATING CONDITIONS

The EUT was programmed to be in continuously transmitting mode.

4.2.6 EUT TEST CONDITIONS

Temperature: 25°C Relative Humidity: 55% Test Voltage: AC 120V/60Hz

4.2.7 TEST RESULTS (9KHZ TO 30MHZ)

Please refer to the Attachment B

Remark:

- (1) The amplitude of spurious emissions which are attenuated by more than 20 dB below the permissible value has no need to be reported.
- (2) Distance extrapolation factor = $40 \log(\text{specific distance} / \text{test distance})$ (dB).
- (3) Limit line = specific limits (dBuV) + distance extrapolation factor.

4.2.8 TEST RESULTS (30MHZ TO 1000 MHZ)

Please refer to the Attachment C.

4.2.9 TEST RESULTS (ABOVE 1000 MHZ)

Please refer to the Attachment D.

Remark:

- (1) No limit: This is fundamental signal, the judgment is not applicable. For fundamental signal judgment was referred to Peak output test.

5. BANDWIDTH TEST

5.1 APPLIED PROCEDURES

FCC Part15 (15.247) , Subpart C			
Section	Test Item	Frequency Range (MHz)	Result
15.247(a)(2)	Bandwidth	2400-2483.5	PASS

5.1.1 TEST PROCEDURE

- a. The EUT was directly connected to the spectrum analyzer and antenna output port as show in the block diagram below,
- b. Spectrum Setting: RBW= 100KHz, VBW=300KHz, Sweep time = 2.5 ms.

5.1.2 DEVIATION FROM STANDARD

No deviation.

5.1.3 TEST SETUP

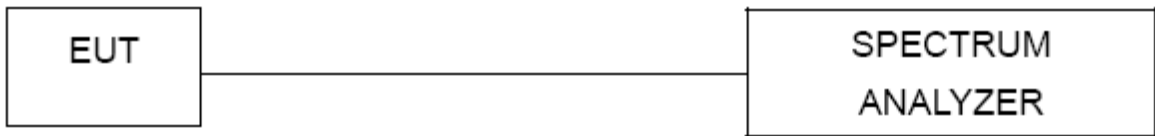

5.1.4 EUT OPERATION CONDITIONS

The EUT was programmed to be in continuously transmitting mode.

5.1.5 EUT TEST CONDITIONS

Temperature: 25°C Relative Humidity: 55% Test Voltage: AC 120V/60Hz

5.1.6 TEST RESULTS

Please refer to the Attachment E.

6. MAXIMUM OUTPUT POWER

6.1 APPLIED PROCEDURES / LIMIT

FCC Part15 (15.247) , Subpart C				
Section	Test Item	Limit	Frequency Range (MHz)	Result
15.247(b)(3)	Maximum Output Power	1 Watt or 30dBm	2400-2483.5	PASS

6.1.1 TEST PROCEDURE

- a. The EUT was directly connected to the power meter and antenna output port as show in the block diagram below,
- b. The maximum peak conducted output power was performed in accordance with method 9.1.2 of FCC KDB 558074 D01 DTS Meas Guidance and FCC KDB 662911 D01 Multiple Transmitter Output.

6.1.2 DEVIATION FROM STANDARD

No deviation.

6.1.3 TEST SETUP

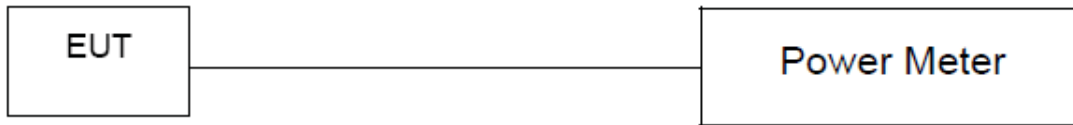

6.1.4 EUT OPERATION CONDITIONS

The EUT was programmed to be in continuously transmitting mode.

6.1.5 EUT TEST CONDITIONS

Temperature: 25°C Relative Humidity: 55% Test Voltage: AC 120V/60Hz

6.1.6 TEST RESULTS

Please refer to the Attachment F.

7. ANTENNA CONDUCTED SPURIOUS EMISSION

7.1 APPLIED PROCEDURES / LIMIT

In any 100 kHz bandwidth outside the frequency band in which the spread spectrum or digitally modulated device is operating, the RF power that is produced shall be at least 20 dB below that in the 100 kHz bandwidth within the band that contains the highest level of the desired power, based on either an RF conducted or a radiated measurement, provided that the transmitter demonstrates compliance with the peak conducted power limits.

7.1.1 TEST PROCEDURE

- a. The EUT was directly connected to the spectrum analyzer and antenna output port as show in the block diagram below,
- b. Spectrum Setting: RBW= 100KHz, VBW=300KHz, Sweep time = Auto.
- c. Offset=antenna gain+cable loss

7.1.2 DEVIATION FROM STANDARD

No deviation.

7.1.3 TEST SETUP

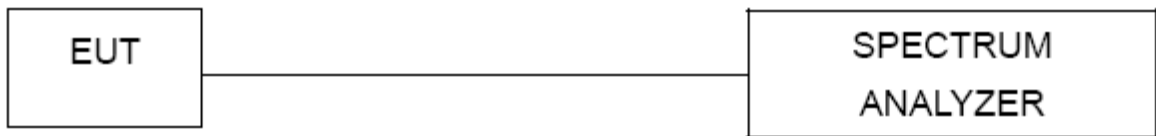

7.1.4 EUT OPERATION CONDITIONS

The EUT was programmed to be in continuously transmitting mode.

7.1.5 EUT TEST CONDITIONS

Temperature: 25°C Relative Humidity: 55% Test Voltage: AC 120V/60Hz

7.1.6 TEST RESULTS

Please refer to the Attachment G.

8. POWER SPECTRAL DENSITY TEST

8.1 APPLIED PROCEDURES / LIMIT

FCC Part15 (15.247) , Subpart C				
Section	Test Item	Limit	Frequency Range (MHz)	Result
15.247(e)	Power Spectral Density	8 dBm (in any 3KHz)	2400-2483.5	PASS

8.1.1 TEST PROCEDURE

- a. The EUT was directly connected to the spectrum analyzer and antenna output port as show in the block diagram below,
- b. Spectrum Setting: RBW=3KHz, VBW=10KHz, Sweep time = Auto.

8.1.2 DEVIATION FROM STANDARD

No deviation.

8.1.3 TEST SETUP



8.1.4 EUT OPERATION CONDITIONS

The EUT was programmed to be in continuously transmitting mode.

8.1.5 EUT TEST CONDITIONS

Temperature: 25°C Relative Humidity: 55% Test Voltage: AC 120V/60Hz

8.1.6 TEST RESULTS

Please refer to the Attachment H.

9. MEASUREMENT INSTRUMENTS LIST

Conducted Emission Measurement					
Item	Kind of Equipment	Manufacturer	Type No.	Serial No.	Calibrated until
1	LISN	EMCO	3816/2	0052765	Mar. 27, 2017
2	LISN	R&S	ENV216	101447	Mar. 27, 2017
3	Test Cable	emci	RG223(9KHz-30MHz)	C_17	Mar. 10, 2017
4	EMI Test Receiver	R&S	ESCI	100382	Mar. 27, 2017
5	50Ω Terminator	SHX	TF2-3G-A	08122901	Mar. 27, 2017
6	Measurement Software	Farad	EZ-EMC Ver.NB-03A1-01	N/A	N/A

Radiated Emission Measurement					
Item	Kind of Equipment	Manufacturer	Type No.	Serial No.	Calibrated until
1	Antenna	Schwarzbeck	VULB9160	9160-3232	Mar. 27, 2017
2	Amplifier	HP	8447D	2944A09673	Nov. 09, 2016
3	Receiver	AGILENT	N9038A	MY52130039	Nov. 02, 2017
4	Test Cable	emci	LMR-400(30MHz-1GHz)	C-01	Jun. 26, 2017
5	Control	CT	SC100	N/A	N/A
6	Position Control	MF	MF-7802	MF780208416	N/A
7	Antenna	ETS	3115	00075789	Mar. 27, 2017
8	Amplifier	Agilent	8449B	3008A02274	Nov. 01, 2017
9	Receiver	AGILENT	N9038A	MY52130039	Nov. 02, 2017
10	Test Cable	emci	EMC104-SM-SM-10000(1GHz-26.5GHz)	C-68	Jun. 26, 2017
11	Controller	CT	SC100	N/A	N/A
12	Broad-Band Horn Antenna	Schwarzbeck	BBHA 9170	9170319	Apr. 23, 2017
13	Microwave Preamplifier With Adaptor	EMC INSTRUMENT	EMC2654045	980039 & HA01	Mar. 27, 2017
14	Active Loop Antenna	R&S	HFH2-Z2	830749/020	Sep. 06, 2017
15	Measurement Software	Farad	EZ-EMC Ver.NB-03A1-01	N/A	N/A

6dB Bandwidth Measurement					
Item	Kind of Equipment	Manufacturer	Type No.	Serial No.	Calibrated until
1	Spectrum Analyzer	R&S	FSP 40	100185	Oct. 10, 2017

Peak Output Power Measurement					
Item	Kind of Equipment	Manufacturer	Type No.	Serial No.	Calibrated until
1	P-series Power meter	Agilent	N1911A	MY45100473	Oct. 25, 2017
2	Wireband Power sensor	Agilent	N1921A	MY51100041	Oct. 25, 2017

Antenna Conducted Spurious Emission Measurement					
Item	Kind of Equipment	Manufacturer	Type No.	Serial No.	Calibrated until
1	Spectrum Analyzer	R&S	FSP 40	100185	Oct. 10, 2017

Power Spectral Density Measurement					
Item	Kind of Equipment	Manufacturer	Type No.	Serial No.	Calibrated until
1	Spectrum Analyzer	R&S	FSP 40	100185	Oct. 10, 2017

Remark: "N/A" denotes no model name, serial no. or calibration specified.
 All calibration period of equipment list is one year.

ATTACHMENT A - CONDUCTED EMISSION

Test Mode : TX MODE

Line

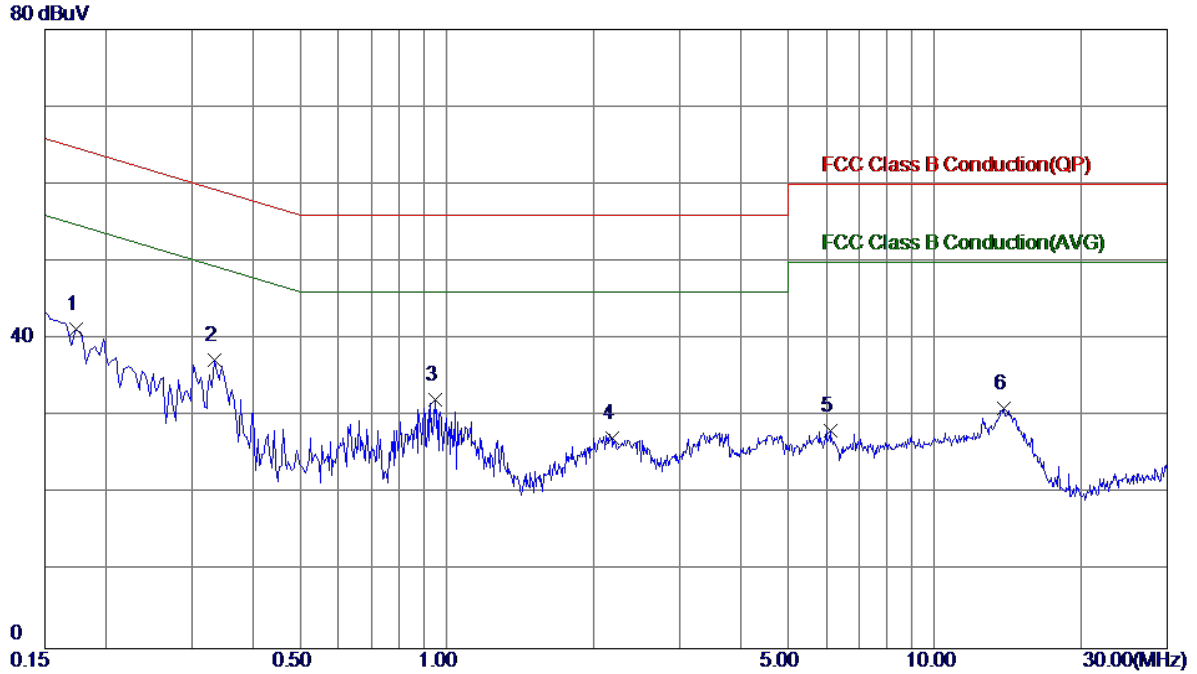

No.	Freq. MHz	Reading Level dBuV	Correct Factor dB	Measure ment dBuV	Limit dBuV	Margin dB	Detector	Comment
1	0.1740	31.70	9.52	41.22	64.77	-23.55	Peak	
2 *	0.3339	27.70	9.53	37.23	59.35	-22.12	Peak	
3	0.9460	22.45	9.76	32.21	56.00	-23.79	Peak	
4	2.1860	17.19	9.96	27.15	56.00	-28.85	Peak	
5	6.1180	18.09	10.08	28.17	60.00	-31.83	Peak	
6	13.8820	20.64	10.33	30.97	60.00	-29.03	Peak	

Test Mode : TX MODE

Neutral

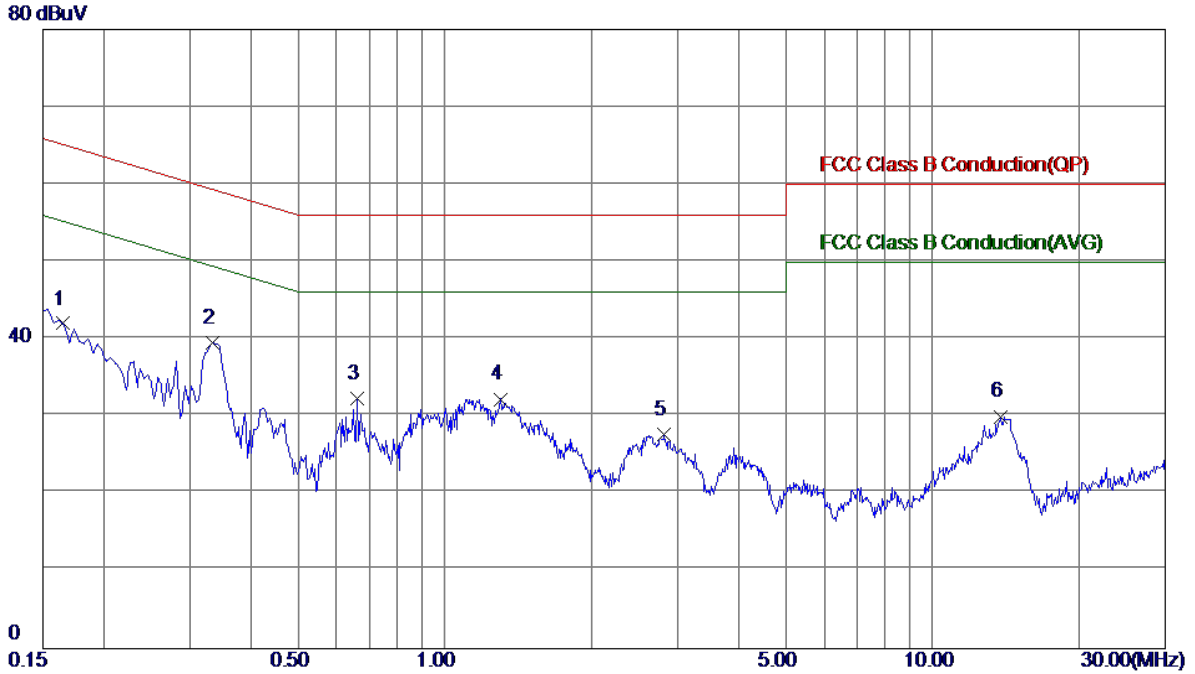

No.	Freq. MHz	Reading Level dBuV	Correct Factor dB	Measure ment dBuV	Limit dBuV	Margin dB	Detector	Comment
1	0.1650	32.55	9.45	42.00	65.21	-23.21	Peak	
2 *	0.3339	29.92	9.53	39.45	59.35	-19.90	Peak	
3	0.6620	22.91	9.45	32.36	56.00	-23.64	Peak	
4	1.3020	22.57	9.67	32.24	56.00	-23.76	Peak	
5	2.8100	17.92	9.79	27.71	56.00	-28.29	Peak	
6	13.8060	19.65	10.35	30.00	60.00	-30.00	Peak	

ATTACHMENT B - RADIATED EMISSION (9KHZ TO 30MHZ)

Test Mode: TX B MODE CHANNEL 01

Ant 0°

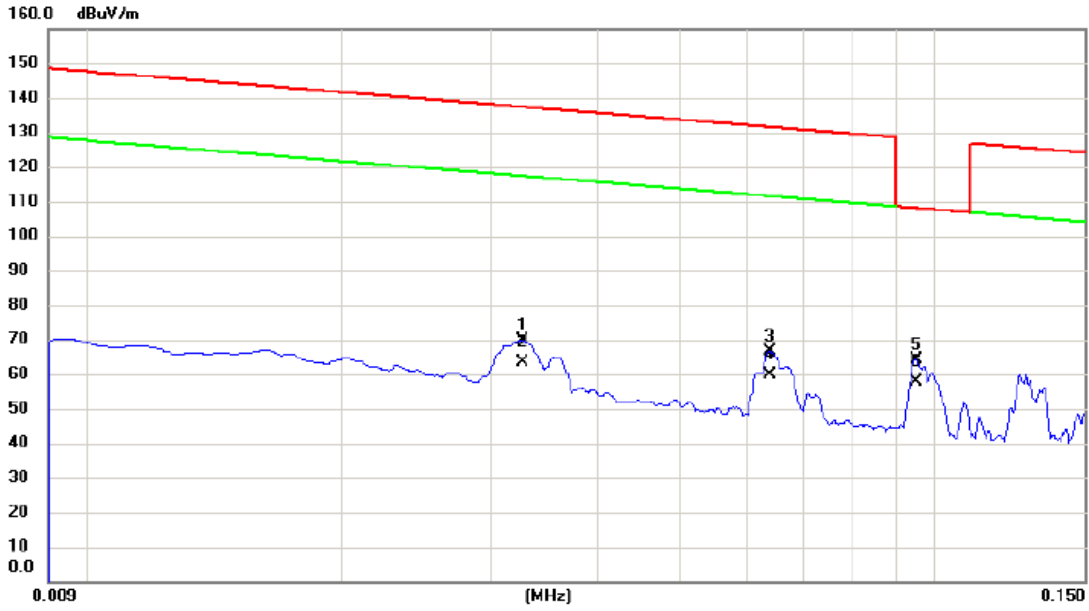

No.	Mk.	Freq. MHz	Reading Level dBuV	Correct Factor dB	Measure- ment dBuV/m	Limit dBuV/m	Margin dB	Detector	Comment
1		0.033	47.78	21.97	69.75	137.34	-67.59	peak	
2		0.033	41.24	21.97	63.21	117.34	-54.13	AVG	
3		0.064	46.92	19.66	66.58	131.48	-64.90	peak	
4		0.064	40.11	19.66	59.77	111.48	-51.71	AVG	
5	*	0.095	45.75	18.64	64.39	108.03	-43.64	peak	
6		0.095	39.34	18.64	57.98	108.03	-50.05	AVG	

Test Mode: TX B MODE CHANNEL 01

Ant 0°

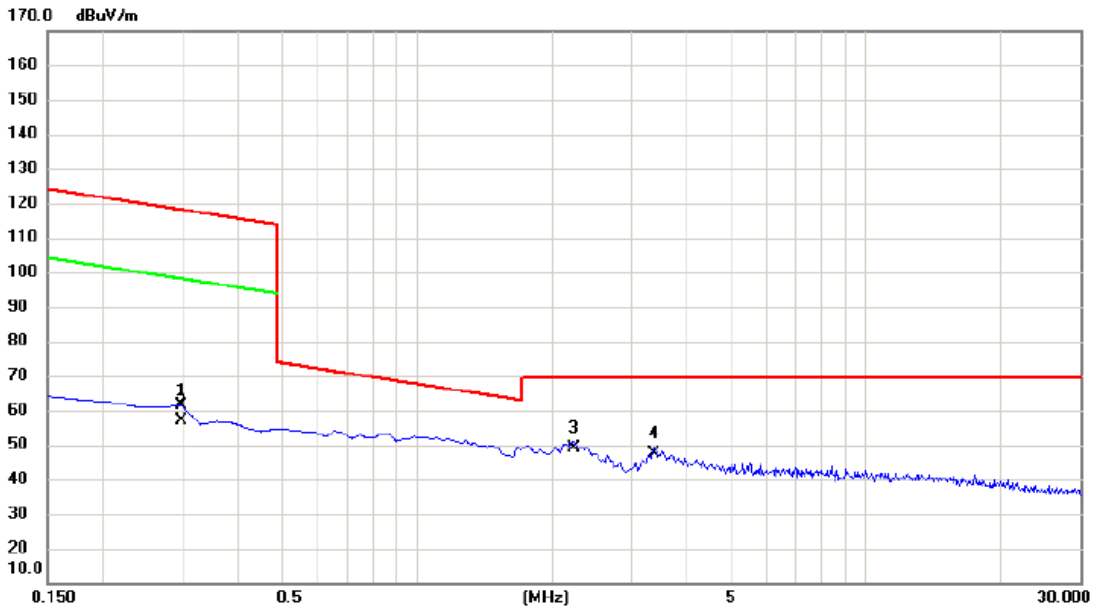

No.	Mk.	Freq. MHz	Reading Level dBuV	Correct Factor dB	Measure- ment dBuV/m	Limit dBuV/m	Margin dB	Detector	Comment
1		0.299	42.70	18.59	61.29	118.08	-56.79	peak	
2		0.299	38.28	18.59	56.87	98.08	-41.21	AVG	
3	*	2.240	31.37	17.60	48.97	69.54	-20.57	QP	
4		3.374	30.05	17.42	47.47	69.54	-22.07	QP	

Test Mode: TX B MODE CHANNEL 01

Ant 90°

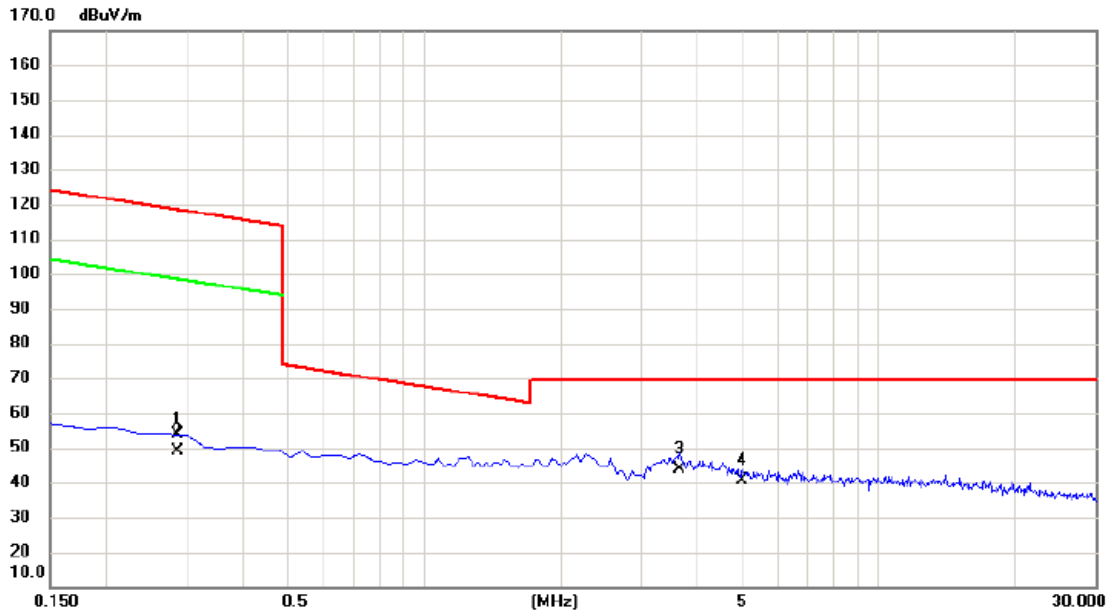

No.	Mk.	Freq.	Reading Level	Correct Factor	Measurement	Limit	Margin	Detector	Comment
		MHz	dBuV	dB	dBuV/m	dBuV/m	dB		
1		0.286	35.37	18.61	53.98	118.47	-64.49	peak	
2		0.286	30.27	18.61	48.88	98.47	-49.59	AVG	
3	*	3.643	25.72	18.00	43.72	69.54	-25.82	QP	
4		5.016	24.01	16.68	40.69	69.54	-28.85	QP	

Test Mode: TX B MODE CHANNEL 01

Ant 90°

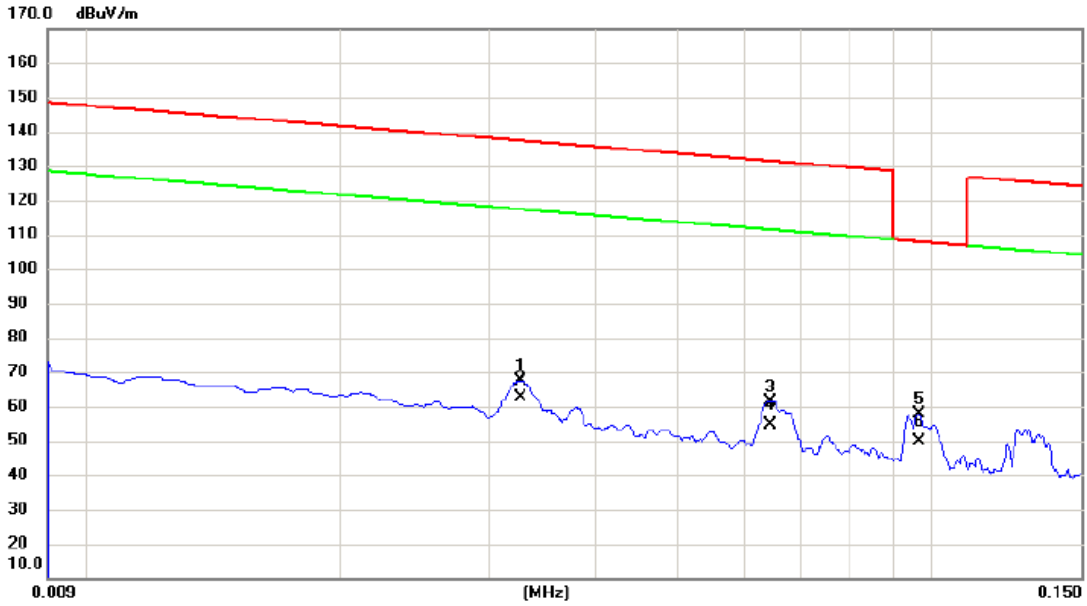

No.	Mk.	Freq. MHz	Reading Level dBuV	Correct Factor dB	Measurement dBuV/m	Limit dBuV/m	Margin dB	Detector	Comment
1		0.033	45.42	21.97	67.39	137.34	-69.95	peak	
2		0.033	40.75	21.97	62.72	117.34	-54.62	AVG	
3		0.064	41.87	19.66	61.53	131.44	-69.91	peak	
4		0.064	35.14	19.66	54.80	111.44	-56.64	AVG	
5	*	0.097	39.12	18.58	57.70	107.91	-50.21	peak	
6		0.097	31.24	18.58	49.82	107.91	-58.09	AVG	

ATTACHMENT C - RADIATED EMISSION (30MHZ TO 1000MHZ)

Test Mode: TX B MODE CHANNEL 01

Vertical

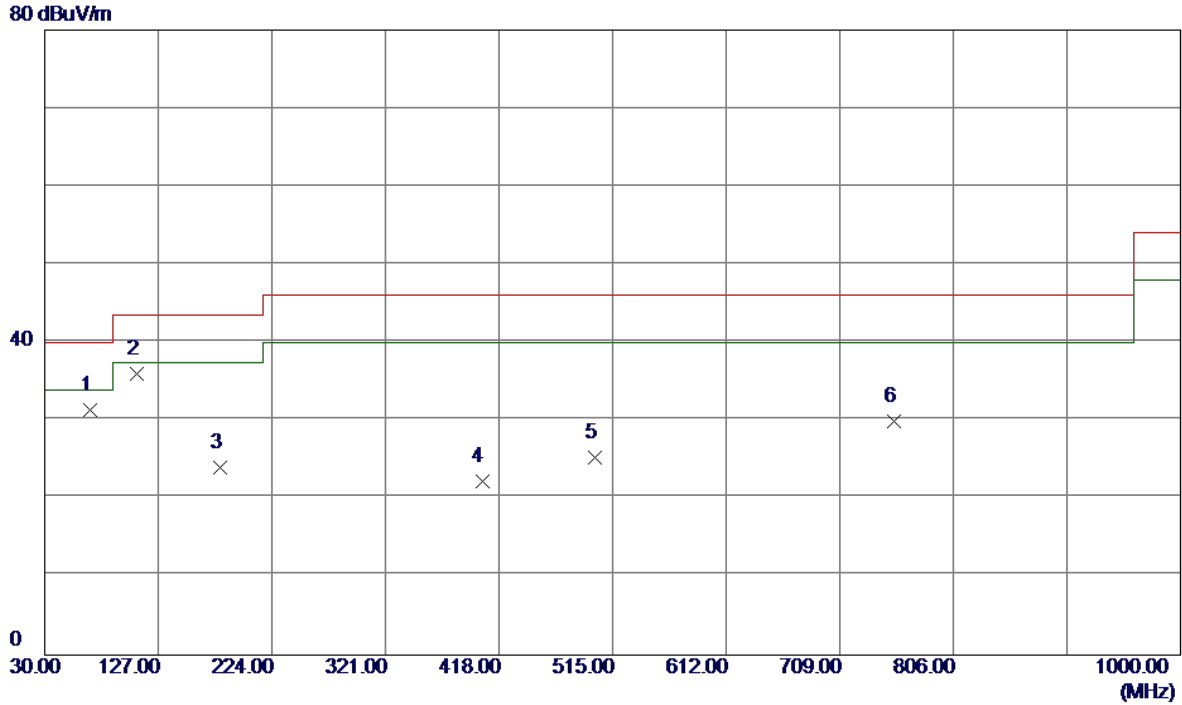

No.	Freq. MHz	Reading Level dBuV/m	Correct Factor dB	Measure ment dBuV/m	Limit dBuV/m	Margin dB	Detector	Comment
1	68.3150	47.47	-16.07	31.40	40.00	-8.60	Peak	
2 *	109.0550	50.69	-14.73	35.96	43.50	-7.54	Peak	
3	179.8650	36.83	-12.83	24.00	43.50	-19.50	Peak	
4	403.4500	30.05	-7.80	22.25	46.00	-23.75	Peak	
5	499.9650	35.04	-9.72	25.32	46.00	-20.68	Peak	
6	755.5600	31.62	-1.72	29.90	46.00	-16.10	Peak	

Test Mode: TX B MODE CHANNEL 01

Horizontal

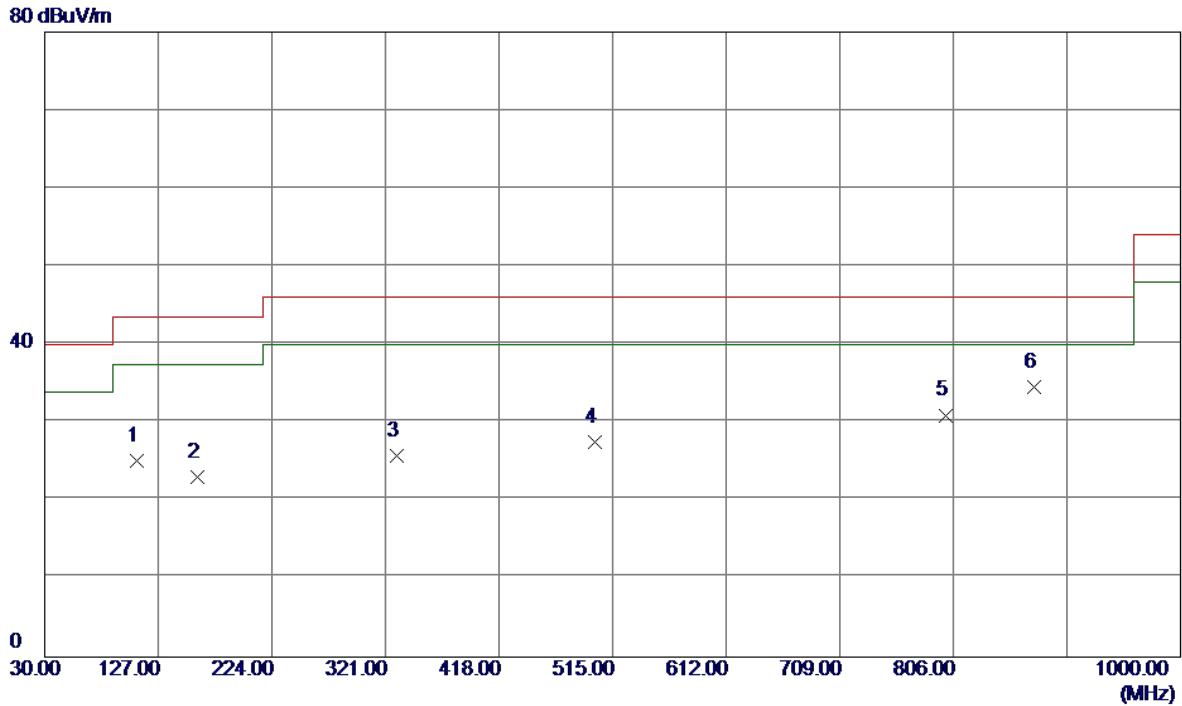

No.	Freq. MHz	Reading Level dBuV/m	Correct Factor dB	Measure ment dBuV/m	Limit dBuV/m	Margin dB	Detector	Comment
1	108.5700	39.87	-14.77	25.10	43.50	-18.40	Peak	
2	160.4650	35.26	-12.15	23.11	43.50	-20.39	Peak	
3	331.1850	36.63	-10.82	25.81	46.00	-20.19	Peak	
4	499.9650	37.30	-9.72	27.58	46.00	-18.42	Peak	
5	799.6950	30.71	0.25	30.96	46.00	-15.04	Peak	
6 *	874.8700	33.87	0.68	34.55	46.00	-11.45	Peak	

Test Mode: TX B MODE CHANNEL 06

Vertical

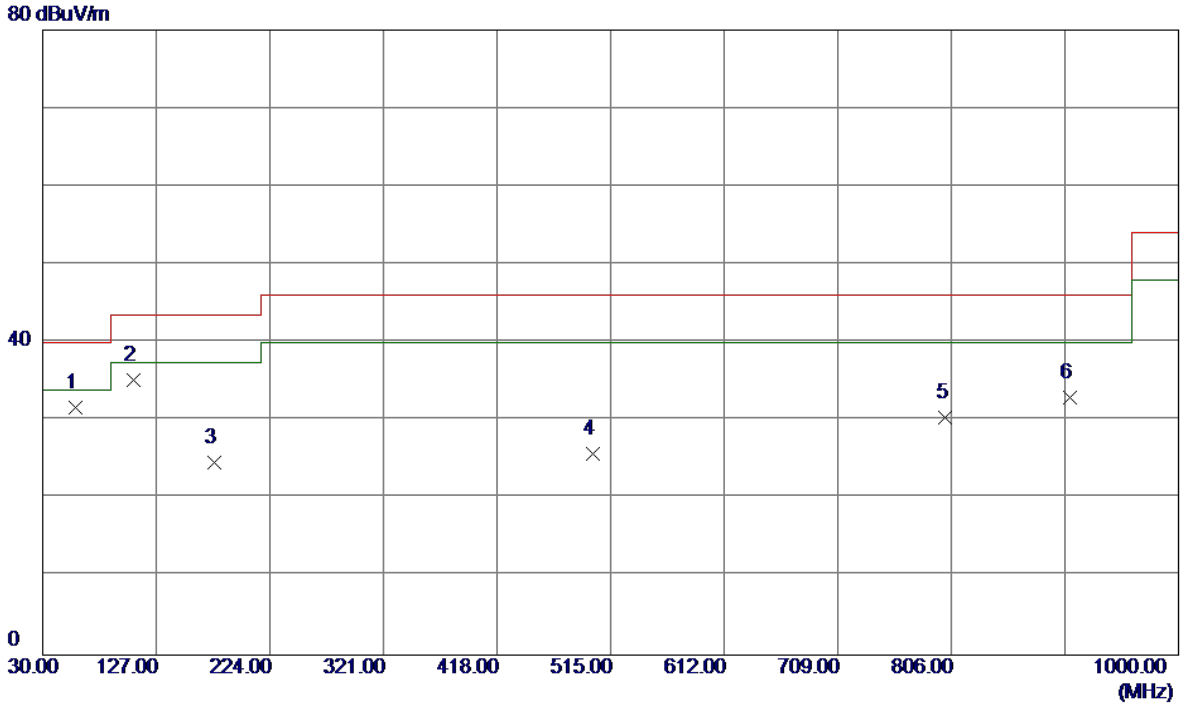

No.	Freq. MHz	Reading Level dBuV/m	Correct Factor dB	Measure ment dBuV/m	Limit dBuV/m	Margin dB	Detector	Comment
1	58.1300	45.52	-13.83	31.69	40.00	-8.31	Peak	
2 *	107.6000	50.10	-14.85	35.25	43.50	-8.25	Peak	
3	176.9550	37.33	-12.66	24.67	43.50	-18.83	Peak	
4	499.9650	35.50	-9.72	25.78	46.00	-20.22	Peak	
5	801.1500	30.20	0.23	30.43	46.00	-15.57	Peak	
6	906.8800	30.42	2.61	33.03	46.00	-12.97	Peak	

Test Mode: TX B MODE CHANNEL 06

Horizontal

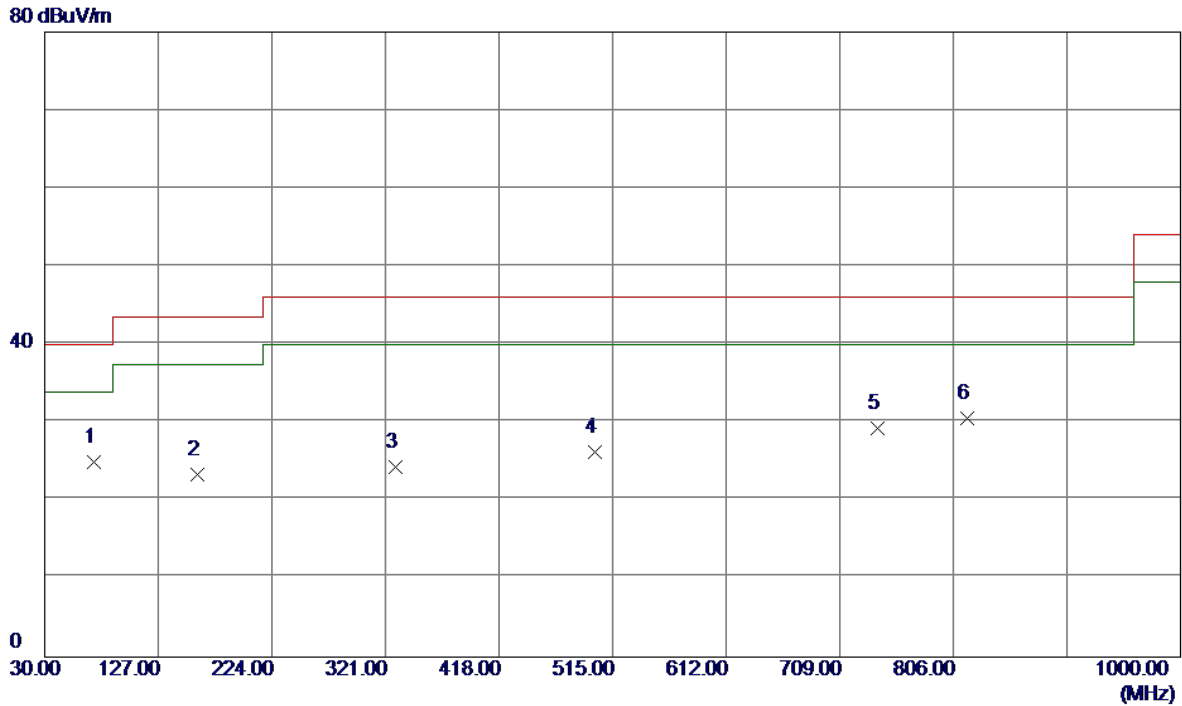

No.	Freq. MHz	Reading Level dBuV/m	Correct Factor dB	Measure ment dBuV/m	Limit dBuV/m	Margin dB	Detector	Comment
1 *	72.1950	41.55	-16.55	25.00	40.00	-15.00	Peak	
2	159.9800	35.46	-12.15	23.31	43.50	-20.19	Peak	
3	329.7300	35.08	-10.79	24.29	46.00	-21.71	Peak	
4	499.9650	35.90	-9.72	26.18	46.00	-19.82	Peak	
5	741.4950	31.27	-1.99	29.28	46.00	-16.72	Peak	
6	818.1250	30.91	-0.29	30.62	46.00	-15.38	Peak	

Test Mode: TX B MODE CHANNEL 11

Vertical

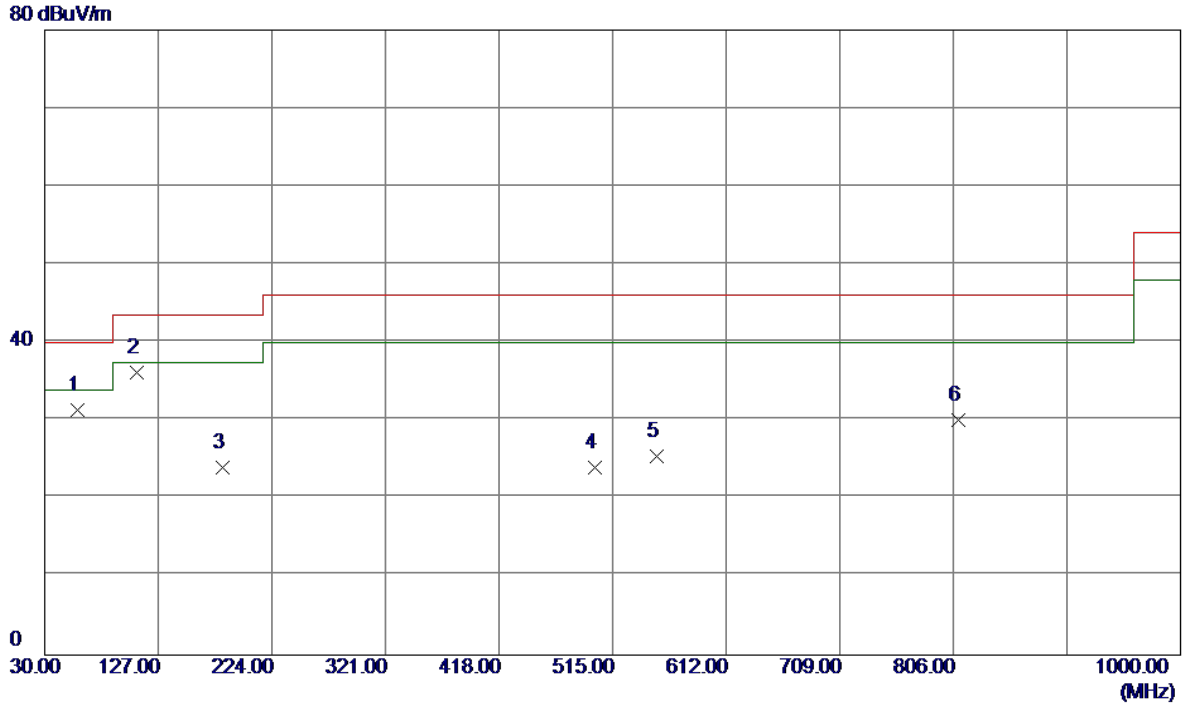

No.	Freq. MHz	Reading Level dBuV/m	Correct Factor dB	Measure ment dBuV/m	Limit dBuV/m	Margin dB	Detector	Comment
1	57.6450	45.10	-13.73	31.37	40.00	-8.63	Peak	
2 *	108.5700	50.89	-14.77	36.12	43.50	-7.38	Peak	
3	181.8049	37.00	-13.04	23.96	43.50	-19.54	Peak	
4	499.9650	33.73	-9.72	24.01	46.00	-21.99	Peak	
5	552.3449	30.06	-4.66	25.40	46.00	-20.60	Peak	
6	810.3650	30.15	-0.05	30.10	46.00	-15.90	Peak	

Test Mode: TX B MODE CHANNEL 11

Horizontal

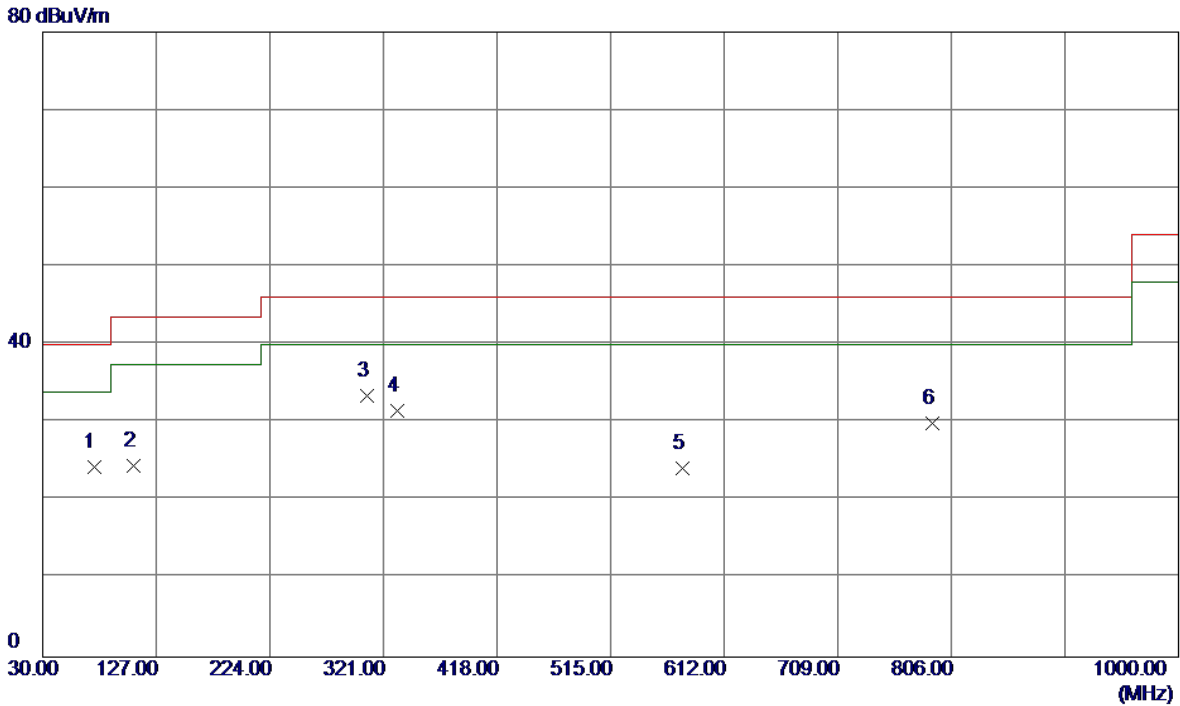

No.	Freq. MHz	Reading Level dBuV/m	Correct Factor dB	Measure ment dBuV/m	Limit dBuV/m	Margin dB	Detector	Comment
1	73.6500	40.95	-16.57	24.38	40.00	-15.62	Peak	
2	108.0850	39.26	-14.81	24.45	43.50	-19.05	Peak	
3 *	307.4200	43.78	-10.32	33.46	46.00	-12.54	Peak	
4	332.6400	42.39	-10.85	31.54	46.00	-14.46	Peak	
5	576.1100	29.98	-5.86	24.12	46.00	-21.88	Peak	
6	789.5100	30.07	-0.21	29.86	46.00	-16.14	Peak	

ATTACHMENT D - RADIATED EMISSION (ABOVE 1000MHZ)

Orthogonal Axis :	X
Test Mode :	TX B MODE 2412MHz

Vertical

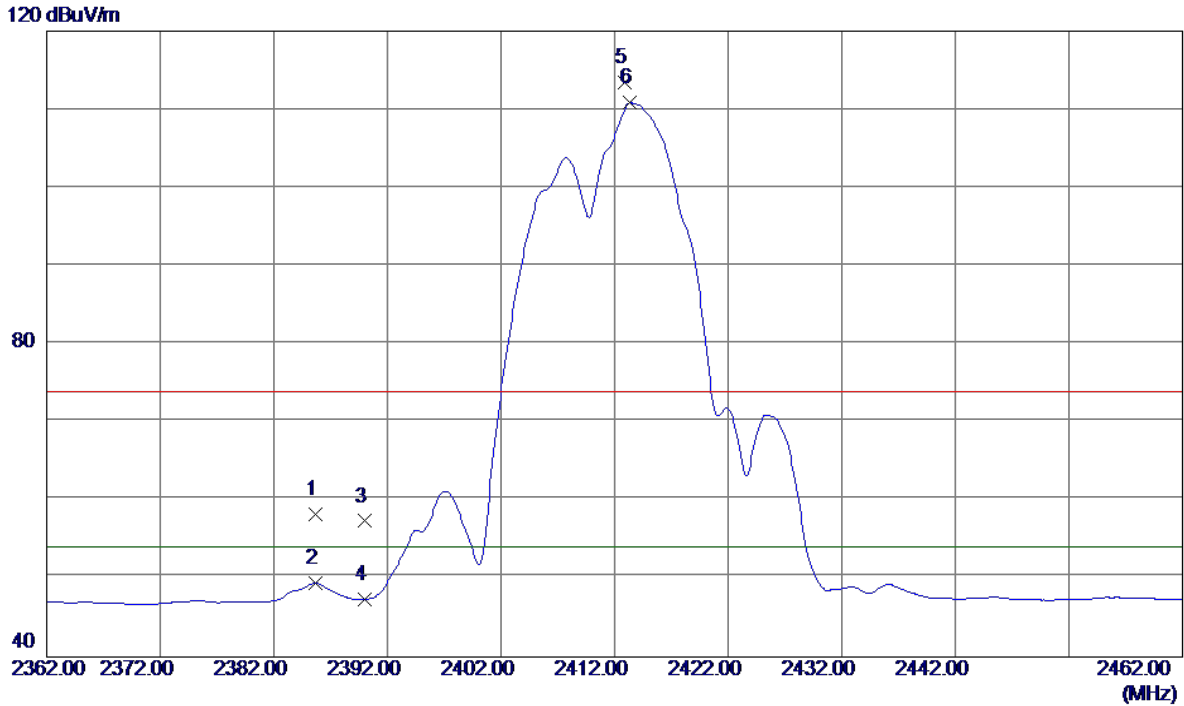

No.	Freq. MHz	Reading Level dBuV/m	Correct Factor dB	Measure ment dBuV/m	Limit dBuV/m	Margin dB	Detector	Comment
1	2385.6500	25.30	32.99	58.29	74.00	-15.71	Peak	
2	2385.6500	16.47	32.99	49.46	54.00	-4.54	AVG	
3	2390.0000	24.35	33.01	57.36	74.00	-16.64	Peak	
4	2390.0000	14.33	33.01	47.34	54.00	-6.66	AVG	
5	2412.9000	80.29	33.11	113.40	74.00	39.40	Peak	No Limit
6 *	2413.3500	77.72	33.11	110.83	54.00	56.83	AVG	No Limit

Orthogonal Axis :	X
Test Mode :	TX B MODE 2412MHz

Vertical

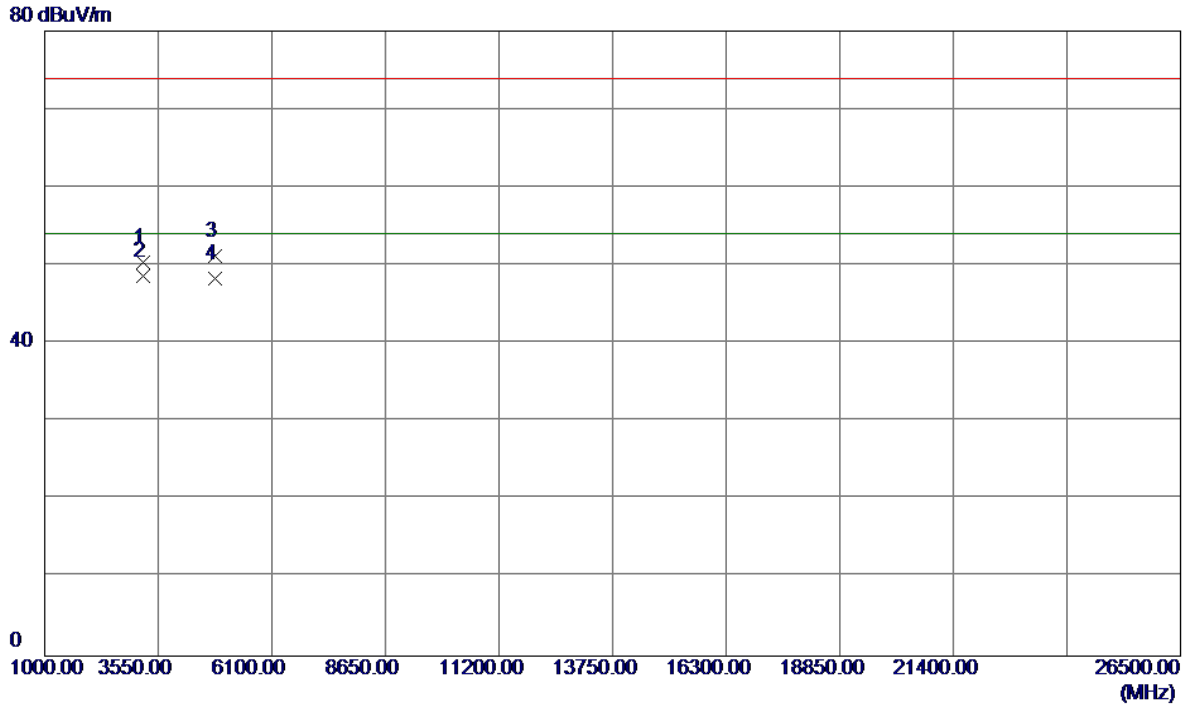

No.	Freq. MHz	Reading Level dBuV/m	Correct Factor dB	Measure ment dBuV/m	Limit dBuV/m	Margin dB	Detector	Comment
1	3215.9000	48.95	1.44	50.39	74.00	-23.61	Peak	
2 *	3215.9630	47.27	1.44	48.71	54.00	-5.29	AVG	
3	4823.9670	46.39	4.85	51.24	74.00	-22.76	Peak	
4	4823.9750	43.41	4.85	48.26	54.00	-5.74	AVG	

Orthogonal Axis :	X
Test Mode :	TX B MODE 2412MHz

Horizontal

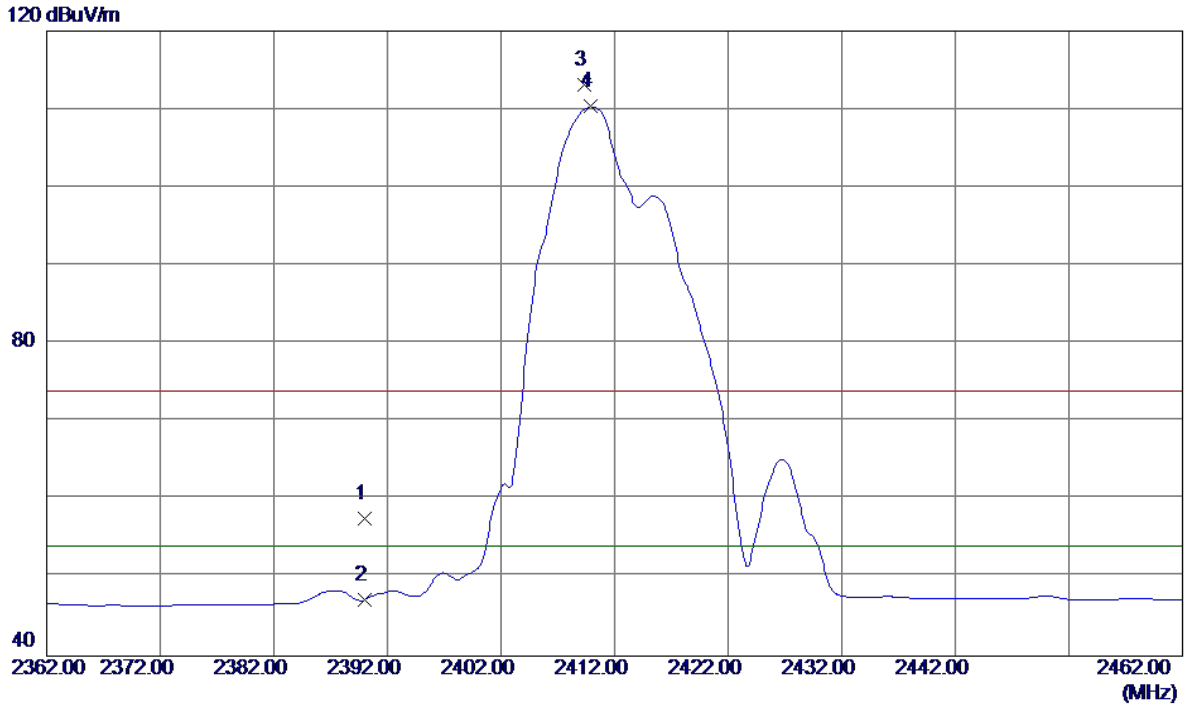

No.	Freq. MHz	Reading Level dBuV/m	Correct Factor dB	Measure ment dBuV/m	Limit dBuV/m	Margin dB	Detector	Comment
1	2390.0000	24.65	33.01	57.66	74.00	-16.34	Peak	
2	2390.0000	14.23	33.01	47.24	54.00	-6.76	AVG	
3	2409.3500	80.02	33.09	113.11	74.00	39.11	Peak	No Limit
4 *	2409.8500	77.25	33.09	110.34	54.00	56.34	AVG	No Limit

Orthogonal Axis :	X
Test Mode :	TX B MODE 2412MHz

Horizontal

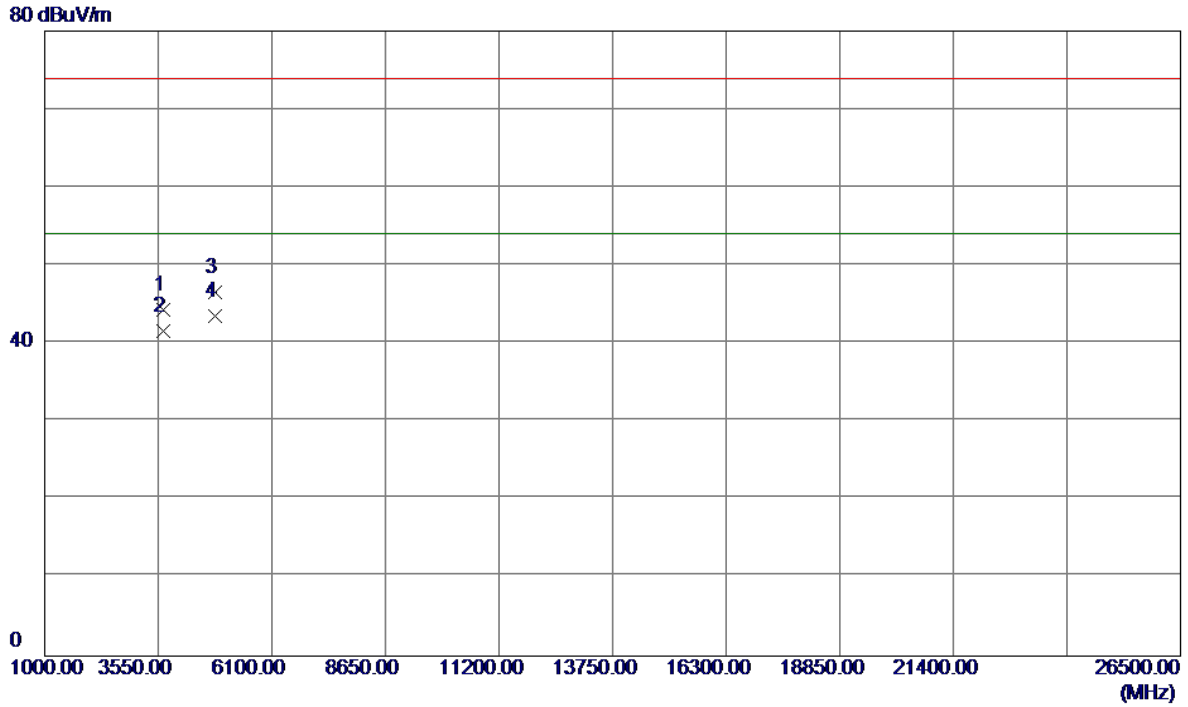

No.	Freq. MHz	Reading Level dBuV/m	Correct Factor dB	Measure ment dBuV/m	Limit dBuV/m	Margin dB	Detector	Comment
1	3666.5950	42.44	1.86	44.30	74.00	-29.70	Peak	
2	3666.6600	39.78	1.86	41.64	54.00	-12.36	AVG	
3	4823.9500	41.70	4.85	46.55	74.00	-27.45	Peak	
4 *	4823.9500	38.68	4.85	43.53	54.00	-10.47	AVG	

Orthogonal Axis :	X
Test Mode :	TX B MODE 2437MHz

Vertical

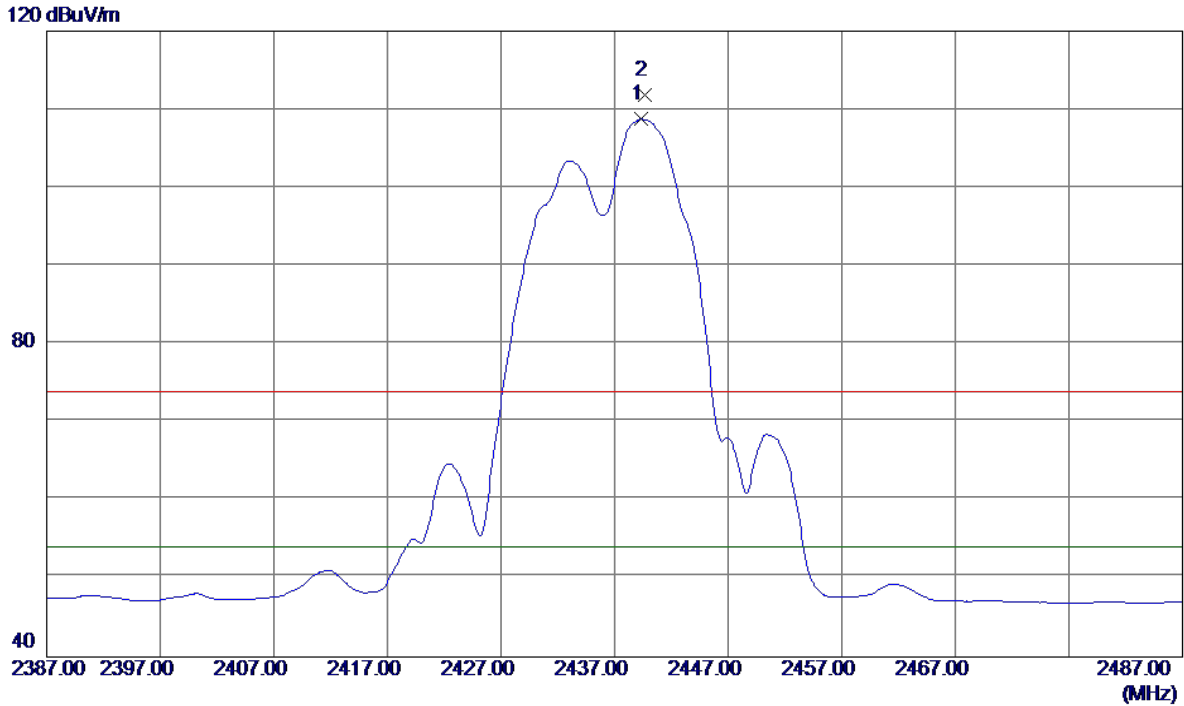

No.	Freq. MHz	Reading Level dBuV/m	Correct Factor dB	Measure ment dBuV/m	Limit dBuV/m	Margin dB	Detector	Comment
1 *	2439.3000	75.55	33.22	108.77	54.00	54.77	AVG	No Limit
2	2439.7000	78.69	33.22	111.91	74.00	37.91	Peak	No Limit

Orthogonal Axis :	X
Test Mode :	TX B MODE 2437MHz

Vertical

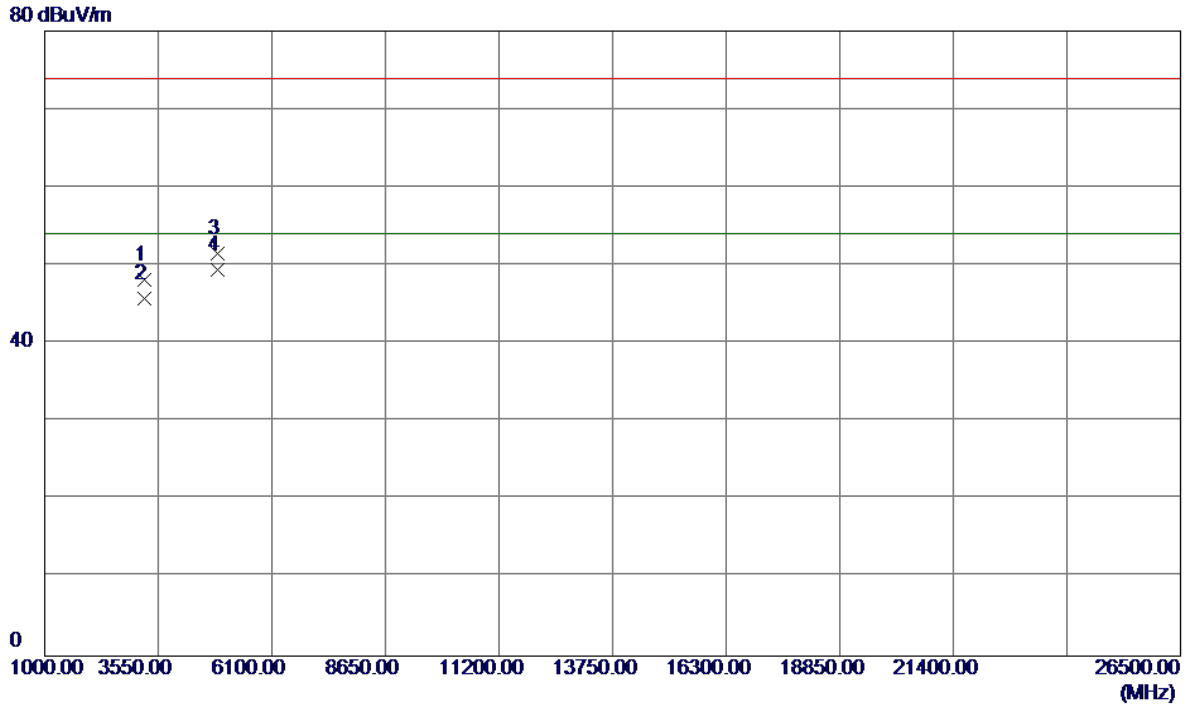

No.	Freq. MHz	Reading Level dBuV/m	Correct Factor dB	Measure ment dBuV/m	Limit dBuV/m	Margin dB	Detector	Comment
1	3249.3000	46.77	1.42	48.19	74.00	-25.81	Peak	
2	3249.3020	44.32	1.42	45.74	54.00	-8.26	AVG	
3	4873.9510	46.42	5.07	51.49	74.00	-22.51	Peak	
4 *	4873.9510	44.37	5.07	49.44	54.00	-4.56	AVG	

Orthogonal Axis :	X
Test Mode :	TX B MODE 2437MHz

Horizontal

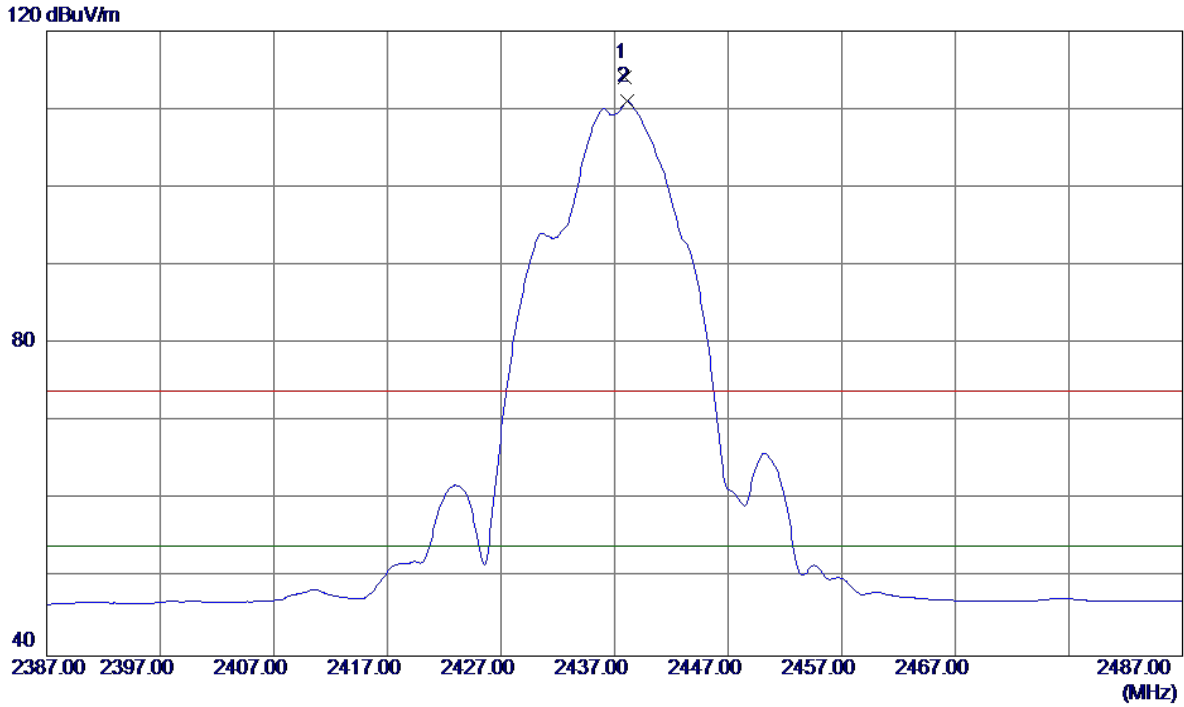

No.	Freq. MHz	Reading Level dBuV/m	Correct Factor dB	Measure ment dBuV/m	Limit dBuV/m	Margin dB	Detector	Comment
1	2437.9000	80.93	33.21	114.14	74.00	40.14	Peak	No Limit
2 *	2438.1500	77.78	33.21	110.99	54.00	56.99	AVG	No Limit

Orthogonal Axis :	X
Test Mode :	TX B MODE 2437MHz

Horizontal

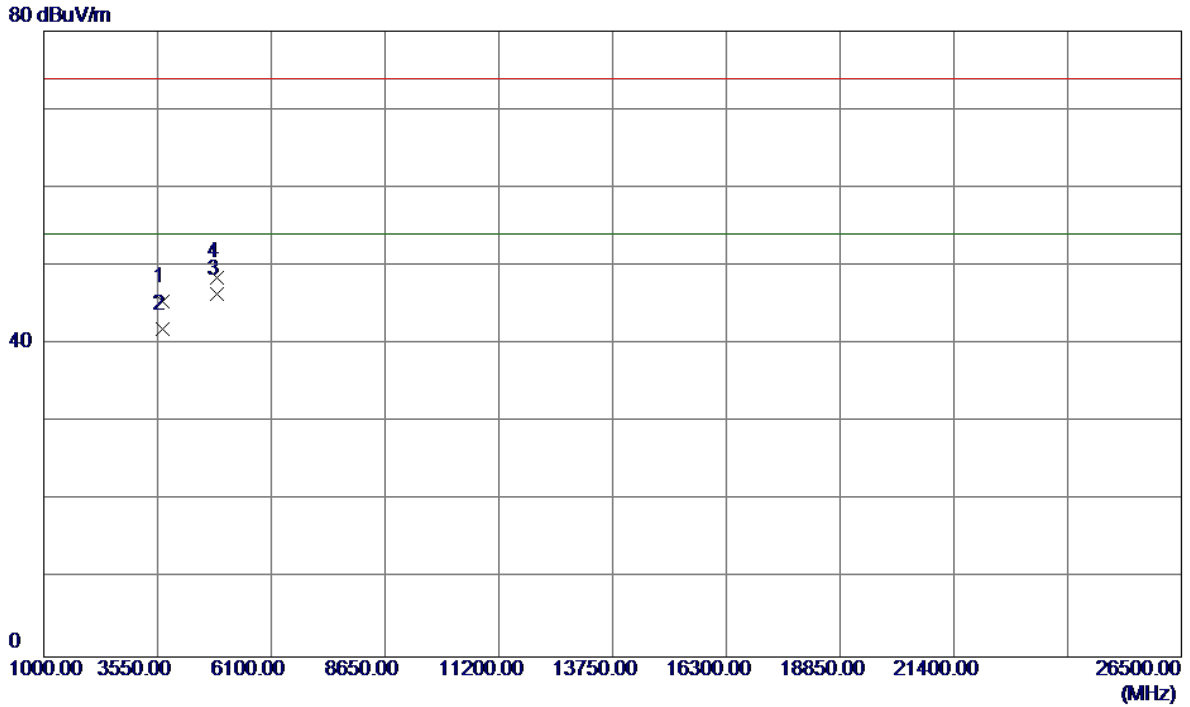

No.	Freq. MHz	Reading Level dBuV/m	Correct Factor dB	Measurement dBuV/m	Limit dBuV/m	Margin dB	Detector	Comment
1	3666.6650	43.61	1.86	45.47	74.00	-28.53	Peak	
2	3666.6750	40.03	1.86	41.89	54.00	-12.11	AVG	
3 *	4873.9550	41.30	5.07	46.37	54.00	-7.63	AVG	
4	4874.0750	43.49	5.07	48.56	74.00	-25.44	Peak	

Orthogonal Axis :	X
Test Mode :	TX B MODE 2462MHz

Vertical

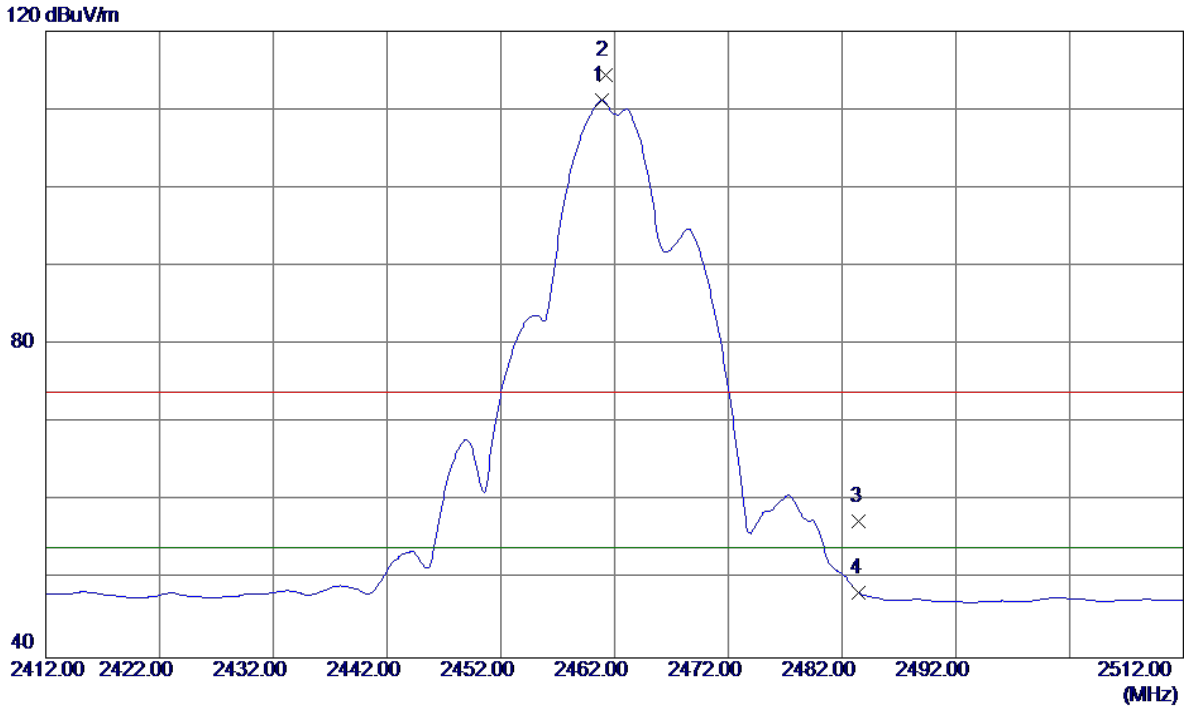

No.	Freq. MHz	Reading Level dBuV/m	Correct Factor dB	Measure ment dBuV/m	Limit dBuV/m	Margin dB	Detector	Comment
1 *	2460.8500	77.95	33.31	111.26	54.00	57.26	AVG	No Limit
2	2461.2000	81.08	33.31	114.39	74.00	40.39	Peak	No Limit
3	2483.5000	24.01	33.40	57.41	74.00	-16.59	Peak	
4	2483.5000	14.88	33.40	48.28	54.00	-5.72	AVG	

Orthogonal Axis :	X
Test Mode :	TX B MODE 2462MHz

Vertical

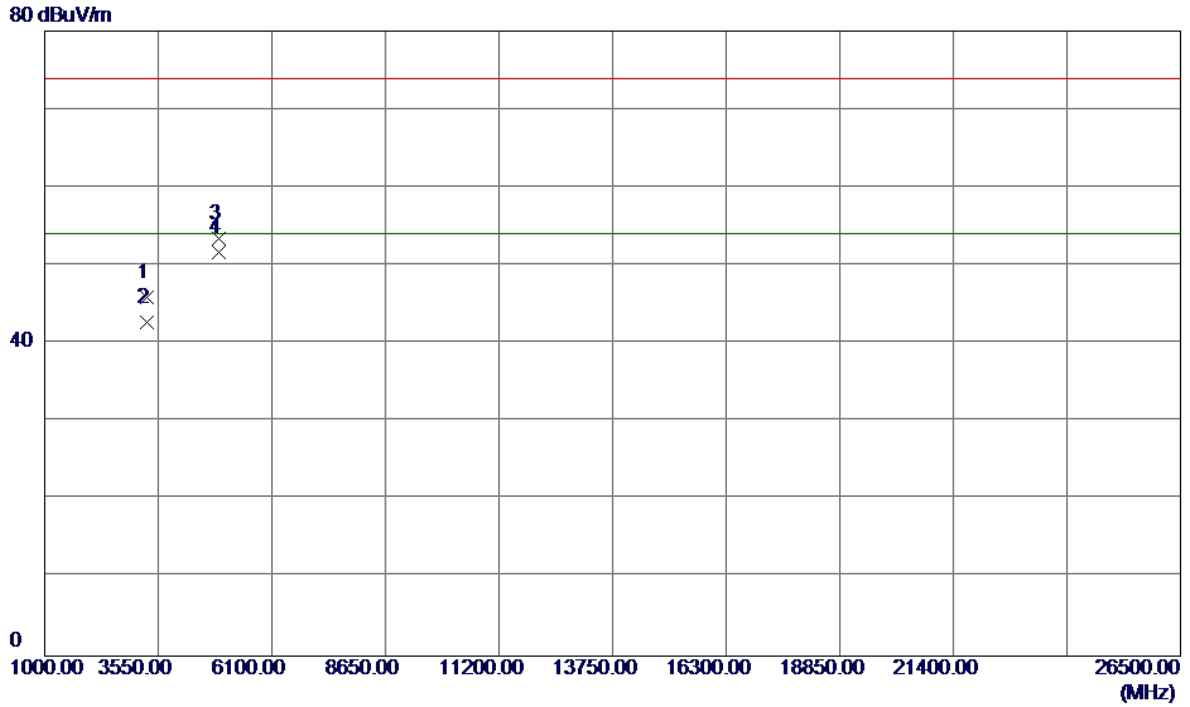

No.	Freq. MHz	Reading Level dBuV/m	Correct Factor dB	Measure ment dBuV/m	Limit dBuV/m	Margin dB	Detector	Comment
1	3282.6200	44.49	1.41	45.90	74.00	-28.10	Peak	
2	3282.6350	41.34	1.41	42.75	54.00	-11.25	AVG	
3	4923.9310	48.11	5.28	53.39	74.00	-20.61	Peak	
4 *	4923.9910	46.45	5.28	51.73	54.00	-2.27	AVG	

Orthogonal Axis :	X
Test Mode :	TX B MODE 2462MHz

Horizontal

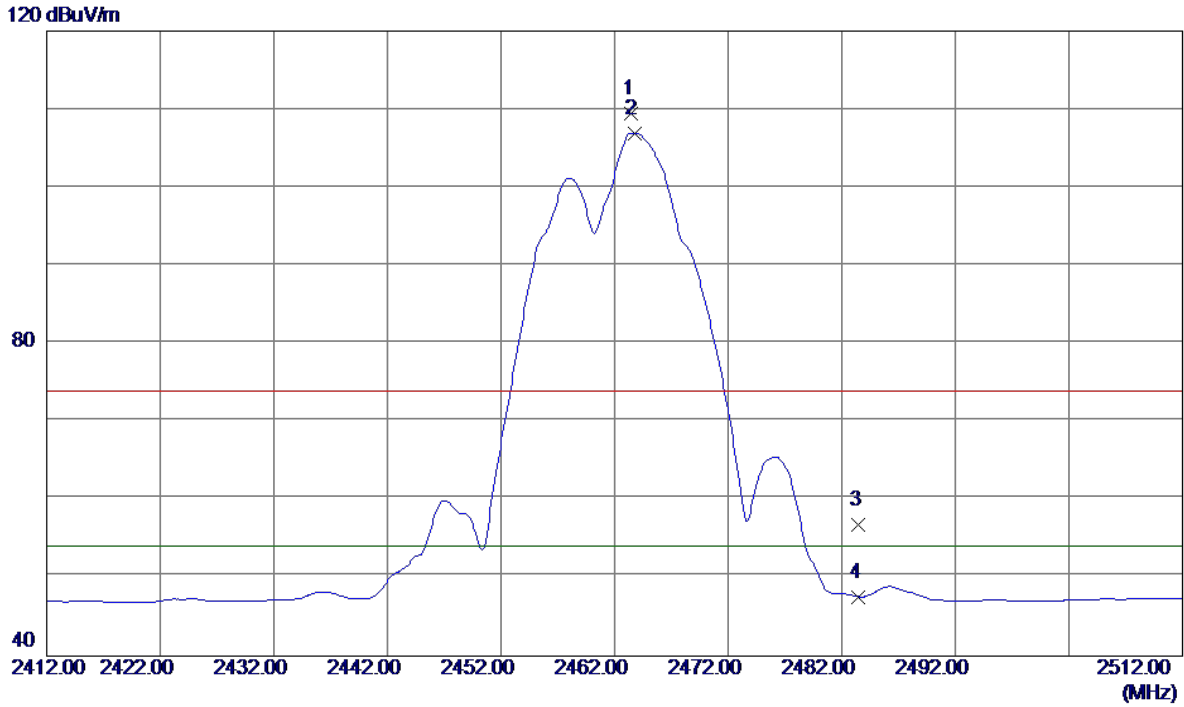

No.	Freq. MHz	Reading Level dBuV/m	Correct Factor dB	Measure ment dBuV/m	Limit dBuV/m	Margin dB	Detector	Comment
1	2463.5000	76.17	33.32	109.49	74.00	35.49	Peak	No Limit
2 *	2463.7500	73.64	33.32	106.96	54.00	52.96	AVG	No Limit
3	2483.5000	23.44	33.40	56.84	74.00	-17.16	Peak	
4	2483.5000	14.19	33.40	47.59	54.00	-6.41	AVG	

Orthogonal Axis :	X
Test Mode :	TX B MODE 2462MHz

Horizontal

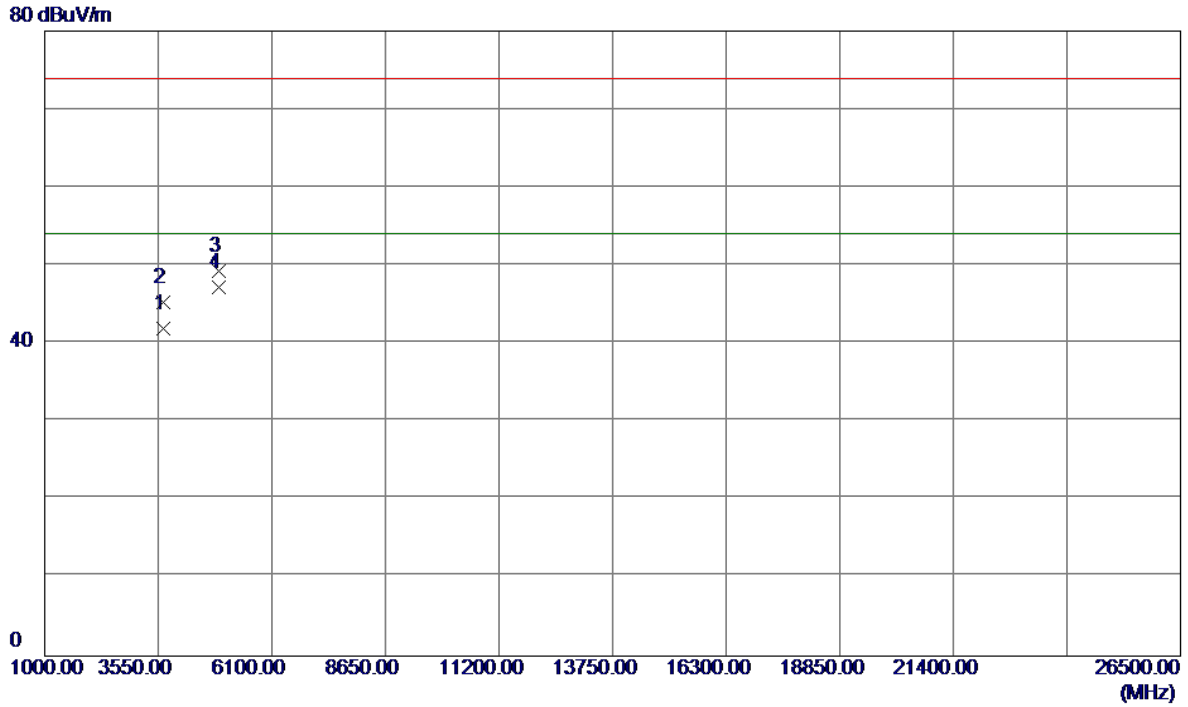

No.	Freq. MHz	Reading Level dBuV/m	Correct Factor dB	Measurement dBuV/m	Limit dBuV/m	Margin dB	Detector	Comment
1	3666.6300	40.09	1.86	41.95	54.00	-12.05	AVG	
2	3666.6980	43.45	1.86	45.31	74.00	-28.69	Peak	
3	4923.9550	44.02	5.28	49.30	74.00	-24.70	Peak	
4 *	4923.9700	41.93	5.28	47.21	54.00	-6.79	AVG	

Orthogonal Axis :	X
Test Mode :	TX G MODE 2412MHz

Vertical

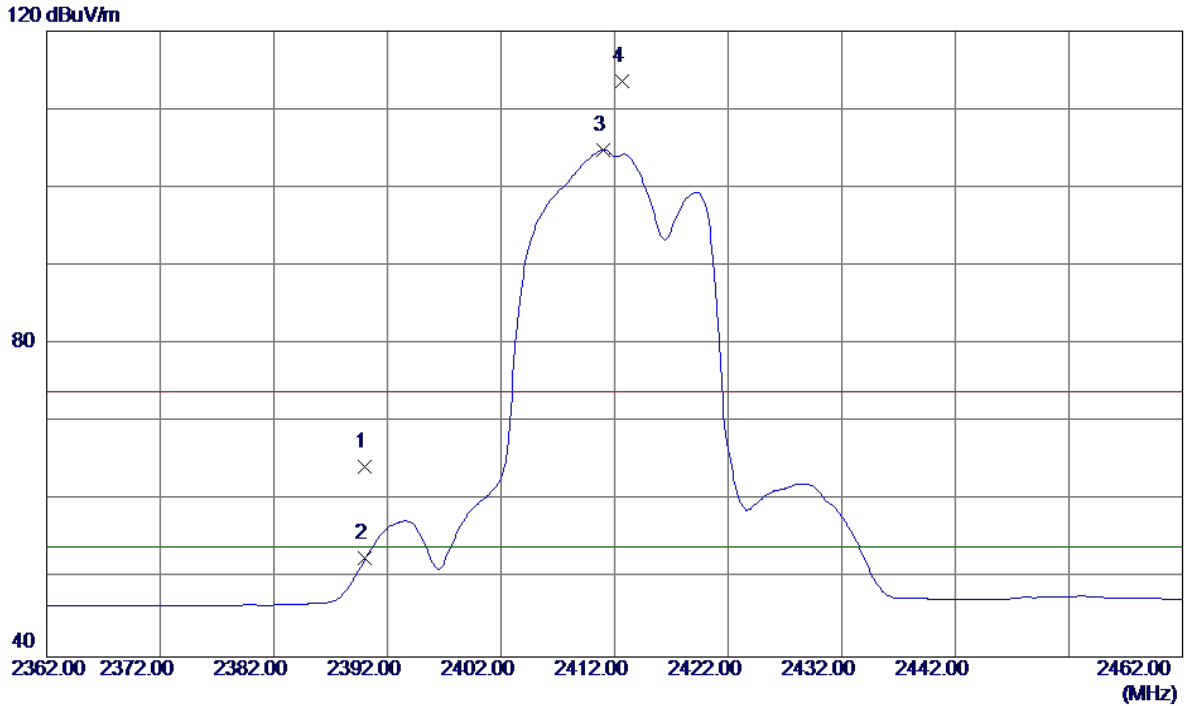

No.	Freq. MHz	Reading Level dBuV/m	Correct Factor dB	Measure ment dBuV/m	Limit dBuV/m	Margin dB	Detector	Comment
1	2390.0000	31.24	33.01	64.25	74.00	-9.75	Peak	
2	2390.0000	19.61	33.01	52.62	54.00	-1.38	AVG	
3 *	2411.0000	71.78	33.10	104.88	54.00	50.88	AVG	No Limit
4	2412.7000	80.42	33.11	113.53	74.00	39.53	Peak	No Limit

Orthogonal Axis :	X
Test Mode :	TX G MODE 2412MHz

Vertical

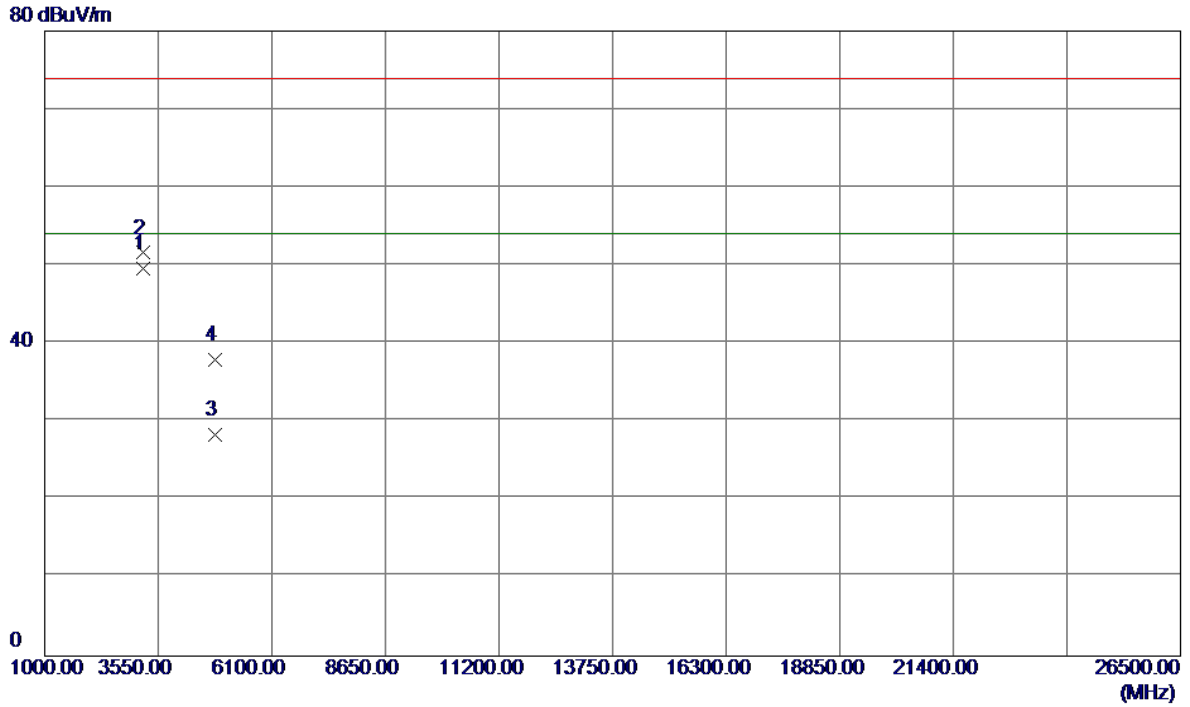

No.	Freq. MHz	Reading Level dBuV/m	Correct Factor dB	Measure ment dBuV/m	Limit dBuV/m	Margin dB	Detector	Comment
1 *	3215.9680	48.23	1.44	49.67	54.00	-4.33	AVG	
2	3216.0009	50.16	1.44	51.60	74.00	-22.40	Peak	
3	4823.9700	23.43	4.85	28.28	54.00	-25.72	AVG	
4	4824.0500	33.09	4.85	37.94	74.00	-36.06	Peak	

Orthogonal Axis :	X
Test Mode :	TX G MODE 2412MHz

Horizontal

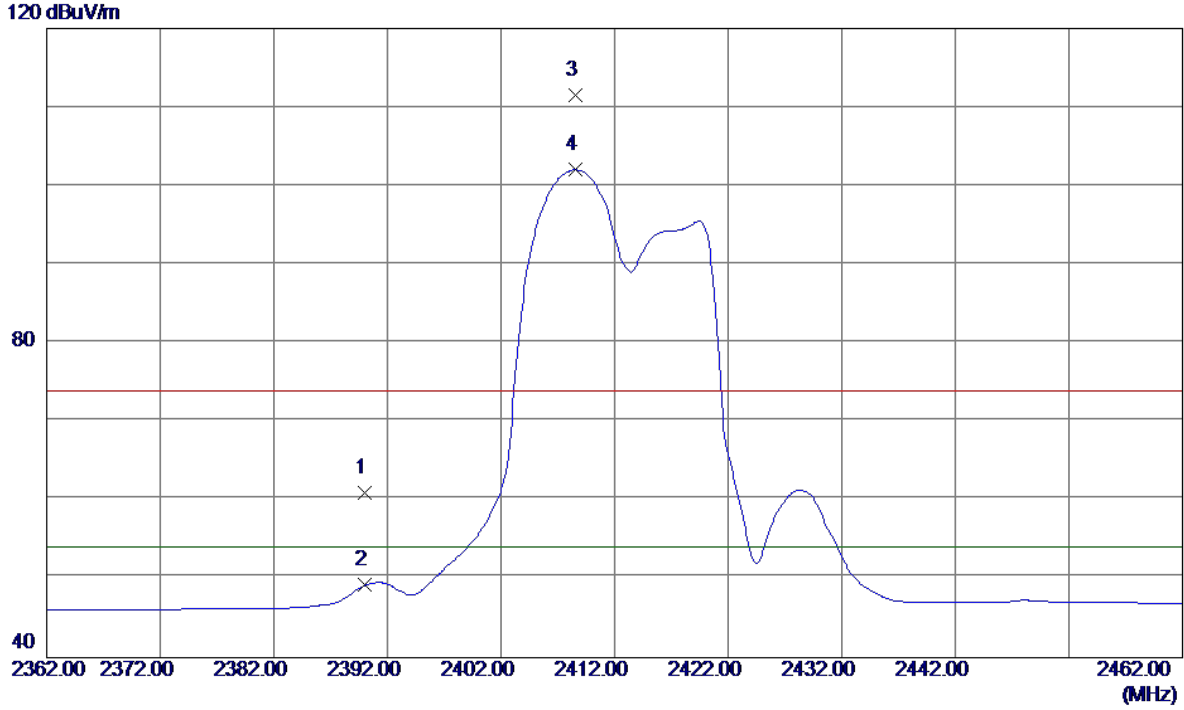

No.	Freq. MHz	Reading Level dBuV/m	Correct Factor dB	Measure ment dBuV/m	Limit dBuV/m	Margin dB	Detector	Comment
1	2390.0000	27.98	33.01	60.99	74.00	-13.01	Peak	
2	2390.0000	16.20	33.01	49.21	54.00	-4.79	AVG	
3	2408.5500	78.41	33.09	111.50	74.00	37.50	Peak	No Limit
4 *	2408.5500	68.94	33.09	102.03	54.00	48.03	AVG	No Limit

Orthogonal Axis :	X
Test Mode :	TX G MODE 2412MHz

Horizontal

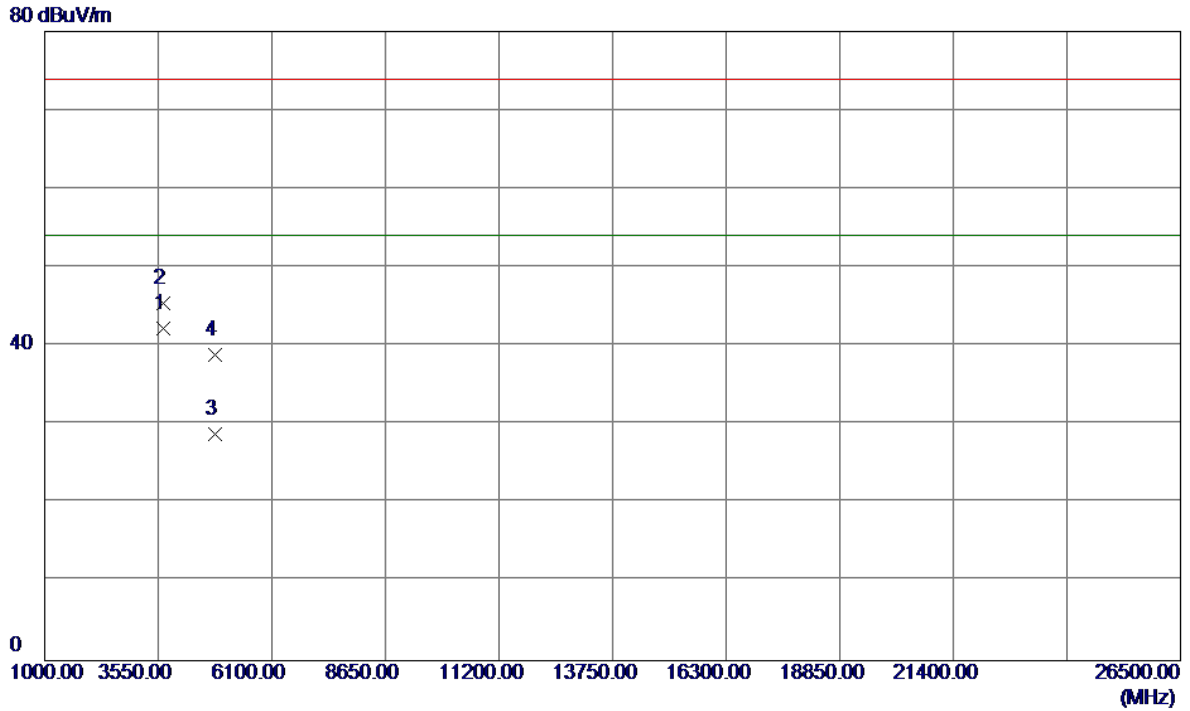

No.	Freq. MHz	Reading Level dBuV/m	Correct Factor dB	Measure ment dBuV/m	Limit dBuV/m	Margin dB	Detector	Comment
1 *	3666.6600	40.35	1.86	42.21	54.00	-11.79	AVG	
2	3666.6720	43.63	1.86	45.49	74.00	-28.51	Peak	
3	4823.8350	23.91	4.85	28.76	54.00	-25.24	AVG	
4	4823.8849	34.01	4.85	38.86	74.00	-35.14	Peak	

Orthogonal Axis :	X
Test Mode :	TX G MODE 2437MHz

Vertical

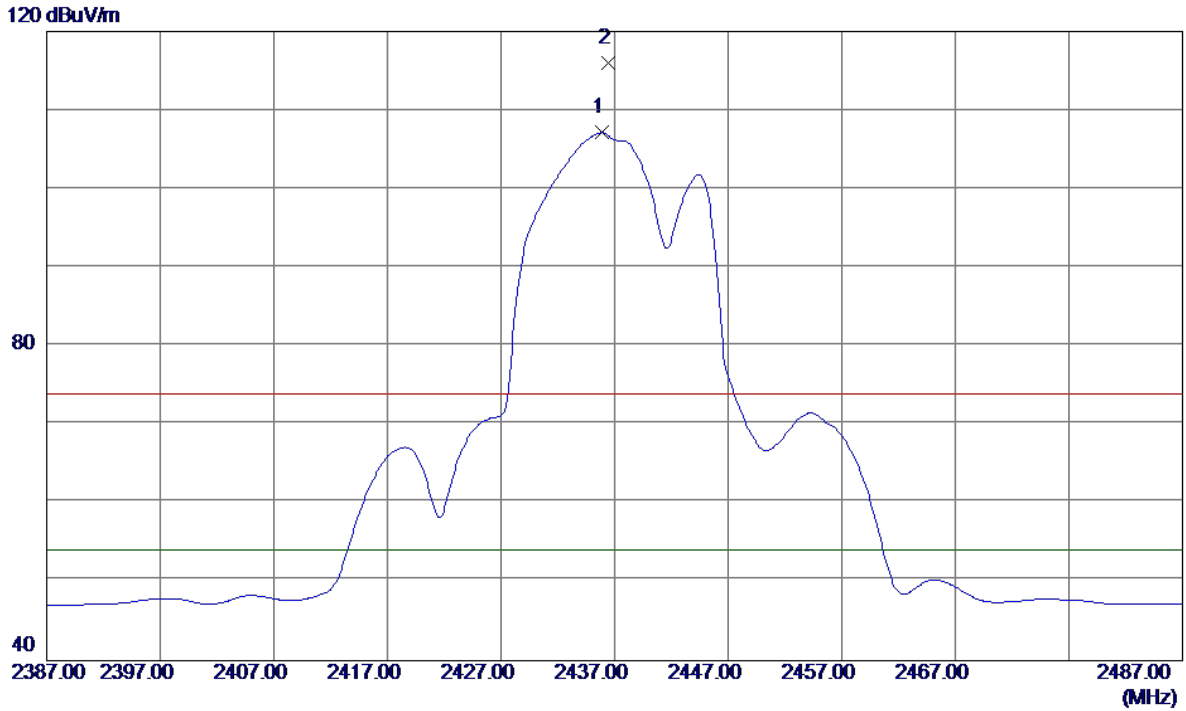

No.	Freq. MHz	Reading Level dBuV/m	Correct Factor dB	Measure ment dBuV/m	Limit dBuV/m	Margin dB	Detector	Comment
1 *	2435.9000	73.96	33.20	107.16	54.00	53.16	AVG	No Limit
2	2436.4000	82.78	33.20	115.98	74.00	41.98	Peak	No Limit

Orthogonal Axis :	X
Test Mode :	TX G MODE 2437MHz

Vertical

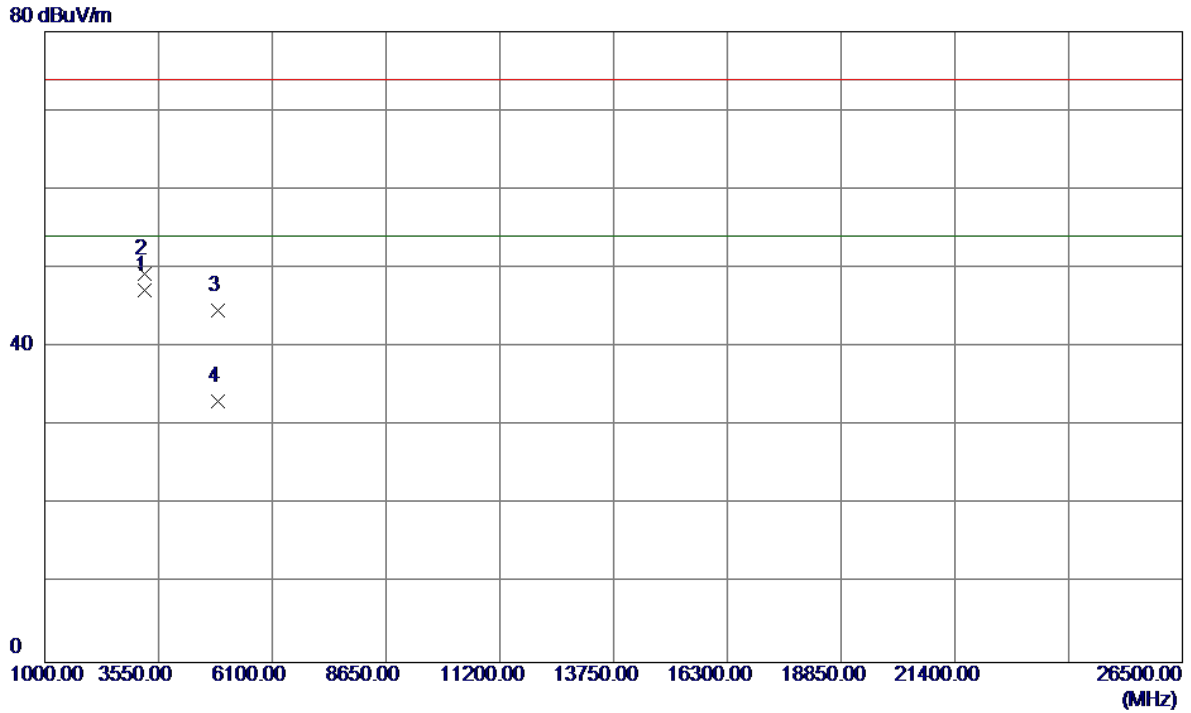

No.	Freq. MHz	Reading Level dBuV/m	Correct Factor dB	Measure ment dBuV/m	Limit dBuV/m	Margin dB	Detector	Comment
1 *	3249.3070	45.72	1.42	47.14	54.00	-6.86	AVG	
2	3249.3200	47.93	1.42	49.35	74.00	-24.65	Peak	
3	4871.2250	39.59	5.05	44.64	74.00	-29.36	Peak	
4	4872.0000	28.08	5.06	33.14	54.00	-20.86	AVG	

Orthogonal Axis :	X
Test Mode :	TX G MODE 2437MHz

Horizontal

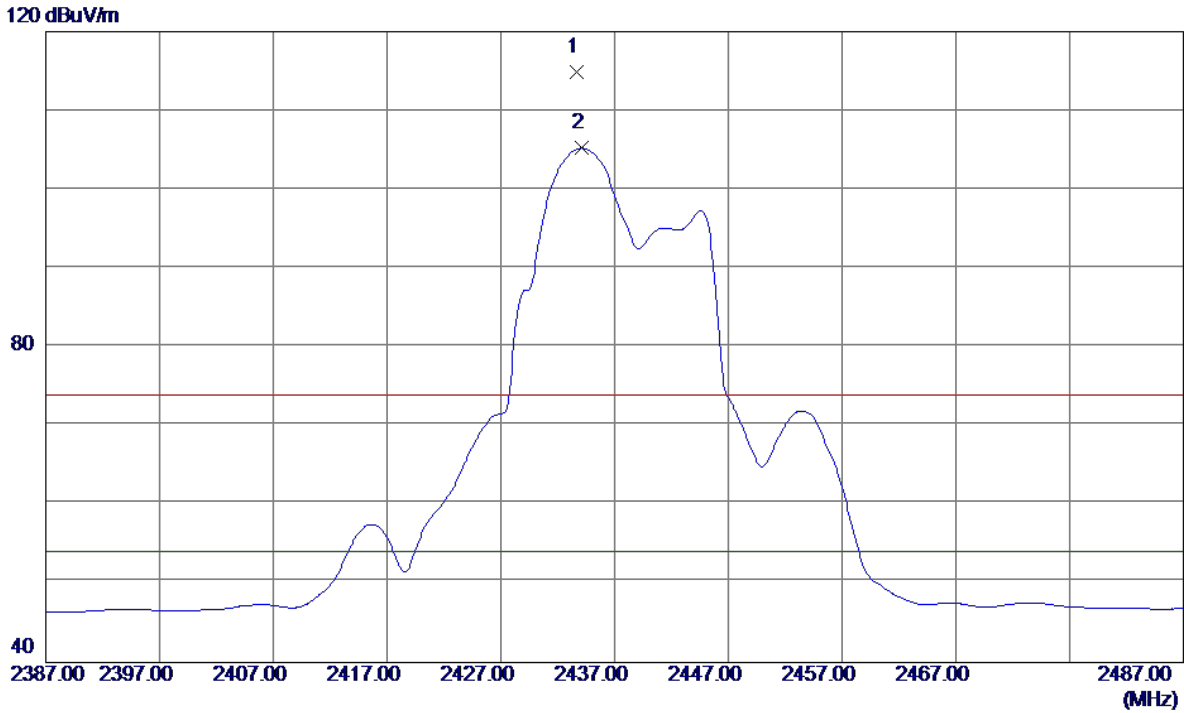

No.	Freq. MHz	Reading Level dBuV/m	Correct Factor dB	Measure ment dBuV/m	Limit dBuV/m	Margin dB	Detector	Comment
1	2433.7000	81.72	33.19	114.91	74.00	40.91	Peak	No Limit
2 *	2434.1000	72.03	33.19	105.22	54.00	51.22	AVG	No Limit

Orthogonal Axis :	X
Test Mode :	TX G MODE 2437MHz

Horizontal

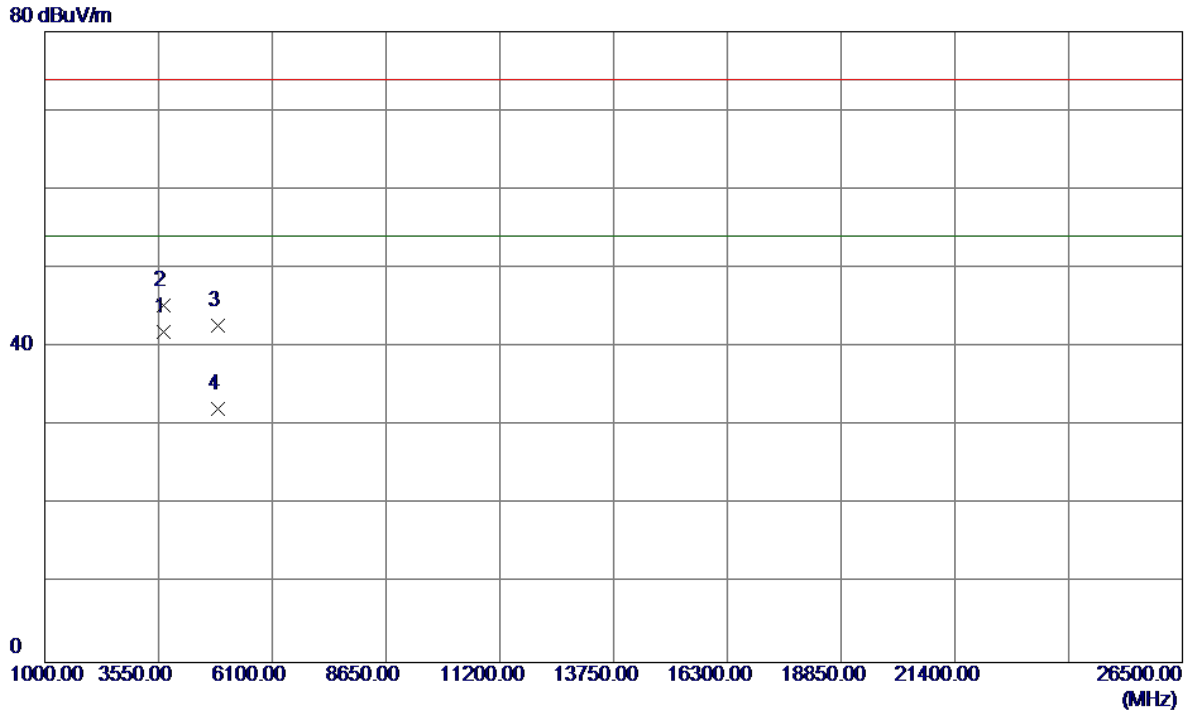

No.	Freq. MHz	Reading Level dBuV/m	Correct Factor dB	Measure ment dBuV/m	Limit dBuV/m	Margin dB	Detector	Comment
1 *	3666.6570	40.08	1.86	41.94	54.00	-12.06	AVG	
2	3666.7140	43.44	1.86	45.30	74.00	-28.70	Peak	
3	4873.7650	37.59	5.06	42.65	74.00	-31.35	Peak	
4	4873.9100	27.04	5.07	32.11	54.00	-21.89	AVG	

Orthogonal Axis :	X
Test Mode :	TX G MODE 2462MHz

Vertical

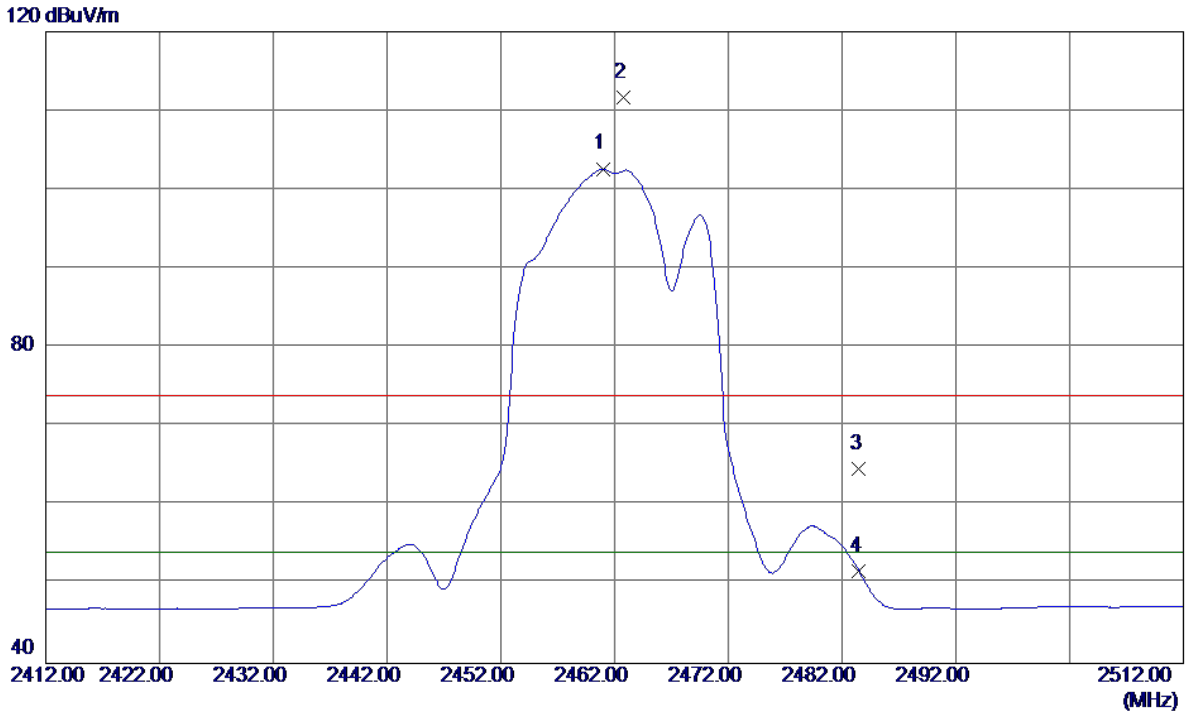

No.	Freq. MHz	Reading Level dBuV/m	Correct Factor dB	Measure ment dBuV/m	Limit dBuV/m	Margin dB	Detector	Comment
1 *	2461.0000	69.33	33.31	102.64	54.00	48.64	AVG	No Limit
2	2462.8000	78.33	33.31	111.64	74.00	37.64	Peak	No Limit
3	2483.5000	31.26	33.40	64.66	74.00	-9.34	Peak	
4	2483.5000	18.30	33.40	51.70	54.00	-2.30	AVG	

Orthogonal Axis :	X
Test Mode :	TX G MODE 2462MHz

Vertical

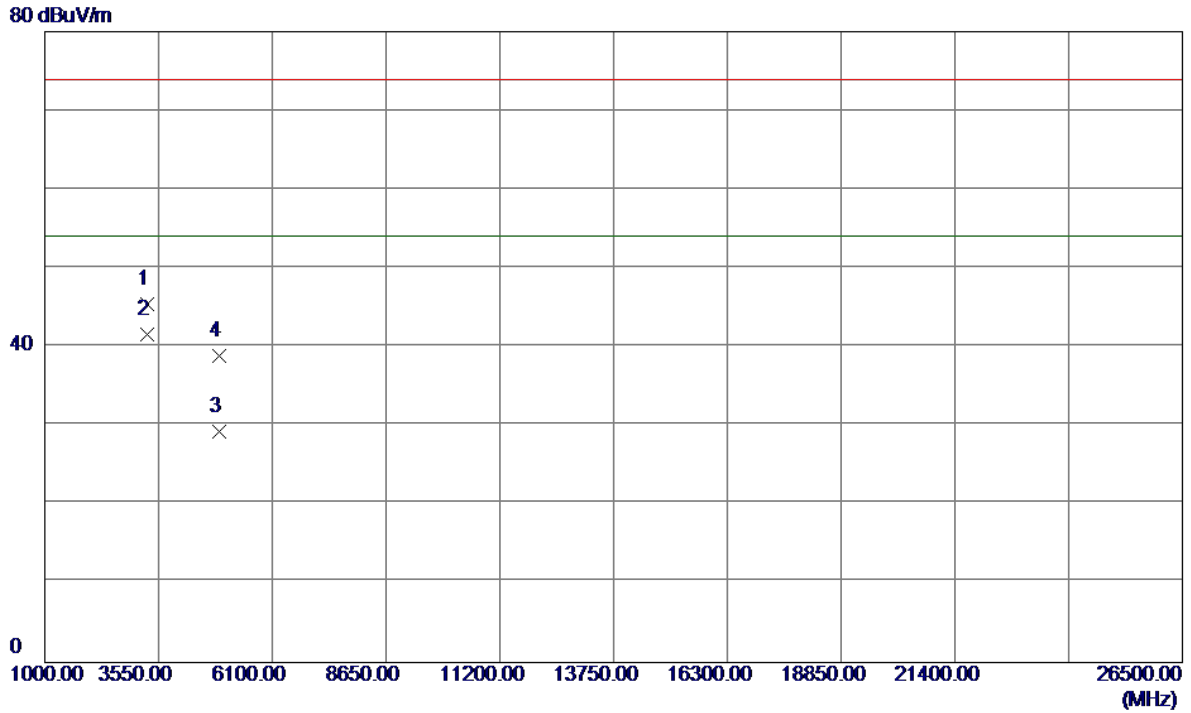

No.	Freq. MHz	Reading Level dBuV/m	Correct Factor dB	Measure ment dBuV/m	Limit dBuV/m	Margin dB	Detector	Comment
1	3282.6530	43.97	1.41	45.38	74.00	-28.62	Peak	
2 *	3282.6550	40.18	1.41	41.59	54.00	-12.41	AVG	
3	4923.8410	23.99	5.28	29.27	54.00	-24.73	AVG	
4	4923.8510	33.54	5.28	38.82	74.00	-35.18	Peak	

Orthogonal Axis :	X
Test Mode :	TX G MODE 2462MHz

Horizontal

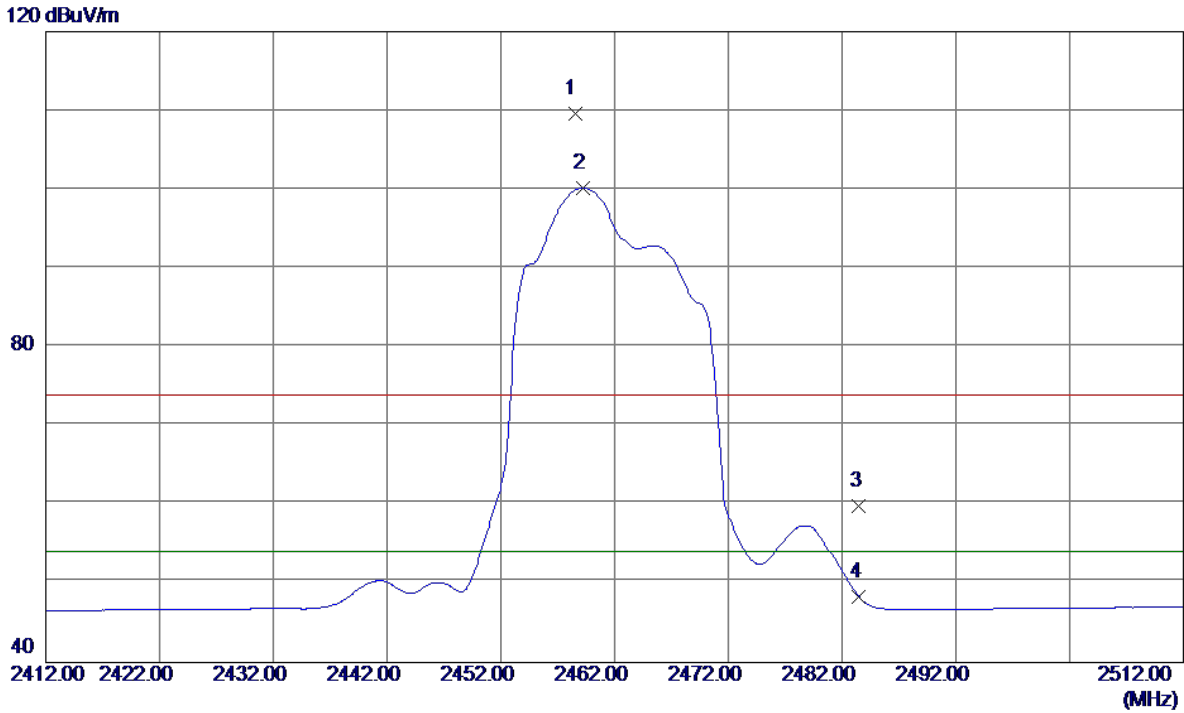

No.	Freq. MHz	Reading Level dBuV/m	Correct Factor dB	Measure ment dBuV/m	Limit dBuV/m	Margin dB	Detector	Comment
1	2458.5000	76.36	33.30	109.66	74.00	35.66	Peak	No Limit
2 *	2459.2000	66.89	33.30	100.19	54.00	46.19	AVG	No Limit
3	2483.5000	26.39	33.40	59.79	74.00	-14.21	Peak	
4	2483.5000	14.92	33.40	48.32	54.00	-5.68	AVG	

Orthogonal Axis :	X
Test Mode :	TX G MODE 2462MHz

Horizontal

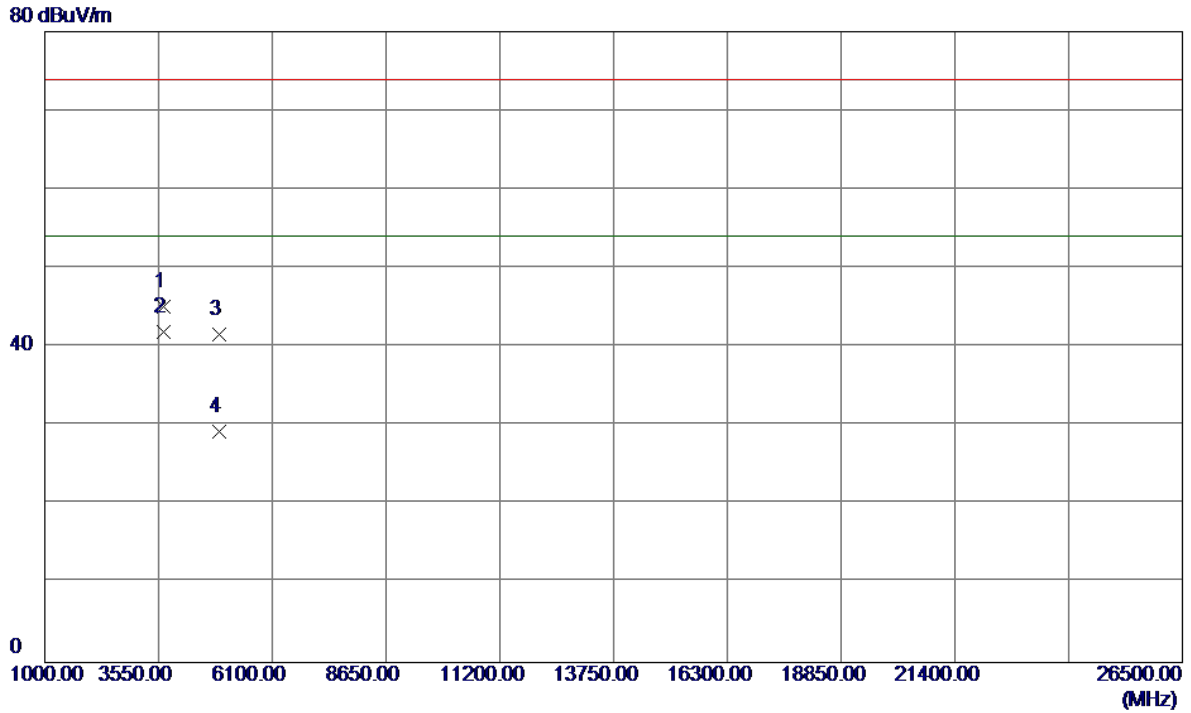

No.	Freq. MHz	Reading Level dBuV/m	Correct Factor dB	Measure ment dBuV/m	Limit dBuV/m	Margin dB	Detector	Comment
1	3666.6350	43.25	1.86	45.11	74.00	-28.89	Peak	
2 *	3666.6480	40.11	1.86	41.97	54.00	-12.03	AVG	
3	4923.8600	36.38	5.28	41.66	74.00	-32.34	Peak	
4	4923.9550	23.94	5.28	29.22	54.00	-24.78	AVG	

Orthogonal Axis :	X
Test Mode :	TX N-20M MODE 2412MHZ

Vertical

120 dBuV/m

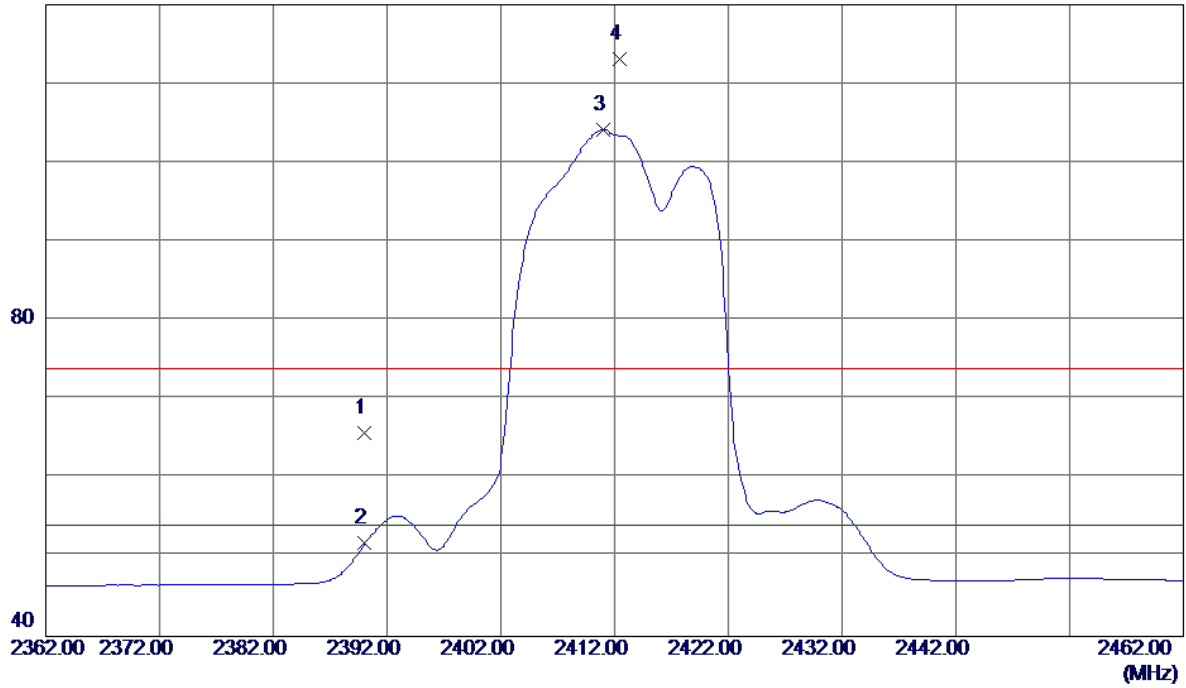

No.	Freq. MHz	Reading Level dBuV/m	Correct Factor dB	Measure ment dBuV/m	Limit dBuV/m	Margin dB	Detector	Comment
1	2390.0000	32.74	33.01	65.75	74.00	-8.25	Peak	
2	2390.0000	18.79	33.01	51.80	54.00	-2.20	AVG	
3 *	2411.0500	71.12	33.10	104.22	54.00	50.22	AVG	No Limit
4	2412.4000	80.05	33.10	113.15	74.00	39.15	Peak	No Limit

Orthogonal Axis :	X
Test Mode :	TX N-20M MODE 2412MHz

Vertical

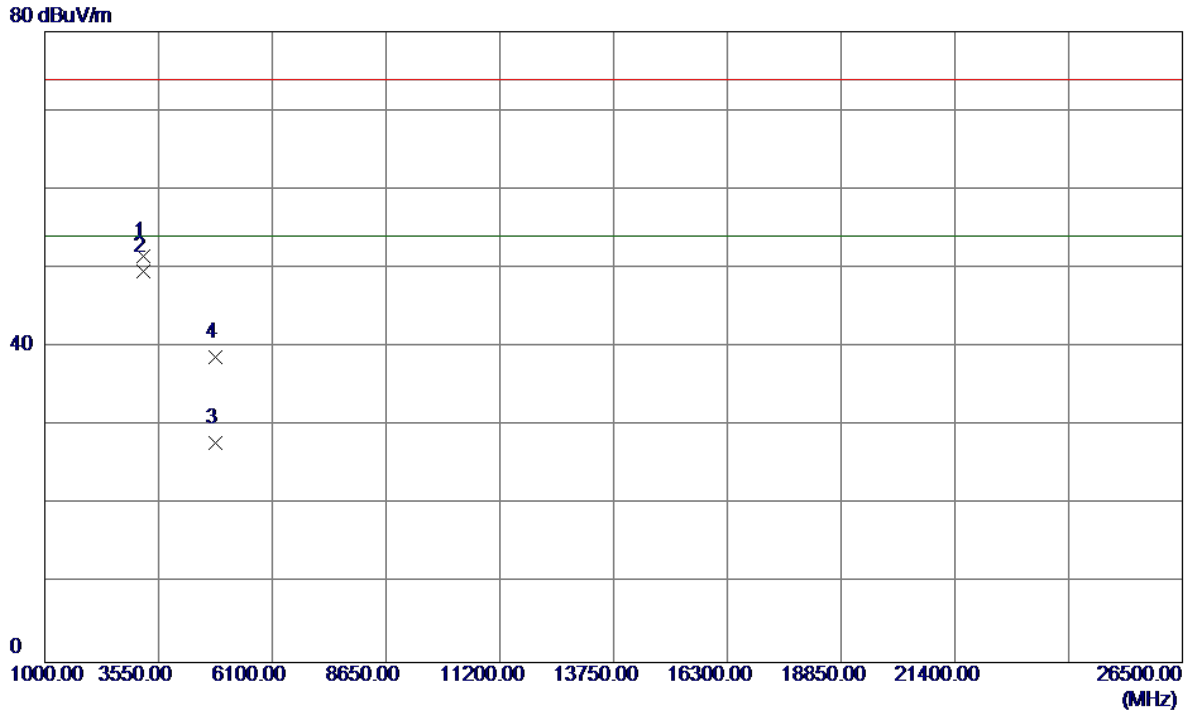

No.	Freq. MHz	Reading Level dBuV/m	Correct Factor dB	Measure ment dBuV/m	Limit dBuV/m	Margin dB	Detector	Comment
1	3215.8870	50.02	1.44	51.46	74.00	-22.54	Peak	
2 *	3215.9520	48.15	1.44	49.59	54.00	-4.41	AVG	
3	4823.9600	23.01	4.85	27.86	54.00	-26.14	AVG	
4	4824.2400	33.89	4.85	38.74	74.00	-35.26	Peak	

Orthogonal Axis :	X
Test Mode :	TX N-20M MODE 2412MHz

Horizontal

120 dBuV/m

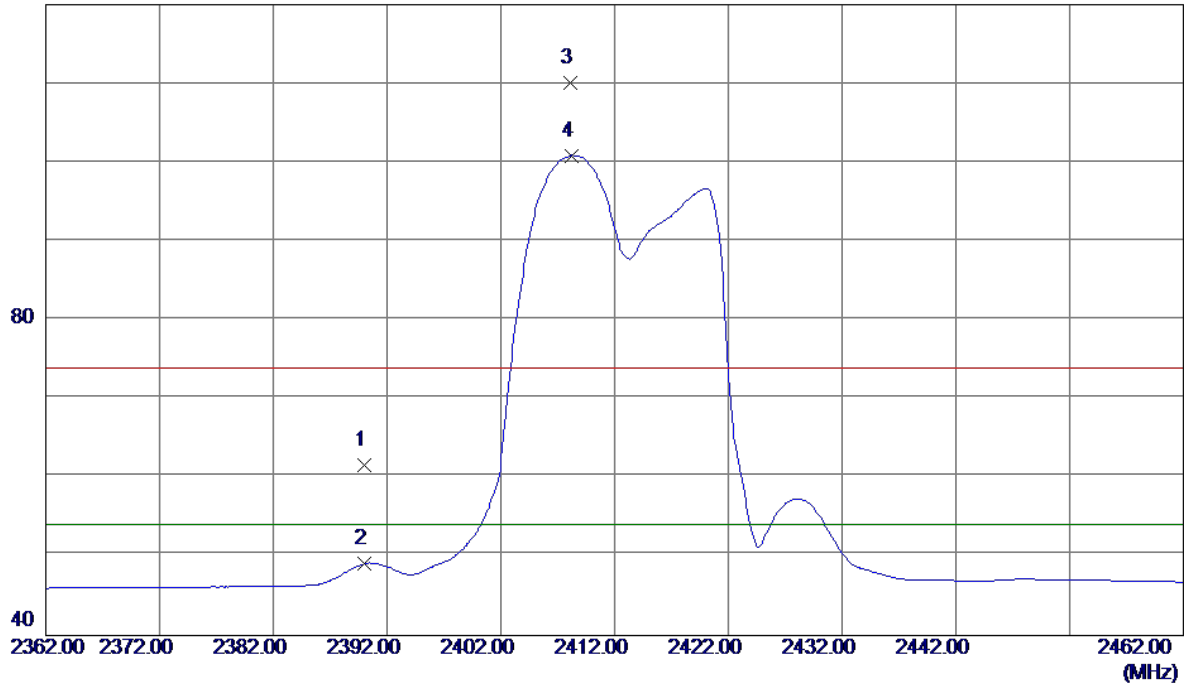

No.	Freq. MHz	Reading Level dBuV/m	Correct Factor dB	Measure ment dBuV/m	Limit dBuV/m	Margin dB	Detector	Comment
1	2390.0000	28.55	33.01	61.56	74.00	-12.44	Peak	
2	2390.0000	16.11	33.01	49.12	54.00	-4.88	AVG	
3	2408.1000	77.04	33.09	110.13	74.00	36.13	Peak	No Limit
4 *	2408.2500	67.79	33.09	100.88	54.00	46.88	AVG	No Limit

Orthogonal Axis :	X
Test Mode :	TX N-20M MODE 2412MHz

Horizontal

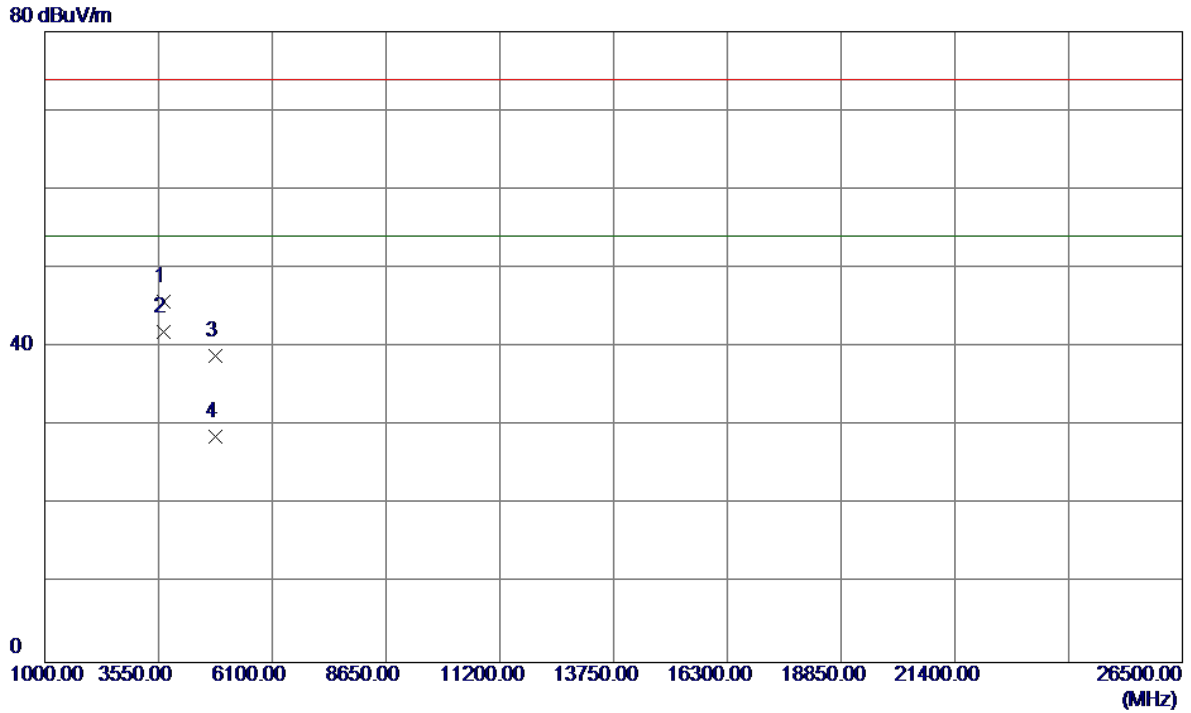

No.	Freq. MHz	Reading Level dBuV/m	Correct Factor dB	Measure ment dBuV/m	Limit dBuV/m	Margin dB	Detector	Comment
1	3666.6520	43.88	1.86	45.74	74.00	-28.26	Peak	
2 *	3666.6600	40.02	1.86	41.88	54.00	-12.12	AVG	
3	4823.9850	34.07	4.85	38.92	74.00	-35.08	Peak	
4	4824.0550	23.81	4.85	28.66	54.00	-25.34	AVG	

Orthogonal Axis :	X
Test Mode :	TX N-20M MODE 2437MHz

Vertical

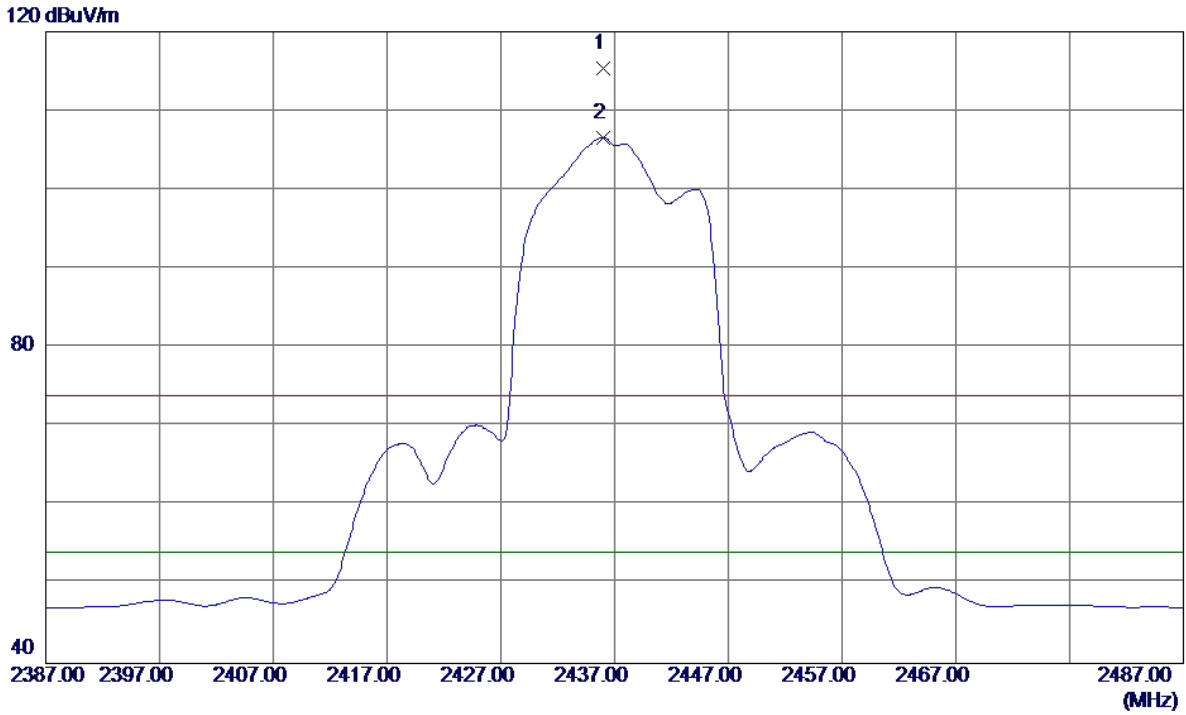

No.	Freq. MHz	Reading Level dBuV/m	Correct Factor dB	Measure ment dBuV/m	Limit dBuV/m	Margin dB	Detector	Comment
1	2435.9500	82.20	33.20	115.40	74.00	41.40	Peak	No Limit
2 *	2436.0000	73.42	33.20	106.62	54.00	52.62	AVG	No Limit

Orthogonal Axis :	X
Test Mode :	TX N-20M MODE 2437MHz

Vertical

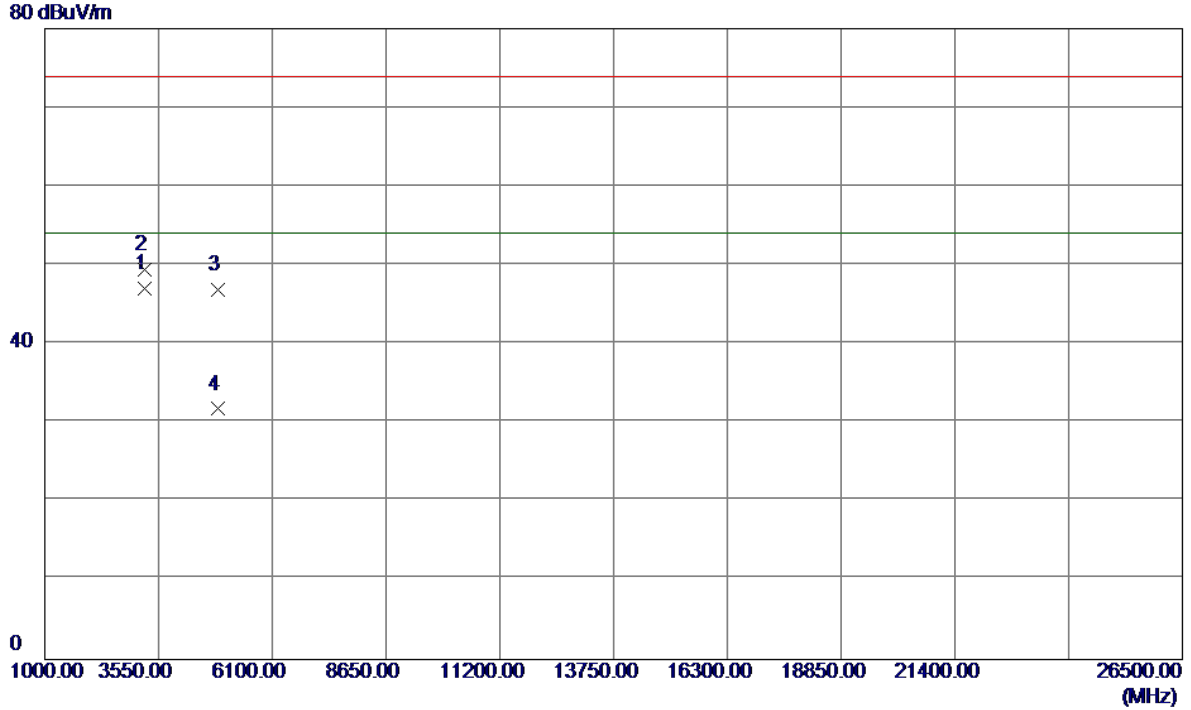

No.	Freq. MHz	Reading Level dBuV/m	Correct Factor dB	Measure ment dBuV/m	Limit dBuV/m	Margin dB	Detector	Comment
1 *	3249.3020	45.66	1.42	47.08	54.00	-6.92	AVG	
2	3249.3470	48.01	1.42	49.43	74.00	-24.57	Peak	
3	4871.9200	41.85	5.06	46.91	74.00	-27.09	Peak	
4	4872.0800	26.70	5.06	31.76	54.00	-22.24	AVG	

Orthogonal Axis :	X
Test Mode :	TX N-20M MODE 2437MHz

Horizontal

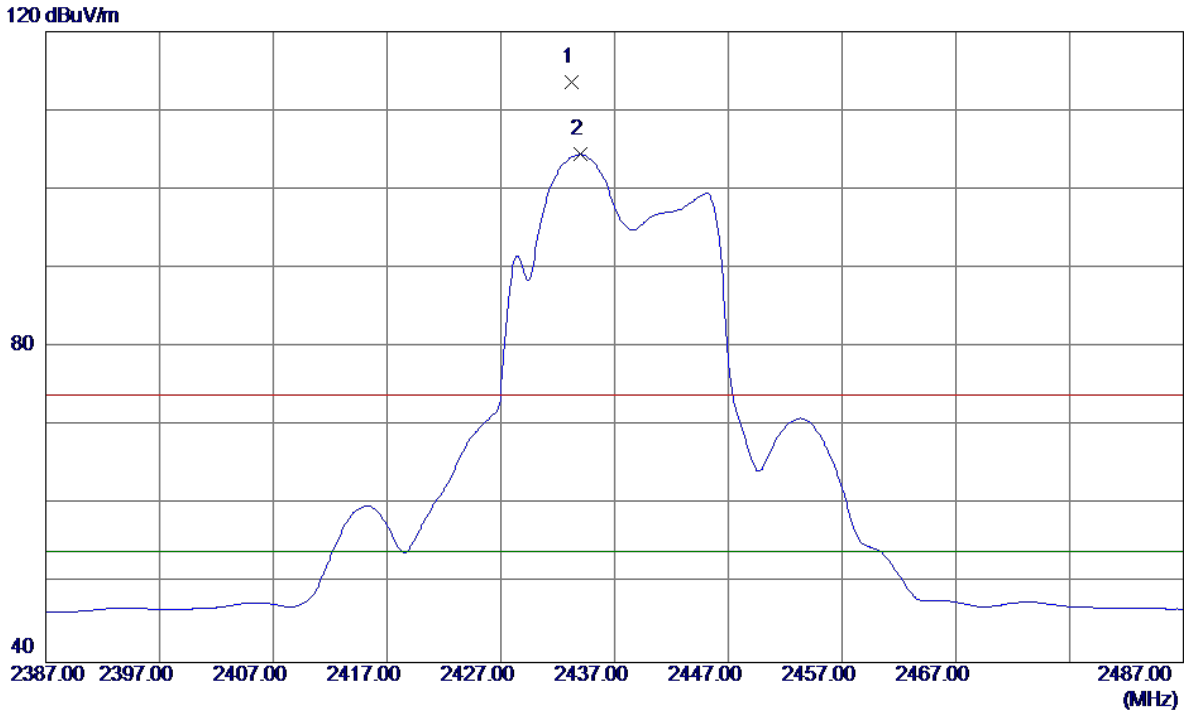

No.	Freq. MHz	Reading Level dBuV/m	Correct Factor dB	Measure ment dBuV/m	Limit dBuV/m	Margin dB	Detector	Comment
1	2433.2000	80.43	33.19	113.62	74.00	39.62	Peak	No Limit
2 *	2434.0000	71.23	33.19	104.42	54.00	50.42	AVG	No Limit

Orthogonal Axis :	X
Test Mode :	TX N-20M MODE 2437MHz

Horizontal

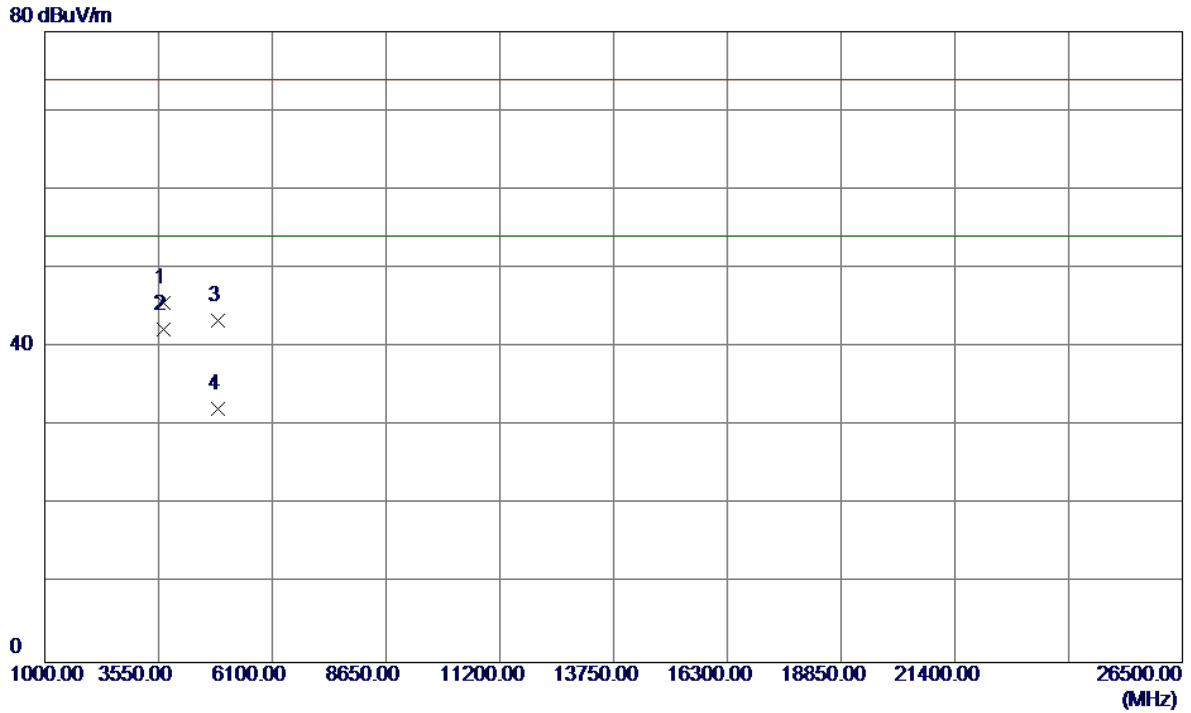

No.	Freq. MHz	Reading Level dBuV/m	Correct Factor dB	Measure ment dBuV/m	Limit dBuV/m	Margin dB	Detector	Comment
1	3666.5850	43.69	1.86	45.55	74.00	-28.45	Peak	
2 *	3666.6470	40.33	1.86	42.19	54.00	-11.81	AVG	
3	4873.9500	38.26	5.07	43.33	74.00	-30.67	Peak	
4	4873.9950	27.10	5.07	32.17	54.00	-21.83	AVG	

Orthogonal Axis :	X
Test Mode :	TX N-20M MODE 2462MHz

Vertical

120 dBuV/m

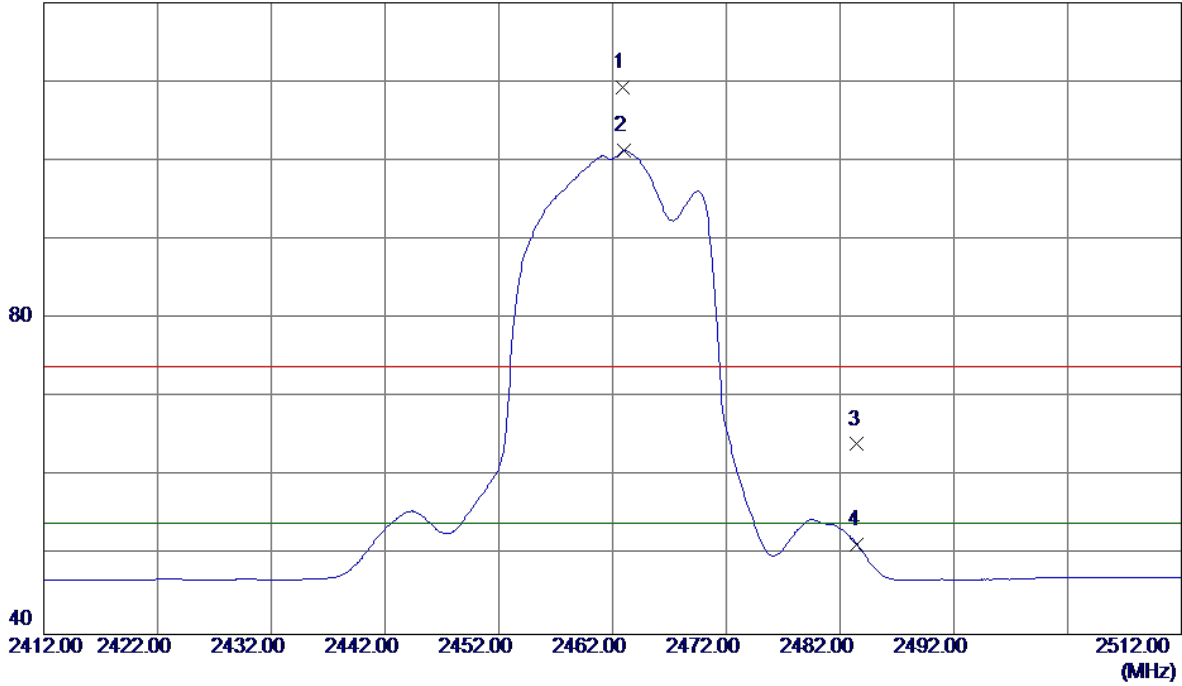

No.	Freq. MHz	Reading Level dBuV/m	Correct Factor dB	Measure ment dBuV/m	Limit dBuV/m	Margin dB	Detector	Comment
1	2462.8500	76.02	33.31	109.33	74.00	35.33	Peak	No Limit
2 *	2463.0000	67.94	33.32	101.26	54.00	47.26	AVG	No Limit
3	2483.5000	30.68	33.40	64.08	74.00	-9.92	Peak	
4	2483.5000	17.94	33.40	51.34	54.00	-2.66	AVG	

Orthogonal Axis :	X
Test Mode :	TX N-20M MODE 2462MHz

Vertical

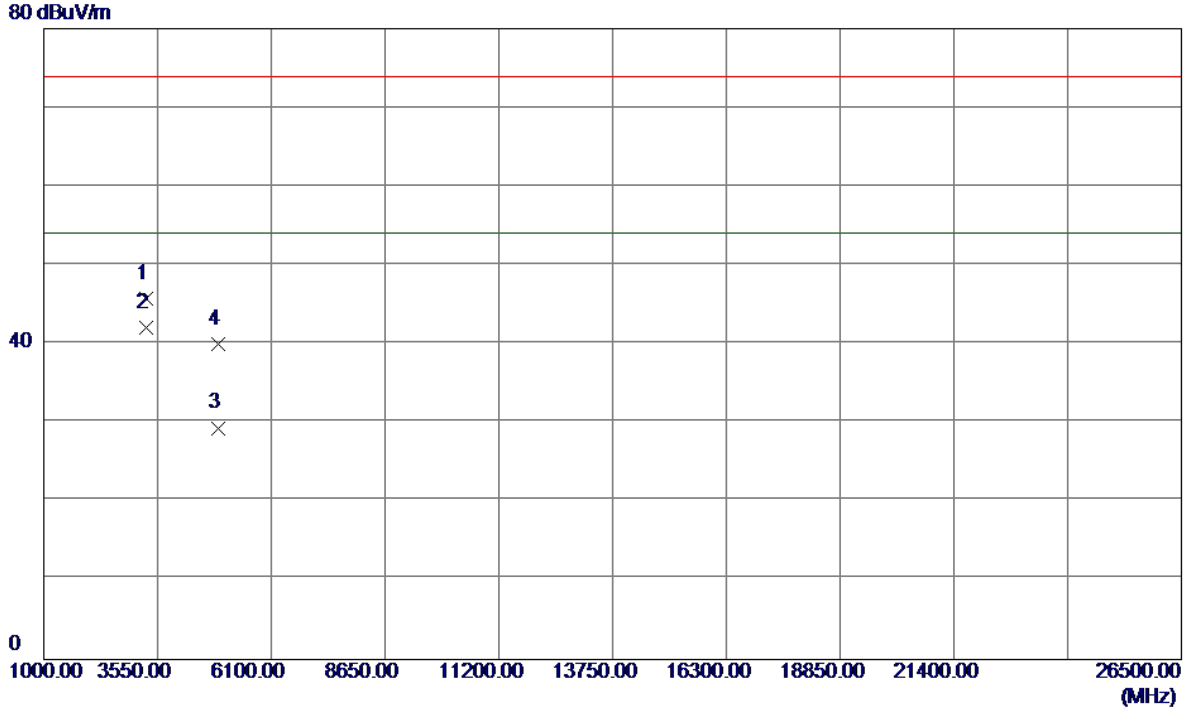

No.	Freq. MHz	Reading Level dBuV/m	Correct Factor dB	Measure ment dBuV/m	Limit dBuV/m	Margin dB	Detector	Comment
1	3282.6330	44.34	1.41	45.75	74.00	-28.25	Peak	
2 *	3282.6370	40.62	1.41	42.03	54.00	-11.97	AVG	
3	4922.8900	24.09	5.27	29.36	54.00	-24.64	AVG	
4	4923.8500	34.66	5.28	39.94	74.00	-34.06	Peak	

Orthogonal Axis :	X
Test Mode :	TX N-20M MODE 2462MHz

Horizontal

120 dBuV/m

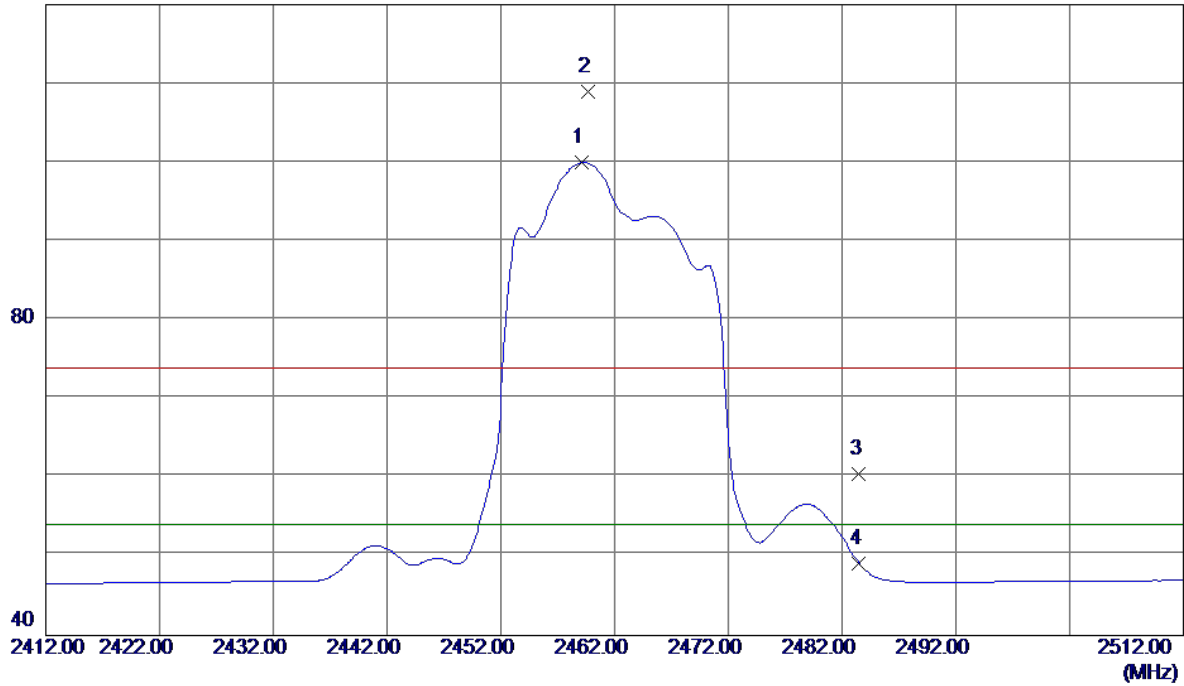

No.	Freq. MHz	Reading Level dBuV/m	Correct Factor dB	Measure ment dBuV/m	Limit dBuV/m	Margin dB	Detector	Comment
1 *	2459.1500	66.73	33.30	100.03	54.00	46.03	AVG	No Limit
2	2459.6500	75.62	33.30	108.92	74.00	34.92	Peak	No Limit
3	2483.5000	27.06	33.40	60.46	74.00	-13.54	Peak	
4	2483.5000	15.76	33.40	49.16	54.00	-4.84	AVG	

Orthogonal Axis :	X
Test Mode :	TX N-20M MODE 2462MHz

Horizontal

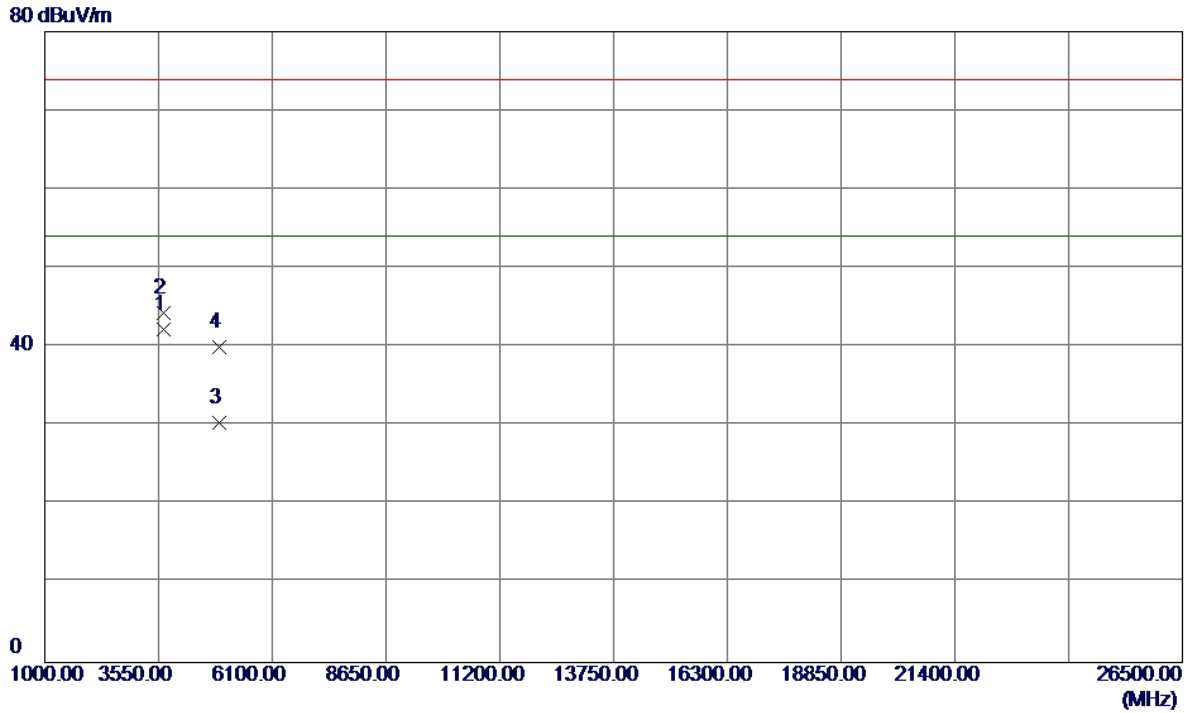

No.	Freq. MHz	Reading Level dBuV/m	Correct Factor dB	Measure ment dBuV/m	Limit dBuV/m	Margin dB	Detector	Comment
1 *	3666.6720	40.32	1.86	42.18	54.00	-11.82	AVG	
2	3666.8770	42.52	1.86	44.38	74.00	-29.62	Peak	
3	4923.9049	25.07	5.28	30.35	54.00	-23.65	AVG	
4	4923.9850	34.68	5.28	39.96	74.00	-34.04	Peak	

Orthogonal Axis :	X
Test Mode :	TX N-40M MODE 2422MHz

Vertical

120 dBuV/m

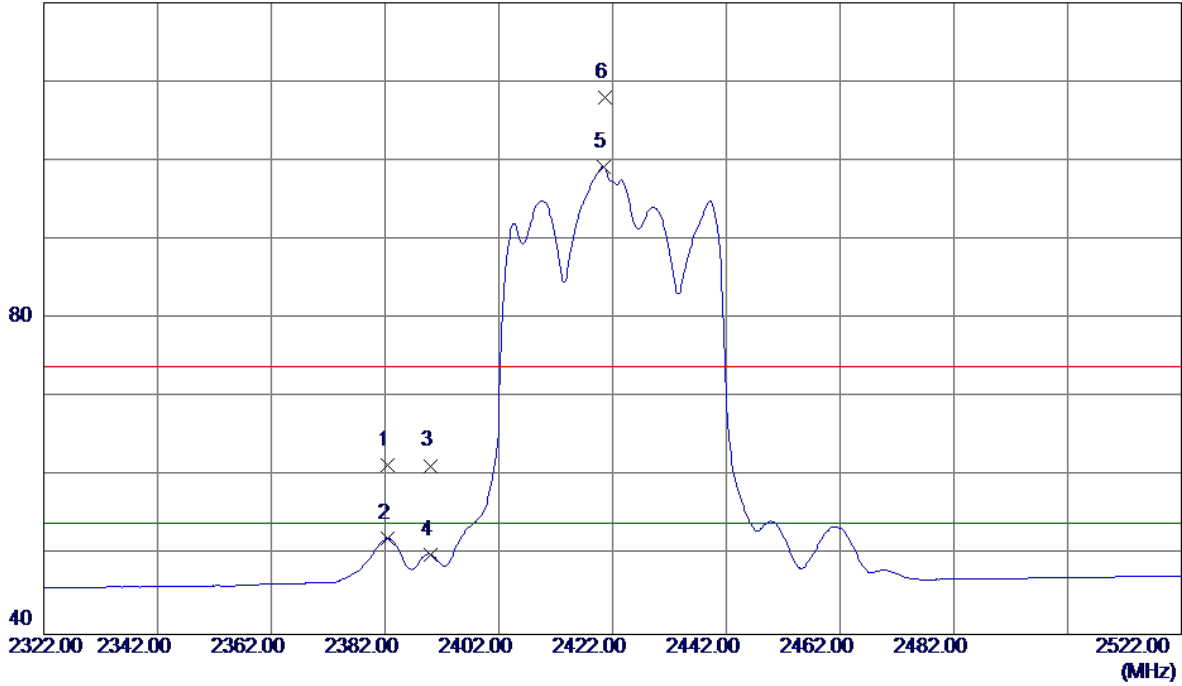

No.	Freq. MHz	Reading Level dBuV/m	Correct Factor dB	Measure ment dBuV/m	Limit dBuV/m	Margin dB	Detector	Comment
1	2382.5000	28.52	32.98	61.50	74.00	-12.50	Peak	
2	2382.5000	19.19	32.98	52.17	54.00	-1.83	AVG	
3	2390.0000	28.35	33.01	61.36	74.00	-12.64	Peak	
4	2390.0000	17.13	33.01	50.14	54.00	-3.86	AVG	
5 *	2420.4000	66.11	33.14	99.25	54.00	45.25	AVG	No Limit
6	2420.7000	74.82	33.14	107.96	74.00	33.96	Peak	No Limit

Orthogonal Axis :	X
Test Mode :	TX N-40M MODE 2422MHz

Vertical

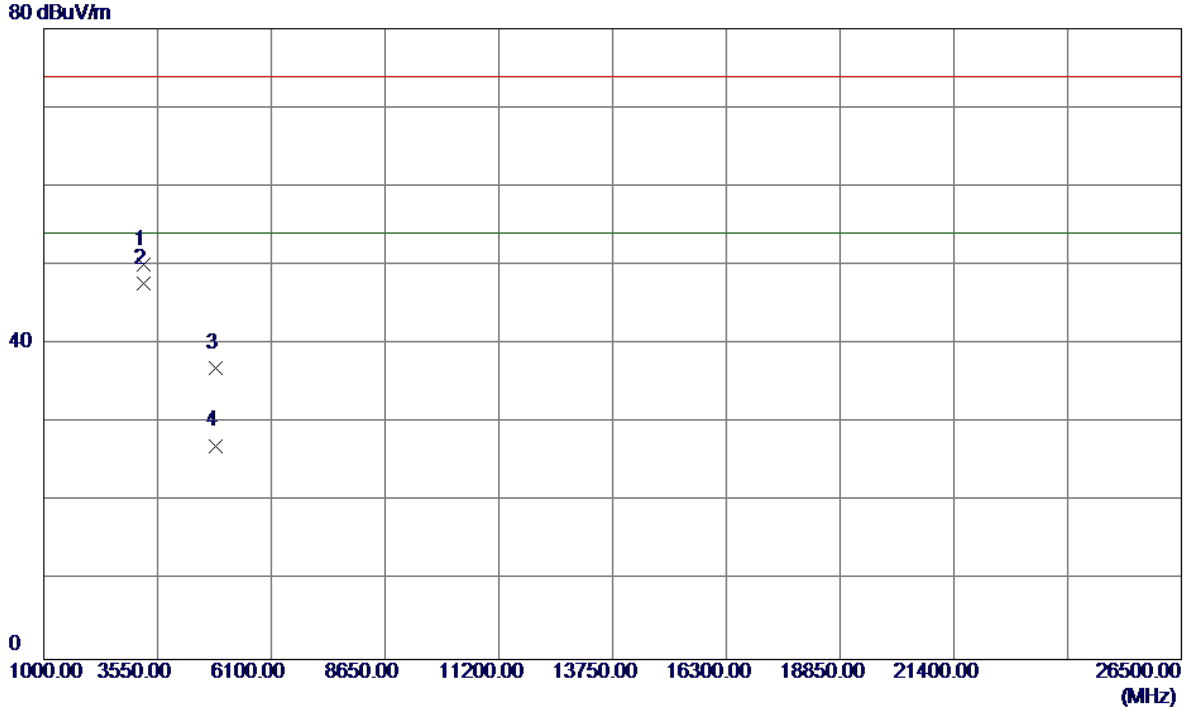

No.	Freq. MHz	Reading Level dBuV/m	Correct Factor dB	Measure ment dBuV/m	Limit dBuV/m	Margin dB	Detector	Comment
1	3229.2730	48.68	1.43	50.11	74.00	-23.89	Peak	
2 *	3229.3090	46.32	1.43	47.75	54.00	-6.25	AVG	
3	4843.5700	32.04	4.94	36.98	74.00	-37.02	Peak	
4	4843.8300	22.18	4.94	27.12	54.00	-26.88	AVG	

Orthogonal Axis :	X
Test Mode :	TX N-40M MODE 2422MHz

Horizontal

120 dBuV/m

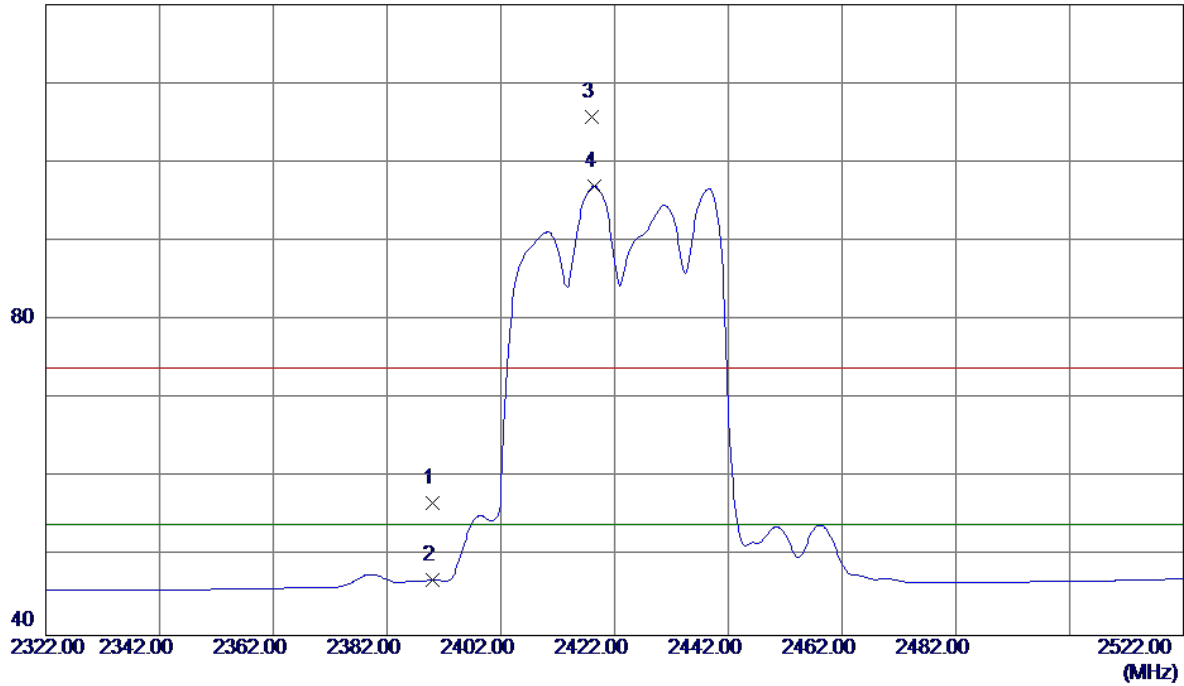

No.	Freq. MHz	Reading Level dBuV/m	Correct Factor dB	Measure ment dBuV/m	Limit dBuV/m	Margin dB	Detector	Comment
1	2390.0000	23.79	33.01	56.80	74.00	-17.20	Peak	
2	2390.0000	14.06	33.01	47.07	54.00	-6.93	AVG	
3	2417.9000	72.64	33.13	105.77	74.00	31.77	Peak	No Limit
4 *	2418.4000	63.80	33.13	96.93	54.00	42.93	AVG	No Limit

Orthogonal Axis :	X
Test Mode :	TX N-40M MODE 2422MHz

Horizontal

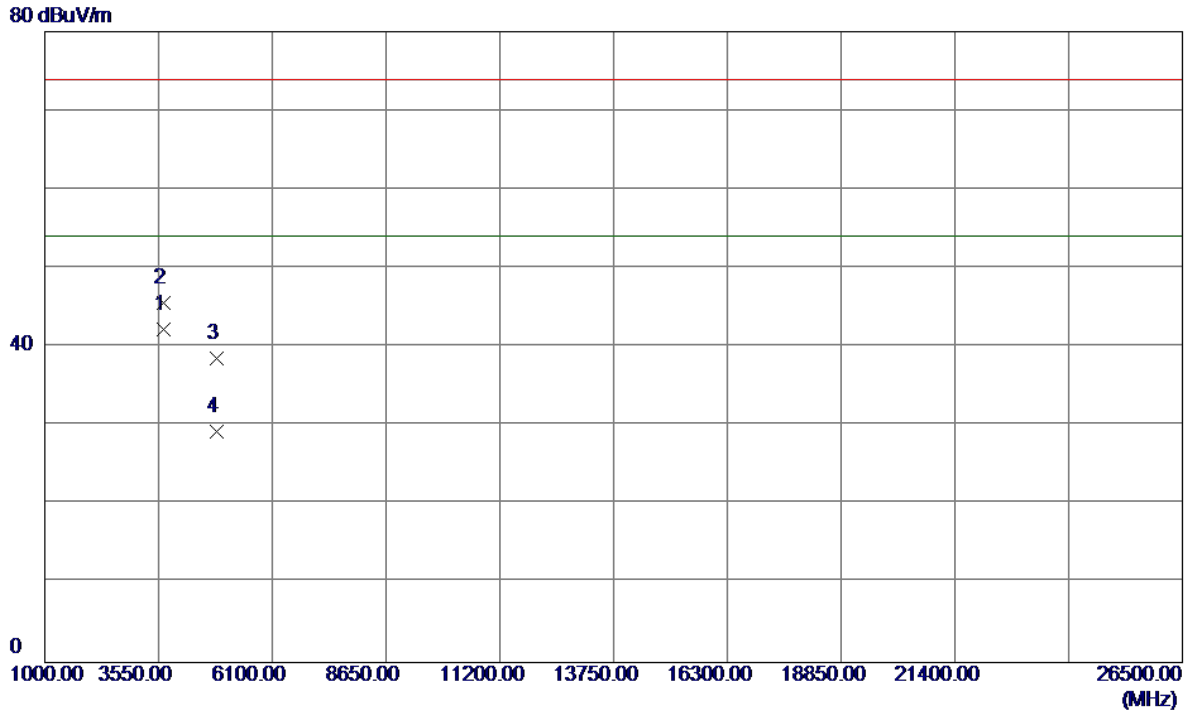

No.	Freq. MHz	Reading Level dBuV/m	Correct Factor dB	Measure ment dBuV/m	Limit dBuV/m	Margin dB	Detector	Comment
1 *	3666.6370	40.32	1.86	42.18	54.00	-11.82	AVG	
2	3666.7220	43.74	1.86	45.60	74.00	-28.40	Peak	
3	4843.9250	33.60	4.94	38.54	74.00	-35.46	Peak	
4	4843.9500	24.36	4.94	29.30	54.00	-24.70	AVG	

Orthogonal Axis :	X
Test Mode :	TX N-40M MODE 2437MHz

Vertical

120 dBuV/m

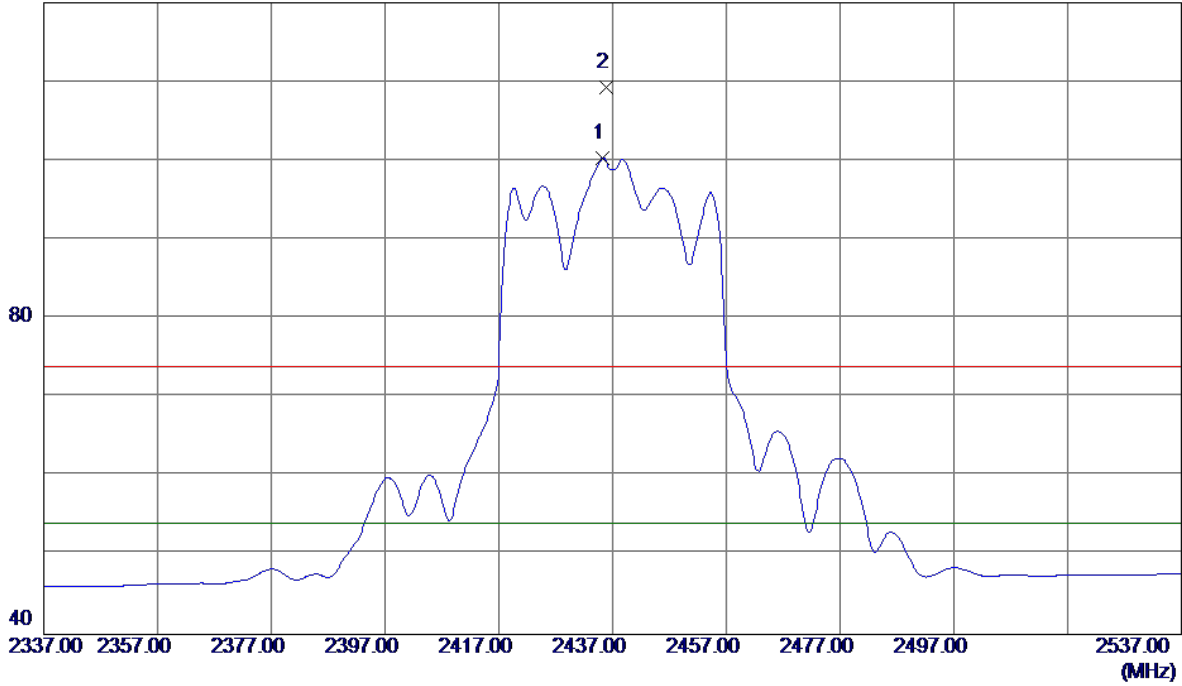

No.	Freq. MHz	Reading Level dBuV/m	Correct Factor dB	Measure ment dBuV/m	Limit dBuV/m	Margin dB	Detector	Comment
1 *	2435.3000	67.17	33.20	100.37	54.00	46.37	AVG	No Limit
2	2435.8000	76.08	33.20	109.28	74.00	35.28	Peak	No Limit

Orthogonal Axis :	X
Test Mode :	TX N-40M MODE 2437MHz

Vertical

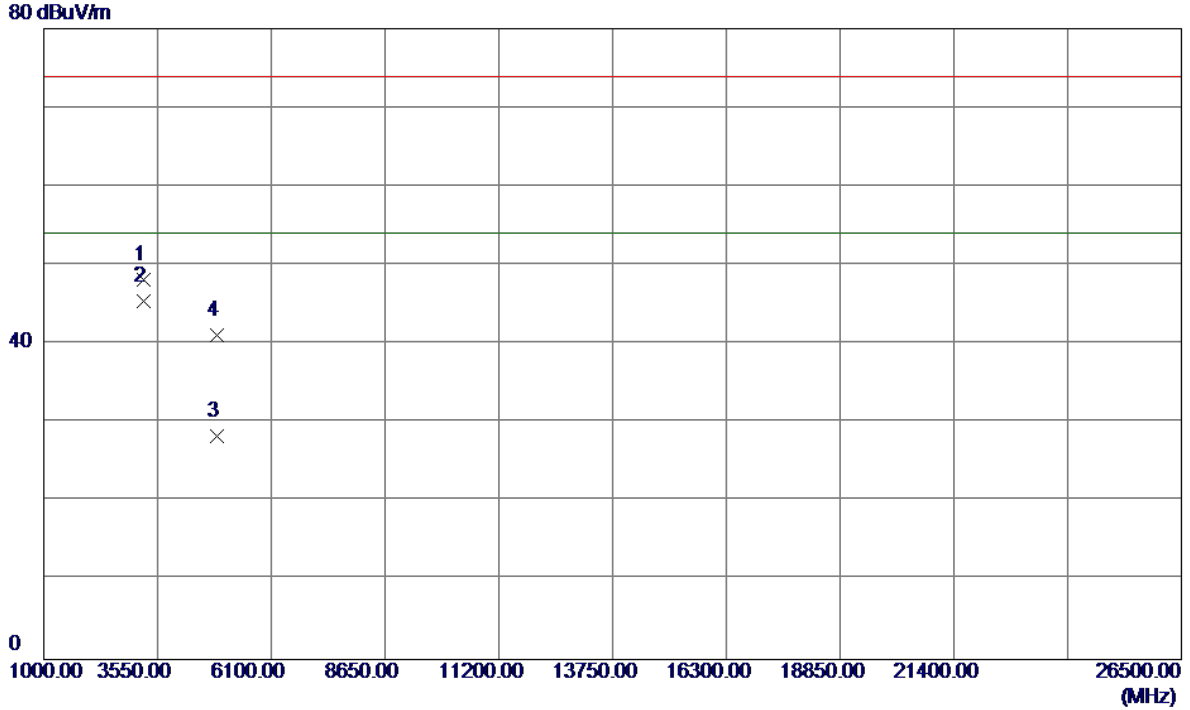

No.	Freq. MHz	Reading Level dBuV/m	Correct Factor dB	Measurement dBuV/m	Limit dBuV/m	Margin dB	Detector	Comment
1	3249.2470	46.77	1.42	48.19	74.00	-25.81	Peak	
2 *	3249.3050	44.09	1.42	45.51	54.00	-8.49	AVG	
3	4873.8900	23.32	5.07	28.39	54.00	-25.61	AVG	
4	4874.1600	36.01	5.07	41.08	74.00	-32.92	Peak	

Orthogonal Axis :	X
Test Mode :	TX N-40M MODE 2437MHz

Horizontal

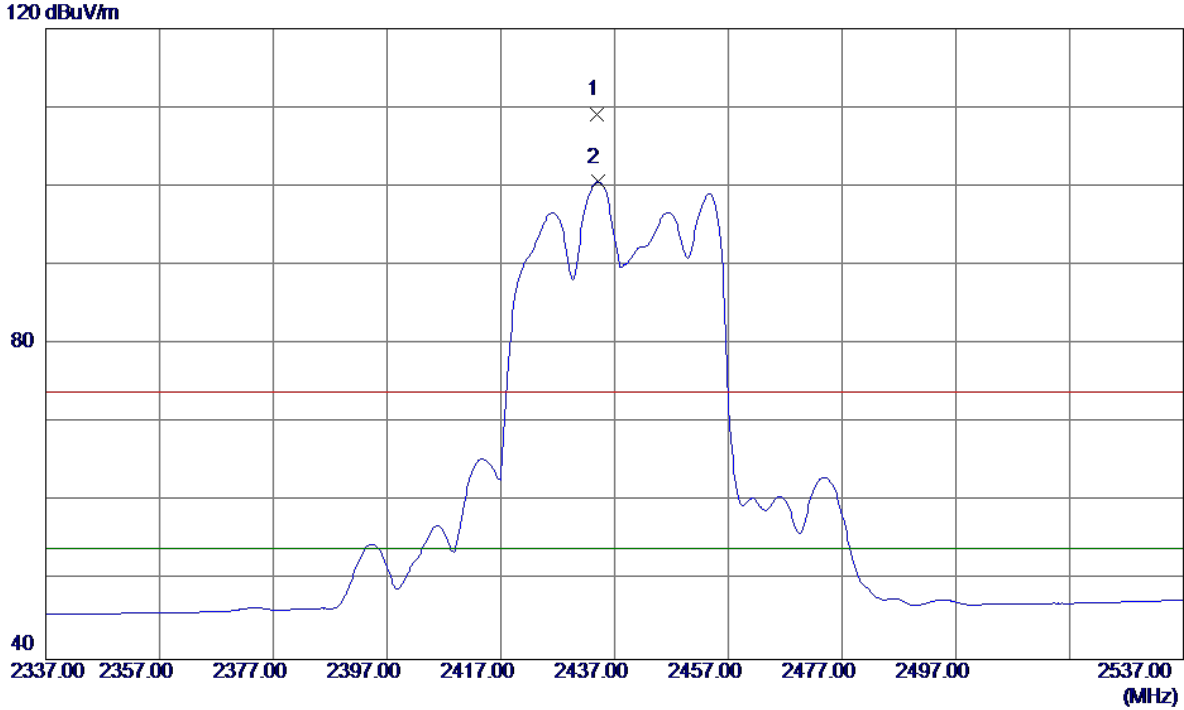

No.	Freq. MHz	Reading Level dBuV/m	Correct Factor dB	Measure ment dBuV/m	Limit dBuV/m	Margin dB	Detector	Comment
1	2433.9000	75.86	33.19	109.05	74.00	35.05	Peak	No Limit
2 *	2434.0000	67.37	33.19	100.56	54.00	46.56	AVG	No Limit

Orthogonal Axis :	X
Test Mode :	TX N-40M MODE 2437MHz

Horizontal

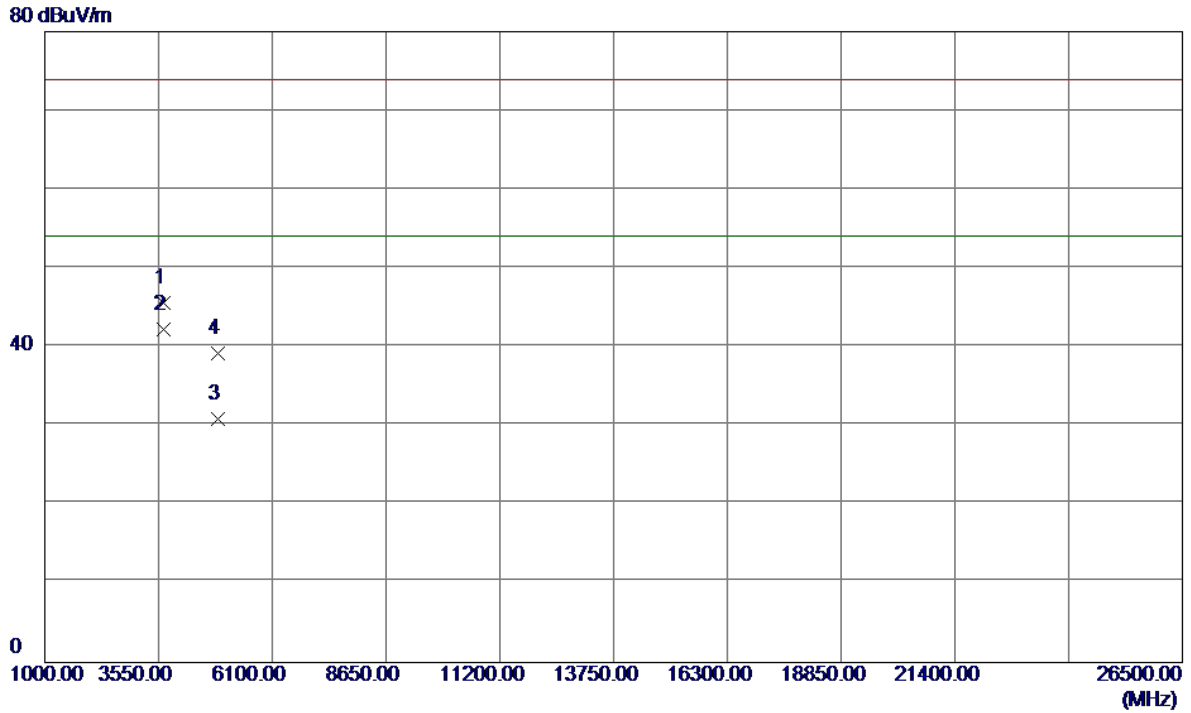

No.	Freq. MHz	Reading Level dBuV/m	Correct Factor dB	Measure ment dBuV/m	Limit dBuV/m	Margin dB	Detector	Comment
1	3666.6370	43.71	1.86	45.57	74.00	-28.43	Peak	
2 *	3666.6470	40.40	1.86	42.26	54.00	-11.74	AVG	
3	4873.9500	25.85	5.07	30.92	54.00	-23.08	AVG	
4	4873.9800	34.07	5.07	39.14	74.00	-34.86	Peak	

Orthogonal Axis :	X
Test Mode :	TX N-40M MODE 2452MHz

Vertical

120 dBuV/m

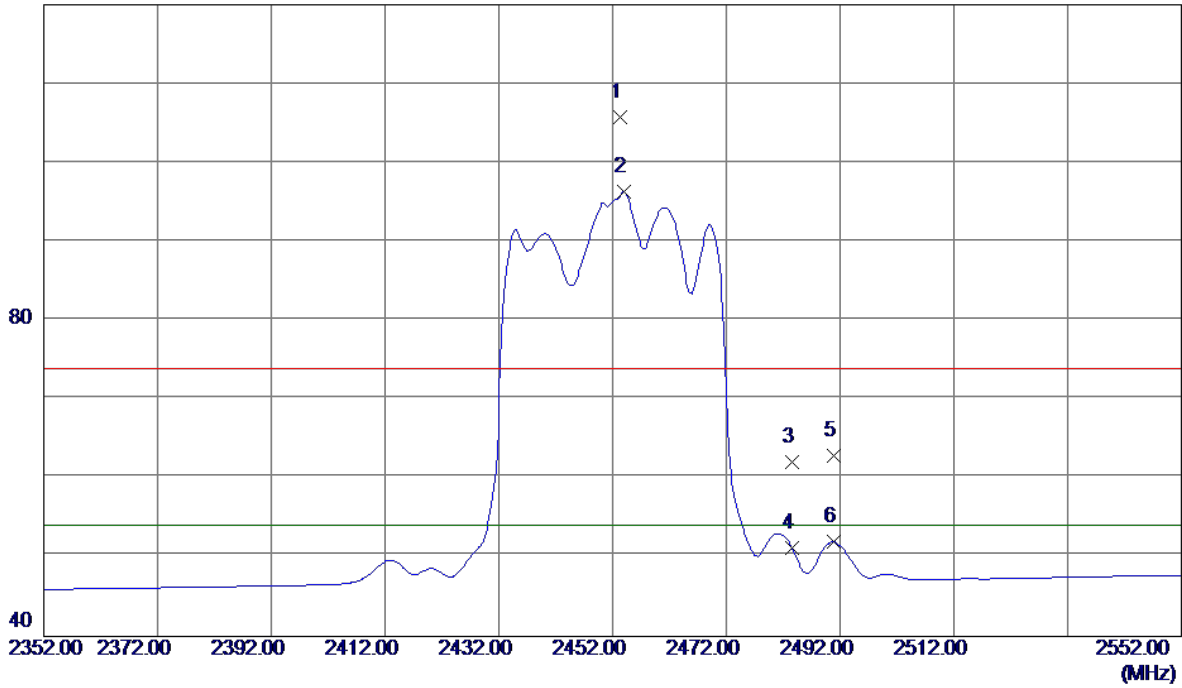

No.	Freq. MHz	Reading Level dBuV/m	Correct Factor dB	Measure ment dBuV/m	Limit dBuV/m	Margin dB	Detector	Comment
1	2453.3000	72.46	33.27	105.73	74.00	31.73	Peak	No Limit
2 *	2453.9000	63.10	33.28	96.38	54.00	42.38	AVG	No Limit
3	2483.5000	28.72	33.40	62.12	74.00	-11.88	Peak	
4	2483.5000	17.75	33.40	51.15	54.00	-2.85	AVG	
5	2490.8000	29.44	33.43	62.87	74.00	-11.13	Peak	
6	2490.8000	18.53	33.43	51.96	54.00	-2.04	AVG	

Orthogonal Axis :	X
Test Mode :	TX N-40M MODE 2452MHz

Vertical

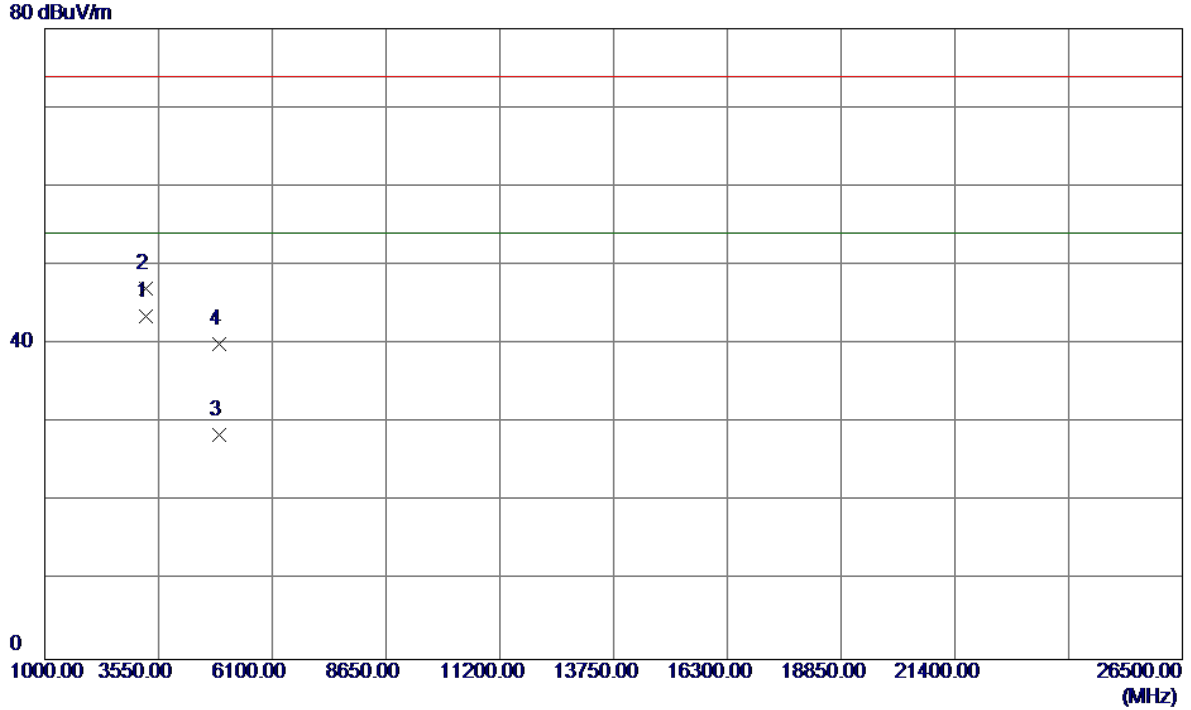

No.	Freq. MHz	Reading Level dBuV/m	Correct Factor dB	Measure ment dBuV/m	Limit dBuV/m	Margin dB	Detector	Comment
1 *	3269.3020	42.06	1.41	43.47	54.00	-10.53	AVG	
2	3269.3580	45.66	1.41	47.07	74.00	-26.93	Peak	
3	4903.9300	23.35	5.19	28.54	54.00	-25.46	AVG	
4	4903.9600	34.74	5.19	39.93	74.00	-34.07	Peak	

Orthogonal Axis :	X
Test Mode :	TX N-40M MODE 2452MHz

Horizontal

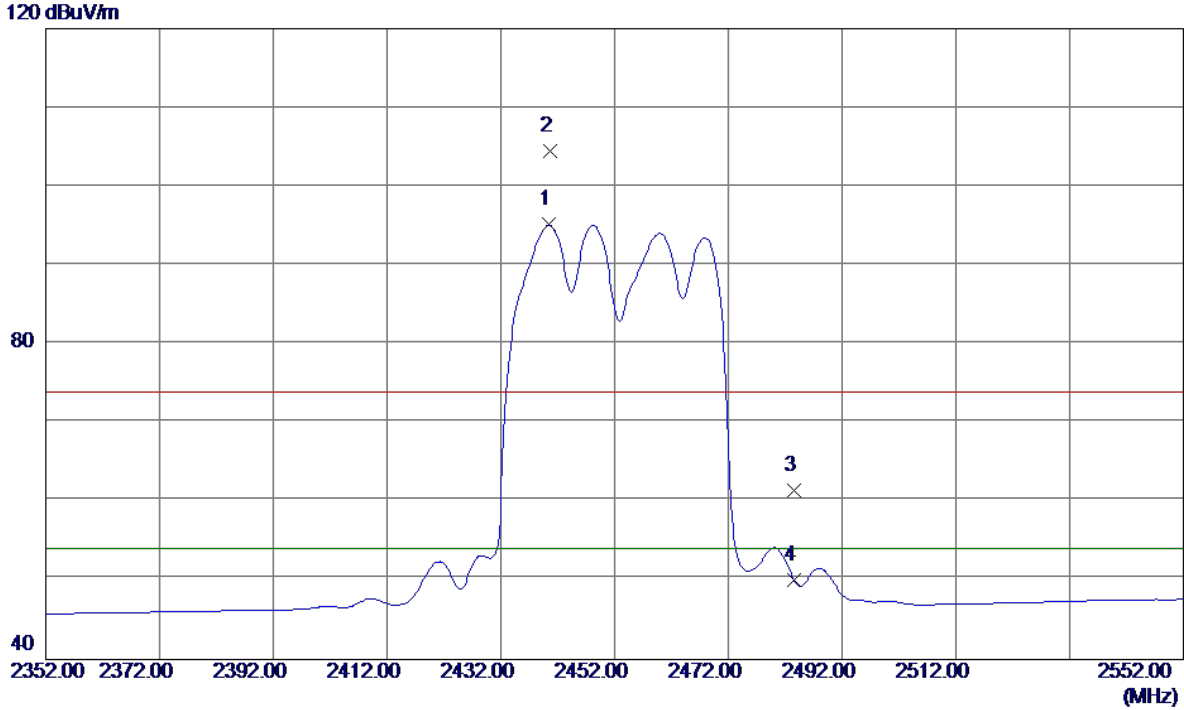

No.	Freq. MHz	Reading Level dBuV/m	Correct Factor dB	Measure ment dBuV/m	Limit dBuV/m	Margin dB	Detector	Comment
1 *	2440.4000	61.90	33.22	95.12	54.00	41.12	AVG	No Limit
2	2440.7000	71.28	33.22	104.50	74.00	30.50	Peak	No Limit
3	2483.5000	28.08	33.40	61.48	74.00	-12.52	Peak	
4	2483.5000	16.62	33.40	50.02	54.00	-3.98	AVG	

Orthogonal Axis :	X
Test Mode :	TX N-40M MODE 2452MHz

Horizontal

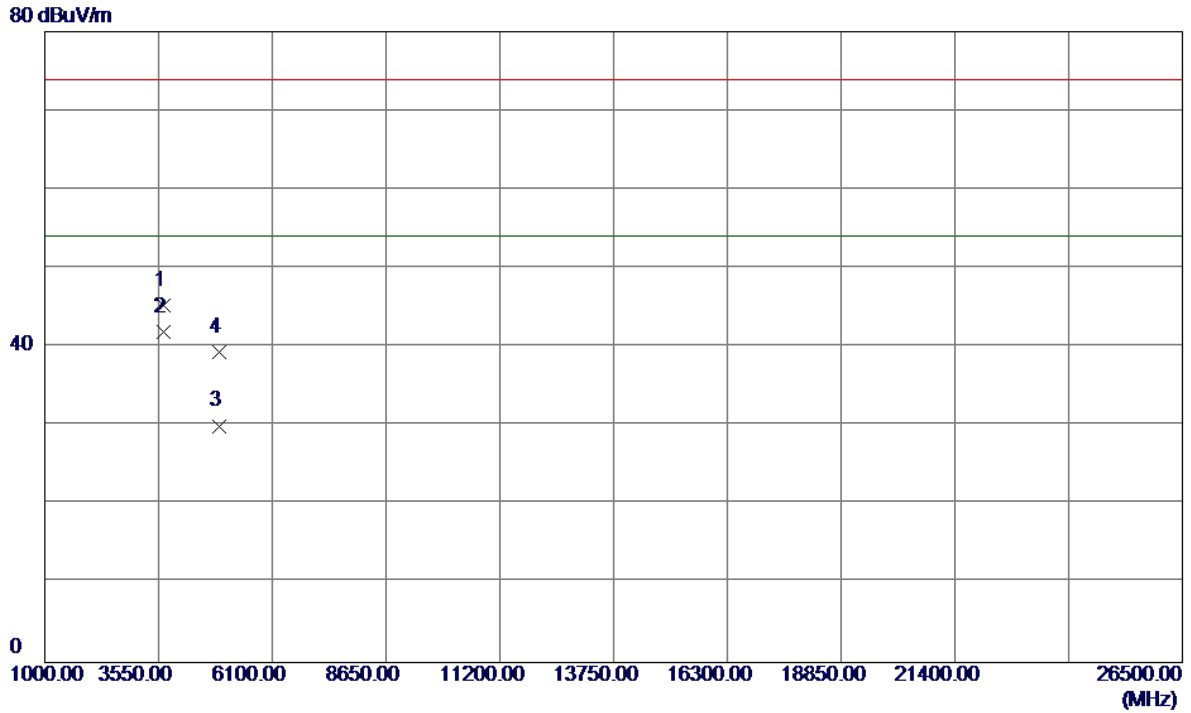

No.	Freq. MHz	Reading Level dBuV/m	Correct Factor dB	Measure ment dBuV/m	Limit dBuV/m	Margin dB	Detector	Comment
1	3666.6420	43.35	1.86	45.21	74.00	-28.79	Peak	
2 *	3666.6570	40.02	1.86	41.88	54.00	-12.12	AVG	
3	4903.9700	24.81	5.19	30.00	54.00	-24.00	AVG	
4	4904.0900	34.10	5.19	39.29	74.00	-34.71	Peak	

ATTACHMENT E - BANDWIDTH

Non-Beamforming

Test Mode : TX B Mode_CH01/06/11

Frequency (MHz)	6dB Bandwidth (MHz)	99% Occupied BW (MHz)	Min. Limit (kHz)	Test Result
2412	8.10	13.48	500	Complies
2437	8.13	13.40	500	Complies
2462	8.56	13.48	500	Complies

TX CH01

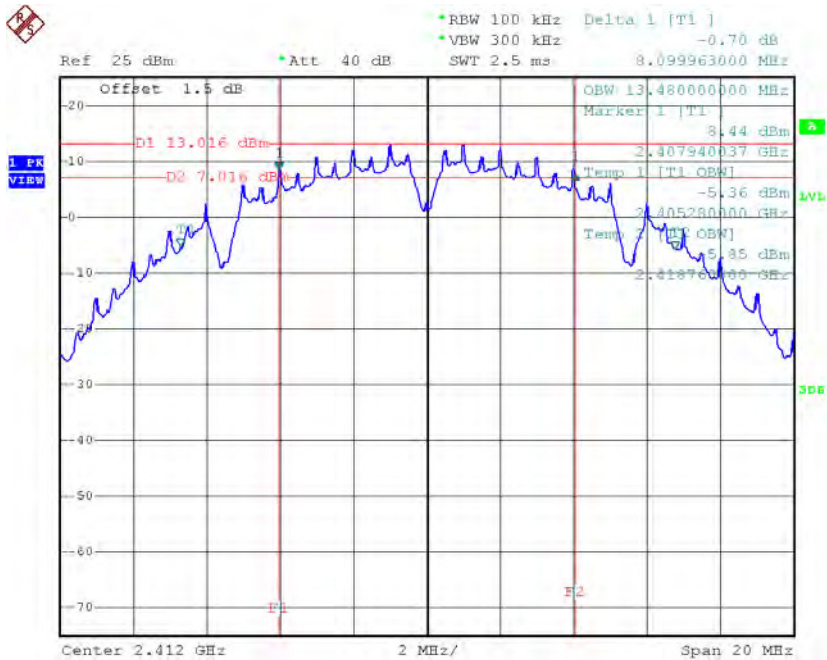

Date: 20.SEP.2016 20:04:07

TX CH06

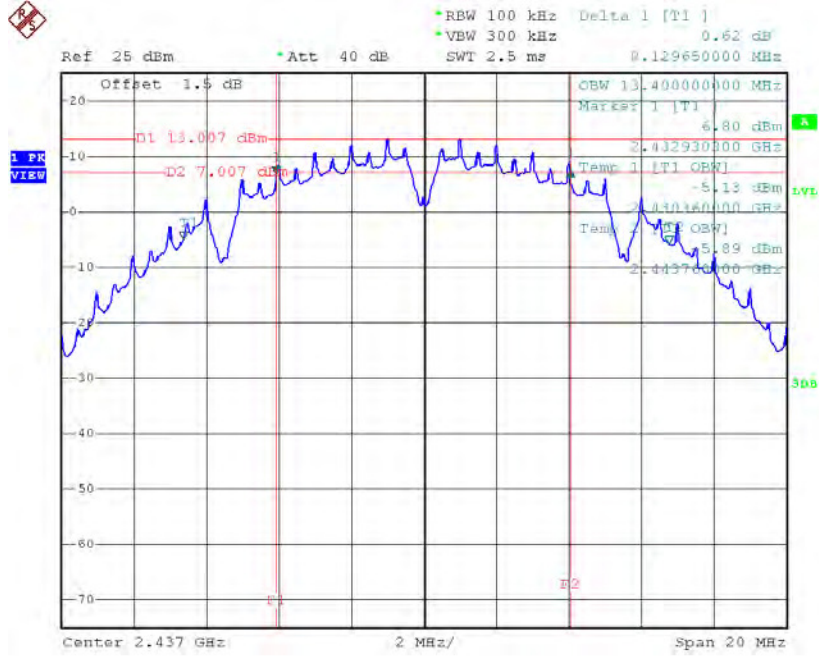

Date: 20.SEP.2016 20:05:38

TX CH11

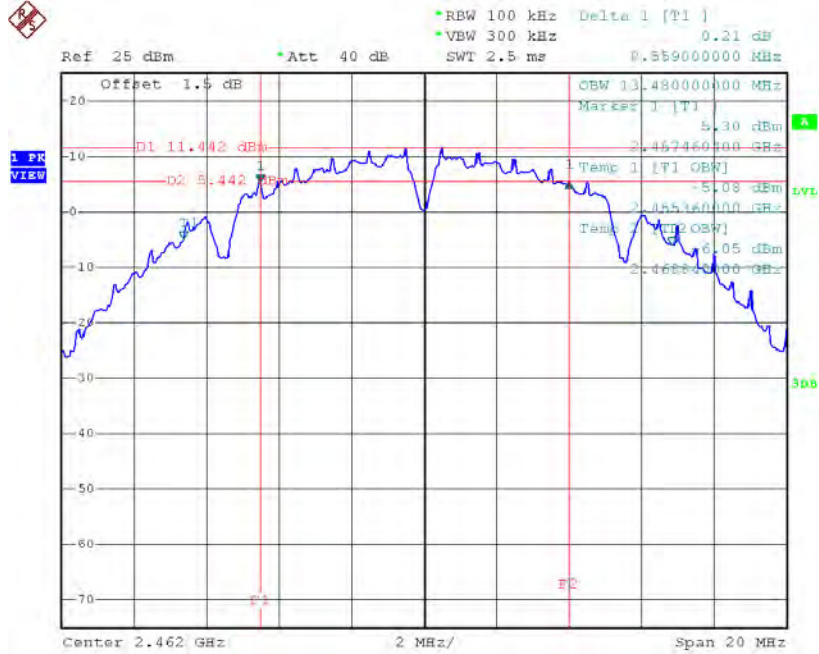

Date: 20.SEP.2016 20:07:14

Test Mode: TX G Mode_CH01/06/11

Frequency (MHz)	6dB Bandwidth (MHz)	99% Occupied BW (MHz)	Min. Limit (kHz)	Test Result
2412	16.35	16.40	500	Complies
2437	16.38	16.40	500	Complies
2462	16.42	16.40	500	Complies

TX CH01

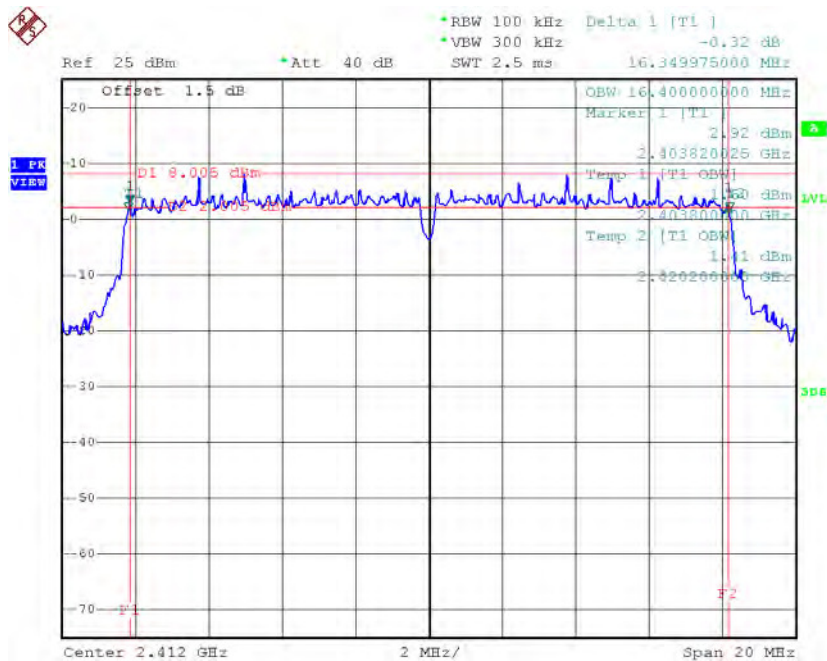

Date: 20.SEP.2016 20:09:50

TX CH06

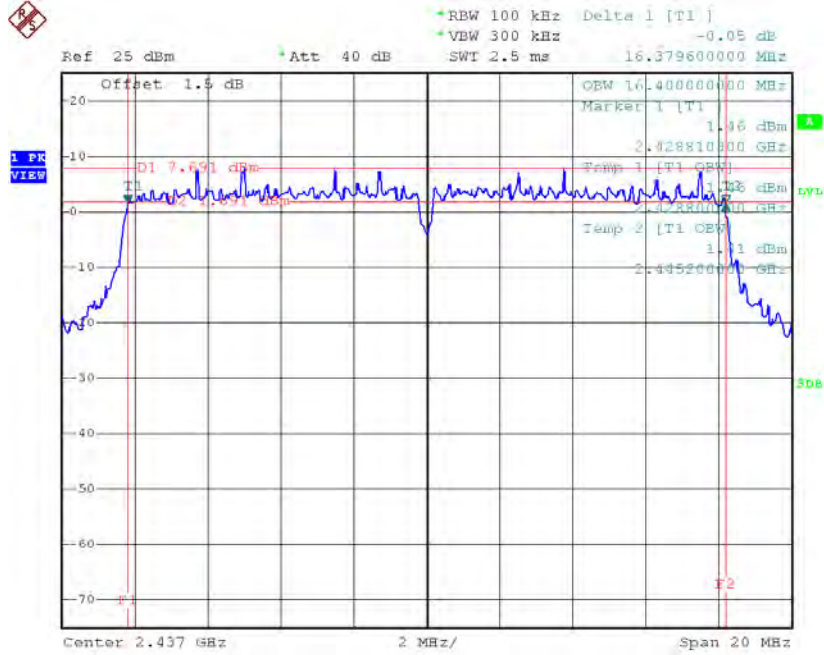

Date: 20.SEP.2016 20:11:03

TX CH11

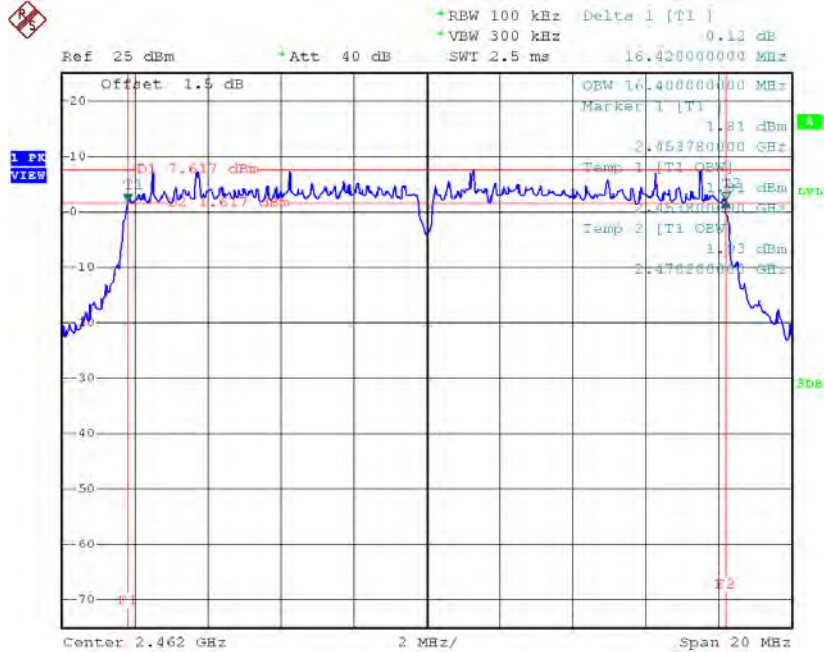

Date: 20.SEP.2016 20:12:04

Test Mode : TX N-20MHz Mode_CH01/06/11

Frequency (MHz)	6dB Bandwidth (MHz)	99% Occupied BW (MHz)	Min. Limit (kHz)	Test Result
2412	17.62	17.60	500	Complies
2437	17.62	17.60	500	Complies
2462	17.60	17.60	500	Complies

TX CH01

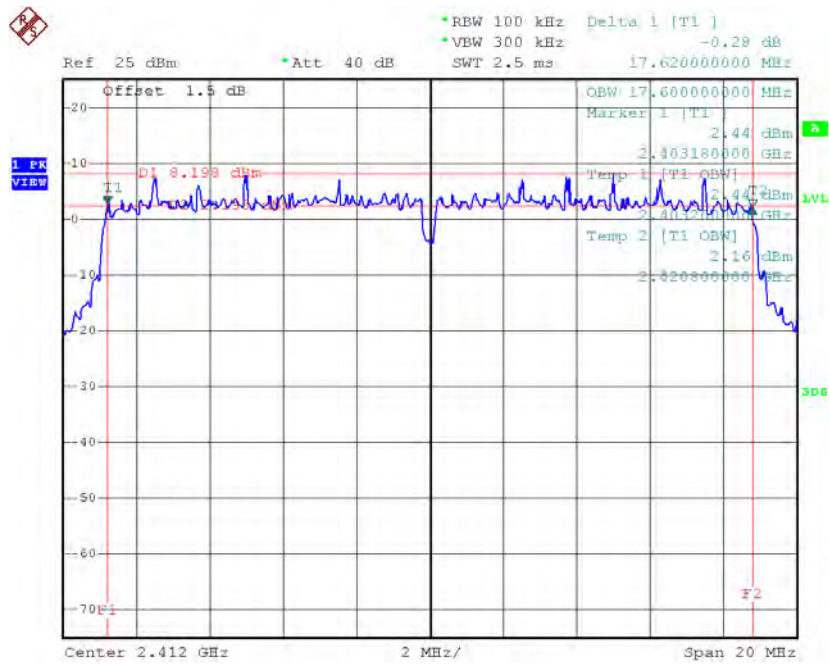

Date: 20.SEP.2016 20:13:17

TX CH06

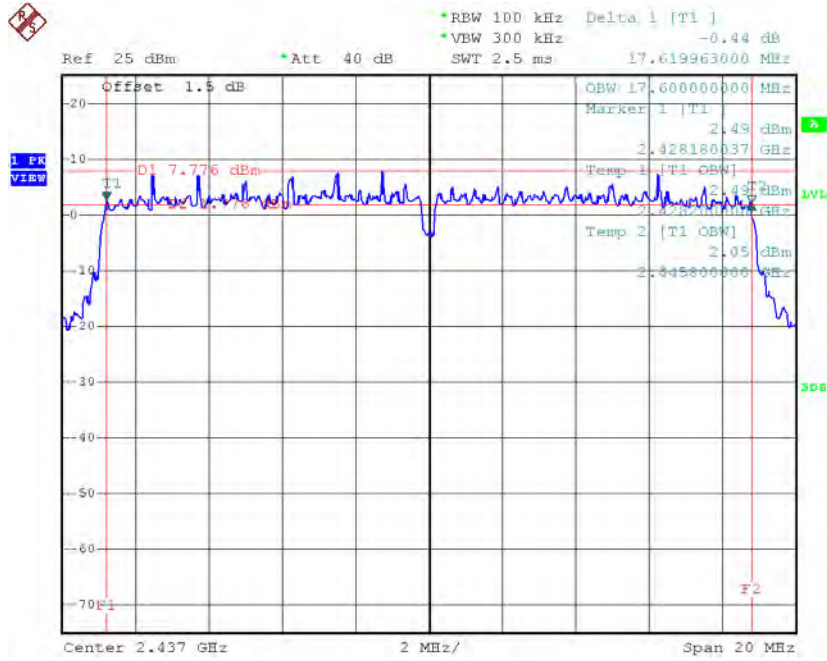

Date: 20.SEP.2016 20:14:52

TX CH11

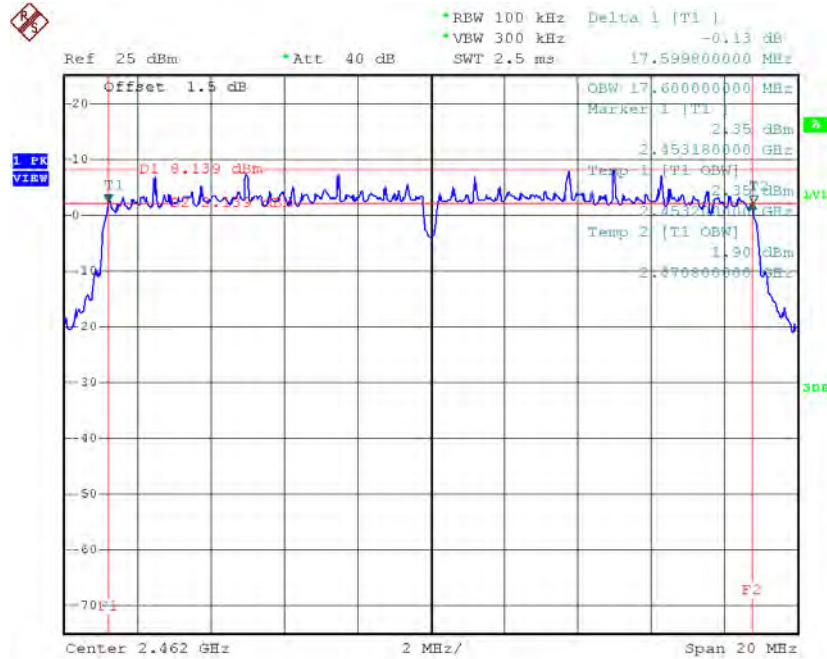

Date: 20.SEP.2016 20:15:50

Test Mode : TX N-40MHz Mode_CH03/06/09

Frequency (MHz)	6dB Bandwidth (MHz)	99% Occupied BW (MHz)	Min. Limit (kHz)	Test Result
2422	36.36	36.08	500	Complies
2437	36.36	36.16	500	Complies
2452	36.08	36.16	500	Complies

TX CH03

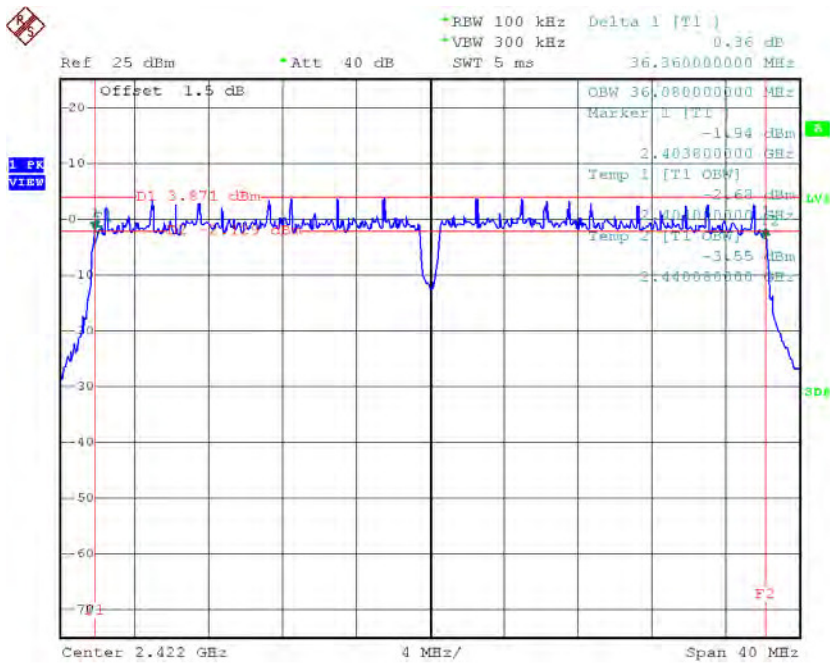

Beamforming

Test Mode : TX N-20MHz Mode_CH01/06/11

Frequency (MHz)	6dB Bandwidth (MHz)	99% Occupied BW (MHz)	Min. Limit (kHz)	Test Result
2412	17.62	17.60	500	Complies
2437	17.62	17.60	500	Complies
2462	17.60	17.60	500	Complies

TX CH01

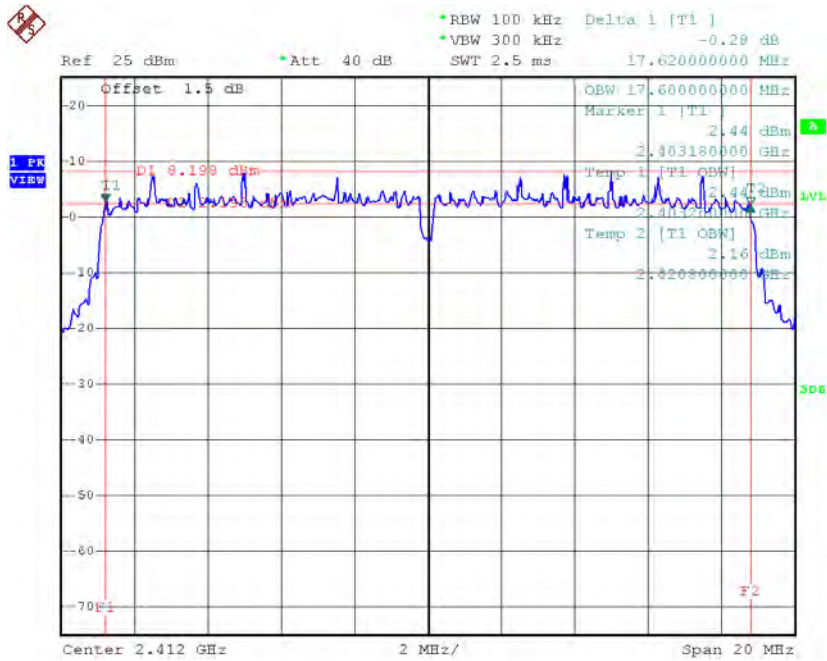

Date: 20.SEP.2016 20:13:17

TX CH06

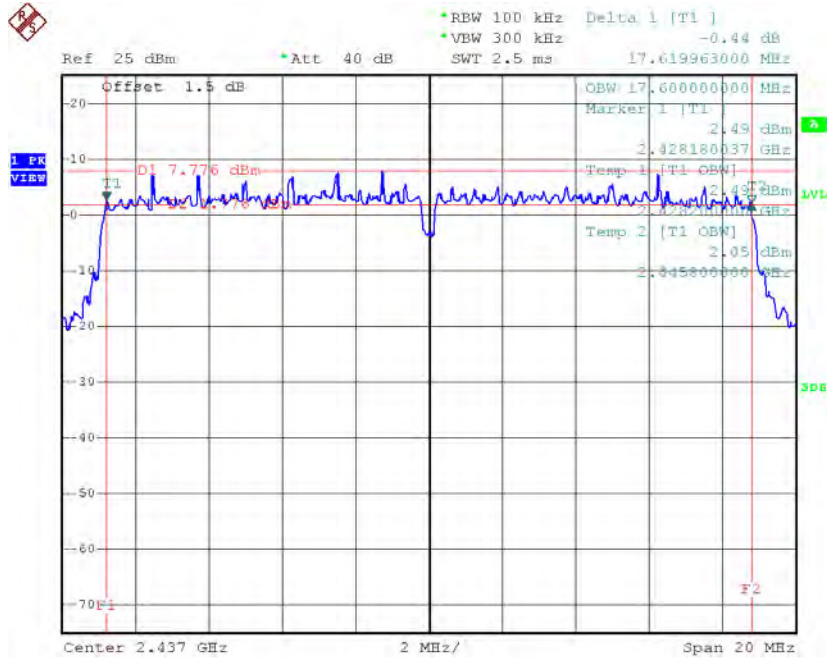

Date: 20.SEP.2016 20:14:52

TX CH11

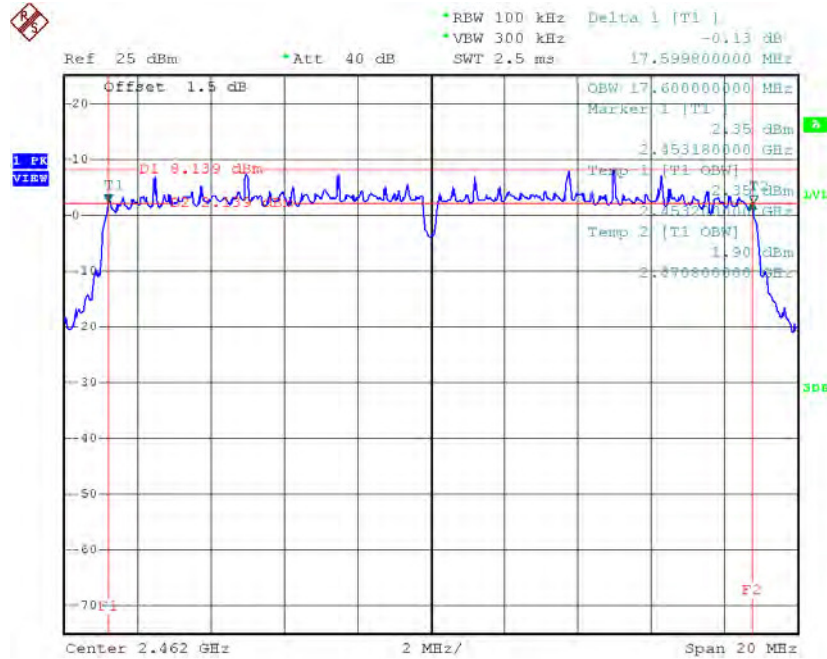

Date: 20.SEP.2016 20:15:50

Test Mode : TX N-40MHz Mode_CH03/06/09

Frequency (MHz)	6dB Bandwidth (MHz)	99% Occupied BW (MHz)	Min. Limit (kHz)	Test Result
2422	36.36	36.08	500	Complies
2437	36.36	36.16	500	Complies
2452	36.08	36.16	500	Complies

TX CH03

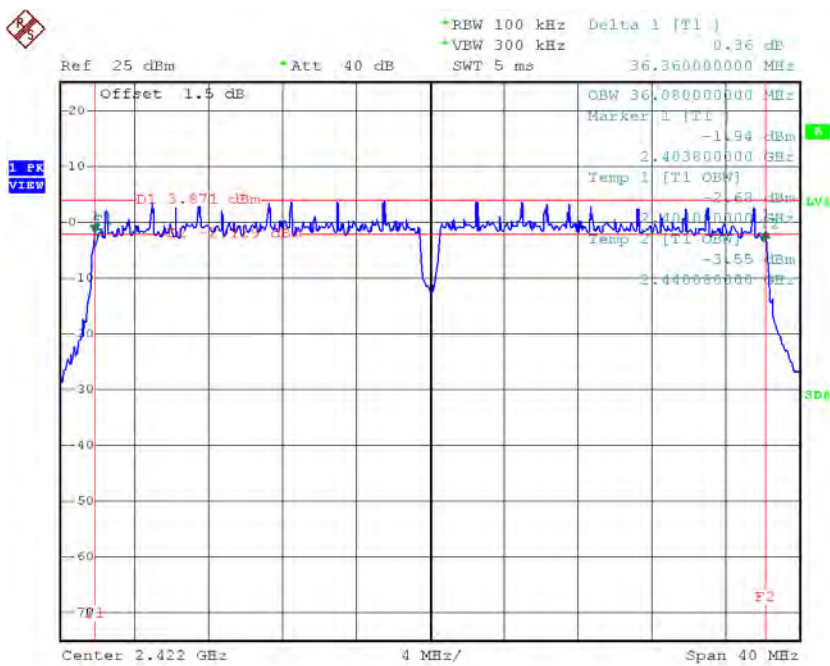

Date: 20.SEP.2016 20:17:00

TX CH06

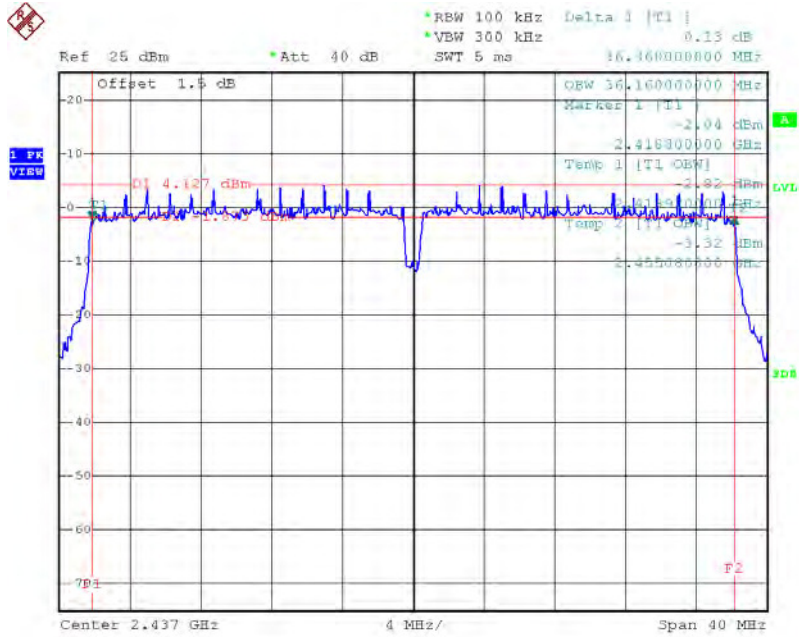

Date: 20.SEP.2016 20:18:09

TX CH09

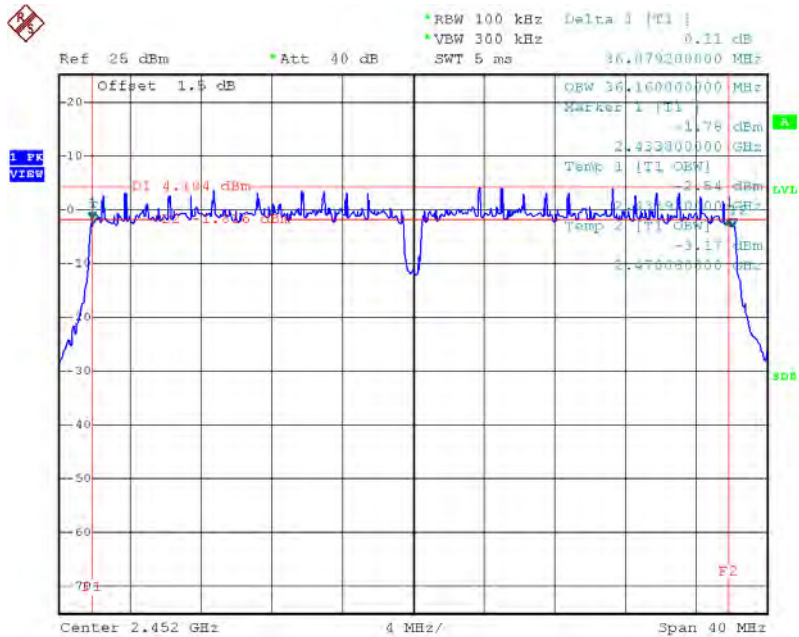

Date: 20.SEP.2016 20:19:10

ATTACHMENT F – MAXIMUM OUTPUT POWER

For 1TX Non-Beamforming

Test Mode :TX B Mode_CH01/06/11					
Frequency (MHz)	Conducted Power (dBm)	Conducted Power (W)	Max. Limit (dBm)	Max. Limit (W)	Result
2412	19.78	0.10	30.00	1.00	Complies
2437	19.44	0.09	30.00	1.00	Complies
2462	19.45	0.09	30.00	1.00	Complies

Test Mode :TX G Mode_CH01/06/11					
Frequency (MHz)	Conducted Power (dBm)	Conducted Power (W)	Max. Limit (dBm)	Max. Limit (W)	Result
2412	16.87	0.05	30.00	1.00	Complies
2437	18.01	0.06	30.00	1.00	Complies
2462	15.94	0.04	30.00	1.00	Complies

Test Mode :TX N20 Mode_CH01/06/11					
Frequency (MHz)	Conducted Power (dBm)	Conducted Power (W)	Max. Limit (dBm)	Max. Limit (W)	Result
2412	15.86	0.04	30.00	1.00	Complies
2437	17.63	0.06	30.00	1.00	Complies
2462	15.91	0.04	30.00	1.00	Complies

Test Mode :TX N40 Mode_CH03/06/09					
Frequency (MHz)	Conducted Power (dBm)	Conducted Power (W)	Max. Limit (dBm)	Max. Limit (W)	Result
2422	15.83	0.04	30.00	1.00	Complies
2437	16.95	0.05	30.00	1.00	Complies
2452	13.96	0.02	30.00	1.00	Complies

For 2TX Non-Beamforming

Test Mode :TX B Mode_CH01/06/11_ANT 1					
Frequency (MHz)	Conducted Power (dBm)	Conducted Power (W)	Max. Limit (dBm)	Max. Limit (W)	Result
2412	19.48	0.09	30.00	1.00	Complies
2437	19.65	0.09	30.00	1.00	Complies
2462	19.25	0.08	30.00	1.00	Complies

Test Mode :TX B Mode_CH01/06/11_ANT 2					
Frequency (MHz)	Conducted Power (dBm)	Conducted Power (W)	Max. Limit (dBm)	Max. Limit (W)	Result
2412	19.24	0.08	30.00	1.00	Complies
2437	19.35	0.09	30.00	1.00	Complies
2462	19.78	0.10	30.00	1.00	Complies

Test Mode :TX B Mode_CH01/06/11_Total					
Frequency (MHz)	Conducted Power (dBm)	Conducted Power (W)	Max. Limit (dBm)	Max. Limit (W)	Result
2412	22.37	0.17	30.00	1.00	Complies
2437	22.51	0.18	30.00	1.00	Complies
2462	22.53	0.19	30.00	1.00	Complies

Test Mode :TX G Mode_CH01/06/11_ANT 1					
Frequency (MHz)	Conducted Power (dBm)	Conducted Power (W)	Max. Limit (dBm)	Max. Limit (W)	Result
2412	15.79	0.04	30.00	1.00	Complies
2437	17.25	0.05	30.00	1.00	Complies
2462	14.83	0.03	30.00	1.00	Complies

Test Mode :TX G Mode_CH01/06/11_ANT 2					
Frequency (MHz)	Conducted Power (dBm)	Conducted Power (W)	Max. Limit (dBm)	Max. Limit (W)	Result
2412	15.94	0.04	30.00	1.00	Complies
2437	17.85	0.06	30.00	1.00	Complies
2462	14.76	0.03	30.00	1.00	Complies

Test Mode :TX G Mode_CH01/06/11_Total					
Frequency (MHz)	Conducted Power (dBm)	Conducted Power (W)	Max. Limit (dBm)	Max. Limit (W)	Result
2412	18.88	0.08	30.00	1.00	Complies
2437	20.57	0.11	30.00	1.00	Complies
2462	17.81	0.06	30.00	1.00	Complies

Test Mode :TX N20 Mode_CH01/06/11_ANT 1					
Frequency (MHz)	Conducted Power (dBm)	Conducted Power (W)	Max. Limit (dBm)	Max. Limit (W)	Result
2412	14.92	0.03	30.00	1.00	Complies
2437	17.85	0.06	30.00	1.00	Complies
2462	14.86	0.03	30.00	1.00	Complies

Test Mode :TX N20 Mode_CH01/06/11_ANT 2					
Frequency (MHz)	Conducted Power (dBm)	Conducted Power (W)	Max. Limit (dBm)	Max. Limit (W)	Result
2412	14.81	0.03	30.00	1.00	Complies
2437	17.64	0.06	30.00	1.00	Complies
2462	14.88	0.03	30.00	1.00	Complies

Test Mode :TX N20 Mode_CH01/06/11_Total					
Frequency (MHz)	Conducted Power (dBm)	Conducted Power (W)	Max. Limit (dBm)	Max. Limit (W)	Result
2412	17.88	0.06	30.00	1.00	Complies
2437	20.76	0.12	30.00	1.00	Complies
2462	17.88	0.06	30.00	1.00	Complies

Test Mode :TX N40 Mode_CH03/06/09_ANT 1					
Frequency (MHz)	Conducted Power (dBm)	Conducted Power (W)	Max. Limit (dBm)	Max. Limit (W)	Result
2422	14.89	0.03	30.00	1.00	Complies
2437	16.07	0.04	30.00	1.00	Complies
2452	12.92	0.02	30.00	1.00	Complies

Test Mode :TX N40 Mode_CH03/06/09_ANT 2					
Frequency (MHz)	Conducted Power (dBm)	Conducted Power (W)	Max. Limit (dBm)	Max. Limit (W)	Result
2422	14.89	0.03	30.00	1.00	Complies
2437	17.25	0.05	30.00	1.00	Complies
2452	12.92	0.02	30.00	1.00	Complies

Test Mode :TX N40 Mode_CH03/06/09_Total					
Frequency (MHz)	Conducted Power (dBm)	Conducted Power (W)	Max. Limit (dBm)	Max. Limit (W)	Result
2422	17.82	0.06	30.00	1.00	Complies
2437	19.71	0.09	30.00	1.00	Complies
2452	15.89	0.04	30.00	1.00	Complies

For 3TX Non-Beamforming

Test Mode :TX B Mode_CH01/06/11_ANT 1					
Frequency (MHz)	Conducted Power (dBm)	Conducted Power (W)	Max. Limit (dBm)	Max. Limit (W)	Result
2412	19.63	0.09	30.00	1.00	Complies
2437	19.78	0.10	30.00	1.00	Complies
2462	19.35	0.09	30.00	1.00	Complies

Test Mode :TX B Mode_CH01/06/11_ANT 2					
Frequency (MHz)	Conducted Power (dBm)	Conducted Power (W)	Max. Limit (dBm)	Max. Limit (W)	Result
2412	19.85	0.10	30.00	1.00	Complies
2437	19.18	0.08	30.00	1.00	Complies
2462	19.28	0.08	30.00	1.00	Complies

Test Mode :TX B Mode_CH01/06/11_ANT 3					
Frequency (MHz)	Conducted Power (dBm)	Conducted Power (W)	Max. Limit (dBm)	Max. Limit (W)	Result
2412	19.85	0.10	30.00	1.00	Complies
2437	19.34	0.09	30.00	1.00	Complies
2462	19.36	0.09	30.00	1.00	Complies

Test Mode :TX B Mode_CH01/06/11_Total					
Frequency (MHz)	Conducted Power (dBm)	Conducted Power (W)	Max. Limit (dBm)	Max. Limit (W)	Result
2412	24.55	0.29	30.00	1.00	Complies
2437	24.21	0.26	30.00	1.00	Complies
2462	24.10	0.26	30.00	1.00	Complies

Test Mode :TX G Mode_CH01/06/11_ANT 1					
Frequency (MHz)	Conducted Power (dBm)	Conducted Power (W)	Max. Limit (dBm)	Max. Limit (W)	Result
2412	14.85	0.03	30.00	1.00	Complies
2437	17.45	0.06	30.00	1.00	Complies
2462	13.48	0.02	30.00	1.00	Complies

Test Mode :TX G Mode_CH01/06/11_ANT 2					
Frequency (MHz)	Conducted Power (dBm)	Conducted Power (W)	Max. Limit (dBm)	Max. Limit (W)	Result
2412	14.63	0.03	30.00	1.00	Complies
2437	17.53	0.06	30.00	1.00	Complies
2462	14.05	0.03	30.00	1.00	Complies

Test Mode :TX G Mode_CH01/06/11_ANT 3					
Frequency (MHz)	Conducted Power (dBm)	Conducted Power (W)	Max. Limit (dBm)	Max. Limit (W)	Result
2412	15.04	0.03	30.00	1.00	Complies
2437	17.50	0.06	30.00	1.00	Complies
2462	13.84	0.02	30.00	1.00	Complies

Test Mode :TX G Mode_CH01/06/11_Total					
Frequency (MHz)	Conducted Power (dBm)	Conducted Power (W)	Max. Limit (dBm)	Max. Limit (W)	Result
2412	19.61	0.09	30.00	1.00	Complies
2437	22.26	0.17	30.00	1.00	Complies
2462	18.57	0.07	30.00	1.00	Complies

Test Mode :TX N20 Mode_CH01/06/11_ANT 1					
Frequency (MHz)	Conducted Power (dBm)	Conducted Power (W)	Max. Limit (dBm)	Max. Limit (W)	Result
2412	13.69	0.02	30.00	1.00	Complies
2437	17.95	0.06	30.00	1.00	Complies
2462	13.84	0.02	30.00	1.00	Complies

Test Mode :TX N20 Mode_CH01/06/11_ANT 2					
Frequency (MHz)	Conducted Power (dBm)	Conducted Power (W)	Max. Limit (dBm)	Max. Limit (W)	Result
2412	13.75	0.02	30.00	1.00	Complies
2437	17.24	0.05	30.00	1.00	Complies
2462	13.69	0.02	30.00	1.00	Complies

Test Mode :TX N20 Mode_CH01/06/11_ANT 3					
Frequency (MHz)	Conducted Power (dBm)	Conducted Power (W)	Max. Limit (dBm)	Max. Limit (W)	Result
2412	13.58	0.02	30.00	1.00	Complies
2437	17.52	0.06	30.00	1.00	Complies
2462	13.69	0.02	30.00	1.00	Complies

Test Mode :TX N20 Mode_CH01/06/11_Total					
Frequency (MHz)	Conducted Power (dBm)	Conducted Power (W)	Max. Limit (dBm)	Max. Limit (W)	Result
2412	18.45	0.07	30.00	1.00	Complies
2437	22.35	0.17	30.00	1.00	Complies
2462	18.51	0.07	30.00	1.00	Complies

Test Mode :TX N40 Mode_CH01/06/11_ANT 1					
Frequency (MHz)	Conducted Power (dBm)	Conducted Power (W)	Max. Limit (dBm)	Max. Limit (W)	Result
2422	13.92	0.02	30.00	1.00	Complies
2437	16.54	0.05	30.00	1.00	Complies
2452	11.24	0.01	30.00	1.00	Complies

Test Mode :TX N40 Mode_CH03/06/09_ANT 2					
Frequency (MHz)	Conducted Power (dBm)	Conducted Power (W)	Max. Limit (dBm)	Max. Limit (W)	Result
2422	13.58	0.02	30.00	1.00	Complies
2437	16.58	0.05	30.00	1.00	Complies
2452	11.05	0.01	30.00	1.00	Complies

Test Mode :TX N40 Mode_CH03/06/09_ANT 3					
Frequency (MHz)	Conducted Power (dBm)	Conducted Power (W)	Max. Limit (dBm)	Max. Limit (W)	Result
2422	13.09	0.02	30.00	1.00	Complies
2437	16.84	0.05	30.00	1.00	Complies
2452	11.40	0.01	30.00	1.00	Complies

Test Mode :TX N40 Mode_CH03/06/09_Total					
Frequency (MHz)	Conducted Power (dBm)	Conducted Power (W)	Max. Limit (dBm)	Max. Limit (W)	Result
2422	18.31	0.07	30.00	1.00	Complies
2437	21.43	0.14	30.00	1.00	Complies
2452	16.00	0.04	30.00	1.00	Complies

For 4TX Non-Beamforming

Test Mode :TX B Mode_CH01/06/11_ANT 1					
Frequency (MHz)	Conducted Power (dBm)	Conducted Power (W)	Max. Limit (dBm)	Max. Limit (W)	Result
2412	19.85	0.10	30.00	1.00	Complies
2437	19.45	0.09	30.00	1.00	Complies
2462	19.35	0.09	30.00	1.00	Complies

Test Mode :TX B Mode_CH01/06/11_ANT 2					
Frequency (MHz)	Conducted Power (dBm)	Conducted Power (W)	Max. Limit (dBm)	Max. Limit (W)	Result
2412	19.66	0.09	30.00	1.00	Complies
2437	19.85	0.10	30.00	1.00	Complies
2462	19.45	0.09	30.00	1.00	Complies

Test Mode :TX B Mode_CH01/06/11_ANT 3					
Frequency (MHz)	Conducted Power (dBm)	Conducted Power (W)	Max. Limit (dBm)	Max. Limit (W)	Result
2412	19.58	0.09	30.00	1.00	Complies
2437	19.28	0.08	30.00	1.00	Complies
2462	19.44	0.09	30.00	1.00	Complies

Test Mode :TX B Mode_CH01/06/11_ANT 4					
Frequency (MHz)	Conducted Power (dBm)	Conducted Power (W)	Max. Limit (dBm)	Max. Limit (W)	Result
2412	19.59	0.09	30.00	1.00	Complies
2437	19.87	0.10	30.00	1.00	Complies
2462	19.45	0.09	30.00	1.00	Complies

Test Mode :TX B Mode_CH01/06/11_Total					
Frequency (MHz)	Conducted Power (dBm)	Conducted Power (W)	Max. Limit (dBm)	Max. Limit (W)	Result
2412	25.69	0.37	30.00	1.00	Complies
2437	25.64	0.37	30.00	1.00	Complies
2462	25.44	0.35	30.00	1.00	Complies

Test Mode :TX G Mode_CH01/06/11_ANT 1					
Frequency (MHz)	Conducted Power (dBm)	Conducted Power (W)	Max. Limit (dBm)	Max. Limit (W)	Result
2412	14.95	0.03	30.00	1.00	Complies
2437	17.45	0.06	30.00	1.00	Complies
2462	13.41	0.02	30.00	1.00	Complies

Test Mode :TX G Mode_CH01/06/11_ANT 2					
Frequency (MHz)	Conducted Power (dBm)	Conducted Power (W)	Max. Limit (dBm)	Max. Limit (W)	Result
2412	14.78	0.03	30.00	1.00	Complies
2437	17.45	0.06	30.00	1.00	Complies
2462	13.65	0.02	30.00	1.00	Complies

Test Mode :TX G Mode_CH01/06/11_ANT 3					
Frequency (MHz)	Conducted Power (dBm)	Conducted Power (W)	Max. Limit (dBm)	Max. Limit (W)	Result
2412	14.87	0.03	30.00	1.00	Complies
2437	17.63	0.06	30.00	1.00	Complies
2462	13.25	0.02	30.00	1.00	Complies

Test Mode :TX G Mode_CH01/06/11_ANT 4					
Frequency (MHz)	Conducted Power (dBm)	Conducted Power (W)	Max. Limit (dBm)	Max. Limit (W)	Result
2412	14.49	0.03	30.00	1.00	Complies
2437	17.36	0.05	30.00	1.00	Complies
2462	13.85	0.02	30.00	1.00	Complies

Test Mode :TX G Mode_CH01/06/11_Total					
Frequency (MHz)	Conducted Power (dBm)	Conducted Power (W)	Max. Limit (dBm)	Max. Limit (W)	Result
2412	20.80	0.12	30.00	1.00	Complies
2437	23.49	0.22	30.00	1.00	Complies
2462	19.57	0.09	30.00	1.00	Complies

Test Mode :TX N20 Mode_CH01/06/11_ANT 1					
Frequency (MHz)	Conducted Power (dBm)	Conducted Power (W)	Max. Limit (dBm)	Max. Limit (W)	Result
2412	13.50	0.02	30.00	1.00	Complies
2437	17.25	0.05	30.00	1.00	Complies
2462	13.25	0.02	30.00	1.00	Complies

Test Mode :TX N20 Mode_CH01/06/11_ANT 2					
Frequency (MHz)	Conducted Power (dBm)	Conducted Power (W)	Max. Limit (dBm)	Max. Limit (W)	Result
2412	13.58	0.02	30.00	1.00	Complies
2437	17.77	0.06	30.00	1.00	Complies
2462	13.98	0.03	30.00	1.00	Complies

Test Mode :TX N20 Mode_CH01/06/11_ANT 3					
Frequency (MHz)	Conducted Power (dBm)	Conducted Power (W)	Max. Limit (dBm)	Max. Limit (W)	Result
2412	13.58	0.02	30.00	1.00	Complies
2437	17.21	0.05	30.00	1.00	Complies
2462	13.13	0.02	30.00	1.00	Complies

Test Mode :TX N20 Mode_CH01/06/11_ANT 4					
Frequency (MHz)	Conducted Power (dBm)	Conducted Power (W)	Max. Limit (dBm)	Max. Limit (W)	Result
2412	13.98	0.03	30.00	1.00	Complies
2437	17.39	0.05	30.00	1.00	Complies
2462	13.32	0.02	30.00	1.00	Complies

Test Mode :TX N20 Mode_CH01/06/11_Total					
Frequency (MHz)	Conducted Power (dBm)	Conducted Power (W)	Max. Limit (dBm)	Max. Limit (W)	Result
2412	19.68	0.09	30.00	1.00	Complies
2437	23.43	0.22	30.00	1.00	Complies
2462	19.45	0.09	30.00	1.00	Complies

Test Mode :TX N40 Mode_CH03/06/09_ANT 1					
Frequency (MHz)	Conducted Power (dBm)	Conducted Power (W)	Max. Limit (dBm)	Max. Limit (W)	Result
2422	13.57	0.02	30.00	1.00	Complies
2437	16.95	0.05	30.00	1.00	Complies
2452	11.25	0.01	30.00	1.00	Complies

Test Mode :TX N40 Mode_CH03/06/09_ANT 2					
Frequency (MHz)	Conducted Power (dBm)	Conducted Power (W)	Max. Limit (dBm)	Max. Limit (W)	Result
2422	14.05	0.03	30.00	1.00	Complies
2437	16.58	0.05	30.00	1.00	Complies
2452	11.90	0.02	30.00	1.00	Complies

Test Mode :TX N40 Mode_CH03/06/09_ANT 3					
Frequency (MHz)	Conducted Power (dBm)	Conducted Power (W)	Max. Limit (dBm)	Max. Limit (W)	Result
2422	13.54	0.02	30.00	1.00	Complies
2437	16.58	0.05	30.00	1.00	Complies
2452	11.74	0.01	30.00	1.00	Complies

Test Mode :TX N40 Mode_CH03/06/09_ANT 4					
Frequency (MHz)	Conducted Power (dBm)	Conducted Power (W)	Max. Limit (dBm)	Max. Limit (W)	Result
2422	13.57	0.02	30.00	1.00	Complies
2437	16.25	0.04	30.00	1.00	Complies
2452	11.84	0.02	30.00	1.00	Complies

Test Mode :TX N40 Mode_CH03/06/09_Total					
Frequency (MHz)	Conducted Power (dBm)	Conducted Power (W)	Max. Limit (dBm)	Max. Limit (W)	Result
2422	19.71	0.09	30.00	1.00	Complies
2437	22.62	0.18	30.00	1.00	Complies
2452	17.71	0.06	30.00	1.00	Complies

For 2TX Beamforming

Test Mode :TX N20 Mode_CH01/06/11_ANT 1					
Frequency (MHz)	Conducted Power (dBm)	Conducted Power (W)	Max. Limit (dBm)	Max. Limit (W)	Result
2412	13.58	0.02	30.00	1.00	Complies
2437	17.65	0.06	30.00	1.00	Complies
2462	13.54	0.02	30.00	1.00	Complies

Test Mode :TX N20 Mode_CH01/06/11_ANT 2					
Frequency (MHz)	Conducted Power (dBm)	Conducted Power (W)	Max. Limit (dBm)	Max. Limit (W)	Result
2412	13.48	0.02	30.00	1.00	Complies
2437	17.85	0.06	30.00	1.00	Complies
2462	13.45	0.02	30.00	1.00	Complies

Test Mode :TX N20 Mode_CH01/06/11_Total					
Frequency (MHz)	Conducted Power (dBm)	Conducted Power (W)	Max. Limit (dBm)	Max. Limit (W)	Result
2412	16.54	0.05	30.00	1.00	Complies
2437	20.76	0.12	30.00	1.00	Complies
2462	16.51	0.04	30.00	1.00	Complies

Test Mode :TX N40 Mode_CH03/06/09_ANT 1					
Frequency (MHz)	Conducted Power (dBm)	Conducted Power (W)	Max. Limit (dBm)	Max. Limit (W)	Result
2422	13.65	0.02	30.00	1.00	Complies
2437	16.54	0.05	30.00	1.00	Complies
2452	11.54	0.01	30.00	1.00	Complies

Test Mode :TX N40 Mode_CH03/06/09_ANT 2					
Frequency (MHz)	Conducted Power (dBm)	Conducted Power (W)	Max. Limit (dBm)	Max. Limit (W)	Result
2422	13.65	0.02	30.00	1.00	Complies
2437	16.54	0.05	30.00	1.00	Complies
2452	11.58	0.01	30.00	1.00	Complies

Test Mode :TX N40 Mode_CH03/06/09_Total					
Frequency (MHz)	Conducted Power (dBm)	Conducted Power (W)	Max. Limit (dBm)	Max. Limit (W)	Result
2422	16.66	0.05	30.00	1.00	Complies
2437	19.55	0.09	30.00	1.00	Complies
2452	14.57	0.03	30.00	1.00	Complies

For 3TX Beamforming

Test Mode :TX N20 Mode_CH01/06/11_ANT 1					
Frequency (MHz)	Conducted Power (dBm)	Conducted Power (W)	Max. Limit (dBm)	Max. Limit (W)	Result
2412	13.78	0.02	30.00	1.00	Complies
2437	17.69	0.06	30.00	1.00	Complies
2462	13.20	0.02	30.00	1.00	Complies

Test Mode :TX N20 Mode_CH01/06/11_ANT 2					
Frequency (MHz)	Conducted Power (dBm)	Conducted Power (W)	Max. Limit (dBm)	Max. Limit (W)	Result
2412	13.92	0.02	30.00	1.00	Complies
2437	17.85	0.06	30.00	1.00	Complies
2462	13.45	0.02	30.00	1.00	Complies

Test Mode :TX N20 Mode_CH01/06/11_ANT 3					
Frequency (MHz)	Conducted Power (dBm)	Conducted Power (W)	Max. Limit (dBm)	Max. Limit (W)	Result
2412	13.54	0.02	30.00	1.00	Complies
2437	17.85	0.06	30.00	1.00	Complies
2462	13.25	0.02	30.00	1.00	Complies

Test Mode :TX N20 Mode_CH01/06/11_Total					
Frequency (MHz)	Conducted Power (dBm)	Conducted Power (W)	Max. Limit (dBm)	Max. Limit (W)	Result
2412	18.52	0.07	30.00	1.00	Complies
2437	22.57	0.18	30.00	1.00	Complies
2462	18.07	0.06	30.00	1.00	Complies

Test Mode :TX N40 Mode_CH01/06/11_ANT 1					
Frequency (MHz)	Conducted Power (dBm)	Conducted Power (W)	Max. Limit (dBm)	Max. Limit (W)	Result
2422	13.65	0.02	30.00	1.00	Complies
2437	16.45	0.04	30.00	1.00	Complies
2452	11.85	0.02	30.00	1.00	Complies

Test Mode :TX N40 Mode_CH03/06/09_ANT 2					
Frequency (MHz)	Conducted Power (dBm)	Conducted Power (W)	Max. Limit (dBm)	Max. Limit (W)	Result
2422	13.95	0.02	30.00	1.00	Complies
2437	16.45	0.04	30.00	1.00	Complies
2452	11.48	0.01	30.00	1.00	Complies

Test Mode :TX N40 Mode_CH03/06/09_ANT 3					
Frequency (MHz)	Conducted Power (dBm)	Conducted Power (W)	Max. Limit (dBm)	Max. Limit (W)	Result
2422	13.47	0.02	30.00	1.00	Complies
2437	16.60	0.05	30.00	1.00	Complies
2452	11.45	0.01	30.00	1.00	Complies

Test Mode :TX N40 Mode_CH03/06/09_Total					
Frequency (MHz)	Conducted Power (dBm)	Conducted Power (W)	Max. Limit (dBm)	Max. Limit (W)	Result
2422	18.47	0.07	30.00	1.00	Complies
2437	21.27	0.13	30.00	1.00	Complies
2452	16.37	0.04	30.00	1.00	Complies

For 4TX Beamforming

Test Mode :TX N20 Mode_CH01/06/11_ANT 1					
Frequency (MHz)	Conducted Power (dBm)	Conducted Power (W)	Max. Limit (dBm)	Max. Limit (W)	Result
2412	13.65	0.02	30.00	1.00	Complies
2437	17.52	0.06	30.00	1.00	Complies
2462	13.88	0.02	30.00	1.00	Complies

Test Mode :TX N20 Mode_CH01/06/11_ANT 2					
Frequency (MHz)	Conducted Power (dBm)	Conducted Power (W)	Max. Limit (dBm)	Max. Limit (W)	Result
2412	13.95	0.02	30.00	1.00	Complies
2437	17.84	0.06	30.00	1.00	Complies
2462	13.24	0.02	30.00	1.00	Complies

Test Mode :TX N20 Mode_CH01/06/11_ANT 3					
Frequency (MHz)	Conducted Power (dBm)	Conducted Power (W)	Max. Limit (dBm)	Max. Limit (W)	Result
2412	14.05	0.03	30.00	1.00	Complies
2437	17.59	0.06	30.00	1.00	Complies
2462	14.03	0.03	30.00	1.00	Complies

Test Mode :TX N20 Mode_CH01/06/11_ANT 4					
Frequency (MHz)	Conducted Power (dBm)	Conducted Power (W)	Max. Limit (dBm)	Max. Limit (W)	Result
2412	14.01	0.03	30.00	1.00	Complies
2437	17.65	0.06	30.00	1.00	Complies
2462	13.65	0.02	30.00	1.00	Complies

Test Mode :TX N20 Mode_CH01/06/11_Total					
Frequency (MHz)	Conducted Power (dBm)	Conducted Power (W)	Max. Limit (dBm)	Max. Limit (W)	Result
2412	19.94	0.10	30.00	1.00	Complies
2437	23.67	0.23	30.00	1.00	Complies
2462	19.73	0.09	30.00	1.00	Complies

Test Mode :TX N40 Mode_CH03/06/09_ANT 1					
Frequency (MHz)	Conducted Power (dBm)	Conducted Power (W)	Max. Limit (dBm)	Max. Limit (W)	Result
2422	13.48	0.02	30.00	1.00	Complies
2437	16.54	0.05	30.00	1.00	Complies
2452	11.08	0.01	30.00	1.00	Complies

Test Mode :TX N40 Mode_CH03/06/09_ANT 2					
Frequency (MHz)	Conducted Power (dBm)	Conducted Power (W)	Max. Limit (dBm)	Max. Limit (W)	Result
2422	13.84	0.02	30.00	1.00	Complies
2437	16.54	0.05	30.00	1.00	Complies
2452	11.77	0.02	30.00	1.00	Complies

Test Mode :TX N40 Mode_CH03/06/09_ANT 3					
Frequency (MHz)	Conducted Power (dBm)	Conducted Power (W)	Max. Limit (dBm)	Max. Limit (W)	Result
2422	13.69	0.02	30.00	1.00	Complies
2437	16.84	0.05	30.00	1.00	Complies
2452	11.58	0.01	30.00	1.00	Complies

Test Mode :TX N40 Mode_CH03/06/09_ANT 4					
Frequency (MHz)	Conducted Power (dBm)	Conducted Power (W)	Max. Limit (dBm)	Max. Limit (W)	Result
2422	13.45	0.02	30.00	1.00	Complies
2437	16.45	0.04	30.00	1.00	Complies
2452	11.25	0.01	30.00	1.00	Complies

Test Mode :TX N40 Mode_CH03/06/09_Total					
Frequency (MHz)	Conducted Power (dBm)	Conducted Power (W)	Max. Limit (dBm)	Max. Limit (W)	Result
2422	19.64	0.09	30.00	1.00	Complies
2437	22.62	0.18	30.00	1.00	Complies
2452	17.45	0.06	30.00	1.00	Complies

ATTACHMENT G - ANTENNA CONDUCTED SPURIOUS EMISSION

For 1TX Non-Beamforming

Test Mode : TX B Mode

TX B mode CH01

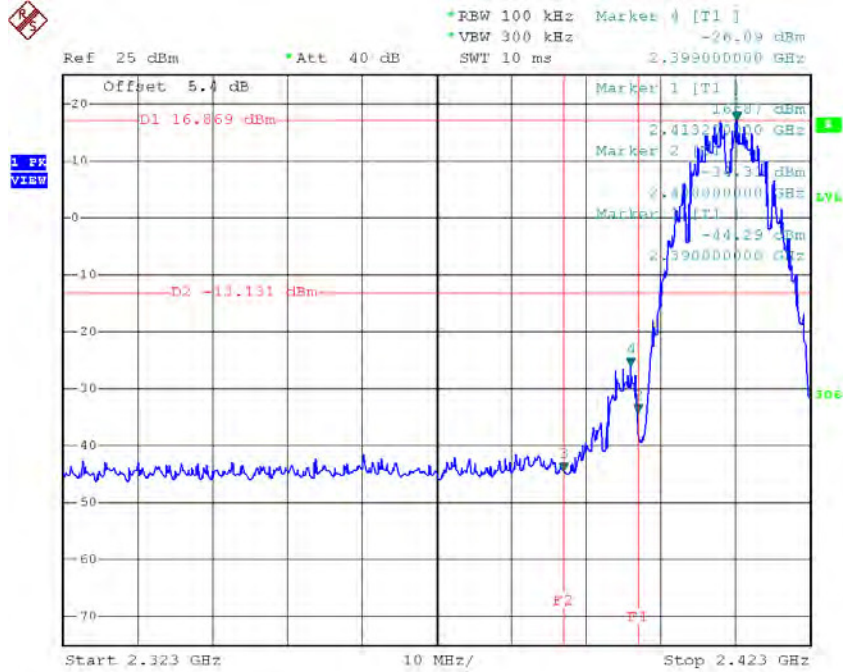

Date: 20.SEP.2016 20:04:46

TX B mode CH11

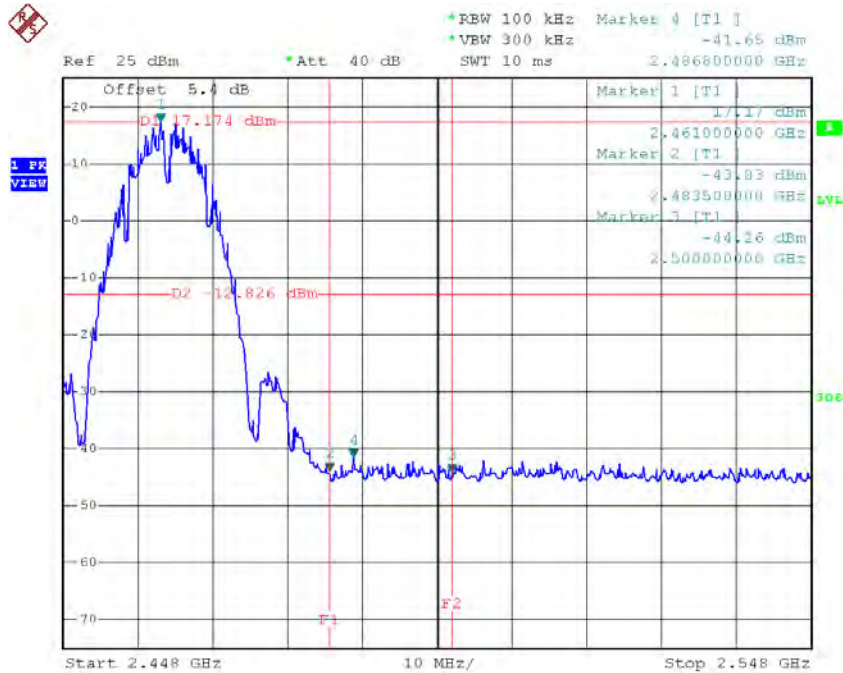

Date: 20.SEP.2016 20:07:53

TX B mode CH01 (10 Harmonic of the frequency)

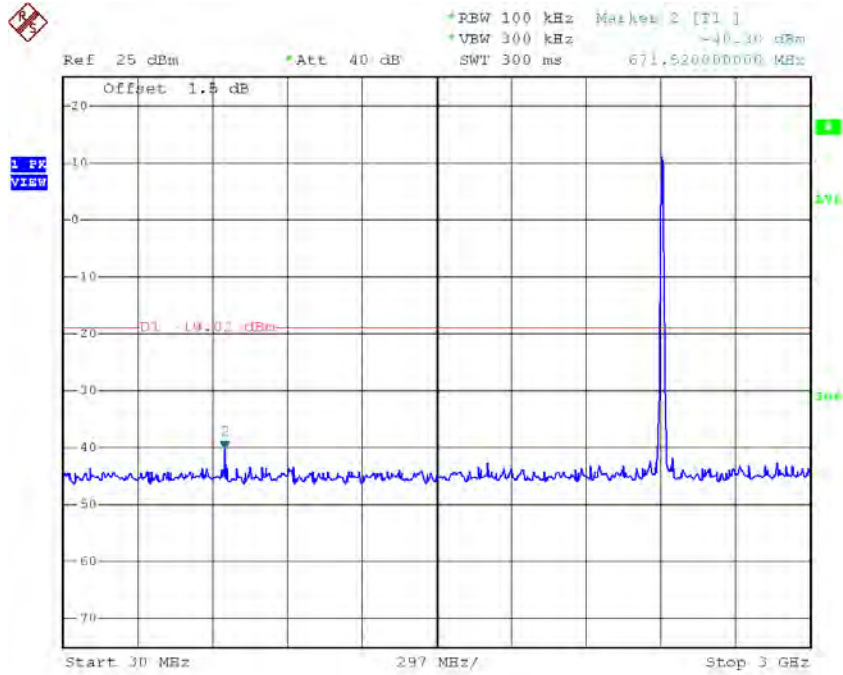

Date: 20,SEP.2016 20:04:22

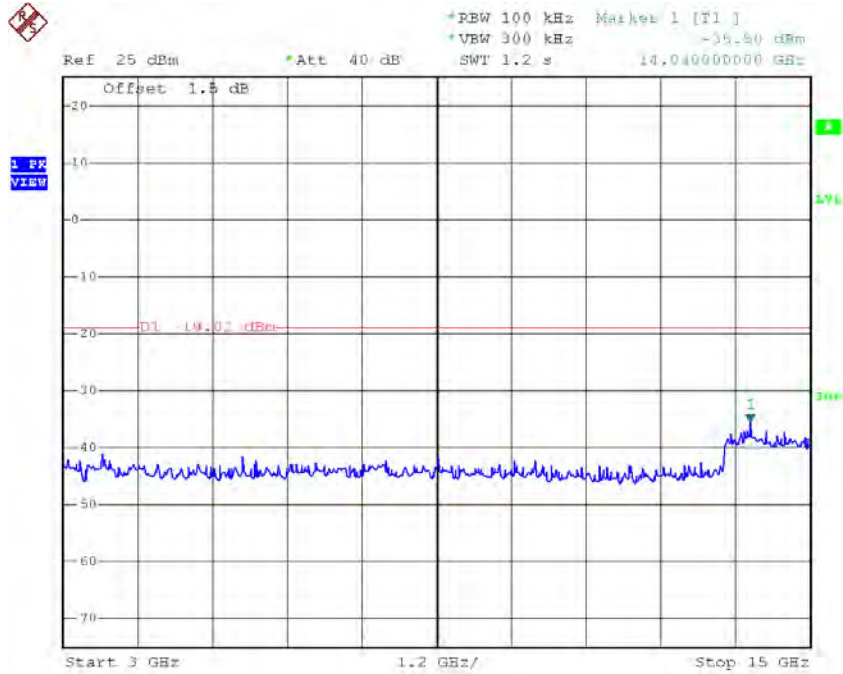

Date: 20,SEP.2016 20:04:30

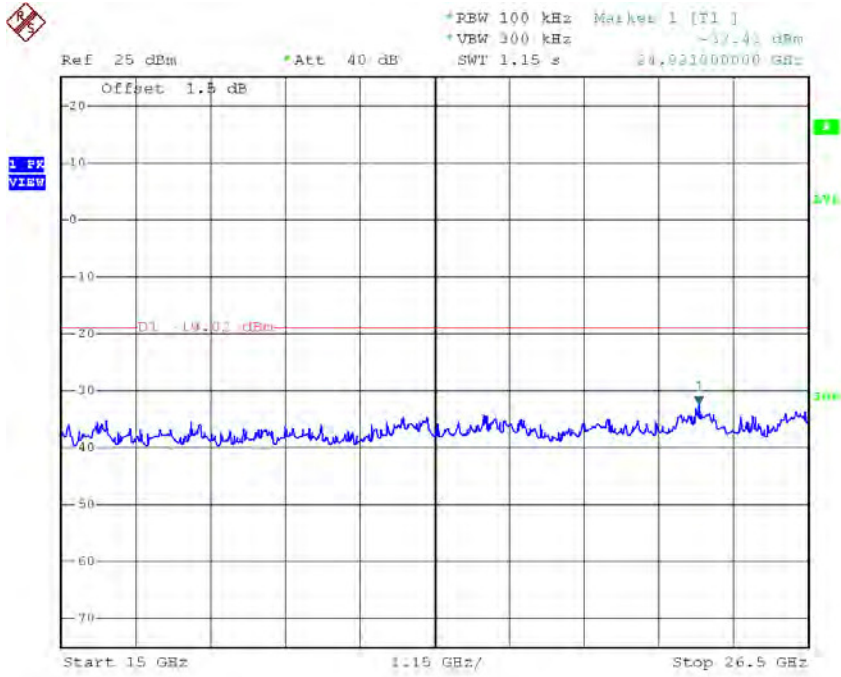

Date: 20,SEP,2016 20:04:38

TX B mode CH06 (10 Harmonic of the frequency)

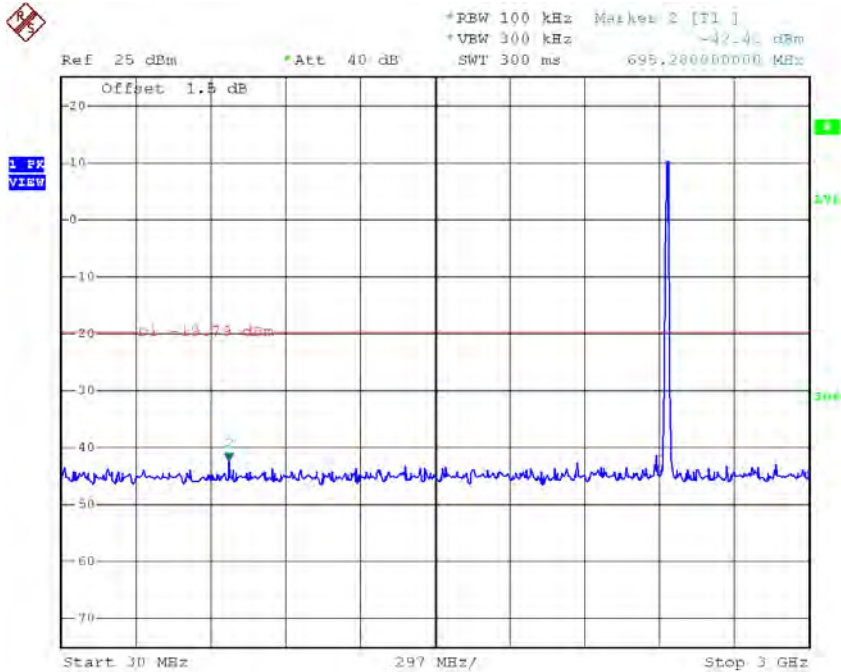

Date: 20,SEP,2016 20:05:52

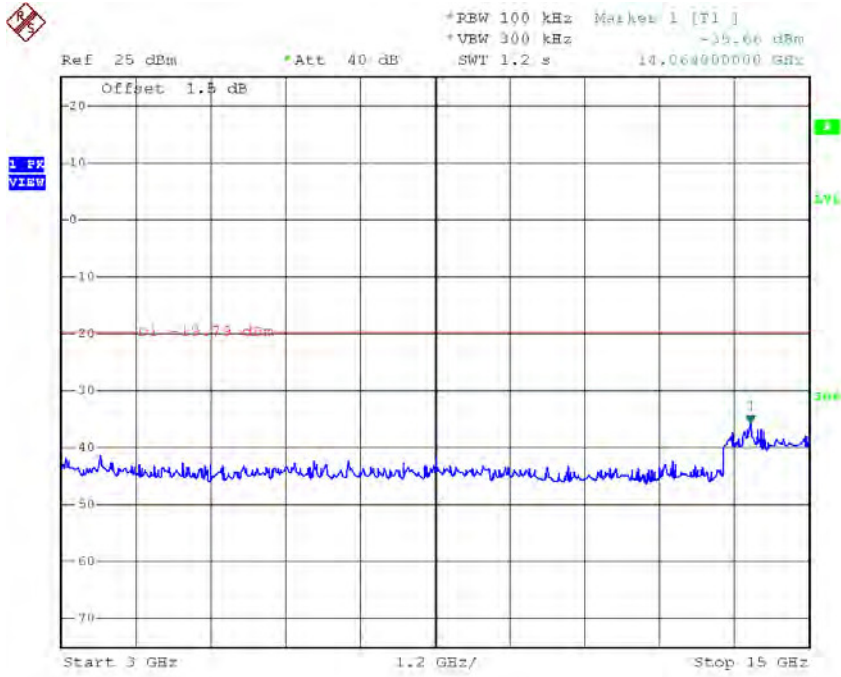

Date: 20.SEP.2016 20:06:00

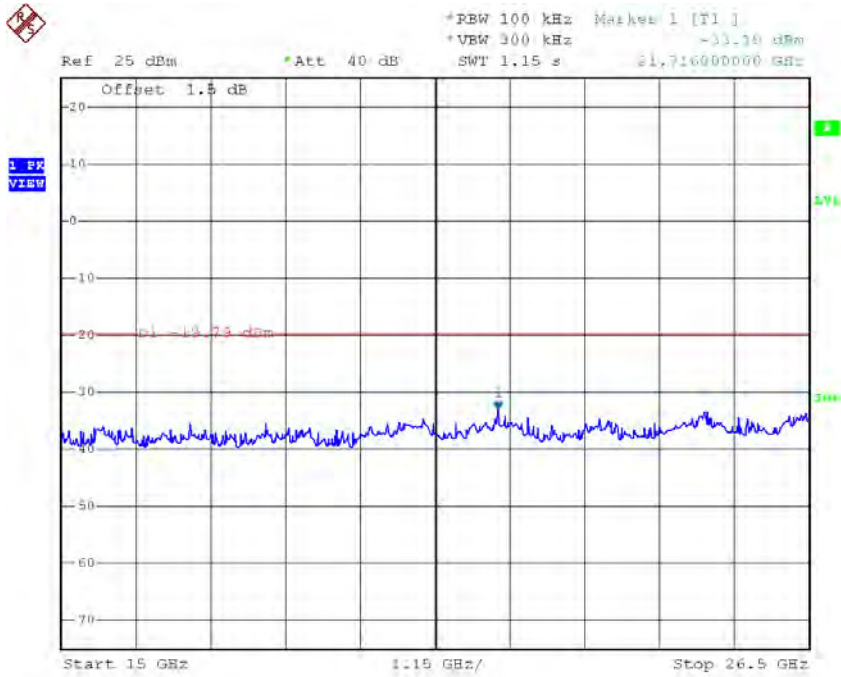

Date: 20.SEP.2016 20:06:09

TX B mode CH11 (10 Harmonic of the frequency)

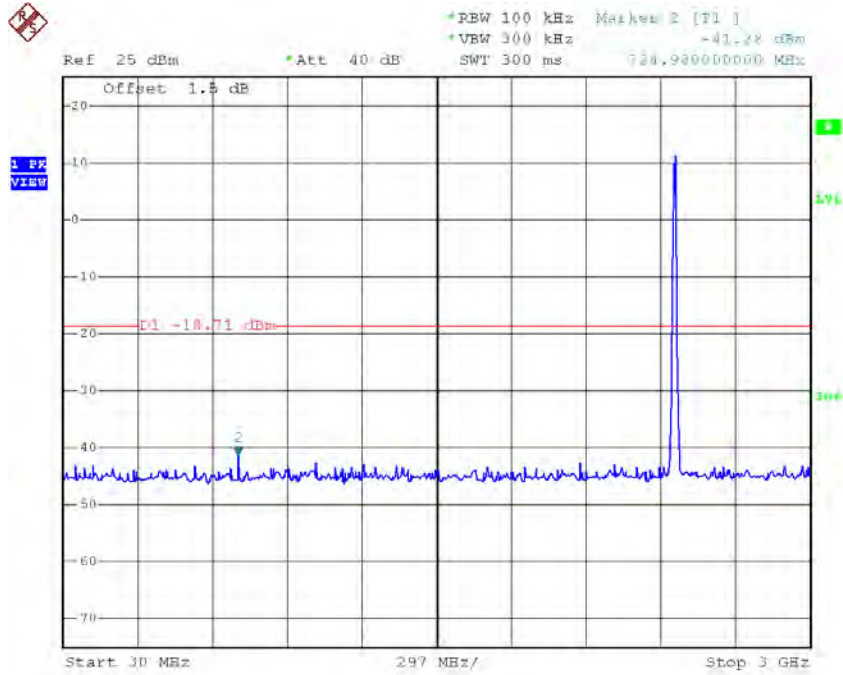

Date: 20,SEP.2016 20:07:29

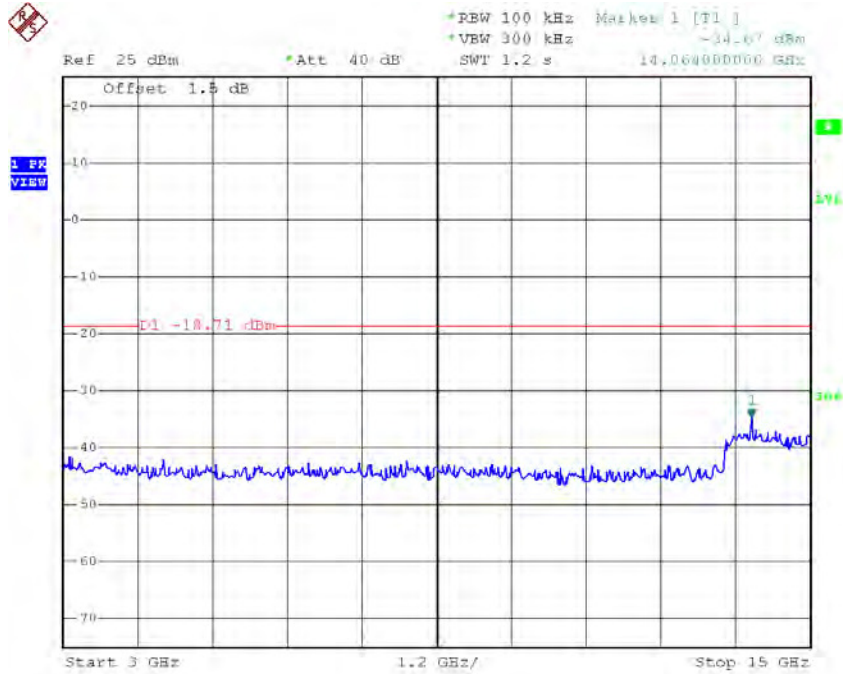

Date: 20,SEP.2016 20:07:37

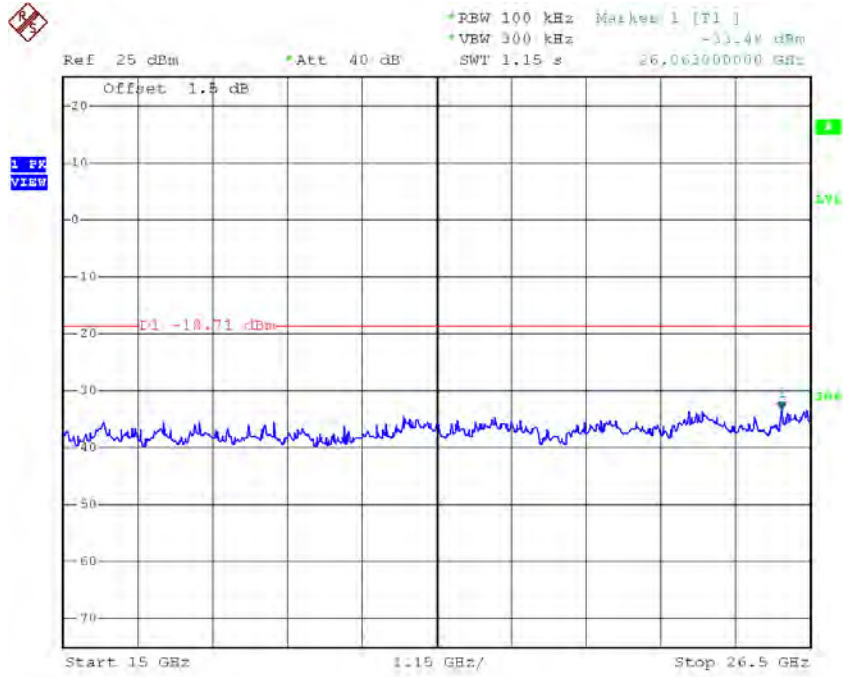

Date: 20.SEP.2016 20:07:46

Test Mode : TX G Mode

TX G mode CH01

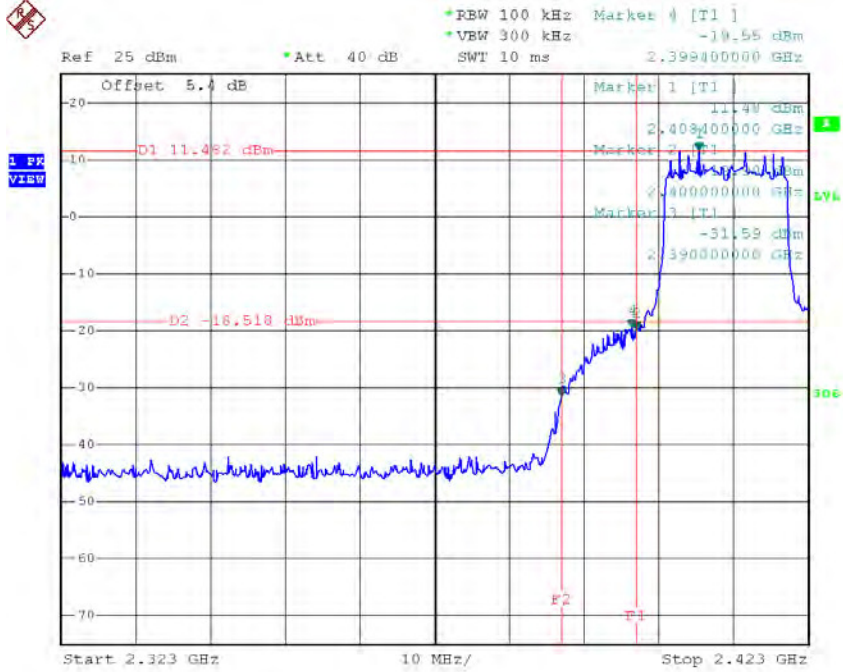

Date: 20.SEP.2016 20:10:29

TX G mode CH11

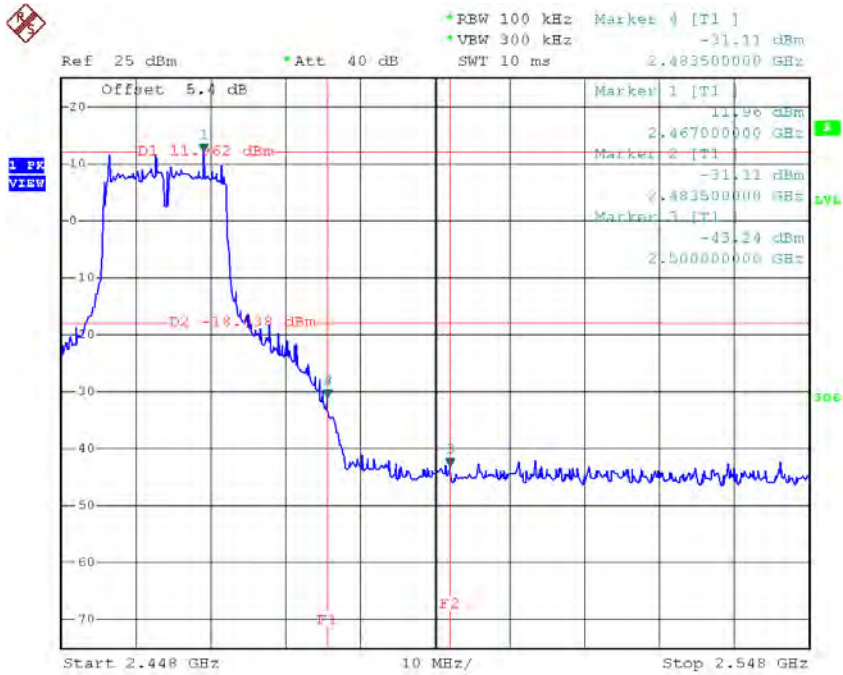

Date: 20.SEP.2016 20:12:43

TX G mode CH01 (10 Harmonic of the frequency)

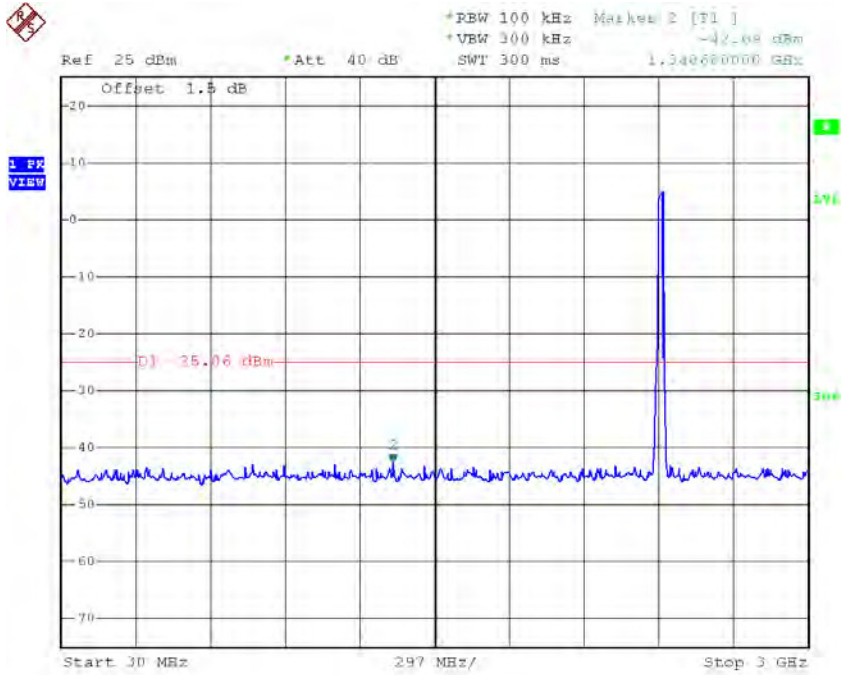

Date: 20,SEP.2016 20:10:04

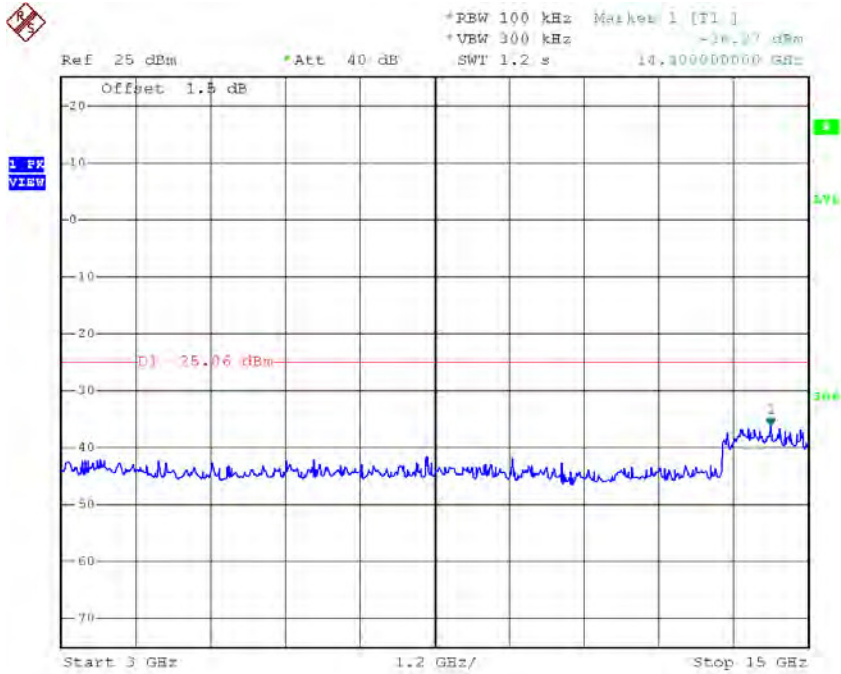

Date: 20,SEP.2016 20:10:13

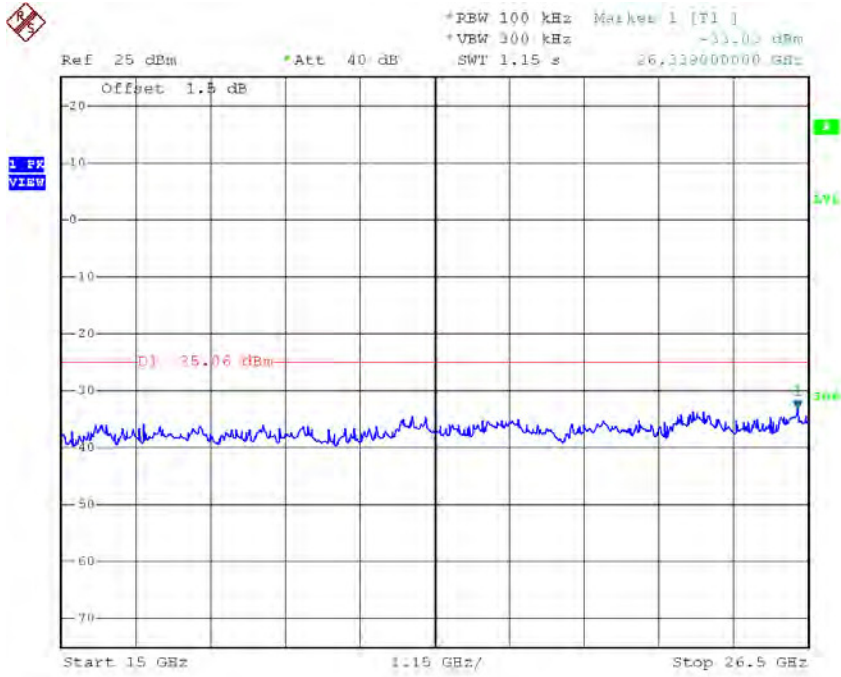

Date: 20,SEP,2016 20:10:21

TX G mode CH06 (10 Harmonic of the frequency)

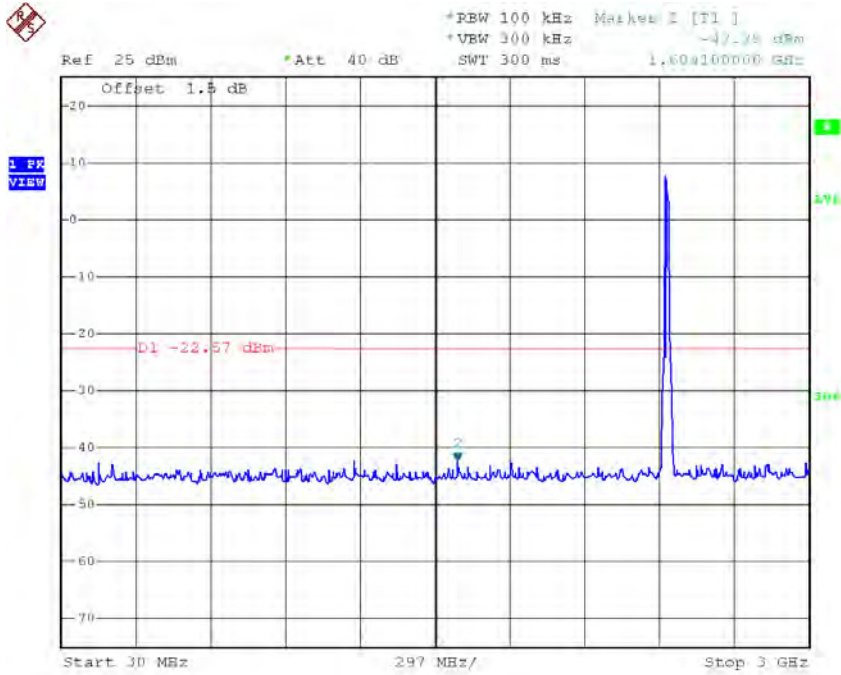

Date: 20,SEP,2016 20:11:17

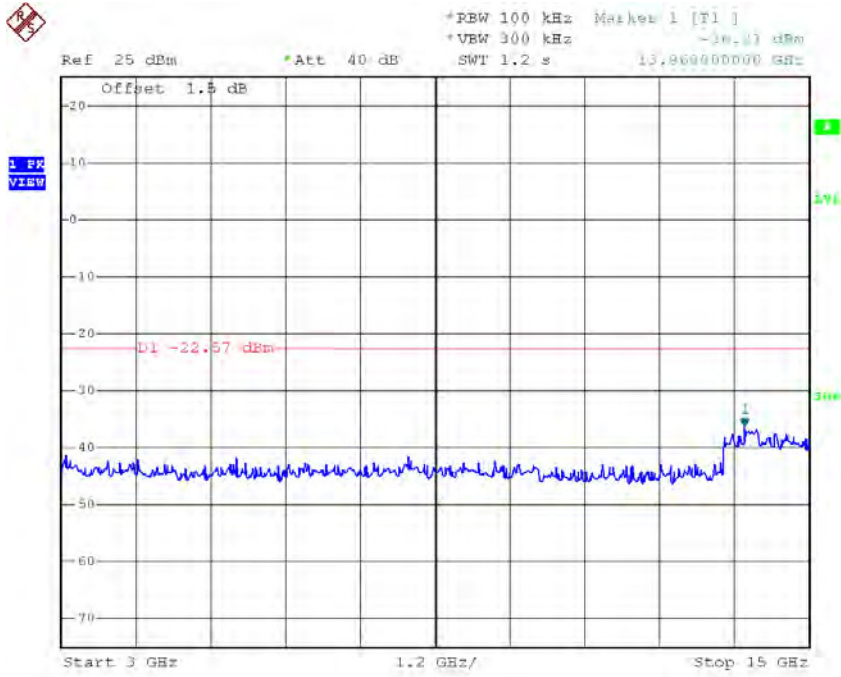

Date: 20.SEP.2016 20:11:25

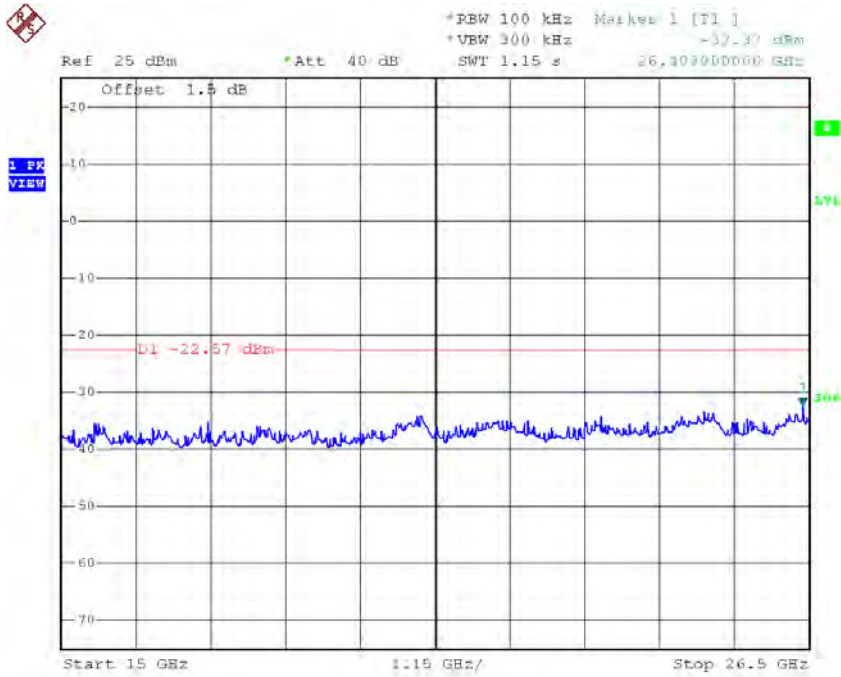

Date: 20.SEP.2016 20:11:34

TX G mode CH11 (10 Harmonic of the frequency)

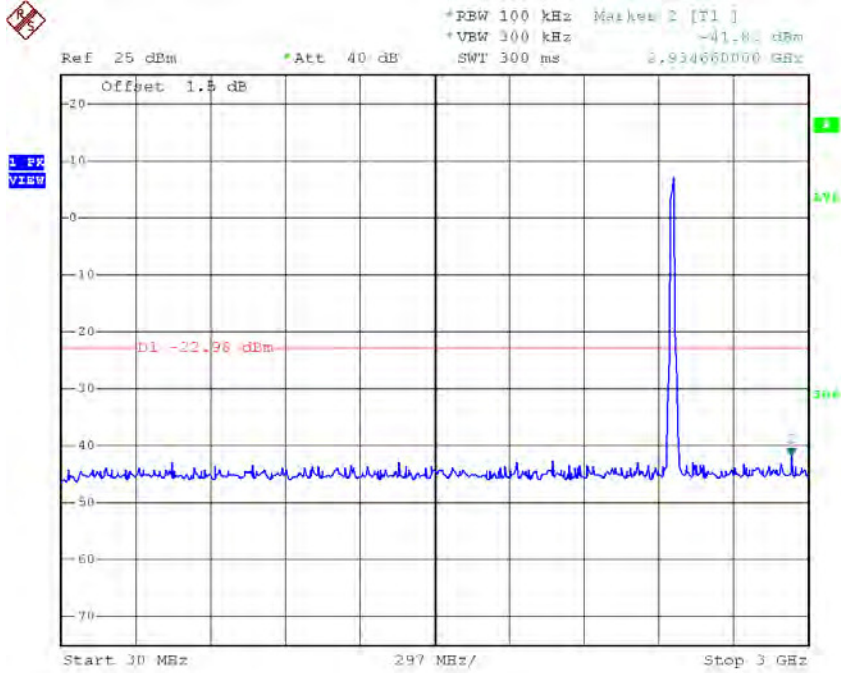

Date: 20.SEP.2016 20:12:18

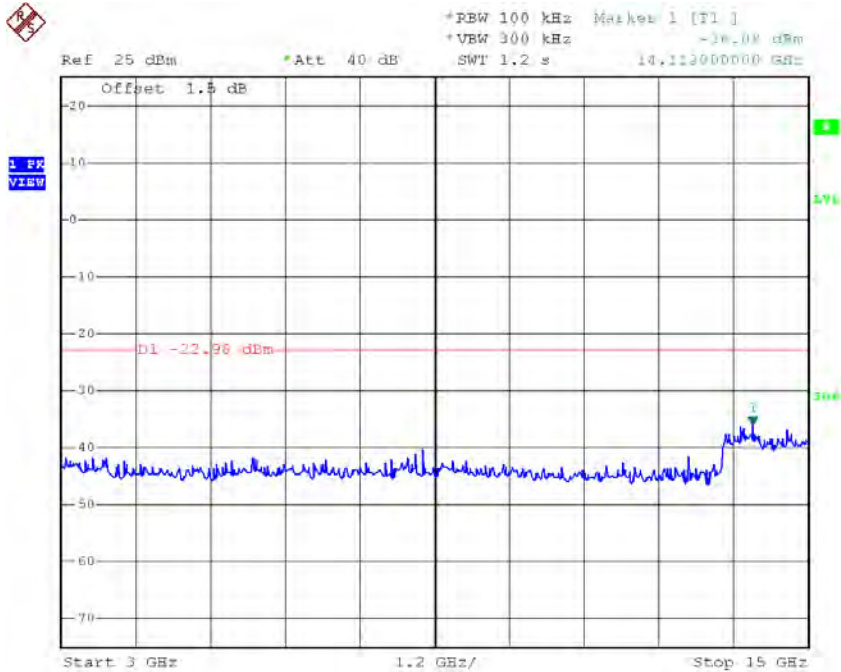

Date: 20.SEP.2016 20:12:27

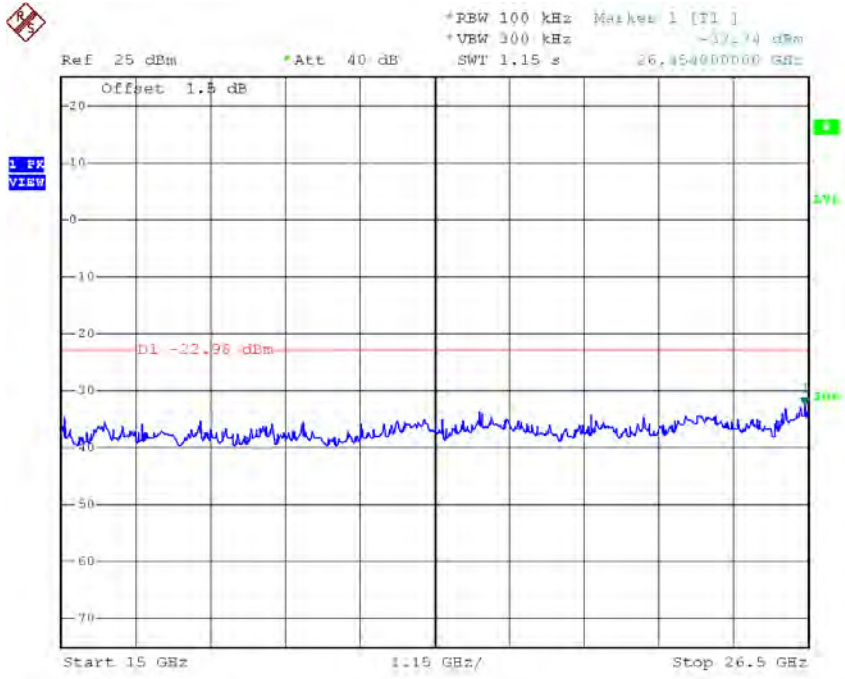

Date: 20.SEP.2016 20:12:35

Test Mode : TX N-20M Mode

TX HT20 mode CH01

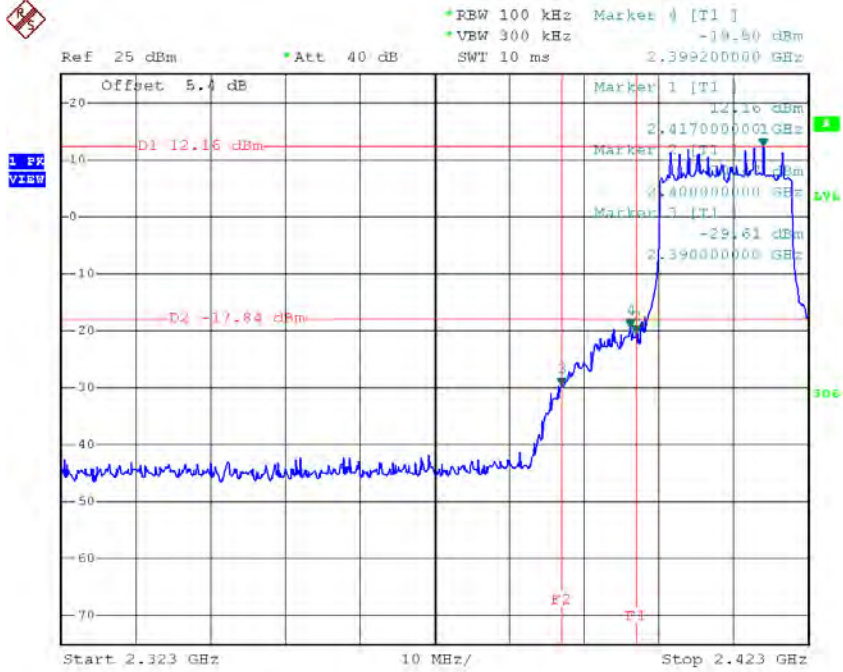

Date: 20.SEP.2016 20:14:25

TX HT20 mode CH11

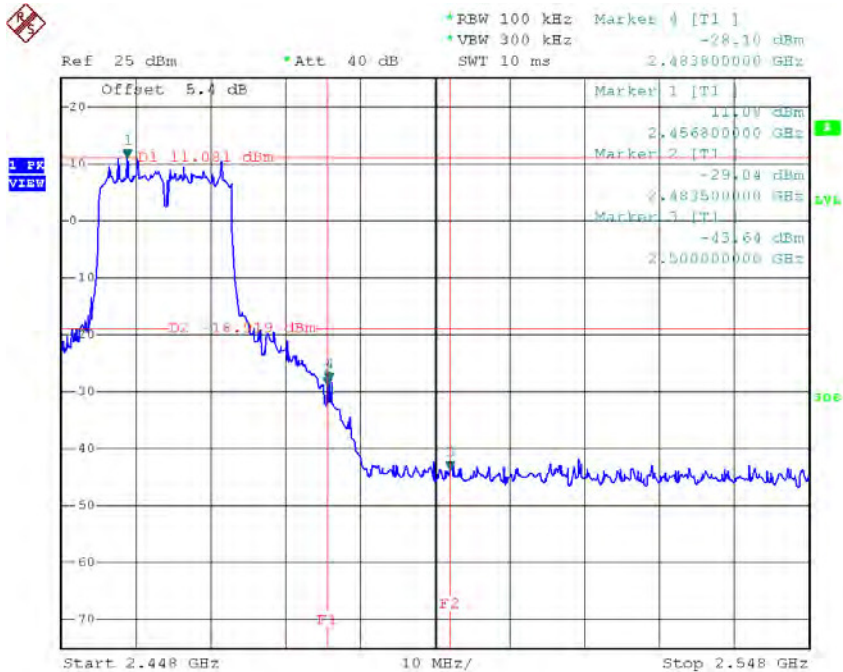

Date: 20.SEP.2016 20:16:28

TX HT20 mode CH01 (10 Harmonic of the frequency)

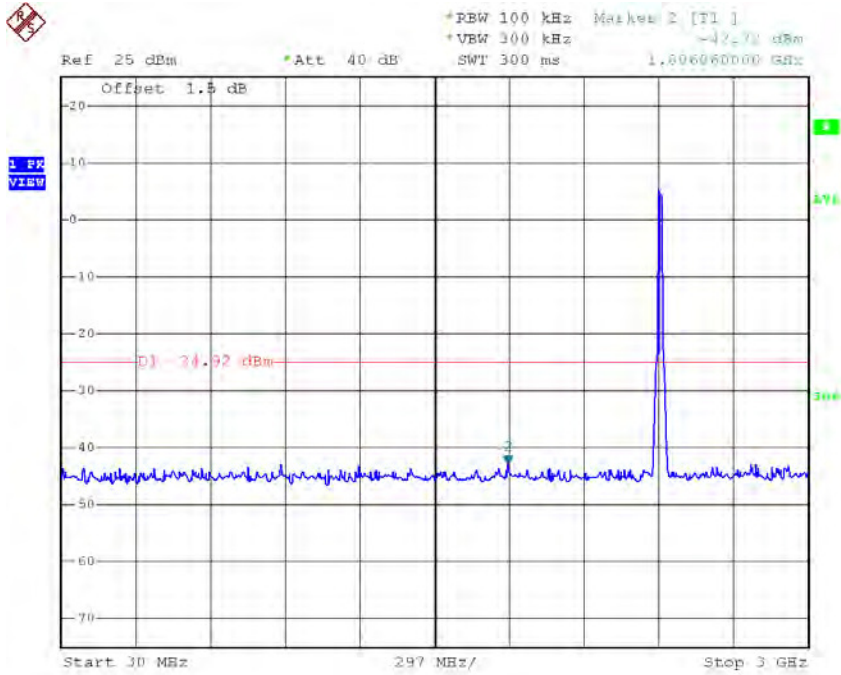

Date: 20,SEP.2016 20:13:31

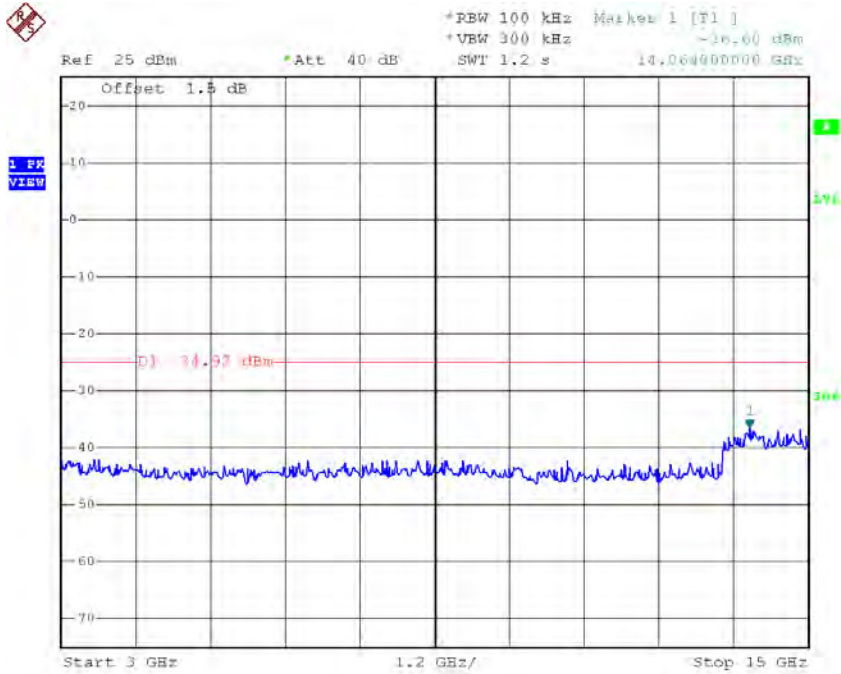

Date: 20,SEP.2016 20:13:40

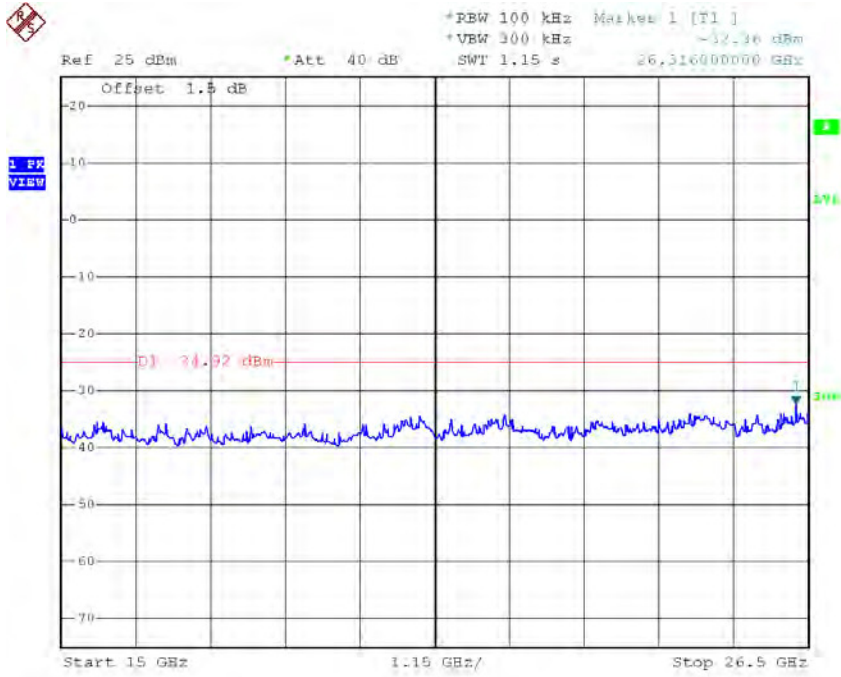

Date: 20,SEP,2016 20:13:48

TX HT20 mode CH06 (10 Harmonic of the frequency)

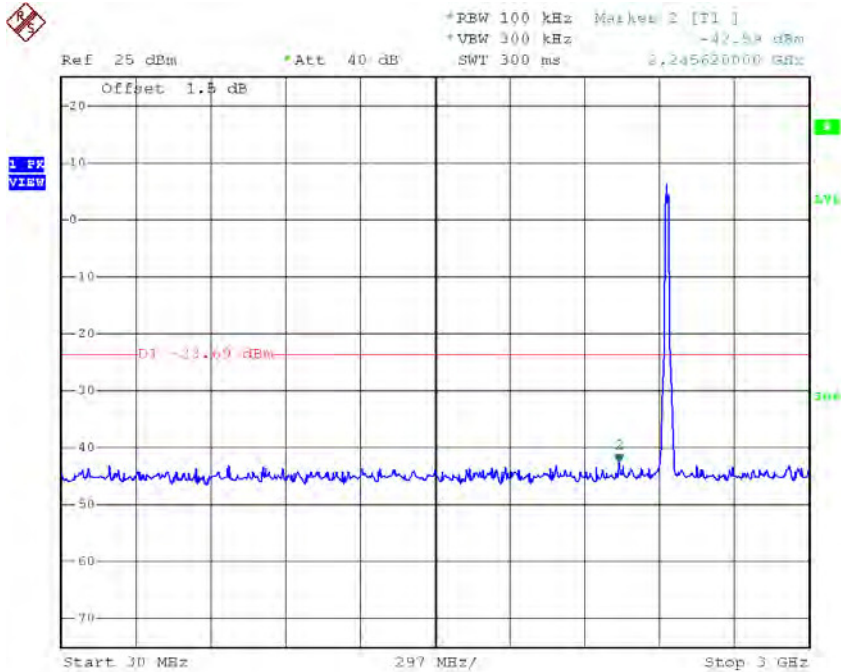

Date: 20,SEP,2016 20:15:06

TX HT20 mode CH11 (10 Harmonic of the frequency)

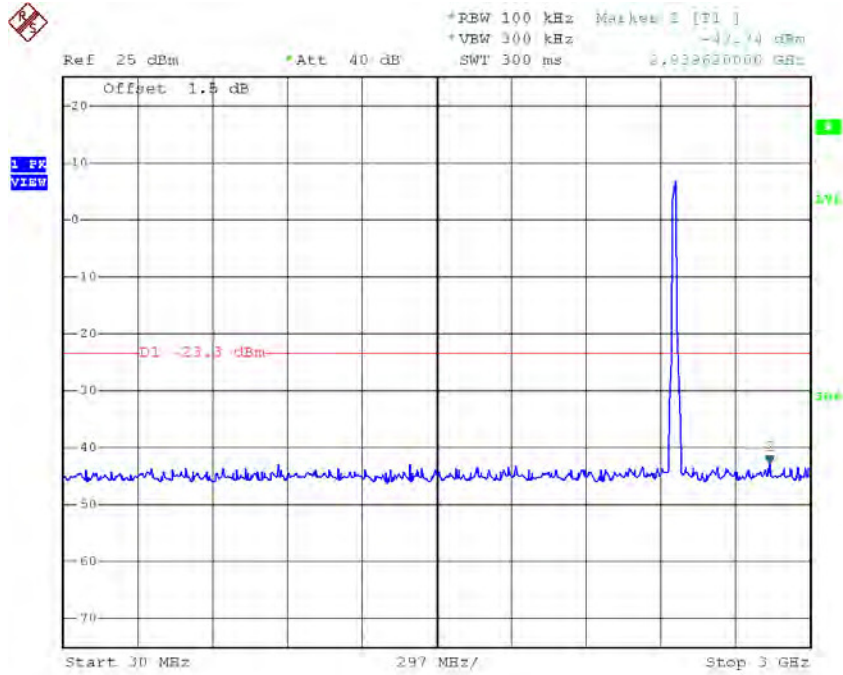

Date: 20.SEP.2016 20:16:04

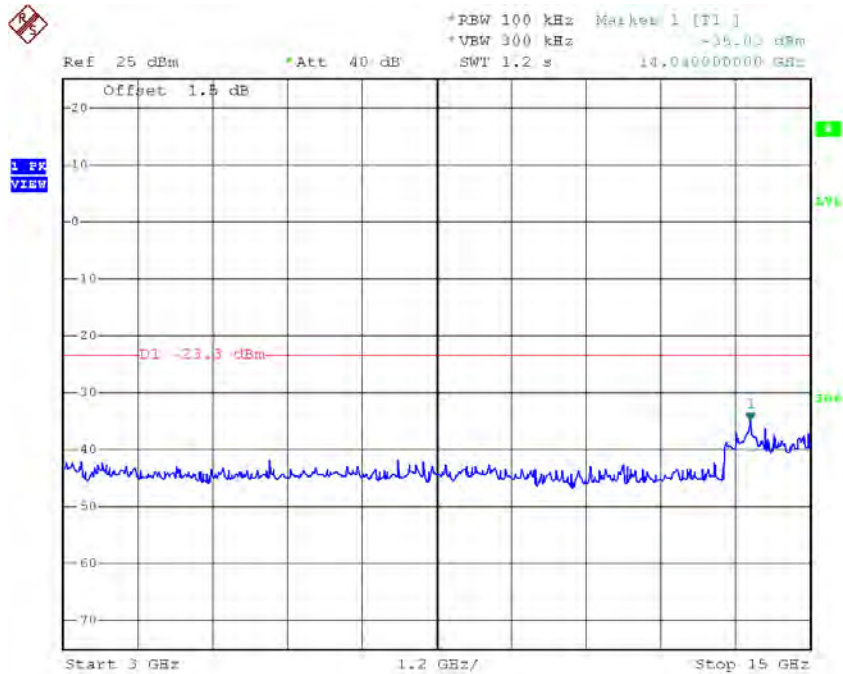

Date: 20.SEP.2016 20:16:12

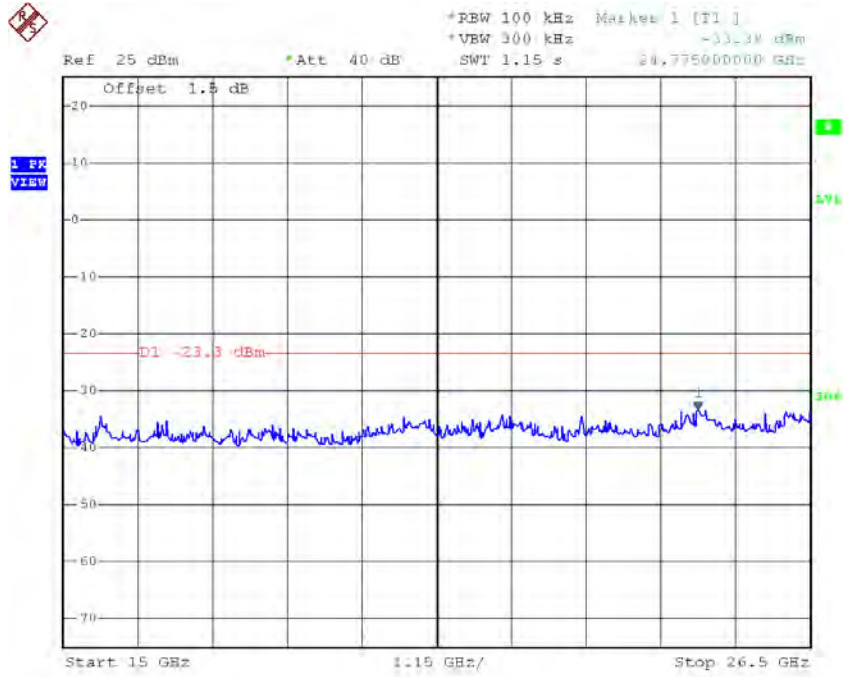

Date: 20.SEP.2016 20:16:20

Test Mode : TX N-40M Mode

TX HT40 mode CH03

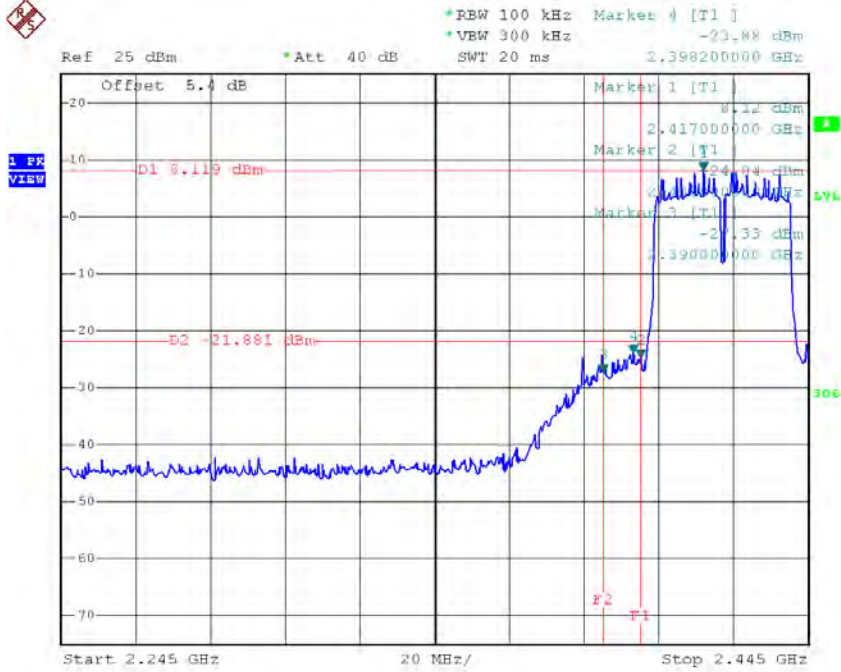

Date: 20.SEP.2016 20:17:38

TX HT40 mode CH09

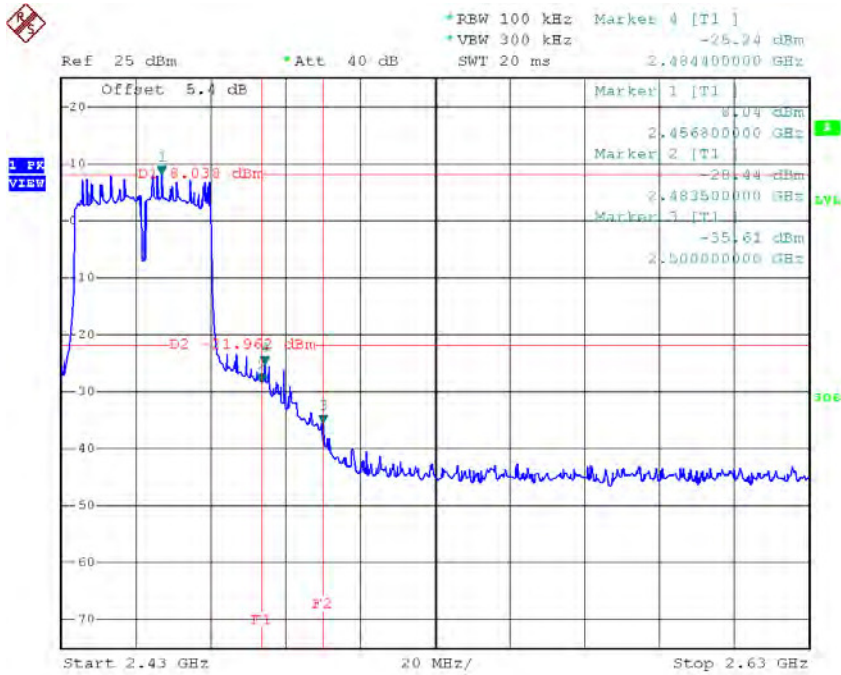

Date: 20.SEP.2016 20:19:49

TX HT40 mode CH03 (10 Harmonic of the frequency)

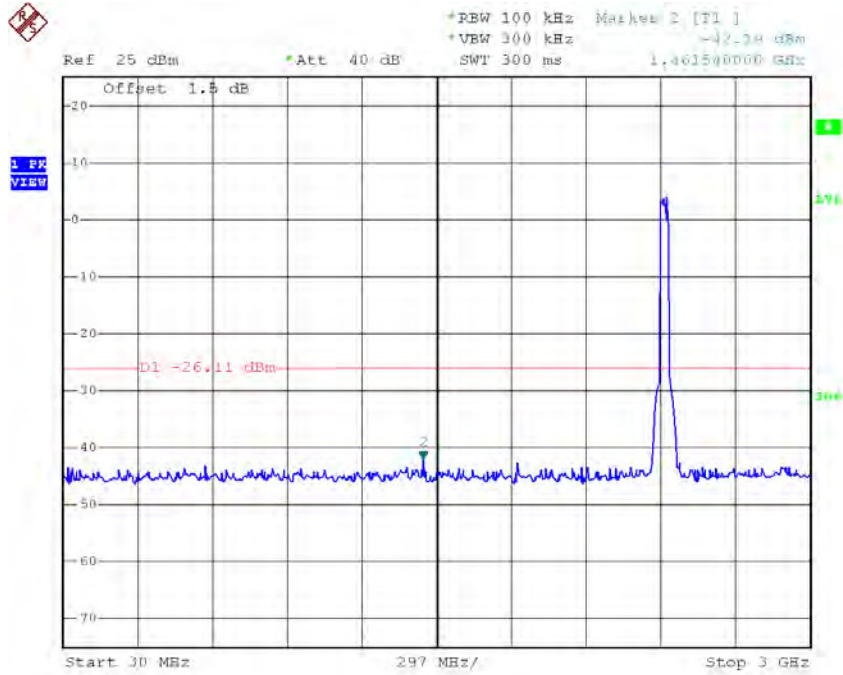

Date: 20,SEP.2016 20:17:14

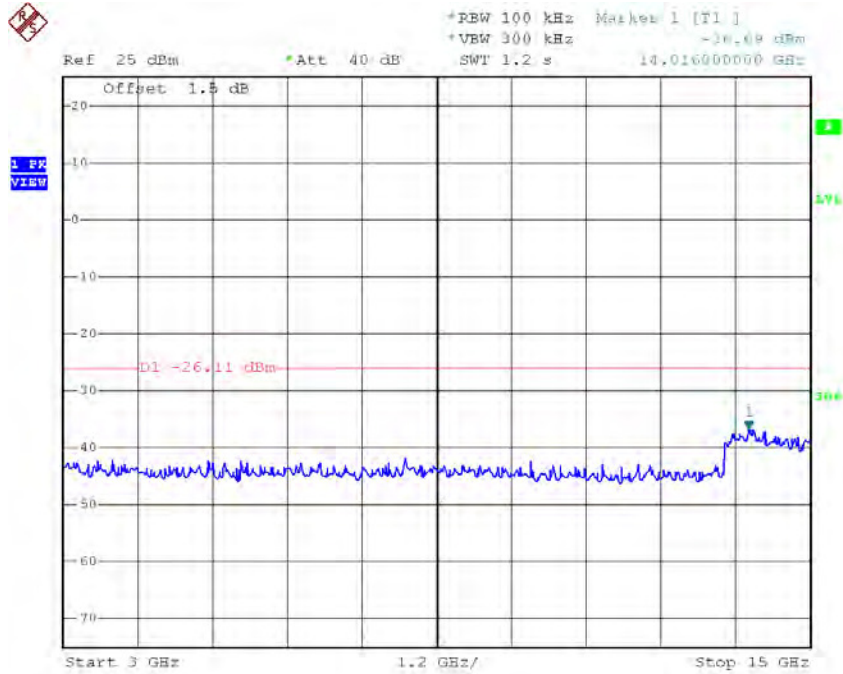

Date: 20,SEP.2016 20:17:22

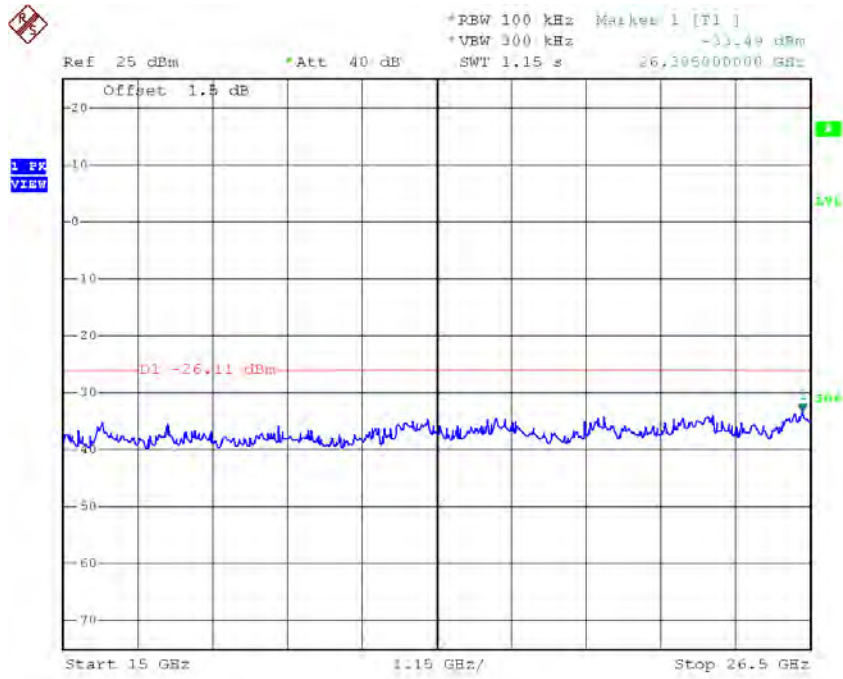

Date: 20.SEP.2016 20:17:31

TX HT40 mode CH06 (10 Harmonic of the frequency)

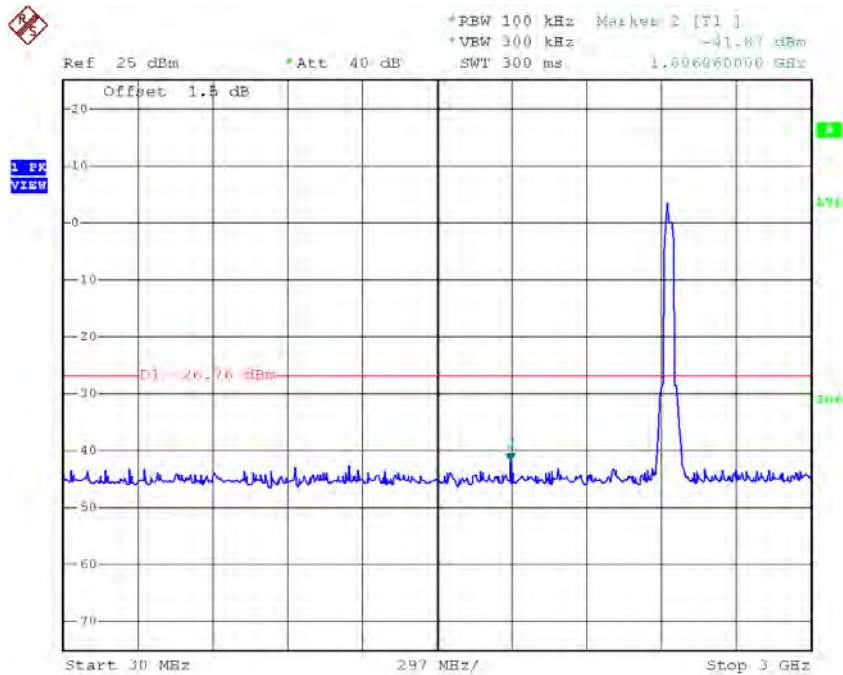

Date: 20.SEP.2016 20:18:23

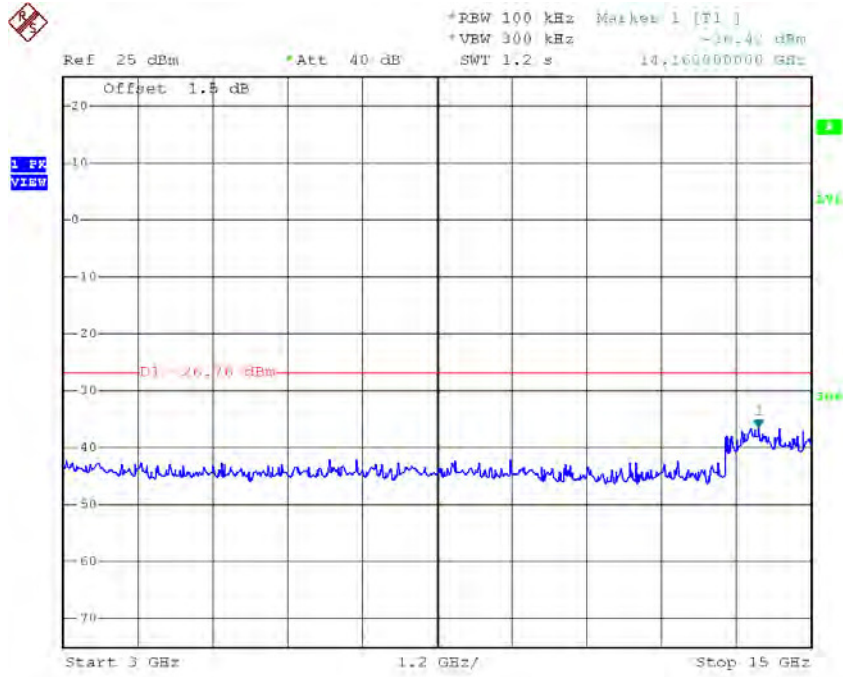

Date: 20.SEP.2016 20:18:31

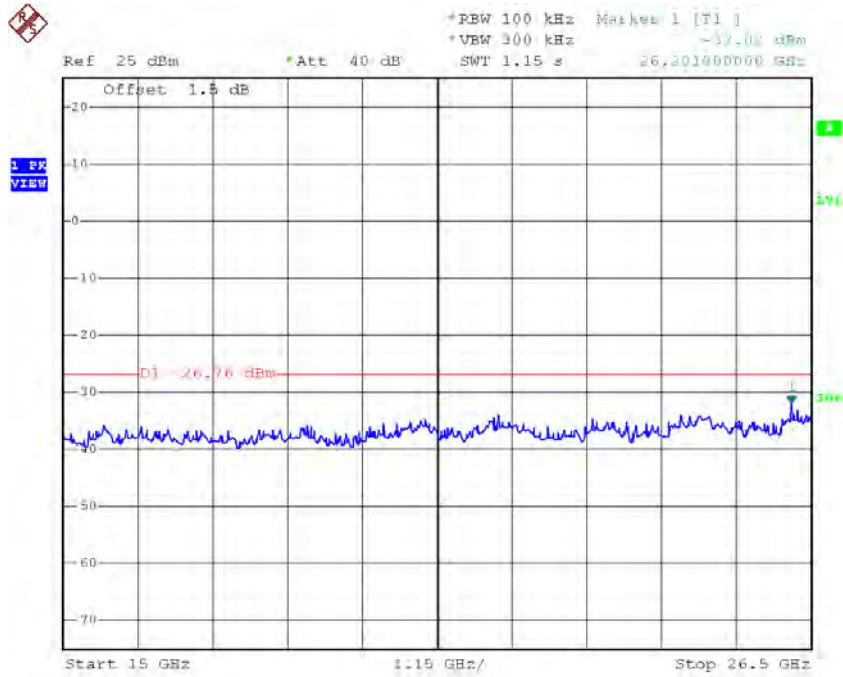

Date: 20.SEP.2016 20:18:40

TX HT40 mode CH09 (10 Harmonic of the frequency)

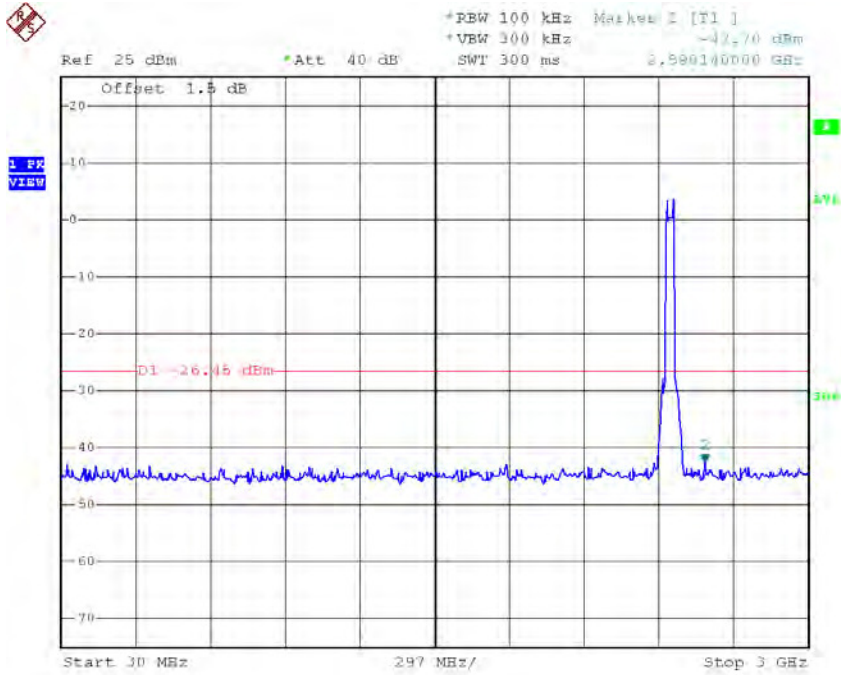

Date: 20.SEP.2016 20:19:24

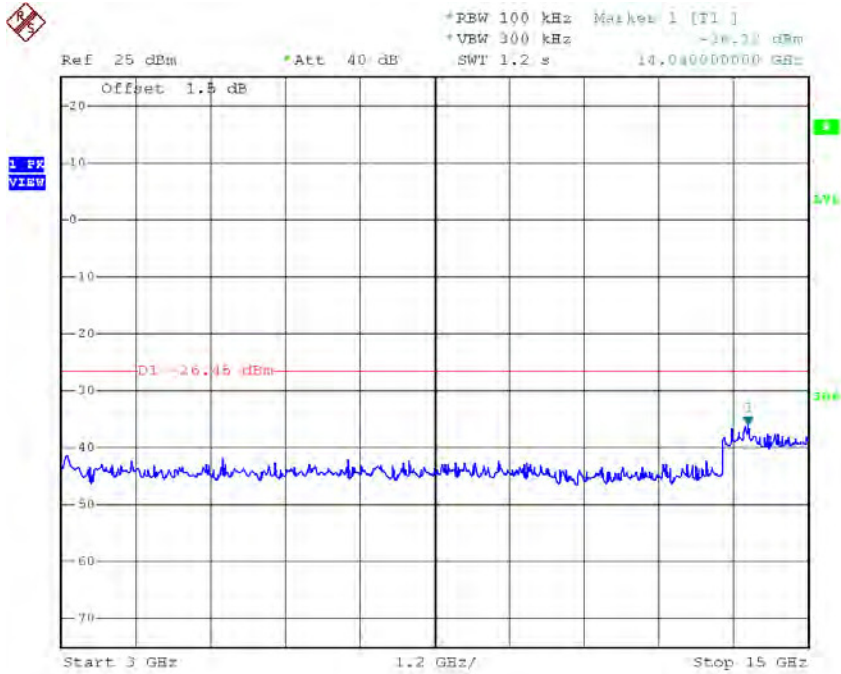

Date: 20.SEP.2016 20:19:33

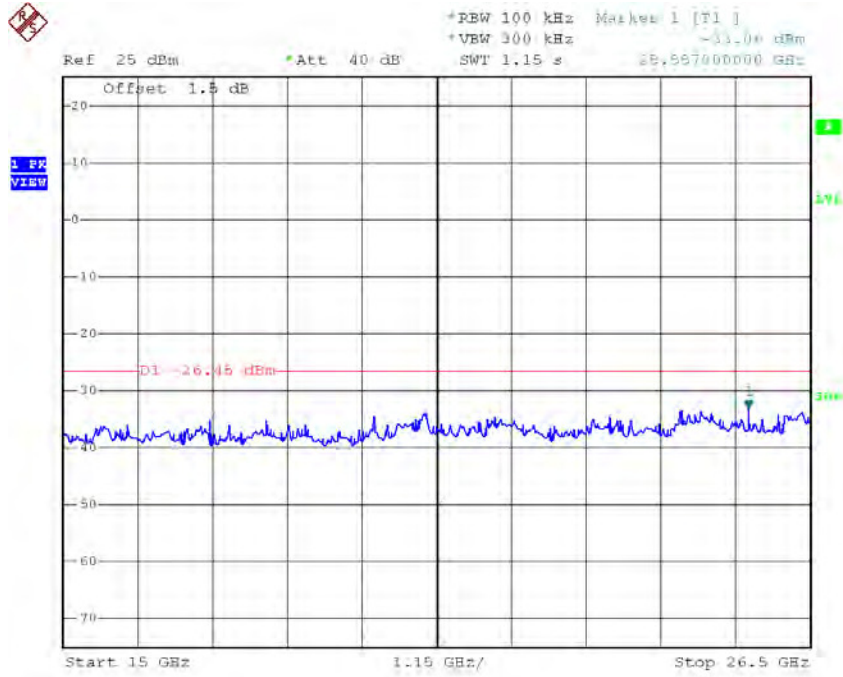

Date: 20.SEP.2016 20:19:41

For 2X Non-Beamforming

Test Mode : TX B Mode_ANT 1

TX B mode CH01

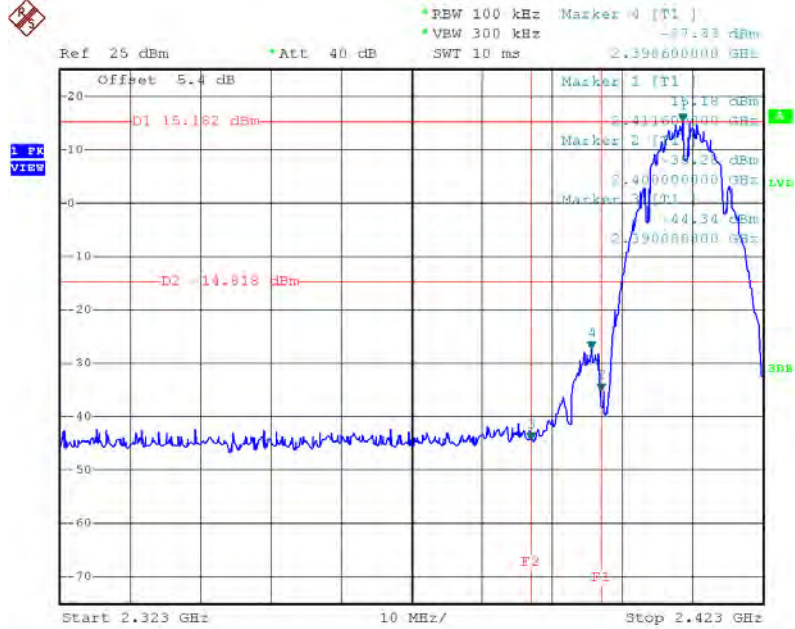

Date: 20.SEP.2016 20:30:35

TX B mode CH11

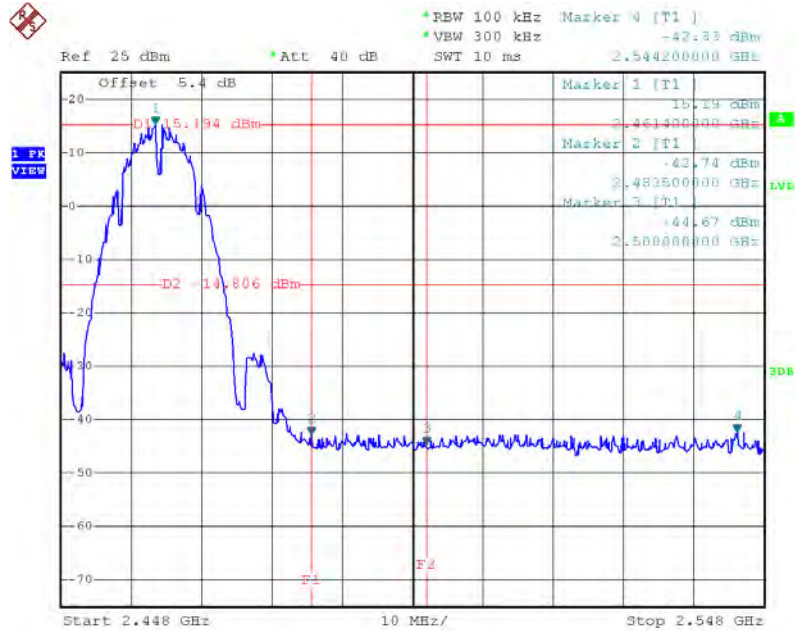

Date: 20.SEP.2016 20:33:40

TX B mode CH01 (10 Harmonic of the frequency)

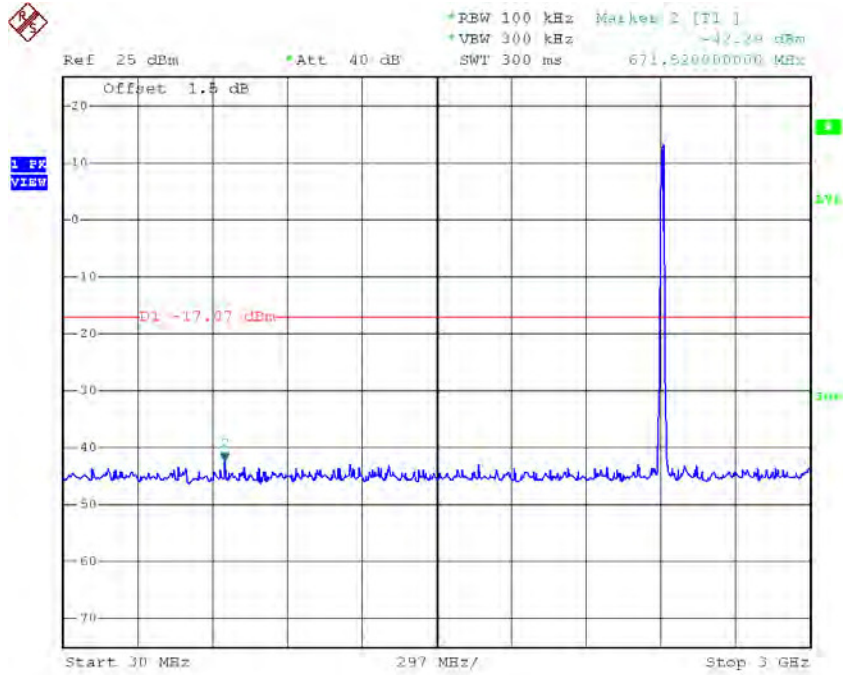

Date: 20,SEP.2016 20:30:10

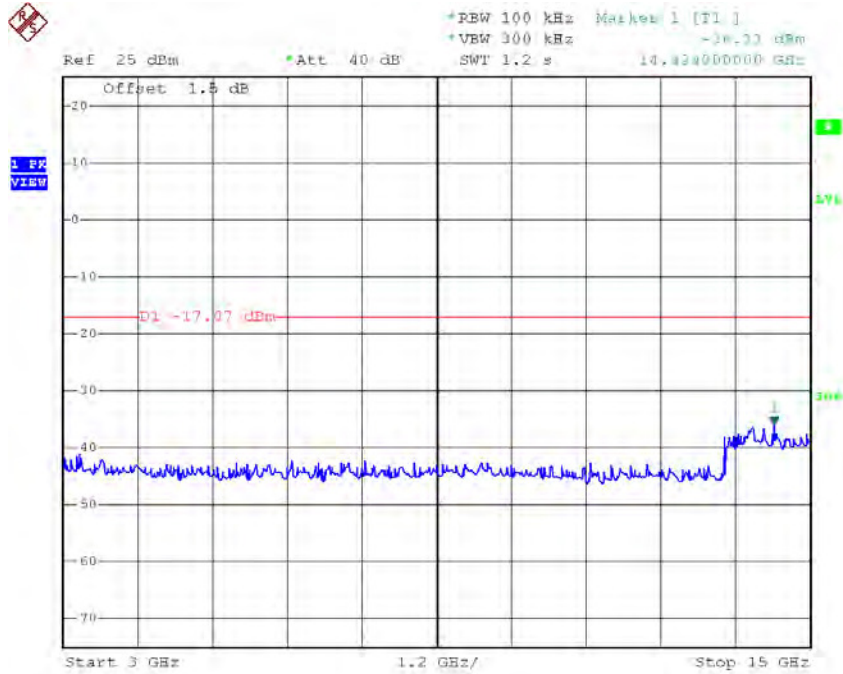

Date: 20,SEP.2016 20:30:18

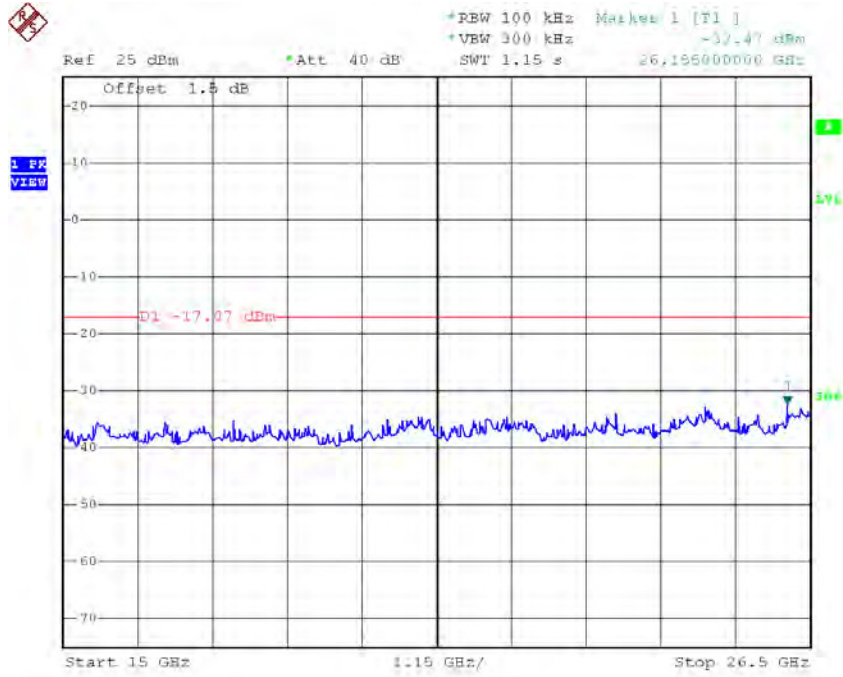

Date: 20,SEP,2016 20:30:27

TX B mode CH06 (10 Harmonic of the frequency)

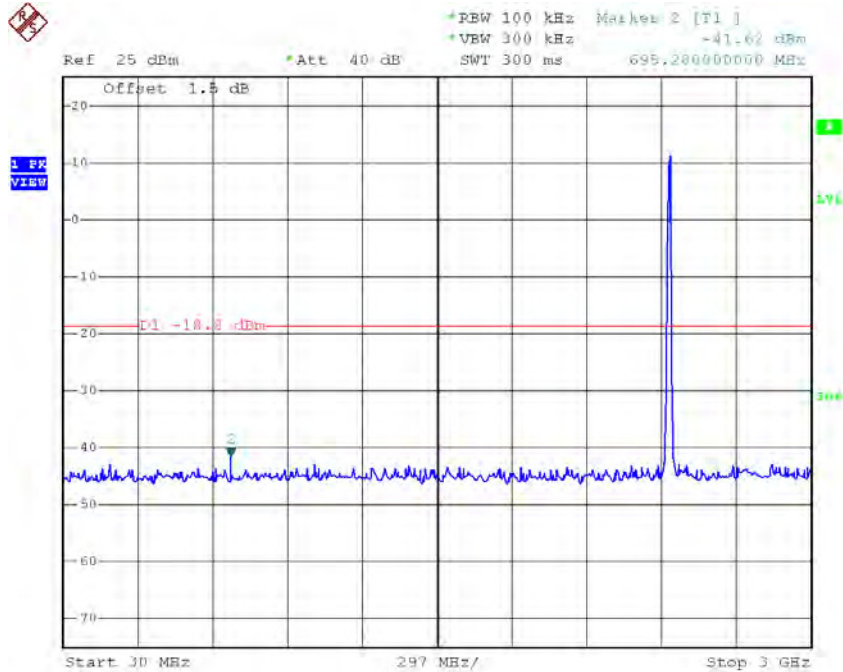

Date: 20,SEP,2016 20:31:54

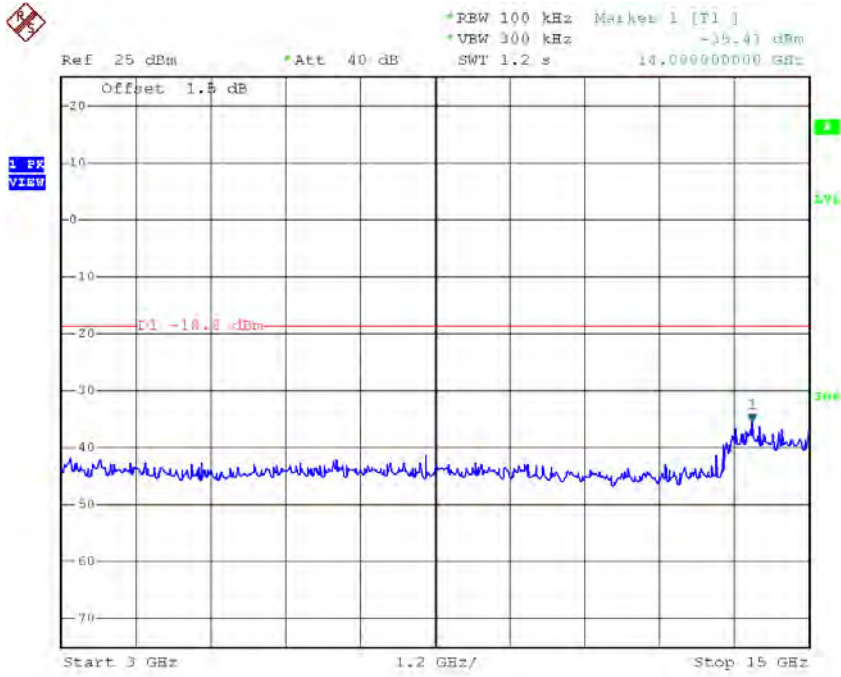

Date: 20.SEP.2016 20:32:02

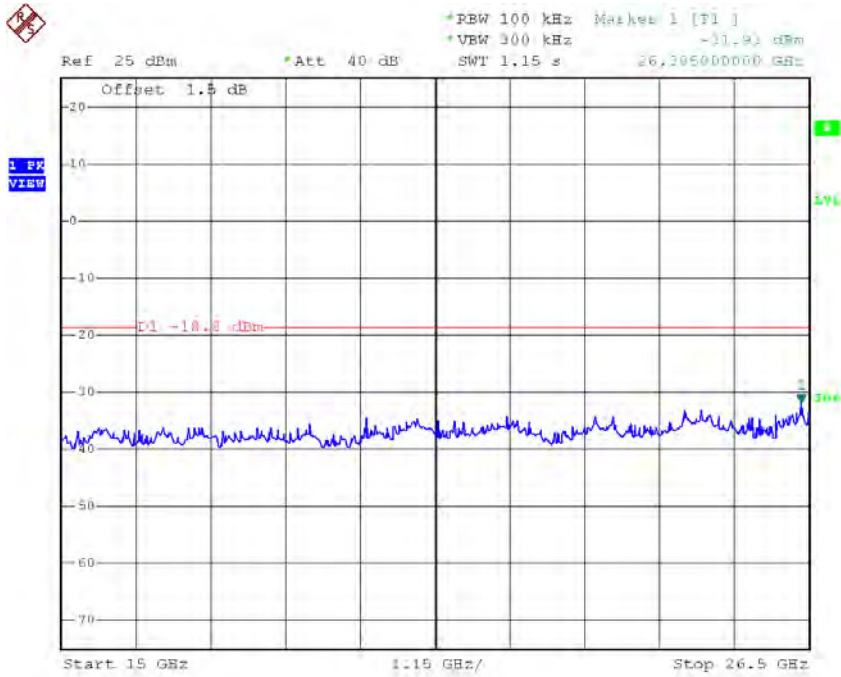

Date: 20.SEP.2016 20:32:11

TX B mode CH11 (10 Harmonic of the frequency)

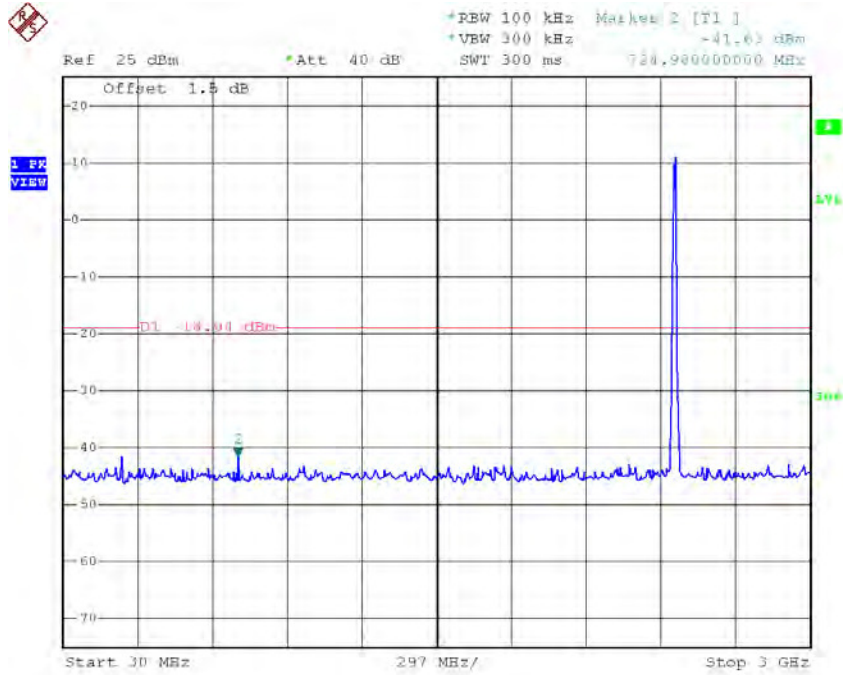

Date: 20,SEP.2016 20:33:16

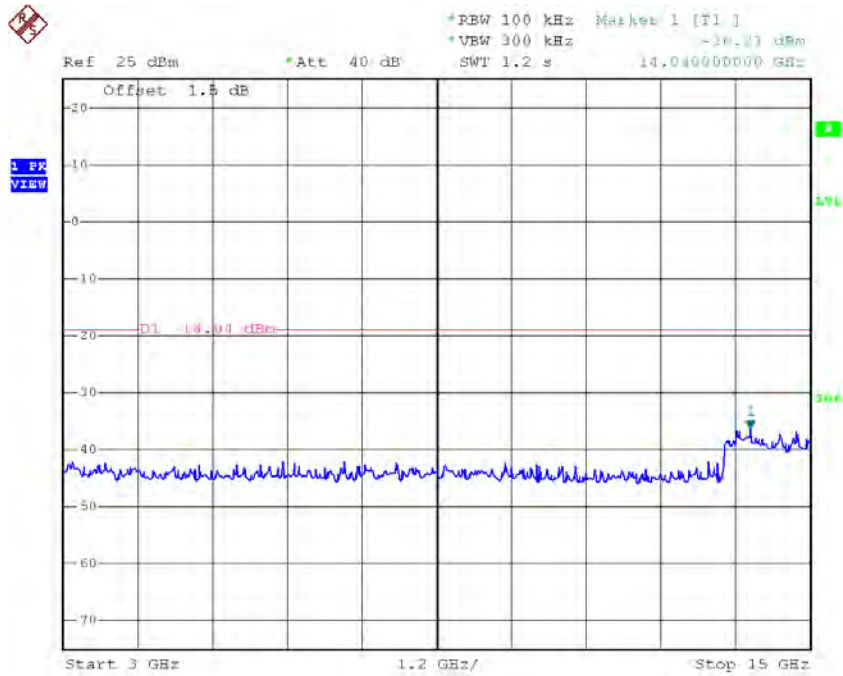

Date: 20,SEP.2016 20:33:24

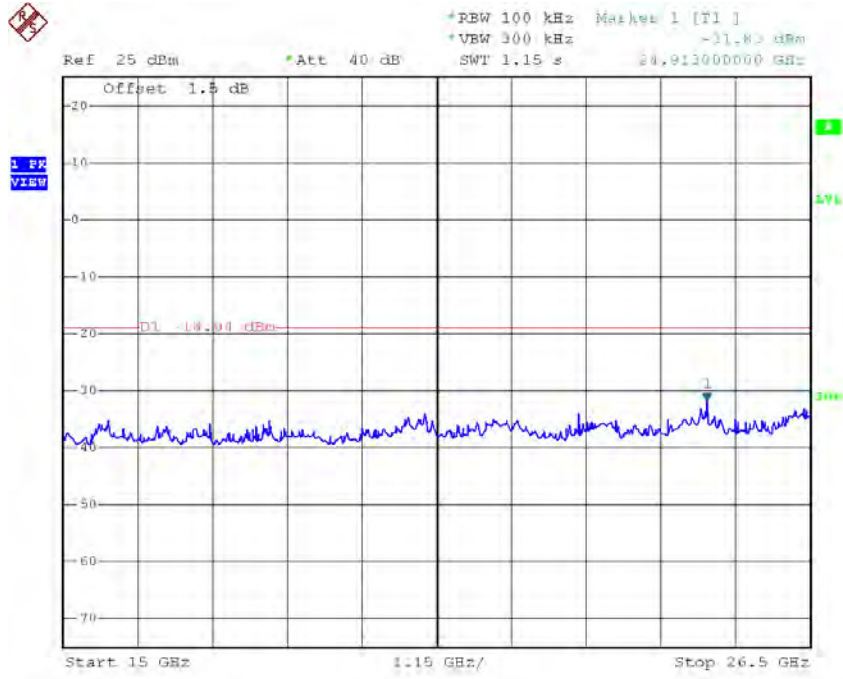

Date: 20.SEP.2016 20:33:32

Test Mode : TX B Mode_ANT 2

TX B mode CH01



Date: 20.SEP.2016 20:48:30

TX B mode CH11

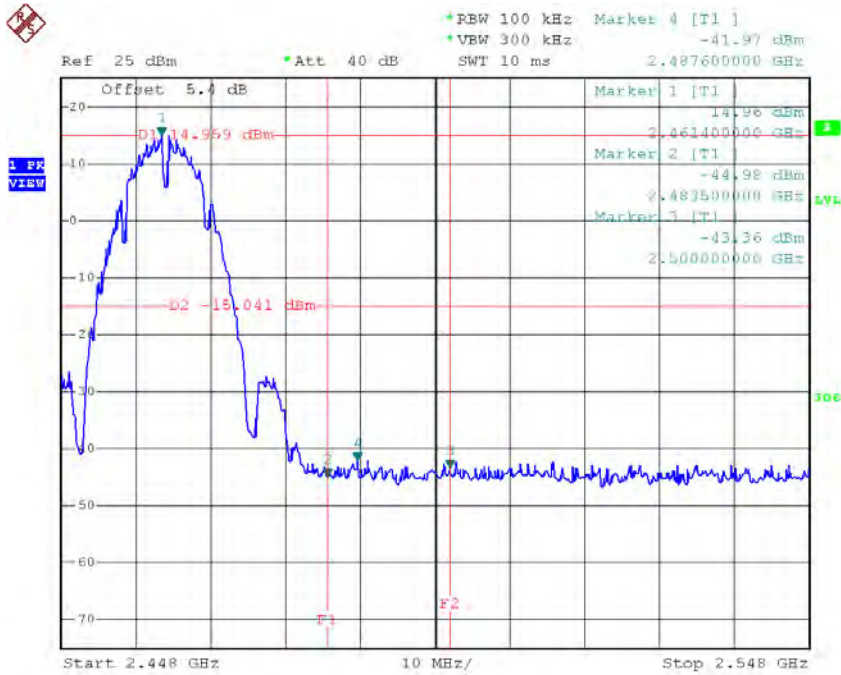

Date: 20.SEP.2016 20:51:30

TX B mode CH01 (10 Harmonic of the frequency)

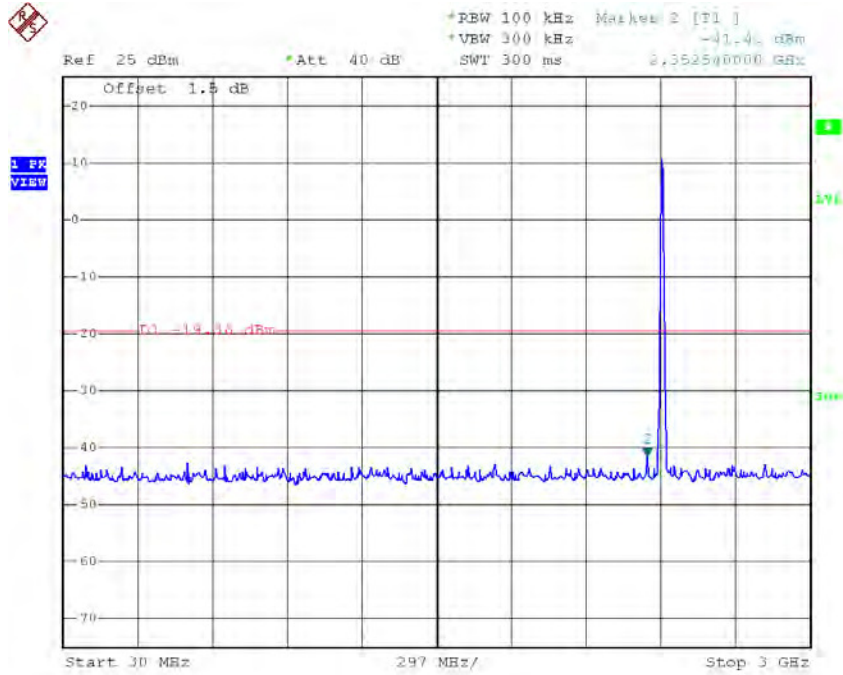

Date: 20,SEP.2016 20:48:05

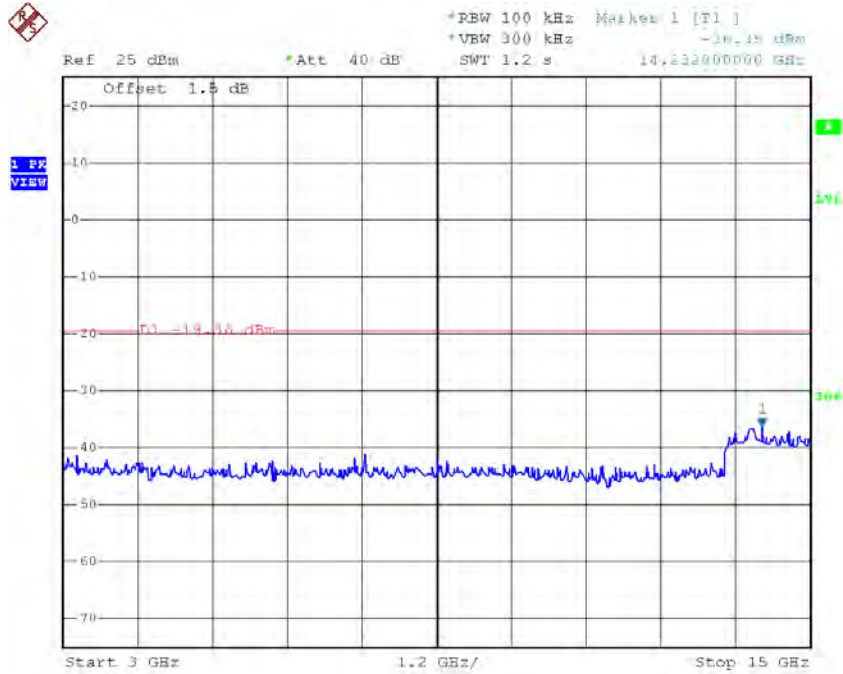

Date: 20,SEP.2016 20:48:14

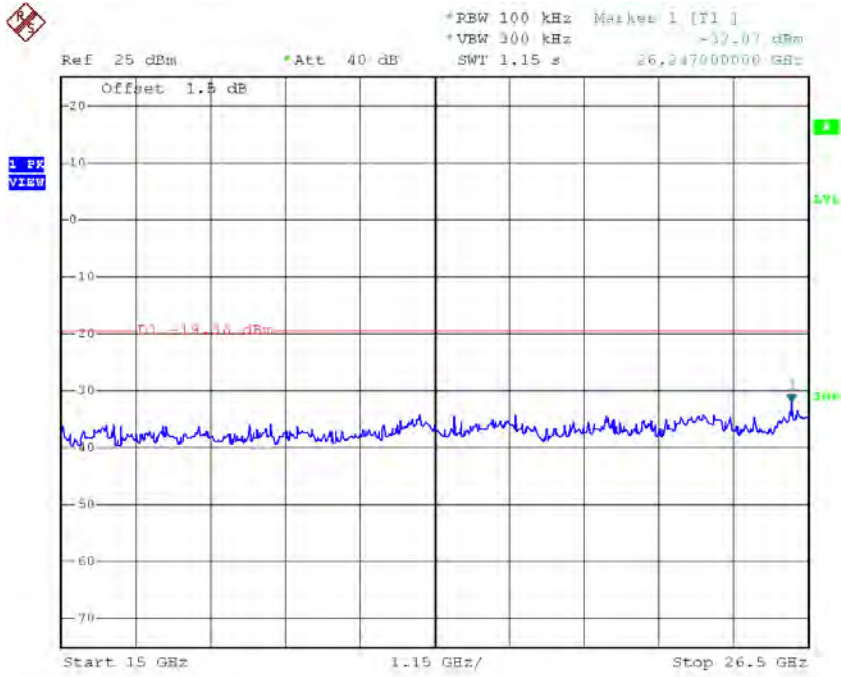

Date: 20,SEP,2016 20:48:22

TX B mode CH06 (10 Harmonic of the frequency)

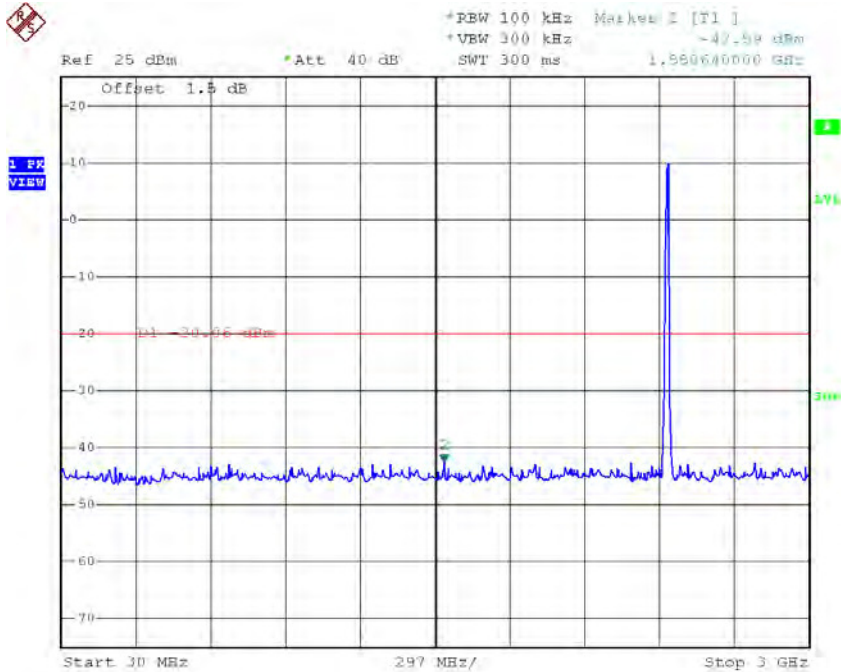

Date: 20,SEP,2016 20:49:44

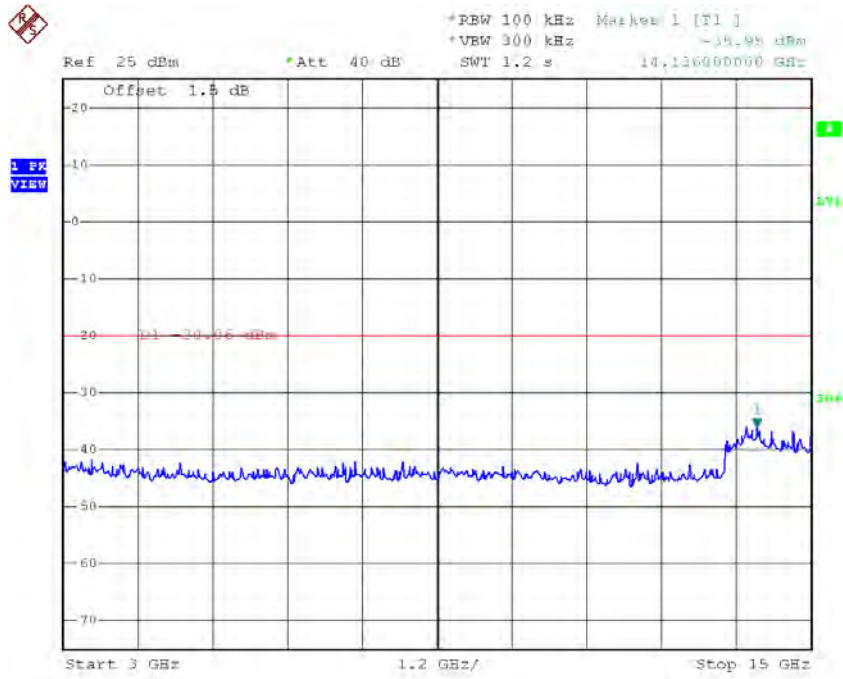

Date: 20.SEP.2016 20:49:53

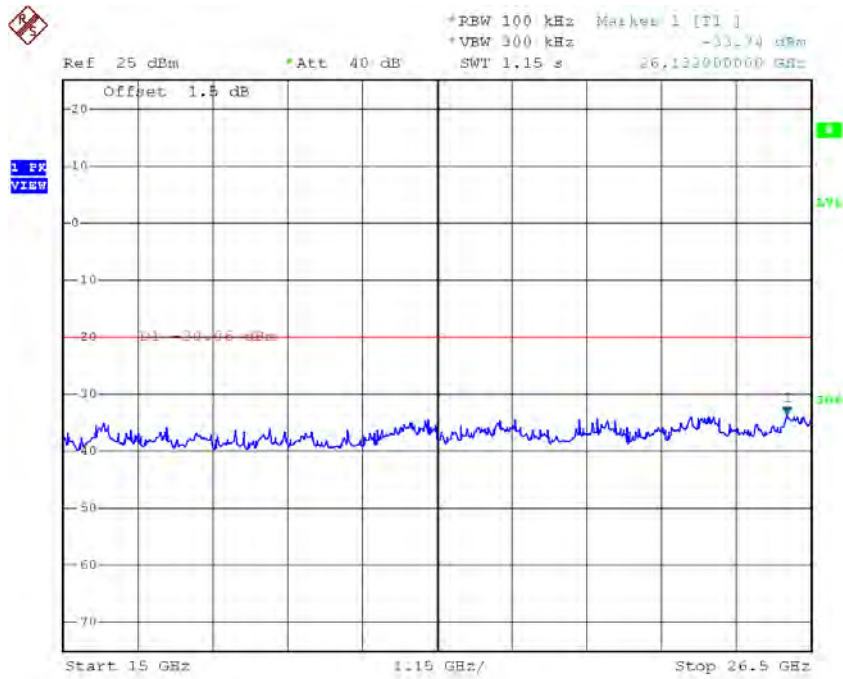

Date: 20.SEP.2016 20:50:01

TX B mode CH11 (10 Harmonic of the frequency)

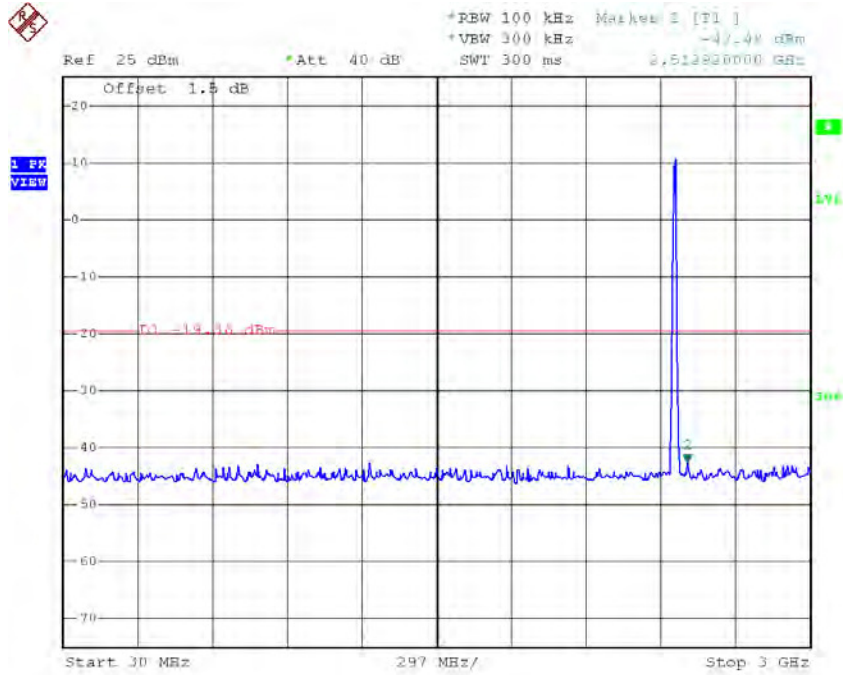

Date: 20,SEP.2016 20:51:06

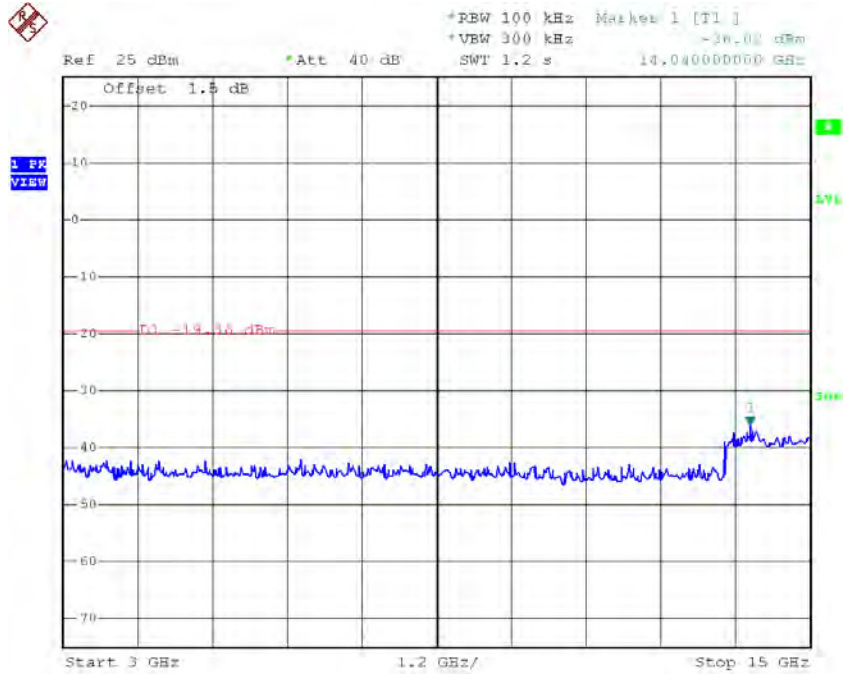

Date: 20,SEP.2016 20:51:14

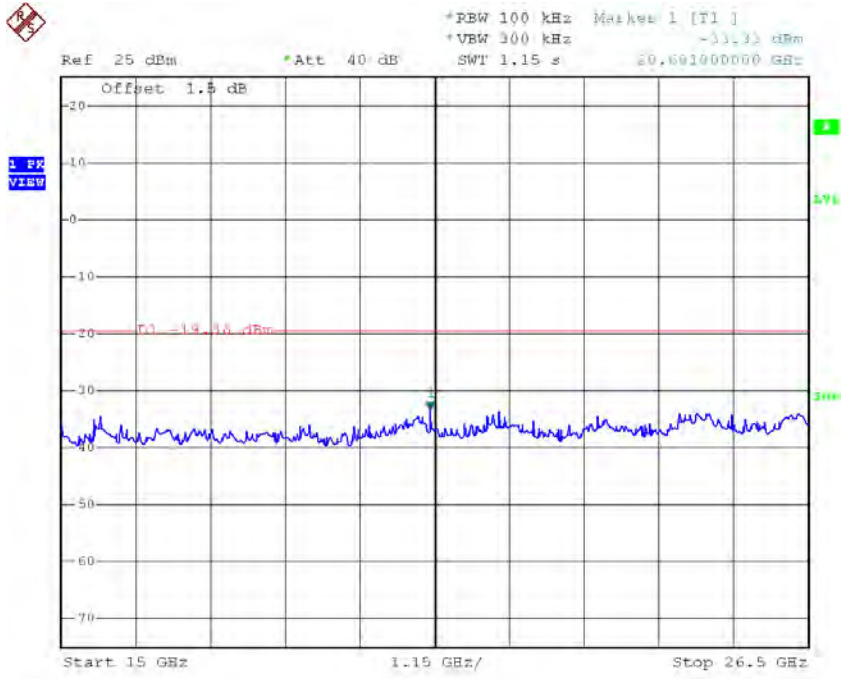

Date: 20.SEP.2016 20:51:22

Test Mode : TX G Mode_ANT 1

TX G mode CH01

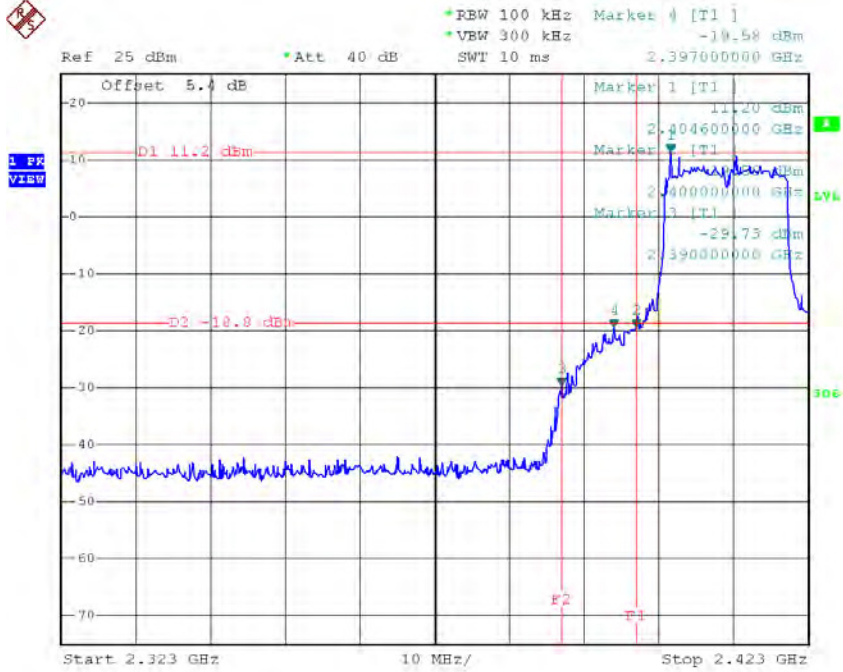

Date: 20.SEP.2016 20:35:23

TX G mode CH11

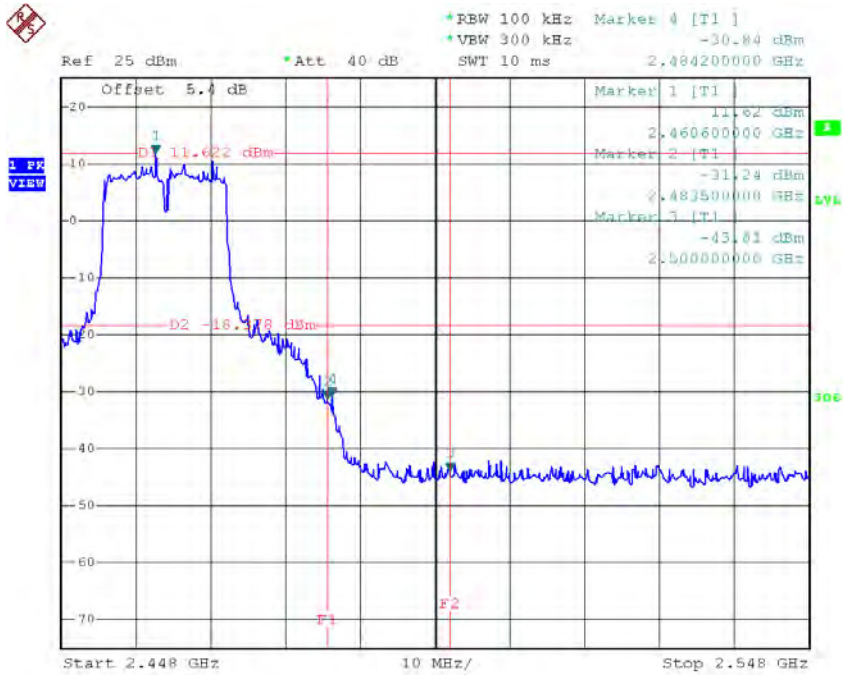

Date: 20.SEP.2016 20:38:04

TX G mode CH01 (10 Harmonic of the frequency)

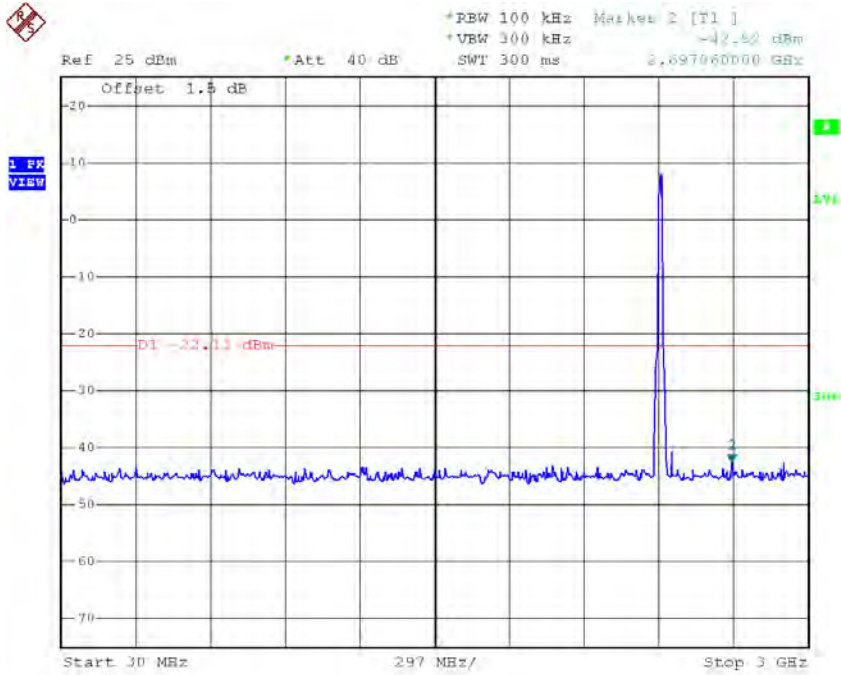

Date: 20,SEP.2016 20:34:31

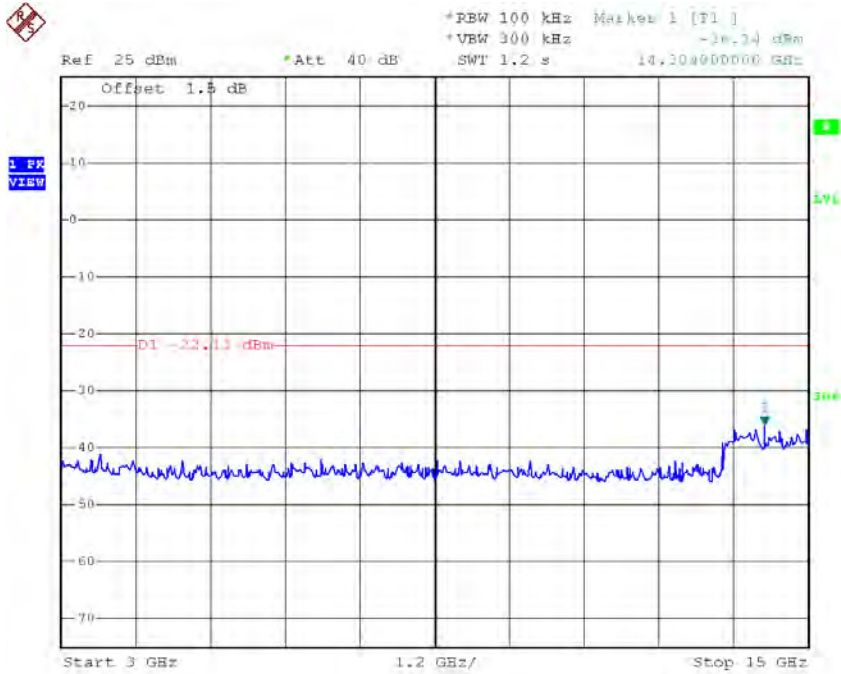

Date: 20,SEP.2016 20:34:40

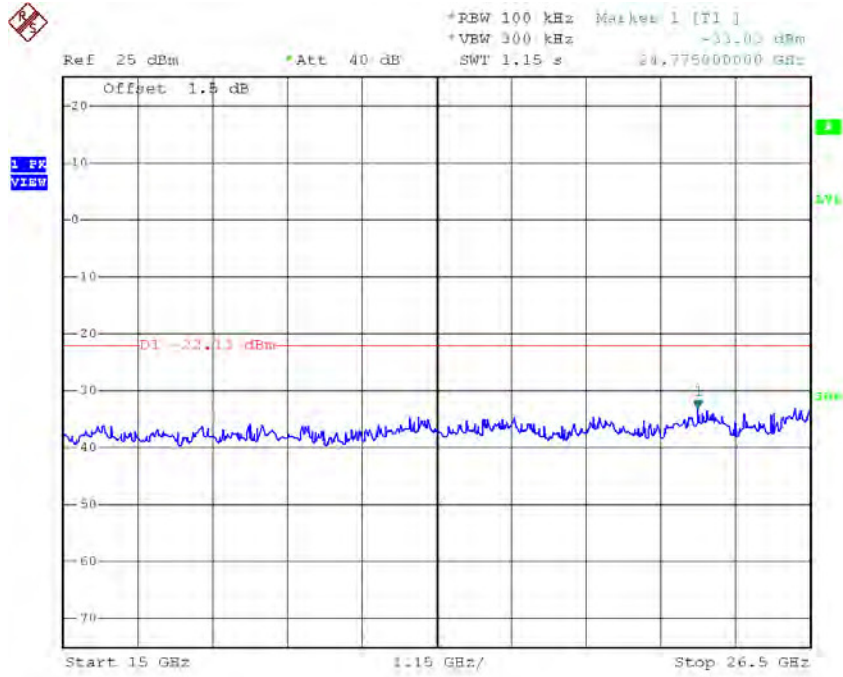

Date: 20,SEP,2016 20:34:48

TX G mode CH06 (10 Harmonic of the frequency)

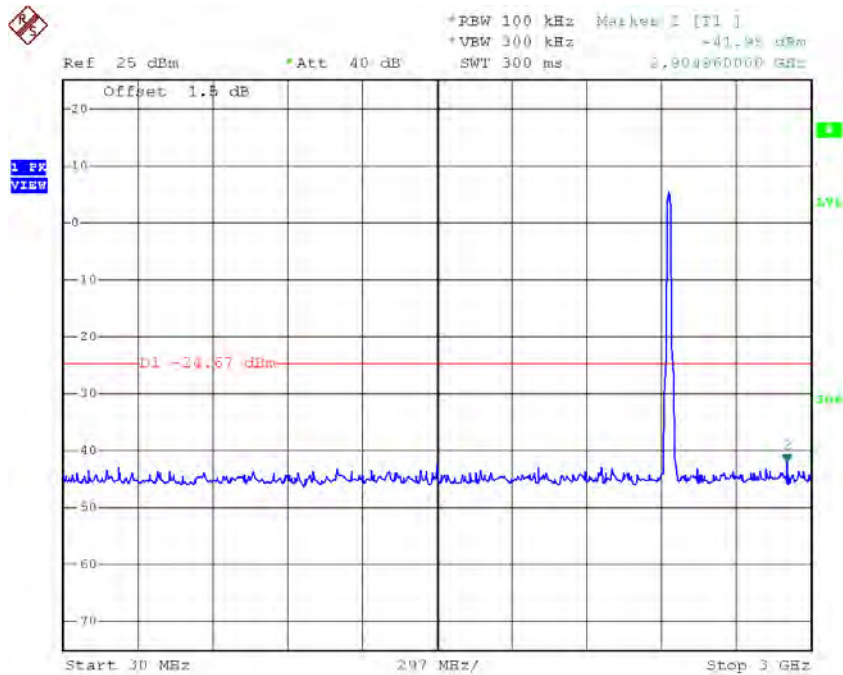

Date: 20,SEP,2016 20:36:28

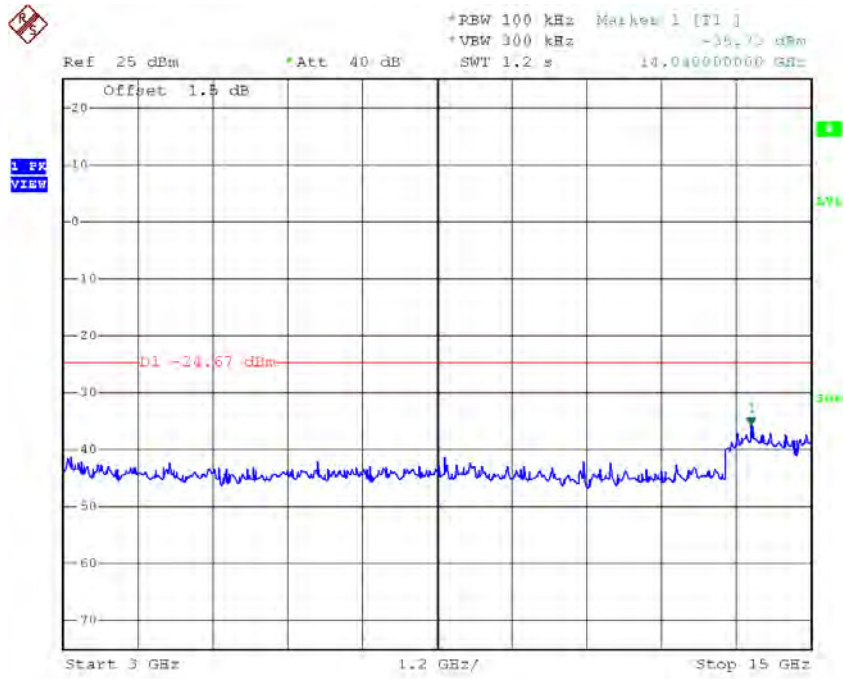

Date: 20.SEP.2016 20:36:36

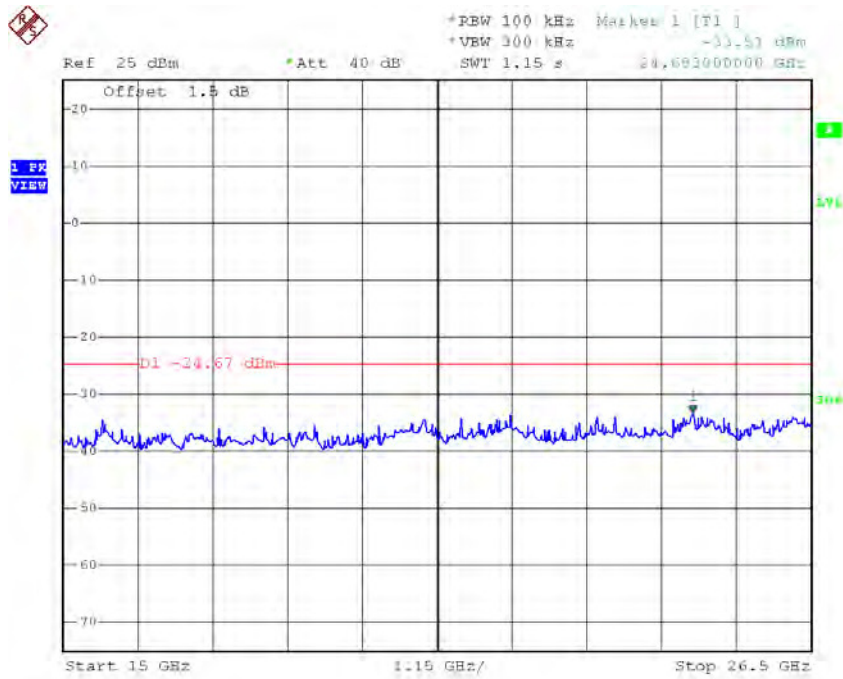

Date: 20.SEP.2016 20:36:45

TX G mode CH11 (10 Harmonic of the frequency)

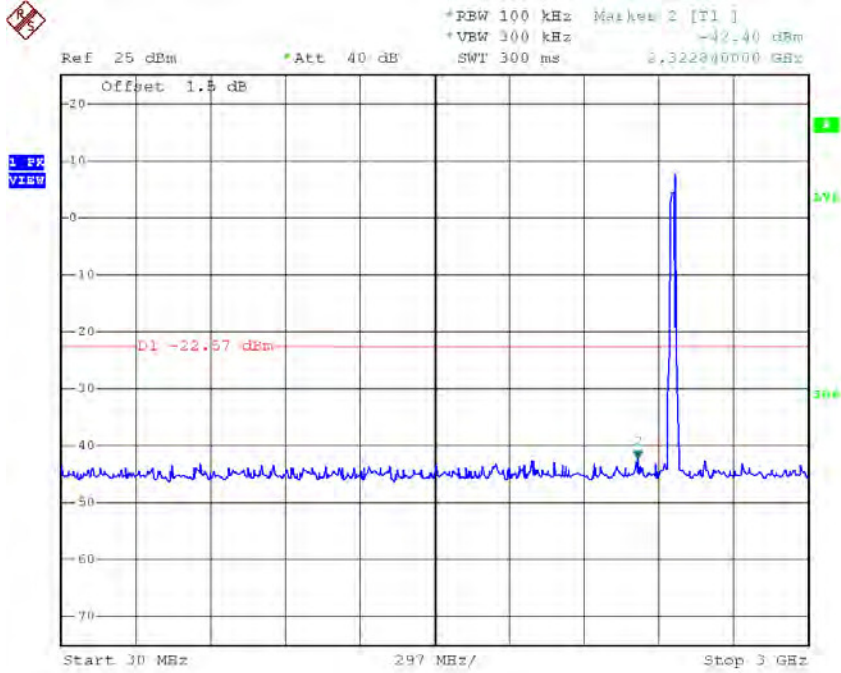

Date: 20,SEP.2016 20:37:40

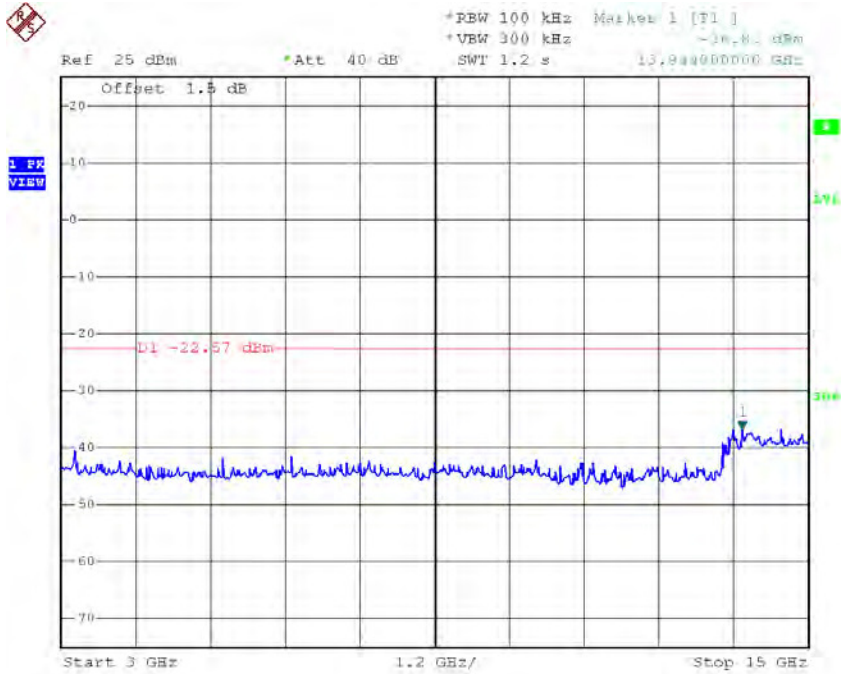

Date: 20,SEP.2016 20:37:48

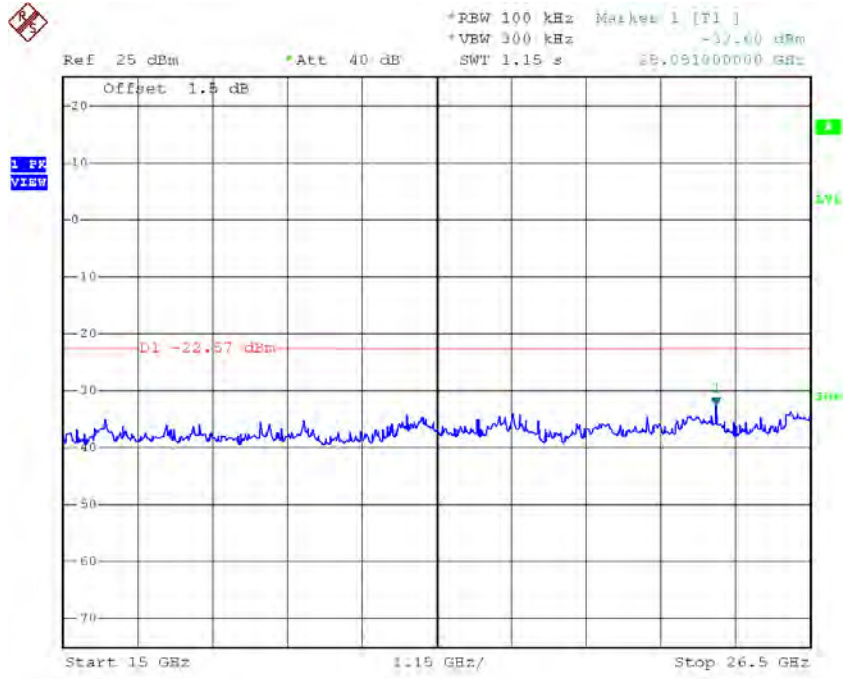

Date: 20.SEP.2016 20:37:56

Test Mode : TX G Mode_ANT 2

TX G mode CH01

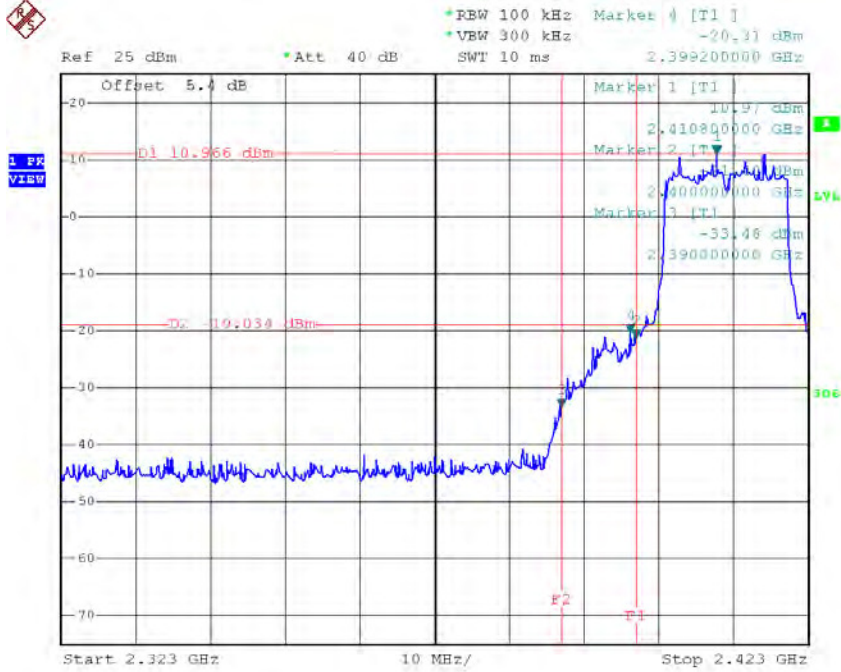

Date: 20.SEP.2016 20:52:54

TX G mode CH11

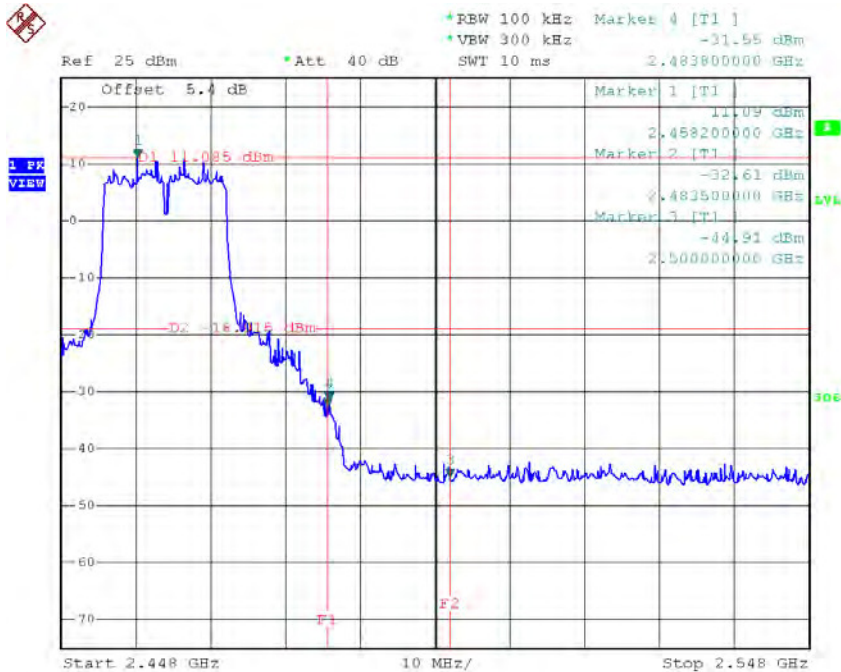

Date: 20.SEP.2016 20:59:13

TX G mode CH01 (10 Harmonic of the frequency)

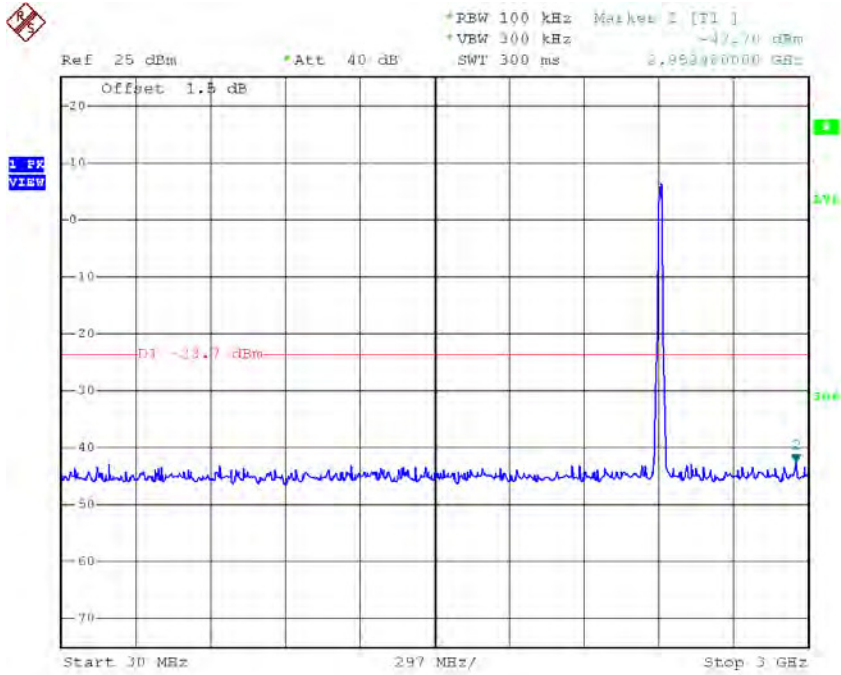

Date: 20,SEP.2016 20:52:30

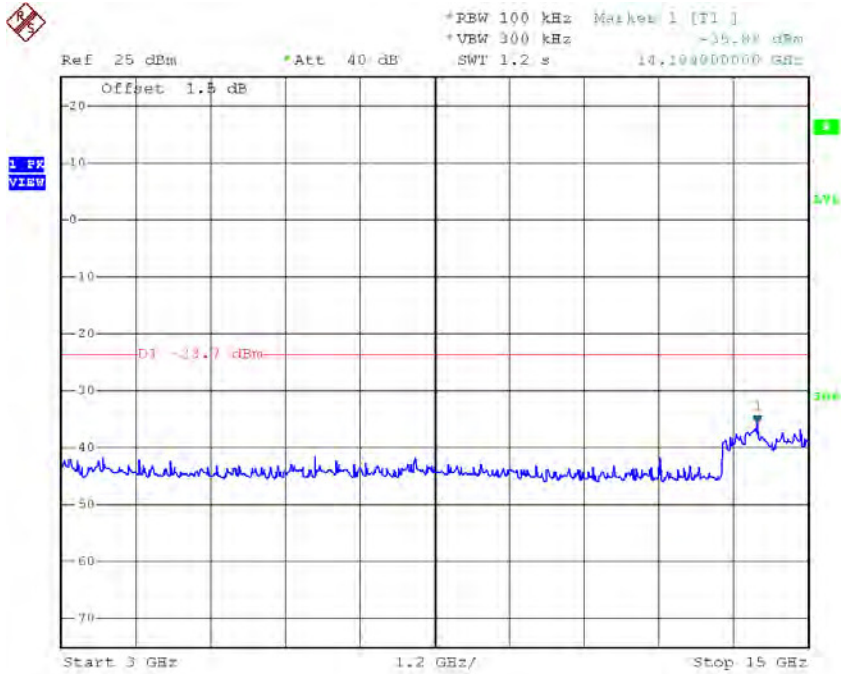

Date: 20,SEP.2016 20:52:38