

FCC Radio Test Report

FCC ID: QISAP6050DN6150DN

This report concerns (check one): Original Grant Class I Change Class II Change

Project No. : 1604C201B
Equipment : Wireless LAN Access Point
Model Name : AP6050DN
Applicant : Huawei Technologies Co.,Ltd.
Address : Administration Building, Headquarters of Huawei Technologies Co., Ltd.,Bantian, Longgang District, Shenzhen 518129 China

Date of Receipt : Sep. 09, 2016
Date of Test : Sep. 09, 2016 ~ Nov. 28, 2016
Issued Date : Nov. 29, 2016
Tested by : BTL Inc.

Testing Engineer : Shawn Xiao
(Shawn Xiao)

Technical Manager : David Mao
(David Mao)

Authorized Signatory : Steven Lu
(Steven Lu)

B T L I N C .

No.3, Jinshagang 1st Road, Shixia, Dalang Town, Dongguan, Guangdong, China.

TEL: +86-769-8318-3000 FAX: +86-769-8319-6000

Declaration

BTL represents to the client that testing is done in accordance with standard procedures as applicable and that test instruments used has been calibrated with standards traceable to international standard(s) and/or national standard(s).

BTL's reports apply only to the specific samples tested under conditions. It is manufacture's responsibility to ensure that additional production units of this model are manufactured with the identical electrical and mechanical components. **BTL** shall have no liability for any declarations, inferences or generalizations drawn by the client or others from **BTL** issued reports.

BTL's report must not be used by the client to claim product certification, approval, or endorsement by NVLAP, NIST, or any agency of the Federal Government.

This report is the confidential property of the client. As a mutual protection to the clients, the public and **BTL-self**, extracts from the test report shall not be reproduced except in full with **BTL's** authorized written approval.

BTL's laboratory quality assurance procedures are in compliance with the **ISO Guide 17025** requirements, and accredited by the conformity assessment authorities listed in this test report.

Limitation

For the use of the authority's logo is limited unless the Test Standard(s)/Scope(s)/Item(s) mentioned in this test report is (are) included in the conformity assessment authorities acceptance respective.

Table of Contents	Page
1 . CERTIFICATION	6
2 . SUMMARY OF TEST RESULTS	7
2.1 TEST FACILITY	8
2.2 MEASUREMENT UNCERTAINTY	8
3 . GENERAL INFORMATION	9
3.1 GENERAL DESCRIPTION OF EUT	9
3.2 DESCRIPTION OF TEST MODES	12
3.3 TABLE OF PARAMETERS OF TEXT SOFTWARE SETTING	14
3.4 BLOCK DIAGRAM SHOWING THE CONFIGURATION OF SYSTEM TESTED	16
3.5 DESCRIPTION OF SUPPORT UNITS	16
4 . EMC EMISSION TEST	17
4.1 CONDUCTED EMISSION MEASUREMENT	17
4.1.1 POWER LINE CONDUCTED EMISSION LIMITS	17
4.1.2 TEST PROCEDURE	17
4.1.3 DEVIATION FROM TEST STANDARD	17
4.1.4 TEST SETUP	18
4.1.5 EUT OPERATING CONDITIONS	18
4.1.6 EUT TEST CONDITIONS	18
4.1.7 TEST RESULTS	18
4.2 RADIATED EMISSION MEASUREMENT	19
4.2.1 RADIATED EMISSION LIMITS	19
4.2.2 TEST PROCEDURE	20
4.2.3 DEVIATION FROM TEST STANDARD	20
4.2.4 TEST SETUP	21
4.2.5 EUT OPERATING CONDITIONS	22
4.2.6 EUT TEST CONDITIONS	22
4.2.7 TEST RESULTS (9KHZ TO 30MHZ)	22
4.2.8 TEST RESULTS (30MHZ TO 1000 MHZ)	22
4.2.9 TEST RESULTS (ABOVE 1000 MHZ)	22
5 . BANDWIDTH TEST	23
5.1 APPLIED PROCEDURES	23
5.1.1 TEST PROCEDURE	23
5.1.2 DEVIATION FROM STANDARD	23
5.1.3 TEST SETUP	23
5.1.4 EUT OPERATION CONDITIONS	23
5.1.5 EUT TEST CONDITIONS	23
5.1.6 TEST RESULTS	23
6 . MAXIMUM OUTPUT POWER TEST	24

Table of Contents	Page
6.1 APPLIED PROCEDURES / LIMIT	24
6.1.1 TEST PROCEDURE	24
6.1.2 DEVIATION FROM STANDARD	24
6.1.3 TEST SETUP	24
6.1.4 EUT OPERATION CONDITIONS	24
6.1.5 EUT TEST CONDITIONS	24
6.1.6 TEST RESULTS	24
7 . ANTENNA CONDUCTED SPURIOUS EMISSION	25
7.1 APPLIED PROCEDURES / LIMIT	25
7.1.1 TEST PROCEDURE	25
7.1.2 DEVIATION FROM STANDARD	25
7.1.3 TEST SETUP	25
7.1.4 EUT OPERATION CONDITIONS	25
7.1.5 EUT TEST CONDITIONS	25
7.1.6 TEST RESULTS	25
8 . POWER SPECTRAL DENSITY TEST	26
8.1 APPLIED PROCEDURES / LIMIT	26
8.1.1 TEST PROCEDURE	26
8.1.2 DEVIATION FROM STANDARD	26
8.1.3 TEST SETUP	26
8.1.4 EUT OPERATION CONDITIONS	26
8.1.5 EUT TEST CONDITIONS	26
8.1.6 TEST RESULTS	26
9 . MEASUREMENT INSTRUMENTS LIST	27
10 . EUT TEST PHOTO	29
ATTACHMENT A - CONDUCTED EMISSION	33
ATTACHMENT B - RADIATED EMISSION (9KHZ TO 30MHZ)	36
ATTACHMENT C - RADIATED EMISSION (30MHZ TO 1000MHZ)	41
ATTACHMENT D - RADIATED EMISSION (ABOVE 1000MHZ)	48
ATTACHMENT E - BANDWIDTH	97
ATTACHMENT F – MAXIMUM OUTPUT POWER	110
ATTACHMENT G - ANTENNA CONDUCTED SPURIOUS EMISSION	130
ATTACHMENT H - POWER SPECTRAL DENSITY	479

REPORT ISSUED HISTORY

Issued No.	Description	Issued Date
BTL-FCCP-1-1604C201B	Original Issue.	Nov. 29, 2016

1. CERTIFICATION

Equipment : Wireless LAN Access Point
Brand Name : HUAWEI
Model Name : AP6050DN
Applicant : Huawei Technologies Co.,Ltd.
Manufacturer : Huawei Technologies Co.,Ltd.
Address : Administration Building, Huawei Base, Bantian, Longgang District ,Shenzhen
518129, P.R.China
Factory : CIG Shanghai Co.,Ltd., Shanghai Branch.
Address : F/2,3 Building 1, No. 505 Jiangyue Road, Minhang District, Shanghai, P.R.
China
Date of Test : Sep. 09, 2016 ~ Nov. 28, 2016
Test Sample : Engineering Sample
Standard(s) : FCC Part15, Subpart C:(15.247) / ANSI C63.10-2013

The above equipment has been tested and found compliance with the requirement of the relative standards by BTL Inc.

The test data, data evaluation, and equipment configuration contained in our test report (Ref No. BTL-FCCP-1-1604C201B) were obtained utilizing the test procedures, test instruments, test sites that has been accredited by the Authority of TAF according to the ISO-17025 quality assessment standard and technical standard(s).

2. SUMMARY OF TEST RESULTS

Test procedures according to the technical standard(s):

Applied Standard(s): FCC Part15 (15.247) , Subpart C			
Standard(s) Section	Test Item	Judgment	Remark
15.207	Conducted Emission	PASS	
15.247(d)	Antenna conducted Spurious Emission	PASS	
15.247(a)(2)	6dB Bandwidth	PASS	
15.247(b)(3)	Peak Output Power	PASS	
15.247(e)	Power Spectral Density	PASS	
15.203	Antenna Requirement	PASS	
15.209/15.205	Transmitter Radiated Emissions	PASS	

NOTE:

(1) "N/A" denotes test is not applicable in this test report.

2.1 TEST FACILITY

The test facilities used to collect the test data in this report is at the location of No.3,Jinshagang 1st Road, Shixia, Dalang Town, Dongguan, Guangdong, China.
BTL's test firm number for FCC: 319330

2.2 MEASUREMENT UNCERTAINTY

Where relevant, the following measurement uncertainty levels have been estimated for tests performed on the EUT as specified in CISPR 16-4-2. The BTL measurement uncertainty is less than the CISPR 16-4-2 U_{CISPR} requirement.

The reported uncertainty of measurement $y \pm U$, where expanded uncertainty U is based on a standard uncertainty multiplied by a coverage factor of $k=2$, providing a level of confidence of approximately 95 %.

A. Conducted Measurement:

Test Site	Method	Measurement Frequency Range	U, (dB)
DG-C02	CISPR	150 KHz ~ 30MHz	2.32

B. Radiated Measurement:

Test Site	Method	Measurement Frequency Range	Ant. H / V	U, (dB)
DG-CB03	CISPR	9KHz~30MHz	V	3.79
		9KHz~30MHz	H	3.57
		30MHz ~ 200MHz	V	3.82
		30MHz ~ 200MHz	H	3.78
		200MHz ~ 1,000MHz	V	4.10
		200MHz ~ 1,000MHz	H	4.06
		1GHz~18GHz	V	3.12
		1GHz~18GHz	H	3.68
		18GHz~40GHz	V	4.15
		18GHz~40GHz	H	4.14

Note: Unless specifically mentioned, the uncertainty of measurement has not been taken into account to declare the compliance or non-compliance to the specification.

3. GENERAL INFORMATION

3.1 GENERAL DESCRIPTION OF EUT

Equipment	Wireless LAN Access Point	
Brand Name	HUAWEI	
Model Name	AP6050DN	
Model Difference	N/A	
Product Description	Operation Frequency	2412~2462 MHz
	Modulation Technology	802.11b:DSSS 802.11g:OFDM 802.11n:OFDM
	Bit Rate of Transmitter	802.11b: 11/5.5/2/1 Mbps 802.11g: 54/48/36/24/18/12/9/6Mbps 802.11n up to 600Mbps
	Output Power (Max.) - (1TX) Non-Beamforming	802.11b: 19.45dBm 802.11g: 17.52dBm 802.11n(20MHz): 17.86dBm 802.11n(40MHz): 15.92dBm
	Output Power (Max.) - (2TX) Non-Beamforming	802.11b: 22.66dBm 802.11g: 20.61dBm 802.11n(20MHz): 20.77dBm 802.11n(40MHz): 17.80dBm
	Output Power (Max.) - (3TX) Non-Beamforming	802.11b: 24.63dBm 802.11g: 22.65dBm 802.11n(20MHz): 22.64dBm 802.11n(40MHz): 18.57dBm
	Output Power (Max.) - (4TX) Non-Beamforming	802.11b: 25.83dBm 802.11g: 23.90dBm 802.11n(20MHz): 23.87dBm 802.11n(40MHz): 19.87dBm
	Output Power (Max.) - (2TX) Beamforming	802.11n(20MHz): 20.94dBm 802.11n(40MHz): 17.07dBm
	Output Power (Max.) - (3TX) Beamforming	802.11n(20MHz): 19.66dBm 802.11n(40MHz): 18.67dBm
	Output Power (Max.) - (4TX) Beamforming	802.11n(20MHz): 17.82dBm 802.11n(40MHz): 17.75dBm
Power Source	#1 DC voltage supplied from AC Adapter. #2 Supplied from PoE. Model: PoE35-54A	
Power Rating	#1 DC 12V 2A #2 PoE -48V	

Note:

- For a more detailed features description, please refer to the manufacturer's specifications or the user's manual.

2. Channel List:

CH01 – CH11 for 802.11b, 802.11g, 802.11n(20MHz) CH03 – CH09 for 802.11n(40MHz)							
Channel	Frequency (MHz)	Channel	Frequency (MHz)	Channel	Frequency (MHz)	Channel	Frequency (MHz)
01	2412	04	2427	07	2442	10	2457
02	2417	05	2432	08	2447	11	2462
03	2422	06	2437	09	2452		

3. Table for Filed Antenna

Ant.	Brand	Model Name	Antenna Type	Connector	Gain (dBi)
1	上海旌泓通信技术有限公司	N/A	Internal	U.FL	6.53
2	上海旌泓通信技术有限公司	N/A	Internal	U.FL	6.53
3	上海旌泓通信技术有限公司	N/A	Internal	U.FL	6.53
4	上海旌泓通信技术有限公司	N/A	Internal	U.FL	6.53

Note:

- (1) The EUT incorporates a MIMO function. Physically, the EUT provides four completed transmitters and receivers (4T4R), all transmit signals are completely uncorrelated, then, **Direction gain = G_{ANT}**, that is Directional gain=6.53.
The out power limit is 30-6.53+6=29.47, the power density limit is 8-6.53+6=7.47.
- (2) **For 2TX with beamforming:**
The EUT with beamforming function, then, Direction gain = G_{ANT}+10log(N_{ANT}/N_{SS}), where N_{SS} = the number of independent spatial streams of data.
For 2TX with beamforming: Directional gain=6.53+10log(2/2)=6.53+0=6.53 dBi.
The out power limit is 30-6.53+6=29.47, the power density limit is 8-6.53+6=7.47.
- (3) **For 3TX with beamforming:**
The EUT with beamforming function, then, Direction gain = G_{ANT}+10log(N_{ANT}/N_{SS}), where N_{SS} = the number of independent spatial streams of data.
For 3TX with beamforming: Directional gain=6.53+10log(3/3)=6.53 +0=6.53 dBi.
The out power limit is 30-6.53+6=29.47, the power density limit is 8-6.53+6=7.47.
- (4) **For 4TX with beamforming:**
The EUT with beamforming function, then, Direction gain = G_{ANT}+10log(N_{ANT}/N_{SS}), where N_{SS} = the number of independent spatial streams of data.
For 4TX with beamforming: Directional gain=6.53+10log(4/4)=6.53 + 0=6.53 dBi.
The out power limit is 30-6.53+6=29.47, the power density limit is 8-6.53+6=7.47.

4.

Operating Mode / TX Mode	1TX	2TX
802.11b	V (ANT 1)	V (ANT 1+ANT 2)
802.11g	V (ANT 1)	V (ANT 1+ANT 2)
802.11n(20MHz)	V (ANT 1)	V (ANT 1+ANT 2)
802.11n(40MHz)	V (ANT 1)	V (ANT 1+ANT 2)

Operating Mode / TX Mode	3TX	4TX
802.11b	V (ANT 1+ANT 2+ANT 3)	V (ANT 1+ANT 2+ ANT 3+ANT 4)
802.11g	V (ANT 1+ANT 2+ANT 3)	V (ANT 1+ANT 2+ ANT 3+ANT 4)
802.11n(20MHz)	V (ANT 1+ANT 2+ANT 3)	V (ANT 1+ANT 2+ ANT 3+ANT 4)
802.11n(40MHz)	V (ANT 1+ANT 2+ANT 3)	V (ANT 1+ANT 2+ ANT 3+ANT 4)

3.2 DESCRIPTION OF TEST MODES

To investigate the maximum EMI emission characteristics generates from EUT, the test system was pre-scanning tested base on the consideration of following EUT operation mode or test configuration mode which possible have effect on EMI emission level. Each of these EUT operation mode(s) or test configuration mode(s) mentioned above was evaluated respectively.

Pretest Mode	Description
Mode 1	TX B MODE CHANNEL 01/06/11
Mode 2	TX G MODE CHANNEL 01/06/11
Mode 3	TX N-20MHZ MODE CHANNEL 01/06/11
Mode 4	TX N-40MHZ MODE CHANNEL 03/06/09
Mode 5	TX Mode

The EUT system operated these modes were found to be the worst case during the pre-scanning test as following:

For Conducted Test	
Final Test Mode	Description
Mode 5	TX Mode

For Radiated Test	
Final Test Mode	Description
Mode 1	TX B MODE CHANNEL 01/06/11
Mode 2	TX G MODE CHANNEL 01/06/11
Mode 3	TX N-20MHZ MODE CHANNEL 01/06/11
Mode 4	TX N-40MHZ MODE CHANNEL 03/06/09

For Band Edge Test	
Final Test Mode	Description
Mode 1	TX B MODE CHANNEL 01/06/11
Mode 2	TX G MODE CHANNEL 01/06/11
Mode 3	TX N-20MHZ MODE CHANNEL 01/06/11
Mode 4	TX N-40MHZ MODE CHANNEL 03/06/09

6dB Spectrum Bandwidth	
Final Test Mode	Description
Mode 1	TX B MODE CHANNEL 01/06/11
Mode 2	TX G MODE CHANNEL 01/06/11
Mode 3	TX N-20MHZ MODE CHANNEL 01/06/11
Mode 4	TX N-40MHZ MODE CHANNEL 03/06/09

Maximum Conducted Output Power	
Final Test Mode	Description
Mode 1	TX B MODE CHANNEL 01/06/11
Mode 2	TX G MODE CHANNEL 01/06/11
Mode 3	TX N-20MHZ MODE CHANNEL 01/06/11
Mode 4	TX N-40MHZ MODE CHANNEL 03/06/09

Power Spectral Density	
Final Test Mode	Description
Mode 1	TX B MODE CHANNEL 01/06/11
Mode 2	TX G MODE CHANNEL 01/06/11
Mode 3	TX N-20MHZ MODE CHANNEL 01/06/11
Mode 4	TX N-40MHZ MODE CHANNEL 03/06/09

Note:

- (1) The measurements are performed at the high, middle, low available channels.
- (2) 802.11b mode: DBPSK (1Mbps)
 802.11g mode: OFDM (6Mbps)
 802.11n HT20 mode : BPSK (13Mbps)
 802.11n HT40 mode : BPSK (27Mbps)
 For radiated emission tests, the highest output powers were set for final test.
- (3) For radiated below 1G test, the 802.11b is found to be the worst case and recorded.
- (4) The EUT was programmed to be in continuously transmitting mode and the transmit duty cycle is not less than 98%.

3.3 TABLE OF PARAMETERS OF TEXT SOFTWARE SETTING

During testing, channel & power controlling software provided by the customer was used to control the operating channel as well as the output power level. The RF output power selection is for the setting of RF output power expected by the customer and is going to be fixed on the firmware of the final end product power parameters of WLAN

1TX Non-Beamforming

Test software version	QRCT		
Frequency (MHz)	2412	2437	2462
802.11b	20	20	20
802.11g	16	18	16
802.11n (20MHz)	15	18	14
Frequency	2422	2437	2452
802.11n (40MHz)	13	16	13

2TX Non-Beamforming

Test software version	QRCT		
Frequency (MHz)	2412	2437	2462
802.11b	20	20	20
802.11g	15	18	15
802.11n (20MHz)	14	18	13
Frequency	2422	2437	2452
802.11n (40MHz)	12	15	12

3TX Non-Beamforming

Test software version	QRCT		
Frequency (MHz)	2412	2437	2462
802.11b	20	20	19
802.11g	14	18	14
802.11n (20MHz)	13	18	12
Frequency	2422	2437	2452
802.11n (40MHz)	11	14	11

4TX Non-Beamforming

Test software version	QRCT		
Frequency (MHz)	2412	2437	2462
802.11b	20	20	19
802.11g	14	18	14
802.11n (20MHz)	13	18	12
Frequency	2422	2437	2452
802.11n (40MHz)	11	14	11

2TX Beamforming

Test software version	QRCT		
Frequency (MHz)	2412	2437	2462
802.11n (20MHz)	13	18	12
Frequency	2422	2437	2452
802.11n (40MHz)	11	14	11

3TX Beamforming

Test software version	QRCT		
Frequency (MHz)	2412	2437	2462
802.11n (20MHz)	13	15	12
Frequency	2422	2437	2452
802.11n (40MHz)	11	14	11

4TX Beamforming

Test software version	QRCT		
Frequency (MHz)	2412	2437	2462
802.11n (20MHz)	12	12	12
Frequency	2422	2437	2452
802.11n (40MHz)	11	12	11

3.4 BLOCK DIAGRAM SHOWING THE CONFIGURATION OF SYSTEM TESTED

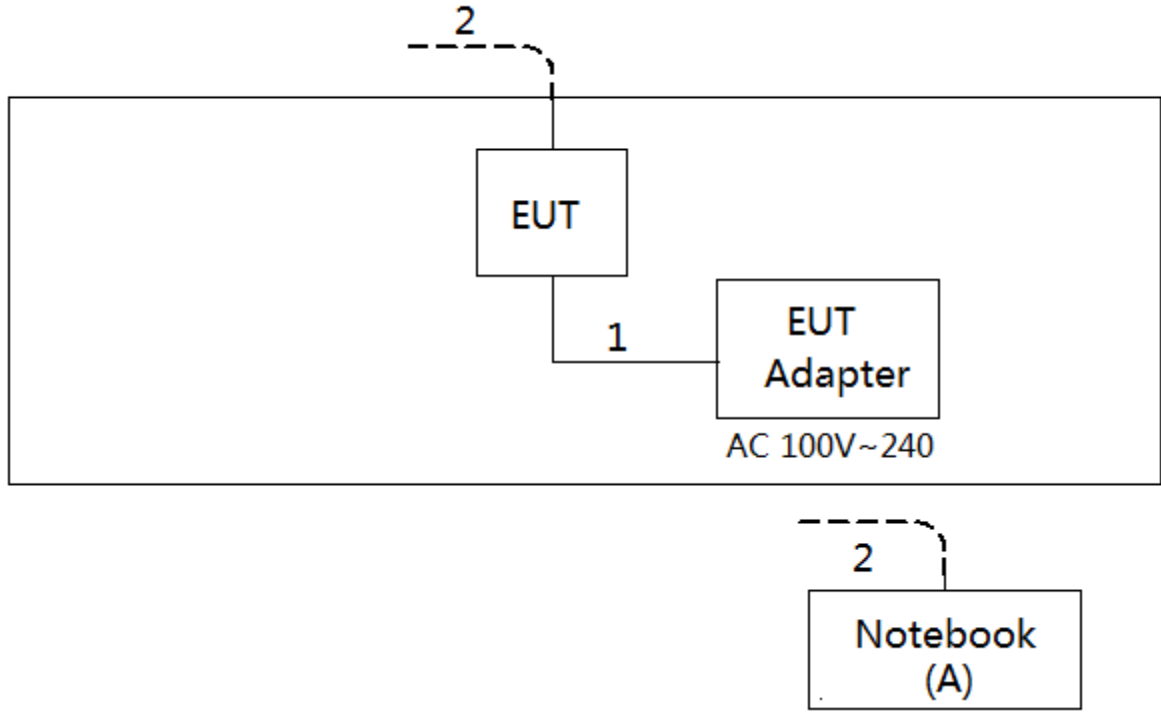

3.5 DESCRIPTION OF SUPPORT UNITS

The EUT has been tested as an independent unit together with other necessary accessories or support units. The following support units or accessories were used to form a representative test configuration during the tests.

Item	Equipment	Mfr/Brand	Model/Type No.	FCC ID	Series No.
A	Notebook	Lenovo	INSPIRON 1420-	DOC	JX193A01SDC 2

Item	Shielded Type	Ferrite Core	Length	Note
1	NO	NO	10m	RJ45 Cable
2	NO	NO	1.5m	Power Cable

4. EMC EMISSION TEST

4.1 CONDUCTED EMISSION MEASUREMENT

4.1.1 POWER LINE CONDUCTED EMISSION LIMITS (Frequency Range 150KHz-30MHz)

Frequency of Emission (MHz)	Conducted Limit (dBµV)	
	Quasi-peak	Average
0.15 -0.50	66 to 56*	56 to 46*
0.50 -5.0	56	46
5.0 -30.0	60	50

Note:

- (1) The limit of " * " decreases with the logarithm of the frequency
- (2) The test result calculated as following:
 Measurement Value = Reading Level + Correct Factor
 Correct Factor = Insertion Loss + Cable Loss + Attenuator Factor(if use)
 Margin Level = Measurement Value - Limit Value

The following table is the setting of the receiver

Receiver Parameters	Setting
Attenuation	10 dB
Start Frequency	0.15 MHz
Stop Frequency	30 MHz
IF Bandwidth	9 KHz

4.1.2 TEST PROCEDURE

- a. The EUT was placed 0.8 meters from the horizontal ground plane with EUT being connected to the power mains through a line impedance stabilization network (LISN). All other support equipments powered from additional LISN(s). The LISN provide 50 Ohm/ 50uH of coupling impedance for the measuring instrument.
- b. Interconnecting cables that hang closer than 40 cm to the ground plane shall be folded back and forth in the center forming a bundle 30 to 40 cm long.
- c. I/O cables that are not connected to a peripheral shall be bundled in the center. The end of the cable may be terminated, if required, using the correct terminating impedance. The overall length shall not exceed 1 m.
- d. LISN at least 80 cm from nearest part of EUT chassis.
- e. For the actual test configuration, please refer to the related Item –EUT Test Photos.

4.1.3 DEVIATION FROM TEST STANDARD

No deviation

4.1.4 TEST SETUP

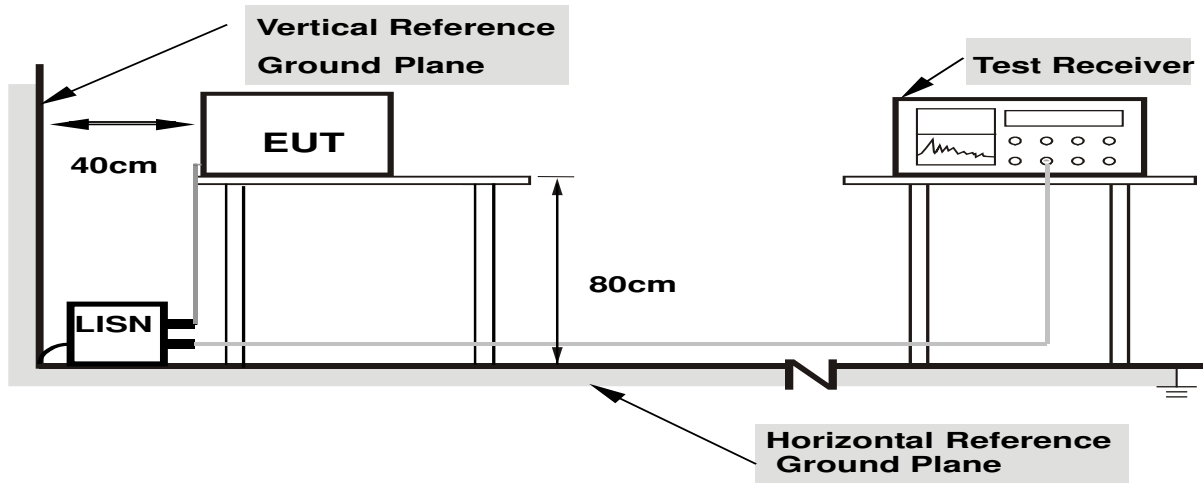

- Note:**
- 1. Support units were connected to second LISN.
 - 2. Both of LISNs (AMN) are 80 cm from EUT and at least 80 from other units and other metal planes

4.1.5 EUT OPERATING CONDITIONS

The EUT was placed on the test table and programmed in normal function.

4.1.6 EUT TEST CONDITIONS

Temperature: 25°C Relative Humidity: 55% Test Voltage: AC 120V/60Hz

4.1.7 TEST RESULTS

Please refer to the Attachment A.

4.2 RADIATED EMISSION MEASUREMENT

4.2.1 RADIATED EMISSION LIMITS

In case the emission fall within the restricted band specified on 15.205(a), then the 15.209(a) limit in the table below has to be followed.

LIMITS OF RADIATED EMISSION MEASUREMENT (9KHz-1000MHz)

Frequency (MHz)	Field Strength (microvolts/meter)	Measurement Distance (meters)
0.009~0.490	2400/F(KHz)	300
0.490~1.705	24000/F(KHz)	30
1.705~30.0	30	30
30~88	100	3
88~216	150	3
216~960	200	3
960~1000	500	3

LIMITS OF RADIATED EMISSION MEASUREMENT (Above 1000MHz)

Frequency (MHz)	(dBuV/m) (at 3 meters)	
	PEAK	AVERAGE
Above 1000	74	54

Notes:

- (1) The limit for radiated test was performed according to FCC PART 15C.
- (2) The tighter limit applies at the band edges.
- (3) Emission level (dBuV/m)=20log Emission level (uV/m).
- (4) The test result calculated as following:
 Measurement Value = Reading Level + Correct Factor
 Correct Factor = Antenna Factor + Cable Loss - Amplifier Gain(if use)
 Margin Level = Measurement Value - Limit Value

Spectrum Parameter	Setting
Attenuation	Auto
Start Frequency	1000 MHz
Stop Frequency	10th carrier harmonic
RBW / VBW (Emission in restricted band)	1MHz / 3MHz for Peak, 1MHz / 1/T for Average

Receiver Parameter	Setting
Attenuation	Auto
Start ~ Stop Frequency	9KHz~90KHz for PK/AVG detector
Start ~ Stop Frequency	90KHz~110KHz for QP detector
Start ~ Stop Frequency	110KHz~490KHz for PK/AVG detector
Start ~ Stop Frequency	490KHz~30MHz for QP detector
Start ~ Stop Frequency	30MHz~1000MHz for QP detector

4.2.2 TEST PROCEDURE

- a. The measuring distance of 3 m shall be used for measurements. The EUT was placed on the top of a rotating table 0.8 meter above the ground at a 3 meter semi-anechoic chamber. The table was rotated 360 degrees to determine the position of the highest radiation.(below 1GHz)
- b. The measuring distance of 3 m shall be used for measurements. The EUT was placed on the top of a rotating table 1.5 meter above the ground at a 3 meter semi-anechoic chamber. The table was rotated 360 degrees to determine the position of the highest radiation.(above 1GHz)
- c. The height of the equipment or of the substitution antenna shall be 0.8m or 1.5m; the height of the test antenna shall vary between 1 m to 4 m. Both horizontal and vertical polarizations of the antenna are set to make the measurement.
- d. For each suspected emission, the EUT was arranged to its worst case and then the antenna was tuned to heights find the maximum reading (used Bore sight function).
- e. The receiver system was set to peak and average detect function and specified bandwidth with maximum hold mode when the test frequency is above 1GHz.
- f. The initial step in collecting radiated emission data is a receiver peak detector mode pre-scanning the measurement frequency range. Significant peaks are then marked and then Quasi Peak detector mode re-measured.
- g. All readings are Peak unless otherwise stated QP in column of Note. Peak denotes that the Peak reading compliance with the QP Limits and then QP Mode measurement didn't perform. (below 1GHz)
- h. All readings are Peak Mode value unless otherwise stated AVG in column of Note. If the Peak Mode Measured value compliance with the Peak Limits and lower than AVG Limits, the EUT shall be deemed to meet both Peak & AVG Limits and then only Peak Mode was measured, but AVG Mode didn't perform. (above 1GHz)
- i. For the actual test configuration, please refer to the related Item –EUT Test Photos.

4.2.3 DEVIATION FROM TEST STANDARD

No deviation

4.2.4 TEST SETUP

(A) Radiated Emission Test Set-Up Frequency Below 1 GHz

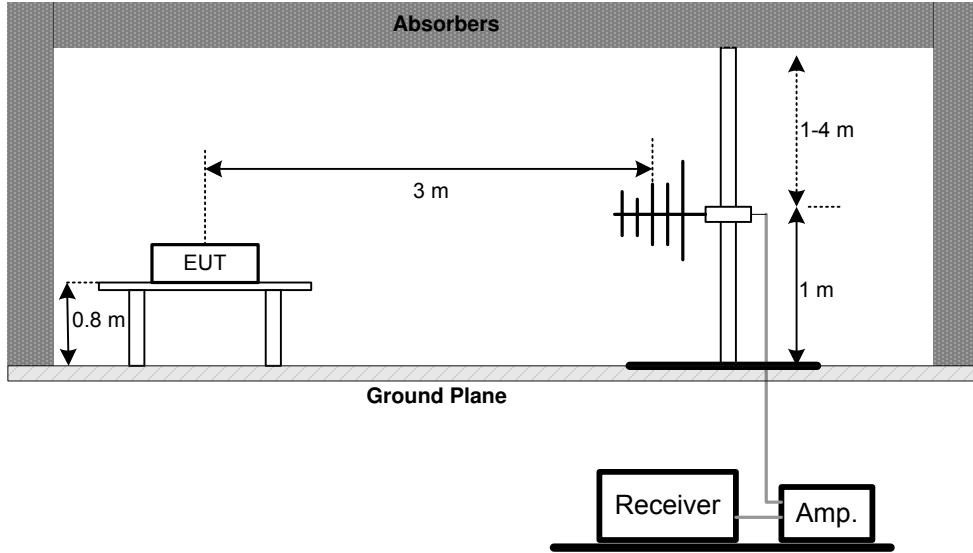

(B) Radiated Emission Test Set-Up Frequency Above 1 GHz

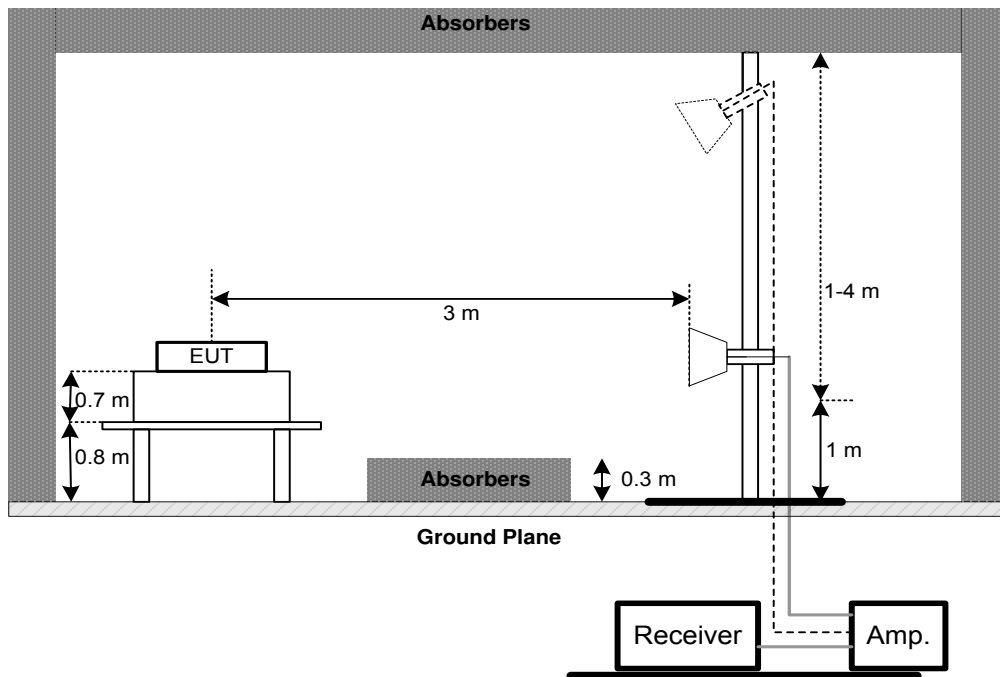

(C) For Radiated Emissions Below 30MHz

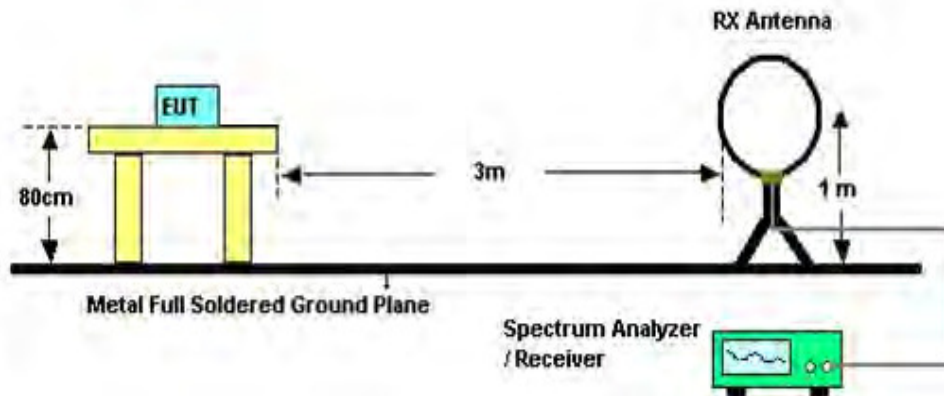

4.2.5 EUT OPERATING CONDITIONS

The EUT was programmed to be in continuously transmitting mode.

4.2.6 EUT TEST CONDITIONS

Temperature: 25°C Relative Humidity: 55% Test Voltage: AC 120V/60Hz

4.2.7 TEST RESULTS (9KHZ TO 30MHZ)

Please refer to the Attachment B

Remark:

- (1) The amplitude of spurious emissions which are attenuated by more than 20 dB below the permissible value has no need to be reported.
- (2) Distance extrapolation factor = $40 \log(\text{specific distance} / \text{test distance})$ (dB).
- (3) Limit line = specific limits (dBuV) + distance extrapolation factor.

4.2.8 TEST RESULTS (30MHZ TO 1000 MHZ)

Please refer to the Attachment C.

4.2.9 TEST RESULTS (ABOVE 1000 MHZ)

Please refer to the Attachment D.

Remark:

- (1) No limit: This is fundamental signal, the judgment is not applicable. For fundamental signal judgment was referred to Peak output test.

5. BANDWIDTH TEST

5.1 APPLIED PROCEDURES

FCC Part15 (15.247) , Subpart C			
Section	Test Item	Frequency Range (MHz)	Result
15.247(a)(2)	Bandwidth	2400-2483.5	PASS

5.1.1 TEST PROCEDURE

- a. The EUT was directly connected to the spectrum analyzer and antenna output port as show in the block diagram below,
- b. Spectrum Setting: RBW= 100KHz, VBW=300KHz, Sweep time = 2.5 ms.

5.1.2 DEVIATION FROM STANDARD

No deviation.

5.1.3 TEST SETUP

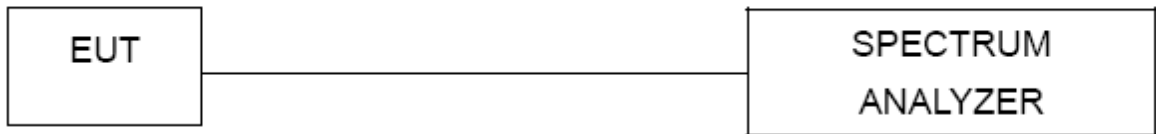

5.1.4 EUT OPERATION CONDITIONS

The EUT was programmed to be in continuously transmitting mode.

5.1.5 EUT TEST CONDITIONS

Temperature: 25°C Relative Humidity: 55% Test Voltage: AC 120V/60Hz

5.1.6 TEST RESULTS

Please refer to the Attachment E.

6. MAXIMUM OUTPUT POWER TEST

6.1 APPLIED PROCEDURES / LIMIT

FCC Part15 (15.247) , Subpart C				
Section	Test Item	Limit	Frequency Range (MHz)	Result
15.247(b)(3)	Maximum Output Power	1 Watt or 30dBm	2400-2483.5	PASS

6.1.1 TEST PROCEDURE

- a. The EUT was directly connected to the power meter and antenna output port as show in the block diagram below,
- b. The maximum peak conducted output power was performed in accordance with method 9.1.2 of FCC KDB 558074 D01 DTS Meas Guidance and FCC KDB 662911 D01 Multiple Transmitter Output.

6.1.2 DEVIATION FROM STANDARD

No deviation.

6.1.3 TEST SETUP



6.1.4 EUT OPERATION CONDITIONS

The EUT was programmed to be in continuously transmitting mode.

6.1.5 EUT TEST CONDITIONS

Temperature: 25°C Relative Humidity: 55% Test Voltage: AC 120V/60Hz

6.1.6 TEST RESULTS

Please refer to the Attachment F.

7. ANTENNA CONDUCTED SPURIOUS EMISSION

7.1 APPLIED PROCEDURES / LIMIT

In any 100 kHz bandwidth outside the frequency band in which the spread spectrum or digitally modulated device is operating, the RF power that is produced shall be at least 20 dB below that in the 100 kHz bandwidth within the band that contains the highest level of the desired power, based on either an RF conducted or a radiated measurement, provided that the transmitter demonstrates compliance with the peak conducted power limits.

7.1.1 TEST PROCEDURE

- a. The EUT was directly connected to the spectrum analyzer and antenna output port as show in the block diagram below,
- b. Spectrum Setting: RBW= 100KHz, VBW=300KHz, Sweep time = Auto.
- c. Offset=antenna gain+cable loss

7.1.2 DEVIATION FROM STANDARD

No deviation.

7.1.3 TEST SETUP



7.1.4 EUT OPERATION CONDITIONS

The EUT was programmed to be in continuously transmitting mode.

7.1.5 EUT TEST CONDITIONS

Temperature: 25°C Relative Humidity: 55% Test Voltage: AC 120V/60Hz

7.1.6 TEST RESULTS

Please refer to the Attachment G.

8. POWER SPECTRAL DENSITY TEST

8.1 APPLIED PROCEDURES / LIMIT

FCC Part15 (15.247) , Subpart C				
Section	Test Item	Limit	Frequency Range (MHz)	Result
15.247(e)	Power Spectral Density	8 dBm (in any 3KHz)	2400-2483.5	PASS

8.1.1 TEST PROCEDURE

- a. The EUT was directly connected to the spectrum analyzer and antenna output port as show in the block diagram below,
- b. Spectrum Setting: RBW=3KHz, VBW=10KHz, Sweep time = Auto.

8.1.2 DEVIATION FROM STANDARD

No deviation.

8.1.3 TEST SETUP



8.1.4 EUT OPERATION CONDITIONS

The EUT was programmed to be in continuously transmitting mode.

8.1.5 EUT TEST CONDITIONS

Temperature: 25°C Relative Humidity: 55% Test Voltage: AC 120V/60Hz

8.1.6 TEST RESULTS

Please refer to the Attachment H.

9. MEASUREMENT INSTRUMENTS LIST

Conducted Emission Measurement					
Item	Kind of Equipment	Manufacturer	Type No.	Serial No.	Calibrated until
1	LISN	EMCO	3816/2	0052765	Mar. 27, 2017
2	LISN	R&S	ENV216	101447	Mar. 27, 2017
3	Test Cable	emci	RG223(9KHz-30MHz)	C_17	Mar. 10, 2017
4	EMI Test Receiver	R&S	ESCI	100382	Mar. 27, 2017
5	50Ω Terminator	SHX	TF2-3G-A	08122901	Mar. 27, 2017
6	Measurement Software	Farad	EZ-EMC Ver.NB-03A1-01	N/A	N/A

Radiated Emission Measurement					
Item	Kind of Equipment	Manufacturer	Type No.	Serial No.	Calibrated until
1	Antenna	Schwarzbeck	VULB9160	9160-3232	Mar. 27, 2017
2	Amplifier	HP	8447D	2944A09673	Nov. 09, 2016
3	Receiver	AGILENT	N9038A	MY52130039	Sep. 04, 2017
4	Test Cable	emci	LMR-400(30MHz-1GHz)	C-01	Jun. 26, 2017
5	Control	CT	SC100	N/A	N/A
6	Position Control	MF	MF-7802	MF780208416	N/A
7	Antenna	ETS	3115	00075789	Mar. 27, 2017
8	Amplifier	Agilent	8449B	3008A02274	Mar. 10, 2017
9	Receiver	AGILENT	N9038A	MY52130039	Sep. 04, 2017
10	Test Cable	emci	EMC104-SM-SM-10000(1GHz-26.5GHz)	C-68	Jun. 26, 2017
11	Controller	CT	SC100	N/A	N/A
12	Broad-Band Horn Antenna	Schwarzbeck	BBHA 9170	9170319	Apr. 23, 2017
13	Microwave Pre-amplifier With Adaptor	EMC INSTRUMENT	EMC2654045	980039 & HA01	Mar. 27, 2017
14	Active Loop Antenna	R&S	HFH2-Z2	830749/020	Sep. 06, 2017
15	Measurement Software	Farad	EZ-EMC Ver.NB-03A1-01	N/A	N/A

6dB Bandwidth Measurement					
Item	Kind of Equipment	Manufacturer	Type No.	Serial No.	Calibrated until
1	Spectrum Analyzer	R&S	FSP 40	100185	Sep. 04, 2017

Peak Output Power Measurement					
Item	Kind of Equipment	Manufacturer	Type No.	Serial No.	Calibrated until
1	P-series Power meter	Agilent	N1911A	MY45100473	Sep. 04, 2017
2	Wireband Power sensor	Agilent	N1921A	MY51100041	Sep. 04, 2017

Antenna Conducted Spurious Emission Measurement					
Item	Kind of Equipment	Manufacturer	Type No.	Serial No.	Calibrated until
1	Spectrum Analyzer	R&S	FSP 40	100185	Sep. 04, 2017

Power Spectral Density Measurement					
Item	Kind of Equipment	Manufacturer	Type No.	Serial No.	Calibrated until
1	Spectrum Analyzer	R&S	FSP 40	100185	Sep. 04, 2017

Remark: "N/A" denotes no model name, serial no. or calibration specified.
 All calibration period of equipment list is one year.

ATTACHMENT A - CONDUCTED EMISSION

Test Mode : TX Mode

Line

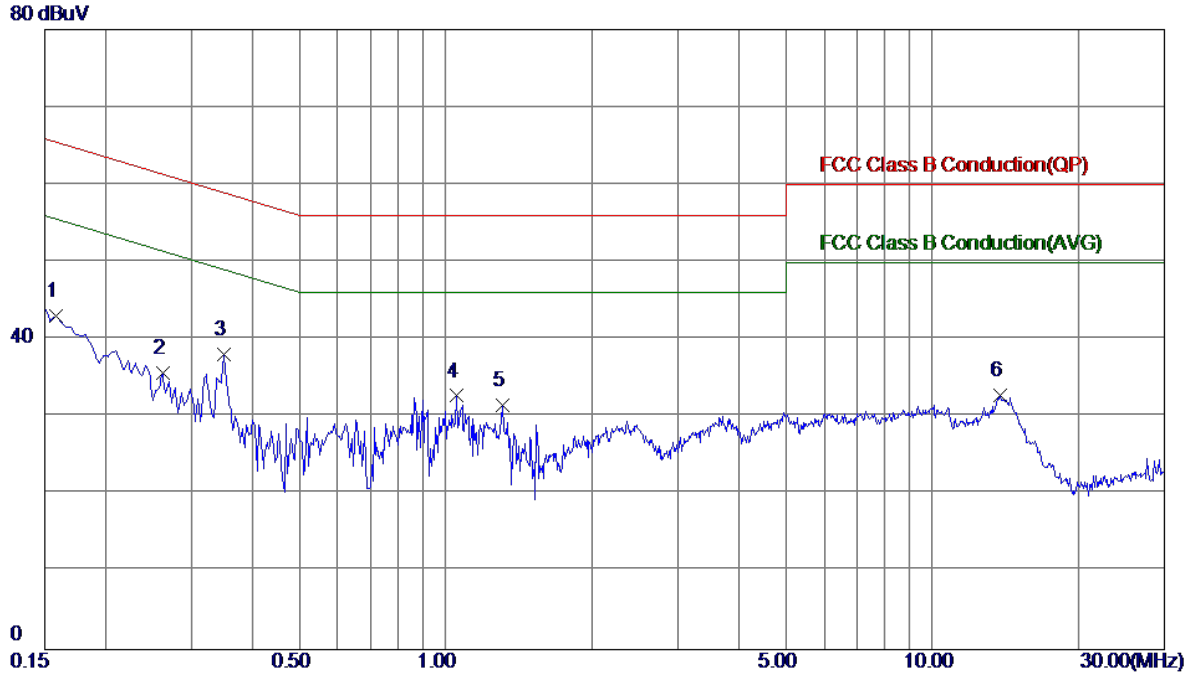

No.	Freq. MHz	Reading Level dBuV	Correct Factor dB	Measure ment dBuV	Limit dBuV	Margin dB	Detector	Comment
1	0.1580	33.57	9.52	43.09	65.57	-22.48	Peak	
2	0.2620	26.09	9.53	35.62	61.37	-25.75	Peak	
3 *	0.3500	28.61	9.53	38.14	58.96	-20.82	Peak	
4	1.0500	22.96	9.76	32.72	56.00	-23.28	Peak	
5	1.3060	21.67	9.80	31.47	56.00	-24.53	Peak	
6	13.8300	22.55	10.32	32.87	60.00	-27.13	Peak	

Test Mode : TX Mode

Neutral

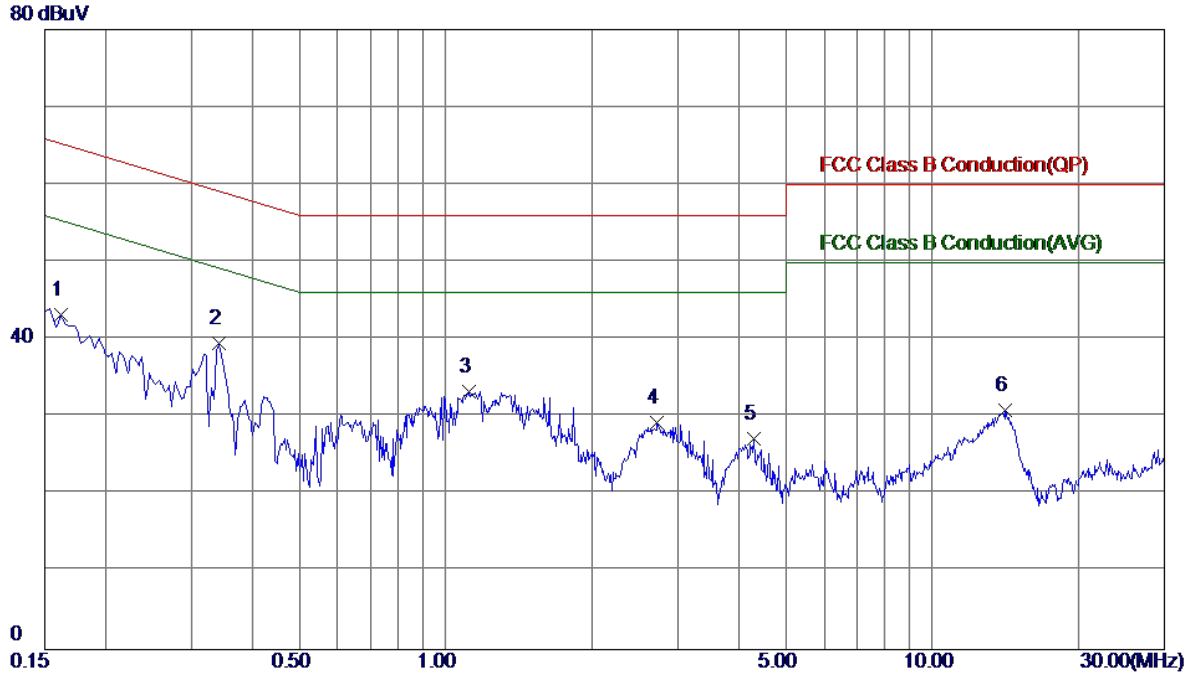

No.	Freq. MHz	Reading Level dBuV	Correct Factor dB	Measure ment dBuV	Limit dBuV	Margin dB	Detector	Comment
1	0.1620	33.75	9.46	43.21	65.36	-22.15	Peak	
2 *	0.3420	29.92	9.53	39.45	59.15	-19.70	Peak	
3	1.1180	23.58	9.66	33.24	56.00	-22.76	Peak	
4	2.7220	19.53	9.79	29.32	56.00	-26.68	Peak	
5	4.3020	17.21	9.92	27.13	56.00	-28.87	Peak	
6	14.1540	20.48	10.35	30.83	60.00	-29.17	Peak	

ATTACHMENT B - RADIATED EMISSION (9KHZ TO 30MHZ)

Test Mode: TX B MODE CHANNEL 01

Ant 0°

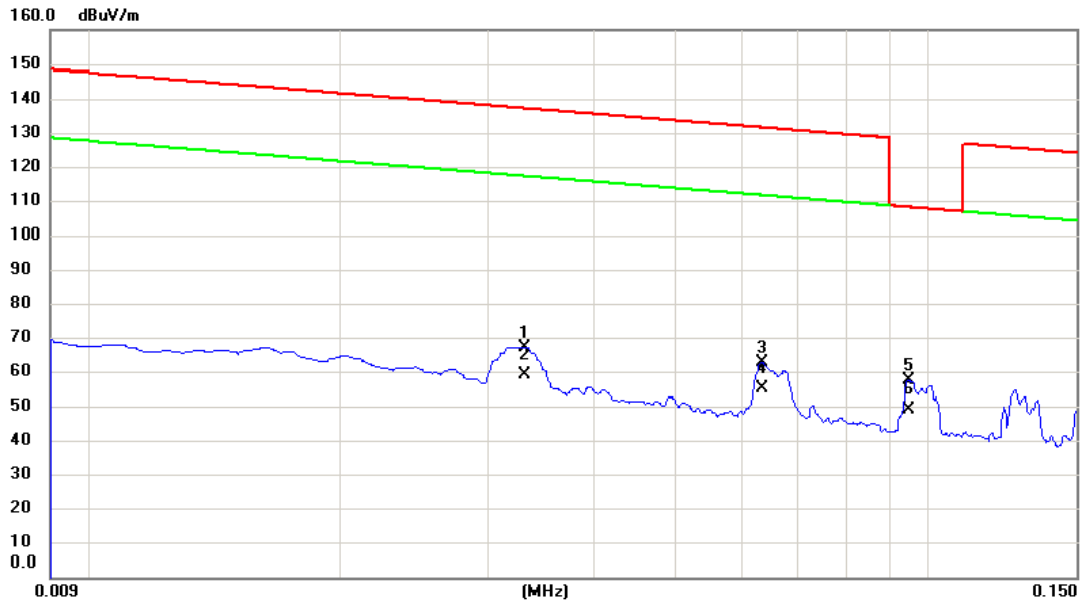

No.	Mk.	Freq. MHz	Reading Level dBuV	Correct Factor dB	Measure- ment dBuV/m	Limit dBuV/m	Margin dB	Detector	Comment
1		0.033	45.26	21.90	67.16	137.21	-70.05	peak	
2		0.033	37.11	21.90	59.01	117.21	-58.20	AVG	
3		0.063	43.04	19.67	62.71	131.56	-68.85	peak	
4		0.063	35.24	19.67	54.91	111.56	-56.65	AVG	
5	*	0.095	38.79	18.66	57.45	108.08	-50.63	peak	
6		0.095	30.45	18.66	49.11	108.08	-58.97	AVG	

Test Mode: TX B MODE CHANNEL 01

Ant 0°

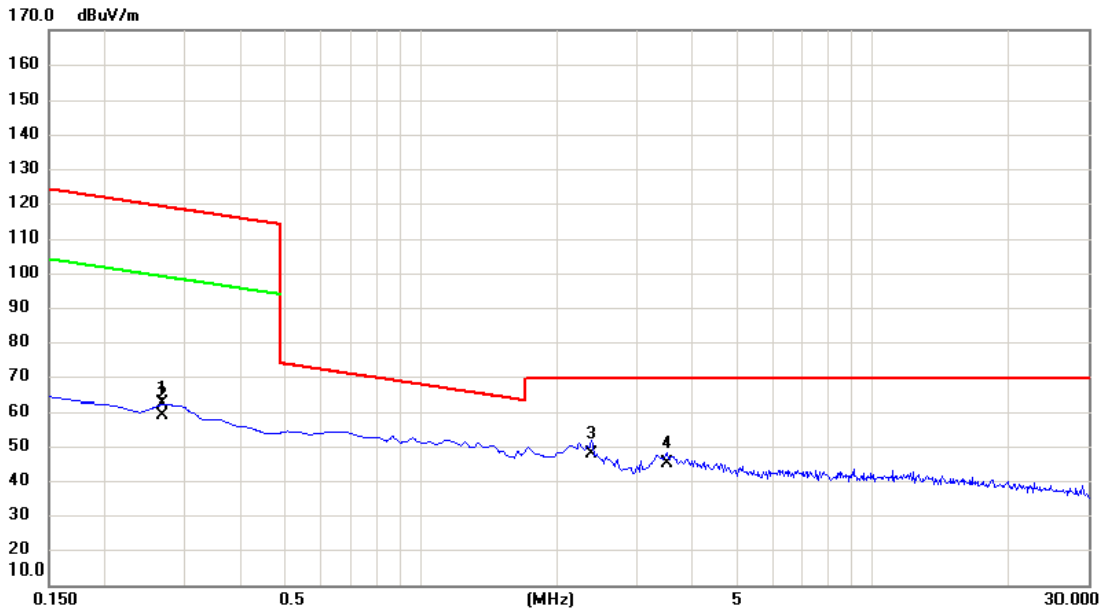

No.	Mk.	Freq. MHz	Reading Level dBuV	Correct Factor dB	Measure- ment dBuV/m	Limit dBuV/m	Margin dB	Detector	Comment
1		0.269	43.70	18.63	62.33	119.00	-56.67	peak	
2		0.269	40.22	18.63	58.85	99.00	-40.15	AVG	
3	*	2.389	30.37	17.40	47.77	69.54	-21.77	QP	
4		3.523	27.32	17.74	45.06	69.54	-24.48	QP	

Test Mode: TX B MODE CHANNEL 01

Ant 90°

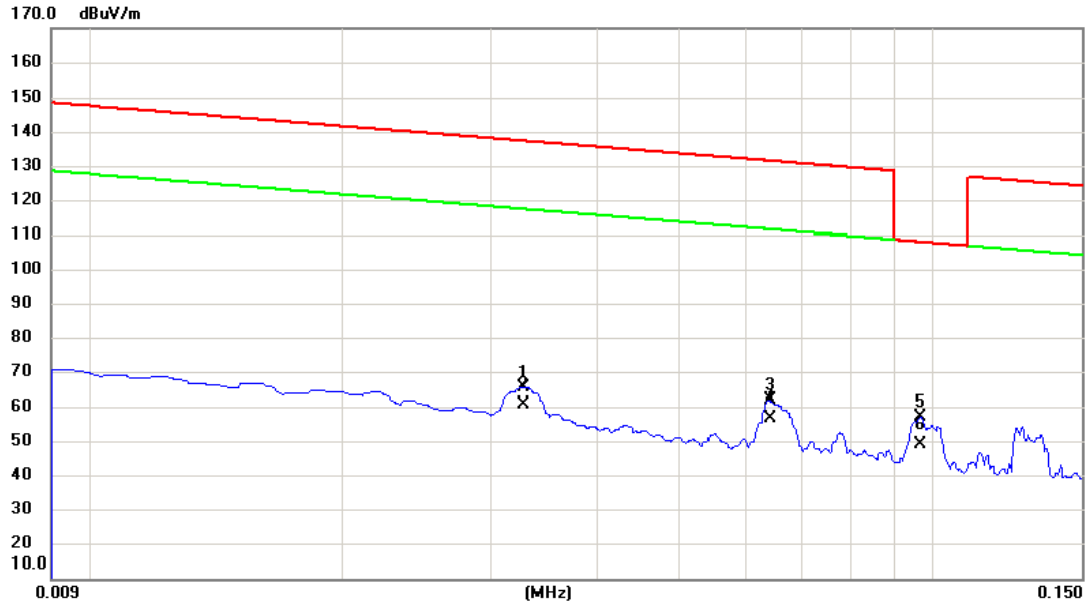

No. Mk.	Freq. MHz	Reading Level dBuV	Correct Factor dB	Measurement dBuV/m	Limit dBuV/m	Margin dB	Detector	Comment
1	0.033	43.51	21.94	65.45	137.29	-71.84	peak	
2	0.033	38.78	21.94	60.72	117.29	-56.57	AVG	
3	0.064	42.13	19.66	61.79	131.47	-69.68	peak	
4	0.064	37.11	19.66	56.77	111.47	-54.70	AVG	
5 *	0.097	38.56	18.58	57.14	107.90	-50.76	peak	
6	0.097	30.58	18.58	49.16	107.90	-58.74	AVG	

Test Mode: TX B MODE CHANNEL 01

Ant 90°

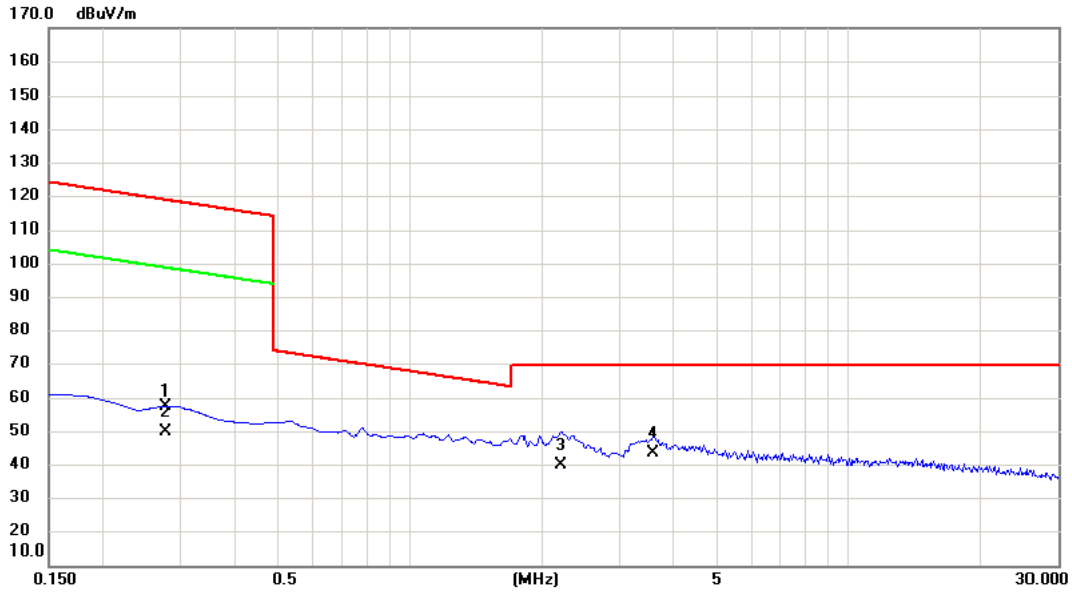

No.	Mk.	Freq. MHz	Reading Level dBuV	Correct Factor dB	Measure- ment dBuV/m	Limit dBuV/m	Margin dB	Detector	Comment
1		0.279	38.68	18.62	57.30	118.70	-61.40	peak	
2		0.279	31.24	18.62	49.86	98.70	-48.84	AVG	
3		2.210	22.34	17.64	39.98	69.54	-29.56	QP	
4	*	3.583	25.49	17.86	43.35	69.54	-26.19	QP	

ATTACHMENT C - RADIATED EMISSION (30MHZ TO 1000MHZ)

Test Mode: TX B MODE CHANNEL 01

Vertical

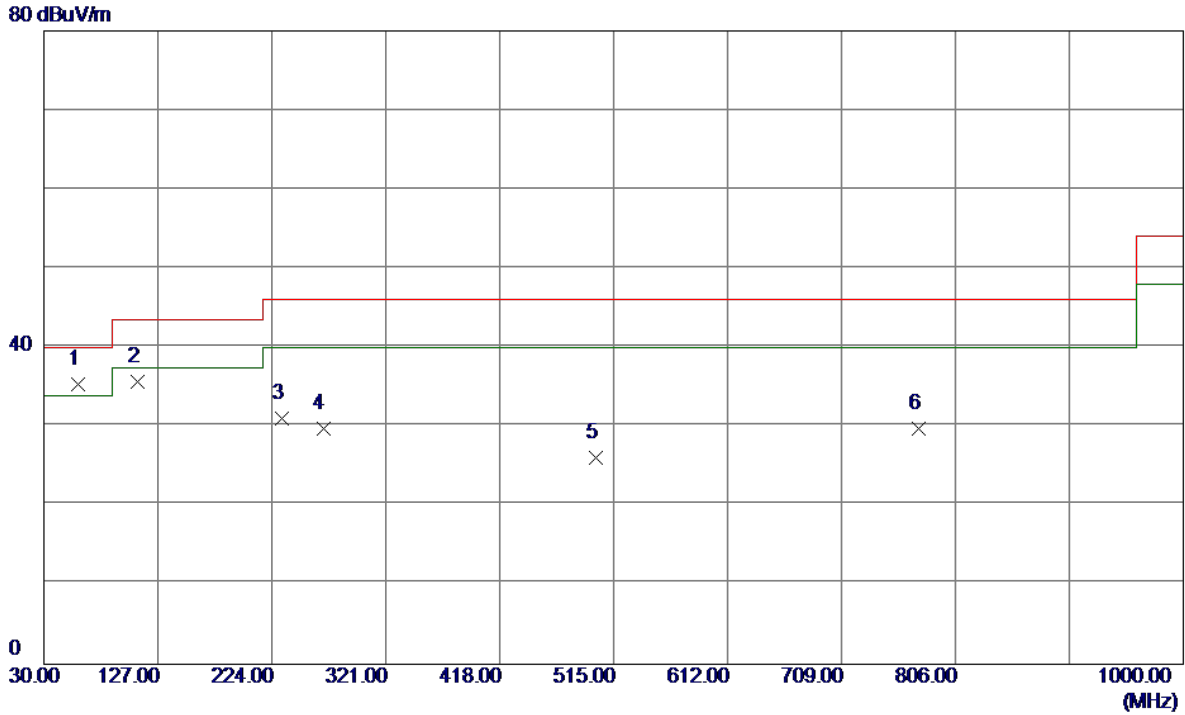

No.	Freq. MHz	Reading Level dBuV/m	Correct Factor dB	Measure ment dBuV/m	Limit dBuV/m	Margin dB	Detector	Comment
1 *	59.1000	49.13	-13.77	35.36	40.00	-4.64	Peak	
2	109.5400	50.38	-14.69	35.69	43.50	-7.81	Peak	
3	232.2450	44.52	-13.46	31.06	46.00	-14.94	Peak	
4	267.6500	43.35	-13.61	29.74	46.00	-16.26	Peak	
5	499.9650	35.77	-9.72	26.05	46.00	-19.95	Peak	
6	774.9600	30.59	-0.86	29.73	46.00	-16.27	Peak	

Test Mode: TX B MODE CHANNEL 01

Horizontal

80 dBuV/m

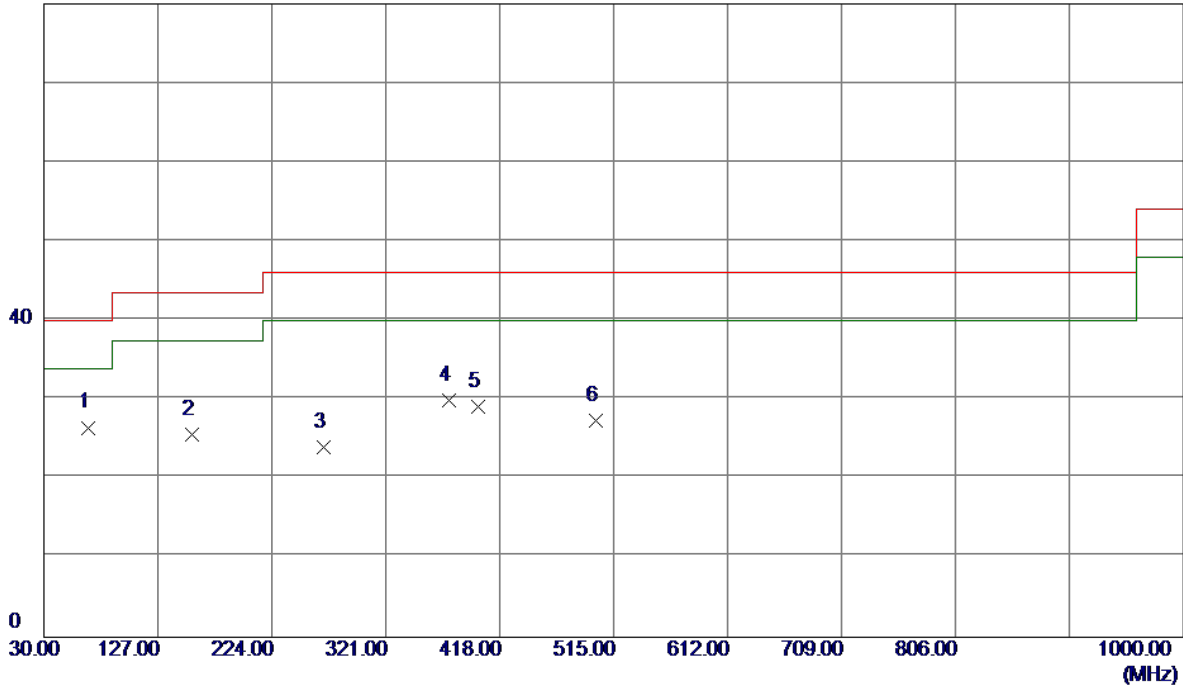

No.	Freq. MHz	Reading Level dBuV/m	Correct Factor dB	Measure ment dBuV/m	Limit dBuV/m	Margin dB	Detector	Comment
1 *	67.8300	42.42	-15.94	26.48	40.00	-13.52	Peak	
2	156.5850	38.00	-12.42	25.58	43.50	-17.92	Peak	
3	268.6200	37.48	-13.53	23.95	46.00	-22.05	Peak	
4	374.8350	39.45	-9.51	29.94	46.00	-16.06	Peak	
5	400.0550	36.97	-7.78	29.19	46.00	-16.81	Peak	
6	499.9650	37.02	-9.72	27.30	46.00	-18.70	Peak	

Test Mode: TX B MODE CHANNEL 06

Vertical

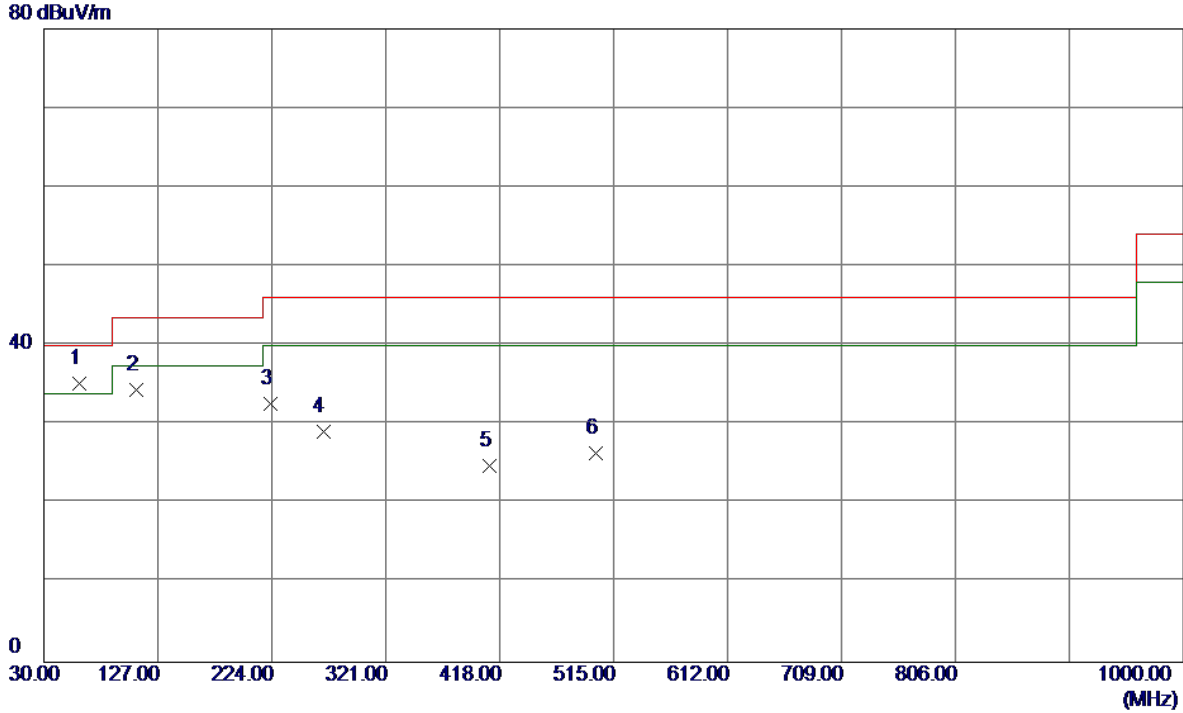

No.	Freq. MHz	Reading Level dBuV/m	Correct Factor dB	Measure ment dBuV/m	Limit dBuV/m	Margin dB	Detector	Comment
1 *	60.0700	48.96	-13.74	35.22	40.00	-4.78	Peak	
2	108.5700	49.13	-14.77	34.36	43.50	-9.14	Peak	
3	223.0300	46.67	-13.99	32.68	46.00	-13.32	Peak	
4	267.6500	42.71	-13.61	29.10	46.00	-16.90	Peak	
5	409.7550	32.68	-7.82	24.86	46.00	-21.14	Peak	
6	499.9650	36.05	-9.72	26.33	46.00	-19.67	Peak	

Test Mode: TX B MODE CHANNEL 06

Horizontal

80 dBuV/m

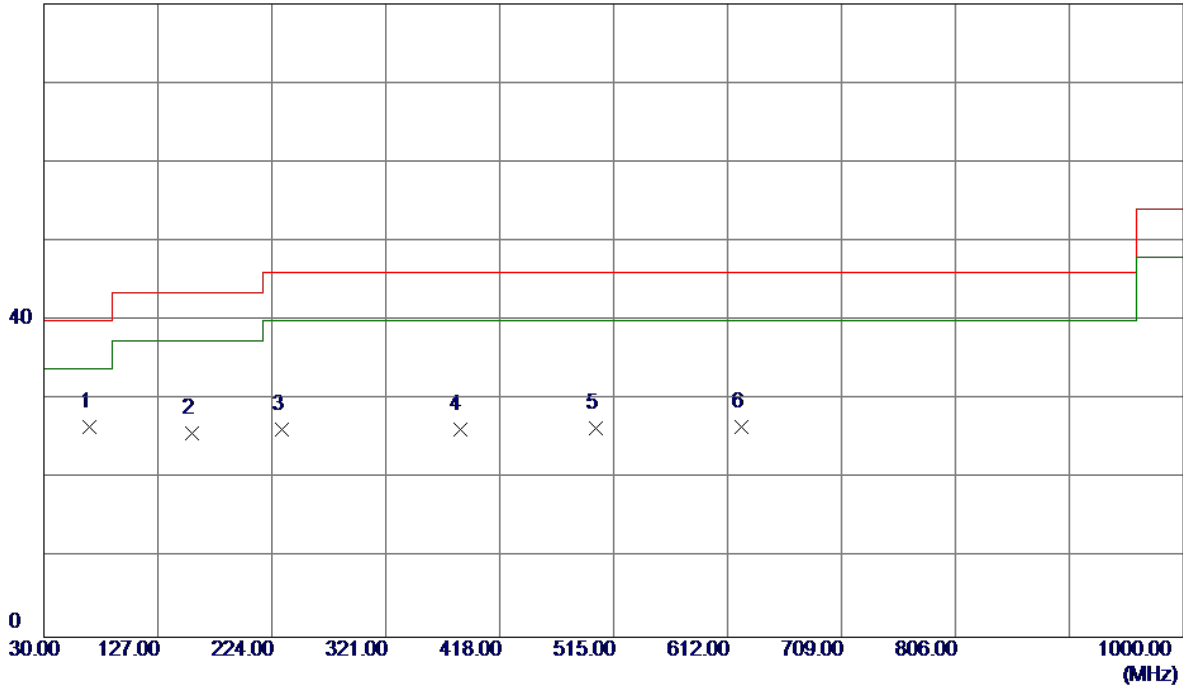

No.	Freq. MHz	Reading Level dBuV/m	Correct Factor dB	Measure ment dBuV/m	Limit dBuV/m	Margin dB	Detector	Comment
1 *	69.2850	42.96	-16.33	26.63	40.00	-13.37	Peak	
2	156.5850	38.20	-12.42	25.78	43.50	-17.72	Peak	
3	232.7300	39.71	-13.48	26.23	46.00	-19.77	Peak	
4	384.0500	35.12	-8.88	26.24	46.00	-19.76	Peak	
5	499.9650	36.14	-9.72	26.42	46.00	-19.58	Peak	
6	624.1250	32.21	-5.67	26.54	46.00	-19.46	Peak	

Test Mode: TX B MODE CHANNEL 11

Vertical

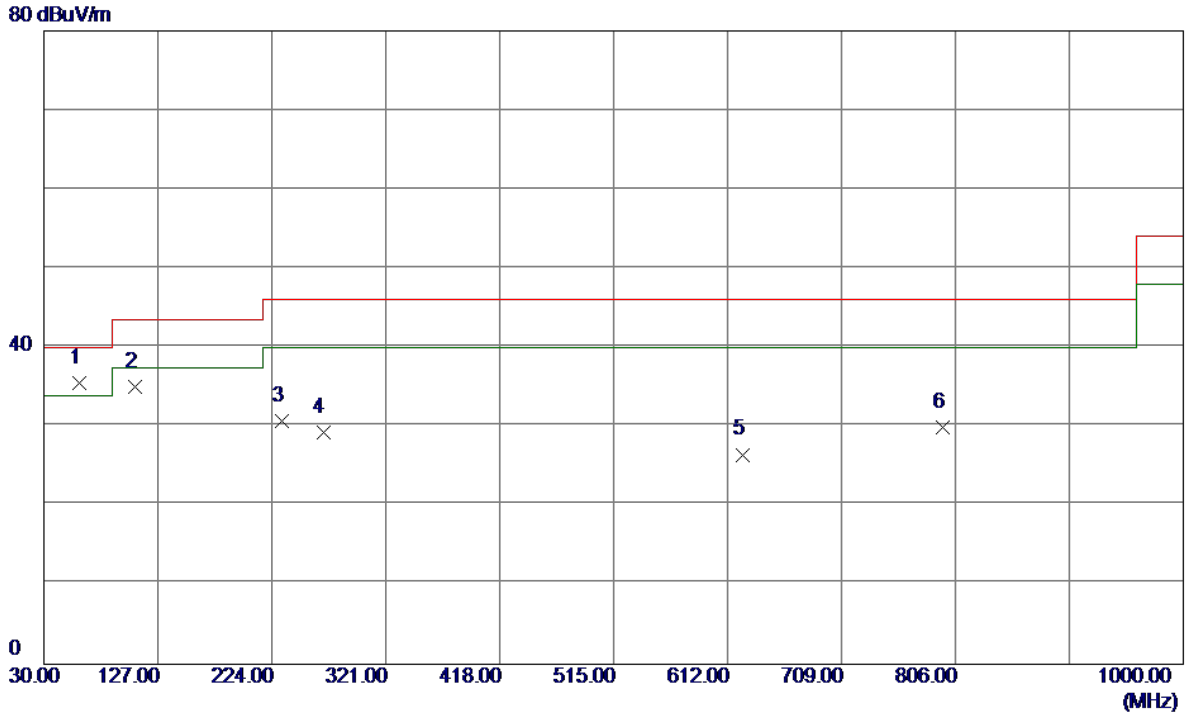

No.	Freq. MHz	Reading Level dBuV/m	Correct Factor dB	Measure ment dBuV/m	Limit dBuV/m	Margin dB	Detector	Comment
1 *	60.0700	49.29	-13.74	35.55	40.00	-4.45	Peak	
2	108.0850	49.80	-14.81	34.99	43.50	-8.51	Peak	
3	232.2450	44.13	-13.46	30.67	46.00	-15.33	Peak	
4	267.6500	42.84	-13.61	29.23	46.00	-16.77	Peak	
5	625.0949	32.09	-5.61	26.48	46.00	-19.52	Peak	
6	794.8449	29.82	0.03	29.85	46.00	-16.15	Peak	

Test Mode: TX B MODE CHANNEL 11

Horizontal

80 dBuV/m

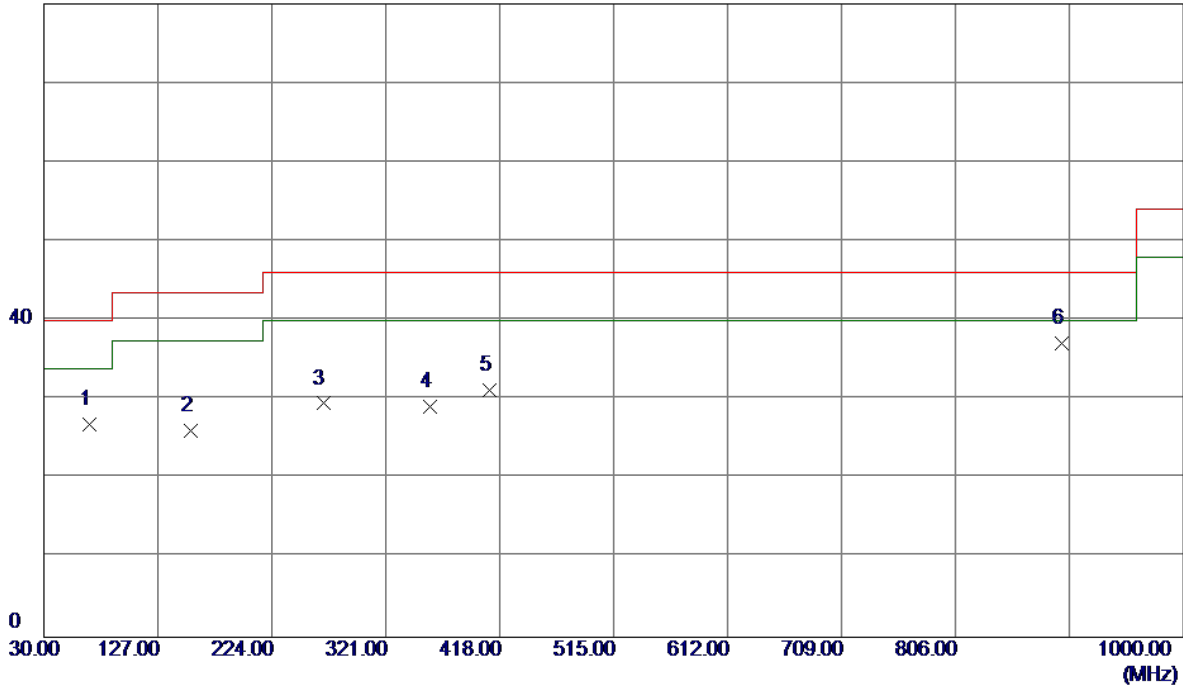

No.	Freq. MHz	Reading Level dBuV/m	Correct Factor dB	Measure ment dBuV/m	Limit dBuV/m	Margin dB	Detector	Comment
1	68.8000	43.12	-16.20	26.92	40.00	-13.08	Peak	
2	154.6450	38.60	-12.58	26.02	43.50	-17.48	Peak	
3	267.6500	43.13	-13.61	29.52	46.00	-16.48	Peak	
4	358.3450	39.84	-10.65	29.19	46.00	-16.81	Peak	
5	409.7550	39.00	-7.82	31.18	46.00	-14.82	Peak	
6 *	896.2100	34.75	2.35	37.10	46.00	-8.90	Peak	

ATTACHMENT D - RADIATED EMISSION (ABOVE 1000MHZ)

Orthogonal Axis :	X
Test Mode :	TX B MODE 2412MHz

Vertical

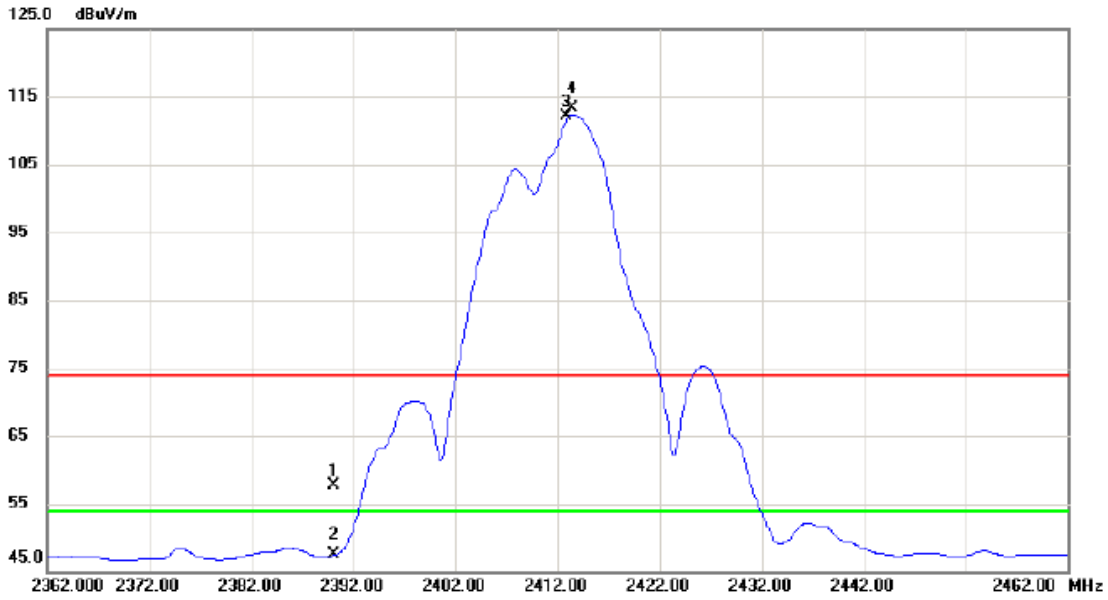

No.	Mk.	Freq.	Reading Level	Correct Factor	Measurement	Limit	Margin	Detector	Comment
		MHz	dBuV	dB	dBuV/m	dBuV/m	dB		
1		2390.000	24.67	33.01	57.68	74.00	-16.32	peak	
2		2390.000	14.41	33.01	47.42	54.00	-6.58	AVG	
3	X	2412.900	79.07	33.10	112.17	74.00	38.17	peak	NO LIMIT
4	*	2413.400	80.19	33.11	113.30	54.00	59.30	AVG	NO LIMIT

Orthogonal Axis :	X
Test Mode :	TX B MODE 2412MHz

Vertical



No.	Freq. MHz	Reading Level dBuV/m	Correct Factor dB	Measure ment dBuV/m	Limit dBuV/m	Margin dB	Detector	Comment
1	3215.9740	41.47	1.44	42.91	54.00	-11.09	AVG	
2	3215.9840	44.71	1.44	46.15	74.00	-27.85	Peak	
3	4823.9200	44.72	4.85	49.57	74.00	-24.43	Peak	
4 *	4823.9750	42.98	4.85	47.83	54.00	-6.17	AVG	

Orthogonal Axis :	X
Test Mode :	TX B MODE 2412MHz

Horizontal

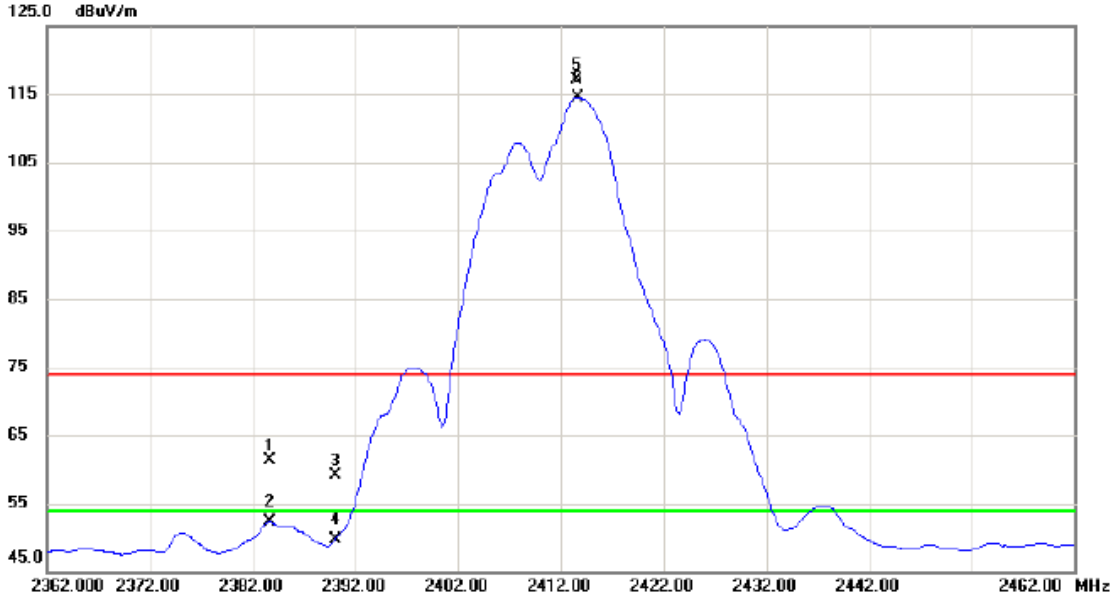

No.	Mk.	Freq. MHz	Reading Level dBuV	Correct Factor dB	Measure- ment dBuV/m	Limit dBuV/m	Margin dB	Detector	Comment
1		2383.700	28.36	32.99	61.35	74.00	-12.65	peak	
2		2383.700	19.26	32.99	52.25	54.00	-1.75	AVG	
3		2390.000	26.13	33.01	59.14	74.00	-14.86	peak	
4		2390.000	16.60	33.01	49.61	54.00	-4.39	AVG	
5	X	2413.500	84.00	33.11	117.11	74.00	43.11	peak	NO LIMIT
6	*	2413.700	81.42	33.11	114.53	54.00	60.53	AVG	NO LIMIT

Orthogonal Axis :	X
Test Mode :	TX B MODE 2412MHz

Horizontal



No.	Freq. MHz	Reading Level dBuV/m	Correct Factor dB	Measure ment dBuV/m	Limit dBuV/m	Margin dB	Detector	Comment
1 *	3215.9400	44.21	1.44	45.65	54.00	-8.35	AVG	
2	3216.0550	46.84	1.44	48.28	74.00	-25.72	Peak	
3	4823.9600	38.35	4.85	43.20	54.00	-10.80	AVG	
4	4824.0600	41.19	4.85	46.04	74.00	-27.96	Peak	

Orthogonal Axis :	X
Test Mode :	TX B MODE 2437MHz

Vertical

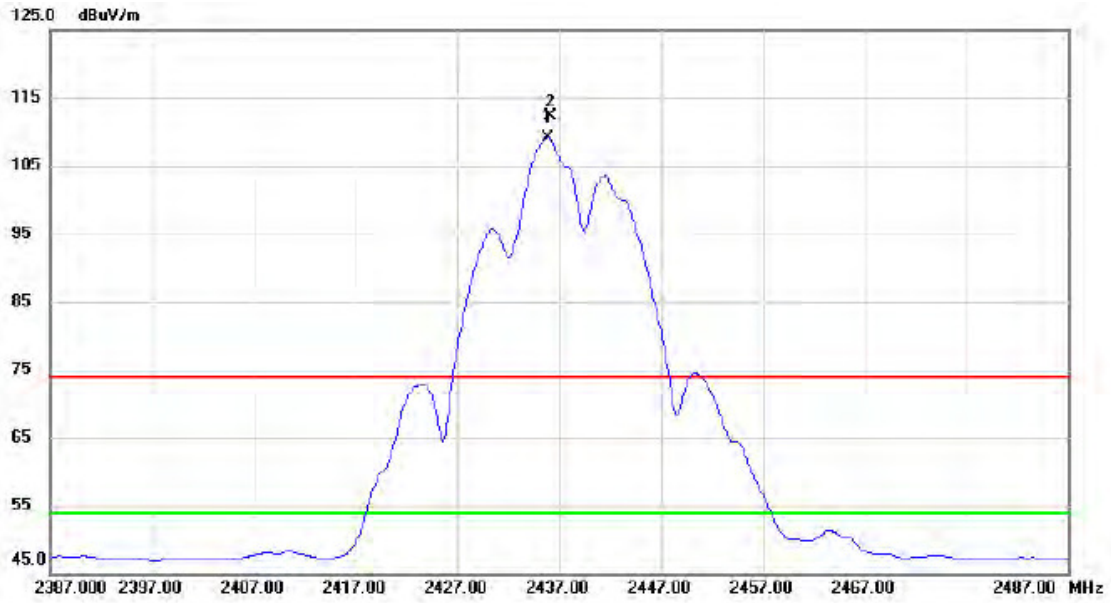

No.	Mk.	Freq.	Reading Level	Correct Factor	Measurement	Limit	Margin	Detector	Comment
		MHz	dBuV	dB	dBuV/m	dBuV/m	dB		
1	*	2435.900	76.00	33.20	109.20	54.00	55.20	AVG	NO LIMIT
2	X	2436.200	79.14	33.21	112.35	74.00	38.35	peak	NO LIMIT

Orthogonal Axis :	X
Test Mode :	TX B MODE 2437MHz

Vertical



No.	Freq. MHz	Reading Level dBuV/m	Correct Factor dB	Measure ment dBuV/m	Limit dBuV/m	Margin dB	Detector	Comment
1	3249.2540	41.96	1.42	43.38	74.00	-30.62	Peak	
2	3249.3040	37.62	1.42	39.04	54.00	-14.96	AVG	
3	4873.9550	40.40	5.07	45.47	74.00	-28.53	Peak	
4 *	4873.9550	37.79	5.07	42.86	54.00	-11.14	AVG	

Orthogonal Axis :	X
Test Mode :	TX B MODE 2437MHz

Horizontal

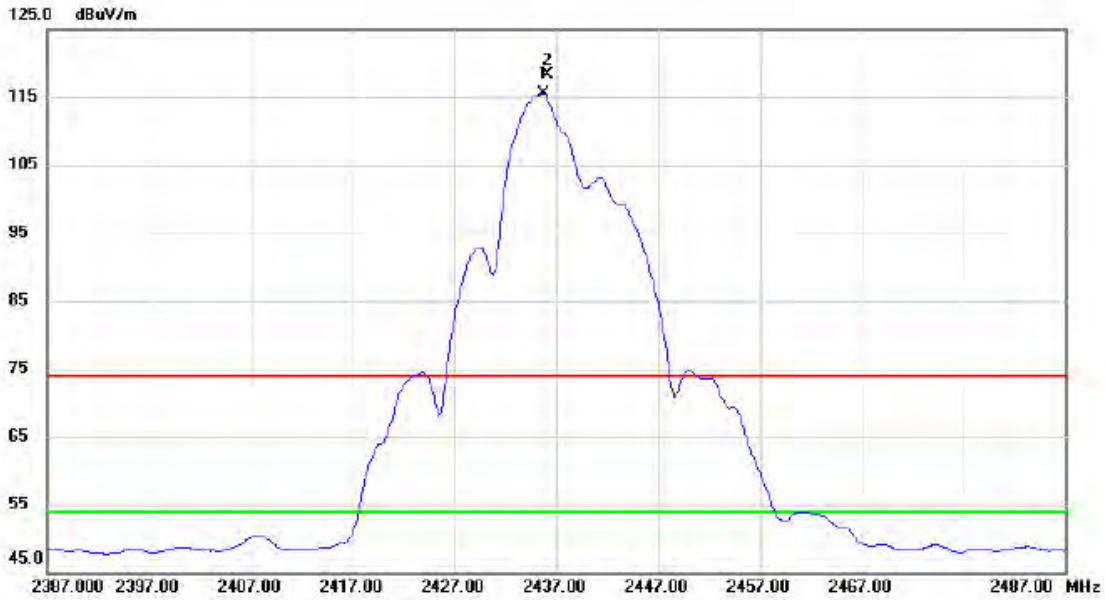

No.	Mk.	Freq.	Reading Level	Correct Factor	Measurement	Limit	Margin		
		MHz	dBuV	dB	dBuV/m	dBuV/m	dB	Detector	Comment
1	*	2435.700	82.35	33.20	115.55	54.00	61.55	AVG	NO LIMIT
2	X	2436.100	85.19	33.21	118.40	74.00	44.40	peak	NO LIMIT

Orthogonal Axis :	X
Test Mode :	TX B MODE 2437MHz

Horizontal



No.	Freq. MHz	Reading Level dBuV/m	Correct Factor dB	Measure ment dBuV/m	Limit dBuV/m	Margin dB	Detector	Comment
1	3249.2850	43.08	1.42	44.50	74.00	-29.50	Peak	
2	3249.3020	39.23	1.42	40.65	54.00	-13.35	AVG	
3	4873.9049	41.27	5.07	46.34	74.00	-27.66	Peak	
4 *	4873.9650	39.28	5.07	44.35	54.00	-9.65	AVG	

Orthogonal Axis :	X
Test Mode :	TX B MODE 2462MHz

Vertical

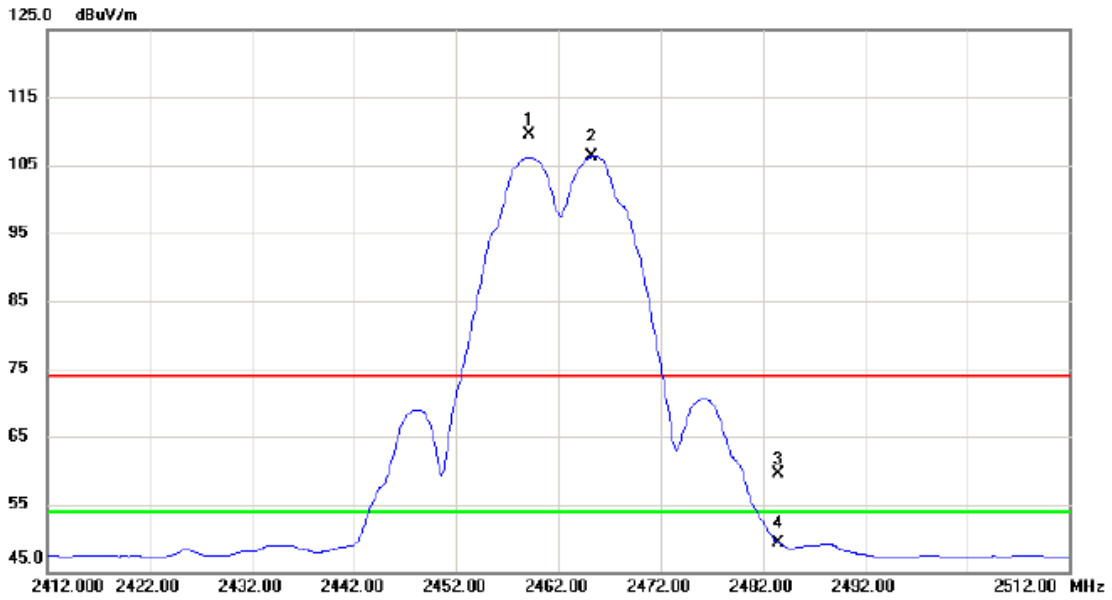

No.	Mk.	Freq. MHz	Reading Level dBuV	Correct Factor dB	Measure- ment dBuV/m	Limit dBuV/m	Margin dB	Detector	Comment
1	X	2459.200	76.15	33.30	109.45	74.00	35.45	peak	NO LIMIT
2	*	2465.300	72.96	33.33	106.29	54.00	52.29	AVG	NO LIMIT
3		2483.500	26.01	33.40	59.41	74.00	-14.59	peak	
4		2483.500	15.99	33.40	49.39	54.00	-4.61	AVG	

Orthogonal Axis :	X
Test Mode :	TX B MODE 2462MHz

Vertical

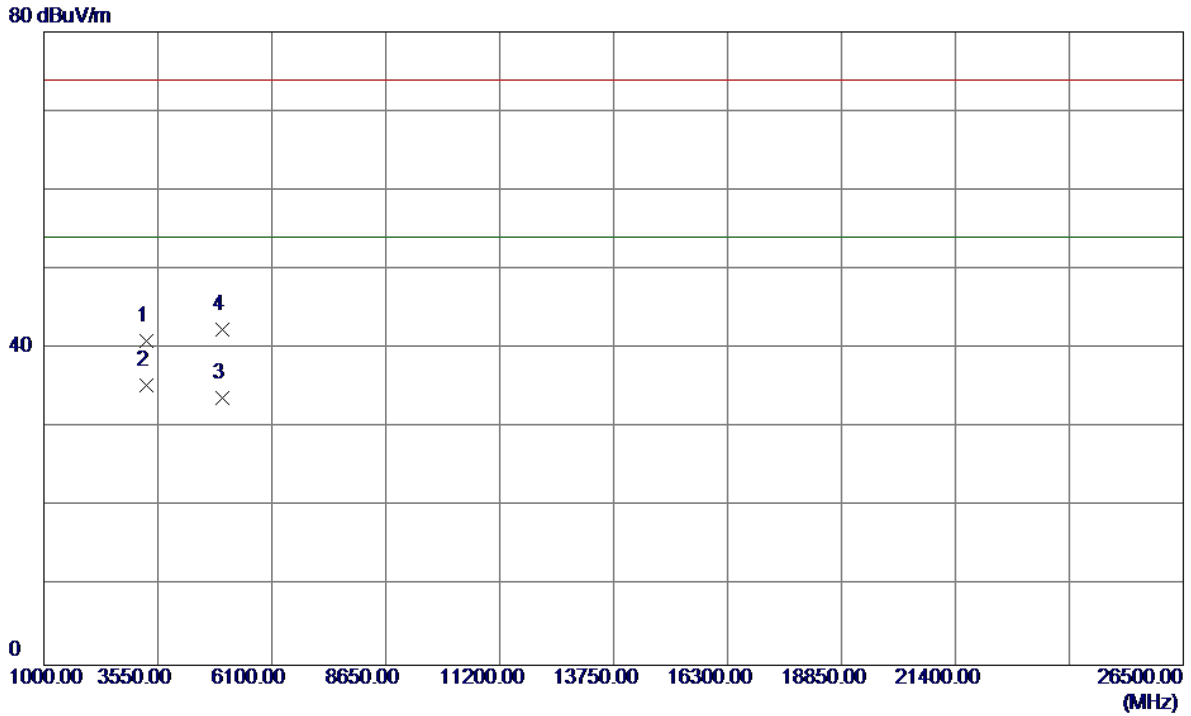

No.	Freq. MHz	Reading Level dBuV/m	Correct Factor dB	Measure ment dBuV/m	Limit dBuV/m	Margin dB	Detector	Comment
1	3282.5040	39.60	1.41	41.01	74.00	-32.99	Peak	
2 *	3282.6040	33.96	1.41	35.37	54.00	-18.63	AVG	
3	5000.1230	28.17	5.60	33.77	54.00	-20.23	AVG	
4	5000.2340	36.84	5.60	42.44	74.00	-31.56	Peak	

Orthogonal Axis :	X
Test Mode :	TX B MODE 2462MHz

Horizontal

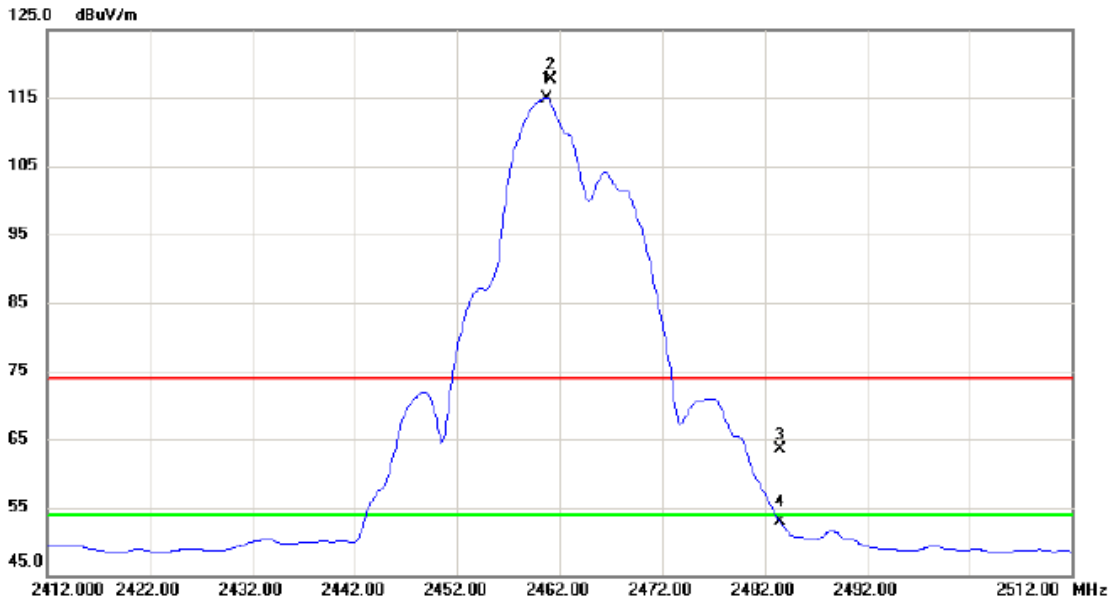

No.	Mk.	Freq. MHz	Reading Level dBuV	Correct Factor dB	Measure- ment dBuV/m	Limit dBuV/m	Margin dB	Detector	Comment
1	*	2460.700	81.66	33.30	114.96	54.00	60.96	AVG	NO LIMIT
2	X	2461.100	84.39	33.31	117.70	74.00	43.70	peak	NO LIMIT
3		2483.500	30.04	33.40	63.44	74.00	-10.56	peak	
4		2483.500	19.59	33.40	52.99	54.00	-1.01	AVG	

Orthogonal Axis :	X
Test Mode :	TX B MODE 2462MHz

Horizontal

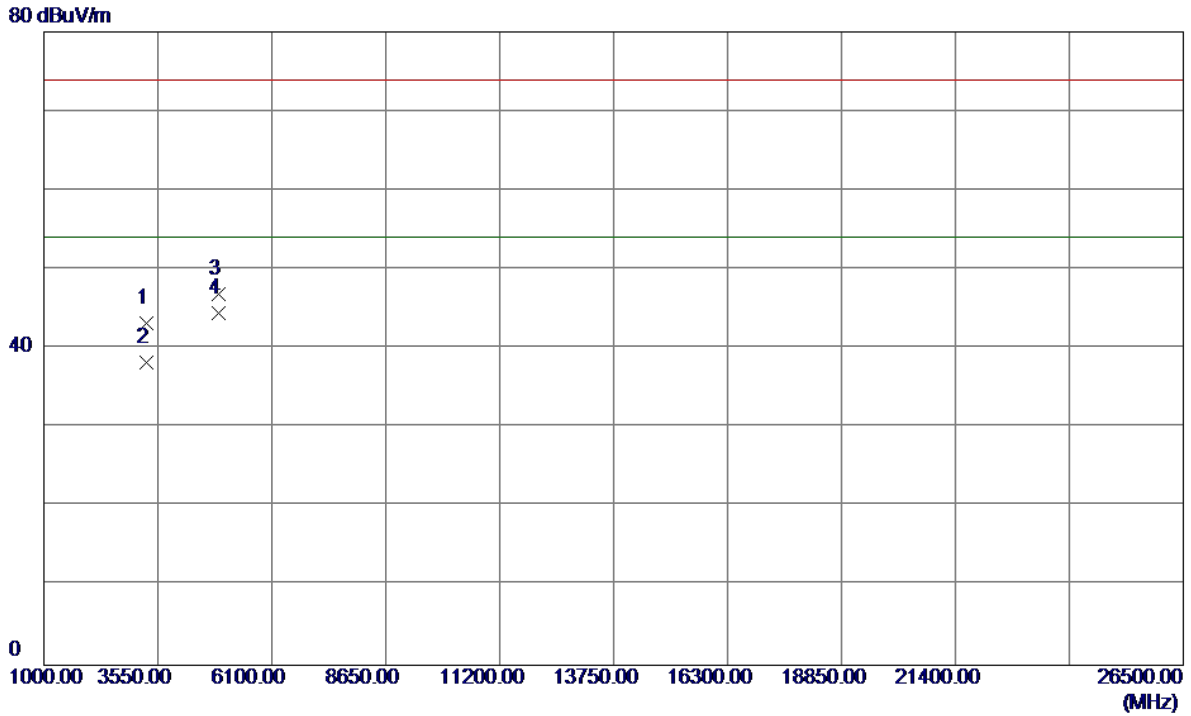

No.	Freq. MHz	Reading Level dBuV/m	Correct Factor dB	Measure ment dBuV/m	Limit dBuV/m	Margin dB	Detector	Comment
1	3282.5480	41.81	1.41	43.22	74.00	-30.78	Peak	
2	3282.6350	36.76	1.41	38.17	54.00	-15.83	AVG	
3	4923.7950	41.67	5.28	46.95	74.00	-27.05	Peak	
4 *	4923.9650	39.25	5.28	44.53	54.00	-9.47	AVG	

Orthogonal Axis :	X
Test Mode :	TX G MODE 2412MHz

Vertical

120 dBuV/m

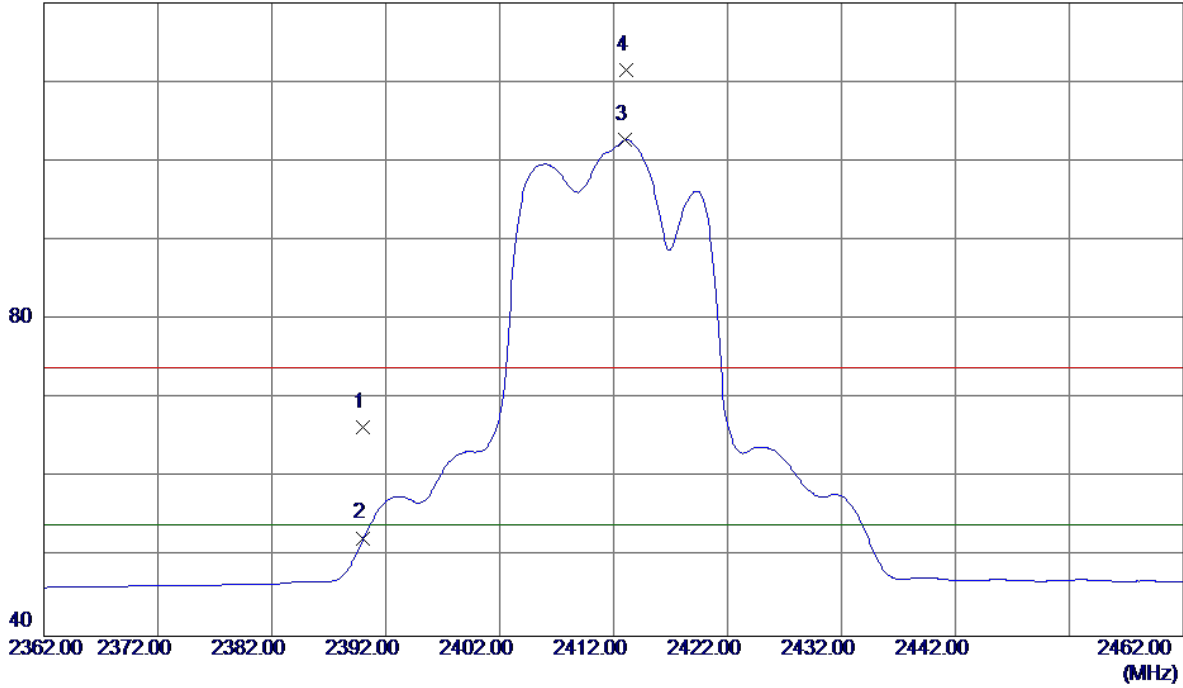

No.	Freq. MHz	Reading Level dBuV/m	Correct Factor dB	Measure ment dBuV/m	Limit dBuV/m	Margin dB	Detector	Comment
1	2390.0000	33.37	33.01	66.38	74.00	-7.62	Peak	
2	2390.0000	19.39	33.01	52.40	54.00	-1.60	AVG	
3 *	2413.0500	69.61	33.11	102.72	54.00	48.72	AVG	No Limit
4	2413.1000	78.43	33.11	111.54	74.00	37.54	Peak	No Limit

Orthogonal Axis :	X
Test Mode :	TX G MODE 2412MHz

Vertical

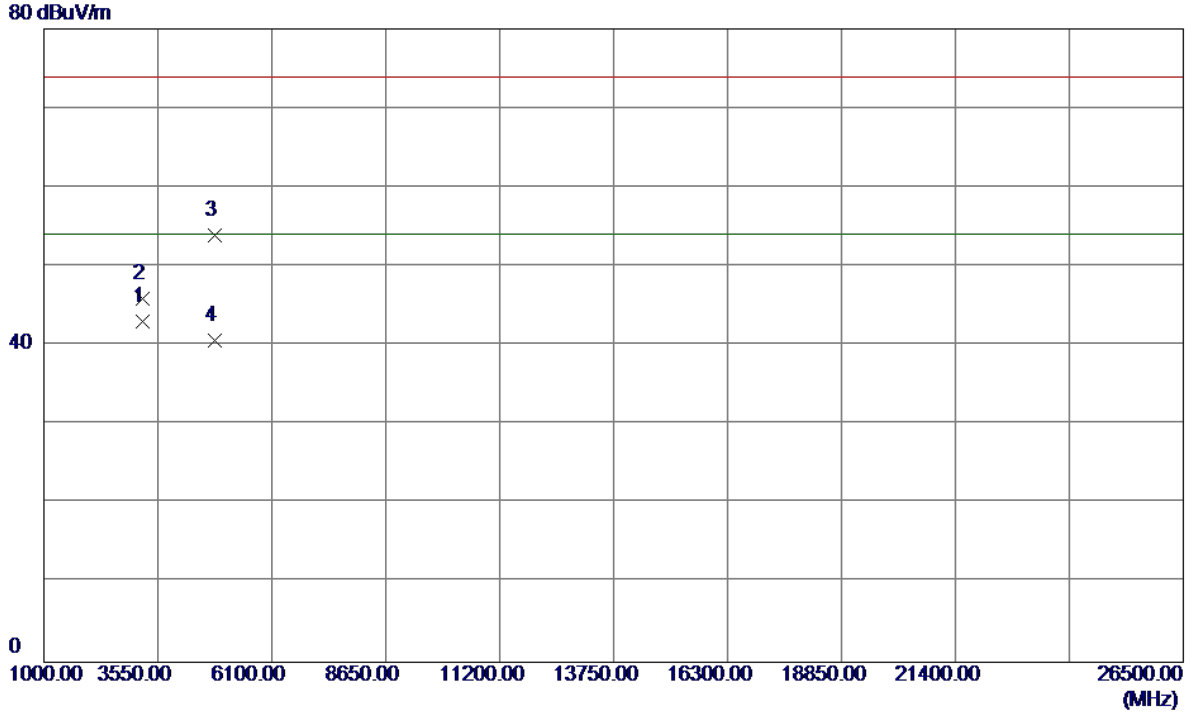

No.	Freq. MHz	Reading Level dBuV/m	Correct Factor dB	Measure ment dBuV/m	Limit dBuV/m	Margin dB	Detector	Comment
1 *	3216.0100	41.57	1.44	43.01	54.00	-10.99	AVG	
2	3216.1220	44.55	1.44	45.99	74.00	-28.01	Peak	
3	4820.3000	49.04	4.84	53.88	74.00	-20.12	Peak	
4	4820.4750	35.85	4.84	40.69	54.00	-13.31	AVG	

Orthogonal Axis :	X
Test Mode :	TX G MODE 2412MHz

Horizontal

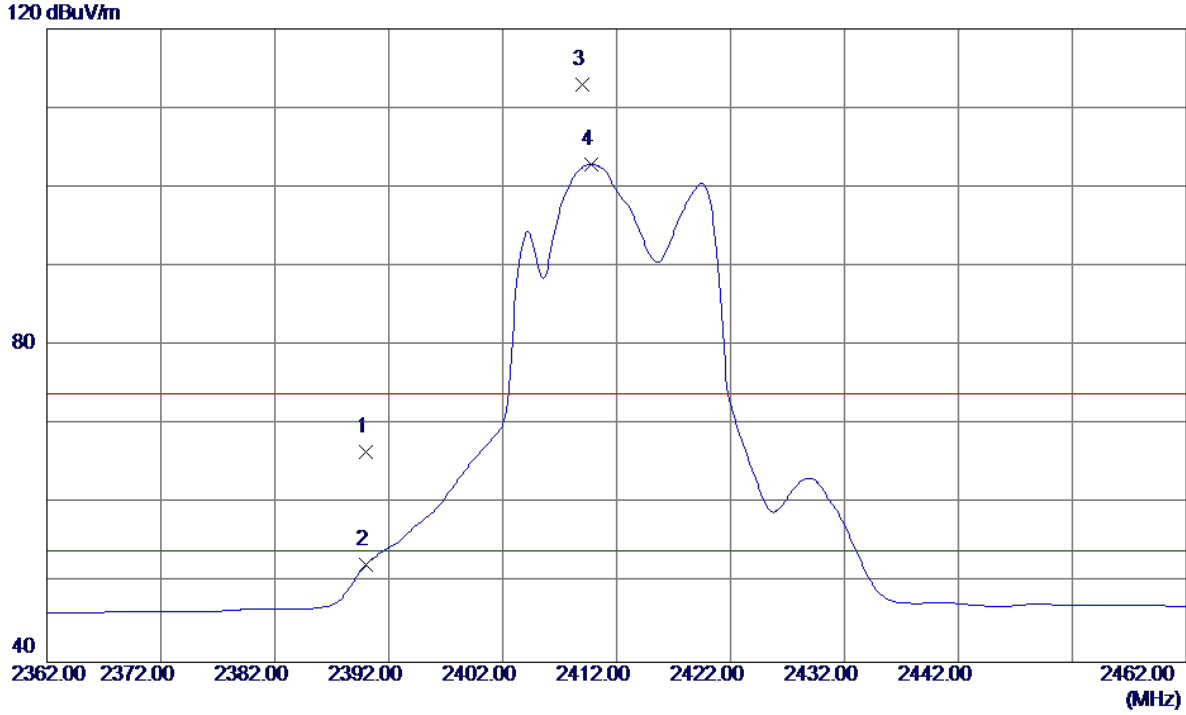

No.	Freq. MHz	Reading Level dBuV/m	Correct Factor dB	Measure ment dBuV/m	Limit dBuV/m	Margin dB	Detector	Comment
1	2390.0000	33.50	33.01	66.51	74.00	-7.49	Peak	
2	2390.0000	19.32	33.01	52.33	54.00	-1.67	AVG	
3	2408.9500	79.90	33.09	112.99	74.00	38.99	Peak	No Limit
4 *	2409.8000	69.77	33.09	102.86	54.00	48.86	AVG	No Limit

Orthogonal Axis :	X
Test Mode :	TX G MODE 2412MHz

Horizontal

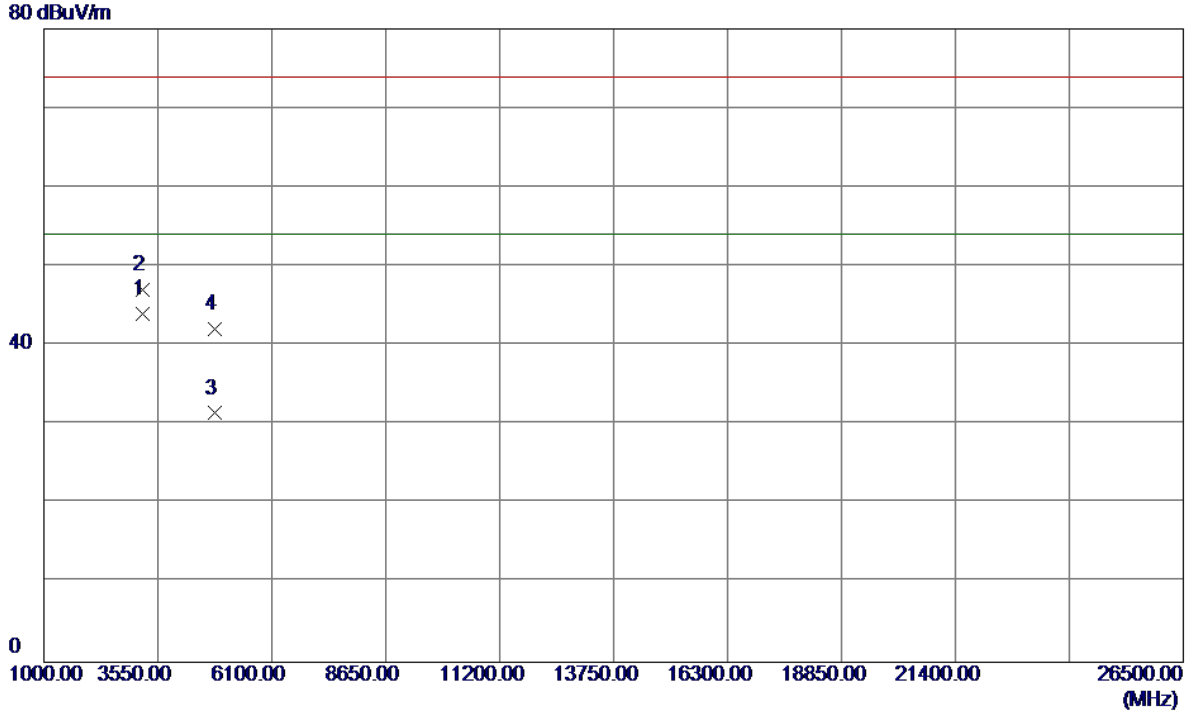

No.	Freq. MHz	Reading Level dBuV/m	Correct Factor dB	Measure ment dBuV/m	Limit dBuV/m	Margin dB	Detector	Comment
1 *	3215.9600	42.58	1.44	44.02	54.00	-9.98	AVG	
2	3215.9680	45.67	1.44	47.11	74.00	-26.89	Peak	
3	4821.1650	26.60	4.84	31.44	54.00	-22.56	AVG	
4	4821.6650	37.31	4.84	42.15	74.00	-31.85	Peak	

Orthogonal Axis :	X
Test Mode :	TX G MODE 2437MHz

Vertical

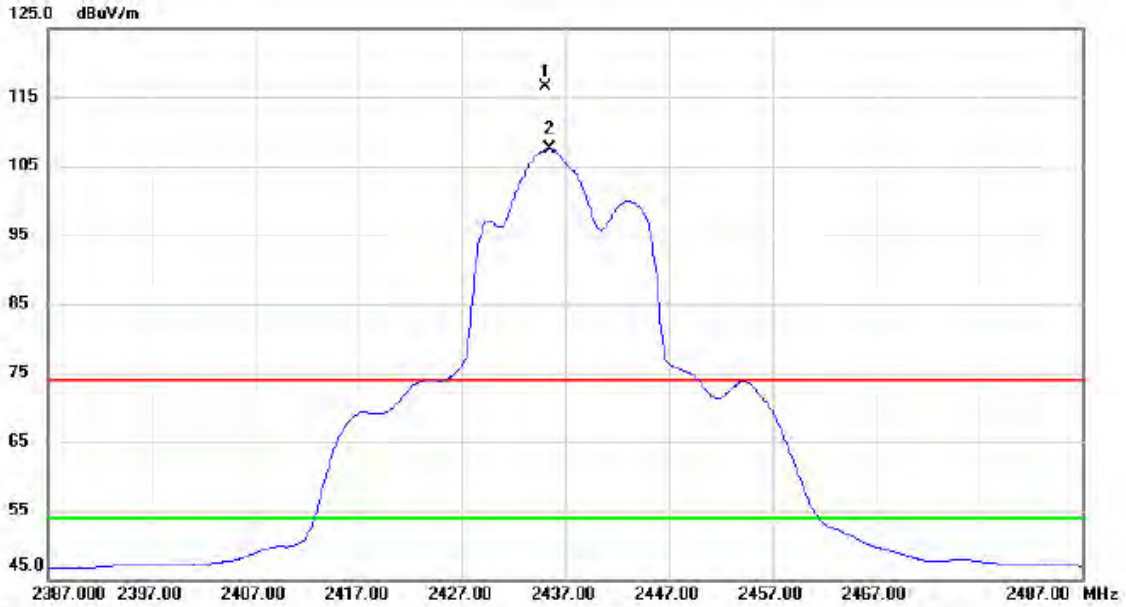

No.	Mk.	Freq. MHz	Reading Level dBuV	Correct Factor dB	Measure- ment dBuV/m	Limit dBuV/m	Margin dB	Detector	Comment
1	X	2435.100	83.35	33.20	116.55	74.00	42.55	peak	NO LIMIT
2	*	2435.500	74.25	33.20	107.45	54.00	53.45	AVG	NO LIMIT

Orthogonal Axis :	X
Test Mode :	TX G MODE 2437MHz

Vertical

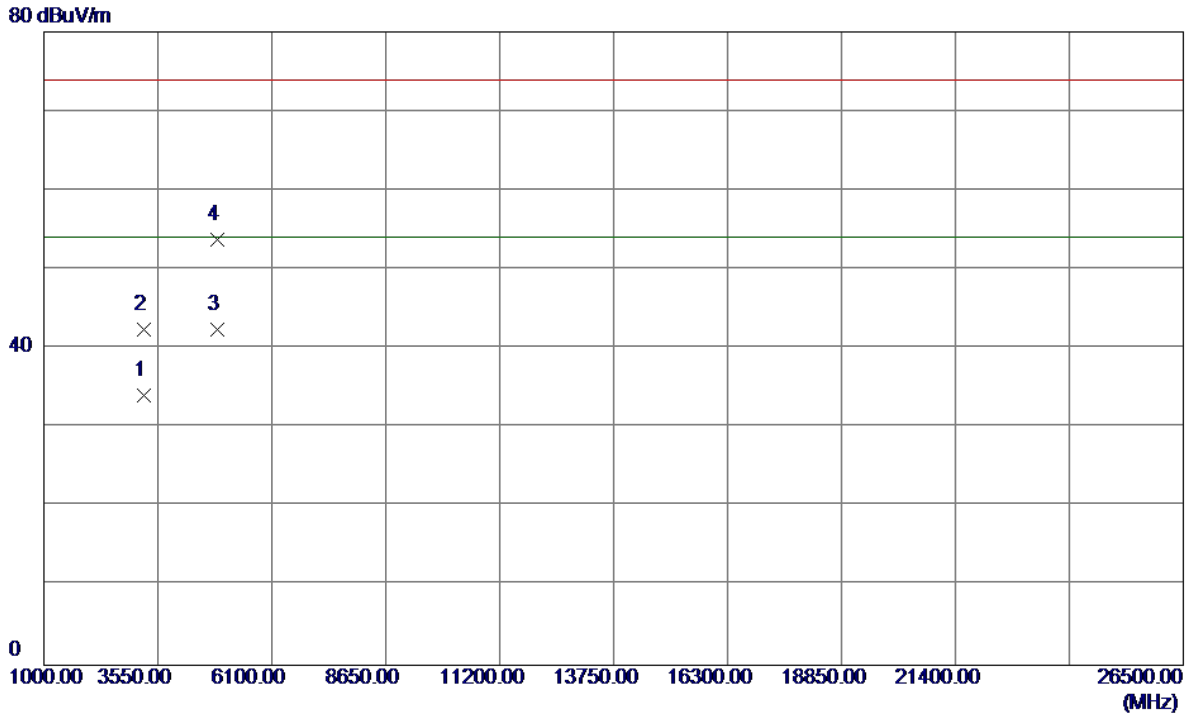

No.	Freq. MHz	Reading Level dBuV/m	Correct Factor dB	Measure ment dBuV/m	Limit dBuV/m	Margin dB	Detector	Comment
1	3249.3550	32.73	1.42	34.15	54.00	-19.85	AVG	
2	3249.3850	41.02	1.42	42.44	74.00	-31.56	Peak	
3 *	4871.6000	37.39	5.06	42.45	54.00	-11.55	AVG	
4	4871.9000	48.72	5.06	53.78	74.00	-20.22	Peak	

Orthogonal Axis :	X
Test Mode :	TX G MODE 2437MHz

Horizontal

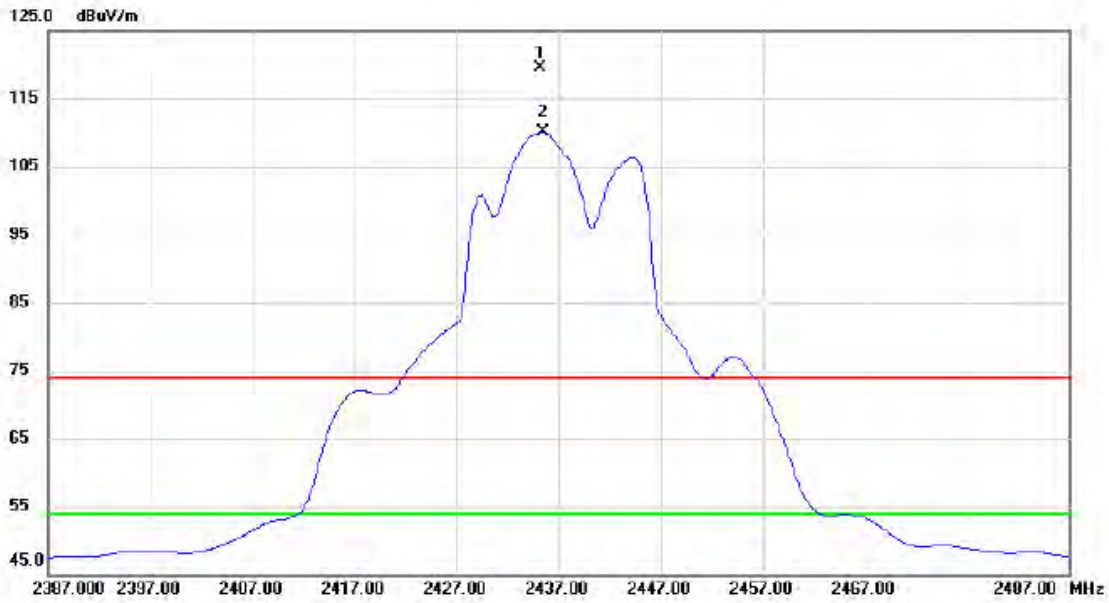

No.	Mk.	Freq. MHz	Reading Level dBuV	Correct Factor dB	Measure- ment dBuV/m	Limit dBuV/m	Margin dB	Detector	Comment
1	X	2435.200	86.32	33.20	119.52	74.00	45.52	peak	NO LIMIT
2	*	2435.400	76.88	33.20	110.08	54.00	56.08	AVG	NO LIMIT

Orthogonal Axis :	X
Test Mode :	TX G MODE 2437MHz

Horizontal

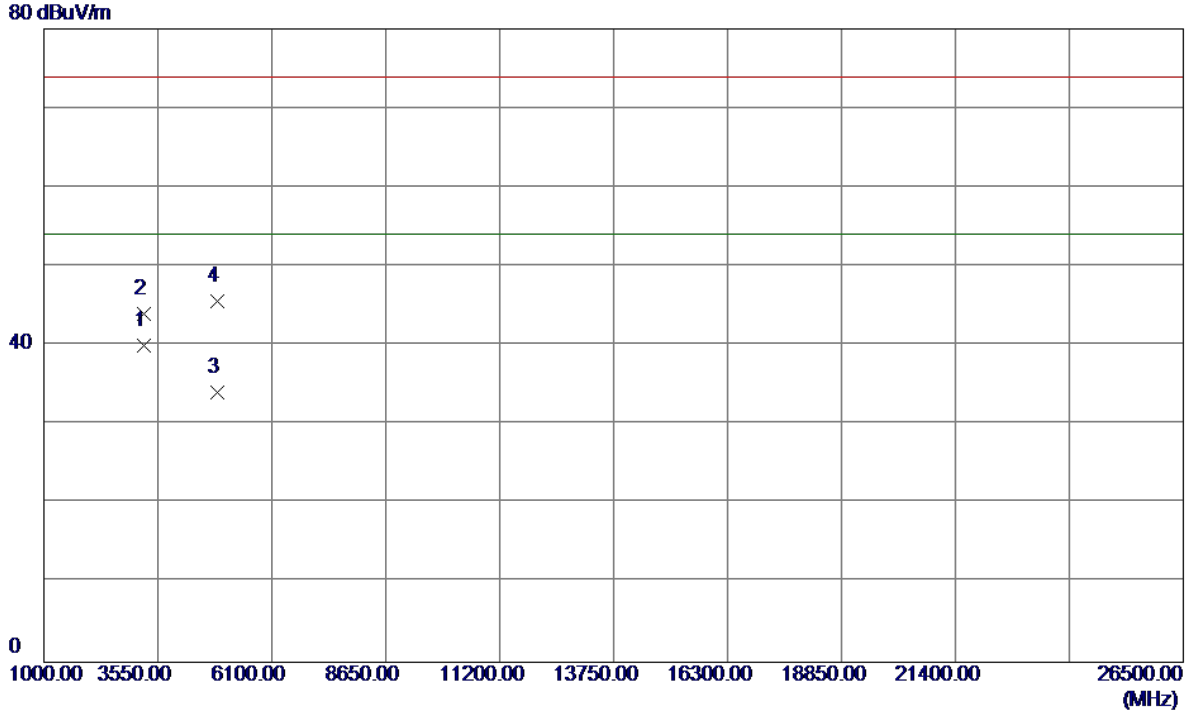

No.	Freq. MHz	Reading Level dBuV/m	Correct Factor dB	Measure ment dBuV/m	Limit dBuV/m	Margin dB	Detector	Comment
1 *	3249.3020	38.51	1.42	39.93	54.00	-14.07	AVG	
2	3249.3600	42.61	1.42	44.03	74.00	-29.97	Peak	
3	4872.1150	29.06	5.06	34.12	54.00	-19.88	AVG	
4	4872.1650	40.55	5.06	45.61	74.00	-28.39	Peak	

Orthogonal Axis :	X
Test Mode :	TX G MODE 2462MHz

Vertical

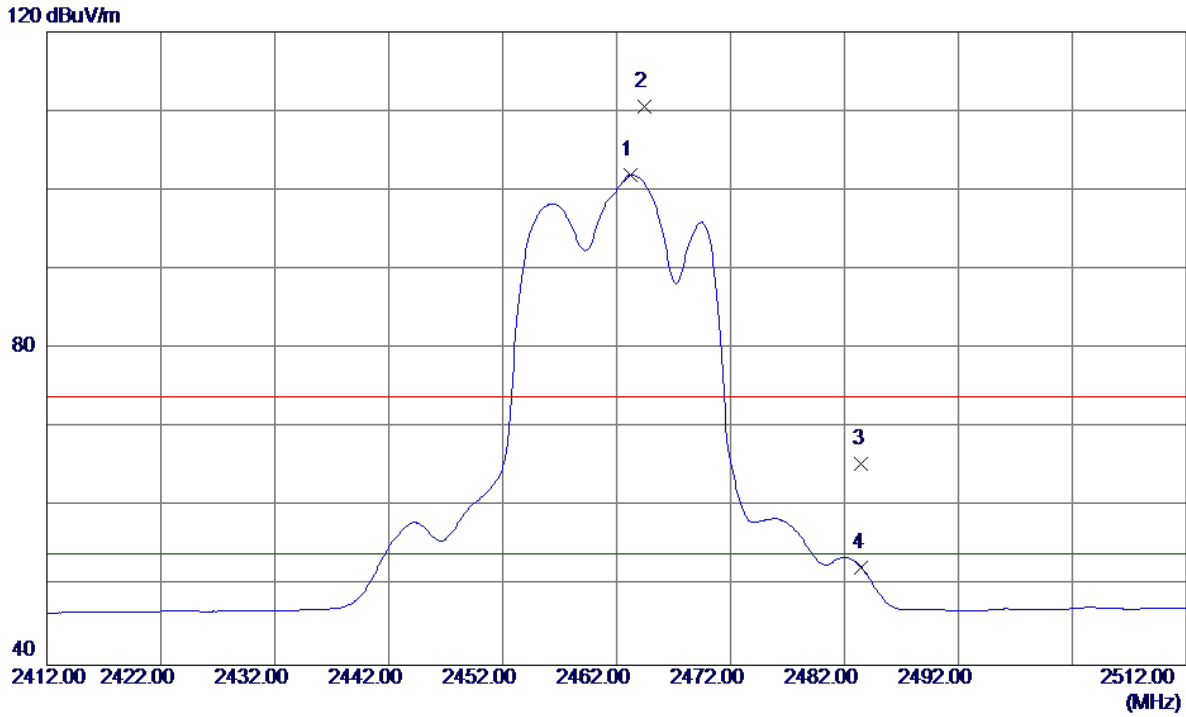

No.	Freq. MHz	Reading Level dBuV/m	Correct Factor dB	Measure ment dBuV/m	Limit dBuV/m	Margin dB	Detector	Comment
1 *	2463.2500	68.66	33.32	101.98	54.00	47.98	AVG	No Limit
2	2464.4500	77.26	33.32	110.58	74.00	36.58	Peak	No Limit
3	2483.5000	32.05	33.40	65.45	74.00	-8.55	Peak	
4	2483.5000	18.91	33.40	52.31	54.00	-1.69	AVG	

Orthogonal Axis :	X
Test Mode :	TX G MODE 2462MHz

Vertical

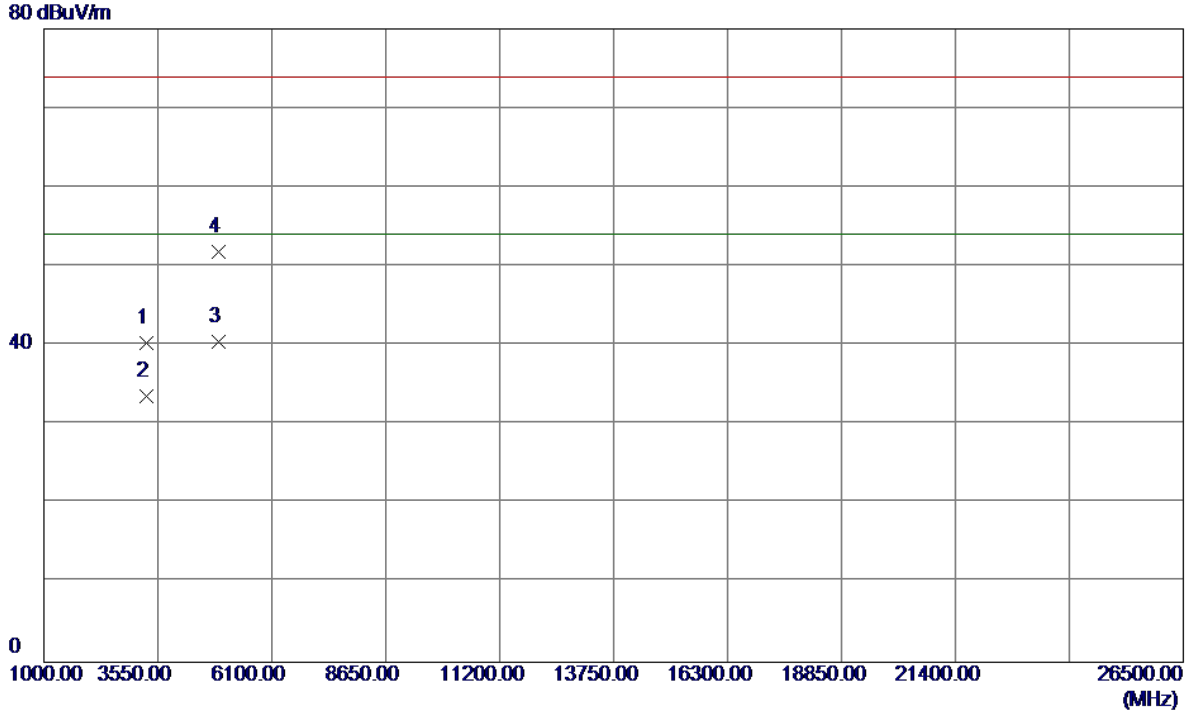

No.	Freq. MHz	Reading Level dBuV/m	Correct Factor dB	Measure ment dBuV/m	Limit dBuV/m	Margin dB	Detector	Comment
1	3282.4900	38.98	1.41	40.39	74.00	-33.61	Peak	
2	3282.6200	32.18	1.41	33.59	54.00	-20.41	AVG	
3 *	4921.9000	35.17	5.27	40.44	54.00	-13.56	AVG	
4	4922.1000	46.52	5.27	51.79	74.00	-22.21	Peak	

Orthogonal Axis :	X
Test Mode :	TX G MODE 2462MHz

Horizontal

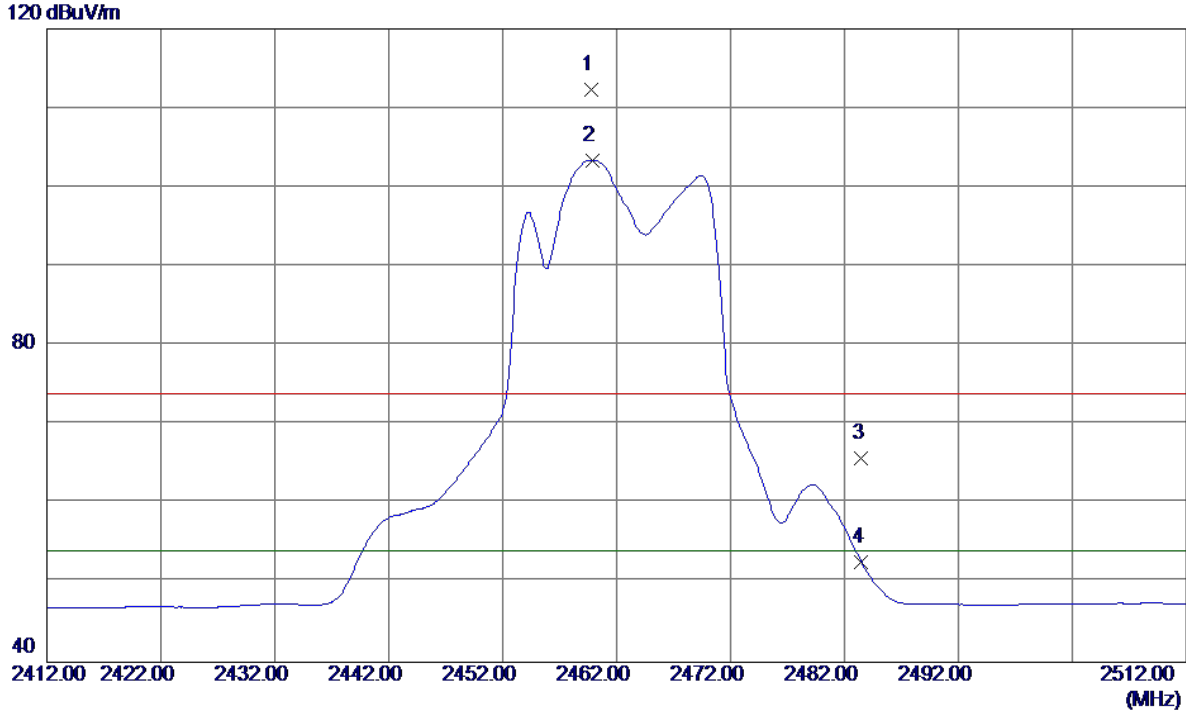

No.	Freq. MHz	Reading Level dBuV/m	Correct Factor dB	Measure ment dBuV/m	Limit dBuV/m	Margin dB	Detector	Comment
1	2459.7500	79.05	33.30	112.35	74.00	38.35	Peak	No Limit
2 *	2459.8500	70.12	33.30	103.42	54.00	49.42	AVG	No Limit
3	2483.5000	32.44	33.40	65.84	74.00	-8.16	Peak	
4	2483.5000	19.29	33.40	52.69	54.00	-1.31	AVG	

Orthogonal Axis :	X
Test Mode :	TX G MODE 2462MHz

Horizontal



No.	Freq. MHz	Reading Level dBuV/m	Correct Factor dB	Measure ment dBuV/m	Limit dBuV/m	Margin dB	Detector	Comment
1 *	3282.6350	35.39	1.41	36.80	54.00	-17.20	AVG	
2	3282.6700	40.77	1.41	42.18	74.00	-31.82	Peak	
3	4921.8650	36.79	5.27	42.06	74.00	-31.94	Peak	
4	4922.1650	26.31	5.27	31.58	54.00	-22.42	AVG	

Orthogonal Axis :	X
Test Mode :	TX N-20M MODE 2412MHz

Vertical

120 dBuV/m

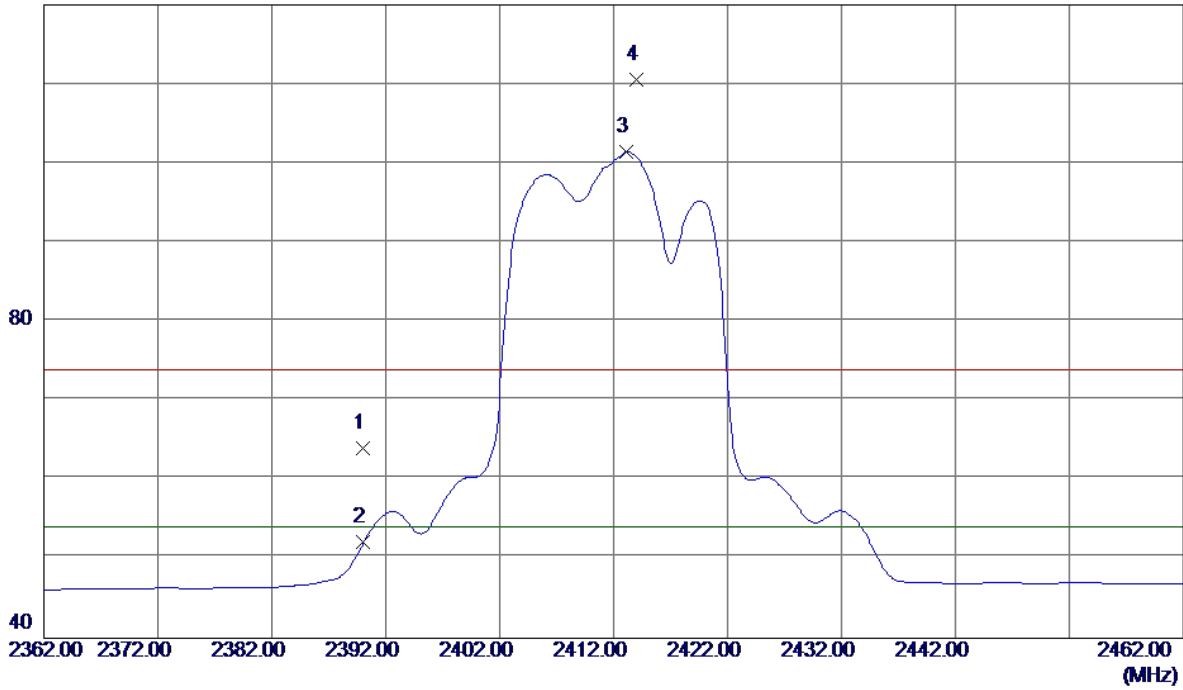

No.	Freq. MHz	Reading Level dBuV/m	Correct Factor dB	Measure ment dBuV/m	Limit dBuV/m	Margin dB	Detector	Comment
1	2390.0000	31.04	33.01	64.05	74.00	-9.95	Peak	
2	2390.0000	19.12	33.01	52.13	54.00	-1.87	AVG	
3 *	2413.1000	68.37	33.11	101.48	54.00	47.48	AVG	No Limit
4	2414.0000	77.43	33.11	110.54	74.00	36.54	Peak	No Limit

Orthogonal Axis :	X
Test Mode :	TX N-20M MODE 2412MHz

Vertical

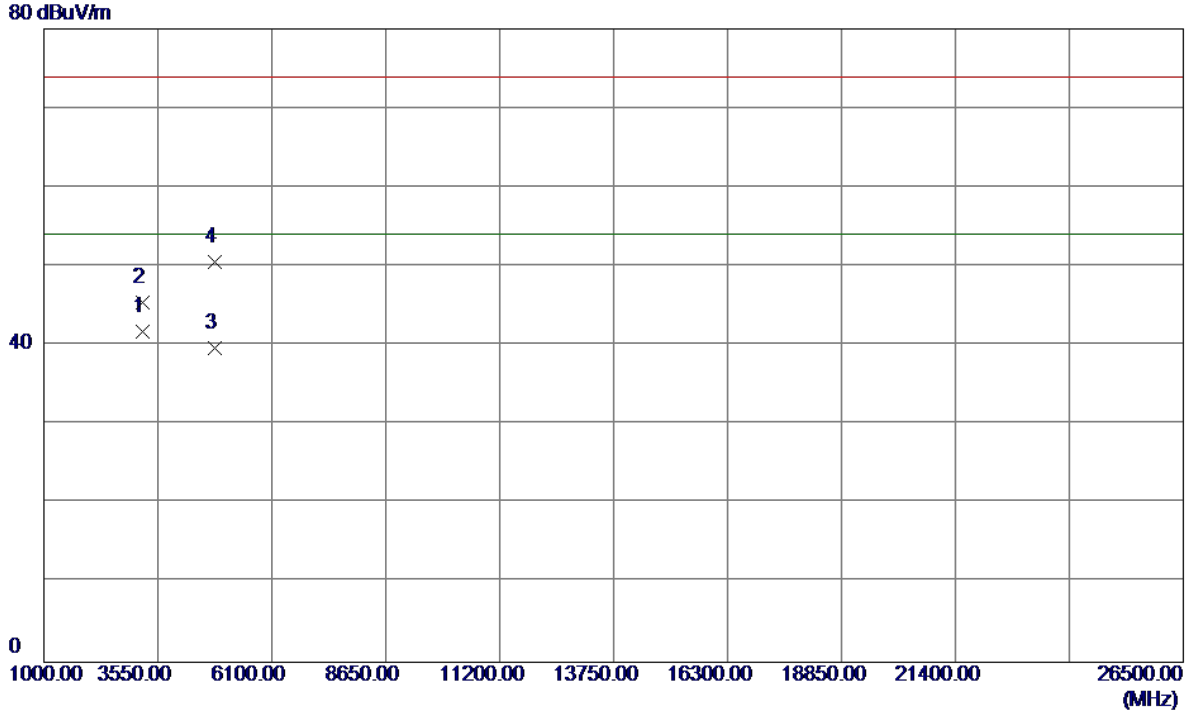

No.	Freq. MHz	Reading Level dBuV/m	Correct Factor dB	Measure ment dBuV/m	Limit dBuV/m	Margin dB	Detector	Comment
1 *	3215.9750	40.39	1.44	41.83	54.00	-12.17	AVG	
2	3215.9850	44.06	1.44	45.50	74.00	-28.50	Peak	
3	4820.5259	34.89	4.84	39.73	54.00	-14.27	AVG	
4	4827.5259	45.68	4.87	50.55	74.00	-23.45	Peak	

Orthogonal Axis :	X
Test Mode :	TX N-20M MODE 2412MHZ

Horizontal

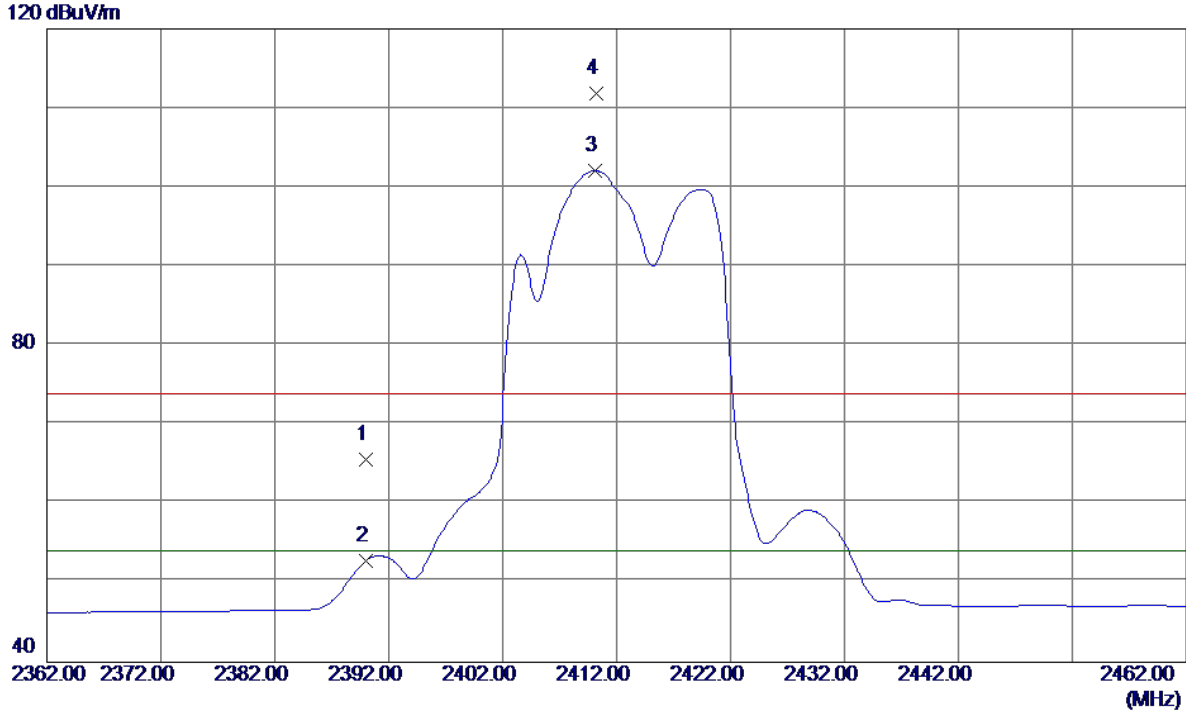

No.	Freq. MHz	Reading Level dBuV/m	Correct Factor dB	Measure ment dBuV/m	Limit dBuV/m	Margin dB	Detector	Comment
1	2390.0000	32.52	33.01	65.53	74.00	-8.47	Peak	
2	2390.0000	19.84	33.01	52.85	54.00	-1.15	AVG	
3 *	2410.1500	69.02	33.09	102.11	54.00	48.11	AVG	No Limit
4	2410.2500	78.71	33.09	111.80	74.00	37.80	Peak	No Limit

Orthogonal Axis :	X
Test Mode :	TX N-20M MODE 2412MHz

Horizontal



No.	Freq. MHz	Reading Level dBuV/m	Correct Factor dB	Measure ment dBuV/m	Limit dBuV/m	Margin dB	Detector	Comment
1	3215.8750	45.20	1.44	46.64	74.00	-27.36	Peak	
2 *	3215.9700	42.53	1.44	43.97	54.00	-10.03	AVG	
3	4820.6650	35.96	4.84	40.80	74.00	-33.20	Peak	
4	4821.5650	25.91	4.84	30.75	54.00	-23.25	AVG	

Orthogonal Axis :	X
Test Mode :	TX N-20M MODE 2437MHz

Vertical

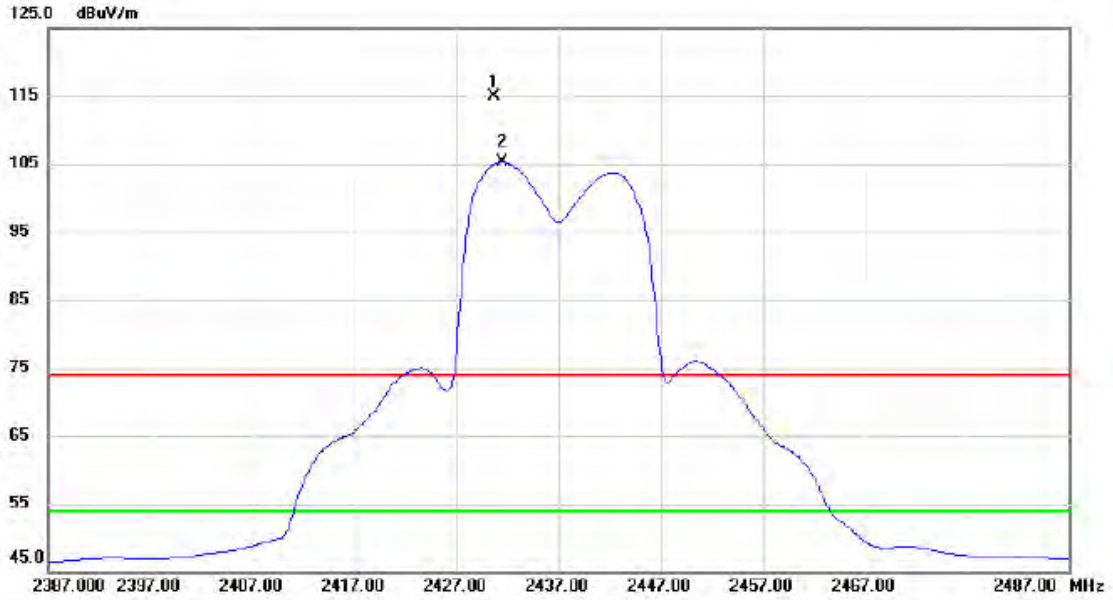

No.	Mk.	Freq.	Reading Level	Correct Factor	Measurement	Limit	Margin		
		MHz	dBuV	dB	dBuV/m	dBuV/m	dB	Detector	Comment
1	X	2430.700	81.81	33.18	114.99	74.00	40.99	peak	NO LIMIT
2	*	2431.400	72.05	33.18	105.23	54.00	51.23	AVG	NO LIMIT

Orthogonal Axis :	X
Test Mode :	TX N-20M MODE 2437MHz

Vertical

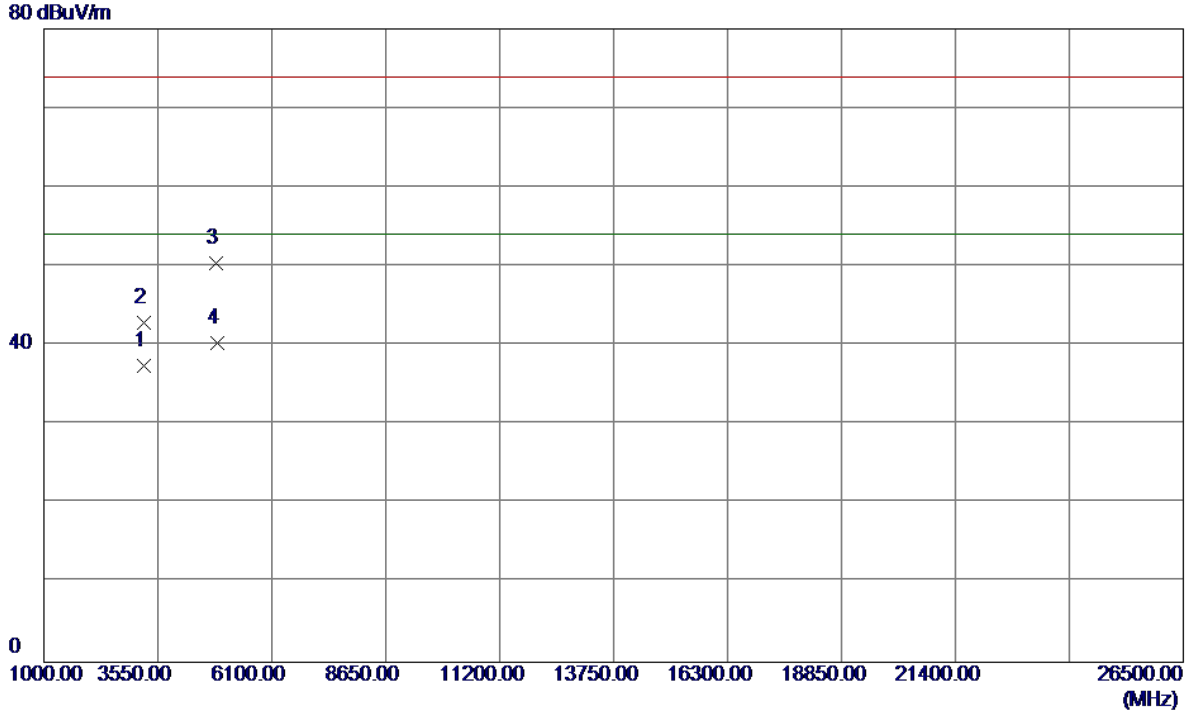

No.	Freq. MHz	Reading Level dBuV/m	Correct Factor dB	Measure ment dBuV/m	Limit dBuV/m	Margin dB	Detector	Comment
1	3249.3020	36.04	1.42	37.46	54.00	-16.54	AVG	
2	3249.3580	41.49	1.42	42.91	74.00	-31.09	Peak	
3	4864.6760	45.44	5.03	50.47	74.00	-23.53	Peak	
4 *	4869.1760	35.26	5.05	40.31	54.00	-13.69	AVG	

Orthogonal Axis :	X
Test Mode :	TX N-20M MODE 2437MHz

Horizontal

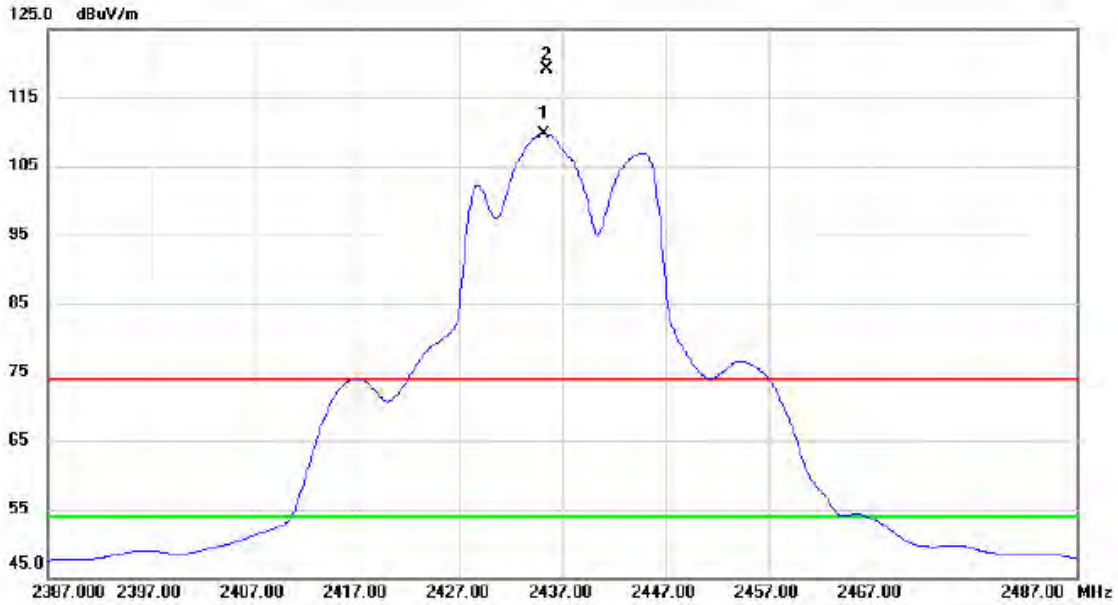

No.	Mk.	Freq.	Reading Level	Correct Factor	Measurement	Limit	Margin	Detector	Comment
		MHz	dBuV	dB	dBuV/m	dBuV/m	dB		
1	*	2435.200	76.50	33.20	109.70	54.00	55.70	AVG	NO LIMIT
2	X	2435.400	85.89	33.20	119.09	74.00	45.09	peak	NO LIMIT

Orthogonal Axis :	X
Test Mode :	TX N-20M MODE 2437MHz

Horizontal

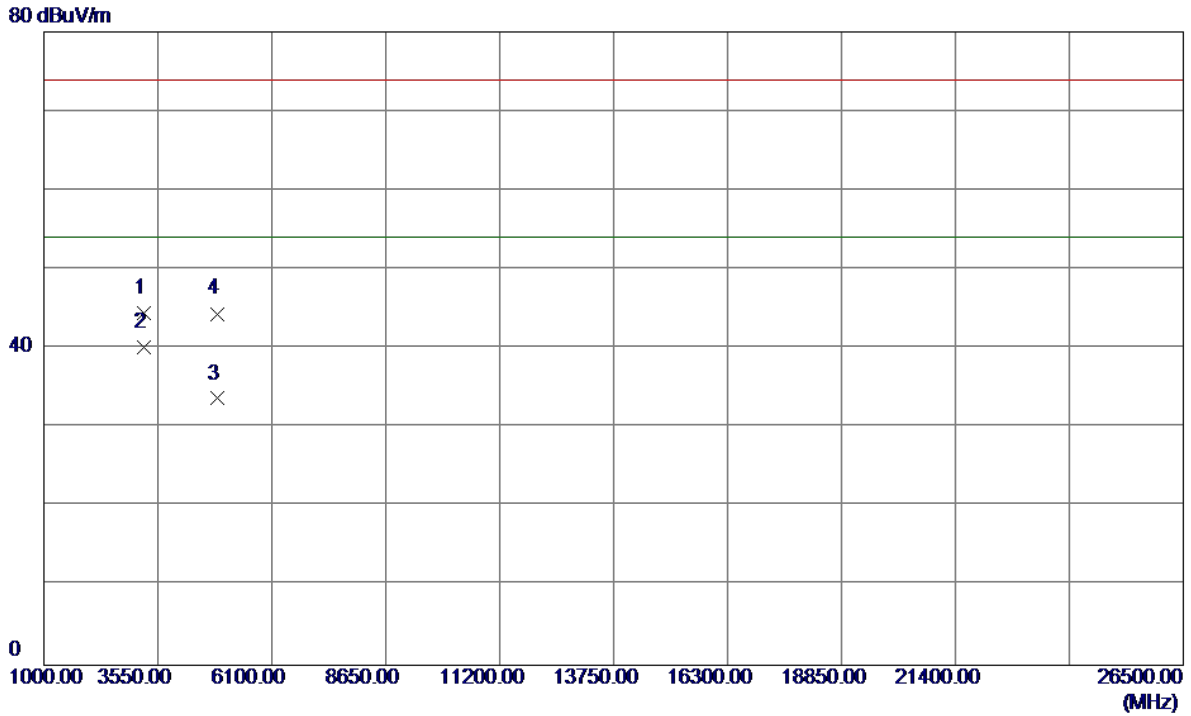

No.	Freq. MHz	Reading Level dBuV/m	Correct Factor dB	Measure ment dBuV/m	Limit dBuV/m	Margin dB	Detector	Comment
1	3249.1800	43.10	1.42	44.52	74.00	-29.48	Peak	
2 *	3249.3050	38.70	1.42	40.12	54.00	-13.88	AVG	
3	4872.3150	28.62	5.06	33.68	54.00	-20.32	AVG	
4	4873.2650	39.34	5.06	44.40	74.00	-29.60	Peak	

Orthogonal Axis :	X
Test Mode :	TX N-20M MODE 2462MHz

Vertical

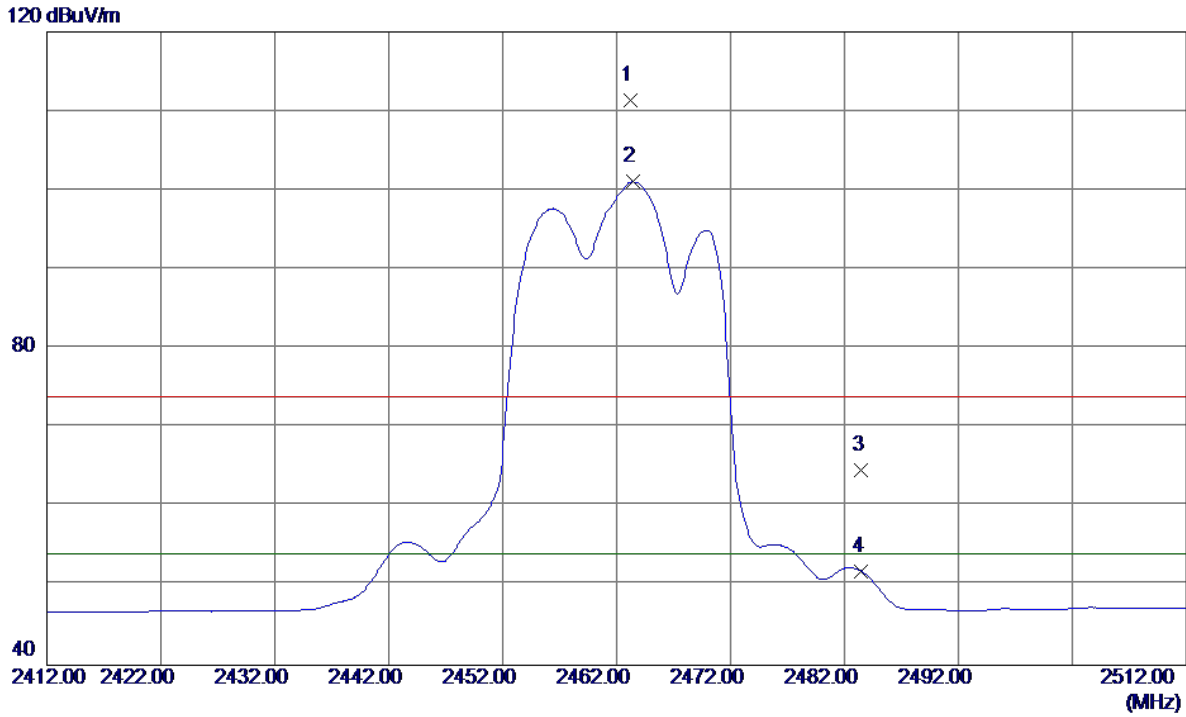

No.	Freq. MHz	Reading Level dBuV/m	Correct Factor dB	Measure ment dBuV/m	Limit dBuV/m	Margin dB	Detector	Comment
1	2463.2000	77.98	33.32	111.30	74.00	37.30	Peak	No Limit
2 *	2463.4500	67.72	33.32	101.04	54.00	47.04	AVG	No Limit
3	2483.5000	31.20	33.40	64.60	74.00	-9.40	Peak	
4	2483.5000	18.47	33.40	51.87	54.00	-2.13	AVG	

Orthogonal Axis :	X
Test Mode :	TX N-20M MODE 2462MHz

Vertical

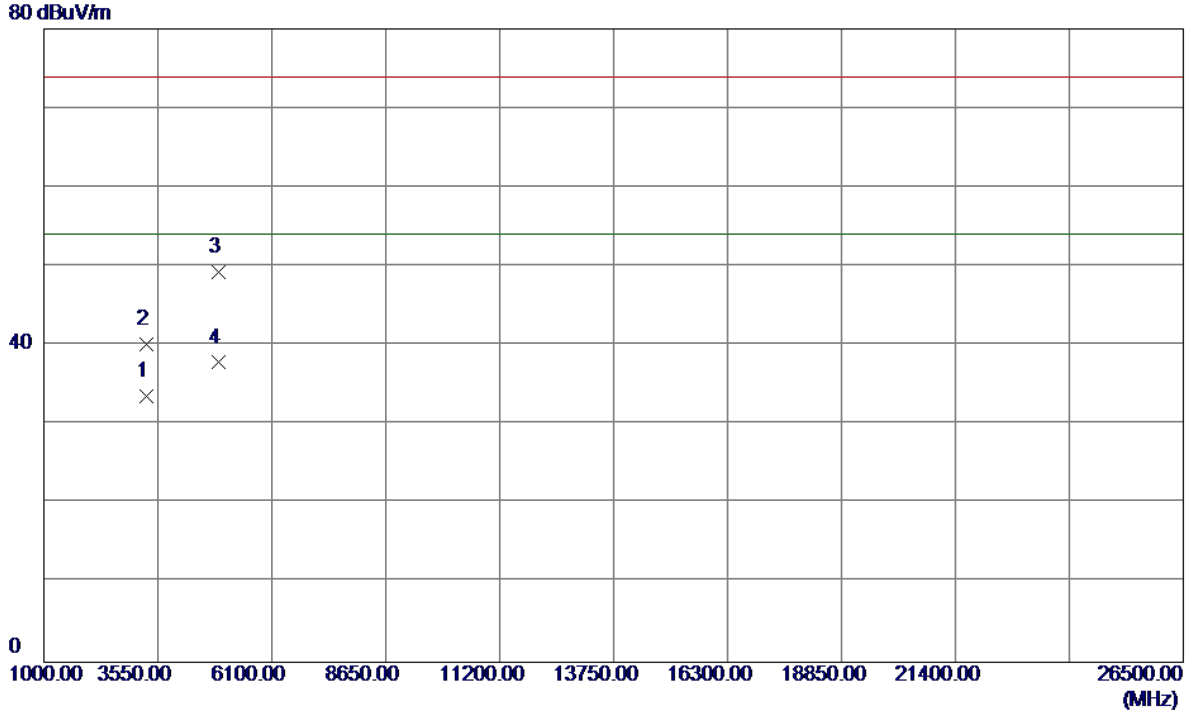

No.	Freq. MHz	Reading Level dBuV/m	Correct Factor dB	Measurement dBuV/m	Limit dBuV/m	Margin dB	Detector	Comment
1	3282.6350	32.14	1.41	33.55	54.00	-20.45	AVG	
2	3282.6900	38.80	1.41	40.21	74.00	-33.79	Peak	
3	4921.9260	43.94	5.27	49.21	74.00	-24.79	Peak	
4 *	4922.2260	32.57	5.27	37.84	54.00	-16.16	AVG	

Orthogonal Axis :	X
Test Mode :	TX N-20M MODE 2462MHz

Horizontal

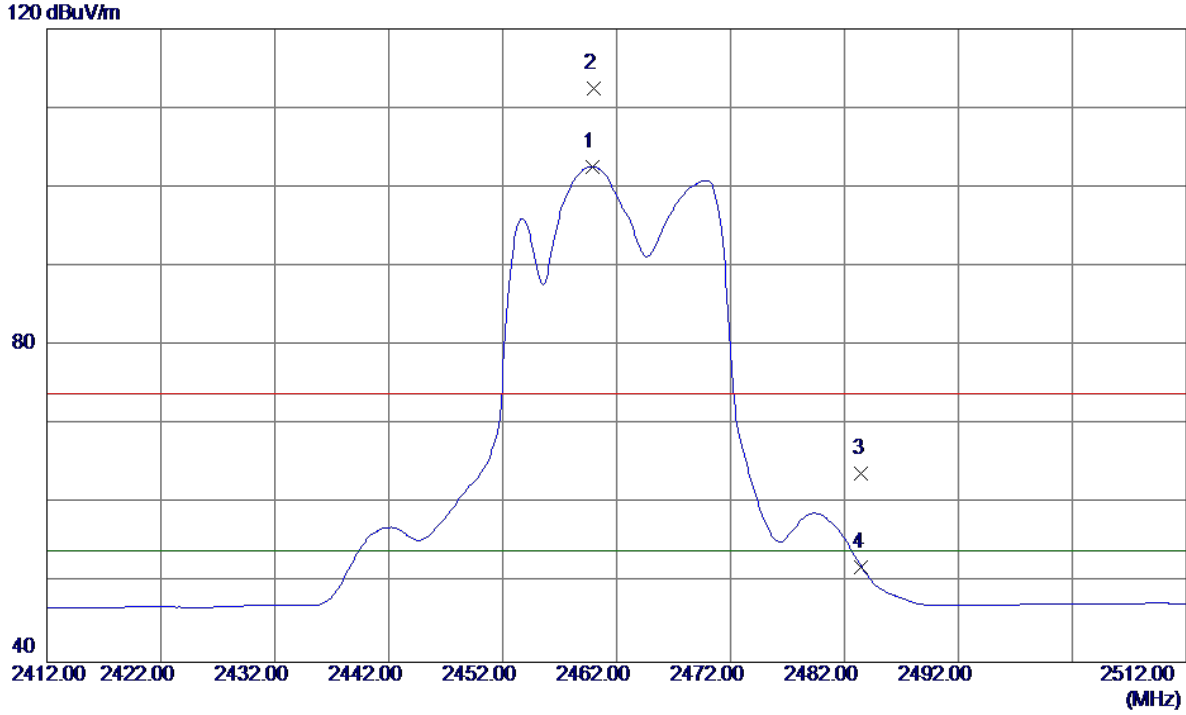

No.	Freq. MHz	Reading Level dBuV/m	Correct Factor dB	Measure ment dBuV/m	Limit dBuV/m	Margin dB	Detector	Comment
1 *	2459.8500	69.29	33.30	102.59	54.00	48.59	AVG	No Limit
2	2460.0000	79.18	33.30	112.48	74.00	38.48	Peak	No Limit
3	2483.5000	30.43	33.40	63.83	74.00	-10.17	Peak	
4	2483.5000	18.64	33.40	52.04	54.00	-1.96	AVG	

Orthogonal Axis :	X
Test Mode :	TX N-20M MODE 2462MHz

Horizontal

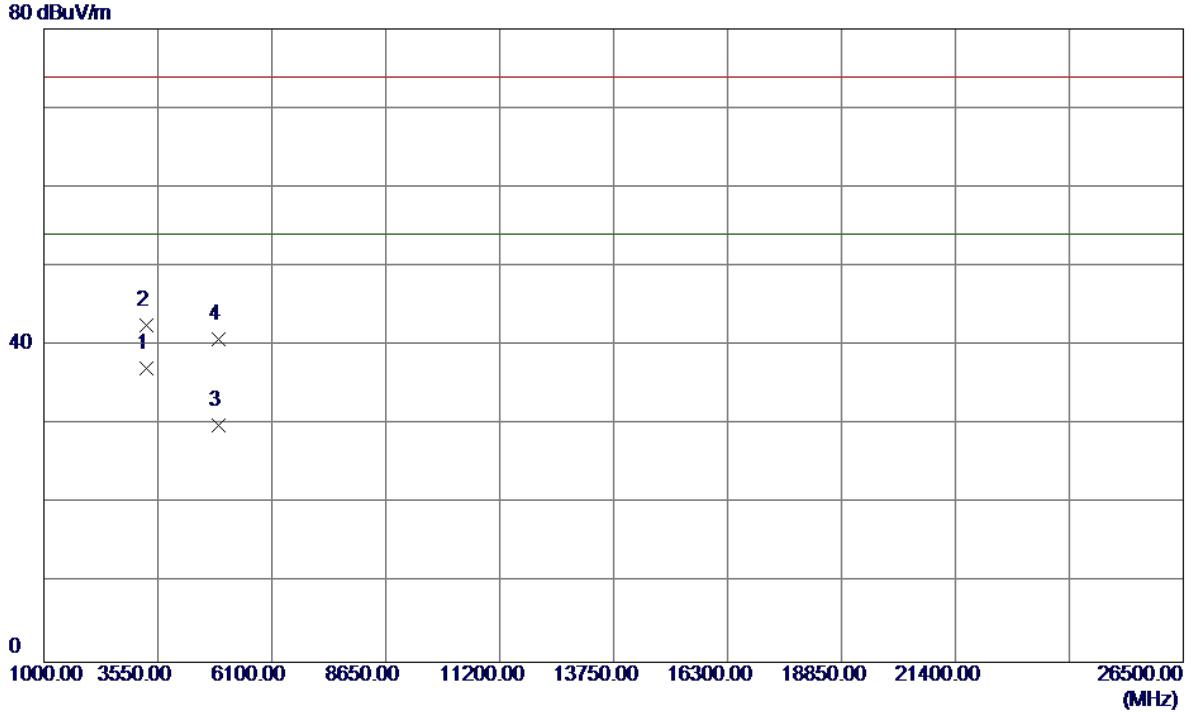

No.	Freq. MHz	Reading Level dBuV/m	Correct Factor dB	Measure ment dBuV/m	Limit dBuV/m	Margin dB	Detector	Comment
1 *	3282.6399	35.73	1.41	37.14	54.00	-16.86	AVG	
2	3282.7850	41.17	1.41	42.58	74.00	-31.42	Peak	
3	4922.6150	24.62	5.27	29.89	54.00	-24.11	AVG	
4	4922.9650	35.56	5.27	40.83	74.00	-33.17	Peak	

Orthogonal Axis :	X
Test Mode :	TX N-40M MODE 2422MHz

Vertical

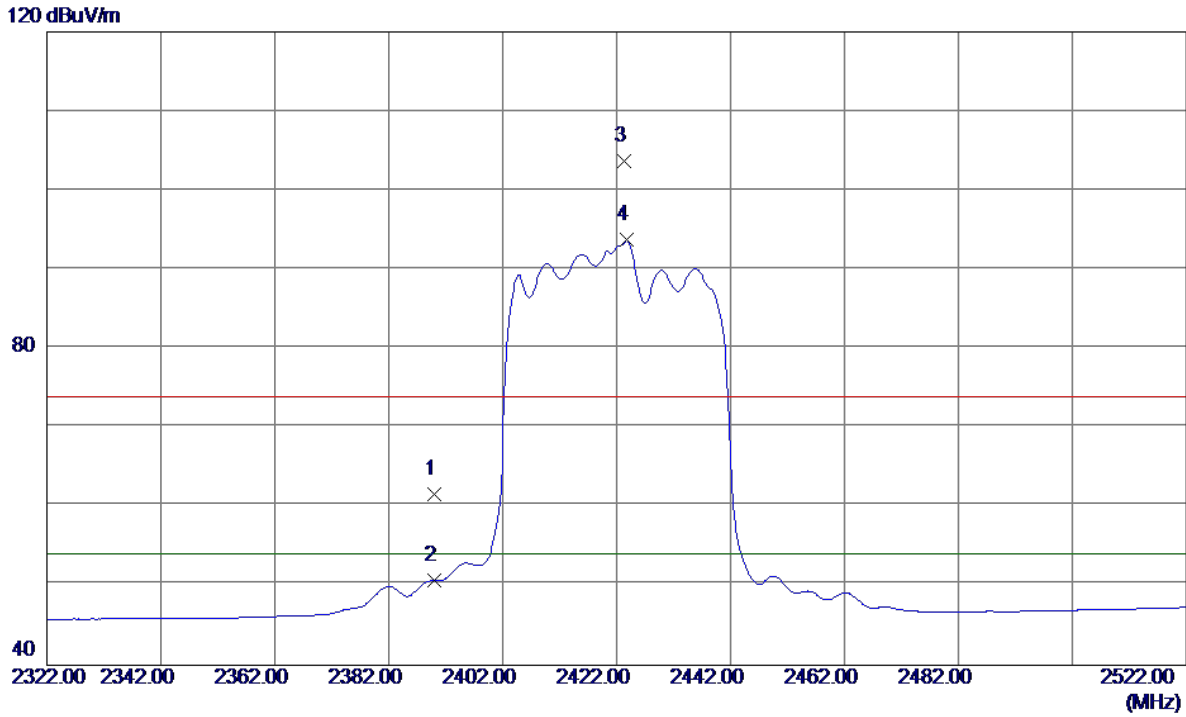

No.	Freq. MHz	Reading Level dBuV/m	Correct Factor dB	Measure ment dBuV/m	Limit dBuV/m	Margin dB	Detector	Comment
1	2390.0000	28.60	33.01	61.61	74.00	-12.39	Peak	
2	2390.0000	17.70	33.01	50.71	54.00	-3.29	AVG	
3	2423.3000	70.47	33.15	103.62	74.00	29.62	Peak	No Limit
4 *	2423.7000	60.54	33.15	93.69	54.00	39.69	AVG	No Limit

Orthogonal Axis :	X
Test Mode :	TX N-40M MODE 2422MHz

Vertical

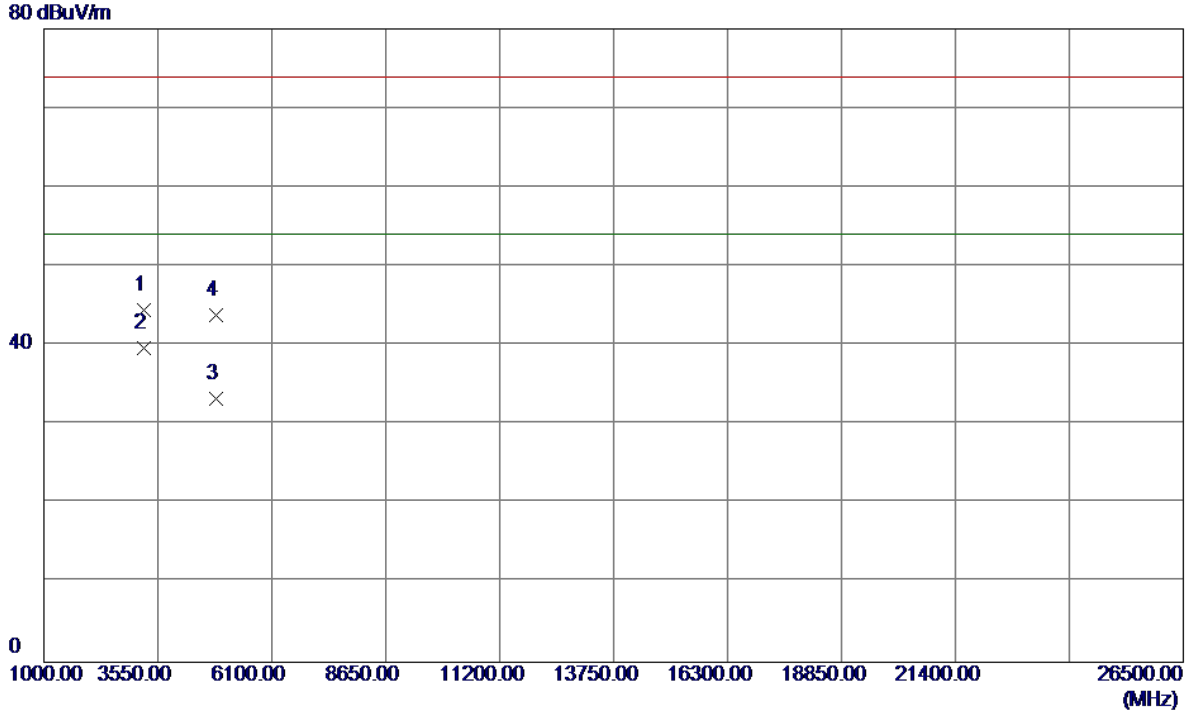

No.	Freq. MHz	Reading Level dBuV/m	Correct Factor dB	Measure ment dBuV/m	Limit dBuV/m	Margin dB	Detector	Comment
1	3229.2660	43.09	1.43	44.52	74.00	-29.48	Peak	
2 *	3229.3110	38.19	1.43	39.62	54.00	-14.38	AVG	
3	4841.1260	28.39	4.93	33.32	54.00	-20.68	AVG	
4	4841.8260	38.89	4.93	43.82	74.00	-30.18	Peak	

Orthogonal Axis :	X
Test Mode :	TX N-40M MODE 2422MHz

Horizontal

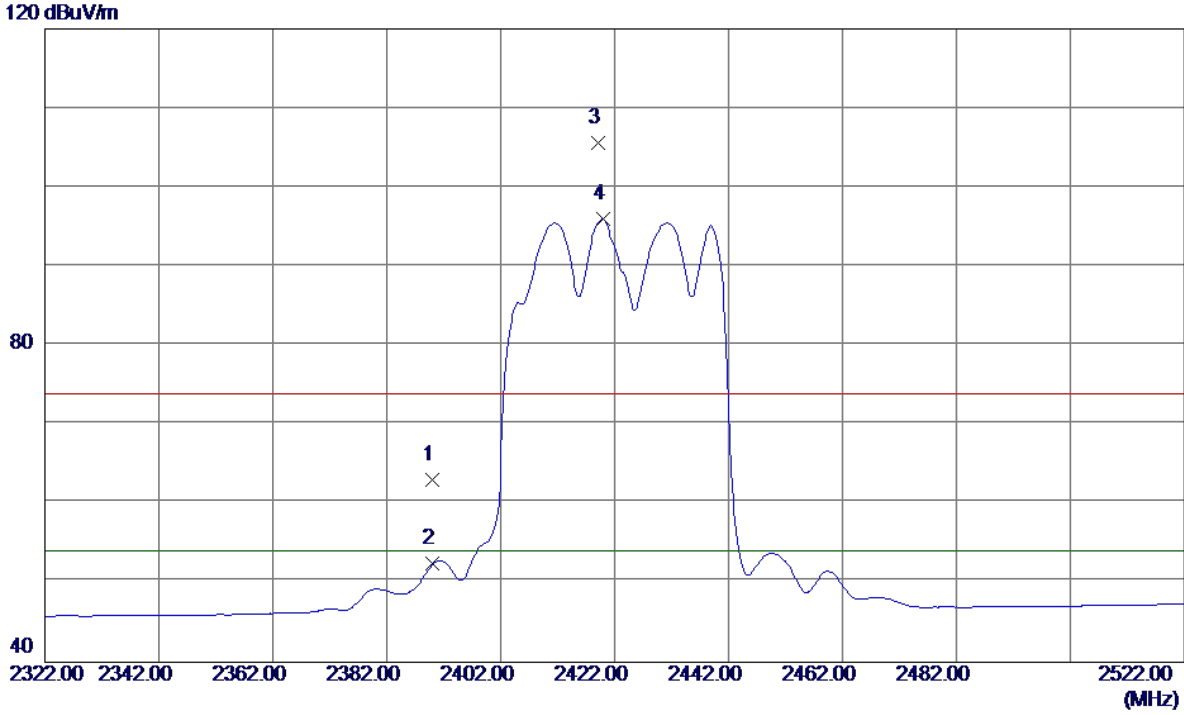

No.	Freq. MHz	Reading Level dBuV/m	Correct Factor dB	Measurement dBuV/m	Limit dBuV/m	Margin dB	Detector	Comment
1	2390.0000	29.98	33.01	62.99	74.00	-11.01	Peak	
2	2390.0000	19.40	33.01	52.41	54.00	-1.59	AVG	
3	2419.2000	72.41	33.13	105.54	74.00	31.54	Peak	No Limit
4 *	2419.9000	62.86	33.14	96.00	54.00	42.00	AVG	No Limit

Orthogonal Axis :	X
Test Mode :	TX N-40M MODE 2422MHz

Horizontal

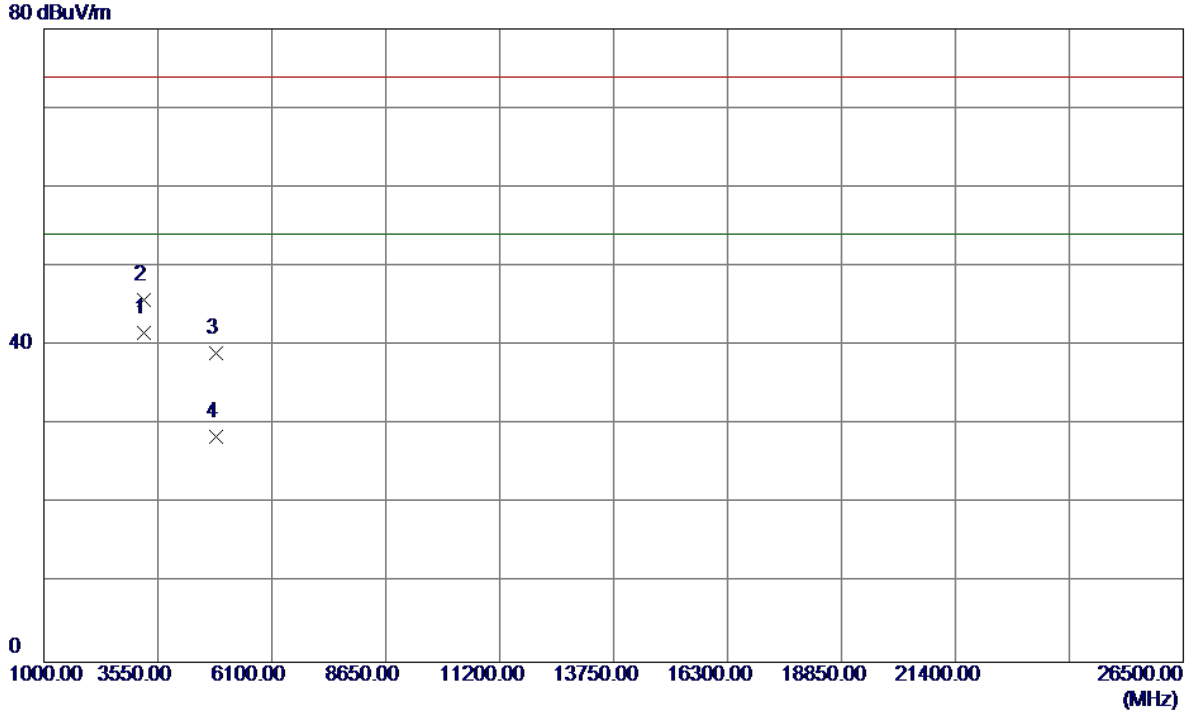

No.	Freq. MHz	Reading Level dBuV/m	Correct Factor dB	Measure ment dBuV/m	Limit dBuV/m	Margin dB	Detector	Comment
1 *	3229.3000	40.24	1.43	41.67	54.00	-12.33	AVG	
2	3229.3720	44.35	1.43	45.78	74.00	-28.22	Peak	
3	4841.0150	34.05	4.93	38.98	74.00	-35.02	Peak	
4	4841.4150	23.55	4.93	28.48	54.00	-25.52	AVG	

Orthogonal Axis :	X
Test Mode :	TX N-40M MODE 2437MHz

Vertical

120 dBuV/m

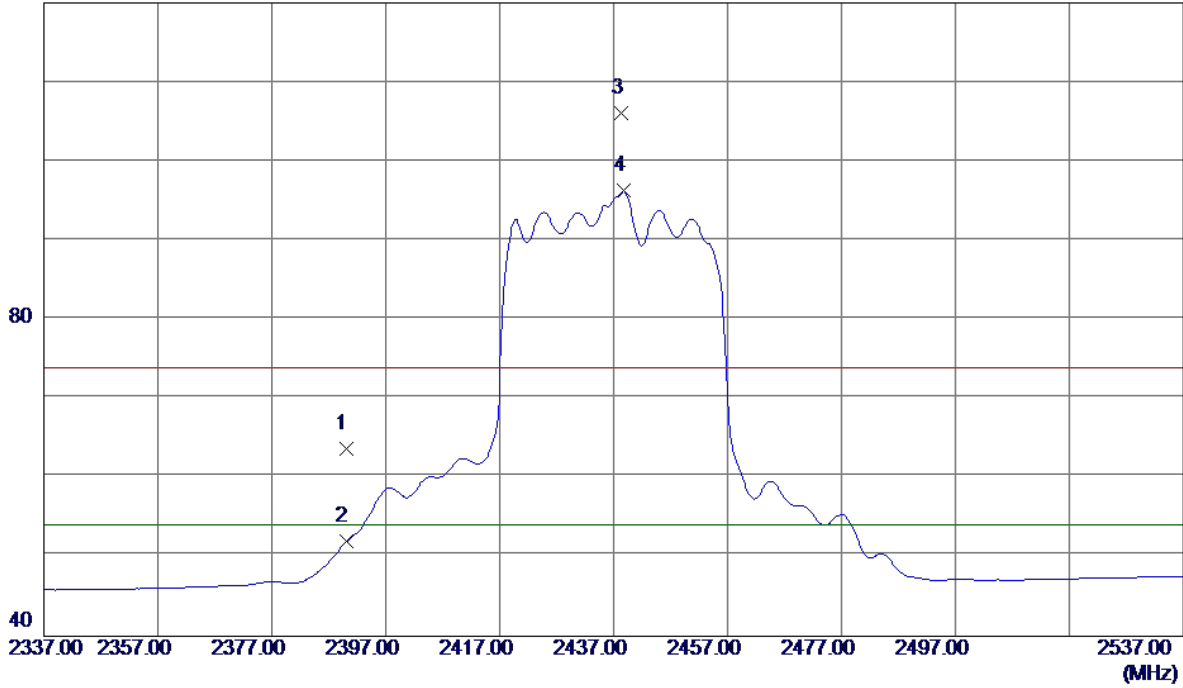

No.	Freq. MHz	Reading Level dBuV/m	Correct Factor dB	Measure ment dBuV/m	Limit dBuV/m	Margin dB	Detector	Comment
1	2390.0000	30.68	33.01	63.69	74.00	-10.31	Peak	
2	2390.0000	18.93	33.01	51.94	54.00	-2.06	AVG	
3	2438.3000	72.94	33.21	106.15	74.00	32.15	Peak	No Limit
4 *	2438.8000	63.07	33.21	96.28	54.00	42.28	AVG	No Limit

Orthogonal Axis :	X
Test Mode :	TX N-40M MODE 2437MHz

Vertical

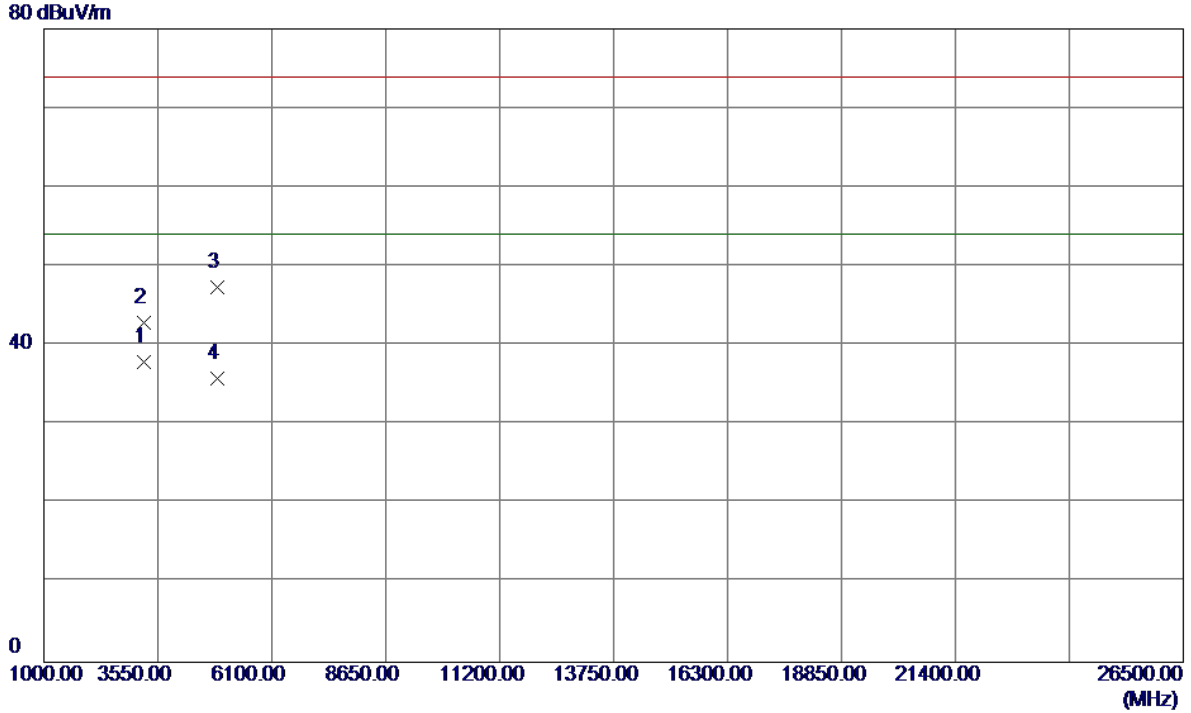

No.	Freq. MHz	Reading Level dBuV/m	Correct Factor dB	Measure ment dBuV/m	Limit dBuV/m	Margin dB	Detector	Comment
1 *	3249.3000	36.56	1.42	37.98	54.00	-16.02	AVG	
2	3249.4720	41.41	1.42	42.83	74.00	-31.17	Peak	
3	4878.4260	42.22	5.08	47.30	74.00	-26.70	Peak	
4	4878.8260	30.71	5.09	35.80	54.00	-18.20	AVG	

Orthogonal Axis :	X
Test Mode :	TX N-40M MODE 2437MHz

Horizontal

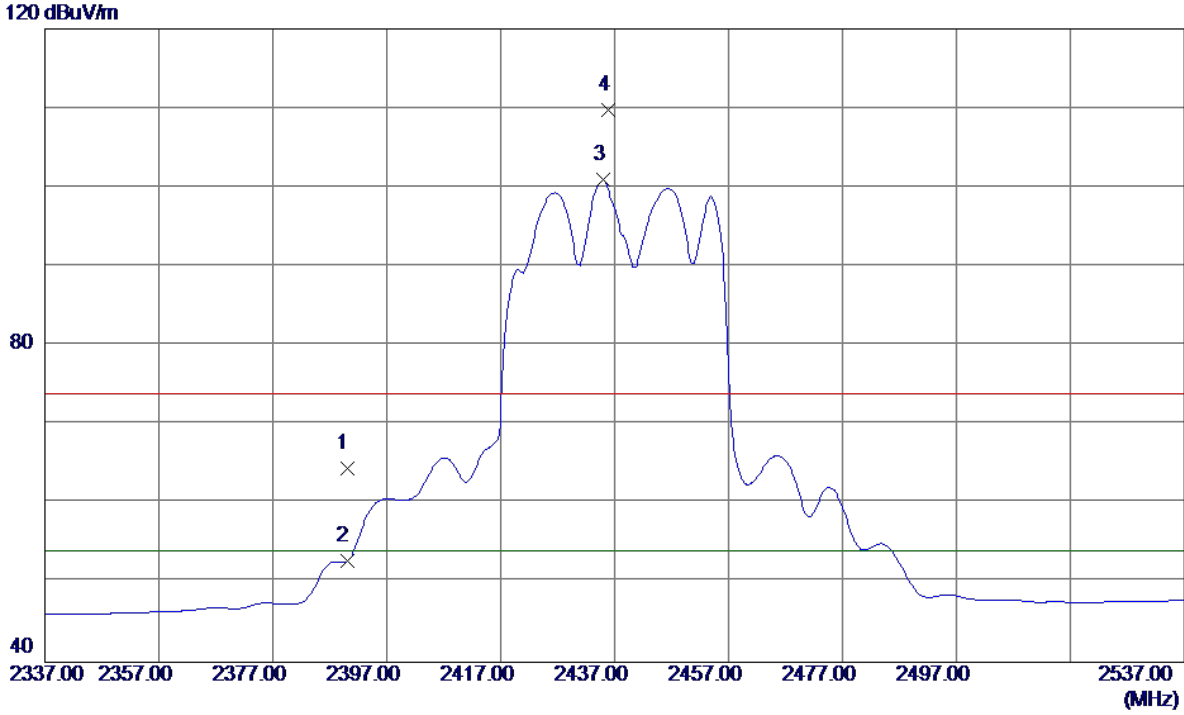

No.	Freq. MHz	Reading Level dBuV/m	Correct Factor dB	Measure ment dBuV/m	Limit dBuV/m	Margin dB	Detector	Comment
1	2390.0000	31.52	33.01	64.53	74.00	-9.47	Peak	
2	2390.0000	19.78	33.01	52.79	54.00	-1.21	AVG	
3 *	2435.0000	67.69	33.20	100.89	54.00	46.89	AVG	No Limit
4	2435.8000	76.57	33.20	109.77	74.00	35.77	Peak	No Limit

Orthogonal Axis :	X
Test Mode :	TX N-40M MODE 2437MHz

Horizontal

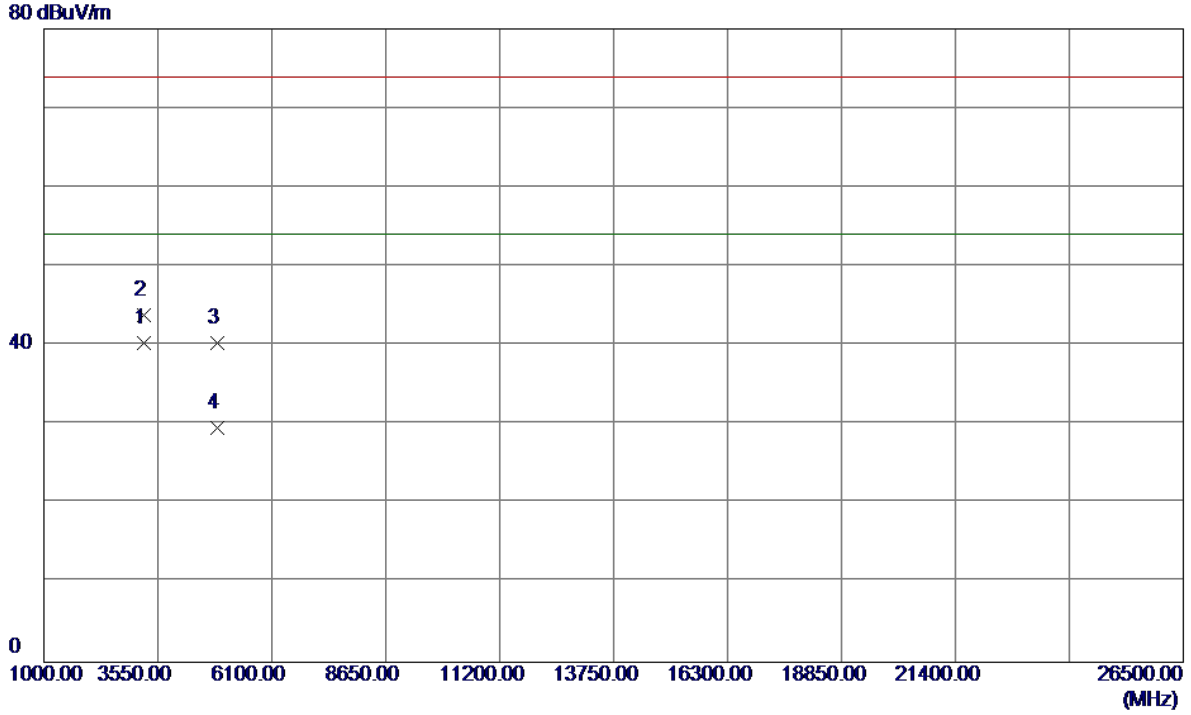

No.	Freq. MHz	Reading Level dBuV/m	Correct Factor dB	Measure ment dBuV/m	Limit dBuV/m	Margin dB	Detector	Comment
1 *	3249.3050	38.89	1.42	40.31	54.00	-13.69	AVG	
2	3249.3100	42.44	1.42	43.86	74.00	-30.14	Peak	
3	4871.6150	35.33	5.06	40.39	74.00	-33.61	Peak	
4	4872.0150	24.55	5.06	29.61	54.00	-24.39	AVG	

Orthogonal Axis :	X
Test Mode :	TX N-40M MODE 2452MHz

Vertical

120 dBuV/m

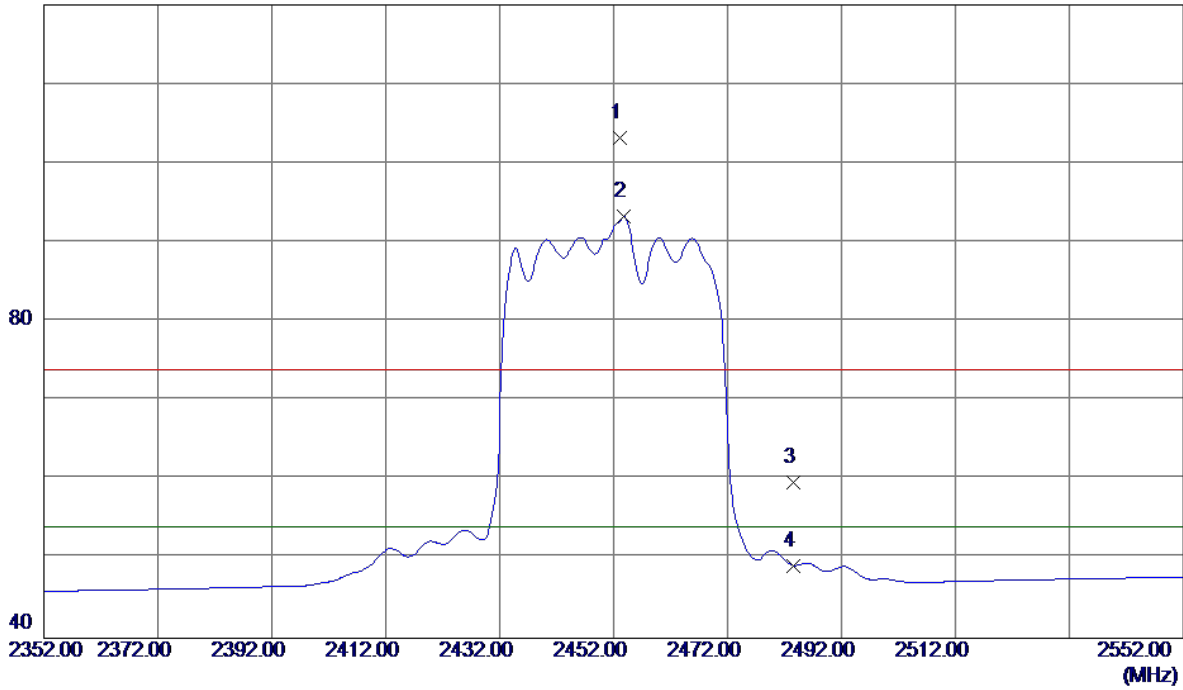

No.	Freq. MHz	Reading Level dBuV/m	Correct Factor dB	Measure ment dBuV/m	Limit dBuV/m	Margin dB	Detector	Comment
1	2453.2000	69.87	33.27	103.14	74.00	29.14	Peak	No Limit
2 *	2453.8000	60.05	33.28	93.33	54.00	39.33	AVG	No Limit
3	2483.5000	26.31	33.40	59.71	74.00	-14.29	Peak	
4	2483.5000	15.78	33.40	49.18	54.00	-4.82	AVG	

Orthogonal Axis :	X
Test Mode :	TX N-40M MODE 2452MHz

Vertical

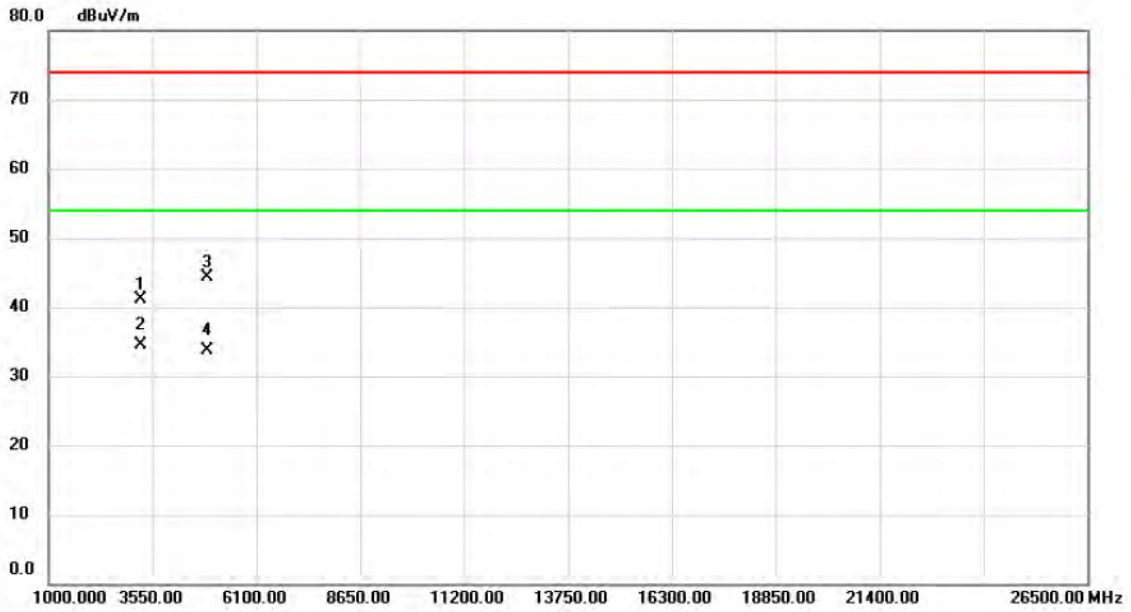

No.	Mk.	Freq. MHz	Reading Level dBuV	Correct Factor dB	Measure- ment dBuV/m	Limit dBuV/m	Margin dB	Detector	Comment
1		3269.196	39.70	1.41	41.11	74.00	-32.89	peak	
2	*	3269.306	33.13	1.41	34.54	54.00	-19.46	AVG	
3		4901.526	39.05	5.19	44.24	74.00	-29.76	peak	
4		4902.026	28.52	5.19	33.71	54.00	-20.29	AVG	

Orthogonal Axis :	X
Test Mode :	TX N-40M MODE 2452MHz

Horizontal

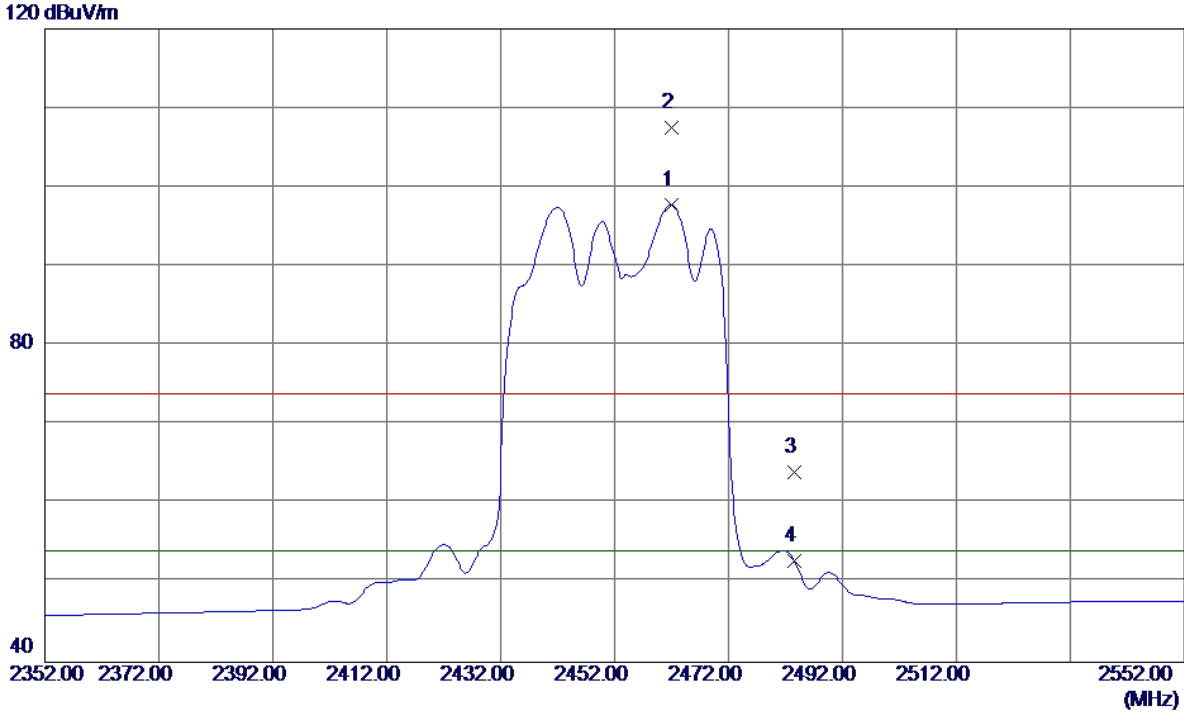

No.	Freq. MHz	Reading Level dBuV/m	Correct Factor dB	Measure ment dBuV/m	Limit dBuV/m	Margin dB	Detector	Comment
1 *	2461.9000	64.46	33.31	97.77	54.00	43.77	AVG	No Limit
2	2462.0000	74.22	33.31	107.53	74.00	33.53	Peak	No Limit
3	2483.5000	30.66	33.40	64.06	74.00	-9.94	Peak	
4	2483.5000	19.39	33.40	52.79	54.00	-1.21	AVG	

Orthogonal Axis :	X
Test Mode :	TX N-40M MODE 2452MHz

Horizontal

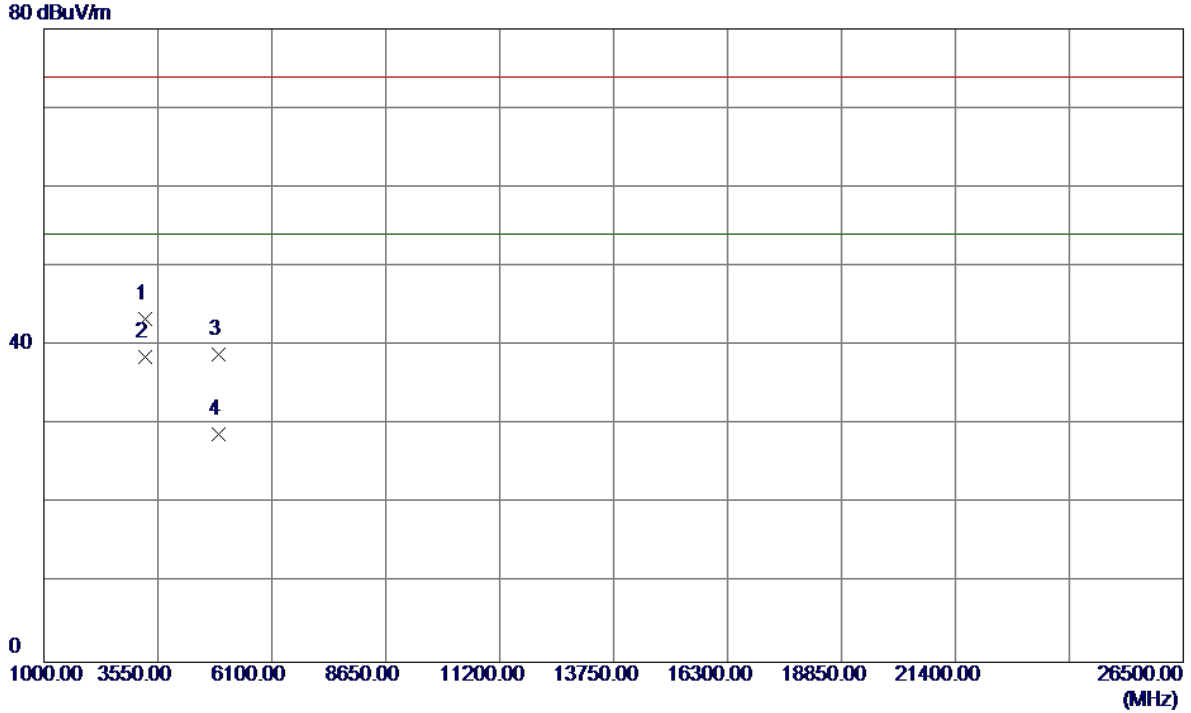

No.	Freq. MHz	Reading Level dBuV/m	Correct Factor dB	Measure ment dBuV/m	Limit dBuV/m	Margin dB	Detector	Comment
1	3269.1820	41.93	1.41	43.34	74.00	-30.66	Peak	
2 *	3269.2950	37.19	1.41	38.60	54.00	-15.40	AVG	
3	4901.2150	33.69	5.18	38.87	74.00	-35.13	Peak	
4	4902.8150	23.66	5.19	28.85	54.00	-25.15	AVG	

ATTACHMENT E - BANDWIDTH

Non-Beamforming

Test Mode : TX B Mode_CH01/06/11

Frequency (MHz)	6dB Bandwidth (MHz)	99% Occupied BW (MHz)	Min. Limit (kHz)	Test Result
2412	8.10	13.44	500	Complies
2437	8.13	13.32	500	Complies
2462	8.10	13.28	500	Complies

TX CH01

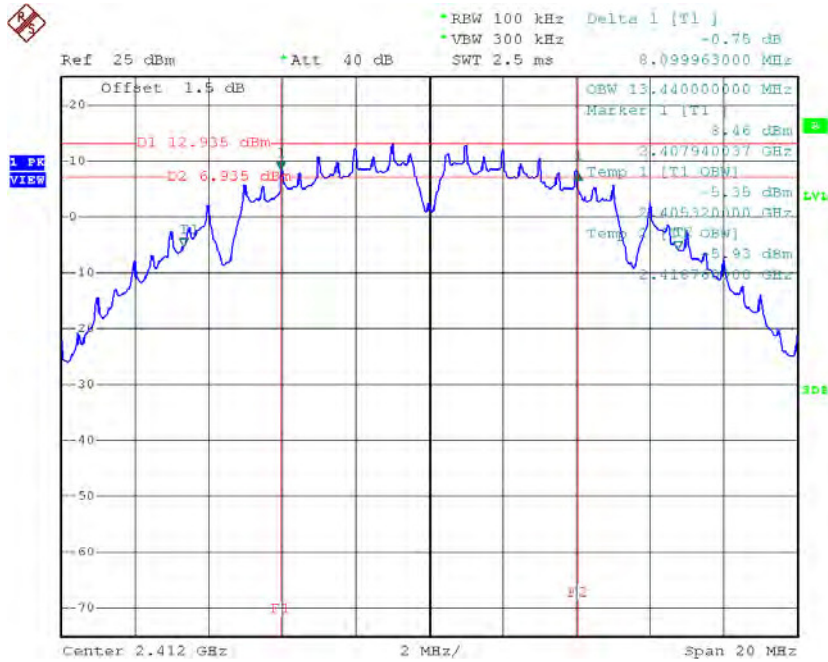

Date: 29.SEP.2016 11:54:23

TX CH06

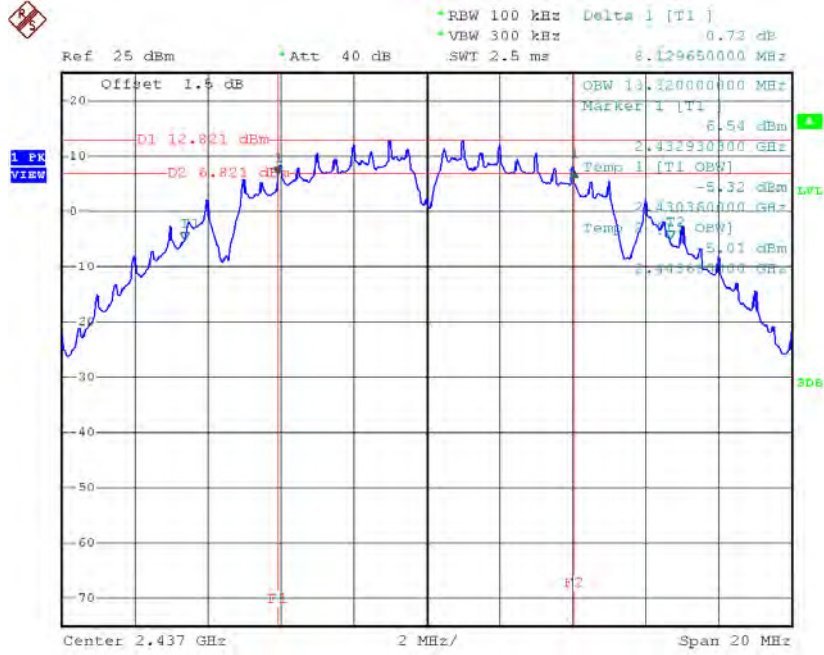

Date: 29.SEP.2016 11:55:50

TX CH11

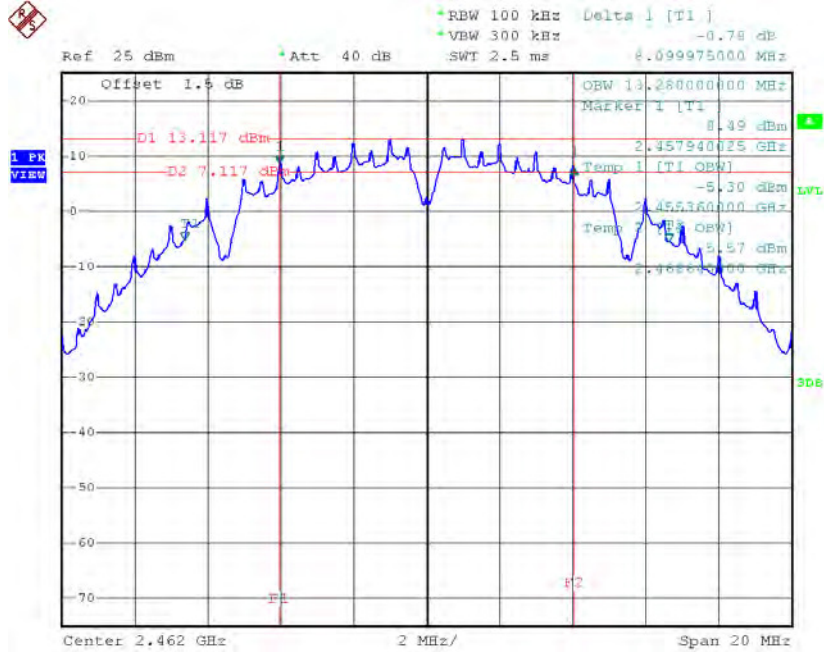

Date: 29.SEP.2016 11:57:07

Test Mode: TX G Mode_CH01/06/11

Frequency (MHz)	6dB Bandwidth (MHz)	99% Occupied BW (MHz)	Min. Limit (kHz)	Test Result
2412	16.40	16.4	500	Complies
2437	16.36	16.4	500	Complies
2462	16.41	16.4	500	Complies

TX CH01

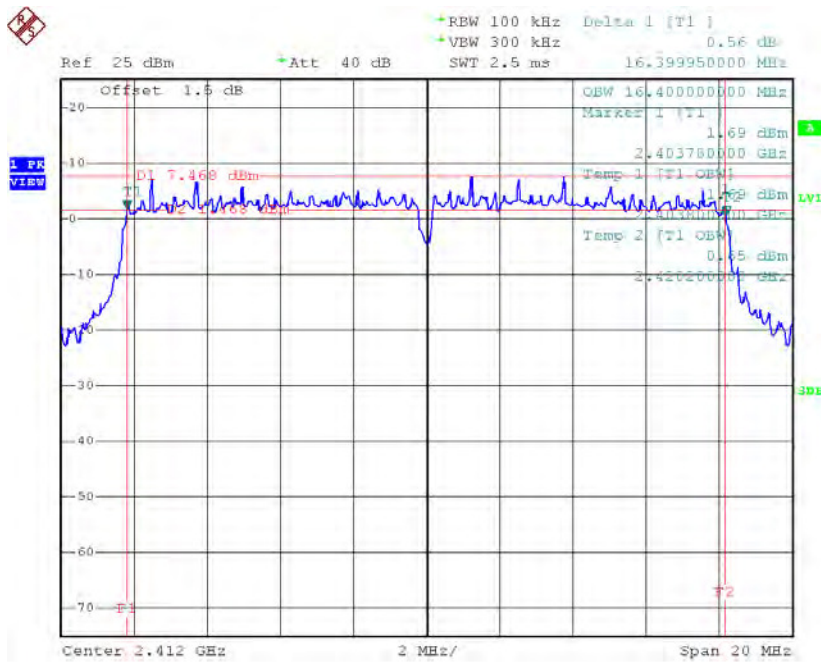

Date: 29.SEP.2016 11:59:54

TX CH06

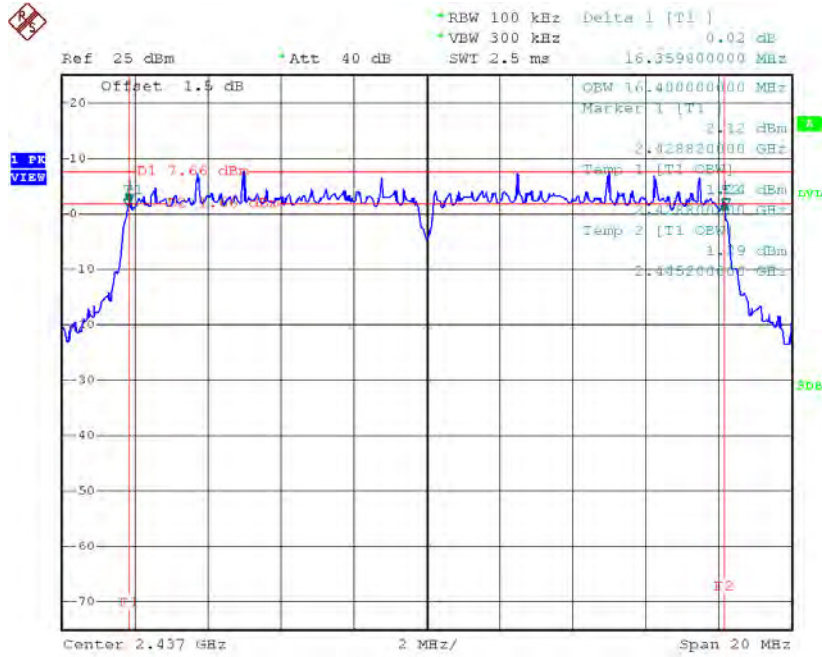

Date: 29.SEP.2016 12:10:09

TX CH11

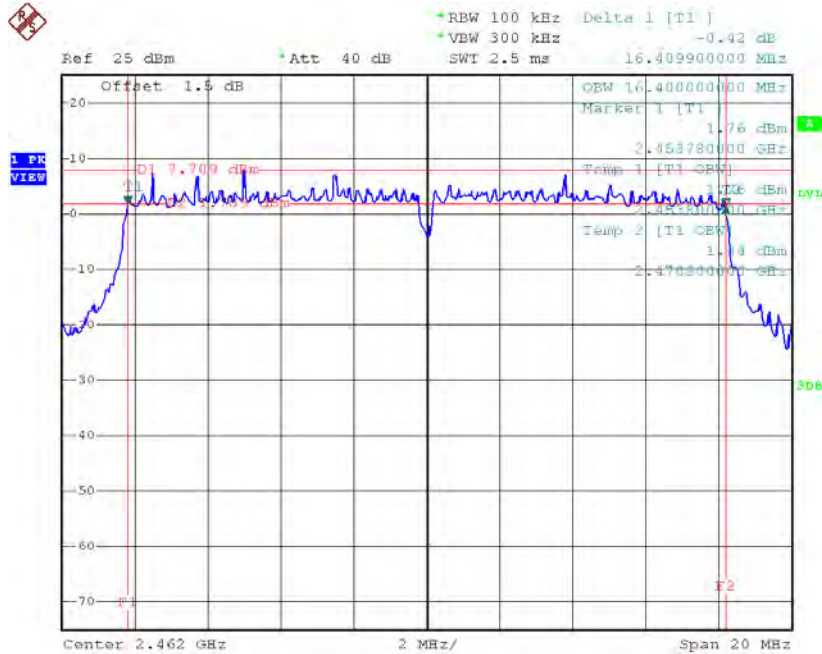

Date: 29.SEP.2016 12:11:12

Test Mode : TX N-20MHz Mode_CH01/06/11

Frequency (MHz)	6dB Bandwidth (MHz)	99% Occupied BW (MHz)	Min. Limit (kHz)	Test Result
2412	17.62	17.6	500	Complies
2437	17.62	17.6	500	Complies
2462	17.66	17.64	500	Complies

TX CH01

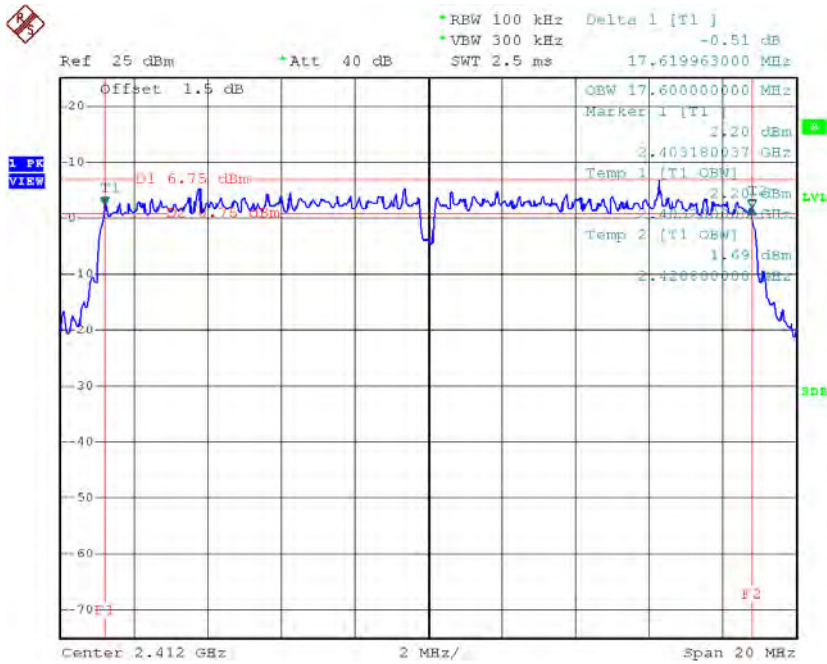

Date: 29.SEP.2016 12:12:34

TX CH06

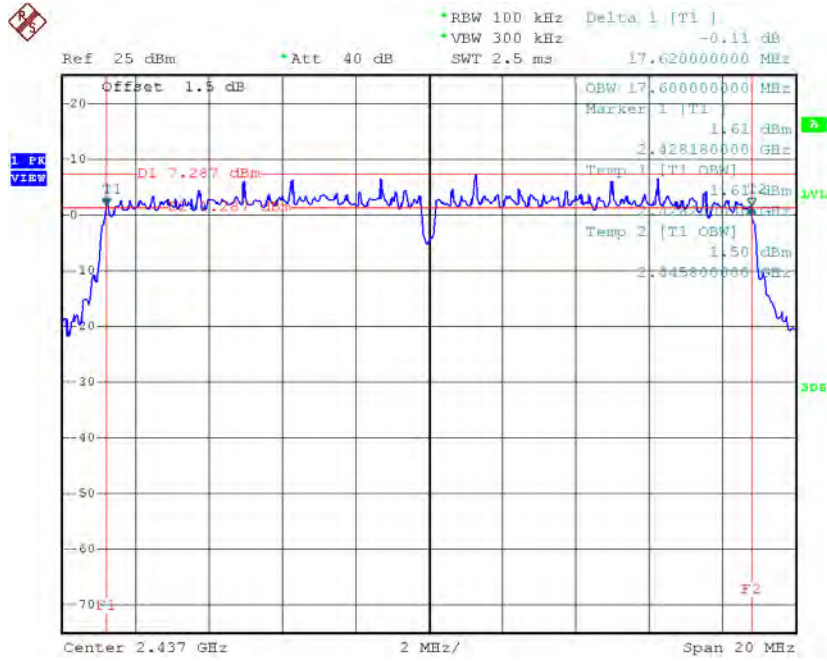

Date: 29.SEP.2016 12:14:36

TX CH11

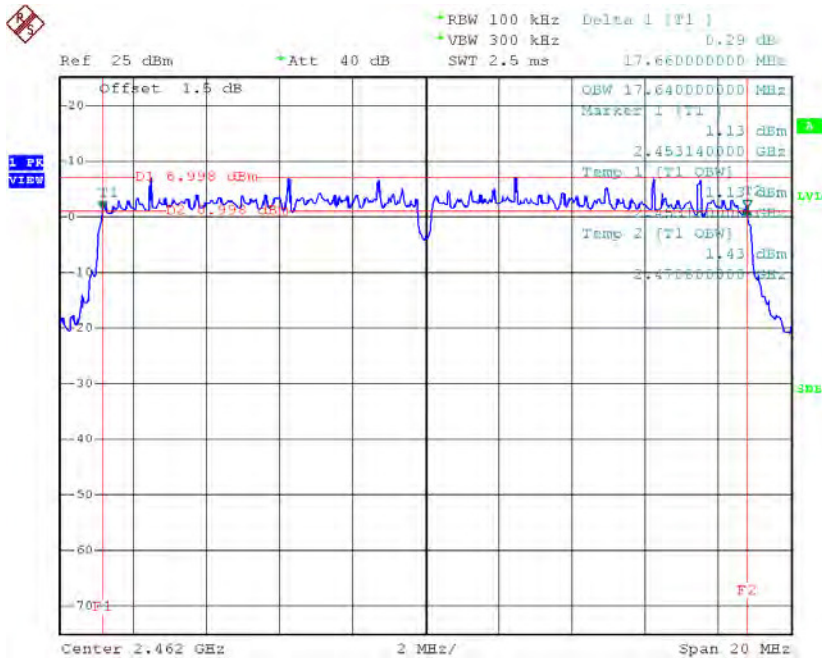

Date: 29.SEP.2016 12:15:36

TX CH06

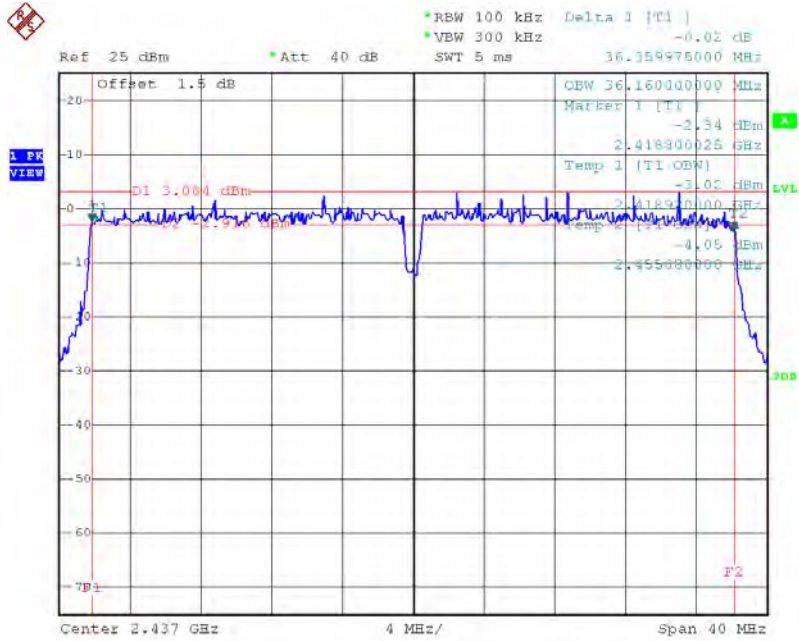

Date: 29.SEP.2016 12:18:03

TX CH09

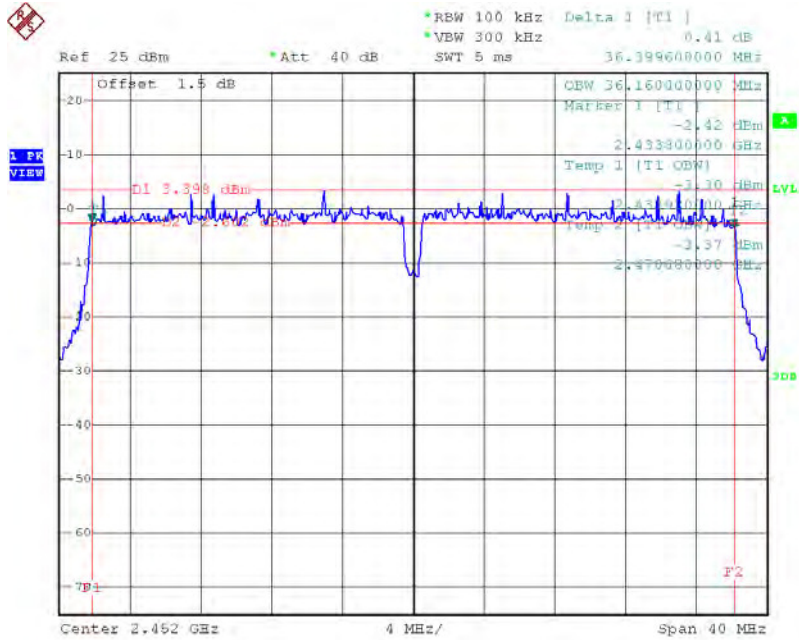

Date: 29.SEP.2016 12:19:07

Beamforming

Test Mode : TX N-20MHz Mode_CH01/06/11

Frequency (MHz)	6dB Bandwidth (MHz)	99% Occupied BW (MHz)	Min. Limit (kHz)	Test Result
2412	17.62	17.6	500	Complies
2437	17.62	17.6	500	Complies
2462	17.66	17.64	500	Complies

TX CH01

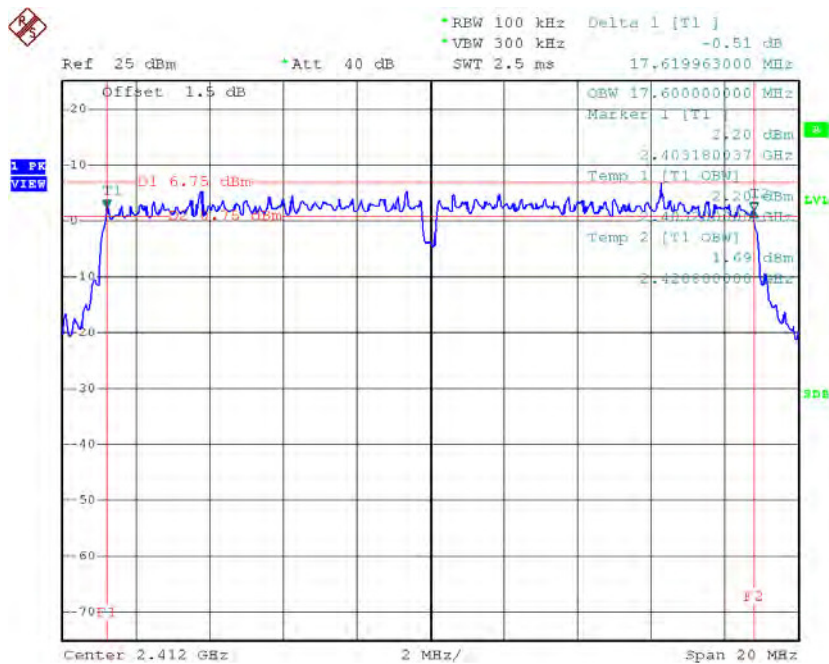

Date: 29.SEP.2016 12:12:34

TX CH06

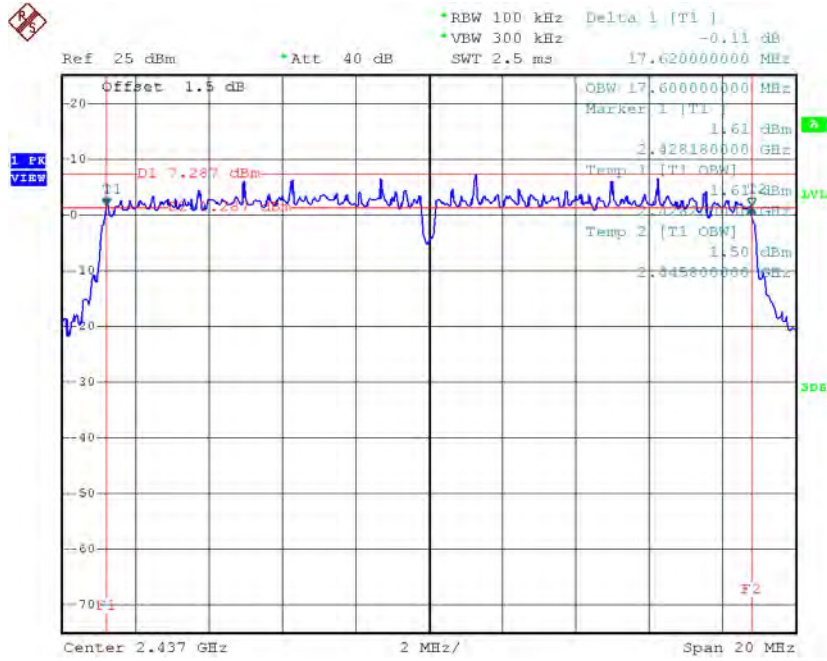

Date: 29.SEP.2016 12:14:36

TX CH11

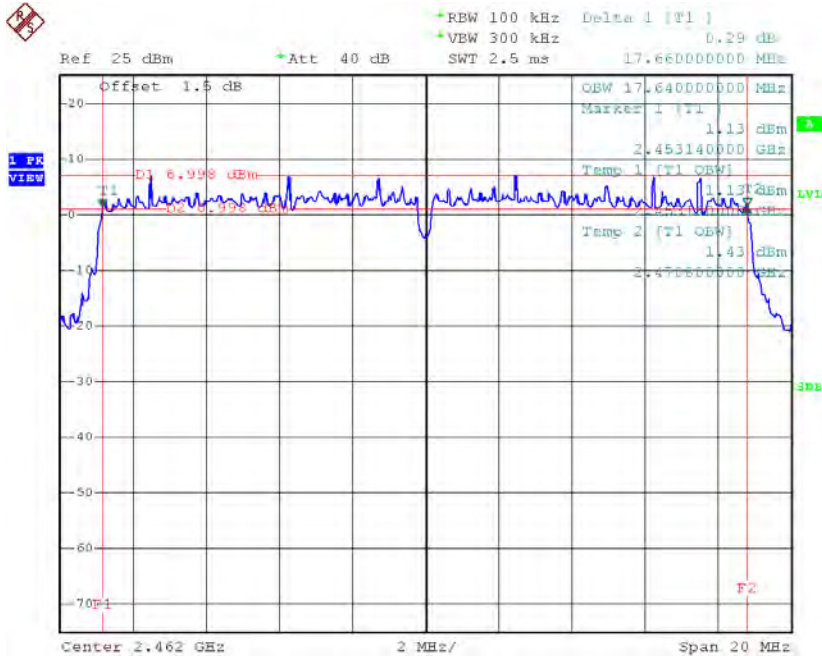

Date: 29.SEP.2016 12:15:36

Test Mode : TX N-40MHz Mode_CH03/06/09

Frequency (MHz)	6dB Bandwidth (MHz)	99% Occupied BW (MHz)	Min. Limit (kHz)	Test Result
2422	36.36	36.16	500	Complies
2437	36.36	36.16	500	Complies
2452	36.40	36.16	500	Complies

TX CH03

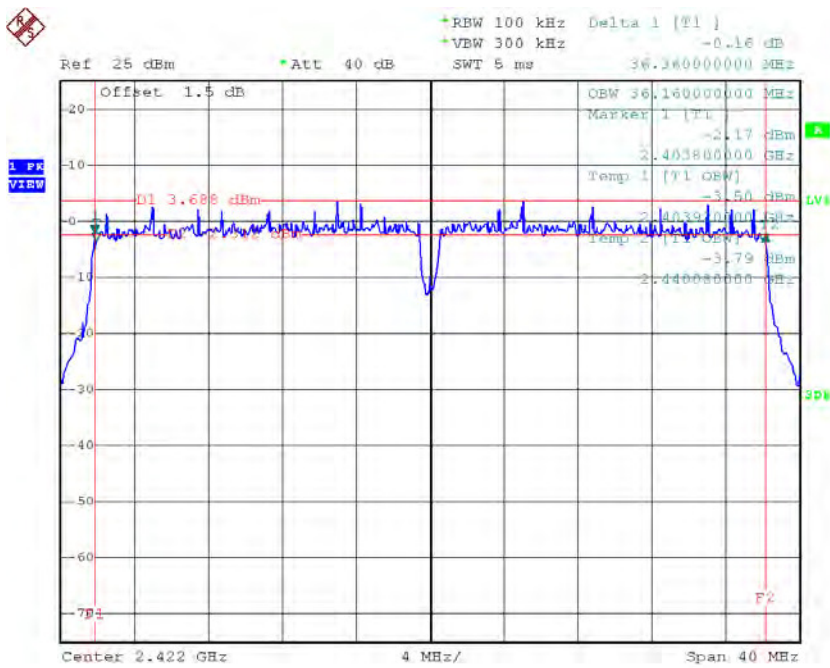

Date: 29.SEP.2016 12:16:53

TX CH06

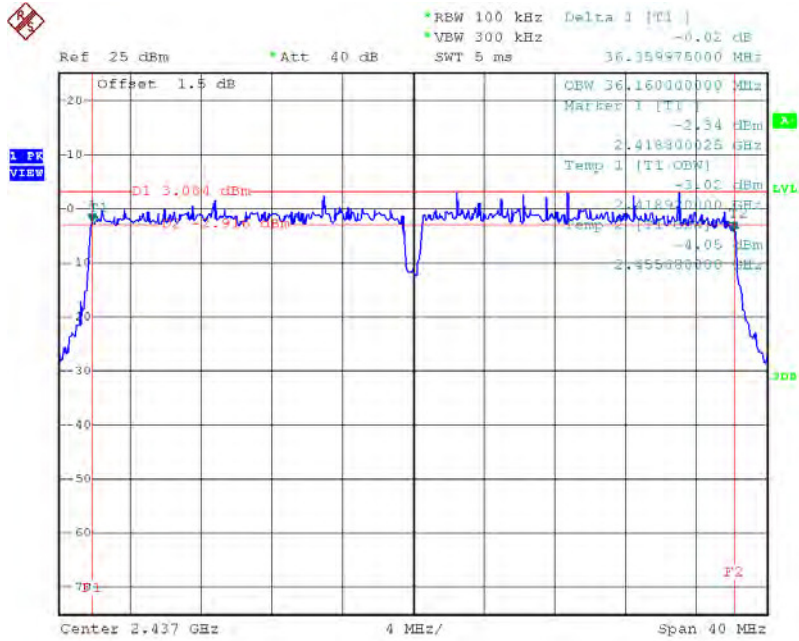

Date: 29.SEP.2016 12:18:03

TX CH09

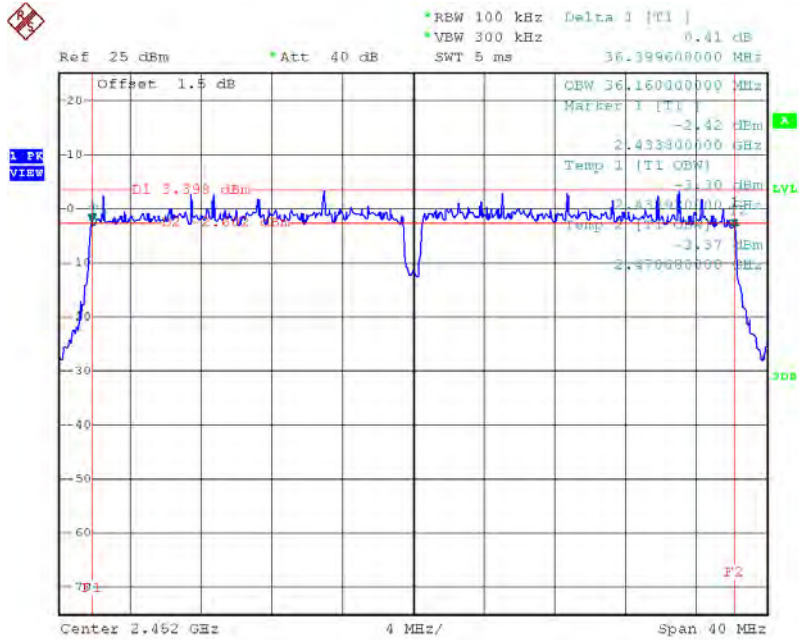

Date: 29.SEP.2016 12:19:07

ATTACHMENT F – MAXIMUM OUTPUT POWER

For 1TX Non-Beamforming

Test Mode :TX B Mode_CH01/06/11					
Frequency (MHz)	Conducted Power (dBm)	Conducted Power (W)	Max. Limit (dBm)	Max. Limit (W)	Result
2412	19.22	0.08	29.47	0.89	Complies
2437	19.15	0.08	29.47	0.89	Complies
2462	19.45	0.09	29.47	0.89	Complies

Test Mode :TX G Mode_CH01/06/11					
Frequency (MHz)	Conducted Power (dBm)	Conducted Power (W)	Max. Limit (dBm)	Max. Limit (W)	Result
2412	15.76	0.04	29.47	0.89	Complies
2437	17.52	0.06	29.47	0.89	Complies
2462	15.85	0.04	29.47	0.89	Complies

Test Mode :TX N20 Mode_CH01/06/11					
Frequency (MHz)	Conducted Power (dBm)	Conducted Power (W)	Max. Limit (dBm)	Max. Limit (W)	Result
2412	14.77	0.03	29.47	0.89	Complies
2437	17.86	0.06	29.47	0.89	Complies
2462	13.82	0.02	29.47	0.89	Complies

Test Mode :TX N40 Mode_CH03/06/09					
Frequency (MHz)	Conducted Power (dBm)	Conducted Power (W)	Max. Limit (dBm)	Max. Limit (W)	Result
2422	12.85	0.02	29.47	0.89	Complies
2437	15.92	0.04	29.47	0.89	Complies
2452	12.76	0.02	29.47	0.89	Complies

For 2TX Non-Beamforming

Test Mode :TX B Mode_CH01/06/11_ANT 1					
Frequency (MHz)	Conducted Power (dBm)	Conducted Power (W)	Max. Limit (dBm)	Max. Limit (W)	Result
2412	19.45	0.09	29.47	0.89	Complies
2437	19.55	0.09	29.47	0.89	Complies
2462	19.42	0.09	29.47	0.89	Complies

Test Mode :TX B Mode_CH01/06/11_ANT 2					
Frequency (MHz)	Conducted Power (dBm)	Conducted Power (W)	Max. Limit (dBm)	Max. Limit (W)	Result
2412	19.84	0.10	29.47	0.89	Complies
2437	19.21	0.08	29.47	0.89	Complies
2462	19.79	0.10	29.47	0.89	Complies

Test Mode :TX B Mode_CH01/06/11_Total					
Frequency (MHz)	Conducted Power (dBm)	Conducted Power (W)	Max. Limit (dBm)	Max. Limit (W)	Result
2412	22.66	0.18	29.47	0.89	Complies
2437	22.39	0.17	29.47	0.89	Complies
2462	22.62	0.18	29.47	0.89	Complies

Test Mode :TX G Mode_CH01/06/11_ANT 1					
Frequency (MHz)	Conducted Power (dBm)	Conducted Power (W)	Max. Limit (dBm)	Max. Limit (W)	Result
2412	14.75	0.03	29.47	0.89	Complies
2437	17.54	0.06	29.47	0.89	Complies
2462	14.82	0.03	29.47	0.89	Complies

Test Mode :TX G Mode_CH01/06/11_ANT 2					
Frequency (MHz)	Conducted Power (dBm)	Conducted Power (W)	Max. Limit (dBm)	Max. Limit (W)	Result
2412	14.69	0.03	29.47	0.89	Complies
2437	17.65	0.06	29.47	0.89	Complies
2462	14.77	0.03	29.47	0.89	Complies

Test Mode :TX G Mode_CH01/06/11_Total					
Frequency (MHz)	Conducted Power (dBm)	Conducted Power (W)	Max. Limit (dBm)	Max. Limit (W)	Result
2412	17.73	0.06	29.47	0.89	Complies
2437	20.61	0.11	29.47	0.89	Complies
2462	17.81	0.06	29.47	0.89	Complies

Test Mode :TX N20 Mode_CH01/06/11_ANT 1					
Frequency (MHz)	Conducted Power (dBm)	Conducted Power (W)	Max. Limit (dBm)	Max. Limit (W)	Result
2412	13.76	0.02	29.47	0.89	Complies
2437	17.95	0.06	29.47	0.89	Complies
2462	12.66	0.02	29.47	0.89	Complies

Test Mode :TX N20 Mode_CH01/06/11_ANT 2					
Frequency (MHz)	Conducted Power (dBm)	Conducted Power (W)	Max. Limit (dBm)	Max. Limit (W)	Result
2412	13.76	0.02	29.47	0.89	Complies
2437	17.56	0.06	29.47	0.89	Complies
2462	12.71	0.02	29.47	0.89	Complies

Test Mode :TX N20 Mode_CH01/06/11_Total					
Frequency (MHz)	Conducted Power (dBm)	Conducted Power (W)	Max. Limit (dBm)	Max. Limit (W)	Result
2412	16.82	0.05	29.47	0.89	Complies
2437	20.77	0.12	29.47	0.89	Complies
2462	15.70	0.04	29.47	0.89	Complies

Test Mode :TX N40 Mode_CH03/06/09_ANT 1					
Frequency (MHz)	Conducted Power (dBm)	Conducted Power (W)	Max. Limit (dBm)	Max. Limit (W)	Result
2422	11.88	0.02	29.47	0.89	Complies
2437	14.76	0.03	29.47	0.89	Complies
2452	11.93	0.02	29.47	0.89	Complies

Test Mode :TX N40 Mode_CH03/06/09_ANT 2					
Frequency (MHz)	Conducted Power (dBm)	Conducted Power (W)	Max. Limit (dBm)	Max. Limit (W)	Result
2422	11.72	0.01	29.47	0.89	Complies
2437	14.82	0.03	29.47	0.89	Complies
2452	11.83	0.02	29.47	0.89	Complies

Test Mode :TX N40 Mode_CH03/06/09_Total					
Frequency (MHz)	Conducted Power (dBm)	Conducted Power (W)	Max. Limit (dBm)	Max. Limit (W)	Result
2422	14.81	0.03	29.47	0.89	Complies
2437	17.80	0.06	29.47	0.89	Complies
2452	14.89	0.03	29.47	0.89	Complies

For 3TX Non-Beamforming

Test Mode :TX B Mode_CH01/06/11_ANT 1					
Frequency (MHz)	Conducted Power (dBm)	Conducted Power (W)	Max. Limit (dBm)	Max. Limit (W)	Result
2412	19.86	0.10	29.47	0.89	Complies
2437	19.83	0.10	29.47	0.89	Complies
2462	18.82	0.08	29.47	0.89	Complies

Test Mode :TX B Mode_CH01/06/11_ANT 2					
Frequency (MHz)	Conducted Power (dBm)	Conducted Power (W)	Max. Limit (dBm)	Max. Limit (W)	Result
2412	19.87	0.10	29.47	0.89	Complies
2437	19.85	0.10	29.47	0.89	Complies
2462	18.66	0.07	29.47	0.89	Complies

Test Mode :TX B Mode_CH01/06/11_ANT 3					
Frequency (MHz)	Conducted Power (dBm)	Conducted Power (W)	Max. Limit (dBm)	Max. Limit (W)	Result
2412	19.86	0.10	29.47	0.89	Complies
2437	19.91	0.10	29.47	0.89	Complies
2462	18.73	0.07	29.47	0.89	Complies

Test Mode :TX B Mode_CH01/06/11_Total					
Frequency (MHz)	Conducted Power (dBm)	Conducted Power (W)	Max. Limit (dBm)	Max. Limit (W)	Result
2412	24.63	0.29	29.47	0.89	Complies
2437	24.63	0.29	29.47	0.89	Complies
2462	23.51	0.29	29.47	0.89	Complies

Test Mode :TX G Mode_CH01/06/11_ANT 1					
Frequency (MHz)	Conducted Power (dBm)	Conducted Power (W)	Max. Limit (dBm)	Max. Limit (W)	Result
2412	13.83	0.02	29.47	0.89	Complies
2437	17.85	0.06	29.47	0.89	Complies
2462	13.94	0.02	29.47	0.89	Complies

Test Mode :TX G Mode_CH01/06/11_ANT 2					
Frequency (MHz)	Conducted Power (dBm)	Conducted Power (W)	Max. Limit (dBm)	Max. Limit (W)	Result
2412	13.91	0.02	29.47	0.89	Complies
2437	17.92	0.06	29.47	0.89	Complies
2462	13.97	0.02	29.47	0.89	Complies

Test Mode :TX G Mode_CH01/06/11_ANT 3					
Frequency (MHz)	Conducted Power (dBm)	Conducted Power (W)	Max. Limit (dBm)	Max. Limit (W)	Result
2412	13.72	0.02	29.47	0.89	Complies
2437	17.86	0.06	29.47	0.89	Complies
2462	13.76	0.02	29.47	0.89	Complies

Test Mode :TX G Mode_CH01/06/11_Total					
Frequency (MHz)	Conducted Power (dBm)	Conducted Power (W)	Max. Limit (dBm)	Max. Limit (W)	Result
2412	18.59	0.07	29.47	0.89	Complies
2437	22.65	0.18	29.47	0.89	Complies
2462	18.66	0.07	29.47	0.89	Complies

Test Mode :TX N20 Mode_CH01/06/11_ANT 1					
Frequency (MHz)	Conducted Power (dBm)	Conducted Power (W)	Max. Limit (dBm)	Max. Limit (W)	Result
2412	13.77	0.02	29.47	0.89	Complies
2437	17.86	0.06	29.47	0.89	Complies
2462	11.86	0.02	29.47	0.89	Complies

Test Mode :TX N20 Mode_CH01/06/11_ANT 2					
Frequency (MHz)	Conducted Power (dBm)	Conducted Power (W)	Max. Limit (dBm)	Max. Limit (W)	Result
2412	13.84	0.02	29.47	0.89	Complies
2437	17.91	0.06	29.47	0.89	Complies
2462	11.89	0.02	29.47	0.89	Complies

Test Mode :TX N20 Mode_CH01/06/11_ANT 3					
Frequency (MHz)	Conducted Power (dBm)	Conducted Power (W)	Max. Limit (dBm)	Max. Limit (W)	Result
2412	13.82	0.02	29.47	0.89	Complies
2437	17.84	0.06	29.47	0.89	Complies
2462	11.79	0.02	29.47	0.89	Complies

Test Mode :TX N20 Mode_CH01/06/11_Total					
Frequency (MHz)	Conducted Power (dBm)	Conducted Power (W)	Max. Limit (dBm)	Max. Limit (W)	Result
2412	18.58	0.07	29.47	0.89	Complies
2437	22.64	0.18	29.47	0.89	Complies
2462	16.62	0.05	29.47	0.89	Complies

Test Mode :TX N40 Mode_CH01/06/11_ANT 1					
Frequency (MHz)	Conducted Power (dBm)	Conducted Power (W)	Max. Limit (dBm)	Max. Limit (W)	Result
2422	10.95	0.01	29.47	0.89	Complies
2437	13.75	0.02	29.47	0.89	Complies
2452	10.81	0.01	29.47	0.89	Complies

Test Mode :TX N40 Mode_CH03/06/09_ANT 2					
Frequency (MHz)	Conducted Power (dBm)	Conducted Power (W)	Max. Limit (dBm)	Max. Limit (W)	Result
2422	10.86	0.01	29.47	0.89	Complies
2437	13.81	0.02	29.47	0.89	Complies
2452	10.73	0.01	29.47	0.89	Complies

Test Mode :TX N40 Mode_CH03/06/09_ANT 3					
Frequency (MHz)	Conducted Power (dBm)	Conducted Power (W)	Max. Limit (dBm)	Max. Limit (W)	Result
2422	10.79	0.01	29.47	0.89	Complies
2437	13.84	0.02	29.47	0.89	Complies
2452	10.73	0.01	29.47	0.89	Complies

Test Mode :TX N40 Mode_CH03/06/09_Total					
Frequency (MHz)	Conducted Power (dBm)	Conducted Power (W)	Max. Limit (dBm)	Max. Limit (W)	Result
2422	15.64	0.04	29.47	0.89	Complies
2437	18.57	0.07	29.47	0.89	Complies
2452	15.53	0.04	29.47	0.89	Complies

For 4TX Non-Beamforming

Test Mode :TX B Mode_CH01/06/11_ANT 1					
Frequency (MHz)	Conducted Power (dBm)	Conducted Power (W)	Max. Limit (dBm)	Max. Limit (W)	Result
2412	19.76	0.09	29.47	0.89	Complies
2437	19.77	0.09	29.47	0.89	Complies
2462	19.73	0.09	29.47	0.89	Complies

Test Mode :TX B Mode_CH01/06/11_ANT 2					
Frequency (MHz)	Conducted Power (dBm)	Conducted Power (W)	Max. Limit (dBm)	Max. Limit (W)	Result
2412	19.81	0.10	29.47	0.89	Complies
2437	19.83	0.10	29.47	0.89	Complies
2462	19.82	0.10	29.47	0.89	Complies

Test Mode :TX B Mode_CH01/06/11_ANT 3					
Frequency (MHz)	Conducted Power (dBm)	Conducted Power (W)	Max. Limit (dBm)	Max. Limit (W)	Result
2412	19.76	0.09	29.47	0.89	Complies
2437	19.78	0.10	29.47	0.89	Complies
2462	19.81	0.10	29.47	0.89	Complies

Test Mode :TX B Mode_CH01/06/11_ANT 4					
Frequency (MHz)	Conducted Power (dBm)	Conducted Power (W)	Max. Limit (dBm)	Max. Limit (W)	Result
2412	19.85	0.10	29.47	0.89	Complies
2437	19.84	0.10	29.47	0.89	Complies
2462	19.79	0.10	29.47	0.89	Complies

Test Mode :TX B Mode_CH01/06/11_Total					
Frequency (MHz)	Conducted Power (dBm)	Conducted Power (W)	Max. Limit (dBm)	Max. Limit (W)	Result
2412	25.82	0.38	29.47	0.89	Complies
2437	25.83	0.38	29.47	0.89	Complies
2462	25.81	0.38	29.47	0.89	Complies

Test Mode :TX G Mode_CH01/06/11_ANT 1					
Frequency (MHz)	Conducted Power (dBm)	Conducted Power (W)	Max. Limit (dBm)	Max. Limit (W)	Result
2412	13.85	0.02	29.47	0.89	Complies
2437	17.83	0.06	29.47	0.89	Complies
2462	13.86	0.02	29.47	0.89	Complies

Test Mode :TX G Mode_CH01/06/11_ANT 2					
Frequency (MHz)	Conducted Power (dBm)	Conducted Power (W)	Max. Limit (dBm)	Max. Limit (W)	Result
2412	13.88	0.02	29.47	0.89	Complies
2437	17.92	0.06	29.47	0.89	Complies
2462	13.79	0.02	29.47	0.89	Complies

Test Mode :TX G Mode_CH01/06/11_ANT 3					
Frequency (MHz)	Conducted Power (dBm)	Conducted Power (W)	Max. Limit (dBm)	Max. Limit (W)	Result
2412	13.86	0.02	29.47	0.89	Complies
2437	17.87	0.06	29.47	0.89	Complies
2462	13.79	0.02	29.47	0.89	Complies

Test Mode :TX G Mode_CH01/06/11_ANT 4					
Frequency (MHz)	Conducted Power (dBm)	Conducted Power (W)	Max. Limit (dBm)	Max. Limit (W)	Result
2412	13.81	0.02	29.47	0.89	Complies
2437	17.91	0.06	29.47	0.89	Complies
2462	13.77	0.02	29.47	0.89	Complies

Test Mode :TX G Mode_CH01/06/11_Total					
Frequency (MHz)	Conducted Power (dBm)	Conducted Power (W)	Max. Limit (dBm)	Max. Limit (W)	Result
2412	19.87	0.10	29.47	0.89	Complies
2437	23.90	0.25	29.47	0.89	Complies
2462	19.82	0.10	29.47	0.89	Complies

Test Mode :TX N20 Mode_CH01/06/11_ANT 1					
Frequency (MHz)	Conducted Power (dBm)	Conducted Power (W)	Max. Limit (dBm)	Max. Limit (W)	Result
2412	12.87	0.02	29.47	0.89	Complies
2437	17.85	0.06	29.47	0.89	Complies
2462	11.86	0.02	29.47	0.89	Complies

Test Mode :TX N20 Mode_CH01/06/11_ANT 2					
Frequency (MHz)	Conducted Power (dBm)	Conducted Power (W)	Max. Limit (dBm)	Max. Limit (W)	Result
2412	12.91	0.02	29.47	0.89	Complies
2437	17.86	0.06	29.47	0.89	Complies
2462	11.86	0.02	29.47	0.89	Complies

Test Mode :TX N20 Mode_CH01/06/11_ANT 3					
Frequency (MHz)	Conducted Power (dBm)	Conducted Power (W)	Max. Limit (dBm)	Max. Limit (W)	Result
2412	12.87	0.02	29.47	0.89	Complies
2437	17.85	0.06	29.47	0.89	Complies
2462	11.84	0.02	29.47	0.89	Complies

Test Mode :TX N20 Mode_CH01/06/11_ANT 4					
Frequency (MHz)	Conducted Power (dBm)	Conducted Power (W)	Max. Limit (dBm)	Max. Limit (W)	Result
2412	12.86	0.02	29.47	0.89	Complies
2437	17.82	0.06	29.47	0.89	Complies
2462	11.82	0.02	29.47	0.89	Complies

Test Mode :TX N20 Mode_CH01/06/11_Total					
Frequency (MHz)	Conducted Power (dBm)	Conducted Power (W)	Max. Limit (dBm)	Max. Limit (W)	Result
2412	18.90	0.08	29.47	0.89	Complies
2437	23.87	0.24	29.47	0.89	Complies
2462	17.87	0.06	29.47	0.89	Complies

Test Mode :TX N40 Mode_CH03/06/09_ANT 1					
Frequency (MHz)	Conducted Power (dBm)	Conducted Power (W)	Max. Limit (dBm)	Max. Limit (W)	Result
2422	10.88	0.01	29.47	0.89	Complies
2437	13.86	0.02	29.47	0.89	Complies
2452	10.81	0.01	29.47	0.89	Complies

Test Mode :TX N40 Mode_CH03/06/09_ANT 2					
Frequency (MHz)	Conducted Power (dBm)	Conducted Power (W)	Max. Limit (dBm)	Max. Limit (W)	Result
2422	10.91	0.01	29.47	0.89	Complies
2437	13.92	0.02	29.47	0.89	Complies
2452	10.93	0.01	29.47	0.89	Complies

Test Mode :TX N40 Mode_CH03/06/09_ANT 3					
Frequency (MHz)	Conducted Power (dBm)	Conducted Power (W)	Max. Limit (dBm)	Max. Limit (W)	Result
2422	10.88	0.01	29.47	0.89	Complies
2437	13.86	0.02	29.47	0.89	Complies
2452	10.85	0.01	29.47	0.89	Complies

Test Mode :TX N40 Mode_CH03/06/09_ANT 4					
Frequency (MHz)	Conducted Power (dBm)	Conducted Power (W)	Max. Limit (dBm)	Max. Limit (W)	Result
2422	10.89	0.01	29.47	0.89	Complies
2437	13.75	0.02	29.47	0.89	Complies
2452	10.86	0.01	29.47	0.89	Complies

Test Mode :TX N40 Mode_CH03/06/09_Total					
Frequency (MHz)	Conducted Power (dBm)	Conducted Power (W)	Max. Limit (dBm)	Max. Limit (W)	Result
2422	16.91	0.05	29.47	0.89	Complies
2437	19.87	0.10	29.47	0.89	Complies
2452	16.88	0.05	29.47	0.89	Complies

For 2TX Beamforming

Test Mode :TX N20 Mode_CH01/06/11_ANT 1					
Frequency (MHz)	Conducted Power (dBm)	Conducted Power (W)	Max. Limit (dBm)	Max. Limit (W)	Result
2412	12.89	0.02	29.47	0.89	Complies
2437	17.85	0.06	29.47	0.89	Complies
2462	11.78	0.02	29.47	0.89	Complies

Test Mode :TX N20 Mode_CH01/06/11_ANT 2					
Frequency (MHz)	Conducted Power (dBm)	Conducted Power (W)	Max. Limit (dBm)	Max. Limit (W)	Result
2412	12.85	0.02	29.47	0.89	Complies
2437	17.86	0.06	29.47	0.89	Complies
2462	11.89	0.02	29.47	0.89	Complies

Test Mode :TX N20 Mode_CH01/06/11_Total					
Frequency (MHz)	Conducted Power (dBm)	Conducted Power (W)	Max. Limit (dBm)	Max. Limit (W)	Result
2412	16.10	0.04	29.47	0.89	Complies
2437	20.94	0.12	29.47	0.89	Complies
2462	15.12	0.03	29.47	0.89	Complies

Test Mode :TX N40 Mode_CH03/06/09_ANT 1					
Frequency (MHz)	Conducted Power (dBm)	Conducted Power (W)	Max. Limit (dBm)	Max. Limit (W)	Result
2422	10.88	0.01	29.47	0.89	Complies
2437	13.86	0.02	29.47	0.89	Complies
2452	10.81	0.01	29.47	0.89	Complies

Test Mode :TX N40 Mode_CH03/06/09_ANT 2					
Frequency (MHz)	Conducted Power (dBm)	Conducted Power (W)	Max. Limit (dBm)	Max. Limit (W)	Result
2422	10.91	0.01	29.47	0.89	Complies
2437	13.92	0.02	29.47	0.89	Complies
2452	10.86	0.01	29.47	0.89	Complies

Test Mode :TX N40 Mode_CH03/06/09_Total					
Frequency (MHz)	Conducted Power (dBm)	Conducted Power (W)	Max. Limit (dBm)	Max. Limit (W)	Result
2422	14.25	0.03	29.47	0.89	Complies
2437	17.07	0.05	29.47	0.89	Complies
2452	14.19	0.03	29.47	0.89	Complies

For 3TX Beamforming

Test Mode :TX N20 Mode_CH01/06/11_ANT 1					
Frequency (MHz)	Conducted Power (dBm)	Conducted Power (W)	Max. Limit (dBm)	Max. Limit (W)	Result
2412	12.78	0.02	29.47	0.89	Complies
2437	14.82	0.03	29.47	0.89	Complies
2462	11.75	0.01	29.47	0.89	Complies

Test Mode :TX N20 Mode_CH01/06/11_ANT 2					
Frequency (MHz)	Conducted Power (dBm)	Conducted Power (W)	Max. Limit (dBm)	Max. Limit (W)	Result
2412	12.82	0.02	29.47	0.89	Complies
2437	14.83	0.03	29.47	0.89	Complies
2462	11.77	0.02	29.47	0.89	Complies

Test Mode :TX N20 Mode_CH01/06/11_ANT 3					
Frequency (MHz)	Conducted Power (dBm)	Conducted Power (W)	Max. Limit (dBm)	Max. Limit (W)	Result
2412	12.86	0.02	29.47	0.89	Complies
2437	14.88	0.03	29.47	0.89	Complies
2462	11.76	0.01	29.47	0.89	Complies

Test Mode :TX N20 Mode_CH01/06/11_Total					
Frequency (MHz)	Conducted Power (dBm)	Conducted Power (W)	Max. Limit (dBm)	Max. Limit (W)	Result
2412	17.67	0.06	29.47	0.89	Complies
2437	19.66	0.09	29.47	0.89	Complies
2462	16.63	0.05	29.47	0.89	Complies

Test Mode :TX N40 Mode_CH01/06/11_ANT 1					
Frequency (MHz)	Conducted Power (dBm)	Conducted Power (W)	Max. Limit (dBm)	Max. Limit (W)	Result
2422	10.85	0.01	29.47	0.89	Complies
2437	13.79	0.02	29.47	0.89	Complies
2452	10.77	0.01	29.47	0.89	Complies

Test Mode :TX N40 Mode_CH03/06/09_ANT 2					
Frequency (MHz)	Conducted Power (dBm)	Conducted Power (W)	Max. Limit (dBm)	Max. Limit (W)	Result
2422	10.81	0.01	29.47	0.89	Complies
2437	13.83	0.02	29.47	0.89	Complies
2452	10.79	0.01	29.47	0.89	Complies

Test Mode :TX N40 Mode_CH03/06/09_ANT 3					
Frequency (MHz)	Conducted Power (dBm)	Conducted Power (W)	Max. Limit (dBm)	Max. Limit (W)	Result
2422	10.83	0.01	29.47	0.89	Complies
2437	13.89	0.02	29.47	0.89	Complies
2452	10.78	0.01	29.47	0.89	Complies

Test Mode :TX N40 Mode_CH03/06/09_Total					
Frequency (MHz)	Conducted Power (dBm)	Conducted Power (W)	Max. Limit (dBm)	Max. Limit (W)	Result
2422	15.72	0.04	29.47	0.89	Complies
2437	18.67	0.07	29.47	0.89	Complies
2452	15.67	0.04	29.47	0.89	Complies

For 4TX Beamforming

Test Mode :TX N20 Mode_CH01/06/11_ANT 1					
Frequency (MHz)	Conducted Power (dBm)	Conducted Power (W)	Max. Limit (dBm)	Max. Limit (W)	Result
2412	11.86	0.02	29.47	0.89	Complies
2437	11.79	0.02	29.47	0.89	Complies
2462	11.69	0.01	29.47	0.89	Complies

Test Mode :TX N20 Mode_CH01/06/11_ANT 2					
Frequency (MHz)	Conducted Power (dBm)	Conducted Power (W)	Max. Limit (dBm)	Max. Limit (W)	Result
2412	11.81	0.02	29.47	0.89	Complies
2437	11.82	0.02	29.47	0.89	Complies
2462	11.75	0.01	29.47	0.89	Complies

Test Mode :TX N20 Mode_CH01/06/11_ANT 3					
Frequency (MHz)	Conducted Power (dBm)	Conducted Power (W)	Max. Limit (dBm)	Max. Limit (W)	Result
2412	11.77	0.02	29.47	0.89	Complies
2437	11.65	0.01	29.47	0.89	Complies
2462	11.81	0.02	29.47	0.89	Complies

Test Mode :TX N20 Mode_CH01/06/11_ANT 4					
Frequency (MHz)	Conducted Power (dBm)	Conducted Power (W)	Max. Limit (dBm)	Max. Limit (W)	Result
2412	11.76	0.01	29.47	0.89	Complies
2437	11.69	0.01	29.47	0.89	Complies
2462	11.75	0.01	29.47	0.89	Complies

Test Mode :TX N20 Mode_CH01/06/11_Total					
Frequency (MHz)	Conducted Power (dBm)	Conducted Power (W)	Max. Limit (dBm)	Max. Limit (W)	Result
2412	17.82	0.06	29.47	0.89	Complies
2437	17.76	0.06	29.47	0.89	Complies
2462	17.77	0.06	29.47	0.89	Complies

Test Mode :TX N40 Mode_CH03/06/09_ANT 1					
Frequency (MHz)	Conducted Power (dBm)	Conducted Power (W)	Max. Limit (dBm)	Max. Limit (W)	Result
2422	10.74	0.01	29.47	0.89	Complies
2437	11.81	0.02	29.47	0.89	Complies
2452	10.79	0.01	29.47	0.89	Complies

Test Mode :TX N40 Mode_CH03/06/09_ANT 2					
Frequency (MHz)	Conducted Power (dBm)	Conducted Power (W)	Max. Limit (dBm)	Max. Limit (W)	Result
2422	10.72	0.01	29.47	0.89	Complies
2437	11.76	0.01	29.47	0.89	Complies
2452	10.77	0.01	29.47	0.89	Complies

Test Mode :TX N40 Mode_CH03/06/09_ANT 3					
Frequency (MHz)	Conducted Power (dBm)	Conducted Power (W)	Max. Limit (dBm)	Max. Limit (W)	Result
2422	10.69	0.01	29.47	0.89	Complies
2437	11.73	0.01	29.47	0.89	Complies
2452	10.71	0.01	29.47	0.89	Complies

Test Mode :TX N40 Mode_CH03/06/09_ANT 4					
Frequency (MHz)	Conducted Power (dBm)	Conducted Power (W)	Max. Limit (dBm)	Max. Limit (W)	Result
2422	10.72	0.01	29.47	0.89	Complies
2437	11.62	0.01	29.47	0.89	Complies
2452	10.81	0.01	29.47	0.89	Complies

Test Mode :TX N40 Mode_CH03/06/09_Total					
Frequency (MHz)	Conducted Power (dBm)	Conducted Power (W)	Max. Limit (dBm)	Max. Limit (W)	Result
2422	16.74	0.05	29.47	0.89	Complies
2437	17.75	0.06	29.47	0.89	Complies
2452	16.79	0.05	29.47	0.89	Complies

ATTACHMENT G - ANTENNA CONDUCTED SPURIOUS EMISSION

For 1TX Non-Beamforming

Test Mode : TX B Mode

TX B mode CH01

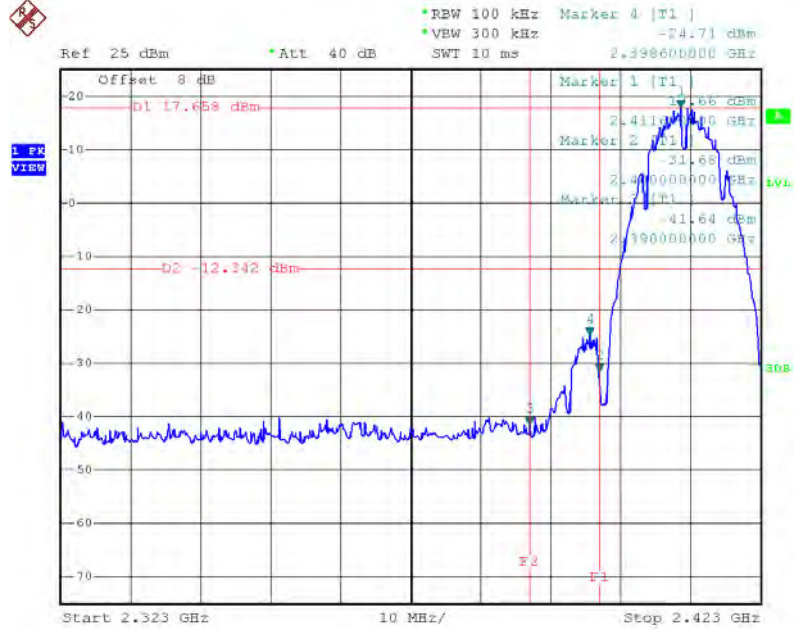

Date: 29.SEP.2016 11:55:02

TX B mode CH11

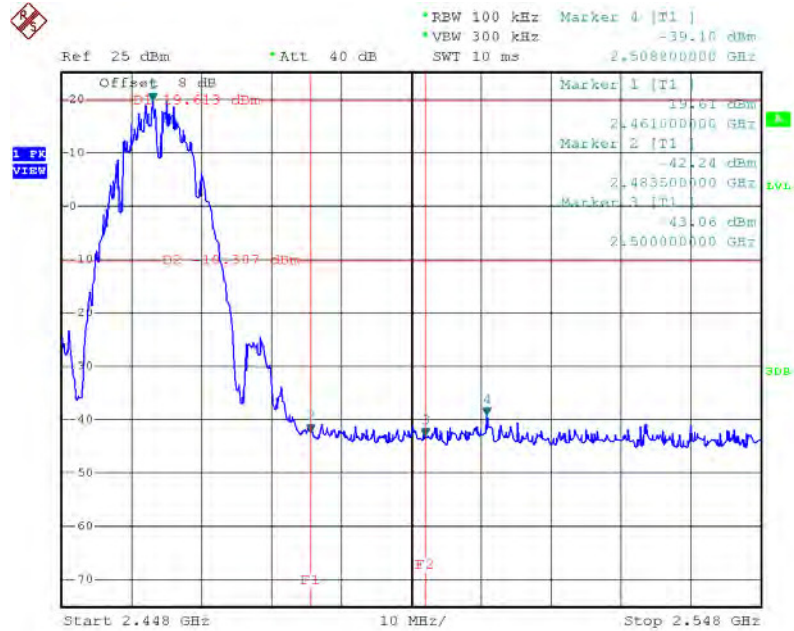

Date: 29.SEP.2016 11:57:46

TX B mode CH01 (10 Harmonic of the frequency)

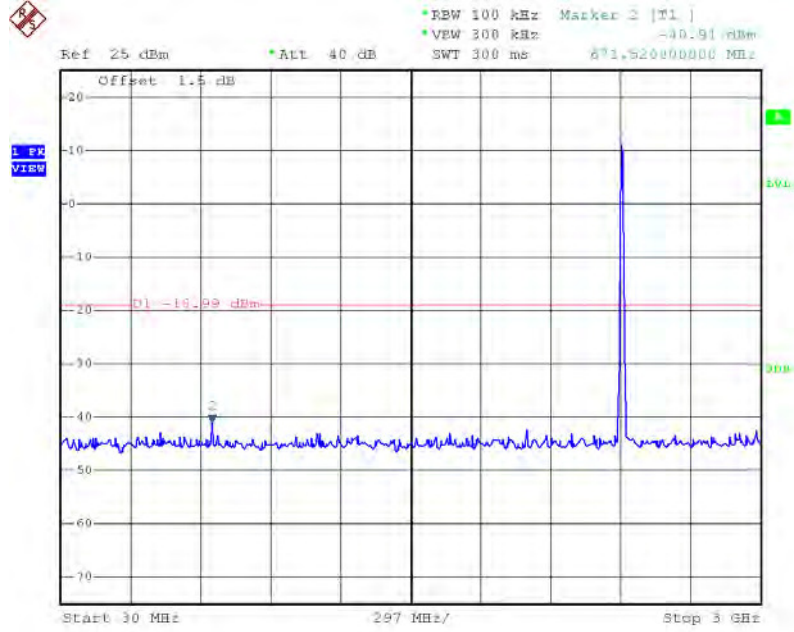

Date: 29.SEP.2016 11:54:37

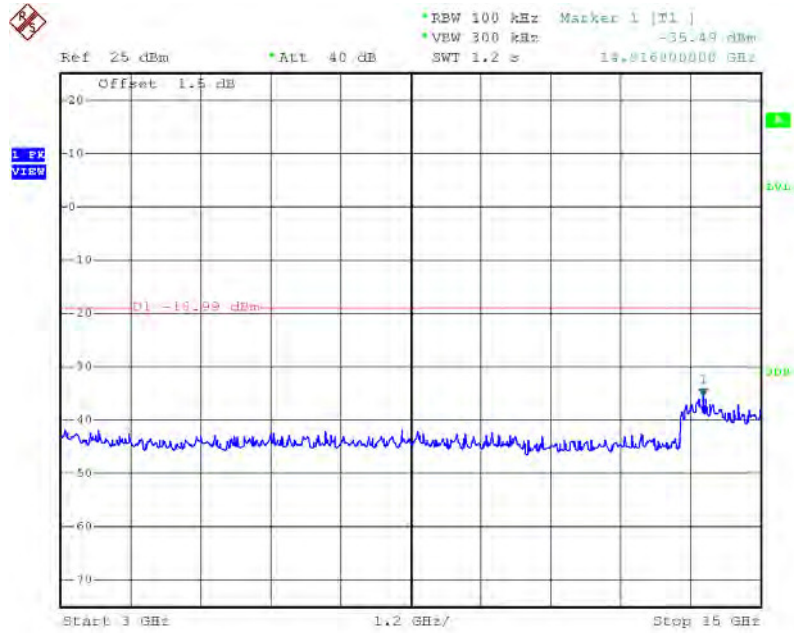

Date: 29.SEP.2016 11:54:46



Date: 29.SEP.2016 11:54:54

TX B mode CH06 (10 Harmonic of the frequency)

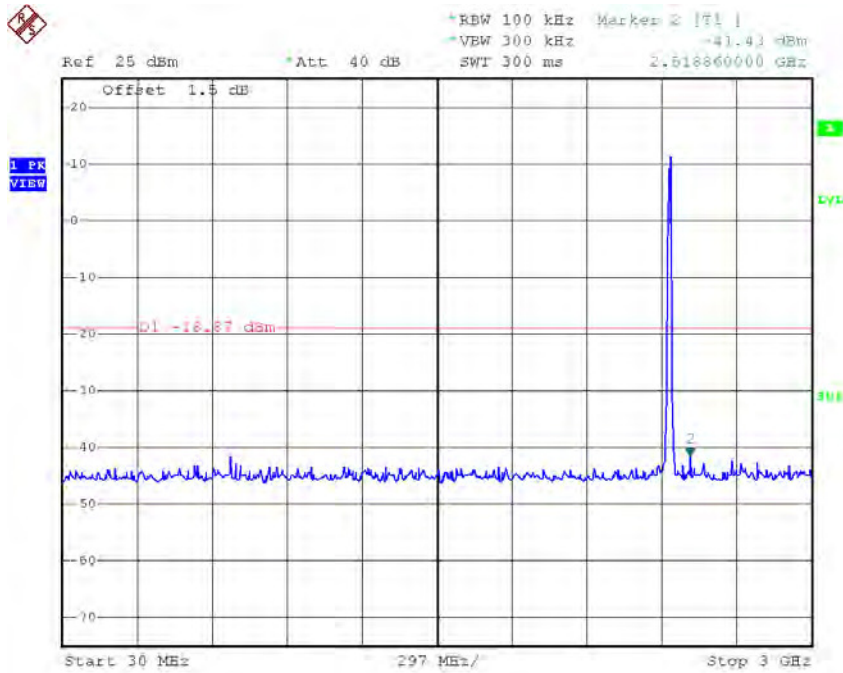

Date: 29.SEP.2016 11:56:04

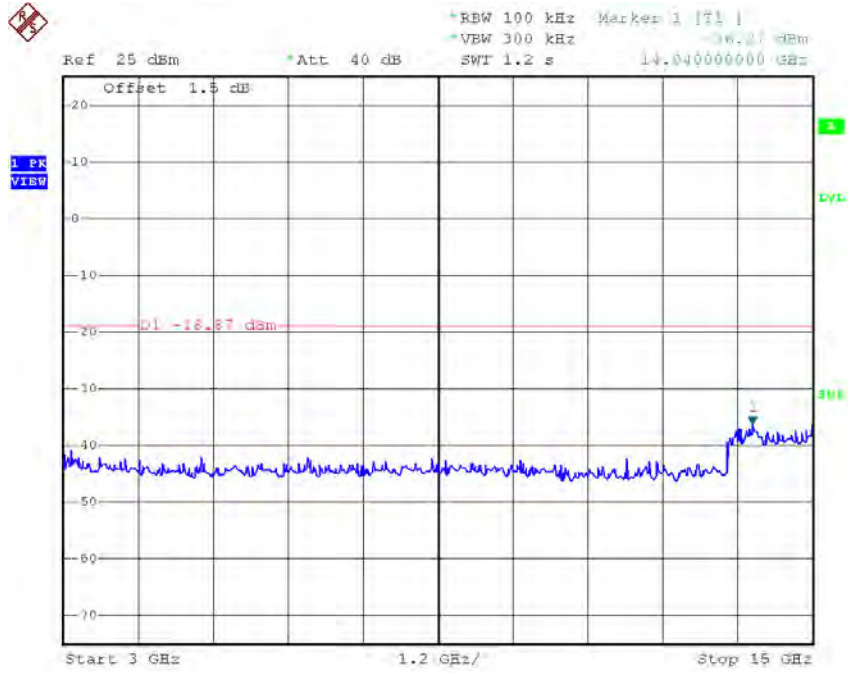

Date: 29.SEP.2016 11:56:12

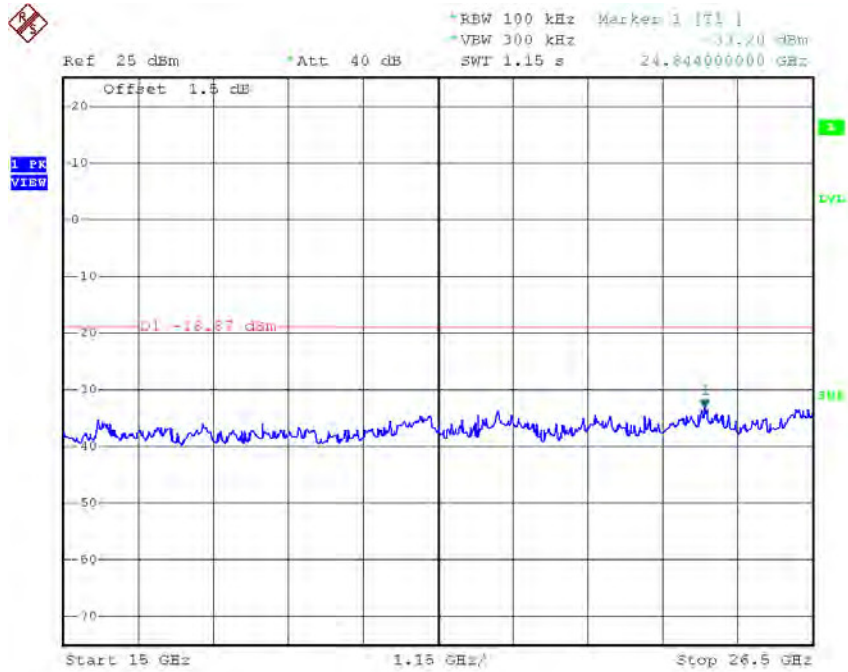

Date: 29.SEP.2016 11:56:21

TX B mode CH11 (10 Harmonic of the frequency)

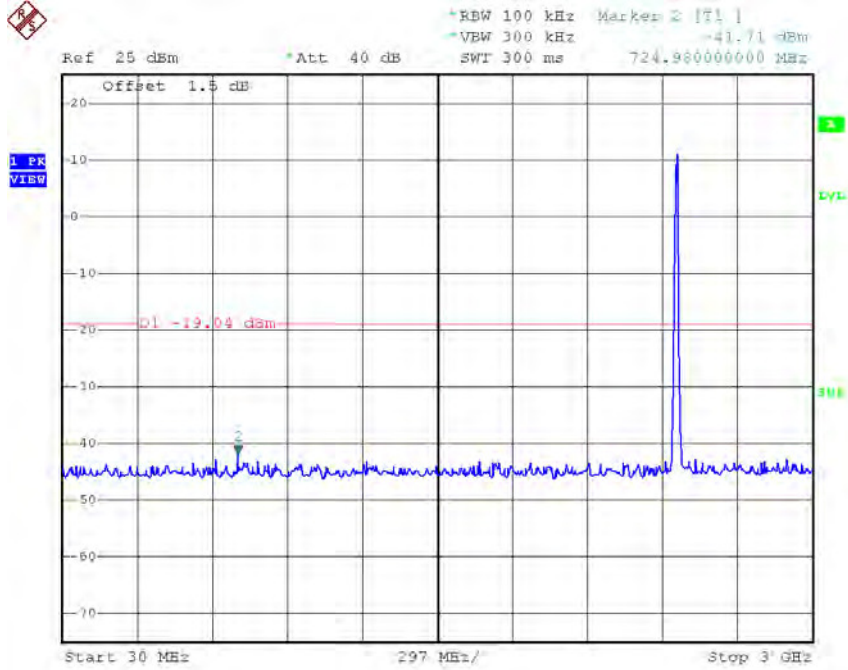

Date: 29.SEP.2016 11:57:21

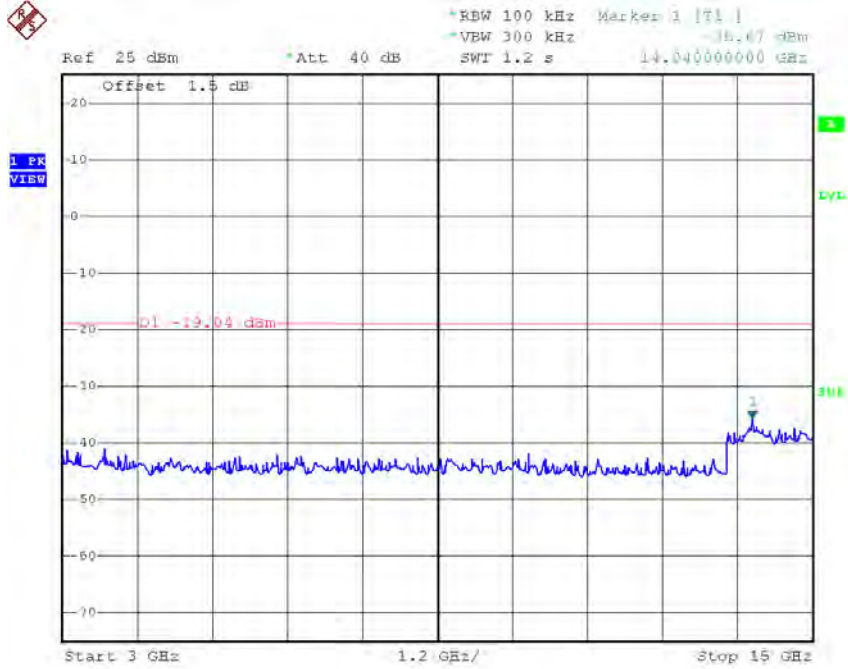

Date: 29.SEP.2016 11:57:30

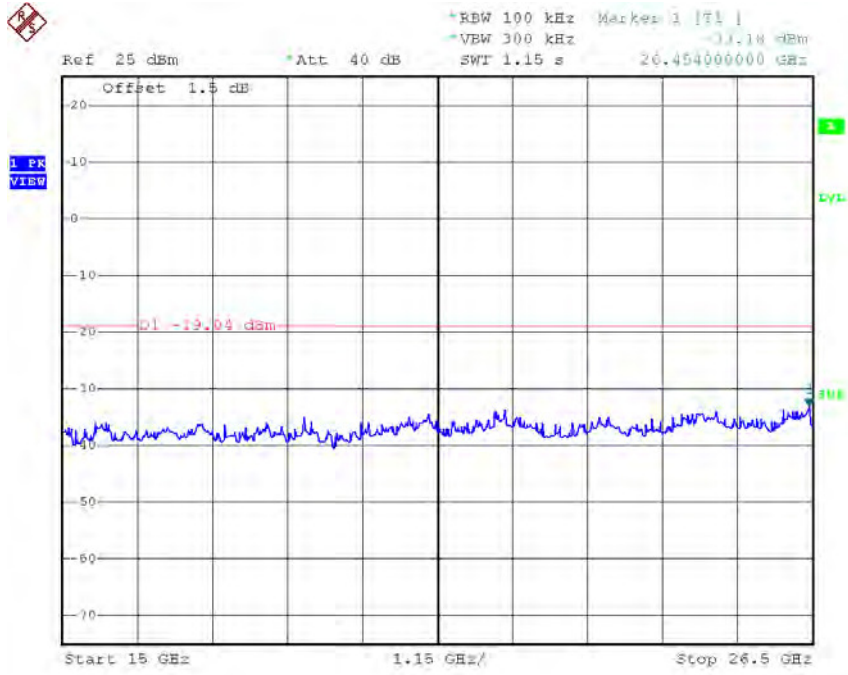

Date: 29.SEP.2016 11:57:38

Test Mode : TX G Mode

TX G mode CH01

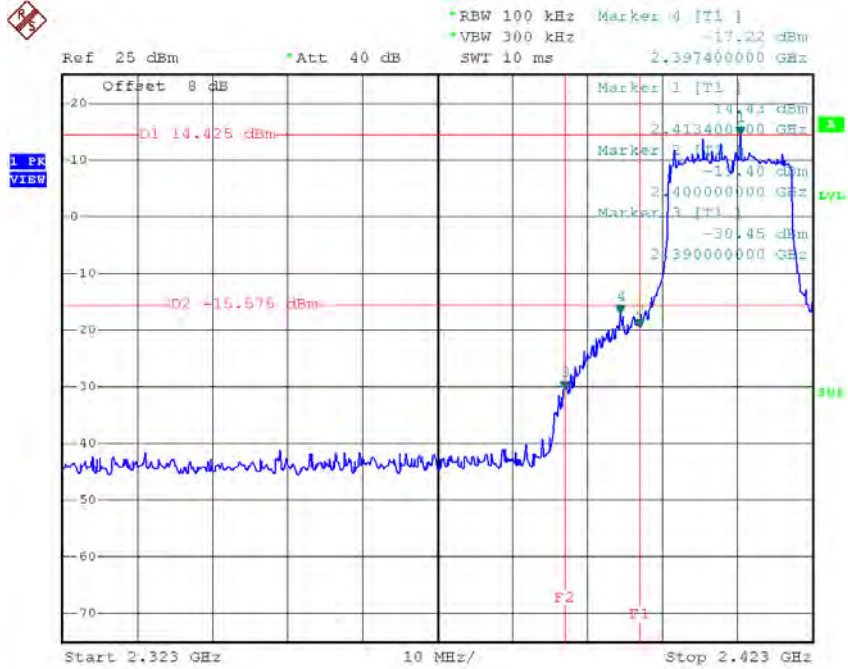

Date: 29.SEP.2016 12:00:34

TX G mode CH11

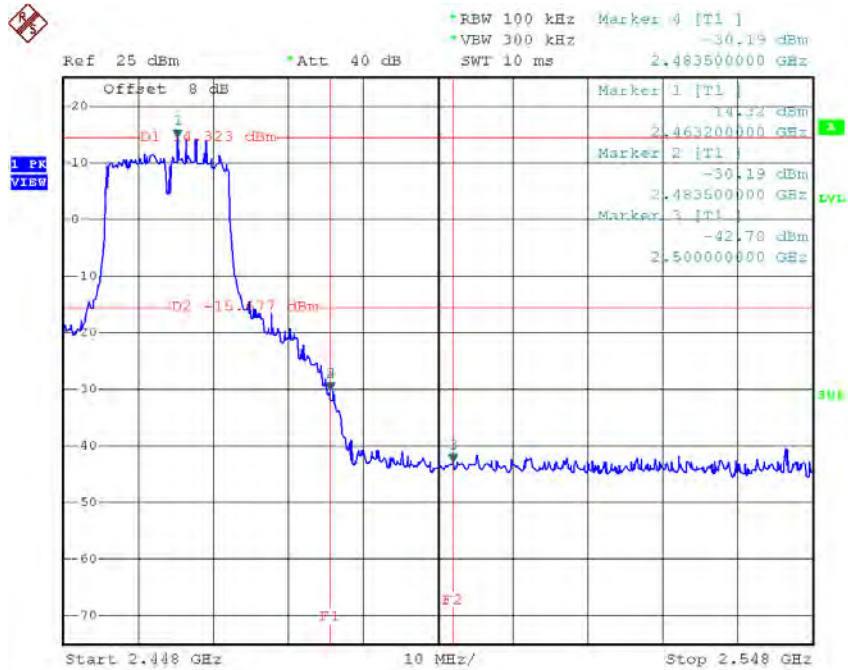

Date: 29.SEP.2016 12:11:51

TX G mode CH01 (10 Harmonic of the frequency)

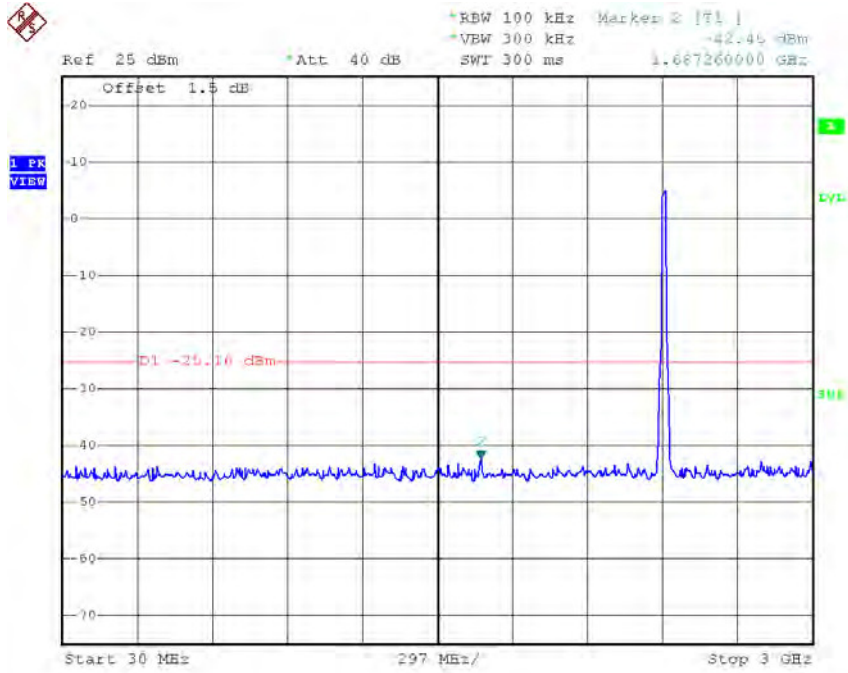

Date: 29.SEP.2016 12:00:09

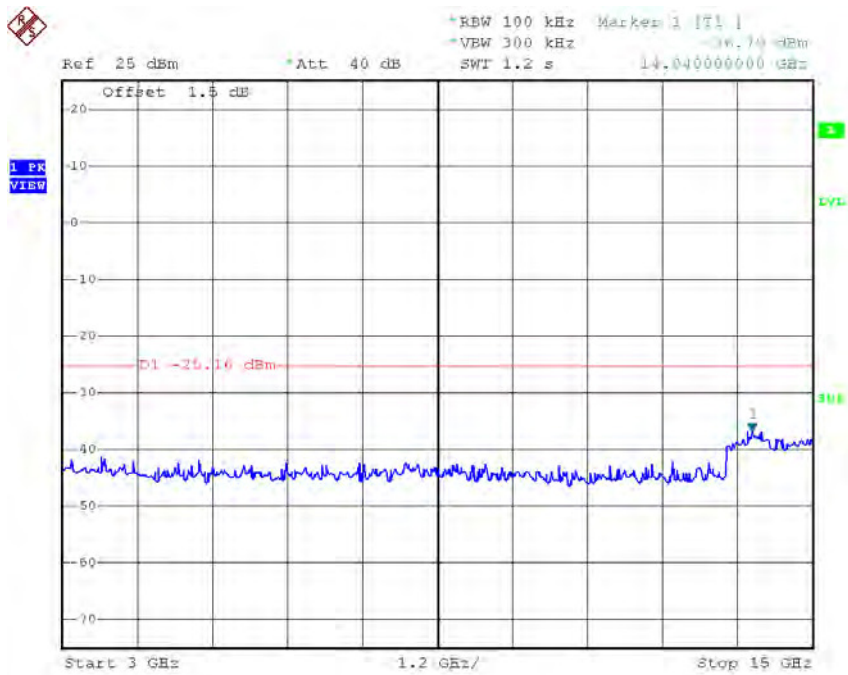

Date: 29.SEP.2016 12:00:17

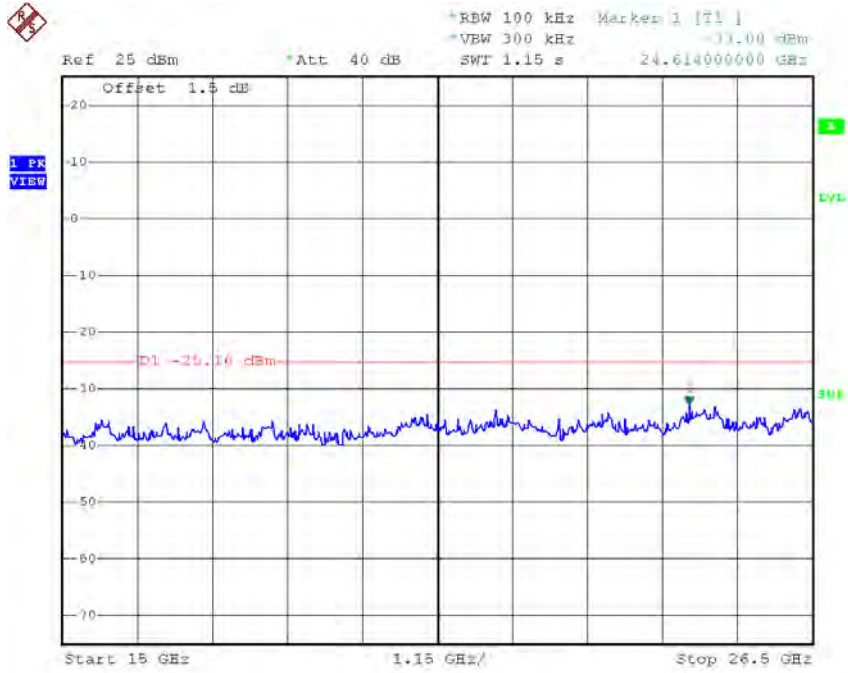

Date: 29.SEP.2016 12:00:26

TX G mode CH06 (10 Harmonic of the frequency)

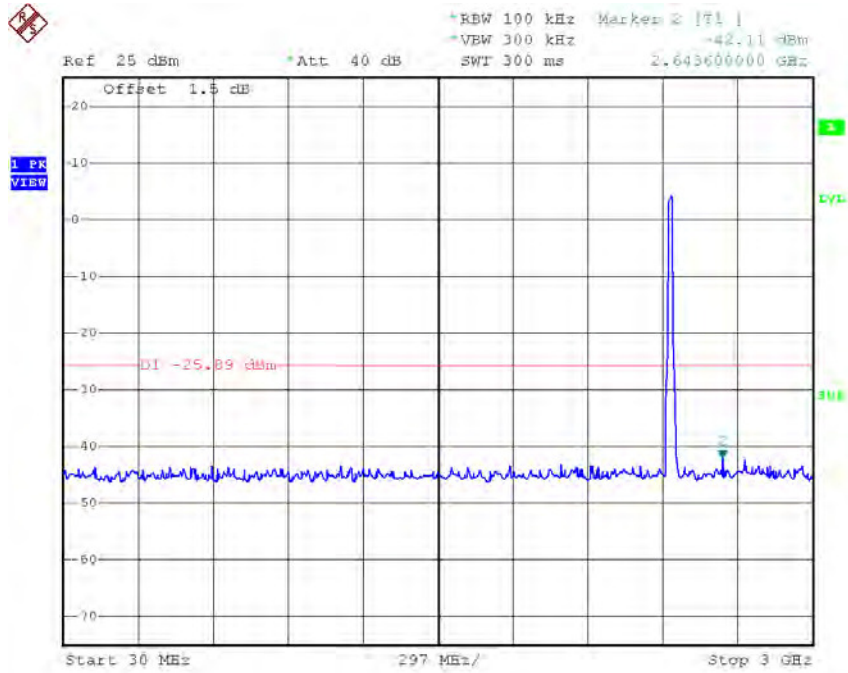

Date: 29.SEP.2016 12:10:23



Date: 29.SEP.2016 12:10:31

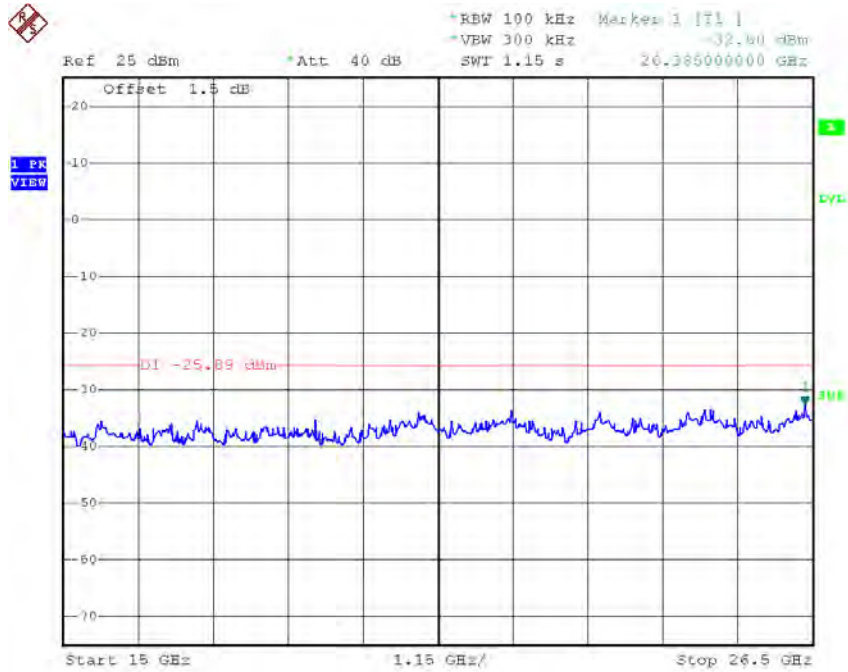

Date: 29.SEP.2016 12:10:40

TX G mode CH11 (10 Harmonic of the frequency)

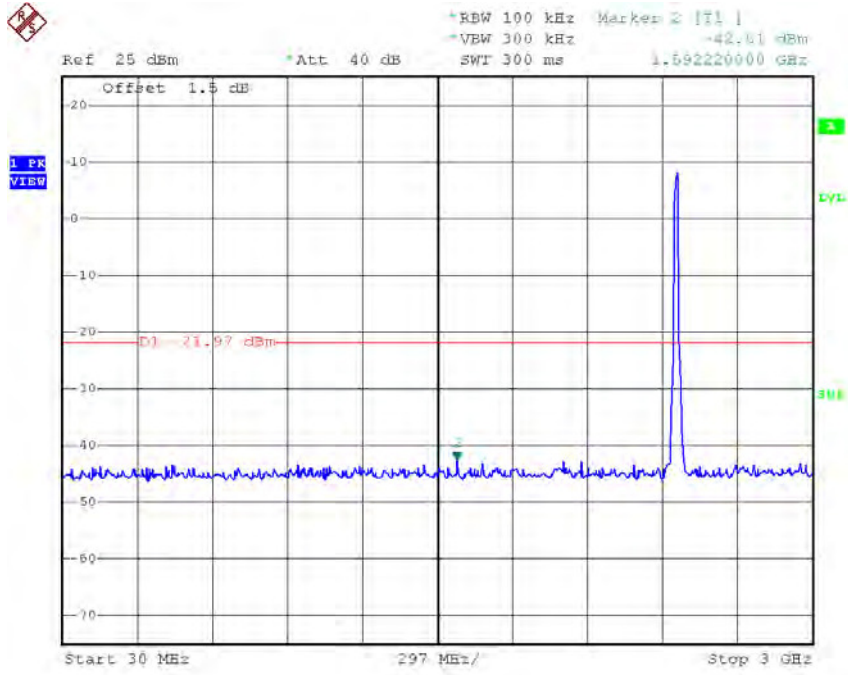

Date: 29.SEP.2016 12:11:26

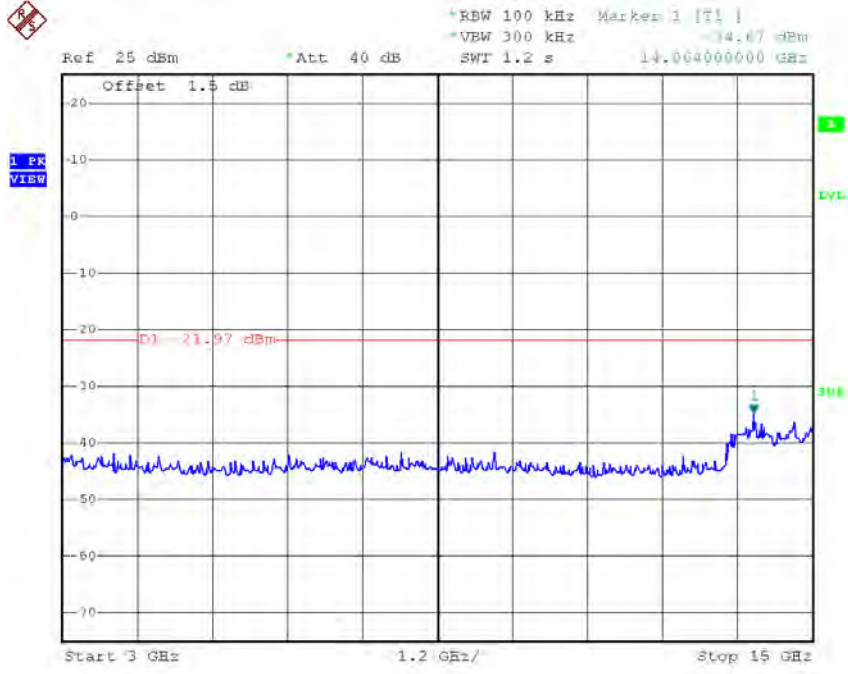

Date: 29.SEP.2016 12:11:34

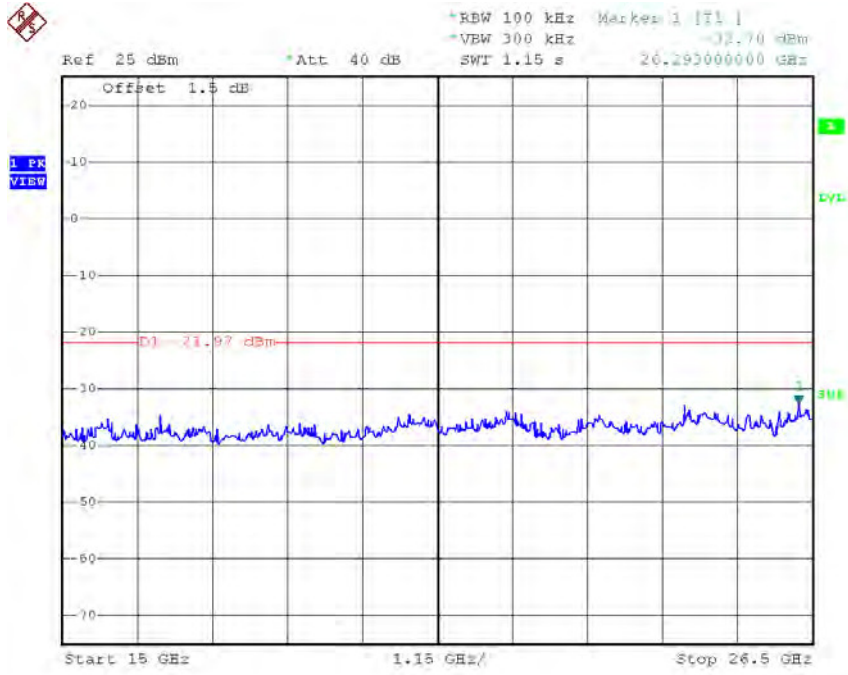

Date: 29.SEP.2016 12:11:43

Test Mode : TX N-20M Mode

TX HT20 mode CH01

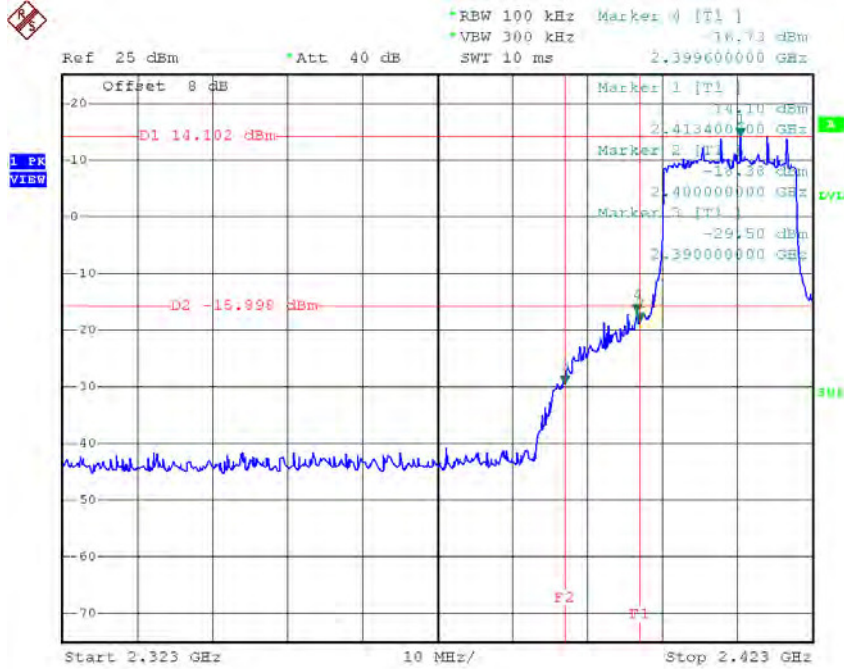

Date: 29.SEP.2016 12:13:58

TX HT20 mode CH11

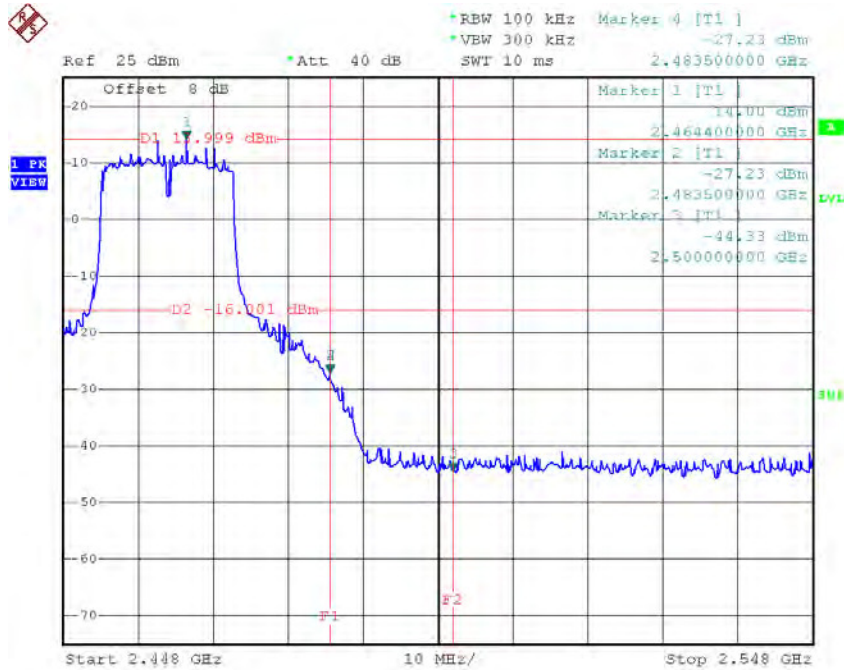

Date: 29.SEP.2016 12:16:14

TX HT20 mode CH01 (10 Harmonic of the frequency)

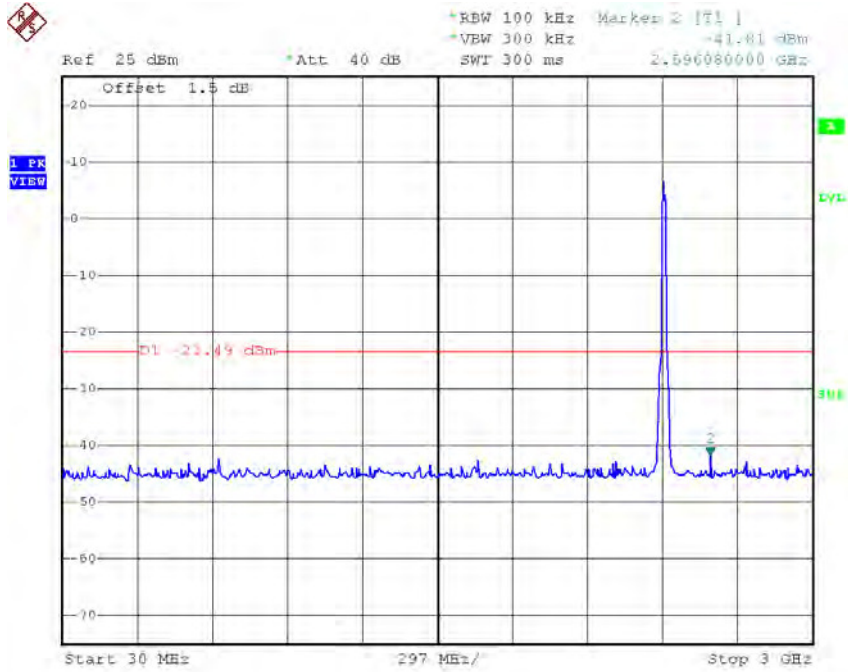

Date: 29.SEP.2016 12:12:48

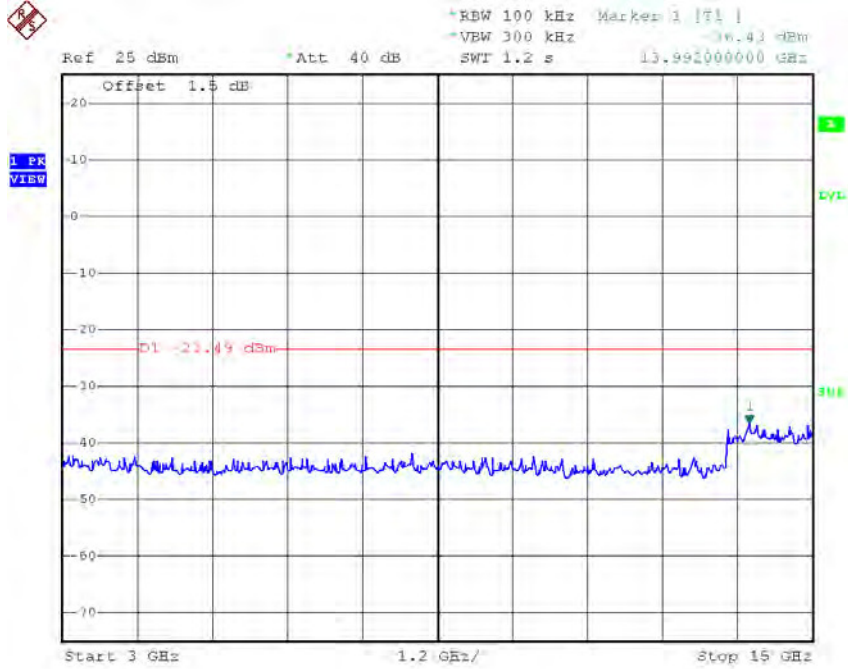

Date: 29.SEP.2016 12:12:56

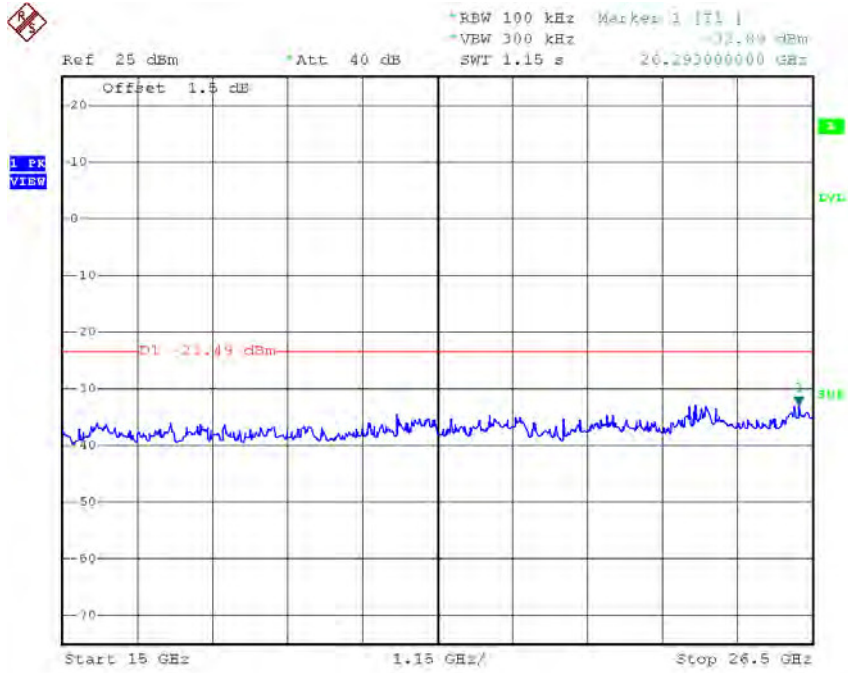

Date: 29.SEP.2016 12:13:04

TX HT20 mode CH06 (10 Harmonic of the frequency)

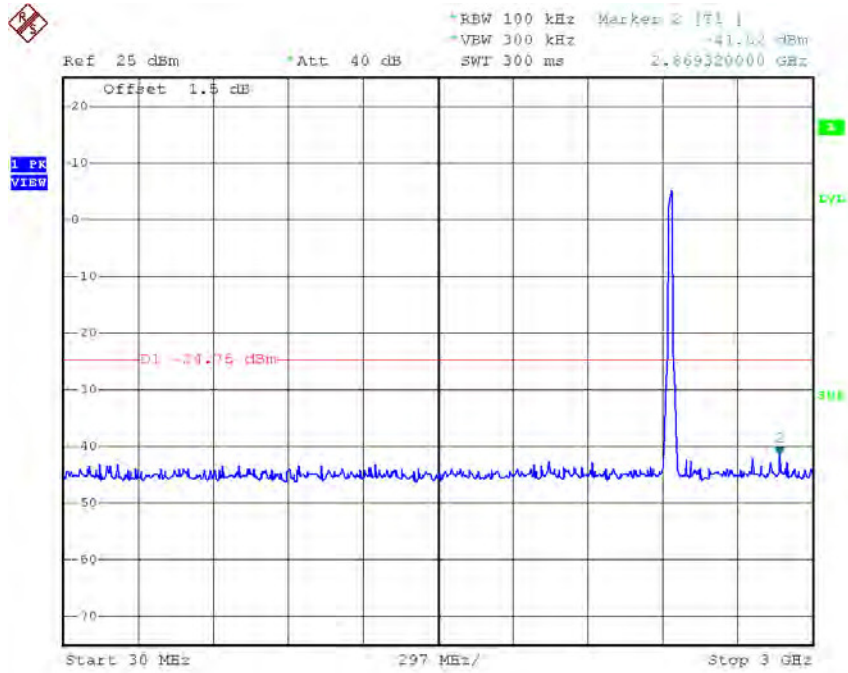

Date: 29.SEP.2016 12:14:50

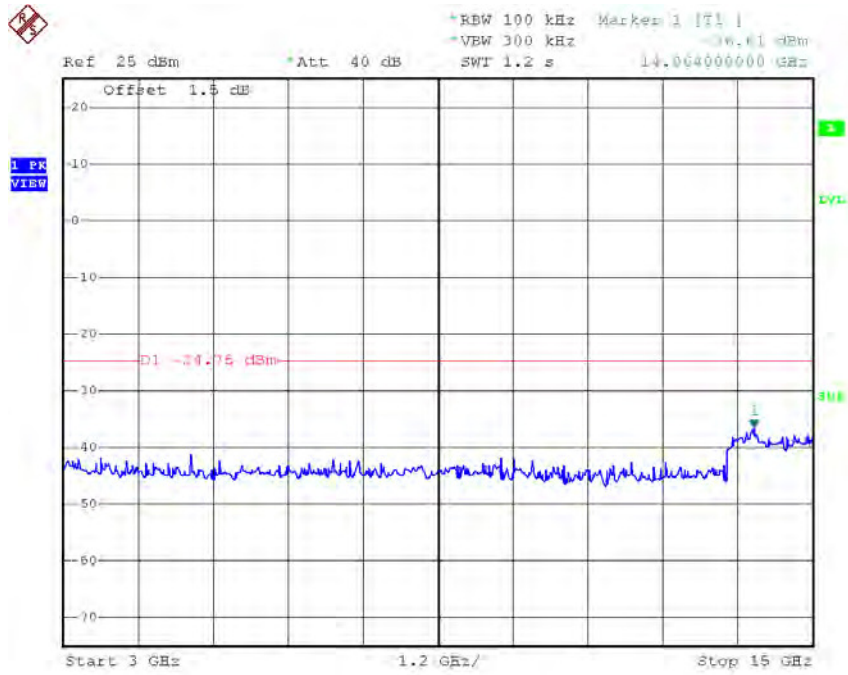

Date: 29.SEP.2016 12:14:59

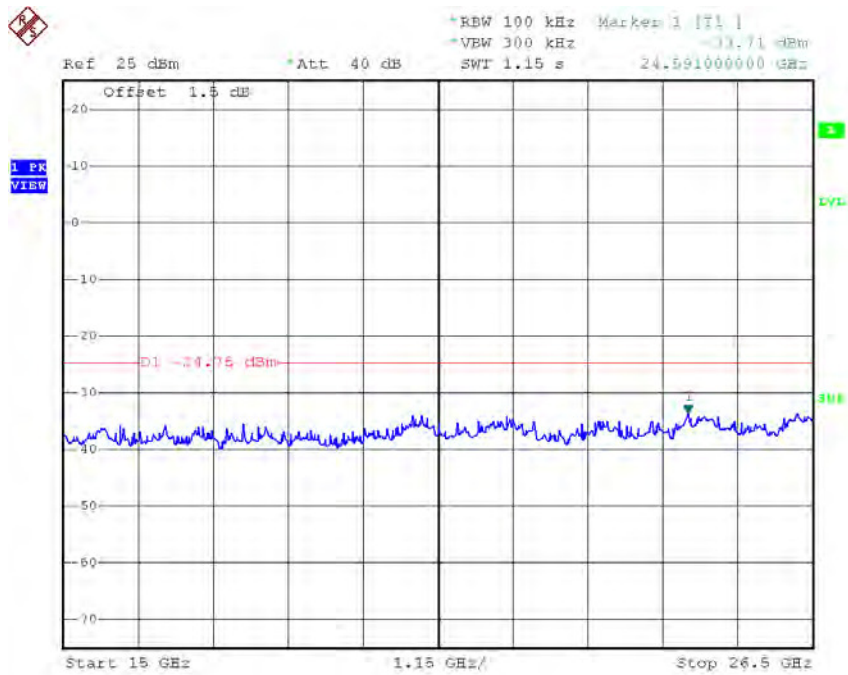

Date: 29.SEP.2016 12:15:07

TX HT20 mode CH11 (10 Harmonic of the frequency)

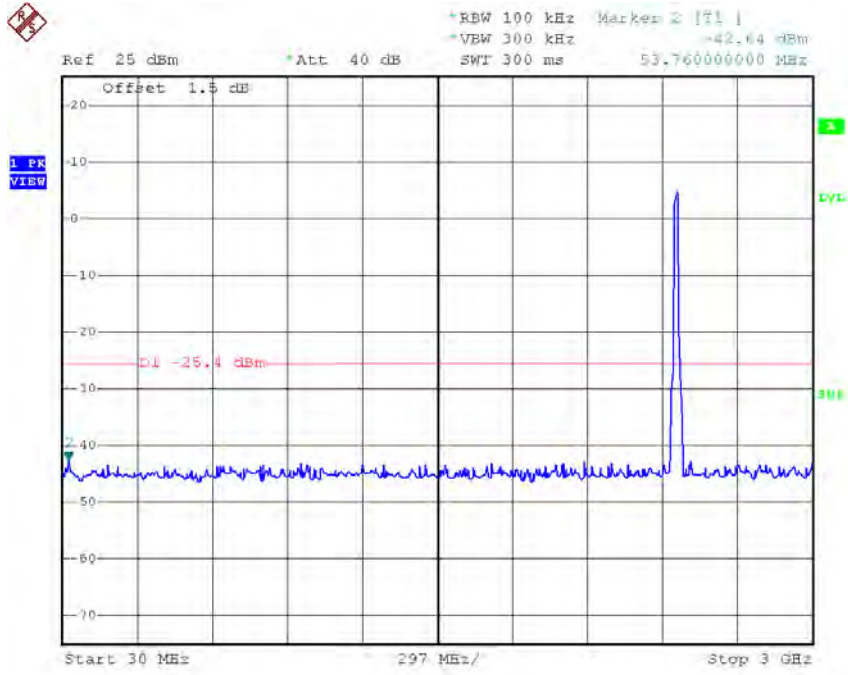

Date: 29.SEP.2016 12:15:49

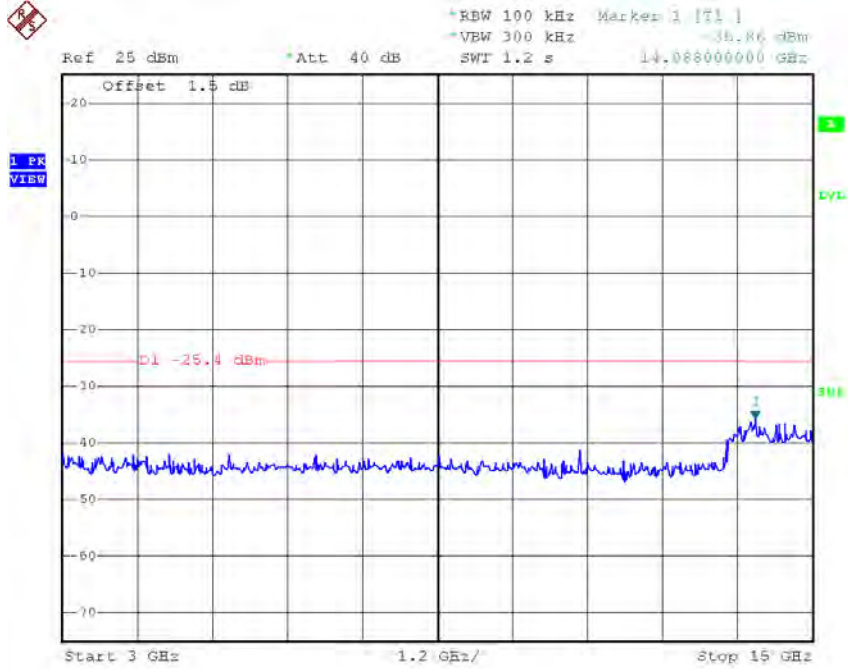

Date: 29.SEP.2016 12:15:58

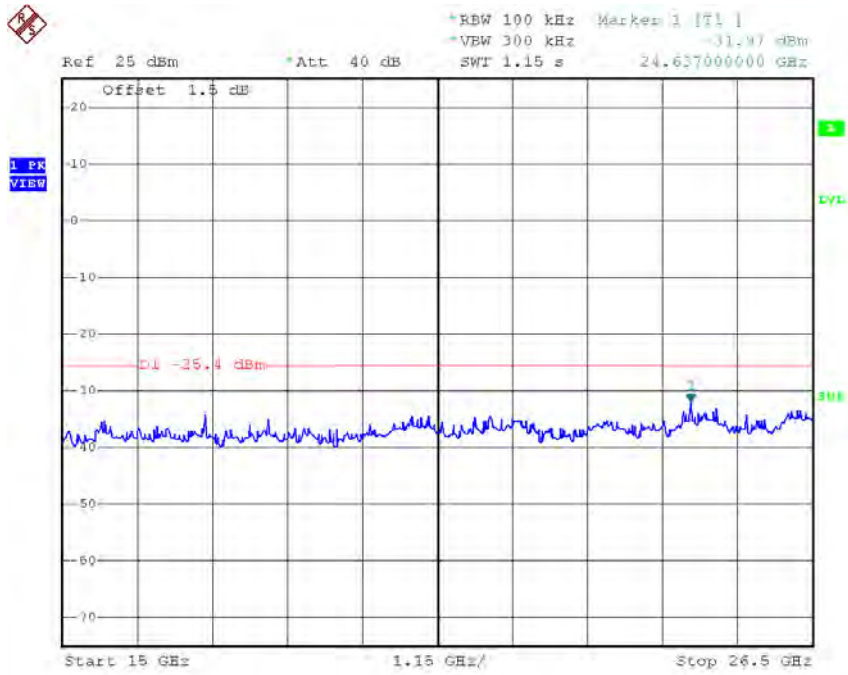

Date: 29.SEP.2016 12:16:06

Test Mode : TX N-40M Mode

TX HT40 mode CH03

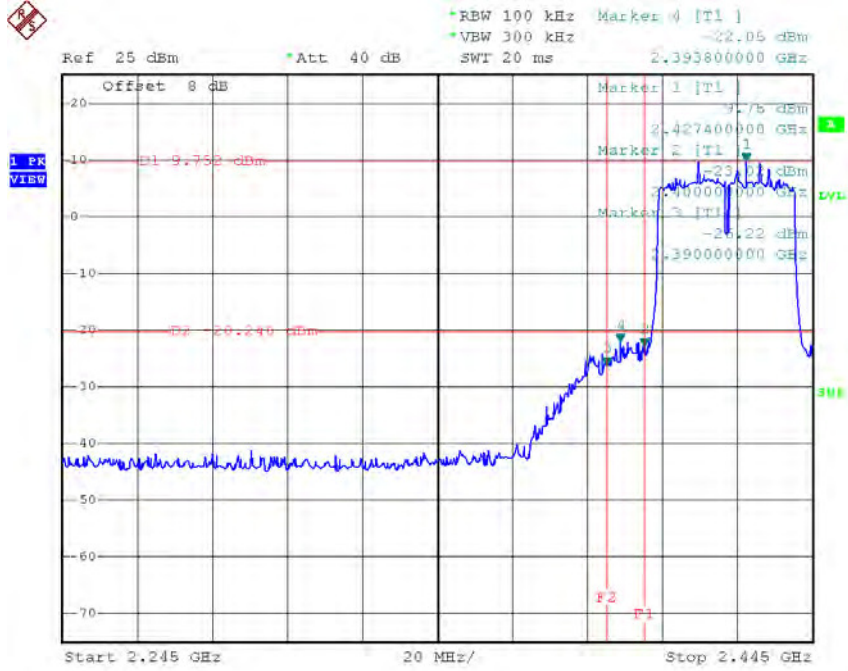

Date: 29.SEP.2016 12:17:32

TX HT40 mode CH09

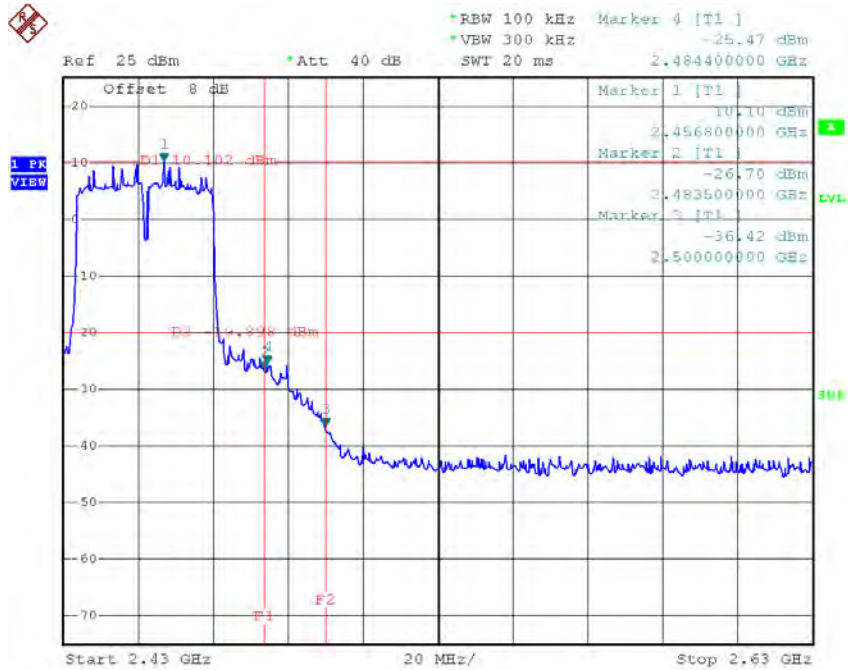

Date: 29.SEP.2016 12:19:46

TX HT40 mode CH03 (10 Harmonic of the frequency)

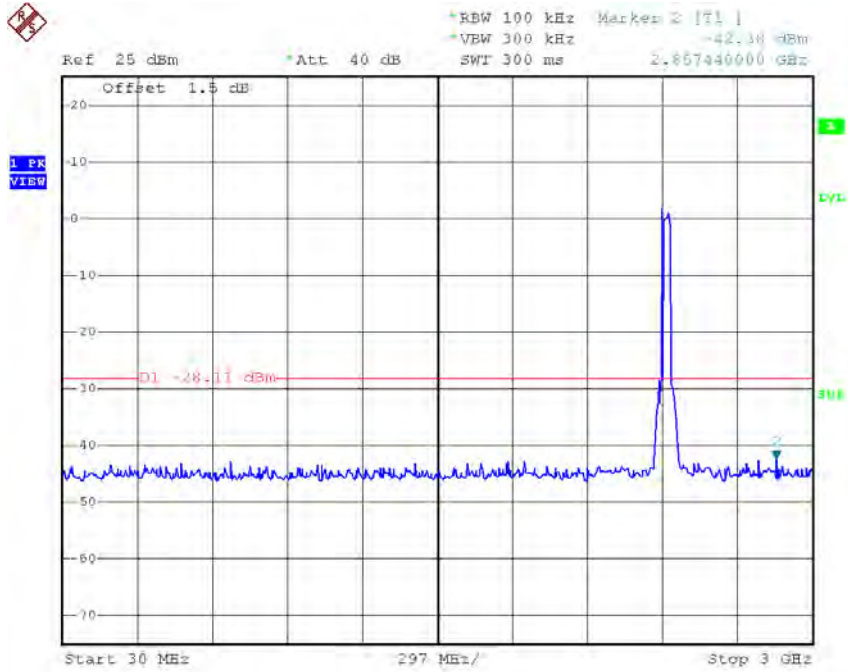

Date: 29.SEP.2016 12:17:07

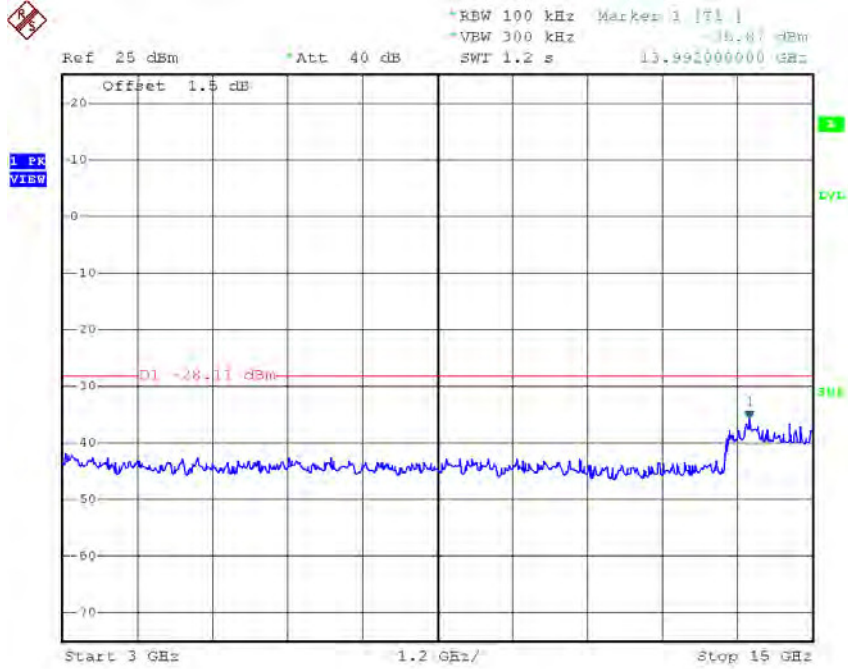

Date: 29.SEP.2016 12:17:15

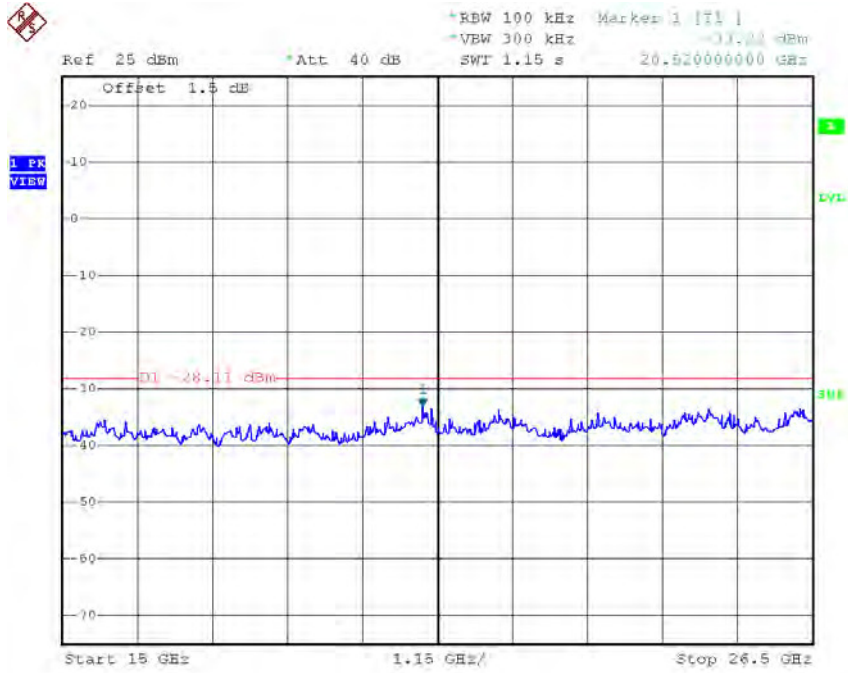

Date: 29.SEP.2016 12:17:24

TX HT40 mode CH06 (10 Harmonic of the frequency)

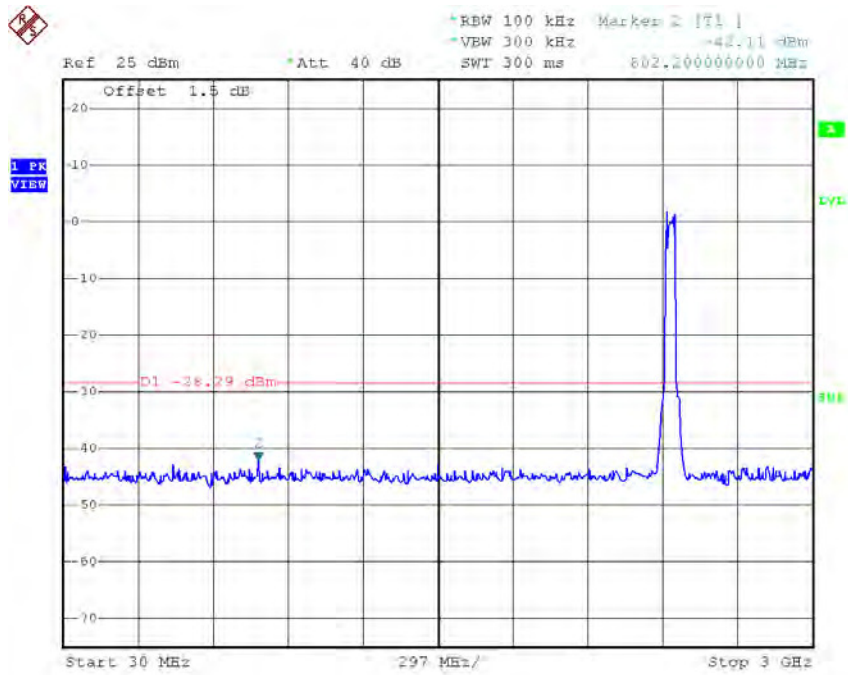

Date: 29.SEP.2016 12:18:17

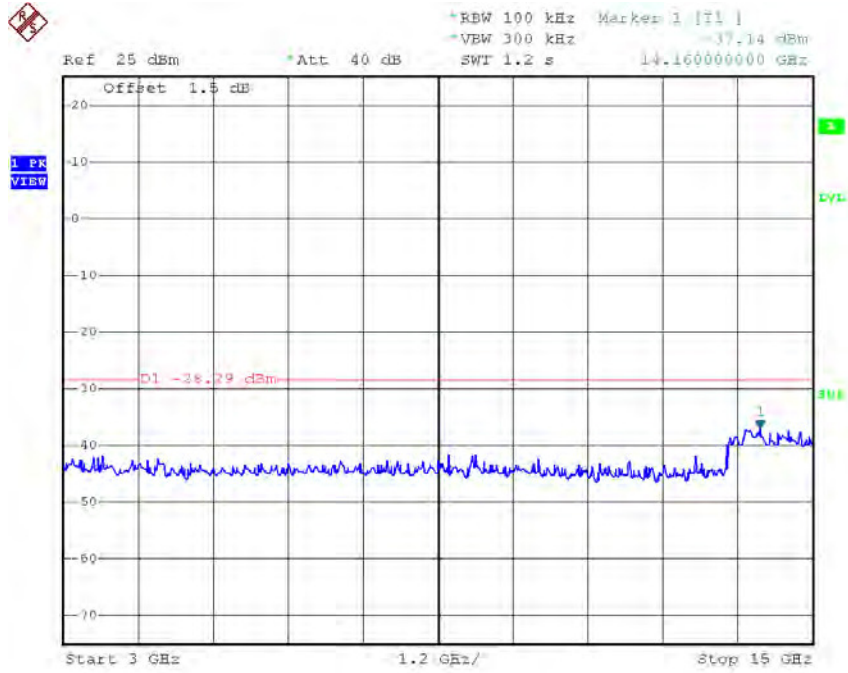

Date: 29.SEP.2016 12:18:25

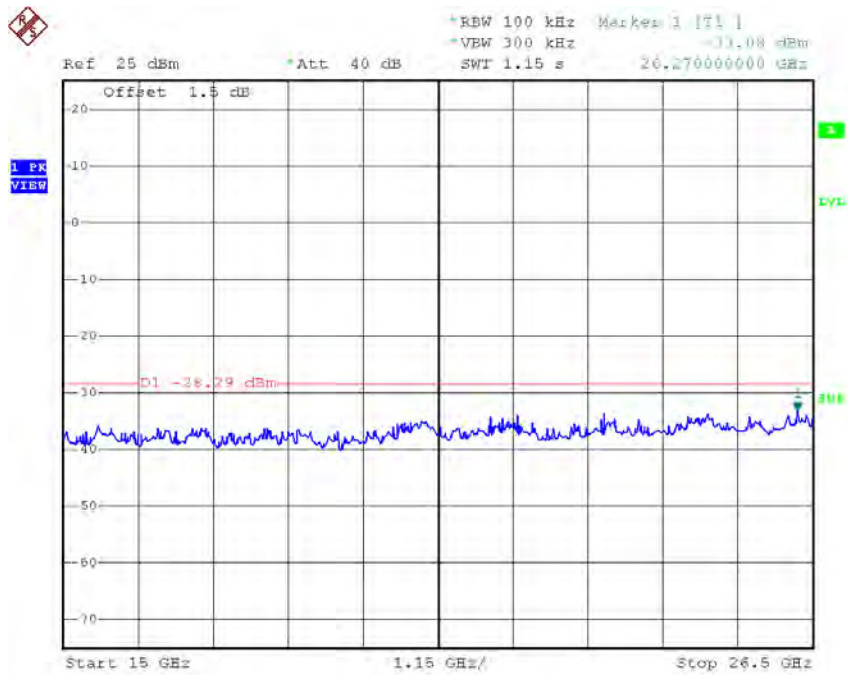

Date: 29.SEP.2016 12:18:34

TX HT40 mode CH09 (10 Harmonic of the frequency)

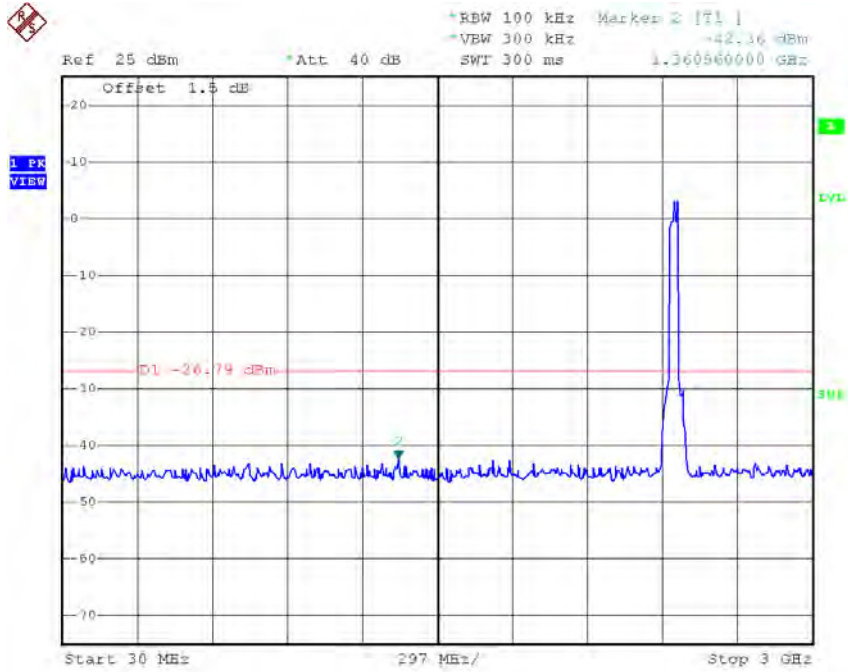

Date: 29.SEP.2016 12:19:21

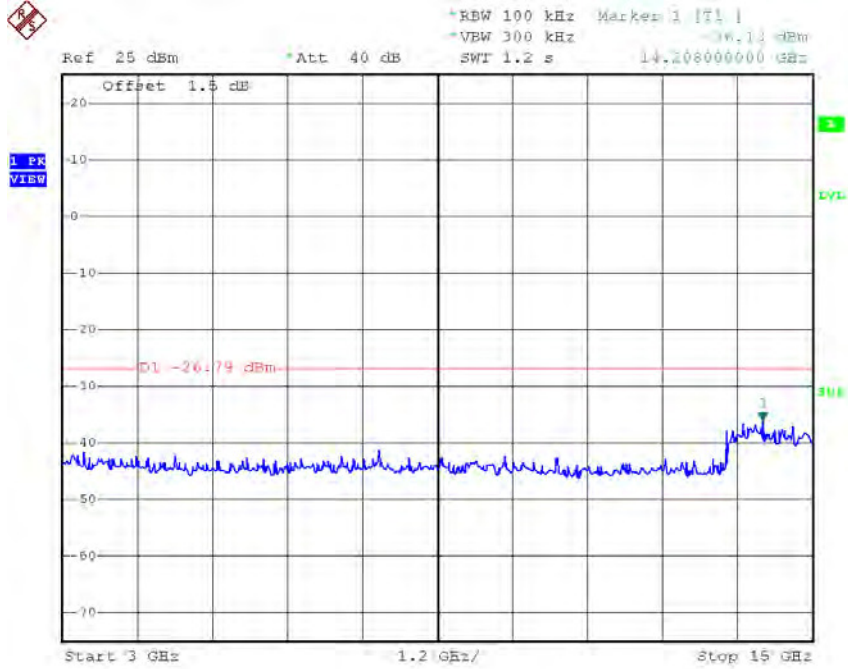

Date: 29.SEP.2016 12:19:29

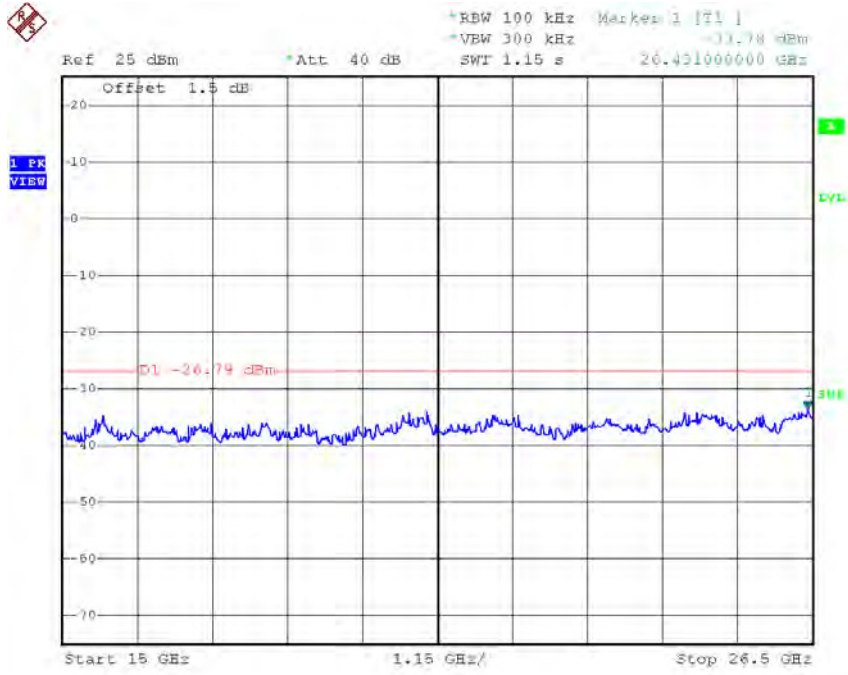

Date: 29.SEP.2016 12:19:38

For 2TX Non-Beamforming

Test Mode : TX B Mode_ANT 1

TX B mode CH01

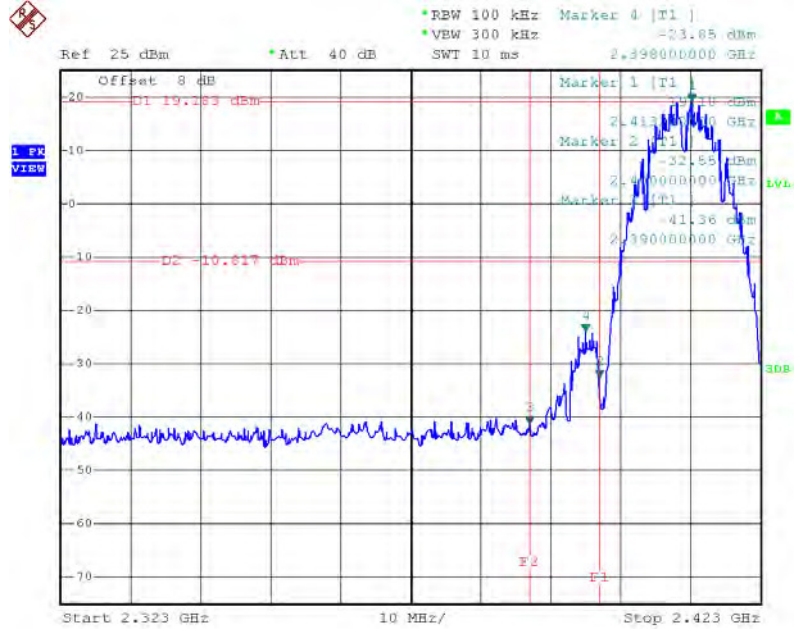

Date: 29.SEP.2016 12:31:37

TX B mode CH11

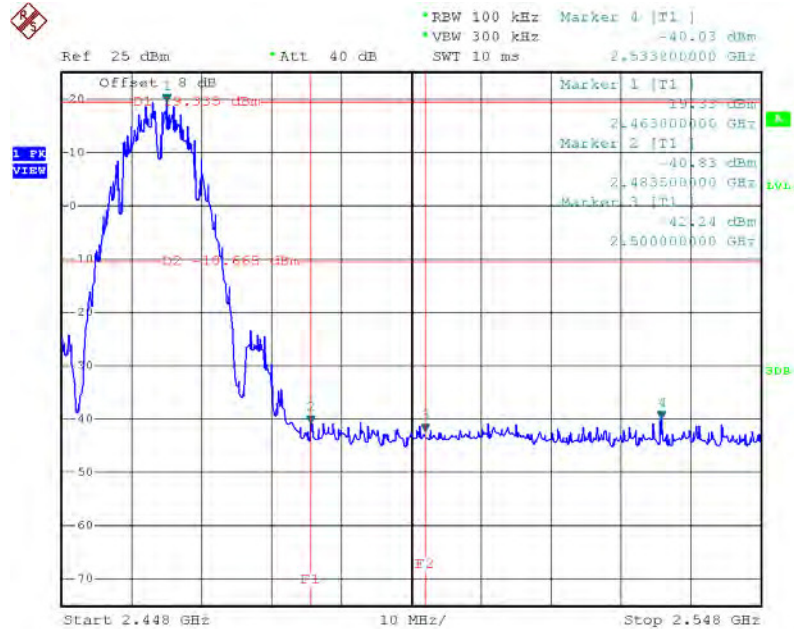

Date: 29.SEP.2016 14:06:11

TX B mode CH01 (10 Harmonic of the frequency)

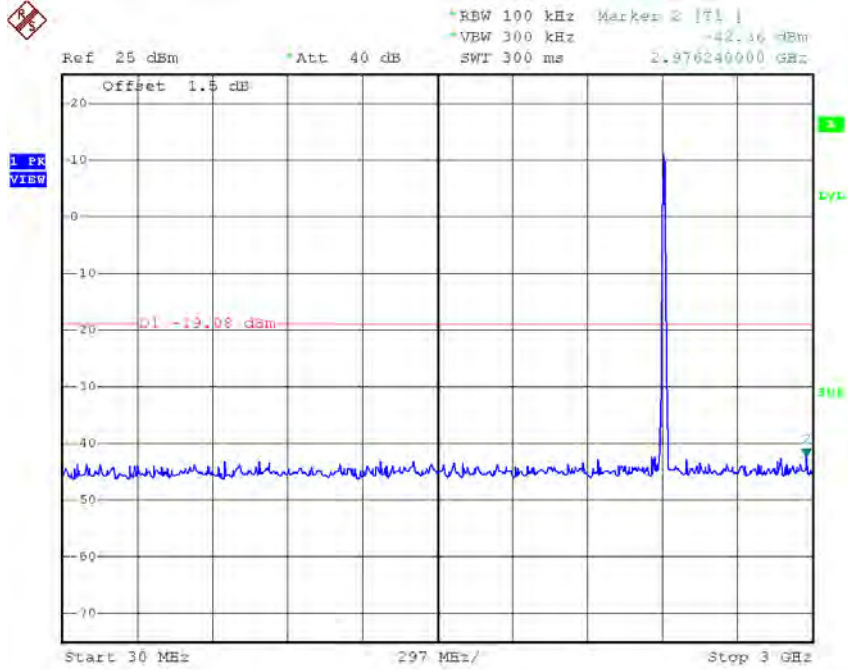

Date: 29.SEP.2016 12:31:13

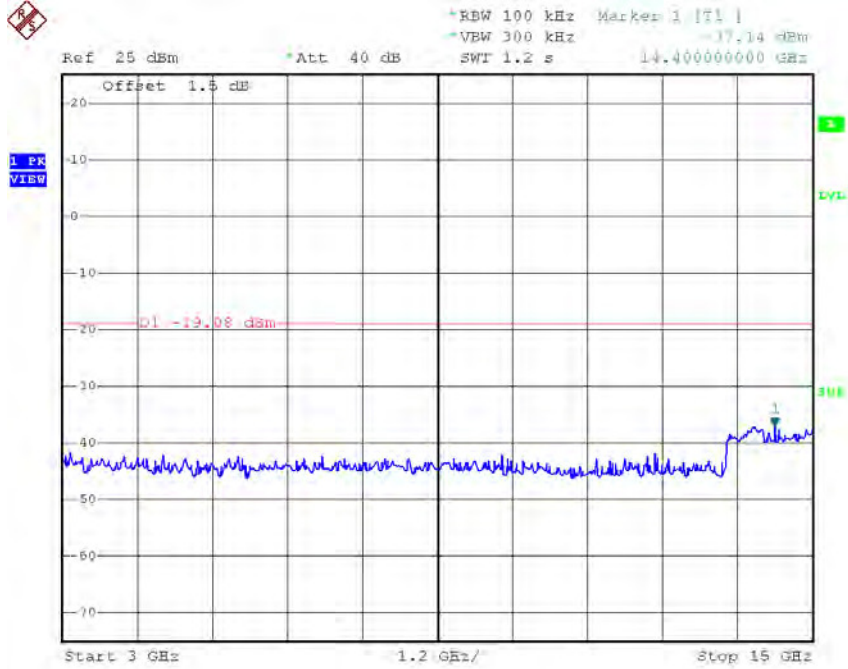

Date: 29.SEP.2016 12:31:21

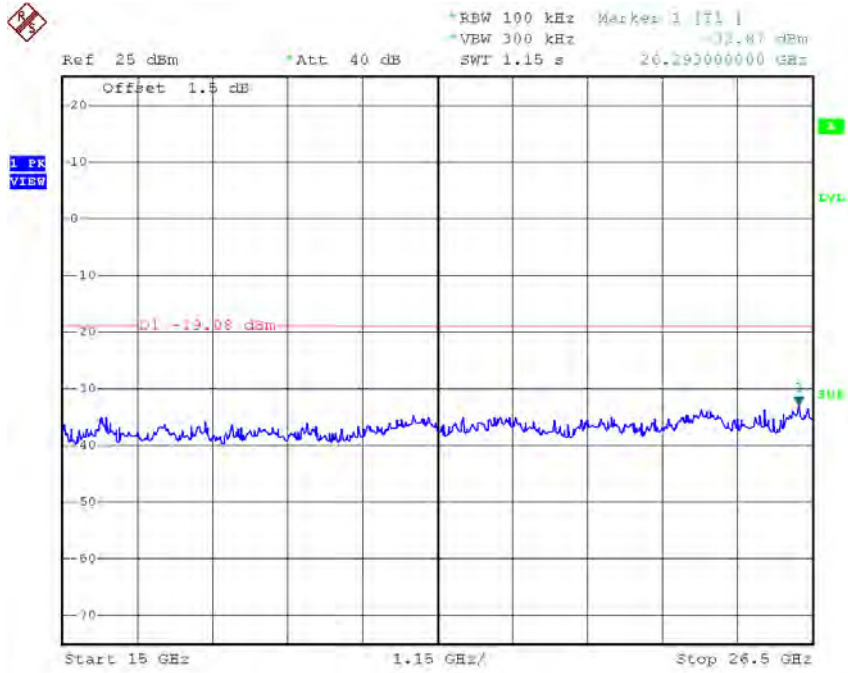

Date: 29.SEP.2016 12:31:29

TX B mode CH06 (10 Harmonic of the frequency)

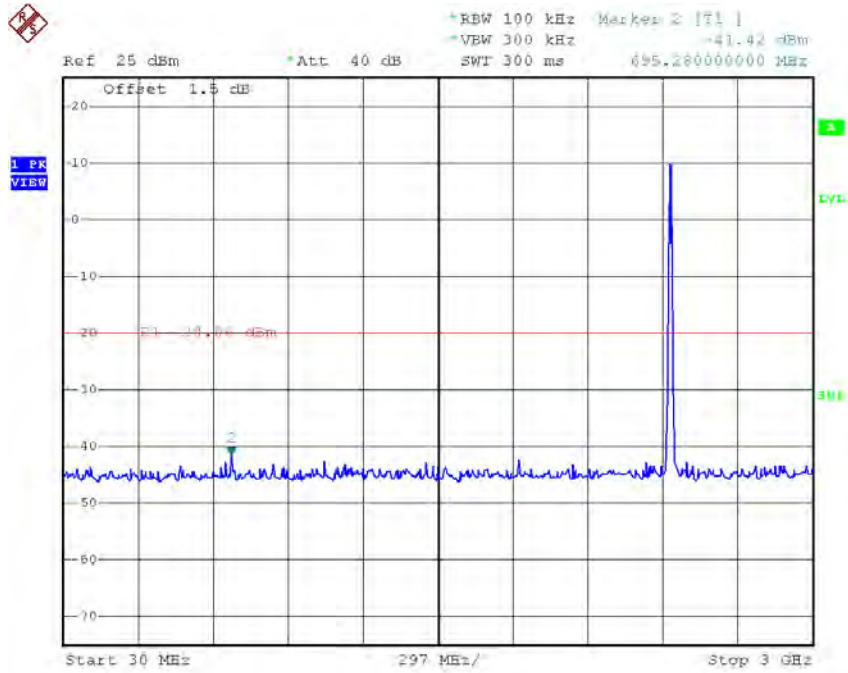

Date: 29.SEP.2016 12:32:42

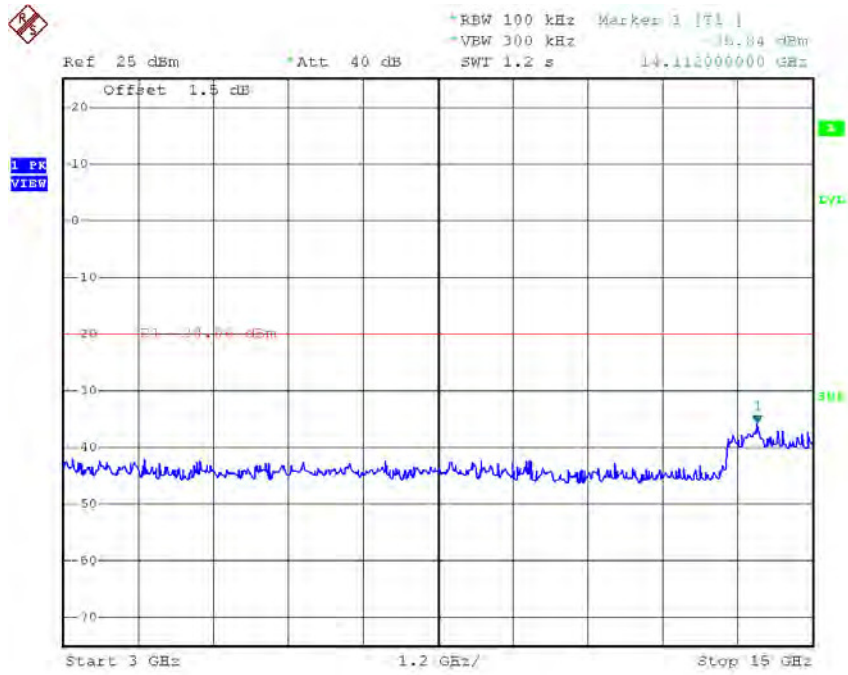

Date: 29.SEP.2016 12:32:50

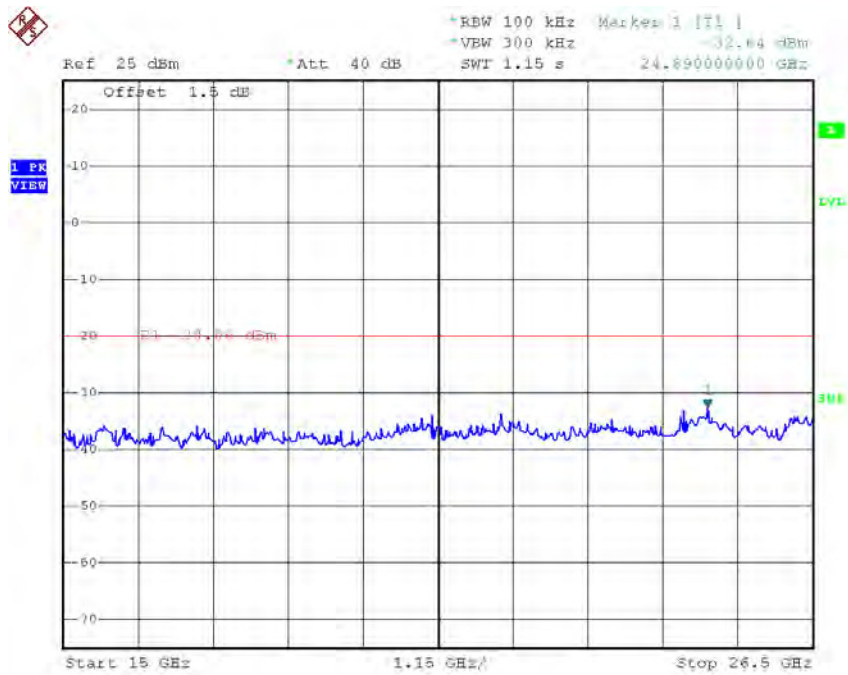

Date: 29.SEP.2016 12:32:58

TX B mode CH11 (10 Harmonic of the frequency)

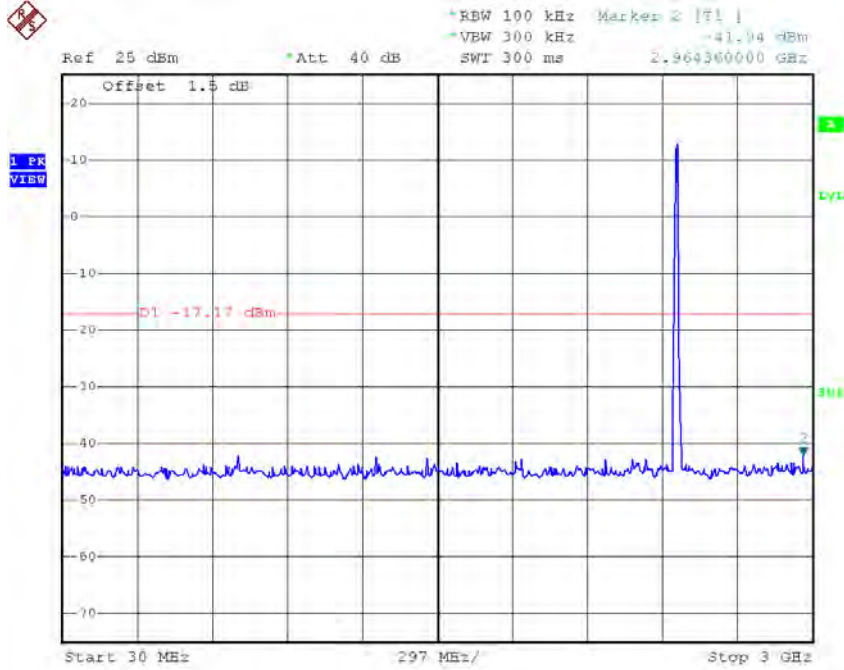

Date: 29.SEP.2016 14:05:47

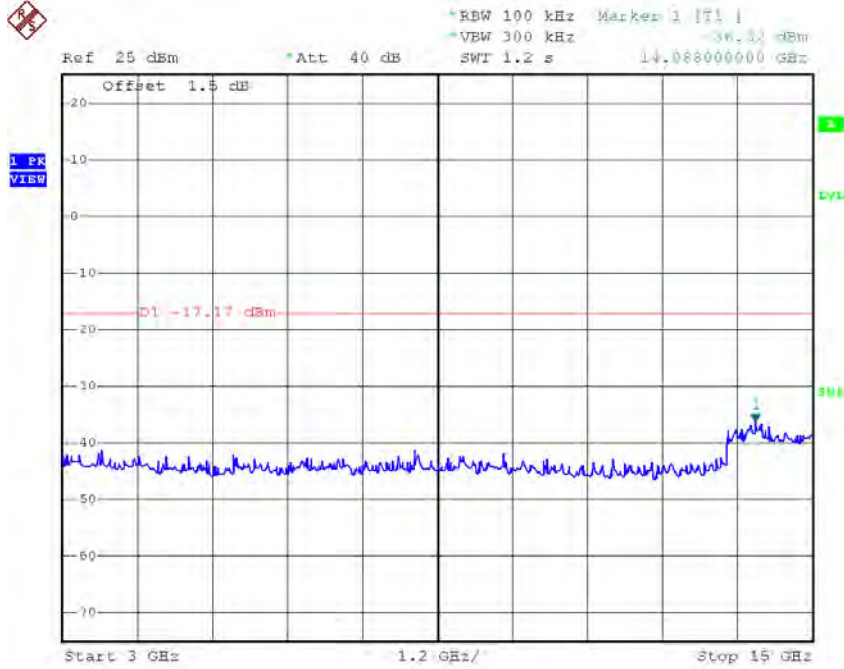

Date: 29.SEP.2016 14:05:55

Test Mode : TX B Mode_ANT 2

TX B mode CH01

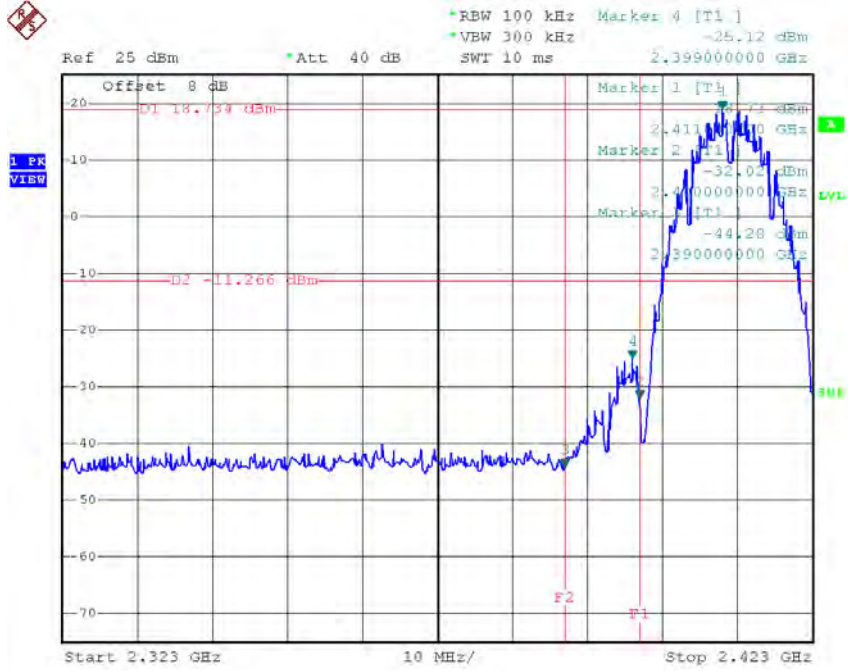

Date: 29.SEP.2016 14:25:35

TX B mode CH11

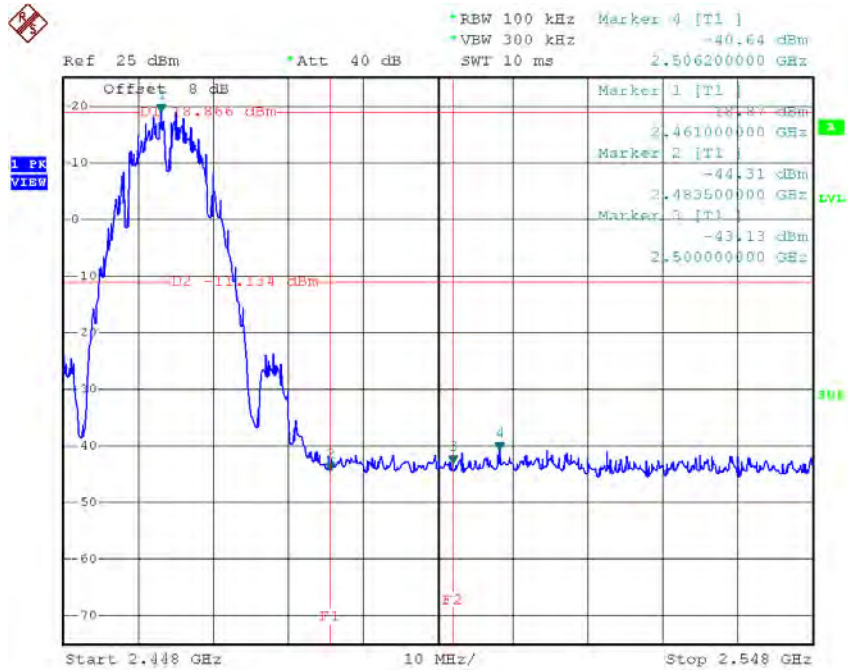

Date: 29.SEP.2016 14:28:24

TX B mode CH01 (10 Harmonic of the frequency)

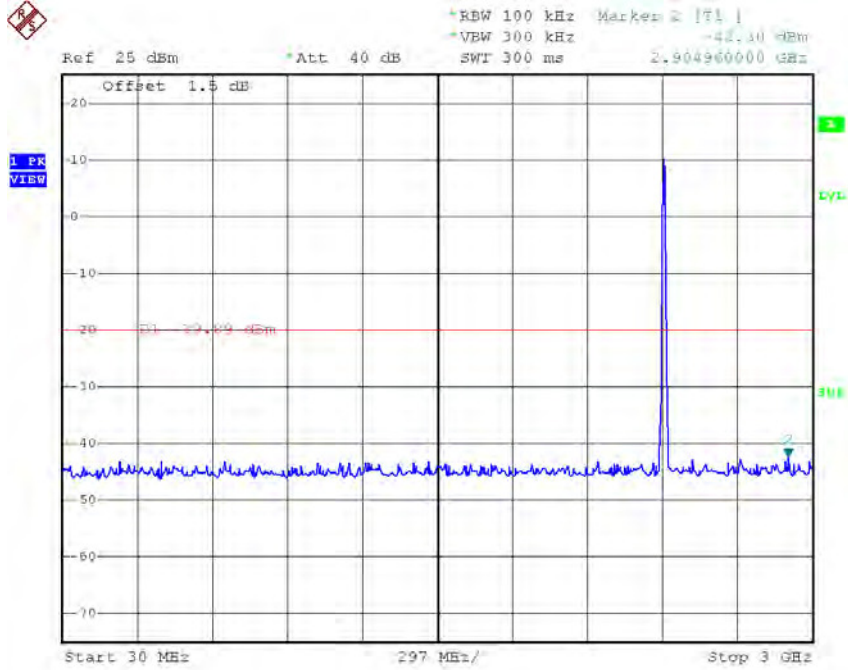

Date: 29.SEP.2016 14:25:10

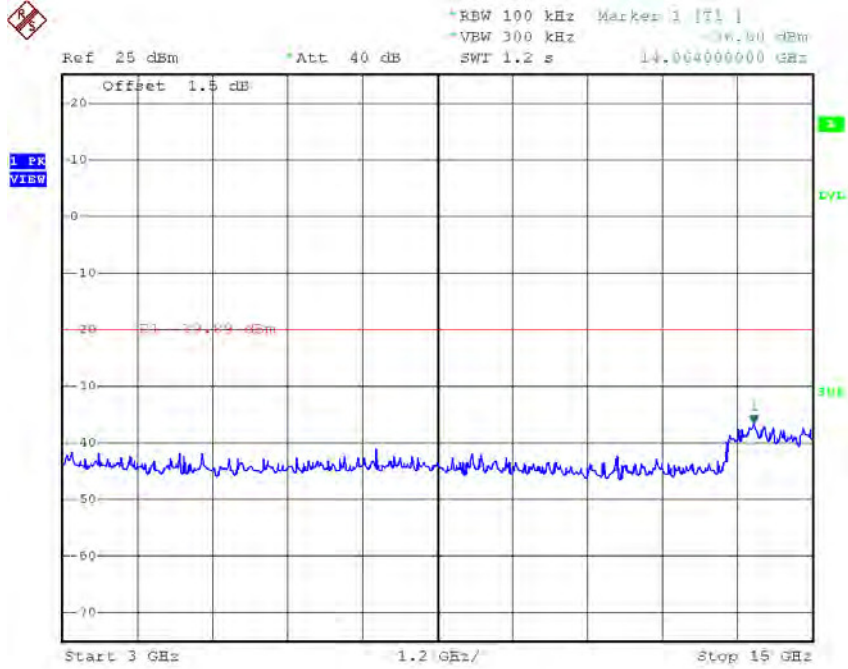

Date: 29.SEP.2016 14:25:19

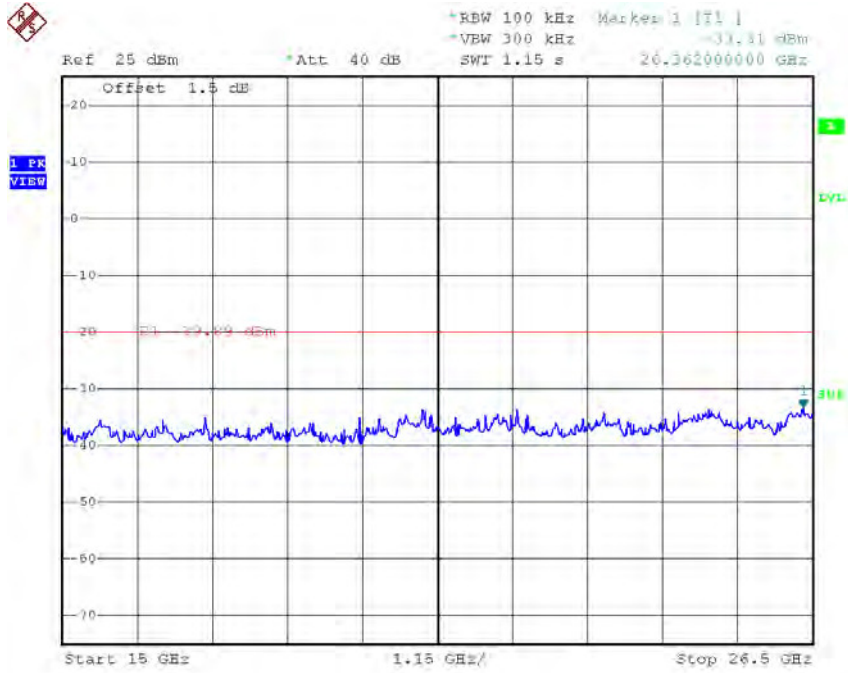

Date: 29.SEP.2016 14:25:27

TX B mode CH06 (10 Harmonic of the frequency)

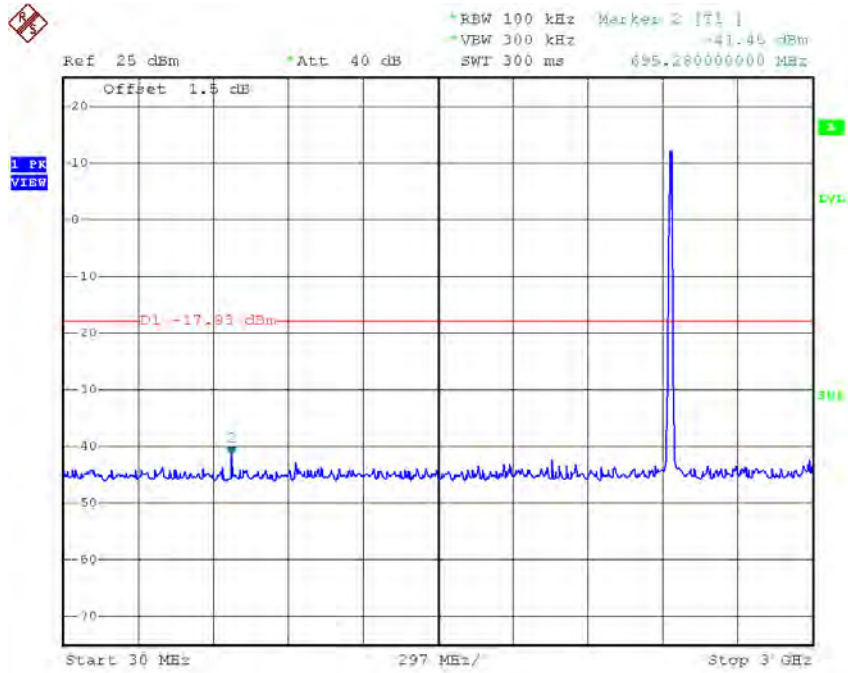

Date: 29.SEP.2016 14:26:39

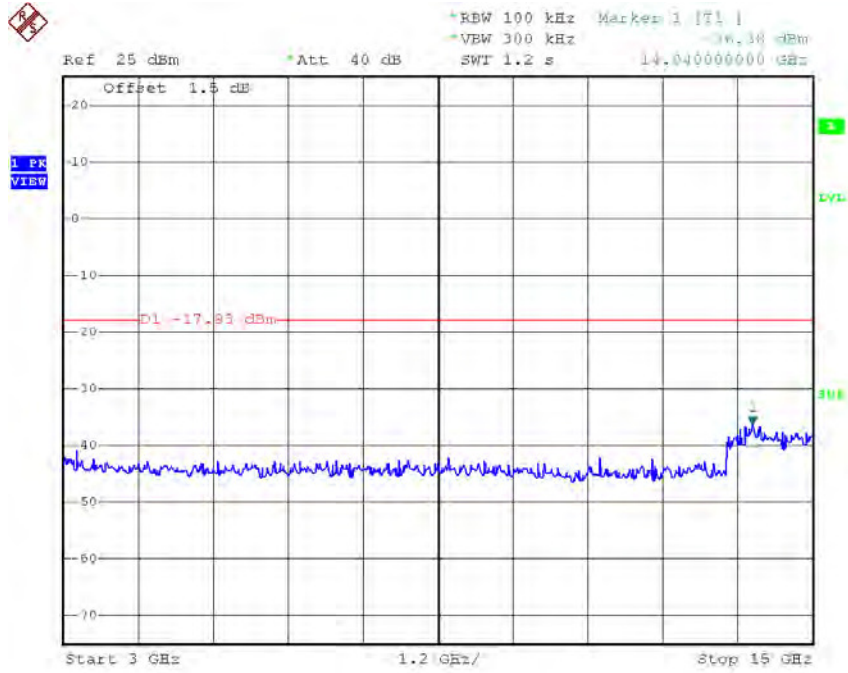

Date: 29.SEP.2016 14:26:48

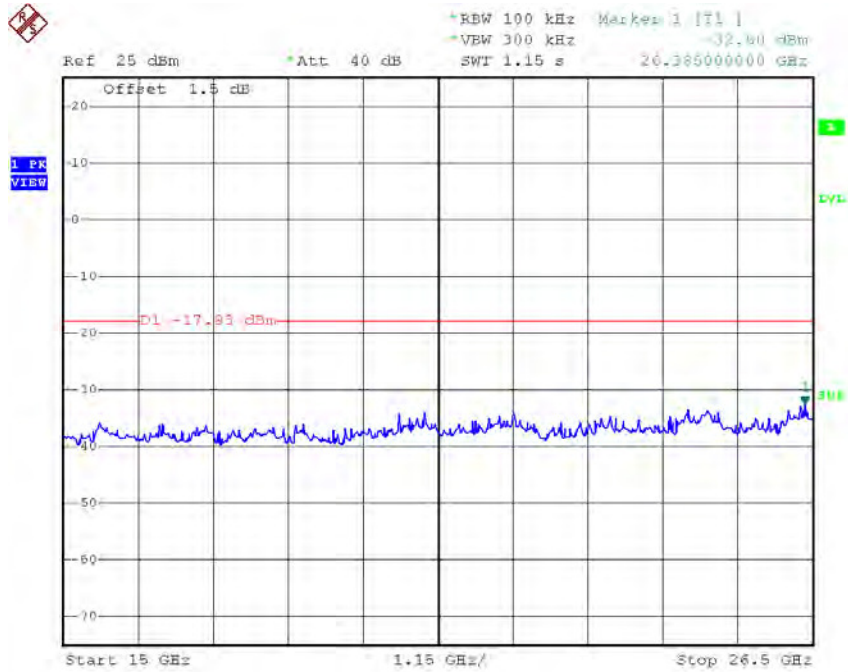

Date: 29.SEP.2016 14:26:56

TX B mode CH11 (10 Harmonic of the frequency)

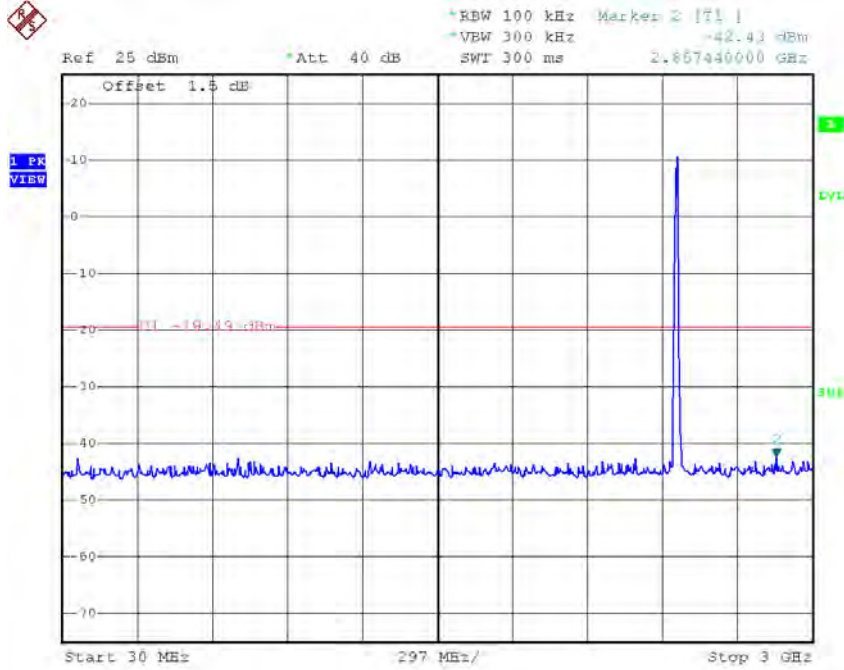

Date: 29.SEP.2016 14:28:00

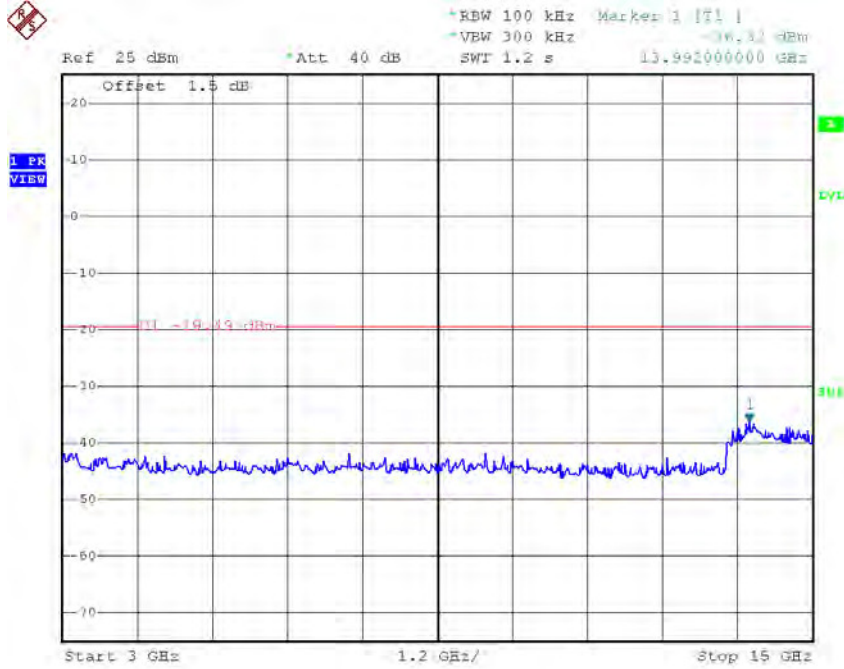

Date: 29.SEP.2016 14:28:08

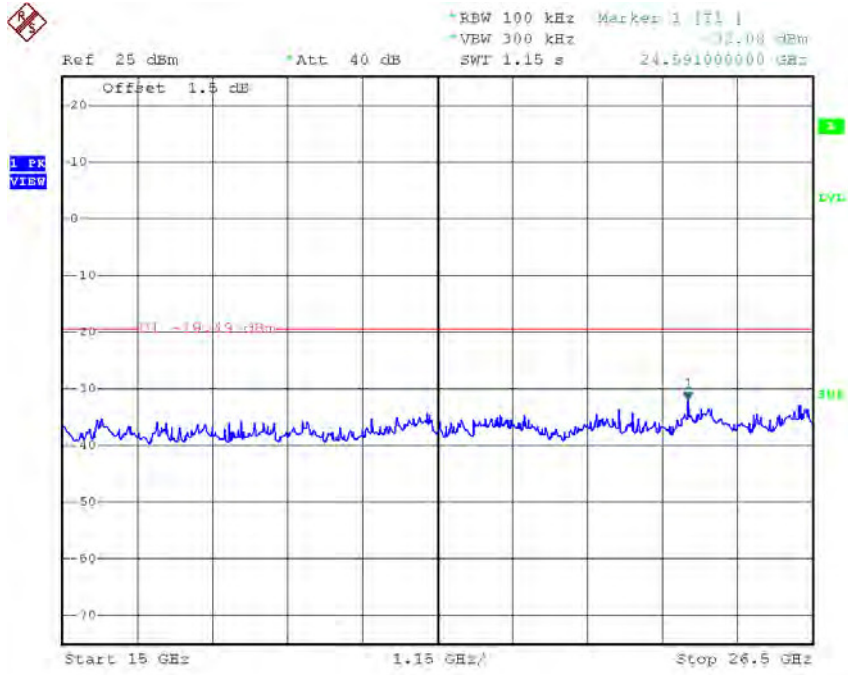

Date: 29.SEP.2016 14:28:16

Test Mode : TX G Mode_ANT 1

TX G mode CH01

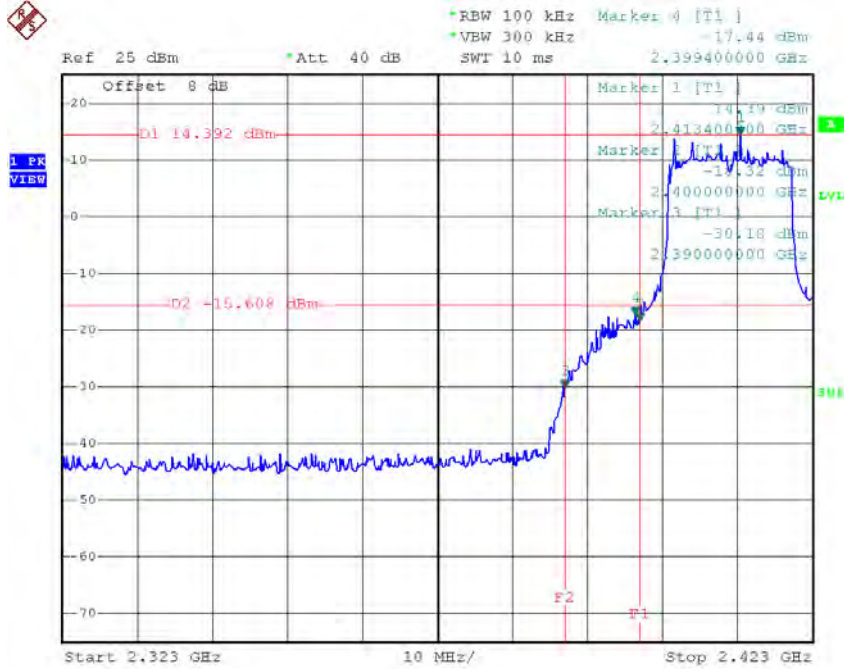

Date: 29.SEP.2016 14:09:43

TX G mode CH11

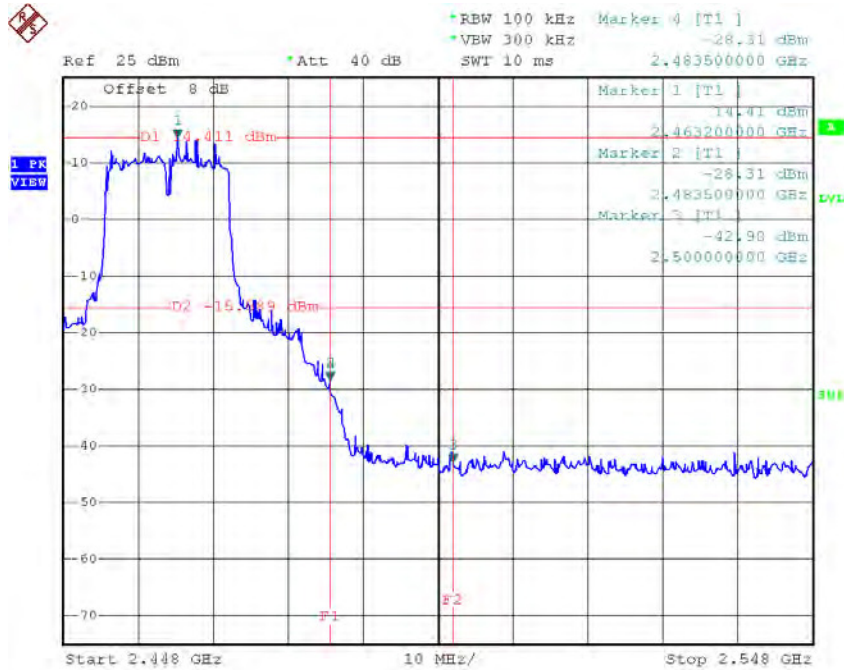

Date: 29.SEP.2016 14:12:06

TX G mode CH01 (10 Harmonic of the frequency)

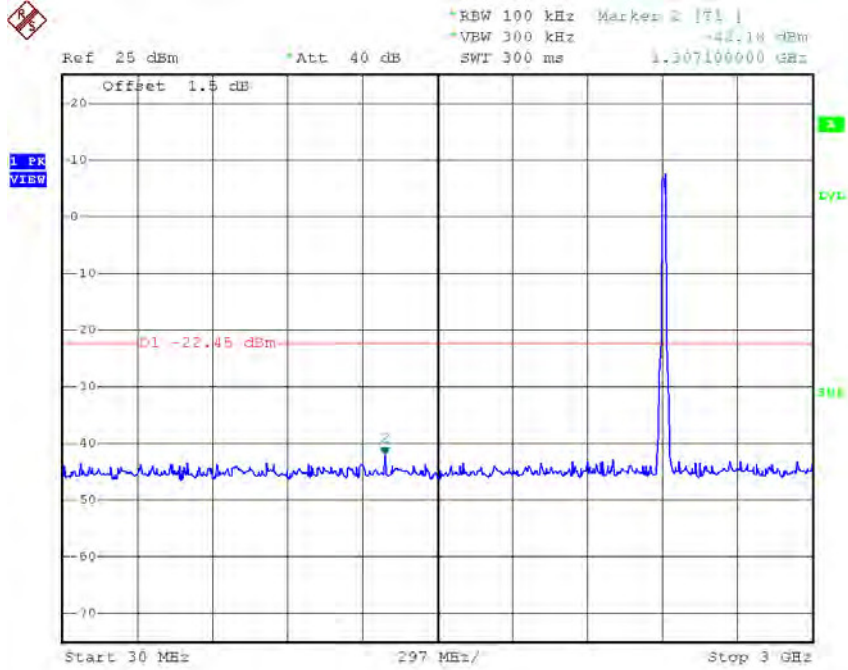

Date: 29.SEP.2016 14:07:32

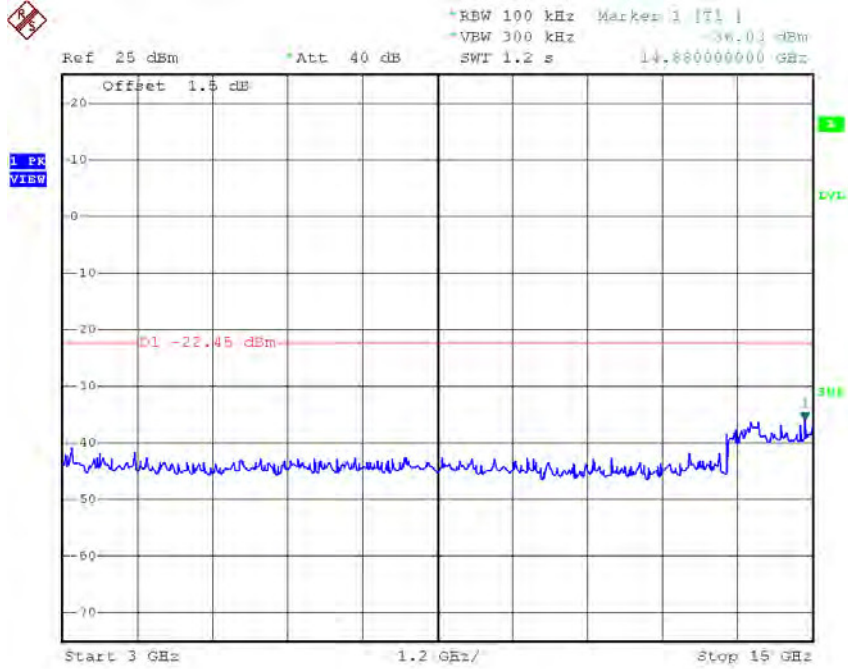

Date: 29.SEP.2016 14:07:40

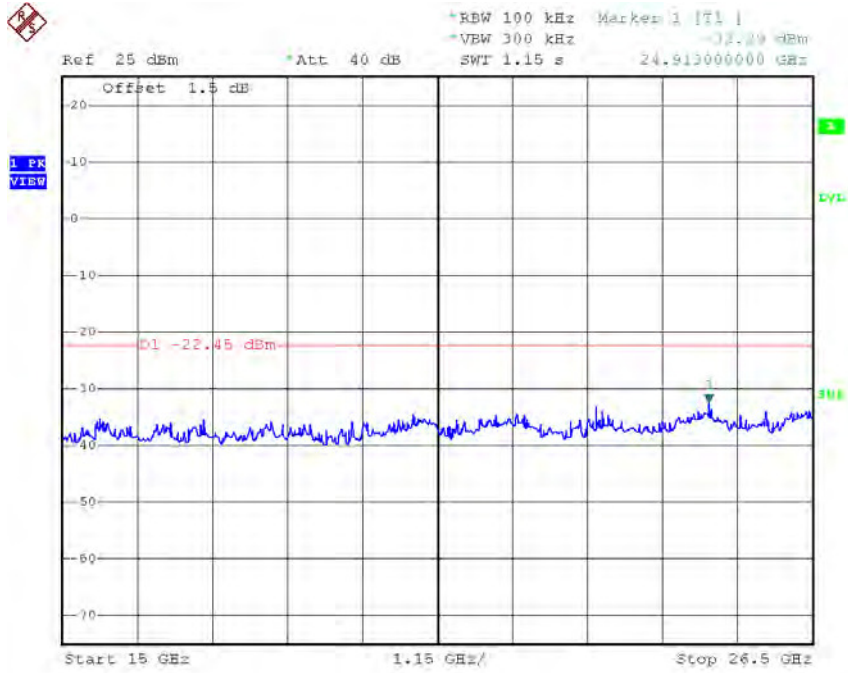

Date: 29.SEP.2016 14:07:49

TX G mode CH06 (10 Harmonic of the frequency)

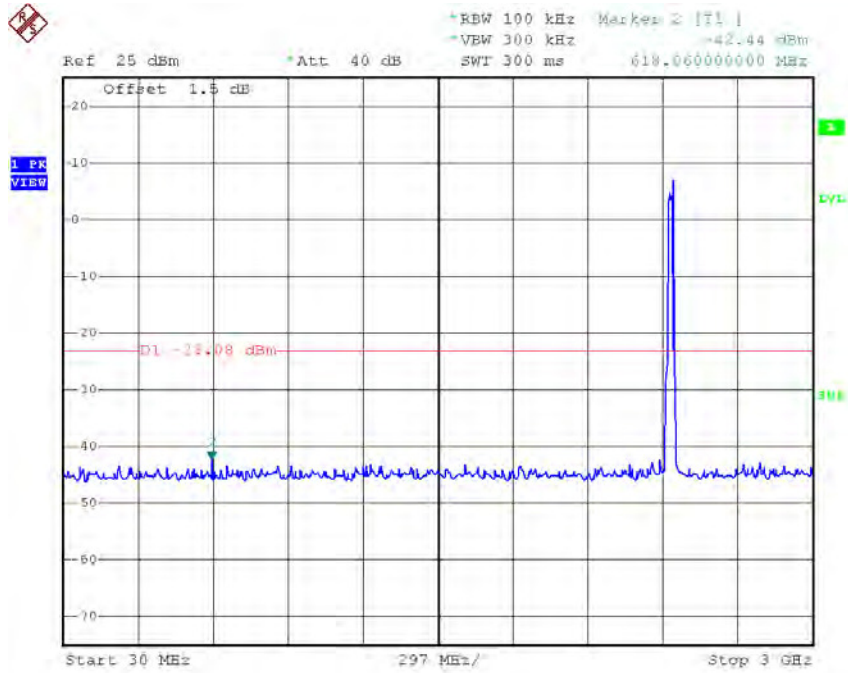

Date: 29.SEP.2016 14:10:38

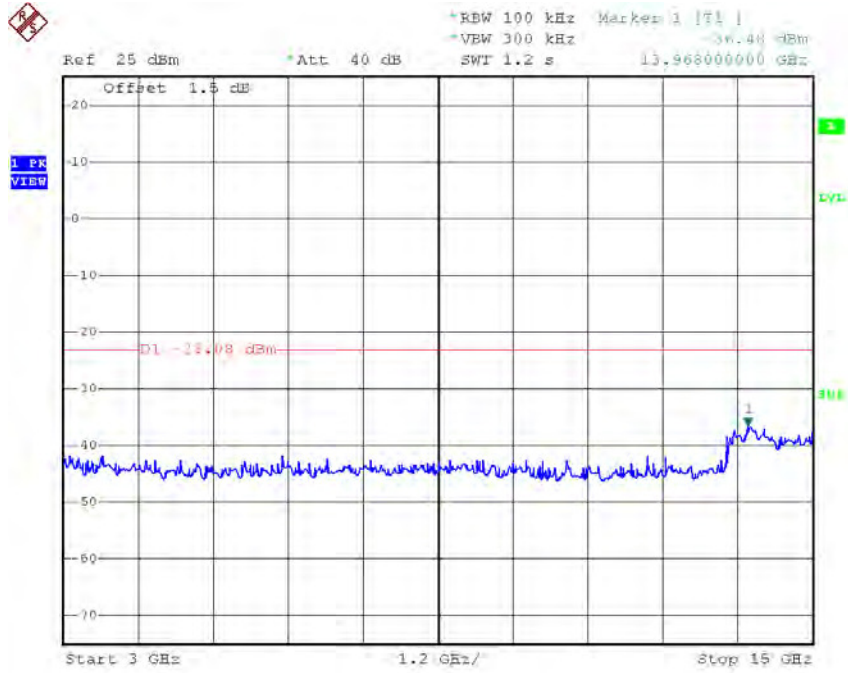

Date: 29.SEP.2016 14:10:47

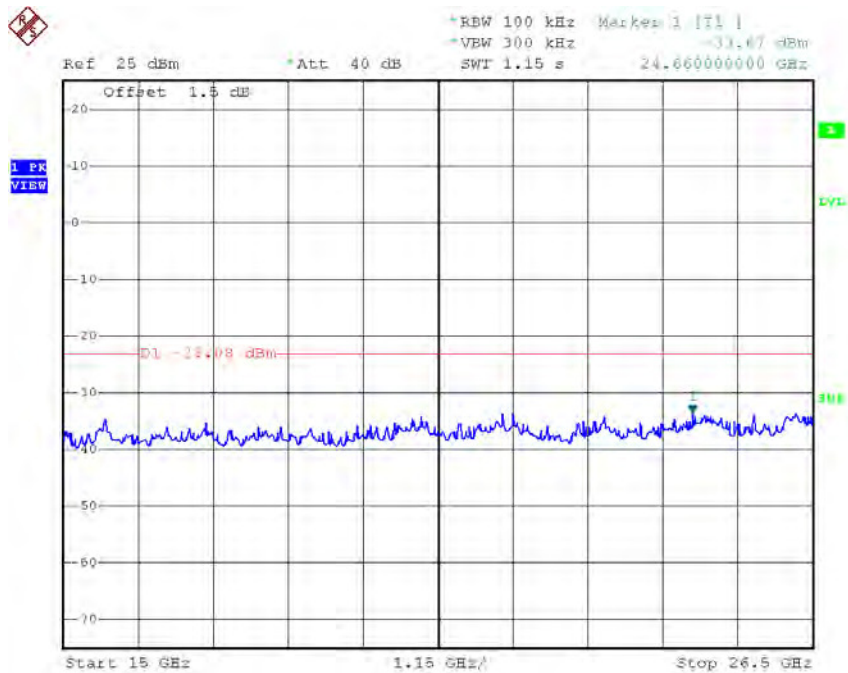

Date: 29.SEP.2016 14:10:55

TX G mode CH11 (10 Harmonic of the frequency)

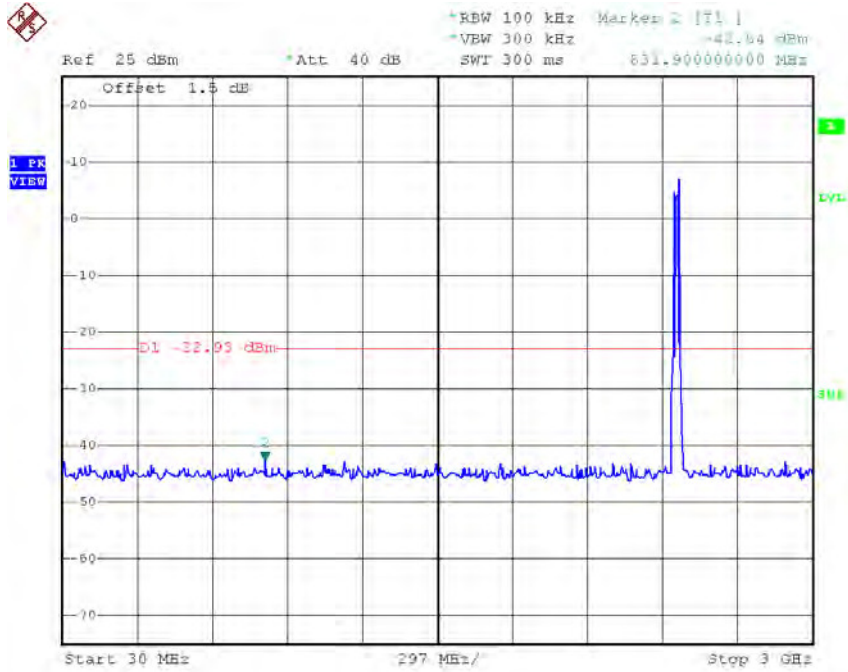

Date: 29.SEP.2016 14:11:41

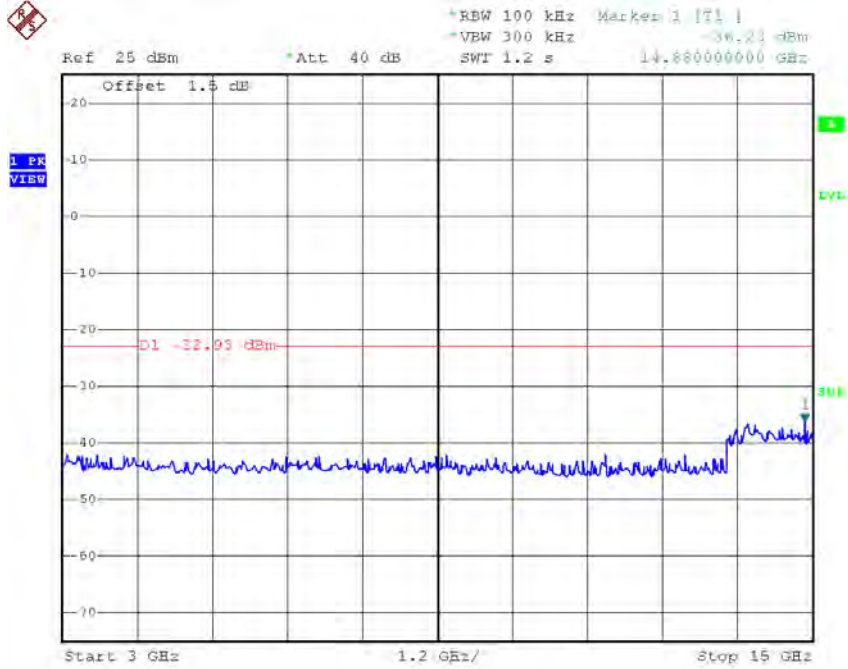

Date: 29.SEP.2016 14:11:49

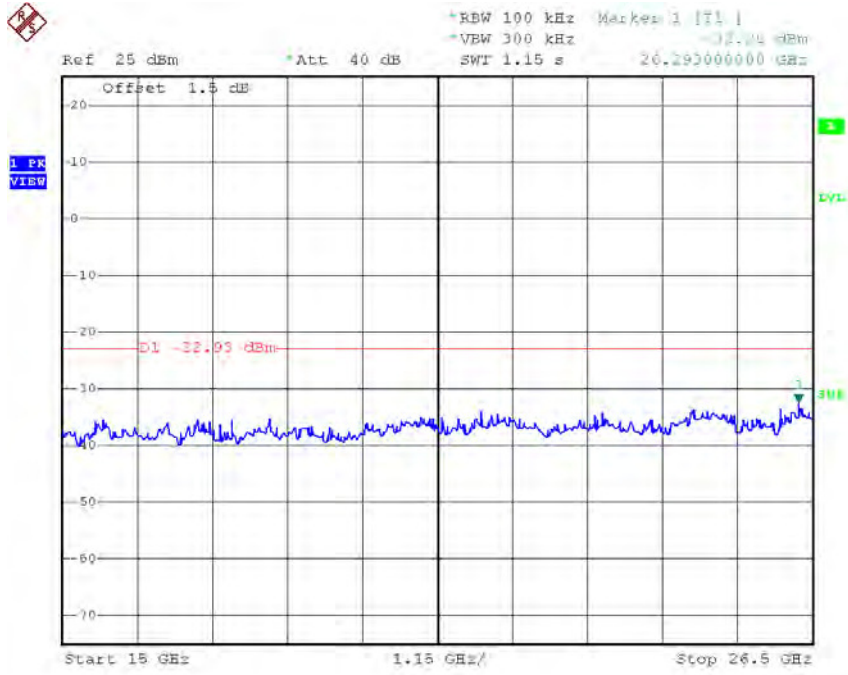

Date: 29.SEP.2016 14:11:58

Test Mode : TX G Mode_ANT 2

TX G mode CH01

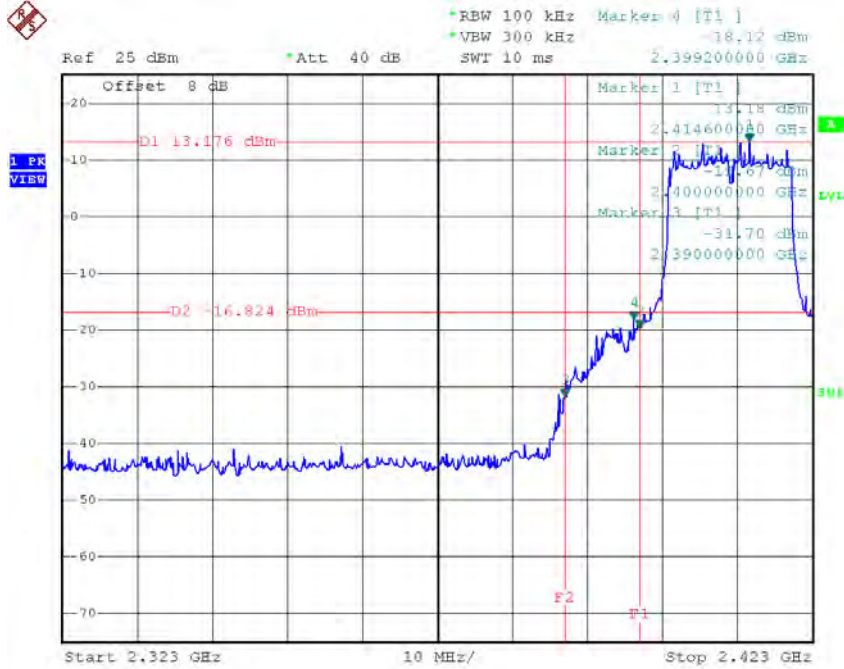

Date: 29.SEP.2016 14:30:39

TX G mode CH11

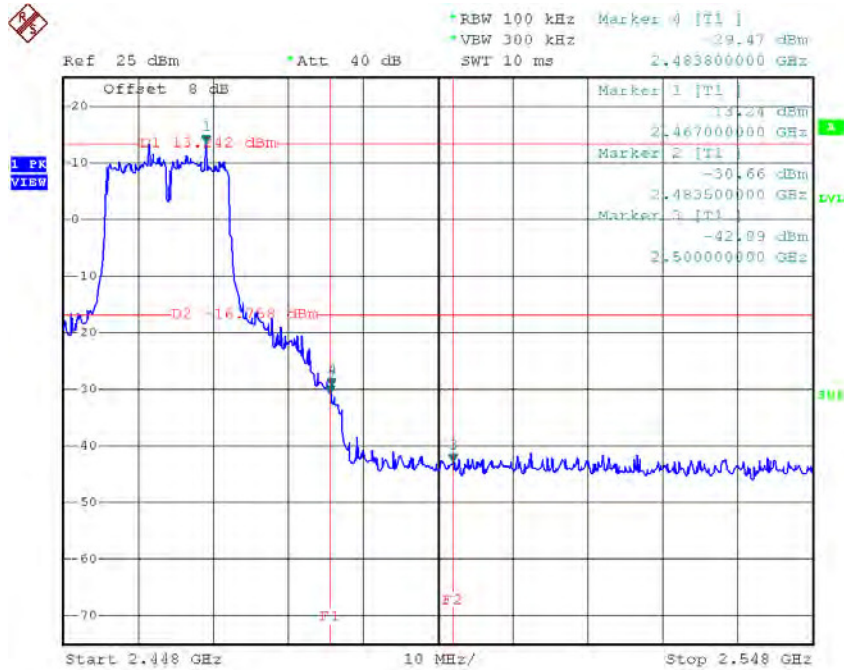

Date: 29.SEP.2016 14:36:13

TX G mode CH01 (10 Harmonic of the frequency)

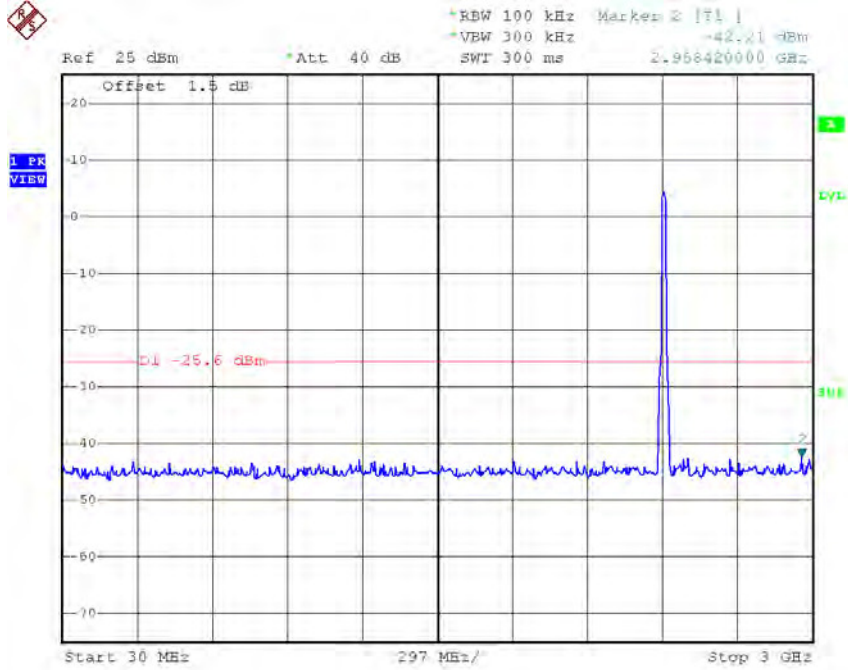

Date: 29.SEP.2016 14:30:15

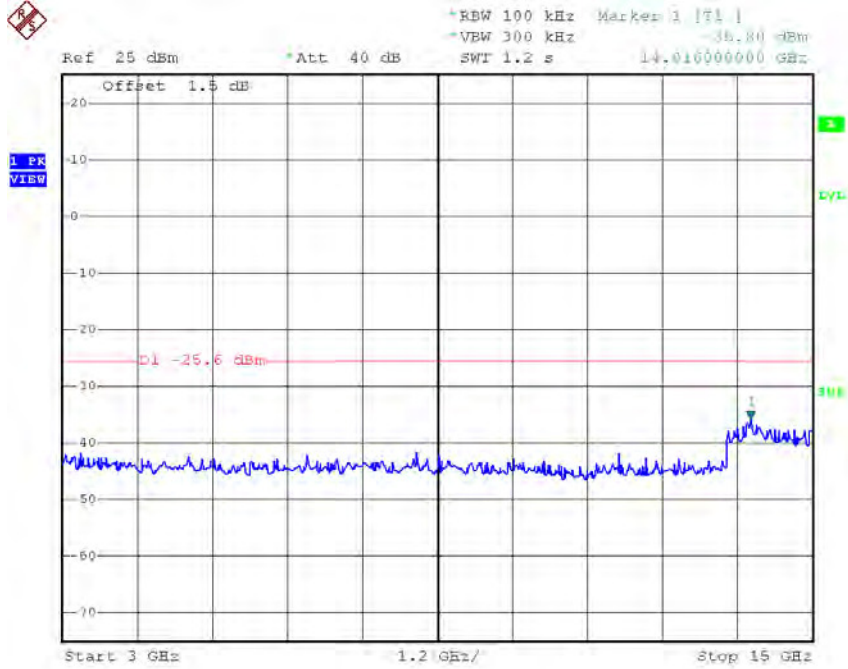

Date: 29.SEP.2016 14:30:23

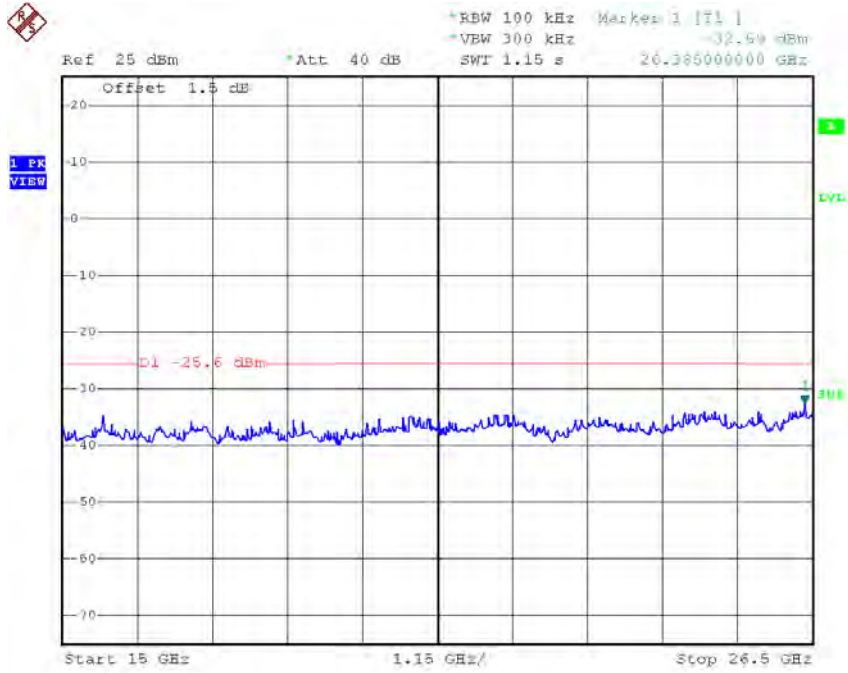

Date: 29.SEP.2016 14:30:32

TX G mode CH06 (10 Harmonic of the frequency)

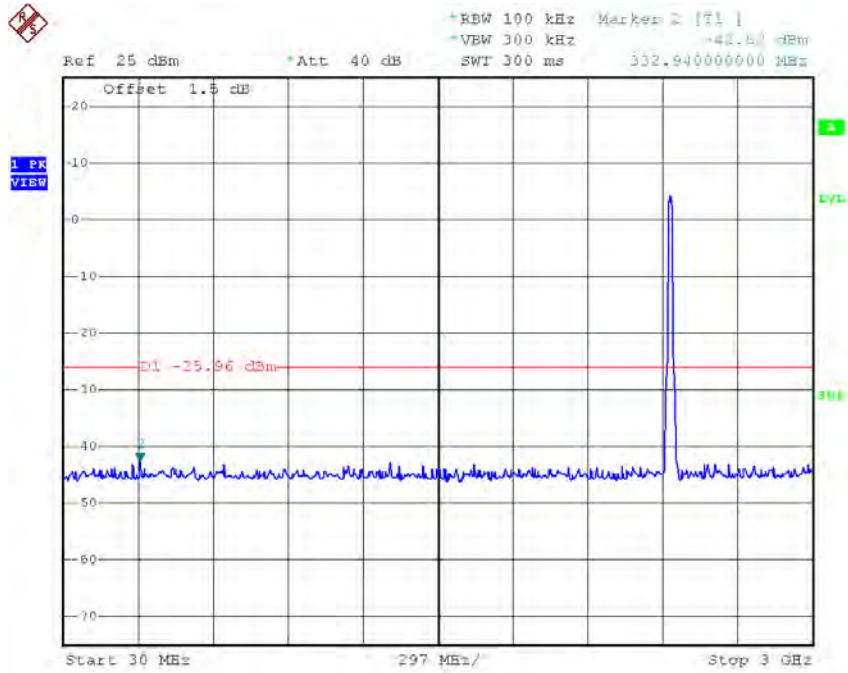

Date: 29.SEP.2016 14:34:46

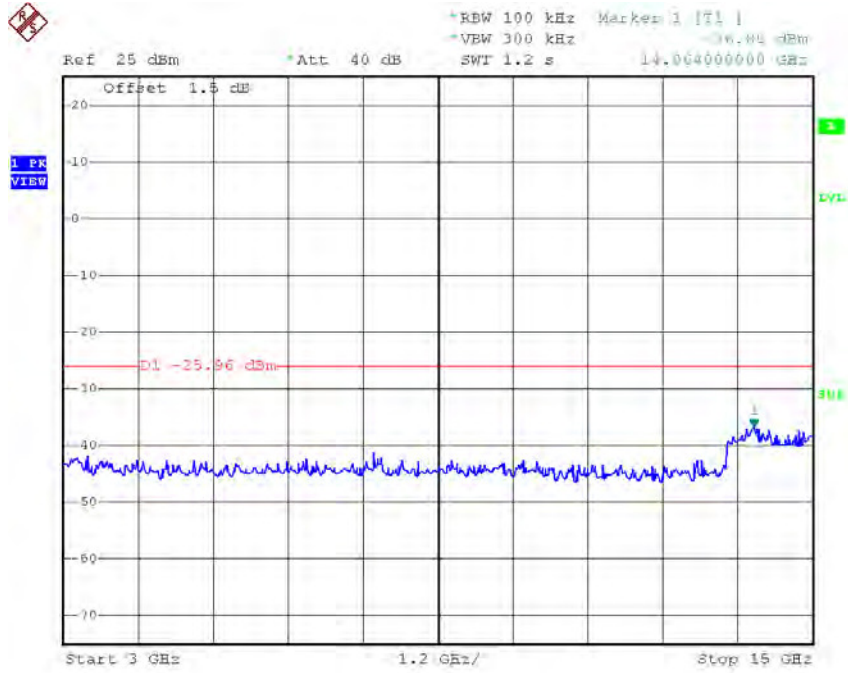

Date: 29.SEP.2016 14:34:55

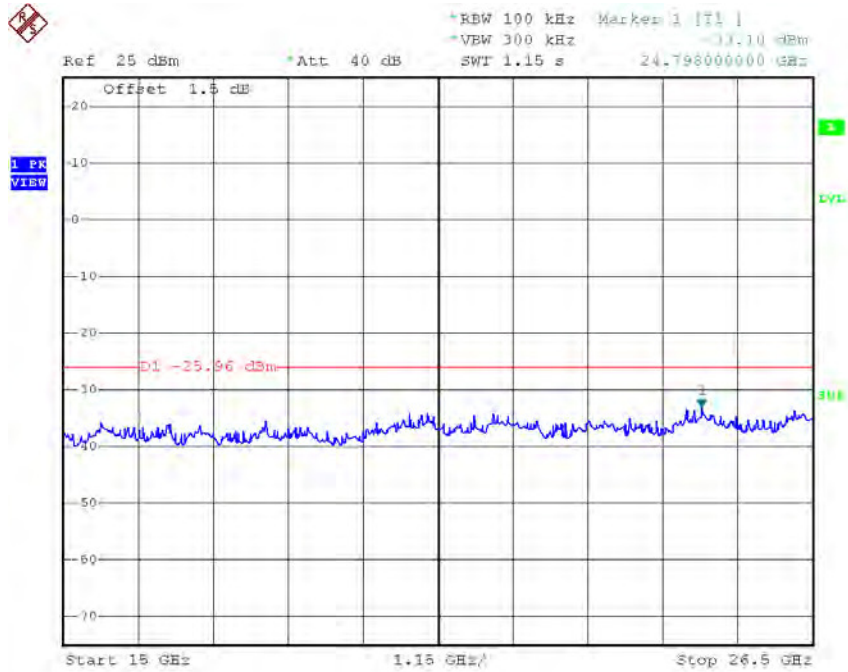

Date: 29.SEP.2016 14:35:03

TX G mode CH11 (10 Harmonic of the frequency)

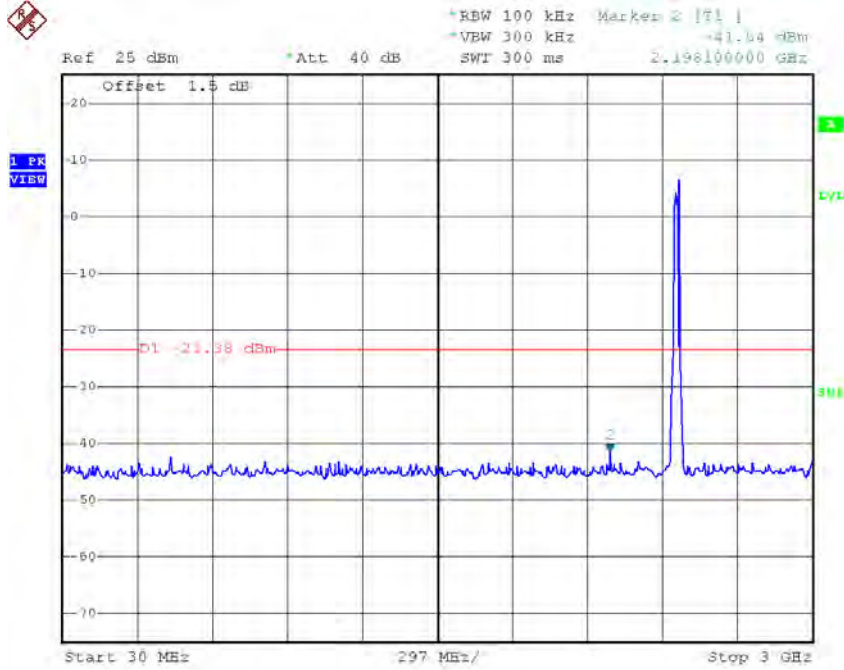

Date: 29.SEP.2016 14:35:48

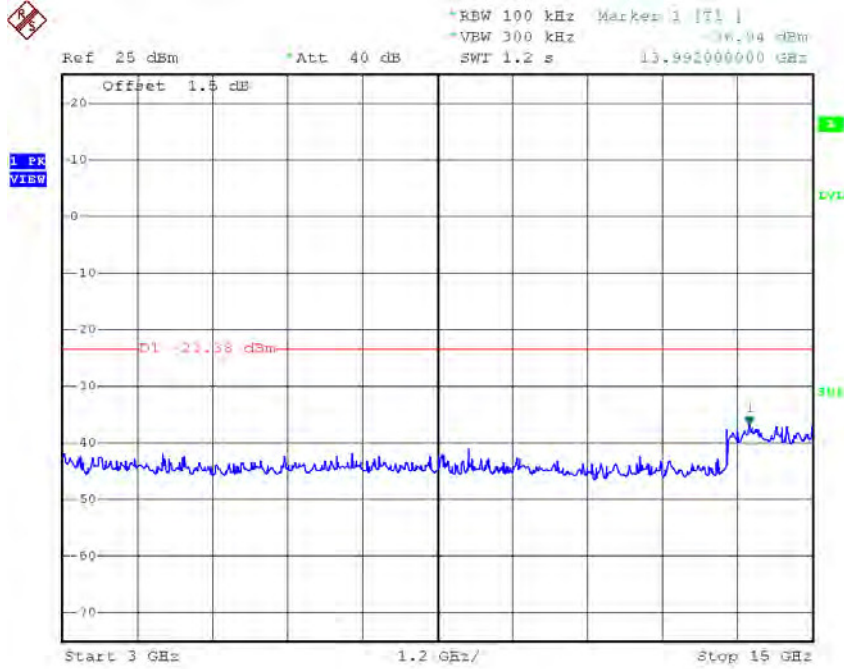

Date: 29.SEP.2016 14:35:57

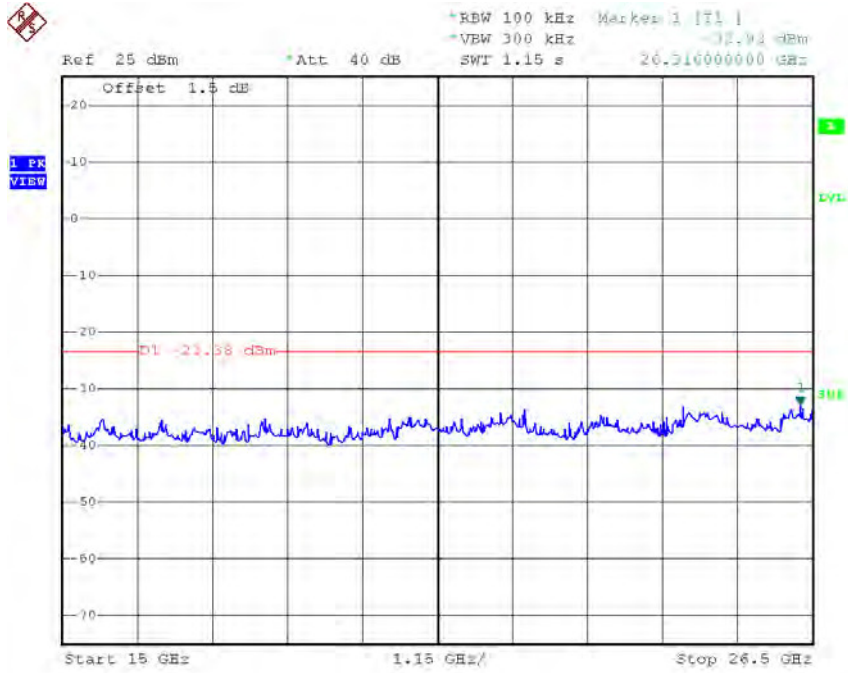

Date: 29.SEP.2016 14:36:05

Test Mode : TX N-20M Mode_ANT 1

TX HT20 mode CH01

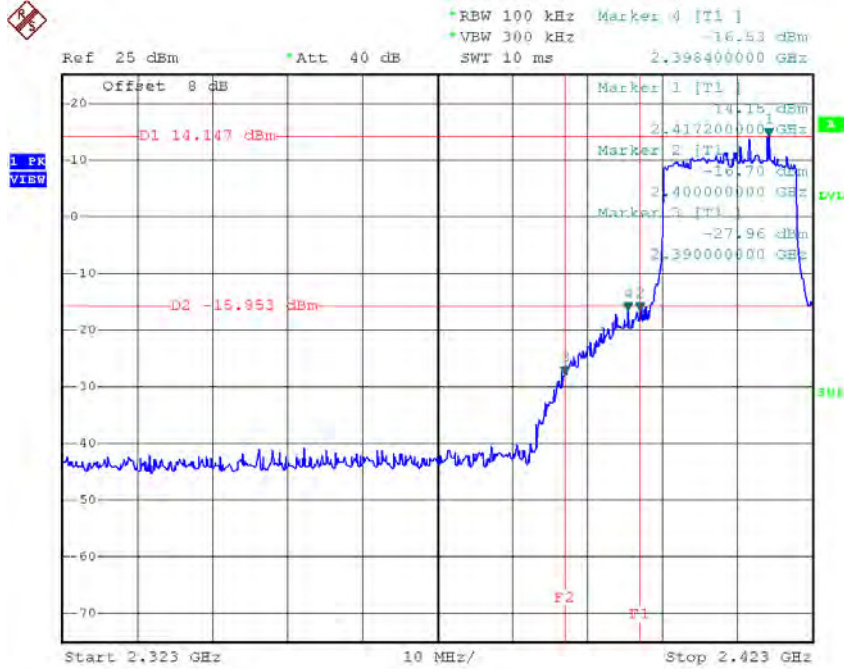

Date: 29.SEP.2016 14:16:54

TX HT20 mode CH11

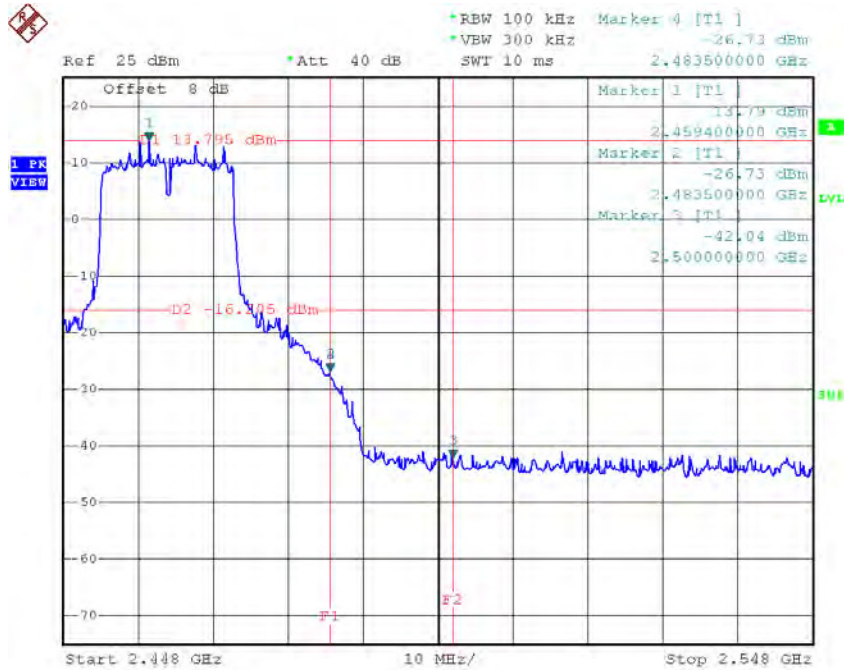

Date: 29.SEP.2016 14:19:03

TX HT20 mode CH01 (10 Harmonic of the frequency)

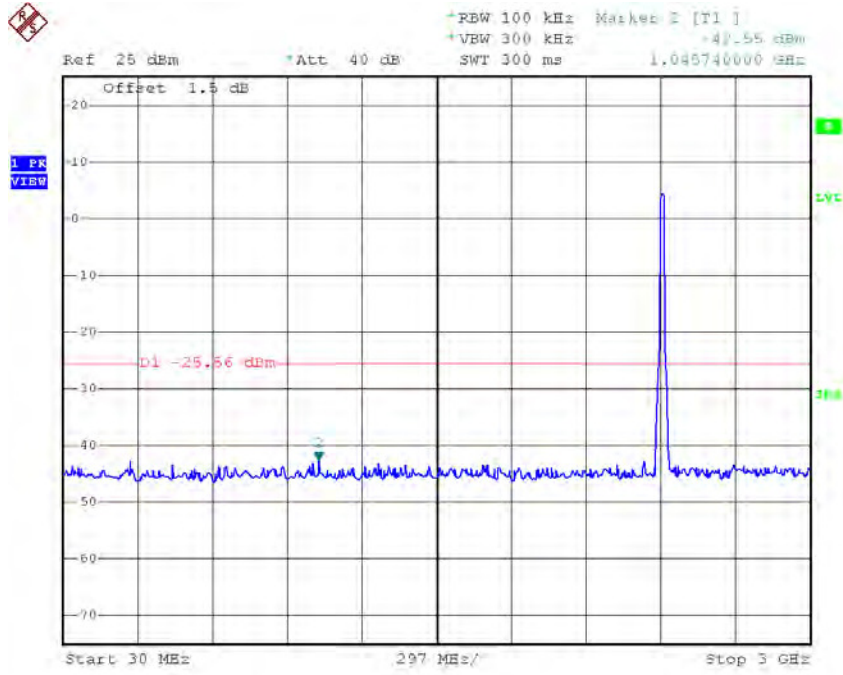

Date: 29.SEP.2016 14:12:55

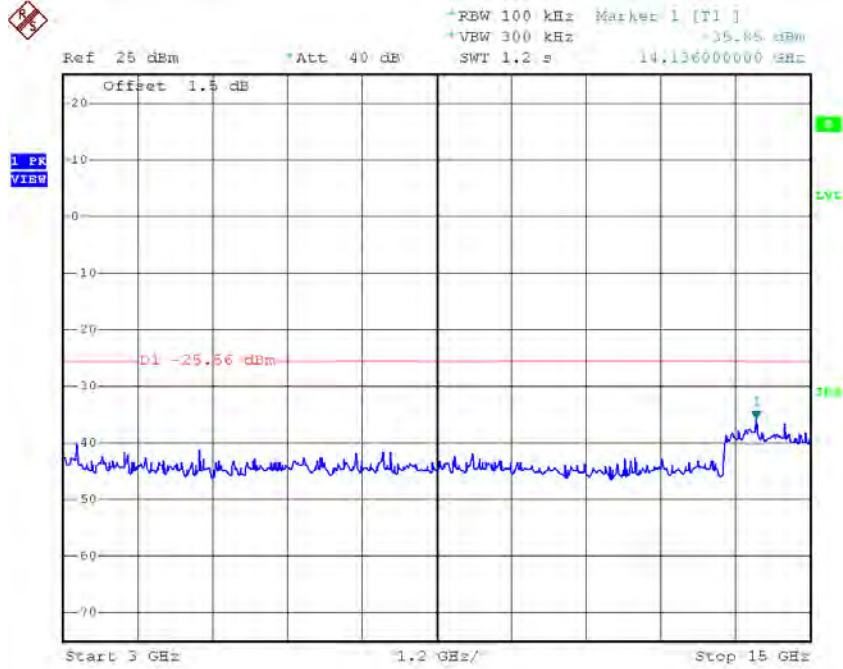

Date: 29.SEP.2016 14:13:04

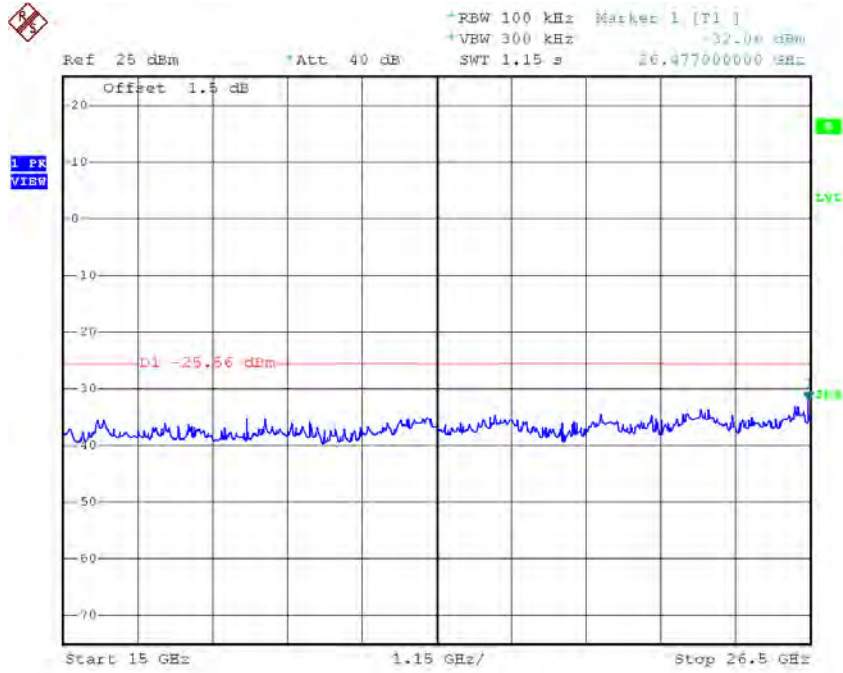

Date: 29.SEP.2016 14:13:12

TX HT20 mode CH06 (10 Harmonic of the frequency)

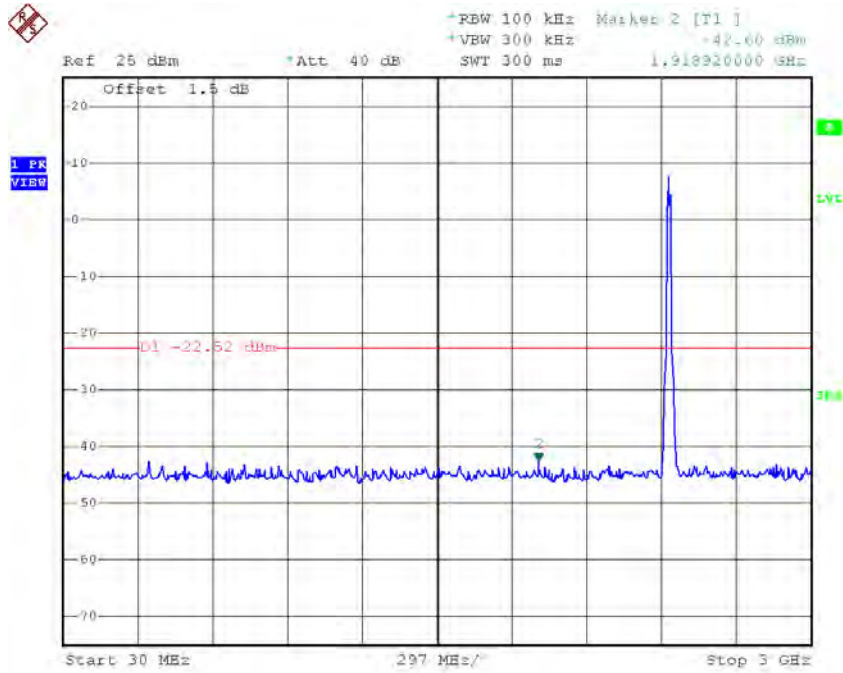

Date: 29.SEP.2016 14:17:39

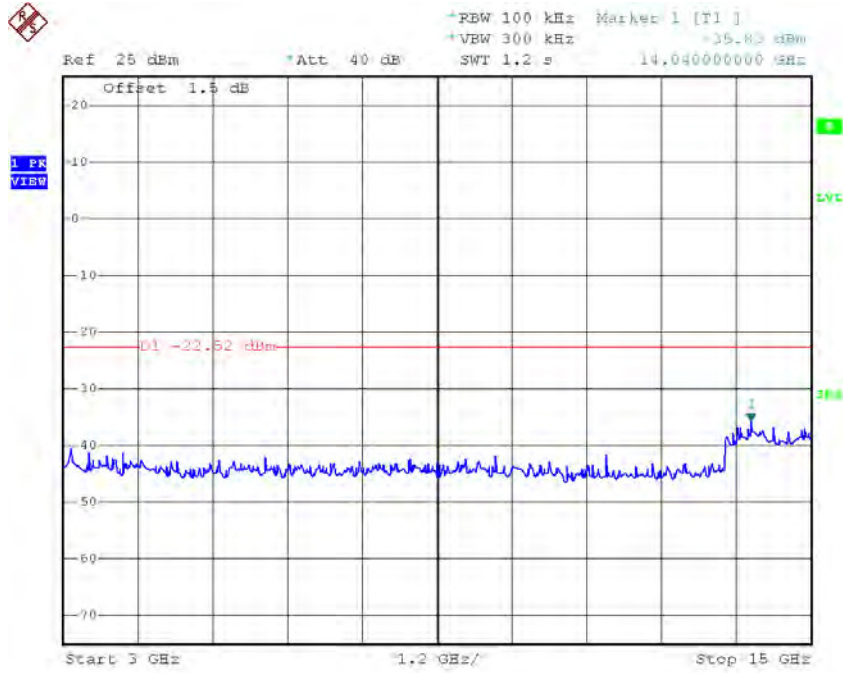

Date: 29.SEP.2016 14:17:47

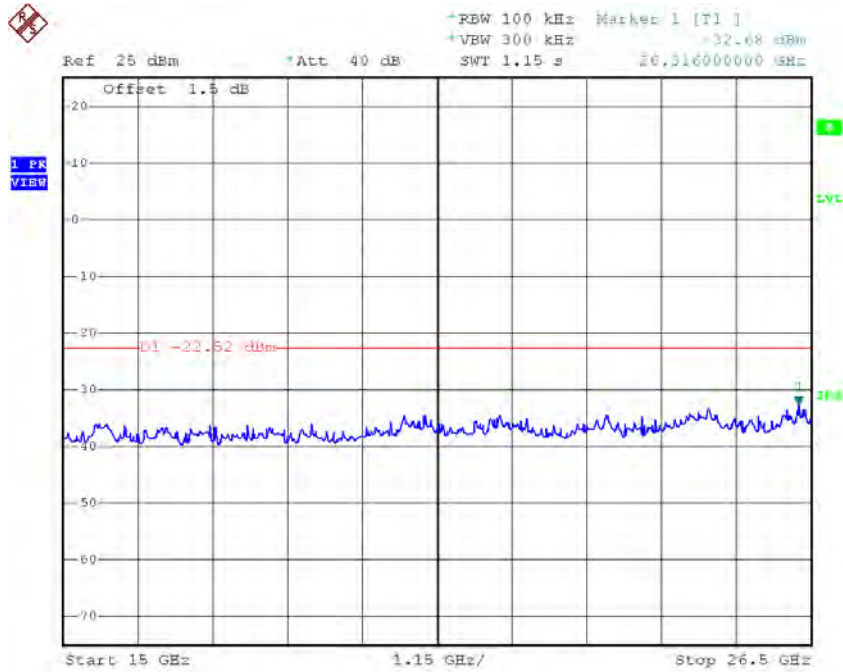

Date: 29.SEP.2016 14:17:55

TX HT20 mode CH11 (10 Harmonic of the frequency)

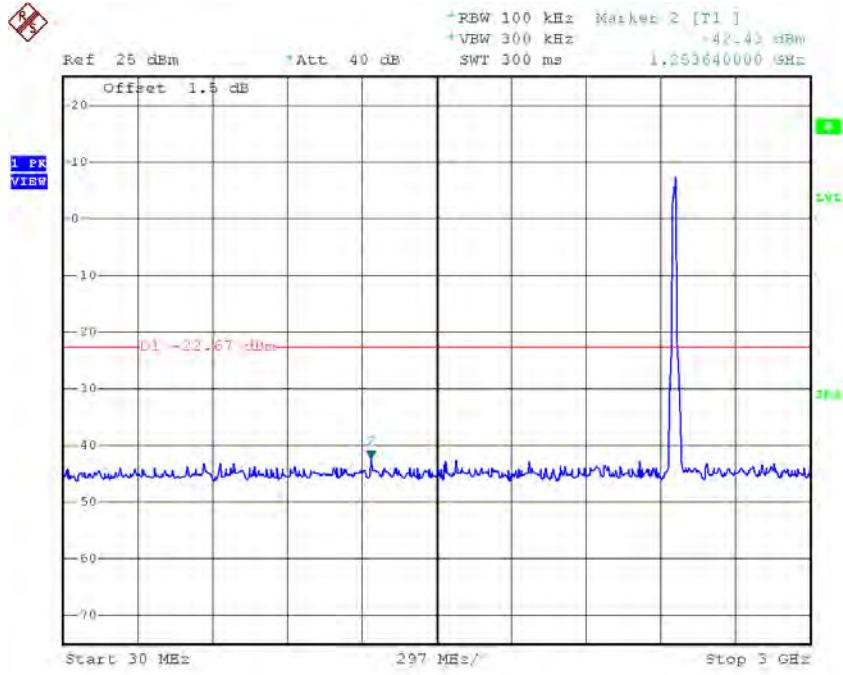

Date: 29.SEP.2016 14:18:39

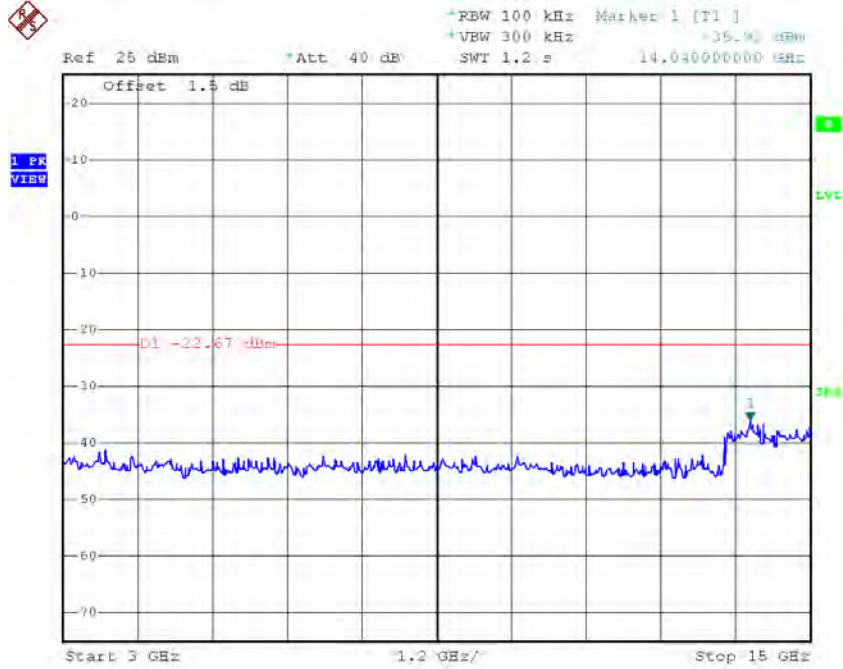

Date: 29.SEP.2016 14:18:47

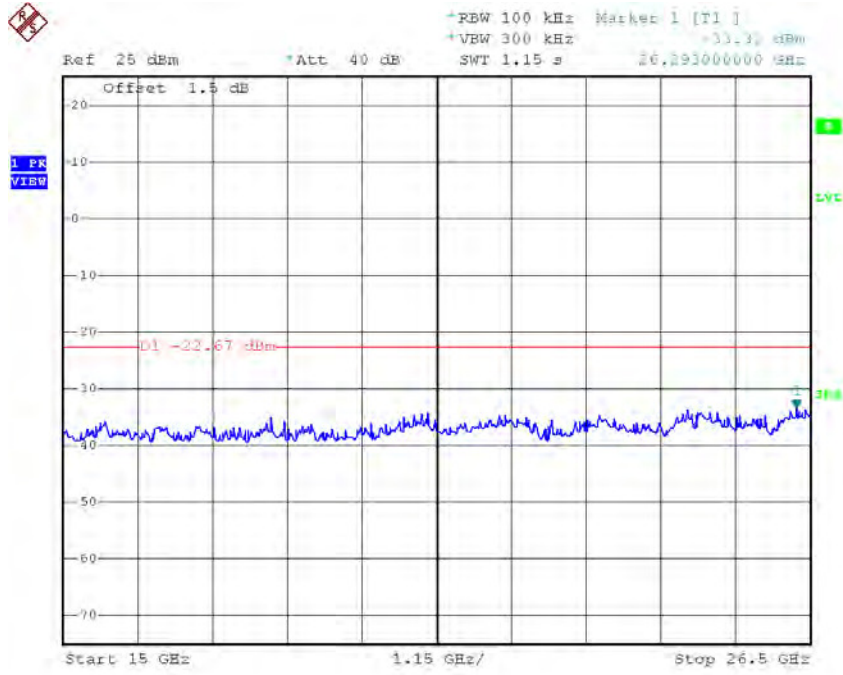

Date: 29.SEP.2016 14:18:55

Test Mode : TX N-20M Mode_ANT 2

TX HT20 mode CH01

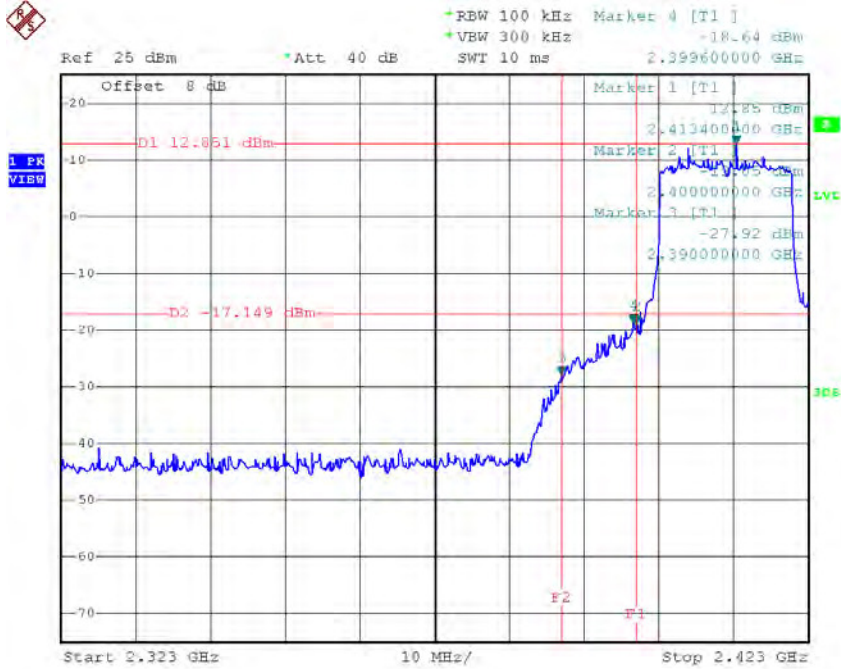

Date: 29.SEP.2016 14:38:32

TX HT20 mode CH11

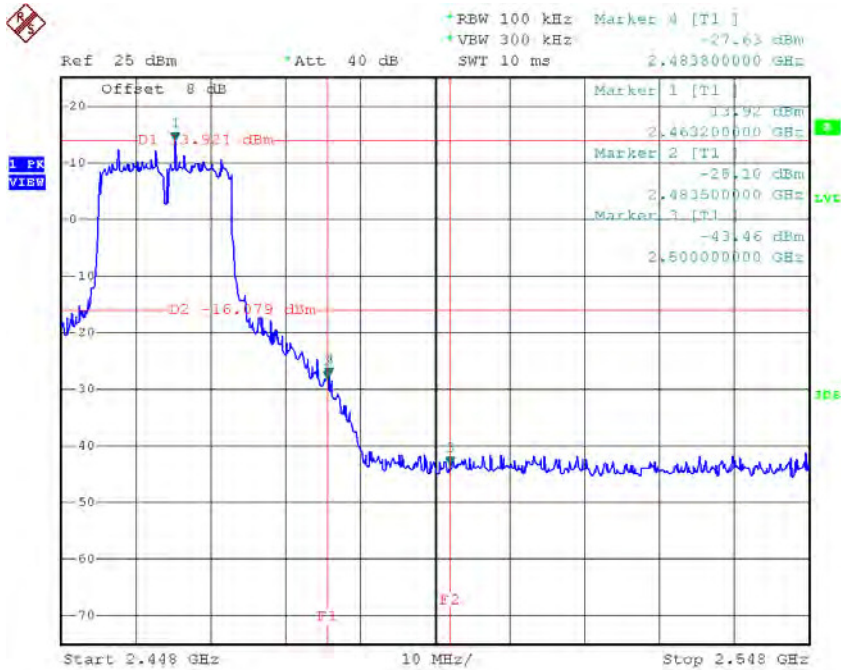

Date: 29.SEP.2016 14:40:47